

CIRCULATION LARGER THAN ANY OTHER RADIO PUBLICATION

# RADIO NEWS

REG. U.S. PAT. OFF.

25 Cents

August

1923

Over 200 Illustrations

Edited by H. GERNSBACK

## 2000 MILES ON A CRYSTAL!



THE 100% WIRELESS MAGAZINE

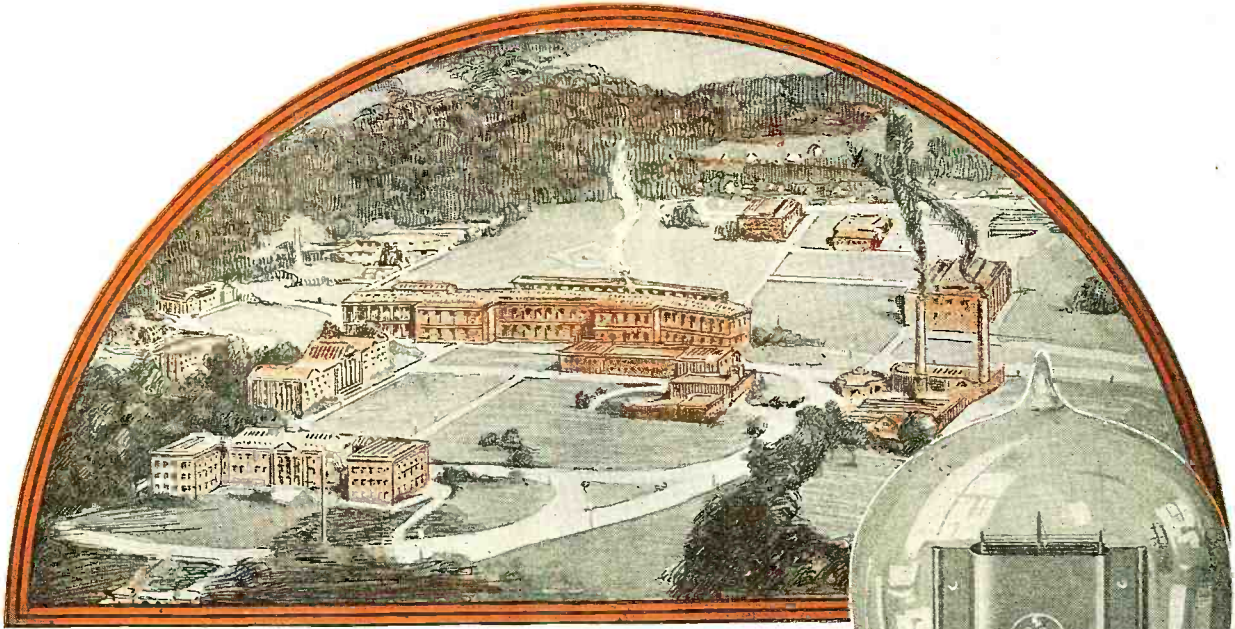

## One of the World's Largest Manufacturers with unlimited resources Builds Cunningham Tubes

**F**ORTY-THREE years ago the carbon filament electric lamp, at that time considered the finest development in the electrical art, came into general use.

The important and ever-growing demand resulted in the building and expansion of mighty factories, and the improvement of factory methods, until today the tungsten filament gas-filled lamp yields eight times the candle power for the same electric input.

In recent years these same highly skilled manufacturers have been devoting a part of their factories, and applying their engineering talent gained through years of experience, to the production of vacuum tubes.

The new Cunningham type C-301-A, Amplifier and Detector represents a combination of these years of manufacturing experience, and the engineering ability contributed by that great scientific organization, the Research Laboratory of the General Electric Company.

The low filament current of only one-fourth of an ampere and the extremely high mutual conductance of 700 micro-ohms, make the C-301-A the most efficient vacuum tube ever built for amateur and entertainment use in radio.

**Patent Notice:** *Cunningham tubes are covered by patents dated 11-7-05, 1-15-07, 2-18-08, and others issued and pending. Licensed for amateur, experimental and entertainment use in radio communication. Any other use will be an infringement.*

*E. J. Cunningham Inc.*

Home Office.  
248 First Street  
San Francisco, Calif.

Eastern Representative:  
Chicago, Illinois



*A Specially  
Designed Tube  
For Every  
Radio Use*

**PERFECT  
FILAMENT  
CONTROL  
FOR  
ALL  
TUBES**

# Ask for the Universal Bradleystat With 3 Terminals

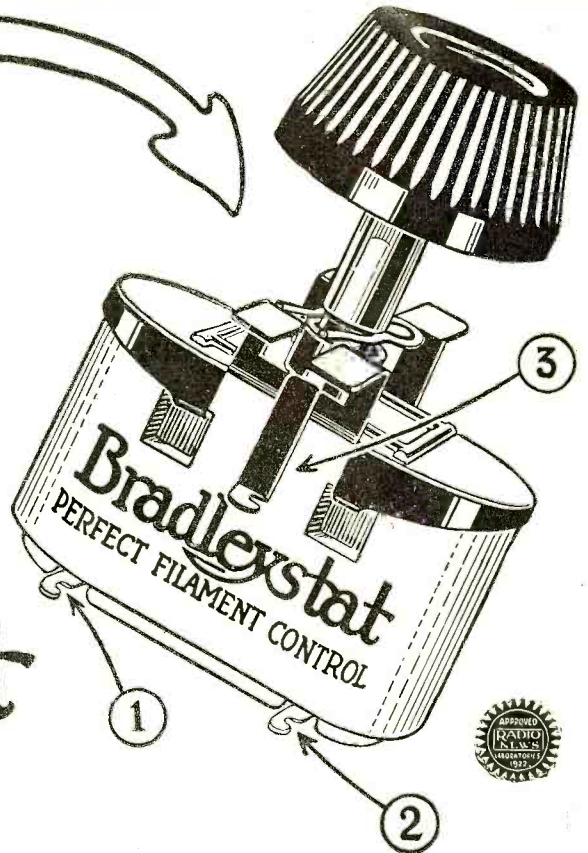

- C-300
- C-301
- C-301A
- WD-11
- WD-12
- UV-200
- UV-201
- UV-201A
- UV-199

## A Perplexing Problem Solved

**T**RY any tube in your radio set! It makes no difference what tube is used, the new universal Bradleystat with three terminals will give perfect filament control. A very simple change of connections and a remarkable range of control make this possible for the first time in radio history. Like former Bradleystat models, the new universal Bradleystat with three terminals is covered by the same iron-clad guarantee of perfect performance, noiseless control and quicker tuning that sold hundreds of thousands of Bradleystats during the past year.

Be prepared to try any new tube by replacing your present rheostats with the new universal Bradleystat. It is the last word in flexible and perfect control. It is backed by twenty years' experience with graphite disc rheostats. *Beware of imitations.* Avoid the use of inferior carbon powder rheostats. The name "Bradleystat" is embossed on container for your protection.

*Mail the coupon below for full information about the latest and most remarkable development in filament control. CLIP THE COUPON, NOW!*

**ALLEN-BRADLEY CO. • 287 Greenfield Ave. • MILWAUKEE, WIS.**

I am pleased to hear that the universal Bradleystat with three terminals has solved the perplexing problem of finding one rheostat for all tubes. This is good news. Please send me full information and explain how it is done.

---

---

---

# RADIO NEWS

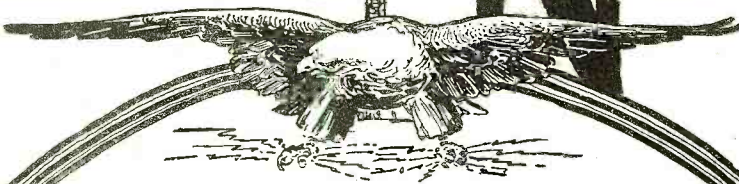

## CONTENTS

VOL. 5

FOR AUGUST

No. 2

Page	Page
Editorial .....By H. Gernsback 127	With the Amateurs.....154
Short Wave Directive Radio Transmission. By Francis W. Dummore and Francis H. Engel 128	A Low Power Phone and C.W. Transmitter, By D. R. Clemons 156
Page the Amateurs.....By J. Farrell 131	A Practical Switching Arrangement, By Eugene R. Weber 153
Recording Fading Signals: Some Interesting Experiments Carried Out with a Special Re- cording Apparatus Designed by Dr. G. W. Pickard ..... 132	Elimination of Reradiation Interference. By D. R. Clemons 158
A New Use for Loud Speakers..... 133	A Well Constructed Portable Set..By C. B. Sides 159
How Bertha Brainard "Broadcasts Broadway." By Golda M. Goldman 134	Awards of the \$50 Radio Wrinkle Contest.... 160
What Radio Can Do For the Country. By Florence T. Harper 135	Correspondence From Readers..... 161
Hetterly's Set.....By Ellis Parker Butler 136	Prize Winning Sketches in the Cover Contest.. 162
The Latest in Radio..... 138	Awards of Our Cover Prize Contest..... 163
Radio Here and There..... 139	Results of the Radio Shower Party..... 163
Recent Developments in Radio, By H. Gernsback 140	Radio News Laboratories..... 164
What Happens to the Speech and Music When Broadcast .....By Jesse Marsten 142	New Radio Patents..... 166
With the Broadcasters ..... 144	With the Sea-Going Op's..... 167
The Wave Filters.....By W. Palmer Powers 145	I-Want-To-Know ..... 168
Electrons, Electric Waves and Wireless Tele- phony—Part VII.....By Dr. J. A. Fleming 146	Practical Radio Slide Rule...By Ralph Batcher 170
Detection .....By Louis Frank 150	Revised List of Broadcasting Stations With New Wave-Lengths ..... 172
Radio Frequency Receiver Design. By Kenneth Harkness 152	Calls Heard ..... 174
Index to Advertisers ..... 124	Book Review ..... 176

RADIO NEWS is published on the 10th of each month. There are 12 numbers per year. Subscription price is \$2.50 a year in U. S. and possessions. Canada and foreign countries, \$3.00 a year. U. S. coin as well as U. S. Stamps accepted (no foreign coins or stamps). Single copies, 25 cents each. A sample copy will be sent gratis on request. Checks and money orders should be drawn to order of EXPERIMENTER PUBLISHING CO., INC. If you should change your address notify us promptly, in order that copies be not mis-carried or lost. No copies sent after expiration.

All communications and contributions to this journal should be addressed to Editor, RADIO NEWS, 812 Jamaica Avenue, Jamaica, New York; or 53 Park Place, New York, N. Y. Unaccepted contributions cannot be returned unless full postage has been included. All accepted contributions

are paid for on publication. A special rate is paid for novel experiments; good photographs accompanying them are highly desirable.

RADIO NEWS, Monthly. Entered as second-class matter at the Post Office at Jamaica, N. Y., under the act of March 3, 1879. Title registered U. S. Patent Office. Copyright, 1924, by E. P. Co., Inc., New York. The Experimenter Publishing Co., 53 Park Place, N. Y. The contents of this magazine are copyrighted and must not be reproduced without giving full credit to the publication.

RADIO NEWS is for sale at all newsstands in the United States and Canada; also at The International News Co., Ltd., Bream's Building, London E. C. 4, England, and at Brentano's 37 Avenue de l'Opera, Paris.

General Advertising Dept., 53 Park Place, New York City. Western Advertising Representatives, Finnican & McClure, 720 Cass Street, Chicago, Ill. Kansas City Representative, Geo. F. Dillon, Republic Bldg., Kansas City, Mo. Pacific Coast Advertising Representatives, A. J. Norris Hill Co., Hearst Bldg., San Francisco, Cal.

Published by EXPERIMENTER PUBLISHING CO., INC.,

Publishers of "Radio News," "Science and Invention" and "Practical Electrician."

Publication Office: Jamaica, N. Y. Editorial and General Offices: 53 Park Place, New York City  
H. GERNSBACK, President S. GERNSBACK, Treasurer R. W. DEMOTT, Secretary

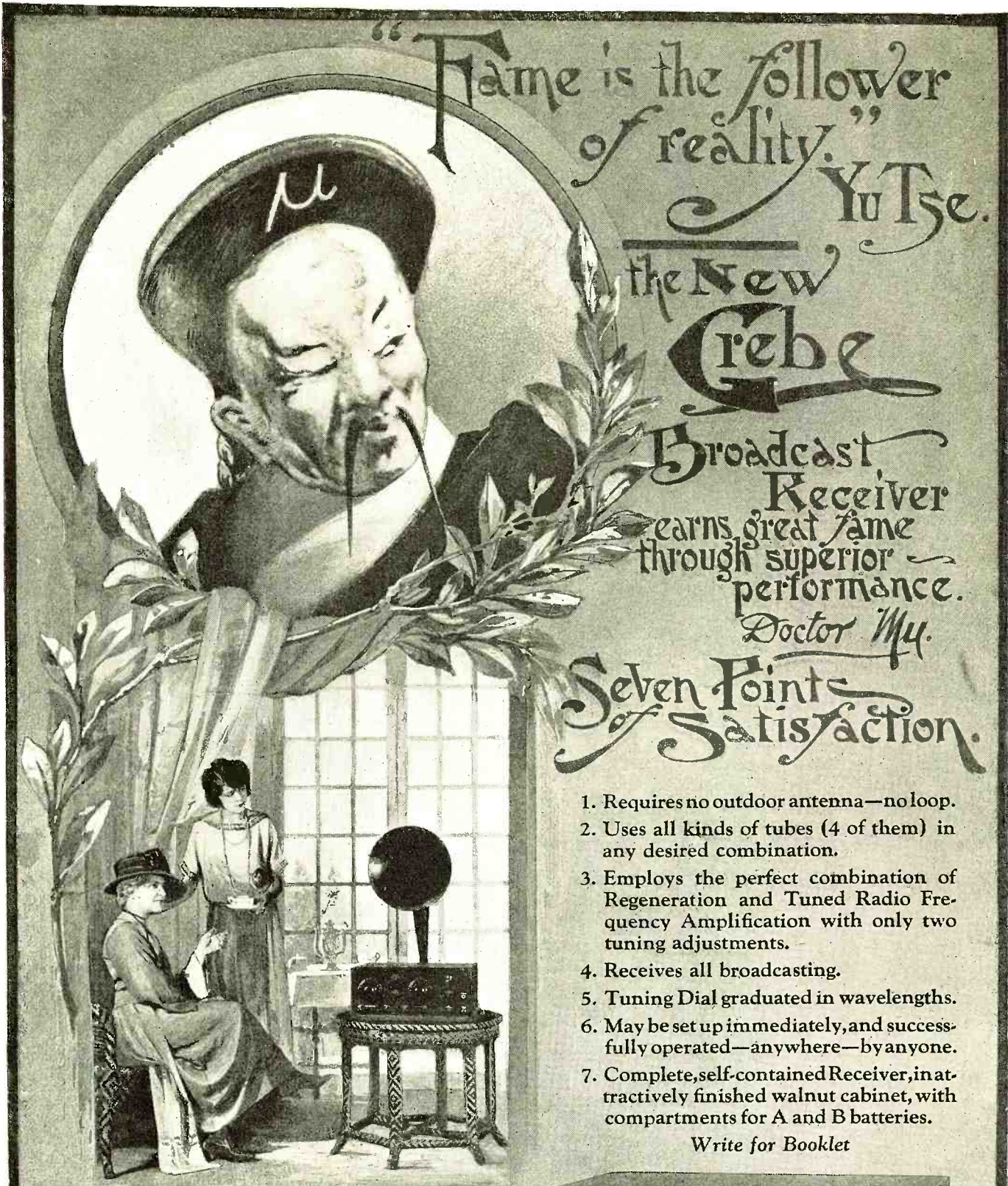

"Fame is the follower  
of reality."  
Yu Tse.

the New  
**Grebe**

Broadcast  
Receiver  
earns great fame  
through superior  
performance.  
Doctor Mu.

Seven Points  
of Satisfaction.

1. Requires no outdoor antenna—no loop.
2. Uses all kinds of tubes (4 of them) in any desired combination.
3. Employs the perfect combination of Regeneration and Tuned Radio Frequency Amplification with only two tuning adjustments.
4. Receives all broadcasting.
5. Tuning Dial graduated in wavelengths.
6. May be set up immediately, and successfully operated—anywhere—by anyone.
7. Complete, self-contained Receiver, in attractively finished walnut cabinet, with compartments for A and B batteries.

Write for Booklet

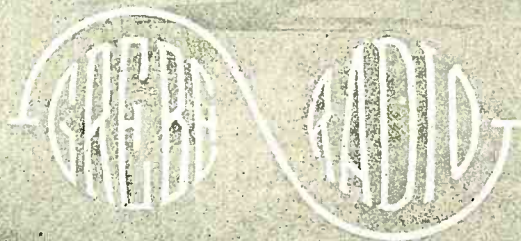

A. H. GREBE & COMPANY, Inc.  
Richmond Hill, N.Y.  
Western Branch, 451 East 3rd St., Los Angeles, Cal.

Licensed under Armstrong  
U. S. Pat. No. 1,113,149

Type CR-12



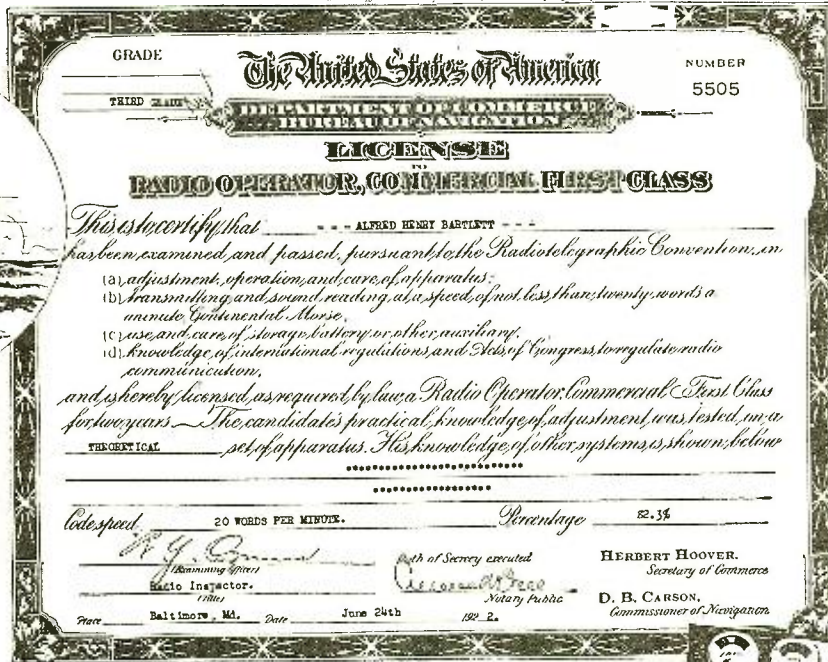

# Get This First Class Radio License You Can Earn Big Money With It

**T**HE best paid positions in Radio go to the men who hold the Government's Commercial License. The radio men on every ship, in every land commercial station, in every broadcasting station, must have one of these licenses. Every radio inspector must pass the first-class license examinations. Engineers, mechanics, installation and maintenance experts must all of them own a Government First-Class Commercial License. It is every radio man's ambition to get a license, not only because it is the highest mark of honor he can get but because it also opens to him all the wonderful opportunities in this great profession.

One of our graduates is now Radio Inspector of Ships and is making approximately \$3000 a year; George Staffa as operator is averaging \$165 per month, which includes living expenses; Emmett Welch of Peculiar, Mo., accepted a position with a large land Radio corporation one week after finishing our course, that is paying him \$300 a month to start; Porter E. Sweeney, one of our 1923 graduates is now with the Western Electric Co., in the Radio Department, on a salary of \$2500 a year to start.

## Get Your First Class Government License This New Easy Way

The National Radio Institute, America's first and largest Radio School, has devised a remarkable new method that makes it easy for you to win your license. No previous experience in electricity or radio is necessary. Lessons, so fascinating they read like an interesting romance, take you step by step through the whole wonderful science of radio. Spare time study at home prepares you in an amazingly short time to pass the government examinations, so you can get one of the fine jobs waiting in this great field.

Prominent radio experts give you personal instruction and advice. They grade your papers, answer your questions, give you every help you want so you can qualify quickly. The diploma we give you upon completion of the course, counts for 5 to 10 credits on all government license examinations.

The most important requirements for a commercial license is a knowledge of the Radio Code. One of the most extraordinary features of the Institute's

### National Radio Institute, Dept. 13-H Washington, D. C.

Send me your free book, "Your Opportunity in Radio," with full particulars about the opportunities in radio, and how you will quickly train me in my spare time at home to obtain a Government First-Class Commercial License. Also tell me how your free Employment Service will help me to a position.

Name ..... Age .....  
Street .....  
State ..... City .....

comprehensive course is the four patented instruments, invented and owned by the National Radio Institute, give you the practical training in radio operation, installation, maintenance and repair which you must have to become an expert.

## Four Radio Instruments Free

Among these instruments is the wonderful Natrometer, said by experts to be the most perfect device ever invented to teach the Radio Code. With this amazing machine you quickly learn how to send and receive code with all the speed, the accuracy and precision of a trained expert operator. No extra equipment is necessary. Simply connect a dry cell, adjust the head-phones, wind the motor, and for twenty minutes you can listen to a reproduction of the code-work of two of the most expert trans-Atlantic operators.

### Interesting Book on Radio Free

Get into this fascinating profession now. The field is wide open; hundreds of positions are open. Find out at once your opportunities in radio. Send for the interesting free book, "Your Opportunity in Radio," which gives complete details of the plan by which the National Radio Institute qualifies you quickly in your spare time at home for a Government Commercial License. If you are sincerely ambitious to win success and wealth in radio, send the coupon, or a post-card, now.



### MAKES MONEY MANUFACTURING SETS

The sudden demand for radiophones and receivers has created a fascinating, good-paying job for me. I have built one large receiver and two small ones, and am getting more. I am the first amateur to hold a license in this vicinity.

E. E. MAILCHECK,  
Route No. 1, Crete, Nebr.

### GETS \$165 A MONTH

I am the only operator on board the "Lake Tulare" and receive a salary of \$125 a month, with an additional \$3 a day food-allowance while in port, totaling a cash pay of approximately \$165 a month.

LEO. A. GOLDBLATT, Baltimore, Md.

### STARTED ME IN BUSINESS

I know you will be glad to hear from me again and that I am getting along fine in the Radio game. I am now an instructor in Radio for a local institution and the rest of the time I am installing sets, selling and operating sets as well. There is no limit to the amount of business one can do. You certainly got me started in a coming business all right.

HARRY E. WATERMAN,  
Box 642, Spokane, Wash.

### EASY TO GET GOOD JOB

Only a short letter to let you know that I am still on board and waiting for the ship to sail. Tell your students for me that a man with a license has no trouble obtaining a good position. Believe me, a job like this is worth a good deal of studying.

L. M. WARKING, JR.,  
S.S. Lake Parnoy, Norfolk, Va.

### \$7.00 A DAY AS OPERATOR

Just sailed this morning for Norfolk, where we are to get a load of coal. I haven't much to do on board, and when in port not that much. I get \$7.00 a day when in port, and can sleep on the ship. Not bad at all.

REVERE B. GURLEY,  
On board S.S. "Lake Figart"

### Pick Out the Job You Want We Will Help You Get It

This is a brief list of the positions in the Radio field today, and the salaries paid:  
Radio Mechanic, \$1,500 to \$1,000 a year.  
Radio Inspector, \$1,800 to \$4,500 a year.  
Radio Salesman, \$2,000 to \$10,000 a year.  
Radio Engineer, \$3,500 a year and up.  
Radio Executives, up to \$15,000 a year.  
Radio Instructor, \$200 to \$500 a month.  
Radio Draftsman, \$7 to \$15 a day.  
First Class Ship Operator, \$105 a month, all expenses paid.  
Second Class Ship Operator, \$95 a month, all expenses paid.  
Third Class Operator, \$85 a month, all expenses paid.  
Commercial Land Station Operator, \$150 a month and up.  
Broadcasting Station Operator, \$125 to \$250 a month.

**NATIONAL RADIO INSTITUTE**  
Dept. 13-H Washington, D. C.

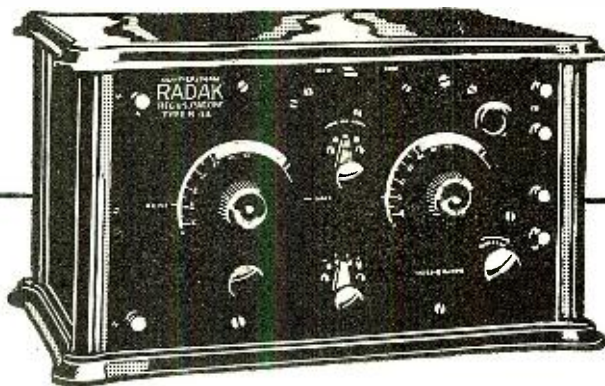

# Radak

## *Is Insulated with Formica*

**T**HE Radak radio equipment manufactured by Clapp-Eastham of Cambridge, Mass., and sold everywhere is made with Formica panels and other Formica insulating parts.

This well-known line has genuine prestige in the radio industry. It is sold and known everywhere — and its endorsement of Formica is a matter of moment to every dealer and amateur.

The judgment of Clapp-Eastham Engineers in selecting Formica is supported by practically all the leading independent radio concerns, who likewise use it.

Formica is the best looking, the most uniform, the most efficient laminated phenolic material for radio uses.

*DEALERS: The Formica Insulation Company supports you with responsive and helpful service and the most aggressive advertising and sales campaign in the industry. Formica dealers can supply you promptly with panels in all standard sizes. They can also supply special sizes when you want them.*

### THE FORMICA INSULATION COMPANY

4618 Spring Grove Ave.

Cincinnati, Ohio

#### SALES OFFICES

50 Church Street.....New York, N. Y.  
422 First Avenue.....Pittsburgh, Pa.  
1042 Granite Bldg., Rochester, N. Y.  
415 Ohio Building.....Toledo, Ohio

1210 Arch Street.....Philadelphia, Pa.  
1819 Lyndale Ave., S. Minneapolis, Minn.  
Sheldon Building.....San Francisco, Cal.  
Whitney Central Bldg.....New Orleans, La.

414 Finance Bldg.....Cleveland, Ohio  
9 South Clinton Street..Chicago, Ill.  
313 Title Building...Baltimore, Md.  
47 King Street.....Toronto, Ontario

---

# FORMICA

Made from Anhydrous Redmanol Resins  
**SHEETS TUBES RODS**

---





EDITORIAL AND GENERAL OFFICES, 53 PARK PLACE, NEW YORK

Vol. 5

AUGUST, 1923

No. 2

## Short Radio Waves

**D**URING the last decade we have as a rule employed for radio communications wave-lengths varying from 10,000 meters down to about 600 meters for commercial work. The broadcast era inaugurated about two years ago witnessed a reduction of this wave-length down to about 360 meters. Long before that time, American amateurs had been transmitting on a wave-length of 200 meters and although our radio experts told us that very long wave-lengths such as 10,000 meters and over were absolutely necessary for long distance work, such as trans-oceanic, the amateur proved with his puny wave-length that he could span the ocean with facility.

Over three years ago, in an editorial, we mentioned and prophesied that the greatest wonders in store for radio lie in short wave-lengths, and we seem to be just about coming to this. About a year ago Marconi made the announcement that he could send radio waves in any direction by means of parabolic wave reflectors. The wave-lengths he used were about 20 meters or thereabouts. This was a great step in advance. Recently Dr. E. F. Nichols, director of the Nela Research Laboratories and his Associate, J. D. Tear, went Marconi one better and actually produced a wave-length of a little less than 1/100th of an inch! This is most extraordinary because for the first time radio waves have been made to overlap heat waves. Heat waves of 1/175th of an inch have been obtained in the laboratory, so that *we have now actually merged radio waves into heat waves.*

Just what this statement means to the future of radio seems impossible to even dimly discern today. One can make the wildest guesses and will probably hit far below the mark. For instance, if we say that the future radio generator may be an ordinary burning candle, this may sound like a wild dream, nevertheless the results of Nichols and Tear will make such a thing possible. If the radio waves can be converted into heat waves, or rather intermingled with them, there is no reason why the flame of an ordinary candle cannot be made to give out radio waves by some sort of transformation which as yet we can only see dimly in the future.

On the practical side, the era of short waves is just

dawning. Recent experiments of Dunmore and Engel, of the Bureau of Standards, have shown that an entirely new field may be opened by short wave-lengths of about 10 meters or less. Such wave-lengths can and will be used for house to house communications in low power radio telephony. These waves can be directed in a beam so that they will only go in one direction. In other words, they can be directed just as a light ray is directed, by a search light, with the advantage that the concentrated radio beams can be made to go much further than light rays.

Hertz, in his famous researches years ago, has shown that electro-magnetic waves—radio waves in other words—can be refracted exactly like light rays. By means of a huge lens made of pitch, Hertz actually focused a beam of radio waves upon a chosen spot. By means of a pitch prism he refracted his waves much as we refract light rays, through a crystal prism. Indeed Nichols and Tear used similar appliances; for instance, they used a focusing lens made of paraffin where Hertz used a lens made of pitch.

There is a tremendous field for research open to the amateur in the wave-lengths between 10 meters and 1 meter, and entirely new fields will be opening up once we avail ourselves of these new wave-lengths. For one thing, interference is practically done away with. Static, the enemy of all radio experimenters, entirely vanishes when such a wave-length as 10 meters is used. For communication between friends and for short distances, up to a few miles, a 10-meter wave-length is ideal and likely to bring out new and unsuspected phenomena. Unless all indications are wrong, there will be a general stampede down to the low wave-length during the next few years. It will be accompanied by entirely new varieties of instruments which we cannot even conceive of clearly today. This is certain, mainly because the frequencies for the low wave-lengths become truly enormous. Thus, for instance, the frequency for 350 meters with its number of oscillations is 856,628. On 200 meters, the frequency has already become 1,499,100 vibrations per second, while for wave-lengths of 10 meters, the frequency has gone up to the tremendous value of 29,982,000 oscillations per second.

H. GERNSBACK.

# Short Wave Directive Radio Transmission\*

By FRANCIS W. DUNMORE and FRANCIS H. ENGEL

Physicist and Assistant Physicist, Radio Laboratory, Bureau of Standards



Fig. 7. Ten-Meter Receiving Set. Note on the Mast the Single Turn Coupler and Detector Tube. The Amplifier May Be Seen on the Left Stool and the Heterodyne on the Right One.

WITH the rapidly increasing use of radio, both for communication and broadcasting purposes, there has arisen the need for some method of transmission which will be free from interference from other stations. For broadcasting, it is obvious that the ideal to be sought for is to reach the greatest number of people. For such broadcast transmission directive antennae are not suitable, but the use of directional antennae for the reception of broadcast radio telephone messages offers a means of reducing interference difficulties at a receiving station. For "point-to-point" communication, however, a method of transmission which restricts the transmitted wave to a comparatively small area is much desired and would have many applications.

There are many cases in which communication is desired between points not easily accessible, so that radio communication is the only practicable means. The use of a method of directive transmission greatly reduces the interference which such communication will cause. There are some new kinds of point-to-point radio communication which

are now being developed, such as the transmission of photographs by radio and the remote control of mechanisms by radio, all of which applications can advantageously be carried on by directive transmission.

Another great advantage to be derived from the use of directional transmission (at very short wave-lengths) is the freedom from strays and other atmospheric electric disturbances. It is generally known that strays are less severe on short wave-lengths than on long wave-lengths and at the very short wave-lengths used by the authors in the experiments herein described, little or no difficulty from this source was experienced. This freedom from static is due both to the short wave-length employed and the extremely small antenna necessary for reception.

Franklin, Marconi, and others have recently performed experiments with directional transmission and reception using wave-lengths of 20 meters and less. At the Bureau of Standards the authors recently conducted a similar series of experiments using a wave-length of 10 meters. It is the purpose of this article to describe the apparatus

used in these experiments and to present the results obtained. The generation and directive radiation of waves of the order of 10 meters resolves itself into (1) the development of a 10-meter electron-tube generator (of suitable power), (2) the development of an efficient directive reflecting system for radio waves of this wave-length, and (3) the development of a 10-meter receiving apparatus.

Before an attempt was made to develop a directive type of antenna for waves of the order of 10 meters in length it was necessary to develop an electron tube generator capable of producing waves of this length. This was no small task with the restriction that only certain types of power tubes were available and these not designed to operate at such high frequencies. A 50-watt tube of the coated filament type was found, however, which could be operated on a wave-length as low as 10 meters. Several circuits and arrangements of plate and grid coils were used before oscillations at this frequency were obtained.

The circuit which was found to operate satisfactorily is shown in Fig. 1. Coil A consists of a single turn 17 cm. in diameter for plate coupling, and coil B is a similar coil for grid coupling. The capacity between the elements of the tube, together with these coils, forms the oscillatory circuit. It is this internal capacity which determines the upper limit of the frequencies obtainable with a given tube.

This short wave generator was coupled to the radiating system (the antenna) D by means of a single turn coil C as shown in Fig. 1. The antenna was made up of two sets of vertical wires as shown at E, Fig. 1. Each set of wires was 1.8 meters long. Adjacent wires were spaced 3 cms. apart.

The arrangement of the antenna with respect to the coils and tube is shown in Fig. 2. It will be noted that all leads were made as short as possible. The glass antenna insulators may be seen above and below the frame holding the generating set.

A system of Lecher wires was used for measuring the wave-length of this short wave generator. Fig. 3 shows a wave meter for measuring wave-lengths of the order of 10 meters. It is noteworthy that the range of this wave meter is one meter, as contrasted with the usual type of wave meter

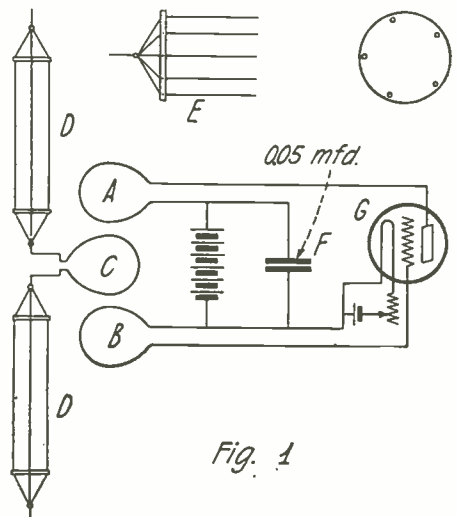

Fig. 1

Circuit of a Ten-Meter Generating Set. Detail of the Aerial is Shown at E.

\*Published by permission of the Director of the Bureau of Standards.

having a wave-length range of 200 or 300 meters.

A method of generating wave-lengths of the order of 10 meters having been found, the next step was to develop a reflecting system so that the radiated power could be transmitted in one direction. There are several methods of obtaining semi-directive transmission, such as by the use of a coil antenna, a long low antenna, etc., but the most efficient method is by the use of short wave-lengths and a reflector of the parabolic type. The wave from this type of reflector is *uni directional*, being similar to a parallel beam of light which has passed through a slit in an opaque screen.

Fig. 4 illustrates the reflector of the parabolic type as constructed. It is in the shape of a segment of a parabolic cylinder and is made by suspending 40 wires from a frame constructed in the form of a parabola. Each of these wires is tuned to 10 meters and they are spaced 30.47 cm. (1 foot) apart. The frame is suspended from a rope stretched between two poles, so that the reflector may be rotated through 360°. The suspended wires are insulated from the frame and from each other, by means of small glass insulators. The focal distance was made one-quarter of a wave-length; that is, 2.5 m. (8 feet 2.4 inches). With this distance determined, the parabolic frame may be constructed. It is important to have a frame of this shape in order to maintain the proper phase relations and to obtain maximum reflection. The 10-meter generating set with antenna is shown suspended at the focus (in the center). The power radiated from this antenna goes out in the direction of the opening of the parabolic cylinder part of which is reflected from the 40 suspended wires.

The receiving apparatus used for reception at these very short wave-lengths is shown in Figs. 5, 6 and 7. Fig. 6 shows the type of coil antenna used for making measurements of the radiated energy about the reflector. Tuning was accomplished by means of a two plate variable condenser and resonance was indicated by means of a galvanometer and thermo-couple. With a single turn coil of this type and only six inches in diameter, strong signals were received from the Bureau of Standards at a point about two miles away. A detector and two stages of audio frequency amplification were used in this reception.



Fig. 4. The Parabolic Reflector at the Transmitting Station. Note the Oscillator in the Box Between the Two Small Cage Aerials Acting as Aerial and Counterpoise.

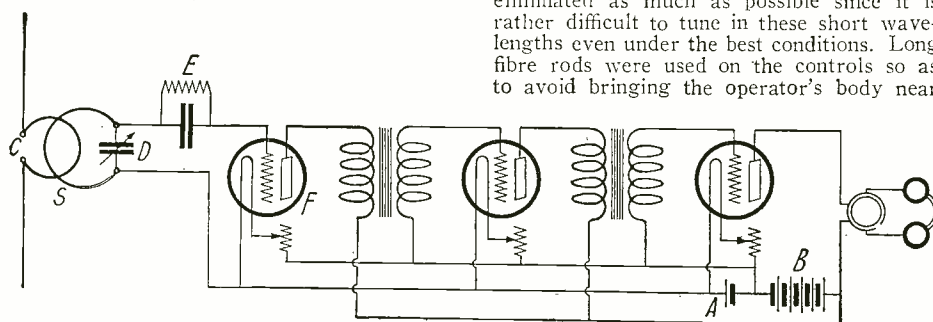
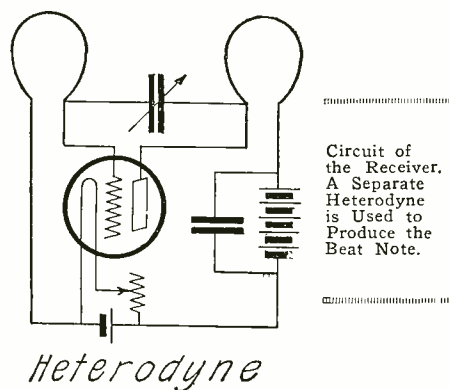

Fig. 5

For receiving signals at greater distances a receiving set consisting of a detector and two stages of audio frequency amplification was used. An external heterodyne was used when receiving continuous wave signals. This is shown in Figs. 5 and 7. Ordinary receiving tubes were used in this set and usual connections employed. The secondary coil "S" of the receiving set (Fig. 5) consisted of one turn of wire and was about twelve inches in diameter. The antenna "C" was made of about fourteen feet six inches of number 12 wire and was suspended on a wooden frame with the coupling coil of the receiving set at the center point.

In constructing a set of this kind it is very important that stray capacities be eliminated as much as possible since it is rather difficult to tune in these short wave-lengths even under the best conditions. Long fibre rods were used on the controls so as to avoid bringing the operator's body near

the apparatus. The detector tube was mounted directly on the antenna support in order to reduce the length of the grid lead to a minimum. The two stage audio frequency amplifier remained on the ground as shown in Fig. 7.

The receiving apparatus described gave very satisfactory results during the tests. Had it been necessary to cover greater distances, it is possible that more refined apparatus, such as the super heterodyne would have allowed reception over considerably greater distances. The addition of a parabolic reflector at the receiving station would also have greatly increased the distance over which the transmitted signals could have been received.

A method of directive transmission and means for reception having been obtained, a series of tests were made to study the nature of the transmission from such a system. For the purpose of making this study the reflector with generator and antenna was rotated, the receiving set remaining stationary about 170 feet from the reflector. The receiving set shown in Fig. 6 was used. As the reflector was rotated, through 360 degrees the galvanometer deflections produced at the receiving set were read for every 10 degree position of the reflector. As the reflector was pointed toward the receiving set, the deflections were a maximum and when it pointed in the opposite direction a minimum deflection was obtained. The results of this study are shown in Figs. 8 to 12.

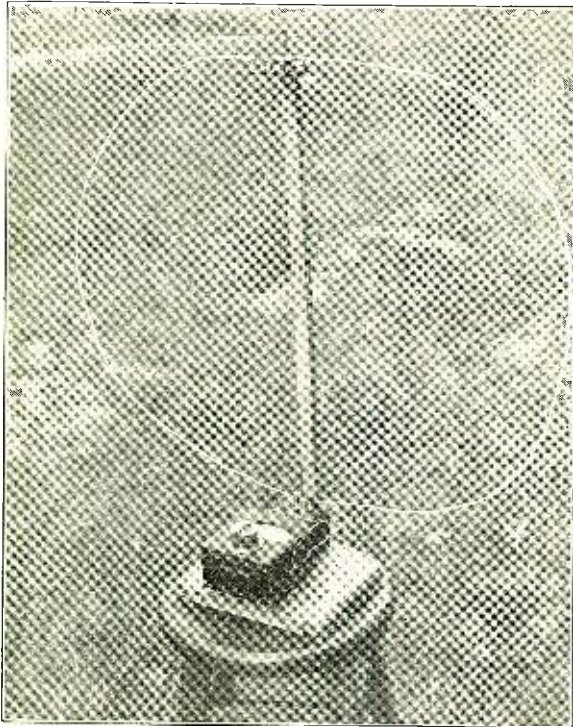

Fig. 6. Above: Receiving Apparatus for Studying Directive Characteristics of Radiation From a Parabolic Reflector. Fig. 3 A 10-Meter Wave-meter. This has a Range of One Meter.

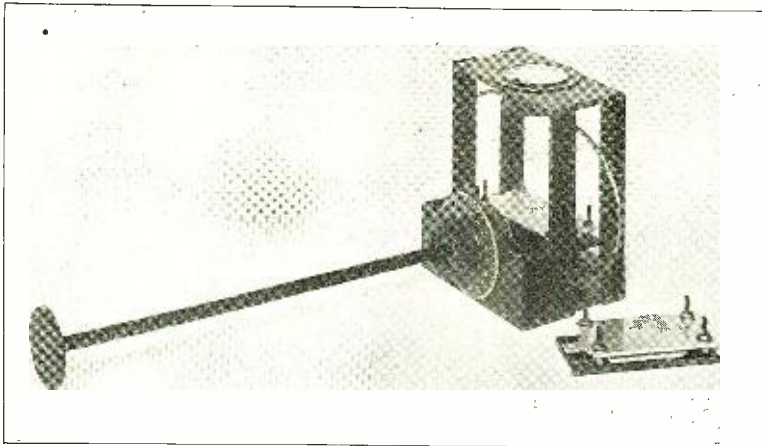

Fig. 3. Assembled 10-Meter Generating Set, Showing Method of Coupling to Antenna.

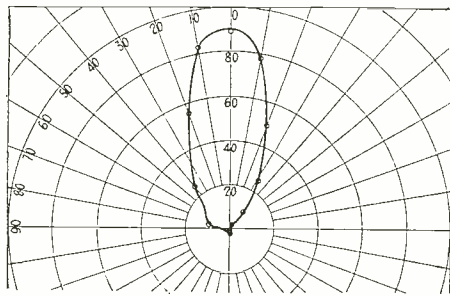
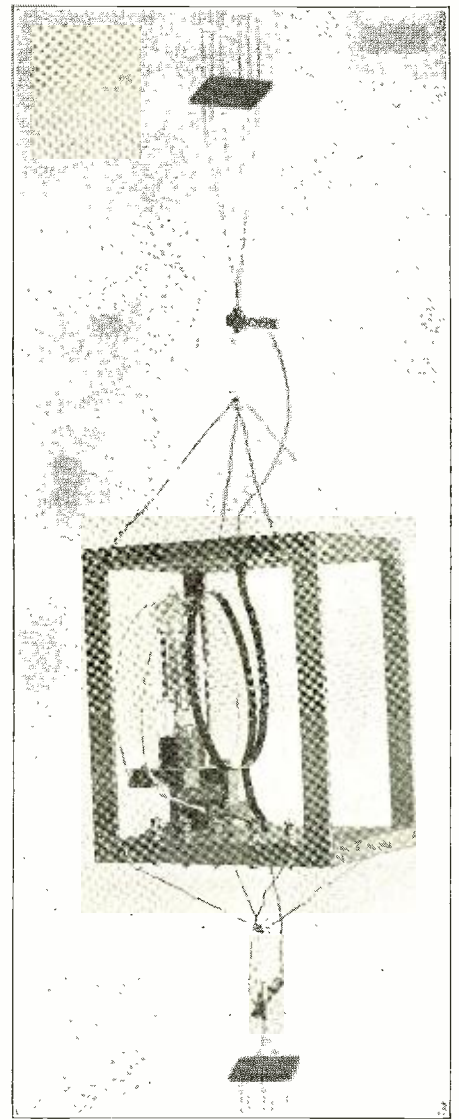

Fig. 10  
Radiation Characteristic Curve of Parabolic Reflector. Aperture = 1.5 Wave-Length.  $\lambda = 10$  Meters. Showing Effect of Increasing the Aperture from 1 to 1.5 Wave-Length.

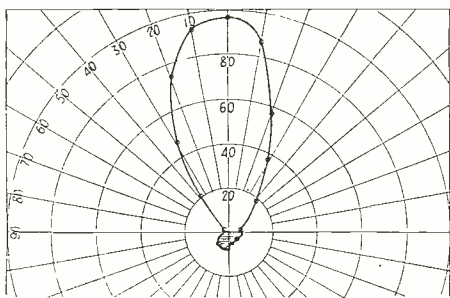

Fig. 11  
Radiation Characteristic Curve of Parabolic Reflector.  $\lambda = 10$  Meters. Aperture = One Wave-Length. Showing Effect of Using 20 Tuned Reflecting Wires.

meters) to 1.5 wave-lengths. This was done by adding 10 tuned wires one foot apart on each end of the parabolic frame which had been extended for this purpose. Fig. 10 indicates the results obtained. It will be seen that there is practically no leakage in the rear of the reflector and that the reflected wave is in a slightly narrower beam than was obtained in Fig. 8.

Fig. 11 shows the results obtained when every other reflecting wire was removed leaving twenty wires instead of forty. It was found necessary to retune the twenty-wires due to the change in capacity effect caused by the removal of neighboring wires. Note that an increase in the number of reflecting wires improves the directive properties.

The effect of making a large opening in the rear of the reflector by taking out ten wires in the center of it is shown in Fig. 12. Note that the directive effect is greatly reduced and the leakage through the rear is considerable.

It will be seen from these curves that the narrower the beam is made the greater the received current. In fact, with no reflector at all the deflection of the receiving galvanometer was zero as against one hundred in the case of good directive transmission.

Absorption of the transmitted energy at this wave-length is very noticeable and was demonstrated by carrying the apparatus shown in Fig. 6 into a large building of steel

(Continued on page 182)

Considerable experimenting was done to obtain the optimum length of the forty reflecting wires. The best results were obtained when the wires were exactly 4.39 meters (14 ft. 5 in.) long. Fig. 8 shows the data taken as mentioned above in polar curve form with this adjustment of the reflecting wires. It will be noted that the radiated power is practically all confined to an angle of 40 or 50 degrees. By turning the reflector 25 degrees off from the position of maximum reception the receiving galvanometer deflection decreased 50 per cent.

Fig. 9 shows the effect of slightly altering the wave-length of the 10 meter generating set at the focus of the parabola. It will be noted that such a change destroys the directive properties completely causing considerable leakage through the rear as shown by the shaded portion. The aperture (opening) of the reflector was changed from one wave-length (10

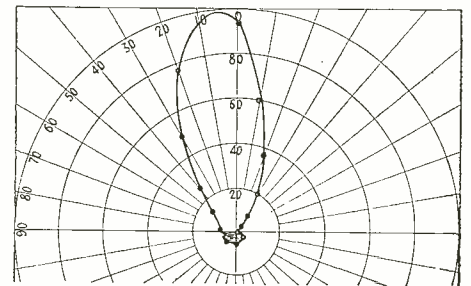

Fig. 8  
Radiation Characteristic Curve of Parabolic Reflector. Aperture One Wave-Length. Showing Effects When Reflecting Wires Are in Tune with the Source.

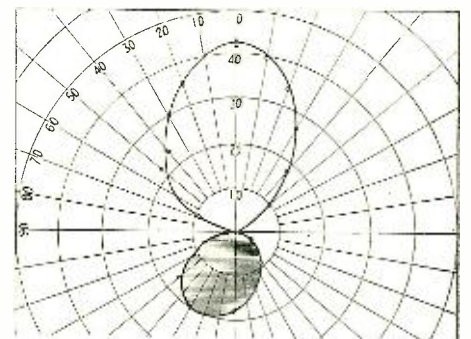

Fig. 9  
Radiation Characteristic Curve of Parabolic Reflector  $\lambda = 10$  Meters. Aperture = One Wave-Length. Showing Effect of Changing the Wave-Length of the Source.

# Page the Amateurs

By J. FARRELL

**L**AST March a devastating spring frost hit the Southern fruit crops. Overnight the peach crop was damaged more than 25 per cent. Other early crops, including strawberries, potatoes and green goods, were proportionately damaged. The farmers of the country wanted quick information on the extent of the loss. Radio was rushed into the service, and information that had formerly taken several days to gather was compiled literally overnight.

"Use of radio in a crop crisis such as this has tremendous value," says W. F. Callander, Chief of the Crop and Livestock Statistics Division of the United States Department of Agriculture. "When frost, drought or storm causes sudden havoc to growing crops, we want the statistics quickly so that immediate action may be taken to repair the loss. The mails and telegraph are too slow. Apparently only radio will do."

Thus epitomized, the live-wire character of an arm of Government that proposes to use aeroplanes in estimating the size and condition of crops, and radio to spread the news quickly over the country is indicated. Yesterday and its methods are discarded for the revolutionizing changes of today.

When the freeze warnings were issued by the weather forecasters last March, the Georgia field representative of the Crop Division immediately broadcast by radio a request for specific information of the extent of the damage. Reports were flashed back from all over the peach belt and the following morning the crop statistician had before him the most comprehensive survey of the situation ever compiled. A brief summary was flashed to Washington. The information was then broadcast from Arlington and relayed to the 90 or more stations handling market and crop news.

## VOLUNTEER REPORTS

As a regular part of its duties this work ties up directly with the activities of the Federal Board of Crop Estimates in preparing national forecasts and estimates of crops.



The Booth from Which the Reports Are Broadcast by Telephone Through Station NAA.

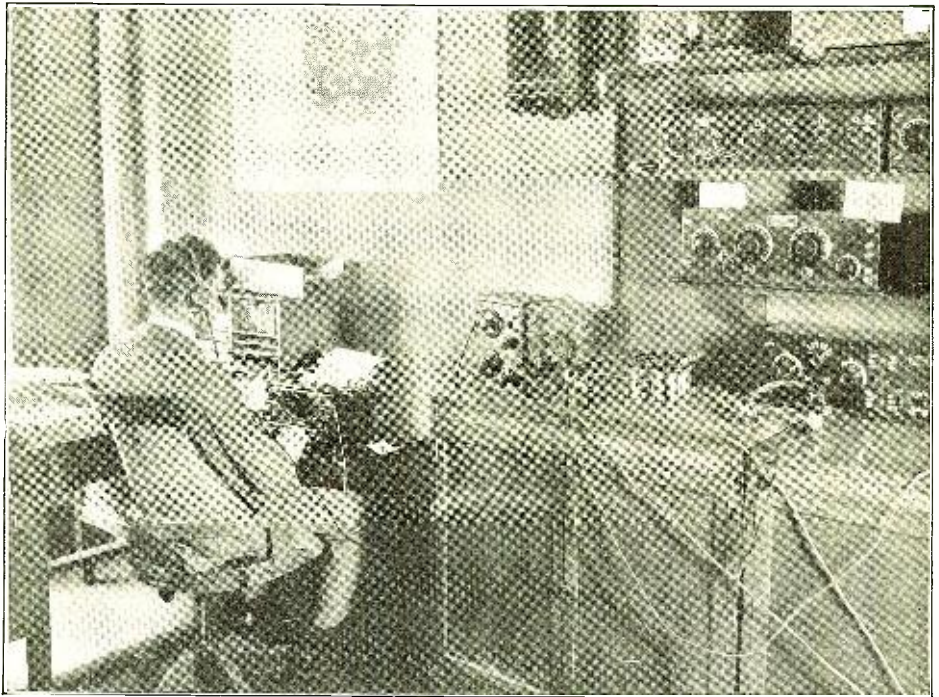

W. J. Holbrook, Radio Operator, at the U. S. Department of Agriculture, Records Crop and Market News Flashed by Broadcasting Stations Over the Country.

More than 200,000 voluntary and paid crop reporters all over the country regularly report to the Board on acreage and condition of growing crops. The service was recently characterized by the International Institute of Agriculture at Rome as the most efficient anywhere in the world, but the Department of Agriculture is continually seeking its improvement. Every possible safeguard to prevent inaccuracies and to make the service mechanically perfect is being erected, and in doing so radio is destined to play an important part.

Of the Crop Board's organization approximately 30,000 workers are township crop reporters, nearly all of whom are practical farmers, and who report monthly on the crops grown in their immediate territory. These reports are forwarded by mail and several days are required to receive and tabulate the information. To speed up the work it is proposed that each of these reporters get in touch with local amateur operators to flash the news by radio to a central receiving point where it would be summarized and rebroadcast to Washington, thus cutting off several days in transmission. At Washington only a small staff of radio receiving operators would be required.

In the issuance of final crop reports every possible precaution is taken to prevent the totals for any of the so-called speculative crops from becoming known to any individual prior to the date of release fixed in advance by the Secretary of Agriculture. Even the tabulators and computers who make up the totals do not know the states to which they pertain, and the final telegraphic reports and comments of the field agents relating to the specu-

lative crops are kept locked in the office of the Secretary until crop reporting day, when they are turned over to the Crop Reporting Board. The entire Board is immediately locked in a room until the minute the report is issued, guards being stationed at the doors, and all telephones disconnected.

## AMATEUR ASSISTANCE DESIRED

In substituting radio for the mail system the assistance of the amateurs is regarded as practically indispensable. With more than 20,000 amateur operators throughout the country little difficulty is seen in pressing a sufficient number into the service to make the plan feasible. A special code system of radio telegraphy would be used. A similar system would be followed by the county and state crop reporters located in every county in the United States, and by the several crop specialists who cover each of the various crops as a whole.

According to Mr. Callander the service has limitless possibilities. Overnight a storm or other paroxysm of nature may cut thousands of bushels from the wheat and corn crops, the fruit crops, an entire field of cut hay may be ruined, and thousands of bales of cotton may be damaged. The loss may occur on crop-reporting day while the Crop Board is in session behind locked doors and entirely cut off from the outside world. The crop report could not possibly take into consideration prevailing conditions and as a result the estimates are anti-dated. With radio bringing into the Board room quick advices of moving conditions, the report can be made representative of conditions at the moment it is released.

## SPECIAL LIVE STOCK REPORTS BY RADIO

Other services being developed by the Crop Division, such as the issuance of special reports on the livestock situation in the Corn Belt and on the Western cattle and sheep ranches, may also utilize radio in collecting data. At present this information is developed by mail and telegraph and frequent delay in getting the news to the pro-

(Continued on page 184)

# Recording Fading Signals

Some Interesting Experiments Carried Out With a Special Recording Apparatus Designed by

**DR. G. W. PICKARD\***

(INVENTOR OF THE CRYSTAL DETECTOR)

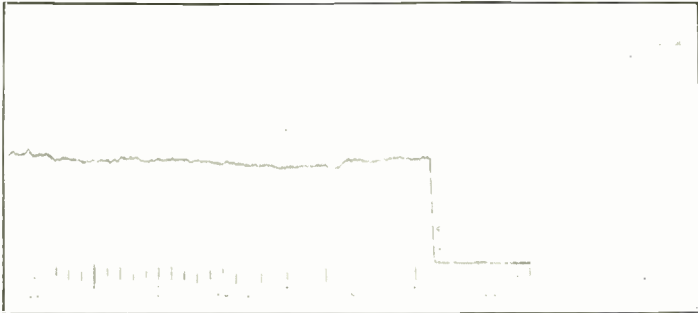

This Record Clearly Shows That For a Local Station There Are No Substantial Variations in Transmission.

**T**HERE are few indeed of the myriad broadcast listeners who have not noted large variations in the intensity of speech and music as received from all save nearby stations. On some evenings, particularly in winter, a very modest receiving equipment will pick up a score of stations, distant over a thousand miles, while on other nights stations outside of, say, a 50-mile radius are practically inaudible. But even on a good evening, nearly everyone has observed striking variations in intensity from minute to minute, and sometimes even from second to second. Unfortunately, a large number of listeners attribute these variations to changes in their receiving sets, and not only waste time twirling knobs in an attempt to restore the signal, but also fill their immediate neighborhood with squeals, which are indeed the only tangible result of their efforts. When the novice goes for an explanation of these happenings to his court of last resort—the radio editor of his daily paper—he is usually told that such variations are caused by “atmospheric conditions”; an answer which probably completely sums up our present day knowledge of this subject, and by its paucity urgently calls for further investigation.

### FADING WAS EVER PRESENT

These variations in radio transmission are by no means peculiar to broadcasting, as they have been observed for some 20 years as a most baffling phase of radio telegraphic transmission. But with the advent of radiophone broadcasting, such observations have passed from a few hundred radio engineers and operators, to an audience of

The Period 7.58 to 8.03 P. M. On This Record Was An Intermission, In Which the Carrier Wave Was Cut Off. The Slight Waviness of the Line Indicates a Certain Small Amount of “Background” Disturbance; a Complex of Distant Spark and Broadcasting Stations, Static, Switching, etc.

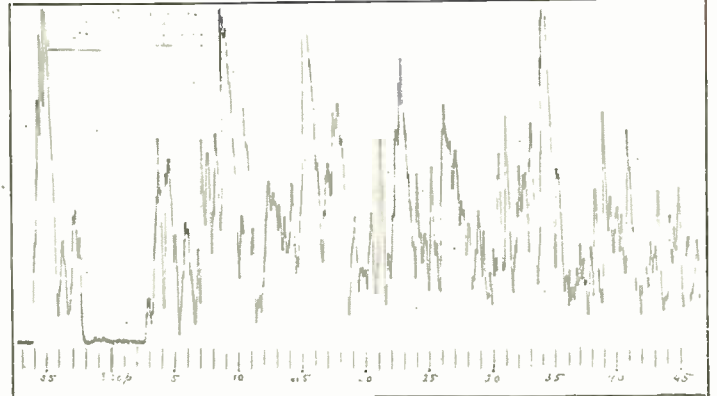

subject, and has furnished RADIO NEWS with some typical samples of his many photographic records, together with a schematic diagram of the simple apparatus required, in the hope that advanced amateurs and others will set up similar apparatus and conduct tests at their stations. Not only will this work be found intensely interesting, but those who undertake it can rest assured that their labors will materially assist in the solution of this long-standing problem.

### THE RECORDER

Fig. 1 is a diagram of the circuit and apparatus employed in receiving and recording the fluctuations in signal strength. The tuner is of the ordinary two-circuit variety, comprising primary and secondary coils L and L-1, respectively, the primary or antenna circuit being tuned by a variable air condenser in series, and the secondary by a shunt condenser of the same type. A loose coupling between the two circuits should be used, in order to eliminate as far as possible all disturbing signals, which would otherwise obscure the record. Four stages

of radio frequency amplification are shown in the diagram, of the customary transformer coupled type, although for most cases one or two stages will be found sufficient, unless a very insensitive galvanometer is used. The grid bias of the first tube is controlled by potentiometer P-1, and the grids of the last three stages by potentiometer P-2. The

plate and filament voltages are indicated on the diagram, and UV-201A tubes are used. It is only natural that a crystal detector is used as shown at D, for its merits as an efficient rectifier were long ago appreciated by Mr. Pickard, who invented the device. A tube rectifier is not satisfactory in this work, as its rectification is not rigorously constant, and the direct current in its output circuit does not as a rule become zero when the input ceases.

G is a galvanometer of the D'Arsonval type, with a mirror instead of a pointer, and is equipped with a shunt box to adjust its deflections to the limits of the record sheet width. The rectified current from detector D swings the galvanometer coil and attached mirror in exact proportion to its strength, from moment to moment, and a tiny pencil of light from a source L is reflected by the galvanometer mirror and focused as a pinhead spot on a revolving cylinder CYL. Around this cylinder is wrapped a sheet of sensitive photographic paper, and the cylinder is rotated once an hour by attachment to the minute hand shaft of a driving clock. TMS is the timemarker source, consisting of a small electric light and lens system, which is momentarily flashed on the lower margin of the record sheet at one-minute intervals. In this way time in minutes is registered in the form of short vertical lines, as shown at the bottom of each of the succeeding figures.

### HOW THE RECORDER WORKS

The operation of the apparatus is as follows: The entire received current from

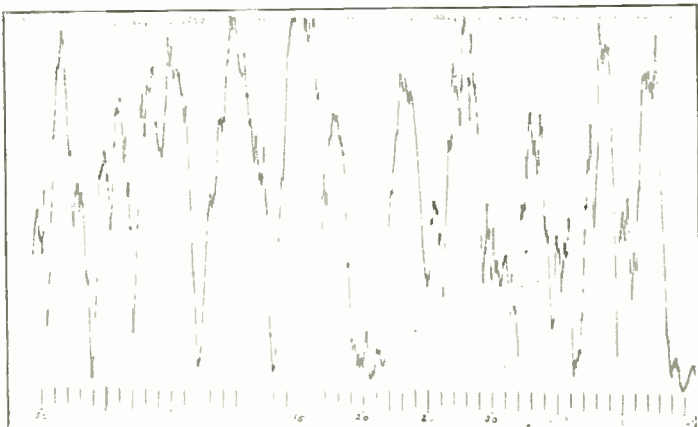

This is a Very Pretty Example of Periodic Fading, the Intensity Dropping to Very Low Values, and Quickly Recovering, With a Marked Rhythm.

some million or more, and it is the purpose of this article not only to show this larger audience the reality of these effects, but also to enlist the cooperation of those who have the inclination to engage in some real radio research work. It is only by the accumulation of such data, gathered at many different points, that we may hope to find the true cause of these variations. The author has recently undertaken an investigation of this

Note the Slow General Increase in Signal Strength From 10.25 to 11.13 P. M., With Short Period Variations Superposed.

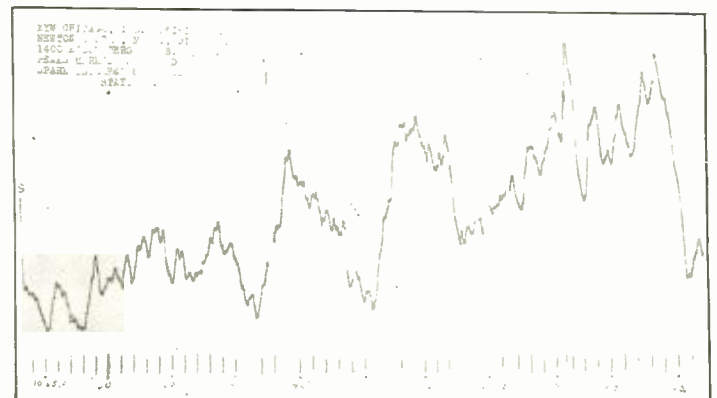

\*Consulting engineer of the Wireless Specialty Apparatus Co.

the distant station, including the carrier wave and its side bands due to modulation, is amplified at radio frequency and impressed upon the rectifier D. A direct current results, whose intensity is not at all dependent upon the modulation at the distant station, but only upon the total received energy. The beam of light, reflected from the galvanometer mirror, swings across the record sheet by an amount dependent upon the value of the detector current, and, in com-

In Making This Record Two Small, Well Separated Aerials Were Used, and, of Course, Two Separate Receiving Sets and Galvanometers. It Will Be Noted That In General the Transmissions From These Two Stations Do Not Vary Together. The Coincidences Between

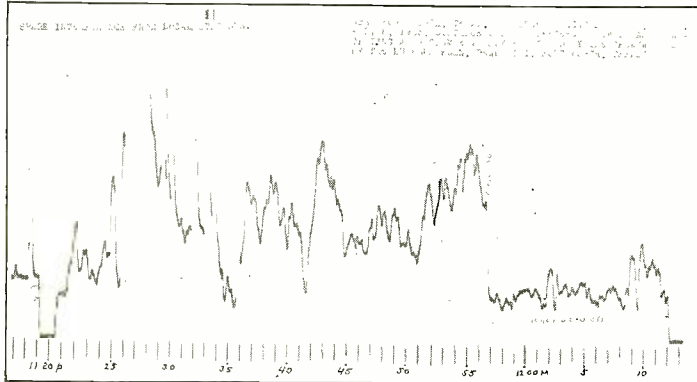
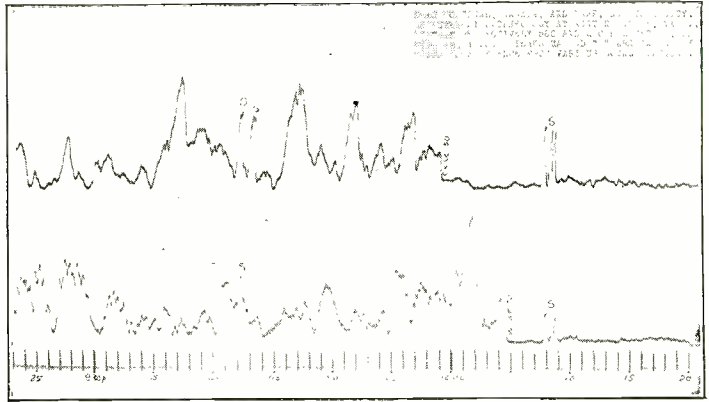

Peaks and Valleys in the Two Traces Are Few, and These Seem to be Purely Accidental. In the Record on the Left, a Very Noticeable Amount of Background Disturbance is Shown. The Station Signed Off at 11:57 P. M., But From That Time Until 12:12 A. M. a Varying Disturbance Is Recorded, Having Nearly Half the Intensity of the Station Itself. At 12:12 A. M. the Galvanometer Circuit Was Opened, and the Short Trace From 12:12 to 12:13 A. M. Gives the Zero Line For This Record.

Fig. 1. A Diagram of the Circuit and Apparatus Employed in Receiving and Recording the Fluctuations in Signal Strength.

bination with the rotation of the cylinder, traces out a curve giving a continuous record of momentary intensities. It is of course necessary that the amplifier and detector should remain absolutely constant over the period of the record, and this is assured by maintaining the filament and plate voltages rigidly constant, and protecting the detector from any jar which would change its sensitiveness. In this connection it is interesting to note that a crystal detector preceded by a radio frequency amplifier is practically immune from electrical disturbances, which would change its adjustment if it were directly coupled to the receiving antenna. Finally, a monitoring telephone is connected in series with the galvanometer and detector, so that the circuits may be initially adjusted, the station identified, and disturbances logged, to later be entered upon the record itself.

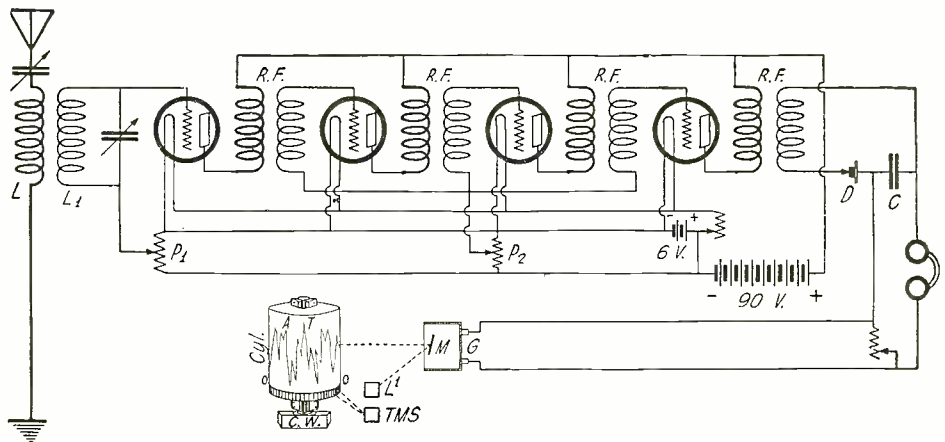

## A New Use for Loud Speakers

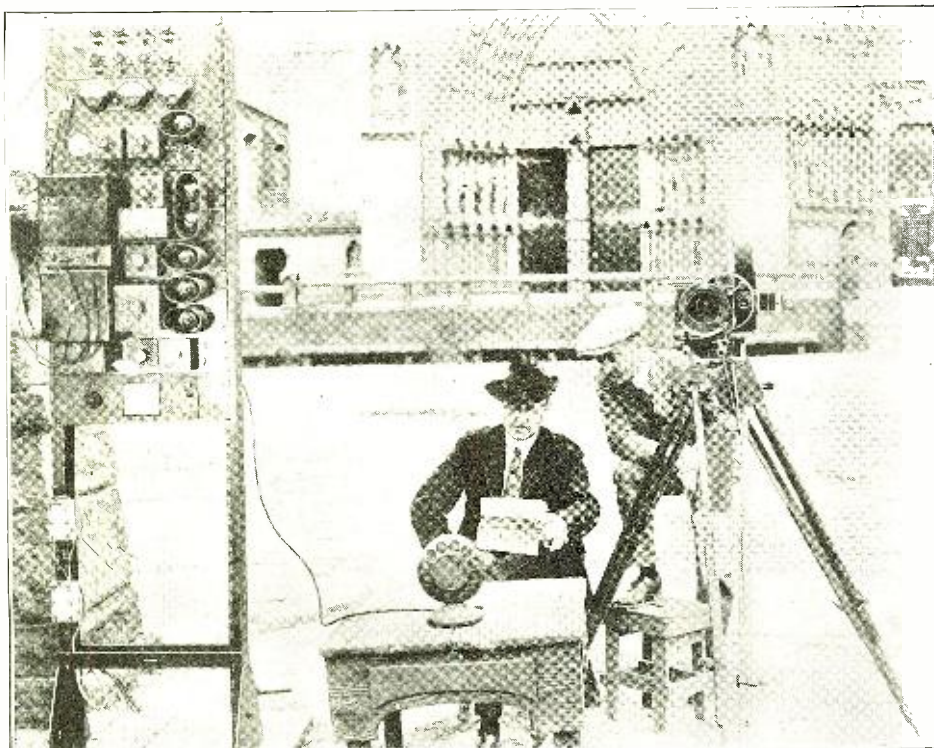

The Cast of Nearly 5,000 People Composing the Production of "The Hunchback of Notre Dame" Was Perfectly Directed By Use of a Western Electric Public Address System.

HANDLING the vast crowds of a motion picture spectacle, involving the minute direction of thousands of "extras" in mob scenes, has been reduced from one of the gravest problems that confront the film producer to one of the simplest operations in his hectic calling. Electricity has smoothed his path toward realism, and the microphone and loud-speaking telephone, operated by power amplifiers, have cut away with one sweep the bonds that once held him to days of painstaking rehearsals, and disappointing fiascos that of yore cost thousands of feet of spoiled negatives.

The most perfect example of what amplifiers can do for the picture producer is seen in the production of "The Hunchback of Notre Dame," super-production being filmed at Universal City. Its cast of nearly five thousand people, working in a setting that covers more than nine acres, was perfectly directed by the most complete installation of its kind ever devised for such work.

The basis of the system is a Western Electric No. 2 Public Address system. To adapt it for use on a film set, various special features have been added to it.

Two boards control the apparatus. One, the power control, handles the current, generated by a motor generator installed in the building that houses the boards, and actuated from the 110-volt line current on the premises. The plate voltage is 350 and the filament 18.

(Continued on page 219)



# How Bertha Brainard "Broadcasts Broadway"

By GOLDA M. GOLDMAN

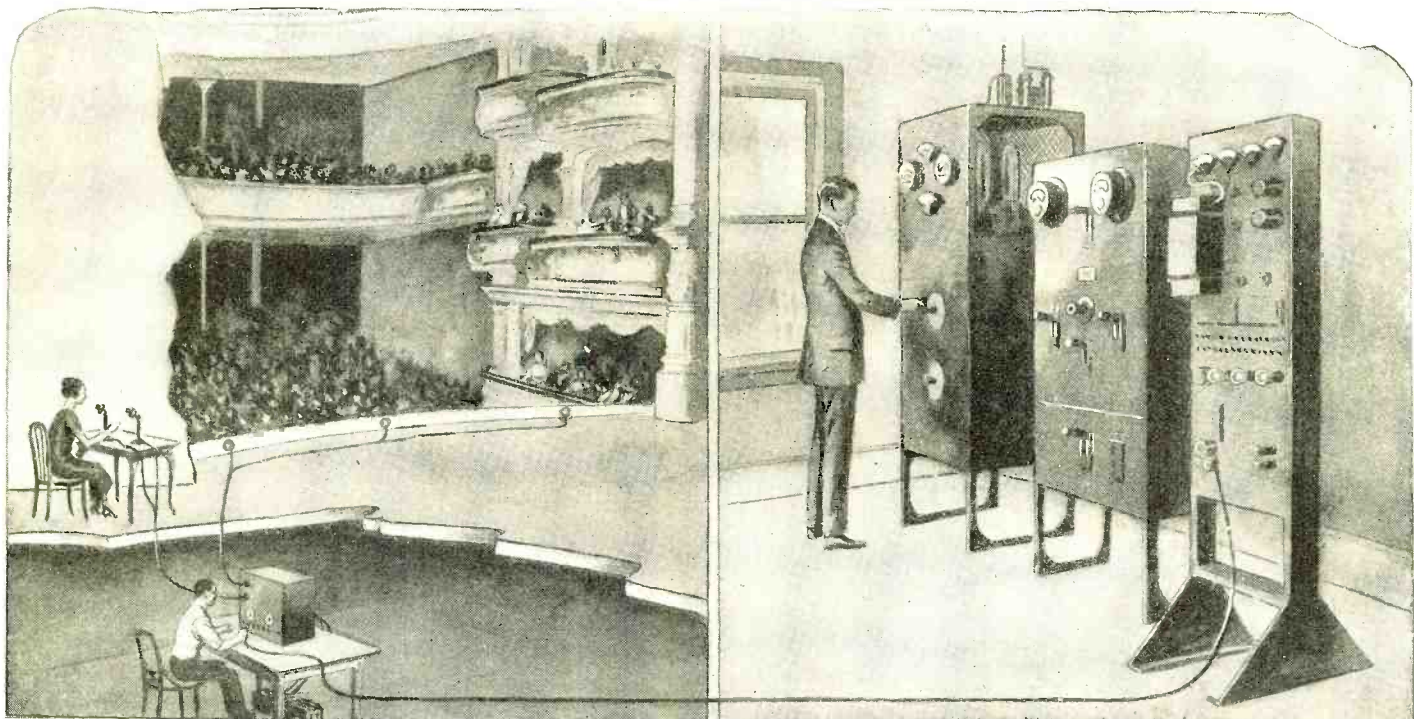

Above is Shown How a Play is Broadcast Directly from the Stage of a Theatre. A Telephone Line Connects the Theatre to the Station, an Amplifier Being Used Under the Stage to Boost Up the Music and Voice Before it is Relayed.

Photo by Courtesy of Radio Corp. of America

On the Left Miss Brainard is Seen Broadcasting "To the World," Which Conceals the Microphone of Station WJZ, the Last News of the Theatrical District of New York City.

"I WISH you could see this dance," says Miss Brainard as she talks to you from the wings of a theatre.

"I wish you could see Bertha Brainard as she 'Broadcasts Broadway,'" is what I thought the first time I saw her in the old Westinghouse studio WJZ in Newark. She is, to be as alliterative as her name, a dainty, delightful, debonair little lady, who would make as charming a picture on the stage as do any of the popular favorites whose work she tells you about. Her hair is her crown of glory, and a very gleaming crown it is at that. She herself said of it once:

"When I want the people to remember me I take off my hat. When I don't care I keep it on!"

Since Miss Brainard's mind is as agile as is her small person as it flashes about the studio, she originated her own "stunt" over a year ago. It occurred to her that radio reaches vast audiences in out-of-town sections, who see, at the most, only one metropolitan newspaper each day,



and in the majority of cases see none at all. These people find it exceedingly difficult to keep abreast of the modern dramatic movements, as such information as they can obtain is culled from the criticisms in the various periodicals. These in most instances are comparatively colorless recitals, lacking the flavor of personal contact with the people and affairs of the theatre.

To Miss Brainard came the idea of giving informal talks by radio on the interesting plays of the day. Mr. Poponoe, studio manager of WJZ, now the Broadcast Central of the Radio Corporation of America, agreed to this plan, and so for the first time Bertha Brainard "Broadcasts Broadway."

The selection of plays for this feature is a very careful one, for so many youngsters listen-in that sex and problem plays in general, regardless of their individual merits, must be avoided. Comedies and musical shows predominate, and for each of these in her pleasant fashion Miss Brainard gives the name and producer of the play, the star

(Continued on page 226)



# What Radio Can Do for the Country

By FLORENCE T. HARPER

**T**O you lucky ones who possess radio sets, I just want to deliver a message of a little country town down in the South Central part of Pennsylvania that is representative of the many country districts throughout our land, even to the detail that its chief claim to recognition is the remembrance of a glorious past.

As country towns go, this one did not follow the prescribed formula of developing into a small industrial center. Whether it was because it was too far from the main railroad line, or because of its previous scholastic precepts, is hard to say, but it refused to change as time went on. And so, to a casual observer, things remained about the same, except that there developed a shrinking tendency both in its younger set and to some extent in the character of its remaining population.

Of course there were store keepers, doctors, lawyers and the like, but the majority were farmers. Spasmodic interest developed about the village post office when the morning mail arrived, after which there would be nothing further to look forward to until the evening train would return its cargo of a few extravagant friends who had the courage to journey to the nearest city on a shopping expedition. The housewife's duties went wearily on with accustomed regularity, and if by chance an hour or so of unoccupied time was discovered on one's hands, it was a terrible problem to devise a way to utilize it.

Sons and daughters, at an early age, conceived the idea that the best alternative for them was to get away to college or to the city as soon as they were out of school, for this environment offered a more proper sedative to their famished spirits.

So the elder folks found themselves quite alone to continue the duties of home and farm, and the many other occupations that fell to their lot, saying nothing of the dreary evenings they were compelled to spend alone with consequent ingrowing dispositions and a shrinking interest in most things worth while. They were out of touch with the rest of the busily interested world and their

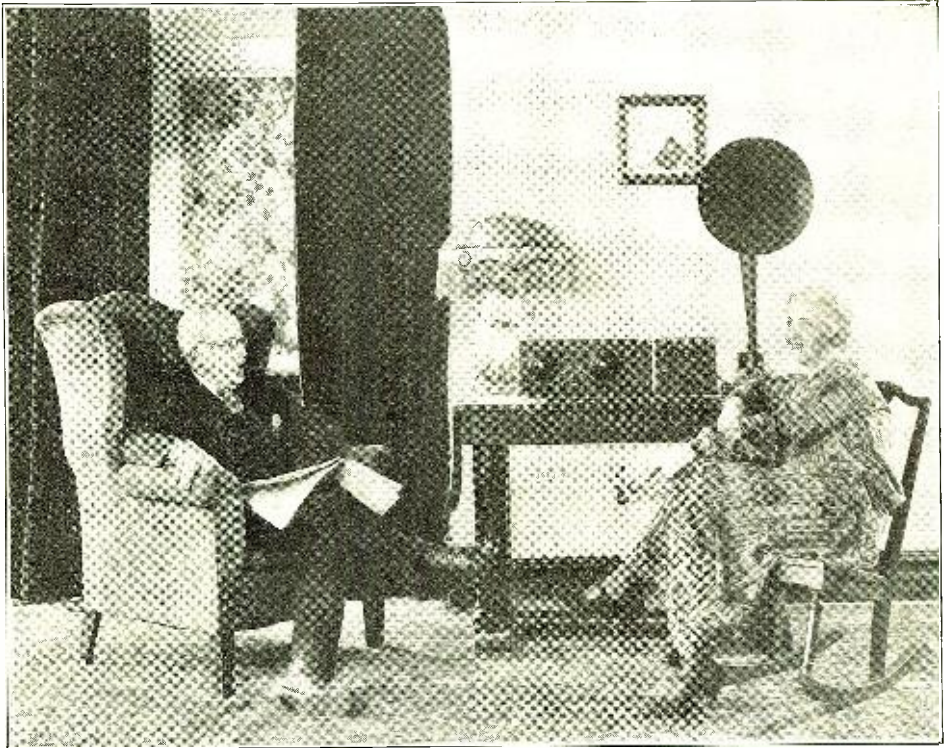

The Pleasure and Benefit Derived from Radio in the Homes of City Residents Are Indisputable. Radio is a Most Satisfactory Source of Diversion. The Tired Business-Man and Housewife Can Sit Back at Ease and Enjoy 57 Varieties of Amusement.

conversations usually turned to the small matter of personalities and noisy gossip as their chief diversions.

That poor little country town away off there in the rolling hills found itself lonely and neglected. Of course in the summer time it was somewhat better, not so lonely and confining. One could get out, go fishing, swimming, camping, picknicking and to the meeting house once a week, or the church socials and the movies. But in the winter

time, it meant being shut in by the glistening snow drifts, and the crisp frosty nights, when a cold, steel-blue sky warns of the need of an extra armful of wood by the stove and the crunching footsteps in the snow outside tell the good wife that everything is being made snug for the night, even if the mercury does drop below zero. The family auto-mo-bile (Ford of course) that once went to New York City is safely tucked away in its winter covers, and jacked up high until the roads become passable again.

But to a youngster it is only six o'clock, and there are three hours of boredom ahead, with nothing to do but finger over the much read books or magazines, and maybe to be tortured a little with some very stale phonograph music. Sister Nan has exhausted her wits in contriving some novelty in the way of entertainment that would tempt her neighbors to face the cold and spend another sociable evening about the big open fire-place.

Time passes heavily on with almost maddening monotony. I have often wondered what the matter was. Now I know; we were out of touch with the rest of the world; out of step. You need someone bigger than you to give you new and better things to think about, good music, lectures, song and laughter and to keep in touch with the world in general.

It is the divine urge in each and every one of us to improve our minds and to progress; nothing can stand still. If we do not go forward, then we go backwards, but the law demands that we "move." A strong desire for the enjoyment of new sensations comes along with education and knowledge. The saddest thing in the world is ignorance; it keeps us in the dark corners and our thoughts are of poverty, unhappiness and all that goes with negative thinking. But with the coming of the biggest discovery of the age, radio, come also light, knowledge,

(Continued on page 176)



However, the City Dwellers Can Little Imagine the Enjoyment the People of the Country Derive from Radio. Far Away from all Activities, These Isolated People Hunger for Something to Break the Monotony of Their Existence. Radio is the Solution.

# Hetterby's Set

By ELLIS PARKER BUTLER

Author of "Pigs is Pigs"

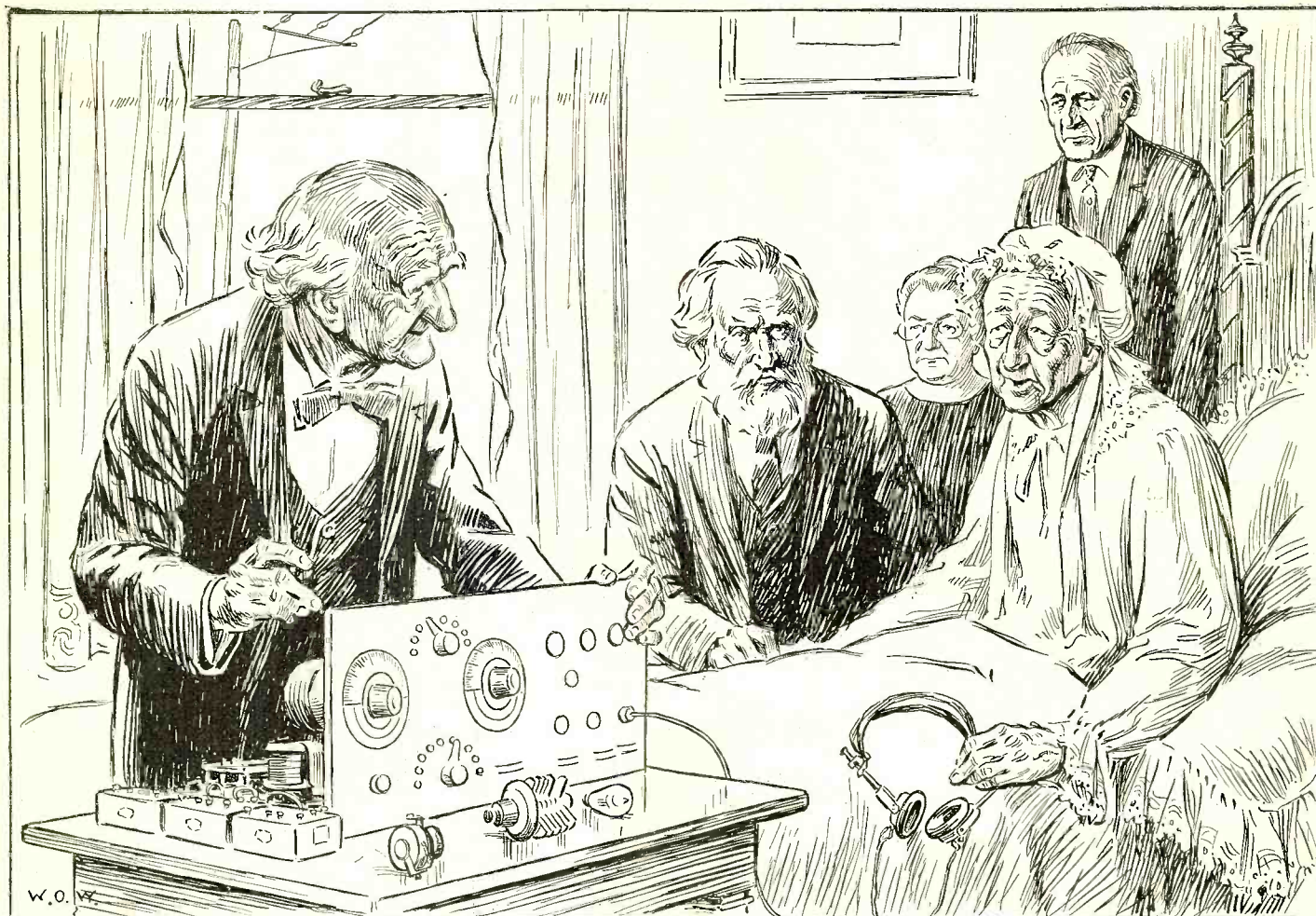

With Trembling Fingers Old Jessica Felt On the Bed For the Ear-Phones; As Her Hands Touched Them She Stared At Her Aged Husband With Tear-Filled Eyes.

REMEMBER, as well as if it were yesterday, the evening young Hetterby came laughing into my father's home, his young wife sort of urging him on, and how he apologized for coming to see us before we had made a formal call on them. I remember, too, how my father shook his hand and said, "That's all right! Come right in! Neighbors should be neighbors," and how my mother said to Mrs. Hetterby, "It's shameful, and that's a fact; we should have called on you long ago, but the truth is that Henry has been so interested in fixing up his radio set that we haven't gone anywhere. We're awful glad you've come!"

Then Mrs. Hetterby said, "Well, it's radio that's made us come, so that evens it up. I simply insisted that Sam come over and hear your radio and see how simple and easy it is to make one like yours—"

And that, you may be sure, set father going, and he led the way into that little back room he calls our "radio room," and in a minute he was explaining the set to Hetterby, and letting Hetterby and his wife hear Newark and Schenectady and Davenport and all those stations that were broadcasting back in those days. And Hetterby was interested, but nothing like as interested, it seemed to me, as Mrs. Hetterby was.

Mrs. Hetterby—Jessica was her name—was one of the dearest and sweetest and snappiest little wives I ever saw. She was

a young darling, if ever there was one, and as happy as a wren, but, of course, she was alone a good deal of the time in our suburb of Westcote.

It wasn't so much that Sam, her husband, went to town every day, for nearly all the Westcote wives' husbands did that, but Westcote is an old and rather aristocratic suburb and a slow place for a newcomer to get acquainted in at any time, and doubly slow since radio came in and the wives hardly bother to go calling at all—just sit at home and listen to radio. So I dare say Jessica Hetterby, in her little new bungalow home next door to us, did feel that her days were rather long and empty, and that it would be pleasant to have a radio set of her own. And, of course, her husband was willing to give his darling young bride anything he could, so they came over to our house to see the radio set my father had made and was using. It was a case of make a set, with Hetterby, for they did not have much money to spare in those days.

So Hetterby looked at my father's set and asked a million and one questions about it, and it was amazing that anyone could ask so many questions about my father's set, for father was no mechanical sharp and his set was the simplest possible. He had it in an old cigar box and it always amazed those who saw it for the first time. There did not seem to be anything to it at all.

There was some wire wrapped on some cardboard, and a crystal as big as the end of a lead pencil and not much else. There was room in the cigar box for three or four more sets of the same kind—it was simple, and that's the truth.

So dear little Jessica fairly danced on tiptoe as Sam asked questions and said, "Yes, I understand that!" and "Yes, I get that!" and "Yes, I see how that is." She said, "Oh, do you really think you can make one, Sam?"

"Sure! Easiest thing you know!" he said, and then he asked my father how long it took him to make the set.

"Two evenings, this one," my father said, "but I'm no mechanical genius. I'm a dub at this sort of thing. You ought to be able to make a set like this in one evening, easy, if you are any sort of a mechanical genius at all."

"And he is!" little Jessica cried, clapping her hands. She hopped right up on her tiptoes and threw her arms around Sam's neck and kissed him. "Oh!" she cried, "we may be able to hear Newark this very night before we go to bed!"

"Well, hardly that," my father said, "because Newark quits at 10:30"—which it did in those days—"but you may hear Ridge-wood, if you can get an aerial up and your ground connection right."

"Well, we can! I just know we can!"  
(Continued on page 222)

# Radio Pictorial

Right: Photo Showing Miss Irene Bowman, Class of '23 at Barnard College, Studying the Operating Characteristics of Vacuum Tubes. Note the Layout of Apparatus Necessary For This Work.

(c) Kadel & Herbert  
Below: "Make Your Boy a Radio Fan and Keep Him Off the Streets At Night." This is the Sage Advice of Mayor George E. Leach, of Minneapolis, Minn. He Is An Ardent Fan Himself. The Photo Shows Him Listening In At His Office In the City Hall.  
© Fotogram, N. Y.

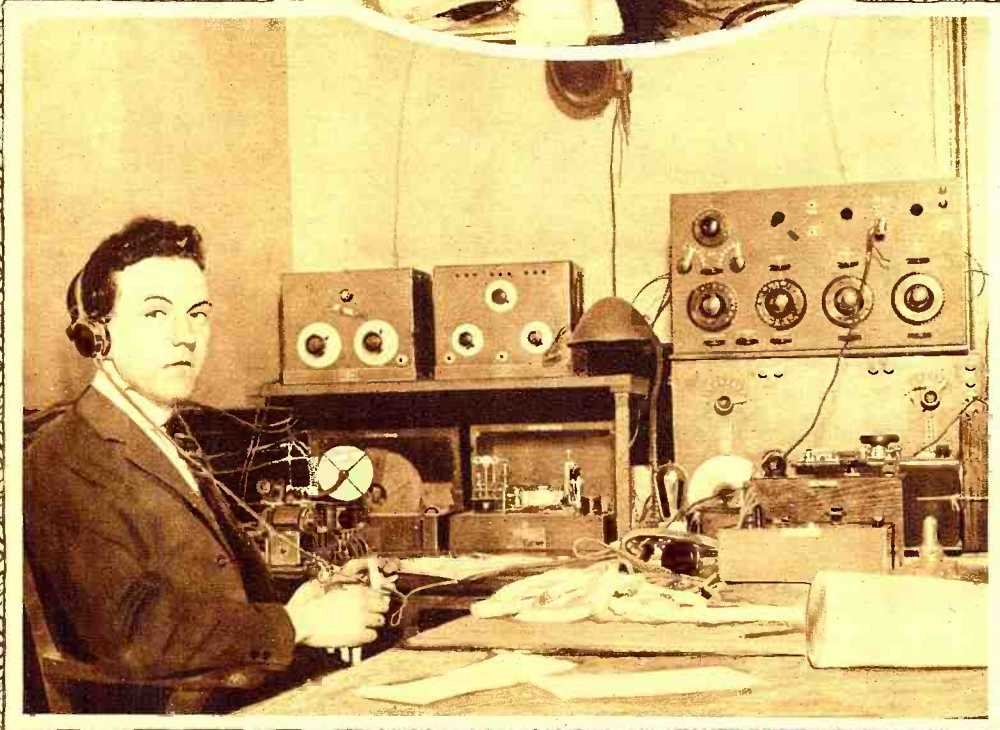
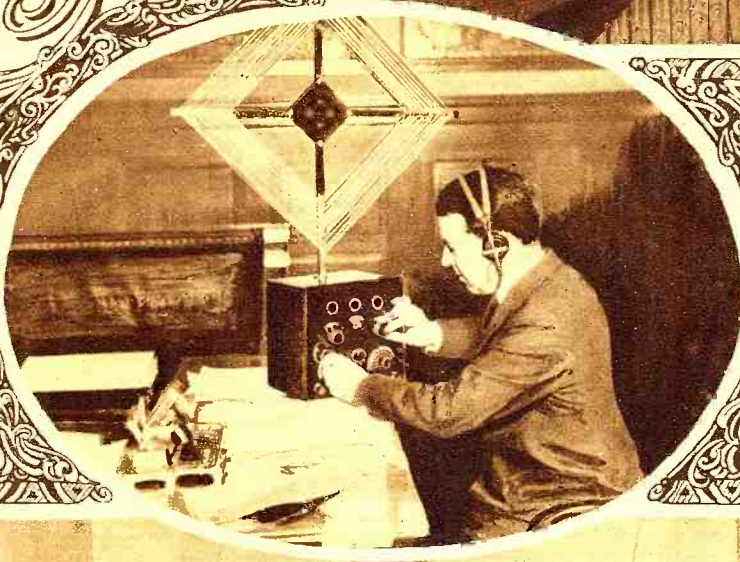
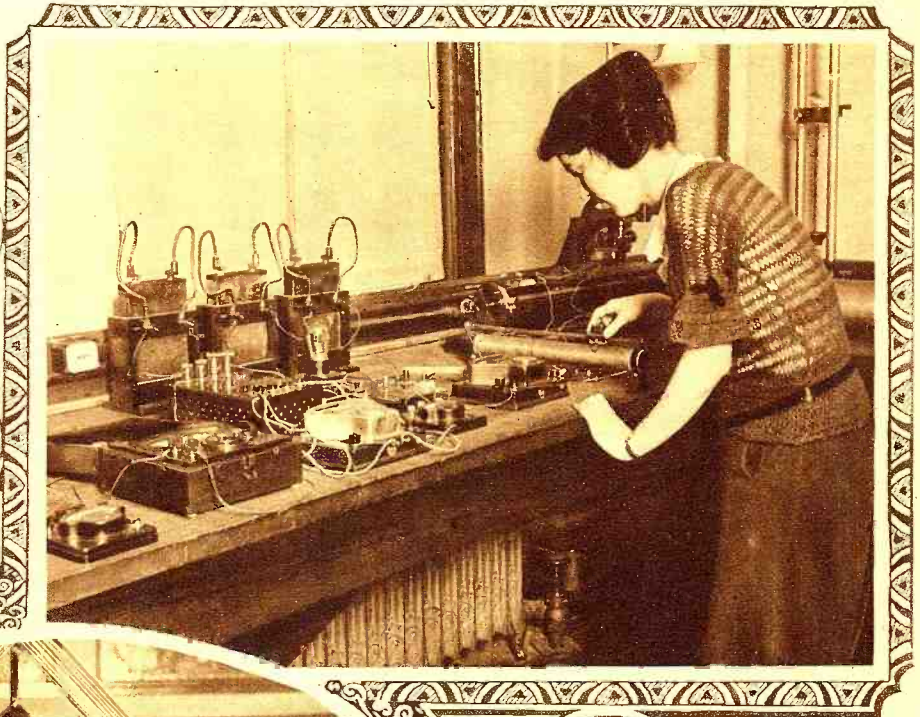
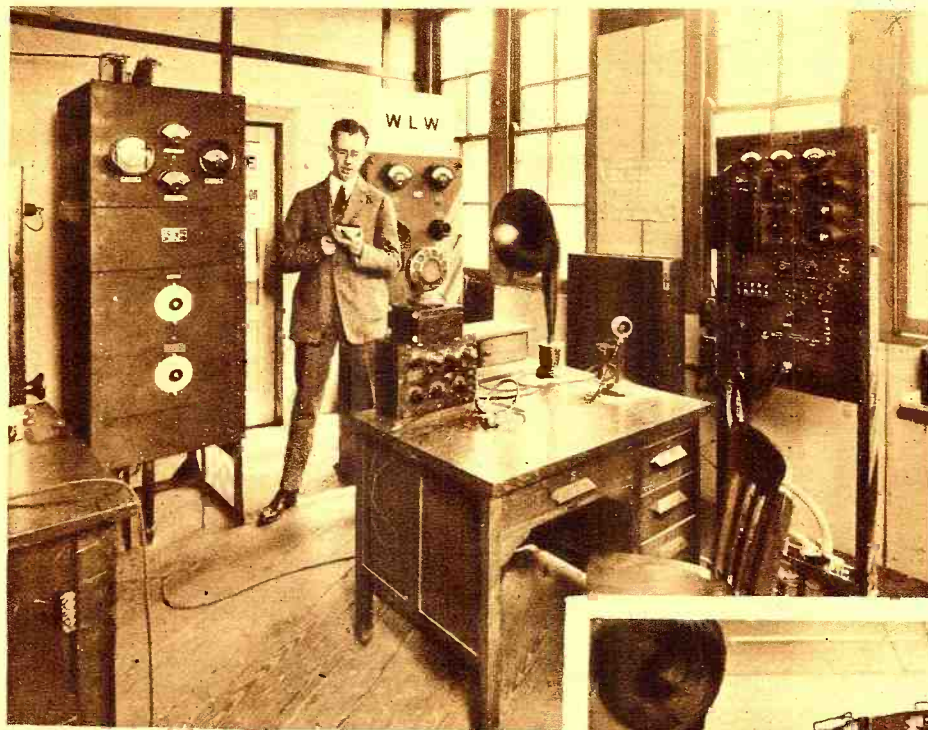

Photo Shows the Radio Apparatus In the Office of the Chief Radio Inspector At the U. S. Customs House, New York City. It Is Here That All Amateurs Must Take Examinations Before Receiving Their Licenses. At the Extreme Left of the Table Can Be Seen the Omnigraph Used For Examining the Applicants For Operators' Licenses.  
© Photoneus, N. Y.

# Pictorial Review



Left: Powel Crosley, Jr., President of the Crosley Manufacturing Co., Dedicating the New 500-Watt Western Electric Radio Broadcasting Equipment At Station WLW, Cincinnati, Ohio. The Transmitting Unit Can Be Seen To the Left of Mr. Crosley, the Speech Amplifier Being to the Right of the Desk. A Complete Receiving Set and Power Amplifier Are Used When Checking Up On the Stations Transmitting. This Is Mounted on the Top of the Desk.

Giant Transmitter of the New Broadcasting Station WJAZ at the Edgewater Beach Hotel, Chicago. This Station Will Be the Most Powerful in the Country, With a 3,000-Mile Radius. The Big Tubes Are Arranged in a Complete Circle Surrounding the Set, So That the Wires Leading to Them Are All of the Same Length. The Studio, Located on the Ground Floor of the Hotel, is Walled With Plate Glass So That the Public Can See Just How the Broadcasting Is Carried On.  
© U. & U.

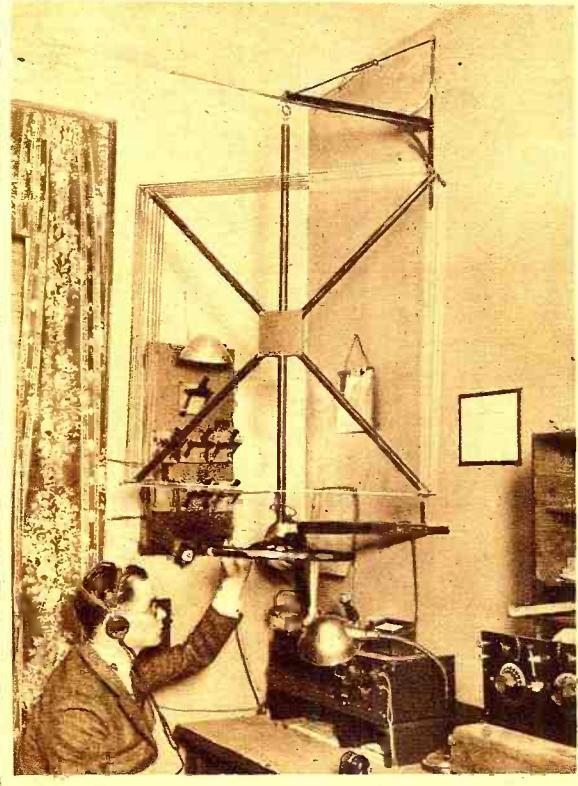
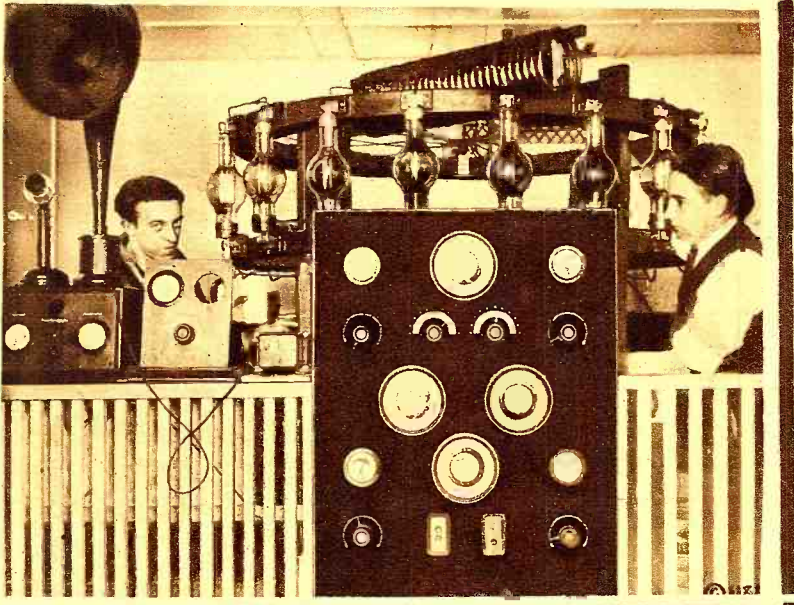

Now That Summer Is Here and Old Man Static Is Getting Busy, the Loop Aerial Is Again Coming Into Its Own. Its Good Directional Qualities, and the Fact That It Reduces Static To a Minimum, Make It Highly Desirable For Summer Use or, in Fact, For Any Time. Wendall Kilmer, a New York Amateur, Mounts His Loop Aerial on the Wall and Turns It By Means Of An Old Automobile Steering Wheel.  
© Kadel & Herbert

## BRIDE WON BY RADIO

By ROSCOE SMITH

"Say it with flowers" is a sentimental phrase that may be popular in some quarters, but it no longer holds good with certain people. At least so says Jack Nelson, program director of Station WDAP, Drake Hotel and Board of Trade Broadcasting Station. Jack hit upon a new idea for conveying romance and it was none other than—hold your breath fans—"SAY IT WITH RADIO."

And Jack said it with radio quite a few times, early in April, broadcasting his sentiments to Miss Madelon Mooney in Toledo for several weeks until the last week in the month of showers, when they were married.

Of course Miss Mooney always listened in at Toledo, but she heard with greater significance the songs that the Northwestern University student was broadcasting, songs that he had written himself. And young Nelson, when he first conceived the idea of a radio courtship, was hampered by certain rules which forbid broadcasting anything save of general interest to the public.

# of Radio Events

Studio of Station WLW of the Crosley Manufacturing Co., Cincinnati, Ohio. From Left to Right In the Picture Are Fred Smith, Director at WLW, Jean T. Have, Violinist, Lucy de Young, Contralto, Mrs. Thomas Prewitt Williams, Accompanist, and Karl Kirk-smith, First Cellist of the Cincinnati Symphony Orchestra. The Artists Are From the Artist Faculty of the Cincinnati Conservatory of Music.



This Trio of New Yorkers Started From the City Hall, New York City, After Having Been Given An Official Send-Off By Mayor Hylan, On a Trip Around the World In Their "Radio Car," a Star Automobile, Especially Equipped With a Radio Receiving Set Furnished By A. H. Grebe & Co. From Left to Right Are Peter Taylor, Radio Expert, Blanding Sloan, Well-Known Scenic Artist, and Mildred Taylor, Writer.

Just how it was done has been suggested by the announcements the program chairman put out before the songs were begun. In a code known only to themselves the two radio lovers readily interpreted such meaning phrases as "I love you," "Received your wire," and "Waiting for your letter," and a lot of other things. There could be no mistake, because Jack Nelson is one of Chicago's most versatile song writers and a playwright.

Anyhow, Jack tells the world he is happy and with his bride, now generally termed the "radio bride," is living happily right in the palatial Drake Hotel, close to Jack's work in one of the world's modern broadcasting stations.

Nelson wrote five musical comedies while he was a student at Northwestern, all of which were presented in Chicago theaters. He is the composer of the famous "WDAP Song," just had two songs placed with New York publishers, and has collaborated with Gus Kahn, composer of "My Buddy," "Carolina in the Morning," and also with Harry Akst, composer of "Dearest," and other song hits.

Photo Shows Edward Kelly, of New York City, Who Has Solved the Tenant Radio Problem By Doing Away With the Usual Outdoor Aerial. He Uses a Large Coil of Wire Wound On a Cardboard Tube, This Acting As a Wave Antenna. Mr. Kelly Has Succeeded In Bringing In a Number of DX Stations As Loud As the Local Ones. His Set is of the Single-Circuit Type Employing a Dry-Cell Tube. The Round Box on the Right of the Window Is His Substitute For An Aerial.



# Recent Developments In Radio

By H. GERNSBACK

Member American Physical Society

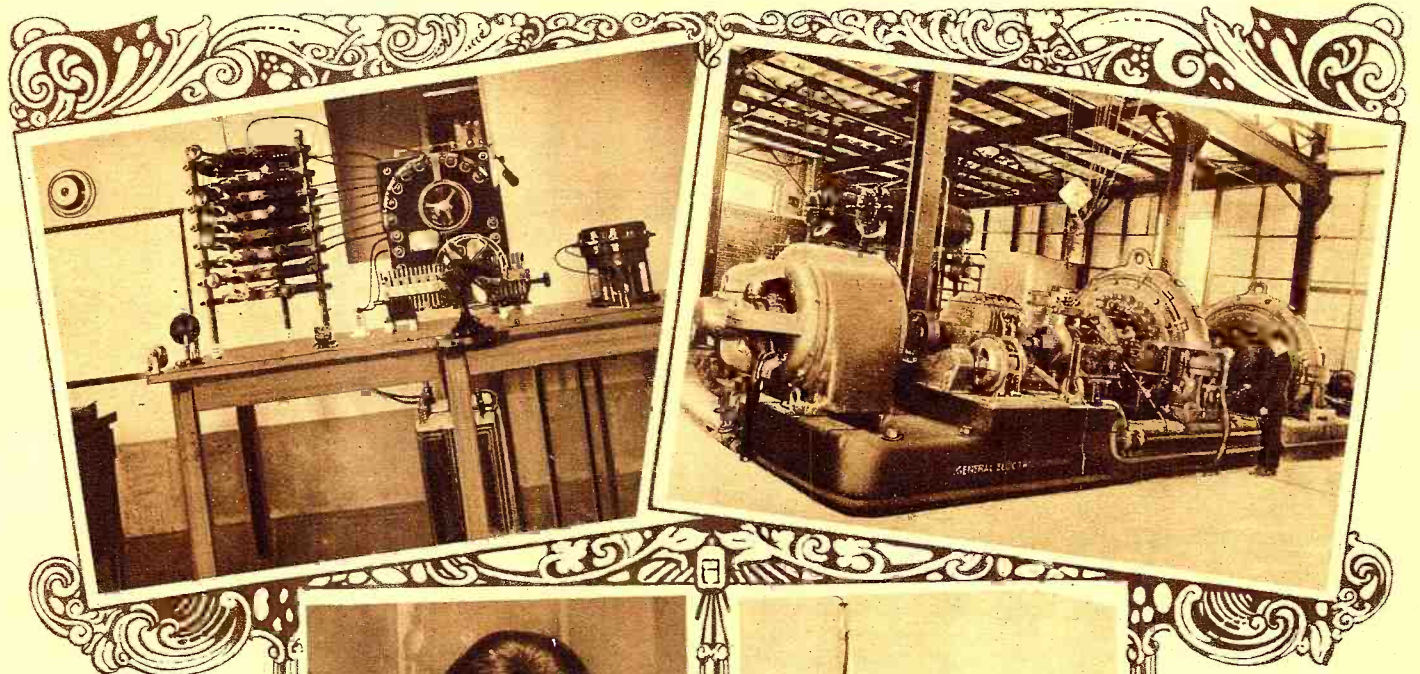

Great Strides Have Been Taken, Particularly in the Design of Vacuum Tubes. The Board Held by the Man Includes, First, the Fleming Two-Element Vacuum Tube Followed by a Three-Element Audiotron, a Radiotron and, Finally, One of the Latest Types of "Peanut Tubes." Further On We Have Three Large Transmitting Tubes of the Type Used Today. The First One Is Of One Hundred Kilowatts Capacity and Two of These Can Do the Same Amount of Work as the Giant Alternator Pictured Directly Above. Note Its Size In Comparison With the Peanut Tube In the Same Photo

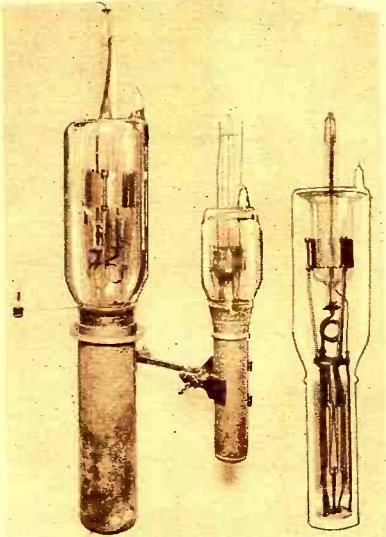

Above, and to the Left, is a Photo of a Complete K.W. Quenched Spark Transmitter of the Type Used by the Navy. These Are Slowly Giving Way to the More Efficient Vacuum Tube Transmitters. Directly Above is a Photo of the Interior of One of the High-Powered Trans-Atlantic Stations. The Picture Shows mainly the Huge High-Frequency Alternators. These, As Well, Are Being Scrapped To Be Replaced by the Vacuum Tube.

WHEN the average man or woman hears the word "Radio" nowadays, he or she immediately thinks of the radio telephone and its recent phenomenal development. Many laymen are still under the impression that the radiophone is a brand new invention, which has only just been developed in 1921. The average layman also has an idea that the radio telephone and the radio telegraph are entirely different things, and have nothing in common.

In the first place, the radio telephone is not a new development. It was first invented by Valdemar Poulsen, the Danish Edison, over fifteen years ago. Later, the American, Dr. Reginald A. Fessenden, also produced a radio telephone of his own, taking out many patents in connection with it. Even in 1915, the radio telephone had been developed to such an extent that words spoken at Arlington, Va., at Eiffel Tower station, Paris, France, and Honolulu, Hawaii, were distinctly heard. Any one who had the proper receiving instruments at that time, or even in Poulsen's time, could have listened in and heard what was going on, even at that early stage of the radio telephone.

Broadcasting in scheduled programs, as

we understand it today, however, has come into use extensively only since about 1921, and from that time on the public at large became interested. It should be noted, however, that the radio telephone and the radio telegraph are of the same family, just as the wire telephone and the wire telegraph work along similar principles. Indeed, the similarity of the radio telegraph and radio telephone is greater than that of their wire cousins. The radio telephone and the radio telegraph both make use of invisible waves set up in space; these are very similar to sound waves, which we all know. Sound waves and radio waves are fundamentally the same, except that the length of the waves varies. Radio waves are rather short, whereas sound waves are much longer. The longer the wave for a given power, the easier it is for it to cover greater distances. If you drop a small pebble into a pond, this will give rise to small waves. These do not travel very far. If, however, you look at one of the great swells in the ocean, you can realize why such a wave, being much longer, will naturally cover a greater distance. So much for the wave part.

Coming back to the radiophone, in which there is so much interest centered at the

present time, we might state that at this time of writing there are over 600 broadcasting stations sending out regular schedules, in the United States. These stations vary from those of great power to the ones of small power, and nearly every large city in the United States today has one or more broadcasting stations. Great centers, such as, for instance, New York, Chicago, or San Francisco, have a great many stations, thus for instance, Los Angeles, has no less than 19 broadcasting stations. All of these operate on either a 360- or 400-meter wave-length at present, and if you have a good long distance vacuum tube receiver (and know how to tune it well) you can enjoy yourself every night by picking from the air dozens of stations scattered all over the country, bringing to your ears lectures, opera, jazz, songs, weather reports, market reports, and what not. The daily papers are publishing the programs of nearby stations, and a good vacuum tube receiver has no trouble in bringing in all of these stations, so that you can hear them over the whole house.

There is hardly a residence today in our large cities that does not have its radio outfit—good, bad, or indifferent, and the time is at hand when a house without its

radiophone will be a curiosity, just as is the home without its piano or phonograph today.

There is no question that, as far as broadcasting is concerned, the United States leads the world today. In England, for instance, the radiophone craze has just begun, but there is still chaos over there, and stations are only now beginning to work. In England, moreover, all broadcasting stations are more or less Government-controlled, and each receiving outfit must be licensed, a thing not known in the United States, where every one may stick up a wire on his roof and receive to his heart's content without paying a nickel for the service. In France there are only a few radiophone broadcasting stations, the Eiffel Tower being the most powerful one, but Argentina and Japan are of interest, where there are stations now being erected that will broadcast, and a few that are already operating. In all other countries, the effort so far has been rather feeble, but there is no question but that during the next few years radio broadcasting stations will dot the entire world, and it will be possible for a man to tune in to

Apparatus Capable of Measuring Two-Millionths Of An Inch. Queer As It May Seem, a Fly Walking On the Long Bar Will Bend It Sufficiently To Register In the Apparatus. The Vacuum Tube Is Responsible For This.

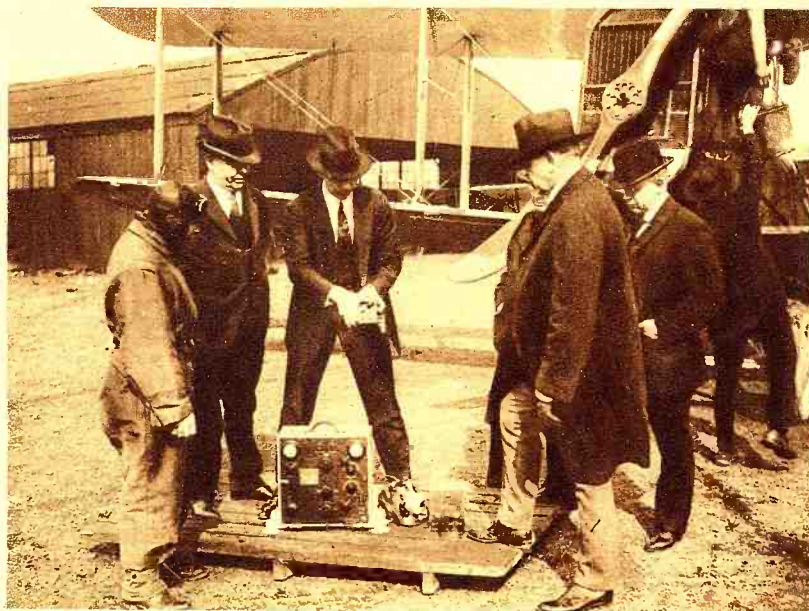

Compact Type of Vacuum Tube Transmitter Used On Aeroplanes. Power For the Tubes Is Derived From a Propeller-Driven Generator. This Is Another Case In Which the Vacuum Tube Plays An Important Part.

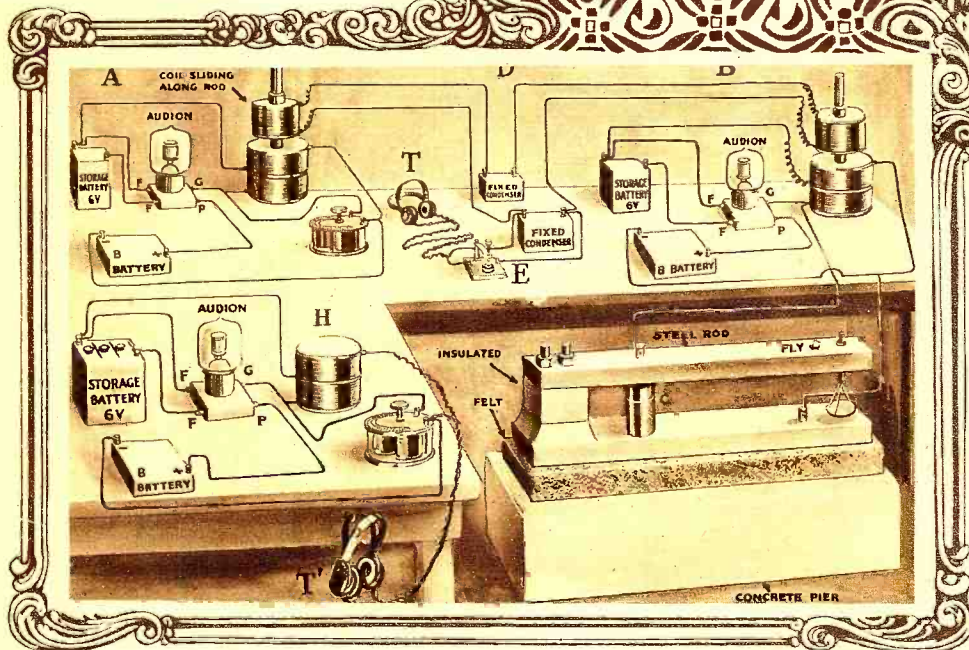

Copenhagen or to Cape Town in South Africa, if he is so inclined.

But what is behind all of this wonderful development? What developments were necessary to bring the present-day radiophone to the commanding position it now holds?

The art of radio today is a great Science by itself, and becomes greater and more powerful each and every day. Its ramifications are of such a nature as to astonish the layman who has not paid much attention to this young giant. As a matter of fact, the really big inventions in radio are hardly ever heard of by the public. But these inventions, bordering on the magical, should be known better by the "man in the street," as they will mean much to his every day life during the next decade.

We are all familiar with Marconi's original "thunder factory," where an operator pressed a key and a vivid, blue-white crashing spark was sent over a metallic gap with a thunder-like noise. This was in the days when radio was young, but even now, when you remember these blue sparks, it suddenly comes to you that it is rather seldom that you see them. Just the same, you know that the

radio traffic, be it telegraph or telephone, goes on. But where is the spark?

It was soon found, after Marconi produced this spark, which produced the waves that were shot out into space, that these methods were wasteful. Only a small percentage of the energy was radiated by the aerial wires. The rest went up in heat. After the spark had been in use for some years, a German invented a sort of noiseless spark, technically called a "quenched spark." Here the spark leaped between metallic discs, separated from each other a few hundredths of an inch. Unless you put your ear close to such a quenched spark gap, as it is technically called, you could no longer hear the noise. Not only was the noise done away with, but the efficiency of the apparatus was increased a good deal.

After the quenched spark, came the Goldsmith and Alexanderson Alternators, machines that sent out the waves without any spark at all. This was another great improvement, and a great deal of energy was saved in the process. Still, with these generators, it was necessary to use large machinery in order to operate them, as they were nothing less than dynamos, in disguise.

So radio matters stood until about 1907, when a revolution in radio occurred. This revolution was due to a little glass bottle, invented by the American, Dr. de Forest, and called the Audion, or, as it is termed today, the Vacuum Tube. This little tube wrought havoc with all pre-conceived notions in radio and, as a matter of fact, threw the entire industry into an upheaval, which, however, was most beneficial. Years before Dr. de Forest, when as a matter of fact he was still wearing short pants, Edison had discovered the so-called "Edison Effect." The Edison Effect was demonstrated with two incandescent lamps in one; in other words, an electric lamp bulb having two filaments that did not touch anywhere, instead of a single filament.

Edison observed the curious fact that when these filaments were lit up by separate batteries, a current could be made to pass from one filament to the other, although they were not physically connected, but, on the contrary, were enclosed in a glass bulb which contained no air; a vacuum, in other words. Dr. de Forest made use of this principle with some modifications, and also enclosed in the tube still a third element, a piece of wire bent to and fro, which he termed the "Grid," due to its resemblance to its kitchen-utensil namesake. It was immediately found that such a tube, properly made, became tremendously sensitive to radio waves—so much so, in fact, that where heretofore we were using thousands of horsepower to bridge a given space with radio waves, only a fraction of the same power is now required to bridge the same gap, thanks to this tube.

It was soon discovered that the sensitivity could be increased into the billions by using a quantity of such tubes connected together in a certain fashion. In technical terms, we use one tube as a "detector," and the balance of the tubes as "amplifiers." In other words, a weak signal, that is, totally inaudible, can be magnified to such an extent that the sounds come roaring out from a horn with ear-splitting intensity. But that is not all.

(Continued on page 219)

## What Happens and Music

By JESSE

What applies to the singer applies equally to an orchestra or band or any other sound-producing mechanism.

Imagine a large room beautifully furnished and draped. It may contain a few chairs, a piano and a table. Apart from these there is no other furniture. The speaker or singer is in this room, perhaps with one of the broadcasting station officials. This room is not built like any other room in a building, but has been specially designed and constructed according to the best acoustical principles to avoid the production of echoes which might otherwise be transmitted with the original sounds. On the table there is what apparently looks like a neat piece of ornamental furniture, or it may be a long cylinder. Or this cylinder may be suspended or supported in mid-air. This is the so-called "microphone" which corresponds to the mouthpiece of the ordinary desk telephone. This microphone picks up the sounds as they leave the singer's or speaker's mouth

and converts these sounds into electrical currents. The construction of the microphone is different from that of the desk telephone, although it accomplishes the same things. It is necessarily different for it has much harder work to do. It has to transform faithfully the most varied sounds from a deep bass to a high soprano, the queer sounds coming from a saxophone and those from a violin or piano, the complex sounds coming from a large orchestra or band. It must pick up each

Below is the Oscillograph Which Permits the Operator to See the Modulated Current and Adjust the Amplifier for Best Results.

(c) U. & U.



Above is Illustrated the Type of Microphone and Control Box Used for Announcing or Broadcasting from Remote Places. On the Right is the Double Microphone Used in the Studio.

© U. & U. and K. & H.

**W**HEN a speech or concert is broadcast from any given point, Newark for example, it reaches out over many, many miles all around it, and arrives at these distant points loud and clear in the receiving telephones. Did the reader ever stop to consider what an amazing feat this really is, that the voice of a singer can be thrown out hundreds of miles into space and heard distinctly? Stand on the corner of any street and try to talk to a person 10' away. You must raise your voice perceptibly. Let that person stand one block away from you and it is almost impossible for him to hear you no matter how high you raise your voice. Yet a singer in Newark is heard in Chicago as clearly and distinctly as though the singer were there in Chicago. Imagine how much energy there is involved when you utter the sound "AH" in a normal tone of voice. Hardly enough to blow a thin sheet of paper placed in front of your mouth. Place a thin piece of paper in front of your mouth and say "Ah" steadily. The paper will not budge visibly. The energy involved is so small that it is almost inconceivable that it could be sent out into space hundreds, and sometimes thousands of miles. Consider the ordinary telephone which may now be resting on your desk and which you use daily. When you speak into this the energy of your speech is amplified by batteries which are connected to the telephone. Yet the energy output of that telephone is only about 0.1 watt. How much energy is this? Just about enough to move a weight of one ounce through a distance of 1' in a second. Yet the voice of a singer which involves ever so much less energy than this is hurled out into space hundreds of miles. How is all this accomplished? Let us trace the path of the speech or the song as it leaves the speaker's or singer's mouth to find this out.

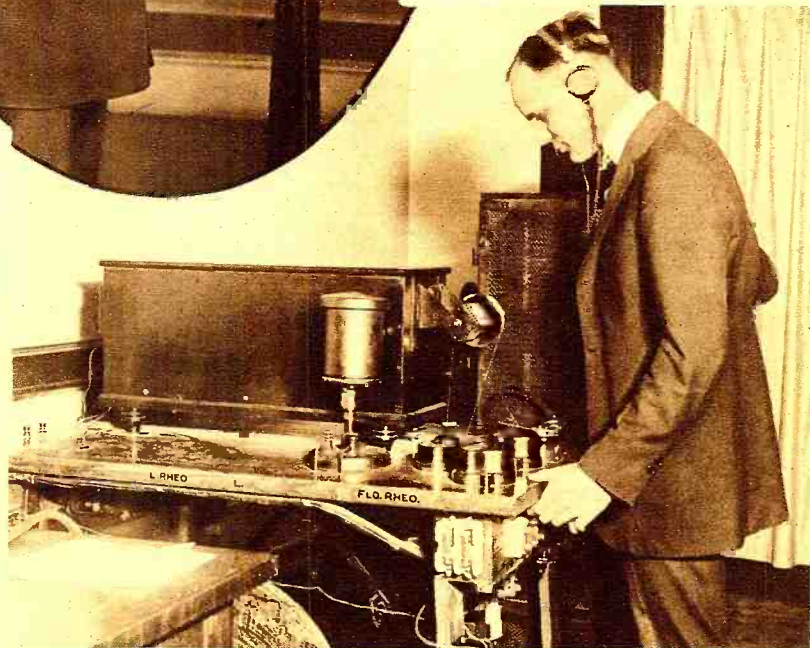



# to the Speech When Broadcast MARSTEN

of these varied sounds faithfully without omitting any or detracting from the quality of any individual sound. The desk telephone is built essentially for human speech as ordinarily used. Hence the microphone used in broadcasting is a much better and more complex device.

As stated, when the sounds leave the singer's or speaker's mouth they strike the microphone which is connected in an electrical circuit. These sounds vary from moment to moment, sometimes low, sometimes high. They produce certain changes in the microphone which changes correspond faithfully to the changes in the speaker's voice. The electrical current in the microphone circuit is correspondingly varied so that the electric current may be considered, as in fact it is, an exact electrical duplicate or photograph of the sounds which leave the singer's or speaker's mouth. However, the energy contained in the original sounds is minute or microscopic and as a result the energy in the electrical duplicate of the microphone is also extremely small. In order to utilize this small energy for broadcasting purposes, it is necessary to magnify it many times.

The electrical current in the microphone, which is the electrical counterpart of the original sounds leaving the performer's mouth, is therefore passed through a speech amplifier which consists essentially of the all-important vacuum tube amplifiers of which there may be three or four associated with specially designed elec-



A Typical Radiophone Transmitter. On the Right is the Control Panel and on the Left the Transmitter Proper.

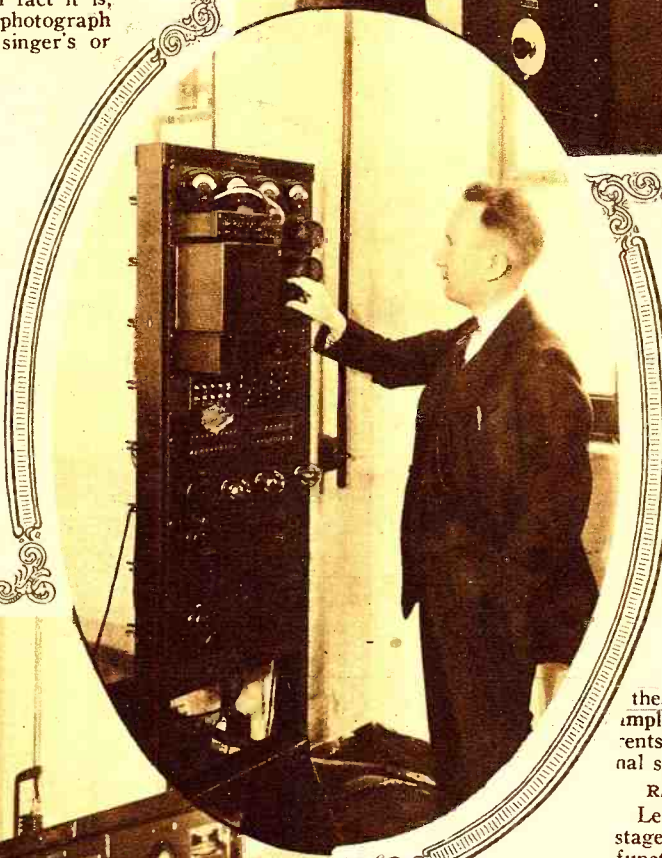

trical circuits. The microscopic currents are here magnified hundreds of times so that they possess much more energy than they did previously.

In the process of this amplification there is always great danger that the original electrical impulses, which were faithful duplicates of the sounds which left the performer's mouth may suffer distortion, in which case the sounds reaching the receiving station will not be like those originally transmitted. The speech amplifier has been specially designed not only to magnify the weak speech impulses, but also to duplicate faithfully without distortion these impulses. Coming out of this speech amplifier, then, are magnified electrical currents which correspond exactly to the original speech.

### RADIO FREQUENCY TRANSMITTER

Let us leave the speech currents at this stage for a moment whilst we consider its function. What is required here is that the speech should be transmitted through the air over large distances. Now, speech currents cannot be transmitted alone, unmodified, through the air, no matter how much they are magnified. They have not the radiating power or ability because they do not vibrate rapidly enough. Only those currents can be radiated through space which vibrate very rapidly. Hence, even if we continued to use more and more speech amplifiers to magnify the original speech currents, we could not radiate this speech through space. What we require is something which does radiate in space and travel over far distances to carry these speech currents along with it. For this purpose we have a radio frequency transmitter connected to the antenna. The radio frequency transmitter generates those currents of extremely high frequency which are able to travel through space, and the antenna is the agency which hurls them into space. This radio frequency transmitter is likewise made up of those all-important instruments, vacuum tubes, only here more powerful ones are used than in the amplifier, for these tubes have to generate a strong enough current to radiate far out into space.

(Continued on page 186)

These Two Pictures Show the Type of Amplifiers Through Which the Voice and Music Are Amplified Before Reaching the Transmitter. An Operator Listens Constantly to Check the Quality and Volume. © Photoneus



# With the Broadcasters

## ADVERTISING CLUB USES UNIQUE METHOD IN PREVENTING FRAUD

At a Wednesday meeting of the San Francisco Advertising Club, held in the Palace Hotel, Elliot M. Epsteen, general counsel of the Club, told in his report of a new method of preventing fraud.

The Advertising Club enforces the "Truth in Advertising" movement. The Better Business Bureau is the division of the organization which deals with that phase of its activities.

Recently, Mr. Epsteen was invited by the Mercantile Trust Co., to speak over the "air" from its Telegraph Hill Station, KFDB, on the work of his organization. He went thoroughly into the work of the Better Business Bureau and showed how millions of

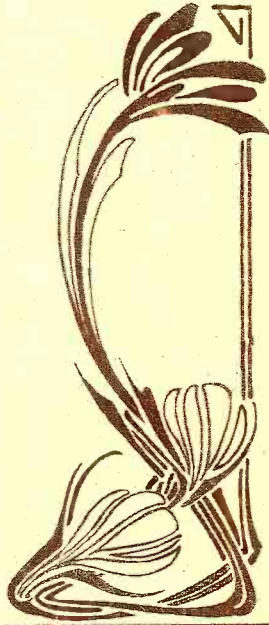

Above: Clyde A. Criswell, a Philadelphia Author, Has the Distinction of Writing the First Play Especially for the Unseen Radio Audience. One of Mr. Criswell's First Radio Dramas, "The Secret Wave," Has Already Been Broadcast by Station WDAR, Philadelphia, and One More Will Be Presented Each Week.

© Kadel & Herbert.

Left: The New British Radio Studio of the British Broadcasting Company, At Savoy Hill, London. In the Foreground is the Microphone Which is of Imposing Size; and on the Right the Chimes.

© U. & U.

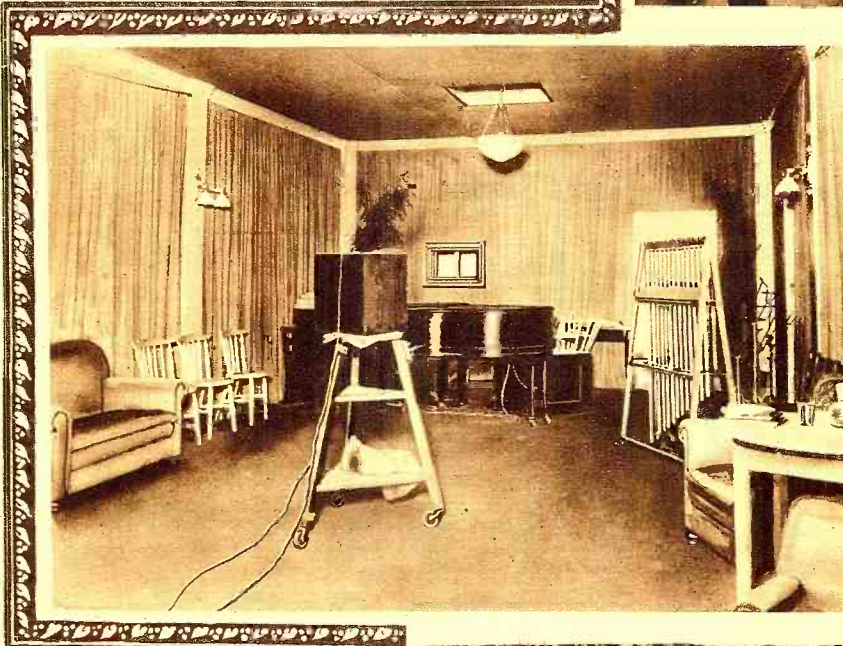

The Stage-Setting of "The Dream of a Radio Fan," a Recent Play, Staged at the Strand Theatre, New York City. The Entire Performance Was Broadcast from Radio Central, New York City.

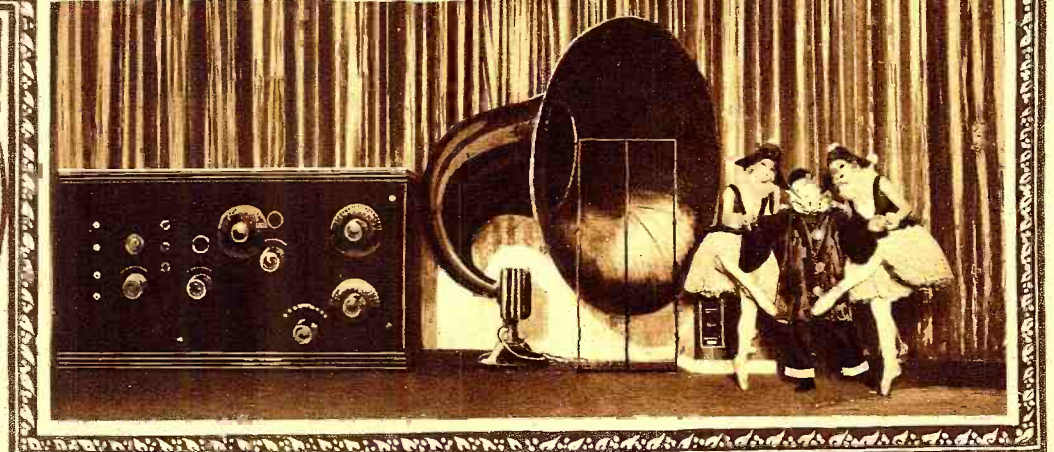

dollars had been saved the public annually through the correcting of false and misleading advertising.

He stressed the fake oil promotions and offered to give disinterested information to any person who desired it.

The next day, an inquiry came from Burlingame. The writer stated that he had a home-made crystal set, and was about to invest in a Texas oil promotion. He sent the mail matter sent to him. With it was an annual report of the company. After

telling of its glowing "intentions," it reported an annual meeting. It told that the auditor did not yet have his financial report ready. It told of how only \$650,000 was yet due on purchased land, and stressed as its

(Continued on page 196)

# The Wave Filters

By W. PALMER POWERS

ASSISTANT PROFESSOR OF ELECTRICAL ENGINEERING STEVENS INSTITUTE OF TECHNOLOGY, HOBOKEN, N. J.

ANY device which will in some measure relieve the interference situation is of interest to the radio broadcast fan. It is the purpose of this article to discuss the question of interference and point out some of the usual methods of improving the selectivity, emphasizing particularly the use of the so-called "filter" or "wave trap."

Radio signals are transmitted in the form of radiated energy. In the transmitting aerial there is a current which is varying at a regular frequency, and a wave is detached from the transmitting aerial for each complete cycle of the aerial current. It appears that these waves do not accumulate along the way, and it is then apparent that each wave is pushed along in space by the succeeding wave. (Somewhat as a wave resulting when a stone is dropped into a pool of water.) This being true, we may say that the first wave has reached a distance equal to the number of waves emitted, times the length of each wave. It has been determined that the velocity of these waves is constant and approximately equal to 300,000,000 meters per second. We are then in a position to say that the velocity equals the frequency times the wave-length; for the first wave will, at the end of one second reach a distance equal to the number of waves emitted (frequency) times the length of each wave (wave-length). This expression is of great importance, because it enables one to express the wave-length in terms of the electric circuits.

$$\text{VELOCITY} = \text{FREQUENCY} \times \text{WAVE LENGTH}$$

Wave-Length Meters	Frequency Per Second
300	1,000,000 cycles
600	500,000 cycles
1,000	300,000 cycles

When several broadcasting stations are operating simultaneously, they may cause considerable confusion at the receiving station because of the fact that they cannot be separated. They are said to be operating on different wave-lengths, and from the foregoing statements it is clear that they are emitting waves of different frequencies.

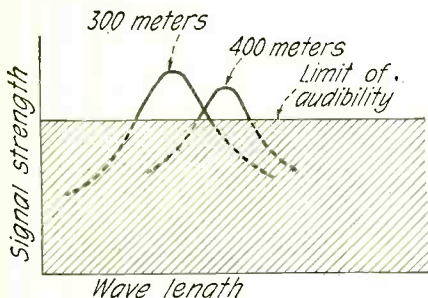

Fig. 1

Illustrating What Occurs in a Receiver When Two Stations Are Audible.

If it were possible to transmit signals on a specific wave-length, or frequency, we would have little difficulty in separating stations even if they were adjusted to nearly the same wave-length. This, however, is not possible since modulations, such as voice waves, cause a change in the carrier-wave frequency. We find that our receiver responds to several wave-lengths on a single adjustment. Stations are considered "broad" and

"sharp," depending upon the manner in which they tune. The result of this chaotic state of affairs is due to the fact that the transmitted energy is distributed over a band of wave-lengths or frequencies, and to the fact that our receivers do not possess the ability to select certain frequencies and reject all others. Fig. 1 illustrates what occurs in a receiver when two stations are audible.

## METHODS OF ELIMINATING INTERFERENCE

The simplest method of eliminating interference is to arrange the transmitters on widely different wave-lengths. This, however, has been quite impossible until very recently, owing to the fact that certain legislation has required that all broadcasting be conducted on a narrow band of wave-lengths. With the new assignment of wave-lengths, we may expect considerable relief, but it is well to remember that the period through which we have just passed has at least provided the incentive to produce selective receivers.

It is generally understood that the multi-circuit receivers are more selective than the single-circuit receivers. The selectivity increases with the number of circuits, but the complexity of control also increases, resulting frequently in a selectivity actually below that of the single-circuit type. Very good results can, however, be obtained with a properly designed single-circuit receiver and the simplicity of operation is a point of interest to many.

The wave filter, as the name implies, is a device which allows a certain wave to pass and rejects all others. It is usually constructed as a separate unit, and may be used with any receiver. It is simply a device which establishes high impedance for a particular wave (frequency). Such a filter, if placed across any circuit, say from aerial to ground, will pass (short circuit) all undesired frequencies, but will reject the desired frequency, this frequency taking the path through the receiver, which, of course, is tuned to the desired frequency. Such an arrangement is indicated in Fig. 2.

If interference from one station only is experienced, the filter may be put directly in the aerial circuit, in series, as shown in Fig. 3.

The filter is now adjusted to the undesired frequency. It rejects the undesired frequency, but allows the adjustment of the entire circuit, by adjustment of the receiver, for any desired frequency. The adjustment of the receiver under these conditions is a little peculiar, owing to the presence of the filter, and the following detailed explanation of the filter characteristics is therefore given.

### FILTER CHARACTERISTICS

The simple wave filter is composed of a parallel combination of inductance and capacity, as shown in Fig. 4.

Such a circuit, when tuned, appears as a high resistance to the resonant frequency. It does not, however, seriously impede the other frequencies. The higher frequencies (shorter waves) pass through the condenser, while the lower frequencies (longer waves) pass through the inductance. It is then apparent that the filter appears as a capacity for the frequencies higher than the resonant frequency, and it appears as an inductance for frequencies lower than the resonant frequency. If these points are kept in

mind, receiver adjustments when using Fig. 3 are easily explained.

Suppose, for instance, that we are rejecting a 400-meter signal, and we are adjusting for reception of a 300-meter signal. The filter is first set for 400 meters, the wave-length markings having previously been determined by the manufacturer. Under this adjustment, 400

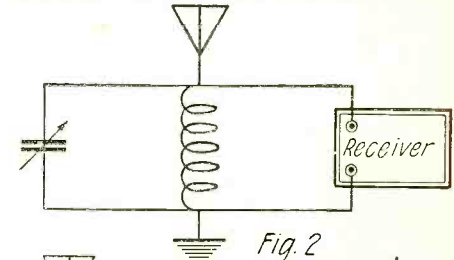

Fig. 2

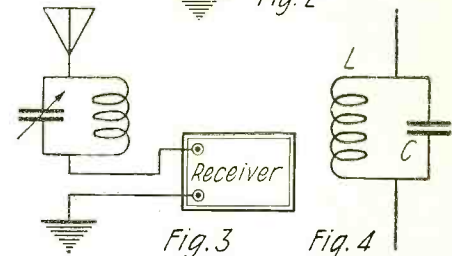

Fig. 3

Fig. 4

Figs. 2 and 3 Show Two Manners In Which a Wave Filter Can Be Connected To a Receiver. As Described In This Article, the Resultant Effects of the Two Are Not the Same. Fig. 4 Shows a Simple Non-Variable Wave Filter.

meters, the filter appears as a condenser for 300 meters. It is, therefore, necessary to increase the inductance of the receiver beyond the point originally used for 300 meters. This increase in inductance is not generally appreciated. In like manner, when rejecting a 300-meter signal and receiving a 400-meter signal, the filter is first adjusted to 300 meters. The filter under these conditions appears as an inductance in the aerial system for 400 meters. It is, therefore, necessary to reduce the inductance of the receiver to receive the 400-meter signal.

If the receiver is the type which tunes with a series condenser in the aerial circuit, it is only necessary to remember that increasing the series condenser setting is equivalent to increasing the series inductance.

A very serviceable filter covering the present broadcast range can be made by using 60 turns of No. 28 D. C. C. copper wire wound closely on a tube of insulating material 3" in diameter, connected in parallel with a good variable condenser of .0005 microfarad capacity.

## TEACHING FOREIGN LANGUAGES BY RADIO

A wireless experiment of great interest is to be made at Sheffield, England, soon. General Ferrie, Director-General of Radio Services to the French Government, has agreed to wireless to three Sheffield schools fitted with listening-in sets a fable and a poem in French.

If the experiment is successful, Mr. F. Lloyd, President of the Sheffield and District Wireless Society, who is collaborating with the Sheffield Education Committee and with General Ferrie, believes it will lead at an early date to scholars in all the principal countries getting a first-hand grasp of foreign languages by listening-in to the teaching in native schools in each country of English, French, German, Italian, or Spanish, as the case may be.

# Electrons, Electric Waves and Wireless Telephony

By DR. J. A. FLEMING, M. A., D. Sc., F. R. S.

## PART VII

IN arrangements for wireless telephony employed before the application of the thermionic valve as a generator of continuous waves, it was necessary to modulate rather large currents of 5 to 10 amperes by a microphone transmitter.

The carbon granule telephone transmitters in ordinary use, such as those above-described, will not operate satisfactorily with

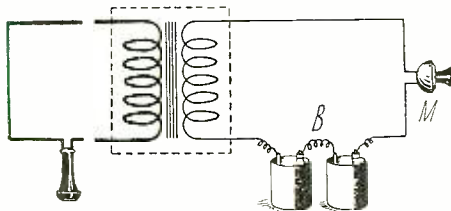

Fig. 78. A Diagram Illustrating a Simple Telephone Circuit. M is the Carbon Microphone Transmitter. B is the Battery. T the Telephone Induction Coil, and R is the Receiving Telephone.

more than about half an ampere of current passing through them. Hence many arrangements were suggested for using a number of transmitters in parallel or together, but it is extremely difficult to secure an equal division of current between the instruments so that all the microphones shall take an equal share of the duty of modulating it. These arrangements need not be described, as they are now rendered unnecessary by the powers and remarkable properties of the thermionic valve as described later on. It is, however, necessary in nearly all cases to associate with the microphone an induction coil for the following reasons.

The variation in resistance of the carbon granule microphone is, in general, only a fraction of its normal resistance, which may be from 30 to 100 ohms. Suppose, then, that such a microphone, in series with a few cells of a battery, is placed in a circuit which has a much higher electrical resistance than the microphone itself. It will be evident that any variation in resistance of the microphone produced by speech made against the diaphragm will only vary the total resistance of the circuit by a much smaller percentage than that by which the resistance of the carbon microphone itself is varied (see Fig. 78).

This difficulty is overcome by the use of

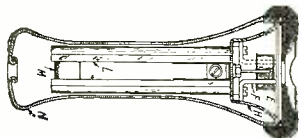

Fig. 79. British Post Office Type of Magneto-Telephone Receiver.

an induction coil as first suggested by Edison. We provide a small induction coil T, consisting of two insulated wires wound over a small bundle of iron wires (see Fig. 78). The resistance of one primary wire may be about 1 ohm, and the resistance of the other, or secondary wire, may be about 25 ohms. If, then, we join in series the primary wire and the carbon microphone M and a battery B of a few low-resistance cells, it will be evident that any variation in the resistance of the carbon microphone due to vibrations of its diaphragm will create variations in the current flowing through the

circuit of nearly equal percentage to the variations in microphone resistance. Then any changes in the current flowing through the primary wire of the induction coil will create corresponding variations in the electromotive force induced in the secondary wire.

The line wires are attached in ordinary wire telephony to the terminals of this secondary circuit, so that the current transmitted is an induced current, and this passes through the receiver telephone R at the listening end.

In the case of wireless telephony, as will be explained later on, the secondary electromotive force is used to vary the potential of the grid of a thermionic valve called a control valve.

A method which avoids the use of an induction coil is to join a number of microphone transmitters in series so that they are all equally affected by the voice, but the total resistance variation is then the sum of the variations of each microphone separately.

The construction of the Bell magneto-receiving telephone has been the subject of numerous improvements in details of construction. In place of a single steel bar magnet as originally used, two bar magnets made of tungsten steel are used, which are fixed

The articles appearing under the above title are a reproduction with some additions of the Christmas Lectures on Electric Waves and Wireless Telephony given by Dr. J. A. Fleming, F.R.S., at the Royal Institution, London, in December and January, 1921-1922. RADIO NEWS has been able to secure the serial rights of publication in this country. The articles are therefore copyright, and rights of publication and reproduction are strictly reserved.

parallel to each other at a little distance apart, and connected at one end by an iron distance piece. Or else an elongated horseshoe magnet is employed (see Fig. 79). On the free outer poles are fixed L-shaped soft iron pole pieces on which coils of insulated wire are wound. The magnets are contained in a non-magnetic metal tube, which is wider at the outer end. On this outer end is fixed a thin disc made of a steel called "Stalloy," which contains about 2.75 per cent. of silicon. This style disc is about 2 1/4" in diameter, and 1/100th" in thickness. This diaphragm is so fixed that there is an interspace of about 0.016", or about 1/60th of an inch between the flat ends of the pole pieces and the inner surface of the metal disc. The lines of magnetic force which spring from one pole of the magnet pass across this air gap through the iron diaphragm, and back across the air gap to the other magnet pole. The circular diaphragm is therefore sucked or cupped in at the centre, due to the magnetic pull of these poles. If, then, an electric current is sent through the coils of wire wound on the pole pieces it will either increase or else weaken this attraction. If we call  $H$  the magnetic force due to the magnet alone, and  $h$  the magnetic force due to the current in the coils, then the force can vary from  $H + h$  to  $H - h$ , according to the direction of the current. The attraction or pull on the diaphragm varies as the square of the

magnetic force or flux, as it should be called, and hence the attractive force varies between  $(H + h)^2$  and  $(H - h)^2$ . The difference is  $4Hh$ , and hence depends on  $H$  as well as  $h$ . It is therefore important to have magnets in the receiver as strong as possible. The material generally used for them is steel containing 5 or 6 per cent. of tungsten, and 1 or 2 per cent. of chromium. The finished magnets are made very hard by quenching from a red heat in ice-cooled water to give



Fig. 81. Double Head Telephone Receiver with Spring Head Band (S. G. Brown).

them the power of retaining magnetism. Recently a type of steel has been invented at Sheffield called *cobaltorom*, containing about 15 per cent. of cobalt and 15 per cent. of chromium. It has a much higher magnetic coercive force than tungsten steel. Moreover, it stores up about double the magnetic energy for the same volume of metal. It has the great advantage that it does not require hardening from a red heat in a liquid, and hence the finished magnets are not so liable to be warped out of shape in quenching.

It is important that the small air gap between the magnet poles and the diaphragm should remain of perfectly constant width. The coils of wire wound on the soft iron pole-pieces are made of fine silk-covered copper wire, and may be of resistance between 60 ohms and 4,000, according to the purposes for which the receiver is used.

In wireless telephony the type of receiver generally employed is called a double head telephone. It has two receivers of watch-shape, attached by flexible joints to a steel or aluminum head-band, which passes over the top of the operator's head and holds the two receivers against the ears.

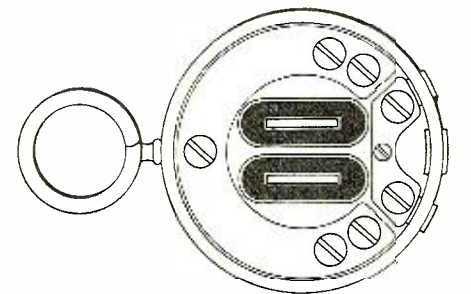

Fig. 80. Watch Form of Magneto-Telephone Receiver with the Diaphragm Removed to Show the Magnet and the Coils.

The receivers are in circular watch-shaped cases, made of ebonite or aluminium (see Fig. 80). The magnets are flat rings of steel, with L-shaped soft iron pole pieces screwed to them, on which are wound rectangular shaped coils of extremely fine silk-covered copper wire (No. 40, or even No. 60, standard wire gauge), so as to obtain a very high resistance of 2,000 to 4,000 ohms. The

two receivers on the headband have their coil circuits in parallel (see Fig. 81).

In the case of loud-speaking receivers the construction is the same as in the portable receivers, but the magnets and diaphragms are larger, and a trumpet-shaped sound projector, like the horn of a gramophone, is attached. A very good example of this type of instrument is the loud speaker of Mr. S. G. Brown, by which telephonic speech can be heard by several hundred persons at once in a large theatre (see Fig. 82).

Mr. Brown has also invented very excellent forms of double head telephones which are in extensive use for wireless telegraphy and telephony. He has devised a form of aluminium head-band and self-adjusting swivel receiver holders, which are comfortable to wear on the head, and by which the receivers are kept gently pressed against the ears (see Fig. 81). The electrical construction of the receivers, as used for wireless telegraphy, is somewhat different to the standard magneto pattern. In place of an iron diaphragm there is an iron reed, or strip of iron, the natural vibration frequency of which can be adjusted by a screw within limits. To this is screwed an aluminum diaphragm, which is coned and spun into a special fitment, which is covered by an ebonite cap with holes in the center (see Fig. 83). The resonance frequency of this receiver can therefore be adjusted to suit the musical note of the wireless signals in telegraphy.

In the case of receivers for wireless telephony this adjustment is not required, but the resonance frequency is adjusted to agree with the mean or standard telephone frequency, generally about 800 or 900 cycles per second. The coils of receivers for wireless telephony in use with valve or crystal receiving sets are now always wound with a direct current resistance of about 4,000 ohms.

**EFFICIENCY AND PROPERTIES OF THE TELEPHONE RECEIVER**

The remarkable fact about a Bell magneto telephone is that the mere vibrations of a small flexible circular iron disc should be capable of impressing on the air waves having the very irregular wave form necessary to create speech sounds. When we consider the complicated nature of our own human organs of speech and the manner in which the larynx, throat muscles, variable mouth cavity, lips, tongue and teeth, are all brought into operation to create articulate sounds, it is wonderful that the mere to and fro motion of a small thin iron disc can do nearly the same thing in creating speech. Another striking thing is the very small electric currents which are capable of creating audible sounds in a telephone receiver, and the extremely small amplitude or extent of motion of the telephone diaphragm in creating such sounds. P. E. Shaw measured, in 1905, the amplitude of diaphragm motion for a just audible sound in a magneto receiver, and found it to be about one-fourteenth part of a millionth of a centimeter, or about one-thirty-fifth part of a millionth of an inch.

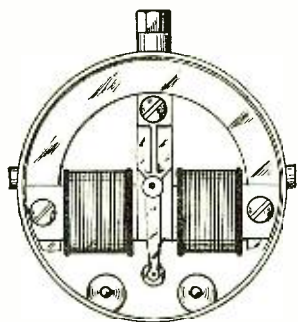

Fig. 83. Interior Construction of the Resonance Telephone Receiver of S. G. Brown. Showing the Vibrating Steel Reed.

The diaphragm of a telephone has, however, a certain natural frequency to which it best responds. It resembles a violin string or harmonium reed in that there is no particular natural frequency at which it will vibrate and yield its fundamental note if it is struck and left to itself. This frequency is called its *resonance frequency*, and in telephones with iron diaphragms about 2 in. in diameter and 1/50th in. thick, the resonance frequency is about 800 or 900. Hence, if we pass through the telephone coils an alternating electric current having this resonance frequency, the amplitude of motion of the diaphragm will be increased from 10 to 30 times when compared with that which it would have for the same current at a different frequency.

In connection with telephone work we require to give numerical values to the loudness of various sounds heard in the telephone. This is stated in terms of their *audibility*. If we pass an alternating current through a telephone of any frequency between, say, 100 and 2,000, we hear, on listening to the receiver, a more or less musical sound. If we apply across the terminals of the telephone a resistance called a shunt, which has no inductance, and gradually decrease this resistance, we shall at last reach a point at which the telephone sound is only

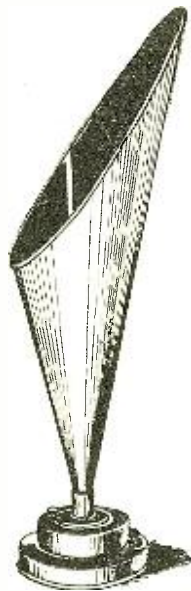

Fig. 82. Loud Speaking Telephone of S. G. Brown

just audible, because part of the current is shunted away from its coils. If the resistance of the telephone coils is  $R$  ohms, and the resistance of the shunt is then  $S$  ohms, then the *audibility* of the sound when the shunt is removed is expressed by the number  $(R+S)/S$ . Strictly speaking, we should say impedances and not resistances. Thus, suppose the telephone had an impedance of 100 ohms, and that we had to shunt the telephone with 2 ohms to just make the sound heard in the telephone inaudible to a normal ear, then the so-called audibility of that sound when the shunt is removed would be  $102/2=51$ .

Shaw found that if the audibility of a just perceptible sound is taken as unity, then the audibility of a loud sound would be about 1,400, and that of an overpowering sound 7,000 or more. Broadly speaking, we may say that the intensity of the sounds emitted may vary from 1, which denotes a just audible sound, to 1,000, which denotes a fairly loud sound.

The displacement or amplitude of motion of the diaphragm may vary from about half a micron ( $=5 \times 10^{-5}$  cm.), which is about the wave-length of a ray of yellow light, to 8 or 10 microns, which is about 1/100th of

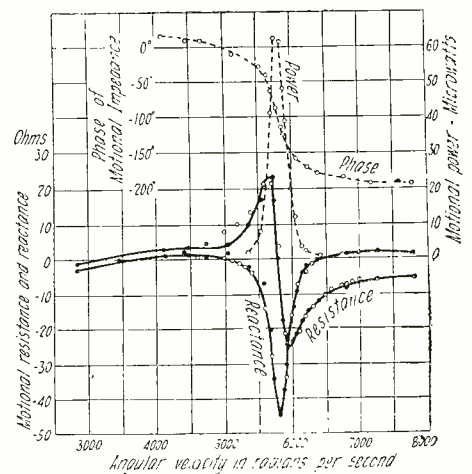

Fig. 84. Curves Obtained by Dr. A. E. Kennelly for the Motional Resistance, Reactance and Power Absorption of a Magneto-Telephone Receiver. Note: The Angular Velocity Signifies 6.28 Times the Frequency of the Alternating Current.

a millimeter. Even in the case of loud telephonic sounds it is very small.

As regards the currents required to produce sounds of various audibilities, Werner Siemens long ago found that with a particular Bell telephone, the interruption of a current of 1/50,000th of a milliampere, when passed through the coils, caused the diaphragm to emit a just audible sound or tick. With more modern receivers the starting or stopping of a current of not more than 1/6th of the above could be detected. If, however, alternating currents are used, the current producing a just audible sound would depend upon whether the frequency of that current agreed with the telephone resonance frequency or not.

Another very remarkable quality of the magneto telephone is its astonishing inefficiency as an energy transforming device. We employ a magneto telephone to transform the energy of the varying electric currents sent through it into energy of aerial sound waves. But the fraction of the energy it so transforms is at most about 1/1,000th or 1/10th of 1 per cent., and, except at resonance frequency, may be only a few parts in 100,000.

The greater part of the electric power given to the coils of a telephone receiver is expended in producing heat in the wire coils and in the diaphragm, in mechanical work in bending the diaphragm and moving it to and fro, and in magnetic energy losses in it, and at most one or two parts in 1,000 of all the power applied is utilized in the production of the speech sound waves.

There is therefore a vast field for possible improvements, and it is curious that, with the exception of the hot wire telephone or Thermophone receiver of De Lange and O. Fischer, invented in Holland, there has been no great departure from the principles of Bell's invention made 47 years ago, although very considerable improvement has taken place in details and in manufacture.

Much research has also been conducted on the properties of the magneto telephone receiver. Many interesting monographs have been published by Prof. A. E. Kennelly and his associates in the Massachusetts Institute of Technology, U. S. A. Kennelly has made measurements, at various frequencies and with different receivers of standard types, of the true resistance, the reactance, and the impedance of the telephone coils.

In general the resistance of a telephone is reckoned as the resistance to direct currents. Thus we speak of a 60-ohm telephone, meaning one of which the coils measure 60 ohms with direct current. The speech currents are, however, alternating currents with a frequency varying from 100 to 2,000, and a mean value of about 800 or 900, corre-

sponding to the resonance frequency of the telephone. The resistance  $R$  with high frequency currents is much greater, perhaps double or more, compared with the direct current resistance. Again, if we measure the inductance  $L$  of the coils at any frequency  $n$ , then the product  $2\pi nL = \omega L$  is called the *reactance* of the coils, and the quantity  $\sqrt{R^2 + \omega^2 L^2}$  is called the *impedance*.

If the resistance, reactance, and impedance of a telephone receiver are measured at the

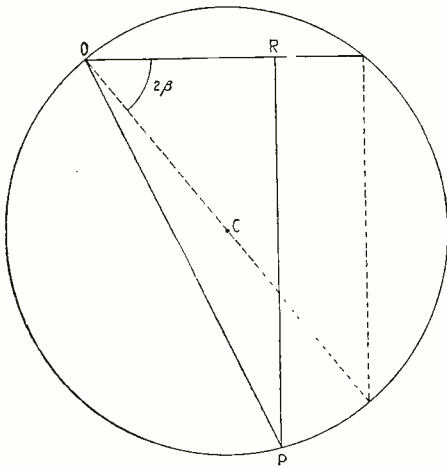

Fig. 85. Circle of Motional Impedance Constructed by Plotting the Motional Resistance Horizontally OR and the Motional Resistance Downwards Vertically RP, the Diameter of the Circle Measuring the Impedance of the Telephone.

same frequency—first when the telephone is emitting sound, and secondly with the diaphragm clamped so that no sound is emitted—and if we subtract the second measurements from the first, the difference gives us the so-called *motional* resistance, reactance, and impedance of the telephone. If these are measured at different frequencies and the values plotted as the ordinates of a curve corresponding to the various frequencies as abscissae, we obtain a set of interesting curves (see Fig. 84). The motional resistance at frequencies far from the resonance frequency is small, then it rises to a maximum, and then suddenly falls to zero at resonance, and passes to a negative maximum. The motional reactance is always negative and a maximum at resonance. The motional power is a maximum at resonance; that means when the frequency of the alternating current used in the measurement agrees with the natural frequency of the telephone diaphragm.

On the other hand, if we plot the motional resistance horizontally and the motional resistance downwards vertically (see Fig. 85), we obtain a circle called the *motional impedance circle*, the diameter of which measures the impedance of the telephone at resonance frequency. The angle which any chord of this circle makes with the horizontal line is called the *depression* angle, and this angle is double of the angle by which the magnetic flux in the telephone magnet lags behind the magnetizing force.

**PRODUCTION OF CONTINUOUS ELECTRIC WAVES**

It is now possible to gather up the threads of all previous explanations and utilize them in making an exposition of the principles and mode of operation of the wireless telephone, which is certainly one of the most wonderful of all the achievements of technical science.

To conduct wireless telephony as contrasted with telephony with line wires, we have to replace the line wire by some agency which will enable us to transmit energy and yet permit us to employ the usual type of microphone transmitter and magneto-receiver used in ordinary telephony with wires at the sending and receiving stations. It has been

found that we can do this by substituting for the connecting wire a stream of undamped or continuous high frequency electro magnetic waves. We must, then, first explain how these waves are created.

There is only one method practically employed at present in small plants, or those of moderate size, and that is by means of the thermionic valve. We have already explained that an incandescent tungsten filament in vacuo emits a torrent of electrons, and that these in the three-electrode valve make their way through the apertures of the surrounding grid and fall upon an anode or collecting plate. To make them do this the anode must be kept at a high positive potential so as to attract to it the negative electrons. This is done by means of a battery, dynamo, or other source of direct electromotive force. The anode must be connected to the filament by an external circuit which includes the above-mentioned source of electromotive force, but also a coil of wire called the plate circuit coil. This plate circuit coil has also its terminals connected to a condenser of a certain capacity, so that the coil and condenser, taken together, provide a circuit in which electric oscillations can take place with a certain natural frequency determined by the capacity of the condenser and the inductance of the coil in accordance with rules already given.

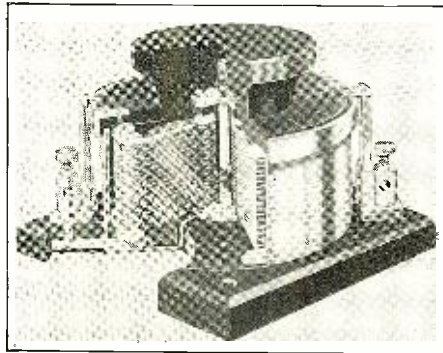

By Courtesy of Marconi Wireless Telegraph Co., Ltd. Fig. 87. An Air Condenser of Variable Capacity Formed With a Set of Fixed Semi-Circular Metal Plates and Similar Movable Plates, Which Latter Can be Brought More or Less Into Proximity to the Former by Rotating the Ebonite Head of the Axis Carrying the Movable Plates. Part of the Condenser in This Illustration is Shown Cut Away So as to Enable the Structure to be Seen and Understood.

If, then, the grid is connected to the filament through another circuit which also includes a coil of wire, and if this last coil, called the grid circuit coil, is placed near to the plate circuit coil and in a certain position, any change in the current in the plate circuit coil will create an induced electromotive force in the grid circuit coil, and this in turn will alter the grid potential and charge the grid either negatively, that is, put more electrons into it, or positively, that is, take free electrons from it. When the grid is made negative it will reduce the electron stream flowing from the filament to the plate, and reduce the current in the external plate circuit or coil. By a proper mode of connection it is possible to make the changes of grid electrification of such sign and nature as to sustain the fluctuations of the plate current, which, in turn, by the mutual inductive action of the plate and grid coils, create the appropriate variations of grid potential.

The grid and plate coils are then said to be coupled for production of oscillations. The plate current then consists of a steady direct current, on which is superimposed an alternating current, or the plate current fluctuates in strength. The power required to produce these oscillations comes from the battery in the plate circuit, but the power is transformed from direct current (D.C.) power to alternating current (A.C.) power.

The action of the thermionic valve in this respect has been compared with a steam engine. The steady pressure of the steam is applied to push forward the piston, but to make the piston oscillate or move backwards and forwards alternately, the steam must be admitted to the cylinder by means of the slide valve, first on one side of the piston, and then on the other. To make the engine self-acting we have to connect the slide valve by some mechanism with the piston so that motions of the piston move the slide valve in the proper manner to maintain the oscillations of the piston. The steam may be compared with the electrons emitted by the filament; the grid is analogous to the slide valve, and the external plate current to the motions of the piston.

The above analogy is, however, very imperfect, and a much better one is as follows: If we connect together in series a Bell magneto telephone, a carbon granule microphone transmitter, and a couple of cells of a battery, a current will flow through the carbon and through the coils of the telephone. If we hold the diaphragms of the transmitter and receiver near together the receiver will emit a shrill musical note, and continue to emit it as long as the two instruments are close together.

The reason is as follows: Small noises in the room set the diaphragm of the transmitter in vibration. This causes compression of the carbon granules, and in turn varies the current, and this makes the receiver emit a sound. This sound actuates the transmitter, and this again reacts on the receiver. Hence continuous sound waves are emitted by the system, and the power to produce them is drawn from the battery.

Just as this coupled receiver and transmitter generate low frequency oscillations of electric current in their circuit, so the coupled thermionic valve circuits react on each other and create high or low frequency electric oscillations in the plate circuit according to the capacity and inductance in the circuit. To radiate electromagnetic waves we have to utilize these oscillations to produce similar oscillations in an *aerial wire*, or radiative circuit. The simplest method, then, of producing undamped or continuous waves (C.W.) by a thermionic valve is by an arrangement as follows:

Let  $V$  (see Fig. 86) be the valve of which  $P$  is the plate or anode cylinder,  $G$  the grid, and  $F$  the filament. Let  $B_1$  be the battery which provides current for incandescing the filament, and  $r$  the regulating resistance. Let the grid be connected with the filament through a coil of wire  $L_2$ , called the grid coil, and let the plate  $P$  be connected with the filament through another coil  $L_1$  and a key  $K$  and high voltage battery  $B_2$  giving a voltage of 200 to 400 volts or more. The negative terminal of  $B_2$  must be in connection with the filament. This battery  $B_2$  must be shunted by a condenser  $C_2$ . The coil  $L_1$  is also shunted by a condenser  $C_1$ . If the degree of coupling or closeness of the coils  $L_1, L_2$  is

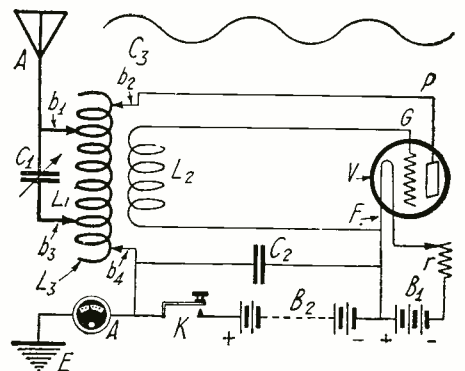

Fig. 86. Arrangement of Circuits for Producing Continuous Electric Waves (C.W.) by a Thermionic Valve.

adjusted, and the direction of their mutual inductance correct, then, as already explained, continuous oscillations will be set up in the circuit of  $L_1$  which are superimposed upon the steady or direct current produced by the battery  $B_2$ . The frequency ( $n$ ) of these oscillations will be determined by the capacity of the condenser  $C_1$  and the inductance of the coil  $L_1$  in such fashion that—

$$n = \frac{5033}{\sqrt{C_1 L_1}}$$

The capacity  $C_1$  must be measured in microfarads or fractions of a microfarad, and  $L_1$  must be measured in millihenries, or fractions of a millihenry, and the square root of the numerical product of  $C_1$  and  $L_1$  divided into the number 5033.

The condenser  $C_1$  is connected to the coil  $L_1$  by sliding contacts  $b_1, b_2$  so that the inductance  $L_1$  can be varied. Also the condenser  $C_1$  is an adjustable capacity indicated symbolically by the arrow crossing two parallel black lines.

In actual practice the coil  $L_1$  is made by winding enamelled copper wire in close turns on an ebonite or fibre tube about 4 or 6 ins. in diameter. The enamel is then scraped or rubbed off a narrow strip parallel to the length of the cylinder, and enables rubbing contacts of brass to be slid along a bar and so make contacts at places  $b_1, b_2, b_3, b_4$ , as desired with the copper wire. The condenser  $C_1$  is made of a number of semi-circular plates of aluminium spaced a little way apart, which are attached to an axis. These plates are so fixed that they can be turned to sandwich in, more or less, between a number of fixed semi-circular plates. The fixed and movable plates are the two plates of the condenser, and by rotating the movable plates so as to bring them more or less in between the fixed plates, the capacity of the condenser is varied (see Fig. 87).

**RADIATION OF CONTINUOUS WAVES**

We have next to make provision for using these oscillations to create continuous electric waves. We have seen that when high frequency oscillations are set up in a straight rod or wire with metal plates at the end, called a Hertzian oscillator, the result is to radiate electromagnetic waves which we have

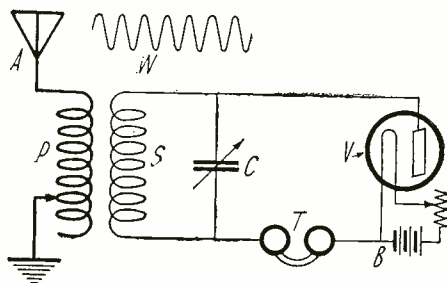

Fig. 88. Simple Form of Receiving Circuit for Wireless Telephony. A is the Aerial, P the Aerial Tuning Coil, C is the Tuning Condenser and V a Fleming Rectifying Valve, T is the Telephone. W Represents the Arriving Carrier Waves.

explained to be vibrations propagated along the electro-lines proceeding from the free electrons in the wire, the rapid to and fro movements of which are the electric oscillations in that wire.

This radiation is effected by connecting to the contact  $b_1$  an aerial wire  $A$ , which consists of two or more copper wires which rise vertically into the air a certain height, and then run horizontally a certain distance, and are insulated at the far or free end (see Fig. 86). At the same time we connect another point  $b_2$  on the inductance coil  $L_1$  through a current-reading instrument  $A$ , called a hot wire ammeter, to a plate  $E$  sunk in the earth, or it may be the water pipes of a building.

The aerial  $A$  has a certain electrical capacity with respect to the earth, and may

be regarded, therefore, as another condenser joined across a section of the coil  $L_1$  between the points  $b_1$  and  $b_2$ . By suitably choosing the points of contact  $b_3$  and  $b_4$ , we can tune together the oscillatory circuits composed respectively of the condenser of capacity  $C_1$  and the section  $L_1$  of the inductance coil, and also the capacity  $C_2$  of the aerial and the section  $L_1 + L_2$  of the inductance coil by making the adjustments so that the product  $C_1 L_1$  is equal to the product  $C_2 (L_1 + L_2)$ .

If, then, we close the key  $K$ , the battery  $B_2$  will send a stream of electrons from the filament of the valve to the plate, and they will find their way back through the coil  $L_1$ . If the grid then becomes slightly negative the electron stream from the battery will be reduced, and by the inductive action of the coils  $L_1$  and  $L_2$  this reduction of plate current can be made to give the grid a slight positive charge, and this then increases the electron stream. Accordingly fluctuations are set up in the plate current. The object of the condenser  $C_2$  shunted across the high voltage battery is to provide a path for the high frequency oscillations thus created in the plate circuit. The varying potential of the terminals of the condenser  $C_1$  then sets up sympathetic oscillations in the aerial wire, and this results in electromagnetic waves being radiated from it in an uninterrupted stream. The ammeter  $A$  placed just above the earth plate  $E$  then indicates a steady high frequency current, which is called the aerial current.

In the actual apparatus the two coils  $L_1$  and  $L_2$  are wound on ebonite tubes or in flat spirals, and so arranged that they can be brought near to or separated from each other to vary the mutual inductance. This coupling must exceed a certain value if the oscillations are to be created by the thermionic valve and electric waves radiated from the aerial. We can determine the frequency of the oscillations when we know the wave-length required or used from the simple relation—

$$\text{frequency} \times \text{wave-length} = \text{velocity of wave.}$$

The velocity of electromagnetic waves through air is nearly 300,000 kilometers per second. Hence, to produce a wave of 300 meters wave-length requires oscillations at the rate of one million per second in the aerial. The standard wave-lengths for amateur wireless telephony and for "broadcasting" lie between 350 and 425 meters. Hence a 400 meter wave requires 750,000 oscillations per second in the aerial. Let us then suppose that we have set up at some place, an aerial and continuous wave (C.W.) generating valve plant, as above described. We can suppose it set in operation and to radiate continuous waves say of 400 meters wave-length. These waves are called the carrier waves.

Next, suppose we have at some other place a receiving station at which there is an aerial properly tuned to the wave-length of the wave sent out by the generating station, and that this receiving aerial is coupled to another closed oscillatory circuit comprising an inductance coil and a condenser with the capacity adjusted to tune it to the aerial circuit (see Fig. 88).

The waves from the transmitting station would strike the aerial of the receiving station and would set up in it feeble electric oscillations of the same frequency. These would generate other similar oscillations in the associated closed condenser circuit. The terminals of this last condenser would then alternate in potential alternately being positive and negative.

Suppose, next, that we connect these condenser terminals to the plate of a two-electrode rectifying valve in series with a telephone, as in Fig. 88.

The valve when its filament is incandescent would permit negative electricity or electrons to pass from the filament to the plate inside the bulb, but not in the opposite direc-

tion. Hence, the telephone coils would be traversed by a steady unidirectional or direct current.

This kind of current produces no effect on the telephone except to create a slight "tick" or sound at the moment the steady current begins or ends. Suppose then that we insert in the external grid circuit of the valve in the transmitting apparatus the secondary circuit of a small telephone induction coil  $I$  (see Fig. 89), and in the primary circuit of the coil a carbon microphone  $M$

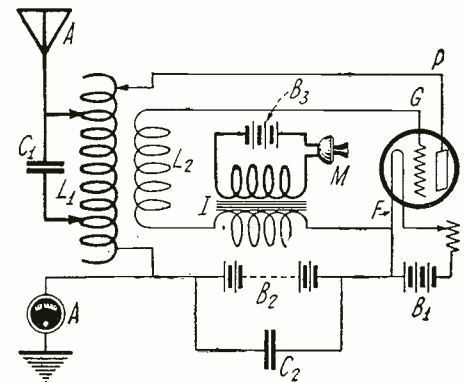

Fig. 89. Circuits of a Simple Form of Wireless Telephone Transmitter, Showing the Speaking Microphone  $M$  Coupled Inductively Through an Induction Coil  $I$  to the Grid Circuit  $L_2$  of the Thermionic Valve.

and battery  $B_3$ . If we speak to this microphone mouthpiece the result will be to create in the grid circuit a fluctuating electromotive force, which will have the wave form of the speech sound, and will have a low frequency or audio-frequency as it is called, because it falls within the limits of the frequencies used in audible speech.

The effect of this will be to increase or diminish the amplitude of the carrier waves radiated. In other words, the speech made to the carbon microphone  $M$  will modulate the amplitude or height of the carrier waves exactly in accordance with the frequency and wave form of the aerial vibrations made by the voice of the speaker.

Let us then consider what the effect of this will be on the receiving apparatus just described. Any increase or decrease in the amplitude of the carrier waves will increase or decrease in the same proportion the direct or rectified current which flows through the magneto telephone in series with the rectifying valve. Hence, if speech is made to the microphone transmitter inserted in the grid circuit of the transmitting valve, the current in the sending aerial, and the amplitude of the carrier waves and therefore the current through the Bell telephone in the receiving current, will vary or change in nearly the same manner as the changes of air pressure made by the voice of the speaker near the microphone.

**PRACTICAL FORMS OF WIRELESS TELEPHONE APPARATUS**

In actual practice the apparatus is a little more complicated. The high voltage required for the plate of the transmitting valve is not always obtained from a battery but from a direct current dynamo, which gives a voltage of several hundred, or even a couple of thousand volts.

Then the modulation of the plate current is not accomplished by placing the microphone-induction coil in the grid circuit of the oscillating valve, but in that of another valve called the control valve.

Lastly, the high voltage of the plate of the generating valve need not be obtained from a direct current dynamo, but by rectifying a low frequency alternating current.

These modifications will best be understood by the description of certain typical forms of wireless telephone transmitter in actual use.

(To be continued in the next issue)

# Detection

AN EXPLANATION OF HOW RADIO SIGNALS ARE MADE AUDIBLE

By LOUIS FRANK

THE radio waves which carry the transmitted speech or dot and dash telegraph signals travel through space all around the transmitting antenna at the speed of light, namely 186,000 miles per second. In the course of their journey these waves encounter nu-

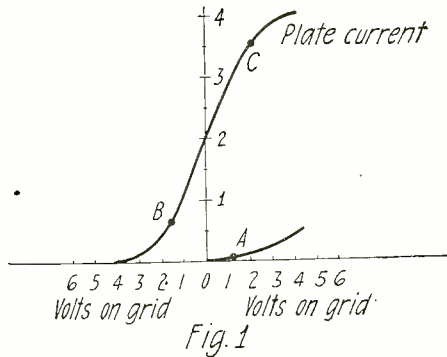

Grid and Plate Current Characteristics of a Vacuum Tube.

merous receiving antennae which gather in some of the energy of these waves and pass them on to the receiving set. When these radio waves are thus passed on to the receiver a number of different operations may be made. The waves may be detected, or they may first be amplified at radio frequency and then detected, and they may be amplified at audio frequency after being detected, and a combination of these three operations may be made. Each of these operations constitutes an essential part of the modern radio receiver and will, therefore, be taken up in this series. The first subject of importance to the beginner in radio is the matter of detection, since most novices will have detection sets before they have amplifying sets.

When the radio wave from the broadcasting or other transmitting station passes down the receiving antenna and into the receiver, while it carries the speech or telegraph message, it is not in the proper condition to operate the headphones and thus convey the transmitted message. The reason for this is that the radio waves have a frequency which is too great to be heard in the telephones. Thus let us consider for a moment the wave which is sent out from some broadcasting station which transmits at 360 meters. The frequency of such a wave is approximately 800,000 cycles per second. Now, the very highest, vibration frequency which the human ear can hear is about 30,000 cycles per second; that is, if any object vibrates 30,000 times per second the human ear will just barely hear it. If it vibrates at a higher rate than 30,000 times per second, the human ear cannot hear or detect the sound. Imagine that the radio wave above mentioned has passed through the receiver and from there directly to the telephones. The current which would flow through the telephones would vibrate at the stupendously rapid rate of 800,000 times per second. If the diaphragm of the telephones could follow the current it would vibrate 800,000 times per second, but even if it did vibrate at this rate, the human ear would not be able to detect the signal, because of the natural limitations of the ear; it simply cannot hear such high frequencies. However, we have been somewhat optimistic in our supposition, for the diaphragm of a telephone receiver cannot possibly follow such rapid variations as 800,000 times per second, for its inertia is altogether too

great to permit it to vibrate so rapidly. In the next place even if the diaphragm did follow these rapid vibrations no sound would be heard. For the radio currents flowing through the phones have a negative and a positive direction through the phones, thus their net effect on the diaphragm would be zero.

In order that the signal carried by the radio waves be made audible, it is necessary to transform these radio waves. For this purpose a detector is employed. Thus a detector is the device which so transforms the radio waves that they become audible in a pair of telephones. It will be evident that the name detector is really a misnomer. The detector does not detect or discover the radio wave. It is the antenna which brings in the radio waves. The detector, in effect, performs an operation on the incoming radio wave which permits us to hear the signals carried by it.

During the development of the art of radio a variety of detectors have appeared, among which may be mentioned the historically important ones of the coherer, the electrolytic detector, and the magnetic detector. These all served their purpose in the early stages of the game, but with developments and improvements they have had to give way to more efficient and sensitive detectors. Among the most efficient, most sensitive and most

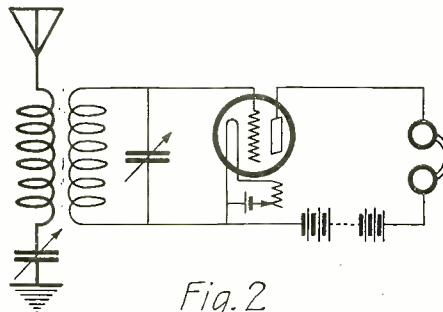

A Radio Receiving Circuit

practicable are the two chief detectors of today, the crystal detector and the vacuum tube detector.

Although the crystal detector is also one of the older detectors of the art it serves a most useful function in present-day broadcast radiophone reception. It is one of the very simplest detectors, very sensitive, extremely easy to operate, and relatively inexpensive. It is also particularly suited to short distance or local broadcast receiving, and for local work is very frequently as good as the vacuum tube. In this article the theory and method of detection of the crystal receiver will not be given, as this subject has been excellently treated in RADIO NEWS before. The reader is recommended to study the article on "The Theory and Operation of Crystal Detectors" by Mr. Bonaventure in the April, 1923 issue, for details of this detector.

We will, however, take up the subject of the vacuum tube detector. This is the most recent type, and up to the present time is the last word in detectors. It is used where the most efficient and sensitive results are required and practically all long distance work is being done with this type of detector. It is, therefore, of interest to inquire how this device operates and what gives it its remarkable sensitivity.

### CONDITIONS FOR DETECTION

Before going into the subject it is well to understand exactly what conditions a

detector must fulfill in order that it make radio waves audible. In other words, what are the conditions of detection? As explained above, there are two main reasons why the radio current through the telephone receiver will not make the diaphragm move: First, the

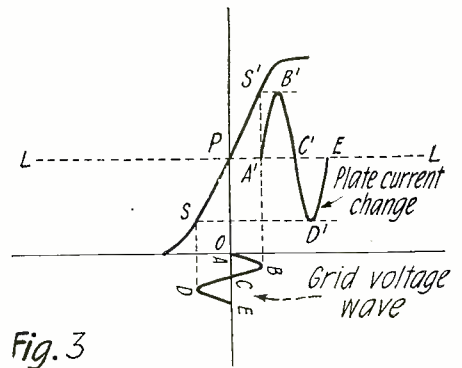

Fig. 3

Along Straight Part of Curve Equal Changes in Plate Current Are Produced by Equal Changes in Grid Voltage, Hence Positive and Negative Changes Neutralize.

positive and negative halves of the radio cycle neutralize each other and hence will not influence the diaphragm; second the frequency of the radio current is above audibility. In order that we hear the signal in the radio wave the detector must then do at least these two things to the radio wave:

1. It must cut off either the positive or negative half of the radio wave so that they do not neutralize each other in their effects on the telephone diaphragm, that is, THE DETECTOR MUST RECTIFY THE RADIO WAVE. This is the first condition for detection.

2. It must transform the radio frequency impulses of the radio wave into audio frequency impulses so that the ear can hear them. This is the second condition for detection.

We are now ready to consider the action of the vacuum tube detector and we will see in our discussion just how the above two conditions for detection are met.

There are two principal methods of detection employing the vacuum tube and these are: (1) plate circuit rectification and (2) grid circuit rectification. Both of these methods are based upon the shape which the characteristic curve of a vacuum tube has, namely on the curvature of the characteristic curve. Fig. 1 shows a typical characteristic curve of a three-element tube, which is obtained by applying different voltages to the grid and measuring the plate current corresponding to these voltages. It will be observed that at the beginning and end of the characteristic curve there is a

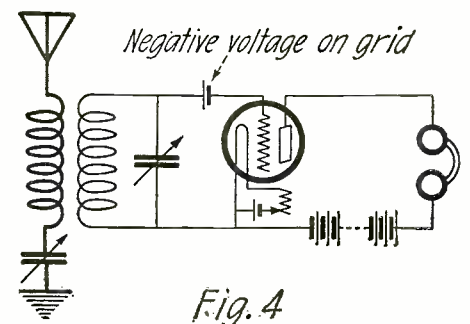

Fig. 4

A Radio Receiving Circuit in Which a Negative Voltage on the Grid is Employed for Purpose of Rectification.



marked curvature, while between points B and C the curve is a straight line, and the middle of this curve is approximately at zero grid potential. Suppose now that a radio frequency voltage is applied to the grid, let us say this voltage is due to a radio signal coming from the receiver in Fig. 2. This radio voltage is designated by the voltage wave ABCD (Fig. 3) which is one cycle of the wave. Now let us see what happens when this radio voltage is thus applied to the grid. When no signal voltage is applied to the grid, namely when it is at zero potential, the plate current is given by OP, and is constant as shown by the straight line LL. When the radio voltage ABCD is now applied, a change takes place. As the grid voltage rises from zero, i.e., point A, to its maximum positive value point B, the plate current also rises as seen from the characteristic curve, since a positive grid voltage produces a rise in plate current. The plate current thus rises from  $A^1$  to  $B^1$ . As the grid voltage drops again to zero, i.e., point C, the plate current does likewise and drops to its normal constant value, namely  $C^1$ . The grid radio voltage now changes its direction and is negative and rises to its negative maximum value, namely to point D. From the characteristic curve we see that a negative grid voltage produces a drop in plate voltage. Hence the plate current now drops below its normal value to point  $D^1$ . When the grid radio voltage rises again to its zero value the plate current also rises to its normal constant value. Now it will be seen that since the changes in the plate cur-

will rise and fall proportionately, according to the characteristic curve; namely, it will rise to  $B^1$  and fall to  $C^1$ . Now when the grid radio voltage swings to the negative cycle it goes to the same maximum, only negative and then comes back to zero. The plate current does likewise again following the characteristic curve, namely it falls to  $D^1$  and then comes back to its normal value  $E^1$ . However, observe this important point: On account of the curvature of the characteristic curve at P, equal grid voltages on positive and negative sides do not produce equal plate current changes. Thus the positive grid voltage AB produces a greater change in plate current than the same negative voltage does. Hence, the negative changes do not neutralize the positive changes in plate current, as they did above, but since the positive

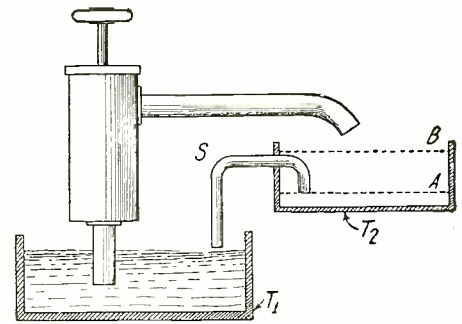

A Water Analogy of the Same Action as Mentioned Below. Each Action of the Pump (Incoming Wave) Goes Further Towards Filling Tank T-2 (Grid Condenser). When a Level B Above A is Reached the Water Will Flow Out Through Pipe S (Grid Leak) and Continue to Flow Until the Level A is Again Reached.

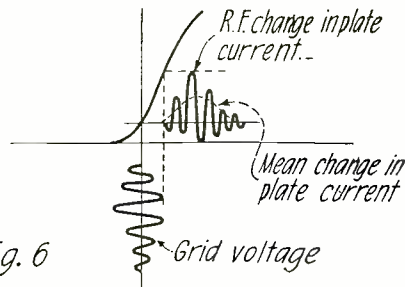

Fig. 6

Radio Frequency Changes in Plate Current Result in a Mean or Average Change of Plate Current Shown by Heavy Line. This Average Change Takes Place at an Audible Frequency.

change is greater than the negative change, there will be a change in the average plate current. In other words we have fulfilled the first condition for detection, namely we have rectified partially the plate current, since a greater change in plate current is produced in one direction than in the other.

Now let us see how the second condition is fulfilled, namely securing an audible effect from radio frequency changes. In order to understand this best, consider a radio wave applied to the grid which wave has varying amplitudes as in Fig. 6. The grid is again made negative by one volt, hence the axis is at minus one volt, Fig. 6. This is frequently called "biasing the grid potential." When the grid voltage varies according to the wave form shown, the plate current likewise varies, as explained above, only the increases are greater than the decreases. As we saw at the beginning of this article, the diaphragm of the telephone cannot follow the rapid radio changes in the plate current. However, since the increases in plate current at radio frequency are greater than the decreases, the average plate current will rise according to the shape shown in Fig. 6. This average change takes place at an audio frequency rate and hence will be recorded by the telephones, and a signal will be heard. It is thus seen that the second condition is met by a sort of integrated effect of all the radio frequency changes combining to produce one

audio frequency change. For every wave this occurs and thus signals are heard. No matter what the shape of the incoming wave is, the above effects will be produced as explained.

It will be observed that the rectifying action is really due to the fact that the characteristic curve is not symmetrical at the lower part, namely equal voltage variations on the grid do not produce equal plate current variations, but it will also be observed that the curve is likewise not symmetrical at the top. Hence, rectification should also be possible at that part of the curve, say by applying a positive potential of one volt to the grid. This is the case. However, detection never takes place at this part of the characteristic curve, for applying a positive potential to the grid causes a grid current to flow to the grid, which always results in high losses of power and hence very poor efficiency in detection. It is always best to use a negative potential on the grid for this purpose. This method is sometimes called "plate circuit rectification" because the current is rectified in the plate circuit.

The second method of detection is the so-called "grid circuit rectification" method so named because we now deal with the current flowing from grid to filament, which current is rectified. In the characteristic curve of Fig. 1 it will be observed that there is a small curve on the positive side of the current axis. This curve is the grid current characteristic, that is, it shows how the current in the grid circuit varies with the grid voltage. It will be observed that for negative grid voltages there is no grid current, while for positive grid voltages there is a small grid current. Just as the plate rectification method depends upon the curvature of the plate current characteristic, the grid circuit rectification method depends upon the curvature of the grid current characteristic. However, the difference between the two methods is the following:

1. While for plate circuit rectification we always use a negative voltage on the

(Continued on page 201)

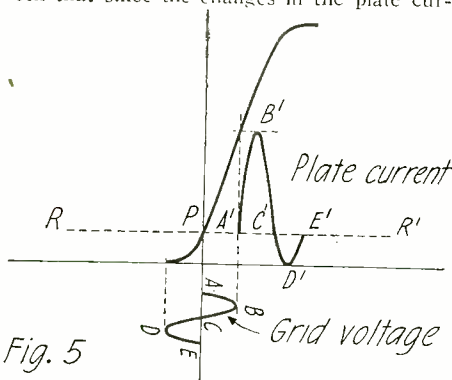
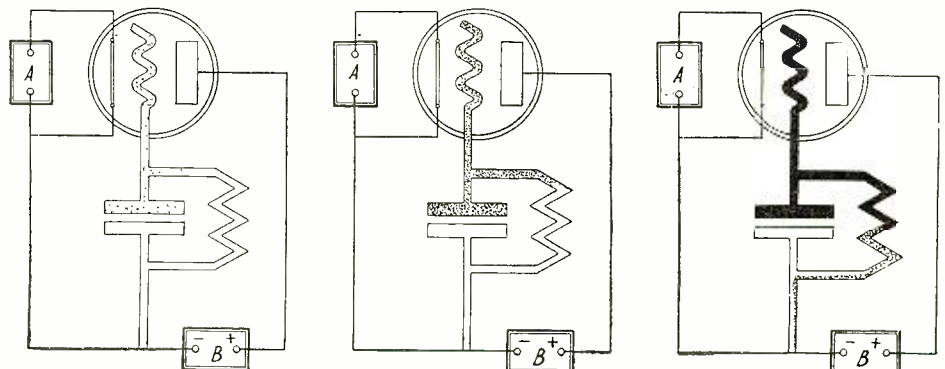

Fig. 5

At P, Where Curvature is Greatest, a Positive Grid Voltage Produces Greater Change in Plate Current Than an Equal Negative Voltage. Hence, Negative and Positive Halves Do Not Neutralize Each Other and Telephones Will Respond.

rent take place along the straight line part of the characteristic, namely between points  $SS^1$ , equal changes in grid voltage will produce equal changes in plate current. In other words, the average value of the plate current does not change, hence a telephone will not record any signal since it operates only when the average value of the plate current changes. We have here a case where the rises in plate current are the same as the drops in plate current, each thus neutralizing the other's effects on the telephone.

Suppose, however, that the circuit in Fig. 2 is changed to that of Fig. 4 by inserting a small battery in series with the grid, connecting the negative pole of the battery to the grid. Suppose that the value of this negative potential which is applied to the grid is one volt, and that again we have a radio signal voltage applied to the grid. The state of affairs is now much different and is represented by Fig. 5. Since the grid is permanently given a negative potential of 1 volt the zero axis is shifted over to the left by the amount of one volt, and the normal plate current is now lower than before and is given by  $RR^1$ . It will be seen that the characteristic curve intersects the plate current axis at the point where its curvature is a maximum. Suppose now that the grid radio voltage rises from A to its maximum positive B and then falls again to zero or C. The plate current



Representing What Takes Place in the Grid Circuit. Each Incoming Wave Goes Further to Charge the Grid Condenser. This Charge Increases Until it Reaches a Value That Will Allow It to Leak Off Through the Grid Leak.

# Radio Frequency Receiver Design

By KENNETH HARKNESS\*

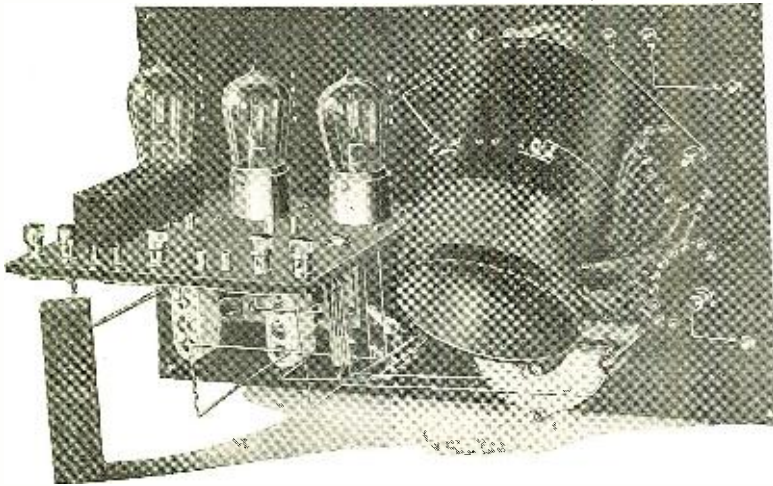

A Rear View of the Two-Stage Radio Frequency Amplifier and Receiver Described in This Article. The Radio Frequency Transformers Are Mounted On the Same Base As the Tubes and Directly Behind Them. A Variocoupler, Together With a Variable Condenser, Is Used For Tuning Purposes.

THE manifold advantages of radio frequency amplification are becoming more and more evident to radio experimenters. For some strange reason this most useful application to radio of the amplifying characteristics of the audion has met with considerable skepticism among amateurs in the United States, and there are still a great number who consider it impracticable. Some time ago the well-known editor of a weekly newspaper radio department invariably informed his inquirers that radio frequency amplification was quite useless below 1,000 meters and it is only quite recently that he has been made to realize he was in error. We were also greatly surprised to see, not long ago, a statement made by the editor of a radio magazine that radio frequency amplification on 200 meters was practically impossible.

Both these editors, who should have known better, and the skeptics among radio amateurs themselves, were evidently under the impression that no progress has been made in radio frequency amplification since the development of the "resistance-coupled" and the "tuned-impedance" amplifiers. Without going into the details of these two methods of radio frequency amplification, we are quite prepared to admit that the first is useless for 200-meter reception and of little use below 1,000 meters, while the second, although fairly efficient on short waves, is too complicated to tune, and limits the number of stages of amplification.

Both these methods of reception have been superseded by transformer-coupled amplification. The design of an efficient radio frequency transformer is no simple matter. It is not our object in this article, however, to discuss the merits and demerits of various existing types of transformers. We merely wish to affirm the fact that a few of those on the market are actually efficient and positively provide the solution of the difficulty experienced in amplifying the high frequencies of short waves.

## SHORT WAVE R. F. AMPLIFICATION DIFFICULT

The great obstacle to the amplification of short waves has been the presence of capacity in the circuits which practically acts as a short-circuit to extremely high frequencies. In the transformer-coupled system of amplification there is capacity between the elements of the vacuum tube, capacity in the wiring between the tubes and transformers, capacity in the transformer windings and between the primary and secondary

windings of the transformer. If any of these values exceed a certain degree it is impossible to amplify short waves efficiently.

The capacity between the elements of the vacuum tube is, of course, fixed by the manufacturer of the tube. There are, however, different types of tubes and invariably the tube with the least internal capacity is the most efficient for radio frequency amplification.

The capacities of the transformer windings and between the primary and secondary windings of the transformer are also fixed by the manufacturer of the transformer.

Therefore, to obtain good results in the amplification at radio frequency of short waves, the amateur will realize the importance of a vacuum tube with low internal capacity and a transformer with low capacity in its windings and between its two windings. It is possible to obtain such vacuum tubes and transformers. The late A.P. amplifier tube was of this type and very efficient for radio frequency work. The new de Forest tube is also very suitable. The latter tube is somewhat similar to the French amplifying tube which is unusually good for amplifying high frequencies.

## WIRING IS IMPORTANT

Thus, if the experimenter makes a proper choice of vacuum tubes and radio frequency transformers, it only remains for him to wire his receiver properly to avoid capacity effects in the wiring connecting together the transformers and vacuum tubes.

It is the purpose of this article to indicate a design of radio frequency receiver which accomplishes this object. The receiver shown in the accompanying photographs is designed to amplify efficiently wave-lengths as low as 200 meters and the apparatus is arranged in such a manner that wiring between the transformers and tube sockets may be kept exceedingly short to avoid loss of efficiency by capacity. Of these leads, the most important are those connecting the secondaries of the radio frequency transformers to the grids of the suc-

ceeding tubes. Next in importance are the plate leads, which should be as short as possible and widely spaced from the grid leads; the length of the other leads is not so important.

If reference is made to the back view photographs shown herewith, the general design of this receiver will be evident. The radio frequency transformers are plugged into sockets on the top of the shelf panel and these sockets are so arranged that the length of the wires connecting the transformer secondaries to the grids of the tubes are not more than one inch in each case. The plate leads are slightly longer but widely spaced from the grid leads.

## NEW FEATURES IMPROVE FLEXIBILITY

There are other features in the design of this receiver which greatly increase its usefulness as well as its efficiency. A telephone jack is attached to the shelf panel so that a small loop aerial may be inserted through the cover of the cabinet, as shown below. In this way the loop may be conveniently revolved in any direction. The wiring diagram of the receiver, shows the manner of wiring to this jack. When the loop is plugged in, it takes the place of the secondary circuit of the tuner, which is opened. The secondary tuning condenser is used to vary the wave-length of the loop circuit. This condenser is provided with a vernier plate which greatly assists in fine tuning. The remainder of the circuit consists of two stages of radio frequency amplification and detector.

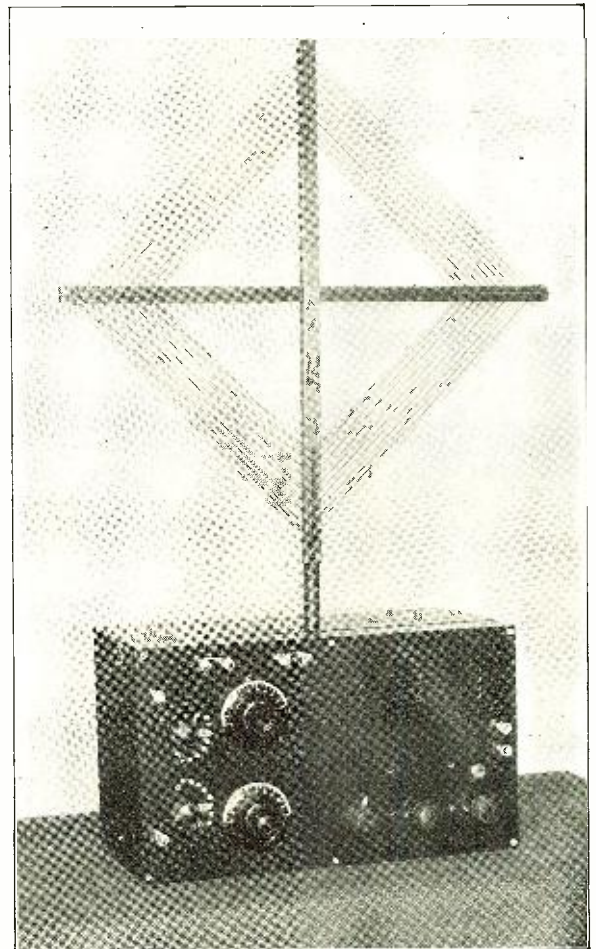

This Shows the Completed Radio Frequency Receiver. The Two Knobs and Dials Are Used for Tuning Purposes. The Small Knob in the Center Controls the Potentiometer, While the Other Two Are the Rheostat Controls.

\*Chief Engineer, The Radio Guild.

The voltage on the grids of the two amplifying tubes is controlled by a potentiometer across the filament battery and by means of this voltage-divider a slight positive bias may be placed on the grids of the amplifying tubes to prevent oscillations in the circuits.

The output circuit is provided with a double-circuit jack so that the telephones may be plugged in the detector plate circuit and the output connected to an audio-frequency amplifier, if loud signals are desired.

The battery terminals are attached to the rear of the shelf panel so that the connections from the batteries may be brought through the back of the cabinet.

When the loop is removed from its jack, the secondary inductance, which consists of the rotor of a special vario-coupler, automatically takes its place in the circuit and extreme long distance reception can then be effected with an outside aerial and ground connected to the primary circuit of the vario-coupler.

However, with the ordinary type of vario-coupler, this would result in a great loss of selectivity. In fact, tests have proven that the ordinary type of vario-coupler in which the secondary revolves inside the primary is practically useless when succeeded by radio frequency amplification. This arrangement is only slightly more selective than the direct-coupled circuit.

**SPECIAL COUPLER USED**

The receiver illustrated employs a special type of coupler which is intended for use only with radio frequency amplification. This coupler was designed by the writer as the result of experiments which proved that the degree of coupling in the ordinary type of vario-coupler could not be made loose enough for the tuner of a radio frequency amplifying receiver. Although the mutual inductance was exceedingly small at the minimum degree of coupling, the physical location of the secondary coil with respect to the primary provided a capacity coupling which, although it would not be disadvantageous in ordinary circuits, nevertheless afforded a sufficient coupling to result in a considerable loss in selectivity when followed by radio frequency amplification. It should be realized that if the sensitivity of a receiver is increased, interference will also be increased unless the receiver is made more selective.

The special type of coupler employed in this receiver is shown in the photograph. The primary coil is wound on the lower end of a long cylindrical form, while the secondary is wound on a smaller coil which revolves inside the primary form at the opposite end. The rotor shaft is set at an angle to permit a 180-degree variation of coupling. This feature permits a very fine adjustment of the coupling.

When the coupling is at a maximum, that is to say when the rotor is in such a position that there is maximum inductive relation between the primary and secondary coils, the secondary coil is separated from the primary by a spacing of 1½" or, from center to center, of 4". Thus there is at no

Another Rear View of the Same Receiver. The Two Rheostats Can Be Seen on the Left of the Panel Followed by the Potentiometer and the Variable Condenser.

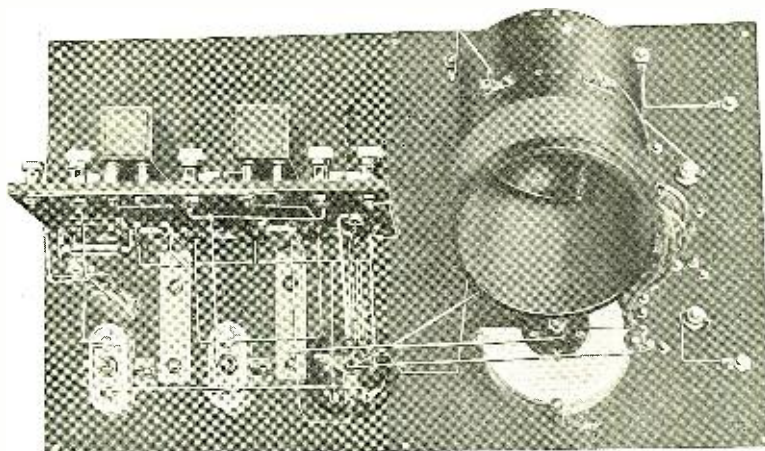

time any appreciable capacity coupling between the primary and secondary circuits, although when the coils are in the position just described there is a certain value of mutual inductance between them. This degree of inductive coupling is not large, but the coupling is sufficiently close when succeeded by radio frequency amplification. It can be still further decreased by revolving the secondary rotor until the two coils are at right angles to each other when the coupling is at a very low minimum.

Experiments have shown that the minimum and maximum degrees of coupling obtainable in this unit provide the proper variation of coupling for selectivity in a radio frequency receiver. Although the coupling is very loose and would result in a loss of signal strength in an ordinary circuit, it is intended only for use with radio frequency amplifying circuits which enormously magnify the incoming oscillations transferred by the coupler from the primary to the secondary coil. It is, therefore, possible to use this extremely loose coupling without any loss, but instead a considerable gain in efficiency, as this loose coupling makes possible a high degree of selectivity.

**ANTENNA CIRCUIT RESISTANCE IS DETRIMENTAL**

In explanation of the reason for this selectivity it will be understood that the antenna circuit, because of its size and decrement, cannot be accurately tuned to any particular frequency without being subject to forced oscillations of different frequencies. Static and atmospheric strays, as well as radio waves of varying frequencies all produce forced oscillations in the antenna irrespective of the wave-length to which it is tuned, although oscillations of the latter frequency will persist longer and reach a greater amplitude than the others, since the circuit is approximately resonant at this frequency.

If the secondary circuit is closely coupled to the antenna, as in the standard type of coupler, these undesirable oscillations caused by interfering signals, static and atmospheric strays, will be transferred to

the secondary circuit and will interfere with reception. In a crystal receiver or straight audion hook-up, a fairly close coupling is required in order to efficiently transfer the energy from the primary to the secondary circuit. Consequently interference is more marked in these circuits.

The regenerative circuit permits a loose coupling between the antenna and secondary circuits because the energy in the secondary circuit is amplified by regeneration. As the energy in the secondary circuit is increased by regeneration, the reaction between the two circuits is also increased so that some of the energy in the secondary circuit is retransferred to the antenna circuit. To maintain resonance, the coupling must be decreased. This decrease of coupling, of course, results in an increase in selectivity as the looser coupling prevents to a greater extent the transfer to the secondary circuit of forced oscillations of undesired frequencies in the antenna circuit.

Now, whereas the amplification of energy by regeneration may reach a certain fixed value, the amplification by radio frequency amplification is greatly in excess of this value when several stages are used. While it is true, then, that regenerative amplification permits a looser coupling than a straight audion hook-up or crystal receiver, it will be evident that radio frequency amplification permits a still looser coupling than the regenerative receiver, and a corresponding increase in selectivity is obtained.

By reason of its proper design, the receiver illustrated in the photographs is a witness to the many advantages which radio frequency amplification affords.

**LONG RANGE OBTAINED**

With this receiver, without loop, antenna, ground or any outside connection whatsoever, we have personally received signals from transmitting stations within a radius of two hundred miles. The "antenna" consisted of the rotor of the vario-coupler, 3" in diameter. With the small loop aerial inserted through the cover of the cabinet and plugged in the jack on the shelf panel, distances of over one thousand miles have been covered with great regularity. The advantages of loop reception are well known—selectivity, directional reception and freedom from static interference. With an outside aerial there is no loss in selectivity because of the special type of coupler, but there is a considerable increase in receiving range.

Although every possible control is included in the receiver, the tuning is not complicated. When receiving with the loop there are only two controls, the secondary tuning condenser and the potentiometer—simplicity itself. When using an outside antenna, the antenna circuit is tuned by two switch sets tapping the primary coil, one controlling multiple turns and the other single turns. The coupling between the circuits is controlled by the rotor of the vario-coupler,

(Continued on page 184)

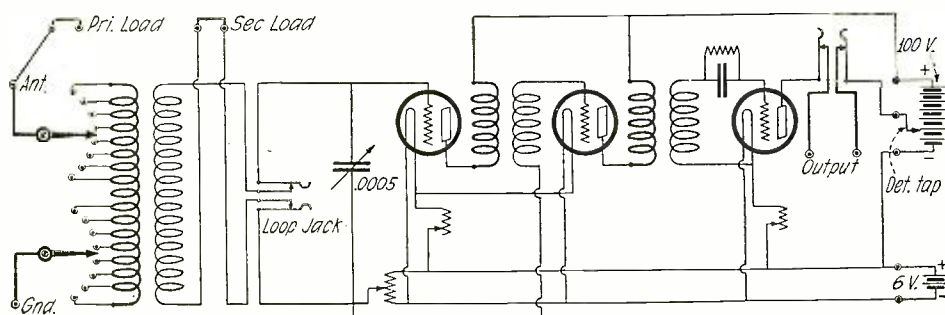

Complete Circuit Diagram of the Radio Frequency Receiver. The First Two Tubes are the Radio Frequency Amplifiers, the Third Being Used for Detection. When a Loop Aerial is Used it is Plugged into the Loop Jack. This Jack is Mounted in the Top of the Cabinet so that the Loop can be Plugged in or Taken Out at Will. When the Loop is in Position the Vario-coupler is Automatically Disconnected.

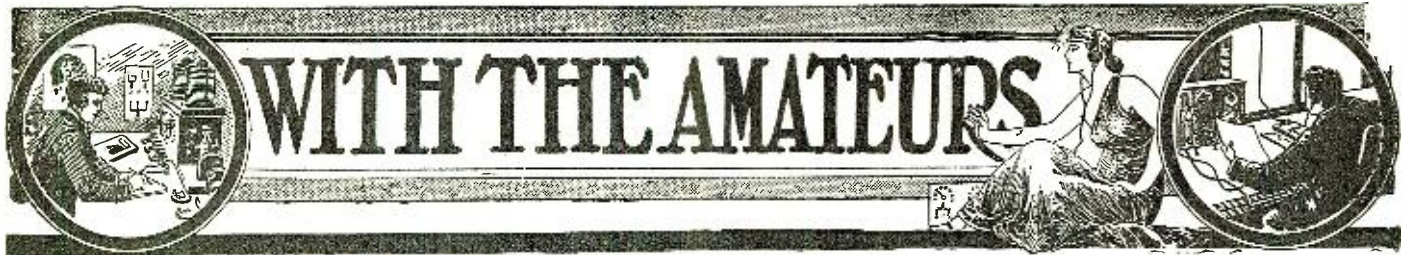

**T**HIS Department is open to all readers. It matters not whether subscribers or not. All photos are judged for best arrangement and efficiency of the apparatus, neatness of connections and general appearance. In order to increase the interest in this department, we prefer to publish photographs of stations accompanied by a picture of the owner.

We prefer dark photos to light ones. The prize winning pictures must be on prints not smaller than 5 x 7". We cannot reproduce pictures smaller than 3½ x 3½". All pictures must bear name and address written in ink on the back. A letter of not less than 100 words giving full description of the station, aerial equipment, etc., must accompany the pictures.

**PRIZES:** One first monthly prize of \$5.00. All other pictures will be paid for at the rate of \$2.00 each.

## 2FZ, Second Prize Winner In Hoover Cup Contest

Owned by **FRANK FRIMERMAN**

This Month's Prize Winner

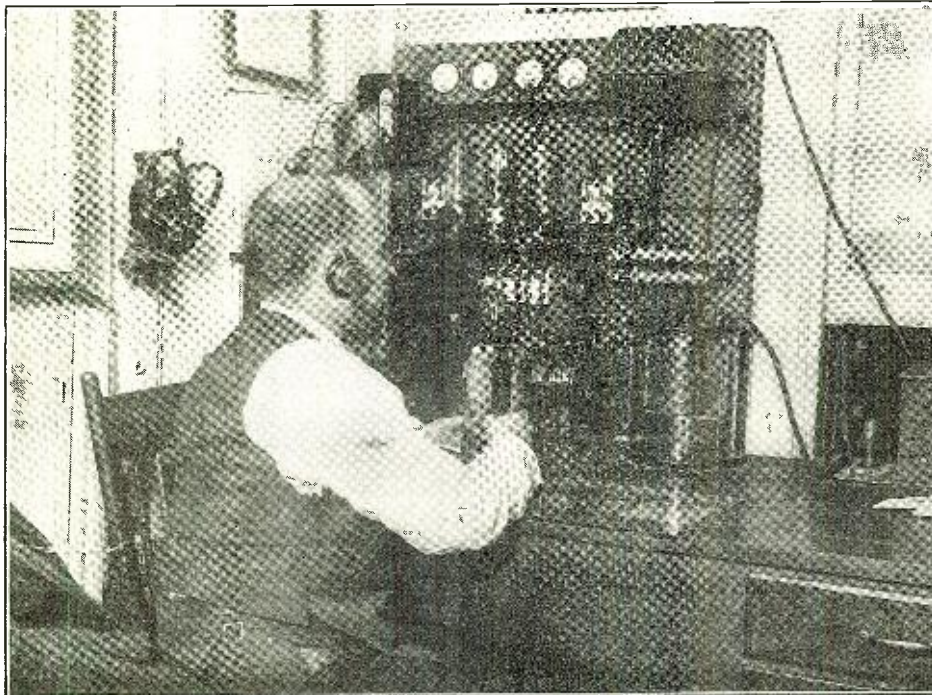

Mr. Frimerman Seated In Front of His Transmitter. The Three 50-Watt Tubes Are Conspicuous, As All 50-Watt Bottles Are. Note the Large Chopper Directly Behind the Microphone, and the Huge Variable Condenser To the Right Of It.

The receiving aerial consists of one 7-strand No. 14 phosphor-bronze wire, 600' long and 75' high. This runs at right angles to the transmitting antenna and connects to a separate switch outside of the house. The receiving ground is made to a water-pipe.

### THE TRANSMITTER

The transmitter of 2FZ uses the Hartley circuit. Three 50-watt tubes are employed and are arranged so that they can be connected in the following combinations: For phone transmission, one oscillator, one modulator and one speech amplifier. For buzzer modulated C. W., two oscillators and one modulator. For pure C. W., three oscillators. A chopper, run by a synchronous motor, can be connected in the circuit for I. C. W. The plate supply is generated by a 1000-volt D. C. Esco motor-generator. Alternating current is employed for the filament supply and is obtained from a 300-watt Acme transformer. Directly above the tubes are four meters, designating plate voltage, plate amperage, grid current and the radiation in amperes. The radiation ammeter is of the thermo-couple type. An electric fan is provided for keeping the tubes cool while in operation.

### THE RECEIVING SETS

Mr. Frimerman has two receiving sets; one which is used for amateur work and the other for the reception of broadcasting and long-wave stations. The set which is used for the reception of amateur signals is of the Reinartz type, employing two variable condensers and a spiderweb coil. One stage of audio frequency amplification is included within the same cabinet,

**S**ITUATED in the heart of The Bronx, Station 2FZ, owned and operated by Mr. Frank Frimerman, 740 Prospect Avenue, New York City, is the solar system for the bulk of New York A.R.R.L. traffic. Although surrounded by numerous large steel structures, which tend to absorb radio energy, Mr. Frimerman has overcome this obstacle by bringing his transmitting and receiving systems up to the highest peak of efficiency. 2FZ is one of the few real DX stations on the East coast. For this reason it is selected by the majority as a reliable medium for the relaying of long-distance traffic.

The interior of Mr. Frimerman's station is a "sight for sore eyes." Very few commercial companies can boast of better installation or a more convenient disposition of apparatus and remote control system than here. There are so many unusual features and worth-while pointers relative to 2FZ that justice can be done only by a complete description.

### THE ANTENNA SYSTEMS

The transmitting antenna is a 24" cage of the "T" type, consisting of six 7-strand No. 14 phosphor-bronze wires, 70' long and 75' from the ground. A six-wire cage lead-in runs directly to a heavy duty lightning switch, mounted on the outside of the house.

A 12-wire fan-type counterpoise, 40' long and 10' from the ground, runs directly under the transmitting antenna. This is connected to the oscillation transformer by heavy cable.

A General View of the Power-Control Panel, Connecting Rack and the Panel That Controls the "B" Voltage For the Vacuum Tubes of the Receiving and Amplifying Units. The Esco Motor-Generator, Which Supplies the Plate Voltage For the Transmitting Tubes, Can Be Seen Directly Behind Mr. Frimerman.

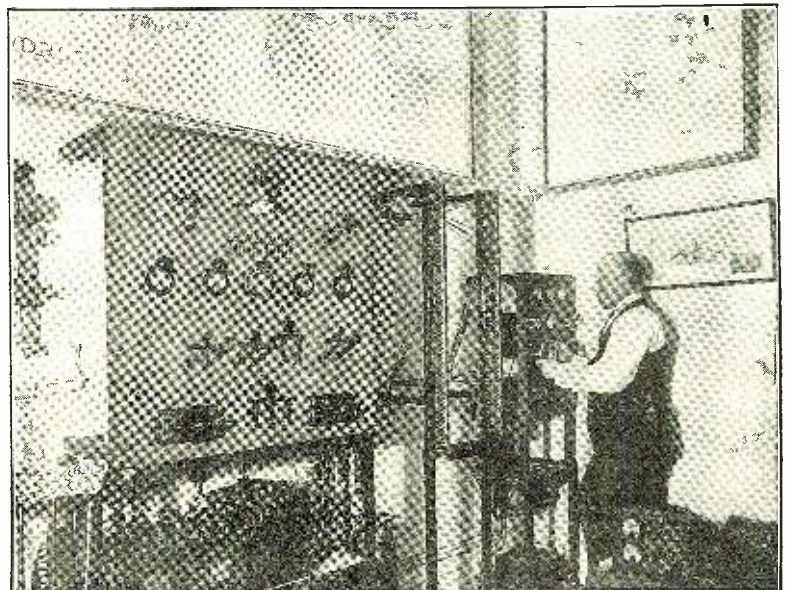

this being all that is usually necessary. The other receiver is of the honeycomb type, employing primary, secondary and tickler coil with the usual series and shunt variable condensers. This receiver is mounted directly on top of the Reinartz tuner. To the right of this, and mounted on porcelain insulators, is the detector and two-stage audio frequency amplifier unit employed with the last mentioned set. A separate one-stage audio frequency amplifier is included for use when great volume is desired. This unit can be connected in cascade with either of the receiving sets. Directly underneath the large map of the world in the photograph may be seen the main control and charging panel. This includes at its top a Tungar rectifier bulb, for use in charging the two 6-volt storage batteries which are used for supplying the current for the filaments of the detector and amplifier tubes in the receiving sets, and the 12-volt storage battery that is used primarily for supplying the current for operating the relays and small lights which make up the remote control system, which is to be described later. Directly under the Tungar rectifier bulb is the fuse rack; these fuses being connected in the circuits of the motor-generator, receiving vacuum tubes, and the filaments of the large transmitting tubes. Should one of these fuses blow, a small red light immediately glows. The closing of any switch upon the panel lights a small lamp.

Meters for the reading of charge and discharge amperes, "A" and "B" battery voltage, and the current consumed by the functioning of the remote control system, are immediately below the fuse rack. At the lower part of the panel are two relays; the one to the left makes and breaks the circuit of the Esco motor-generator, and the one to the right makes and breaks the circuit of the small charging generator. "B" voltage for the tubes in the receiving sets is obtained either from block "B" batteries or from two small Signal-Corps type motor-generators. This circuit is controlled by a small panel to the right of the connecting rack; this includes two rheostats for the control of the "B" voltage produced by the generators. The connecting rack itself, which is between the two control panels, is the most unusual feature, and 2FZ is probably the only station that employs one. All connections of the remote control system, as well as those from the control panel, receiving set and transmitting set, are run to this rack, where it is possible to change an entire circuit or strap over from one circuit to another.

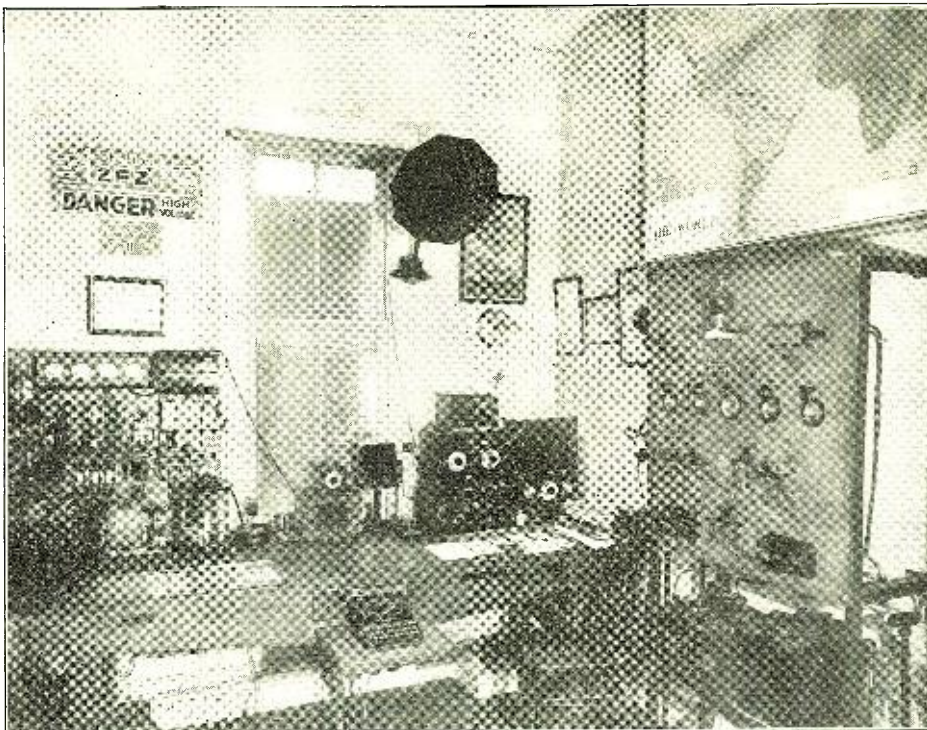

This Photo Shows the Transmitting Set and Receiving Units Particularly Well. The Small Cabinet in the Center of the Table is the Termination of the Remote Control System. All Operations Can Be Controlled From This Center.

#### THE REMOTE CONTROL SYSTEM

Directly in the center of the operating table is the heart of the remote control system. By means of cam switches and plugs and jacks, any operation in any part of the room can be started or stopped at will. By inserting a plug in a definite jack the aforementioned combinations of the transmitting tube connections are instantly made and by throwing a cam switch the tubes light up, the electric fan starts and the relay on the control panel closes the circuit of the motor-generator supplying the plate voltage. Changing from one receiver to another and connecting the separate amplifier into either receiver, are as well accomplished from this small cabinet in front of the operator.

Of special interest are the maps upon the wall. The large map of the United States, which unfortunately cannot be seen in these photographs, has upon it small lights of different colors, designating the locations of the principal ship-to-shore, trans-oceanic and broadcasting stations. The principal amateur stations with which 2FZ runs regular sched-

ules are also designated by small lights. Large lights with numbers printed upon them show the location of each and every radio district in the United States. This rather unique arrangement is also controlled from the small cabinet in the center of the operating table.

Mr. Frimerman has spent many years in bringing this station up to its present point of development. All of the work was done by himself and it is to be understood that no radio engineers or electricians participated in either the design or the installation of this station. All of the wiring, a good deal of which runs underneath the tiled floor, was made by Mr. Frimerman. There is little wonder that Station 2FZ was one of the winners in the Hoover Cup Contest.

### Roy Jordan's Station Wyeville, Wis.

THE following is a description of my station, together with a general view of the apparatus. The main antenna is a "T" type cage, 80' long, consisting of five wires, equally spaced around hickory hoops 18" in diameter. A four-wire cage lead-in drops from the center of the main span. The antenna is held aloft by two built-up wooden masts, each 80' high. These masts taper from 8" square at the bottom, to 4" square at the top, and are securely guyed in all directions. Directly under the main span, and about 8' from the ground, I have a counterpoise, of the same dimensions, which at present is being used in connection with various reception tests. A single wire, 150' long and 20' high, as well as two small loop aerials, are also available for testing.

My receiver consists of de Forest panels. This receiver is of the three-circuit type, using honeycomb coils for primary, secondary and tickler. Two large de Forest Vernier variable condensers are employed, one being connected across the primary coil, and the other across the secondary. A three-stage audio frequency amplifier, using R.C.A. transformers, is mounted in the smaller cabinet, to the right of the receiver proper. Both receiving and amplifying instruments are entirely home-designed and assembled. An R-3 Magnavox is used when

(Continued on page 225)

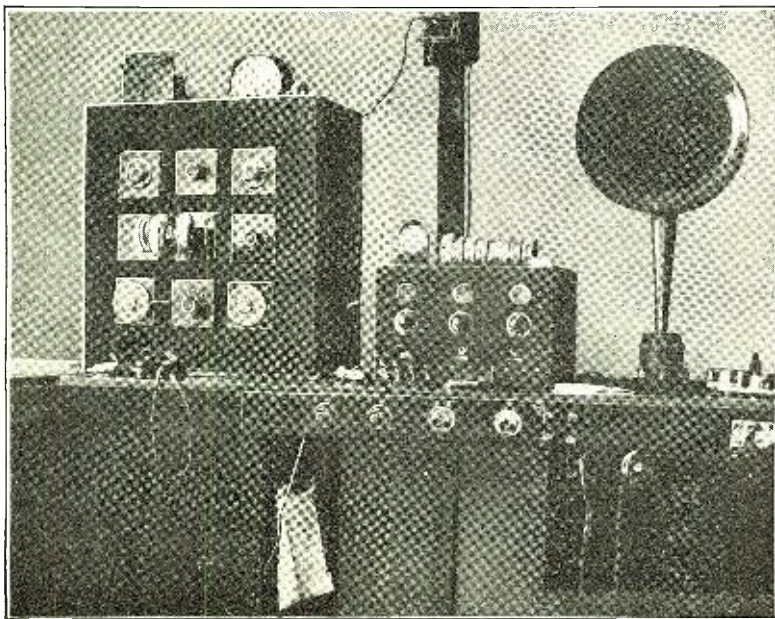

A View of Mr. Jordan's Station. This Was But Recently Licensed and Has Received the Call Letters 9ALL. A 5-Watt S.P.C.W. Transmitter Is Employed, But Is To Be Replaced By a 10-Watt C.W. I.C.W. and Phone Set.



# A Low Power Phone and C. W. Transmitter

By D. R. CLEMONS\*

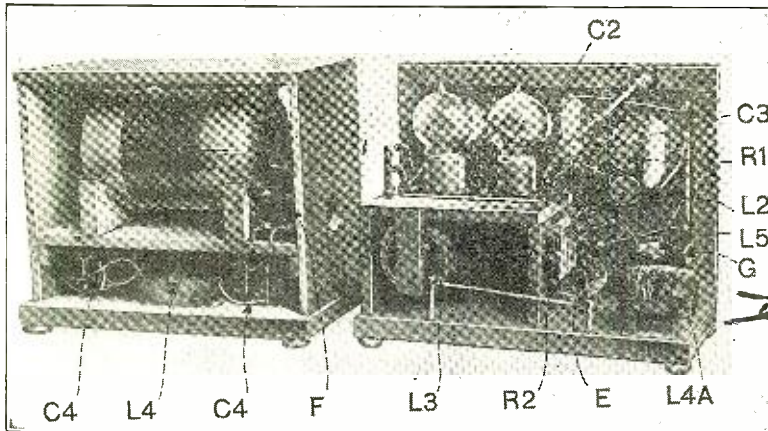

**P**ARTS necessary for a radio telephone or continuous wave telegraph set are shown in the illustrations. An instrument was desired for speech or code transmission and also to be applicable as a generator of high frequency oscillations for laboratory measurements, hence filament, grid and plate terminals are provided for employing any desired oscillatory system. Finally, the outfit was to be set up as cheaply as possible, therefore, nearly everything in it is original.

Fig. 1 is a lettered diagram showing a Colpitts oscillatory system having separate modulator tube and auxiliaries. Filaments of two 5-watt Western Electric power tubes form a series circuit through a 12-ohm resistance,  $R_2$ , retarding coils  $L_3$ , and 30 volts of storage battery. A 30- to 350-volt dynamotor supplies plate potential through a filter, fuses at F and G and the large inductance  $L_4A$ . A potential of several volts for microphone or buzzer is obtained by shunting a portion of  $R_2$ , buzzer or microphone being plugged in at jack E. A grid bias voltage of  $-15$  is also provided by this method. To use both tubes in parallel for straight C. W., or for laboratory use as a plain oscillator, the link at X is opened and grids are connected together by shunt A, the plates being connected by shunt B, which must bridge reactance coil  $L_3$ . In such cases a variable grid leak is adjusted.

### FILAMENT CIRCUIT FOR 30 VOLTS (W. E. TUBES)

Fig. 2. This arrangement is very good and is possible when the phone is used on farm lighting circuits, or where 30-volt dynamotors are employed for plate potential. Both tubes should be of similar type and characteristics. Western Electric 5-watt tubes require seven filament volts, so two in series require 15 volts. Since such tubes require 1.35 amperes, a resistance  $R_2$  of 12 ohms establishes a drop of the remaining 15 volts. Coils  $L_3$  are iron cored, low resistance impedances for reducing motor commutator surges entering the filament circuit from the battery. Since a  $-15$ -volt drop exists across the oscillator tube and resistance  $R_2$ , a proper

negative voltage may be placed on the modulator tube grid by attaching the lower secondary terminal of modulation transformer to some point on  $R_2$ . This is necessary if

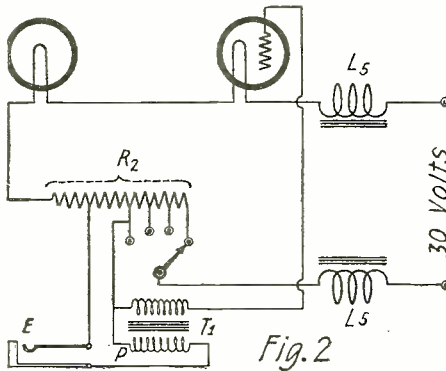

Circuit Arrangement Used for Obtaining the Filament Supply from a Farm Lighting-Plant.

the tube is to function along a straight portion of its curve, otherwise bad distortion would result. The exact voltage required will depend partly upon the plate voltage and should be found by test; however, about

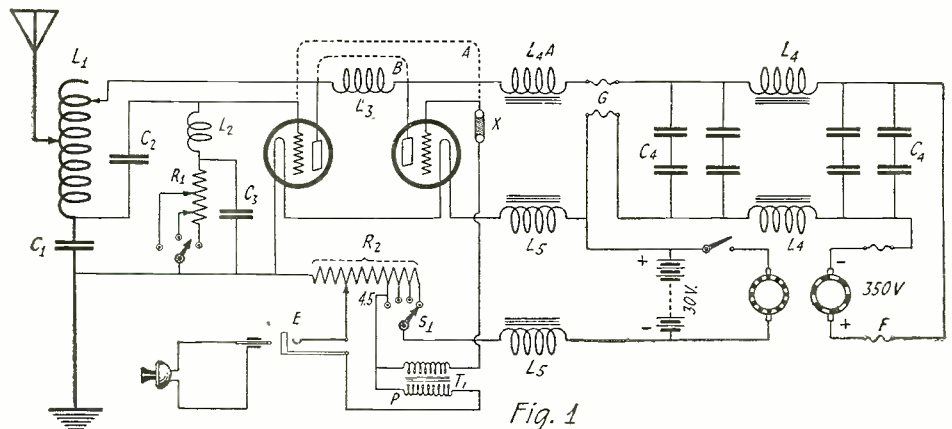

The Complete Circuit Diagram of the Phone and C.W. Transmitter, Including the Power Unit and Filter System. The Two Tubes Can Be Used in Parallel for C.W. by Opening Link "X" and Connecting the Grids and Plates Together by Shunts "A" and "B."

6 ohms of  $R_2$  will be required for a plate voltage of 350. Resistor  $R_2$  is sketched in Fig. 9 and is tapped at 6, 8, 10 and 12 ohms for filament adjustment by switch  $S_1$ . Transformer primary  $T_1$  includes jack E and 4 ohms of resistance in  $R_2$ , thus giving 5 volts for the microphone or buzzer.

### FILAMENT CIRCUIT FOR RADIOTRON 202

Fig. 2. Radiotrons require 7.5 filament volts at 2.35 amperes, hence the arrangement would be similar as shown in Figs. 1 and 2 except that  $R_2$  should be of Nicrome 22, wound as shown in Fig. 9. This gauge averages 1 ohm per foot, so 12 feet would be required.

### FILAMENT CIRCUIT FOR 12-VOLT SUPPLY (UV-202 OR W. E. TUBES)

Fig. 3. If only 12 volts were available, as might be the case where plate voltage is obtained from an independent source, both tubes would be in parallel, as in Fig. 3. Since a 5-volt external drop would be necessary, two 5-ohm rheostats having 3-ampere capacity would be included in each filament. This arrangement would provide sufficient microphone or buzzer potential, but the grid bias voltage on the modulator may be too low, requiring a "C" battery of several volts with its negative side to the grid. Such a battery would be included in the grid circuit in series with the transformer secondary. Either UV-202 or W. E. 5-watt tubes may be employed.

### MOTOR GENERATOR AND FILTER

A Westinghouse dynamotor operating directly from a 30-volt storage battery gives a plate voltage of 350 at .08 ampere. A felt-lined cradle supports the dynamotor within a separate cabinet, the filter system being built into the base, making a very satisfactory arrangement. A constant plate voltage is desirable in radiophone equipment, but even well designed dynamos possess a slight potential difference between segments which, as they come rapidly into position under the brushes successively, cause a rise and fall of potential amounting to several volts. This change produced several hundred times in one second passes on to the plate circuits

\*Radio Instructor, Dodge's Radio Institute.

as "commutator ripples" resulting in tonic variations of amplitude of the transmitted energy. As a result of "ripples" a disagreeable noise is heard in a receiver and speech is also of relatively poor quality, particularly at harmonic tone frequencies. Since slight variations are not overcome in generator design, it is necessary to reduce such currents to a much steadier condition by filtering. Such a filter system is mounted within the generator cabinet shown and consists of two 1/4-henry inductances  $L_4$  with eight 1-microfarad condensers  $C_4$  connected as shown in Fig. 1. Since economy may begin here, paper telephone condensers of 1 mfd. each may be safely used if first tested carefully, as, say, on 220 volts A. C. Such condensers are obtainable from telephone salvaging stores. Chokes  $L_4$  are constructed as shown in Fig. 7, although they may be built as shown in Fig. 8, which is of much simpler construction. In Fig. 7 a soft iron bar 3/4" in diameter is cut 2 1/2" long and is drilled and tapped for 8-32 machine screws at each end. Several layers of Empire cloth are wrapped about the core, then 1,500 turns of No. 28 insulated copper with flexible terminals are wound into layers 2" long. The winding is covered with Empire cloth. The magnetic circuit is completed through two half rectangles of laminated core-steel shaped to enclose the winding, the ends join at Y and are clamped by screw S, where several discs of mica form an air gap between the core and ends Y of Fig. 7. Empire cloth is then wrapped about the core as at V.

The scheme in Fig. 8 may be used by making two wooden blocks 2" square with a 3/4" hole at the center. These are forced over a 3/4" fibre tube 2 1/2" long, forming a bobbin for the winding. A large bundle of closely packed iron core wires are passed through the tube and bent backward as shown. This method is used at  $L_4A$  and  $L_5$ . Choke coils  $L_5$  retard motor commutator waves entering the filament circuit

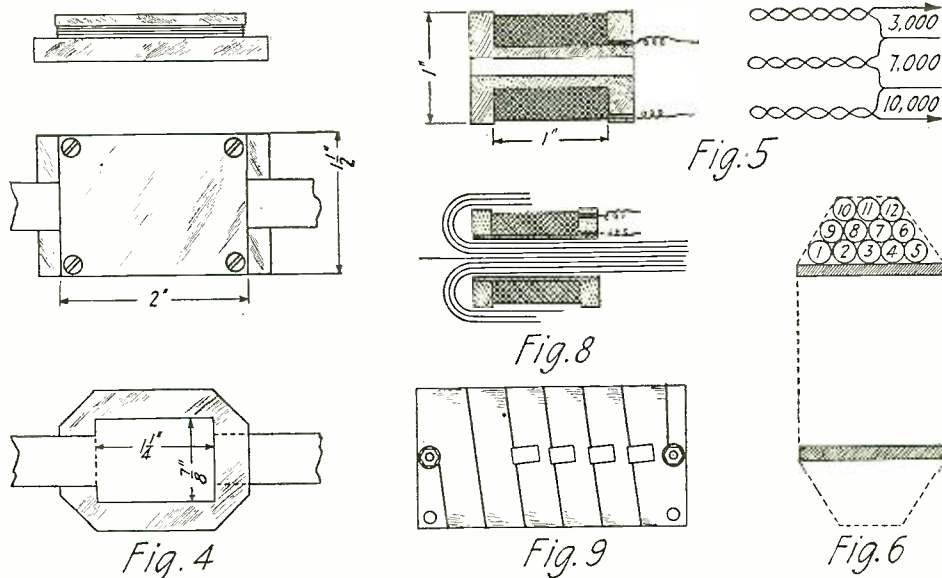

Design Data for the Construction of the Condensers, Chokes and Resistances Which Make Up the Filter System of the Power Supply Unit.

It contains 1,800 turns of No. 28 copper wire, built up as in Fig. 8.

Since 75 milliamperes of current move in coils  $L_4$  and  $L_4A$ , their direct current resistance must be low to prevent a large potential

CONDENSERS  $C_1$ ,  $C_2$  AND GRID CONDENSERS

All these are made similarly as shown in Fig. 4, where two small strips of bakelite are cut and drilled to form a clamp for the mica condenser. Each condenser is adjusted for a capacity of .0005 mfd., by cutting two copperfoil strips 1 1/4" by 7/8", with a projecting end for connection as shown. These strips are separated by several mica sheets of about .003" when compressed. These capacities may be approximated since none are critical.

Inductance  $L_2$  is a small coil of 3 millihenries wound upon a wooden bobbin shown in sketch No. 5. About 350 turns of No. 26 cotton covered wire will be required. Likewise, the grid leak  $R_1$  is a bifilar wire-wound resistance unit tapped for 3,000, 7,000 and 10,000 ohms. A section of 38 manganin resistance wire is cut to length and doubled, the bight being first wound upon the spool, allowing both parallel wires to be wound in at the same time, making the unit quite non-inductive. Since such wound resistors have capacity predominating,  $C_3$  may not be required, but it should be used if vitro-enamel resistors are employed as leaks.

Filament resistor  $R_2$  is wound upon a thin strip of bakelite as shown in Fig. 9. Twelve feet of No. 22 Nicrome is tapped at 6, 8, 10 and 12 ohms by soldering in copper tabs after winding onto the frame. Five ohms of this same resistor is shunted for a microphone current of about 0.1 ampere. Either microphone or buzzer may be connected in for use at jack E. Modulation transformer T-1 appeared in the July, 1922 issue of RADIO NEWS. All filament wiring is kept very close to avoid inductive loops. Supports, cabinets and panels are of kiln dried

(Continued on page 194)

Left: Exterior View of the Power Unit and Filter System. Right: Outside of the Transmitting Unit. The Antenna Inductance is Mounted Atop of the Cabinet.

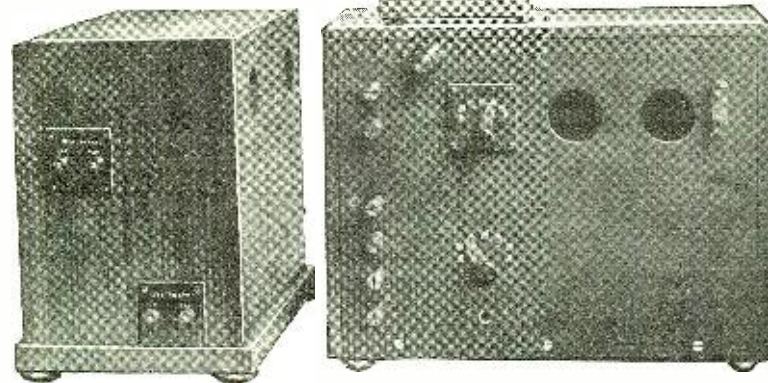

from the battery. Each is 100 turns of No. 14 enameled wire built up as in Fig. 8, except that wooden end pieces are not used. Modulation inductance  $L_4A$  is a large inductance coil of low ohmic resistance, to hold the plate potential quite steady while potentials of the modulator are changing.

drop within them. If too fine wire were used, say 40, a drop of about 24 volts per coil would make a total drop of 75 volts, reducing the plate-filament voltage to 275. In  $L_4$  and  $L_4A$  the total resistance is 135 ohms, which causes a drop of 10 volts only, allowing 340 on the plate.

HIGH FREQUENCY CHOKE  $L_4$

This is a layer wound inductance of 3 millihenries wound up as shown in Fig. 6; 100 turns of No. 26 cotton on a 2" tube. This coil keeps high frequencies from entering the modulator tube. Against radio frequency potentials it presents 28,000 ohms reactance; but for voice frequencies from the modulator tube only several ohms are present, which is partly copper resistance, hence a relatively coarse wire should be employed here. Antenna coil  $L_1$  is a spiral coil of 36 turns of No. 16 double cotton covered, wound upon a wooden frame of radial wooden pins. Several tabs are soldered to the coil, which is of 145 microhenries, clips being provided for adjustment.

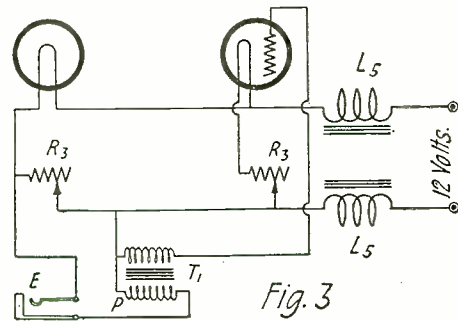

When Using an External Filament Supply of Not Over 12 Volts, the Filaments Are Connected in Parallel.

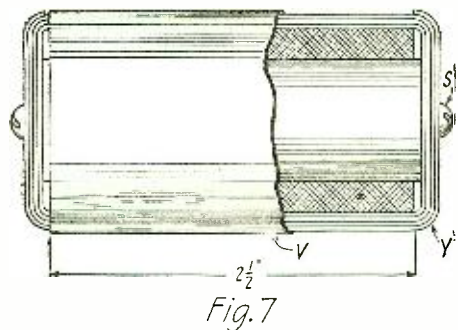

Appearance of a Completed Choke Coil of the Type Used in the Filter Circuit.

# A Practical Switching Arrangement

By EUGENE R. WEBER, A. M. A. S. M. E.

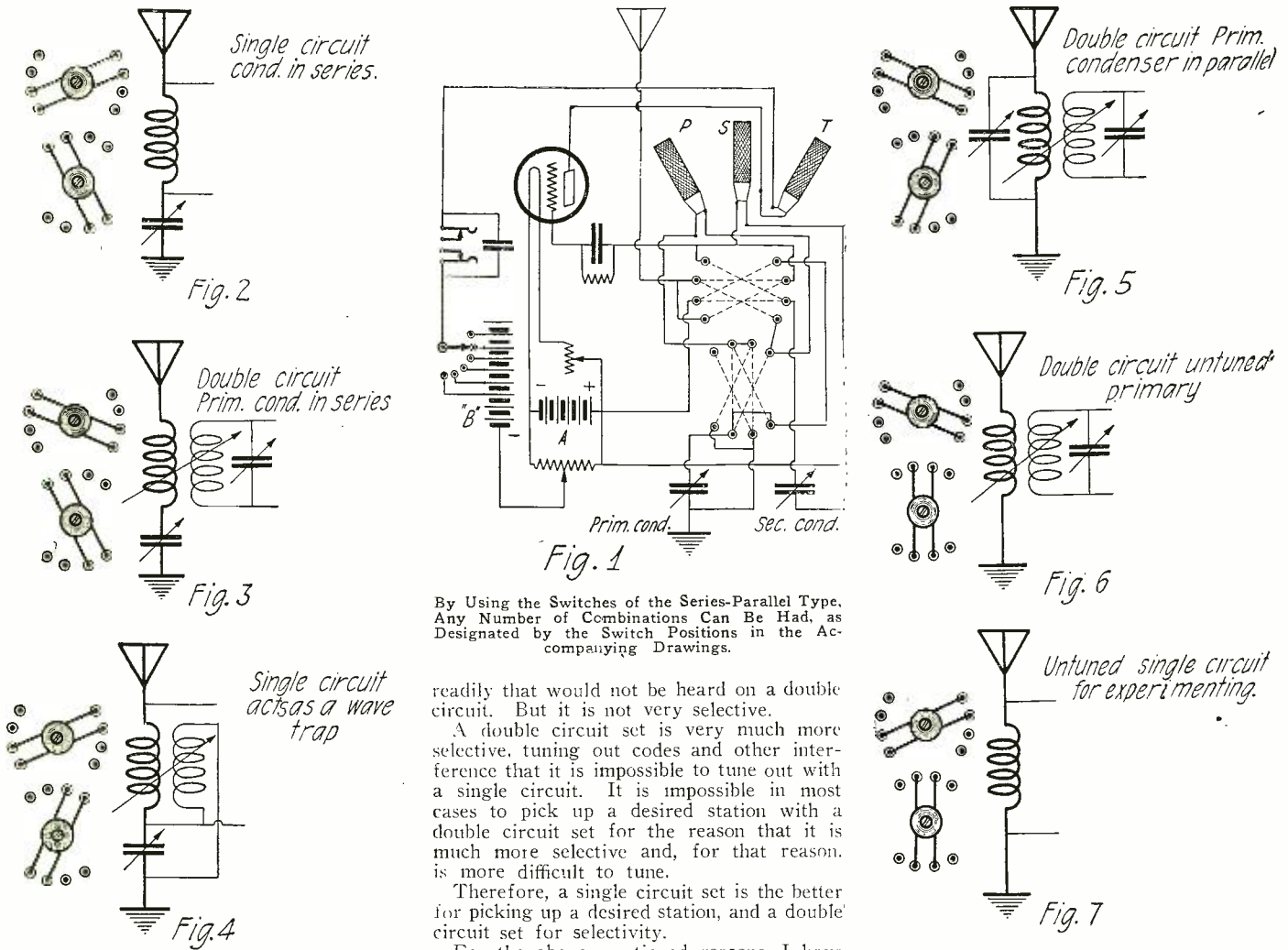

By Using the Switches of the Series-Parallel Type, Any Number of Combinations Can Be Had, as Designated by the Switch Positions in the Accompanying Drawings.

readily that would not be heard on a double circuit. But it is not very selective.

A double circuit set is very much more selective, tuning out codes and other interference that it is impossible to tune out with a single circuit. It is impossible in most cases to pick up a desired station with a double circuit set for the reason that it is much more selective and, for that reason, is more difficult to tune.

Therefore, a single circuit set is the better for picking up a desired station, and a double circuit set for selectivity.

For the above mentioned reasons, I have worked out the switching arrangement shown herewith in Fig. 1, whereby I can switch from a single circuit (after I have tuned in the station I desire to hear and note what they are broadcasting) to a double circuit and turn the secondary condenser dial until I hear the same voice or song, etc., and I am reasonably sure that when the station announces, it will be the station I desire to hear, also that a large percentage of interference will be eliminated. The positions of these

switches and the circuits obtained are shown in Figs. 2 to 10.

The writer used a regenerative hook-up with honeycomb coils, but the same arrangement would apply to a non-regenerative set or any other type of coils.

I am sure that anyone trying this switching system will be more than repaid for his time and trouble. All the equipment necessary are two series parallel switches and a few feet of wire.

**H**AVING tried both single and double circuits and proved their respective merits to my own satisfaction, I have come to the conclusion that both circuits are the best.

The single circuit is the easier to tune, provides a ready way of picking up desired stations, (as one soon becomes familiar with the position of the primary condenser dial for a given station) and signals can be heard

## Elimination of Reradiation Interference

By D. R. CLEMONS\*

**W**HEN receiving broadcast programs there are usually many undesirable noises due to other regenerative receiving sets in the vicinity, or transmitting stations on slightly different wave-lengths. Good selective receivers overcome these to a certain extent. For ordinary coupled receivers using plate and grid variometers, and for receivers equipped with a tickler coil for regeneration, a very simple and efficient little device may be easily built which greatly or completely reduces whistling due to transmitters tuned close to the desired wave-length, yet does not change the desired station's signal strength or characteristics at all.

The method employed is to insert a decade resistance box into the antenna circuit, as shown in Fig. 1. In operation with various receivers and antennae, whistling and para-

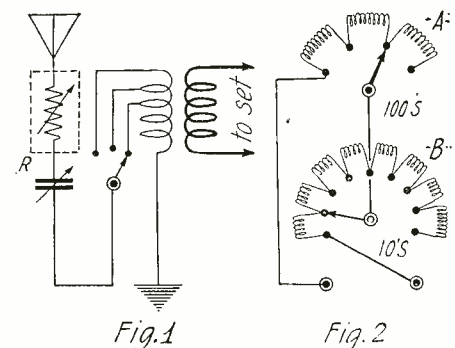

The Decade Resistance of Fig. 2 is Represented by "R" in Fig. 1. This Should Be Variable, in Steps of 10 Ohms.

sitic noises might be heard even though the receiver were ordinarily critically adjusted. Then about 80 ohms is added in the box; immediately the signal fades, but is brought back by readjusting the plate variometer or filament current slightly. The signal then stands out clearly as before, but without the usual disturbing noises. By again increasing resistance and slightly retuning, the desired station can be made very loud.

Resistances required on different antennae are about 60 to 250 ohms, so any decade box may be employed if it is non-inductively wound and capable of adjustment from zero to 350 ohms in 10-ohm steps. If these are to be built for this purpose, the box may be quite small, but should be permanently mounted for use in the station. Since the unit is not extremely critical, resistors may be accurate to, say, 5 per cent,

\*Radio Instructor, Dodge's Radio Inst.



so after determining the resistance per foot of the wire to be used, lengths may be roughly approximated and wound upon small wooden or cardboard bobbins.

The instrument is built with two adjustments: one of 10-ohm steps, the second having three steps of 100 ohms each. Switch levers, contact points, binding posts and resistances are mounted upon a small 1/4" bakelite panel 4" by 6". The wooden box is of 3/8" cypress, built to house the parts suitably, as shown in Fig. 3. One switch is provided with 10 contact points which increase values to 90 ohms; the upper switch has four contacts, building to 300 ohms. The resistances are, of course, most important and should be carefully made. Since the currents are very small, a fine resistance wire as, say, 30 or 38 gauge, may be used. If an ordinary continuous winding were employed, considerable inductance would result in the larger resistors which would, of course, detune the aerial circuit. So the winding is bifilar to make it nearly non-inductive. The wire for a resistance coil is first cut to length and then doubled. By starting the bight first, the two lengths wind in closely, coming to the terminals as a parallel pair. The scheme of winding in either Fig. 4 or Fig. 5 may be used. In Fig. 4, 12 small lengths are cut from a 3/8" diameter dowel pin (flag stick, etc.), each cylinder being 1 1/4" long, and is drilled through with 1/8" hole as at C, Fig. 4. The

length of wire is doubled and the bight firmly bound to the bobbin with several turns of silk thread. D. Fig. 4, then wound in as evenly as possible until about 1" remains from terminals, where it is again wrapped with thread and given a coat of shellac. These 10- and 100-ohm units are mounted as shown in Figs. 3 and 4, where each wooden bobbin is slipped over a match-stem forced into holes arranged in a semi-circle close to the contact points; a drop of glue holds the bobbin securely. Connections are made by soldering both terminals to contacts as in Fig. 2. In winding the larger 100-ohm units, two layers of winding may be required. Another method is to wind the wire about a slab of bristol-board or fibre cut 3/8" by 1 1/4", as shown in Fig. 5 at E. Such units may be mounted by gluing the strips into slots cut into a narrow strip of wood, G in Fig. 5. The entire resistance may be wound upon one long strip bent into a semi-circle, taps being made at 10-ohm intervals for the smaller 90-ohm group.

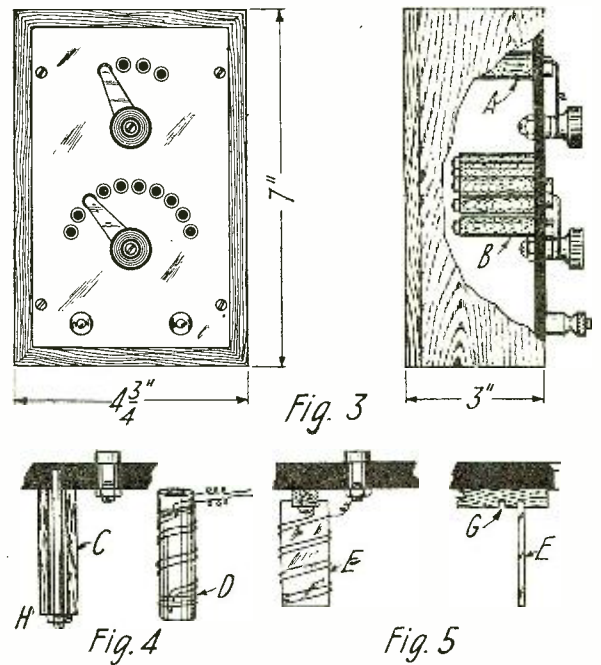
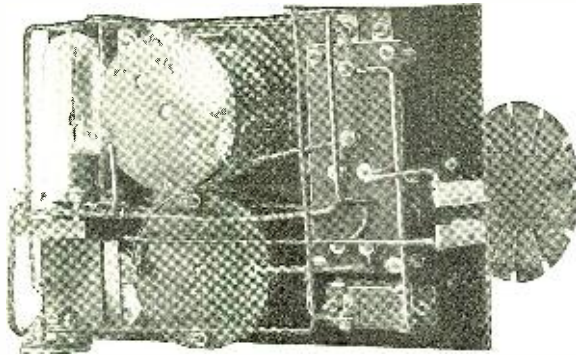

Fig. 3 Gives the Constructional Details for the Decade-Resistance Box. Figs. 4 and 5 Show the Manner in Which the Resistance Units Are Wound and Attached to the Panel. No. 36 Manganin Wire is Suitable.

# A Well Constructed Portable Set

By C. B. SIDES



Two Views of the Portable Regenerative Set Built by Mr. Sides. As Seen, Spiderweb Coils Are Employed for Primary. Secondary and Tickler. Tuning is Accomplished by Two Variable Condensers.

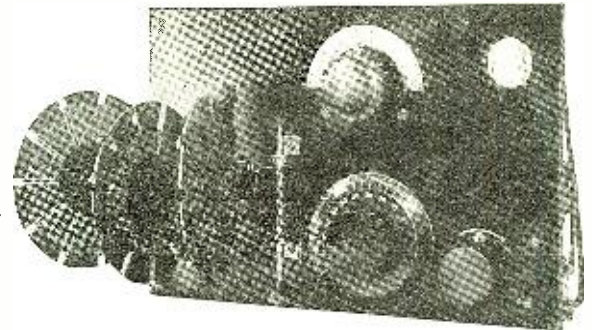

THIS entire set, with the exception of the "A" and "B" batteries, is contained in a box 10" by 6 1/2" by 2 3/4". The covering of this cabinet is of modeled leather and when closed would grace any drawing room table.

On the right hand side of the panel is the tube socket, tube rheostat and phone jack, all of which are mounted as one unit upon a strip of brass, being insulated from each

other by mica insulators. All exterior battery connections are made from cord tip jacks mounted on the back of the panel. Two of these jacks are also used for plugging in the antenna and ground connections. Spiderweb coils are used for tuning and connected up as a three-circuit regenerative hook-up, as shown in Fig. 1. These are of the plug-in type and when not in use, may be taken out and will fit nicely in the top of the box.

Tuning is made more flexible by the employment of two .001 mfd. variable condensers, one being in parallel with the antenna circuit and the other in the secondary grid circuit, as seen in the diagram. A novel cam arrangement is used for adjusting the primary tickler coils, this method allowing the use of knobs some distance from the coils, thereby eliminating the annoyance of body capacity. This set has given exceptional results.

From my home in Buffalo, New York, I have picked up broadcasting stations in Dallas, Atlanta, Jefferson City, Louisville, Kansas City, Pittsburgh, Toronto, and some others.

With the type of coils used, regeneration is very easily controlled, being progressive, thanks

to the loose coupling between the coils. In this set either a WD-11 or UV-199 tube may be used, the A and B batteries, phones and antenna wire being carried in another box of about the same size as the receiver. If it is desired to receive longer wavelengths larger coils may be plugged in and the receiver is then suitable for the reception of foreign press or high power stations.

For the vacationist who does not want to carry a heavy load but wishes to have a radio set with him, this type is truly ideal.

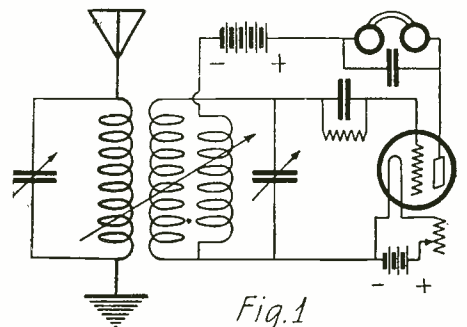

The Circuit of the Portable Receiver Described in This Article. The Positive Pole of the "A" Battery Should Be on the Left Side, Instead of On the Right As Shown, When Such Tubes as the UV-199 or C-299 Are Used. Since They Function Best As Detectors With the Grid Slightly Positive.

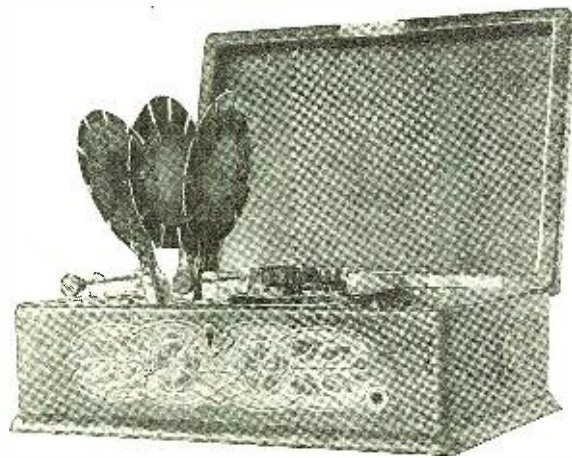

A Top View of Mr. Sides' Portable Set. Note the Arrangement for Adjusting the Spiderweb Coils.

# Awards of the \$50 Radio Wrinkle Contest

## First Prize

### MAKING A VERNIER RHEOSTAT By THOMAS W. BENSON

After a radio set is constructed, it is often found that the filament control is not sufficiently close for efficient operation. When such is the case and it is undesirable to replace the rheostats with vernier rheostats, an attachment can be made as shown in the

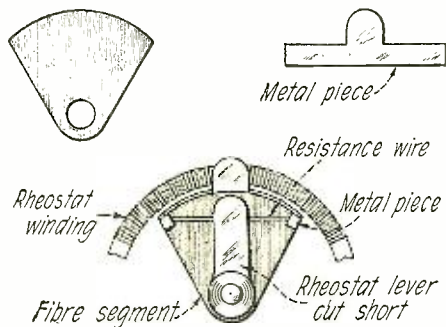

A Vernier Rheostat That is Easily Made. The Long Lever Moves Only When the Short Lever is at One or the Other Extreme End.

accompanying illustration that will convert the strip-wound rheostats into vernier control.

It is simply a segment of fibre cut to the shape shown, with a hole large enough to fit around the collar carrying the rheostat lever. A piece of spring brass or German silver is cut as shown and the ears bent up around the fibre with a short length of resistance wire that may be cut from the rheostat winding, clipped under the ears and soldered thereto. The extended piece is used to make contact with the rheostat winding, as shown in the view of the assembled vernier.

This attachment is put under the rheostat lever which is bent to touch the single wire. The operation should be clear. When the knob is turned, the whole device will turn and give rough adjustment, but backing up on the knob will cause the arm to move over the single wire, giving fine adjustment.

## Second Prize

### AN EXCELLENT VARIABLE GRID LEAK By ALLEN H. FOX

The variable grid leak condenser herein described has been used for over a year, and for durability, ease and permanence of adjustment, can't be beat.

Referring to the drawing: "A" is a piece

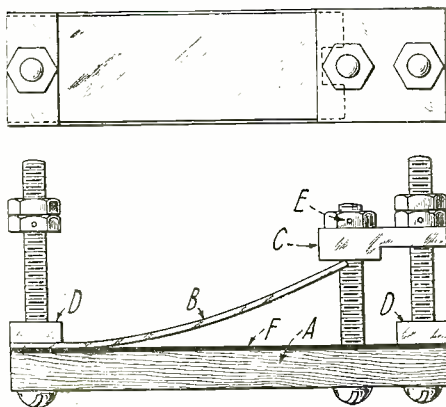

A Variable Grid Leak That is Free from Wear. The Spring Strip "B" Progressively Shorts the High Resistance "F." When Pressed Downward by the Adjusting Nut "E."

of hard rubber, bakelite or formica, on which is a strip of cloth "F," dipped in India ink and clamped firmly in place by pieces of brass strip "D." A strip of spring brass "B," made of copper or phosphor-bronze, cuts out parts of "F" through the action of turning the machine screw which pulls "C" against "D." Either "A" or "C" must be threaded for this screw.

The two outside machine screws were placed 2 1/8" on centers. This takes care of any of the flat rolled condensers on the market to-day. The correct grid condenser is fastened to the two outside screws with two nuts, together with the leads to the instruments.

"E" is an ordinary straight pin used to keep the nuts from turning. Two nuts turned up tight may be used instead.

This instrument is preferably mounted with the screw heads up or the adjusting screw at the top. This affords a dust protector over the leak proper and also facilitates adjustment which can be done with a well insulated screwdriver. In this way a continuous adjustment can be obtained without removing the hand, to eliminate body capacity.

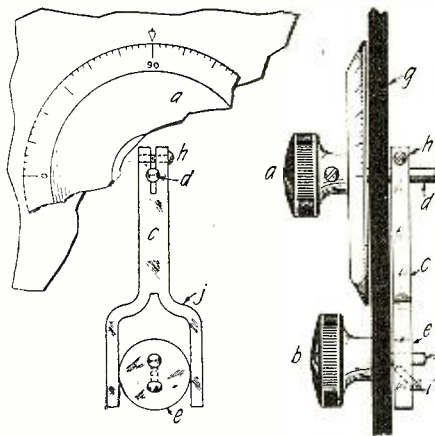

This Type of Mechanical Vernier Works Very Well. Its Operation Relies on Friction and is Controlled by a Rotating Cam.

## A COMPACT AERIAL

I have an aerial erected in my back yard and it's such a "howling" success, I would not change it for a little bit. Have used it for two months and have been roof gazing in that time on my travels along our elevated railroads and I have not seen any constructed along the same lines as mine.

I am sure none could be more successful and because of that fact and the originality of it (although some other fellow may have arrived at it the same as I), I am sending you a sketch of it. I have tried to make the sketch as clear as possible. The usual rule for an aerial is to have a swinging horizontal arm at each end. I have a vertical arm at each end strapped to the mast. Using a pulley and rope at both the top and the bottom of each vertical arm, I am able to draw the entire aerial as tight as a fiddle. The top of the aerial is on a level with the roof of a two story house, and I do not experience the effect of a pocket.

I tried a tap on each length of the aerial with no success and came back to the one tap on the lowest wire (like the sketch) and it proved the most successful.

I believe the success is mainly due to the manner of control I have of always being able to draw up a little on any corner of the aerial and having it always nice and tight, thereby always getting good results. Would be glad to have any of your subscribers call here and look it over.

Contributed by C. Oliver Corry.

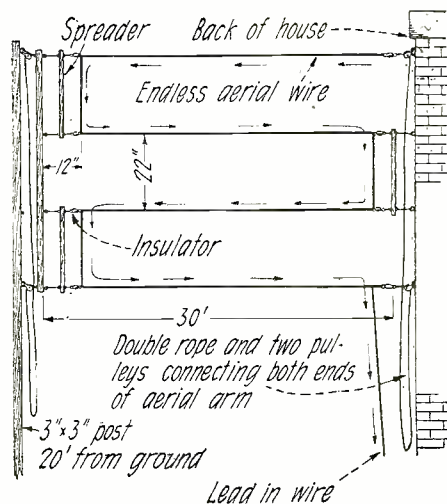

The Novel Aerial Built by Mr. Corry, of 1925 Fontaine St., Philadelphia. Excellent Results Are Claimed.

## PRIZE WINNERS

### FIRST PRIZE, \$25

*Making a Vernier Rheostat*

By THOMAS W. BENSON

2508 E. Mammouth St.,

Philadelphia, Pa.

### SECOND PRIZE, \$15.

*An Excellent Variable Grid Leak*

By ALLEN H. FOX,

615 Ontario St., S. E.,

Minneapolis, Minn.

### THIRD PRIZE, \$10.

*A Fool-Proof Vernier Attachment*

By BODO TA-BELL,

3824 Maybelle Ave.,

Oakland, Calif.

## Third Prize

### A FOOL-PROOF VERNIER ATTACHMENT

By BODO TA-BELL

The following is a description of an easily constructed Vernier attachment that is smooth in its operation and that has no back lash. The customary dial "A" is connected to the shaft "D" by a set screw, said shaft controlling a variometer, variocoupler, variable condenser or other instrument. Most of the instruments are placed about 3/8 of an inch, or more, from the panel, which gives ample room for this attachment. This Vernier is made of a piece of brass "C," about 1/4"x3/8" and about 5" long. This bar is slotted 2" along its length and bent to shape, as at "J." At the other end a hole is drilled, slightly larger than the shaft. The set screw "H" at the slotted end is adjusted so that the bar slightly drags on the shaft. The knob "B" has a short shaft, to which is fastened an eccentric piece of fibre. "G" is the panel. Rough tuning is accomplished by rotating the dial, after which a fine adjustment is made with the knob "B." In case there is not room enough at the back of the panel, this arrangement can easily be mounted on the front so as to be between the panel and the dial.

# Correspondence from Readers

## THE ITCH FOR DISTANCE

Editor, RADIO NEWS:

After reading an article by Armstrong Perry entitled "The Itch for Distance," which appeared in RADIO NEWS for April, I feel that there is a logical defense which might be set forth for "Sarcoptes Scabiei" or itchmite of radio.

Those of us who continually seek new stations in preference to listening in all evening to local broadcasts are not afflicted by any such itch as Mr. Perry describes. Rather, we are impelled by the same urge which brought about the development of the boat, the automobile, the telephone, telegraph, the airplane and every other invention or device which has had as its object the elimination or reduction of the disadvantages which distance has had upon the inhabitants of the earth since the origin of man.

Mr. Perry's article brings to mind the old song which has been often sung in meetings of the Grange as well as at other gatherings of farmers entitled "Don't Leave the Farm, Boys." Judging from the number of Captains of Industry who lead the nation today, the old song either was not sung enough or did not make a very strong appeal.

It is my opinion that men are prompted to tune in to stations as far distant as practicable from them by an inherent curiosity to ascertain whether radio developments embodied in their set have actually cut down the effect of distance.

We know by instinct that when we are brought in contact with people who live at a distance from us, we will develop interests which we will share in common. Time and again this has made us more broad-minded. As a Nation, we are united because 48 states share a large number of interests in common. We become more united as a Nation as we develop a greater number of such interests.

The desire of the man in the East to listen in to concerts broadcast from the Middle West will eventually result in the development of a receiving apparatus that will enable us to receive any or almost any station in the country. When such a set is generally used, we will understand and appreciate the viewpoints of the cotton grower of the South, and the lumberman, miner or fruit grower of the West.

I recently listened in to a talk which the speaker stated was made to "You farmers of the Great Northwest." It was a talk on the value of the radio to farmers isolated from almost all the influences of civilization. *It made me think.* It is my recollection that the broadcasting station was WHA at Madison, Wis. I received an entirely different viewpoint. If I could hear such a talk from other sections of the country I would consider myself a better American citizen because I would be more familiar with the general problems of the country and was not surfeited with only such interests as might be classed as purely local. Had it not been my "misfortune" to be afflicted with the described itch, I should never have heard the talk mentioned above. In fact, I should have been unable to keep my set tuned in to this station all the time it was broadcasting.

The fact that so many try station after station without waiting to hear the programs broadcast may be accounted for to a certain extent by what they hear being broadcast. Frankly I will admit that whenever I hear "Lovin' Sam" broadcast, or its equivalent, I invariably tune out the guilty station and try for something which to me is more acceptable. I can get all of that I want right near home.

In short, I think that it is just as reason-

able to expect radio fans to try for distance in receiving broadcasts as it is for men to try to travel faster or by more direct routes. The earth is our home and no matter if at times it does seem large, we will eventually master it. These poor itch-crazed fans are no different from the pioneers of old, except that they may do their exploring from the comforts of an easy chair in a well lighted and warm room.

Yours, until all the peoples of the world are made one by radio.

O. E. ROBERTS, JR.,  
Washington, D. C.

## CONFIRMATION

Editor, RADIO NEWS:

We are pleased indeed when we find someone who is fair and square enough to tell the truth as he sees it, although it may squeeze someone's toes. Your article, "The Radio Experimenter," in the May number of RADIO NEWS, is the "best ever." My firm has been building crystal sets since Janu-

### Interesting Articles Appearing in the August Issue of "Practical Electrics"

Loud Speakers and Movies.  
Dry Weather Electrical Storms.  
Studying Lightning. Dr. Albert Neuburger.  
Experimental D.C. Transformer. By Amedeo Giolitto.  
Cutting Metals with Electric Arc.  
Novel Electrophorous. By Dr. Alfred Gradenwitz.  
Silver Plated Leyden Jars.  
Plante Storage Battery.  
Magnetic Gravity Motor.  
Wheatstone Slide Wire Bridge. By A. P. Peck.  
New York's Electric Map. By T. O'Connor Sloane, Ph.D.  
Windshield Cleaner.

ary 1, and, with no exception, each and every one of over 200 installed has a range of approximately 600 miles, without batteries or tubes. As you know, of course, the salesman (expert), the newspaper (expert), and the assistant engineers (very expert) invariably say the range of a crystal set is 25 miles. Tell 'em, Mr. Gernsback, for you certainly made a few hundred friends in this burg this time.

W. H. WHITNEY,  
Cleveland, Ohio.

## A GOOD IDEA

Editor, RADIO NEWS:

If I knew code I should have a more kindly feeling toward the ham who intrudes on my concert programs and I think the great majority of the novices would feel the same softening influence.

It has just dawned on me that here is a great chance for the amateur to create a kindly feeling in his favor. That he needs a friend at court is only too manifest. Almost every listener in on radio would be glad to know enough code to enable him to get into the game as a listener, but almost every one finds it too hard after perusal of the code card to follow even the slowest code that he hears. Neither does he wish to spend money on a sending machine as he has no intention of being professional and reimbursing himself from wages.

Here is where the amateur fits in. Let him send some slow code, not the ordinary jargon of abbreviations, but well rounded sentences on matters of general interest. I really believe that if the amateurs here and there put in a few minutes at this now and then they would find that instead of being execrated they would be listened to eagerly. Let such a friendly amateur ask for cards. He will get them and more and more as his pupils take hold. Is not this worth trying? If it goes well, the society of amateurs could enlarge it to a system.

Here also is your chance, Mr. Gernsback. I am only a little insignificant crystal set listener and my letter is likely to pass unnoticed or be casually read, but if you boost it, it will go.

JUNIUS T. HANCHETT,  
Antrim, N. H.

## WE WILL

Editor, RADIO NEWS:

I was very much pleased to note that your judges awarded seventh prize to my answer to your "Who Will Save the Radio Amateur" contest.

Since writing the article I have continued to test for interference with local radiophone listeners, and in one case succeeded in securing very profuse apologies from one ardent radiophone fan who operates a Westinghouse R.C. and Magnavox about one mile from my station. He admitted after the test that he had been blaming me for "noises" that continued after my station signed off. At the present time (being a conscientious soul) he is busy retracting all the things he ever said about me to all his and my friends.

I am operating a 10-watt tube set, with a four-wire T-type aerial in the attic of my house (about 25' long) and a 20' lead, single wire, to the set. With 375 volts on the plate this set has been heard 90 miles on phone, and reported QSA in Milwaukee, Kalamazoo, Gloversville, N. Y., Philadelphia, Pa., and Washington, D. C., on C.W.

All my radio education has been secured from RADIO NEWS, which explains why I take up your time "strutting my stuff" in the paragraph above.

The most important thing in connection with the prize contest for me now is, of course, the \$25. I have selected several of your advertisers who will get the greater part of it.

I hope you will continue to be prosperous so that you may have many more prize contests.

FRANK H. FANNING,  
Radio 9KZ,  
Ashland, Ky.

## WHAT DO YOU THINK?

Editor, RADIO NEWS:

A question has been uppermost in my mind for some time, and I have as yet failed to find an answer. I am sure that some one has found it, and it seems logical to assume that RADIO NEWS is the medium through which the answer may appear.

If you or I were to ask any man, who declares himself an expert on Wireless Telegraphy or Radio, if it is possible for one living over 200 miles from the nearest broadcasting station to receive broadcast programs successfully, using a simple crystal receiver, what would he say? We know that he would say that since the working range of a simple crystal receiver is from 25 to 50 miles, greater distances are improbable. It has been said hundreds of times, and those very words have discouraged many a would-be radio enthusiast of limited means.

(Continued on page 194)

# Prize Winning Sketches in the Cover Contest

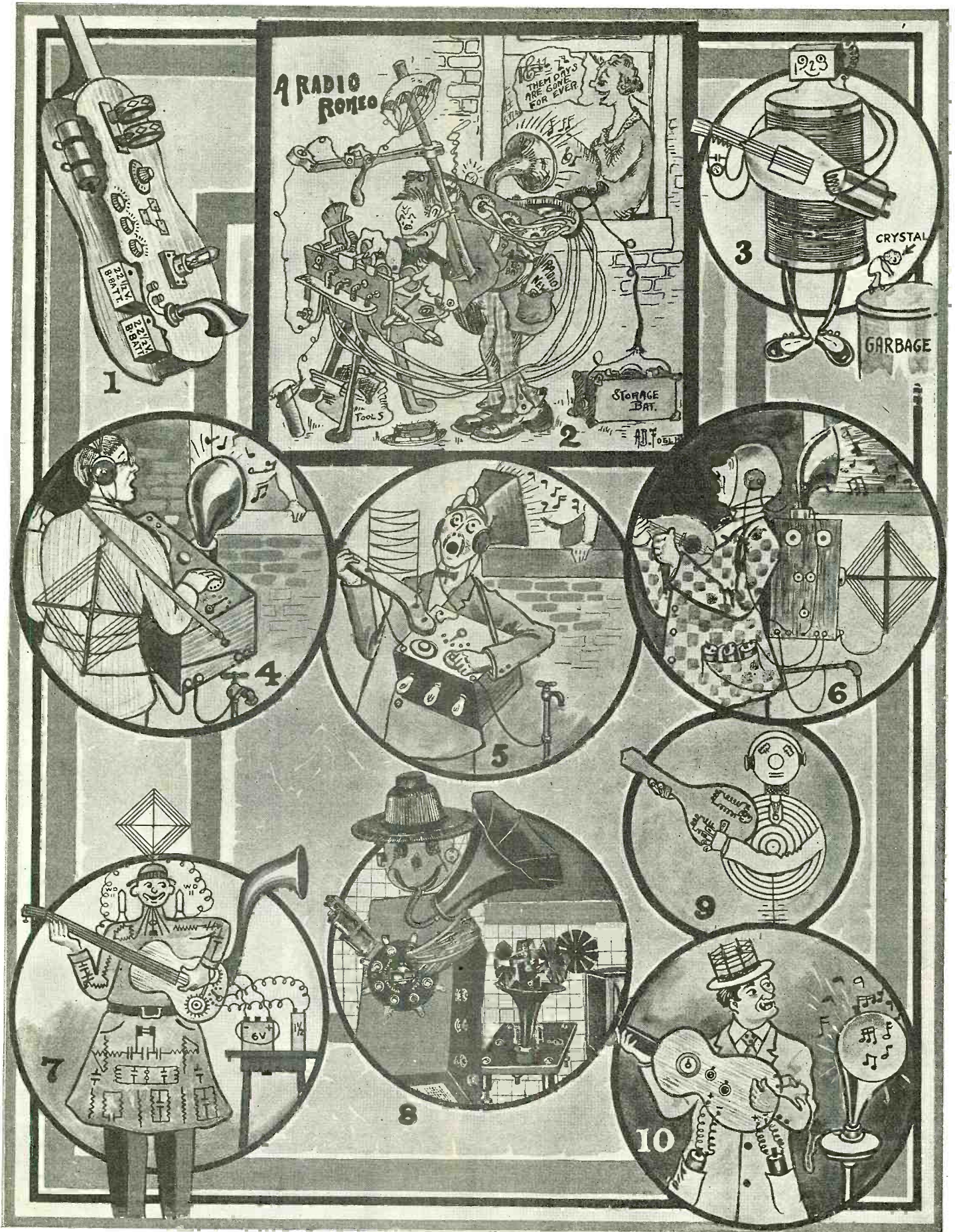

Sketches Nos. 4, 5 and 6, First Prize, Won by Mr. L. B. Robbins. Sketch No. 2, Second Prize, Won by Mr. A. B. Fogle. Sketch No. 10, Third Prize, Won by Mr. G. E. Mitchell. Sketch No. 8, Fourth Prize, Won by Mrs. Cora M. Ward. Sketch No. 7, Fifth Prize, Won by Mr. J. A. Walter Ransom. Sketch No. 3, First Honorable Mention, Awarded to Mr. Lenard F. Howard. Sketch No. 9, Second Honorable Mention, Awarded to Mr. G. Bonhag. Sketch No. 1, Third Honorable Mention, Awarded to Mr. L. C. Craddock.

# Awards of Our Cover Prize Contest

IN our April issue we announced our \$100.00 cover prize contest.

As it will be remembered, on account of our big radio shower party, it became necessary to mutilate our cover design for which we apologized and to show that we really meant it, we offered \$100.00 in prizes for the best suggestion of the hidden design of this cover.

Well, the contest was a howling success. It also showed us something we did not know before; namely that many of our readers, not only 100, but thousands, seem to be budding artists, who know how to wield the pencil as well as the brush.

A total of 2,856 designs and illustrations were submitted, the greater majority of the entries being accompanied by designs. But there was the usual fly in the ointment. Most of the contributors did not take the trouble to read our conditions and we reprint the following from the April issue:

"Cut out a piece of white paper and put it over the circle in our printed cover. Then

draw a picture giving your version of the Radio Romeo."

The result was that the greater majority sent in designs that were substantially the same as our artist's original, which was used on our May cover. This, however, was not at all what we wanted. We wanted a different design, *not the one which was obvious and logical*. For that reason we said that we wanted your version of the Radio Romeo.

In awarding the prizes, we have been guided by originality and humor and we trust that everyone is satisfied. Those who in advance duplicated our own Radio Romeo may feel consoled by the fact that they had guessed our own version correctly. We are glad to say that there were a great many hundreds who, without ever having seen the design printed a month later on the May cover, came marvelously close to the original.

We thank our readers for the great interest they have shown in the contest.

## Prize Winners

- FIRST PRIZE, \$50  
L. B. Robbins, Harwich, Mass.
- SECOND PRIZE, \$20  
A. B. Fogle, 705 Miller Ave., Shelbyville, Ind.
- THIRD PRIZE, \$15  
G. E. Mitchell, 3330 Eastside Ave., Cincinnati, O.
- FOURTH PRIZE, \$10  
Mrs. Cora M. Ward, R. F. D. 6, Schenectady, N. Y.
- FIFTH PRIZE, \$5  
J. Walter Ransom, 41 Carlisle St., Hanover, Pa.
- FIRST HONORABLE MENTION  
Lenard F. Howard, 983 W. 6th St., Los Angeles, Calif.
- SECOND HONORABLE MENTION  
George Bonhag, 229 North 19th St., East Orange, N. J.
- THIRD HONORABLE MENTION  
L. C. Craddock, East 1028 Mission Ave., Spokane, Wash.

## Results of the Radio Shower Party

AFTER considerable delay and labor on the part of the judges, we are at last ready with the results of the Radio Shower Party. Since thousands responded, we were unable to award all the prizes in time for the publication of the complete list of winners in the July issue of RADIO NEWS.

Due to the fact that not many listeners in the distant zones were able to pick up

Broadcasting Station WJZ, the answers from these points were few. This left a number of unused prizes in the 4th, 5th, 6th, 7th, 8th, 10th, 11th and 12th zones. In order to make use of these, the list of prizes of the 2nd zone were rearranged and the left-over prizes of the other zones included. This was done because of the tremendous response from the 2nd zone. This revised list is published below, together with

the names and addresses of the winners. The lists of prizes for the other zones are unchanged in their order, as published in our April issue.

There is no doubt that the Radio Shower Party met with great success. We are in hopes that all who participated will be satisfied. The judges did their best in making the awards and feel that each and every decision was justifiable.

## Prize Winners

- | ZONE 1 |  | Prize  | Prize   | Prize |  |
|--------|--|--------|---|-------|--|
| 1st    | L. Cleveland, 57 Richmond Ave., Worcester, Mass.         | 37th   | Miss E. M. Rice, 143 Mass. Ave., Suite 6, Boston 17, Mass.    | 15th  | B. Manning, 60 N. Columbus Ave., Mount Vernon, N. Y.                                     |
| 2nd    | H. Reichard, Manchester Green, Manchester Green, Conn.   | 38th   | A. Worth, 102 Main St., Nantucket, Mass.                      | 16th  | K. M. Swezey, 159 Milton St., Brooklyn, N. Y.  |
| 3rd    | M. Coffin, Box 682, Groveland, Mass.                     | 39th   | F. A. Rowe, Church St., Manchester, Mass.                     | 17th  | J. Bister, 141 E. Post Rd., Mamaroneck, N. Y.  |
| 4th    | E. J. Guillemette, 98 Monroe St., Norwood, Mass.         | 40th   | R. A. White, 182 Pearl St., Holyoke, Mass.                    | 18th  | V. R. Grobholz, 327 Woodward St., Jersey City, N. J.                                     |
| 5th    | Wesley C. Newcomb, Auburn, N. Y.                         | 41st   | L. Cowles, 100 Lodge Rd., Burlington, Vt.                     | 19th  | C. Peterson, 53 Elysian Ave., Nyack, N. Y.   |
| 6th    | A. E. Sinell, 207 Holden St., Worcester, Mass.           | 42nd   | W. G. Hazard, 35 Greenough Ave., Jamaica Plain, Mass.         | 20th  | R. T. Shinn, P. O. Box 1225, Belmar, N. J.   |
| 7th    | J. D. Guillemette, 11 O, 70 Magill St., Pawtucket, R. I. | 43rd   | P. C. Michel, R.D. No. 1, W. Suffield, Conn.                  | 21st  | H. G. Elliott, Jr., Camp Alfred Vail, Oceanport, N. J.                                   |
| 8th    | W. S. Atwood, 10CUH, 80 Sea St., New Haven, Conn.        | 44th   | R. B. Waterhouse, P.O. Box 92, Bourne, Barnstable Co., Mass.  | 22nd  | L. H. Odell, General Delivery, Glen Echo, Md.  |
| 9th    | E. R. Edgecomb, 14 Hempstead Ct., New London, Conn.      | 45th   | J. E. Frisbee, Portsmouth, N. H.                              | 23rd  | J. H. Smith, 1315 Harvard St., N.W., Washington, D. C.                                   |
| 10th   | Geo. Olson, 18 Frank St., Stamford, Conn.                | 46th   | A. Simard, 14 Rockdale Ave., Lowell, Mass.                    | 24th  | C. A. Jacoby, 57 Park Terrace, West Orange, N. J.  |
| 11th   | H. J. Baker, 584 Columbia Rd., Dorchester, Mass.         | 47th   | S. W. Trippie, 24 Holmes Ct., Portsmouth, N. H.               | 25th  | Mrs. Mary E. Latsey, 587 Riverside Dr., New York City.                                   |
| 12th   | E. S. Pack, Briggs Corner, Attleboro, Mass.              | 48th   | R. C. Arnaud, Greenfield, Mass.                               | 26th  | K. R. Van Tassel, 99 N. Genesee St., Geneva, N. Y.                                       |
| 13th   | E. J. Mumroe, 120 Waterman Ave., East Providence, R. I.  | 49th   | W. T. Dungan, 68 New Britain Ave., Hartford, Conn.            | 27th  | J. R. Flaherty, 1058 E. 98th St., Brooklyn, N. Y.  |
| 14th   | C. W. Radoslovich, 16 Perth Rd., Arlington 75, Mass.     | 50th   | W. C. Crooks, Pascoag, R. I.                                  | 28th  | E. Kiefer, Northport, L. I., N. Y.   |
| 15th   | E. von Szupping, 276 Orchard St., Bridgeport, Conn.      | 51st   | E. Kauth, Lakewood, R. I.                                     | 29th  | E. V. Hard, 1089 Delaware Ave., Buffalo, N. Y.   |
| 16th   | E. H. Clask, 29 Linden St., E. Hartford, Conn.           | 52nd   | Miss E. T. Wilson, 61 Morgan St., New Bedford, Mass.          | 30th  | J. Rosati, 943 E. 229th St., New York City.  |
| 17th   | I. O. Miner, Spring St., E. Greenwich, R. I.             | 53rd   | A. R. Nichols, Cowesett, R. I.                                | 31st  | A. J. Banks, 2020 Lawrence St., N.E., Washington, D. C.                                  |
| 18th   | E. E. Davis, Sagamore, Mass.                             | 54th   | E. Z. Lane, Mechanic Falls, Me.                               | 32nd  | J. F. Dobson, Jr., 95 Driscoll Ave., Rockville Center, L. I., N. Y.                      |
| 19th   | Mrs. C. C. Alvord, 441 Pleasant St., Worcester, Mass.    | 55th   | G. W. Brown, 6 Peters St., S. Boston, Mass.                   | 33rd  | F. Graves, Andover, Andover, N. Y.   |
| 20th   | D. E. Docekal, 550 Mechanic St., Fitchburg, Mass.        | 56th   | V. A. Perkins, 53 State St., Brewer, Me.                      | 34th  | J. E. Haway, Box 124, Katonah, N. Y.   |
| 21st   | J. M. Osborne, 49 Mountfort St., Suite 3, Boston, Mass.  | 57th   | L. Van Derlip, 40 Orchard St., W. Hartford, Conn.             | 35th  | O. W. Homestead, 454 43rd St., Brooklyn, N. Y.   |
| 22nd   | P. A. Chadwick, 251 Cedar St., Bridgeport, Conn.         | 58th   | J. G. Park, Main St., Groton, Mass.                           | 36th  | E. C. Walter, 126 W. 129th St., New York City.   |
| 23rd   | W. Balch, 46 Green St., Hudson, Mass.                    | 59th   | T. Gretchell, 6 Cedar St., Plainville, Conn.                  | 37th  | H. B. Phelps, Buck Dorm., R.P.I., Troy, N. Y.  |
| 24th   | Bert Rinck, 54 Washington Ter., Bridgeport, Conn.        | 60th   | R. J. Enscoe, 180 Newhall St., New Haven, Conn.               | 38th  | E. J. Green, 34 Carroll Ave., Takoma Park, Washington, D. C.                             |
| 25th   | H. Schroeder, 23 Walker St., Salesville, R. I.           | ZONE 2 |   |       |  |
| 26th   | I. C. Geer, 11 1/2 Pratt Ave., Beverly, Mass.            | 1st    | J. C. Dimmock, 1640 Macombs Rd., New York City.               | 39th  | H. P. Truessedell, 29 Mountain Ave., Summit, N. J.                                       |
| 27th   | R. H. Given, care Island Falls Garage, Island Falls, Me. | 2nd    | J. E. Porter, 101 You St., N. W., Washington, D. C.           | 40th  | J. A. Cahill, 823 Washington St., Hoboken, N. J.   |
| 28th   | H. L. Andrews, 242 Waban Ave., Waban, Mass.              | 3rd    | R. Batcher, 745 So. 158th St., Jamaica, L. I., New York.      | 41st  | C. C. Odell, Fredonia, N. Y.   |
| 29th   | G. U. Anderson, Waterbury, Conn.                         | 4th    | R. D. Zucker, 507 Main St., Union Hill, N. J.                 | 42nd  | Nathan Pfeffer, 2132 Daly Ave., The Bronx, New York City.                                |
| 30th   | H. J. Mackin, 208 Hurd Ave., Bridgeport, Conn.           | 5th    | C. G. Schultz, 30 North Mountain Ave., Montclair, N. J.       | 43rd  | S. T. Dickinson, Lieut. Pay Corps, U. S. N., P. O. Box 113, Times Plaza, Brooklyn, N. Y. |
| 31st   | S. D. Parsons, Box 86, N. Gorham, Me.                    | 6th    | J. P. Hughes, 3309 Park Ave. (Apt. 4M), New York City.        | 44th  | Mrs. W. Koenig, 45 Smith St., Paterson, N. J.  |
| 32nd   | J. E. Bates, 86 Maple Ter., Mittineague, Mass.           | 7th    | Lawrence Abselon, Front Ave., Bronxville, N. Y.               | 45th  | Jacob A. Buckwalter, care Independent, Collegeville, Pa.                                 |
| 33rd   | D. Fine, 226 Smith St., R.F.D. No. 3, Attleboro, Mass.   | 8th    | J. F. Swan, Box 285, Seneca Falls, N. Y.                      | 46th  | J. Henry, 14 Cross St., West Orange, N. J.   |
| 34th   | E. L. Scott, 647 Broadway, E. Providence, R. I.          | 9th    | De Witt Stetten, Jr., 115th W. 87th St., New York City.       | 47th  | H. W. Holcombe, 144 W. Fourth St., New York City.  |
| 35th   | E. F. Weston, Holliston, Mass.                           | 10th   | J. E. Diamond, 40 Crary Ave., Mount Vernon, N. Y.             |       |  |
| 36th   | G. E. Allen, Hazardville, Conn.                          | 11th   | R. Washburne, 100 Watching Ave., Plainfield, N. J.            |       |  |
|        |  | 12th   | H. O. Wassmann, 14 W. Lincoln Pl., Freeport, N. Y.            |       |  |
|        |  | 13th   | O. E. Roberts, Jr., 813 Ingraham St., N.W., Washington, D. C. |       |  |
|        |  | 14th   | H. M. Klotz, 600 W. 174th St., New York City.                 |       |  |

(Continued on page 203)



## Apparatus Awarded Certificates

### NOVO "B" BATTERY

This "B" battery, which is manufactured by the Novo Manufacturing Co., of 424-438 W. 33rd Street, New York City, comprises 15 of the large type cells giving a total voltage of 22.5. The cells are enclosed in a heavy paper box and sealed in with sealing wax, thus protecting the cells from moisture and prolonging the open circuit life of the battery. Standing idle for two months, the voltage remained constant at 22.5. When

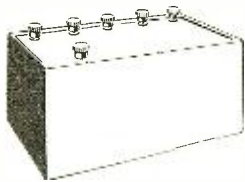

placed on a 10-milliampere discharge rate, the voltage dropped to 22. At the end of 48 hours the voltage dropped to 18.5 and the current to 8 milliamperes, representing a total of 8.38 watt hours. On opening the circuit, the voltage increased to 19 and after standing idle for one day, the voltage rose to 20. There are 1½-volt taps from 16.5 volts to 22.5 volts. Each tap is provided with an insulated binding post cap so that there is little possibility of accidentally short circuiting the battery.

Arrived in excellent packing.  
AWARDED THE RADIO NEWS LABORATORIES CERTIFICATE OF MERIT NO. 168.

### MAGNAVOX LOUD TALKER

The Magnavox loud talker is of the electro dynamic type, comprising a movable coil attached to a metal diaphragm. The movable coil is placed in a powerful magnetic field, which is furnished by



an electromagnet energized by a 6-volt battery. Telephonic currents flowing through the movable coil cause it to vibrate up and down, perpendicular to the magnetic lines of force of the magnetic field. The movement of the coil is limited only by the elastic limit of the diaphragm, there being no pole tips to strike, as in the case of many other types

of loud talkers. This accounts for the great amount of volume possible from this instrument. The impedance of the movable coil is very low, so that a step down transformer is used between the output of the amplifier and the movable coil. The electromagnet or field winding consumes one ampere at six volts. As high as 2,000 milliamperes of telephonic current may pass through the movable coil without injuring the instrument. When connected to our audibility meter and standing 6' from the horn, the sensitivity of the instrument was found to be greatest between frequencies of 360 and 3,800 cycles per second. The greatest sensitivity was found at 2,200 cycles, at which frequency the sound was just audible when the instrument was energized from a source of 22 microvolts. It required 4,000 microvolts to produce an audible sound at 160 cycles and 420 microvolts at 2,850 cycles. At 4,700 cycles only 126 microvolts were required to produce an audible sound, which indicates that this frequency must be near the resonance frequency of the diaphragm. The sensitivity was found to be practically constant within the above limits, which is necessary in order to avoid distortion. The sensitivity was about the same as that of other loud talkers of different makes. A metal horn is used, which is heavily coated with a "crystalline" finish which dampens out metallic sounds.

This instrument is manufactured by The Magnavox Company, 2701 East 14th Street, Oakland, Cal.

Arrived in excellent packing.  
AWARDED THE RADIO NEWS LABORATORIES CERTIFICATE OF MERIT NO. 167.

### THE PORTENA LOOP AERIAL

The unique feature of this loop antenna, manufactured by J. Nazeley, Palisade, N. J., is the method in which it can be folded and packed in its tubular container, making it ideal for portable use. The antenna, when opened, snaps into place and can be set in the heavy metal support, which also acts as a cover for the tubular container when folded. There are 16 turns of wire, spaced about ½". The outside of the loop measures 20" on each side.

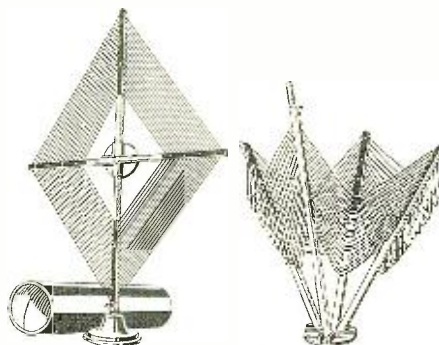

When shunted by a 23-plate variable condenser, the circuit responded to a wavelength range of from 190 meters to 650 meters, thus covering all the amateur and broadcast stations' wave-lengths. This loop is called the "Portena" by the manufacturer.

AWARDED THE RADIO NEWS LABORATORIES CERTIFICATE OF MERIT NO. 184.

### KELLOGG V.T. SOCKET

The vacuum tube socket shown in the illustration is of moulded red bakelite, with phosphor bronze contact springs, insuring

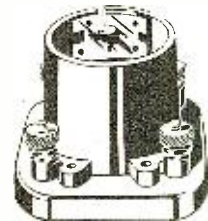

tight contact with the prongs of the vacuum tube. The unique feature of this socket is the method in which the moulded material is strengthened at the slot in the side of the socket. Many sockets are weak at this point and break, while this socket is strengthened by means of a metal insert moulded into the material.

Arrived in excellent packing.  
AWARDED THE RADIO NEWS LABORATORIES CERTIFICATE OF MERIT NO. 182.

### KELLOGG HEADSET

The Kellogg Switchboard & Supply Company, Adams and Aberdeen Streets, Chicago, Ill., has submitted for test the head-set which is shown in the illustration. This head-set we found to have a total resistance of 2,584

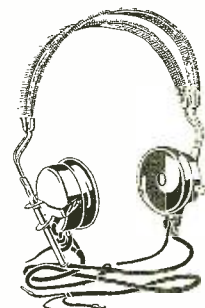

ohms, and was found to be very sensitive to frequencies ranging from 200 to 4,700 cycles per second, which include practically all of the audio frequencies used in modern broadcast receiving. In addition to being sensitive to weak signals, the head-set would also reproduce loud signals and music without distortion or rattling. The diaphragm is of small diameter and the pole tips are small, measuring ¼x⅛". The phones are the standard two-pole type. The head-band is so designed that the head-set can be worn with comfort.

Arrived in good packing.  
**AWARDED THE RADIO NEWS LABORATORIES CERTIFICATE OF MERIT NO. 170.**

**SOMERVILLE KNOB AND DIAL**

The metal dial shown in the illustration, which is manufactured by the Somerville Radio Laboratory, 176-178 Washington

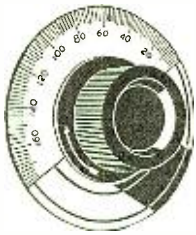

Street, Boston, Mass., is unique in that it is silver plated with a satin finish, so that station call letters or other notes can be marked directly on the dial. This will facilitate tuning in stations which were previously received and marked on the dial. Both 3" and 4" diameter dials were submitted. The knob is of moulded insulating material and fitted with a set screw for mounting on a shaft. The scale is distinctly stamped in black in the metal.

Arrived in good packing.  
**AWARDED THE RADIO NEWS LABORATORIES CERTIFICATE OF MERIT NO. 171.**

**TAIT KNOB AND DIAL**

This knob and dial, which are manufactured by the Tait Knob & Dial Co., 11 East 42nd Street, New York City, differ from the usual construction in their method of attaching to a shaft. There is a chuck arrangement, similar to that used on many drills, which fits over the shaft, after which the knob is screwed tight which clamps the knob and dial to the shaft, thus preventing slipping and insuring perfect alignment. No set screws are used. Both knob and dial are of moulded insulating material, with a scale

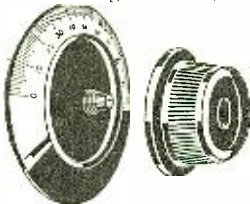

plainly marked on the dial. The dial submitted was 4" in diameter.

Arrived in good packing.  
**AWARDED THE RADIO NEWS LABORATORIES CERTIFICATE OF MERIT NO. 173.**

**BELL KNOB AND DIAL**

The Bell Mfg. Co., 11 Elkins Street, Boston, Mass., has submitted for test the 3 1/2" dial shown in the illustration. This dial is of excellent moulded insulating material, and arranged to be attached to a shaft by means of a set screw, threaded in a metal bushing which is moulded in the knob. The construction is very accurate, insuring perfect alignment between the dial and the panel and shaft upon which it is mounted. The scale is clearly engraved on the dial.



Arrived in good packing.  
**AWARDED THE RADIO NEWS LABORATORIES CERTIFICATE OF MERIT NO. 175.**

**RICO TRI-POLE HEAD-SET**



The well-known tri-pole head-set, which is manufactured by the Radio Industries Corporation, 131 Duane Street, New York City, was found to be very sensitive to weak signals, and would also reproduce the loud signals and music with great volume and without distortion or rattling. The salient features of these phones are the simple magnetic system and the arrangement providing for adjusting the distance between the diaphragm and the pole tips. This is accomplished by means of a soft rubber washer placed under the diaphragm, which flattens out as the cap is tightened. There are three poles in each phone, one at the center which contains the winding, and two of opposite polarity from the center pole located diametrically opposite each other at the edge of the diaphragm. The cord is marked in order that the phones may be connected so that the current flowing through the magnet winding will assist the permanent magnetic field of the phones. They are made in 2,000, 3,000 and 4,000-ohm resistance. The 2,000-ohm phones were found to have a resistance of 2,026 ohms. The head-band is so constructed that the head-set can be worn comfortably.

Arrived in excellent packing, with instruction sheet enclosed.

**AWARDED THE RADIO NEWS LABORATORIES CERTIFICATE OF MERIT NO. 172.**

**WESKEN HEAD-SET**

This head-set, submitted by Stevenson Brothers Sales & Engineering Co., Finance and Richlord Streets, Pittsburgh, Pa., is very small in size and was found to be extremely sensitive to weak signals. It would also reproduce loud signals and concerts, loud enough to fill a large room with sound, without distortion or rattling. The resistance was found to be 2,982 ohms. Tests were made at frequencies ranging from 200 to 4,700 cycles per second. The diaphragm is clamped directly on a metal back, thus preventing any changes in the distance between



the diaphragm and pole tips, due to unequal expansions from changes in temperature. The diaphragm is 1 13/16" in diameter and the pole tips 1/4 x 1/8". The phones are of standard construction, employing two poles at the center of each phone. The shell and cap are of moulded material.

Arrived in good packing.  
**AWARDED THE RADIO NEWS LABORATORIES CERTIFICATE OF MERIT NO. 174.**

**FROST HEAD-SET**

H. H. Frost Company, 154 W. Lake Street, Chicago, Ill., submitted samples of both 2,000 and 3,000-ohm phones for test. These phones are shown in the illustration and are of moulded material and of stand-

ard construction, employing two poles at the center of each phone. The pole tips measure 1/4 x 1/2". The sensitivity was measured at frequencies ranging from 200 to 4,700 cycles per second. The 2,000-ohm phones were slightly more sensitive than the 3,000-ohm phones. The phones would reproduce loud signals without distortion. The resistance of the 2,000-ohm phones was found to be

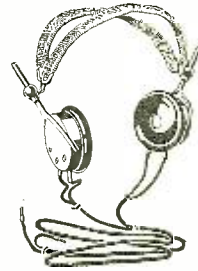

2,110 ohms, and the 3,000-ohm phones, 3,099.

Arrived in good packing.  
**THE 2,000-OHM PHONES ARE AWARDED THE RADIO NEWS LABORATORIES CERTIFICATE OF MERIT NO. 176.**

**THE 3,000-OHM PHONES ARE AWARDED THE RADIO NEWS LABORATORIES CERTIFICATE OF MERIT NO. 177.**

**STROMBERG-CARLSON HEAD-SET**

The 2,000-ohm head-set shown in the illustration was found to have a resistance of 2,106 ohms and was very sensitive to weak signals at frequencies ranging from 200 to 4,700 cycles per second. Loud signals were also reproduced without distortion. The shells are of moulded construction. The phones are of the conventional design, having two poles at the center. The pole tips are slotted in two places. The head-band is so designed that the phones may be worn with comfort, and can be clamped on



the ears tightly so as to exclude external noises. These phones are manufactured by the Stromberg-Carlson Telephone Mfg. Co., Rochester, N. Y.

Arrived in good packing.  
**AWARDED THE RADIO NEWS LABORATORIES CERTIFICATE OF MERIT NO. 181.**

**DICTOGRAPH HEAD-SET**

The 3,000-ohm phones shown in the illustration, which are manufactured by the Dictograph Products Corporation, 220 West 42nd Street, New York City, were found to be extremely sensitive to weak signals and also reproduced the loud signals with-



out distortion or rattling. The phones are small in size, having diaphragms 1 1/13" in diameter. The pole tips measure 1/4 x 1/8".

(Continued on page 225)



### RADIO METHOD AND APPARATUS

(Patent 1,447,165, issued to Frederick A. Kolster, of Washington, D. C., Feb. 27, 1923.)

This invention relates to apparatus for transmitting or receiving electro-radiant energy or electro-magnetic waves for the transmission of intelligence, as for telegraphy or telephony, or for signaling in general, or for any other purpose.

This invention resides in apparatus of the character referred to comprising a closed circuit whose distributed capacity and inductance are preferably very small or substantially nil, the closed circuit, and particularly the inductance or coil therein, operating as a capacity area connected through tuning apparatus, as variable inductance, with the earth or any counterpoise capacity.

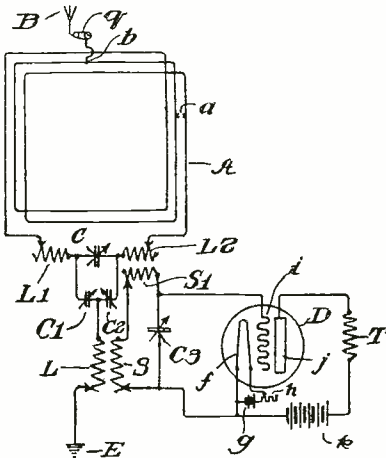

Receiving apparatus embodying this invention is an absolute direction finder or a true radio compass whereby the location of a source of radiant energy may be determined. Such receiving apparatus serves also as an excellent interference preventer, that is, for permitting reception of signals from a desired station to the exclusion of signals from other stations differently located with respect to the receiving station, and to the exclusion of atmospheric or natural electrical effects.

Transmitting apparatus embodying this invention has the property of not only transmitting energy of greater intensity in some directions than others, but has also the property of causing transmission of energy of great intensity in a

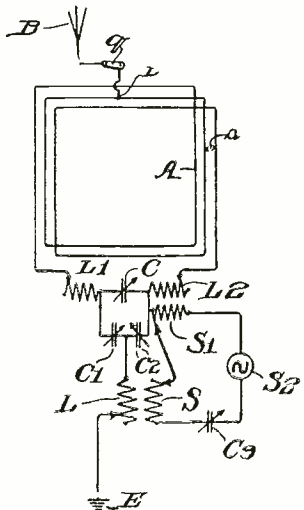

desired direction, and no or practically no energy in opposite direction.

There are shown two diagrammatic views of modified receiving and transmitting apparatus embodying this invention.

### RECEIVING SYSTEMS FOR RADIANT ENERGY

(Patent 1,439,363, issued to John Hays Hammond, Jr., of Gloucester, Mass., Dec. 19, 1922.)

This invention relates to an insulator for supporting an antenna upon a marine vessel, such as a submarine or submersible torpedo. There are

provided means, controlled by the insulator, for short-circuiting a signal controlled circuit, making it unresponsive to signals, when a wave or water

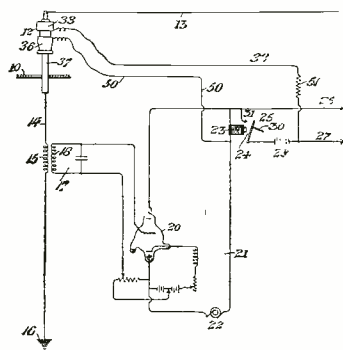

submerges the antenna support, and to restore normal operating conditions when the antenna support is out of contact with the water or wave. This pertains as well to systems wherein signals are transmitted for the operation of the control mechanism, for purposes of steering a torpedo or submarine, where, in such cases, it has been found that a wave washing over the antenna would break the said signal into two component parts, thus giving the wrong signal for the control mechanism. The main purpose of this invention is to insure a signal being broken into two or more separate signals through the action of waves.

### METHOD AND APPARATUS FOR SELECTIVITY TRANSFERRING ELECTRICAL OSCILLATORY ENERGY

(Patent 1,438,828, issued to Harry W. Houck, of New York, N. Y., Dec. 12, 1922.)

This invention relates to a method and apparatus for transferring efficiently electrical oscillatory energy from one electrical system or circuit to another system or circuit without attenuation in such a manner as to simultaneously transfer electrical oscillations of any or all frequencies lying within a predetermined broad band of frequencies.

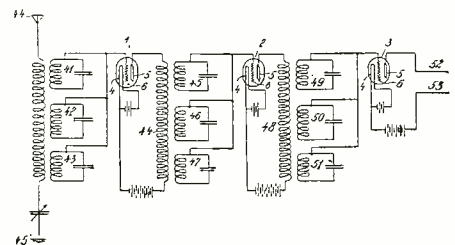

To this end the principle of resonance is utilized and it is expanded in accordance with this invention to provide what will be termed a sharply tuned electrical system for a broad band of frequencies, in contra-distinction to the usual sharply tuned system for a given frequency, or an extremely narrow band of frequencies, or to the well known so-called broadly tuned systems. The expansion of resonance in accordance with this invention is accomplished by the use of a plurality of serially arranged electrically associated tuned oscillatory circuits, each of which is resonant to a given frequency, but whose collective effective resonance range includes or equals a broad band of frequencies. By interposing, coupling or linking the serially associated tuned oscillatory circuits with the source of electrical oscillatory energy, all electrical oscillations of frequencies lying within the effective resonance range of the tuned circuits will be transferred to the system or circuits electrically associated with tuned circuits without attenuation.

The invention may be utilized in connection with the generation, transmission and reception of electrical oscillatory energy, or, in the amplification of the received energy in wave signaling systems, it being particularly adaptable for this use.

### METHOD AND ELECTRIC CIRCUIT ARRANGEMENT FOR NEUTRALIZING CAPACITY COUPLING

(Patent 1,450,080, issued to Louis A. Hazeltine, of Hoboken, N. J., March 27, 1923.)

This invention relates to the neutralizing of capacity coupling between two electric circuits,

which capacity coupling results in the transmitting of undesirable disturbances from one circuit to the other.

It has long been known from practical experience that the presence of capacity coupling between the primary and secondary circuits of a radio receiver results in the transmitting of undesired signal oscillations, particularly those of short

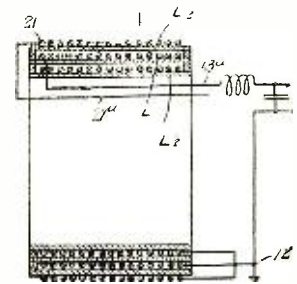
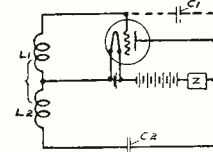

wave-length, from the primary to the secondary circuit. This reduces the selectivity of the receiver and frequently prevents the reception of the desired signal, which is drowned out by a more powerful signal of a different wave-length.

This invention is directed to the elimination of the undesirable effects of capacity coupling between two circuits such as are described in the foregoing examples. This is accomplished briefly as follows: An auxiliary circuit is provided which is electromagnetically coupled to one of the two original circuits which we will call the first circuit, and capacitively coupled to the other, or second circuit. If a disturbing voltage then exists in the second circuit, it will cause currents to flow both in the first circuit and in the auxiliary circuit, due to the capacity couplings. The electro-magnetic coupling between the auxiliary circuit and the first circuit is then arranged so that the magnetic effects of these two circuits will neutralize one another and so will result in no voltage across the first circuit. Conversely, if a disturbing voltage exists in the first circuit, it will result in no voltage across the second circuit, by the well known reciprocal properties of electric circuits.

The arrangement of the auxiliary circuit will depend on the forms of the original circuits. In some cases it is necessary to add coils or capacities to the original circuits to provide the required couplings, while in other cases the couplings may be obtained from coils present for other purposes or from inherent capacities.

### RADIO COMMUNICATION

(Patent 1,440,834, issued to Charles V. Logwood, Chicago, Ill., Jan. 2, 1923.)

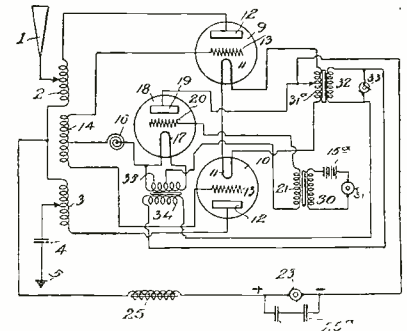

This invention relates to radio communication, and is particularly directed to systems that are employed for the transmission of signals through the medium of high frequency currents. The objects of the invention are to provide a signalling system which is simple and efficient and economical in manufacture, as well as the systems of the character set forth, wherein the electrical power of

(Continued on page 190)





## Leviathan To Have Most Modern Radio Installation

**E**CLIPSED only in importance by her powerful machinery and delicate controls, the radio installation aboard the *Leviathan*, which re-entered the trans-Atlantic service in the month of June flying the U. S. Line's flag, is now the most powerful and elaborate steamship radio equipment in the world. The contract to equip the *Leviathan* with a super-power marine radio installation was recently signed with the U. S. Shipping Board by the Radio

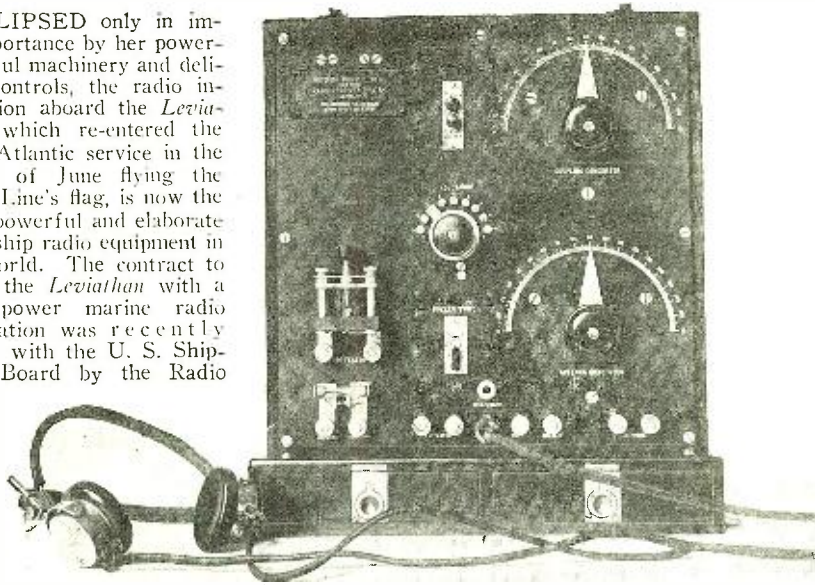

The Type of Receiving Set Installed in the Life-Boats of the *Leviathan*. These Were Especially Built by the Independent Co., for This Purpose.

Corporation of America. This gives to America the distinction of radio supremacy upon the seas.

Once a transporter of American doughboys and now a palatial hotel, the *Leviathan's* radio equipment will enable her passengers to exchange messages with two continents regardless of her position on the high seas. With equipment six times as powerful as that carried by the average ocean greyhound, uninterrupted communication with points 3,000 miles distant is assured. Upon leaving her berth in New York Harbor, the *Leviathan's* radio officers will be able to link the huge vessel with various marine centers in Europe and to communicate with America when leaving European ports.

In addition to telegraph service, a radio telephone installation which will provide voice contact with other vessels and shore stations is also to be installed. While it is not expected that a commercial telephone service will be inaugurated immediately upon the *Leviathan* going into commission, it is quite probable that shore stations will, in the no distant future, be erected to handle wireless telephone traffic from ships in mid-ocean to points inland over the conventional land line system. When such arrangements have been made passengers and officers on vessels at sea may establish contact with those on shore at their homes or offices and speak with them with the same facility and ease that accompanies an ordinary telephone conversation.

Aside from its commercial importance, the protection of life at sea is the chief function of marine radio service. That this vital function be performed with a degree of re-

liability exceeded by no other vessel afloat, the installation on the *Leviathan* will permit simultaneous communication by telephone and telegraph. A special emergency set will also be installed. Thus, should one or two sets become imperative due to a mishap, the third or emergency set may be relied upon to summon assistance. Furthermore, two of the life boats are fitted with emergency radio apparatus.

The principal transmitter consists of a high-power vacuum tube outfit which will deliver to the main antenna about six times as much power as the apparatus now used on the average steamship. A rapid transfer switch will enable the operator to shift the wave-length of this transmitter in an instant. The second is a duplex telephone outfit which will permit simultaneous telephone and continuous wave telegraph communication. The third or emergency sending equipment is a standard spark set which will normally operate on 600 meters. Several super-sensitive vacuum tube receivers will be used for reception.

### Lifeboat Radio On the Leviathan

By CLAUDE CATHCART LEVIN

**T**HE *Leviathan* in addition to being equipped with the most modern radio apparatus on any merchant ship in the world will have two of her lifeboats fitted with transmitting and receiving apparatus equal to that fitted on many vessels as the

main unit. The apparatus on both boats is identical so that a description of the installation on one will suffice for both. The boat is not an ordinary lifeboat but is 50' long with an inclosed top and sides with two masts spaced 25' apart.

The lifeboat which is motor driven is divided into several water-tight compartments, in the mid ship one of which is located the radio apparatus. This boat and its sister is designed to tow the rest of the *Leviathan's* lifeboats, in case of disaster. Undoubtedly, the captain will have charge of one of these, should it be necessary to abandon ship. The compartment in which the apparatus is situated contains in addition, only an operating table which has been specially built and a chair for the operator. The Morse key is mounted on the table in the regular manner.

The transmitting apparatus consists of a  $\frac{1}{2}$  K.W. panel quenched gap transmitter made by the Independent Wireless Telegraph Co. It is three feet high by eighteen inches wide, both ways, and is of the C. & W. impact type being mounted on the operating table. The motor which is specially wound for 32 volts is located underneath the table. A separate compartment houses the bank of six 32-volt Edison cells which will keep the set in operation for four hours. Leads come through the steel bulkhead to the motor. The batteries are charged by means of Keroel generating unit which runs independently of the main propulsion motor of the boat. The receiver has been especially built by the Independent Co. for this installation.

The antenna is unique in that it stretches from the bow to the top of the forward mast to the after mast and down to the stern. Its four wires begin at the bow at a single point and diverge to the mast head where they run parallel for the 34' distance between the masts and then converge to a single point at the stern. The apparatus radiates two amperes on 600 meters and four amperes on 300 meters. At a test recently held at the ship yard in Newport News, the messages sent out were heard 170 miles away. The entire installation was inspected by representatives of the United States Shipping

(Continued on page 188)

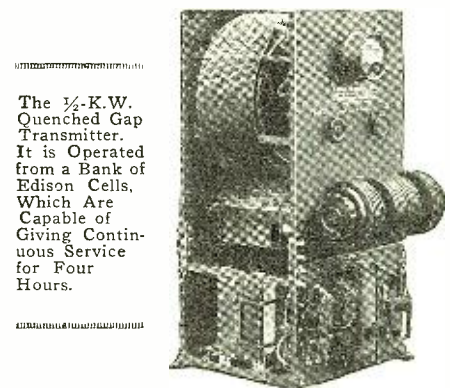

The  $\frac{1}{2}$ -K.W. Quenched Gap Transmitter. It is Operated from a Bank of Edison Cells, Which Are Capable of Giving Continuous Service for Four Hours.



**T**HIS Department is conducted for the benefit of our Radio Experimenter. We shall be glad to answer here questions for the benefit of all, but we can publish only such matter as is of sufficient interest to all.

1. This Department cannot answer more than three questions for each correspondent.
2. Only one side of the sheet should be written upon; all matter should be typewritten or else written in ink. No attention paid to penciled matter.
3. Sketches, diagrams, etc., must be on separate sheets. This Department does not answer questions by mail free of charge.
4. Our Editors will be glad to answer any letter, at the rate of 25c for each question. If, however, questions entail considerable research work, intricate calculations, patent research, etc., a special charge will be made. Before we answer such questions, correspondents will be informed as to the price charge.

You will do the Editor a personal favor if you will make your letter as brief as possible.

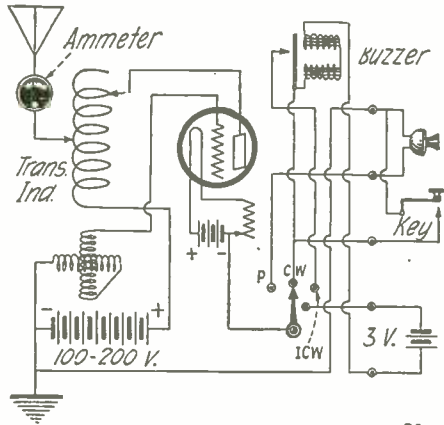

Here is a Good Circuit for a Low-Power Phone, I.C.W., and C.W. Transmitter. This is Similar to the Paragon 5-Watt Transmitter.

Q-720

**INDUCTION**

(718) Mr. Wm. J. Moulton, Acushnet, Mass., writes:  
Q. 1. I cannot understand how the current gets from the stator to the rotor of a variocoupler when there is no electrical connection. Please explain.

A. 1. This is what is known as induction. Any wire carrying current has a magnetic field, known as lines of force, surrounding it. If a wire or any conductor is drawn rapidly through these lines of force, a current is induced in the wire. As an alternating current is flowing in the primary of the variocoupler, the lines of force are expanding and collapsing in unison with the alternations of the current. When this happens it is equivalent to moving the secondary through stationary lines of force. When the magnetic field expands and collapses, it is cut by the stationary wire of the secondary, thus generating a current in the secondary winding. For a full explanation of induction we refer you to standard textbooks on radio.

**TUBES FOR FLEWELLING CIRCUIT**

(719) Mr. L. H. Montgomery, Jr., Nashville, Tenn., asks:

Q. 1. Please mention which tube is most successful in the Flewelling circuit.

A. 1. Any hard tube may be used in this circuit, but an amplifying tube would give best results. We would suggest the UV-201-A or the VT-2.

**5-WATT TRANSMITTER**

(720) Mr. H. L. Pearson, St. Louis, Mo., requests:

Q. 1. Kindly publish a hook-up similar to the Paragon 5-watt transmitter. This can be used as a C.W., I.C.W., or phone transmitter.

A. 1. This hook-up will be found in these columns.

**TAPPED H. C. COILS**

(721) Mr. John D. Flewelling, Jr., Union City, Mich., asks:

Q. 1. Can a honeycomb coil be tapped? If so, how many taps should there be on a coil of 25 turns?

A. 1. A honeycomb coil can be tapped by soldering leads at certain intervals, on the side of the coil. This can be done with advantage with a large coil, but for one of 25 turns it would not be necessary.

**DATA ON WAVE TRAP**

(722) Mr. H. O. Ten Eyck, Bethlehem, Pa., wants to know:

Q. 1. What size wire and tube, and how

many turns, should be used with a condenser of .001 mfd. capacity, for the construction of a wave-trap?

A. 1. This would depend upon the wave-length for which the wave-trap is desired. We presume that a trap for the broadcast wave-length is desired. This is constructed by winding 45 turns of No. 24 S.C.C. wire on a 3" tube. Shunted by a variable condenser of .001 mfd. it will respond to wave-lengths from 220 to 600 meters.

**R. F. WITH STANDARD REGENERATIVE RECEIVER**

(723) Mr. F. H. Manning, Portsmouth, Ohio, asks:

Q. 1. Please show the hook-up of Q. 616, in the March issue, with one stage of radio frequency added.

A. 1. It is not advisable to add only one stage of R. F. to a receiver using a variometer for regeneration, as the results obtained will be no better, as regeneration is sacrificed in this circuit. At least two stages would be needed before any improvement is noticed.

Q. 2. Will a multi-range or an all-wave coupler work well on this set?

A. 2. These instruments are designed to be used in a single-circuit receiver and would not function efficiently on the higher waves in a three-circuit receiver. The secondary inductance would be sufficient to tune to only about 500 meters, when shunted by a variable condenser of .0005 mfd. capacity.

Q. 3. Could I use more than 22½ volts on my detector tube (UV-200) without hurting it?

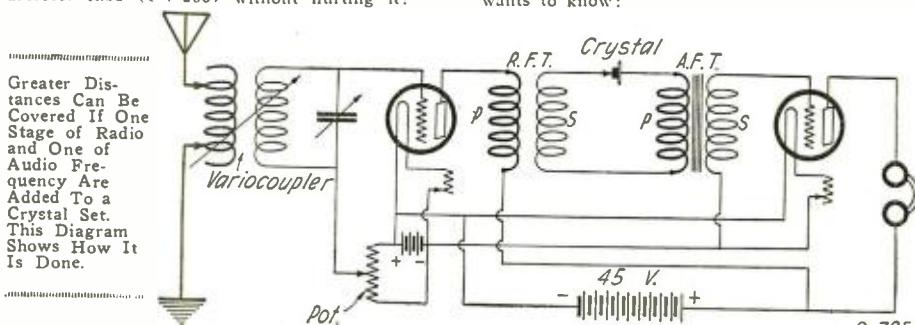

Q-725

A. 3. This depends entirely upon the characteristics of the tube. As a rule, this detector works best with from 18 to 22½ volts on the plate, but this must be determined by experiment.

**COMBINATION TRANSMITTER AND RECEIVER**

(724) Mr. H. M. Wolfe, Savannah, Ga., wants to know:

Q. 1. On the diagram shown in answer to Q. 659 of the May issue, describing a combination transmitter and receiver, what size honeycomb coil should be used for a 200 or 240-meter set?

A. 1. A coil of 25 turns should be satisfactory in this set, for this wave-length. All condenser capacities would remain the same.

Q. 2. Give data on length of antenna and number of wire for this set.

A. 2. A flat top, inverted "L," antenna, having a length of 60', can be used. Four wires are used, spaced at least 2' apart. The lead-in should not exceed 50'.

**R. F. WITH CRYSTAL**

(725) Mr. A. Valverde, Havana, Cuba, writes:

Q. 1. Please publish a hook-up showing how one stage of radio frequency can be added to my crystal set.

A. 1. This circuit appears on these pages.

Q. 2. May I add one step of radio frequency amplification to this set? Please publish this hook-up.

A. 2. This has also been shown on this diagram.

Q. 3. What results as to distance and volume of sound may I get from each one of them?

A. 3. With R. F. alone the range will be

greatly increased although the volume will not be much greater than the crystal set. With the A. F. the volume will be about four times as great, but the distance will remain about the same as with the crystal set alone.

**PHONES**

(726) Mr. C. L. King, Edwards, Ill., requests:  
Q. 1. What is the difference between 5-10-1000 ohm phones?

A. 1. The ohmage of a phone is determined by the number of turns on the pole pieces. A five-ohm phone would have comparatively few turns as compared with a phone of 1000 or 1500 ohms.

Q. 2. Which is best for a crystal or tube set?

A. 2. A pair of phones with an ohmage of 1000 for each phone is usually used for both crystal and tube sets.

Q. 3. What are the different kinds of transformers, and what are their uses?

A. 3. There are many kinds of transformers, but we presume that you refer to transformers used in receiving sets. There are radio and audio frequency amplifying transformers. The radio frequency transformer is used to amplify the signals at radio frequency before they reach the detector. The audio frequency transformer amplifies the signals at audio frequency after they are rectified by the detector.

**THE NEW WAVE-LENGTHS**

(727) Mr. F. O. Stevens, Brooklyn, New York, wants to know:

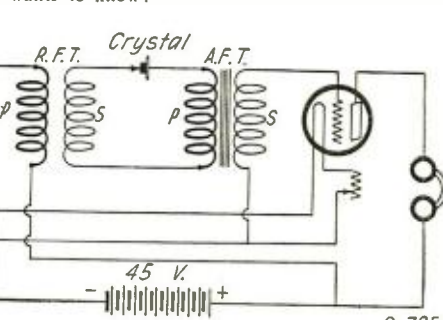

Q-725

Q. 1. Since the new broadcast wave-lengths have come into effect, I miss half of the stations because my set will not tune high enough. How can I raise my wave-length?

A. 1. Most of the sets in use today are unable to reach the higher wave-lengths, due to insufficient inductance or capacity in the secondary circuit. The secondary of the variocoupler should have at least 50 turns of wire to cover the new wave-lengths. The secondary may be rewound to this number, or a small fixed condenser of

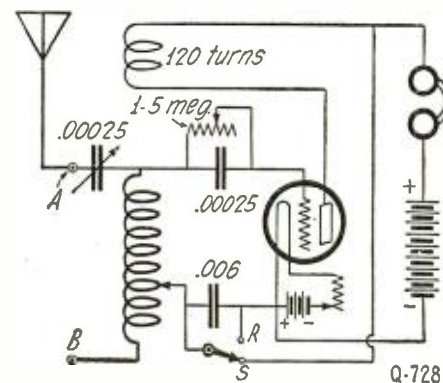

Q-728

The Improved and Simplified Flewelling Circuit is Shown Here. Excellent Results Should be Obtained From This Circuit.

about .0003 mfd. capacity may be connected in parallel with the secondary variable condenser. This condenser should have a switching arrangement, so that it could be cut out of the circuit for the lower waves. If a variometer is used to tune the secondary circuit, the fixed condenser should be connected from the filament side of the secondary to the grid side of the variometer. The primary of the coupler, as a rule, has sufficient inductance, but, if necessary, a honeycomb coil of about 35 turns may be connected in the antenna circuit. A honeycomb coil receiver can, of course, tune to any wave-length by simply changing the coils.

**LATEST FLEWELLING CIRCUIT**

(728) Mr. Wayne K. Hackett, Los Angeles, Cal., desires:

Q. 1. Kindly publish a hook-up of the Flewelling circuit:

A. 1. This circuit appears on these pages. A switch is used to change from "super" to plain regenerative. When used as a "super" either the antenna or ground may be connected to the antenna binding post. When used as a plain regenerative, the ground is connected, as shown by the dotted lines.

Q. 2. Can a switch be used in a radio frequency amplifier, to switch out the various stages?

A. 2. For an arrangement of this kind a switch should be used for each stage. This has been shown in answer to Q. 471, in the October, 1922, issue of RADIO NEWS, which may be obtained from our circulation department.

**QUERIES ON REFLEX**

(729) Mr. S. M. Hurst, Prague, Okla., wants to know:

Q. 1. Referring to the reflex circuit shown in Q. 611, I would like to know if honeycomb coils would be better than a variocoupler using a variometer for regeneration.

A. 1. If regeneration is desired, honeycomb coils are recommended, as it is not possible to use as variometer for regeneration when radio frequency is used. We would not advise regen-

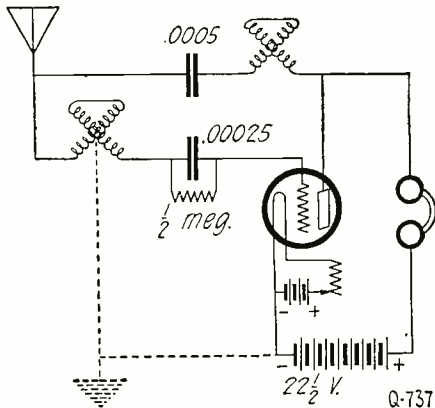

Very Good Results Are Claimed For This Circuit. If a Ground Is Used With the Aerial It Is Connected As Shown By the Dotted Lines.

eration in this circuit, however, as it would only make the set a great deal more difficult to operate efficiently.

Q. 2. What ratio should the transformers have?

A. 2. This depends upon the type of transformer and varies with each make, a ratio of two or three to one, is generally used in air core transformers.

**TUNING TROUBLE**

(730) Mr. Eugene H. Isaacs, New York City, writes:

Q. 1. I have a two-variometer and variocoupler receiving set and my aerial is about 250' long, including the lead-in. I get no tuning whatever on the taps or variable condenser in series with antenna. What is wrong?

A. 1. Your antenna is altogether too long for good results on the broadcast wave-lengths. The natural period of this antenna is about 340 meters, and we would suggest that you shorten it to 150' or less. You should also check your ground connection.

**RADIOLA GRAND**

(731) Mr. Harry Wilson, New Rochelle, N. Y., requests:

Q. 1. Please publish the circuit of the Radiola Grand, showing all values.

A. 1. This hook-up will be found in these columns. The push-pull method of amplification is used and special transformers are necessary. A tapped resistance is shunted across the primary of the second transformer to control the volume of sound.

**MULTIPLE LOUD-SPEAKERS**

(732) Mr. O. Ingmar Oleson, Ambrose, N. D., writes:

Q. 1. Why cannot several loud speakers be

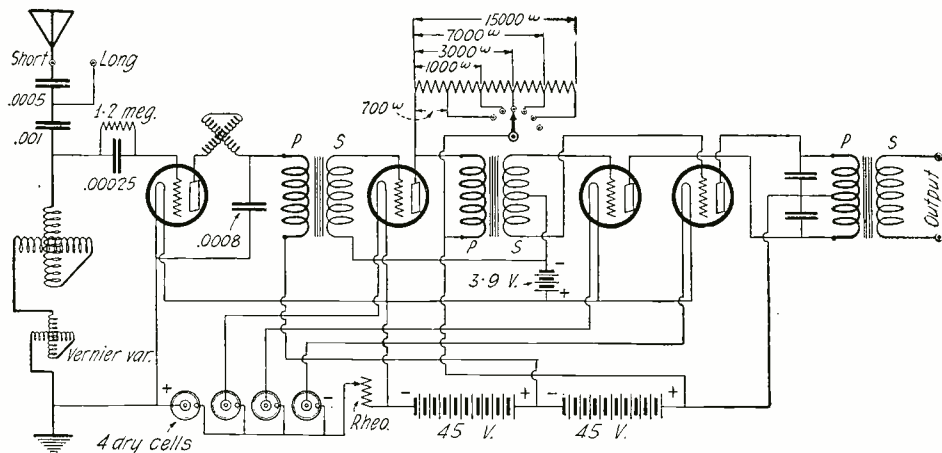

(731) The Circuit of the Radiola Grand. The Push-Pull Method of Amplification Is Used, and Special Transformers Are Necessary.

operated from the same set, thereby increasing the sound?

A. 1. We do not believe that any noticeable increase in volume would be had with an arrangement of this kind. As this would constitute a divided circuit, the energy received by each loud speaker would be only a portion of the total, and the sound produced would be reduced in each loud speaker correspondingly.

Q. 2. Should the grid return be connected to the positive or negative of the "A" battery for the detector and amplifier?

A. 2. For the detector the grid return should be connected to the positive, and for the amplifiers to the negative side of the "A" battery.

**QUESTIONS ON TUBES**

(733) Mr. A. R. Marshall, Stony Creek, Va., asks:

Q. 1. Is the UV-199 superior to the WD-11, UV-200 or the UV-201-A as a detector?

A. 1. The UV-199, although not designed as a detector, gives very good results when used in this capacity. We believe that it will prove just as efficient as any of the aforementioned tubes when used in a detector circuit.

Q. 2. In a three-tube set, using UV-201-A tubes, how many dry batteries are used and how are they arranged?

A. 2. Four dry cells should be connected in series for the filament of the UV-201-A. It would be better, however, to use four more cells connected in parallel with the other four, to give longer life to the batteries.

**A. F. WITH REINARTZ CIRCUIT**

(734) Mr. Leslie E. Stone, Richmond, Va., requests:

Q. 1. Please show a hook-up with one or two stages added to the Reinartz circuit.

A. 1. This hook-up appears on these pages.

**ANTENNA INTERFERENCE**

(735) Mr. M. E. Lecroix, Montreal, Canada, wants to know:

Q. 1. Does an aerial installed on a roof cause non-reception from a loop used directly under the antenna?

A. 1. An antenna should affect the loop in no way under these circumstances. If the loop is in a steel building, reception might be impaired and the directional effect would most likely be nullified.

**WD-11 AS AN AMPLIFIER**

(736) Mr. H. I. Troan, Shellbrook, Canada, writes:

Q. 1. Will the WD-11 give the same volume on a loud-speaker as the standard six-volt tubes?

A. 1. Although fairly efficient as an amplifier, the WD-11 will not give as great a volume of sound as standard tubes, such as the UV-201-A or VT-2.

Q. 2. Can the WD-11 be used in the Flewelling circuit?

A. 2. Yes, this tube can be used in the

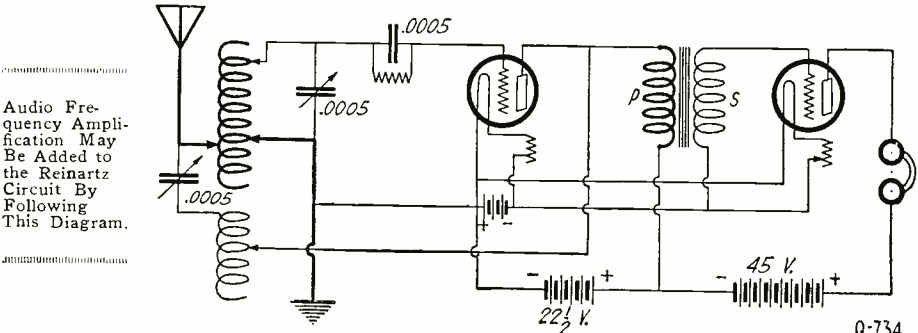

Audio Frequency Amplification May Be Added to the Reinartz Circuit By Following This Diagram.

Q-734

# Practical Radio

By RALPH

Author of Prepared

## CONSTRUCTIONAL DETAILS

Procure two smooth flat cards having their smaller dimensions somewhat larger than the largest of the accompanying scales. For convenience the four scales will be called Sections A, B, C and D. First cut out Sections B and D, in the form of a square, being careful not to trim away any of the numbers. Paste these scales on opposite sides of one of the cards, taking care that the centers of the circles coincide. The best way of doing this is to punch small holes with a pin in the center of each section B and D and another hole in the center of the card. When these three holes are in line, the centers are together. A small dot in the center of each section indicates where the hole should be punched. Dry the card after pasting, under pressure between flat surfaces to prevent warping.

Then paste sections A and C on opposite sides of the other card, getting the centers together in the same way, and dry flat. When dry, carefully trim off the edge around section A outside of the circle, leaving no margin. This leaves a round disc with scales on each side. It will be found that section C is a little smaller, but this is intentional.

Returning to the square card with sections B and D, cut out the circular slot on section D indicated by the letters "s-t-u-v-w-x," cutting clear through the card. This operation is best done with a sharp

PLANS were published in the July issue for an easily constructed radio slide rule, designed to solve the special problems involved in the construction of layer-wound inductance coils, and in the determination of wave-lengths from the inductance and capacity values in the circuit. This article will disclose a similar instrument that will indicate the capacity of a variable condenser of the semi-circular plate type with air dielectric.

On the reverse side of the computer, other scales give the solution of the problem of two or more condensers in series. When two condensers are connected in series the resulting capacity is always less than that of either condenser alone, the exact value being ordinarily determined with the formula appearing at the center of the scale section C. This slide rule gives the answer to this formula directly.

In cases where three condensers are in series, determine the effective capacity of two of them in series and then determine the resultant capacity when the third condenser is connected in series with an imaginary condenser having a capacity equal to the answer obtained with the first two.

The scales have ranges greater than those required for ordinary radio frequency circuits. If, however, it is desired to use the chart for series condenser problems, for other ranges, multiply the three scales  $C_1$ ,  $C_2$  and  $C$  by .001, .01, 10 or 100, or any other factor desired and use as before. The only rule necessary to follow is to multiply each scale by the same factor.

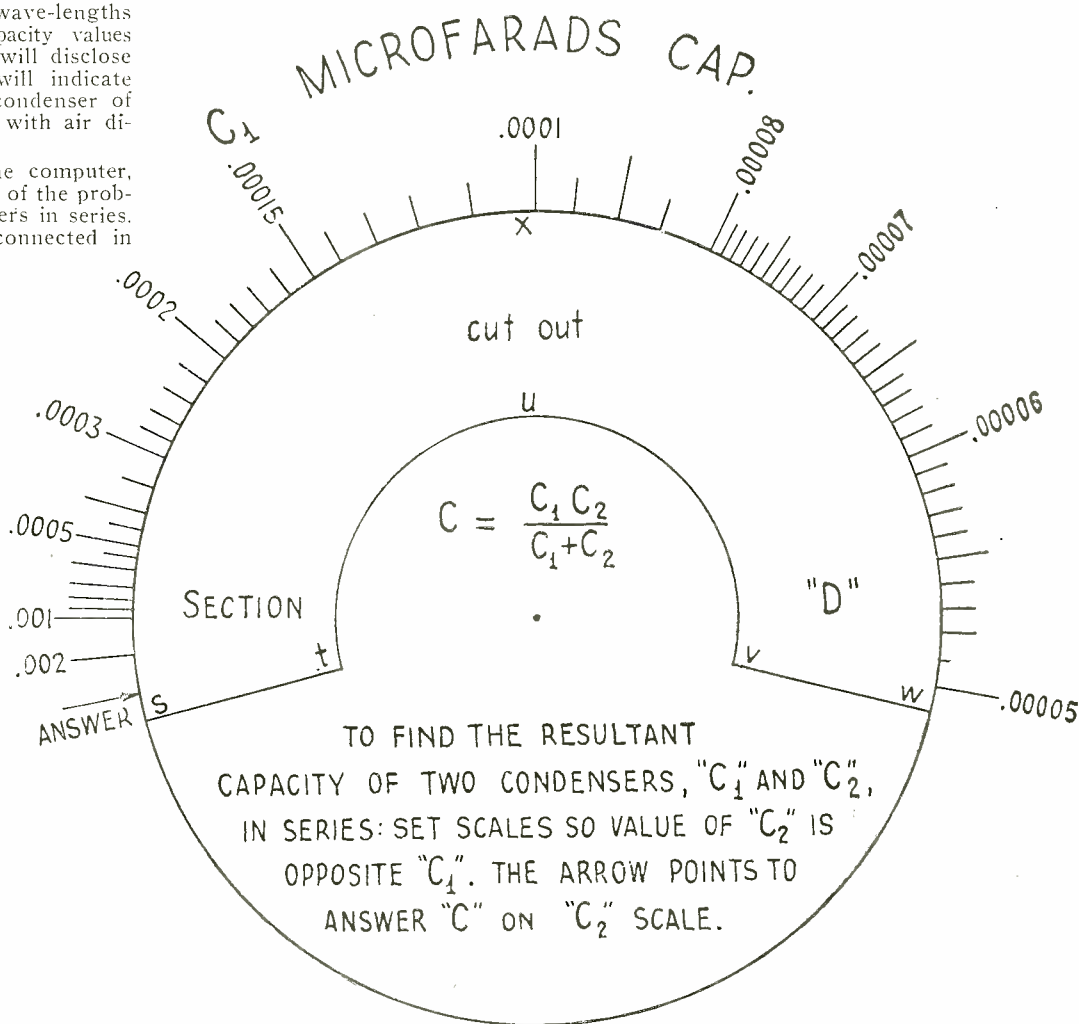
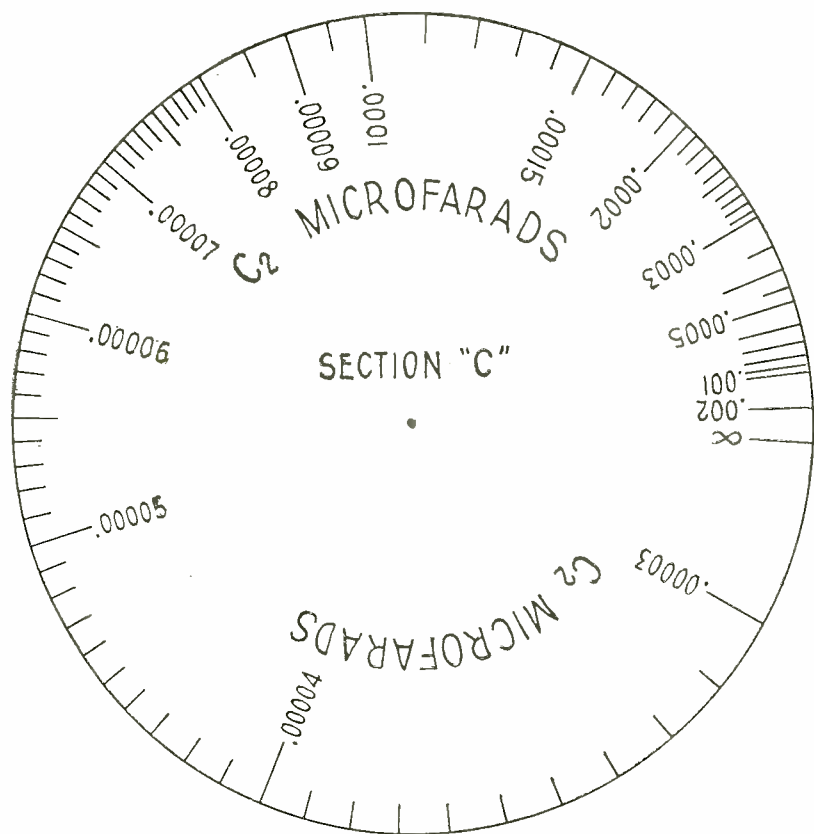

# Slide Rule

## BATCHER

### Radio Measurements

knife. It is desirable to cut exactly on the lines and curves bounded by the above letters. The removal of this section will not affect the scales on section B on the other side, since the latter is somewhat larger.

Then lay the rectangular card on the table with section B up. On top of this place the circular card with face A up, and fasten the two together with a small rivet or paper fastener eyelet inserted through the center holes. The smaller disc should be free to turn about the center. When this is done the computer is complete. If it is constructed according to these plans, the outer diameter of section A should be even with the inner diameter of section B, and the scales of section C will show through the window opposite the scales on section D.

#### D. TERMINATION OF CONDENSER CAPACITY USING SPECIAL COMPUTER METHOD OF OPERATION

A great many of the condensers available at the present time are rated according to the number of plates rather than by their capacities. The maximum capacity of such condensers may be determined by the aid of the special chart.

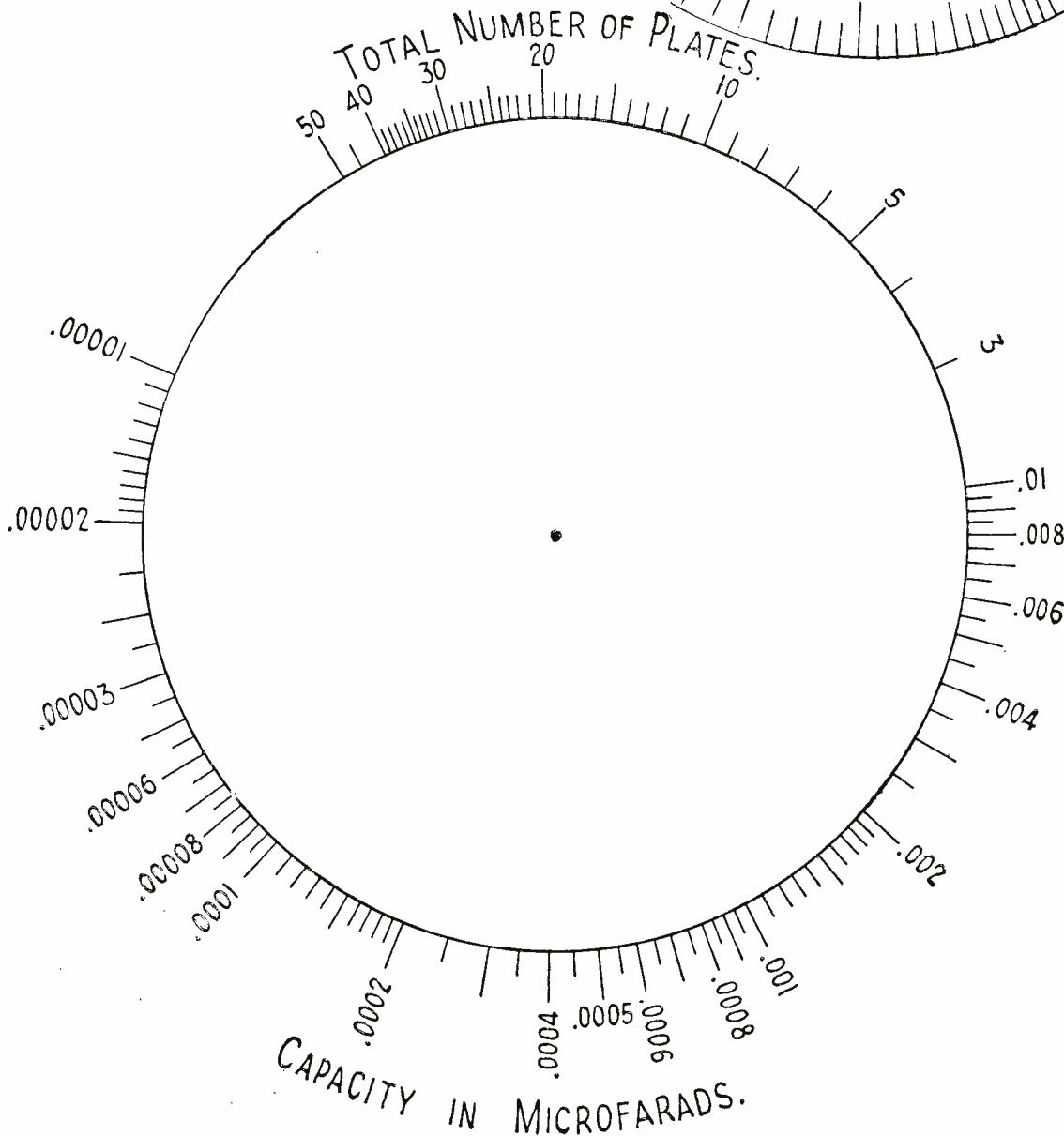
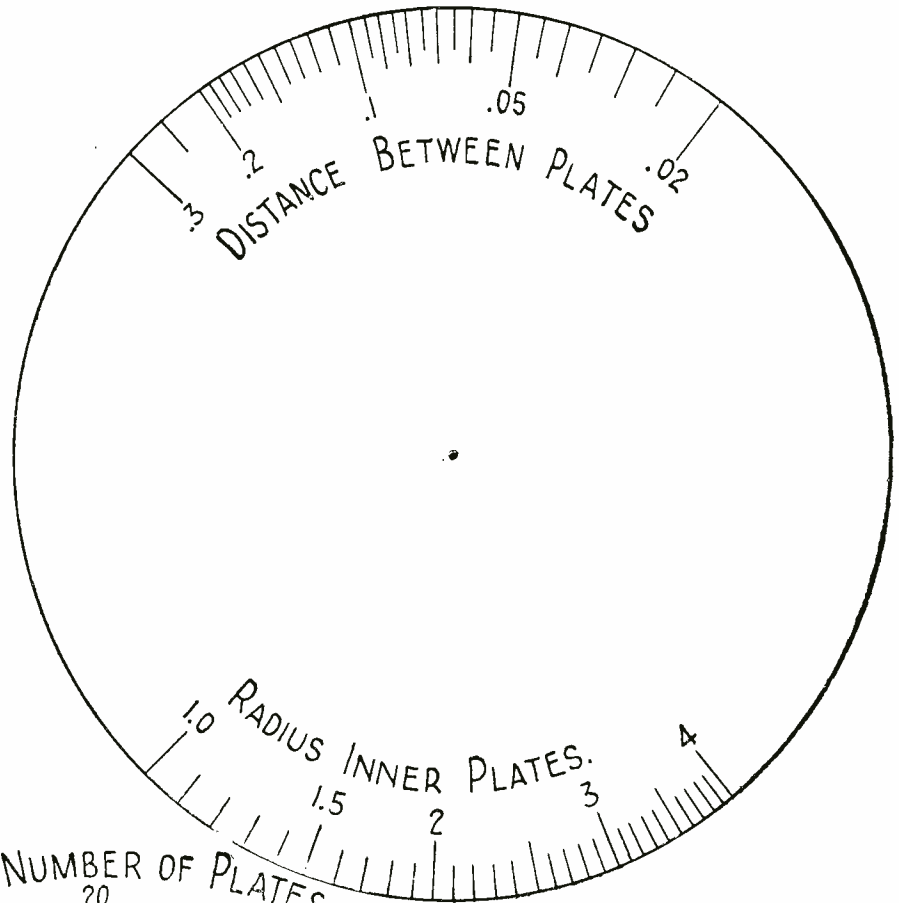

Measure the radius of the plates (inner) and the distance between the plates, and determine the total number of plates. Set the disc so that the "spacing" value is opposite the total plates value. The capacity value may then be read di-

When Cut Out and Assembled These Discs, Composing the Slide Rule, Tell at a Glance the Capacity of a Known Size Condenser, or the Size Condenser for a Known Capacity. The Resultant Capacity of Two Condensers in Series Can Also Be Determined.

rectly opposite the value of the radius of the inner plates.

#### CAPACITY OF CONDENSERS IN SERIES, USING SPECIAL COMPUTER METHOD OF OPERATION

The reverse side of this card is used to determine the effective capacity of two condensers in series. Set the disc so that the values of these capacities are opposite each other. The arrow (answer) will point directly to the effective or resultant capacity.

# Revised List of Broadcasting Stations with New Wave-Lengths to June 8th

Call	Station	Wave-Lengths	Call	Station	Wave-Lengths	Call	Station	Wave-Lengths
KFAV	Abbot Kinney Co., Venice, Cal.	258	WPE	Central Radio Co., Inc., Independence, Mo.	360	KFFE	Eastern Oregon Radio Co., Pendleton, Ore.	360
WEAK	Abercrombie, Julius B., St. Joseph, Mo.	360	WLAS	Central Radio Supply Co., Hutchinson, Kan.	244	WRAC	Economy Light Co., Escanaba, Mich.	360
KFDA	Adler's Music Store, Baker, Ore.	360	WNAQ	Charleston Radio Elect. Co., Charleston, S. C.	360	KMX	Electric Lighting Supply Co., Los Angeles, Cal.	360
WTAW	Agricultural & Mechanical College of Texas, College Station, Tex.	360	KFGP	Cheney Radio Co., Cheney, Kan.	229	KFCH	Electric Service Station, Billings, Mont.	360
WMAV	Alabama Polytechnic Inst., Auburn, Ala.	250	WAAF	Chicago Daily Drivers Journal, Chicago, Ill.	286	KYO	Electric Shop, Honolulu, T. H.	360
WSY	Alabama Power Co., Birmingham, Ala.	360	WMAQ	Chicago Daily News, Chicago, Ill.	448	KFAN	Electric Shop, Moscow, Idaho	360
WCAR	Alamo Radio Elect. Co., San Antonio, Texas	360	WJAZ	Chicago Radio Laboratory, Chicago, Ill.	448	WLAV	Electric Shop, Inc., Pensacola, Fla.	360
WGAW	Albright, Ernest C., Altoona, Pa.	261	KFGD	Chickasha Radio & Elect. Co., Chickasha, Okla.	248	WPI	Electric Supply Co., Clearfield, Pa.	360
KZM	Allen, Preston D., Oakland, Cal.	360	KFBS	Chronicle News, Gas & Electric Supply Co., Trinidad, Colo.	360	WFAH	Electric Supply Co., Port Arthur, Texas	360
KGO	Altadena Radio Lab., Altadena, Cal.	360	WIAQ	Chronicle Publishing Co., Marion, Ind.	360	KDZI	Electric Supply Co., Woonathee, Wash.	360
WRAU	Amarillo Daily News, Amarillo, Tex.	360	WDM	Church of the Covenant, Washington, D. C.	360	WQAM	Electrical Equipment Co., Miami, Fla.	360
WJLB	American Radio Co., Lincoln, Neb.	360	WIZ	Cino Radio Mfg. Co., The Cincinnati, Ohio	360	KFGZ	Emmanuel Missionary College, Berrien Springs, Mich.	268
WGP	American Radio & Research Corp., Medford Hillside, Mass.	360	KUS	City Dye Works & Laundry Co., Los Angeles, Cal.	360	KSL	Emporium, The, San Francisco, Cal.	360
KFEZ	American Society of Mech. Engrs., St. Louis, Mo.	360	WBU	City of Chicago, Chicago, Ill.	286	WCAH	Entrekin Electric Co., Columbus, Ohio	286
WEAF	American Telephone & Telegraph Co., New York, N. Y.	492	WRR	City of Dallas, Police & Fire Signal Dept., Dallas, Texas	360	WTAS	Erbstein, Charles E., Elgin, Ill.	275
WIAU	American Trust & Savings Bank, Le Mars, Iowa	360	KFAQ	City of San Jose, San Jose, Cal.	360	WBAJ	Erner & Hopkins Co., The, Columbus, Ohio	360
WPAA	Anderson & Webster Elect. Co., Wahoo, Neb.	360	KFEB	City of Taft, Taft, Cal.	360	WWJ	Ervin Electrical Co., Parsons, Kan.	360
WRAV	Anioch College, Yellow Springs, Ohio	360	WON	Clark University, Worcester, Mass.	360	KUO	Evening News Assn., Detroit News, Detroit, Mich.	517
WQAJ	Ann Arbor Times News, Ann Arbor, Mich.	360	WSAC	Clemson Agricultural College, Clemson College, S. C.	360	WEAA	Examiner Printing Co., The, San Francisco, Cal.	360
KFI	Anthony, Earle C. Inc., Los Angeles, Cal.	469	KUY	Coast Radio Co., El Monte, Cal.	360	KFHJ	Fallain & Lathrop, Flint, Mich.	360
WOAG	Apollo Theatre, Belvidere, Ill.	224	WHAC	Cole Bros. Elect. Co., Waterloo, Iowa	360	WDAY	Fallon Co., Santa Barbara, Cal.	360
WQAK	Appel-Higley Elect. Co., Dubuque, Iowa	360	WQAL	Cole County Tel. & Tel. Co., Mattoon, Ill.	360	WRP	Fargo Radio Service Co., Fargo, N. D.	244
KQP	Apple City Radio Club, Hood River, Ore.	360	WOAK	Collins' Hardware Co., Frankfort, Ky.	360	WGR	Federal Institute of Radio Telegraphy, Camden, N. J.	360
WFAT	Argus-Leader, Sioux Falls, S. D.	360	KFCK	Colorado Springs Radio Co., Colorado Springs, Colo.	360	WCE	Federal Tel. & Tel. Co., Buffalo, N. Y.	360
KFGL	Arlington Garage, Arlington, Ore.	234	KFHA	Colorado State Normal School, Gunnison, Colo.	360	WCAC	Findley Electric Co., Inc., Minneapolis, Minn.	360
WABG	Arnold Edwards Piano Co., Jacksonville, Fla.	248	WMC	Commercial Publishing Co., Memphis, Tenn.	500	KFFP	Fink Jewelry Co., John, Fort Smith, Ark.	360
WMAD	Atchison County Mail, Rockport, Mo.	360	WAAH	Commonwealth Electric Co., Inc., St. Paul, Minn.	360	KFDX	First Baptist Church, Noberly, Mo.	275
WGM	Atlanta Constitution, Atlanta, Ga.	429	WCAZ	Compton, Robt. E., & Carthage College, Carthage, Ill.	360	WDAX	First Baptist Church, Shreveport, La.	360
WSB	Atlanta Journal Co., Atlanta, Ga.	429	WPAU	Concordia College, Moorhead, Minn.	360	WIAA	First National Bank, Centerville, Iowa	360
WDAJ	Atlanta & West Point R. R. Co., College Park, Ga.	360	WIL	Continental Electric Supply Co., Washington, D. C.	360	KFGX	First Presbyterian Church, Orange, Texas	250
WPAM	Auerbach & Guettel, Topeka, Kan.	360	WIAH	Continental Radio Mfg. Co., Newton, Iowa	360	KFBG	First Presbyterian Church, Tacoma, Wash.	360
KFEX	Augsburg Seminary, Minneapolis, Minn.	261	WEAI	Cornell University, Ithaca, N. Y.	286	KTW	First Presbyterian Church, Seattle, Wash.	360
KFER	Auto Electric Service Co., Ft. Dodge, Iowa	231	WFEY	Cosradio Company, The, Wichita, Kan.	360	WKAP	Flint, Dutee Wilcox, Cranston, R. I.	360
KDZF	Automobile Club of So. Calif., Los Angeles, Calif.	278	WHAS	Courier Journal & Louisville Times, Louisville, Ky.	400	WDAL	Florida Times Union, Jacksonville, Fla.	360
WDAO	Automotive Electric Co., Dallas, Texas	360	WHK	Cox, Warren R., Cleveland, Ohio	360	KFCP	Flygare, Ralph W., Ogden, Utah	360
WHAE	Automotive Electric Service Co., Sioux City, Iowa	360	KFGQ	Crary Hardware Co., Boone, Iowa	226	WVI	Ford Motor Co., Dearborn, Mich.	273
KFBC	Azbill, W. K., San Diego, Calif.	360	WLW	Crosley Manufacturing Co., Cincinnati, Ohio	360	WPA	Fort Worth Record, Fort Worth, Texas	360
WOAS	Bailey's Radio Shop, Middletown, Conn.	360	KFDO	Cutting, H. E., Bozeman, Mont.	248	WIAJ	Fox River Valley Radio Supply Co., Neenah, Wis.	224
WEAR	Baltimore American & News Publishing Co., Md.	360	WLAG	Cutting & Washington Radio Corp., Minneapolis, Minn.	417	WSAL	Franklin Electrical Co., Brookville, Ind.	246
WOR	Bamberger, I. & Co., Newark, N. J.	405	WWB	Daily News Printing Co., The, Canton, Ohio	360	WABC	Fulwider-Grimes Battery Co., Anderson, Ind.	229
WPAY	Bangor Radio Lab., Bangor, Me.	360	WCAG	Daily States Pub. Co., New Orleans, La.	360	WIAK	Galveston Tribune, Galveston, Texas	360
WABI	Bangor Ry. & El. Co., Bangor, Me.	240	WNAX	Dakota Radio Apparatus Co., Yankton, S. D.	244	WGAI	Gass, W. H., Shenandoah, Iowa	360
WBBD	Barbey Battery Service, Reading, Pa.	224	WFAA	Dallas News & Dallas Journal, Dallas, Texas	476	WQAY	Gaston Music & Furniture Co., Hastings, Neb.	360
KFFZ	Barnes Amusement Co., Al. G., Dallas, Texas	226	WEAX	Daly, T. J. M., (Argenta), Little Rock, Ark.	360	WGY	General Electric Co., Schenectady, N. Y.	380
WQAA	Beale, Horace A., Jr., Parkersburg, Pa.	360	WCAK	Daniel, Alfred P., Houston, Texas	360	WPAQ	General Sales & Engr. Co., Frostberg, Md.	360
WAAL	Beamish Elect. Co., Minneapolis, Minn.	360	WEAU	Davidson Bros. Co., Sioux City, Iowa	360	WOAD	Friday Battery & Elect. Co., Sigourney, Iowa	360
WMAM	Beaumont Radio Equipment Co., Beaumont, Tex.	360	WBAH	Daxton Co., The, Minneapolis, Minn.	360	WMAH	General Supply Co., Lincoln, Neb.	254
KDZR	Bellingham Publishing Co., Bellingham, Wash.	261	WIAF	De Cortin, Gustave A., New Orleans, La.	360	WAAS	Georgia Radio Co., Inc., Decatur, Ga.	360
KFIF	Benson Tech. Student Body, Portland, Ore.	360	WJX	De Forest Radio Tel. & Tel. Co., New York City	360	KFDV	Gilbrech & Stinson, Fayetteville, Ark.	360
WEB	Benwood Company, Inc., The, St. Louis, Mo.	360	KFKH	Denver Park Amusement Co., Lakeside, Colo.	226	WAAK	Gimble Bros., Milwaukee, Wis.	280
KRE	Berkeley Gazette, Berkeley, Cal.	360	KZN	Desert News, The, Salt Lake City, Utah	360	WIP	Gimbel Bros., Philadelphia, Pa.	509
KJS	Bible Institute of Los Angeles, Cal.	360	WCX	Detroit Free Press, Detroit, Mich.	517	WQAC	Gish, E. B., Amarillo, Texas	360
WRAN	Black Hawk Electrical Co., Waterloo, Iowa	229	KOP	Detroit Police Dept., Detroit, Mich.	286	KFGY	Gjelhaug's Radio Shop, Baudette, Minn.	224
KFHB	Boardwell, P. L., Hood River, Ore.	280	WCAV	Dice Electric Co., J. C., Little Rock, Ark.	360	KDZX	Glad Tidings Tabernacle, San Francisco, Cal.	360
WKAY	Brennan College, Gainesville, Ga.	360	KFHI	Dixon, Charles V., Wichita, Kan.	224	KJQ	Gould, C. O., Stockton, Cal.	360
WLAN	Broad St. Baptist Church, Columbus, Ohio	360	KFZ	Doerr Mitchell Elect. Co., Spokane, Wash.	283	KFFV	Graceland College, Lamoni, Iowa	360
WQAH	Brook-Anderson Elect. Eng. Co., Lexington, Ky.	254	WPAC	Donaldson Radio Co., Okmulgee, Okla.	360	WKAL	Gray & Gray, Orange, Texas	360
KNN	Bullock's, Los Angeles, Cal.	360	KFAT	Donohue, Dr. S. T., Eugene, Ore.	275	KNT	Grays Harbor Radio Co., Aberdeen, Wash.	263
KFDR	Bullneck's Hardware & Sporting Goods, York, Neb.	360	WPAJ	Doolittle Radio Corp., New Haven, Conn.	268	KFEJ	Greason, Guy, Tacoma, Wash.	360
KFEY	Bunker Hill & Sullivan Mining & Const. Co., Kellog, Idaho	360	WRK	Doron Brothers Electric Co., Hamilton, Ohio	360	WLAX	Greencastle Community Broadcasting Station, Greencastle, Ind.	231
WIAS	Burlington Hawk-Eye Home Elect. Co., Burlington, Iowa	360	KQV	Doubleday-Hill Electric Co., Pittsburgh, Pa.	360	WQAZ	Greensboro Daily News, Greensboro, N. C.	360
WDZ	Bush, James L., Tuscola, Ill.	278	WMU	Doubleday-Hill Electric Co., Washington, D. C.	261	WSAJ	Grove City College, Grove City, Pa.	360
KFBB	Buttrey & Co., F. A. Hayre, Mont. Calvary Baptist Church, New York, N. Y.	360	WMAJ	Drivers Telegram Co., Kansas City, Mo.	275	WHAI	Hafner Supply Co., Joplin, Mo.	360
WQAO	Capper Publications, Topeka, Kan.	360	WCAS	Dunwoody, Wm., Hood Industrial Inst., Minneapolis, Minn.	360	WCBA	Haimbach, Chas. W., Allentown, Pa.	280
WIAQ	Casper Community Radio Corp., Casper, Wyo.	360	WCAU	Durham & Co., Philadelphia, Pa.	286	KPO	Hale Bros., Inc., San Francisco, Cal.	423
WQAW	Catholic University of America, Washington, D. C.	360				KGG	Hallock & Watson Radio Service, Portland, Ore.	360
KFFH	Central Christian Church, Shreveport, La.	266				WLK	Hamilton Mfg. Co., Indianapolis, Ind.	360
WDAD	Central Kansas Radio Supply, Linsborg, Kan.	360				WOAT	Hamp, Boyd Martell, Wilmington, Del.	360

Call	Station	Wave-Lengths	Call	Station	Wave-Lengths	Call	Station	Wave-Lengths
WOAA	Hardy, Dr. Walter, Ardmore, Okla.	360	KMO	Love Electric Co., Tacoma, Wash.	360	WGAM	Orangeburg Radio Equip. Co., Orangeburg, S. C.	360
WDAK	Hartford Courant, Hartford, Conn.	261	WWL	Loyola University, New Orleans, La.	360	KFDJ	Oregon Agri. College, Corvallis, Ore.	360
KFDP	Hawkeye Radio Supply Co., Des Moines, Iowa	278	WOAR	Lundskow, Henry P., Kenoska, Wis.	360	KDYQ	Oregon Institute of Tech., Portland, Ore.	360
WEAS	Hecht Co., Washington, D. C.	360	WOAO	Lyradium Mfg. Co., Mishawaka, Ind.	360	WHAP	Otta & Kuhms, Decatur, Ill.	360
WIAI	Heers Stores Co., Springfield, Mo.	360	WKAX	MacFarlane, Wm. A., Bridgeport, Conn.	231	WIAH	Outlet Co., The, Providence, R. I.	360
KFGV	Heidbreder Radio Supply Co., Utica, Neb.	224	KFCV	Mahaffey, Jr., Fred, Houston, Texas	360	WKAA	Paar, H. F., & Republican Times, Cedar Rapids, Iowa	360
WEAD	Henry Radio & Elect. Supply, Atwood, Kan.	268	WBAW	Marietta College, Marietta, Ohio	360	WIAR	Paducah Evening Sun, Paducah, Ky.	360
KXD	Herald Publishing Co., Modesto, Cal.	360	WWAY	Marigold Gardens, Chicago, Ill.	360	WMAC	PAGE, J. Edward, Cazenovia, N. Y.	360
KQW	Herrford, Charles D., San Jose, Cal.	360	KFFQ	Marksheffel Motor Co., Colorado Springs, Colo.	360	WOC	Palmer School of Chiropractic, Davenport, Iowa	484
WFAJ	Hill, P. A., Savannah, Ga.	360	WIAD	Marquette University, Milwaukee, Wis.	360	WOAH	Palumbo Radio Corp., Charleston, S. C.	360
WHAO	Hollister Miller Motor Co., Emporia, Kan.	360	WDAG	Martin, J. Laurence, Amarillo, Texas	263	WMAT	Paramount Radio Corp., Duluth, Minn.	360
WAAZ	Horn, Reuben H., San Luis Obispo, Cal.	360	WOC	Maus Radio Co., Lima, Ohio	266	WNAB	Park City, Daily News, Bowling Green, Ky.	360
KFBE	Howe, Richard Harris, Granville, Ohio	229	WBS	May, D. W., Inc., Newark, N. J.	360	WABD	Parber High School, Dayton, Ohio	283
WJD	Howlette, Thomas F. J., Philadelphia, Pa.	360	KFAD	McArthur Bros. Mercantile Co., Phoenix, Ariz.	360	WGAQ	Patterson, W. G., Shreveport, La.	360
WGL	Hughes Electrical Corp., Syracuse, N. Y.	360	WTP	McBride, George M., Bay City, Mich.	360	WOAZ	Penick-Hughes Co., Stamford, Texas	360
WDAI	Huntington & Guerry, Inc., Greenville, S. C.	360	KFHII	McCue, Ambrose A., Neah Bay, Wash.	283	KFHL	Penn College, Oshtemo, Iowa	227
WQAV	Huntington Press, Huntington, Ind.	360	KFFX	McGraw Co., The, Omaha, Neb.	278	WOAV	Pennsylvania National Guard, Erie, Pa.	242
WIAY	Hurlburt-Still Electrical Co., Houston, Texas	360	KFFC	Meier & Frank Co., Alder St., Portland, Ore.	360	WPAB	Pennsylvania State College, State College, Pa.	360
WEV	Huse Publishing Co., Norfolk, Neb.	360	KFFC	Mercantile Trust Co. of California, San Francisco, Cal.	509	WBAK	Pennsylvania State Police Dept. of Harrisburg, Pa.	360
WIAG	Hutchinson Elect. Service Co., Hutchinson, Minn.	360	WMAZ	Mercer University, Macon, Ga.	268	WTAC	Penn. Traffic Co., Johnstown, Pa.	360
WFAN	Hutton & Jones Elect. Co., Warren, Ohio	248	WOU	Metropolitan Utilities District, Omaha, Neb.	360	WNAV	Peoples Tel. & Tel. Co., Knoxville, Tenn.	360
WLAZ	Ideal Apparatus Co., Evansville, Ind.	360	WFAW	Miami Daily Metropolis, Miami, Fla.	360	WIAP	Peoria Star Co., Peoria, Ill.	280
WNAM	Independent School District of Boise City, Boise, Idaho	270	WJAR	Michigan Agricultural College, East Lansing, Mich.	360	WTAM	Perham, D. M., Cedar Rapids, Iowa	360
KFAU	Interstate Electric Co., New Orleans, La.	360	WBAF	Middleton, Fred M., Moorestown, N. J.	360	WPAF	Peterson's Radio Co., Council Bluffs, Iowa	360
WGV	Iowa State College, Ames, Iowa	360	WOAE	Midland College, Fremont, Neb.	360	WPAP	Phillips, Theodore D., Winchester, Ky.	360
WOT	Iris Theatre, Houston, Texas	360	WDAF	Midwest Radio Central, Inc., Chicago, Ill.	360	KDZG	Pierce & Co., Cyrus, San Francisco, Cal.	360
WEAY	Iverson, Harry C., Waco, Texas	360	WOS	Missouri State Marketing Bureau, Jefferson City, Mo.	360	WHAU	Pierce Elect. Co., Tampa, Fla.	360
KFDZ	Jackson's Radio Eng. Lab., Waco, Texas	360	WFAQ	Missouri Wesleyan College and The Cameron Radio Co., Cameron, Mo.	360	KFFY	Pincus & Murphy, Inc., Alexandria, La.	275
WJAD	James Milklin University, Decatur, Ill.	360	WEAP	Mobile Radio Co., Inc., Mobile, Ala.	360	WOK	Pine Bluff Co., The, Pine Bluff, Ark.	360
WBAO	J. & M. Electric Co., Amsterdam, N. Y.	360	KFCF	Moore, Frank A., Walla Walla, Wash.	360	WJAS	Pittsburgh Radio Supply House, Pittsburgh, Pa.	360
WPAS	J. & M. Electric Co., Utica, N. Y.	273	WQAE	Moore Radio News Station, Springfield, Vt.	360	WKAH	Planet Radio Co., West Palm Beach, Fla.	360
WSL	Jenkins, Franklin W., St. Louis, Mo.	244	KFCQ	Motor Service Station, Casper, Wyo.	360	KWGW	Portable Wireless Telephone Co., Stockton, Cal.	360
KFB	Jenkins Furniture Co., Boise, Idaho	360	WABF	Mt. Vernon Register News Co., Mt. Vernon, Ill.	234	KGW	Portland Oregonian, Portland, Ore.	492
KFFR	Jensen, Valdemar, New Orleans, La.	268	WAF	Mullins Elect. Co., Wm. A., Tacoma, Wash.	360	WOAQ	Portsmouth Kiwanis Club, Portsmouth, Va.	360
WVAB	Jordan, W. V., Louisville, Ky.	360	KGB	Mulrony, Marion A., Honolulu, Hawaii	360	WMH	Precision Equipment Co., Cincinnati, Ohio	243
WIAB	Joslyn Automobile Co., Rockford, Ill.	360	KGU	National Guards Missouri, St. Louis, Mo.	266	WOAR	Press Publishing Co., Muncie, Ind.	360
WIAK	Journal Stockman Co., Omaha, Neb.	278	KFGJ	Nebraska Radio Elect. Co., Lincoln, Neb.	360	KSS	Prest & Dean Radio Research Laboratory, Long Beach, Cal.	360
WOAP	Kalamazoo College, Kalamazoo, Mich.	360	KFDU	Nebraska Wesleyan University (Lincoln, Neb.), University Place, Neb.	360	WOS	Prince Walter Co., Lowell, Mass.	266
WMAX	K. & K. Radio Supply Co., Ann Arbor, Mich.	360	WCAJ	Nelson Co., I. R., Newark, N. J.	263	KSD	Pulitzer Publishing Co., St. Louis, Mo.	546
WCBB	K. & K. Radio Supply Co., Greenville, Ohio	240	WAAM	Nevada Machinery & Elect. Co., Reno, Nev.	360	WBA	Purdue University, W. Lafayette, Ind.	360
WIK	K. & L. Electric Co., McKeesport, Pa.	360	KDZK	Newark Radio Lab., Newark, Ohio	240	WLAN	Putnam Hardware Co., Houlton, Me.	360
WDAF	Kelley-Duluth Co., Duluth, Minn.	360	WBBA	Newburgh News Printing & Pub. Co., Newburgh, N. Y.	360	KDZO	Pyle & Nichols, Denver, Colo.	360
WTG	Kesselman O'Driscoll Co., Milwaukee, Wis.	261	WCAB	New Mexico College of Agriculture & Mech. Arts, State College, N. M.	360	WCAW	Quincy Electric Supply Co., Quincy, Ill.	360
WCAE	Kimbell-Ups on Co., Sacramento, Cal.	360	KOR	New York Police Dept., New York, N. Y.	360	WLAT	Radio and Specialty Co., Burlington, Iowa	360
WJAT	Kingshighway Presbyterian Church, St. Louis, Mo.	360	WLAW	New York Radio Laboratories, Binghamton, N. Y.	360	KFHP	Radio Bug Products Co., Kearney, Neb.	246
WJAP	Kirk, Jim, Sparks, Nev.	360	WIAV	Nichols Hinefine Bassett Lab., Edgewood, R. I.	231	WRAF	Radio Club, Inc., Laporte, Ind.	224
WCAY	Knicht-Campbell Music Co., Denver, Colo.	360	WEAG	Nielsen Radio Supply Co., Phoenix, Ariz.	360	WY	Radio Corp. of America, New York	405
KFBK	Koch, John R., Charleston, W. Va.	273	KFCR	Noel, Leon T., Tarkio, Mo.	360	WIZ	Radio Corp. of America, New York	455
WNAW	Kunzmann, Henry, Fort Monroe, Va.	360	WIAT	North Carolina State College, Raleigh, N. C.	360	WKAQ	Radio Corp. of America, San Juan, P. R.	360
WKAV	Laconia Radio Club, Laconia, N. H.	360	WLAC	North Central High School, Spokane, Wash.	252	KFAW	Radio Den. The, Santa Ana, Cal.	360
WABA	Lake Forest College, Lake Forest, Ill.	266	KFIO	North Dakota Agri. College, Agricultural College, N. D.	360	WGAX	Radio Elec. Co., Washington C. H., Ohio	360
WABII	Lake Shore Tire Co., Sandusky, Ohio	249	WPAK	North Plainfield, Borough of N. Plainfield, N. J.	252	KFFX	Radio Flec. Shon, Douglas, Wyo.	263
WGAL	Lancaster Elect. Supply & Const. Co., Lancaster, Pa.	248	WEAM	Northern Commercial Co. of Alaska, Northern States Power Co., St. Croix Falls, Wis.	248	WVAG	Radio Engineering Lab., Waterford, N. Y.	360
WHAL	Lansing Capitol News, Lansing, Mich.	248	WLAJ	Northwest Radio Service Co., Seattle, Wash.	270	WVAY	Radio Equipment & Mfg. Co., Davenport, Iowa	360
KFIC	Laskowitz, Phillip, Denver, Colo.	224	WLAG	North Western Radio Co., Inc., Madison, Wis.	360	KFEP	Radio Equipment Co. (Jos. L. Turre), Denver, Colo.	240
WABB	Lawrence, Dr. John B., Harrisburg, Pa.	266	KJTR	Northwestern Radio Mfg. Co., Portland, Ore.	360	WOAX	Radio Equipment Co., Peoria, Ill.	360
KFBL	Leese Bros., Everett, Wash.	224	KGN	Norton Laboratories, Lockport, N. Y.	360	WQAT	Radio Equipment Corp., Westhampton, Va.	360
KFGH	Leland Stanford Jr. Univ., Stanford Univ., Cal.	360	WMAK	Nushawg Poultry Farm, New Lebanon, Ohio	360	WRAY	Radio Sales Corp., Scranton, Pa.	360
WNAT	Lennig Bros. Co., Philadelphia, Pa.	360	WPG	Ocean City Yacht Club, Ocean City, N. J.	254	WRAO	Radio Service Co., St. Louis, Mo.	360
WSAH	Leonard, Jr., A. G., Chicago, Ill.	360	WIAD	Ohio Mechanics Institute, Cincinnati, Ohio	360	KJL	Radio Shop, The, Sunnyvale, Cal.	360
WGAU	Limb, Marcus G., Wooster, Ohio	226	WAAD	Ohio State University, Columbus, Ohio	360	WKY	Radio Shop, Oklahoma City, Okla.	360
WGAU	Lindsay, W. W., Jr., Redley, Cal.	360	WEAO	Okfuskee County News, Okemah, Okla.	360	WRAS	Radio Supply Co., McLeansboro, Ill.	360
KMC	Lit Bros., Philadelphia, Pa.	395	WKAJ	Oleson, O. K., Hollywood, Cal.	360	WMAB	Radio Supply Co., Oklahoma City, Okla.	360
WKAS	Lloyd, Cecil E., Pensacola, Fla.	360	KFAJ	Omaha Central High School, Omaha, Neb.	360	KFDC	Radio Supply Co., Spokane, Wash.	360
WDAR	Lombard College, Galesburg, Ill.	360	KFCZ	Omaha Grain Exchange, Omaha, Neb.	360	KNV	Radio Supply Co. of Cal., Los Angeles, Cal.	360
KWB	Los Angeles Examiner, Los Angeles, Cal.	360	WAAW	Orangeburg Radio Equip. Co., Orangeburg, S. C.	360	WRAH	Read, Stanley N., Providence, R. I.	360
KW	Los Angeles Union Stock Yards, Los Angeles, Cal.	360	WAAW	Orangeburg Radio Equip. Co., Orangeburg, S. C.	360	WGF	Register & Tribune, Des Moines, Iowa	360
KFCL	Louisiana State University, Baton Rouge, La.	254	WAAW	Orangeburg Radio Equip. Co., Orangeburg, S. C.	360	WHAZ	Reynolds Polytechnic Inst., Troy, N. Y.	380
KFGC	Louisiana State University, Baton Rouge, La.	254	WAAW	Orangeburg Radio Equip. Co., Orangeburg, S. C.	360	WBAU	Reynolds Publishing Co., Hamilton, Ohio	258
						KLZ	Reynolds Radio Co., Inc., Denver, Colo.	360
						WNAR	Rhodes, C. C., Butler, Mo.	360
						KDZE	Rhodes Co., The, Seattle, Wash.	360
						WRAA	Rice Institute, Houston, Tex.	360
						KFCM	Richmond Radio Shop, Richmond, Cal.	360
						WKN	Richman-Crosby Co., The, Memphis, Tenn.	360

Call	Station	Wave Lengths	Call	Station	Wave Lengths	Call	Station	Wave Lengths
WHA	Roberts Hardware Co., Clarksburg, W. Va.	360	KDYS	Star Bulletin Pub. Co., Honolulu, T. H.	360	WOAN	Vaughan, James D., Lawrenceburg, Tenn.	360
WNL	Rockwell, R. J., Omaha, Neb.	360	KFHR	Star Elec. & Radio Co., Seattle, Wash.	270	WLAK	Vermont Farms Mach. Co., Bellows Falls, Vt.	360
KFD	Ross Arbuckle Garage, Iola, Kan.	246	WKAC	Star Pub. Co., Lincoln, Neb.	275	WSAV	Vick, Clifford W., Houston, Tex.	360
KNJ	Roswell Public Service Co., The, Roswell, N. M.	360	KFAE	State College of Washington, Pullman, Wash.	360	WCAM	Villanova College, Villanova, Pa.	360
WMAF	Round Hills Radio Corp., Dartmouth, Mass.	360	WRAC	State Normal School, Mayville, N. D.	360	KFAV	Virgin's Radio, Medford, Ore.	360
WTAU	Ruegy Battery & Elect. Co., Tecumseh, Neb.	360	WHAA	State University of Iowa, Iowa City, Iowa	283	WLAJ	Waco Elec. Supply Co., Waco, Tex.	360
WIAW	Saginaw Radio & Elect. Co., Saginaw, Mich.	360	WBAX	Stenger, John H., Jr., Wilkes-Barre, Pa.	360	WMAW	Wahpeton Elect. Co., Wahpeton, N. D.	360
WCAD	St. Laurence University, Canton, N. Y.	360	WBAD	Sterling Elec. Co., Minneapolis, Minn.	360	WDAS	Waite, Samuel A., Worcester, Mass.	360
WEW	St. Louis University, St. Louis, Mo.	360	WBBC	Sterling Radio Equip. Co., Sterling, Ill.	229	WWZ	Wanamaker, John, New York, N. Y.	360
WVW	St. Martin's College, Lacey, Wash.	258	WCK	Stix-Baer-Fuller, St. Louis, Mo.	360	WOO	Wanamaker, John, Phila., Pa.	509
KFDD	St. Michael's Cathedral, Boise, Ida.	360	WFI	Strawbridge & Clothier, Philadelphia, Pa.	395	WBAR	Ward, R. A., Beloit, Kan.	360
WCAL	St. Olaf College, Northfield, Minn.	360	WBAL	Superior Radio & Tel. Co., Columbus, Ohio	286	KLS	Warner Brothers, Oakland, Cal.	360
WPAT	St. Patrick's Cathedral, El Paso, Texas	360	WFB	Superior Radio Co., Superior, Wis.	360	KHQ	Wasmer, Louis, Seattle, Wash.	360
KFCD	Salem Elect. Co., Salem, Ore.	360	WHD	Sweeney School Co., Kansas City, Mo.	411	WMAR	Waterloo Electrical Sup. Co., Waterloo, Iowa	360
WCAO	Sanders & Stayman Co., Baltimore, Md.	360	WDAE	Syracuse Radio & Tel. Co., Syracuse, N. Y.	286	KFBD	Welch, Clarence V., Hanford, Cal.	360
WQAF	Sandusky Register, Sandusky, O.	240	WBL	Tampa Daily Times, Tampa, Fla.	360	KFJD	Weld County Ptg. & Pub. Co., Greeley, Colo.	236
WVAC	Sanger Bros., Waco, Tex.	360	WRW	T. & H. Radio Co., Anthony, Kan.	261	KZV	Wenatchee Battery & Motor Co., Wenatchee, Wash.	360
KMJ	San Joaquin Light & Power Corp., Fresno, Cal.	360	WRAD	Tarrytown Radio Research Lab., Tarrytown, N. Y.	273	WQAO	West Texas Radio Co., Abilene, Texas	360
WRAB	Savannah Board of Public Education, Savannah, Ga.	360	KDYL	Taylor Radio Shop, Marion, Kan.	360	WHD	West Virginia University, Morgantown, W. Va.	360
KDYM	Savoy Theatre, San Diego, Cal.	252	WNAS	Telegram Pub. Co., Salt Lake City, Utah	360	WBAY	Western Elec. Co., New York, N. Y.	492
WIAO	School of Engineering & Milwaukee & Wisconsin, Milwaukee, Wis.	360	KFBU	Texas Radio Corp. & Austin Statesman, Austin, Tex.	360	KFAF	Western Radio Corp., Denver, Colo.	360
WHN	Schubel, Geo., Ridgewood, N. Y.	360	WRAR	Thomas, Bishop N. S., Laramie, Wyo.	360	WOO	Western Radio Co., Kansas City, Mo.	360
WOAN	Scranton Times, Scranton, Pa.	360	KFBH	Thomas, Jacob Carl, David City, Neb.	226	KFCY	Western Union College, LeMars, Iowa	360
WVW	Scruggin, J. L., Oak, Neb.	360	WHAB	Thomas Musical Co., Marshfield, Ore.	360	KYW	Westinghouse Elect. & Mfg. Co., Chicago, Ill.	345
KDZT	Seattle Radio Assn., Seattle, Wash.	360	KFBJ	Thompson, Clark W., Galveston, Texas	360	KDPM	Westinghouse Elect. & Mfg. Co., Cleveland, Ohio	270
WSAP	Seventh Day Adventist Church, New York, N. Y.	360	WFAM	Thoreau, Sidney I., Platte, S. D.	236	KDKA	Westinghouse Elect. & Mfg. Co., E. Pittsburgh, Pa.	326
KFFA	Shelton, R. O., Dr., San Diego, Cal.	242	WMAI	Times Mirror Co., Los Angeles, Cal.	395	WRZ	Westinghouse Elect. & Mfg. Co., Springfield, Mass.	337
WEAN	Shepard Co., Providence, R. I.	360	KDYS	Times Pub. Co., St. Cloud, Minn.	360	WQAD	Whiteall Elect. Co., Waterbury, Conn.	242
WNAC	Shepard Stores, Boston, Mass.	360	KLX	Tribune, The, Inc., Great Falls, Mont.	360	WJH	White & Boyer Co., Washington, D. C.	273
WFAV	Sheridan Elect. Serv. Co., Rushville, Neb.	360	WDAH	Tribune Pub. Co., Oakland, Cal.	360	WIAK	White Radio Lab., Stockdale, O.	360
WLAO	Shilling, A. E., Kalamazoo, Mich.	360	WMAA	Trinity Methodist Church, So. El Paso, Texas	360	WEAH	Wichita Board of Trade & Landers Radio Co., Wichita, Kan.	360
WNAV	Ship Owners' Radio Service, Baltimore, Md.	360	WUAB	Tucker Elec. Co., Liberal, Kan.	360	WPAD	Wieboldt & Co., W. A., Chicago, Ill.	360
WDT	Ship Owners' Radio Service, Stapleton, N. Y.	360	WAAC	Tuland University of La., New Orleans, La.	360	WHAV	Wilmington Elect. Specialty Co., Wilmington, Del.	360
WNJ	Shotten Radio Mfg. Co., The, Albany, N. Y.	360	WLAL	Tulsa Radio Co., Tulsa, Okla.	360	WFAR	Winner Radio Corp., Denver, Colo.	360
KDZB	Siefert, Frank E., Bakersfield, Cal.	360	WKAV	Turner Cycle Co., Beloit, Wis.	242	WRAP	Winter Park Elect. Const. Co., Winter Park, Fla.	360
WDAU	Slocum & Kibburn, New Bedford, Mass.	360	WQAF	Tyler Commercial College, Tyler, Texas	360	WBAN	Wireless Phone Corp., Paterson, N. J.	244
KFDY	Smith, E. H., Dr., Hillsboro, Ore.	360	WRAJ	Union College, Schenectady, N. Y.	360	WNO	Wireless Telephone Co., Jersey City, N. J.	360
KFYW	Smith-Hughes & Co., Phoenix, Ariz.	360	WJAX	Union Trust Co., Cleveland, Ohio	390	WPAH	Wisconsin Dept. of Markets, Wau-paca, Wis.	360
KNT	Smith, T. W., Eureka, Cal.	360	WKAN	United Battery Service Co., Montgomery, Ala.	226	WNAP	Wittenberg College, Springfield, O.	360
WNAQ	Sommes Motor Co., Washington, D. C.	242	WAAP	United Elec. Co., Wichita, Kan.	360	WFAW	Woose, Carl C., Syracuse, N. Y.	234
WGAZ	South Bend Tribune, South Bend, Ind.	360	WPO	United Equip. Co., Memphis, Tenn.	360	WOAN	Wolff, Franklyn J., Trenton, N. J.	240
WFAZ	South Carolina Radio Shop, Charleston, S. C.	360	KFDH	University of Ariz., Tucson, Ariz.	360	WOAW	Woodmen of the World, Omaha, Neb.	360
WCAT	So. Dak. School of Mines, Rapid City, S. D.	240	KOI	University of Cal., Berkeley, Cal.	360	WOAL	Woods, W. E., Webster Grove, Mo.	360
KFDY	So. Dak. State College of Agri. & M. Art., Brookings, S. D.	360	WHAG	University of Cincinnati, Cincinnati, Ohio	222	WIAY	Woodward & Lothrop, Washington, D. C.	360
WSAB	Southeast Mo. State Teachers College, Cape Girardeau, Mo.	360	KFAJ	University of Colo., Boulder, Colo.	360	WLAH	Woodworth, Samuel, Syracuse, N. Y.	234
KDPT	Southern Electrical Co., San Diego, Cal.	360	WRN	University of Illinois, Urbana, Ill.	360	WWAN	Wormser Brothers, Laredo, Tex.	360
WOAI	Southern Equipment Co., San Antonio, Tex.	360	WLB	University of Minn., Minneapolis, Minn.	360	WBAP	Wortham-Carter Pub. Co., Fort Worth, Tex.	476
WBT	Southern Radio Corp., Charlotte, N. C.	360	WAAN	University of Mo., Columbia, Mo.	360	WWAD	Wright & Wright, Inc., Philadelphia, Pa.	360
WGAR	Southwest American, Fort Smith, Ark.	360	WFAV	University of Neb., Lincoln, Neb.	360	WKAJ	W. S. Radio Supply Co., Wichita Falls, Texas	360
WQAB	Southwest Mo. State Teachers College, Springfield, Mo.	360	WNAD	University of Okla., Norman, Okla.	360	WAAJ	Yahrling-Rayner Piano Co., Youngstown, Ohio	360
WOAU	Sowder-Bolling Piano Co., Evansville, Ind.	360	WHAM	University of Rochester, Rochester, N. Y.	360	KFIQ	Yakim Valley Radio Broadcasting Assn., Yakim, Wash.	224
WGAD	Spanish-American School of Radio Telegraphy, Ensanada, P. R.	360	WFAJ	University of S. D., Vermillion, S. D.	360	KOA	Y. M. C. A., Denver, Colo.	360
WSAA	Sprague Elect. Co., B. S., Marietta, Ohio	360	WOM	University of Texas, Austin, Tex.	360	WABF	Y. M. C. A., Washington, D. C.	283
WPAF	Spratley, Henry C., Poughkeepsie, N. Y.	360	WCAN	University of Vermont, Burlington, Vt.	360	WKC	Zamoiski Co., Jos. M., Baltimore, Md.	360
KFAP	Standard Pub. Co., Butte, Mont.	360	WHA	University of Wis., Madison, Wis.	360	WIAE	Zimmerman, Mrs. Robt. E., Vinton, Iowa	360
WEAB	Standard Radio Equip. Co., Fort Dodge, Iowa	360	WSAI	U. S. Playing Card Co., Cincinnati, Ohio	309			

### Calls Heard

5LG, A. K. TATUM, ALAMOGORDO, N. M. (MOSTLY ONE TUBE)

C.W.: 2KF, 3ZO, 5AAE, 5AEC, 5AER, 5AHC (5AHD), 5AHR, 5AGN, 5AKY, (5AKZ), 5ATP, 5AUU, 5AIB, 5AKI, 5AKN, 5AKY, 5AMO, 5AMW, 5BM, 5C, 5EK, 5EN, 5ET, 5FT, 5GA, 5GG, 5GJ, 5GN, 5GR, 5HZ, 5IT, 5IZ, 5KC, 5KE, 5KK, 5KP, 5KW, 5MO, (5MN), 5MT, 5NK, 5NN, 5OK, 5OI, 5OV, 5PD, 5PX, 5OI, 5OM, 5RN, 5SP, 5TP, 5UI, 5VM, (5VO), 5VY, 5XAD, 5XAJ, 5XB, 5XD, 5XV, 5YK, 5ZA, 5ZAD, 5ZAK, 5ZAT, 5ZAV, 5ZD, 5ZH, 6AAK, 6AHU, 6AIC, 6AIV, 6ATY, 6AVN, 6BA, 6BAH, 6BAW, 6BE0, 6BGN, 6BLC, 6BIX, 6BIY, 6BOD, 6BQC, 6BOD, (6BUN), 6BU0, 6BUR, 6BV, 6BVF, 6BVG, 6CBU, 6CGU, 6EC, (6CBI), (6BU), 6HV, 6KM, 6MH, 6TW, 6VG, 6XAJ, 6ZAO, 6ZH, 6ZZ, 7ABB, 7AFW, 7HS, 7HO, 7PE, 7LN, 7ZF, 7ZG, 7ZN, 7ZU, 7ZV, 8CF, 8CNO, 8CUT, 9AAH, 9AAU, 9ABV, 9ABZ, 9AEC, 9AED, 9AET, 9AHZ, 9AHV, 9ALG, 9AOG, 9APP, 9ARZ, 9ASO, 9AUU, (9AVW), 9AYL, 9AYU, 9BIB, 9BII, 9BJK, 9BK, 9BKJ, 9BOD, 9BRI, 9BTO, 9BUN, 9BXM, 9BXC, 9BXT, 9BY, 9BZE, 9BZH, 9BZI, 9BZZ, 9CAA, 9CAC, 9CAO, 9CBA, 9CCV, (9CCZ).

9CFI, 9CFY, 9CGA, 9CIP, 9CIV, 9CKM, 9CLQ, 9CMK, 9CUC, 9CVC, 9CVO, 9CWI, 9CAN, (9DEZ), 9DGA, 9DGV, 9DHW, 9DIB, 9DN, 9CRW, 9DSM, (9DTE), 9DVI, 9DWN, 9EAE, 9EAK, 9EJ, 9EFA, 9EHW, 9EY, 9FV, 9HK, 9IF, 9JP, 9QP, 9SS, 9U, 9UU, 9VE, 9XAO, 9YB, 9ZT. SPK: 5TP, 5UD, 5XAJ, 6APH, 6APL, 9ASO, 9BFO. PHONF: 5AHD, 5AKI, 5AKZ, 5LT, 5XAJ, 5XD, 6CBI.

JOHN H. ECKARDT, FRESNO, CALIF. (ONE TUBE)

6AW, 6AAK, 6AFA, 6AHV, 6AOP, 6AO, 6AOQ, 6AUU, 6BAH, 6BEG, 6BGC, 6BIH, 6BOQ, 6BOP, 6BUO, 6BWE, 6BNA, 6CAN, 6CAY, 6CEU, 6CK, 6CKL, 6CPS, 6CGD, 7ABS, 7ADR, 7AFW, 7CH, 7JE, 7NA, 7OH, 7OT, 7ZT, 7ZU, 9CFY, 9QL, 9CZG.

8DFK, WAVERLY, N. Y.

1AB, 1AGM, 1AR, 1ARM, 1ASK, 1BAS, 1BFT, 1BME, 1BNL, 1RZI, 1CDO, 1CH, 1DL, 1HJ, 1JH, 1JV, 1MC, 1NY, 1XA, 1XX, 2AA, 2AHP,

2AIP, 2ANM, 2BG, 2BRG, 2CJ, 2CM, 2CPA, 2CT, 2CXC, 2PZ, 2TJ, 3ABW, 3AH, 3AKQ, 3AP, 3AS, 3ASO, 3ATS, 3AWU, 3BH, 3BJ, 3BMN, 3BO, 3BSS, 3BVA, 3BWT, 3CB, 3CC, 3CEQ, 3CKN, 3CO, 3GL, 3HA, 3IJ, 3JJ, 3ME, 3OE, 3RF, 3SI, 3TJ, 3TR, 4EW, 4FT, 4KC, 4MR, 5EC, 5NA, too many 8's, 9AA, 9APS, 9ARI, 9ATO, 9BCF, 9BCL, 9BDS, 9BIJ, 9BO, 9BOD, 9BY, 9BZL, 9CBA, 9CDB, 9CDO, 9CGF, 9CHK, 9CHO, 9CJM, 9CIR, 9CKM, 9CNV, 9CR, 9CTR, 9CVO, 9DCR, 9DHR, 9DI, 9DOV, 9DUO, 9DZN, 9ECE, 9EL, 9EP, 9ER, 9OR, 9UL, 9UO, 9VZ.

JOHN E. HORTON, POINT, TEXAS (ONE TUBE)

AH C. W.—5AEJ, 5ADG, 5AFU, 5DHB, 5EK, 5XAJ, 5XZ, 5ZA, 5ZM, KDKA, KFAD, KFAF, KFEL, KFFO, KHI, KIZ, KOR, KSD, KUO, KYW, DM7, WAAP, WAAW, WAAZ, WBAP, WBL, WBT, WCAG, WCAL, WCAR, WCAS, WCAY, WCAZ, WCK, WCM, WCX, WDAE, WDAJ, WDAO, WDAF, WFAH, WFAJ, WFAV, WFEV, WFW, WFAA, WFAJ, WGF, WGM, WGV, WGY.

(Continued on page 188)



# MAGNAVOX

## Radio in Summer

THE man who purchases a Magnavox for its clearness of reproduction, finds additional advantages in its use which contribute greatly to his enjoyment of Radio.

For instance, due to its extreme sensitivity, the Magnavox can clearly reproduce signals which otherwise would be indistinguishable.

This means a great increase in distance range—more stations brought within the Magnavox owner's reach.

Magnavox Reproducers and Power Amplifiers can be used with any receiving set of good quality. Without Magnavox, no receiving set is complete.

**Magnavox R2 Reproducer and 2 stage Power Amplifier (as illustrated)**  
\$115.00

**R2 Magnavox Reproducer with 18-inch curvex horn:** the utmost in amplifying power; requires only .6 of an ampere for the field . . . . \$60.00

**R3 Magnavox Reproducer with 14-inch curvex horn:** ideal for homes, offices, etc. . . . \$35.00

**Model C Magnavox Power Amplifier** insures getting the largest possible power input for your Magnavox Reproducer.

AC-2-C, 2-stage, \$55.00

AC-3-C, 3-stage, \$75.00



*A clearer Radio voice,  
sounding above the  
tumult of vacation time*

WHEN days are spent in summer's outdoor playgrounds, Magnavox needs only an instant's notice to supply dance music, sporting news or entertainment for all.

Open places test impartially the real quality of Radio reproduction—with Magnavox equipment your receiving set will give superbly adequate performances, indoors or out, the year 'round.

*Magnavox products can be had of good dealers everywhere. Send for copy of unusual booklet.*

The Magnavox Co., Oakland, California  
New York: 370 Seventh Avenue

# MAGNAVOX

## Radio

### The Reproducer Supreme

## What do you want to know about fibre?



**R**ADIO builders everywhere are using vulcanized fibre in their products. They know that it is a perfect non-conductor, that it is non-corrosive, that it is more easily worked than rubber. They know that it is much less costly than any of the materials for which it is substituted.

But often a manufacturer will refrain from using vulcanized fibre because he is not sure of all of its qualities. He knows exactly what rubber, or metal or wood will do—how he can work it and what it will cost him.

Can't we clear up these questions—make plain just what fibre is, just what it will do and just how you can use it to advantage in your product?

The National Vulcanized Fibre Company has three-fold facilities for the production and delivery of Vul-Cot Fibre—fibre with a nation-wide reputation. Each step of its manufacture is under such close supervision that we can guarantee it to be pure—free from foreign material.

The experience of years in the manufacture of Vul-Cot Fibre and Vul-Cot fibre parts for many of the nation's greatest manufacturers is at your disposal. Write today.

**National Vulcanized  
Fibre Company**  
Wilmington, Del.

## Book Review

**101 RECEIVING CIRCUITS** (The Green Book). By M. B. Sleeper. 6"x9", 47 pages. Published by M. B. Sleeper, Inc., Technical Publisher, 88 Park Place, New York City.

For a person who likes to experiment with different receiving circuits, or for one who is undecided as to what type of circuit he wishes to use, this little book becomes invaluable. Diagrams, covering various types of regenerative, super-regenerative, super-heterodyne, reflex, radio frequency, Reinartz, Flewelling and neutrodyne sets, are included, as well as circuits of simple crystal receivers, etc. A list of radio symbols is contained in the front of the book for the convenience of those who are unfamiliar with conventional diagrams. Many helpful hints are included in the text, which should assist the reader in perfecting his own receiving set.

**SIX SUCCESSFUL RADIO SETS** (The Red Book). By M. B. Sleeper. 6"x9", 47 pages. Published by M. B. Sleeper, Inc., Technical Publisher, 88 Park Place, New York City.

Six Successful Radio Sets is a little book describing in detail the construction and operation of five different types of receiving sets, and a two-stage audio frequency amplifier. These sets have been especially selected as the most practical and efficient types of those of the present time. The design, data and instructions for building are complete. The panel layout dimensions and the means of wiring are given in connection with the description of each set. Nothing is left to the imagination.

**AMATEUR RADIO CALL-BOOK**. 6 $\frac{3}{4}$ " x9 $\frac{3}{4}$ ", 159 pages. Published by Radio Directory and Publishing Company, 45 Vesey Street, New York City.

The Amateur Radio Call-Book fills the want for a complete radio directory of existing radio stations. The list includes the call-letters and locations of amateurs, special amateurs, technical and training stations, radiophone broadcasting stations of the United States and Canada, commercial land stations and Army and Navy land stations of the United States; also the principal high-powered trans-oceanic stations of the world, with their respective work wave-lengths, type of transmitters and press schedules.

A detailed description of the construction and operation of the well known Reinartz receiver, in conjunction with a one-stage audio-frequency amplifier, is included in the front pages of this book.

The most attractive feature of this directory is the two-color map of the United States and Canada, 3x3 feet, showing radio district boundaries, standard time lines and geographical locations of broadcasting stations. An alphabetical list of broadcasting stations is contained on the map, as well as in the book. The map is of such size that there is ample room for the insertion of call letters of new broadcasting stations.

**LISTEN-IN RADIO RECORD**. Arranged by Roy C. Baker. 5 $\frac{1}{2}$ "x8 $\frac{1}{2}$ ". Flexible fabrikoid binding. Gold stamping, 160 pages. Printed on bond paper to take ink. Published by Lothrop, Lee & Shepard Company, 275 Congress Street, Boston, 9, Mass.

The advance in the quality and quantity of radio broadcasting during the past year and the variety of programs offered have led to a demand by the public for a means of keeping permanent records of such broadcasts. The Listen-In has been compiled for this purpose, and will enable radio enthusiasts to record the programs of various stations heard. This little book contains as well a complete list of broadcasting stations and a double-page map of the United States, showing locations of all the principal stations. Space is provided for an additional recording of new broadcasting stations, this space being so arranged that the corresponding dial adjustments on the receiving set may be noted after the stations' call-letters.

The introductory article—"How to Receive Radio Broadcasts," by Lloyd C. Greene, Radio Editor of the Boston *Globe*—covers the construction and operation of a simple and efficient type of regenerative receiving set. This is followed by a page of radio tips, which prove invaluable as reference.

**GETTING ACQUAINTED WITH RADIO RECEIVERS**. By Paul Godley. 6"x9", 32 pages. Published by Adams-Morgan Company, Upper Montclair, N. J.

Mr. Godley has well succeeded in explaining the operation of radio receivers, in non-technical language, so that the novice should find it easily understandable.

Although the book is concerned mostly with the operation of the Paragon RA-10 and RD-5 receivers, the information given in the book is written in such a manner that it could be applied to any type of receiving set.

Of general interest are the chapters covering the vacuum tube, tuning and resonance, regeneration, antennae systems, body-capacity effects, and the faults of receiving sets and their remedies.

A glossary is included in the rear of the book, giving the simplified definitions of the most widely used radio terms.

**RADIO TELEPHONY FOR AMATEURS**. By Stuart Ballantine. 5 $\frac{1}{2}$ "x8 $\frac{1}{2}$ ", cloth bound, 296 pages, fully illustrated. Published by David McKay Company, Philadelphia.

Starting with the fundamental principles of electricity, upon which radio telephony is based, Mr. Ballantine well prepares the reader for the following chapters, covering its more complicated actions. The book is written in such a comprehensible form that the word "wading" cannot be applied to the reading of its contents. The entire subject of radio telephony is boiled down to the point of conciseness, yet nothing of importance is left out.

The action of the vacuum tube is explained in the forepart of the book, followed by its applications to numerous types of circuits. Much helpful data is given on antennae systems, this including as well the construction of aeriels and grounds for both transmitting and receiving. Of particular interest is the information covering the construction and operation of radiophone transmitters and receivers.

**RADIO HOOK-UPS**. Published by the Rauland Manufacturing Co., 200 No. Jefferson St., Chicago, Ill.

A small booklet, containing 22 hook-ups of receiving sets in conjunction with radio and audio-frequency amplifiers. Much helpful data on radio and audio-frequency transformers, especially the "All American" manufacture, is included in the forepart of the booklet, as well as a page of symbols. This pamphlet will be sent to anyone upon the receipt of two cents to cover the postage.

**DER FUNKTELEGRAPHISCHE WETTERUND ZEITZEICHENDIENST**. By H. Thurn. Published by M. Krayn, Verlagsbuchhandlung, Berlin W. 10.

In its 82 pages this little work gives an excellent presentation of two phases of wireless work.

The first phase treated of is the prediction of weather changes by radio. The practice, as far as developed before the World War, is given and the subsequent operations in recent days, in Germany and abroad, are treated of. A list of stations of the German radio weather service is supplied, with their code letters. The stations are 21 in number and a further list gives the same information of the International European Stations—37 in number.

It may not seem ungenerous to express the hope that the weather predictions abroad run higher in percentage of accuracy than they do here.

The second subject treated is time service and, within the limits of some 40 pages, the matter is quite fully described, with a number of illustrations and diagrams. Time service is not only a very definite thing, but is of the greatest importance to navigation at sea. An error in time gives a ship the wrong longitude and, as the ocean is crossed eastward and westward, this error is the worst and most dangerous.

We commend the book to our readers.

## What Radio Can Do for the Country

(Continued from page 135)

music and education. Radio broadcasts the world's best treasures.

Go to the four corners of the globe, and you will not be isolated if you have your radio set with you. Just like Aladdin's lamp, the marvelous, bounteous gift of radio broadcasting comes to you through unknown space, with gifts that are beyond your wildest dreams. It so happened that in this little country town there lived an estimable citizen known to all as "Uncle George." He had spent most of his life in the steel industry, had retired from active work and had settled down to a quiet, sedate existence in that very quiet country com-

(Continued on page 181)

BUILD YOUR SET WITH BARAWIK STANDARD RADIO GOODS

PLATE CIRCUIT "B" BATTERIES

You can make real savings on these batteries. Don't pay more. We guarantee them to equal any on the market regardless of price. Absolutely uniform. Extra long life.



- G180 Signa Corps type, small size, 15 cells, 2 1/2 volts. Each... \$9.50
G184 Variable Large Navy size, 6 1/2 x 4 1/2 inches 6 cans, giving range from 10 1/2 to 2 1/2 volts in 1 1/2 volt steps. Each... \$1.80
G188 Combination Tapped 45 volts 30 cell, 3 1/2 x 3 1/2 battery. Tapped to give 45, 22 1/2, 21, 19 1/2, 18 and 16 1/2 volts. Handles both detector and amplifier tubes. Each... \$3.35

HOMECHARGER BATTERY CHARGING RECTIFIER

Charge your battery at home over night for a few cents. Simply connect to any 110 volt 60 cycle light socket, turn on current and rectifier does the rest automatically. Will work for years without attention. Simple connections. Gives a tapering charge which batteries should have. You can make it pay a profit charging your friends' auto batteries. Long connecting cords with pair of battery clips.

- G201 For 6 volt battery... \$13.95
G203 For 12 volt battery... \$19.95

STORAGE "A" BATTERY

A very high grade battery for radio service. Guaranteed for three years. Properly cared for will give many more years of service for filament lighting. Made of best new materials. Full capacity. The best battery buy on the market. Try one of these batteries on your set for 10 days. If at the end of that time you are not fully satisfied with the battery return it and we will refund the purchase price.

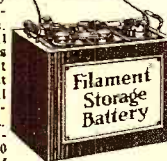

- G194 6 volt, 40 ampere size. Each... \$10.00
G196 6 volt, 30 ampere size. Each... \$12.50

VACUUM TUBES

Standard Brands—Gunningham Radiotron. Every one guaranteed new and perfect. We will ship brand in stock unless you specify otherwise.

- G105 Detector, UV200 C300 Ea. \$4.30
G112 Amplifier, UV201A C301A 5.95
G118 5 Watt Transmitter... 7.70
G107 WJ11 1 1/2 v. Fil. Each... 5.95
G101 WD12, Each... 5.95
G102 UV199, Each... 5.95
G103 UV199, Socket... 5.9c
G104 UV199 Adapter... 4.9c
G108 WJ11 Socket, Each... 4.9c
G109 WJ11 Adapter, Each... 4.8c

FILAMENT CONTROL RHEOSTATS

Best grade. High heat resisting base. Diam. 2 1/2 in. cup 1 1/2 amp. Resist. 6 ohms. 1 1/4 in. knob with pointer. 75c value.

- G131 25 Ohm Rheostat for 301A, 201A tubes... 69c
POTENTIOMETER
Same style as above rheostat. Gives fine battery adjustment. Resistance 140 ohms. G133 Each... 89c
VERNIER RHEOSTAT
Gives exceedingly fine control of "A" battery current. A necessity for best receiving results. G135 Each... 89c

VACUUM TUBE SOCKETS

Our Special Socket. A wonderful value. Moulded entirely of brown bakelite. Four binding post connections. Right angled contact springs.

- G140 Each... 39c
High Grade combination type for panel or table mounting. Metal tube. High insulation base. One of the best sockets made. G148 Each... 45c
TWO AND THREE GANG SOCKETS
These sockets make it easy to build a detector and amplifier units and make a neat, compact workmanlike job. Perfectly made of high grade materials. Quickly mounted on panel or base.
G147 Two-gang socket... \$1.05
G149 Three-gang socket... \$1.45

GALENA DETECTOR

Easy fine adjustment. Crystals mounted in cup. Moulded base and knob. Brass parts polished nickel finish. An unequalled value. G732 Each... 50c

DETECTOR CRYSTALS CAREFULLY TESTED

- G736 Galena, Arlington tested, per piece. 19c
G738 Silicon, Arlington tested, per piece. 19c
G735 Tested, Galena, per piece. 9c
G737 Tested, Silicon, per piece. 9c

WE PAY TRANSPORTATION CHARGES EAST OF THE ROCKIES THE PRICES QUOTED DELIVER THE GOODS TO YOUR DOOR FAST SERVICE—TRY US AND BE CONVINCED

THIS GUARANTEE PROTECTS YOU—Examine the goods we ship you. They must suit you in every respect. If you are not satisfied with your purchase return the goods at once and we will refund the price you paid.

"HONEYCOMB" COILS

Carefully made—fine looking coils. Highest efficiency. Low distributed capacity effect, low resistance—high self inductance. Very firm impregnation. Range given in meters when varied with 2001 variable condenser. Mounted coils have standard plug mountings.

Table with columns: Turns, Range, Art No., Not Mttd. No., Art Price. Lists various coil models and their prices.

COIL MOUNTINGS

G340 Three-coil mounting, \$3.95
G341 Two-coil mounting, \$2.95
High grade fine looking mountings. Polished brass composition. Center receptacle stationary, two outer ones adjusted by knobs. Takes any standard mounted coil.

RADIO JACKS AND PLUGS

Finest grade jacks. Improved design. Best materials. Phosphor bronze springs. Silver contact points. Nickel finish. Mount on panels 1/4 to 1/2 in. thick.

- G390 Open circuit, Each... 43c
G391 Closed circuit, Each... 49c
G392 Two circuit, Each... 60c
G393 Single circuit filament cont. 69c
G394 Two circuit filament cont. 85c
G395 Plug, Large space with set screws for attaching cord. Each... 49c

BINDING POSTS

Brass, polished nickel finish. Washer and 6-32 in. screw extending 3/4 in.
G370 Large size—barrel and knob 3/4 in. long, dozen. 85c
G372 Smaller size—barrel and knob 9-16 in. long, dozen. 70c
G374 Large size with conical nesting knob, dozen. 50c
G376 Large size with hole for phone tip or wire, dozen. 80c
G378 Small size with hole for phone tip or wire, dozen. 55c

SWITCH CONTACT POINTS

Brass polished nickel finish. All have 1/2 in. long size 6-32 screws and two nuts. All prices the same. Dozen 18c. Hundred \$1.05. Order by Article Number.
G360 Head, 1/4 in.; Diam. 1/4 in. High
G362 Head, 3-16 in.; Diam. 1/4 in. High
G363 Head, 3-16 in.; Diam. 1-16 in. High

SWITCH LEVERS

Moulded composition knob. Exposed metal parts polished nickel finish. Fitted with panel bushing, spring and two set screws. A high grade switch.
G382 1/2 in. Radius } 19c Ea.
G381 1/4 in. Radius }
G380 1 in. Radius }

SWITCH LEVER STOP

Brass, polished nickel finish. G388—Dozen 18c. Hundred \$1.05

ONE-PIECE DIAL AND KNOB

Moulded in one piece of polished black composition with clean plain engraved scale and numerals in contrasting white enamel. Ribbed knob to fit the hand. An attractive neat pattern.

- G900 2 in. Diam. for 3-16 in. shaft. Ea. 19c
G901 2 in. Diam. for 1/4 in. shaft. Ea. 19c
G904 3 in. Diam. for 3-16 in. shaft. Ea. 25c
G905 3 in. Diam. for 1/4 in. shaft. Ea. 25c
G906 3/2 in. Diam. for 3-16 in. shaft. Ea. 35c
G907 3/2 in. Diam. for 1/4 in. shaft. Ea. 35c

OUTDOOR LIGHTNING ARRESTER

G980 Price... \$1.58
Protect your instruments with this lightning arrester. You cannot afford not to. Weatherproof porcelain case. Air Rad type. Permanent. Durable. The most practical quality arrester obtainable. Underwriters approved.

VARIOMETER

G410—Completely assembled, price \$2.69
Perfect in design and construction. Accurate wood forms of genuine solid mahogany. Correct inductive ratios. Solid baked windings. Positive contacts. Highest efficiency. A real bargain.
G411—Not assembled nor wound but all parts complete except wire, including winding form. \$1.48

MOULDED VARIOMETER

Polished black moulded rotor and stator forms. Maximum inductance with greatest efficiency and minimum distributed capacity. A high grade durable instrument that will make up into a set you will be proud of and will get the best results. Wave length 180 to 600 meters. 4 1/2 in. square, 1 1/2 in. thick. G412 Price including mounting brackets \$3.48

IMPROVED 180° VARIO-COUPLER

G418 Price... \$2.89
Our price shows you a big saving. An instrument of highest quality. The most efficient type of coupler, insures sharper tuning and louder signals. Primary and secondary wound on genuine bakelite tubes. Secondary connections through soldered flexible cables eliminates contact noises. Primary has 7 taps. Can be panel or table mounted. Range 180 to 650 meters.

MAGNET WIRE

Insulated copper wire. Best quality even drawn wire, one piece to a spool. Prices quoted are for 8 oz. spools.
Double Cotton Covered Enamelled Insulation Green Silk Covered
Number G990 Number G992 Number G991
Gauge Price Gauge Price Gauge Price
20... 50c 20... 45c 20... \$0.78
22... 60c 22... 55c 22... 1.00
24... 75c 24... 65c 24... 1.25
26... 95c 26... 85c 26... 1.50
28... 1.15 28... 1.00 28... 1.75
30... 1.35 30... 1.20 30... 2.05

STRANDED ANTENNA WIRE

Coiled of fine copper strands. Very flexible. High tensile strength. Best for aerials. G248—100 ft. coil 72c G249—500 ft. coil \$3.20

SOLID BARE COPPER WIRE

Solid bare copper wire for aerials, leads or wiring instruments.
Solid Bare Copper Wire, size 14 G240—100 ft. coil 49c G242—500 ft. coil \$2.35
Solid Bare Copper Wire, size 12 G244—100 ft. coil 67c G245—500 ft. coil \$3.05

ANTENNA INSULATORS

G260 Size 1 1/2 x 3 1/2. Two for... 17c
G267 Size 2 1/2 x 3 1/2. Two for... 55c
G264 Size 1 1/2 x 4. Two for... 69c
G266 Size 1 1/2 x 10 1/2. Two for... \$1.28

PHONE AND GRID CONDENSERS

A compact style of condenser that is very satisfactory. Conducting sheets and dielectric are wound on fiber strip with eyelets for mounting and connections. Each 12c
G170 Phone Condenser .001 Mfd.
G172 Phone Bridging Condenser .0005 Mfd.
G174 Grid Condenser .00025 Mfd.
G175 Condenser .006. Each... 25c
G176 Grid Condenser .00025 with pencil mark lead. Each... 24c

TUBULAR GRID LEAKS AND CONDENSERS—MOUNTED STYLE

Very convenient. Permits quick change of leaks or condensers of varying capacities.
Grid Leaks Price Each Resistance
G880... 5 Meg. G855... 2. Meg.
G881... 1 Meg. G857... 3. Meg.
G883... 1.5 Meg. G859... 5. Meg.

GRID AND PLATE CONDENSERS

Price, each
G632 .0001 Mfd. For special circuits.
G634 .00025 Mfd. For U.V.201 and Cun. 301
G636 .0005 Mfd. For U.V.200 and Cun. 300

OUR SPECIAL AUDIO FREQUENCY AMPLIFYING TRANSFORMERS

As high as three stages can be used without howling due to proper impedance ratio, minimum distributed capacity, low core losses and proper insulation. Mounted style has bakelite panel with binding post connections. Unmounted has core and coils assembled with two holes in core for fastening to apparatus.

- G234 10 to 1 Mounted. Each... \$3.48
G235 10 to 1 Unmounted. Each... 2.95
G236 3 to 1 Mounted. Each... 3.40
G237 3 to 1 Unmounted. Each... 2.85

BARAWIK SPECIAL PANEL MOUNTING VARIABLE CONDENSERS

G812 43 plate .001 Mfd. \$1.73
G813 21 plate .0005 Mfd. 1.43
G814 11 plate .00025 Mfd. 1.32
G815 3 plate Vernier... 98
These are especially high grade condensers and we guarantee them to be mechanically and electrically perfect. Fine polished end plates of heavy bakelite. Shafts 1/4 inch diameter. Sturdy, heavy aluminum alloy plate perfectly spaced to insure smooth, even reliable capacity. Our low prices save you money. These condensers are of the very best make and are not to be compared with many inferior cheap condensers offered. We guarantee them to please you or your money back.

COMBINATION VERNIER VARIABLE CONDENSERS

G824 23 plate .0005 Mfd. with dial and knobs. Price... \$2.89
G825 13 plate .001 Mfd. with dial and knobs. Price... \$3.45
The latest improvement in condensers consists of regular variable condenser controlled by large knob and dial mounted with a three plate vernier condenser, which is controlled by separate knob mounted on dial. This arrangement permits of very fine tuning. Compact convenient mounting on panel. High grade design and construction. Finely finished.

STANDARD BRAND HEADSETS

G751 Baldwin Type with universal jack plug... \$11.75
G755 Baldwin Type Unit with cord \$5.50
G756 Red-Head, 3000 ohm... 5.78
G757 Branded, 2000 ohm... 6.90
G770 2000 ohm Barawik... 3.75
G751 Murdock 50, 2000 ohm... 4.20
G752 Murdock 50, 3000 ohm... 4.95
G764 Prost, 2000 ohm... 4.20
G766 Prost, 3000 ohm... 5.85
G758 Western Electric, 2200 ohm... 9.50

CABINETS

Fine looking cabinets solidly built. Elegant hand rubbed finish. You will be proud of your set mounted in one of these cabinets. Hinged tops. Front rabbeted to take panels. Panels not included. Prices are transportation paid.

Table with columns: Panel Size, Inside Dimensions (High, Wide, Deep), Art. No., Price Each. Lists various cabinet models and their dimensions and prices.

RADIO "BAKELITE" PANELS

Notice our very low prices on this fine quality material. We supply genuine Bakelite, Condensite, Celoron or Formica, all of which are materials with practically identical mechanical, chemical and electrical properties. Machines well without chipping. Won't warp. Waterproof. Highest mechanical and dielectric strength. Attractive natural polished black finish which can be sanded and oiled for extra fine work.

Table with columns: Panel Size, 1/2" thick, 3-16" thick, 1/4" thick. Lists panel sizes and prices for different thicknesses.

VARIABLE GRID LEAK

Pencil mark type. Resistance may be varied exactly as needed. G160 Each... 18c

GRID CONDENSER

G162 Mounting holes spaced to fit lugs of above leak. Cap. .00025 MF. \$1.40
G163 Same as 162 but higher grade. Enclosed in metal case. 39c

To "Make Your Own"  
 ASK FOR  
 "Consolidated" E.I. Company  
 OR  
 Patterns 25c. Books

These books and patterns were written and prepared by well known experts. They cover every desired phase of radio. Technically correct but so simple that even a child can understand them.

See Full Page Ad on Pages 200 and 232

The following Dealers carry a complete assortment of Consolidated Patterns at 50c and E. I. Books at 25c.

- |   |  |   |  |
|---|--|---|--|
| Albany, N. Y., Albany Radio Corp.                 | Cleveland, O., Radio Electric Shop                   | New Orleans, La., Rose Radio Supply Co.         | Pittsburgh, Pa., Ludwig Hommel & Co.         |
| Albany, N. Y., Havens Electric Co.                | Cleveland, O., Radio Eng. & Sales Co.                | Newport, R. I., George H. Chase                 | Pittsburgh, Pa., Gain-a-Day Electric Co.     |
| Albany, N. Y., Ignition Service Supply Co.        | Cleveland, O., Oliver C. Schroeder                   | New York City, Con'tal Rad. & El. Sup. Co.      | Pittsburgh, Pa., Liberty Incan. Sup. Co.     |
| Albany, N. Y., Schroeder Electric Co.             | Columbus, O., Hall Electric Co.                      | New York City, Penno & Co.                      | Pittsburgh, Pa., Pitts. Radio & App. Co.     |
| Albany, N. Y., Lonsberg Bk. & Mus. House          | Corasopolis, Pa., T. G. O'Donovan                    | New York City, Frank Radio Co.                  | Pittsburgh, Pa., U.S. Radio Co. of Penna.    |
| Allentown, Pa., Hess Brothers                     | Cumberland, Md., J. A. Fulton & Co.                  | New York City, Fremont Radio Co.                | Pittsburgh, Pa., Douthett Hill Co.           |
| Allentown, Pa., F. & W. Grand Stores              | Dallas, Tex., Huey & Philip Hdwre Co.                | New York City, J. J. Kelleher Elec. Shop        | Plainsfield, N. J., F. & W. Grand Stores     |
| Altoona, Pa., Altoona Elec. Sup. Co.              | Dallas, Tex., Southwest Radio Supply Co.             | New York City, David Killech & Co.              | Plattsburg, N. Y., H. E. Atwater             |
| Anthony, Kans., Le Roy Hughbanks Rad. Co.         | Dallas, Tex., Radio Equipment Co.                    | New York City, Liberty Radio Co.                | Portland, Me., L. M. Cleveland Co.           |
| Astoria, L. I., Astoria Radio Shop                | Dayton, Ohio, Wilkie News Company                    | New York City, R. H. Macy & Co.                 | Portland, Me., Chisholm Brothers             |
| Atchison, Kans. Low & Bythe Company               | Denton, Tex., Ebers Hardware Co.                     | New York City, Manhattan Elec. Sup. Co.         | Portland, Ore., Stubbs Electric Co.          |
| Atlanta, Ga., Capital Electric Co.                | Denver, Colo., Electrical Auto App. Co.              | New York City, Overland Radio & Eq. Co.         | Portland, Ore., Hynson Electric Co.          |
| Atlantic City, N. J., Paramount Radio Sup.        | Denver, Colo., Pratt Book Store                      | New York City, Peerless Light Co.               | Pottstown, Pa., Pottstown Radio Sup. Co.     |
| Attitash, Mass., Sweet Accessory Shop             | Denver, Colo., Reynolds Radio Co.                    | New York City, Radio Specialty Co.              | Providence, R. I., Union Electric Sup. Co.   |
| Auburn, Me., G. L. Foss                           | Des Moines, Ia., H. W. King                          | New York City, Stanley & Patterson              | Providence, R. I., H. I. Elec. Equip. Co.    |
| Baltimore, Md., Jos. A. Becker                    | Des Moines, Ia., Iowa Radio Co.                      | New York City, Viking Radio Co.                 | Providence, R. I., F. & W. Grand Stores      |
| Baltimore, Md., Jos. M. Zamolski                  | Detroit, Mich., Federal Elec. Supply Co.             | New York City, The Winchester Store             | Providence, R. I., E. & H. Supply Co.        |
| Baltimore, Md., Wilbur Electric Co.               | Detroit, Mich., Twentieth Cen. Radio Co.             | New York City, Army & Navy Dist. Co.            | Reading, Pa., F. & W. Grand Stores           |
| Baltimore, Md., Backarach Radio Co.               | Detroit, Mich., Crowley Milner Co.                   | New York City, Chamberlain Elec. Co.            | Rochester, N. Y., Hickson Elec. Co.          |
| Baltimore, Md., F. & W. Grand Stores              | Detroit, Mich., McCauley Brothers                    | New York City, Economy Radio                    | Rochester, N. Y., Rochester Elec. Sup. Co.   |
| Baltimore, Md., W. W. Hentzschel                  | Duluth, Minn., Kelley Duluth Co.                     | New York City, Elec. Service Eng. Co.           | Rochester, N. Y., Wheeler Green El. Sup. Co. |
| Batavia, N. Y., H. F. Smith                       | Easton, Pa., F. & W. Grand Stores                    | New York City, Goldfinger Bros.                 | Rochester, N. Y., Eastman Radio Co.          |
| Bethlehem, Pa., Lehigh Radio Company              | Edmonton Alta. Can., Diller Book Co.                 | New York City, R. G. Haslinger                  | Rochester, N. Y., R. Schmidt & Co.           |
| Billings, Mont., Borgerson Brothers               | Eureka, Ill., Klaus Radio Co.                        | New York City, Herbert & Haeggen                | Rochester, N. Y., E. C. Sykes & Co.          |
| Birmingham, Ala., Interstate Electric Co.         | Fergus Falls, Minn., Grande & Sether                 | New York City, Allied Radio Co.                 | Rochester, N. Y., Neisner Brothers           |
| Bluefield, W. Va., Burgess Electric Co.           | Flushing, L. I., The Electric Shop                   | New York City, American News Co.                | Rock Island, Ill., H. E. Gelhart & Co.       |
| Boston, Mass., Atlantic Radio Company             | Port Worth, Tex., H. C. Meacham Co.                  | New York City, J. Belmuth                       | Rock Island, Ill., Bardsley Specialty Co.    |
| Boston, Mass., Cutter & Wood Supply Co.           | Galveston, Tex., Galveston Wireless Sup. Co.         | New York City, J. H. Bunnell & Co.              | Rock Island, Ill., Valle Co.                 |
| Boston, Mass., Seth Fuller Co.                    | Gardner, Mass., Gardner Hardware Co.                 | New York City, Butler Bros.                     | St. Joseph, Mo., Empire Electric Co.         |
| Boston, Mass., International Radio Corp.          | Gloucester, N. J., Lenney's Variety Store            | New York City, Carnahan & Dalzell, Inc.         | St. Joseph, Mo., Manchester's Book Store     |
| Boston, Mass., Lewis Electric Supply              | Granite City, Ill., Rosenberg Dent. Store            | New York City, Broadway Radio Corp.             | St. Louis, Mo., The Benwood Co.              |
| Boston, Mass., F. D. Pitts Co.                    | Great Bend, Kans., Gt. Bend Radio El. Co.            | New York City, P. M. Dreyfuss Co., Inc.         | St. Louis, Mo., Fuetterer Battery Service    |
| Boston, Mass., Williams Book Stores               | Greensburg, Pa., H. Hamilton                         | New York City, Delta Electric Co.               | St. Louis, Mo., Linze Electric Supply Co.    |
| Boston, Mass., J. B. Hunter & Co.                 | Hamilton, O., Radio Co.                              | New York City, Fordham Radio & Spec. Co.        | St. Louis, Mo., Ernest Electric Co.          |
| Boston, Mass., James H. Jones                     | Hartford, Conn., Elec. Sup. & Equip. Co.             | New York City, F. & W. Grand Stores             | St. Louis, Mo., Foster Book & Cigar Co.      |
| Bridgeport, Conn., V. Grant                       | Hartford, Conn., F. & W. Grand Stores                | New York City, I. L. Lewis & Co.                | St. Louis, Mo., Security Auto Supply Co.     |
| Brooklyn, N. Y., Brooklyn Radio Serv. Co.         | Havana, Cuba, Diamond News Co.                       | New York City, Lowe Motor Sup. Co.              | St. Louis, Mo., Stewart                      |
| Brooklyn, N. Y., O. Olsen                         | Havana, Cuba, Liberia De Jose Albeite                | New York City, Rova Radio Stores                | St. Paul, Minn., North-West Elec. Eq. Co.    |
| Brooklyn, N. Y., Tollner Electric Co.             | Helena, Mont., Van Blaricom Co.                      | New York City, Live Wire Elec. Co.              | St. Paul, Minn., Premier Radio Co.           |
| Brooklyn, N. Y., Anderson Electric Co.            | Hoboken, N. J., International Book Store             | New York City, Marks Elec. & Radio Co.          | St. Paul, Minn., Pioneer Electric Co.        |
| Brooklyn, N. Y., Brooklyn Radio Center            | Holyoke, Mass., Haskell Electric Co.                 | New York City, Models-8 Stores                  | St. Paul, Minn., St. Paul Book & Sta. Co.    |
| Brooklyn, N. Y., Jobs Radio Service               | Independence, Mo., Melodian Co. of America           | New York City, Philing Street Shop              | St. Paul, Minn., Crist Mfg. Shop             |
| Brooklyn, N. Y., Halperin Elec. Sup. Co.          | Indianapolis, Ind., Alamo Sales Corp.                | New York City, Wehman Bros.                     | Salen Mass., Salem Plumb. & Lgt. Sup. Co.    |
| Brooklyn, N. Y., Brooklyn Elec. Lamp and Nov. Co. | Indianapolis, Ind., Capital Radio Sup. Co.           | New York City, A. & A. Electric Co.             | Salisbury, N.C., T. M. Casey's Elec. Shop    |
| Brooklyn, N. Y., F. & W. Grand Stores             | Indianapolis, Ind., Hatfield Electric Co.            | New York City, Acme Radio Co.                   | San Francisco, Calif., Leo J. Meyers Co.     |
| Brooklyn, N. Y., Globe Radio & Bat. Shop          | Jacksonville, Fla., Southern Electric Co.            | New York City, Am. Elec. Tech. App. Co.         | San Francisco, Calif., Conrad Richter        |
| Brooklyn, N. Y., Hunt & Vinee Company             | Jacksonville, Fla., Holt Electric Co.                | New York City, Atlas Elec. Supply Co.           | Schenectady, N. Y., Finch & Hahn             |
| Brooklyn, N. Y., S. S. Kresge                     | Jensy City, N. J., F. & W. Grand Stores              | New York City, Atlas Radio Co.                  | Seattle, Wash., Northern Radio & Elec. Co.   |
| Brooklyn, N. Y., G. Kleinteleh                    | Johnson City, Tenn., Bishop Electric Co.             | New York City, Bergmaler Bros.                  | Seattle, Wash., Northwest Radio Service      |
| Brooklyn, N. Y., C. G. Rosewall                   | Kansas City, Mo., Western Radio Co.                  | New York City, Frankla Radio Shop               | Seattle, Wash., Archway Book Store           |
| Brooklyn, N. Y., J. Streiff                       | Kansas City, Mo., Donaldson Radio & Service Station. | New York City, J. Gabler                        | Seattle, Wash., Willamson Electric Co.       |
| Buffalo, N. Y., Denmark                           | Kansas City, Mo., Vulcanizers Sup. Co.               | New York City, Globe Radio Shop                 | Shanghai, China, E. Evans & Son, Ltd.        |
| Buffalo, N. Y., McCarthy Bros. & Ford             | London, Ont., Wm. Gird & Co.                         | New York City, Greenwich                        | Shreveport, La., Interstate Electric Co.     |
| Buffalo, N. Y., Robertson Cataract Elec. Co.      | Los Angeles, Calif., Leo J. Merberg                  | New York City, Hygrade Electric Co.             | Springburg, S. C., Brill Electric Co.        |
| Burlington, N. J., Bur'ln Elec. & Nov. Co.        | Los Angeles, Calif., S. California Elec. Co.         | New York City, International Radio Store        | Springfield, Mass., Whitall Electric Co.     |
| Butte, Mont., Montana Electric Co.                | Los Angeles, Calif., West. Radio Elec. Co.           | New York City, J. Kelleher                      | Stamford, Conn., Fairbanks Electric Co.      |
| Cambridge, Mass., Clapp-Eastham Co.               | Los Angeles, Calif., Radio Concert & Equip.          | New York City, Marlen Hardware Co.              | Stamford, Conn., Artlora                     |
| Camden, N. J., Neisner Brothers                   | Los Angeles, Calif., Naltek Book Store               | New York City, Met. Type & Radio Co.            | Stillwater, Okla., Stillwater Electric Shop  |
| Camden, N. J., Frank White & Brother              | Los Angeles, Calif., Brode Electric Co.              | New York City, Nassau Radio & Co.               | Sydney, Australia, N. S. W. Bookstall        |
| Carrollton, Mo., Carrollton Radio Shop            | Louisville, Ky., Sutcliffe Company                   | New York City, Time Sq. Auto Sup. Co.           | Syracuse, N. Y., Hughes Electric Corp.       |
| Centerville, Ia., H. E. Luther                    | Lowell, Mass., G. A. Hill Co.                        | New York City, Triggers                         | Syracuse, N. Y., Alexander Grant Sons        |
| Champaign, Ill., H. C. Swannell & Son             | Lyons, Kans., B. I. Case                             | Niagara Falls, N. Y., Messersmith & Sons        | Tacoma, Wash., W. A. Mullens Electric Co.    |
| Charleston, W. Va., John R. Koch                  | Macon, Ga., J. W. Burke Co.                          | Norristown, Pa., E. M. Law                      | Terre Haute, Ind., National Auto Sup. Co.    |
| Charleston, S. Car., S. Caro. Radio Shop          | Memphis, Tenn., Street Electric Co.                  | Oakland, Calif., Warner Brothers                | Toledo, Ohio, Kuebler Radio Co.              |
| Charlotte, N. C., Smith Novotoy Elec. Co.         | Milwaukee, Wis., Julius Andrae & Co.                 | Omaha, Neb., Wolfe Electric Co.                 | Toledo, Ohio, W. J. Nardl Electric Co.       |
| Chester, Pa., Neisner Brothers                    | Milwaukee, Wis., Dewey Sport Goods Co.               | Ottawa, Ont., Can., Photographic Stores         | Toronto, Ont., Can., T. Eaton, Ltd.          |
| Chicago, Ill., Harry Alter & Co.                  | Milwaukee, Wis., Badger Radio Co.                    | Ottawa, Ont., Can., A. H. Jarvis Co.            | Trenton, N. J., Radio Chain Stores           |
| Chicago, Ill., Barawik Company                    | Minneapolis, Minn., Jacob Andressen Co.              | Pass., N. J., J. L. David                       | Trenton, N. J., M. M. Flerin & Son, Inc.     |
| Chicago, Ill., Beckley-Ralston Co.                | Minneapolis, Minn., Findley Elec. Sup. Co.           | Paterson, N. J., Federal Radio & Elec. Co.      | Troy, N. Y., F. & W. Grand Stores            |
| Chicago, Ill., Chicago Radio App. Co.             | Minneapolis, Minn., Nagel Hdwre Co.                  | Paterson, N. J., F. & W. Grand Stores           | Union Hill, N. J., N. Friedman               |
| Chicago, Ill., Electric Appliance Co.             | Minneapolis, Minn., Reinhard Bro. Co. Inc.           | Paterson, N. J., S. S. Kresge                   | Uniontown, Pa., Frederick Piano Co.          |
| Chicago, Ill., Inland Electric Co.                | Minneapolis, Minn., Sterling Elec. Co.               | Pawtucket, R. I., Delancey Felch & Co.          | Utica, N. Y., M. F. Dent Co.                 |
| Chicago, Ill., Marshall-Field & Co.               | Missoula, Mont., Peerless Elec. Sup. Co.             | Philadelphia, Pa., Gimbel Brothers              | Utica, N. Y., Utica Electric App. Co.        |
| Chicago, Ill., A. C. McClurg & Co.                | Montreal, Can., Millen & Son, Ltd.                   | Philadelphia, Pa., Phila. Wir. Sales Corp.      | Waco, Tex., Jackson's Radio Enk. Lab.        |
| Chicago, Ill., Newark Electric Co.                | Nashville, Tenn., Zibart Brothers                    | Philadelphia, Pa., H. C. Roberts Elec. Sup. Co. | Washington, D. C., Harry C. Grove, Inc.      |
| Chicago, Ill., Henry Paulson & Co.                | Newark, N. J., Hamberger & Co.                       | Philadelphia, Pa., Sayre Level Radio Co.        | Washington, D. C., National Radio Institute  |
| Chicago, Ill., Sears-Roebuck & Co.                | Newark, N. J., Bassett Radio Sup. Co.                | Philadelphia, Pa., Goetz Music Stores           | Washington, D. C., Con'tal Elec. & Sup. Co.  |
| Chicago, Ill., Chicago Cut Radio Book Co.         | Newark, N. J., Davis Electric Co.                    | Philadelphia, Pa., Ross Frankford Mus. Co.      | Watertown, Wis., D. F. Kusel Co.             |
| Chicago, Ill., Community Book Store               | Newark, N. J., Eddies Wireless Ex.                   | Philadelphia, Pa., F. & W. Grand Stores         | Watertown, Wis., F. & W. Grand Stores        |
| Chicago, Ill., Lenstar Radio Co.                  | Newark, N. J., S. S. Kresge                          | Philadelphia, Pa., E. P. Noll & Co.             | West Hoboken, N. J., The Heraco Exchange     |
| Chicago, Ill., Pettitt Book Co.                   | Newark, N. J., F. & W. Grand Stores                  | Philadelphia, Pa., Roberts Bros. Elec. Co.      | West New York, N. J., West N. Y. Heraco      |
| Chicago, Ill., McArthur Electric Co.              | Newark, N. J., J. F. & W. Grand Stores               | Philadelphia, Pa., G. W. Snell Co.              | Wheeling, W. Va., Gee Electric Co.           |
| Chicago, Ill., P. O. News Company                 | Newark, N. J., Bannister & Pollard                   | Philadelphia, Pa., Eisenberg & Schaeffer        | Wilkes-Barre, Pa., Foster Radio & Elec. Co.  |
| Cincinnati, O., Midwest Radio Co.                 | Newark, N. J., Essex Mfg. Co.                        | Philadelphia, Pa., W. T. Grant                  | Wilmington, Del., Wilton Elec. Spec. Co.     |
| Cincinnati, O., Milnor Electric Co.               | Newark, N. J., W. T. Grant Co.                       | Philadelphia, Pa., Neisner Brothers             | Wilmington, Del., Neisner Brothers           |
| Cincinnati, O., Precision Equipment Co.           | Newark, N. J., United Elec. Supply Co.               | Philadelphia, Pa., New York Radio Co.           | Winnipeg, Can., T. Eaton Co., Ltd.           |
| Cincinnati, O., Murray Spring Co.                 | New Brunswick, N. J., Schmelder Brothers             | Philadelphia, Pa., Post Clear Store             | Worcester, Mass., Neisner Brothers           |
| Cincinnati, O., Reuter Electric Co.               | New Orleans, La., The Electric Shop                  | Philadelphia, Pa., Schimmel Electric Co.        | Yonkers, N. Y., F. & W. Grand Stores         |
| Cleveland, O., Elliott Electric Co.               | New Orleans, La., Interstate Electric Co.            | Phoenix, Ariz., Nielson Radio Sup. Co.          | York, Neb., Bullocks                         |
| Cleveland, O., Newman-Sterr Co.                   | New Orleans, La., Nola Radio Company                 | Pittsburgh, Pa., Goldsmith & Sons Co.           | Zanesville, Ohio, Fergus Electric Co.        |

Order direct from these dealers. If your dealer cannot supply you send us his name and address

The Conrad Co.  
 INC.

233 Fulton Street, New York City

Publishers of Consolidated Patterns  
 Sales Agents for E. I. Co. Books

# A TRIUMPH IN RADIO ACHIEVEMENT!

**\$10<sup>00</sup>** Without Tube

Including Two Interchangeable Inductance Coils

## NATIONAL MONODYNE

Trade Mark

### TUBE SET

(Model GT-1)



## CLARITY      VOLUME      DISTANCE      SIMPLICITY      ECONOMY

For many months our radio engineers have been exerting their efforts toward developing the ideal tube set. They knew that millions of homes would welcome the low priced instrument that embodied simplicity of operation with a minimum cost of up-keep. They wanted an instrument that would bring in volume and distance, clear and loud, with a single control, an instrument that would be classed as a work of art, the possession of which anyone would be proud. That their untiring efforts have been crowned with success is now certain.

The NATIONAL MONODYNE TUBE AIRPHONE includes all these features and more.

The **MONODYNE** CIRCUIT is one of the most radical advances in radio engineering since the advent of the Armstrong Circuit. Parts heretofore considered essential are omitted and one simple tuning control gives a selectivity equal, if not superior, to that of sets costing hundreds of dollars. A child can operate it.

### SIMPLICITY

The NATIONAL MONODYNE uses but one dry cell tube, preferably the WD-12 or any other standard dry cell tube, such as the UV-199 or C-299 types. Local broadcasting comes in astonishingly loud and clear, without distortion.

The tube socket is of a new design and most practical because it holds the tube with a positive grip on all four prongs for a depth of more than one-quarter of an inch.

The NATIONAL MONODYNE AIRPHONE will find especial favor with experimenters because of its adaptability in many different hook-ups, a thing not possible with any other low priced outfit.

### LONG DISTANCE

In our New York laboratory tests, we repeatedly heard stations KYW at Chicago, WOC at Davenport, Iowa, and many others, quite loud and clear. This without resorting to any mode of amplification.

The NATIONAL MONODYNE is the most practical tube set made, and is complete in all details. It is only 6 1/2 inches long, 4 1/4 inches wide, and 2 3/4 inches high of durable, compact and rugged construction. The entire casing is moulded from hard rubber composition.

The NATIONAL MONODYNE has a receiving capacity and range of about 1500 miles. 75-foot aerial is recommended for best results.

### ALL WAVE LENGTHS

With the outfit are furnished two interchangeable fixed double inductance coils for various wave lengths, ranging from 200 to 600 meters.

## THE IDEAL VACATION SET

DISTRIBUTORS—Write for Territory. DEALERS—For Price List.

**NATIONAL  
AIRPHONE  
CORPORATION**  
18 HUDSON ST.      NEW YORK

### SEND NO MONEY

COUPON

R.N.-3

National Airphone Corporation,  
18 Hudson Street, New York City, N. Y.

Gentlemen:

Please send me prepaid One (1) NATIONAL MONODYNE tube set, Model GT-1, for which I will pay the postman \$10.00. If within five days I do not find the apparatus all you claim for it, I may return same to you in good condition and you will refund the full purchase price.

NAME .....

STREET AND NO. ....

CITY ..... STATE .....

“Sorry, old man, I don’t know enough about radio; you’d better ask \_\_\_\_\_”

(Can YOUR Name be put here?)

Is your knowledge of radio limited? Do you have to go to others for advice?

Or are you recognized as an authority? Do your friends come to YOU?

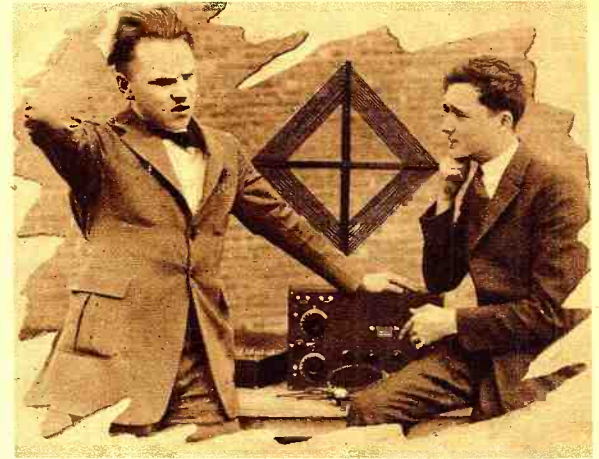

## Learn Radio the Kenneth Harkness Way

**Y**OU ought to have such a comprehensive knowledge of the whole subject of radio reception that you are never at a loss, and can solve immediately all practical and technical problems.

You might gain this knowledge by spending years in experimentation; by wading through hundreds of abstruse mathematical treatises you may eventually piece together the knowledge you are seeking. Others had to take this course, but

### There is a New and Simpler Method Open to You

In his lucid, entertaining style, Kenneth Harkness makes the whole subject of radio reception as clear as day in his new book “The Theory & Practice of RADIO FREQUENCY AMPLIFICATION” just off the press.

Mr. Harkness is one of the foremost radio authorities in the country particularly as a specialist on radio frequency amplification. His clarity of expression; the easily understood manner in which he explains even the most complicated phases of the theory of radio have made him internationally known as “the exponent of advanced radio in everyday language.”

The book covers the entire subject of radio reception, from its elementary laws to its advanced principles. Radio frequency amplification—the most modern development—is explained in detail. No previous knowledge is necessary for a thorough mastery of this book.

### Build Your Sets the Harkness Way

The Radio Guild, Inc., pioneer manufacturers of radio frequency amplifying apparatus,

-----SEND NO MONEY-----

THE RADIO GUILD, INC.,  
256 West 34th Street,  
New York, N. Y.

Please send my copies of “The Theory & Practice of Radio Frequency Amplification” and “The Construction and Operation of Super-Regenerative Receivers” by Kenneth Harkness. I will pay the postman \$1.25 plus a few cents postage upon delivery.

(Note: If you do not want the book on super-regeneration, check here  and upon delivery pay the above price less 25c.)

Name .....  
Address .....  
City ..... State .....

(Outside U. S., cash with order.)

have granted permission to the author to reveal in this book the design, construction and wiring of several different types of their famous receivers. Some of the sets are already on the market; others have just been developed in the laboratories of the Radio Guild and are disclosed by Mr. Harkness for the first time.

The assembly and construction are explained thoroughly and illustrated by scores of diagrams, mechanical drawings and action photographs. The combination of text and illustrations unfolds each consecutive step in the construction of these receivers with the graphic clearness of a moving picture. Nothing like this has ever been published before.

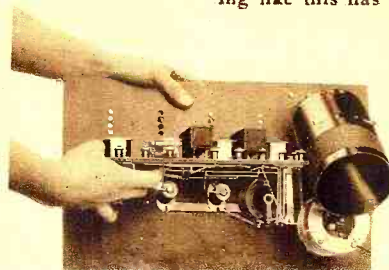

One of the moviegraphs from Kenneth Harkness' book showing the construction of a receiver.

Mr. Harkness writes with a background of years of vivid, colorful experience. As a manufacturer, hundreds of receivers have passed through his hands and the practical knowledge he has gained of operation design, assembly and trouble-shooting is now at your disposal.

Nothing we can say will describe the pleasure and instruction you will derive from reading this latest and most comprehensive work on

radio reception.

Mail the coupon below NOW and receive your copy in return. SEND NO MONEY—simply mail the coupon. When the book arrives pay the postman only \$1.00 plus a few cents postage.

### Special Low-Price Offer

To induce prompt action on your part, the senders of the first five hundred coupons received by us will be given the opportunity of obtaining, at the astonishingly low price of \$1.25, the two books “The Theory and Practice of RADIO FREQUENCY AMPLIFICATION” and “The Construction and Operation of Super-Regenerative Receivers,” both by the same author. The latter book is now in its third edition.

To take advantage of this offer, DON'T DELAY—mail the coupon NOW.

### The Radio Guild, Inc.

256 West 34th Street  
New York, N. Y.

Specialists in Radio-Frequency Amplification

### How many of these questions can YOU answer?

1. What is the difference between A.C. and D.C. current?
2. What are the principles of radio telephony?
3. Why is a rectifier used and what are the principles of its operation?
4. What does “heterodyne” mean? When is this system used in a radio receiver?
5. Can you give a full and detailed explanation of the effects of “inductance” and “capacity” in an A.C. circuit?
6. Can you briefly contrast the effects of inductance reactance and capacity reactance in an A.C. circuit?
7. What are the principles of resonance?
8. Can you define “mutual induction”? What effect does “coupling” have upon the resonance curve of coupled oscillatory circuits?
9. Why does an audio-frequency transformer have a very close coupling and a radio-frequency transformer a very loose coupling?
10. What effect has a coupling variation upon the audibility and selectivity of an inductively coupled receiver?
11. Can you explain the operation of a vacuum tube as a rectifier—as an amplifier—as an oscillator?
12. Can you explain in detail all the factors that enter into the design of a radio-frequency transformer in a multi-stage radio-frequency amplifier?
13. Do you know the process of manufacturing a radio-frequency transformer—the different stages of its construction?
14. Why is a loop directional? When should it be used?
15. Do you know the principles underlying a new type of tuner for radio-frequency amplifying receivers which ensures selectivity better than a loop but with much greater receiving range?
16. Do you know how to construct a complete receiver with two stages radio, detector and three stages of audio-frequency amplification? This set is so sensitive it picks up stations a thousand miles away on a loop.
17. Do you know how to construct a tuner and radio-frequency amplifier (2 stages) which can be used with any standard receiving set to increase its sensitivity or with a detector and audio-frequency amplifier? This set has a single switch to completely cut out the r.f. amplifier when it is not required.
18. Do you know how to make a high-frequency oscillator to cover all wave lengths?
19. Do you know how to make a simple one tube receiver which is so sensitive that it will operate a loudspeaker well and receive long distances?

Don't even try to answer the last question! If you haven't read the new book by Kenneth Harkness you don't know about this new set which has just been developed in the laboratories of the Radio Guild. Read about it and then judge for yourself. Two other sets built on the same NEW principle as the one tube set but even more sensitive are also described by Mr. Harkness. All the above questions and hundreds more are answered in detail in this amazing book. MAIL THE COUPON TODAY AND GET YOUR COPY IMMEDIATELY!

(Continued from page 176)

munity. To one who had so far found plenty of uses for all his time, the long days of inactivity added nothing to his native good nature, which developed a longing for something to occupy his time.

Now, Uncle George had two sons who were very diligently following in Father's footsteps out in the great steel mills. One day these thoughtful boys sent him a first-class radio receiver and in due time, with not a little skepticism, the father erected an aerial and installed the set in his study.

Of course it did not work perfectly at first, but with a little perseverance that clinched the old gentleman's interest, reception came in quite clearly from many of the Eastern and Western broadcasting stations. I have seen the most delightful twinkle creep into Uncle George's blue eyes when he succeeded in tuning in some particularly distant station; yes, a twinkle and a fire that his old friends thought had died out many years before. So in Uncle George's household an entirely new era began. His house became the popular evening rendezvous for young and old. He began with three tubes in the receiver, and headphones; these satisfied him for a time, then he wanted to share his great joy with his neighbors, so he next added an amplifier and a loud speaker, and then there was fun for all; the results were amazing.

A thing that worried them was that perhaps some time when he was listening in (as one does on the party telephone line) he might pick up something that was going on in their own homes and that would never do. But a new sociability had been created; a new topic of conversation had come into the community and to its credit, he it said, replaced much of the former small talk of the town gossips that smoldered around the stove of the village grocery store, or the postoffice, or any of the chief gossiping centers.

Dances were given to music that came from well nigh a hundred miles away, wonderfully clear, living music that had never been heard in that part of the world before. Lectures by famous orators, talks on health, education, thrift, politics and little journeys into the homes of the great. Sketches from the "hits" of Broadway, and big musical productions; fine sermons on Sunday from city churches with music from the choir that made his old heart throb the faster. Talks to the farmer were broadcast on better farms, and a general market report of the day; with these and the weather forecast and time signals, he had about every thing he could possibly desire.

"Uncle George" certainly was popular; some farmer friends miles out in the hills came in to see and hear the new *Radiator*, as they called it, and very soon they heard "This is WJZ, broadcasting from the Waldorf-Astoria studio, New York City," words could not express their surprise and astonishment. One old farmer recollected that 15 years before he had been in that same old Waldorf-Astoria Hotel

There was a general consultation about this radio, in which most of them expressed their doubts. Their farmer friend said, "They do great stunts in New York City," and went on to tell his experiences when he stopped at that same hotel, but they were not going to take his word, and there was an earnest inquiry as to what was what. So, after many evenings of listening in, each one said he would have one of those things if it took the last cow on the farm to buy it.

Now, fancy what a miracle had happened to these farmers, who had never really been to a big city, and whose thoughts were never permitted to wander any further away than the pig pen, or cow stable, to suddenly come in from the fields, switch on the current in a radio receiver, get the price of wheat, the farm and market report direct, and then the

# WESTINGHOUSE

## Radio "A," "B" and "C"

### BATTERIES

How often has your triumph in getting a distant signal been short-lived because of your inability to *hold* the signal? The batteries—have you looked there for the trouble? Get the best. Fine tuning requires batteries that are *even-powered* as well as full-powered. Westinghouse Batteries are built with that very important point in mind. They are as steady, even-discharging, noiseless as the highest radio and battery engineering can make them. And once you're equipped with Westinghouse Batteries your battery expense is virtually ended; they'll last indefinitely—can be easily, repeatedly and economically re-charged.

At radio dealers and Westinghouse Battery Service Stations everywhere.  
Write for illustrated folder.

WESTINGHOUSE UNION BATTERY CO.  
Swissvale, Pa.

Westinghouse "A" Batteries are full-capacity, slow-discharge, long-life batteries. Made in 4, 6 and 8 volt sizes, with 5, 9 and 13 plates per cell, to meet various filament-battery requirements.

Westinghouse "B" Batteries The 22-MG-2 (22 volts) is a marvel for long, steady, noiseless service. Glass case; visible interior; sealed-in tops. Larger types, too; also 2-volt single "C" cells.

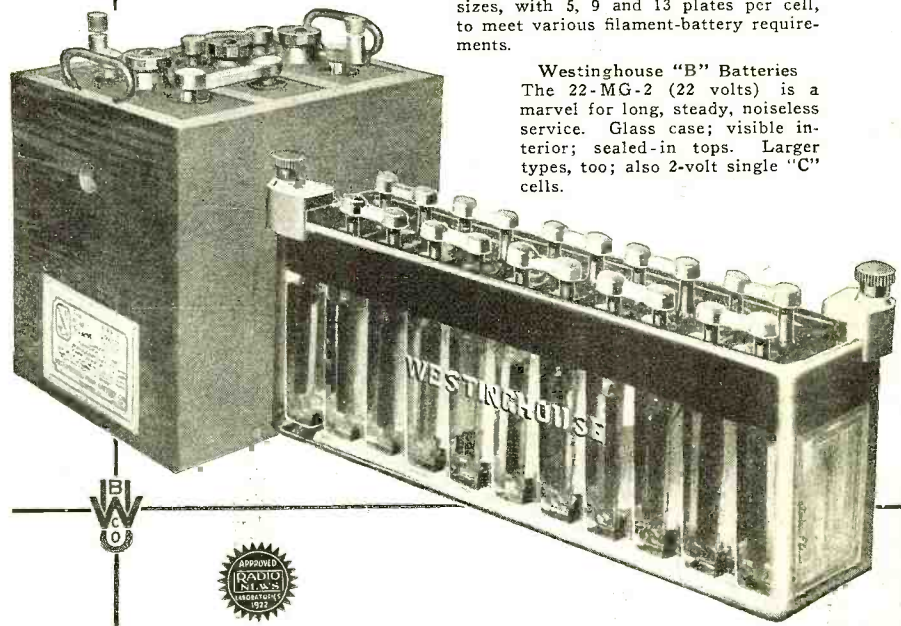

### Give Your Crystal Set A Fair Chance

A Crystal set, when properly equipped, is the ideal method of radio reproduction—clear, musical, economical. But the best crystal set ever made will not reproduce properly with a poor crystal.

### M.P.M. (Million Point Mineral) Crystal

has made the Crystal Set successful. Unsolicited testimonials are constantly being received, reporting records up to 1200 miles. Don't discard your Crystal Set until you have given "M.P.M." a trial. Send 25c and name of your radio dealer for sample unmounted crystal. 35c for mounted. Insist upon M.P.M.

M. P. M. SALES CO., Dept. N., 247 So. Central Ave., Los Angeles, Calif.

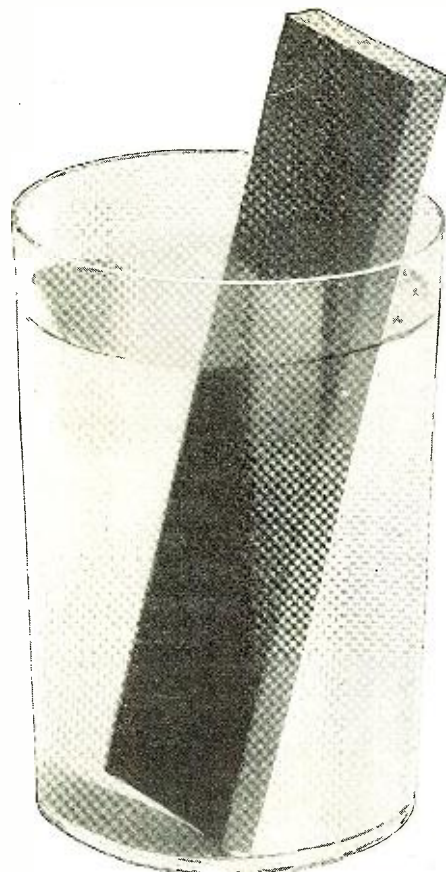

# WATER

Water is a good conductor of electrical currents. When a panel absorbs moisture it loses a good part of its insulation value—it permits leaks and short circuits—it damages reception.

Radion Panels are impervious to water. Even if immersed in water they positively could not absorb enough moisture to injure reception results. That's one of several reasons why Radion is the supreme insulation for wireless use.

## 18 STOCK SIZE PANELS

Radion, being an insulation material especially made for wireless use, has the lowest phase angle difference, lowest dielectric constant, highest resistivity and supreme moisture, gas and acid repelling properties.

Panels, Dials, Knobs, V. T. Sockets, Antenna Insulators, Phone Caps, Etc.

American Hard Rubber Co.,  
11 Mercer St. New York

# RADION

"The Supreme Insulation"

weather forecast for the next 48 hours. This last was a valuable bit of information; hundreds of crops could be saved with this advanced knowledge. It meant that they should plant or should not plant the following day. I tell you, when a farmer has been at work all day in the fields, he needs a complete relaxation in the evening; his mental faculties just itch for some diversion, something to listen to. He wants to hear the news of the day, to get in closer touch with the world. We all grow tired of routine. The local newspaper is soon read and the small gossip of the supper table is usually exhausted with the desert.

In the city when our day's work is done and we want amusement and diversion, we can very easily buy it; we are within a stone's throw of the "gay white way," where tickets may be bought for the movies, the latest Broadway hits, concerts, and lectures. We have such a variety to choose from. I sometimes feel we have lost the ancient grace of creating our own amusements. We have the preference of listening in, or going out direct to the places from which they are broadcasting. So you see it is not only a luxury in the country to have Radio, but a real necessity. If we are to remain one of the leading agricultural countries of the world, we must keep the farmer and the old homestead a living reality; together they are the meal ticket of the country and without their efforts we cannot live.

"How can you keep them down on the farm?" There is more truth than poetry in this old song. We are not going to do it entirely by giving the farmers more credit, and bigger profits on their crops, which would satisfy them for a while. The younger generation is looking at it from another point of view. Maybe it was spring time when you passed along and the tinkle of a bell arrested your attention as you observed a prim little school ma'am gather her flock to their studies, 30 or 40 of them, fine healthy to-morrow's citizens; little tots, and fine stalwart chaps, who could handle a plow as well as their fathers. Maybe you wondered as you drove on past the widely

scattered farms why it was that out there, where everything was so fresh and fine, and so much profitable work was to be done, there was always a lack of hands to do it?

Where are those same school boys and girls of five years ago? You can look for most of them in some congested manufacturing center, such as the steel mills of Pittsburgh, or the cotton mills on the coast, or in some big city floating along with the masses, eeking out a mere existence. They have traded their birthright for a meager day to day existence, and for what? For just one thing and that is to be in touch with the world. That means life, music, theaters, dances, concerts, and associating with people of mutual interests. Man is a social animal and can not bear to live alone any great length of time.

This wonderful gift of Radio, together with the cheap and practicable automobile, will do more to correct the above mentioned condition than anything else in the world. I believe it is particularly for those away out in the silent hills, and small country districts. Radio reception is more nearly perfect there and access is had to a far greater distance and selection. I represent myself as one who has enjoyed radio reception both in the heart of New York and in the rolling hills, and let me tell you my Radio set was worth 100 per cent more to me in the hills than when I was within rifle-shot range of a broadcasting station. And it is to this point of view that I wish to call your attention; to where this vast field of Radio is most needed, and I am sure it will be appreciated and will accomplish a world of good. This great land of ours will always continue to be great so long as its agrarian population, as in the past, remains the backbone of America.

Now you Sons and Daughters of the farm who have long ago drifted away from the old homestead, and left the old folks in utter loneliness, don't you think it would be a fine surprise to deny yourself a few pleasures, and with money thus saved buy them one of those Radiators that Uncle George and his friends are enjoying to-night?

## Short Wave Directive Radio Transmission

(Continued from page 130)

and stone construction. Although a large deflection was obtained on the galvanometer just before entering the doorway, the deflection became zero as soon as the apparatus was placed inside the door. Quite a reduction in the received current was noticed whenever any large object was in the path of the transmitted waves.

Telephony of very good quality was accomplished by using the circuit shown in Fig. 13. This circuit employs constant current modulation and was found to give excellent results. The use of telephony facilitated the making of observations at a distance.

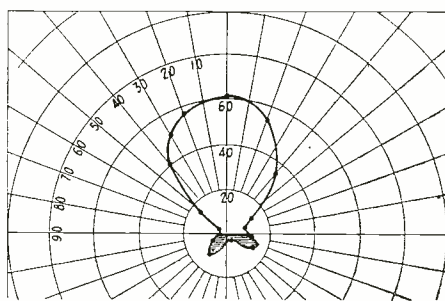

Fig. 12

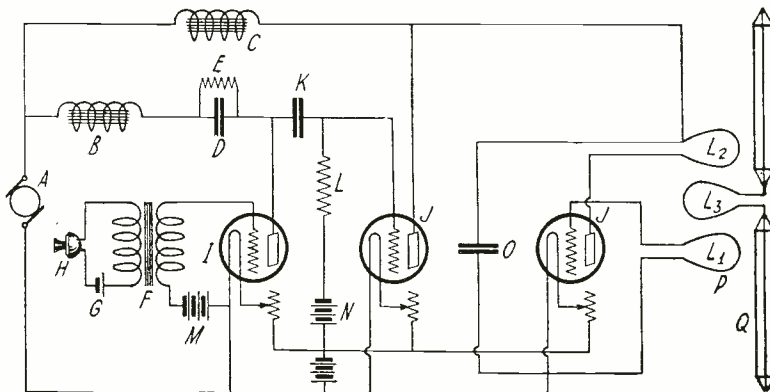
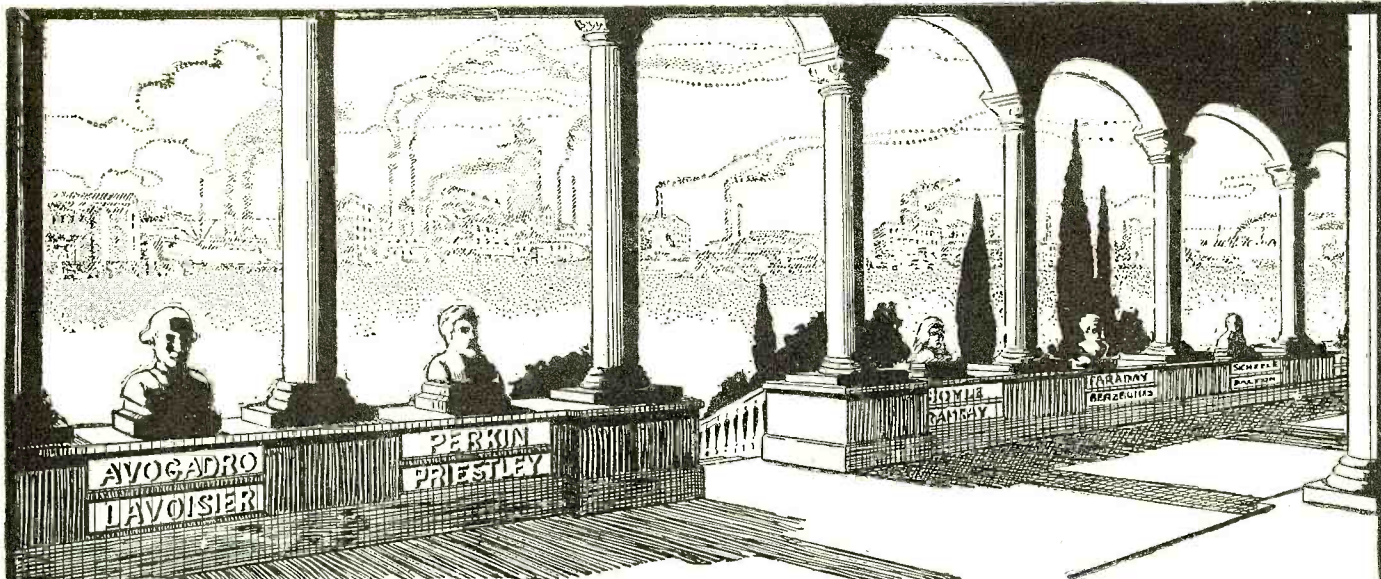

Fig. 13

Fig. 12. Showing Effect of Removing the 10 Reflecting Wires Nearest the Vertex of the Parabola. A Schematic Drawing of a 10-Meter Radiophone Transmitting Set is Shown on the Right.





# THE HALL OF FAME

## Will There Be A Niche For You?

NO man knows what is in store for him. Men now famous in business and scientific worlds were obscure only yesterday. Men today unknown may leave their names in the HALL OF FAME. Great discoveries have been born over night—marvelous scientific deeds sometimes were the results of decades of labor, other times the outcome of a scant week's research. Truly, no man can tell what the future holds for him. But it is within the power of each and everyone of us to control our own destinies, by self-training and diligent study to fit ourselves to render a lasting service to the world—a service that will bring reward, perhaps in fame, perhaps in riches. You control your own future.

## Great Growth of Chemistry

### What It Means to YOU

It is the growth of chemistry that has made the past century the most wonderful period in man's history. In a few years the chemist has changed the industrial customs of the world. In a little more than one century he has advanced civilization by ten centuries. Do you know you can learn chemistry at home in your leisure hours? You can—hundreds of others are learning now!

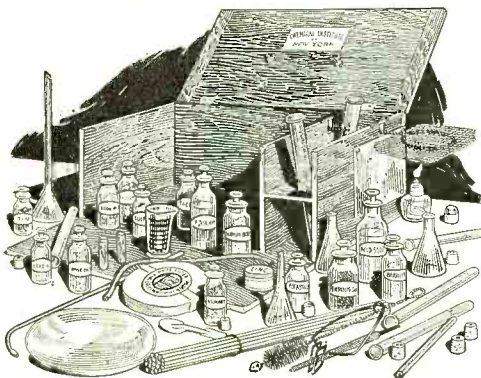

**Dr. T. O'Connor Sloane**  
Will Teach You Chemistry  
in Your Own Home

The Chemical Institute of New York, of which Dr. T. O'Connor Sloane is Educational Director, was founded to fill the need of ambitious, far-sighted men who realize and recognize the splendid future chemistry offers them, but who cannot spare the time nor the money to attend college. Dr. Sloane, a foremost authority on chemistry, will teach you and will give you any individual help you may require. He will personally go over your papers, correct them, point out your faults, and place you on the path which bears foot-prints of many who have trod it on to the HALL OF FAME.

## Experimental Equipment Furnished to Every Student

We give to every student without additional charge this chemical equipment, including forty-two pieces of laboratory apparatus and supplies, and seventeen different chemicals and reagents. These comprise the apparatus and chemicals used for the experimental work of the course. The fitted heavy wooden box serves not only as a case for the outfit but also as a useful laboratory accessory for performing countless experiments. Full particulars about this special feature of our course are contained in our free book, "Opportunities for Chemists."

## Easy Monthly Payments

You don't have to have even the small price of the course to start. You can pay for it in small monthly payments—so small that you won't feel them. The cost of our course is very low, and includes everything, even the Experimental Equipment—there are no extras to buy with our course. Our plan of monthly payments places a chemical education within the reach of everyone.

## Chemical Institute of New York, Inc.

Home Extension Division 8.

66-R-West Broadway, New York City

## Industries Need Chemists—

### Pay Them Good Salaries

Industrial plants of all kinds have awakened to the need of skilled, trained chemists. Good salaries are paid them. There is no reason why you, too, cannot join this small army of trained men who are reaping material benefits from their knowledge that guards and advances civilization!

## —and Special 30-Day Offer!

Besides furnishing the student with his Experimental Equipment, we are making an additional special offer for a short while only. You owe it to yourself to find out about it. Write today for full information and free book, "Opportunities for Chemists." Send the coupon right now while it is fresh in your mind. Or just write your name and address on a postal and mail it to us. But whatever you do, act today. Signing the coupon may prove the most important event in your life—mail it at once and let our book give you the facts.

## Act Now!

CHEMICAL INSTITUTE OF NEW YORK  
Home Extension Division 8

66-R-West Broadway, New York City

Please send me at once without any obligation on my part, your free Book, "Opportunities for Chemists," and full particulars about the Experimental Equipment given to every student. Also tell me about your plan of payment and special 30-day offer.

NAME.....

ADDRESS.....

CITY.....

STATE..... R.N. 8-23

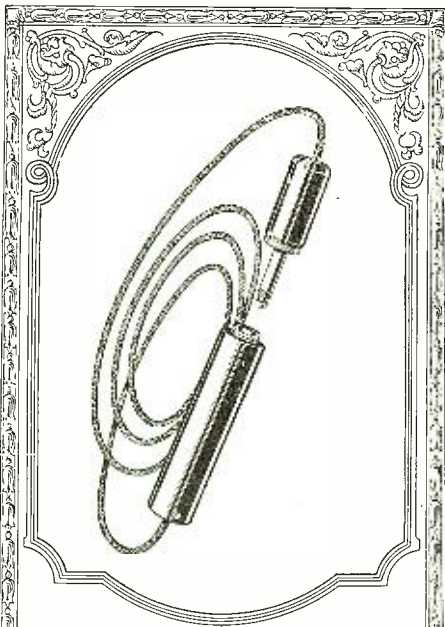

THE Frost-Radio Extension Cord shown above is one of the handiest loud speaker attachments you ever saw. Connects set in one room with speaker in another. Attractively priced.

# FROST RADIO

Offers highest quality for little money

IT goes without saying that every Frost-Radio product is made just a little better than the purchaser expects. That's a Frost policy. And yet Frost-Radio costs you less than the unknown, unadvertised, "orphan" lines, due to tremendous Frost production.



## FROST FONES

No. 162 2000 ohm set \$5.00  
No. 163 3000 ohm set \$6.00

The extension Cord pictured above is typical of Frost-Radio value. Ten foot cord, with cord tip plug and fibre covered jack, fone cord tinsel conductors, costs but \$2.50. (Same length, twisted pair conductor, \$2.00). Fifty foot cord, complete, (tinsel) \$6.50; (twin pair) \$3.00. Sold in 10, 20, 30, 40, 50 and 100 foot lengths.

Your dealer handles Frost-Radio. See him today.

**HERBERT F. FROST, Inc.**  
154 W Lake Street, CHICAGO  
30 Church Street, NEW YORK

In conclusion, it may be said that directive radio communication on short wave-lengths, employing the type of apparatus described, has been found to be practicable and to merit much more comprehensive investigation and use. Its great advantages are apparent, especially for certain classes of communication and specialized work, and it is very probable that its development and use will be one of the future problems for the radio engineers.

## Page the Amateurs

(Continued from page 131)

ducers most interested is experienced. It is seen that with the use of radio, these producers may have a current moving picture of the entire situation and use it effectively in planning shipments to market, a service that would also benefit consumers through stabilization of market supplies.

To Z. R. Pettet, Agricultural Statistician at Atlanta, Georgia, belongs the credit for demonstrating the practicability of radio in crop work. His quick action in the frost emergency and the satisfactory results obtained have convinced his superiors at Washington headquarters of the possibilities of radio along general crop-reporting lines as well as in emergency work. Development of a nation-wide service that will make crop news quickly available is now under way. General reports will be rendered by radio telephony, but for information that may have a speculative effect on market prices radio telegraphy and amateur operators will be used.

Once there was an amateur operator who made a quick survey of the radio field and decided that his end was near. At each new radio development his gloom darkened. Then lo! Light dawned. Rather than to diminish the scope of his activities he saw that the new developments tended to accentuate his importance. His possibilities of usefulness were greater than ever before. Particularly in agriculture is this true. Amateurs, stand by!

## Radio Frequency Receiver Design

(Continued from page 153)

but again the most important controls are the secondary condenser and the potentiometer. The coupling only requires adjustment when interference is experienced.

### LOADING COILS MAY BE INCLUDED

The receiver is also provided with binding posts for the inclusion of loading coils, if it is desired to receive on higher wave-lengths. These binding-posts appear on the top left hand side of the front panel in the photo. The loading coils may consist of duo-lateral coils very loosely coupled together. An additional variable condenser would also be required in series with the ground to tune the antenna circuit. Different radio frequency transformers would be necessary to amplify these higher waves.

The construction of a receiver of this type should not be a formidable task for the radio amateur, especially with the assistance of the photographs here published, which show in detail the apparatus and its disposition, together with the wiring diagram of Fig. 1. The dimensions of the front panel are 17½"x10½" and those of the shelf panel are 8" wide by 7¾" deep.

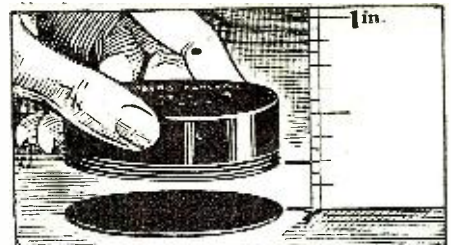

## POWERFUL MAGNETS

### Compare—Then Buy!

Test the magnets in each head set. See how far they will pick up their diaphragms.

Then you will find that Stromberg-Carlson Head Sets have powerful magnets.

These powerful magnets with the equally powerful windings are two reasons why they are unexcelled for long distance reception.

## STROMBERG-CARLSON RADIO HEAD SETS

have other distinctive features—

The receivers are layer wound and layer insulated.

The ear caps cover the ears.

The receivers are balanced as to volume.

The adjustment rods telescope.

Order Stromberg-Carlson apparatus through your electrical merchandise dealer or write for descriptive circular.

Stromberg-Carlson Telephone Mfg. Co.  
Rochester, N. Y.



## CUT PRICES

To Consumers

	Regular List	Our List
1½-volt Tube .....	\$ 6.00	\$ 4.50
1½-volt Amp. Tube....	6.75	4.75
Baldwin type C Phones	16.00	13.00
Magnavoxes .....	45.00	37.00
Murdock Phones, 2000 Ohm .....	5.00	4.20
Murdock Phones, 3000 Ohm .....	6.00	4.90
Acme Transformers ...	5.00	4.20
Plugs .....	1.50	.59
Rheostats .....	1.00	.50
Moulded Sockets .....	.75	.45
B Batteries, 22½-volt..	1.25	.80
Crystal Detectors .....	1.00	.60
Contact Points, per doz.	.35 per doz.	.15
Switches, tapered knob	.35	.20
Honeycomb Coils, all sizes 25% discount.		
Paragon Ra 10.....	110.00	68.00
Variometers .....	3.50	2.50
Variocouplers .....	1.50	1.10
Dreyfuss Phones .....	8.00	7.00
3-inch Dials .....	.75	.30
Rheostat Dials .....	.50	.23
No. 14 Hard-drawn Aerial Wire, C ft....	.60 C ft.	.38

We give a discount of 10% on all standard merchandise not listed.

MAIL ORDERS ONLY NO STORE TRADE

Mail check or money order.

No stamps or currency.

## RADIO CUT PRICE CO.

320 Broadway, New York City

# \$1000<sup>00</sup> in prizes

*for the best results with radio frequency. Read how you can enter this Summer's contest.*

FOR the fifty best articles setting forth how radio frequency has helped conquer summer static and other forms of interference (such as from spark transmitting stations and your neighbor's radiating receiving set) the Acme Apparatus Company will pay a total of one thousand dollars in cash and radio apparatus.

Each article submitted must narrate the personal experiences and experiments of the writer in securing distant stations, in avoiding interference and distortion, and in securing volume and clearness of reception. Wiring diagrams showing the hook-ups used to secure these results will add greatly to the value of the article. No

article shall exceed five hundred words.

Radio and audio frequency transformers of any make or brand will be eligible. The contest starts June first and ends September thirtieth. In case of a tie, each tying contestant will receive the full amount of the prize. All articles must bear a postmark of not later than October first. Do not stay out of the contest for fear that you are not an "expert." A novice with natural mechanical or electrical ability may hit on a combination which will win the first prize—\$250.00 in cash. Send the coupon or apply to any radio dealer to secure the four page folder explaining complete details of contest, the judges, the prizes to be given, etc.

# ACME

*for amplification*

ACME APPARATUS COMPANY  
Cambridge, Mass.

Gentlemen:—Please send me full details of radio frequency contest.

Name .....

Street .....

City ..... State .....

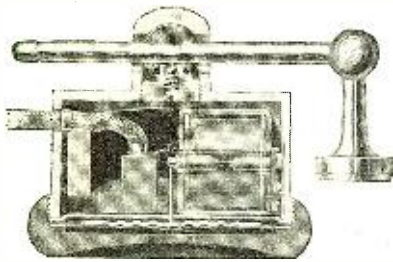

Patented in U. S. and all foreign countries

Get stations  
you never heard  
before — use  
**Radiotive  
Phones**

Radiotive phones and loud speakers are of the balanced armature type, equipped with non-magnetic, corrugated diaphragms, and are guaranteed to be 100% efficient.

This construction brings in the weakest signals and reproduces without distortion. The chief operator on the S.S. Aquitania keeps in constant touch with England and foreign countries by using Radiotive phones.

Lovers of good music and clear articulation prefer Radiotive units. The better dealers carry them. Write us today for descriptive folder.

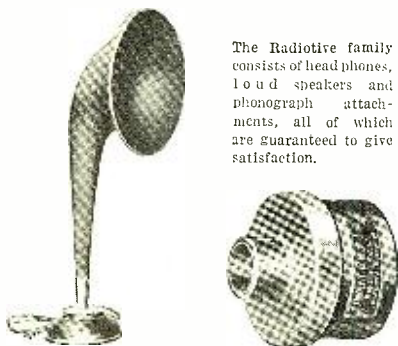

The Radiotive family consists of head phones, loud speakers and phonograph attachments, all of which are guaranteed to give satisfaction.

**RADIOTIVE CORPORATION**

Factory, 5317 21st Ave., Brooklyn, N. Y.  
Sales Office, 105 West 40th Street, New York



**What Happens to the  
Speech and Music  
When Broadcast**

(Continued from page 143)

The radio frequency currents which are generated by the vacuum tube transmitter are transferred to the antenna by means of electrical circuits. When these currents flow up and down in the antenna, radio waves are produced which then travel outward. However, in the state in which they then are, they cannot do anything as far as speech goes; they are merely in a position to carry along with them any speech signals which are impressed on them. The reader should remember that these waves, generated in the antenna by the radio frequency generator, are merely the agents for transporting the speech to distant points, for speech currents cannot travel alone through space. They are the speech carriers, or "carrier waves" as they are called.

So far, we have magnified faithfully the original speech or sounds which left the performer's mouth until the magnified current is many hundred times stronger than the original speech current, and we have generated the radio frequency waves which are waiting to transport the speech to distant points. In order that the radio frequency waves be able to carry these speech currents most efficiently, it is necessary that the speech currents be magnified and properly impressed on the radio frequency carrier waves. If the speech currents are not sufficiently magnified the carrier waves will not transport them as far as they would otherwise. Furthermore, unless the speech currents are properly impressed on the carrier waves they will not be transported and if they are, they may be very badly distorted, so that the person receiving the signals will hardly be able to recognize the sounds.

**THE MODULATOR CIRCUIT**

In order to properly impress the speech currents on the carrier waves, a special circuit must be employed called the "modulator circuit," which again employs that versatile instrument, the vacuum tube. This modulator circuit places the speech current on the carrier wave in the proper manner so that the latter will transport the speech most efficiently and without distortion. However, in order that this be properly done, the speech currents must be amplified a certain amount. The strength of the speech current when it emerges from the speech amplifier (where we last left it) is not sufficient for this. Hence another vacuum tube amplifier is employed called the "modulation amplifier." The speech currents which leave the speech amplifier are then passed through this modulation amplifier. The speech currents are now magnified to a sufficient value where they are able to be passed through the modulator tubes, of which there are as many as there are radio frequency oscillator tubes. When the speech current finally leaves these modulator tubes they are sufficiently strong to modify the radio carrier waves, which then transport them through space.

Throughout all these various operations through which the speech passes, one important thing must be avoided, namely, distortion. It is easily seen that there are many chances for the speech currents to be altered ever so little, so that they will deviate from their original true form. But if this happens, the music which we receive may be nothing more than discord. The various circuits are therefore most carefully designed so that nothing untoward may happen to these sound currents, and so that they are finally hurled out from the antenna into space in their original state.

We now have traveling through space at a tremendous speed, 186,000 miles per sec-

**L'RADIO  
Parts and Accessories  
TIME TESTED**



L'Radio Headphone  
1 B-200-Ohm \$6.00

L'Radio Headphones. Exceptionally comfortable and wonderfully clear. The pleasure of radio reception is increased many times with the easy fitting, clear tone L'Radio Headphones. The highest and sweetest notes are accurately reproduced. It is the nearest approach to listening to the person direct.

Used as loud speaker unit, the amplified tones are without distortion and metallic sounds. There is tone and volume that will please everyone.



L'Radio Plug  
No. 60

Price 90c

When you plug in with an L'Radio Plug, you need have no fear of partial shorts or poor contacts. L'Radio plugs are made of the best insulation—rigidly assembled—will retain their high standard of quality in use.

Home charging is the only satisfactory method of maintaining a radio battery. The more permanent the installation the more satisfactory the service will be.

Non Tunes are arranged to mount permanently against a wall out of the way, with permanent wiring. No extra trouble to charge with the Non Tune.

Special patented relay lock makes it absolutely safe to operate without attention.



No. 16 Non Tune Radio Rectifier  
Price \$19.00.

Write for Bulletin 101C

It's Service That Counts

**Leich Electric Co.**  
Genoa, Illinois

**SPEED UP YOUR PRODUCTION**

—by sawing bakelite, formica, brass, copper, carbon, or wood on a

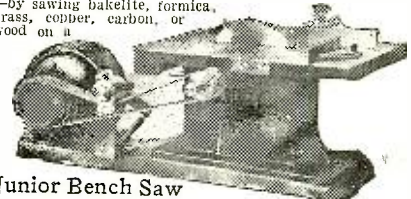

**Junior Bench Saw**

A precision machine especially adapted to rapid and accurate work. All metal construction. Top 10"x13" elevates for grooving. Special guide accommodates panels as long as 24". Saws 1 1/2" stock. Easily driven by 1/2 h.p. or 1-3 h.p. motor. Attachments for grinding, sanding and dadoing. Special saws for bakelite, brass, etc. furnished from stock. Write today for descriptive literature on the Junior Bench Saw and other Boice Built Bench Machines and Motors.

W. & J. BOICE Dept. 708 Toledo, Ohio



"Built first to Last!"  
**RADIO PRODUCTS**  
Coto-Coil Co.  
Providence, R. I.

*More Reasons Why*

**CROSLEY**  
 Better - Cost Less  
 Radio Products  
 are  
*so Much Better*

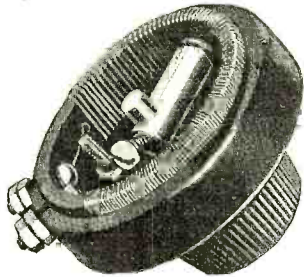

The new Crosley Duostat universal duo-wound rheostat for all makes of tubes is sold separately from Crosley radio sets if desired, complete as shown in the illustration above. Price .....85c

By perfecting the new Crosley Duostat universal filament control rheostat, the Crosley Manufacturing Company has made giant strides in bringing within reach of all, the true reproduction of signals from the air. This rheostat, (patent pending) properly controls all makes of tubes, including the new "A" and 199 and makes Crosley instruments even more efficient than ever before because of the:

1. Efficient, smooth, uniform control of all tubes duo-wound to low and high resistance 10 to 20 ohms.
2. Plunger type contact actuated by a special spring, insuring uniform pressure at all times.
3. Spring washers producing uniform tension.
4. Positive rugged stop at zero resistance or "on" position.
5. Circuit interrupted at "off" position.
6. Resistance material having zero temperature co-efficient.
7. Winding protected by a black moulded shell of high heat insulating material.
8. Electrical connections substantial in construction.
9. Design of parts to prevent warping.
10. Extremely low operating temperature with all tubes.

The outstanding performance of all Crosley instruments is due to the effective co-operation of the new filament control rheostat with the other parts.

*For Sale at Best Dealers Everywhere*

*Write for Free Catalog*

**CROSLEY MANUFACTURING COMPANY**  
 822 ALFRED STREET CINCINNATI, OHIO

New York Office, C. B. Cooper  
 1803 Tribune Bldg., 154 Nassau St.

Boston Office, B. H. Smith  
 929 Blue Hill Ave., Dorchester

Chicago Office, 1311 Steger Bldg.,  
 28 E. Jackson Blvd., R. A. Stemm, Mgr

Philadelphia Office, J. H. Lyte  
 65 North 63rd St

St. Louis Office, Rob't W. Bennett Co.  
 1326 Syndicate Trust Bldg.

Crosley Radio Receivers have a universal appeal. The Model X pictured here is the last word in efficiency. It sells at \$55 in spite of its new features and advanced manufacturing cost.

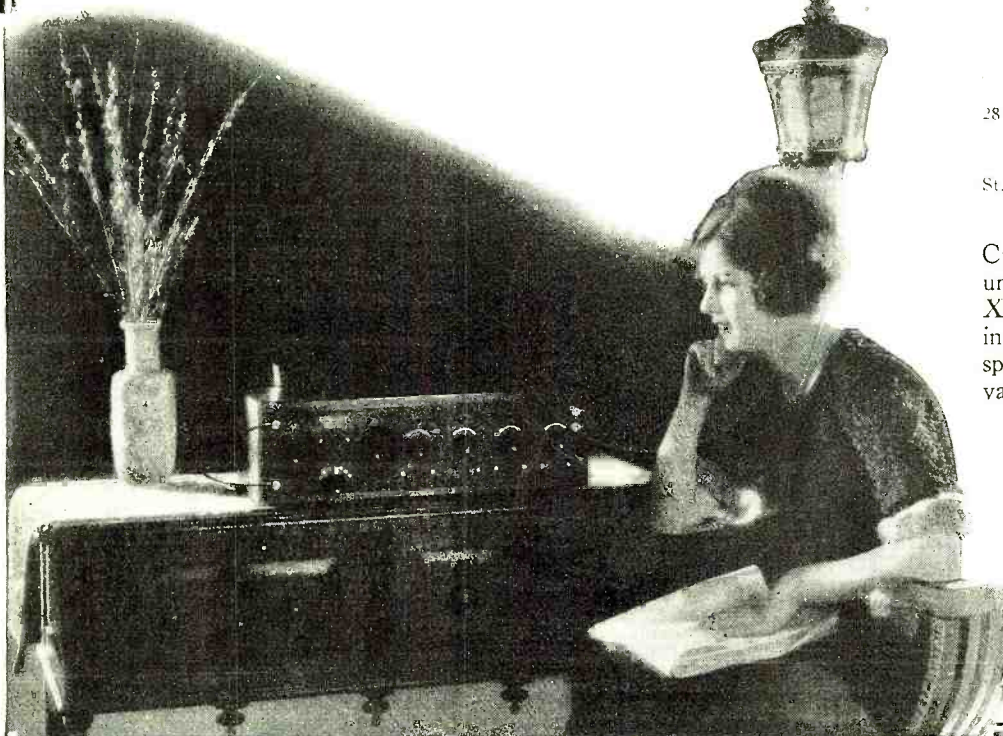



Warren Radio Loop, Cut Away to Show Construction.

**FOR CAMPING AND VACATION USE**

WITH a Warren Radio Loop you can easily take your present set with you to camp, shore or mountain, or you can build a very compact portable set. The Warren Loop fits inside a small cabinet and combines aerial and tuning device. All enclosed so that damp, dirt and rough usage cannot harm it. Various types according to your requirements. Write for Bulletin T102.

**A Type For Every Set At The Best Dealers**

Type A-737 (300-700 meters) 6 inches square—non-directional .....	\$10.00
Type A-7236 (175-1000 meters) 6 inches square—non-directional .....	12.00
Type B-2537 (300-700 meters) 18 inches square—directional .....	20.00
Type BL-2520 (200-18,000 meters) with honeycomb coil, 18 inches square—directional .....	25.00

**V-DE-CO RADIO MFG. CO.**  
ASBURY PARK, N. J.  
Dept. N

and, a radio frequency wave which is carrying with it some song or concert or lecture. As it travels through space it gets weaker and weaker, the farther away it gets from the antenna. In its travels through space, the wave strikes a number of antennæ which are on the lookout for it, by being tuned to its frequency, and these antennæ snatch from the wave a portion of its energy, but only a very thin portion, for after the wave has passed through space it has not much energy left in it. Yet this tiny energy is sufficient to bring the sounds in loudly and clearly.

The radio wave carrying with it the speech currents flows down the receiving antenna and into the receiver. Probably with this wave there are a number of other waves also clamoring to get into the receiver. Unless these other waves are shut out, the signals will be a hodge-podge because all these waves are contributing their little speeches which together do not make much sense or music. By properly tuning the receiver we shut the door of the receiver in the face of these interfering waves, but permit the wave we want to sneak in, as it were, through a trap door.

We now have in our receiver the radio waves which have carried with them the speech or music currents which we want to hear. But the energy in these waves is now extremely minute for they have had to travel a long way and in their travel they have lost some in the atmosphere, some while traveling through houses and perhaps across mountains, and much of their energy has been stolen by other antennæ, which have been on the lookout for them. So that there may be as little energy left in them now as there was originally in the voice of the performer which was, as we saw, ridiculously small. We must, therefore, magnify the energy in the received wave so that we will be able to hear it. This is done by means of the "radio frequency amplifier," which employs the vacuum tube to increase the strength of the received energy. Here again, as in the case when the speech was being transmitted, we must be very careful not to alter or distort the speech. By using the proper kind of tubes and the proper kind of electrical circuits we are able to magnify the

energy sufficiently without distorting the speech which has been carried along.

However, we cannot hear the music or speech yet because it is still in the grip, we might say, of the radio frequency carrier wave. All we wanted the radio frequency wave for was to carry the speech currents to the receiver. Now that it has carried the speech currents to the receiver we have no further use for it. We therefore pass these magnified waves through a "detector," which may be again a vacuum tube or sometimes a crystal mineral, which separates the speech currents from the radio currents, and passes these speech currents to the telephones. We now have our original speech currents which were transmitted from the broadcasting studio in the telephones and the original sounds are heard, just as a conversation is heard when the speech currents flow in the receiver of your desk telephone.

It is possible that the sounds heard in the telephones are weak, for the waves may have had to travel so far that less energy was left in them than we imagined. Or it may be that the sounds heard are loud enough to be heard by the person wearing the telephones, but not loud enough to be heard by other people in the same room. These received signals or sounds may be increased in volume by using an "audio frequency" amplifier to amplify the sounds so that they are stronger. This audio frequency amplifier corresponds exactly with the speech amplifier employed at the transmitter to increase the intensity of the speech currents. By amplifying the signals this way, they may be made loud enough to be passed through a special telephone called a "loud speaker" which will fill a room with the music or lecture.

The original sounds have had to pass over long distances, through many obstacles, and through many operations to reach their final destination, pure and undistorted, true and faithful to the original sounds which left the mouth of the performer. It may be said that eternal vigilance is the price of this achievement.

Large Carbon and Copper Contacts that cannot BURN or STICK.

Sturdy Vibrator gives Dependable Service.

## A Good Name--Ten Years Old!

Non-fusible carbon contactors that cannot BURN or STICK, permit a high charging current not satisfactorily obtained by other methods.

This is only one of the many features embodied in F-F Chargers; only one point of superiority that has helped to establish their ten year old reputation as "the one dependable charger." You buy genuine satisfaction with the

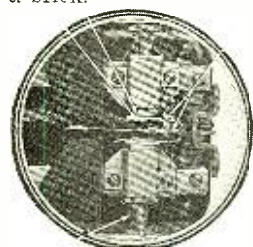

Adjustment Held Permanent. Easily Adjusted.

### F-F BATTERY CHARGER

It will quickly and easily keep your RADIO "A" and "B", and Auto Storage Batteries in active service. Seven types, attractively priced, to fill your needs. What are they? Present users, write for details of the new F-F "B" Battery Charging Attachment.

F-F Battery Chargers are sold by the better dealers. If yours cannot supply you, mention his name and send us remittance with express or postal charges on 9 lbs. for quick shipment.

Bulletin No. 32 Sent on Request

The France Mfg. Co.

10432 Berea Road

Cleveland, Ohio

Pioneer Manufacturers of Patented Battery Chargers

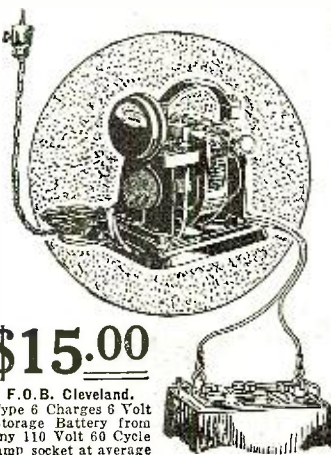

**\$15.00**

F. O. B. Cleveland. Type 6 Charges 6 Volt Storage Battery from any 110 Volt 60 Cycle lamp socket at average rate of 6 Amperes.

## With the Sea-going Operators

(Continued from page 167)

Board and by Gibbs Brothers, the Naval Architects who have charge of reconditioning the ship and all expressed themselves as entirely pleased with the installation and performance.

At sea, the operator who is assigned to this boat will have charge of the installation and probably will be required to send out test signals about once a week on both 300 and 600 meters. It will probably be interesting for amateurs to listen in for these test signals provided they are sent out at a prearranged time.

## Calls Heard

(Continued from page 174)

WGY, WHA, WHAB, WHAH, WHAS, WHB, WHX, WHZ, WIAO, WIAS, WIAR, WJAB, WIAD, WJAH, WJAX, WKAA, WKAF, WKAL, WKY, WLAB, WLAG, WLAI, WLAL, WLB, WLK, WLW, WMAK, WMB, WMC, WNAD, WNAS, NY, WOAA, WOAC, WOAI, WOAN, WQAO, WOAW, WOAZ, WOC, WOI, WOK, WOO, WOS, WPA, WPE, WPAC, WPAD, WPAH, WRR, WRAP, WSAS, WSB, WSY, WTAW, WTK, WUZ, WWAC, WWAY, WWI, WWJ, PWX, and Frank H. Jones, somewhere in Cuba. Also Canadian stations CHCQ, CPGC and CJCG.

Insure your copy reaching you each month. Subscribe to Radio News—\$2.50 a year. Experimenter Publishing Co., 53 Park Place, N. Y. C.

# SUPER-HETERODYNE RECEIVER NEW ADVANCED MODEL "C"

The Ideal Receiver for Long Distance Broadcast Reception

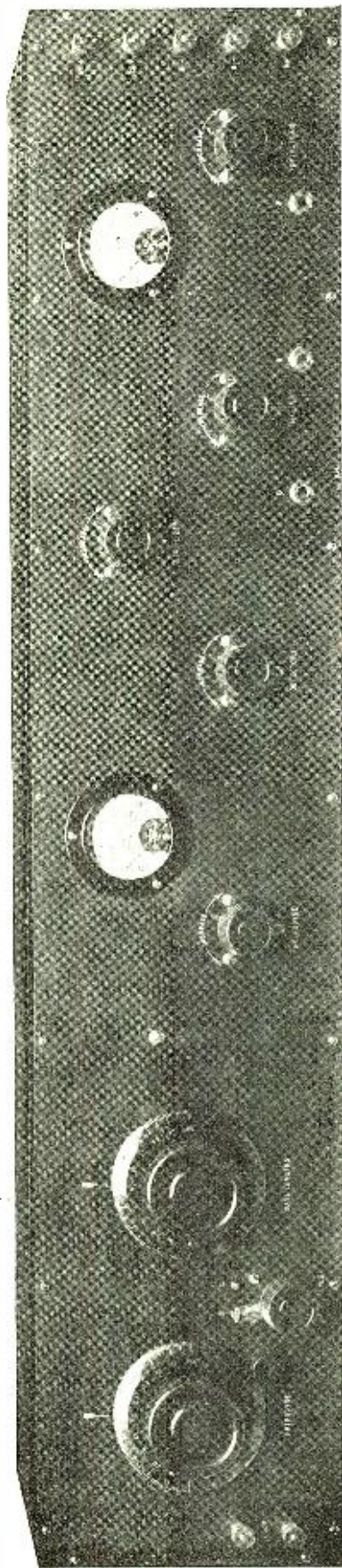

Model "C" Super-Heterodyne. Wave-length Range 160 to 850 Meters. Dimensions 40"x8"x7<sup>3</sup>/<sub>4</sub>". Weight 42 lbs.

**Simplicity**—Only 2 variable dials for all wave-lengths between 160 and 850 meters

**Efficiency**—Uniform maximum radio frequency amplification over the entire wave-length range

**Range**—2000 mile night range using Radio Corp. loop, corresponding increase with good antenna

**Selectivity**—Most selective method of reception known, works completely through local broadcasters

**Tubes**—Use UV201A or UV199 throughout, 3 stages tuned radio, 2 stages audio, 2 detectors, oscillator

Learn More About This Remarkable Receiver. Write for Catalog 73

**Experimenters Information Service** 531 WEST 46th STREET  
NEW YORK CITY

Designers of the Highest Class Radio Apparatus in the World

# The Greatest Book on RADIO ever written

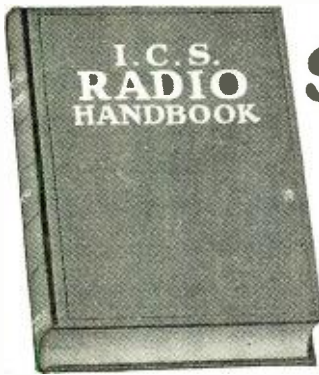

only

**\$1**

562 pages  
Pocket  
Size

Compiled by HARRY F. DART, B.S.E.E.  
Formerly with the Western Electric Co.,  
and U. S. Army Instructor of Radio  
Technically edited by F. H. DOANE

JUST off the press! The greatest book on radio ever written. Price only \$1. Filled with sound, practical, tested information for every radio fan, from beginner to hard-boiled owl. Written, compiled and edited by radio experts of national reputation.

Every page tells you something useful. And there are 562 pages! More than 150 illustrations and diagrams!

You may dip into this I. C. S. Radio Handbook at random, or hunt up special information you want, or read it right through. Different types of receiving and sending hook-ups are explained; proposed insurance regulations; lists of broadcasting stations; radio compass stations; interesting experiments; definitions; codes and symbols; technical data and thousands of suggestions for getting more pleasure out of radio. Will save you from wasting money on things that won't work.

Send \$1 to-day and get this 562-page I. C. S. Radio Handbook before you spend another cent on parts. Money back if not satisfied.

TEAR OUT HERE

INTERNATIONAL CORRESPONDENCE SCHOOLS  
Box 8280, Scranton, Penna.

I enclose One Dollar. Please send me—post-paid—the 562-page I. C. S. Radio Handbook. It is understood that if I am not entirely satisfied I may return this book within five days and you will refund my money.

Name.....

Address.....

**LEARN ELECTRICITY IN 3 MONTHS**

Make this the most profitable and enjoyable summer of your life. Come to Chicago. The electrical center and the country's greatest summer resort city. Learn Electricity in America's oldest, largest and best equipped school. Earn your way, free employment dept.

**FREE R. R. FARE** If you come now we will pay your railroad fare and give you free a course in auto truck and tractor electricity, a course in radio, and a life scholarship in the great Coyne School. This is the greatest offer ever made by a school. Write at once for particulars as we cannot keep this offer open long.

**Write Today Coyne**

Trade and Engineering Schools  
1300-1310 W. Harrison St.,  
Dept. C-504 Chicago, Ill.

- CANADIAN 2BN (ONE TUBE)
- 1AF, 1AP, 1AR, 1BO, 1CK, 1CO, 1CY, 1CNI, 1CNP, 1CPI, 1CPC, 1CPP, 1CRU, 1XSI, 1CZ, 1GV, 1II, 1IL, 1JV, 1KC, 1KW, 1MC, 1MY, 1OW, 1PA, 1SN, 1TS, 1WC, 1ZE, 1ACB, 1AKL, 1AJ, 1AL, 1AMB, 1AOP, 1AOL, 1AOM, 1ARK, 1ARP, 1ARY, 1ASI, 1AST, 1ATC, 1ATJ, 1AWW, 1AXR, 1AYZ, 1BAN, 1BAS, 1BCF, 1BDI, 1BES, 1BIY, 1BKQ, 1BKR, 1BMS, 1BOQ, 1BRI, 1BRQ, 1BSD, 1BTR, 1BYG, 1CIV, 1CMF, 1CMP, 1CNE, 2BB, 2BD, 2DA, 2DK, 2EL, 2FI, 2FL, 2G, 2HJ, 2HT, 2KF, 2LE, 2LW, 2MX, 2OM, 2PA, 2RM, 2SO, 2WB, 2WR, 2XO, 2ABM, 2ABO, 2ACD, 2ACG, 2AEG, 2AFP, 2AGA, 2AGB, 2AGD, 2AIF, 2AIS, 2AJA, 2AJT, 2ANM, 2AOL, 2ASL, 2AWF, 2AXK (2AVV), 2BFE, 2BGV, (2BGW), 2BJG, 2BKT, 2BLP, 2BNZ, 2BOU, 2BRB, 2BRG, 2BRX, (2BTW), 2BYC, 2CCD, (2CFB), 2CGT, 2CJP, 2CLA, 2COA, 2CPP, 2CRD, 2COZ, 2CVJ, 2CXW, 3AX, 3BA, 3BJ, 3BO, 3FO, 3FS, 3GF, (3GZ), 3HD, 3HE, (3HG), 3HJ, 3HS, 3II, 3IN, 3IZ, 3JJ, 3JL, 3KO, 3LE, 3MB, 3ME, 3MO, 3NB, 3NI, 3OE, 3PZ, 3SU, (3TA), 3TP, 3TJ, 3TR, 3VG, (3VV), 3WF, 3XM, 3XN, 3XO, (3ZO), 3ZP, 3ZS, 3AAO, 3AIF, 3AIS, 3AJD, 3AJJ, 3AKR, 3ALJ, 3ANO, 3ASL, 3ASP, 3AUV, 3BAO, 3BEI, 3BEL, 3BPU, 3BGG, 3BIF, 3BIJ, 3BIT, 3BJC, 3BLU, 3BLP, 3BLZ, 3BSF, 3BVA, 3BWT, 3CAV, 3EBM, 3COD, 3CEL, 3CCU, 3CRB, 3CTZ, 3CVF, 3CDV, 4BY, 4EB, 4FG, 4NT, 4IF, 4PU, 5DA, 5GG, 5HI, 5XI, 5ZU, 5ZAV, 5ZAW, 5AGG, 7GS, 7ZU, 8AG, 8AL, 8AM, 8AW, 8BF, 8BN, (8BO), 8BY, 8CF, 8CK, 8CO, 8CY, 8EO, 8ER, 8FO, 8FT, 8HN, 8IH, 8IJ, 8II, 8JU, 8JY, 8LO, 8MZ, 8RJ, 8UF, 8UR, 8UT, 8VI, 8VY, 8WA, 8WP, (8XE), 8ZO, 8ZW, 8ABM, 8ACN, 8AFU, 8AIG, 8AII, 8AIV, 8AKQ, 8ALF, 8ALR, 8ALT, 8AMM, 8AMP, 8ANB, 8AOI, 8AOL, 8AQQ, 8AQQ, 8ARD, 8ASE, 8ASV, (8ATX), (8AVD), 8AZO, 8BAR, 8BBE, 8BCH, 8BCF, 8BCO, 8BFM, 8BGL, 8BIN, 8BLN, 8BMG, 8BPN, 8BTO, 8BUT, 8BVT, 8BWK, 8BZD, 8CAE, 8CCB, 8CCZ, 8CEI, 8CFJ, 8CFH, 8CFP, 8CGA, 8CGJ, 8CGU, 8CGY, 8CHU, 8CJH, 8CIV, 8CJ, 8CJZ, 8CKO, 8CKU, 8CKV, 8CKZ, 8CLV, 8CM, 8CMT, 8CNB, 8CNO, 8COM, 8CPX, 8CON, 8CRB, 8CRN, 8CRV, 8CSE, 8CTZ, 8CU, 8CUR, 8CVR, 8CVM, 8CWX, 8CWU, 8CXF, 8CYT, 8CZ, 8DAA, 8DAK, 8DFA, 8DGU, 8EHI, 8KAK, 8DTO, 8DAK, 9BA, 9BM, 9BU, 9BV, 9CU, 9DK, 9EI, 9EH, 9LH, 9OB, 9OF, 9PV, 9QA, 9QR, 9UR, 9UU, 9VM, 9VZ, 9XI, 9XU, 9YL, 9ZT, 9AAK, 9AAP, 9AAV, 9ABU, 9AEN, 9AEP, 9AFK, 9AFN, 9AIC, 9AIX, 9ALG, 9AMI, 9AMP, 9AMR, 9AMT, 9ANO, 9APE, 9APO, 9APS, 9APW, 9ARZ, 9ASE, 9ASJ, 9AUL, 9AUY, 9AVK, 9AVZ, 9AZA, 9BAB, 9BAQ, 9BCB, 9BCV, 9BDB, 9BHD, 9BHG, 9BHM, 9BJI, 9BMN, 9BOO, 9BRK, 9BRY, (9BTA), 9BTL, 9BZF, 9CAG, (9CBA), 9CBL, 9CBM, 9CEH, 9CNU, 9CVO, 9CPA, 9CKM, 9CNV, 9CMK, 9CMN, 9CTV, 9CYW, 9DAN, (9DAW), 9DBF, 9DCB, 9DDU, 9DEE, 9DFB, 9DGE, 9DGV, 9DKY, 9DSW, 9DUO, 9DVL, 9DWM, 9ZAA, 9EHI, 9EIO, 9EKF, 9ERA, 9ELB.
- Spark—1AKC, 2OM, 8AEZ. Never listen for them.
- Phone—1SN, 9XU.
- Canadian—1BO, bunch of 2's, 3CG, 3CO, 3CO, 3FO, 3GE, 3GK, 3HE, 3IN, 3JL, 3KO, (3NI), 3OL, (3PG), 3TA, 3TR, (3XN), (3ZS), (9AL), 9BJ, 9BV, 9BY, 9ZT.

radiation is materially increased. A system of this character, designated by the illustrated circuit diagram, is claimed to be of such arrangement as to lengthen the distance of the transmission of signals such as wireless telephone, without distortion, to a distance greater than has heretofore been obtained with simple non-complicated circuits. The invention consists, substantially, in the combination, construction, location and relative arrangement of parts and circuits employed in connection therewith.

## New Radio Patents

(Continued from page 166)

**RADIO APPARATUS**  
(Patent 1,437,772, issued to John B. Nowlan, of Denver, Colo., Dec. 5, 1922.)  
The object of this invention is to provide a radio receiving apparatus of high selectivity whereby signals transmitted on adjacent wave-lengths may be received and isolated for reproduction without undue interference.  
The radio receiving apparatus of the present invention comprises an insulated panel carrying the radio equipment supported on the rear thereof and housed within a cabinet. The apparatus includes a radiofrequency oscillating circuit which may be an antenna ground circuit or a coil collector circuit or a ground system balanced against a free ended extended conductor. The oscillation circuit shown in the drawings includes a primary inductance tapped at selected points to switch contacts whereby the desired amount of inductance may be included in the oscillating circuit.  
Inductively associated with the primary winding are two coupling coils, arranged at opposite ends of the primary inductance and adjustably mounted to the primary inductance. One of the coupling coils forms the secondary and carries an inductance tapped at selected intervals and

## RT-A 2

The Audio Frequency Transformer that gives you perfect Tone Quality and High Amplification without distortion. Moisture-proof—it is ideal for the seashore. Letters received every day state that RT-A2 passes every test and fulfills the most critical requirements of experts and amateurs.



Use RT-A2 transformers at once and enjoy better radio reception. Price \$6.50 at all good dealers.

**RASLA SALES CORPORATION**  
National Distributors  
Dept. A, 10 E. 43rd St., New York City

## CONNECTICUT RADIO EQUIPMENT

Variable Condensers, Transformers, Head Phones, Etc.

**CONNECTICUT TELEPHONE COMPANY**  
HARTFORD, CONNECTICUT

## FADA RADIO HANDBOOK

10¢

T-E-L-L-S the "how" about Radio receiving. Worth its weight in gold to every radio fan. Send your dime. F. A. D. ANDREA, INC. 1581-A Jerome Ave., N.Y.C.

**FADA RADIO EQUIPMENT**

## VARIABLE CONDENSERS

3-Plate Vernier	.....\$0.75
23-Plate .0005 Mfd.	..... 1.75
43-Plate .001 Mfd.	..... 2.25
24-Plate Balanced Cond.	..... 3.75
44-Plate Balanced Cond.	..... 4.75

Aluminum Plates, accurate spacings. Please send 10c additional for postage. Money back if you are not satisfied.

**MONTROSE MFG. CO.**  
1200 Bedford Ave., Brooklyn, N. Y.

## CARTER AUTOMATIC RHEOSTAT

The Latest The Best

Eliminates first and second stage jacks. Decidedly simplifies amplification. Clock-spring Digital connection insures consistently reliable operation.

No. 3, 6-ohm, for U.V. 200 tube	.....\$2.25 ea.
No. 3-C, 20-ohm, for U.V. 201 tube	.....\$2.50 ea.
No. 3-D, 30-ohm, for U.V. 199 tube	.....\$2.50 ea.

Write for Bulletin on Distinctive Carter Products.

**CARTER RADIO CO., 209 S. State St., CHICAGO**

Do you know that the Ernest Electric Radio Headset is the best in the world?

## Price only \$3.98

Plus 20c postage—Total, \$4.18

**Ernest Electric Co.**  
4847 Easton Ave., St. Louis, Mo.



## AMPERITE

AUTOMATIC FILAMENT CURRENT ADJUSTER FOR EVERY STANDARD TUBE ELIMINATES RHEOSTATS

EXPELS ALL TUBE TROUBLE

FROM YOUR DEALER OR **RADIAL COMPANY** 554 GRAND AVE., NEW HAVEN, CONN. \$1.10 WITH MOUNTING

Insure your copy reaching you each month. Subscribe to Radio News—\$2.50 a year. **EXPERIMENTER PUBLISHING CO.** 53 Park Place, New York City.



# "Rasco Has It"

Partial List of Goods Listed in  
"Rasco" Catalog  
No. 9

- Detectors
- Navy Knobs
- Switch Handles
- Pointers
- Lock Nuts
- Cord Tips
- Copper Ribbon
- Switches
- Crystal Cups
- Sliders
- Litz Wire
- Rotors
- Panel Scales
- Switch Levers
- Condenser Plates
- Carbon Balls
- Audio-Frequency Transformers
- Radio Panels
- Name Plates
- Crystals
- Bornite
- Silicon
- Radiocite
- Condensers
- Ground Clamps
- Plugs
- Contact Arms
- Aerial Connectors
- Bus Bar Wire
- Enamelled Wire
- Transformer Coils
- Copper Strip
- Flexible Cord
- Knobs
- Panel Knobs
- Key Knobs
- Binding Posts
- Lock Posts
- Machine Screws
- Switch Stops
- Telegraph Key Knobs
- Hard Rubber
- Binding Posts
- Nickel-plated Switch Points
- Zinc Spark Gap Ends
- Panel Switches
- Mounted Crystals
- Tin Foil
- Rheostat Windings
- Spring Clips
- Antenna Connectors
- Lock Fork
- Spacing Washers
- Carbon Grains
- Blow Torches
- Minerals
- Copper Pyrites
- Iron Pyrites
- Soft Metal (Hugonium)
- Threaded Brass Rod
- Cord Tip Jacks
- Vacuum Tube Sockets
- Mica Diaphragms
- Radio Cement
- Choke Coils
- Magnet Wire
- Brass Rod
- Grid Leak Condensers
- Phone Cords
- Metal Dials
- Universal Panel Bearing Handles
- Switch Knobs
- Potentiometer Windings
- Binding Post Name Plates
- Spaghetti-Insulating Tubing
- Radio Frequency Transformers
- Instrument Posts
- Hexagon Nuts
- Spring Binding Posts
- Switch Studs
- Cap Nuts
- Brass Lugs
- Copper Lugs
- Dials
- Lubricated Switches
- Panel Switch Levers
- Mica Sheets
- Vario-Coupler Rotor
- Battery Switches
- Switch Blades
- Selenium
- Diaphragms
- Carbon Buttons
- Transformer Stampings
- Solderall
- Galena
- Zincite
- Mineral Sets
- Brass Washers
- Copper Braid
- Jacks
- Rheostat Windings
- Vacuum Tube Fuses
- Lock Washers
- Dial Verniers
- Resistances
- Silk Wire
- Honeycomb Coils
- Phone Condensers
- Separable Cord Tips
- Composition Dials
- Plugs
- Aerial Insulators
- Phones

# "Build Your Own!"

THE Radio Specialty Company, "RASCO" for short, is probably the most unique radio parts supply house in the United States, if not in the world today. This Company makes a specialty of **SMALL ORDERS**. No order can be too small to get immediate and prompt attention, for the simple reason that most of our orders are small.

The reputation of this Company was built solely on service. Ask any of your acquaintances what they think of "RASCO" goods, "RASCO" service, "RASCO" promptness! Thousands of unsolicited testimonials on file prove that we serve the public best!

Many houses claim that their orders are shipped within twenty-four hours. A year's record in our Order Department actually shows that over 99% of our orders leave within twelve hours after receipt. We invite you to try "RASCO" service on a 50c order. **MAKE US PROVE WHAT WE SAY.**

Sixty-eight per cent of all of our customers come back for more goods after they have tried our service once. The reason is very simple, as we specialize in very small orders. We could not stay in business if we had to look for new customers continually.

**"RASCO" SERVICE IS WHAT COUNTS!**

## "Rasco" Catalog No. 9

The new "RASCO" catalog, No. 9, will prove a revelation to the man who "builds his own." In this catalog are listed more parts and more items than you have previously thought possible to obtain.

The new "RASCO" catalog contains over 500 different radio items, and has been greatly enlarged over the preceding one. **IT NOW CONTAINS 64 PAGES. INSTEAD OF 40.**

## Price Reductions

Many items have been reduced to give our customers the benefit of the lower prices that enlarged production makes possible.

**Factories in Brooklyn, N.Y., and Elkridge, Md.**

These two factories, where our screw machine work, our stamping and our composition work is turned out, make it possible for us to offer the very lowest prices in the country.

## 75 Vacuum Tube Hook-Ups!

These hook-ups of ALL important vacuum tube connections are given in clear diagrams with complete explanations. This is the one and only catalog containing such a wealth of information on all Vacuum Tube sets, giving all the correct values of all the elements, so that any amateur can readily hook up a set with the instructions furnished.

All Armstrong Circuits: These important circuits are explained clearly, all values having been given, leaving out nothing that could puzzle you. Just to name a few of the Vacuum Tube circuits: The V.T. as a detector and one-step amplifier; regenerative circuit; DeForest ultraudion; V.T. to receive undamped and spark signals; Armstrong circuits; one-step radio frequency amplifier and detector; three stage audio-frequency amplifier; short wave regenerative circuits; V.T. radio telephone; 4-stage radio frequency amplifiers; radio and audio frequency amplifier, inductively coupled amplifier; Armstrong superautodyne; radio frequency amplifier and crystal detector; combination V.T. detector one stage amplifier; two stage radio frequency amplifier and detector with feedback coupling (regenerative); regenerative receiver, using single spider web coil; Armstrong super-regenerative circuit; two stage radio frequency amplifier coupled to a two-circuit tuner, using two-slide tuner and regenerative detector; one to ten mile radiophone transmitter; three stages radio frequency, two stages audio-frequency, loop reception; crystal detector with rectification; one tube super-regenerative receiver; short wave regenerative receiver with two variocouplers, capacity-coupled tuner; trap circuit to eliminate interference; selective circuit to eliminate interference.

If you were to buy a book containing all of these 75 Hook-ups you would have to spend from \$3 to \$5.00 to secure the same information.

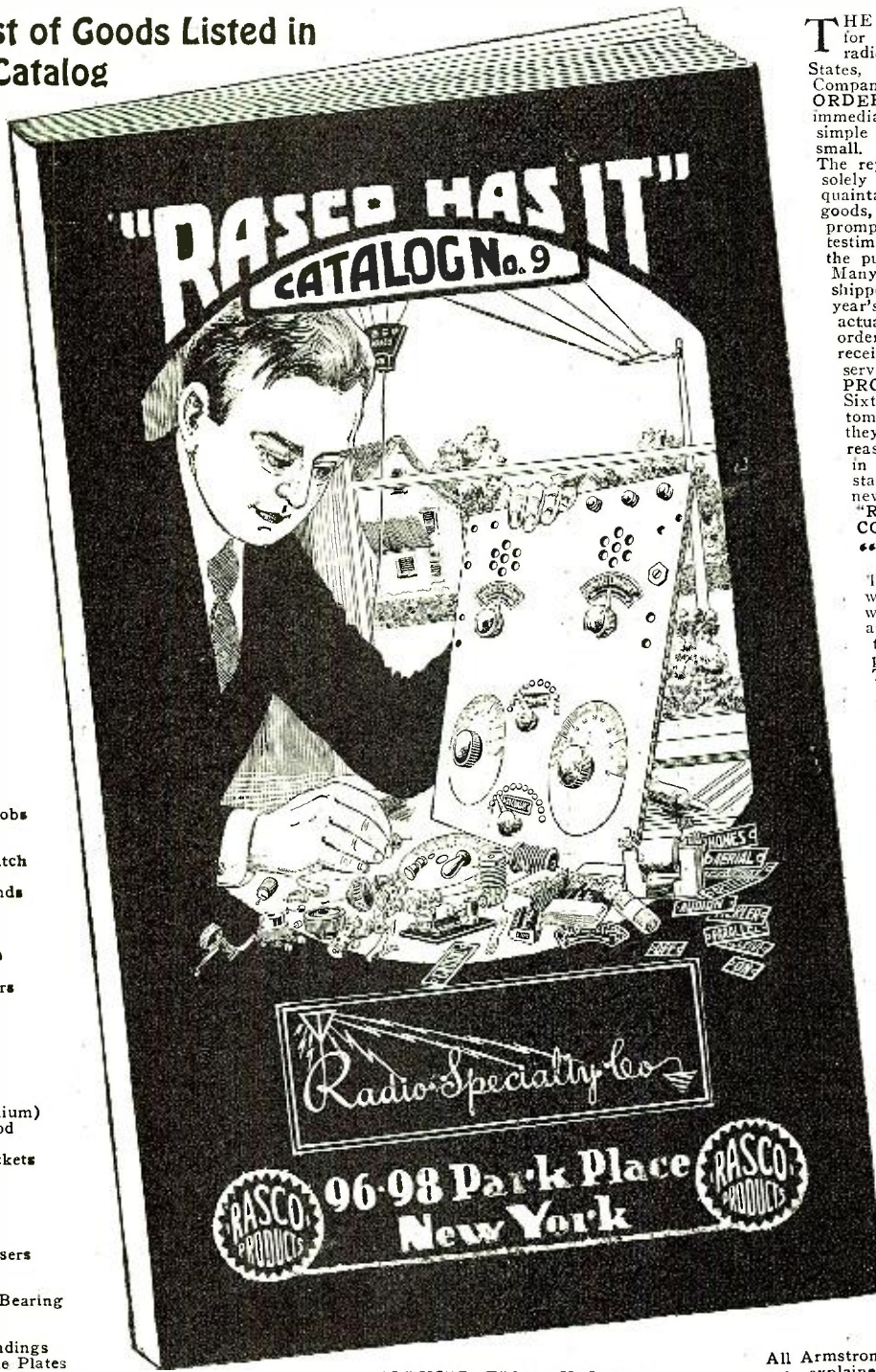

ILLUSTRATION FULL SIZE

## 300 Illustrations

This catalog contains over three hundred illustrations. On account of its very great cost, it can not be distributed free of charge.

**Mailed only on receipt of 15c. in stamps or coin**

This business was originated with the sole purpose to cater to the amateur who has small orders. **ALL OF OUR ORDERS ARE SMALL** and that is why your small order will never be side-tracked by us. A trial order will make you a life customer. "We can stick you only once." Try us with a 50c order.

ALL GOODS PREPAID

## DEALERS

Get Our Special Proposition

Factories  
Brooklyn, N. Y. — Elkridge, Md.



**98 PARK PLACE, NEW YORK CITY**

# KRC

## RADIO

### KUALITY SERVICE

**Kilbourne & Clark Mfg. Co.**  
Head Office and Works: Seattle

BRANCH OFFICES:  
Portland San Francisco Los Angeles  
New York City

For 10 years we have built radio apparatus for ships, shore stations, U. S. Navy, amateur and experimental use.

OUR MERCHANDISING LINE

Receivers	Plugs
Amplifiers	Jacks
Head Phones	Adapters
Lead-Speakers	Sockets
Condensers	Amp. Transformers
Rheostats	Variometers
Potentiometers	Variocouplers
Switches	C. W. Apparatus

COMPLETE LINE OF MOULDED PARTS

WATCH THIS SPACE FOR THE LATEST SPECIALTIES



CONTINUOUSLY VARIABLE RADIO FREQUENCY AMPLIFYING TRANSFORMER

Two Stage ..... \$10.00  
Single Stage ..... 5.50  
Range 150—550 Meters

CAN BE ACCURATELY TUNED TO ANY WAVE LENGTH BETWEEN THESE LIMITS

## WORKING KNOWLEDGE OF THE CODE AND RADIO LICENSE ALL IN ONE WEEK

Rapid Learning Records as reported by many Beginners in all Districts who are now Licensed Operators FREE on request.

**BKUMA YRLSBUG**  
(Trade Mark)

### C. K. DODGE

DEPT. N MAMARONECK, N. Y.

arranged with a mechanical switch and position-varying means whereby the period and coupling of the circuit associated with the coupling coil may be varied. By means of this secondary coupling coil, broad adjustment of coupling between the circuits is secured. There is provided a vernier adjustment coil series connected with the broad adjustment coil whereby accurate adjustment in coupling between the circuit including the primary inductance and the secondary receiving circuit is secured. The vernier coil is constructed of small inductance relatively to the inductance of the broad adjustment coil. The coupled circuit including the broad adjustment coil and the vernier adjustment is provided with tuning means and connected to an electron tube detector circuit. A selective bypass condenser is connected in the

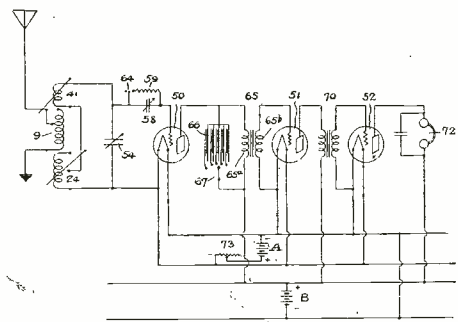

output circuit of the detector tube in shunt with the primary winding of an audio frequency transformer, the secondary of which connects to the input circuit of a multistage audio frequency electron tube amplifier. All of the tubes have their filament circuits and plate circuits supplied from common A and B batteries. On the receiver panel of the apparatus there are provided connections for loading the primary inductance, the broad adjustment secondary coupling coil and the vernier coupling coil.

The grid condenser employed in the grid circuit of the electron tube detector is of the variable type and a switch is provided on the receiver for selectivity, cutting out the grid leak or connecting the grid leak in shunt with the grid condenser. The panel is also provided with connections and a switch for securing different values of plate potential for the electron tubes.

#### SYSTEM FOR WIRELESS TRANSMISSION OF WRITING, PICTURES, AND THE LIKE

(Patent 1,436,676, issued to Magne Hermod Petersen of Christiania, Norway, Nov. 28, 1922.)

The present invention relates to the systems for transmission of writing, pictures, and the like, in which part of the current circuit of an alternating current generator connected to the transmission leads is short-circuited by means of a contact arrangement, which is so actuated by means of the writing at the sending station that the short circuiting is started or interrupted by means of a contact needle passing over the written lines.

On the drawing is diagrammatically illustrated a form of the invention.

Fig. 1 illustrates a diagram for a sending station and Fig. 2 the diagram for a receiving station.

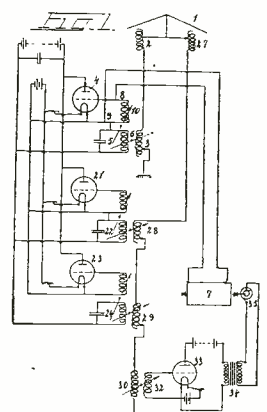

As in all ordinary radio systems there is used a sender and a receiver. This sender comprises an antenna, 1, with an extension coil, 2, and the secondary winding, 3, of a high frequency transformer. By means of the extension coil, 2, the wave-length of the antenna oscillations is regulated, and by means of the secondary winding of the high frequency transformer, energy is received from the sending apparatuses.

The sending apparatuses comprise a vacuum tube generator, 4, of known construction and effect. This vacuum tube generator generates continuous (undamped) oscillations, the wave-length of which is adapted for the purpose, for instance, 600 m. The wave-length is regulated by means of the oscillating circuit, 5—6, and the oscillations are transformed from the primary winding, 6, of the high frequency transformer to the secondary

## Hear them all, all the time

Don't miss a program Charge your A and B Batteries at home with a **Valley Battery Charger**



**Simple:**  
Plugs in on a light socket just like a lamp. Clamps to battery terminals.

**Safe:**  
Cannot overcharge your battery. Ammeter immediately indicates incorrect connections.

**Quick:**  
Will charge the ordinary radio battery from bedtime one night to listening-in time the next.

At radio dealers—or write us.

**Valley Electric Co.**  
St. Louis, Mo.



WOI WMC WDAP KDYX PWX

# KLAUS

## RADIO SERVICE

### Makes Money for Dealers



**Get Free Bulletin**

Klaus Radio Dealers receive expert service in radio problems and in radio merchandising. Our dealers *make more money*. We want a dealer in every city and town. Some territory is still open. Write for our trade discount lists and the "Klaus Radio Bulletin."

**KLAUS RADIO & ELECTRIC CO.**  
Authorized Distributors  
Dept. 200 EUREKA, ILL.

## RADIO HEAD SETS

# TRIMM

PROFESSIONAL  
Retail for \$7.65  
DEPENDABLE  
Retail for \$5.00  
**TWO WONDER VALUES**  
TRIMM RADIO MFG. CO.  
Dept. 43, 24-30 S. Clinton St. Chicago, Ill.

winding, 5, and emanate from the antenna in the form of electro-magnetic waves. 7 is the sending cylinder of the copy telegraph apparatus. The telegram, comprising a picture or writing of any kind, is transferred chemigraphically to the cylinder in such a manner that the lines are electrically insulating. During the rotation of the cylinder a contact needle describes a helical line on the same. When the contact needle touches the metal a contact is formed, and this contact is broken when the needle is passing over a line of the writing or picture. From the contact needle and metal of the sending cylinder, two lines lead to the screen circuit of the vacuum tube gener-

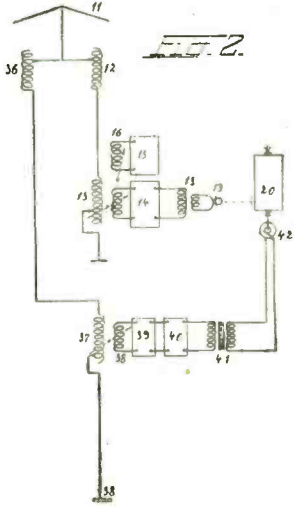

ator, and are connected at points, 8, 9, in parallel to the screen coil, 10. It will be understood that when the contact needle on the cylinder is in contact with the same, coil 10 is short circuited, whereby the emanation of waves from the antenna is intercepted, and when the contact needle passes an insulating part of writing, the short circuiting is interrupted, and continuous (undamped) waves emanate from the antenna as in a modern radio station provided with vacuum tube sender. The waves emanated are taken up at the receiving station by the antenna 11 and conducted over the antenna coil 12 to the antenna coil 13 of the receiving transformer, whereupon it is transferred inductively to high frequency intensifying detector

# ATWATER KENT

RECEIVING SETS AND PARTS

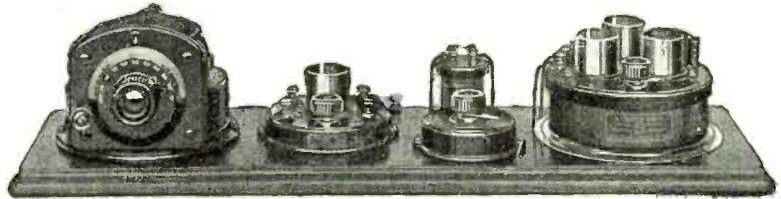

*This is one of several sets made up in various combinations of parts. All sets and parts are described in an illustrated folder.*

ATWATER KENT Sets and Parts are ideal for summer use due to their compact and rugged construction and the fact that they are moisture-proof. They are made mostly of condensite and are thoroughly water-proofed.

*Send for the illustrated folder*

ATWATER KENT MANUFACTURING COMPANY  
4943 STENTON AVE. Radio Dept. PHILADELPHIA, PA.

## Here's good news for the lovers of *REAL* RADIO MUSIC

**H**ERE'S a new Audio Frequency Transformer that, on actual test, has shown that it gives greater amplification and greater fidelity of reproduction over the whole range of orchestral music.

From the slow rhythmic beat of the kettle drums (30 or less cycles per second) to the upper octaves of the piccolo (8000 cycles per second) every instrument in the orchestra and every note played by that instrument is reproduced more strongly, purely, faithfully than you had dreamed possible.

Install one on your present set. The result will be a revelation to you of what radio can mean in your home.

And the same engineering skill, based on twenty-three years' experience in the manufacture of communication apparatus, is behind every Federal Guaranteed Radio Product.

There are now more than 120 separate, individual Radio Products in the complete Federal line.

From head-sets to grid-leaks you will find each Federal product to be the best of its kind. You are *sure* of satisfaction. We *guarantee* it.

*Send today for illustrated catalog, describing them fully.*

**Federal Telephone and Telegraph Company**  
BUFFALO, N. Y.

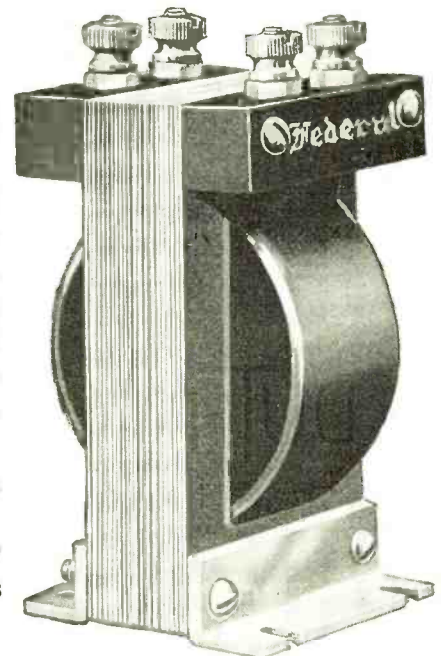

**Federal Standard**

Audio Frequency  
Transformers

**No. 65**

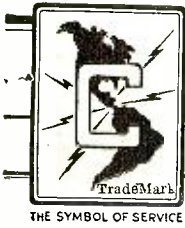

# CONTINENTAL

"New York's Leading Radio House"

## Radiola II

### Portable Set for Summer!

PRICE  
**\$97.50**

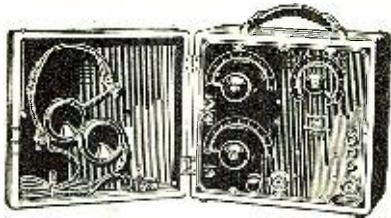

Step into our show room and let us demonstrate to you the Radiola II.

In the woods, on the road, over the water, anywhere—Radiola II never fails to please its listeners

Standard products give standard performance. Radiola II may be installed anywhere at any time, and will bring in programs from far and near.

A few of the characteristics which

Dealers! Give the Radiola II a chance to boost your Summer Sales and watch it sell itself. Send your orders in now.

"Modern Radio"—A two hundred and eight page catalog of Radio equipment, supplies and apparatus sent for twenty-five cents.

Distributors for R. C. A.

add greatly to the quality of this set are its strength of construction, simplicity of operation, economy, using UV-199 dry cell tubes, sensitivity and the handsomely finished case, which makes the set self contained.

2038-Q

CONTINENTAL RADIO and ELECTRIC CORPORATION

SIX and FIFTEEN WARREN STREET, NEW YORK, U. S.

## DUTHO Rechargeable Storage "B" Batteries

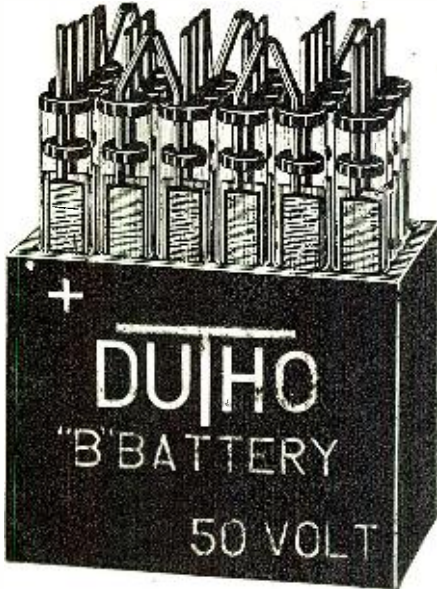

Build a DUTHO into your set: will not leak, absolutely noiseless, emits no fumes, easily recharged, large capacity, small size, will last indefinitely.

**25 Volt \$5.00**

SIZE 3"x2½"x6"

**50 Volt \$9.00**

SIZE 3"x4½"x6"

**100 Volt \$17.00**

SIZE 3"x8½"x6"

**Chemical Rectifier \$1.95**

Dealers: Write Today for our attractive Sales Proposition

½ ACTUAL SIZE

DURKEE-THOMAS PRODUCTS CO.

1228 Folsom St.

San Francisco, Cal.

Variable Grid Leaks	.....	\$.45 each
Tubular Grid Leaks (all resistance)	.....	.50 each
Tubular Grid Leaks mounting	.....	.35 each
Single V. T. Sockets Type S-10	.....	.90 each
Triple V. T. Sockets Type S-4	.....	2.70 each
Bakelite WD-11 Sockets	.....	.50 each

RADIO SERVICE & MFG. CO.  
(Established 1918)

Factory—Lynbrook, L. I.

We carry a Complete Line of Radio Apparatus

# D E N V E R

COLORADO

9ZAF

REYNOLDS  
RADIO CO.

KLZ

1534 Glenarm St.

LARGE RADIO DISTRIBUTORS

and low frequency intensifier of a known type and placed together in apparatus 14. The said high frequency circuits can, however, not be used directly for driving the receiving apparatuses of the copying telegraph. The receiving apparatuses, which can be used, comprise oscillograph receivers, spark receivers and others.

## A Low Power Phone and C. W. Transmitter

(Continued from page 157)

cypress carefully treated with shellac. Tube cabinet is 10" by 13" by 6" deep.

Unfortunately, both tubes and a generator are expensive, but it is possible to obtain cheaply a used 500-volt shunt wound motor of, say, 1/10 h. p. which, when driven by a suitable motor, gives excellent results. The combination should cost less than twenty dollars.

## Correspondence from Readers

(Continued from page 161)

If some one should write in saying that he had received programs over a distance of 800 or 1,000 miles, with a simple crystal receiver, what an argument he would start.

And, furthermore, if this same person should declare that he was receiving ARC stations on the above mentioned receiver, using two small honeycomb coils which may be purchased for less than one dollar, that would settle his fate. Every radio fan would be in favor of putting him in a padded cell and calling an alienist.

Now that I suggest these three possibilities, some one will ask "Can it be done"? I answer, "It can be done, and is being done right now."

Here's what is puzzling me. "Do experts think these things impossible?" "Do they think, by concealing the facts, to encourage the credulous public to purchase more expensive sets?" "Has no one happened to stumble onto the secrets contained in the simple receiving set?"

KENNETH OVERLY,  
Grant, Michigan.

## GUILTY STATIONS

Editor, RADIO NEWS:

I wish to make a few comments on the item appearing in the April, 1923, issue of RADIO NEWS entitled "Radiations." I only regret that the real offenders have not seen it, or, having seen it, fail to heed it. Such powerful stations as WSB, WBAP, WFAA, WGM, WEAY and even WOC at Davenport have been guilty of acknowledging telegrams and telephone calls via radio. It is very tiresome and annoying, after having heard a splendid selection, to have the spell broken by a long list of acknowledgments. It perhaps gives the sender of the telegram a degree of satisfaction to hear his name mentioned by such novel means, but it is very provoking to others.

I am sure if we should go to hear a famous orchestra or noted singer some evening, we should be disgusted beyond measure to have someone come out after each number and make an announcement. So is it with radio. True, with radio we can tune out the offending station, but it is very likely that we should tune in another committing the same offense, as this practice seems to be becoming universal. I do not think the offending stations are guilty of any intentional wrong-doing; they merely need to have the matter brought before them. I trust you will have more to say concerning

this unlawful practice in later editions of your valued magazine, and probably it will fall into the hands of those who need it most.

H. K. MAYFIELD.  
Horse Cave, Ky.

**AN IMPROVEMENT**

Editor, RADIO NEWS:

I read Mr. J. R. Tonnehill's description on "Reducing Interference" in the March RADIO NEWS. I heartily agree with everything he says, except that it is rather inconvenient with so many switches, so I have enclosed a hook-up which I think is much simpler.

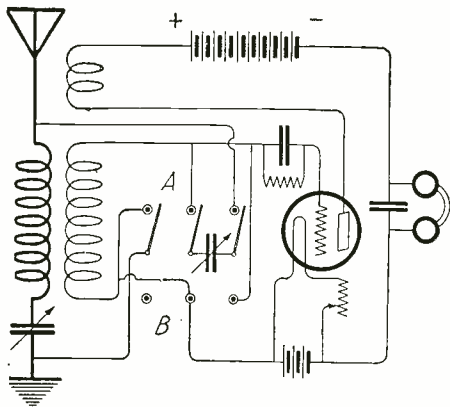

A Simple Switching Arrangement by Means of Which the Receiver Can Be Made a Single or Double Circuit Type.

My first set was a single circuit and I had the same trouble that Mr. Tonnehill had and many others are having. I discarded this and built a honeycomb set, but I missed the single circuit for its simple tuning and loudness, so I employed the accompanying hook-up.

The switch is of an anti-capacity triple-pole type; when thrown up to A the regular two-circuit is being used, and when thrown to B the primary coil must be pulled out and you then have a single circuit.

JOHN HOLAPIAN.

**MORE FROM NEW ZEALAND**

Editor, RADIO NEWS:

I notice in a recent number of your publication an article on DX work by amateurs on 200 meters. I believe it was written from Honolulu and the author gave some long distance reception records. Also in a previous number, a station operator in Samoa accomplished some wonderful reception. Previous to reading these articles I never considered it worth while trying to receive American amateurs in New Zealand, as we were so far away from our cousins. However, when I learned that during the month of May this year tests were to be conducted with Australia by American amateurs, I thought it possible that reception could be accomplished here. The following were copied without H. F., using three steps of A. F. on an aerial erected near a beach over sandy ground. The aerial has an average height of 20' and is 150' in length. The earth consisted of a clean kerosene tin filled with water and sunk in dry sand, also fences (wire) as counterpoises.

Saturday, March 17, 1923. 4XJ De 6ZH, 6:35 p. m., N. Z. time (about 19:00 G. M. T.). (CQ de 6ZH) 6ZH heard often, good sigs. 5XB de 6ANH, 7:05 p. m. (QTC hr QSR? 5XB de 6ANH.) 9AIX de 6ANH, very clear and strong sigs. (R. O. K., QTC hr QTC QSV? 9AIX de 6ANH.) Msg hr K No. 1 to T. H. McNeil, 302 East — Kansas City, Mo.: "Hope u all . . . etc. 5ZA de 6? Did

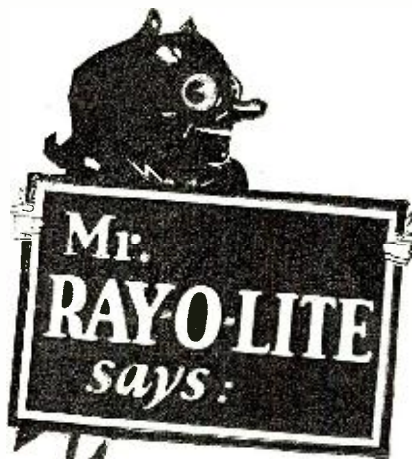

**Improve Radio Reception**

You don't know what *real* radio is 'till you've tried WD-11 or WD-12 Dry Battery Tubes with a Ray-O-Vac "A" Dry Cell. The cost of a single cell is small and it lasts a long time. And say! when you get them set up, you won't know the old set.

Everybody knows that this combination of Ray-O-Vac "A" with dry battery tubes gives clearer signals. The limit of your set is picked up easily and sounds as though you were right in the same room. Units 1, 2, 4, or 6-cell. Send for the free booklet "How to Get the Most out of Radio," full of interesting things about the use and care of your set. Also gives a complete list of official broadcasting stations with their signals.

Ask your dealer for this new battery—

**FRENCH BATTERY & CARBON COMPANY**  
Madison Wisconsin

Atlanta Dallas Denver Chicago New York  
Minneapolis Kansas City



Use Ray-O Vac "B" Batteries for sustained voltage, longer service and elimination of noise.

**RAY-O-VAC**  
*The Battery that Completes Radio*

**Hit it anywhere!**

MAGNETITE RADIO-CRYSTAL—the world's most sensitive and efficient Crystal-Detector. GIBBONS-DUSTIN RADIO MFG. CO., 518 West 9th St., Los Angeles, Cal., U. S. A., owners and national distributors.

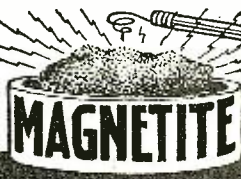

Magnetite Radio-Crystal is unaffected by handling or moisture and will render efficient service indefinitely. Ideal crystal for REFLEX Circuit and R. F. MOUNTED or UNMOUNTED. Price 50 cents at all Dealers—or mailed direct—GUARANTEED.

**ELECTRIC SOLDERING IRON**

EVERY RADIO FAN has been looking for this iron for both radio and home use. Operates on A. C. or D. C. current. GUARANTEED any year. Sent anywhere in U. S. or Canada. Parcel Post prepaid on receipt of money order for \$2.28. FANS Send 2c stamp for our list of RADIO BARGAINS

**228**

**RADIO BARGAINS**  
17 N. LA SALLE ST. CHICAGO

**RADIO SCHOOL**

All our graduates are placed. Shortage still exists.

Send for Catalog

**MASSACHUSETTS RADIO & TELEGRAPH SCHOOLS Inc.**  
18 Boylston St. Boston, Mass.  
G. R. ENTWISTLE, Radio Director

# DELTA

## Gold Stripe Radio Headsets

No. 500  
2200 Ohm  
**\$6.00**

No. 501  
3200 Ohm  
**\$6.50**



**Absolutely equal or superior to other standard makes at much higher prices**

DEALERS AND JOBBERS  
Write or Wire Today for Dealer Discounts

Many thousands in service everywhere and this is representative of what scores of users have to say about them.

An Institution of 13 Years Standing.



Home of Nationally Famed Delta Electric Products.

"I am the owner of a pair of DELTA GOLD STRIPE RADIO HEADSETS, (2200 Ohms.)  
"I have compared my DELTA Phones with a pair of 3000 Ohm Phones I have and would prefer the DELTA anytime. The DELTA is certainly great."  
CHARLES H. SMITH,  
8 Coleman Ave., Hudson Falls, N. Y.

### DELTA ELECTRIC COMPANY

470 Delta Block Marion, Ind.

Standard Makers of Radio Apparatus, Bicycle Lamps, Auto Spotlights, Lanterns, Flashlights and Flashlight Batteries

NEW YORK SAN FRANCISCO WINNIPEG

not get call letters. QRN. 6CGW ex 61F CQ QSL de 6CGW, 9:55 p. m. 8BCH de 6CFM. March 18, 1923. 2FP de 8? Did not get call letters. QRN, 6:45 p. m. 6FF De 6OZ, good sigs. Also 6ZZ, very good sigs. March 21, 1923. 1BCG and 3FQ de 8ZT, 10:05 p. m. Also about March 1, 9DOK and 5ADO de 6BFV were also heard.

I think the above performance is much more creditable to American amateurs than crossing the Atlantic. The distance from New Zealand to 8ZT is about 8,000 miles. A marked fading of signals is noticeable and makes reception difficult, but the signals from local stations (spark) also fade, so perhaps it is due to local conditions. It is noticeable that when an amateur is calling he is nearly always readable when he starts up, but fades away when he is signing off. Most of the 6's heard were good and clear.

Amateurs in New Zealand are now coming into their heritage, as regulations are being issued at present for transmission, the power being limited to 50 watts for Grade 1 amateurs. We receive all the big stations of the world here, including England, and who knows before long we New Zealand amateurs may yet get into communication with your amateurs. I should be glad if any of the above amateurs would drop a line, giving me particulars of their power, etc., also type of circuits.

Your magazine is eagerly looked forward to each month, and as far as the amateurs go, it is the authority on radio. The writer has been reading it ever since it started as "Modern Electrics."

IVAN. H. O'MEARA,  
Gisborne, New Zealand.

### GOOD WORK

Editor, RADIO NEWS:

Being a kid amateur, perhaps I have no business nosing my way into the doings of some of my elders; however, loving the keys of a typewriter almost as well as the brass I will take a wang at it.

Much has been said in regard to the honey-comb inductance. I will state some of my experiences with a standard H. C. hook-up using only one variable condenser and that in shunt with the secondary. With this circuit I have repeatedly heard KDKA, WGY, WWJ, WSB, WBAP, and such near-by stations as Minneapolis, Fargo, Davenport, and Kansas City I hear regularly.

I am able to tune out almost all interference, and if I had another condenser it no doubt would add greatly to its selectivity.

I have thoroughly enjoyed the letters on "why radio sales fall off." I have had similar troubles myself.

Will some other young amateur please write me?

ALBIN L. SWANSON,  
Wheaton, Minn.

## A LOUD SPEAKER and REPRODUCER IN ONE BRISTOL AUDIOPHONE

MORE THAN A LOUD SPEAKER the AUDIOPHONE is a real reproducer of the original broadcasting. It is easy to listen to the Audiophone reproduction, because they are so perfect. The speech, songs and instrumental music are not blurred or disguised by mechanical distortion. You get all the fine shadings and every inflection. In fact, the very personality of the artist seems to be present as you listen.

DEVELOPED in the laboratories of an engineering firm known the world over for recording instruments of precision.

COMPLETE in every way and ready to connect to the receiving set.

NO AUXILIARY BATTERIES are required for magnetizing.

ADAPTED for use on all types of two or three stage power amplifiers.



### AUDIOPHONE

MADE IN TWO MODELS:  
BRISTOL AUDIOPHONE SR. Loud Speaker, Size of Horn 15-inches Diameter, Price ..... **\$32.50**

BRISTOL AUDIOPHONE JR. Loud Speaker, Size of Horn 11-inches Diameter, Price ..... **\$22.50**

THE BRISTOL SINGLE STAGE POWER AMPLIFIER for use with the usual two-stage amplifier can be furnished, which will greatly increase the range of the Audiophone where desirable. Price ..... **\$25.00**

Write for Bulletin 3006-S.

### THE BRISTOL COMPANY, WATERBURY, CONN.

Boston New York Philadelphia Pittsburgh Detroit  
Chicago San Francisco



Parts and Accessories for makers of radio apparatus



Details and Prices on request  
GENERAL RADIO CORPORATION  
Mrs. E. Distributors of  
First Quality Radio Equipment  
including MUSIC MASTER RADIO AMPLIFIER  
10th and Cherry Streets Philadelphia

## RADIO

Complete Stock—Both Sets and Parts—All Makes

### ROSE RADIO SUPPLY

129 Camp Street New Orleans, La.  
Send 10c for latest catalog

## Preventing Fraud by Radio

(Continued from page 144)

great asset, a two million dollar lawsuit it holds against another company.

Needless to say, the intended investor will keep his money.

Thus the Better Business Bureau has made use of the newest method of communication; literally from the very air, an unsuspecting investor was saved from having his money taken from him.

As Mr. Epstein stated at the meeting, "If the Mercantile Trust Company had never done anything else with its radio equipment, this one case has more than justified its existence."

*proven best filament control*



*- challenges the world*

### 2000 Miles on 1 Tube with a FIL-KO-STAT

*From Paul H. Woodruff  
Editor Industrial Power, Chicago.*

"I am of the opinion that the Fil-Ko-Stat is the best filament control and have recommended it highly. It is a fact that, I picked up two Los Angeles stations, KHJ and KWH with a single tube regenerative detector shortly after installing it."

*Recommended and sold by  
dealers in high quality  
radio supplies.*

Takes the place of your rheostat!  
Occupies little space on panel.  
No redrilling necessary.

Made and guaranteed by



PRICE

**\$2**

Proven by every test to surpass any and all rheostats and filament controls, Fil-Ko-Stat rightly challenges the world.

Laboratory research proves Fil-Ko-Stat to have a fine adjustment area (which means ability to control filament heat and electronic flow) eighteen times greater than that of the wire rheostat and several times that of the next best filament control.

Actual use proves Fil-Ko-Stat the most accurate control for any tube from "peanut" to "power." Full resistance 30 ohms.

It has no screws or adjustments to tamper with. It is triple tested and regulated at the factory to the ideal "off" position for

UV 200, 201, 201A, WD11, WD12,  
UV199, DV6A, W. E. Peanut, etc., etc.

It is non-microphonic, operates noiselessly, eliminating all "frying."

It has no disks to break or chip and its reliability and durability are guaranteed by the manufacturer.

If you have never tried tuning with your filament control, start with a Fil-Ko-Stat. It brings in strong and clear D. X. stations you never heard before.

If your dealer has no Fil-Ko-Stats in stock, send his name and your remittance direct to

**RADIO STORES CORPORATION**

Sole International Distributors

Dept. RN8 . . . 218-222 West 34th Street, New York

The filament control of infinite adjustment

# FIL-KO-STAT

DISTINCTLY DESIGNED TO UTILIZE THE GREAT TUNING POSSIBILITIES OF THE VACUUM TUBE ITSELF.

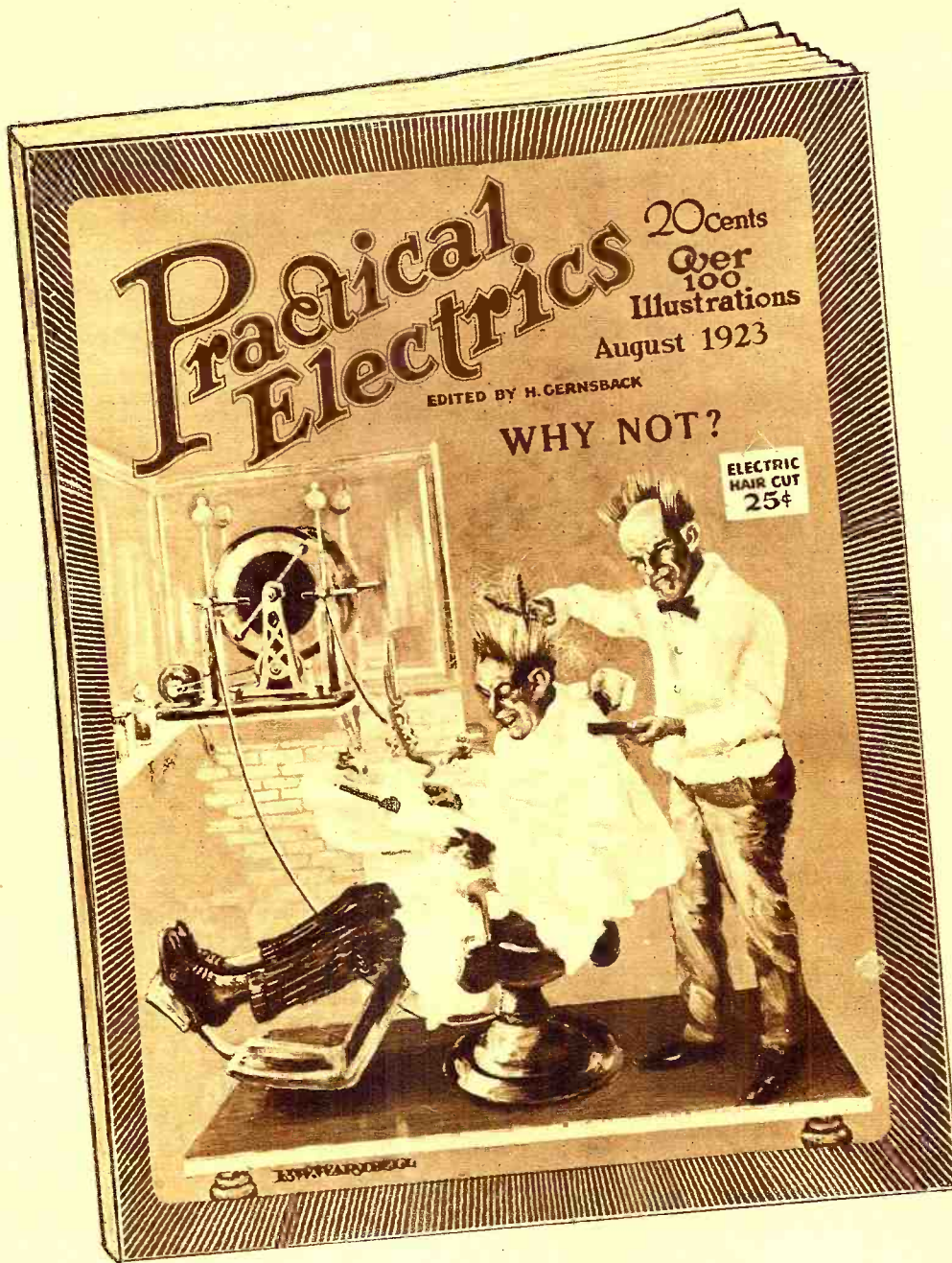

This magazine is edited by **H. GERNSBACK** also Editor of **RADIO NEWS** and **SCIENCE and INVENTION**

100 Articles Over 100 Illustrations

FOR SALE AT ALL NEWS STANDS

20c. the Copy  
\$2.00 a Year  
Canada and Foreign \$2.50 a Year

SEND FOR **FREE** SAMPLE COPY TODAY

See Coupon Below for **SPECIAL OFFER**

**“The Electrical Magazine for Everybody”**

**P**RACTICAL ELECTRICS is probably the most novel magazine of its kind ever conceived. It is personally edited by H. Gernsback, editor of SCIENCE & INVENTION and RADIO NEWS. Mr. Gernsback, who founded the old “Modern Electrics” as well as the “Electrical Experimenter,” knows thoroughly what his readers want and have wanted for many years. PRACTICAL ELECTRICS, the 100% electrical magazine eclipses the best that was in “Modern Electrics” and “Electrical Experimenter.”

Electricity covers such a tremendous field that the man who does not keep abreast with it does himself a great injustice. PRACTICAL ELECTRICS covers that field from every angle. It is written in plain every-day language that all can understand. It portrays the entire electrical development of the month faithfully in non-technical language. It caters to everyone interested in electricity, be he a layman, an experimenter, an electrician or an engineer—each will find in this magazine a department for himself and plenty more.

The August issue now on the news-stands contains 48 pages and over 100 different articles and over 100 illustrations, with an artistic cover in three colors. Professor T. O’Conor Sloane, Ph.D., is associate editor of the magazine.

**INTERESTING ARTICLES IN AUGUST “PRACTICAL ELECTRICS”**

- New Magnetic Tricks.
- Loud Speakers and Movies.
- Dry Weather Electrical Storms.
- Studying Lightning. By Dr. Albert Neuberger.
- Experimental D. C. Transformer. By Amedeo Giellita.
- Cutting Metals With Electric Arc.
- Novel Electrophorous. By Dr. Alfred Gradenwitz.
- Silver Plated Leyden Jars.
- Plante Storage Battery.
- Magnetic Gravity Motor.
- Wheatstone Slide Wire Bridge. By A. P. Peck.
- New York’s Electric Map. By T. O’Conor Sloane, Ph.D.
- Electric Windshield Cleaner.

**PRIZES**

This magazine offers a number of prizes, as follows:

Our \$50.00 Prize Contest for Junior Electricians and Electrical Experimenters includes as its elements simplicity, as great a degree of novelty as possible, and practicability.

\$3.00 for the best article on Elec-Tricks, the new department.

\$3.00 for the best “short-circuit,” the semi-humorous department.

In addition to this, the magazine pays high prices for all electrical experiments, electrical articles, etc.

See Current Issue for Full Details.

This issue also contains articles by some of the greatest electrical writers, workers and students. The magazine will prove a revelation to any one interested in electricity.

Every issue besides its many other features contains the following departments:

- “New Things Electric”
- “Experimental Electrics”
- “Electrical Digest
- “Junior Electrician”
- “Elec-Tricks”
- “Motor Electrics”
- “Short Circuits”

“How and Why” (Questions and Answers.)

Make all checks payable to: “Practical Electrics Co.”

**SPECIAL OFFER**

Gentlemen: Although your regular price is \$2.00 per year, you will accept my subscription at \$1.75 per year (Canada and foreign \$2.25). I enclose the money herewith and I have written my name and address in margin below.

R. N. 8-23.

**PRACTICAL ELECTRICS CO., 53 Park Place, New York**



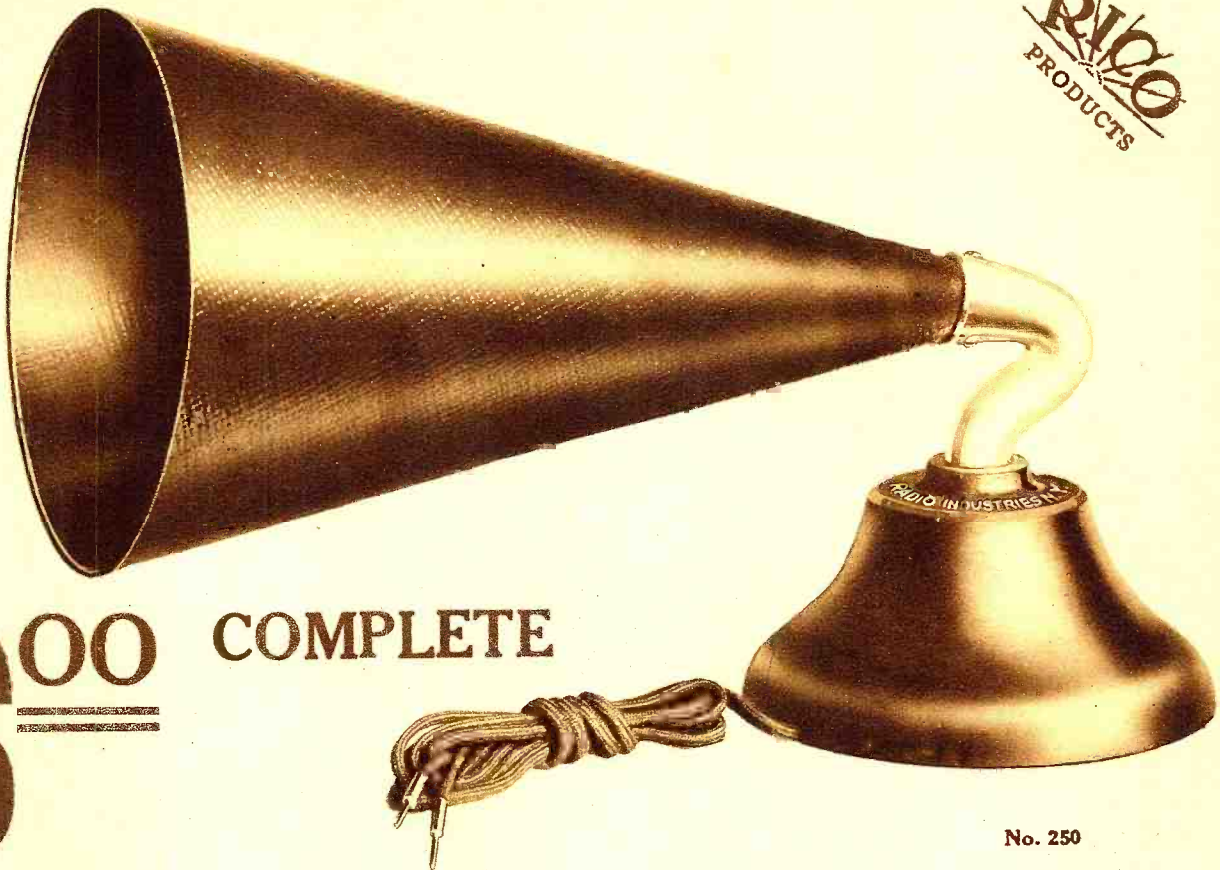

**\$6.00 COMPLETE**

No. 250

## The "Rico" TUNED Melotone Speaker

**T**HIS loud speaker is the outcome of several thousand experiments, and we present it to the American radio public in full confidence that we have produced the lowest priced and at the same time the highest class loud speaker on the market today.

The "RICO" TUNED MELOTONE SPEAKER is not a makeshift, not a toy, but a high grade scientific instrument, built in very large quantities in order to give the public the advantage of our low manufacturing costs.

These are the specifications:

- Adjustable and tuned "RICO" Loud Talker, fitted in cast metal base, handsomely finished, with two coats of baked enamel;
- Nickel-plated and polished gooseneck;
- Full fibre horn;
- Five-foot attachment cord.

### THE TUNED FEATURE

Our cross-section diagram shows our new adjustable feature, by which it is possible to make this loud talker give out almost any sound within reason. The MELOTONE SPEAKER can not possibly shatter nor rattle under any circumstances.

The new development comprises a specially-formed, pure Para Rubber Gasket, accurately made, upon which the diaphragm rests. By tightening or loosening the shell of the receiver its diaphragm approaches or recedes the desired distance toward or away from the pole pieces. So remarkable is this adjustment, and so wonderfully exact does it work, that any sound volume or quality can be readily obtained.

For instance, a given adjustment will bring in certain qualities of sound heretofore unobtainable. It is in your power to TUNE the MELOTONE SPEAKER in such a manner that if you wish a moderate amount of sound you can readily obtain it, or if you wish volume, as, for instance, band concerts, the adjustment can be made instantaneously.

By means of this new adjusting feature, the diaphragm can be moved to or from the pole pieces from .006" to .025". To make the adjustment, simply screw the case within the base of the speaker slightly backward or forward. No screws, no nuts, no fussing, no damaged diaphragm.

### ACOUSTIC FEATURES

After you have listened to all of the expensive loud talkers, all we request is that you give ours a trial. You will find that it compares favorably with the higher priced loud speakers on the market. The "RICO" MELOTONE SPEAKER gives quality and volume, without distortion, due to the tuned feature.

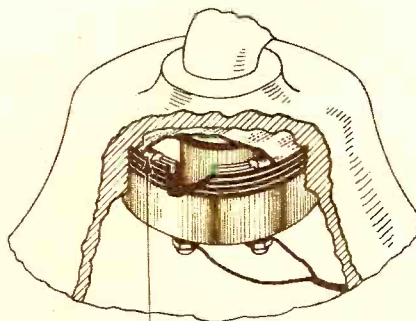

RUBBER GASKET

On two or three stages of amplification, any good radio outfit with the "Rico" Melotone Speaker will bring in the sounds loud and clear to fill a large room or hall. The fibre horn gives the mellow tone that is sought by every radio enthusiast. There is a richness of sound that compares most favorably with the most expensive horns on the market today.

In appearance, the "RICO" MELOTONE LOUD SPEAKER is a rich-looking and accurately, as well as scientifically-constructed instrument, that looks rich anywhere, among the best furnishings. Yet the size is not so large that the apparatus will appear cumbersome. Base is equipped with felt, to overcome resonance effects and to prevent the marring of table tops.

The dimensions are as follows: Length overall, 14½ inches; Length of horn, 11½ inches; Diameter of bell, 6¾ inches; Total height of instrument, 9 inches; Diameter of base, 5 13/16 inches; Total net weight, 3 lbs.

Each MELOTONE SPEAKER is enclosed in a heavy corrugated box, and we guarantee safe delivery to you.

Order from your dealer or direct from us.

### SPECIAL OFFER

We are so convinced that you will be enthusiastic about this loud speaker that we make this unusual offer:

### SEND NO MONEY

USE COUPON BELOW

We require no money in advance,—no deposit. All you need to do is to sign the coupon and we will send the MELOTONE Speaker at once, the minute we hear from you.

All MELOTONE Speakers are guaranteed to be as represented by us in this advertisement.

Note: The "RICO" TUNED MELOTONE Loud-Speaker No. 250 must be used in connection with a 1- or 2-stage amplifier or more.

Send for free illustrated literature of "Rico" Head-phones; "Rico" Phonoadapters; "Rico" tuned loud-speaker phones; fibre "Ricohorns."

### SEND NO MONEY

COUPON

R.N.-8

Radio Industries Corporation  
131 Duane Street, New York

Gentlemen:—Please send me by Parcel Post one "Rico" TUNED Melotone Speaker for which I will pay the postman the amount of \$6.00 plus postage.

You guarantee that the "Rico" TUNED MELOTONE speaker is exactly as represented by you.

NAME .....

STREET AND NO. ....

CITY ..... STATE .....

**RADIO  
INDUSTRIES  
CORPORATION**

131 Duane Street, New York City

Cable Address: Ricotrade, New York.

California, Washington and Oregon Distributors:

Chicago Distributor

Triangle Electric Co., 160 W. Lake St., Chicago, Ill.

# Three New Popular Radio Patterns

These three additions to the "Radio Constructor Series" comprise full size working diagrams and complete instructions for building three of the most popular radio sets now in vogue.



PACKET No. 4

## A REINARTZ RECEIVER

PACKET No. 5

## A REFLEX RECEIVER

PACKET No. 6

## A COCKADAY RECEIVER

Each packet contains complete instructions for the construction of these circuits including the tools required, parts needed, directions and pattern for drilling, mounting and wiring and most important of all, full instruction on how to tune the circuit. Sets constructed from these plans have been thoroughly tested and pronounced perfect.

Each Packet  
Complete

**50c**

## FOUR NEW SUPPLEMENTS

### To the Famous 20 Radiophone Diagrams and Hook-ups

We could not improve the ones we already had but to live up to our policy of keeping our plans and diagrams up to date we added in sheet-form the COCKADAY CIRCUIT, REFLEX CIRCUIT, REINARTZ CIRCUIT AND NEUTRODYNE CIRCUIT. The other circuits in this series are:

- |   |   |
|---|---|
| 1. Single Slide Tuning Coil with Crystal Detector.      | 11. Combination Circuit for Long and Short Wave.                            |
| 2. Double Slide Tuning Coil with Crystal Detector.      | 12. Detector and Two Stage Amplifier with automatic Filament control Jacks. |
| 3. Loose Coupler with Crystal Detector.                 | 13. Single Circuit Regenerative Tuner.                                      |
| 4. Regenerative set, using 2 slide tuner.               | 14. Circuit for elimination of induction from power lines.                  |
| 5. Plain Audion Detector Circuit.                       | 15. Loop Aerial Receiver.   |
| 6. Feed-back Circuit with a loose Coupler.              | 16. Radio and Audion frequency amplifier.                                   |
| 7. Armstrong Feed-back Circuit.                         | 17. Circuit of a C.W. Transmitter for low power.                            |
| 8. Standard Short Wave Regenerative Set.                | 18. 5-Watt Radio-phon.  |
| 9. Honey-comb coil Receiver for all wave lengths.       | 19. 10-Watt Phone and C W. Transmitter.                                     |
| 10. Short Wave Regenerative set, with 2 step amplifier. | 20. High Power C.W. Transmitter   |

In addition to the above connection diagrams, the packet also includes a four-page instruction pamphlet, explaining each diagram in detail, also, "HOW TO READ DIAGRAMS"—"HOW TO FOLLOW CIRCUITS" and, A COMPLETE KEY OF THE MOST COMMONLY USED RADIO SYMBOLS.



This Packet, Complete  
with 4 New Supplements

**50c**

*Order From Dealers Whose Names Appear on Page 178*

If Your Dealer Cannot Supply You, Send Us His Name and Address

*The Conrard Co.*  
INC.

233 Fulton Street, New York City

Formerly the  
Consolidated Radio Call Book Co.

## Detection

(Continued from page 151)

grid, for grid circuit rectification we must use, by some means to be described later, a positive potential on the grid, for the grid current only flows when the grid has a positive potential.

2. Grid circuit rectification requires the use of a so-called "grid condenser and leak," seen in the circuit diagram of Fig. 7, where  $C_g$  is the grid condenser and  $R_g$  is the grid leak.

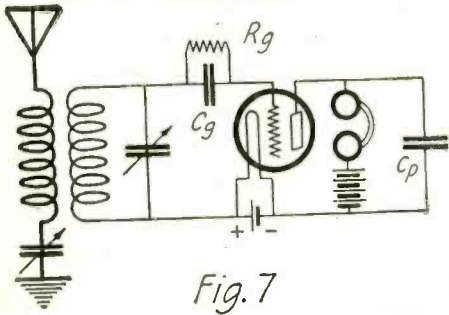
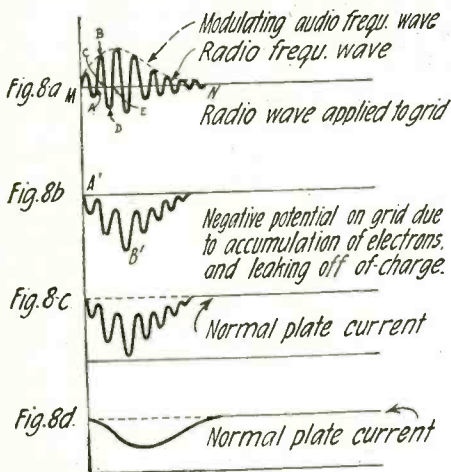

Fig. 7

Receiving Set with Grid Leak and Condenser.

The explanation for the detecting action of the tube when it employs a grid condenser and leak is quite complicated and difficult, but if the reader will pay close attention to the following explanation and follow each point carefully he will obtain a very good idea as to what is happening.

Suppose that we are operating our detector set without the grid leak resistance  $R_g$ , and are only using the grid condenser  $C_g$ , as in Fig. 9. Fig. 8 (a) represents the incoming radio wave which is part of a modulated radio telephone wave such as might be sent out from a broadcasting station. The individual cycles such as ABCD are the radio frequency cycles, while the cycle designated by the dotted line (which is really the modu-



Showing the Effect and Resultant Plate Current Produced by a Radio Frequency Wave Collected by a Receiving Set of the Vacuum Tube Type

lating frequency) is the audio frequency. Now let us see what occurs when this wave is impressed on the grid. When the upper or positive part of the cycle, namely ABC, is applied to the grid, the grid is charged with a positive potential. As a result there is a flow of electrons to the grid in accordance with the grid current characteristic of Fig. 1. These electrons accumulate on the grid, since the condenser  $C_g$  insulates the grid from the rest of the circuit; hence the electrons cannot flow off the grid. Consequently the net result of this flow of electrons to the grid is that the grid is left with a negative charge, as all electrons are negative. When the lower or negative half of the cycle, namely CDE, is applied, the grid has a

# A new battery charger, noiseless and indestructible

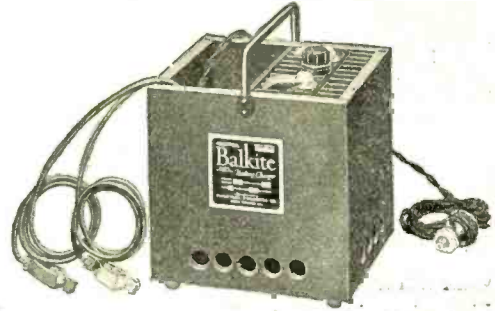

### FANSTEEL BALKITE

is a new metal developed for this charger. It acts as a valve, allowing alternating current to flow into the battery but not out of it. It is the most efficient charger valve made, is practically indestructible, and does away with noisy, delicate vibrators and fragile bulbs.

The Gould Battery Company is also marketing, under the Fansteel Balkite Patents, a complete battery and recharging unit known as the Gould Unipower, into which this charger, under the name, "The Fansteel Balkite Rectifier," has been incorporated.

The Fansteel Balkite Battery Charger for Radio "A" Batteries is an entirely new type of electrolytic rectifier, based on the use of Fansteel Balkite, a new and rare metal developed for this purpose. It does away with all noise, cannot deteriorate through use or disuse, has nothing to replace, adjust, or get out of order, cannot discharge or short circuit the battery, and requires no attention. There are no moving parts, bulbs, or fuses. It will not overcharge, and cannot fail to operate when connected to the battery and line current. It is unaffected by temperature or fluctuations in line current, and will charge a completely dead battery. It is simple, efficient, and indestructible except through abuse.

FANSTEEL  
**Balkite**  
PATENTS APPLIED FOR  
Battery Charger

The Fansteel Balkite Battery Charger will charge the ordinary 6 volt radio "A" battery at 3 amperes, and a 12 volt at 1 1/2 amperes, from 110 AC, 60 cycle current. It comes complete and ready for use. Get it from your dealer, or use the coupon below.

Price, \$18

FANSTEEL PRODUCTS CO., Inc., No. Chicago, Ill.

Dealers and Jobbers: The Fansteel Balkite Battery Charger does away with complaints and replacement troubles. Write for literature and discounts.

FANSTEEL PRODUCTS CO., North Chicago, Ill.

Enclosed please find \$18. Send me the Fansteel Balkite Battery Charger for Radio "A" Batteries. If I am not entirely satisfied I will return it and you will refund my money.

Name.....  
Street.....  
City..... State.....

(1A)

275  
475  
275  
\$10.25

## "B" BATTERIES

Depleted "B" Batteries are usually the cause of your troubles in receiving. Eliminate it. Buy your "B" Batteries direct from Manufacturer to Consumer. No old stock batteries, but fresh tested batteries, with a 100 per cent efficiency at 50 per cent less in price:—

	LARGE	MEDIUM	SMALL
22 1/2 Volt plain .....	\$1.25	\$1.00	\$0.70
22 1/2 Volt variable .....	\$1.38	\$1.13	\$0.75
45 Volt plain .....	\$2.50	\$1.75	—
45 Volt variable .....	\$2.75	\$2.00	—

Any other type of battery on order. Send Money Order or Order for C. O. D.

**ROSENDAL & CO., 4 Stone Street, New York**

# "ESCO" Battery Chargers

To meet an insistent demand for  
**RUGGED—**  
**RELIABLE**  
**NEVER FAILING**  
**MOTOR-**  
**GENERATORS.**

For charging Batteries in Wireless Operation. We have developed a complete line of **MANY SIZES.** With or without panel boards. **ESCO** quality thruout. You know what that means.

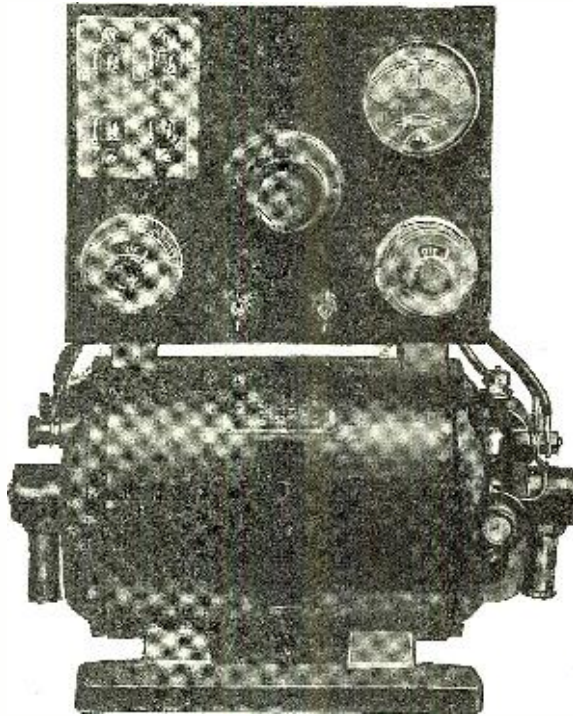

Ask for Bulletin 242

## ELECTRIC SPECIALTY CO.

211 South Street  
**STAMFORD, CONN., U. S. A.**  
 Pioneers in Developing Quality Wireless Apparatus

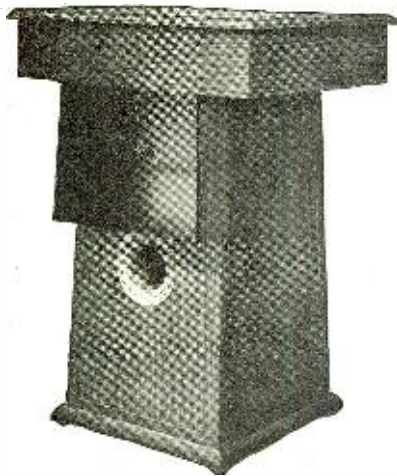

PATENT PENDING

## THE FAVORITE

A perfected radio cabinet. A powerful generator of radio waves. Eliminates static and danger from lightning. No loop, no aerial, no ground or other attachments necessary, has good range, provides for sharp selective tuning, operates any good hook-up and any vacuum tube. Carries and conceals all batteries and equipment and is a beautiful piece of household furniture.

*Write for descriptive matter and prices.*

MANUFACTURED BY

### G. A. BARTHOLOMEW

409 Guardian Building

Cleveland, Ohio

*(Will lease shop rights to other manufacturers)*

## EISEMANN

**RADIO UNITS**  
 Made to the highest electrical and mechanical standards.  
**EISEMANN MAGNETO CORP'N**  
 Chicago BROOKLYN, N.Y. Detroit

## ENGRAVING MACHINES

For  
**RADIO PANELS**  
 And Other Radio Engraving

**ENGRAVERS & PRINTERS MACHINERY CO.**  
 Sag Harbor, N. Y.

negative potential impressed on it, and this negative potential simply prevents any more electrons from filament flowing to the grid. As the electrons which are already lodged on the grid cannot leak off in any way, the ultimate result of the first cycle of radio voltage applied to the grid is that the grid is left with a certain negative charge. When the next positive half-cycle of the wave is applied to the grid, there is again a flow of current from filament to grid which electrons are again lodged on the grid and prevented from escaping, due to the fact that the grid is insulated by means of condenser  $C_g$ .

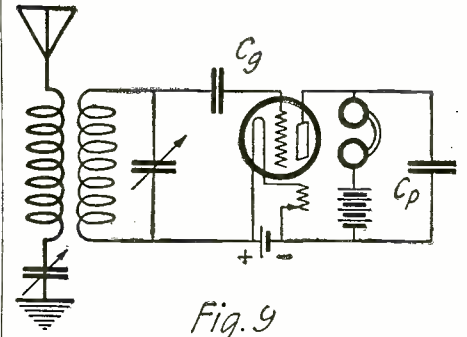

The Grid Condenser  $C_g$  Insulates the Grid from the Rest of the Circuit.

This results in the negative charge on the grid increasing. When the next negative half-cycle of the radio wave is applied to the grid it prevents further flow of electrons from filament to grid, but the negative electrons already on the grid cannot leak off. This process increases until the negative charge on the grid increases to a high value. Now if nothing is done to reduce this negative charge on the grid, the plate current will decrease to extremely low values, as seen from the characteristic curve of Fig. 1, which shows that for high values of negative grid voltage the plate currents are low or zero. This would result in making the detector tube inoperative, which is contrary to our aim.

Suppose now that we connect across the grid condenser  $C_g$  a high resistance  $R_g$  as in Fig. 7. It will immediately be seen by the reader that the negative electrons which are lodged on the grid by the previous process now have an opportunity to leak off by way of this high resistance, or leak, flowing to the filament. The lower the resistance of this leak the shorter time will it take for this negative charge to leak off. If it is made too low this negative charge may leak off in the time it takes to complete one radio frequency cycle, in which case the grid will always be at the same potential. However, if the resistance is made sufficiently high it will take a longer time for the negative charge on the grid to leak off. By selecting the proper value for the grid leak we can so arrange it that the grid negative charge leaks off in the time in which it takes to complete one audio frequency cycle, as shown in Fig. 8 (b). Due to the effect of the electrons flowing to the grid the negative charge on the grid increases as shown by the curve  $A^1B^1$ . At  $B^1$  the grid is already charged to its maximum negative potential. However, when this potential has been reached the charge begins to leak off by way of the leak resistance  $R_g$  and when the end of the audio cycle is reached, the entire negative charge has leaked off and the grid is again at its original potential.

The above entire process repeats itself all over with the succeeding radio waves. When the grid voltage varies, as shown in Fig. 8 (b), the plate current likewise varies, since according to the plate current characteristic the plate current follows the grid variations. As a result, Fig. 8

(c) shows that the plate current likewise decreases as the grid voltage increases, and as the leak begins to work the plate current rises again to its original value. However, the telephones do not follow the radio frequency variations of the plate current for reasons given at the beginning of the article, but it does follow the mean audio variations in current as shown in Fig. 8 (d). Hence the telephones will respond to this change in current and signal will be recorded. In fact, it is shown by oscillographs that the plate current varies in both a radio frequency manner as in Fig. 8 (c) and in audio frequency manner as in 8 (d). Since the telephones only respond to the audio frequency component arrangements are made whereby the radio frequency current is prevented from flowing through the telephones. This is accomplished by the use of the stopping condenser  $C_p$  across the phones, which offers a low reactance to the radio frequency current and thus by-passes it.

Experiment shows that best results are secured when the grid is given an initial positive charge, contrary to the plate rectification method which requires a negative charge. This initial positive charge on the grid serves, as it were, to start the electrons flowing to the grid. The positive charge is generally secured by connecting the grid leads to the positive terminal of the filament battery as in Fig. 7.

The reason that this particular method of detection is so extremely efficient and sensitive is that the amplifying properties of the tube are brought into play. Thus from Fig. 1 we see that for small positive voltages on the grid, where it is usually worked, as at point A, for best detection, the plate currents used are on the straight-line portion of the plate curve. Thus very small changes in grid voltage produce the maximum change in the plate current, resulting in high sensitivity.

Now both of the above methods apply to such radio waves as are sent out by spark or modulated telegraph stations, or the broadcasting stations. For waves which are not modulated by speech or are not interrupted at audible frequencies these means of detection will not apply. For continuous waves other methods must be used, which methods are very important in the radio art. These methods will be described in the next article on detection.

### Results of the Radio Shower Party

(Continued from page 163)

- 48th P. Chevalier, 391 Rock Rd., Glen Rock, N. J.
- 49th M. Clarke, 174 25th St., Elmhurst, L. I., N. Y.
- 50th H. P. Ward, Leonia, N. J.
- 51st C. P. Miller, 1790 Clinton Ave., The Bronx, New York City.
- 52nd R. E. Carpenter, Jr., Park Hotel, Plainfield, N. J.
- 53rd J. C. Weir, 107 N. 3rd St., Newark, N. J.
- 54th E. M. Harman, 93 Lyceum St., Geneva, N. Y.
- 55th F. S. Bryant, 427 W. 256th St., New York City.
- 56th A. Brooke, 21 Faneuil Pl., New Rochelle, N. Y.
- 57th M. Nelson, 1224 74th St., Brooklyn, N. Y.
- 58th D. D. FitzGerald, Fairhaven, N. J.
- 59th Henry K. Hamje, 252 N. Centre St., Orange, N. J.
- 60th D. V. Ashley, 16 Riverside Dr., Binghamton, N. Y.
- 61st F. Meess, Oakhurst, N. J.
- 62nd J. C. Karnes, 1418 Longiellow St., N.W., Washington, D. C.
- 63rd J. R. Lauffer, 203 8th Ave., Brooklyn, N. Y.
- 64th W. Michaels, Room 101, 155 Main St., W., Rochester, N. Y.
- 65th T. H. Becker, 224 Broad St., Newark, N. J.
- 66th W. Lamont, Wawarsing, N. Y.
- 67th H. G. Kerstin, 665 E. 39th St., Brooklyn, N. Y.
- 68th J. Himovitch, 3317 Snyder Ave., Brooklyn, N. Y.
- 69th R. Thompson, Hunt, N. Y.

# RADIOGEM

## The Dollar Radio Receiving Set

The Simplest Radio Outfit Made  
—Yet as Practical as the Most Expensive!

You need know absolutely nothing about wireless to operate and enjoy the RADIOGEM. It is so sturdy, so simply constructed that it is small wonder radio engineers who have tested it have pronounced the RADIOGEM a brilliant achievement. The RADIOGEM is a crystal radio receiving set for everyone at a price anyone can afford.

**Why The RADIOGEM Can Be Sold For Only \$1**

Here's the secret: The RADIOGEM Construction eliminates all unnecessary trimmings, cabinets and the like, which do not play any part in the operation of a set. You receive the RADIOGEM unassembled, together with a clearly written instruction book, which shows you how to quickly and easily construct the set, using only your hands and a scissor. The outfit comprises all the necessary wire, contact points, detector mineral, tube on which to wind the coil, etc., etc. The instruction book explains simply and completely the principles of radio and its graphic illustrations make the assembling of the RADIOGEM real fun. Remember the RADIOGEM is a proven, practical radio receiving set and will do anything the most expensive crystal set will do.

**The RADIOGEM is the Prize Winner of the Age**

Out of hundreds of radio models submitted recently in a great nation-wide contest, radio engineers, the judges, unanimously chose the RADIOGEM as the winner—the simplest radio-receiving set made! And the RADIOGEM costs you nothing to operate; no form of local electricity is required.

Sent Postage Prepaid on receipt of \$1—stamps, money-order or check.

**Order Your Radiogem To-day—**  
or send for Free Descriptive Circular

# DEALERS

The RADIOGEM is the wonder item of the radio age. It is storming the country, for the RADIOGEM'S price is so low everyone is able to buy one. Write immediately for full particulars before that shop across the street beats you to it.



Hear the programs of the Broadcasting Stations on the RADIOGEM



**\$1** without PHONE or AERIAL  
(Patent Pending)

### What They Say About RADIOGEM

I am enclosing herewith \$1.00 to pay for the Radiogem. I had it carefully wound by our wireless operator and find that it works beautifully—fully as good as any crystal set we know of.

Radiogem received, which we assembled and were very much astonished at results obtained and the clearness and volume of tone produced.

The greatest distances I heard on one of your sets is 1000 miles, having heard WGY at Schenectady, N. Y. I think your set is the best I have ever sold at any price.

On an aerial 150 feet long and 20 high one of my customers has heard WOC and WBB, KSD, WMC on one of your sets using a Peerless headset.

Herewith P.O.M.O. amt. \$1.00 for another "RADIOGEM." The one received is O.K. Placed about 15 ft. of picture cord under front porch and grounded to a gas meter, and heard the Sacramento Bee and Sacramento Broadcasting Union much better than with my large crystal set.

Your RADIOGEM RECEIVER is a wonder. I have received every station in Philadelphia with it much louder than with a high-priced crystal set.

Your two Radiogem sets received last night, and one was wired up for testing. WOC is about 40 miles away, and their signals could be heard with headphones on table. After they quit KYW at Chicago about 170 miles east was heard. Every word could be plainly heard here. WMC at Memphis, Tenn., could also be easily heard and understood.

We find that this set does a great deal more than you claim for it. We took WEAF on our audion set last night; this being the Baltimore American Broadcasting station, and then cut in the Radiogem and got excellent results. After the Baltimore concert was over, we continued to use the audion set and about ten o'clock were listening to WEAF—New York—and a little later we disconnected the audion set entirely and hooked up the Radiogem, very clearly hearing both piano music and announcement of name of station and its location.

You claim a radius of 20 miles over your "Radiogem" is sometimes a possibility. You should adhere to the truth. I constructed one for my mother, installed it with an aerial, and she listens not once in a while, but at her will, to Schenectady, Newark, New York, or Providence, R. I., and her home is Attleboro, Mass. I can't give your set too much praise.

(Names and Addresses on Request)

Those Broken and Burned-Out  
**VACUUM TUBES**  
Can Be Repaired

and Guaranteed Too!  
If your dealer does not know, send direct to us.  
W.D. not accepted for repairs

**Harvard Radio Laboratories**  
P. O. Box 1781  
BOSTON, MASS. 9  
Tubes returned P.P., C.O.D.

**WOC--TRESKO**  
Licensed Armstrong U. S. Patent  
No. 1113149

Two things that made Davenport famous. A complete 2000 mile Armstrong regenerative tuner for \$25.00. Use it with any make bulb W.D. 11 or 12, or dry battery operation as well as storage battery. Portable set to use at camp or in your machine. Complete with bulb, batteries and phones, etc., \$37.50. Circulars free. This set received the Chicago American Regional Prize of \$350.00.

**TRESKO**  
Tri City Radio Elec. Supply Co.  
Box 148 Davenport, Iowa

# "CLEAR TONE"

A Highly Efficient Four Tube Unit

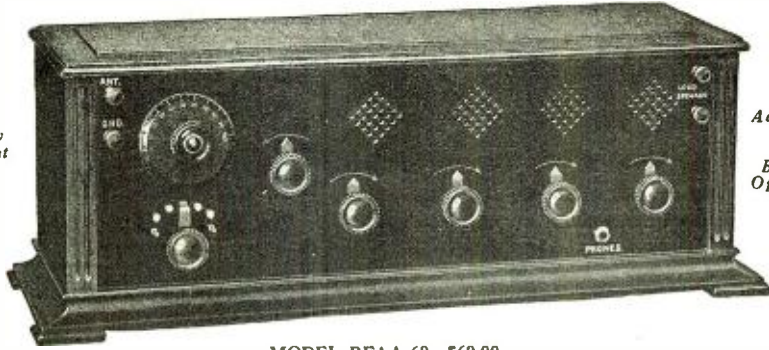

Adaptable For Dry Battery Operation

MODEL RFAA-60—\$60.00  
(Not including accessories)

## "From Afar"—"Wherever You Are"

Whether camping, boating or touring you can while away the balmy summer evenings with Music, Entertainment, the "news of the day"—all faithfully reproduced by the "CLEAR-TONE" Model 60.

Operating on ordinary dry batteries, in connection with the famous O.T. Silvertone tubes, the necessity for a storage battery is eliminated, and the vacationist will find the "CLEAR-TONE" Model 60, the ideal all-round receiver.

See one at your dealers, or write direct for literature.  
(Jobbers—Certain territory still available)

### THE CLEAR-TONE RADIO COMPANY

MCMILLAN and ESSEX PLACE

CINCINNATI, OHIO

TWO MILES OF WIRE IN THESE LITTLE

## "ALL-AMERICAN" Amplifying Transformers

Just think! 11,000 feet of No. 40 gauge enameled magnet wire are used in every type of "All-American" Audio Frequency Transformer.



"All-American" Transformers have also a very large iron core, made up of hundreds of high silicon lamination; and both winding and core are effectively insulated by the vacuum process.  
"All-American" Radio and Audio Frequency Transformers will INCREASE YOUR SUMMER RANGE. Use with Reflex, Neutrodyne, Cockaday or any of the reliable circuits.

**AUDIO FREQUENCY TRANSFORMERS AMPLIFY** detected signals many-fold, permitting loudspeaker reception where otherwise only headphones would be audible.

Type R-12 (Ratio 3 to 1) \$4.50      Type R-21 (Ratio 5 to 1) \$4.75  
Type R-13 (Ratio 10 to 1) \$4.75

**RADIO FREQUENCY (Type R-10)** has a non-magnetic core permitting it to be tuned accurately in a Neutrodyne circuit. Also adapted to all other circuits. Will bring distant signals to your detector through either a loop or outdoor aerial. Fits into any standard tube socket. Type R-10 (150 to 550 meters) \$4.50.

Ask your dealer for FREE "All-American" Hand Book of Radio Hookups. If he cannot supply you, send two cent stamp for postage and name of your dealer.

**RAULAND MFG. Co.**  
200 No. Jefferson St., Chicago, Ill.



## Two "Little Wonder" Radio Books

Every Radio Fan Should Have

How to Make Wireless Receiving Apparatus



The 20 radio constructors who wrote the book know how articles should be made from simple materials.

Only modern apparatus is described, such as Receiving set without aerial or ground, magnetic detector, wireless relay, wireless lecture set, etc., etc. Book has 100 pages, each 5 x 7 inches, 90 illustrations, many full pages, paper bound, in two colors.

Price 35 Cents

Either of these books sent to any address postpaid upon receipt of price.

Dealers Write for Wholesale Discounts.

How to Make Wireless Sending Apparatus



Contains information on how to make 30 different pieces of wireless sending apparatus from materials, easily obtained.

Tells How to Make an Experimental Arc Set, Speaking Arc, Quenched Gap, 1/4 K. W. Transformer, Oscillation Transformer, Photo Phone, etc., etc.

Book has 100 pages (size, 7 x 5 inches), 88 illustrations, paper cover printed in two colors.

Price 35 Cents

EXPERIMENTER PUBLISHING CO., 53 Park Place, N. Y. City

- 70th J. T. Lansing, 11 Grove Terrace, Montclair, N. J.
- 71st M. G. Johnston, U. S. Marine Hospital, Stapleton, S. I., N. Y.
- 72nd C. E. Jacquart, 222 Main St., South River, N. J.
- 73rd H. E. Smith, 20 Newman St., Hackensack, N. J.
- 74th G. N. Garrison, 2AWM, East Orange, N. J.
- 75th C. Turner, 1346 73rd St., Brooklyn, N. Y.
- 76th H. Grah, 885 Cauldwell Ave., New York City.
- 77th H. Straat, 294 Crescent St., Brooklyn, N. Y.
- 78th J. J. Yela, Jr., Nyack P. O., Nyack, N. Y.
- 79th W. Thorne, 101 Holder Hall, Princeton, N. J.
- 80th H. Aiken, 50 W. 112th St., New York City.
- 81st W. F. Rue, 36 Laurel Ave., Trenton, N. J.
- 82nd F. Donnelly, 605 Marshall St., Elizabeth, N. J.
- 83rd I. Meyer, 880 W. 180th St., New York City.
- 84th E. J. Holligan, 457 Broadway, Westwood, N. J.
- 85th H. H. Kingston, Jr., Room 101, B. R. & P. Ry. Bldg., 155 Main St., W., Rochester, N. Y.
- 86th H. Glover, Ridgewood Rd., Milburn, N. J.
- 87th I. Grumbine, 137 Highland Ave., Jersey City, N. J.
- 88th J. M. Gregory, Morristown, N. Y.
- 89th D. H. Smith, 74 Freeman Ave., East Orange, N. J.
- 90th Franklin O'Hara, Lowville, N. Y.
- 91st P. Rafferty, Jr., 119 Hobart Ave., Summit, N. J.
- 92nd H. H. Manville, 8419 115th St., Richmond Hill, N. Y.
- 93rd R. F. Beers, 1477 Brooklyn Ave., Brooklyn, N. Y.
- 94th J. D. Ivers, 878 Tiffany St., New York City.
- 95th R. F. Gurney, Huntington Station, Suffolk Co., L. I., N. Y.
- 96th W. H. Stewart, 717 9th Ave., New York City.
- 97th J. C. Gabriel, 126 Lefferts Rd., Yonkers, N. Y.
- 98th J. Eddy, 226 Temple St., Fredonia, N. Y.
- 99th H. Malatsky, 55 Bergen St., Brooklyn, N. Y.
- 100th J. F. Bull, 64a W. 13th St., Bayonne, N. J.
- 101st M. H. Merritt, Westmoreland, N. Y.
- 102nd C. Matthews, Rockaway, Morris Co., N. J.
- 103rd W. Merrill, 317 Mountain Rd., West Hoboken, N. J.
- 104th A. Suiffen, 30 Summer St., Port Chester, N. Y.
- 105th S. S. Kennedy, 1312 Connecticut Ave., Washington, D. C.
- 106th R. K. Mosier, 55 Fifth St., Mamaroneck, N. Y.
- 107th C. L. Jaeger, P. O. Box 43, Suffern, N. Y.
- 108th H. A. Yoc, 55 Sherwood Ave., Ossining, N. Y.
- 109th I. Morgan, 48 E. 76th St., New York City.
- 110th R. H. Thomas, 87 Sicard St., New Brunswick, N. J.
- 111th E. V. Edwards, 1300 North Ave., New Rochelle, N. Y.
- 112th H. S. Miller, 1335 15th St., N.W., Washington, D. C.
- 113th J. F. L. Bruen, Leonia, N. J.
- 114th A. J. Macer, Jr., Westfield, N. Y.
- 115th B. C. Fischer, 525 Elizabeth Ave., Elizabeth, N. J.
- 116th A. J. Macer, 32 Bank St., Westfield, N. Y.
- 117th Mrs. M. K. Bloomfield, 140 Brunswick St., Newark, N. J.
- 118th M. Andersen, 1103 Washington St., Hoboken, N. J.
- 119th S. D. Stedman, 186 Bedford Ave., Rutherford, N. J.
- 120th M. L. Bruckner, 229 Norwood Ave., Brooklyn, N. Y.
- 121st H. Kaye, 8736 115th St., Richmond Hill, N. Y.
- 122nd J. D. Armstrong, care Rutgers College and The State University of New Jersey, Military Dept., New Brunswick, N. J.
- 123rd F. W. Forrest, Ridgewood, N. J.
- 124th A. B. Dime, 306 Kissend Blvd., Flushing, N. Y.
- 125th Eastern Film Finishing Co., Avon-by-the-Sea, N. J.
- 126th J. G. Massey, Apt. 2, The New Berne, Mass. Ave. and 126th St., N.W., Washington, D. C.
- 127th J. P. Christianson, Am. Car & Foundry Co., 165 Broadway, New York City.
- 128th W. J. Eck, 47 Adams St., N.W., Washington, D. C.
- 129th E. Peterson, 18 Grove Pl., East Orange, N. J.
- 130th T. Heatley, 792 Fairmount Pl., The Bronx, New York City.
- 131st P. B. Reed, Jr., 46 Belevue Ave., Ossining, N. Y.
- 132nd P. M. O'Neill, 33 W. Hayes Ave., Corona, L. I., N. Y.
- 133rd L. S. Haskins, Glenham, Dutchess Co., N. Y.
- 134th E. Herlin, 36 Verandah Pl., Brooklyn, N. Y.
- 135th W. D. Seppali, 4120 Eighth Ave., Brooklyn, N. Y.
- 136th R. M. Rohrbach, Sea Cliff, N. Y.
- 137th A. Abelson, 1808 Pitkin Ave., Brooklyn, N. Y.
- 138th W. G. Wortham, 17 W. Hazelwood Ave., Rahway, N. J.
- 139th George Schaub, 1561 Ave. A, New York City.
- 140th R. W. Williams, R.F.D. No. 2, Plainfield, N. J.

- 141st G. Bender, 145 Hutton St., Jersey City, N. J.
- 142nd F. W. Dunn, 417 Park Ave., East Orange, N. J.
- 143rd Louis Gancher, 67 W. 94th St., New York City.
- 144th Mrs. M. A. B. Sweeney, 1459 E. 59th St., Brooklyn, N. Y.
- 145th L. E. Herzog, 505 Fifth Ave., New York City.
- 146th A. Kahn, 337 3rd St., Union Hill, N. J.
- 147th T. G. Edwards, B. C. Stage, Watertown, N. Y.
- 148th G. W. Heghinian, 265 Dahill Rd., Brooklyn, N. Y.
- 149th C. R. Davison, 807 9th Ave., Belmar, N. J.
- 150th Dr. Al. R. Curtis, 88 Woodward Ave., Rutherford, N. J.
- 151st A. Johnson, 53 Campbell Ave., Belleville, N. J.
- 152nd W. G. Gutmueller, 1068 Carroll St., Brooklyn, N. Y.
- 153rd A. M. Chase, 736 Ackerman Ave., Syracuse, N. Y.
- 154th C. V. Weiler, 136 Main St., Flemington, N. J.
- 155th G. A. Melton, 122 Jackson Ave., Mineola, N. Y.
- 156th J. W. Armstrong, Cuylerville, N. Y.
- 157th F. J. Henmann, Stapleton, S. I., N. Y.
- 158th M. Bellone, 471 Gravesend Ave., Brooklyn, N. Y.
- 159th H. von Kleist, 184 Riverdale Ave., Yonkers, N. Y.
- 160th G. L. Lang, E3 Monmouth St., Red Bank, N. J.
- 161st E. Walter, 51 N. Delancy Pl., Atlantic City, N. J.
- 162nd A. P. Danz, 56 Myrtle Blvd., Larchmont, N. Y.
- 163rd H. Gesswein, 221 Sherman Ave., Roselle Park, N. J.
- 164th M. W. Brink, 571 Rutherford Ave., Trenton, N. J.
- 165th E. H. Tait, 154 Sherman Ave., Trenton, N. J.
- 166th L. R. Ferguson, Chief Chemist, Genesee Pure Food Co., Le Roy, N. Y.
- 167th E. E. Fardlon, 46 Treno St., New Rochelle, N. Y.
- 168th Donald Baker, 219 River St., Salamanca, N. Y.
- 169th W. G. Patterson, Glen Gardner, N. J.
- 170th S. Efron, 506 W. 147th St., New York City.
- 171st L. Rosenberger, 129 W. 98th St., New York City.
- 172nd G. H. McNeill, 3427 34th Pl., N.W., Washington, D. C.
- 173rd F. F. Quimby, 410 Lincoln Ave., Avon-by-the-Sea, N. J.
- 174th G. V. Hanley, Room 910, 165 Broadway, New York City.
- 175th Harry M. Valentine, 18th St. and 7th Ave., Whitestone, L. I., N. Y.
- 176th H. O. Jennings, City Island, N. Y.
- 177th R. G. Guyer, 861 Carroll St., Brooklyn, N. Y.
- 178th E. Seaven, The Mapewood Apts., Hempstead, N. Y.
- 179th A. J. Gardner, 42 Mercer St., Newark, N. J.
- 180th J. F. Brown, Wellsville, N. Y.
- 181st C. E. Wilson, 37 Forest Ave., Caldwell, N. J.
- 182nd F. Merker, Wellsville, N. Y.
- 183rd H. Huttmeier, Box 246, Walkkill, N. Y.
- 184th H. West, R.F.D. No. 1, Wellsville, N. Y.
- 185th W. Arnott, Jr., Greenport, N. Y.
- 186th D. S. Hemphill, 1341 Pugsley Ave., Westchester, The Bronx, New York City.
- 187th D. J. Reid, 97 Unger Ave., Buffalo, N. Y.
- 188th E. Smith, Modena, Ulster Co., N. Y.
- 189th S. S. Marsh, Jr., Midwood Terrace, Madison, N. J.
- 190th R. P. Langer, P. O. Box 189, Pearl River, Rockland Co., N. Y.
- 191st C. D. Mitchell, 216 Berkeley Ave., Bloomfield, N. J.
- 192nd F. E. Field, 281 E. Main St., Somerville, N. J.
- 193rd R. Cohn, 8518 105th St., Richmond Hill, N. Y.
- 194th R. Lehmann, 816 Rose St., West Hoboken, N. J.
- 195th T. D. DeVore, 140 Furman St., Syracuse, N. Y.
- 196th J. T. Livingston, 477 E. Main St., Somerville, N. J.
- 197th W. A. Seger, Ardsley, N. Y.
- 198th W. H. Bohlke, 15 Home St., Metuchen, N. J.
- 199th F. Nichols, care Nichols Hotel, 52 E. Main St., Patchogue, N. Y.
- 200th C. C. Schmehl, 983 Jennings St., The Bronx, New York City.
- 201st F. W. Paepke, 139 40th St., Corona, N. Y.
- 202nd H. S. Meighan, 92 Prospect Ave., Mamaroneck, N. Y.
- 203rd J. Frank, Jr., 61 Woodmere Blvd., Woodmere, N. Y.
- 204th E. J. Simmons, 2354 Webber Ave., New York City.
- 205th C. Atkinson, Pointville, N. J.
- 206th J. J. Burns, Jr., 327 Beekman Ave., The Bronx, New York City.
- 207th G. A. Nellis, 37 Burchard Ave., East Orange, N. J.
- 208th S. S. Gulick, 73 W. Kinney St., Newark, N. J.
- 209th T. Phillips, 26 Montgomery Ave., Tompkinsville, S. I., N. Y.
- 210th C. J. Hubbs, 474 Decatur St., Brooklyn, N. Y.

# For Distance-Power-Tone Quality

## Tie to "Michigan" Radio Receivers

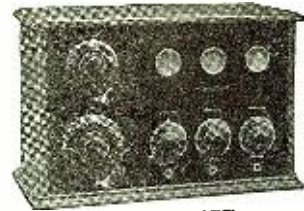

"SENIOR" SET

The nightly long-distance triumphs of owners of "Michigan" Receivers bring us a grist of letters every day.

"Wonderful," they say. "Surpass any instruments in town for distance and clearness. Simply marvelous the way your Split Hair Vernier Dial Adjuster enables me to control the tuning. Wish I had known of Michigan Sets before. Would have saved me a lot of fussing."

## "Michigan" Regenerative Receivers The Last Word in Long-distance Radio Reception



"JUNIOR" SET

They are licensed under Armstrong's U. S. Patent No. 1,113,149 and pending letters patent No. 807,388. These patents cover *Regeneration*, the soul of radio and the only means to clear, long distance reception.

**Metal Panel** eliminating body capacity effects. It is easily removable—a great convenience.

**Patented "Michigan" Split Hair Vernier Dial Adjuster** permits a fineness and accuracy of tuning that can be secured in no other way.

**Michigan "Senior" Receiver—Detector Regenerative Receiving Set**, with two stages of amplification. For Loud-speaker or Headphone reception. Covers the whole country, from coast to coast. Price without accessories or tubes, \$125.00.

**Michigan "Junior" Tuner-Detector Regenerative Receiving Set**, without amplification. For headphone reception only. Price without accessories or tubes, \$57.50.

Also ask about the "Michigan" Two Stage Amplifier and our exclusive line of Condensers, Variocouplers, Variometers, Rheostats, etc. When you send for circular, give us the name of your favorite Radio dealer.

## MICHIGAN RADIO CORPORATION

GRAND RAPIDS, MICHIGAN

### RADIO Catalogue

# FREE!



One copy of this complete Catalogue of Radio outfits, parts, dictionary of Radio terms and instructions—one copy is yours FREE.

It quotes the lowest prices, amazingly low prices, on everything for the expert and the amateur. Every improved part, the most up-to-date outfits, everything that is needed—at the lowest possible prices. Send for your copy of this FREE Radio Catalogue. Address Department No. 2-R.

MONTGOMERY WARD & CO.

Chicago      Kansas City      St. Paul  
Portland, Ore.      Ft. Worth

# FREE

## RADIO CATALOG

of Standard Quality Parts  
AT REDUCED PRICES

*Our Guarantee Protects You*

Write for our Catalog No. 100

### GREAT LAKES RADIO CO.

136 W. LAKE STREET, CHICAGO, ILL.

WANTED—Back numbers of Radio News, Dec., 1921, Jan. and Feb., 1922. Experimenter Publishing Co., 53 Park Place, New York City.

**RADIO SE-AR-DE PRODUCTS**

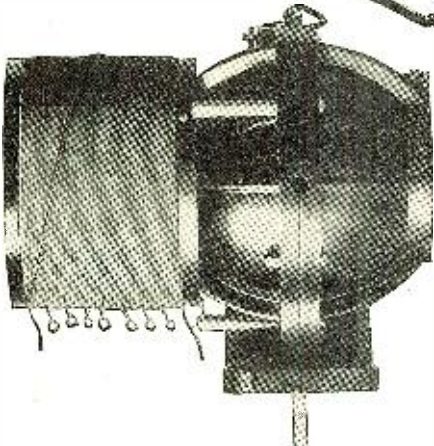

**SE-AR-DE Molded RADIOMETER**

*Build Your Own Single Circuit Tuner*

CATALOGUE No. 165

**\$13.00**

Range . . . . . 180—3100M  
" . . . . . 300—3280M

**R. MITCHELL & CO.**  
255 ATLANTIC AVENUE BOSTON, MASS.

- 211th W. H. Stewart, 717 9th Ave., New York City.
- 212th J. A. Boland, cor. Warren & Osborne Sts., Keyport, N. J.
- 213th R. B. Conner, 3700 Connecticut Ave., N.W., Washington, D. C.
- 214th W. C. Whitford, 11 Preston Ave., Hornell, N. Y.
- 215th W. C. Cooke, 950 St. Mark's Ave., Brooklyn, N. Y.
- 216th P. G. Weiller, 50 Lenox Ave., East Orange, N. J.
- 217th W. C. Graham, 150 Orchard St., Newark, N. J.
- 218th E. J. Beutell, Rahway, N. J.
- 219th J. Le Hilobreth, 8 Ave. B, Bayonne, N. J.
- 220th A. Klemm, 340 Goodwin Ave., Wortendyke, N. J.
- 221st M. Steiner, 225 Church St., So. Amboy, N. J.
- 222nd W. J. Sweeney, 1459 E. 9th St., Brooklyn, N. Y.
- 223rd B. Beri, 338 E. 106th St., New York City.
- 224th B. P. Reynolds, Leicester, N. Y.
- 225th A. D. Mowery, 330 Mountain Ave., Westfield, N. J.
- 226th J. E. Brady, Jr., 73 Ave. B, Bayonne, N. J.
- 227th W. B. Gurney, Huntington, L. I., N. Y.
- 228th E. V. Molkus, 2413 Madison St., Brooklyn, N. Y.
- 229th Miss K. M. Macken, 65 E. Bayard St., Seneca Falls, N. Y.
- 230th L. Berkowitz, 783 Beck St., The Bronx, New York City.
- 231st R. Bennett, Oakhurst, N. J.
- 232nd S. H. Alexander, Tenafly Rd., Englewood, N. J.
- 233rd R. F. Comegys, 60 Main St., Mt. Holly, N. J.
- 234th R. Leib, 766 Grote St., The Bronx, New York City.
- 235th R. Walsh, Oradell, N. J.
- 236th L. A. Phillips, George St., Tenafly, N. J.
- 237th T. R. Goldsborough, Asst., Exr., Div. 16 (Radio), U. S. Patent Office, Washington, D. C.
- 238th C. A. Pearson, North Arlington, N. J.
- 239th D. M. Miers, 126 Jefferson Ave., Hasbrouck Heights, N. J.
- 240th J. D. Jacobus, Birstown, N. J.
- 241st R. Smith, 331 South 1st Ave., Mount Vernon, N. Y.
- 242nd G. Cowan, 522 E. 19th St., Brooklyn, N. Y.
- 243rd W. B. Sullivan, 228 Roseland Ave., Essex Falls, N. J.
- 244th G. A. Johnston, 954 67th St., Brooklyn, N. Y.
- 245th R. L. Horn, 102 E. Pearl St., Burlington, N. J.
- 246th H. W. Paullin, 165 Main St., Hackettstown, N. J.
- 247th W. M. Pickslay, 349 Seneca Ave., Mt. Vernon, N. Y.
- 248th R. W. Erickson, 114 Bartholdi Ave., Jersey City, N. J.
- 249th P. C. Donovan, care Naval Air Station, Lakehurst, N. J.
- 250th C. R. Langmuir, Hudson Ave., Englewood, N. J.
- 251st I. Cumming, 558 Argyle Ave., Orange, N. J.
- 252nd S. Rodger, 102 Franklin St., Ogdensburg, N. Y.
- 253rd E. Blackburn, 22 Hawthorne Pl., Summit, N. J.
- 254th J. Muehlke, 521 Tuckahoe Rd., Tuckahoe, N. Y.
- 255th H. Shattuck, R.F.D. No. 1, Silver Springs, N. Y.
- 256th A. De Rosa, 354 E. 124th St., New York City.
- 257th F. J. Voeljel, 149 Fifth St., Weehawken P. O., N. J.
- 258th R. S. Coffin, 1422 E. 9th St., Brooklyn, N. Y.
- 259th W. J. Romani, 69 Vanderveer Ave., Woodhaven, L. I., N. Y.
- 260th W. H. Rankin, Prest. W. H. Rankin Co., 1 W. 37th St., New York City.
- 261st O. Niedhardt, 8734 94th St., Woodhaven, L. I., N. Y.
- 262nd M. A. Hernandez, 12 W. 104th St., New York City.
- 263rd E. F. Sasher, 229 95th St., Brooklyn, N. Y.
- 264th F. C. Schwarz, 366 Union St., Brooklyn, N. Y.
- 265th R. Proddow, Jr., 226 Broad St., Red Bank, N. J.
- 266th G. H. Minnerly, 446 E. 176th St., New York City.
- 267th L. Schaefer, 28 Herman St., E. Rutherford, N. J.
- 268th C. E. Mason, care E. L. Mason & Son, Essex, N. Y.
- 269th J. Ilanso, 96 Hobart Ave., Summit, N. J.
- 270th W. S. Huffmire, 346 E. 28th St., Brooklyn, N. Y.
- 271st E. P. King, 572 8th Ave., Astoria, L. I., N. Y.
- 272nd H. N. Bowman, 825 W. 178th St., New York City.
- 273rd R. H. Baker, 8th and Elmer Sts., Vine-land, N. J.
- 274th E. H. Chase, care Oak Ridge Farm, R.F.D. No. 1, Edmeston, N. Y.
- 275th P. J. Wesley, 94 W. 46th St., Bayonne, N. J.
- 276th D. J. Galligan, 1443 Tea St., Washington, D. C.
- 277th H. C. Deuchler, 743 So. 12th St., Newark, N. J.
- 278th J. H. Colket, Jr., 44 Monroe Pl., Brook-lyn, N. Y.

**MIRACO GETS 'EM 1500 MILES AWAY!**



Users of MIRACO Radio Frequency Broadcast Receivers in either model shown report wonderful results. St. Louis hears Schenectady—Davenport hears Newark—Cincinnati hears San Francisco.

Reception is clear and distinct, tuning is very sharp and there is practically no interference.

MIRACO sets may be used with either 1½ Volt Dry Cell or 6 Volt Storage Battery.

Model M-W, 4 tube set—price \$54.50  
Model K, 2 tube set—price \$29.50.

Order your MIRACO set today, or send for NEW Bulletin.

**DEALERS — AGENTS — DISTRIBUTORS**  
*Write for our proposition TODAY.*



**The Midwest Radio Company,**  
804 Main Street : : : Cincinnati, Ohio



**Atlas AMPLITONE**  
LOUD SPEAKER

**Natural Re-PRODUCTION**

No blast or distortion. Its exclusive, patented feature,—the adjustable, double diaphragm,—produces the radio programs in their original naturalness. Tuneable to your set and receiving conditions

Let your ears be the judge. Hear the Atlas Amplitone at your dealer's. Write for interesting booklet.

*Letters from Users Requested*

**\$25.00** What have you accomplished with your Atlas Amplitone? Tell us about it.

**Multiple Electric Products Co., Inc.**  
Radio Division  
3 Orange Street, Newark, N. J.

**The Wonder Tube of the Age**



**MARGO Detector Vacuum TUBES**

**1 1/2 Volt \$1.00**

Socket 25c.

Operates on one dry cell either with or without B Battery. Wiring diagram FREE with each tube. 10c extra for parcel post insured. Send 10c for A B C of Radio; also our latest catalog—contains a list of the many special bargains we offer. Write for it.

**Modell's**  
ESTABLISHED 1898

191 Fulton Street Dept. 5  
New York City 5 New York Stores  
America's Greatest Radio Mail Order House





## Just What You Wanted And Nobody Had It For You

Because the furniture manufacturers have thus far failed to provide a really practical radio table we had to make one of our own to supply the urgent demand.

The "Signal" R-500 Radio Table is a beautiful piece of highly polished, mahogany-finished gumwood furniture; with brass-footed legs and inserted casters.



### It Holds All Batteries, Charger, Phones-- Everything You Want to Store Away

Height 30", top 20 x 36". Price, f.o.b. Menominee, \$22.00.  
Attractive discounts to Jobbers and their dealers.

**SIGNAL** Electric  
Mfg. Co.

Factory and General Offices:  
1912 Broadway, Menominee, Mich.

Atlanta, Boston, Chicago, Cleveland, Minneapolis, Montreal,  
New York, Pittsburgh, St. Louis, San Francisco, Toronto.  
You'll find our local address in your Telephone Directory.

# One Thousand Boys Wanted

**W**E want one thousand boys to sell subscriptions to RADIO NEWS, SCIENCE AND INVENTION and PRACTICAL ELECTRICS during their vacations. We will pay a generous commission for this work and help you in every way. Our three publications are leaders in their fields, ready sellers and this is an offer well worth your while. A few spare hours a day will bring you a handsome return. Write regarding our proposition at once and be the first one to get started in your vicinity.

## Experimenter Publishing Co.

HERBERT H. FOSTER, Sales Manager

53 Park Place

New York

- 346th R. J. Smith, Box 394, Morristown, N. J.
- 347th A. Peters, 846 E. 215th St., New York City.
- 348th H. Jacobson, 459 Claremont Parkway, New York City.
- 349th H. B. Simpson, 418 E. 23rd St., Brooklyn, N. Y.
- 350th J. A. Carpenter, 53 Morse Ave., Rutherford, N. J.
- 351st O. E. Putnam, 730 E. 182nd St., New York City.
- 352nd R. T. Barr, 1857 Nostrand Ave., Brooklyn, N. Y.
- 353rd R. Proctor, Jr., Foothill Ave., Holis, N. Y.
- 354th S. Clacke, 967 St. John's Pl., Brooklyn, N. Y.
- 355th R. Scott, Wayland, N. Y.
- 356th A. F. Herzog, Box 544, Centre Moriches, L. I., N. Y.
- 357th W. P. Muller, 141 Manhattan Ave., Jersey City, N. J.
- 358th R. H. Neill, 352 Berwyn Ave., Trenton, N. J.
- 359th P. Freeman, 37 Aubrey Rd., Upper Montclair, N. J.
- 360th W. Z. Baldwin, 205 Casino Ave., Cranford, N. J.
- 361st S. Greenberg, 110 W. 113th St., New York City.
- 362nd L. B. Smith, 160 Lewis St., Perth Amboy, N. J.
- 363rd D. Talbot, Park Ave., Wortendyke, N. J.
- 364th C. P. Bliss, Prof. of Mechanical Engineering, 2226 Loring Pl., New York City.
- 365th H. F. Graves, 25 Dayan St., Lowville, N. Y.
- 366th J. Chelnowski, 283 E. 17th St., Brooklyn, N. Y.
- 367th J. D. Moore, Jr., 1148 83rd St., Brooklyn, N. Y.
- 368th L. T. Schuberg, 117 Downs St., Kingston, N. Y.
- 369th B. Kreiger, 120-14 Newport Ave., Rockaway Park, N. Y.
- 370th E. W. Herold, 55 Kenmore Ave., Newark, N. J.
- 371st D. Thorn, 85 Druce Ave., Yonkers, N. Y.
- 372nd A. Braun, 220 Hooper St., Brooklyn, N. Y.
- 373rd A. H. Gfroer, 313 No. Park Ave., Buffalo, N. Y.
- 374th W. A. Putnam, Jr., 75 Willow St., Brooklyn, N. Y.
- 375th G. Huhby, 27 W. 68th St., New York City.
- 376th J. Cooke, 1810 Holland Ave., The Bronx, New York City.
- 377th R. H. Bogert, 90 Ella St., Bloomfield, N. J.
- 378th C. Haurand, 72 Fairview Ave., N. Plainfield, N. J.
- 379th D. Crampton, 189 Horton Ave., New Rochelle, N. Y.
- 380th J. Reitz, 23 Greeley Ave., Grant City, S. I., N. Y.
- 381st W. Miller, Jr., Belford, N. J.
- 382nd J. Ganchez, 72 Ridgefield Ave., Ridgefield Park, N. J.
- 383rd J. W. McCormack, 1095 Blvd. E., West New York, N. J.
- 384th R. D. Whitlock, Jr., R.F.D. No. 2, Asbury Park, N. J.
- 385th M. Pekarskey, 219 E. 10th St., New York City.
- 386th H. Wunderlich, Jr., 550 Jackson Ave., The Bronx, New York City.
- 387th C. Van Leer, Jr., 1858 Ontario Pl., Washington, D. C.
- 388th F. M. Middlesworth, 39 Emmet St., Newark, N. J.
- 389th S. A. McElroy, 1 Johnson Ave., Hackensack, N. J.
- 390th G. H. White, 1310 Sheppard St., Washington, D. C.
- 391st G. Smith, 61 Stryker Ave., Woodside, L. I., N. Y.
- 392nd R. Losey, 24 Kerrlyn Court, Elizabeth, N. J.
- 393rd R. D. Fribourg, 441 7th St., S.W., Washington, D. C.
- 394th C. Prindle, So. Highland Ave., South Nyack, N. Y.
- 395th L. L. Levy, 390 So. 5th St., Brooklyn, N. Y.
- 396th M. B. S. Jacobus, Blairstown, N. J.
- 397th W. M. Garrett, 156 Todd Pl., N.E., Washington, D. C.
- 398th G. G. Abruzzo, 61 Fulton Ave., Sta. J., Brooklyn, N. Y.
- 399th T. Schall, 222 Vandeventer Ave., Astoria, L. I., N. Y.
- 400th F. G. Clayton, 607 Emory St., Asbury Park, N. J.
- 401st W. J. Pusey, P. O. Box 262, Haskell, N. J.
- 402nd J. Powers, Jr., 27 Clinton Ave., Ossining, N. Y.
- 403rd A. E. Alemand, 242 Park Ave., Plainfield, N. J.
- 404th J. G. Le Gendre, Box 145, Katonah, N. Y.
- 405th N. E. Earle, 849 42nd St., Brooklyn, N. Y.
- 406th G. L. Koehler, 40 Superior Rd., Queens P. O., Bellerose, L. I., N. Y.
- 407th W. S. McKenney, 207 Donaldson Ave., Rutherford, N. J.
- 408th R. S. Burnap, 44 Lenox Ave., E. Orange, N. J.
- 409th F. Knobloch, 1040 E. 232d St., The Bronx, New York City.
- 410th E. Fowler, 199 Central Ave., Madison, N. J.
- 411th H. Boynton, 210 Franklin St., Merchantville, N. J.
- 412th W. A. Reichers, 116-13 95th Ave., Richmond Hill, N. Y.
- 413th R. F. Steel, Blackwood, N. J.
- 414th C. Wenz, 238 Junction Ave., Corona, L. I., N. Y.

- 415th F. Koch, Franklin Ave., Tenafly, N. J.
- 416th R. E. Mollberg, 1311 St. John's Pl., Brooklyn, N. Y.
- 417th T. L. Lawson, 34 Wilson Ave., Newark, N. J.
- 418th W. J. Mulcahy, 194 Norfolk St., Newark, N. J.
- 419th C. Peters, Port Chester, N. Y.
- 420th J. R. Barrett, Box 104, Port Monmouth, N. Y.
- 421st Mrs. M. McCarthy, 167 S. Elliott Pl., Brooklyn, N. Y.

**PRIZE LIST FOR THE SECOND ZONE**

1. 1 Reflex Regenerative Receiving Set—De Forest Tel. & Tel. Co., and 1 W. T. 501 Peanut Tube and Adapter—Radio Research Guild.
2. 1 R O R N Tuned Radio Frequency Amplifier Unit—A. H. Grebe & Co., Inc.
3. 1 R O R N Tuned Radio Frequency Amplifier Unit—A. H. Grebe & Co., Inc.
4. 1 RORN Tuned Radio Frequency Amplifier Unit—A. H. Grebe & Co., Inc.
5. 1 RORN Tuned Radio Frequency Amplifier Unit—A. H. Grebe & Co., Inc.
6. 1 RORN Tuned Radio Frequency Amplifier Unit—A. H. Grebe & Co., Inc.
7. 1 RORN Tuned Radio Frequency Amplifier Unit—A. H. Grebe & Co., Inc.
8. 1 D4 Single Circuit Regenerative Set—Radiocraft Co., Inc., and 1 W. T. 501 Peanut Tube and Adapter—Radio Research Guild.
9. 1 D412 Detector and Two Stage Amplifier—Acme Apparatus Co., and 1 W. T. 501 Peanut Tube and Adapter—Radio Research Guild.
10. 1 D412 Detector and Two Stage Amplifier—Acme Apparatus Co., and 1 W. T. 501 Peanut Tube and Adapter—Radio Research Guild.
11. 1 D412 Detector and Two Stage Amplifier—Acme Apparatus Co., and 1 W. T. 501 Peanut Tube and Adapter—Radio Research Guild.
12. 1 D412 Detector and Two Stage Amplifier—Acme Apparatus Co., and 1 W. T. 501 Peanut Tube and Adapter—Radio Research Guild.
13. 1 D412 Detector and Two Stage Amplifier—Acme Apparatus Co., and 1 W. T. 501 Peanut Tube and Adapter—Radio Research Guild.
14. 1 Type 215 General Two-Step Amplifier—General Radio Co., and 1 W. T. 501 Peanut Tube and Adapter—Radio Research Guild.
15. 1 Timmons Talker—J. S. Timmons Co., and 1 Carter Two-way Plug—Carter Radio Co.
16. 1 Kellogg Head Set, 1 Kellogg Variable Condenser, 1 Kellogg Variocoupler, 1 Kellogg Variometer, 1 Kellogg Rheostat, 1 Kellogg Socket, 1 Kellogg Plug, 3 Kellogg Jacks—Kellogg Switchboard & Supply Co.
17. 1 80-Ampere Willard All Rubber Radio "A" Battery—Willard Storage Battery Co.
18. 1 Crosley Model "V" Regenerative Receiver—Crosley Mfg. Co., and 1 W. T. 501 Peanut Tube and Adapter—Radio Research Guild.
19. 2 Rasla Radio Frequency Transformers and 2 Rasla Audio Frequency Transformers—Rasla Sales Corp., National Distributors for Radio Service Laboratories.
20. 2 Rasla Radio Frequency Transformers and 2 Rasla Audio Frequency Transformers—Rasla Sales Corp., National Distributors for Radio Service Laboratories.
21. 2 Rasla Radio Frequency Transformers and 2 Rasla Audio Frequency Transformers—Rasla Radio Corporation, National Distributors for Radio Service Laboratories.
22. 2 Rasla Radio Frequency Transformers and 2 Rasla Audio Frequency Transformers—Rasla Sales Corp., National Distributors for Radio Service Laboratories.
23. 2 Rasla Radio Frequency Transformers and 2 Rasla Audio Frequency Transformers—Rasla Sales Corp., National Distributors for Radio Service Laboratories.
24. 1 Fremont Tuner and Detector—Fremont Radio Sales Co., and 1 W. T. 501 Peanut Tube and Adapter—Radio Research Guild.
25. 1 Home Charger—Automatic Electrical Devices Co.
26. 1 Homecharger—Automatic Electric Devices Co.
27. 1 6-Volt 110 A. H. Marko Storage Battery—Marko Storage Battery Co.
28. 1 Certified Radiotrician Course—National Radio Institute.
29. 1 Warren Radio Loop Type 2537, V-De-Co.—Radio Mfg. Co.
30. 1 A & B Battery Charger—Valley Electrical.
31. 1 "Signal" Crystal Receiving Set—Signal Elec. Mfg. Co.
32. 1 National Airphone Crystal Set, Model G—National Airphone Corp., and 1 W. T. 501 Peanut Tube and Adapter—Radio Research Guild.
33. 1 Ricohorn—Radio Industries Corp., and 1 Carter Two-way Plug—Carter Radio Co.
34. 1 Crystal Radio Set—Standard Radio & Elec. Co., and 1 W. T. 501 Peanut Tube and Adapter—Radio Research Guild.
35. 4 No. 269 22½-Volt Variable "B" Batteries—Novo Mfg. Co., Inc.
36. 1 Set Constructional Drawings of Ten-Tube Super-Heterodyne—Experimenters Information Service.
37. 1 Gould Radio "B" Battery—Gould Storage Battery Co.
38. 1 Dictograph 3000 Ohm Head Set—Dicto-



## MU-RAD RECEIVERS SUPREME

The reception of far distant stations, heralded by owners of ordinary sets as a rare achievement, is the common experience of those who own MU-RAD Receivers. Only a 2-foot loop aerial required. Sensitivity finer than anything you have ever known. Faithful reproduction. Selects with amazing ease and sharpness. Yet these highly perfected sets are very simply operated. Guaranteed to receive 1000 miles, minimum. The maximum record is broken every week. Send for literature.

*The New*  
**Star in**  
the **Radio**  
**World**



### MU-RAD LABORATORIES, INC.

801 FIFTH AVE. ASBURY PARK, NEW JERSEY

# RUSONITE



**CRYSTAL RECTIFIER**

**MULTIPOINT** (Patent Pending)  
A Synthetic CRYSTAL DETECTOR  
sensitive over its entire surface.

Eliminates all detector troubles. Extraordinary clearness and volume. Endorsed by Radio experts and press. Sold in Sealed Packages only. Join the ever increasing Rusonite fans.

Price, Sensitive guaranteed **50c**

**RUSONITE CATWHISKER** **25c**

14 Karat Gold Multiple Contact Super Sensitive

Order from your dealer or direct from us.  
**RUSONITE PRODUCTS CORP.**  
15 Park Row, N. Y. Dept. "N"

# DON'T

BUY YOUR RADIO EQUIPMENT  
UNTIL YOU HAVE SENT  
FOR OUR PRICE LIST

*It Will Pay You To Write*

## Cut Rate Radio Co.

P. O. Box 472 Newark, N. J.

# What of the Boat Owners?

*Are you selling to the best summer radio buyers in the world—the owners of boats and yachts?*

Every boat owner is planning to install a radio set in his boat. He is 100% susceptible to your message.

And remember—he buys most when the radio business is dullest!

The boatman's favorite magazine is



It tells him all about his boat and also contains an interesting Radio Section in every issue.

*If you want to reach the largest number of boat-owners use*

**MoToR BoatinG**  
119 West  
40th Street  
New York  
N. Y.

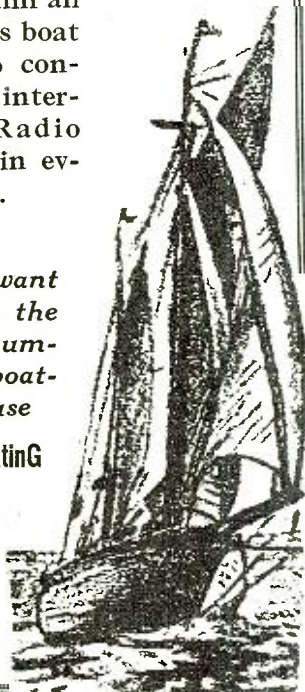

FREE

Complete price list of radio parts.  
Write Aitken Radio Co.,  
504 Superior St., Toledo, Ohio.

- graph Products Corp., and 1 Carter Two-way Plug—Carter Radio Co.
39. 1 5-Watt Power Tube—Automatic Elec. Devices Co.
  40. 1 Trimm "Professional" 3000 Ohm Head Set—Trimm Radio Mfg. Co., and 1 Carter Two-way Plug—Carter Radio Co.
  41. 1 Connecticut Variable Condenser—Connecticut Telephone & Elec. Co.
  42. 1 Goodman Wave Tuner—L. W. Goodman.
  43. 1 Cole Audio Frequency Transformer—A. B. Cole, Inc.
  44. 1 Frost 3000 Ohm Head Set—Herbert H. Frost, and 1 No. 138 Multiple Fone Plugs—Herbert H. Frost.
  45. 1 Murdock Loud Speaker—Wm. J. Murdock Co., and 1 Carter Two-way Plug—Carter Radio Co.
  46. 1 Murdock Head Set No. 56—Wm. J. Murdock Co., and 1 Carter Two-way Plug—Carter Radio Co.
  47. 1 Double Head Set—Radio Industries Corp., and 1 Carter Two-way Plug—Carter Radio Co.
  48. 1 Membership in The Radio Guild Co-operative Service Bureau—The Radio Guild.
  49. 1 Audio Frequency Transformer—Connecticut Telephone & Elec. Co.
  50. 1 Fada Variocoupler—Frank A. D. Andrea.
  51. 1 Large Type "B" Battery—Hipwell Mfg.
  52. 1 22½-Volt Defelco "B" Battery—Defelco Battery Corp.
  53. 1 45-Volt "B" Battery—National Electrical Novelty Co., Inc.
  54. 1 WorkRite Variocoupler—WorkRite Mfg. Co.
  55. 1 WorkRite Variometer—WorkRite Mfg. Co.
  56. 1 Audio Frequency Transformer—Connecticut Telephone & Electric Co.
  57. 1 Fada Variocoupler—Frank A. D. Andrea.
  58. 1 Large Type "B" Battery—Hipwell Mfg. Co.
  59. 1 22½-Volt Defelco "B" Battery—Defelco Battery Corp.
  60. 1 45-Volt "B" Battery—National Electrical Novelty Corp.
  61. 1 WorkRite Variocoupler—WorkRite Mfg. Co.
  62. 1 WorkRite Variometer—WorkRite Mfg. Co.
  63. 1 No. 1 Complete Patterns, Diagrams & Instructions for Making Short Wave Regenerative Set; 1 No. 2 Complete Patterns, Diagrams & Instructions for Making Detector and Amplifier Radio Units; 1 No. 3 Complete Instructions and Blue Prints for Making Radiophone Crystal Set; 1 Twenty Radio Phone Diagrams and Hook-ups of Crystal and Audion Receiving Circuits, Amplifier Circuits, Regenerative Circuits, with Key Chart of Symbols and Pamphlet, How to Read Diagrams; 1 Fourteen Radio Formulae and Diagrams; 1 Complete and Detailed Instructions, How to Build and Install Every Known Aerial for the Amateur—Consolidated Radio Call Book Co.
  64. 1 Variometer—F. R. S. Radio Corp.
  65. 1 National Airphone Crystal Set, Model G—National Airphone Corp., and 1 W. T. 501 Peanut Tube and Adapter—Radio Research Guild.
  66. 1 Ricohorn—Radio Industries Corp., and 1 Carter Two-way Plug—Carter Radio Co.
  67. 1 Crystal Set—Standard Radio & Elec. Co., and 1 W. T. 501 Peanut Tube and Adapter—Radio Research Guild.
  68. 4 No. 269 22½-Volt Variable "B" Batteries—Novo Mfg. Co., Inc.
  69. 1 Set Constructional Drawings of a 10 Tube Super-Heterodyne—Experimenters Information Service.
  70. 1 Gould Radio "B" Battery—Gould Storage Battery Co.
  71. 1 Dictograph 3000 Ohm Head Set—Dictograph Products Corp., and 1 Carter Two-way Plug—Carter Radio Co.
  72. 1 Trimm "Professional" 3000 Ohm Head Sets—Trimm Radio Mfg. Co., and 1 Carter Two-way Plug—Carter Radio Co.
  73. 1 Loud Speaker—Standard Metal Mfg. Co., and 1 Carter Two-way Plug—Carter Radio Co.
  74. 1 Connecticut Variable Condenser—Connecticut Telephone & Electric Co.
  75. 1 Goodman Wave Tuner—L. W. Goodman.
  76. 1 Cole Audio Frequency Transformer—A. B. Cole, Inc.
  77. 1 Frost 3000 Ohm Head Set—Herbert H. Frost, and 1 Frost No. 138 Multiple Fone Plugs—Herbert H. Frost.
  78. 1 Murdock Loud Speaker—Wm. J. Murdock Co., and 1 Carter Two-way Plug—Carter Radio Co.
  79. 1 Murdock Head Set No. 56—Wm. J. Murdock Co., and 1 Carter Two-way Plug—Carter Radio Co.
  80. 1 Double Head Set—Radio Industries Corp., and 1 Carter Two-way Plug—Carter Radio Co.
  81. 1 Membership in The Radio Guild Co-operative Service Bureau—The Radio Guild.
  82. 1 Audio Frequency Transformer—Connecticut Telephone & Electric Co.
  83. 1 Fada Variocoupler—Frank A. D. Andrea.
  84. 1 Large Type "B" Battery—Hipwell Mfg.
  85. 1 22½-Volt Defelco "B" Battery—Defelco Battery Corp.
  86. 1 45-Volt "B" Battery—National Electric Novelty Co.
  87. 1 WorkRite Variocoupler—WorkRite Mfg.
  88. 1 WorkRite Variometer—WorkRite Mfg. Co.
  89. 1 National Airphone Crystal Set Model "G"—National Airphone Corp., and 1 W. T. 501 Peanut Tube and Adapter—Radio Research Guild.
  90. 1 Ricohorn—Radio Industries Corp., and 1 Carter Two-way Plug—Carter Radio Co.

**Wave Trap**

TRADE MARK  
PATENT APPLIED FOR

**The Missing Link in RADIO**

**Stops Interference!**

John A. Burchrichter, 207 E. Ohio St., Indianapolis, Ind., says:  
"My set is about ten blocks from one of the local stations and when they started broadcasting, it meant that ended everything for the evening. After your Wave Trap was installed, they were tuned out completely."  
"Had expected with the approach of warm weather to take down my set until next fall but while other local 'Listeners In' are almost entirely cut off by STATIC, I am enjoying the programs just as much as in the cold months."  
"Have covered distances that heretofore have been impossible and really consider the Wave Trap the greatest invention since radio."  
Use the "FERBEND WAVE TRAP" for real results.  
**THE ORIGINAL WAVE FILTER.**

**Ferbend Electric Co.**  
25 E. SOUTH WATER ST.  
**CHICAGO**

**A Five Year Guarantee GOES WITH EVERY**

**ARTHUR PUDLIN'S VARIABLE HIGH RESISTANCE LEAK**

Can Be Used for Panel Mountings  
Endorsed by  
Cutler-Hammer Mfg. Co.,  
Flewellling and Others

We will at any time within a period of 5 Years replace free of charge any Arthur Pudlin Variable High Resistance Leak that does not work satisfactorily.  
This leak is guaranteed to give a resistance from 1/10 to 5 megohms.

**COMPLETE WITH BASE**  
Price with .00025 Mica Condenser...\$1.00  
Price without Condenser.....75c  
If your dealer does not carry them, send purchase price and dealer's name to

**Arthur Pudlin Engineering Co.**  
Dept. R.N. 1540 Broadway, New York  
We also Manufacture  
Tubular Glass Grid Leaks In All Megohms. 35 cents

**SPECIALLY \$6.95 PRICED**

Brand new blue steel, double safety automatics bought before recent tariff raise and offered at special prices for a limited time. Regular \$22.00, 25-calibre, 7-shot automatic, 4 1/4-in. long, our No. 78B 110, special at \$6.95.  
Or regular \$25.00 heavy service 32-calibre, 10-shot automatic, 5 1/2-in. long, our No. 78B 120, special at \$9.75. EXTRA MAGAZINE FREE with each gun. Both sizes shoot all standard cartridges.  
**PAY POSTMAN ON DELIVERY** plus postage.  
Money back promptly if Not Satisfied.  
**CONSUMERS CO., Dept. 78B 1265 Broadway, N.Y.**

**New York Coil Company's**  
New Radio Frequency Transformers Are a Revelation  
**Price \$4.00**  
Many Other New Devices. Literature Ready  
338 Pearl Street, New York City, N. Y.

- 91. 1 Crystal Set—Standard Radio & Elec. Co., and 1 W. T. 501 Peanut Tube and Adapter—Radio Research Guild.
- 92. 4 No. 269 22½-Volt Variable "B" Batteries—Novo Mfg. Co., Inc.
- 93. 1 Set Constructional Drawings of a 10 Tube Super Heterodyne—Experimenters Information Service.
- 94. 1 Gould Radio "B" Battery—Gould Storage Battery Co.
- 95. 1 Dictograph 3,000 Ohm Head Set—Dictograph Products Corp., and 1 Carter Two-way Plug—Carter Radio Co.
- 96. 1 Trimm "Professional" 3,000 Ohm Head Set—Trimm Radio Mfg. Co., and 1 Carter Two-way Plug—Carter Radio Co.
- 97. 1 Loud Speaker—Standard Metal Mfg. Co., and 1 Carter Two-way Plug—Carter Radio Co.
- 98. 1 "Signal" 43 Plate Variable Condenser—Signal Elec. & Mfg. Co.
- 99. 1 Goodman Wave Tuner—L. W. Goodman.
- 100. 1 Cole Audio Frequency Transformer—A. B. Cole, Inc.
- 101. 1 Frost 3000 Ohm Head Set—Herbert H. Frost, and 1 Frost No. 138 Multiple Fone Plug—Herbert H. Frost.
- 102. 1 Murdock Loud Speaker—Wm. J. Murdock Co., and 1 Carter Two-way Plug—Carter Radio Co.
- 103. 1 Murdock Head Set No. 56—Wm. J. Murdock Co., and 1 Carter Two-way Plug—Carter Radio Co.
- 104. 1 Double Head Set—Radio Industries Corp., and 1 Carter Two-way Plug—Carter Radio Co.
- 105. 1 Membership in The Radio Co-Operative Service Bureau—The Radio Guild.
- 106. 1 Type 231 A General Amplifying Transformer—General Radio Co.
- 107. 1 Fada Variocoupler—Frank A. D. Andrea.
- 108. 1 Large Type "B" Battery—Hipwell Mfg.
- 109. 1 22½-Volt Defelco "B" Battery—Defelco Battery Co.
- 110. 1 WorkRite Variocoupler—WorkRite Mfg.
- 111. 1 WorkRite Variometer—WorkRite Mfg. Co.
- 112. 1 National Airphone Crystal Set Model "G"—National Airphone Corp., and 1 W. T. Peanut Tube and Adapter—Radio Research Guild.
- 113. 1 Ricohorn—Radio Industries Corp., and 1 Carter Two-way Plug—Carter Radio Co.
- 114. 1 Crystal Set—Standard Radio & Elec. Co., and 1 W. T. 501 Peanut Tube and Adapter—Radio Research Guild.
- 115. 4 No. 269 22½-Volt Variable "B" Batteries—Novo Mfg. Co., Inc.
- 116. 1 Set Constructional Drawings of a 10 Tube Super-Heterodyne—Experimenters Information Service.
- 117. 1 Gould Radio "B" Battery—Gould Storage Battery Co.
- 118. 1 Dictograph 3000 Ohm Head Set—Dictograph Products Corp., and 1 Carter Two-way Plug—Carter Radio Co.
- 119. 1 Trimm "Professional" 3000 Ohm Head Set—Trimm Radio Mfg. Co., and 1 Carter Two-way Plug—Carter Radio Co.
- 120. 1 Loud Speaker—Standard Metal Mfg. Co., and 1 Carter Two-way Plug—Carter Radio Co.
- 121. 1 Goodman Wave Tuner—L. W. Goodman.
- 122. 1 Cole Audio Frequency Transformer—A. B. Cole, Inc.
- 123. 1 Frost 3000 Ohm Head Set—Herbert H. Frost, and 1 Frost No. 138 Multiple Fone Plug—Herbert H. Frost.
- 124. 1 Murdock Loud Speaker—Wm. J. Murdock Co., and 1 Carter Two-way Plug—Carter Radio Co.
- 125. 1 Murdock Head Set No. 56—Wm. J. Murdock Co., and 1 Carter Two-way Plug—Carter Radio Co.
- 126. 1 Double Head Set—Radio Industries Corp., and 1 Carter Two-way Plug—Carter Radio Co.
- 127. 1 Membership in the Radio Guild Co-Operative Service Bureau—The Radio Guild.
- 128. 1 Fada Variocoupler—Frank A. D. Andrea.
- 129. 1 Large Type "B" Battery—Hipwell Mfg.
- 130. 1 22½-Volt Defelco "B" Battery—Defelco Battery Corp.
- 131. 1 WorkRite Variocoupler—WorkRite Mfg.
- 132. 1 WorkRite Variometer—WorkRite Mfg. Co.
- 133. 1 National Airphone Crystal Set Model "G"—National Airphone Corp., and 1 W. T. 501 Peanut Tube and Adapter—Radio Research Guild.
- 134. 1 Ricohorn—Radio Industries Corp., and 1 Carter Two-way Plug—Carter Radio Co.
- 135. 1 Crystal Set—Standard Radio & Elec. Co., and 1 W. T. 501 Peanut Tube and Adapter—Radio Research Guild.
- 136. 4 No. 269 22½-Volt Variable "B" Batteries—Novo Mfg. Co., Inc.
- 137. 1 Set Constructional Drawings of a 10 Tube Super-Heterodyne—Experimenters Information Service.
- 138. 1 Gould Radio "B" Battery—Gould Storage Battery Co.
- 139. 1 Dictograph 3000 Ohm Head Set—Dictograph Products Corp., and 1 Carter Two-way Plug—Carter Radio Co.
- 140. 1 Trimm "Professional" 3000 Ohm Head Set—Trimm Radio Mfg. Co., and 1 Carter Two-way Plug—Carter Radio Co.
- 141. 1 Loud Speaker—Standard Metal Mfg. Co., and 1 Carter Two-way Plug—Carter Radio Co.
- 142. 1 Goodman Wave Tuner—L. W. Goodman.
- 143. 1 Cole Audio Frequency Transformer—A. B. Cole, Inc.
- 144. 1 Frost 3000 Ohm Head Set—Herbert H. Frost, and 1 Frost No. 138 Multiple Fone Plug—Herbert H. Frost.
- 145. 1 Murdock Loud Speaker—Wm. J. Murdock Co., and 1 Carter Two-way Plug—Carter Radio Co.

# How to Get the Most Out of a Single Tube

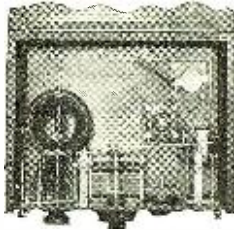

Duo-Reflex simplicity assures neat, compact, cabinet installation. Detailed blue prints are on sale by dealers at 25c per set

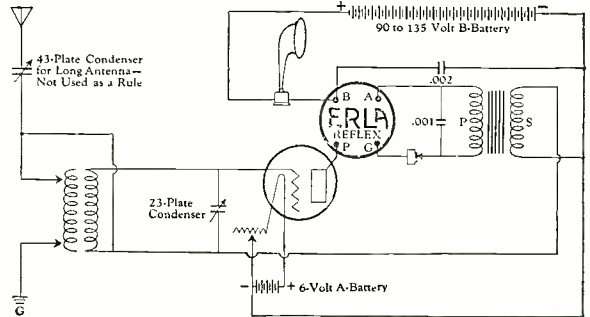

## Use Duo-Reflex Hook-Up and Erla Transformers

You will never know the full range and power of a single tube until you have operated Duo-Reflex, the most powerful single-tube circuit ever built. Under conditions at all favorable, a wide compass of stations is brought in through a loud speaker, and headphones extend the range from coast to coast. Equally improved is the tuning, so sharp and selective as to eliminate interference almost at will. Modulation, likewise, is flawless, with complete absence of static and parasitic noises.

Due to low current consumption, Duo-Reflex is operated successfully on dry cells. This, combined with light weight, makes it readily portable.

Especially designed for Duo-Reflex, and the major essential of its power, is the Erla radio frequency transformer. Synchronizing perfectly the reflected radio and audio frequency impulses, it provides unequalled magnification without distortion. A complete description of Duo-Reflex, together with directions for its construction, is given in Erla Bulletin No. 13, obtainable gratis from leading radio dealers. Or write us direct, giving your dealer's name.

Electrical Research Laboratories  
Dept. C 2515 Michigan Ave., Chicago

# ERLA



Erla radio frequency transformers maintain unequalled amplification over a waveband of 200 to 900 meters. AB 1, 2, 3, \$4. Reflex, \$5



Erla bezels, in bright nickel or dull enamel, improve any receiving cabinet 100%. Made in 1" and 1½" sizes to fit any ¼" to ¾" panel. 20c



Absolute accuracy in Erla fixed condensers eliminates a major source of trouble in apparatus construction. Eleven sizes, 35c to \$1 each

**"True-Tone"**  
SUPERSENSITIVE  
3000 Ohms

**The Only Quality 3000-Ohm Guaranteed Head Set for \$5 00**

**TRUE - TONE RADIO MFG. CO.**  
188 No. La Salle Ave. CHICAGO, ILL.

**"Read'em"**  
Binding Posts

**With Knobs That Won't Come Off**

Anyone can "read 'em." All popular styles—Antenna, Ground, Fones, A and B Battery plus and minus—abbreviations of different names engraved on knobs. Radio users—ask your dealer for "Read 'em." Dealers—write for our proposition on this big seller. Write Dept. A for liberal profit proposition.

**The Marshall-Gerken Co.**  
Manufacturers  
Toledo, Ohio

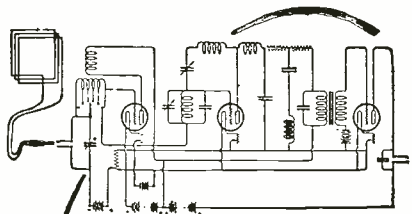

# Supreme for Simple Sets or Super Stations

## bakelite dilecto!!

The foremost radio engineers and the wiser amateurs rely on Bakelite-Dilecto (xx grade.)

Its many amazing qualities make it the perfect material for radio panels, bases, frames and various insulation requirements Used in the U. S. Navy any Signal Corps over eight years--and SATISFYING!

Any electrical man can get B D X X for you, shaped and drilled. Demand it for best results.

The Continental Fibre Co.,  
Factory: Newark, Delaware.

Dealer Service From:

New York, 233 Broadway  
Chicago, 332 S. Michigan Ave.  
Pittsburgh, 301 Fifth Ave.  
San Francisco, 75 Fremont St.  
Seattle, 95 Connecticut St.  
Los Angeles, 411 S. Main St.

### KLOSNER RADIO PRODUCTS

Send for free literature.

KLOSNER IMPROVED APPARATUS CO.  
2024 BOSTON ROAD NEW YORK CITY

### CHARGE YOUR BATTERY

(RADIO OR AUTO)

at HOME for a NICKEL

The HOMCHARGER

POPULARLY PRICED—PAYS FOR ITSELF

SEND FOR THE AUTOMATIC ELECTRICAL DEVICES CO.

FREE BOOK, 118 W THIRD ST.—CINCINNATI, OHIO.

#### GREEN SEAL

AIR-WAY RADIO Equipment appeals to the discriminating user for its genuine quality at fair prices. Write for Free Air-Way Bulletin of Complete Sets and Standard Parts. Attractive dealer proposition.

Air-Way Electric Appliance Corporation, Toledo, Ohio.

146. 1 Murdock Head Set No. 56—Wm. J. Murdock Co., and 1 Carter Two-way Plug—Carter Radio Co.
147. 1 Double Headset—Radio Industries Corp., and 1 Carter Two-way Plug—Carter Radio Co.
148. 1 Membership in the Radio Guild Co-operative Service Bureau—The Radio Guild.
149. 1 Fada Variocoupler—Frank A. D. Andrea.
150. 1 Large Type "B" Battery—Hipwell Mfg.
151. 1 22½-Volt Defelco "B" Battery—Defelco Battery Corp.
152. 1 WorkRite Variocoupler—WorkRite Mfg.
153. 1 WorkRite Variometer—WorkRite Mfg. Co.
154. 1 National Airphone Crystal Set Model "G"—National Airphone Corp., and 1 W. T. 501 Peanut Tube and Adapter—Radio Research Guild.
155. 1 Ricohorn—Radio Industries Corp., and 1 Carter Two-way Plug—Carter Radio Co.
156. 4 No. 269 22½-Volt Variable "B" Batteries—Novo Mfg. Co., Inc.
157. 1 Crystal Set—Standard Radio & Elec. Co., and 1 W. T. 501 Peanut Tube and Adapter—Radio Research Guild.
158. 1 Set Constructional Drawings of a 10 Tube Super-Heterodyne—Experimenters Information Service.
159. 1 Gould Radio "B" Battery—Gould Storage Battery Co.
160. 1 Dictograph 3000 Ohm Head Set—Dictograph Products Corp., and 1 Carter Two-way Plug—Carter Radio Co.
161. 1 Trimm "Professional" 3000 Ohm Head Set—Trimm Radio Mfg. Co., and 1 Carter Two-way Plug—Carter Radio Co.
162. 1 Loud Speaker—Standard Metal Mfg. Co., and 1 Carter Two-way Plug—Carter Radio Co.
163. 1 Goodman Wave Tuner—L. W. Goodman.
164. 1 Cole Audio Frequency Transformer—A. B. Cole, Inc.
165. 1 Frost 3000 Ohm Head Set—Herbert H. Frost, and 1 Frost No. 138 Multiple Fone Plug—Herbert H. Frost.
166. 1 Murdock Loud Speaker—Wm. J. Murdock Co., and 1 Carter Two-way Plug—Carter Radio Co.
167. 1 Murdock Head Set No. 56—Wm. J. Murdock Co., and 1 Carter Two-way Plug—Carter Radio Co.
168. 1 Double Head Set—Radio Industries Corp., and 1 Carter Two-way Plug—Carter Radio Co.
169. 1 Membership in The Radio Guild Co-operative Service Bureau—The Radio Guild.
170. 1 Fada Variocoupler—Frank A. D. Andrea.
171. 1 Large Type "B" Battery—Hipwell Mfg.
172. 1 22½-Volt Defelco "B" Battery—Defelco Battery Corp.
173. 1 WorkRite Variocoupler—WorkRite Mfg.
174. 1 WorkRite Variometer—WorkRite Mfg. Co.
175. 1 National Airphone Crystal Set Model "G" Peanut Tube and Adapter—Radio Research Guild.
176. 1 Ricohorn—Radio Industries Corp., and 1 Carter Two-way Plug—Carter Radio Co.
177. 1 Crystal Set—Standard Radio & Elec. Co., and 1 W. T. 501 Peanut Tube and Adapter—Radio Research Guild.
178. 4 No. 269 22½-Volt Variable "B" Batteries—Novo Mfg. Co., Inc.
179. 1 Set Constructional Drawings of a 10 Tube Super-Heterodyne—Experimenters Information Service.
180. 1 Gould Radio "B" Battery—Gould Storage Battery Co.
181. 1 Dictograph 3000 Ohm Head Set—Dictograph Products Corp., and 1 Carter Two-way Plug—Carter Radio Co.
182. 1 Trimm "Professional" 3000 Ohm Head Set—Trimm Radio Mfg. Co., and 1 Carter Two-way Plug—Carter Radio Co.
183. 1 Goodman Wave Tuner—L. W. Goodman.
184. 1 Ames Variocoupler—Picard Radio Corp.
185. 1 Cole Audio Frequency Transformer—A. B. Cole, Inc.
186. 1 Frost 3000 Ohm Head Set—Herbert H. Frost, and 1 Frost No. 138 Multiple Fone Plug—Herbert H. Frost.
187. 1 Murdock Loud Speaker—Wm. J. Murdock Co., and 1 Carter Two-way Plug—Carter Radio Co.
188. 1 Murdock Head Set—Wm. J. Murdock Co., and 1 Carter Two-way Plug—Carter Radio Co.
189. 1 Double Head Set—Radio Industries Corp., and 1 Carter Two-way Plug—Carter Radio Co.
190. 1 Membership in the Radio Guild Co-operative Service Bureau—The Radio Guild.
191. 1 Fada Variocoupler—Frank A. D. Andrea.
192. 1 Large Type "B" Battery—Hipwell Mfg.
193. 1 22½-Volt Defelco "B" Battery—Defelco Battery Corp.
194. 1 Mahogany Resistor Radion Panel—American Hard Rubber Co.
195. 1 WorkRite Variocoupler—WorkRite Mfg.
196. 1 WorkRite Variometer—WorkRite Mfg. Co.
197. 1 Barkelew Lightning Arrester Switch—The Barkelew Electric Mfg. Co.
198. 1 No. 1 Complete Patterns, Diagrams & Instructions for making Short Wave Regenerative Set; 1 No. 1 Complete Patterns, Diagrams & Instructions for making Detector and Amplifier Radio Units; 1 No. 3 Complete Instructions and Blue Prints for making Radiophone Crystal Set; 1 Twenty Radio Phone Diagrams and Hook-ups of Crystal and Audion Receiving Circuits, Amplifier Circuits, Regenerative Circuits, Sending Circuits, with Key Chart of Symbols and Pamphlet, How to Read Diagrams; 1 Fourteen Radio Formulae and Diagrams; 1 Complete and Detailed Instructions, How to Build and Install Every Known Aerial for the Amateur—Consolidated Radio Call Book

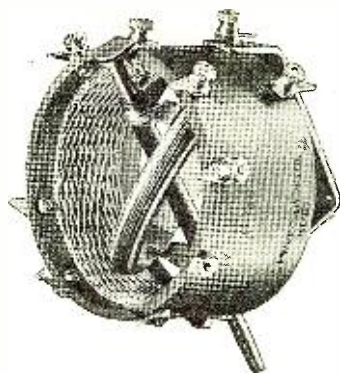

Hook up practically any of the latest circuits with a

## B-T VERNIER TUNER

Gives unequalled results on REINARTZ all REFLEX, ULTRA-AUDION and numerous other circuits. Switches and taps not necessary. All positive contacts. Detailed diagrams make wiring easy. 180—750 meters.

Guaranteed to do even more than you expect. PRICE .....\$5.00

Ask your dealer—or write direct.

## Bremer-Tully Mfg. Co.

Canal & Harrison CHICAGO

## RHAMSTINE VICTOPHONE

The Perfect Loud-Speaker



Price

\$7.50

Complete with Cord

This reasonably priced unit makes it possible for you to secure great volume when attached to a horn or the tone-arm of your phonograph. Compare it with others—even those selling at double the price—and the Victophone will be your choice. Order yours now.

### J. THOS. RHAMSTINE\*

2162 E. LARNED ST., DETROIT MICH.  
\*Maker of Radio Products



## "MASTER"

Skeleton Type RHEOSTATS

are designed to meet the demand

for efficient, inexpensive rheostats. Require one hole only for panel mounting. Adjustable for panel thickness up to 3/8 inch. Genuine Bakelite knob.

No.	Price
RS-107	..... \$ .85
Resistance 6 ohms	
RS-108	..... .85
Resistance 3 ohms	
RS-109	..... 1.25
Resistance 20 ohms (Potentiometer)	
PS-604	..... 1.75
Resistance 250 ohms	



Write for Bulletin RN-105, illustrating and fully describing complete line.

## Radio Division UNION CONSTRUCTION CO.

OAKLAND :: CALIFORNIA

- 199. 1 Variometer—F. R. S. Radio Corp.
- 200. 1 Year's Subscription to SCIENCE & INVENTION—Experimenter Publishing Co.
- 201. 1 Year's Subscription to RADIO NEWS—Experimenter Publishing Co.
- 202. 1 A. C. H. Sharp Tuner Dial—A. C. Hayden Radio & Research Corp.
- 203. 1 A. C. H. Sharp Tuner Dial—A. C. Hayden Radio & Research Corp.
- 204. 1 Brach Lightning Arrester—L. S. Brach Mfg. Co.
- 205. 1 Formica Panel—The Formica Insulation Co.
- 206. 1 Year's Subscription to PRACTICAL ELECTRICS—Practical Electrics Co., Inc.
- 207. 1 Westwyre Condenser—The Westwyre Co.
- 208. 1 Bradleyometer—Allen Bradley Co.
- 209. 1 Memory Course—C. K. Dodge.
- 210. 1 Antenna Plug—Chas. Freshman Co., Inc.
- 211. 1 Bradleysstat—Allen Bradley Co.
- 212. 1 Variable Resistance Leak with .00025 Micon Condenser—Chas. Freshman Co., Inc.
- 213. 1 Klosner Model 200 Vernier Rheostat—Klosner Improved Apparatus Co.
- 214. 1 Resistance Unit and Mountings—Daven Radio Co.
- 215. 1 Pair Bates Ear Cushions for Head Sets—Bates and Company.
- 216. 1 Consolidated Radio Call Book—Consolidated Radio Call Book Co., Inc.
- 217. 1 Autostat—Automatic Electrical Devices Co.
- 218. 1 Autostat—Automatic Electrical Devices Co.
- 219. 1 Barkelew Four-Phone Plug—The Barkelew Elec. Mfg. Co.
- 220. 1 ShurGrip Plug—Martin-Copeland Company.
- 221. 1 Bradleyadapter—Allen Bradley Co.
- 222. 1 Bradleyswitch—Allen Bradley Co.
- 223. 1 Battery Testing Outfit—The Chaslyn Co.
- 224. 1 Saturn Perfect Jack—Saturn Mfg. & Sales
- 225. 1 Radiogem Receiving Set—The Radiogem Corp.
- 226. 1 Marco W.D. 11 Adapter—Martin-Copeland.
- 227. 1 Marco W.D. 11 Adapter—Martin-Copeland.
- 228. 1 Saturn Automatic Plug—Saturn Mfg. & Sales Co.
- 229. 1 Set Phone Clips—Star Mfg. Co.
- 230. 5 W. D. 11 Fuses—Radio Equipment Co.
- 231. 1 .006 Micon Condenser—Chas. Freshman Co., Inc.
- 232. 1 Year's Subscription to SCIENCE & INVENTION—Experimenter Publishing Co.
- 233. 1 Year's Subscription to RADIO NEWS—Experimenter Publishing Co.
- 234. 1 A. C. H. Sharp Tuner Dial—A. C. Hayden Radio & Research Corp.
- 235. 1 A. C. H. Sharp Tuner Dial—A. C. Hayden Radio & Research Corp.
- 236. 1 Brach Lightning Arrester—L. S. Brach Mfg. Co.
- 237. 1 Formica Panel—The Formica Insulation Co.
- 238. 1 Year's Subscription to PRACTICAL ELECTRICS—The Practical Electrics Co.
- 239. 1 Westwyre Condenser—The Westwyre Co.
- 240. 1 Bradleyometer—Allen Bradley Co.
- 241. 1 Memory Course—C. K. Dodge.
- 242. 1 Antenna Plug—Chas. Freshman Co., Inc.
- 243. 1 Variable Resistance Leak with .00025 Micon Condenser—Chas. Freshman Co., Inc.
- 244. 1 Bradleysstat—Allen Bradley Co.
- 245. 1 Klosner Model 200 Vernier Rheostat—Klosner Improved Apparatus Co.
- 246. 1 Resistance Unit and Mountings—Daven Radio Co.
- 247. 1 Pair Bates Ear-Cushions for Head Sets—Bates & Company.
- 248. 1 Consolidated Radio Call Book—Consolidated Radio Call Book Co.
- 249. 1 Autostat—Automatic Electrical Devices Co.
- 250. 1 Autostat—Automatic Electrical Devices Co.
- 251. 1 Barkelew Lightning Arrester Switch—The Barkelew Elec. Mfg. Co.
- 252. 1 Aero Plug—Star Mfg. Co.
- 253. 1 Bradleyadapter—Allen Bradley Co.
- 254. 1 Bradleyswitch—Allen Bradley Co.
- 255. 1 Battery Testing Outfit—The Chaslyn Co.
- 256. 1 Saturn Perfect Jack—Saturn Mfg. & Sales
- 257. 1 Radiogem Receiving Set—The Radiogem Corp.
- 258. 1 Saturn Automatic Plug—Saturn Mfg. & Sales Co.
- 259. 1 Set Phone Clips—Star Mfg. Co.
- 260. 5 W. D. 11 Fuses—Radio Equipment Co.
- 261. 1 .006 Micon Condenser—Chas. Freshman Co., Inc.
- 262. 1 Bradleyswitch—Allen Bradley Co.
- 263. 1 Battery Testing Outfit—The Chaslyn Co.
- 264. 1 Saturn Perfect Jack—Saturn Mfg. & Sales
- 265. 1 Radiogem Receiving Set—Radiogem Corp.
- 266. 1 Saturn Automatic Plug—Saturn Mfg. & Sales Co.
- 267. 5 W. D. 11 Fuses—Radio Equipment Co.
- 268. 1 .006 Micon Condenser—Chas. Freshman Co., Inc.
- 269. 1 No. 1 Complete Patterns, Diagrams & Instructions for Making Short Wave Regenerative Set; 1 No. 2 Complete Patterns, Diagrams & Instructions for Making Detector and Amplifier Radio Units; 1 No. 3 Complete Instructions and Blue Prints for Making Radiophone Crystal Set; 1 Twenty Radio Phone Diagrams and Hook-ups of Crystal and Audion Receiving Circuits, Amplifier Circuits, Regenerative Circuits, Sending Circuits, with Key Chart of Symbols and Pamphlet, How to Read Diagrams; 1 Fourteen Radio Formulae and Diagrams; 1 Complete and Detailed Instructions, How to Build and Install Every Known Aerial for the Amateur—Consolidated Radio Call Book Co.

# A screw-driver you can carry in your pocket



Pocket  
Screw-Driver  
No. 231  
Price, \$1.00



Mr. Punch says:  
"Carry this screw-driver in your pocket—it will come in handy, and save you time and trouble."

**L**ARGE enough to be practical—small enough to carry in your pocket—that's this Goodell-Pratt Screw-Driver.

Consists of a hollow handle, with a chuck, three various size blades, and a reamer. When not in use, the chuck and blades are kept in the handle. Blades are made of fine tool steel. Handle is nickel-plated, polished, and buffed.

One of the most convenient tools made, and one that ought to be a part of every radio enthusiast's equipment.

### Other tools for radio use

In the Goodell-Pratt line of 1500 Good Tools are many that, like this Pocket Screw-Driver, will prove a great help to anyone who tinkers with radio equipment.

Write for Catalog No. 15. It shows the complete line of Goodell-Pratt 1500 Good Tools.

**GOODELL-PRATT COMPANY**

*Toolsmiths*

Greenfield, Mass., U. S. A.



## Loud Speaker Quality

Years of experience were required to perfect the acoustics of a victrola. It will only cost a small amount to make your Victor Talking Machine a RADIO LOUD SPEAKER, with a "Beeko" Radio-Phone attachment.

Sample by mail 40c. Send stamp for catalog 45-R.

Liberal discount in quantities.

**J. H. BUNNELL & COMPANY**  
32 PARK PLACE NEW YORK

## RADIO "BUGS" GET INTO BUSINESS for YOURSELF

Why not turn your hobby into money? You can easily make \$15.00 a day, or as much more as you like, by our wonderful plan of selling Radio direct to the millions of people just waiting for our better parts or sets.

We furnish everything you need at lowest factory prices and tell you how to build a profitable business of your own.

Knott products are up to the minute. Knott plans are unique and unbeatable. Radio is just beginning to come into its own. Are you? Want to make more money? Want to be your own boss? Write TODAY for FREE instructions How To Sell Real Radio.

**E. R. KNOTT MACHINE CO.,**  
1-J. Ellery St., S. Boston 27. Mass.

**WANTED**—Back numbers of Radio News, Dec., 1921, Jan. and Feb., 1922. Experimenter Publishing Co., 53 Park Place, New York City.



Size 8" x 8" All Over

## Genuine Western Electric Microphone

Including six feet of cord, Attachment plug, Breast plate, Shoulder straps, Transmitter.

### All for \$1.00

Sent prepaid upon receipt of Money Order.

These are all BRAND NEW microphone transmitters, not second hand. They were used by the Army and Navy as regular equipment. Each instrument has been thoroughly tested, and was originally made to sell at \$7.50.

Every radio experimenter needs one of these transmitters. Particularly useful because with it you have both of your hands free for operating your set. Nearly every one or two tube radio receiver can be converted into a radio transmitter. Most text books show how this can be accomplished. These microphone transmitters may sometimes save lives or property when connected to the radio receiving outfit!

The microphone is of a supersensitive type and is entirely water proof. Remember, it was made for war purposes and only the best of material was used in it.

The microphone has a double swivel arrangement so that any adjustment can be made either to or away from the mouth or side ways, if you want to push it out of the way.

Other uses: The microphone can be detached from the breast plate and attached to your set permanently if you so desire.

Or it may be used for land line work inasmuch as it has a wonderfully sensitive microphone.

Due to its peculiar filter plate, this transmitter can be used where there is an unusual amount of noise and still the spoken words will come out clear on the other end.

The entire transmitter is nicely finished and is heavily zinc plated all over. It positively will not rust.

As only a few hundred of these transmitters are left, we urge you to place your order at once. Money refunded if not exactly as represented.

# ROVA

Department R

167 West 18th Street, New York City

270. 1 Variometer—F. R. S. Radio Corp.
271. 1 Year's Subscription to SCIENCE & INVENTION—Experimenter Publishing Co.
272. 1 Year's Subscription to RADIO NEWS—Experimenter Publishing Co.
273. 1 A. C. H. Sharp Tuner Dial—A. C. Hayden Radio & Research Corp.
274. 1 A. C. H. Sharp Tuner Dial—A. C. Hayden Radio & Research Corp.
275. 1 Brach Lightning Arrester—L. S. Brach Mfg. Co.
276. 1 Formica Panel—The Formica Insulation Co.
277. 1 Year's Subscription to PRACTICAL ELECTRICS—Practical Electrics Co., Inc.
278. 1 Westwyre Condenser—The Westwyre Co.
279. 1 Bradleyometer—Allen Bradley Co.
280. 1 Memory Course—C. K. Dodge.
281. 1 Antenna Plug—Chas. Freshman Co., Inc.
282. 1 Variable Resistance Leak with .00025 Micon Condenser—Chas. Freshman Co., Inc.
283. 1 Bradleystat—Allen Bradley Co.
284. 1 Klosner Model 200 Vernier Rheostat—Klosner Improved Apparatus Co.
285. 1 Resistance Unit and Mountings—Daven Radio Co.
286. 1 Pair Bates Ear Cushions for Head Sets—Bates & Company.
287. 1 Consolidated Radio Call Book—Consolidated Radio Call Book Co.
288. 1 Autostat—Automatic Electric Devices Co.
289. 1 Autostat—Automatic Electric Devices Co.
290. 1 Barkeley Four Phone Plug—Barkeley Elec. Mfg. Co.
291. 1 Jewel Detector—Star Mfg. Co.
292. 1 Bradleyadapter—Allen Bradley Co.
293. 1 Bradleyswitch—Allen Bradley Co.
294. 1 Battery Testing Outfit—The Chaslyn Co.
295. 1 Saturn Perfect Jack—Saturn Mfg. & Sales Co.
296. 1 Radiogem Receiving Set—The Radiogem Corp.
297. 1 Saturn Automatic Plug—Saturn Mfg. & Sales Co.
298. 5 W. D. 11 Fuses—Radio Equipment Co.
299. 1 .006 Micon Condenser—Chas. Freshman Co., Inc.
300. 1 No. 1 Complete Patterns, Diagrams and Instructions for making Short Wave Regenerative Set; 1 No. 2 Complete Patterns Diagrams and Instructions for making Detector and Amplifier Radio Units; 1 No. 3 Complete Instructions and Blue Prints for making Radiophone Crystal Set; 1 Twenty Radio Phone Diagrams and Hook-ups of Crystal and Audion Receiving Circuits, Amplifier Circuits, Regenerative Circuits, Sending Circuits, with Key Chart of Symbols and Pamphlets How to Read Diagrams; 1 Fourteen Formulae and Diagrams; 1 Complete and Detailed Instructions—How to Build and Install Every Known Aerial for the Amateur—Consolidated Radio Call Book 1 43 Plate Ames Variable Condenser—Picard Radio Corp.
301. 1 Year's Subscription to SCIENCE & INVENTION—Experimenter Publishing Co.
302. 1 Year's Subscription to RADIO NEWS—Experimenter Publishing Co.
303. 1 A. C. H. Sharp Tuner Dial—A. C. Hayden Radio & Research Corp.
304. 1 A. C. H. Sharp Tuner Dial—A. C. Hayden Radio & Research Corp.
305. 1 Brach Lightning Arrester—L. S. Brach Mfg. Co.
306. 1 Formica Panel—The Formica Insulation Co.
307. 1 Year's Subscription to PRACTICAL ELECTRICS—Practical Electrics Co., Inc.
308. 1 Westwyre Condenser—The Westwyre Co.
309. 1 Bradleyometer—Allen Bradley Co.
310. 1 Memory Course—C. K. Dodge.
311. 1 Antenna Plug—Chas. Freshman Co., Inc.
312. 1 Variable Resistance Leak with .006 Micon Condenser—Chas. Freshman Co., Inc.
313. 1 Bradleystat—Allen Bradley Co.
314. 1 Klosner Model 200 Vernier Rheostat—Klosner Improved Apparatus Co.
315. 1 Resistance Unit and Mountings—Daven Radio Co.
316. 1 Pair Bates Ear Cushions for Head Sets—Bates & Company.
317. 1 Consolidated Radio Call Book—Consolidated Radio Call Book Co.
318. 1 Autostat—Automatic Electrical Devices.
319. 1 Autostat—Automatic Electric Devices Co.
320. 1 Barkeley Four Phone Plug—The Barkeley Electric Mfg. Co.
321. 1 Bradleyadapter—Allen Bradley Co.
322. 1 Bradleyswitch—Allen Bradley Co.
323. 1 Battery Testing Outfit—The Chaslyn Co.
324. 1 Saturn Perfect Jack—Saturn Mfg. & Sales Co.
325. 1 Radiogem Receiving Set—Radiogem Corp.
326. 1 Saturn Automatic Plug—Saturn Mfg. & Sales Co.
327. 5 W. D. 11 Fuses—Radio Equipment Co.
328. 1 .006 Micon Condenser—Chas. Freshman Co., Inc.
329. 1 No. 1 Complete Patterns, Diagrams and Instructions for making Short Wave Regenerative Set; 1 No. 2 Complete Patterns, Diagrams and Instructions for making Detector and Amplifier Radio Units; 1 No. 3 Complete Instructions and Blue Prints for making Radiophone Crystal Set; 1 Twenty Radio Phone Diagrams and Hook-ups of Crystal and Audion Receiving Circuits, Amplifier Circuits, Regenerative Circuits, Sending Circuits, with Key Chart of Symbols and Pamphlet How to Read Diagrams; 1 Fourteen Radio Formulae and Diagrams; 1 Complete and Detailed Instructions—How to Build and Install Every Known Aerial for the Amateur—Consolidated Radio Call Book Co.

## AN EASY JOB!

Building your own Radio set with Walnart products makes it possible to complete your set with less labor in half the time.

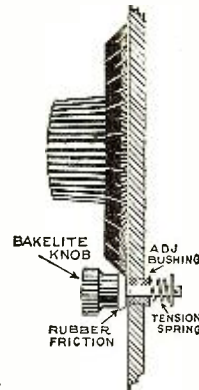

## Walnart Vernier Adjuster 25c.

Can be mounted in five minutes. Drill  $\frac{1}{4}$ " hole below dial; insert bushing and shaft; push in cotter pin and you can tune in the elusive far away station.

## Walnart New Inductance Switch \$1.00



Why drill 10 holes and mount 10 switch points when all you need drill is one hole to mount this Walnart positive connection inductance switch in a few minutes? The compact design of this switch has brought down the cost of manufacturing and made it possible to offer it to you at \$1.00.

Ask your dealer for these and other Walnart products. If he can not supply, send draft or money order and your dealer's name. We will supply your needs.

*JOBBERS: Join the money-making crowd of Walnart Representatives.*

*DEALERS: Write for discounts and literature.*

**WALNART ELEC. MFG. CO.**  
1249 W. Van Buren St., Chicago, Ill.



**World Radio Batteries**  
**SAVE YOU 50%**  
WRITTEN 2YR. GUAR.

### Satisfaction Guaranteed

We maintain the same high quality material and workmanship found on the most expensive batteries and still are able to allow our remarkably low sale price by greatly reducing our overhead and sale costs.

Thousands of users enjoy the dependable qualities of our battery. World Battery owners "tell their friends." This is our best proof of performance.

**ORDER TODAY**—We ship C.O.D. subject to inspection or will allow 5 per cent for cash with order. **WRITTEN 2-YEAR GUARANTEE** to each purchaser. Save 50 per cent on your next battery and get better service and longer life. **Special Summer Offer**—Just clip this ad, mail in with your order and we will include one Eveready "B" Battery, free of charge. Write today—NOW.

**WORLD BATTERY COMPANY**  
Dept. 10  
1219 S. Wabash Ave., Chicago, Ill.

6 volt 60 Amps... \$10.00  
6 volt 80 Amps... 12.50  
6 volt 100 Amps... 14.50  
6 volt 120 Amps... 16.00



- 331. 1 Year's Subscription to SCIENCE & INVENTION—Experimenter Publishing Co.
- 332. 1 Year's Subscription to RADIO NEWS—Experimenter Publishing Co.
- 333. 1 A. C. H. Sharp Tuner Dial—A. C. Hayden Radio & Research Corp.
- 334. 1 A. C. H. Sharp Tuner Dial—A. C. Hayden Radio & Research Corp.
- 335. 1 Brach Lightning Arrester—L. S. Brach Mfg. Co.
- 336. 1 Formica Panel—The Formica Insulation
- 337. 1 Year's Subscription to PRACTICAL ELECTRICS—The Practical Electrics Co.
- 338. 1 Westwre Condenser—The Westwre Co.
- 339. 1 Bradleyometer—Allen Bradley Co.
- 340. 1 Memory Course—C. K. Dodge.
- 341. 1 Antenna Plug—Chas. Freshman Co., Inc.
- 342. 1 Variable Resistance Leak with .006 Micon Condenser—Chas. Freshman Co., Inc.
- 343. 1 Bradleystat—Allen Bradley Co.
- 344. 1 Klosner Model 200 Vernier Rheostat—Klosner Improved Apparatus Co.
- 345. 1 Resistance Unit and Mountings—Daven Radio Co.
- 346. 1 Consolidated Radio Call Book—Consolidated Radio Call Book Co., Inc.
- 347. 1 Autostat—Automatic Electrical Devices Co.
- 348. 1 Autostat—Automatic Electrical Devices Co.
- 349. 1 Barkelew Four Phone Plug—The Barkelew Electric Mfg. Co.
- 350. 1 Bradleyadapter—Allen Bradley Co.
- 351. 1 Bradleyswitch—Allen Bradley Co.
- 352. 1 Battery Testing Outfit—The Chaslyn Co.
- 353. 1 Saturn Perfect Jack—Saturn Mfg. & Sales
- 354. 1 Radiogem Receiving Set—The Radiogem Corp.
- 355. 1 Saturn Automatic Plug—Saturn Mfg. & Sales Co.
- 356. 5 W. D. 11 Fuses—Radio Equipment Co.
- 357. 1 .006 Micon Condenser—Chas. Freshman Co., Inc.
- 358. 1 No. 1 Complete Patterns, Diagrams and Instructions for making Short Wave Regenerative Set; 1 No. 2 Complete Patterns, Diagrams and Instructions for making Detector and Amplifier Radio Units; 1 No. 3 Complete Instructions and Blue Prints for making Radiophone Crystal Set; 1 Twenty Radio Phone Diagrams and Hook-ups of Crystal and Audion Receiving Circuits, Amplifier Circuits, Regenerative Circuits, Sending Circuits, with Key Chart of Symbols and Pamphlet How to Read Diagrams; 1 Fourteen Radio Formulae and Diagrams; 1 Complete and Detailed Instructions—How to Build and Install Every Known Aerial for the Amateur—Consolidated Radio Call Book Co.
- 359. 1 Year's Subscription to SCIENCE & INVENTION—Experimenter Publishing Co.
- 360. 1 Year's Subscription to RADIO NEWS—Experimenter Publishing Co.
- 361. 1 A. C. H. Sharp Tuner Dial—A. C. Hayden Radio & Research Corp.
- 362. 1 A. C. H. Sharp Tuner Dial—A. C. Hayden Radio & Research Corp.
- 363. 1 Brach Lightning Arrester—L. S. Brach Mfg. Co.
- 364. 1 Formica Panel—The Formica Insulation
- 365. 1 Year's Subscription to PRACTICAL ELECTRICS—The Practical Electrics Co.
- 366. 1 Westwre Condenser—The Westwre Co.
- 367. 1 Bradleyometer—Allen Bradley Co.
- 368. 1 Memory Course—C. K. Dodge.
- 369. 1 Antenna Plug—Chas. Freshman Co., Inc.
- 370. 1 Variable Resistance Leak with .006 Micon Condenser—Chas. Freshman Co., Inc.
- 371. 1 Bradleystat—Allen Bradley Co.
- 372. 1 Klosner Model 200 Vernier Rheostat—Klosner Improved Apparatus Co.
- 373. 1 Resistance Unit and Mountings—Daven Radio Co.
- 374. 1 Pair Bates Ear Cushions for Head Set—Bates & Company.
- 375. 1 Consolidated Radio Call Book—Consolidated Radio Call Book Co., Inc.
- 376. 1 Autostat—Automatic Electrical Devices Co.
- 377. 1 Autostat—Automatic Electrical Devices Co.
- 378. 1 Barkelew Four Phone Plug—The Barkelew Electric Mfg. Co.
- 379. 1 Bradleyadapter—Allen Bradley Co.
- 380. 1 Bradleyswitch—Allen Bradley Co.
- 381. 1 Battery Testing Outfit—The Chaslyn Co.
- 382. 1 Saturn Perfect Jack—Saturn Mfg. & Sales
- 383. 1 Radiogem Receiving Set—Radiogem Corp.
- 384. 1 Saturn Automatic Plug—Saturn Mfg. & Sales Co.
- 385. 5 W. D. 11 Fuses—Radio Equipment Co.
- 386. 1 .006 Micon Condenser—Chas. Freshman Co., Inc.
- 387. 1 No. 1 Complete Patterns, Diagrams and Instructions for making Short Wave Regenerative Set; 1 No. 2 Complete Patterns, Diagrams and Instructions for making Detector and Amplifier Radio Units; 1 No. 3 Complete Instructions and Blue Prints for making Radio Phone Crystal Set; 1 Twenty Radio Phone Diagram and Hook-ups of Crystal and Audion Receiving Circuits, Amplifier Circuits, Regenerative Circuits, Sending Circuits, with Key Chart of Symbols and Pamphlet How to Read Diagrams; 1 Fourteen Radio Formulae and Diagrams; 1 Complete and Detailed Instructions—How to Build and Install Every Known Aerial for the Amateur—Consolidated Radio Call Book.
- 388. 1 Year's Subscription to SCIENCE & INVENTION—Experimenter Publishing Co.
- 389. 1 Year's Subscription to RADIO NEWS—Experimenter Publishing Co.

The Most Efficient Compact Inductance Ever Used in Radio

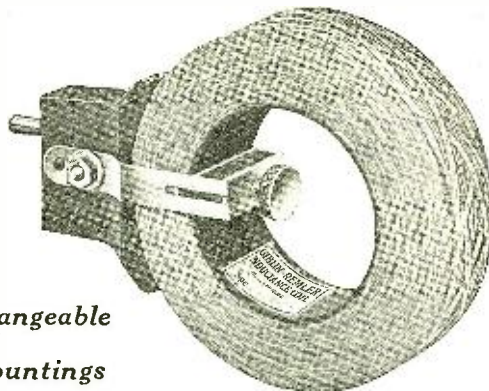

Interchangeable with all Coil Mountings

USE GIBLIN-REMLER COILS for receiving over the entire range of broadcast wave lengths— 228-546 METERS

THERE are two reasons why Giblin-Remler Coils constitute the very best system of broadcast reception under the new assignment of wave lengths for broadcasting stations ranging from 248 to 546 meters.

First: The coil is so designed as to have maximum inductance, minimum distributed capacity, and minimum high-frequency resistance for a given number of turns. These are the three features most essential to obtain maximum signal strength and maximum selectivity.

Second: It is possible, by the use of the accompanying table, to select a single set of coils for use with condensers of .001 mfd. capacity, that will efficiently cover this entire range of broadcast wave lengths.

Furthermore, the use of Giblin-Remler Coils insures greatest possible flexibility. By merely changing one or more of the coils your set may be made to cover any desired range of wave lengths.

Type and Number of Turns, Mounted	Price, Mounted	Type and Number of Turns, Unmounted	Price, Unmounted	Inductance in Milli-Henrys at 1000 cycles Accuracy 1/2 per cent. Natural Wave Length in Meters Accuracy 1/2 per cent.	Distributed Capacity, Pico Farads Accuracy 1 per cent.	Wave Length Range in Meters of .00004 mfd. min.		High Frequency Resistance in Ohms at Wave Length shown
						Min.	Max.	
RG 20M 1.50		RG 20U .70		.030	39	14.3	63	334
RG 25M 1.50		RG 25U .70		.041	47	15.2	75	389
RG 35M 1.50		RG 35U .70		.083	87	23.4	128	550
RG 50M 1.60		RG 50U .80		.169	114	21.6	185	785
RG 75M 1.65		RG 75U .85		.377	163	19.8	266	1170
RG 100M 1.70		RG 100U .90		.666	217	19.9	358	1550
							1000	2000
RG 150M 1.75		RG 150U .95		1.503	281	14.8	512	2320
RG 200M 1.80		RG 200U 1.00		2.68	374	14.7	690	3110
RG 250M 1.90		RG 250U 1.10		4.20	424	12.1	860	3880
RG 300M 2.00		RG 300U 1.20		6.11	494	11.2	1030	4860
RG 400M 2.10		RG 400U 1.30		11.04	618	9.7	1380	6300
RG 500M 2.30		RG 500U 1.50		17.50	747	9.0	1730	7900
							2000	5000
RG 600M 2.30		RG 600U 1.60		29.2	1024	10.1	2260	10250
RG 750M 2.65		RG 750U 1.85		39.0	1249	11.3	2650	11850
RG 1000M 3.40		RG 1000U 2.50		71.6	1620	10.3	3570	16000
RG 1250M 3.80		RG 1250U 2.90		108.0	1930	9.7	4380	19700
RG 1500M 4.40		RG 1500U 3.50		159.8	2300	9.3	5300	23800
							1000	2000
							5000	10000
							10000	20000

These tests have been made by Robert F. Field of Cruft High Tension Electrical Laboratory, Harvard University, Cambridge, Mass.

REMLER RADIO MANUFACTURING COMPANY

Factory and Home Office  
248 First Street, San Francisco, Cal.

Eastern Sales Office  
Chicago, Ill.

GIVE YOUR EARS A TREAT!—USE

# RED-HEADS

3000 Ohms

Now \$6.50

With Military Head-Band and Cord

At your dealers or direct on receipt of price.

A Triumph in Radio, Receiver Design

The Newman-Stern Co. Newman-Stern Building Cleveland, O.

## Radio Supplies at Cut Prices

- Brands or Federal Headsets..... \$5.95
- Jefferson Transformers..... 3.75
- Aeme Audio Transformers..... 3.95
- Aeme Radio Transformers..... 4.25
- Amplifying Transformers..... 3.25
- 22 1/2 Volt Variable "B" Batteries Small..... .90
- 22 1/2 Volt Variable "B" Batteries Large..... 1.75
- 45 Volt Variable "B" Batteries..... 2.50
- Eveready Variable "B" Batteries No. 763 22 1/2 V. 1.25
- Eveready Variable "B" Batteries No. 766 22 1/2 V. 2.25
- Eveready Variable "B" Batteries No. 767 45 V. 4.10
- 43 Plate Variable Condensers..... 1.95
- 25 Plate Variable Condensers..... 1.75
- 3 Plate Vernier Condensers..... .65
- 3 Inch Dials..... .35
- Moulded Sockets..... .15
- Tapered Knob Rheostats..... .15

ALL MAIL ORDERS MUST INCLUDE POSTAGE

**KENSINGTON RADIO SUPPLY CO.**  
4417 18th Ave., Brooklyn, N. Y.

Insure your copy reaching you each month. Subscribe to Radio News—\$2.50 a year. Experimenter Publishing Co., 53 Park Place, N. Y. C.

# Gould Radio Batteries



Gould Radio "B" Battery. (Patent applied for.) The design prevents current leakage. 24 volts in variable 2-volt steps. Non-sloping hard rubber case. \$8.50 f.o.b. factory.

Announcement of an extraordinary development — a permanent power plant for home radio—will be made in the next issue of this magazine.

Look for the Gould advertisement in the September issue.

Gould Radio "A" Battery. Used by the various Radio Branches of the U. S. Government. 60 A.H. to 160 A.H. \$18.00 to \$33.00 f.o.b. factory.



**GOULD STORAGE BATTERY CO.**  
30 East 42nd St., New York  
Plant: Depew, N. Y.

- 390. 1-A. C. H. Sharp Tuner Dial—A. C. Hayden Radio & Research Corp.
- 391. 1 A. C. H. Sharp Tuner Dial—A. C. Hayden Radio & Research Corp.
- 392. 1 Formica Panel—The Formica Insulation
- 393. 1 Year's Subscription to PRACTICAL ELECTRICS—Practical Electrics Co., Inc.
- 394. 1 Westwyre Condenser—The Westwyre Co.
- 395. 1 Bradleyometer—Allen Bradley Co.
- 396. 1 Memory Course—C. K. Dodge.
- 397. 1 Antenna Plug—Chas. Freshman Co., Inc.
- 398. 1 Variable Resistance Leak with .006 Micon Condenser—Chas. Freshman Co., Inc.
- 399. 1 Bradleystat—Allen Bradley Co.
- 400. 1 Klosner Model 200 Vernier Rheostat—Klosner Improved Apparatus Co.
- 401. 1 Resistance Unit and Mountings—Daven Radio Co.
- 402. 1 Pair Bates Ear Cushions for Head Set—Bates & Company.
- 403. 1 Consolidated Radio Call Book—Consolidated Radio Call Book Co.
- 404. 1 Autostat—Automatic Electrical Devices Co.
- 405. 1 Autostat—Automatic Electrical Devices Co.
- 406. 1 Barkeley Four Phone Plug—The Barkeley Electric Mfg. Co.
- 407. 1 Bradleyadapter—Allen Bradley Co.
- 408. 1 Bradleyswitch—Allen Bradley Co.
- 409. 1 Battery Testing Outfit—The Chaslyn Co.
- 410. 1 Saturn Perfect Jack—Saturn Mfg. & Sales
- 411. 1 Radiogem Receiving Set—Radiogem Corp.
- 412. 1 Saturn Automatic Plug—Saturn Mfg. & Sales Co.
- 413. 1 .006 Micon Condenser—Chas. Freshman Co., Inc.
- 414. 1 No. 1 Complete Patterns, Diagrams and Instructions for making Short Wave Regenerative Set; 1 No. 2 Complete Patterns, Diagrams and Instructions for making Detector and Amplifier Radio Units; 1 No. 3 Complete Instructions and Blue Prints for making Radio Phone Crystal Set; 1 Twenty Radio Phone Diagrams and Hook-ups of Crystal and Audion Receiving Circuits, Amplifier Circuits, Regenerative Circuits, Sending Circuits, with Key Chart of Symbols and Pamphlet How to Read Diagrams; 1 Fourteen Formulae and Diagrams; 1 Complete and Detailed Instructions—How to Build and Install Every Known Aerial for the Amateur—Consolidated Radio Call Book.
- 415. 1 Year's subscription to SCIENCE & INVENTION—Experimenter Publishing Co.
- 416. 1 Year's Subscription to RADIO NEWS—Experimenter Publishing Co.
- 417. 1 A. C. H. Sharp Tuner Dial—A. C. Hayden Radio & Research Corp.
- 418. 1 A. C. H. Sharp Tuner Dial—A. C. Hayden Radio & Research Corp.
- 419. 2 Formica Panel—The Formica Insulation
- 420. 1 Year's Subscription to PRACTICAL ELECTRICS—Practical Electrics Co., Inc.
- 421. 1 Westwyre Condenser—The Westwyre Co.
- 422. 1 Bradleyometer—Allen Bradley Co.
- 423. 1 Memory Course—C. K. Dodge.
- 424. 1 Antenna Plug—Chas. Freshman Co., Inc.
- 425. 1 Variable Resistance Leak with .006 Micon Condenser—Chas. Freshman Co., Inc.
- 426. 1 Bradleystat—Allen Bradley Co.
- 427. 1 Klosner Model 200 Vernier Rheostat—Klosner Improved Apparatus Co.
- 428. 1 Resistance Unit and Mountings—Daven Radio Co.
- 429. 1 Pair Bates Ear Cushions for Head Set—Bates & Company.
- 430. 1 Consolidated Radio Call Book—Consolidated Radio Call Book Co.
- 431. 1 Autostat—Automatic Electrical Devices Co.
- 432. 1 Autostat—Automatic Electrical Devices Co.
- 433. 1 Barkeley Four Phone Plug—The Barkeley Electric Mfg. Co.
- 434. 1 Bradleyadapter—Allen Bradley Co.
- 435. 1 Bradleyswitch—Allen Bradley Co.
- 436. 1 Battery Testing Outfit—The Chaslyn Co.
- 437. 1 Saturn Perfect Jack—Saturn Mfg. & Sales.
- 438. 1 Radiogem Receiving Set—Radiogem Corp.
- 439. 1 Saturn Automatic Plug—Saturn Mfg. & Sales Co.
- 440. 1 .006 Micon Condenser—Chas. Freshman Co., Inc.

**ZONE 3**

- 1st W. S. Halstead, Founder's Hall, Haverford College, Haverford, Pa.
- 2nd H. C. Rupp, Broadcast Listener, 48 Montgomery Ave., Shippensburg, Pa.
- 3rd H. B. Davenport, 1631 N. 61st St., Philadelphia, Pa.
- 4th S. Hoffman, 150 S. George St., York, Pa.
- 5th E. S. Grubb, Box 116, R.F.D. No. 4, Hampton, Va.
- 6th R. W. Leonhard, R.F.D., Wexford, Pa.
- 7th E. C. Beatty, Station of E. C. Beatty, Moorefield, W. Va.
- 8th L. H. Copeland, U. S. C. G. Station, Cape Henry, Va.
- 9th J. B. Clarke, McLean, Va.
- 10th F. L. Sharp, 221 Beech St., So., Clarendon, Va.
- 11th H. W. Bennett, Germantown, Md.
- 12th J. H. Coon, Jamestown, Pa.
- 13th E. W. Barlow, 47 Admiral Blvd., Dundak, Md.
- 14th Mrs. J. J. Robertson, Rt. 1, Box 100, Buchanan, Va.
- 15th G. F. Cook, Box 146, Arlington, Va.
- 16th C. F. Clark, Culpeper, Va.
- 17th G. H. Fleming, Jr., 217 N. Chestnut St., Butler, Pa.
- 18th B. Shaffer, Box 296, Somerset, Pa.
- 19th J. J. Goergen, S. Langhorne, Bucks Co., Pa.
- 20th R. L. Downey, 103 Hale Ave., Princeton, W. Va.

## HEADBANDS

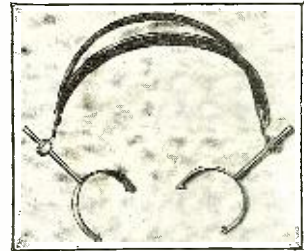

Simple friction slide adjustment. Most satisfactory on the market. No thumb screws to bother with or to catch in the hair. Two yoke sizes fit any 'phones. Bands covered in Black or Khaki webbing. Prompt deliveries on any quantity.

\$500,000.00 worth of special and automatic machinery assures quantity output and guaranteed delivery for manufacturers and dealers on any radio equipment.

Submit sample of product. Write for prices.

**THE AUTOYRE CO.**  
OAKVILLE, CONN.

## THE DEMCAL

The Variable Condenser with a Straight Line—Wave Length Curve

Approximately zero capacity when plates are disengaged

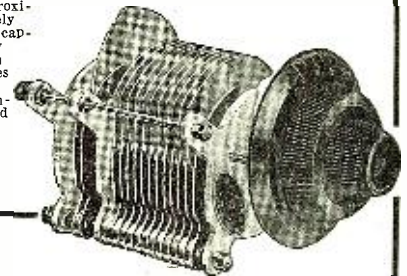

**RADIO ACHIEVEMENT**  
In the Straight Line—Wave Length Curve

3 plate DEMCAL variable condenser	.....	\$2.50
11 plate DEMCAL variable condenser	.....	3.50
11 plate DEMCAL variable vernier condenser	.....	6.50
23 plate DEMCAL variable condenser	.....	5.00
23 plate DEMCAL variable vernier condenser	.....	8.00
43 plate DEMCAL variable condenser	.....	6.50
43 plate DEMCAL variable vernier condenser	.....	10.00

**CALDBECK TOOL & MFG. CO.**  
208-10 E. Walnut St. Des Moines, Iowa

## Starting a Company?

Save expenses and taxes by organizing on the popular, COMMON LAW plan under a pure DECLARATION OF TRUST. No experience required to fill in DEMAREE STANDARD FORMS, issue shares and begin doing business at once. Genuine DEMAREE FORMS are nationally known, approved by attorneys and utilized by successful concerns throughout the United States. Send for large, free pamphlet (D40) containing valuable information that you may need. C. S. DEMAREE, legal blank publisher, 708 Walnut, Kansas City, Missouri.



### Something New

A real Loud Talking Detector made of B-Metal. 100 per cent superior to any crystal. Puts new life into your Radio set. Guaranteed for ONE YEAR. CHEAPEST in the long run. If your dealer is unable to supply it, we will.

B-Metal Refining Co.,  
3134 Trumbull Ave.,  
Detroit, Mich.

## F. D. PITTS CO.

(Incorporated)  
RADIO MERCHANDISE  
WHOLESALE EXCLUSIVELY  
219 Columbus Avenue,  
BOSTON, MASS., U. S. A.

### W.T.501 DETECTOR TUBE

\$2

2

For tube sets, use our special Adaptor, 75c extra. To convert crystal sets into tube sets, use special socket, 40c extra.

Radio Research Guild  
40 Clinton Street  
Newark, N. J.

- 21st W. Morrison, 4301 Liberty Heights, Baltimore, Md.
- 22nd Miss H. J. Jacobs, 1811 E. 33d St., Baltimore, Md.
- 23rd H. F. McConnell, 4515 Springfield Ave., Philadelphia, Pa.
- 24th R. S. Colvin, Fort Story, Cape Henry, Va.
- 25th F. S. Priest, Jr., Hanover Ave., Norfolk, Va.
- 26th C. F. Probst, 19 Wine St., Hampton, Va.
- 27th W. F. Kendall, 238 N. Third St., Harrisburg, Pa.
- 28th H. R. Baker, Huntington Valley, Pa.
- 29th J. Scofield, Lanham, Md.
- 30th F. Brockman, Jr., Duke & Phila. Sts., York, Pa.
- 31st W. H. Marshall, 221 N. Broadway, Scottsdale, Pa.
- 32nd L. Brickhouse, P. O. Box 264, Cape Charles, Va.
- 33rd S. V. Ellis, Waverly, Va.
- 34th Miss A. E. Price, 5 Vincent Pl., Montclair, N. J.
- 35th C. W. Herr, 703 Liberty St., Franklin, Pa.
- 36th N. W. Hill, Huntingdon, Pa.
- 37th W. B. Harrison, Jr., Miller School, Va.
- 38th W. L. Eikenberry, 204 Analomink St., E. Stroudsburg, Pa.
- 39th J. M. Thorne, 54 E. Market St., York, Pa.
- 40th H. E. Hobbs, R.F.D. No. 2, Chevy Chase, Linden, Md.
- 41st G. A. Gale, Walsey Farm, Queenstown, Md.
- 42nd E. D. Zook, Millcreek, Pa.
- 43rd A. E. Grieshaber, Urbanna, Va.
- 44th W. C. Smith, 6314 H. St., Philadelphia, Pa.
- 45th G. B. Fitzgerald, 16 E. Locust St., Mechanicsburg, Pa.
- 46th A. Norden, Jr., 25 S. Ashmead Pl., Germantown, Philadelphia, Pa.
- 47th H. M. Collins, Box 216, Mt. Troy Rd., Millvale, Pa.
- 48th H. H. Leh, 32 Green St., Nazareth, Pa.
- 49th H. K. Ellis, 518 Washington Ave., Phoenixville, Pa.
- 50th C. P. McCabe, Box 394, 426 Schenck Ave., Butler, Pa.
- 51st J. B. Bell, Torrance, Westm'd Co., Pa.
- 52nd G. W. Korman, Osceola Mills, Pa.
- 53rd A. L. Larrick, 318 N. Main St., Winchester, Va.
- 54th E. W. Chappell, Bank St., Urbanna, Va.
- 55th J. M. Bridges, 248 S. Hanover St., Carlisle, Pa.
- 56th A. W. Sheasley, War Vets Hospital, Mont Alto, Pa.
- 57th F. Dahlin, West Moshannon, Pa.
- 58th M. F. Walters, R.F.D. No. 2, Box 14-A, Middleburg, Pa.
- 59th C. Herrick, Shinglehouse, Pa.
- 60th E. R. Rhodes, Luray, Va.

**ZONE 4**

- 1st G. Anderson, 403 Jefferson St., Port Clinton, O.
- 2nd P. Rinkes, R.R. No. 2, Box 8½, St. Clairsville, O.
- 3rd J. H. Brumbaugh, 1612 Lake Ave., Wilmette, Ill.
- 4th B. Millen, 203 High St., Lebanon, Ky.
- 5th D. F. Starr, Box 15, Sinclair Ave., Steubenville, O.
- 6th E. M. Wise, 330 Victoria Pl., Toledo, O.
- 7th H. G. Simmons, 217 Kingston Rd., Kokomo, Ind.
- 8th Norman C. Hurd, 188 Rob Roy Ave., Fort Thomas, Ky.
- 9th J. M. Fowle, 2520 Scottwood Ave., Toledo, Ohio.
- 10th J. E. Wilson, 506 Shelby St., Frankfort, Ky.
- 11th C. C. Beacham, Chesterville, O.
- 12th W. A. Triplett, Montgomery Motor Co., 12 E. High, Mt. Sterling, Ky.
- 13th C. Coleman, 308 Alta Ave., Danville, Ky.
- 14th H. C. Clark, The Athens Electric Co., 29 S. Court St., Athens, O.
- 15th A. Owen, 2556 Scottwood Ave., Toledo, O.
- 16th G. T. Bucy, R.F.D. No. 3, Newark, O.
- 17th C. A. Gasser, Amer. Tel. and Tel. Co., Maumee, O.
- 18th C. M. Hauser, 360 White St., Toledo, O.
- 19th J. J. Stosick, 729 Montana Ave., S. Milwaukee, Wis.
- 20th W. J. Baker, Route 14, Dayton, O.
- 21st R. Earhart, 2722 Hampshire Rd., Cleveland, Ohio.
- 22nd H. Gettles, Wellston, O.
- 23rd M. De Ford, Box 32, Toboso, O.
- 24th F. Adcock, 116 W. Hickman St., Winchester, Ky.

**ZONE 5**

- 1st K. Richardson, Box 1013, Ft. Lauderdale, Fla.
- 2nd J. T. Foy, Clemson College, S. C.
- 3rd F. V. Long, Radio 41H, Boca ratone, Fla.
- 4th W. F. Rose, 507 Alabama Ave., Birmingham, Ala.
- 5th B. F. Robertson, Clemson College, S. C.
- 6th Mrs. H. G. Utley, 407 W. Second Ave., Gastonia, N. C.
- 7th J. W. Robertson, Tuscaloosa, Ala.
- 8th H. G. Elliot, 27 E. 4th St., Atlanta, Ga.
- 9th F. L. Northrop, Tarpon Springs, Fla.
- 10th H. D. Kennedy, 28 Stockton St., Jacksonville, Fla.
- 11th W. Moore, care Austin Motor Co., Tuscaloosa, Ala.
- 12th N. S. Foy, Clemson College, S. C.
- 13th W. Garrard, 1430 N. 12th Ave., Birmingham, Ala.
- 14th D. M. May, 112 N. Everett St., B. nettsville, S. C.
- 15th A. J. Humphrey, Box 1273, Wilmington, N. C.
- 16th H. F. Richardson, 316 35th St., N. E., Miami, Fla.

# Permanently Satisfactory

Radak C23 Radio Frequency sets are a permanent investment — NOT A SUMMER MAKESHIFT.

SUMMER or WINTER this apparatus will stand up to your most exacting requirements and will harmonize with all surroundings.

The NEW RADAK models are invariably mentioned wherever quality instruments are discussed.



## Model C23 Price \$125.00

One stage Tuned Radio Detector.

Two stages of Audio.

Operates on either dry cells or storage batteries.

Bulletin describing Model C23 sent free upon request.

Insist upon RADAK for best results.

If your local Dealer cannot supply you, write us direct!

*DEALERS—write for our proposition—it means dollars to YOU.*

# Radak

**CLAPP-EASTHAM COMPANY**

107 MAIN STREET

CAMBRIDGE, MASS.

## Radio for Your Auto



This latest improvement will enable you to have a loud speaker right in your auto, as you are running along the road.

This complete set, consisting of detector and two-stage amplifier is entirely portable, weighing only seven pounds, and requires no storage battery. It uses UV 199 tubes, and flashlight battery for filament. It can be carried anywhere, and has a range of up to 3,000 miles. Get our complete catalog.

**STEINMETZ WIRELESS MFG. CO.**

5705 Penn Avenue

Pittsburgh, Pa.

## Rainbow Multi-Plug & Cable



Put this type on your new set it is small and may be mounted anywhere with cord and plug \$4.00 Type P.M.



Put this type on seven binding posts of your present set. With cord and plug \$5.00 Type B.P.



Put your Batteries on shelf in basement and run this 8 ft. cable through floor to set.

5A and B. Battery wires in cable. Antenna and ground are separate leads from cap. Guaranteed not to impair efficiency of set. For sale by all Jobbers and Dealers.

Fully covered by patents applied for. **Manufactured by HOWARD B. JONES**  
608 S. Canal St. Chicago, Ill.

# HERE!



## Buy Only a Non-Selective Transformer

Good quality demands equal amplification for all frequencies within the voice range. The 3.7 to 1 ratio of the Type 231A amplifying Transformer gives maximum amplification without distortion, in multi-stage as well as in single stage amplifiers.

High ratio amplifying Transformers are selective—and selective transformers have a resonant peak that causes serious distortion.

The General Radio Co.'s type 231A Transformer is suitable for use with UV-201A, 201, 199, WD-11, 12 and tubes of similar plate impedance. \$5.00.

At your dealers, or direct from us: Two educational folders, "Quality Amplification," and "Quality Condensers." Ask your dealer or write us. Send for free Radio Bulletin 914N.

## GENERAL RADIO CO.

Manufacturers of  
**Radio and Electrical  
Laboratory Apparatus**

CAMBRIDGE, MASSACHUSETTS

5419

# Build Your Own HAZELTINE NEUTRODYNE with FREED-EISEMANN Licensed Essential Parts



Complete wiring diagram, instructions, etc. sent in special container with patented essential parts. Three NEUTROFORMER COILS

mounted on variable condensers, and DOUBLE NEUTRODON (as illustrated), sent for \$21.50. Ask your dealer to show you these parts, as well as complete assembled five-tube Neutrodyne Set in mahogany cabinet, Model NR-5, \$150.

Or send 25c for Neutrodyne Constructor which shows "How to Make the Neutrodyne"

**FREED-EISEMANN RADIO CORPORATION**  
Dept. E  
255 Fourth Avenue New York  
Licensed by I. R. M. Inc. Under Hazeltine Patents

- 17th L. T. Smith, Jr., 615 E. Holmes St., Huntsville, Ala.
- 18th H. P. Black, 326 Clematis Ave., West Palm Beach, Fla.
- 19th J. R. Williams, Jr., 11 Meeting St., Charleston, S. C.
- 20th A. E. Windle, Box 818, Wilmington, N. C.
- 21st H. Reeves, 5 Church St., Wilmington, N. C.
- 22nd Lt. H. W. Duncan, 17th F. A., Ft. Bragg, N. C.
- 23rd L. Spell, Bonifay, Fla.
- 24th G. Welles, 1876 N. W. 22nd Court, Allapattah, Fla.
- 25th L. B. Coleman, Selma, Ala.
- 26th H. V. Manning, care Manning & Wink, Etowah, Tenn.
- 27th L. Clayton, 1931 Forbes St., Jacksonville, Fla.
- 28th B. Smith, Charlotte, N. C.
- 29th C. Enuis, 110 N. Ellis St., Salisbury, N. C.
- 30th H. H. Iier, Hillsboro, N. C.
- 31st C. R. Rodwell, Jr., Warrenton R. R. Co., Warrenton, N. C.
- 32nd W. P. Stainback, 411 Charles St., Henderson, N. C.
- 33rd L. M. Lester, Raeford, N. C.
- 34th B. M. Boyd, 19A Burton Ave., Montgomery, Ala.
- 35th R. Hatt, 393 Brad St., Darlington, S. C.
- 36th G. L. Pritchard, 5 Hancock St., Oxford, N. C.
- 37th D. Alston, Box 29, Warrenton, N. C.
- 38th J. Duncan, 608 Seigle Ave., Charlotte, N. C.
- 39th L. Thomas, 510 Sherman St., Albany, Ala.
- 40th C. G. Council, Parkton, N. C.
- 41st J. S. Winget, Box 234, Gastonia, N. C.
- 42nd J. A. Shuford, Lincolnton, N. C.
- 43rd A. L. Godwin, Bonifay, Fla.
- 44th J. B. Wood, Greshamville, Ga.
- 45th H. Wiggins, 603 4th Ave., W., Albany, Ala.
- 46th W. Cockrell, Box 144, Swannanoa, N. C.
- 47th J. Wood, 8 Woodward Ave., Montgomery, Ala.
- 48th W. Sessoms, Box 145, Raeford, N. C.
- 49th H. W. Holt, Warrenton, N. C.
- 50th Ralph Coady, Hopkins, Fla.

### ZONE 6

- 1st C. M. Stanley, 2219 W. 49th St., Minneapolis, Minn.

### ZONE 7

- 1st E. A. Ralfe, Wynne, Ark.
- 2nd Gary Flowers, Wynne, Ark.

### ZONE 9

- 1st H. W. Hiscocks, 55 Barker St., Niagara Falls, Ont., Can.
- 2nd A. C. Parsons (3QA), 42 Winnifred St., Smith's Falls, Ont., Can.
- 3rd T. J. Davison, Avondale Farm, Brockville, Ont., Can.
- 4th J. E. Caughey, Wallaceburg, Ont., Can.
- 5th R. A. Brown, 310 Rubidge St., Peterboro, Ont., Can.
- 6th F. Powers, Bridgewater, N. S., Can.
- 7th R. Hills, P. B. 375, Truro, N. S., Can.
- 8th J. A. Kemp, 20 Laviolette Ave., Three Rivers, Que., Can.
- 9th H. Fairbourn, Can. Pac. Ry. Co., Brockville, Ont., Can.
- 10th W. J. Thomson, 157 Church St., Brockville, Ont., Can.
- 11th L. F. Knight, Box 438, Prescott, Ont., Can.
- 12th C. P. Strowger, 131 Marlboro St., Brantford, Ont., Can.
- 13th A. F. Powers, District IX, Lunenburg, N. S., Can.
- 14th F. E. White, 118 Adelaide St., London, Ont., Can.
- 15th A. E. Warren, N. Augusta, Ont., Can.
- 16th F. J. McGoldrick, P.O. Box 796, Bridgewater, N. S., Can.
- 17th W. Loughheed, 286 Runnymede Rd., Toronto, Ont., Can.
- 18th Miss N. Anderson, 121 Le Jeune St., Three Rivers, Que., Can.
- 19th A. Henry, Walkworth, Ont., Can.
- 20th L. W. Johnson, 89 Scott St., Thomas, Ont., Can.
- 21st R. M. Fowler, 277 Rubridge St., Peterboro, Ont., Can.
- 22nd Grant Allen, Walkworth, Ont., Can.
- 23rd C. L. Palmer, 53 Langarth St., London, Ont., Can.
- 24th A. J. Knowlton, 2 Silver Birch Ave., Radio Station 3AAE, Toronto, Ont., Can.
- 25th C. H. Nixon, P.O. Box 338, Kentville, N.S., Can.
- 26th K. S. Rogers, Canadian Radio 9AX, 53 Bayfield St., Charlottetown, P. E. Island, Can.
- 27th H. L. Blaikie, Box 255, Truro, Ont., Can.
- 28th J. White, Box 273, Truro, N. S., Can.
- 29th Chas. E. Slack, Abbotsford, P. O., Can.
- 30th W. Parenteau, 8 Bellerive S., Cape Madeleine, Champlain Co., P. O., Can.
- 31st S. R. B. Walker, 65 Oxford St., Guelph, Ont., Can.
- 32nd G. F. Mann, Ridgeway, Ont., Can.
- 33rd S. Cross, 80 Montreal St., Sherbrooke, Que., Can.
- 34th L. C. Meyer, Western, Ont., Can.
- 35th G. F. MacRae, 217 St. John St., Fredericton, N. B., Can.
- 36th L. G. Fontaine, 64 Ave. de Salaberry, Quebec, P. Q., Can.
- 37th B. M. Ingleson, 103 Millicent St., Toronto, Ont., Can.
- 38th J. W. Horning, Sydenham, Ont., Can.
- 39th A. E. Sanford, Brighton, Ont., Can.
- 40th Fritz Dakin, Digby, N. S., Can.
- 41st M. F. Backhouse, Stewiacke, Col. Co., N. S., Can.
- 42nd Rev. Bro. Barthelemy, Académie Girouard, St. Hyacinthe, P. Q., Can.
- 43rd H. F. Archibald, Wolfville, N. S., Can.

## Radio Dealers Tie Up With Ludwig Hommel & Co.

- (1) Their discounts are liberal.
- (2) They wholesale to dealers exclusively and do not compete with their dealers by retailing.
- (3) They carry an enormous stock of sending and receiving material, insuring you quick shipment and a positive source of supply.
- (4) They maintain a Dealer's Service Department to help you with your problems. This service is free and cheerfully given.
- (5) They are distributors for the Radio Corporation of America and all the other leading manufacturers.
- (6) You can rely absolutely on Ludwig Hommel & Company apparatus. It is guaranteed by the manufacturers and by them.
- (7) They do more advertising than any other distributors of Radio Apparatus and refer to their dealers consumers' inquiries resulting from that advertising.
- (8) They have been wholesale distributors for 16 years and play square with everybody at all times.

Ask for Hommel's Encyclopedia of Radio Apparatus 225S and order your requirements now for immediate delivery.

**LUDWIG HOMMEL & CO**  
530-534 FERNANDO ST. PITTSBURGH, PENNA.



## THE SATURN "Automatic" Radio Plug

**\$1.25**

Truly "Automatic"

Also

## SATURN "Perfect" Jacks

They are all their name implies—"Perfect"

From 50c. to 80c. each

The Saturn Mfg. & Sales Co., Inc.

Dept. R.N.

48 Beekman Street

New York, N. Y.

WHATEVER YOU WANT WHEREVER YOU ARE Let Us Get It For You

## AMSTERDAM SERVICE EXCHANGE

Amsterdam, Ohio, U. S. A.

Radio and Cablegrams "Service"

**CORYDON SNYDER CODE METHOD**  
TRADE MARK REG.

YOU WILL LEARN THE WIRELESS CODE IN 3 HOURS OR LESS BY THIS METHOD.

NOW 50c AND YOUR MONEY BACK IF NOT SATISFIED.

Send to

**CORYDON SNYDER**

1161 So. Ridgeland Ave.,

OAK PARK ILL.

- 44th C. W. Bailey, 346 Clinton St., Toronto, Ont., Can.
- 45th S. H. McNeill, Smith's Falls, Ont., Can.
- 46th J. Fassett, care Acadia Sugar Refinery, Woodside, Dartmouth, N. S., Can.
- 47th A. B. Mann, Stewiacke, N. S., Can.
- 48th G. W. Griggs, 298 Dalhousie St., Brantford, Ont., Can.
- 49th G. W. Young, Ridgeway, Ont., Can.
- 50th H. R. Ryckman, 517 Nelson St., London, Ont., Can.
- 51st G. A. Sandoz, Emscote Cottage, Francklyn St., Halifax, N. S., Can.
- 52nd A. E. Goyo, 313 Monmouth Rd., Town of Mount Royal, Montreal, Can.
- 53rd Bert MacLeod, R. R. No. 2, Cornwall, Ont., Can.

## A New Use for Loud Speakers

(Continued from page 133)

Eight transmitters were supplied with the system, usable at any point in the big setting. By means of a control switch in the switchboard house, the director can be connected to any point at once. In the control room is a monitor horn, by which the operator can instantly detect the condition of the apparatus, and 12 Western Electric 6A horns, connectable in multiple, are distributed at the important points. These are specially designed for this type of work. Three are in multiple over the big replica of Notre Dame Cathedral, the rest in and about the old buildings on the Paris streets reproduced in the setting.

Seven circuits lead off the volume control switchboard for the 12 horns and any number may be connected for any special needs. In the control house is a potentiometer control ranging over 24 points to regulate distance of carrying. Each reproducer has in addition a rheostat control.

The volume indicator in the control house is an innovation in this type of system. It operates on a new principle, and is in effect a galvanometer showing 15 points on proper regulation.

A field telephone set enables the director on the scenes to talk back to the switchboard in case of any derangement of the apparatus.

The first three steps of amplification are single, and the fourth or final is a "Push-Pull" arrangement—in effect power amplification.

Radio messages can be received by use of a Radio Receiver, and amplified over the board and broadcast in the same manner as the director's messages are transmitted. A loop antenna is used for this.

The uses of the set on the picture lot are manifold. Most important, of course, is the work of directing the mob scenes, one director in the tower overlooking the action being able instantly to direct any part of the crowd. It is also used similarly for paging players on the big lot.

The "inspirational music," a valued adjunct to acting for films, is also broadcast for the crowds of players over the apparatus. In fact, the set has made possible for the first time in film history the use of music for mob scenes. Radio concerts between waits are given the crowds of actors, too, thus strengthening morale and creating an esprit de corps that alone has saved a small fortune in the big picture, according to Wallace Worsley, director, and Lon Chaney, star of the production.

## Recent Developments In Radio

(Continued from page 141)

Dr. de Forest had used his invention for a few years only, when it was found that if this tube were reversed it could be used for transmitting purposes, instead of for receiving. In other words, the Vacuum Tube can be made to send out powerful radio

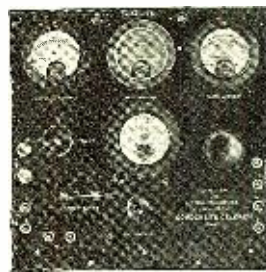
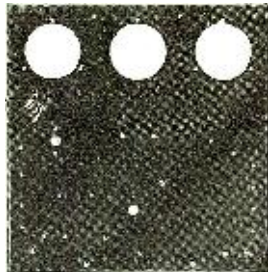
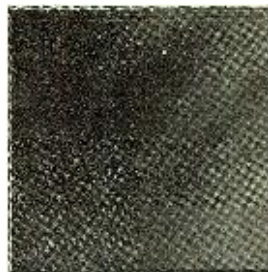

## BAKELITE Condensite REDMANOL

The United States Navy Department, the Signal Corps, and the leading Radio Manufacturers, without exception, have adopted our material in one form or another.

They use it because it's a standardized product of uniform qual-

ity, and because it is ideally adapted to the manufacture of radio apparatus.

In Laminated form its surface and volume resistivity are extremely high and the dielectric losses quite low as shown by the following Bureau of Standards Tests:

PROPERTIES	HARD RUBBER	LAMINATED PHENOLIC INSULATING MATERIALS
Dielectric strength, volts/mm	10,000 to 38,000	27,000 to 45,000
Tensile strength, lbs. per square inch	3,500 to 6,500	10,000 to 25,000
Water absorbed in twenty-four hours immersion, percentage of weight	0.02	0.2 to 1.0
Thermal expansivity at 20 to 60 degrees Centigrade	60 to 80 x 10 <sup>6</sup>	20 to 30 x 10 <sup>6</sup>
Heat	At 65.5C. (150F.) hard rubber softens perceptibly; at 100C. (212F.) it is so soft it may be bent easily; at 115.5C. (240F.) it becomes leathery and may easily be cut with a knife; melts at 200C. (392F.)	Not readily inflammable; will withstand continuously temperature of 149C. (300F.) Heat tends to complete reaction and volatile substances are driven off.
Sunlight	Discolors and disintegrates after a few months; the sulphur of the hard rubber is oxidized, forming the equivalent of sulphuric acid; this may take up ammonia from the air or may attack the filling materials forming the various sulphates on the surface; the surface resistivity is greatly reduced.	No visible effect.

Divisions of  
**BAKELITE CORPORATION**

**BAKELITE**  
General Bakelite Co.  
8 West 40th St. New York

**Condensite**  
Condensite Co. of America  
Bloomfield, N. J.

**REDMANOL**  
Redmanol Chemical  
Products Co.  
636-678 West 22nd St.  
Chicago, Ill.

Our licensed fabricators are prepared to furnish radio parts molded from our products and also machined or engraved panels in large or small quantities at very reasonable prices. Names on request.

**BAKELITE CORPORATION**  
Address the Divisions

## The Material of a Thousand Uses

### HYGRADE SPECIALS

- 200 ft. 7 strand No. 22 Copper aerial wire...\$1.25
  - Morse Eureka Test Clips, per dozen..... .50
  - Skinderviken Transmitter Buttons..... .95
  - No. 763 Eveready 22½ V. Variable B. Bat..... 1.25
  - No. 766 Eveready 22½ V. Variable B. Bat..... 1.98
  - No. 767 Eveready 45 V. Variable B. Battery..... 3.98
  - 2000 Ohm Murdock No. 56 Head Sets..... 3.75
  - 3000 Ohm Murdock No. 56 Head Sets..... 4.25
  - Federal or Brandes Head Sets Complete..... 5.95
  - Dictograph 3000 Ohm Head Sets..... 5.98
  - Fada or Framingham Rheostats..... .65
  - Acme Amplifying Transformers (new type)..... 3.75
  - Acme R. F. Transformers, Types R2—R4..... 3.98
  - 6 Volt Marko Storage Batteries..... 8.95
  - Firco (Bull Dog Grip) Phone Plugs..... .75
  - Federal Amplifying Transformers..... 4.75
  - 23 Plate Var. Cond. Bakelite Ends..... 1.49
  - 43 Plate Var. Cond. Bakelite Ends..... 1.95
- All orders must include Parcel Post charges.

**Hygrade Electrical Novelty Co.,**  
41 West 125th Street New York, N. Y.

### TWO SUPERSENSITIVE CIRCUITS

(Both Copyrighted)

My Highly Improved Reinartz brings in all important stations on both coasts and Mexican border, loud, clear and without distortion. We dance to music from Atlanta received on one loud Baldwin unit. Build one of these wonderful sets from my blueprints and specifications, price 50c, or with a perfect and complete double wound spiderweb coil, \$3.00 by mail. No other windings used. Photo of my set on a glass panel with every order.

My W. D. I. Circuit is especially designed for use with the "Pickle" tube and brings out the full value of that little tube as no other circuit can. Stations 1000 miles away come in clearly on one tube. This set is small, complete, portable. For the man who wishes the highest efficiency this is the set to build. Price of blueprint and specifications 50c, or with complete and perfect windings \$3.00. Photo of set with every order.

Either set is cheap and easy to build, easy to operate. Everything clearly shown.

S. A. Twitchell, 1927 Western Ave., Minneapolis, Minn.

**KILLOCH HEAD SET**  
2000 OHM \$3.25 POSTPAID IN U. S. A.  
Baldwin Head Set \$8.75 Postpaid in U. S. A.  
Send For Radio Catalogue  
**DAVID KILLOCH CO., 57 Murray St., N. Y. City**

**Chelsea Regenerative Equipment**  
Licensed Under Armstrong U. S. Patent  
October 6, 1914  
Write for Bulletin No. 7  
**CHELSEA RADIO COMPANY, CHELSEA, MASS.**

## USE A C H SHARP TUNER DIALS

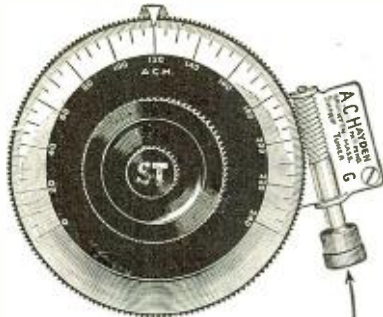

Why the A.C.H. is different

3 in. DIAL

156-t0-1

4 in. DIAL

215-t0-1

Rough tuning with dial or one thousandth of an inch in either direction.

### Money Back Guarantee

Price ACH 3" Dial complete..... \$2.50  
 Price ACH 4" Dial complete..... 5.00  
 Regular fitting 5/16" hole, 1/4" and 3/16". Bushings, 5c. each extra. 10c for all.

### LONG DISTANCE A C H DETECTOR SET UNWIRED



PRICE \$20.00 Including 2-3" ACH Dials  
 WRITE FOR 3 WAYS TO PURCHASE

## A. C. HAYDEN RADIO & RESEARCH CO.

Brockton, Mass., U. S. A.  
 Mail Orders sent prepaid in U. S. A.

waves as well as receive waves. The transmitting tube, therefore, takes the place of the old Marconi Spark Gap, and the more recent Alexanderson Generators. Indeed a tube recently constructed by one of our great electrical companies handles over 1,000,000 Watts, and does not take up much more space than an ordinary desk drawer. But this tube can handle sufficient energy to throw radio waves across continents and oceans. Already our big trans-Atlantic stations, which comprise many acres of ground to house their machinery, are doomed on account of this new monster tube. The future radio station power plant will be located in a small room less than 10 feet square, instead of so many acres. And, best of all, a Vacuum Tube handles the energy with much greater economy than the Generators did before.

The versatility of this tube, which has often been called "Aladdin's Lamp" quite appropriately, does not stop here. For instance, when a man in New York picks up his telephone receiver and asks for a friend in San Francisco, he little realizes that he could not do so at all were it not for the Vacuum Tube. Without this it would be impossible to speak over such great distances. Only the perfection of the Vacuum Tube makes the long distance wire telephone possible.

You would not think it possible to measure 2/1,000,000 of an inch. This, however, can be done readily by means of the Ultramicrometer, an instrument that would not have been in existence without the use of the Vacuum Tube.

Imagine a bar of steel, 10" long, and 1/2" thick. If a fly hops upon this rod, the small weight of the fly will depress this heavy rod a sufficient amount so that it can be measured on the Ultramicrometer—a thing almost impossible to conceive, but true, nevertheless.

In the latter part of 1922, the War Department sent a radio message to an airplane aloft, and this message came out in the form of a tape with the words typed upon it in plain English. In other words, the order was given by radio and the message was typed in intelligible words, in ordinary characters that everyone could understand. The operator made his reply likewise, from the airplane, and the message was received in the War Department on a printed strip, in the English language. All of this has been accomplished thanks to the wonderful Vacuum Tube.

We do not stop here, however. John Hays Hammond, Jr., has repeatedly demonstrated that he can control an airplane from the ground entirely by radio, without the necessity of having an operator aboard. In other words, it is possible today to send a radio-controlled airplane over the enemy's lines or fortifications, and drop bombs at will. All of this can be directed by radio from the ground, at a distance. Again the Vacuum Tube makes this possible.

Recently the Navy Department sent out a battleship on which there was not a human being aboard. Impossible as it seems, the battleship was entirely controlled by radio, from shore, and it was not possible for the maneuvering "enemy" ships to stop the operation of this radio-controlled vessel. All the controls were made by radio. Thus the ship was steered, made to go in a circle, reversed and run backwards. The oil fuel was fed into the furnaces by means of radio control, and there was not a time when the huge monster was not in full control by its distant operator.

There is no question but that in the future we shall have such radio-controlled monsters and their uses are not entirely confined to the sea, because the United States Army has already experimented with radio-controlled tanks, which can be sent out into the enemy's lines without a human being on board to guide them. Again it is the frail little

The choice of foremost Engineers for over 17 years.

Sold by all dealers

## BRACH VACUUM RADIO PROTECTOR

Approved by the National Board of Fire Underwriters

Ask YOUR Insurance Agent

L. S. BRACH MFG. CO., Newark, New Jersey

## SOLDERALL

Metal in Paste Form

Handy Tubes 25¢

Every Electrical Connection Needs Solderall for Perfect Reception.

The Only Convenient Metal Solder

Look for this Label

Ask your Dealer

### Improve Your Present Set or Make a New One Better by Using

### Branston Lateral Wound Honeycomb Inductance Coils

(Licensed under DeForest Patents)  
 Ask your "Old Timer" Radio friend why sets using Honeycomb Coils are best.

Send 4c in stamps for Series 1 "Hook-Up" Circular showing five good Honeycomb coil hook-ups and Catalog of famous Branston Radio materials. Write today. Give us name of your Radio Dealer. If he can't supply you, let us know.

CHAS. A. BRANSTON, Inc.  
 817 Main St., Buffalo, N. Y.  
 In Canada Chas. A. Branston, Ltd., Toronto, Ont.



### Practical Radio Operating

Code room equipped with Kleinschmidt automatic transmitter, thorough preparation for passenger and freight ship radio operator's position. Write today for our booklet

"When in New York Pay Us a Visit" Arc-Spark-Vacuum Tubes.

Y. M. C. A. RADIO SCHOOL  
 "Best Radio School in the East"  
 158 East 86th Street, New York City

A QUALITY BATTERY

Always Dependable

Marko Storage Battery Company  
 1404 Atlantic Ave.  
 Brooklyn N. Y.

# Summer Static Overcome

"Good-bye Aerial"

## ANTENELLA

No aerial or antenna needed

All outside wiring, aerial, lightning arresters, switches and other inconveniences so inductive to static are eliminated.

Merely plug Antenella in any light socket and you can enjoy all Radio pleasures in any room in your home, apartment or hotel. No current consumed.

New Improved

## ANTENELLA NOW ONLY \$1.25

formerly \$2.00

At your dealers—otherwise send purchase price and you will be supplied postpaid.

## Chas. Freshman Co. Inc.

Radio Condenser Products  
 106 SEVENTH AVENUE, NEW YORK

Vacuum Tube that does the work, as without its use there would not be any radio-controlled airplane, battleship, or tank.

During the war the Vacuum Tube had its fire baptism, and some of the greatest inventions in radio really were made during that time.

Before the war we used aerials, generally; that is, overhead wires, in order to receive radio messages. During the war, the so-called "Loop, or Indoor Aerial" was developed to a wonderful degree. Although the Loop, which is nothing but a wire wound on a square frame, was known before the war, it was never used much. At that time, when it was not possible to use aerials, the loop aerial came into use more and more, and it is now only a question of time when all outdoor aerials will disappear.

The great advantage of the loop type or indoor aerial is that it has directional qualities. By this is meant that if you have a loop receiver and Chicago is broadcasting a concert, you turn the loop so that its edge, or narrow side, points toward Chicago. You will then receive the music or entertainment with maximum intensity.

This quality is made use of in the Radio Compass. When the captain of a ship, nowadays wishes to know what his position is at sea, he does not make any lengthy calculations, as he used to do of yore. He picks up his telephone and calls down to "Sparks," the Radio Operator on board the ship, and utters these few laconic words: "What is our position?" Immediately "Sparks" gets in touch with the nearest land station. There are usually two such stations which receive the call. The distance between these two land stations is known exactly to the land operators. By means of well-known triangulation methods, the position of the ship is ascertained accurately within a few yards, in less than three minutes from the time the call comes in from the distant ship. The land operator of the compass station then radios back to the ship and gives the ship its exact location, exact within a few yards, as mentioned above. In other words, a captain nowadays, if he is in a fog, or during the night, when he has no means for direct observation, can, within a few minutes, ascertain the exact position of his ship. This is not a theory or a dream, because it now happens several hundred times each and every day, all over the world.

Another surprising development of radio is sending pictures from a distance. This is not a new invention either, as it has been known for the last 15 years, but the use of the Vacuum Tube has made the invention commercially practical, and it is not uncommon these days to have pictures sent from France to America by radio, within a few minutes. The Frenchman, Belin, who has made a specialty of such picture-transmission, has achieved remarkable results. The principle is quite simple: Each station, either receiving or sending, has a revolving cylinder upon which the picture, properly prepared, is wrapped. A stylus then travels over the picture, making contacts on certain parts, and these contacts are translated into radio waves, and are shot out to any distance required. At the other end a similar stylus actuates upon a cylinder, and in a few minutes the picture has been assembled, and can then be reproduced by the regular process. Thus it is possible today, by means of such a machine, to radio important photographs or pictures across land and sea in the short space of a few minutes.

Another surprising new use for radio has been found recently in mining. By means of radio waves it is now possible to accurately locate ore or coal deposits. The principle is simple: Radio waves pass through solid substances as easily as light passes through a solid glass block. As long as we have only plain earth or sand, the radio waves travel through such strata without much difficulty. If, however, the waves

# Brandes



## This man knows Radio!

HE knows how to get the *best* out of his set. New hook-ups, new tubes, new parts—he tests them all and finds the best. He was a wireless fan long before radio became the greatest indoor sport. Fifteen years ago he used Brandes. Today he still sticks to his Brandes *Matched Tone* Headset.

He knows that its *Matched Tone* assures a clear and harmonious reception of the worldful of interesting news which his set picks up. He gets it all—perfectly—with a Brandes.

Made in Canada and England by  
Canadian Brandes Limited, Toronto and London  
Distributed in Canada by Perkins Electric Limited  
Toronto — MONTREAL — Winnipeg  
Distributors in Australia and New Zealand  
International Electric Co., Wellington, N. Z.

C.Brandes, Inc. — 237 Lafayette St., N.Y.C.

## Matched Tone

TRADE MARK REG. U.S. PAT. OFF.

## Radio Headsets



### The How and Why of Radio Apparatus

By H. W. SECOR, E.E.



This newest book on radio matters fills a distinct gap in wireless literature. While the treatment is made as understandable and as free from mathematics as possible, it at the same time incorporates a wealth of technique and instruction for the Radio Amateur—the Radio Operator—the Installation and Designing Expert—as well as teachers and students of the subject in general. A very broad field has been covered by the author, giving a great amount of information not found in other text-books. If you are engaged in any branch of the Radio or allied arts you will surely need this latest contribution to radio literature. This newest of Radio Works has 160 pages, 6 x 9 in. Hundreds of illustrations and tables. Cloth bound in Vellum de Luxe, stiff covers, hand-sewed, gold stamped, ea. \$1.75

Every phase of experimental electricity is treated comprehensively in plain English. New Experiments are described and explained and nearly every application of Electricity in modern life is given in simple language.

A masterpiece. Explains every electrical device from a push button and bell to the biggest generator made. Worth its weight in gold for the man who wishes to know about electricity, and to the experimenter it is still more valuable because of its many facts, tables, etc.

The Best Electrical Text-Book on the Market. Size of Book is 6 x 9. The book contains 128 pages and more than 400 illustrations. Cloth bound, stiff covers, \$1.25 hand-sewed, green and black stamped, each

### Experimental Electricity Course in 20 Lessons

By S. GERNSBACK and H. W. SECOR, E.E.



DEALERS—Ask for Wholesale Discounts

EXPERIMENTER PUBLISHING CO., Inc., 53 Park Place, New York

Your Phone Plus Fibertone Makes  
a Beautiful Musical Instrument

**A better  
horn at  
a lower  
price \$8**

A vast increase in the demand for the Fibertone has brought a decrease in the price to \$8. With new scientific developments by men living in the atmosphere of perfect musical instruments, this becomes a great event in radio history. Pleasurable radio entertainment can now be had at a cost that is not a burden to the average enthusiast's pocketbook.

The true-toned performance of the Fibertone is due to its construction of fiber. No vibrative sounds can possibly mar the clearness of its amplification, as often occurs in horns of metal.

Your nearest dealer will be glad to demonstrate the Fibertone to you.

Dealers, write for information.

Fiber Products Company  
240-F N. 10th Street, Newark, N. J.

**FIBERTONE**



encounter ores or coal veins, they are obstructed or deflected. An observer at the other end can readily tell whether the signals are coming through strongly or faintly, and if they do come faintly he will know that the waves have been obstructed. By using a certain index and by actual observations it can be calculated not only as to whether the substance is ore or coal, but the depth and horizontal contour of the valuable deposits can be ascertained by radio as well.

**Hetterby's Set**

(Continued from page 136)

Jessica cried, "Come on, Sam, we'll go right down to the electric shop and get what you need this very minute, and I'll help you wind the wire and everything, and we'll be hearing a really truly radio program before we have to put the cat out and lock up the house for the night!"

So she went away laughing, dragging Sam by the arm and making him hurry. They turned down toward the main street and that was the last we saw of her for almost a week. Then we happened to meet her on the street one day and mother asked her how she liked the radio.

"Well, we haven't got it quite ready to work yet," she said a little soberly. "Sam decided he'd have one a little better than yours. When we went down to the electric shop he saw a—a something or other; I don't know whether it was what he calls a grid-leak or a vernier or what; maybe it was a different sized wave-length—and the electric shop man explained a different way to make a radio set, so Sam is making that kind. It takes a little longer, but Sam says it will be ever so much better."

After that we used to see Jessica every now and then and we always asked how the radio set was getting along, but it was never quite ready to use. She was just as cheerful and hopeful as ever, and just as sure Sam would have the set ready to use in a day or two, but Sam was always discovering something new and better to put in his set, and then he had to tear the set all apart and begin over again. One week he would discover a new quick-acting vernier rheostat or a new style tubular grid-leak and he would junk everything and begin again, and the next week he would hear of a new filament bulb that was built like a link of bologna sausage, with terminals at each end, and he would decide not to have a crystal set but a tube set, and he would junk everything and begin again. Or he would hear of somebody's brand new pretzel-curve spider-web winding and throw away all his variometers and vario-couplers, and start in on a new set. He was always just about ready to go ahead and finish the set and put up his aerial, but ten minutes later he would hear of a new sort of something or other or a new kind of circuit somebody in New Zealand or Timbuctoo had invented, and he would junk everything and begin again.

About a year and a half after Jessica and Sam had first come to our house to see father's radio, Jessica's first baby was born—a fine eight-pound boy. For the first week Sam called the boy Steinmetz Hetterby; the second week he called him DeForest Hetterby; the third week he called him Atwater Kent Hetterby. And I believe that boy never did get an actual hold-fast name until he was twenty-one and chose one for himself—we all called him "Bub" up to the time he was twenty-one, because Sam was everlastingly getting interested in some new radio appliance and naming the boy after its inventor. There was one awful week during which the boy hid in the attic and wept day and night because his father had decided his name was to be Modulated High-Frequency Electromagnetic Voltage Het-

**a Chi-Rad Special!**  
for W.D.11 tubes—



Standard, threaded rubber, Willard's, specially adapted for use with W. D. 11 tubes. Supply current at 2 volts to one W. D. 11 tube for 210 hours on a single charge. Rechargeable. Brand new, size 4x5 1/2 x7 inches—Chi-Rad guaranteed.

2-Volt Willard Charged . . . \$7.50  
2-Volt Willard Dry . . . . . 6.50

These same Willards can be adapted to deliver 8 volts for pure D. C. for C. W. Transmitters. Better than a generator because no filter is necessary. Much less expensive.

In lots of 40 (320 volts) \$160.00

(Better prices on larger quantities.)  
Specify dry or charged when ordering.

Chicago Radio Apparatus Co.  
415 S. Dearborn St. Chicago, Ill.

**SALESMEN**

Largest radio publishing organization in the world, wants salesmen, either whole or side line, to sell an assortment of 20 books to the trade.

Liberal commission to hustlers.

Box 233, RADIO NEWS  
New York City.

**199 NECESSITIES**

WIMCO 199 SOCKET . . . . . \$ .75  
WIMCO 199 C SOCKET . . . . . 1.00  
WIMCO 199 ADAPTER . . . . . .75

Send for free literature.  
Jobbers' inquiries solicited.  
THE WIRELESS MFG. CO., Canton, Ohio  
MANUFACTURERS—DISTRIBUTORS

**PHANTOM - CIRCUIT**

Build Your Own. This marvel of mystery, using no loop, no aerial and no ground brings in music instead of interference. We have heard stations 950 miles distant on one tube. By using WD-11 tube set can be entirely self contained. Very easy to build from our instructions, use your own spare parts, nothing complicated like radio frequency or super regenerative. Only one tuning control. Complete instructions, with hookup and photo of circuit mailed to you for 50 cents. Stamps accepted.  
Vesco Radio Shop Box RN-704 Vacaville, Calif.

RADISCO RADIO PRODUCTS  
THE RADIO DISTRIBUTING COMPANY  
Newark, New Jersey

**Wireless Course in 20 Lessons**

By S. Gernsback, A. Lescaurba and H. W. Secor, E.E.  
(11th Edition)

A course that tells you everything you wish to know about "wireless," starting lesson No. 1 by explaining the Principles of Electricity. By simple, easy stages, this wonderful Course takes you into "Wireless" by the use of simple language so skillfully used that you understand every word. There is a lesson devoted to Theory and Mathematics. The last lesson is devoted to a history of Wireless. This Course has been considerably revised in order that it meet many important changes which have occurred in Radio Telegraphy and Telephony within recent years. Size of book is 7x10 1/4 in. 160 pages, 350 illustrations, 30 tables. Cloth bound in Vellum de Luxe, stiff covers, hand-sewed, gold stamped, \$1.75 each . . . . .

Same book, limp binding, colored cover . . . . . \$0.75  
EXPERIMENTER PUBLISHING CO.  
53 Park Place New York City



terby. But if the boy had been older and wiser he would not have wept over that, because he might have known his father would rechristen him plain KDKA Hetterby the next week. The boy, when he was twenty-one, took the name John Hetterby; he told us he had had all the fancy names he could stand and wanted something plain and common for a change.

John was as fine a lad as I ever knew and when he was eighteen and graduated from High School he went immediately into a grocery store as a delivery boy, and by the time he was twenty-one he had worked up to a clerkship, and the family was able to live pretty well on what he earned, although there were six other children by that time. Sam Hetterby had, of course, given up his job in town. When he was not busy junking a radio set he had about completed, or beginning a new one of which he had just heard the details, he was busy all day before the blackboard he had rigged up, drawing spirals that meant one thing and wiggles inside a circle that meant another, trying to work out improvements on a new Flewelling circuit, or on a new three-tube reflex circuit, or on a Colpits oscillator circuit. Every time he had a new and better system worked out on the blackboard, he would put another mortgage on the house and buy a hundred and sixty new parts and set to work, but when he had worked three days at it, he would pause with a screw driven half way into something or other and turn and look at his blackboard and jump up and begin erasing a symbol here and a jigjag there, and presently he would have eight magazines and a new box of white chalk and he would be all tied up in a new and better hook-up that would be a world-beater if he ever got it figured out.

My father lived to be a fine old man with white whiskers, and he died happily with a pair of ear-phones on his ears, listening to a church service that seemed to hold a lot of comfort for him, and for years his only expense had been a little battery renewal and a new ten cent crystal now and then, but poor dear Jessica Hetterby would not come in and listen to our radio.

"No," she used to say, "Sam wouldn't like it. Sam's got his almost ready now—he's only got another day's work on it—and then, if the .006 mfd. condenser comes from that firm in Hong Kong, I'll be hearing our own set, and that will be so nice! I can't tell you how I have longed and longed to hear a real good radio program, but I'll be hearing one in a couple of days now at the most. I'll be so happy!" And then she would tell my sister that the dentist said her new false teeth would never be noticed at all, and ask my sister where was the best place to buy a switch of false hair—gray hair.

I remember that it was the day the doctor advised me to give up golf because my arteries were hardening—nothing serious, you understand; merely a usual result of old age—that Jessica came over to our house, leaning on her cane, and said she hoped to invite us over the next night to hear Sam's set.

"He has just rebuilt it completely," she said—she mumbled a little, having no teeth at all now—cheerfully, "and he says the alternating kick-back circuit he is using is going to be wonderful. All he is waiting for is the new Awkawahk gasgometer he ordered from the Eskimo Radio Supply Company at Rajavik. There's a wonderful program tomorrow night; you *will* come over, won't you?"

She was so eager and it was all so pitiful that we said we would, but it was a year later before we ever did go to Jessica's house. Little Roger, her eldest great-grandchild, came over to our house and said his great-grandma wanted us to go over, please, because great-grandpa Hetterby was just



## Don't Fiddle, Fuss and Fume

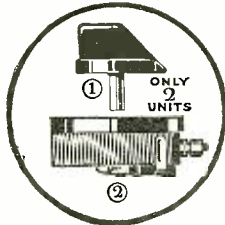
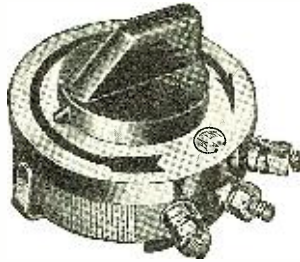

Here are two new additions to the line of Pacent Radio Essentials that can be depended upon to give permanent satisfaction without FUSSING.

### The Pacent Rheostat

Made in Resistances of 6, 10, 20 or 30 Ohms

The construction in two units makes it very simple to install or to adapt to panel or table mounting. Once mounted, no parts can loosen. The knob or dial cannot turn beyond its range. Smooth rotation makes precise adjustment easy. Catalogue No. 85 (complete with silvered dial) \$1.00.

Pacenter Potentiometer

Same design, resistance 375 ohms, \$1.25.

### Pacenter "Forty" Universal Plug

A perfect plug for every radio requirement. The low price enables you to have one at the end of every phone cord.

Other Pacent Radio Essentials that will help you get more from your equipment are Pacent Standard Jacks, Plugs, Multijacks, Twinadapters, Duo-jacks, Audioformers, Variable condensers, Duo-lateral coils.

Write for Bulletin N-8

PACENT ELECTRIC CO., INC.

22 Park Place, New York

Sales Offices: Chicago, Philadelphia, St. Louis, Washington, D. C., Minneapolis, San Francisco, Jacksonville.

# Pacenter

RADIO ESSENTIALS

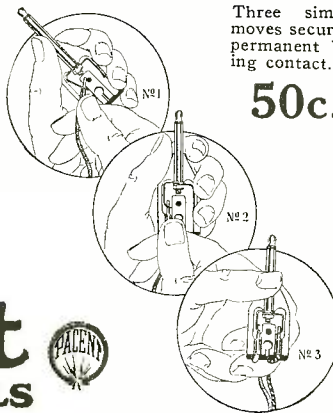

Three simple moves secure a permanent biting contact.

50c.



## Qualities Best—Prices Lowest

The Largest Radio Store in the World offers out-of-town buyers the same bargains that crowd the floors with Chicago buyers from early morning 'till late at night every week day.

As a sample of hundreds of bargains, we offer by mail prepaid

\$10.00 value long range Radio Headsets, \$3.65

Two hundred other wonderful bargains. All goods ordered are shipped the day the order is received.

Send in your name for our weekly catalogue price list. It will astonish you.

**CHICAGO SALVAGE STOCK STORE**

509 South State St., Dept. R.N., Chicago, Ill.

## JONES CONDENSER CLEANER



10c.

Pat. Applied For

**HERE IT IS**

Clean those dusty, dirty condensers. Stop that noise every time you come to a certain spot. You will notice the difference at once. Mounted 24 on a card.

Standard Jobbers and Dealers Discounts. Sample mailed for 12 cents.

HOWARD B. JONES, 612 S. Canal St., Chicago

Insure your copy reaching you each month. Subscribe to Radio News—\$2.50 a year. Experimenter Publishing Co., 53 Park Place, N. Y. C.

# W. L. DOUGLAS

## NAME AND PORTRAIT

is the best known shoe trade mark in the world. It stands for the highest standard of quality at the lowest possible cost. For economy and satisfactory service, wear shoes that bear this trade mark.

**W. L. DOUGLAS** constant endeavor for 47 years has been to make reliable, well made, stylish shoes at reasonable prices. The satisfactory service and the protection afforded by the name and price stamped on the sole of every pair have given the people confidence in W. L. Douglas shoes.

If you have been paying high prices for shoes, examine the W. L. Douglas \$7.00 and \$8.00 shoes. They are exceptionally good value and will give you satisfactory service.

**WEAR W. L. DOUGLAS SHOES AND SAVE MONEY.**

**\$5. \$6. \$7. \$8. & \$9. SHOES FOR MEN & WOMEN**  
**\$4.50 & \$5.00 SHOES FOR BOYS**

**WE WOULD BE GLAD TO HAVE YOU VISIT**

W. L. Douglas factories at Brockton, Mass., examine the high grade leathers used, and see how carefully good shoes are made by skilled shoemakers under the supervision of experienced men, all working with an honest determination to make the best shoes that can be produced for the price.

ASK YOUR DEALER FOR W. L. DOUGLAS SHOES. IF HE CANNOT SUPPLY YOU, WRITE FOR CATALOG.

W. L. Douglas Shoe Co.  
 172 Spark Street, Brockton, Mass.

**TO MERCHANTS: If no dealer in your town handles W. L. Douglas shoes, write today for exclusive rights to handle this quick-selling, quick turn-over line.**

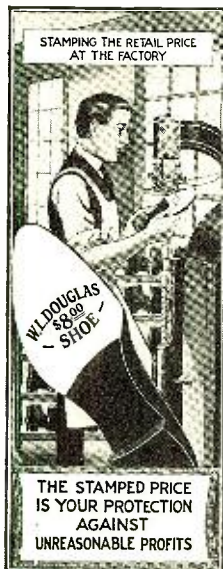

## PATENTS TRADE-MARKS AND COPYRIGHTS

Before disclosing an invention, the inventor should write for our blank form "RECORD OF INVENTION". This should be signed and witnessed and if returned to us together with model or sketch and description of the invention we will give our opinion as to its patentable nature. Radio and Electrical cases a specialty.

Our illustrated Guide Book, "HOW TO OBTAIN A PATENT," sent Free on request. Highest References Prompt Attention Reasonable Terms

FREE COUPON

**VICTOR J. EVANS & CO., Patent Attorneys**

Chicago Offices: 1114 Tacoma Bldg.	Pittsburgh Offices: 514 Empire Bldg. New York Offices: 1001 Woolworth Bldg.	Philadelphia Offices: 714-715 Liberty Bldg.	San Francisco Offices: Hobart Bldg.
---------------------------------------	---	--	--

MAIN OFFICES: 919 NINTH, WASHINGTON, D. C.

Name ..... Address .....

## PATENTS If You Have an Invention and Desire to Learn How to Secure a Patent

Send for our Free Guide Book, HOW TO GET YOUR PATENT. Tells our terms and methods. Send model or sketch and description of your invention and we will give our opinion as to patentable nature. Our documentary **PROOF OF INVENTION** is intended for your protection and will be sent you without charge. Write for it.

**RANDOLPH & CO.**  
 Dept. 459 Washington, D. C.

NAME .....  
 STREET .....  
 CITY ..... STATE .....

## PATENTS

**C. L. PARKER**  
 Formerly Member  
 Examining Corps,  
 U. S. Patent Office.  
 PATENT - LAWYER  
 McGill Bldg., Wash., D. C.

**Patents, Trade Marks, Copyrights, Patent Litigation**  
 Handbook for Inventors, "Protecting, Exploiting and Selling Inventions," sent upon request.

## PATENTS

Send sketch or model today for examination and report. Record of Invention blank on which to disclose your invention and new guide book, "How to Obtain a Patent," sent free. Promptness assured. Highest references. **WRITE TODAY. CLARENCE A. O'BRIEN, Registered Patent Lawyer, 1051 Southern Bldg., Washington, D. C.**

going to complete his radio set and she wanted us to be there and hear it.

"She says please come right away, because she don't feel very well and she thinks you'd better come soon."

I must say that, as she lay there in her bed, she was very good looking for a woman of ninety-five. Weak and feeble she was, of course, but eagerness had given her a high color, and they had propped her up on her pillow. She was all in lacy bed garments, with a lace cap that covered her sparse and snow-white hair, and John, her elderly son, sat on a chair at the bedside, holding the dear old lady's hand. She did look so sweet and fond and trustful as she looked at old Sam, who was tinkering with his set in the corner of the room. A pair of ear phones were already on Jessica's ears, ready to be hooked onto the set the moment Sam said the word. Out of the window we could see the aerial stretching to a pole at the far side of the yard. I raised my eyebrows questioningly, looking at John.

"No," he said, "it is nothing serious. She's not sick. The doctor advised her to go to bed, but he says she will spruce up and be herself again and good for another ten years once she hears father's radio. It's the waiting—the long and patient waiting—that has worn her down. But it is all right now."

"Are you sure?" I asked.  
 "Yes," John said, "I'm sure. This time father will surely complete the set he is working on. It cannot be otherwise. There is nothing left for him to change to. He has tried every style of battery, and every style of home charger, and every mounting of crystals, and every kind of tube. He has used every kind of battery clip, wire-connecting clip, base switch, filament control rheostat, potentiometer, rheostat, condenser and grid leak. He has used every circuit ever invented or discovered, and every improvement on them. He has tried everything that has been patented and everything that has not been patented. He has used every possible combination. He has used every kind of detector. He has used everything and he has tried everything. There is nothing he can imagine that is different from what he has tried, and he is satisfied that the set he is building now is the best possible set that can be made. "Father," he said to Sam, "how long before you will be done?"

The old man—he was almost one hundred years old, but remarkably spry for his years—looked up and put one hand behind an ear.

"Hey?" he queried in his aged squeaky voice.

"How long before you will be done? How long before we can begin to hear something over your radio?" John shouted.

"Ten minutes," the old man squeaked. He turned to his set and began adjusting wires. "Don't be so blamed impatient! You got to give a man a little time; I don't want any of these cheap, one-horse sets, like the kind you old man's father had."

Poor old Jessica removed her ear phones.

"What does he say?" she cried with alarm. "He doesn't say he's going to start in and make a new set, does he?"

"No, Mother; no!" John assured her. "He won't do that now. There is none he has not tried. Be comforted, Mother, dear. He says the set will be ready in ten minutes."

"Ten years? Did he say ten years?" she cried with fright, for she had quite full experience of the radio fan who never more than gets a set ready to use than he tears it apart to make another.

"Ten minutes," John said. "Not ten years; only ten minutes, Mother dear, and then you will hear a real radio program. Don't be impatient, dear Mother; Father is working as fast as he can now. Just be calm and take things as easily as you can. Here, I'll read you the program."

So he began, holding his mother's poor

thin hand, and read her the program—Russian dance from Moscow; banquet, with speeches, to the President of the United States of Asia at Canton; chorus by the trained soprano kangaroos broadcasted from Australia; ten minute sermon by Rev. Jukes, missionary to Central Africa; bird chorus by the chulu birds of South America, broadcast from the headwaters of the Amazon; ragtime from Ridgewood.

Tears of joy ran down Jessica Hetterby's furrowed old cheeks as her gray haired son read these words and at that moment old Sam Hetterby straightened his bent back and said, "There!" He had fixed the last wire. With trembling fingers old Jessica felt on the bed for the ear-phones, but before her hands touched them she stared at her aged husband with tear-filled eyes. The old man, with his hand to his ear, was listening at the window, and we heard all too clearly the sound he heard. It was a newsboy running through the street.

"Wuxtry! Wuxtry paper! Wuxtry!" he was shouting. "Great excitement! Feller invents a new radio circuit! Wuxtry! Feller invents a new radio circuit."

With a cry of distress John Hetterby reached for his mother, but he was too late. In her throes of agonized despair she had tied herself in a knot and, as she straightened out, her backbone snapped in three places. She had stood all the radio-set remaking she could. She was dead!

But old Samuel Hetterby was tottering down the stairs, an eager light in his eyes.

"Boy, wait! Boy, wait!" he called as he tottered after the newsboy.

### Roy Jordon's Station

(Continued from page 155)

entertaining visitors. A pair of Baldwin & Murdock phones are employed most of the time. The power supply for the receiver, amplifier and loud-speaker consists of two high amperage Willard Storage Batteries, with a third battery held in reserve. I use separate "B" batteries for the amplifier tubes. As will be noticed, all controls for the "A" and "B" batteries, Magnavox and battery-charger, are arranged, conveniently, along the desk front. To the operator's right, and within easy reach, is the "mill," which is used a great deal in copying. Reception on this set is as good, I believe, as any I have ever heard. Have received broadcasting stations in 32 states, on both the Atlantic and Pacific coasts, and the Gulf of Mexico, besides hearing regularly from four sections of Canada and Havana, Cuba. I have heard amateur signals from nearly all districts. When using the large G-R coils, I hear several high-powered stations, but to date have identified only NSS and YN. I am planning a small C.W. set, for the near future, and hope to have same installed and working before summer. The cage antenna was designed early in the fall, with this end in view. I should like very much to correspond with other bugs using honeycombs and apparatus of the same type as mine.

### Radio News Laboratories

(Continued from page 165)

On account of their small size and light weight, the phones may be worn a long time with comfort. The total resistance was found to be 3,186 ohms. The shells are of metal with black caps of insulating material. Arrived in good packing.

AWARDED THE RADIO NEWS LABORATORIES CERTIFICATE OF MERIT NO. 188.

# The Receiver famous thru Performance Telmaco

Type B-R Receiver

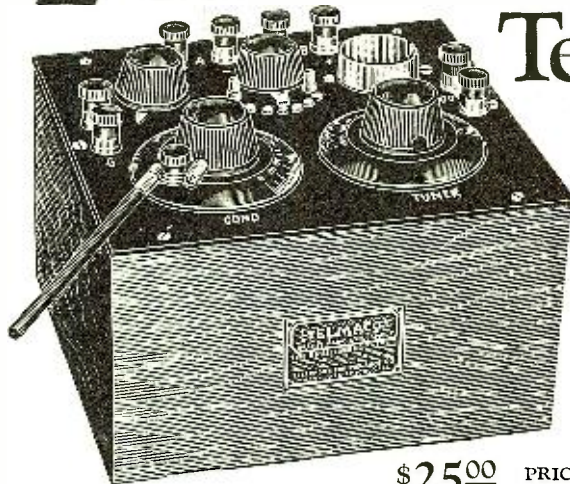

fully meets the requirements of the discriminating purchaser because of the following features:

**EFFICIENCY OF OPERATION:** Securing volume, distance (1500 miles with single tube is not unusual), selectivity: broadcasting stations one-half mile distant are tuned out by a slight turn of condenser dial.

**EASE OF OPERATION** enabling the novice to secure satisfactory results.

**HIGHEST QUALITY OF WORKMANSHIP AND MATERIALS.**

**\$25.00** PRICE within the reach of everybody.

Tri-City Radio Electric Supply Co., licensed under Armstrong U. S. Patent No. 1113149, Oct. 6, 1914.

**Telmaco BA 2-Stage Amplifier for the Above \$20.00**

### Our New Radio Guide Book Sent at Your Request

Our new 64-page Catalog No. TCR contains twenty of the most popular radio circuits printed in blue. These include the Hazeltine Neutrodyne, Grimes Inverted, Colpitts, Flewelling, Reinartz, Diode Electrad, Heterodyne, Super-Regenerative and many others. Each article used in circuit is attractively pictured instead of appearing in straight schematic form. Besides containing blue prints, the best in radio is also illustrated and described. Catalog sent postpaid for ten cents. Each circuit worth double."

Send for your copy today

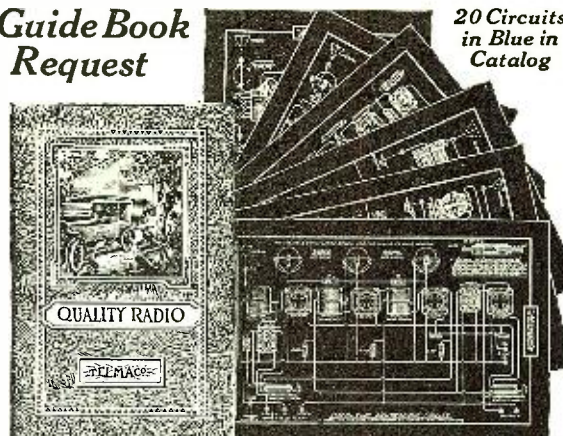

20 Circuits in Blue in Catalog

**JOBBERS** We have an attractive proposition for a few more bona-fide Jobbers **DEALERS** If your Jobber cannot supply you order direct

**TELMACO** Radio Division **TELEPHONE MAINTENANCE CO.**  
Quality Radio Exclusively 20 So. Wells St., Dept. B, Chicago, Ill.

## LEARN THE CODE AT HOME

"Just Listen—The Omnigraph will do the teaching"

with the

### OMNIGRAPH

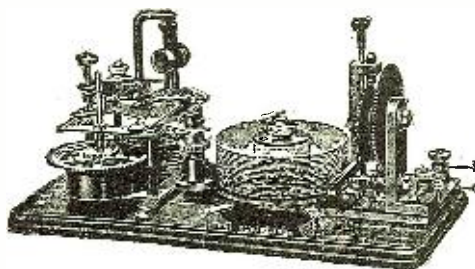

THE OMNIGRAPH Automatic Transmitter will teach you both the Wireless and Morse Codes—right in your own home—quickly, easily and inexpensively. Connected with Buzzer, Buzzer and Phone or to Sounder, it will send you unlimited messages, at any speed, from 5 to 50 words a minute.

THE OMNIGRAPH is not an experiment. For more than 15 years, it has been sold all over the world with a money back guarantee. The OMNIGRAPH is used by several Depts. of the U. S. Govt. in fact, the Dept. of Commerce uses the OMNIGRAPH to test all applicants applying for a Radio license. The OMNIGRAPH has been successfully adopted by the leading Universities, Colleges and Radio Schools.

Send for FREE Catalog describing three models, \$14 to \$30. DO IT TODAY.

**The Omnigraph Mfg. Co., 20 Hudson St., New York City**

If you own a Radio Phone set and don't know the code—you are missing most of the fun

# U.S. PATENTS



**SEND FOR THIS FORM**

## Don't Lose Your Rights

Before disclosing your invention to anyone send for blank form "Evidence of Conception" to be signed and witnessed. A sample form together with printed instructions will show you just how to work up your evidence and establish your rights before filing application for patent. As registered patent attorneys we represent hundreds of inventors all over the U. S. and Canada in the advancement of inventions. Our schedule of fees will be found reasonable. The form "Evidence of Conception" sample, instructions relating to obtaining of patent and schedule of fees sent upon request. Ask for them,—a postcard will do.



270 OURAY BLDG., WASHINGTON, D. C.  
"Originators of form Evidence of Conception"

# PATENTS

## To the Man with an Idea

I offer a comprehensive, experienced, efficient service for his prompt, legal protection and the development of his proposition. Send sketch, or model and description, for advice as to cost, search through prior United States patents, etc. Preliminary advice gladly furnished without charge. My experience and familiarity with various arts frequently enable me to accurately advise clients as to probable patentability before they go to any expense.

Booklet of valuable information and form for properly disclosing your idea free on request.

Write today.

**RICHARD B. OWEN**  
PATENT LAWYER

2 Owen Building, Washington, D. C.  
2276A Woolworth Bldg., New York City

## BECOME A PROFESSIONAL PHOTOGRAPHER



**EARNING \$35 TO \$25 A WEEK**  
Three to six months' course. Motion Picture, Commercial, Portraiture. Practical instruction. Modern equipment. Ask for Catalog No. 56.

N. Y. INSTITUTE OF PHOTOGRAPHY  
NEW YORK CHICAGO BROOKLYN  
141 W. 36th St. 630 S. Wabash Ave. 505 State St.

**ENINGER WILL SAVE**  
**40**  
**BIG MONEY SAVINGS FOR YOU**  
Used and rebuilt motorcycles, single and twins, \$25 to \$100. Used bicycles, \$5.00; tandems, \$10. All machines guaranteed 12 good working orders. New bicycles and motorcycles at factory prices. You save dealers' profits. Motorcycle and bicycle accessories from \$5.00 to \$1.00. Complete line of parts and supplies.  
Eninger Cycle Co., Rochester, N. Y.  
**YOU GET 25 TO 50 DOLLARS**

**PATENTS** As one of the oldest patent firms in America we give inventors at lowest consistent charge, a service noted for results, evidenced by many well known Patents of extraordinary value. Book, Patent-Sense, free. Lacey & Lacey, 631 F St., Wash. D. C. Estab. 1888.

## How Bertha Brainard "Broadcasts Broadway"

(Continued from page 134)

or stars, author of the book and lyrics, and a brief and interesting summary. The conclusion is a short paragraph on the types of persons who might be interested in this particular presentation.

### BROADCAST INCREASES AUDIENCE

Letters to Miss Brainard indicate that her informal talks have had exactly the result that she anticipated. As she frequently adds to her outline a description of unusual gowns or stage-settings, those who cannot get to see the plays at all feel that they have been visualized for them, while those who make periodic visits to the big town, as buyers, etc., know when they come here just what there is on Broadway to appeal to their tastes, and so get the utmost enjoyment out of their time and money.

But when in one of the charming new studios of WJZ or WJY, Bertha Brainard stands before the great globe in which a microphone is cleverly inserted, and Broadcasts Broadway "to the world," she is performing only a part of her interesting duties. An equally important activity is that in which as A.B.N. (Announcer Brainard of New York) she broadcasts Broadway productions directly from the stage and wings of the theater.

When some production has been brought particularly to her attention Miss Brainard sees the show. If it strikes her as being proper material for her widely varied audience, she brings it to Mr. Poponoc's attention. His approval obtained, the next stage is to gain the manager's permission to broadcast. Once he agrees, Miss Brainard sees the play four or five times from the front, notes costumes, scenery and action, and particularly times every detail, such as overtures, curtains, and dances. She then works out a careful introduction covering the same main details as in her other talks—that is, the author, producer, cast and a summary of the scenes to be broadcast. She also explains anything in the action which may tend to confuse those hearing the words but not seeing the accompanying action; for instance, a burst of applause always marks Miss Ethel Barrymore's first appearance on the stage, and the listener-in would naturally be unable to account for this. Or in a musical comedy, the dialogue is interrupted by a dance, so Miss Brainard speaks of it in advance. Stage settings and costumes come in for a particular emphasis in this type of broadcasting, and here our announcer feels that a woman certainly has an advantage over a man announcer, since she observes clothes and other accessories so much more naturally.

"I think," she smiled at me, "that a man saying, 'Miss Peterkins is wearing a black velvet gown with a rope of pearls,' would be just too sweet!"

### SPECIAL WIRES CONNECT STAGE TO STATION

In order that Station WJZ broadcast directly from the stage, the Western Union gives them a special direct line from Aeolian Hall to the theater. To the end of this heavy wire the Radio Corporation engineers attach two finer wires inside the theater. One of these is connected with the stage microphones, one with A.B.N.'s special microphone in the wings, all of which are joined to a portable voice amplifier. The microphones on the stage, which may number anywhere from two to five, are almost always placed down by the footlights and are quite invisible to the audience. If there is an unusual amount of work done toward the back of the stage, one may be placed

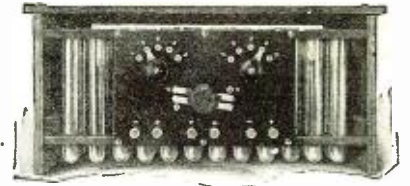

## KICO Storage "B" Batteries Give Long Service at Low Cost.

Alkaline type, will not sulphate or buckle. Not harmed by short-circuiting, overcharging, or standing idle. Panel switches afford single cell variations. Easily re-charged from any 110-volt A.C. line by means of small home rectifier. One charge lasts three to six months in detector plate circuit.

Prices	16 cell	22 volt	Plain	(With Panels)
without	24 cell	32 volt	\$ 5.50	
rectifier:	36 cell	48 volt	\$ 7.25	\$11.75
	50 cell	68 volt	\$ 9.50	\$14.00
	78 cell	100 volt	\$12.50	\$17.00
	108 cell	145 volt	\$17.50	\$22.50
	Mounted rectifier		\$23.50	\$28.50
	Unmounted rectifier		\$ 1.00	
	Mounted rectifier		\$ 2.50	

### Satisfaction Guaranteed

Money is refunded if user is not satisfied after 30 day trial. Write for full information on "A" and "B" Batteries.

## Kimley Electric Company, Inc.

2665 Main Street Buffalo, N. Y.



NA-ALD Special Socket No. 499



NA-ALD De Luxe No. 400



NA-ALD De Luxe No. 400

## It's the contact that counts

The Na-ald Special Socket No. 499 is a sturdy little socket with a dependable contact for the G. E. No. 199 dry-cell tube. It has special slot construction, and is moulded of genuine Bakelite. The heat from soldering connections will not affect Na-ald sockets.

### Price 50 cents

Na-ald Adaptor for No. 199 tube, \$1.00

The dual-wipe contact strips of the Na-ald De Luxe socket avoid the trouble experienced with the socket of conventional design. Because of thorough cure and high dielectric properties Na-ald sockets keep plate to grid losses at a minimum (of particular importance in Flewelling Circuit or in Radio Frequency).

### Price 75 cents

Booklet with diagram of Hazeltine's Neutrodyne Circuit and other selected circuits packed with each Na-ald product or sent in exchange for cover taken from any Na-ald carton.

**Alden Manufacturing Co.**  
Manufacturers of Sockets for Every Tube and Requirement  
Dept. K 52 Willow Street  
Springfield, Mass.



**You can be quickly cured, if you**  
**STAMMER**  
Send 10 cents for 288-page book on Stammering and Stuttering, "Its Cause and Cure." It tells how I cured myself after stammering 20 yrs. B. N. Boque, 889 Boque Bldg., 1147 N. Ill. St., Indianapolis

## ARE YOU SELF-CONSCIOUS?

Embarrassed in company, lacking in self-control? Let me tell you how you can overcome these troubles. M. VERITAS, 1400 Broadway, New York City

**OLD MONEY WANTED**  
\$2 to \$500 EACH paid for hundreds of old or odd coins. Keep ALL old money, it may be VERY VALUABLE. Send 10 cents for New Ill's COIN VALUE BOOK, size 4x6. Get Posted. We pay Cash. CLARKE COIN CO., Ave. 78, Le Roy, New York

there, and two are occasionally attached to the fronts of the stage-boxes. Usually, however, those in the footlights suffice. When Miss Brainard finishes talking through hers, it is switched off, and those on the stage thrown open. This change may be made either way at any time during the performance, so that she may talk during the intermissions, or explain during one of the aforementioned pauses exactly what is transpiring.

So keen are the stage transmitters that listeners-in may even hear the click of a telephone receiver, or the staccato tap-tap-tap of a dancer's heels as she does a spirited Spanish dance. Engineers in the wings keep the receivers on constantly, so that they can judge how the sound is going out, and the transmission is kept on the mark by means of their portable voice amplifier.

At perhaps five minutes before the overture begins, Miss Brainard, standing in the wings on the prompt side of the stage, begins her carefully timed introduction. The house electricians watch her, she raises her hand, and simultaneously with her last words the overture begins, her microphone is switched off and the stage microphones are switched on and for the next hour or two, "The Play's the thing."

Ordinarily a large company is not told in advance that they are going to broadcast, and learn that fact only as they are about to go on. Then excitement reigns, and the chorus immediately begins to wonder whether mother and wife and little brother are listening in. Of course the entire company plays at an unusually high pitch that night, realizing that their audience is unlimited, so that an especially fine performance is presented.

**ACTORS SUBJECT TO "BROADCAST FRIGHT"**

Miss Brainard tells many interesting anecdotes about the effect produced upon the actors when told what is about to happen. Even the greatest among them are not immune from the excitement, and are for a little time at least a trifle nervous. When the "Laughing Lady" was sent out, hardly a voice was natural for the first few minutes and even Miss Barrymore talked at a mad pace. The effect seems to be much the same as on a first night, for the company is so impressed by the size of its audience and the distances to be reached that they feel unsure of themselves for a brief space. Mr. Wallace, the publicity manager, relates that on the above-mentioned occasion Mr. Harrison Peters hoped that no outrageous offers would reach them from Finland!

It is also circulated that when one very successful play which had already been enjoying a six months' run was broadcast, some of the principals were found on the stage before the curtain went up, and one of them was saying:

"Let's just run over this scene. I don't feel quite sure of the lines!"

The great majority of the actors, particularly the stars, welcome the innovation as a great and interesting advance in the art of the theater, and rush off into the wings between their scenes to listen-in on the engineer's phones. Their greatest regret seems to be that they cannot hear their own voices as they go out. Some of them even say a word of greeting at the end of the performance. One youthful star, who has made a particularly strong and lovable appeal this winter, became so nervous while doing this that quite unconsciously he hugged Miss Brainard with his left arm as tightly as possible during the whole speech, and gazed at her in dumb amazement when he found himself in that position as he concluded.

**MANY PLAYS ALREADY BROADCAST**

The musical comedy artists seem to feel the strain less than the others, and will play just as high if Mr. Gus Edwards is re-

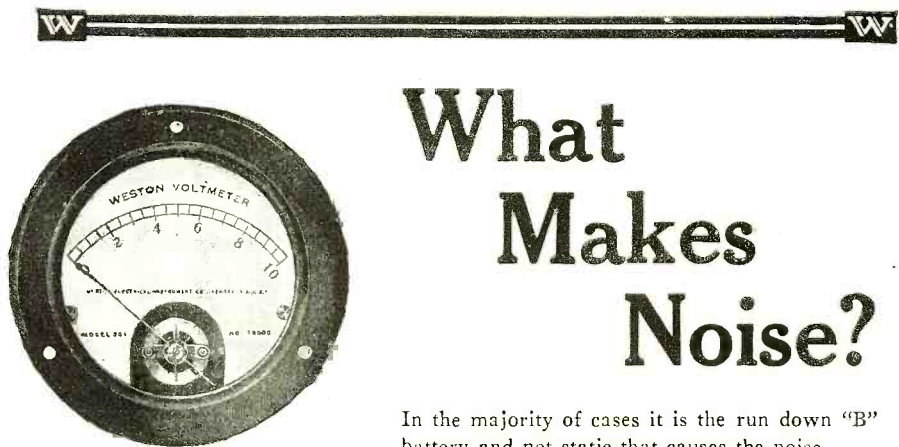

Weston Voltmeter

*Booklet J, and other Radio literature describes and illustrates these various Weston Instruments. Everyone interested in Radio should have this important data. Write for it today.*

# What Makes Noise?

In the majority of cases it is the run down "B" battery and not static that causes the noise.

The "B" battery manufacturers recommend the discarding of 22½ volt batteries when they drop below 17 volts and 45 volt batteries when they reach 34 volts.

The Weston Voltmeter will tell you exactly the condition of your batteries.

An accurate instrument at a reasonable price.

**WESTON ELECTRICAL INSTRUMENT COMPANY**  
173 Weston Avenue Newark, N. J.

Branches In All Principal Cities



STANDARD - The World Over

## "PIONEER" Instruments

Give the finishing touch of completeness to any Radio Set.

They will usually put an end to distressing tube noises, giving you a clearness of reception that will make every minute a delight.

Note that the "Pioneer" Coupler is built like a Variometer, with inside winding to the stator sphere—original with us.

- "Pioneer" Variocoupler ..... \$7.00
- "Pioneer" Variometer ..... 6.50

Sold by our Dealers, everywhere, under a guarantee of satisfaction or your money back.

"Pioneer" Instruments are molded from Bakelite in our own plant, by special machinery and finished in a dark mahogany shade, of extraordinary beauty and richness.

Winding is with coarse copper wire, covered with silk (not cotton) thread.

Hardware is bronze, heavily nickeled.

Workmanship is of the very highest type, extremely accurate in close-coupled balance.

If your Dealer cannot supply you, remit as above, and Instruments will be sent postpaid. Give name and address of Dealer you wish to favor.



GALESBURG, ILL., U. S. A.

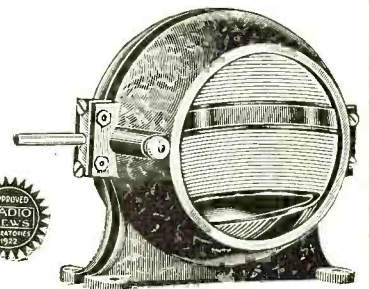

"Pioneer" Variometer  
Price, each, postpaid \$6.50

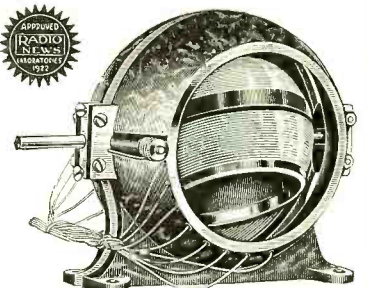

"Pioneer" Variocoupler  
Price, each, postpaid \$7.00

**NOVO**  
**"B" BATTERIES**  
WITH INSULATED BINDING POSTS  
& DETACHABLE WIRE CONNECTOR  
**NOVO MFG CO.**  
424 W 33<sup>RD</sup> ST NEW YORK - 5311-50 DEARBORN ST CHICAGO.

*The AMERTRAN*  
American Transformer Co., Newark, N. J.  
super audio frequency amplifying transformer  
—Audibility amplification, 38.6—  
without distortion  
Perfect tone Price \$7. Maximum volume

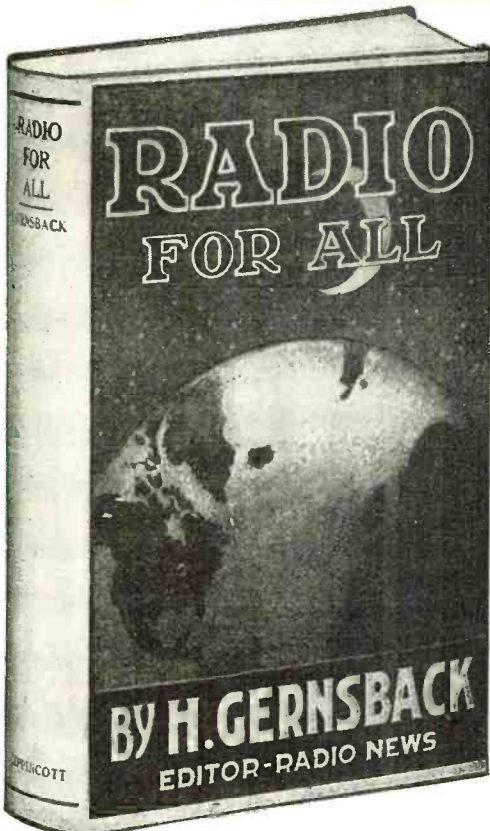

# RADIO FOR ALL

By H. GERNSBACK

Editor "Radio News," "Science and Invention" and "Practical Electrics"

With over 130 illustrations and diagrams, and 12 photographs, 300 pages, size 8 1/4" x 5 1/2".

What the novice in radio needs is a book in which he can get all the information necessary for him to understand radio telephony and telegraphy, to make or buy a receiving set suitable to his means, to know how to operate his set, and after he has an understanding of the radio art, information that will enable him to advance and get the most out of his outfit. All this must ordinarily be dug out of text-books, pamphlets and government publications, but the aim of this book is to have all the data and information that the beginner will need from the time that he takes up radio. It is a permanent, comprehensive reference book for the dyed-in-the-wool dabbler in Radio.

### What the Book Is.

A combination of a radio course for the novice in radio telegraphy and telephony with a reference book for the more experienced amateur. Half a dozen books in one.

### For the Beginner.

- The theory of radio carefully explained with drawings.
- Description of and instruction for operating instruments of receiving and sending sets, with all picture diagrams of the wiring of the apparatus.
- How to make your own receiving set, costing from \$3.00 to \$50.00.
- How to read diagrams; for every picture diagram there is a corresponding technical diagram using the symbols instead of drawings.
- How to tune sharply and eliminate interference from other stations.
- How to protect your set from lightning and the laws regarding installation.
- Explanation of time and weather signals.

### For the More Experienced Amateur.

- How to make a practical vacuum tube detector, two stage amplifier set costing less than \$50.00, that will work.
- How the radio compass works.
- All about underground aeriels, loop aeriels and directional aeriels.
- Formulae for finding wave length; miscellaneous formulae for finding capacity of condenser and other instruments. Tables of wire resistances, wave lengths and their corresponding frequencies, approximate wave lengths for different aeriels, tuning coil data, and much more invaluable information.

### Special Features.

- Lists of all the broadcasting stations in the United States and Canada for concerts, time signals, weather reports, press, stock market reports, etc., with their call, wave length and time of sending.
- Detailed description of Washington weather signals and their translation.
- Description of a modern broadcasting station and its operation.
- Large map showing location of all U. S. radio telephone broadcasting stations suitable for hanging up in radio room.
- Collection of miscellaneous radio information for the amateur.

### In Other Words.

The information that you ordinarily have to dig out of government publications, text-books, pamphlets, etc., is handily combined in this one book.

The Complete Book of All Radio Information  
PRICE POSTPAID **\$2.00**

PRACTICAL ELECTRICS COMPANY

53 PARK PLACE, NEW YORK CITY

# Each a Leader In Its Field

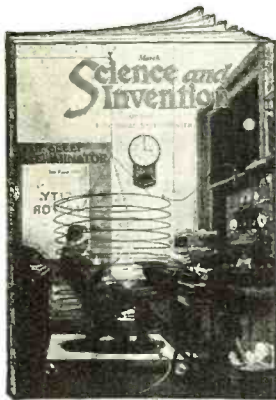

## Science & Invention

Is one of the most interesting magazines published. It is more interesting than fiction.

It is profusely illustrated and covers in word and picture the latest achievements in the sciences—in Invention, Astronomy, Physics, Chemistry, Electrics, Mechanics, etc.

It has a large section devoted exclusively to Radio. SCIENCE & INVENTION has the distinction of being more often quoted than any other magazine in the world.

More than 100 large pages—with over 300 illustrations, drawings, etc.

Special prize contests are offered each month.

On all newsstands, 25c a copy.

## Subscription Prices

Science & Invention	} One Year 12 Issues
Radio News	
	\$2.50
	Each

(Add 50c to the cost of each magazine for Canada or Foreign)



## Radio News

"The 100 Per Cent Wireless Magazine"

The Largest Radio Magazine in the World

Is read by more than a million Radio enthusiasts each month.

Its position as the leader of all Radio publications is universally recognized by dealers, radio manufacturers and every branch of the radio industry and its pages reflect their confidence.

RADIO NEWS contains more articles by Radio Experts—more specific information—detailed drawings—illustrations and news—than is published in any other magazine.

More than 200 large pages monthly. Profusely illustrated.

On all newsstands, 25c a copy.

## FREE PRESENTS FOR SUBSCRIPTION RAISERS.

Write for our Premium Catalog containing valuable rewards given away FREE.

Premium Dept.  
Experimenter Pub. Co.  
53 Park Place, N. Y.

Experimenter Publishing Co., Inc., 53 Park Place, New York, N. Y.

ported in the house as they will for a radio audience.

The first play to be broadcast in this fashion was "The Gold Fish" in which Miss Marjorie Rameau was starred last year. Since then a great number have traveled far through the air, among them such popular attractions as "The Old Soak," "Sally, Irene and Mary," "The Dancing Girl" from the Winter Garden, "Caroline," "The Fool," "Romeo and Juliet," with Jane Cowl. The majority of these have broadcast only a portion of the play, but some of them have gone out in their entirety, including such fine productions as "The Mikado" by the De Wolf Hopper Opera Company from a Newark theater; the Augustus Thomas production of "As You Like It"; and one of the biggest coups of all was "The School for Scandal," which the Players' Club presented with an all-star cast containing John Drew, Ethel Barrymore, Richard Mantell, Walter Hampton, and many other notables.

From this impressive list of plays, producers and actors, it is obvious that this broadcasting of plays must have justified itself not only from an artistic and recreational standpoint but from a business standpoint as well. When Miss Brainard conceived the idea in the spring of 1922, producers laughed at her and predicted that such a procedure would result in empty theaters. To one such man she said:

"This thing is going to be a success just as all the other broadcasting has been. Why not be one of the first to put it over? If you don't you'll come to me within a year and ask me to do one of your plays."

And he did.

Statistics are to be had for the asking from any of the theaters which have broadcast, indicating the numbers who have come to the box offices for tickets stating that they heard the play on their radio sets and felt they had to see it. Gallery and balcony receipts especially show results. On one occasion 16 men sat in their club room and heard part of a performance through their loud-speaker. So surprised and impressed were they with its enjoyable qualities that they suggested the play for a club outing at their next meeting, with the result that the club took the house for one night.

Producers to a man make the obvious answer to questions on the value to them of this work.

"It's the greatest advertising stunt that has yet been invented, and if it did not pay we wouldn't be doing it."

And ordinarily they add:

"Of course, Miss Brainard is largely responsible for its success. She seems to know what the public wants, has the personality to put it over, and has the ability to think on her feet, which is essential to any undertaking."

The only possible objection which could be made to this type of broadcasting is that which was made in the beginning by those producers who held out against it, namely, that hearing the play in this way, there would be no incentive to visit the theater, and so the theatrical business would be ruined. I think Mr. Charles D. Isaacson, who has broadcast over two hundred fine concerts, answers this most ably when he says:

"Human beings will always be more interesting than their pictures or voices. I may telephone to the woman I love and listen to her voice over the wire, and I may lift her photograph and gaze tenderly upon it, but I prefer to be with her herself. . . . When people are listening to the radio they are not being fully satisfied and never will be, not while human beings are in existence."

**DON'T WORRY**

It is comforting to us radio fans to know that these bandits we read about are looking for people with money.



**"A Chinaman's Chance"**

on keeping your tube is about what you take in operating a bulb set without the protection of the

## RADECO SAFETY FUSE

(Patent Pending)

—a risk that's entirely unnecessary when the Radeco Fuse, slipped on the filament terminals of the tube makes "blowing out" absolutely impossible, even by accident. Fits any standard tube used in any standard socket. Does not affect efficiency of set.

### 50c each

At your Dealers or by Mail

## RADIO EQUIPMENT CO.

630 WASHINGTON STREET, BOSTON, MASS.  
New England's Oldest Exclusive Radio House

Different tubes require different capacity fuses. When ordering state exactly what tube fuses are for.

## This "UNITED" Audio Frequency Amplifying Transformer

is a little "gem" of radio engineering—magnetically shielded, Ratio 5 to 1—a wonder-worker in producing loud, clear-toned signals, from any distance. At your dealer's \$4.50.



**"United" Variable Condensers** have a new vernier dial assembly, original with us, that makes fine tuning a joy.

43 plate.....\$6.50	5 plate.....\$5.00
23 plate..... 6.00	3 plate..... 4.75
11 plate..... 5.50	Postpaid.

Vernier alone; can be attached to any \$2.50 plate condenser by drilling one hole.. **\$2.50**

Show this ad to your dealer and ask him to supply your needs at the above prices. If he cannot do so, remit to us direct, under our money-back guarantee and give us name and address of dealer you wish to favor.

### UNITED MFG. & DISTRIBUTING CO.

9705 COTTAGE GROVE AVENUE,

New York Office: 50 Church St. New York, N. Y.	CHICAGO, ILL.	San Francisco Office: 709 Mission St. San Francisco, Cal.
--	------------------	---

— **FREE** —

A book on how to get "Better Results from Radio"—Write to Willard Storage Battery Company, 281 East 131st St., Cleveland, Ohio

## Willard

STORAGE BATTERY

**VULCANIZED FIBRE**

Be sure and specify **"WILMINGTON FIBRE"**

Sheets, Rods, Tubes, Washers, Etc., Specialties

Wilmington Fibre Specialty Co. Wilmington, Del.  
Branch Offices "Everywhere"

# OPPORTUNITY AD-LETS

Follow these advertisements every month. Reliable advertisers from all over the country offer their most attractive specials in these columns.

Classified advertising rate fifteen cents a word for each insertion. Ten per cent discount for 6 issues, 20 per cent discount for 12 issues. Name and address must be included at the above rate. Cash should accompany all classified advertisements unless placed by an accredited advertising agency. No advertisement for less than 10 words accepted.

Objectionable or misleading advertisements not accepted. Advertisements for the October issue must reach us not later than August 1st

**THE Net Paid CIRCULATION OF RADIO NEWS IS OVER 200,000**

EXPERIMENTER PUBLISHING CO., INC., 53 Park Place, New York, N. Y.

## Agents Wanted

**Big Money and fast sales.** Every owner buys gold initials for his auto. You charge \$1.50; make \$1.35. Ten orders daily easy. Write for particulars and free samples. American Monogram Co. Dept. 133, East Orange, N. J.

**Insyde Tyres** in your old casings give from 3 to 5 thousand miles more service. Positively prevent punctures and blowouts. Used over and over again. Low priced. Big money saver. Agents wanted. Write for terms. American Accessories Co., B 792 Cincinnati, Ohio.

**Amateur Agents Wanted** in every city and town to sell radio apparatus. A few stocking agencies still open. Delfelco, 12 Meeting Street, Pawtucket, R. I.

**Earn big money fast** applying gold initials to autos. Every owner buys—\$1.35 profit on \$1.50 sale—particulars and samples free. Write quick. Lithogram Co., Dept. 32, East Orange, N. J.

**Free Book.** Start little Mall Order Business. Home employment evenings. Pier, 250-A, 74 Cortland St., N. Y.

**Agents Wanted** in every city and town to sell standard radio apparatus. Attractive discounts given. If interested, write us at once stating age and radio experience. Wilmington Electrical Specialty Co., Inc., 912 Orange St., Wilmington, Delaware.

**We want Salesmen and Agents,** either whole or side line, to sell our low priced radio books to the trade. Excellent proposition for live wires. The E. I. Company, Publishers, 233 Fulton Street, New York City.

## American Made Toys

**Manufacturers on Large Scale,** also homeworkers, wanted to manufacture Metal Toys and Novelties. Millions needed of Barking Dogs, Wag Tail Pups, Wild Animals, Automobiles, Indians, Cowboys, Baseball Players, Cannons, Toy Soldiers, Crowing Roosters, Statues of Liberty, Miniature castings of Capitol, Bathing Girl Souvenirs and others. Unlimited possibilities. Guaranteed Casting forms furnished manufacturers at cost price from \$5.00 up, with complete outfit. No experience or tools necessary. Thousands made complete per hour. We buy goods all year and pay high prices for finished goods. Cash on delivery. Contract orders placed with manufacturers. Catalogue and information free. Correspondence invited only if you mean business. Metal Cast Products Co., 1696 Boston Road, New York.

## Automobiles

**Automobile owners,** garagemen, mechanics, send today for free copy America's most popular motor magazine. Contains helpful articles on over-hauling, repairing, ignition, carburetors, batteries, etc. Automobile Digest, 528 Butler Bldg., Cincinnati.

**Automobile owners,** including Fords are using Singer Automatic Priming Cups, because they give instant starting, reduce carbon, and save 30 per cent gasoline or money refunded. Trial set \$1 postpaid. Agents wanted. Fortune for good hustler. \$23 Heed Building, Philadelphia, Penna.

## Business Opportunities

**Become a Landscape Architect.** Dignified, Exclusive Profession. Little competition. \$5,000.00 to \$10,000.00 income for experts. Easy by our method. Begin earning 3 weeks after you enroll. Write today. American Landscape School, 11R, Newark, N. Y.

**Sell us your spare time.** You can earn Fifteen to Fifty dollars weekly showing at home. No canvassing, pleasant, profitable profession easily, quickly learned by our simple graphic block system, artistic ability unnecessary. We instruct you and supply work. Wilson Methods, Limited, Dept. J, Toronto, Canada.

## Chemistry

"Popular Chemistry" magazine. The Experimenter's Monthly. 75c per year. Wright Laboratory, Caldwell, New Jersey.

**Learn Chemistry at Home—Dr. T. O'Connor Sloane,** noted educator and scientific authority will teach you. Our home study correspondence course fits you to take a position as chemist. See our full page ad on page 183 of this issue. Chemical Institute of New York, 66 West Broadway, New York City.

## Ford Owners

**Sport Cars, fast, saucy,** hug the turns and stick to the road—make you glad you're a Ford owner. Can easily be built by aid of life-size "Red-1-Kut" patterns and picture instructions. The "Pal" system delivered complete with pressed metal streamline tail for \$6.40. Garage men make big money building them. Send 5-cent coin for prospectus on making sport cars—"Jifty" Tops and "Gosum" Windshields. Kuempel Co., 320 Kuempel Bldg., Guttenberg, Iowa.

## Books

**Radio Books Latest and Best.** Catalog free. Ray Dobbins, 146 West 27th St., Indianapolis, Ind.

"Lights, Colors, Tones and Nature's Finer Forces", including Vibrations, colors; Electromagnetics; Odometry; Radio; Coldlights; Inventions; Marvelous Opportunities. Illustrated; 270 pages, \$2.00. Table contents free. Stevens Publishers, 242 Powell, San Francisco, Calif.

**The How and Why of Radio Apparatus,** by H. W. Secor, E. E. This newest book on radio matters fills a distinct gap in wireless literature in that, while the treatment is made as understandable and as free from mathematics as possible, it at the same time incorporates a wealth of technique and instruction for the Radio Amateur—the Radio Operator—the Installation and Designing Expert—as well as teachers and students of the subject in general. A very broad field has been covered by the author, at the same time giving a great deal of information not found in other text books. If you are engaged in any branch of the Radio or allied arts at all you will surely need this latest contribution to radio literature, which is destined to be found on every radio man's book shelf before long. A glance at the following list of chapters gives but a very scant idea of the extensive and useful radio knowledge provided in its text: The Induction Coil; The Alternating Current Transformer; Radio Transmitting Condensers; The Spark Gaps; Radio-Transmitting Inductances; Radio Receiving Tuners; Radio Receiving Condensers; Detectors; Telephone Receiver; Radio Amplifiers; Construction of a Direct Reading Wavemeter and Decimeter; Antenna Construction; The Calculation and Measurement of Inductances; Appendix containing very useful tables, covering all subjects treated in this very unusual book. This newest of Radio Works, cloth bound in Vellum de Luxe, Gold Stamped and Hand Sewed, has 160 pages, Size of book, 6 1/2 x 9 inches. The How and Why of Radio Apparatus. Postpaid, \$1.75. Experimenter Publishing Co., Book Dept., 53 Park Place, New York City.

**Experimental Electricity Course in 20 Lessons.** By S. Gernsback and H. W. Secor, E. E. A course of the theory and practice of Electricity for the Experimenter. Every phase of experimental electricity is treated comprehensively in plain English. New experiments are described and explained and nearly every application of Electricity in modern life is given. 160 pages—400 illustrations. Flexible cloth cover, 75c, postpaid. Stiff cloth cover, \$1.25 postpaid. Experimenter Publishing Co., Book Dept., 53 Park Place, New York City.

**Wireless Course in 20 Lessons.** By S. Gernsback, A. Lescaurba and H. W. Secor, E. E. Tells you everything you want to know about "Wireless"—theory, practice and history. A clear, concise course on every phase of this subject. 160 Pages—350 illustrations, 30 tables. Stiff cloth cover, \$1.75. Postpaid. Experimenter Publishing Co., Book Dept., 53 Park Place, New York.

**How to Make Wireless Receiving Apparatus.** 100 Pages—80 illustrations. Only strictly modern radio apparatus are described in this book and the illustrations and descriptions are so clear and simple that no trouble will be experienced in making the instruments. Paper covered, 35c, postpaid. Experimenter Publishing Co., Book Dept., 53 Park Place, New York City.

**How to Make Wireless Sending Apparatus.** 100 Pages—58 illustrations. Written and published entirely for the wireless enthusiast who wants to make his own radio apparatus. Contains more information on "how to make it" than any other book we know of. Paper bound 35c, postpaid. Experimenter Publishing Co., Book Dept., 53 Park Place, New York City.

**How to Make Radio Frequency Amplifiers.** This book is for the more advanced amateur, showing the construction of the Radio Frequency Amplifying Transformer and giving complete constructional data. It shows the application of Radio Frequency to amplifying units that the amateur may already possess and gives 15 hook-ups showing practically every use Radio Frequency Amplifying Transformers can be put to. 32 pages, 15 illustrations; bound in beautiful two-color cover. Prepaid 25c. The E. I. Company, 233 Fulton St., New York City.

**Major Armstrong's New Epoch-Making Invention** Will Solve Your Loop Antenna Problem. The New Armstrong Super-Regenerative Circuit is a means now that is made possible with two vacuum tubes and an indoor loop antenna to receive broadcasting music up to 100 miles distant. Our engineering department has compiled a pamphlet that gives an exposition of the theory of operation with full working directions, etc. A large blue-print is included with this pamphlet. Your dealer cannot supply you with these pamphlets. Send us 25c and we will mail to you this wonderful exposition prepaid. Tell your dealer to ask us for our proposition. The E. I. Company 233 Fulton St., New York City.

**Science and Invention Bound Volume No. 9.** May 1921-April 1922; contains 1200 pages with over 1500 illustrations and over 700 articles by the foremost American and Foreign writers. We have also a limited amount of the following Bound Volumes of Science and Invention (Electrical Experimenter): Vol. No. 6—May 1918 to April 1919; Vol. No. 7—May 1919 to April 1920; Vol. No. 8—May 1920 to April 1921. Each volume bound in stiff board covered with green vellum and gold stamped. Price for volume No. 9—\$2.25. Price for volume No. 6, 7 or 8—\$2.00. All four volumes \$7.00, sent express collect. Experimenter Publishing Co., 53 Park Place, New York City.

## Correspondence Courses

**Dollars Saved—Used** correspondence courses of all kinds sold, rented and exchanged. List free. (Courses bought.) Lee Mountain, Pisgah, Alabama.

## Exchange

**Amateur Agents** wanted in every city and town to sell radio apparatus. A few stocking agencies still open. Delfelco, 12 Meeting Street, Pawtucket, R. I.

**Bargain!** All parts for Super-Regenerative. Frank Foster, Nocona, Tex.

**1500 mile Vacuum tube receiver** \$24.50. Radio, 4418 Market, Philadelphia.

**200-20,000 Meter Receiver** including Radiotron \$35.00. Two Step Amplifier \$22.00. Smith, 4416 Market, Philadelphia, Pa.

**Grebe and other apparatus** at less than half. In perfect condition. Write for price. Will exchange for Omnigraph. Jas. H. Townsend, McDonald, N. C.

**Edison Elements for Storage B Batteries.** Six to ten cents per pair postpaid. (Depending solely on size of order). I handle strictly first grade elements only. A. J. Hanks, 608 Montgomery Street, Jersey City, N. J.

## Help Wanted

**Detectives Needed Everywhere.** Work home or travel. Experience unnecessary. Write, American Detective System, 1908 Broadway, N. Y.

**We want Salesmen and Agents,** either whole or side line, to sell our low priced radio books to the trade. Excellent proposition for live wires. The E. I. Company, Publishers, 233 Fulton Street, New York City.

**Earn \$25 Weekly,** spare time, writing for newspapers, magazines. Experience unnecessary; details free. Press Syndicate, 5655, St. Louis, Mo.

**All men, women, boys, girls,** 17 to 60, willing to accept Government Positions, \$117-\$190, traveling or stationary, write, Mr. Ozment, 251, St. Louis, Mo., immediately.

**Be a Mirror Expert, \$3-\$10 a day;** spare time home at first; no capital; we train, start you making and silvering mirrors. French method. Free prospectus. W. R. Derr, Pres., 26 McKinley St., Baldwin, N. Y.

**Detectives earn big money.** Travel, instructions by ex U. S. Secret Service agent. Write for particulars. J. H. Harrison, 304 Kansas City Life Bldg., Kansas City, Mo.

## Improved Made Toys

**We show you how to earn big money easily** with our casting forms making Whistling Birds, Wild Animals, Crowing Roosters, Automobiles, Baseball Players, Statue of Liberty, Indians, Toy Soldiers, Cowboys, Barking Dogs, Wag Tail Pups, Miniature castings of Capitol, Bathing Girl Souvenirs and others. No experience necessary. We furnish you with molds and necessary outfit from \$3.50 up. We buy large quantities of finished goods at highest prices. Spot cash. Send for catalogue and information free. The Improved Metal Casting Co., 342 East 145th Street, New York.

## Instruction

**Learn Chemistry at Home—Dr. T. O'Connor Sloane,** noted educator and scientific authority, will teach you. Our home study correspondence course fits you to take a position as chemist. See our full page ad on page 183 of this issue. Chemical Institute of New York, 66 West Broadway, New York City.

**Used Correspondence Courses** only one quarter original price. Free bargain price list 1000 courses. Courses bought. Students' Exchange, 45 West 42d St., New York.

## Languages

**World-Romic System.** Masterkey to All Languages. Primers, 23 languages, \$1.94 each language: English, French, German, Italian, Portuguese, Spanish. Pronunciation-Tables, 102 languages, 30c each language. Languages Publishing Company, 8 West 40th Street, New York.

## Mail Order Business

**Advertise.** Newspapers, magazines. List on request. Pennell Company, Covington, Kentucky.

## Motorcycles—Bicycles

**Don't buy a Bicycle Motor Attachment** until you get our catalog and prices. Shaw Mfg. Co., Dept. 6, Galesburg, Kansas.



## Miscellaneous

Wanted Radio News dated July, Aug., Sept., Oct. 1919, Dec. 1920, Dec. 1921, Jan., Feb. 1922, Box 125, Radio News.

Wanted to Buy—Feuerstein Automatic Card Printing Press. First class shape. Cheap for Cash. C. F. Denny, Wilson, N. C.

Make money with your camera. Lancaster, Box 967, Los Angeles.

Pean-Orange Groves. Easy terms. Dept. K, Suburban Orchards Co., Ocean Springs, Miss.

We manufacture Wood Turnings. Your inquiries solicited. Prices reasonable to responsible people. Large or small orders. Wood Specialty Co., Collins, Ohio.

Crystal Gazing. An art. Can you Scry? Lessons 50c. Explanatory Book 75c. Also Crystals. Crystal Gazing Company, 522 Station "B," Kansas City, Missouri.

## Office Devices

Save half on office machines, equipment, addressers, Multigraphs, Duplicators, Dictaphones. Pruitt Company, 172 North Wells, Chicago.

## Old Money Wanted

\$2 to \$500 Each paid for hundreds of old or odd coins. Keep All Old Money, it may be very valuable. Send 10 cts. for new illustrated Coin Value Book. 4x6. Get posted. We pay cash. Clarke Coin Company, Ave. 80, Litchy, N. Y.

## Patent Attorneys

Inventors: Protect your Invention through A. M. Wilson, Inc., Washington, D. C. Over 25 years of efficient, expert, confidential service. Skilled in Radio-Electrical, Chemical and Mechanical fields. Our new illustrated Patent Book, giving much necessary and very useful information which every inventor should know, will be sent free upon request. Prompt and careful attention. Highest references. Moderate fees. Send sketch or model for our careful opinion and preliminary advice. Write today to A. M. Wilson, Inc., (Radio 3 ARH), 325 Victor Bldg., Washington, D. C.

Millions spent annually for ideas! Hundreds now wanted! Patent yours and profit! Write today for free books—tell how to protect yourself, how to invent, ideas wanted, how we help you sell, etc., 301 Kresge Bldg., American Industries, Inc., Washington, D. C.

Patents. Send drawing or model for examination and report as to patentability. Advice and booklet free. Highest references. Best results. Promptness assured. Watson E. Coleman, Patent Lawyer, 624 F Street, Washington, D. C.

Patents—Inventors should write for Free Guide Books and Record of Invention Blank before disclosing invention. Send model or sketch of your invention for our Free opinion of its patentable nature. Radio Electrical, Chemical, Mechanical and Trade-Mark experts. Victor J. Evans & Co., 922 Ninth, Washington, D. C.

Patent. Electrical cases a specialty. Pre-war charges. B. P. Fishburne, 340 McGill Bldg., Washington, D. C.

Patents Secured. Prompt service. Avoid dangerous delays. Send for our "Record of Invention" form and Free Book telling How to Obtain a Patent. Send sketch or model for examination. Preliminary advice without charge. Highest Reference. Write today. Jacobi & Jacobi, 413 Ouray Bldg., Washington, D. C.

Patents—Send for form "Evidence of Conception" to be signed and witnessed. Form fee schedule, information free. Lancaster and Allwine, 269 Ouray Bldg., Washington, D. C.

Patents procured. Send sketch or model today for examination, prompt report and advice. No charge for preliminary advice. Write for free booklet and blank form on which to disclose your idea. Highest references. Promptness assured. Clarence A. O'Brien, Registered Patent Lawyer, 751 Southern Building, Washington, D. C.

Inventors—Record invention legally before disclosing to others. Our Invention-Record and Data Sheet shows how. Sent free and valuable information given on patent procedure, costs, etc. Report on patentability includes copies of patents nearest your idea. O'Connell & O'Connell, 402 Jenifer Building, Washington, D. C.

Patents and Trade-Marks. 64-page Book free. Excellent references. 23 years' experience. Robb, Robb & Hill, 1109 Hanna Bldg., Cleveland, Ohio, 948 McLachlen Bldg., Washington, D. C.

Patent applications filed on partial payment plan. Trade-marks, copyrights. Milo B. Stevens & Co., 692 F Street, N. W., Washington, D. C.

Patent Sense. The Book the Inventor Keeps. Free. See Lacey's ad, page 225.

## Personal

Lonesome—Join our club—make acquaintances everywhere. Big illustrated book with descriptions and photos, sent in plain wrapper for ten cents. Bonafide Co., Dept. 58, Kansas City, Mo.

Exchange cheery letters with new friends. Write Betty Lee, Inc., 4254 Broadway, New York City. Stamp appreciated.

Exchange interesting letters with new friends. Dolly G. Gray, Box 189, Denver, Colo.

Exchange letters with new friends everywhere. Pleasant pastime, particulars free—Smiths Box 1167Y, Denver, Colo.

Exchange Cheery Letters with new friends. Write Betty Lee, Inc., 4254 Broadway, New York City. Stamp appreciated.

## News Correspondents

Earn \$25 Weekly Spare Time writing for newspapers, magazines. Experience unnecessary; details free. Press Syndicate, 566 St. Louis, Mo.

## Postcards and Pictures

French Colonies Free—Beautiful Picture Set, Native Chiefs, Tigers, Victorials. 2c postage. Empire Stamp Company, Toronto, Canada.

## Radio Equipment

Edison Elements for making "B" Batteries 6c per pair; tubes 2c each. Nickel Wire, Insulators, and Cabinets, at reasonable prices. Todd Electric Co., 178 Lafayette St., New York City.

## Salesmen Wanted

Lightning—Strange Battery Compound. Charges discharged batteries instantly. Eliminates old method entirely. Gallon free to agents. Lightning Co., St. Paul, Minn.

## Scenery to Rent

Settings for Opera, Plays, Minstrels. Plush Drops. Address Amelia Grain, Philadelphia.

## Stamps and Coins

Stamps—50 varieties, Brazil, Peru, Cuba, etc., 10c. 50 different U. S. 25c. 1,000 hinges, 10c. 1,000 mixed, 40c. List free. C. Stegman, 3958 Cote Brillante, St. Louis, Missouri.

## Telegraphy

Telegraphy—Both Morse and Wireless taught thoroughly and quickly. Tremendous demand. Big salaries. Wonderful opportunities. Expense low; chance to earn part. School established fifty years. Catalog free. Dodge's Institute, 31 St., Valparaiso, Ind.

Learn Wireless Code quickly, easily, cheaply. Dollar complete. Red stamp brings particulars. John Percival, 2115 York, Des Moines, Iowa.

## Ventriloquism

Ventriloquism taught almost anyone at home. Small cost. Send 2c stamp today for particulars and proof. Geo. W. Smith, Room M-550, 125 N. Jefferson Ave., Peoria, Ill.

## Wanted to Buy

Full Value Paid for Old Gold Jewelry, Watches, Diamonds, crowns, bridges, dental gold, silver, platinum, gold or silver ore, magnet points, old false teeth. Packages returned if our offer is not satisfactory. United States Smelting Works (The Old Reliable), 120 So. State St., Dept. 16, Chicago, Ill.

## Wireless

Selling out! 500 Audio Frequency units, 200 Radio Frequency units, list \$12.00. Special \$3.75. Send money order, or shipped c.o.d. Immediate delivery. International Radio Sales & Service, 12 Otis St., Medford, Mass.

Special tubes UV201, UV201A, UV199, WD11, WD12, C301, C301A, C299, \$5.50. Electric Soldering Iron \$3.00. Bradleysats \$1.60. Radiola "R.C." Complete \$123.65. Postage Paid. C. H. Anderson, Lewistown, Mont.

Memorize the Code. Send one dollar and get my new short cut. You can learn the code in less than an hour. E. Dwyer, 191 Linden Ave., Brooklyn, N. Y.

Wanted, Live amateur agents in every town to sell radio apparatus to the users. Write immediately for exclusive territory and liberal discount schedule. No capital required. Radio Exchange, 511 Seventh St., Sioux City, Ia.

Build your sets with quality parts and get sure results, Radio Parts Co., Box 56, Dunellen, N. J.

Radio Cabinets—Better Cabinets at lower Prices—Marvin B. Fallgatter, Waupaca, Wis.

Det. Tube Repairs—Radiotrons, Cunningham, DeForest, etc., at \$2.75. Amplifiers \$3.00. U.V. 202, W. D. 11's \$3.50, etc. Quick service, prompt deliveries and satisfactory results guaranteed. S. Strobel & Co., 3923 N. 6th St., Philadelphia, Pa.

3 Inch Dials 25c. 9 x 24 Panels—\$2.10. 23 Variocondensers \$1.25. Regenerative Tube Set \$16.00. Catalogue Free. Wholesale, Retail. Stewart Radio Supply Co., 3124 Cherokee, St. Louis, Mo.

Marvelous distance hook-ups, just perfected, cheap and simple. Only Ten cents. S. K. W., 10 Westwood Drive, S. F., Calif.

Boys! Don't Overlook This. The "Rasco" Baby Detector. Greatest detector ever brought out with molded base. Fully adjustable. See former advertisements in this publication, or our catalog. Detector with Galena Crystal, complete \$6c, the same detector with Radiocets Crystal, 75c prepaid. Send for yours today. Radio Specialty Company, 96-98 Park Place, New York City.

Attention!—50 Vacuum tube hook-ups. The greatest collection of vacuum tube circuits ever brought under two covers at such insignificant cost. These diagrams will be found in the great "Rasco" catalog, which contains raw materials and parts in a greater profusion than any other catalog. 15c in stamps, or coin, will bring the catalog to you. Radio Specialty Co., 96-98 Park Place, N. Y.

For Immediate Delivery—Tubes, Magnavox, Westinghouse Receiving Sets, Phones, Condensers, Rheostats, Variometers, Couplers, Panels, Transformers, V. T. Sockets, Dials, Switch Points, and full line of parts. R. B. Electric Co., Galva, Ill.

## Wireless (continued)

Tweet Loop Arrangement for long-distance Broadcasting and D.X. reception. No Radio Frequency—Good work on detector only. Very simple. Description and diagram for one dollar. T. J. M. Daly, Little Rock, Ark.

Special—Sold to highest bidder. DeForest M. R. 6s, Sorsine Tunits. Hobart Radio Co., Hobart, N. Y.

Build your own electrolytic storage battery charger. Plates and complete instructions, \$1.00. Descriptive circular free. Peerless Electrical Parts Co., 105 Harris, Rochester, N. Y.

Magnavox Type R3, Latest nationally advertised models in original sealed factory cartons. List \$35. Special introductory offer \$25. Radio Central, Dept. R, Abilene, Kansas.

Pacific Coast Stations are heard in Pittsburgh with variometer and two Rogers Receiving Radiometers (Condensite molded variometers). Radiometers \$1.00 each. Postage prepaid. Rogers Radio Company, No. 5133 Woodworth St., Pittsburgh, Pa.

Wireless Course in 20 Lessons. By S. Gernsback, A. Lescaurba and H. W. Secor, E. E. Tells you everything you want to know about "Wireless"—theory, practice and history. A clear, concise course on every phase of this subject. 160 pages—350 illustrations, 30 tables. Stiff cloth cover, \$1.75, postpaid. Experimenter Publishing Co., Book Dept. 53 Park Place, New York.

How to Make Wireless Receiving Apparatus. 100 pages—80 illustrations. Only strictly modern radio apparatus are described in this book and the illustrations and descriptions are so clear and simple that no trouble will be experienced in making the instruments. Paper covered, 35c, postpaid. Experimenter Publishing Co., Book Dept., 53 Park Place, New York City.

How to Make Wireless Sending Apparatus—100 pages—88 illustrations. Written and published entirely for the wireless enthusiast who wants to make his own radio apparatus. Contains more information on "how to make it" than any other book we know of. Paper bound, 35c, postpaid. Experimenter Publishing Co., Book Dept. 53 Park Place, New York City.

How to Make Radio Frequency Amplifiers. This book is for the more advanced amateur, showing the construction of the Radio Frequency Amplifying Transformer and giving complete constructional data. It shows the application of Radio Frequency to amplifying units that the amateur may already possess and gives 15 hook-ups showing practically every use Radio Frequency Amplifying Transformers can be put to. 32 pages, 15 illustrations; bound in beautiful two-color cover. Prepaid 25c. The E. I. Company, 233 Fulton St., New York City.

Major Armstrong's New Epoch-Making Invention Will Solve Your Loop Antenna Problem. The New Armstrong Super-Regenerative Circuit is a means now that is made possible with two vacuum tubes and an indoor loop antenna to receive broadcasting music up to 100 miles distant. Our engineering department has compiled a pamphlet that gives an exposition of the theory of operation with full working directions, etc. A large blue-print is included with this pamphlet. Your dealer cannot supply you with these pamphlets. Send us 25c and we will mail to you this wonderful exposition prepaid. Tell your dealer to ask us for our proposition. The E. I. Company, 233 Fulton St., New York City.

The How and Why of Radio Apparatus, by H. W. Secor, E. E. This newest book on radio matters fulfills a distinct gap in wireless literature in that, while the treatment is made as understandable and as free from mathematics as possible, it at the same time incorporates a wealth of technique and instruction for the Radio Amateur—the Radio Operator—the Installation and Designing Expert—as well as teachers and students of the subject in general. A very broad field has been covered by the author, at the same time giving a great deal of information not found in other text books. If you are engaged in any branch of the Radio or allied arts at all you will surely need this latest contribution to radio literature, which is destined to be read on every radio man's book shelf before long. A glance at the following list of chapters gives but a very scant idea of the extensive and useful radio knowledge provided in its text: The Induction Coil; The Alternating Current Transformer; Radio Transmitting Condensers; The Spark Gaps; Radio-Transmitting Inductances; Radio Receiving Tuners; Radio Receiving Condensers; Detectors; Telephone Receivers; Radio Amplifiers; Construction of a Direct Reading Wavemeter and Decrementer; Antenna Construction; The Calculation and Measurement of Inductances; Appendix containing very useful tables, covering all subjects treated in this very unusual book. This newest of Radio Works, cloth bound in Vellum de Luxe, Gold Stamped and Hand Sewed, has 160 pages. Size is 6 1/2 x 9 1/2 inches. The How and Why of Radio Apparatus. Postpaid, \$1.75. Experimenter Publishing Co., Book Dept., 53 Park Place, New York City.

Experimental Electricity Course in 20 Lessons. By S. Gernsback and H. W. Secor, E. E. A course of the theory and practice of Electricity for the Experimenter. Every phase of experimental electricity is treated comprehensively in plain English. New experiments are described and explained and nearly every application of Electricity in modern life is given. 160 pages—400 illustrations. Flexible cloth cover, 75c. Postpaid. Stiff cloth cover, \$1.25, postpaid. Experimenter Publishing Co., Book Dept., 53 Park Place, New York City.

Wireless Course in 20 Lessons. By S. Gernsback, A. Lescaurba and H. W. Secor, E. E. Tells you everything you want to know about "Wireless"—theory, practice and history. A clear, concise course on every phase of this subject. 160 pages—350 illustrations, 30 tables. Stiff cloth cover, \$1.75, postpaid. Experimenter Publishing Co., Book Dept., 53 Park Place, New York City.

How to Make Wireless Receiving Apparatus. 100 pages—80 illustrations. Only strictly modern radio apparatus are described in this book and the illustrations and descriptions are so clear and simple that no trouble will be experienced in making the instruments. Paper covered, 35c, postpaid. Experimenter Publishing Co., Book Dept., 53 Park Place, New York City.

How to Make Wireless Sending Apparatus. 100 pages—88 illustrations. Written and published entirely for the wireless enthusiast who wants to make his own radio apparatus. Contains more information on "how to make it" than any other book we know of. Paper bound, 35c, postpaid. Experimenter Publishing Co., Book Dept., 53 Park Place, New York City.

# NEW 25c BOOKS

## That Every Novice or Amateur Needs

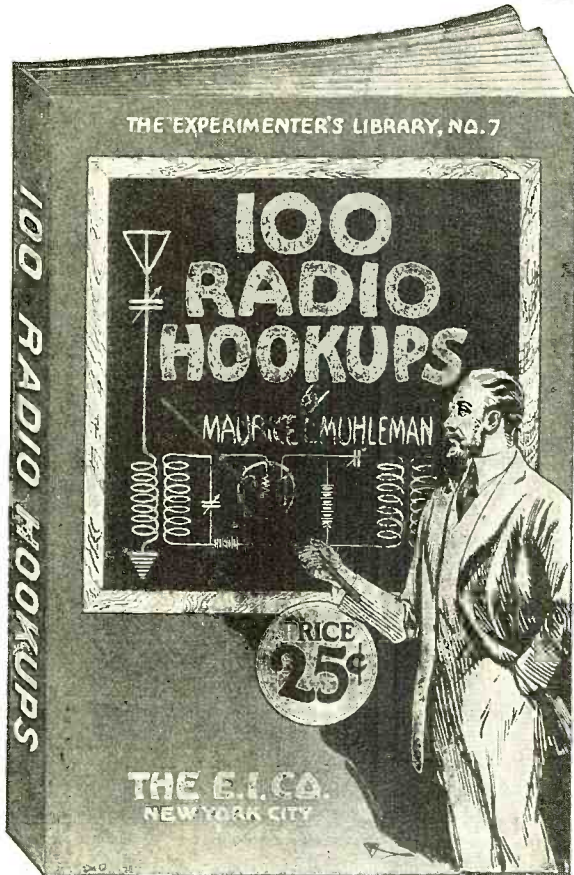

### 100 Radio Hook-ups

By M. L. MUHLEMAN

A book for both the novice and advanced radio amateur containing a varied selection of hook-ups from the simple crystal to the more elaborate circuits, with a circuit for every requirement. Crystal hook-ups, combined crystal with radio and audio frequency amplifiers, non-regenerative, and regenerative vacuum tube circuits with and without radio and audio amplifiers. Amplifier units, with straight jacks, filament and switching arrangements, power amplifiers, choke coil, resistance coupled and transformer coupled radio frequency amplifiers.

Includes all of the latest, one and multi-tube hook-ups including the numerous types of Reflex, super regenerative, super-Heterodyne, Neutrodyne, Reinartz, Flewelling, and Bishop. The values and constants of all apparatus employed in the hook-ups are given. A list of radio symbols is included, which are of material help to the reader in determining the meaning of the conventional hook-up diagrams. The text includes much helpful information.

52 Pages—Two-Color Cover ..... **25c.**

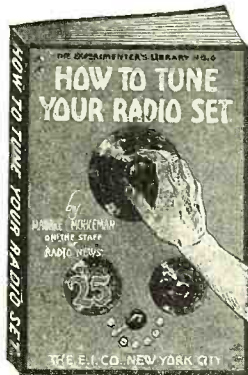

This book covers in comprehensive form, the fundamental principles of tuning. The characteristics of radio waves are fully described and illustrated. Illustrations are used so that the non-technical reader can easily understand the identical actions as applied to radio. Several chapters are devoted to the use and functions of all radio apparatus. The book describes how to tune such sets as the Reinartz, Flewelling, Neutrodyne, radio frequency amplifier receivers and other.

52 pages,  
25 Illustrations  
Prepaid ..... **25c**

A non-technical book for the beginner. Gives complete constructional data on the building of a complete Crystal Detector Set, Tuning Coil, Loose Coupler and a Single Audion Tube Set with Amplifying Units. It furnishes all dimensions and working drawings of every part that must be constructed by the amateur. Written in plain, simple language that anyone can understand. The opening chapter gives a complete description of the theory of radio and tells what it's all about, teaching the principles of wireless so that the constructor knows what he is doing.

48 Pages, 26 Illustrations  
Bound in Beautiful Two-Color Cover. Size, 5½ x 7½ in. Prepaid ..... **25c**

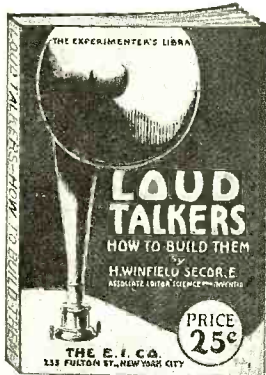
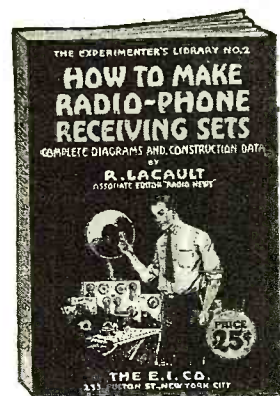

This book describes and gives complete data for building two distinct types of loud talkers. One chapter deals with improvised loud talkers, and gives complete instructions on how to build suitable horns for use in loud receivers of the Baldwin and other types. In preparing these designs, the point has been constantly kept in mind to use the simplest parts possible, so that anyone can build a successful loud talker, equivalent to the commercial types, costing \$40.00 or more.

48 pages, Profusely Illustrated  
Prepaid ..... **25c**

This book is for the more advanced amateur, showing the construction of the Radio Frequency Amplifying Transformer and giving complete constructional data. It shows the application of Radio Frequency to amplifying units that the amateur may already possess and gives 15 hook-ups showing practically every use Radio Frequency Amplifying Transformers can be put to.

32 Pages, 15 Illustrations  
Bound in Beautiful Two-Color Cover. Size, 5½ x 7½ in. Prepaid ..... **25c**

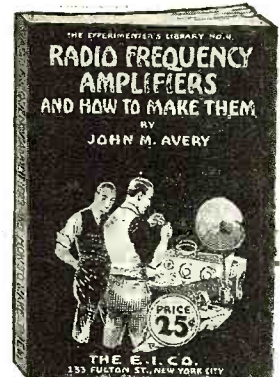

A complete list of dealers carrying these books will be found on page 178

If your dealer cannot supply you—order direct from us—giving dealer's name and address.

**THE E. I. COMPANY (THE CONSRAD CO.) 233 Fulton St., N. Y. City**  
Selling Agents

# WORKRITE TUNER TEAM

WorkRite Super Variometer

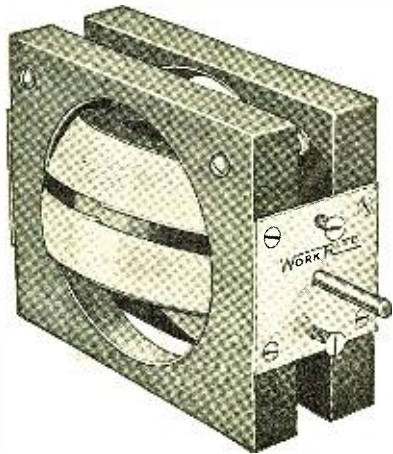

**\$3.50**

EACH

*Enormous  
Production  
Makes  
This  
Price  
Possible*

WorkRite 180° Super Variocoupler

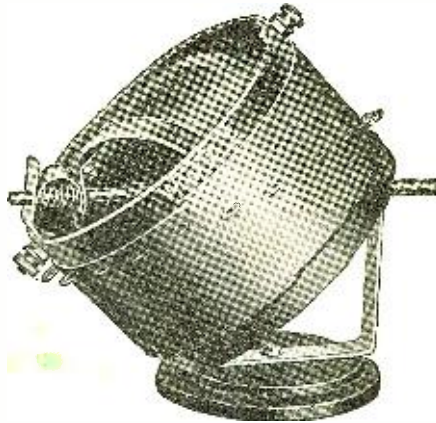

Two WorkRite Variometers and one WorkRite Variocoupler make up the "WorkRite Tuner Team", the most selective circuit possible. The WorkRite Variometer is made from fine grade mahogany, handsomely finished. Very sensitive and sharp to tune. All metal parts are made from brass and nicked. The WorkRite 180° Super Variocoupler is made from moulded Bakelite. It is wound with green silk and has 12 taps. Range 150 to 705 meters. Look at this low price.

WorkRite Super Variometer .....\$3.50      WorkRite 180° Super Variocoupler .....\$3.50

## New WorkRite Vernier Rheostat \$1.00

The latest and best in Rheostats. 50,000 adjustments for \$1.00. Pushing the knob way in turns off the filament. Turning the knob gives the very finest adjustment. Often a turn of 1/32 inch will clear up a station or separate two stations. This Rheostat is made with three different resistances so that there is a WorkRite Rheostat for any tube now on the market.

WorkRite Vernier Rheostat, 6 ohms..... \$1.00  
 WorkRite Vernier Rheostat, 15 ohms..... \$1.10  
 WorkRite Vernier Rheostat, 30 ohms..... \$1.25



PATENT APPLIED FOR

## WorkRite E-Z-Tune Dial

When you want to get a very fine adjustment on your variometers, variocouplers, condensers, etc., you always grasp your dial on the outer edge for more leverage. Right there is where you will find a knurled flange that just fits your grasp on the WorkRite E-Z-Tune Dial. You can easily make a turn of a hair's breadth. Made of the finest material, highly polished. Easily the "Snappiest" dial on the market. 3 1/2 in. diameter. Specify whether 3/16 in. or 1/4 in. shaft.

Price 75c

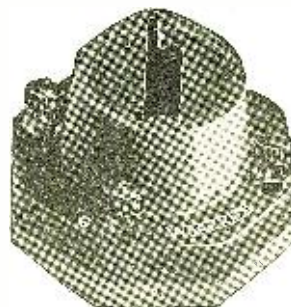

## WorkRite Nonmicrophonic Socket

Here is the right socket for your UV199 Tube. It is moulded with a sponge rubber base in one piece which is even better than the soft rubber recommended for use with this tube. Very neat and attractive. Price ..... 60c

## WorkRite Resistance Cartridge



No need to buy a new Rheostat to get the required 30 ohms resistance for the UV199 Tubes or the 15 ohms for the 201A and 301A Tubes. Just put a WorkRite Resistance Cartridge in the circuit with your old 5 or 6 ohm Rheostat. Price 15 or 25 ohm... **40c**

## Other WorkRite Products

### WorkRite Hydrometer

You need one for your "A" Battery. Full instructions for the care of battery included with each instrument. Price 75c

### WorkRite Switch Set

Just what you want. Remove parts and use the block for a template in drilling panel. Switch arms and points made to work together. Price complete, 50c.

### WorkRite Concert Headset

Extremely sensitive and free from distortion. Phone cases made from aluminum. Try the WorkRite Concert Phones side by side with any on the market. Price \$6.00

*"WorkRite Radio Parts WorkRite"*

# THE WORKRITE MANUFACTURING COMPANY

5522 EUCLID AVENUE

CLEVELAND, OHIO

(Branch Office, 536 Lake Shore Drive, Chicago)

# A Two Tube Radiola

## [ Radiola RS ]

**B**UILT like Radiola Senior—but with two tubes instead of one. For greater distance—and a chance to use a loud speaker on the nearby stations. The same compactness and portability. The same sensitivity and exactness of construction. If the Senior performed wonders for a one-tube set—count on new wonders for the new RS.



Radiola RS  
complete with  
tubes, dry batteries  
and headset,  
\$87.50

Light enough to carry with you. Powerful enough, with its Radiotrons WD-11—detector and one-step amplifier—to listen in from farthest mountain top camp to the big cities. Neat—and finely finished, as every Radiola is. What a summer of fun it means!

Are you listening in to  
**BROADCAST CENTRAL**  
The Radio Corporation's  
great Duplex Station  
WJZ-WJY  
Aeolian Hall, New York City

This symbol of quality is  
your protection



*"There's a Radiola for every purse"*

at the nearest Radio or Electrical Store  
Radio Corporation of America

Sales Department  
233 Broadway, New York  
District Sales Offices  
10 So. LaSalle St., Chicago, Ill.      433 California St., San Francisco, Cal.

# Radiola

REG. U. S. PAT. OFF.



**RADIO CORPORATION OF AMERICA**  
Dept. 2065 (address nearest office listed)  
Please send me your free Radio Booklet describing  
sets from \$25 to \$350.

Name \_\_\_\_\_

Street Address \_\_\_\_\_

City \_\_\_\_\_

R.F.D. \_\_\_\_\_

State \_\_\_\_\_