

# RADIO NEWS

REG. U.S. PAT. OFF.

25 Cents  
October  
1922

Over 175 Illustrations

Edited by H. GERNSBACK

*Es  
re  
radio  
nateur  
med  
10%  
Fe  
m  
e  
ge 624*



RECEIVING LUNCH BY RADIO  
50 YEARS HENCE

CIRCULATION LARGER THAN ANY OTHER RADIO MAGAZINE





# Cunningham tubes

The Heart of  
Your Home Receiving Set

**AMPLIFIES AS  
IT DETECTS**

*—enjoy clear reception by  
using Cunningham Tubes*



**TYPE C-300  
GAS CONTENT  
DETECTOR**

**\$5<sup>00</sup>**

**TYPE C-301  
HIGH VACUUM  
AMPLIFIER**

**\$6<sup>50</sup>**

**PATENT NOTICE**  
Cunningham tubes are covered by patents dated 11-7-05, 1-15-07, 2-18-08 and others issued and pending. Licensed only for amateur or experimental uses in radio communication. Any other use will be an infringement.

Cunningham Detector Tube, type C-300, insures clearest reception for all radio messages, concerts, press and weather reports.

The rigid specifications to which these tubes are built in the General Electric Laboratories determine their uniform operation and perfect clearness.

Cunningham Amplifying Tube, type C-301, is conceded to be the most efficient amplifier ever produced. For complex and multi-stage circuits, freedom from distortion and absence of all tube noises as well as for the operation of loud speaking telephones and devices requiring considerable power, this tube has no equal.

If your dealer cannot supply you, write us direct for the name of a Radio Dealer who can.



The trade mark **GE** is the guarantee of these quality tubes. Each tube is carefully inspected and tested before leaving the G. E. factory.

248 First Street  
San Francisco, Calif.

Trading as  
**AUDIOTRON MFG. COMPANY**

154 West Lake Street  
Chicago, Illinois



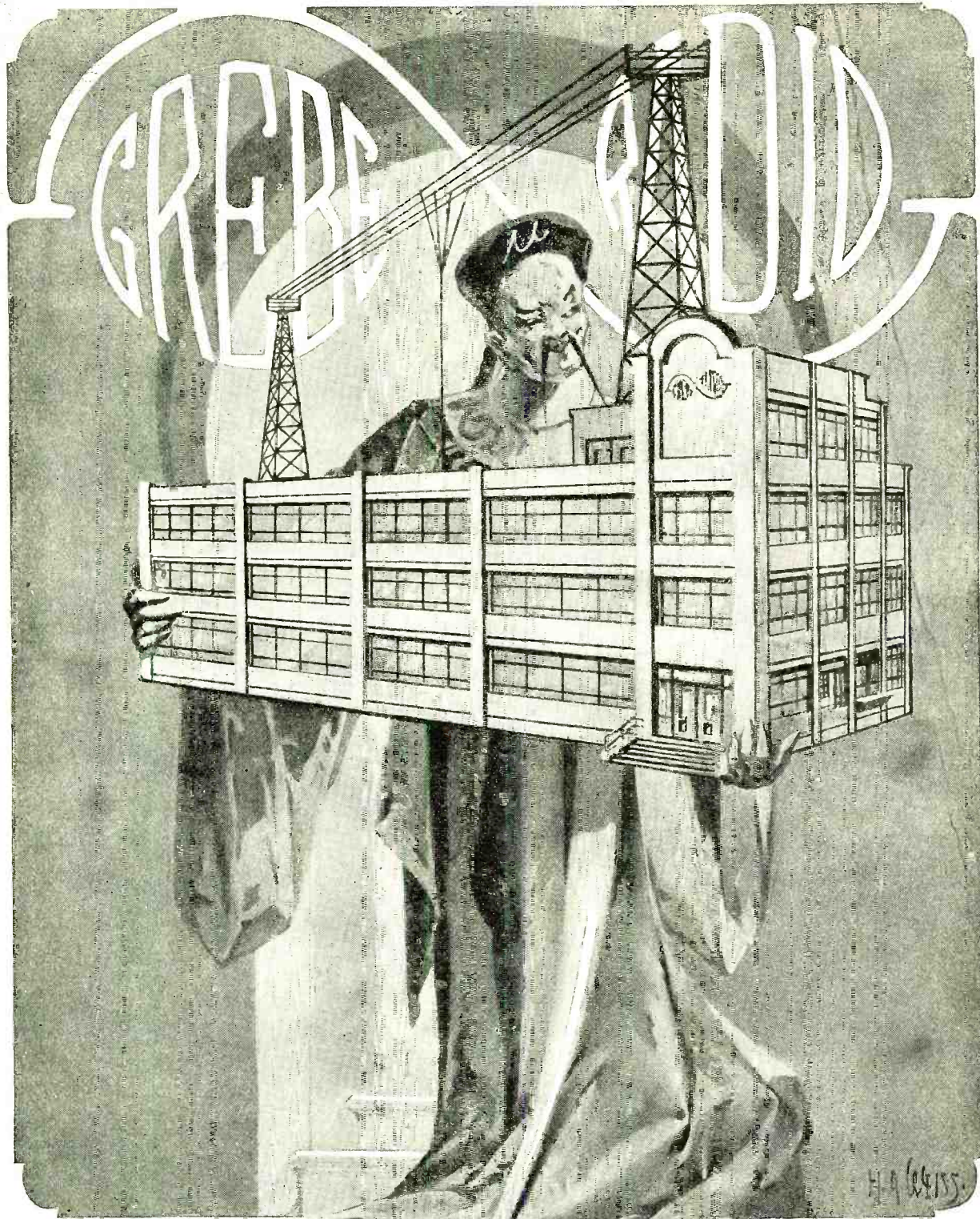

TREASURES OF GOLD AND JADE  
SAID LAO TZU, DESERVE A  
PROPER DWELLING !  
" GREBE RADIO IS NOW HOUSED IN A  
MANNER BEFITTING ITS EXCELLENCE. "

*Doctor Wu*



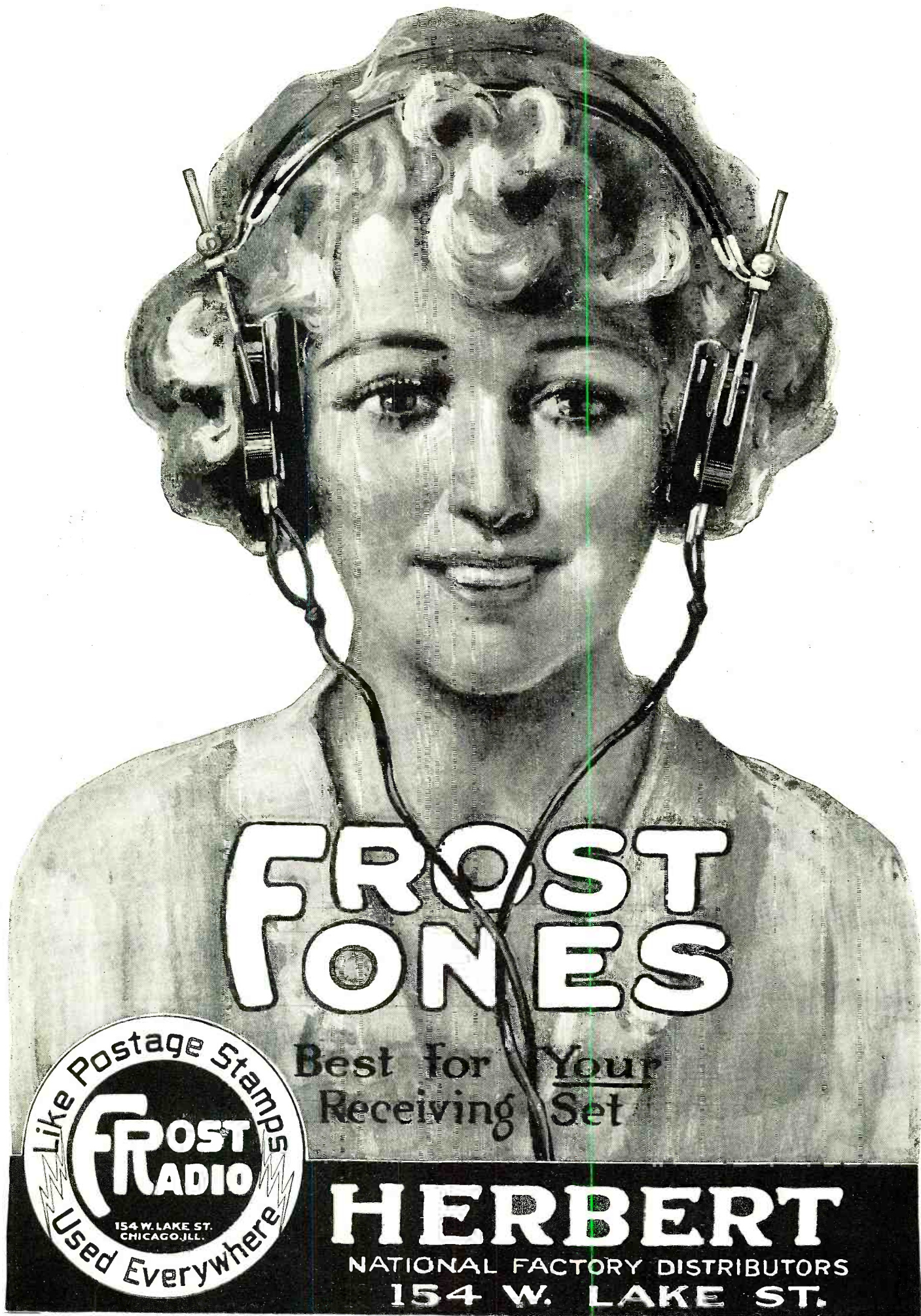

# FROST FONES

Best for Your Receiving Set

Like Postage Stamps  
**FROST RADIO**  
 154 W. LAKE ST. CHICAGO, ILL.  
 Used Everywhere

**HERBERT**  
 NATIONAL FACTORY DISTRIBUTORS  
 154 W. LAKE ST.



# A Quality Achievement



Fully  
Guaranteed  
by the  
Name

No. 162 . . \$5.00  
2000 Ohm Set

No. 163 . . \$6.00  
3000 Ohm Set

The Ideal  
Receivers  
for Use  
With Home  
Radio  
Receiving  
Sets

## Frost Improved Plugs



Frost-Radio Plug No. 132—\$1.00



Frost-Radio Cord-Tip Plug No. 137—\$1.25

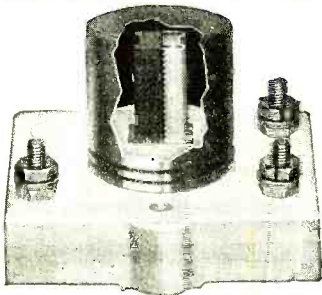

## FROST-RADIO PROTECTOR

Listed by Underwriters' Laboratories under April, 1922, Regulations. No interference. Never grounds. Mounts indoors. Price \$1.50. Good deliveries on this approved device.

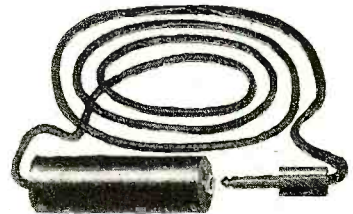

Frost-Radio Extension Cord  
Lengths from 10 to 100 feet

Loud speaker can be placed anywhere and connected with Radio Set with Frost-Radio Extension Cord.

# H. FROST

TO THE ELECTRICAL-RADIO JOBBER  
CHICAGO, ILL. U.S.A.





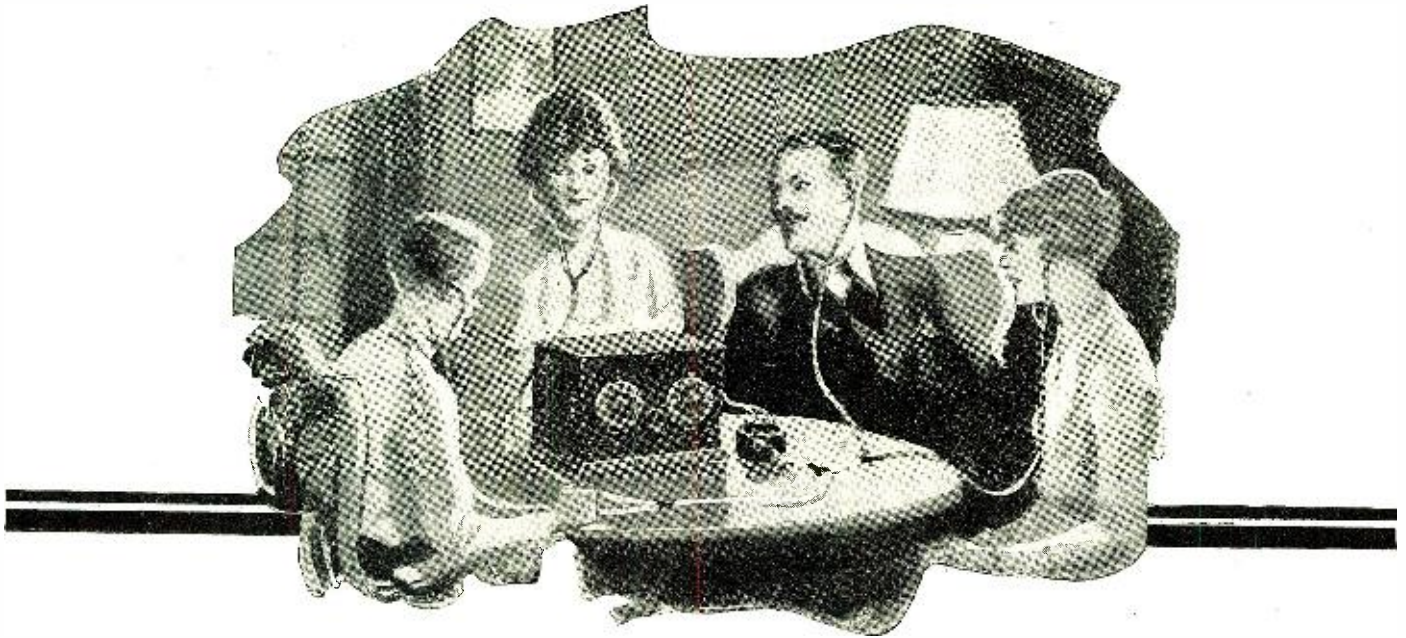

# 4 People for \$5

**T**HAT'S what the Radisco Phonoscope means to your radio receiving set. Four people can listen in on a crystal or audion set where only one could before with ordinary head phones. Since head phones cost from \$5 to \$15 each the expense for phones to let the whole family listen in would be from \$20 to \$60 or more. The Radisco Phonoscope allows four people to listen in as easily and clearly at a cost of only \$5.

Briefly, this is the way it works. A receptor is provided into which one receiver of your present head set can be automatically inserted. The signals received by your head set will then be transmitted through pure para rubber tubing to the four listening

ends of the Phonoscope itself. These are very comfortable and easily adjustable to the tension you desire. Four people for \$5 can hear each concert comfortably.

The Phonoscope is but one of the hundred products sold by the Radio Distributing Company and its agents throughout the country. If your dealer cannot supply you, send money direct with name of dealer. Money gladly refunded within 15 days if you are not perfectly delighted with the results you secure. 10c to cover mailing charges will bring you a copy of the new Radisco Radio Catalog. **THE RADIO DISTRIBUTING COMPANY, Newark, N. J., U. S. A.**

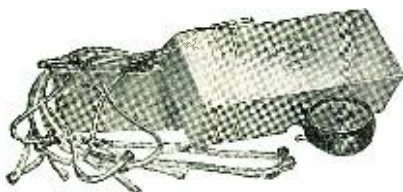

*Radisco Phonoscope, Price \$5*



*Radisco Heliphone, Price \$5*  
(Pocket receiver)



*Radisco Vario-coupler, Price \$6.50*

# RADISCO RADIO PRODUCTS





# - and that's not all

OF course we are not seriously advocating that golf enthusiasts proceed to equip themselves with a radio set while playing, still they will find a radio set just as refreshing as the nineteenth hole, especially after supper on the veranda. If it's too cool to sit outside there is no better fun than listening in on the news and doings of the world over one of the many types of Radisco receiving sets.

These sets may be had in a range of prices suitable to the most lean and emaciated or plump and prosperous pocket-books. There is a set suitable for Tommy just turning seven and another for his dad who

owns the only bank in town. Some Radisco receiving sets are of the simple crystal detector type and others range up to the long range high power set with two stages of amplification and loud speaker attachment so a whole roomful can hear.

In addition to complete sets the Radisco line comprises all kinds of radio parts and accessories. There is great fun in building your own set. Write us for full information and interesting radio catalog. THE RADIO DISTRIBUTING COMPANY, Newark, New Jersey, U. S. A.

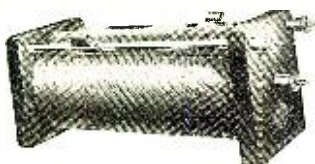

*Radisco Two Slide Tuner*  
Price \$4.00



*Radisco Lily Horn and Coupler*  
Scientifically designed fibre horn; no distortion. only 95c. Coupler connects all makes of phones to Victor, Columbia and other phonographs—also to Lily Horn. Price 60c.



*Radisco Duplex Phonograph Adaptor*  
Price \$2.50

# RADISCO RADIO PRODUCTS



# REMLER

*Cunningham*

APPARATUS THAT RADIATES QUALITY

No. 82 Rotary Switch  
1 1/2" Radius  
Price, 50c

No. 90 Bearing Type, Rotary Lever Switch  
1 1/2" Radius  
Price, 75c

No. 91 Bearing Type Rotary Lever Switch  
1" Radius  
Lever  
Price, 60c

No. 94 Rotary Switch  
1/4" Collar  
1" Radius  
Price, 40c

No. 95 Rotary Lever Switch  
1" Radius  
Price, 50c

No. 83 Rotary Lever Switch  
3/16" Collar  
1" Radius  
Price, 40c

No. 97 REMLER GRID CONDENSER  
.00025 MFD.

No. 97 Fixed Grid Condenser  
Price, 20c

No. 96 Variable Grid Leak  
Price, 40c



Type No. 100  
3-inch Bakelite Dial with Knob and Bushing 75c

## Remler Parts For Your Set

On this page are shown the popular line of Remler switches, the Remler Fixed Grid Condenser, the Remler Variable Grid Leak and the famous Remler Dial.

This represents but a small fraction of the Quality Radio Apparatus that has put Remler in the leading position it holds today. This small fraction, however, is built with the same care, accuracy and precision that has made the entire Remler line universally known as Quality Radio Apparatus.

It is becoming more and more apparent that Remler Apparatus is preferred in the building of sets because of its uniformity of construction—the well balanced proportion of each item giving an accurate and a pleasing appearance to the finished set.

Insist on Remler parts. If your dealer cannot supply you, write us direct for the name of a Radio dealer who can.

# REMLER RADIO MFG. CO.

E.T. CUNNINGHAM GENERAL MGR.

248 FIRST ST. SAN FRANCISCO, CAL.

154 W. LAKE ST. CHICAGO, ILL.



# REMLER

*Cunningham*

## Giblin-Remler INDUCTANCE COILS

**APPARATUS  
- THAT -  
RADIATES  
QUALITY**

Type, and Number of Turns, Mounted	Price, Mounted	Type, and Number of Turns, Unmounted	Price, Unmounted	Inductance in Milli-henry at 1000 cycles. Accuracy 1/2%		Natural Wave Length in Meters. Accuracy 1/2%	Distributed Capacity, in micro-microfarads. Accuracy 1%	Wave Length Range in Meters using Condenser of .001 max. and .00004 mfd. min.		High Frequency Resistance in Ohms at Wave Length shown			
				Min.	Max.			200	500	1000	2000		
RC 20M	1.50	RC 20U	.70	.030	39	14.3	63	334	1.1				
RC 25M	1.50	RC 25U	.70	.041	47	15.2	75	389	1.5				
RC 35M	1.50	RC 35U	.70	.083	87	25.4	128	550	3.5				
RC 50M	1.60	RC 50U	.80	.169	114	21.6	185	785	8.8	4.4			
RC 75M	1.65	RC 75U	.85	.377	163	19.8	266	1170	28.3	12.1	6.2		
RC 100M	1.70	RC 100U	.90	.666	217	19.9	358	1550	80.3	26.8	12.6		
									1000	2000	5000	10000	
RC 150M	1.75	RC 150U	.95	1.503	281	14.8	512	2320	69.3	23.8	7.1		
RC 200M	1.80	RC 200U	1.00	2.68	374	14.7	690	3110	50.6	12.5			
RC 250M	1.90	RC 250U	1.10	4.20	424	12.1	860	3880	87.5	19.9			
RC 300M	2.00	RC 300U	1.20	6.11	494	11.2	1030	4680	141	29.3	13.8		
RC 400M	2.10	RC 400U	1.30	11.04	618	9.7	1360	6300		54.6	22.3		
RC 500M	2.30	RC 500U	1.50	17.50	747	9.0	1730	7900		93.1	34.9		
									2000	5000	10000	20000	
RC 600M	2.40	RC 600U	1.60	29.2	1024	10.1	2260	10250	111	43.8			
RC 750M	2.65	RC 750U	1.85	39.0	1249	11.3	2660	11850		64			
RC1000M	3.40	RC1000U	2.50	71.6	1620	10.3	3570	16000		123			
RC1250M	3.80	RC1250U	2.90	108.0	1930	9.7	4360	19700					
RC1500M	4.40	RC1500U	3.50	159.8	2300	9.3	5300	23800					

This table compiled by Robert F. Field of Cruft High Tension Electrical Laboratory, Harvard University, Cambridge, Mass.

### The Ideal Loading Coil

These new inductance coils will increase the wavelength range of your short wave receiving set.

There is nothing more fascinating than the reception of radio messages from high-power stations located thousands of miles away. These stations use wave lengths between 1000 and 25,000 meters. This is far above the receiving range of the average receiver designed for amateur broadcast reception.

Inserting Giblin-Remler Coils of the proper values (determined from the table shown on this page) and shunted by a variable condenser, in series with the antenna circuit and the secondary circuit of your receiver, will increase its wavelength range any desired amount.

The Giblin-Remler Coil makes possible the reception of high-power, long wave foreign stations, as well as time signals, press and weather reports from various naval stations thruout the United States.

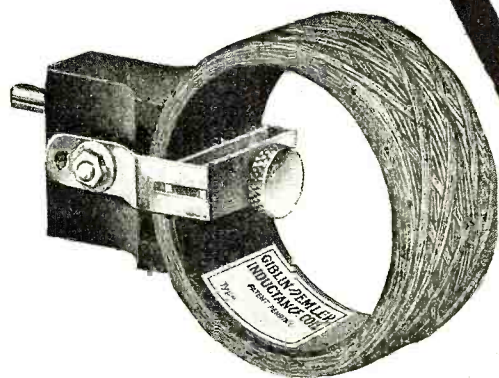

Maximum Inductance and Minimum Distributed Capacity

### REMLER RADIO MFG. CO.

E. T. CUNNINGHAM  
General Manager

248 First Street, San Francisco, Calif.  
154 W. Lake Street, Chicago, Ill.



**Fada-facts—**

a guarantee to you that every statement made in Fada advertisements is an absolute fact, without exaggeration, and Fada stands ready to prove it.

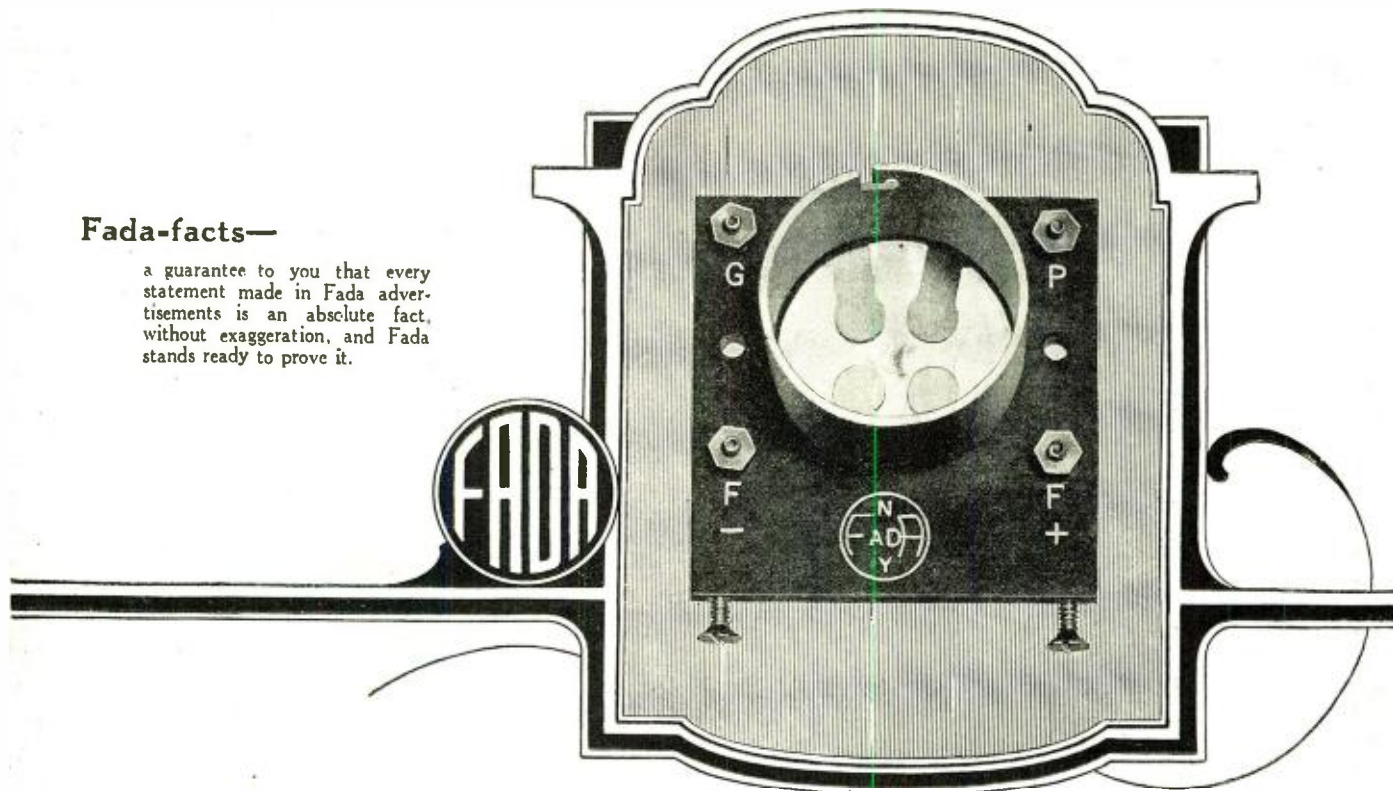

Fada Double Tube Socket

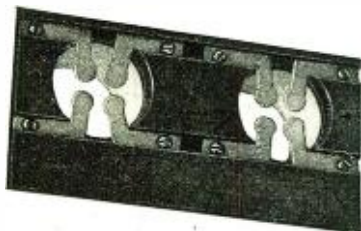

Bottom View of Double Tube Socket



Fada Triple Tube Socket

*Nine Reasons Why—***Fada Sockets are Good Sockets**

1. **Base is made of genuine Condensite.** High frequency insulation resistance meaning little voltage losses
2. **Contact Springs set in Trenches.** Springs are thus immovable except as a tension against the tube contact points.
3. **Contact Springs made of Phosphor Bronze.** The best spring temper with grain of metal lengthwise of spring.
4. **Metal Inserts in Base** threaded for panel mounting. No chance of cracking base when assembling.
5. **Socket Tube is offset on Base.** So designed to allow ample room for mounting Fada rheostat back of socket.
6. **Brass Socket Shell** and can't break at the bayonet joint like the moulded shellac or porcelain sockets.
7. **Screw Holes for Base Mounting.** All screws are counter-sunk below the surface so socket can be set on metal without shorting connections.
8. **Terminals are Plainly Marked.** Four terminals are marked and filament battery polarity shown.
9. **Single, Double and Triple Sockets.** Fada sockets can be supplied in these sizes.

Single Tube Socket.....	\$1.00
Double Tube Socket.....	2.00
Triple Tube Socket.....	3.00

*Fada Rheostats. Switches. Crystal Detectors. Vario-Couplers. Receiving Sets. and Detector-Amplifiers are good instruments. Ask your radio dealer.*

**FRANK A. D. ANDREA**

1581-A JEROME AVE., NEW YORK CITY

# Fada-Facts



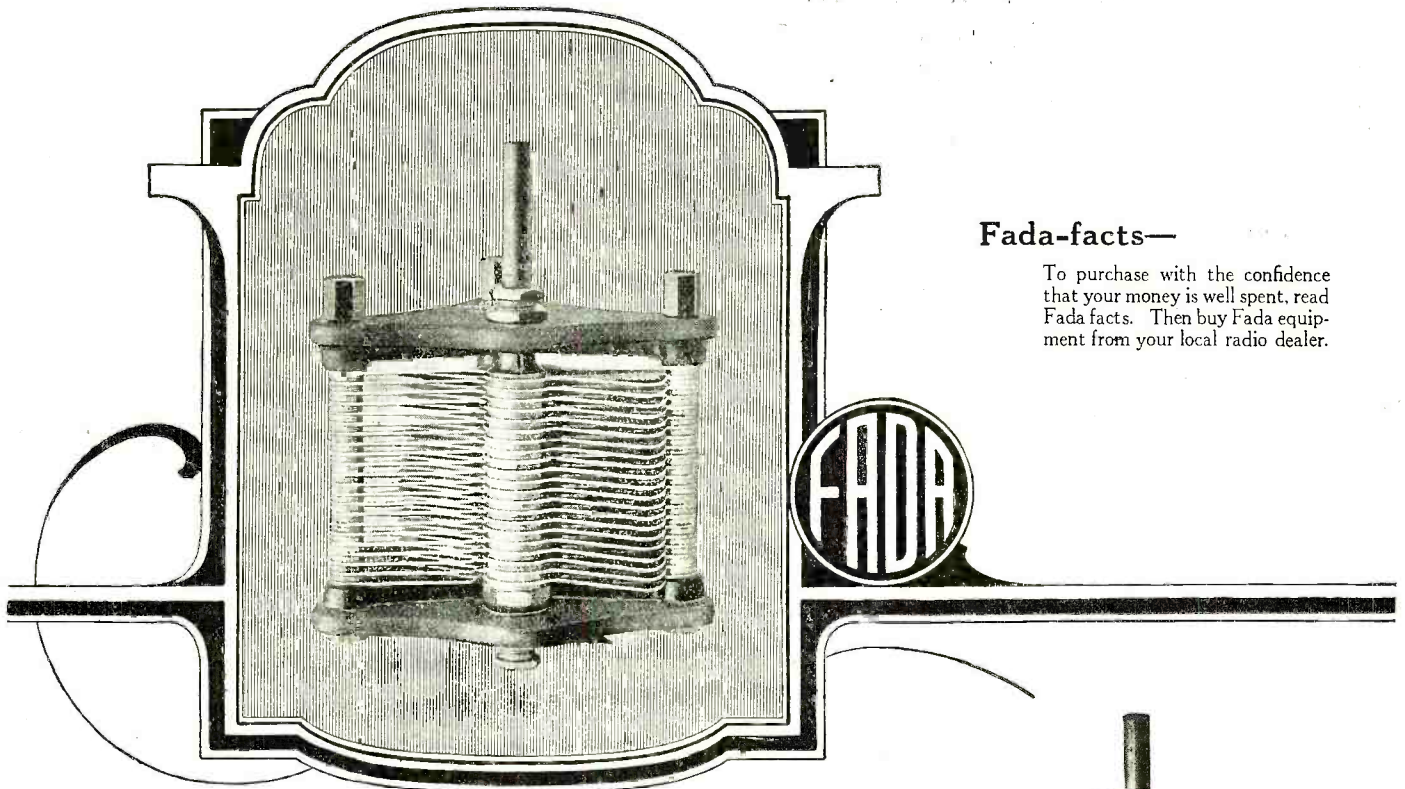

**Fada-facts—**

To purchase with the confidence that your money is well spent, read Fada facts. Then buy Fada equipment from your local radio dealer.

*A New Arrival—*

**Fada Variable Condensers**

Seven points in the construction of Fada Variable Air Condensers that places them among the best on the market.

1. **End Plates made of Condensite.** A good insulator that protects you from condenser losses.
2. **End Plates ribbed to secure extra strength.**
3. **Plates made of hard Aluminum.** Every plate perfectly flat, true and accurate.
4. **Spacing Washers Uniform.** Special manufacturing method makes washers true to size and perfectly flat.
5. **Positive Thrust Adjustment.** Socket nuts designed to give permanent adjustment at both end plates.
6. **Rotary Motion Positive.** Holds any setting because of good thrust adjustment and steel spring washer.
7. **Larger Capacities at Less Cost.** Fada Condensers are so accurately made and assembled with uniform spacing of plates that the capacity of the 23 plate unit is as high as .0007 mfd.

3 Plate (vernier) .0006 mfd. ....	\$2.50
13 Plate .0004 mfd. ....	3.50
23 Plate .0007 mfd. ....	4.00
43 Plate .0015 mfd. ....	4.50
23 Plate (vernier) .0007 mfd. ....	6.00
43 Plate (vernier) .0015 mfd. ....	6.50

*A new Fada catalogue handbook is now ready. This book is not for sale but a copy will be promptly mailed upon receipt of 5 cents to cover postage. It's a How-To-Do-It Book and you should have it.*

**FRANK A. D. ANDREA**  
1581-A JEROME AVE., NEW YORK CITY

**Fada-Facts**

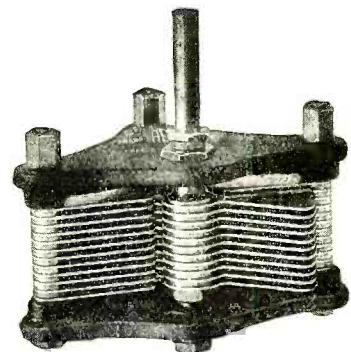

Thirteen Plate Fada Condenser  
Capacity .0004 mfd.

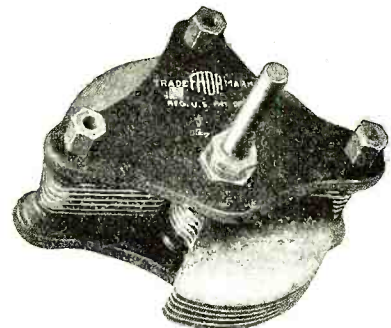

Twenty-three Plate Fada Condenser  
Capacity .0007 mfd.

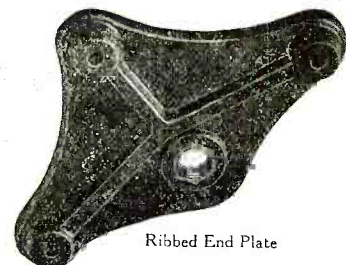

Ribbed End Plate



# NATIONAL

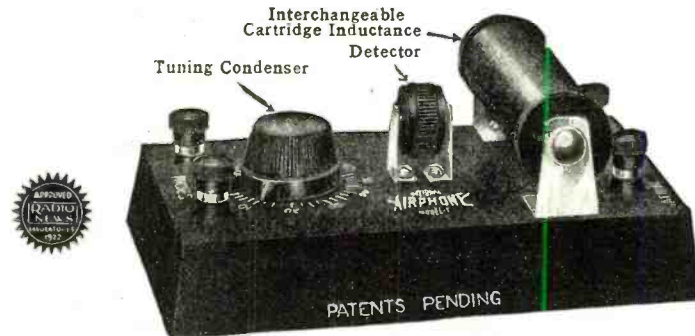

*Price \$12.50*

(Without Phones)

## NATIONAL AIRPHONE

(MODEL G)

Endorsed by Engineers as the Greatest Radiophone Ever Seen or Heard  
Easily Operated Even by a Child

To operate simply connect aerial, ground and head-phones. Will receive radio broadcast entertainments and commercial reports within a radius of 25 miles; Code signals 1000 miles and over depending upon coils used.

### Outstanding Points of Superiority:

1. Most Compact Radiophone Receiving Set Made:  $6\frac{1}{2}$ " long,  $4\frac{1}{4}$ " wide,  $2\frac{3}{4}$ " high—small enough to put in coat pocket or desk drawer.
2. Rugged construction throughout, nothing to get out of order, insuring long life in service.
3. Entire casing constructed of hard rubber composition. No wood, no warping, no losses through leakage.
4. Ultra-sensitive Foolproof Detector; entirely enclosed in composition case. Air and dust proof, no fussy minerals, no Catwhisker, no balls nor springs. To adjust for maximum sensitivity simply rotate the black disk slowly while tapping it.
5. Elimination of all switches, current taps and switchpoints prevents loss of electrical energy.
6. Use of interchangeable cartridge tuning coils gives wide range over which radiophone broadcast or radio telegraph signals can be heard. 25 miles or over for radiophone concerts; up to 1000 miles for telegraph signals depending upon coils used.
7. Two Cartridge tuners, supplied with each outfit; one takes in general broadcasting stations 150 to 400 meters, the other ranges from 500 to 1000 meters.
8. Variable Mica Condenser used is acme of simplicity—high capacity, impossible to short-circuit.
9. Anyone without previous experience can operate a NATIONAL AIRPHONE, no delicate adjustments necessary, no fussing.

*Distributors—Write for Exclusive Territory  
Dealers—Send for Price List*

TRADE MARK  
18 Hudson St.

NATIONAL  
**AIRPHONE**  
CORPORATION

REG. U.S. PAT. OFF.

New York



# AIRPHONE

Pronounced by Experts to Be the Greatest Radiophone Crystal Outfit Ever Produced. Awarded the Certificate of Merit by the "Radio News Laboratories"

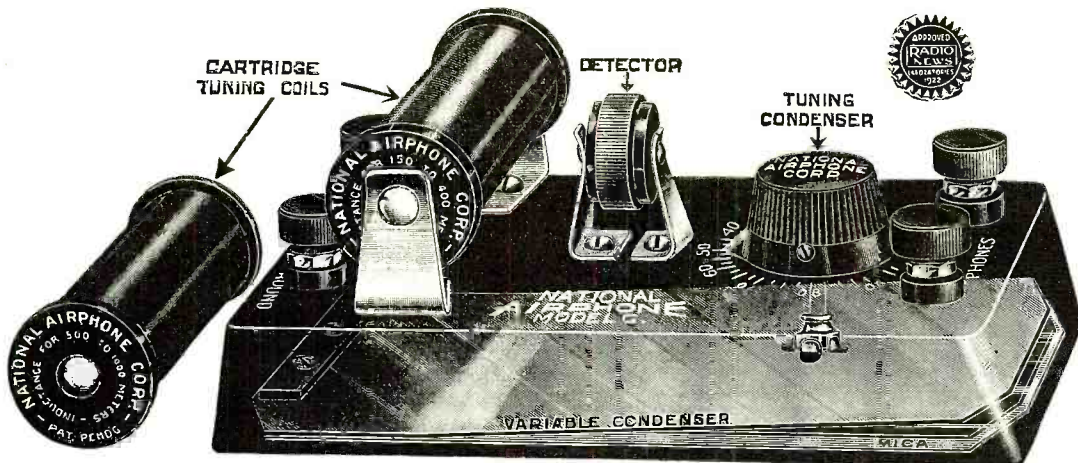

**\$12<sup>50</sup>**

**Without  
Phones**

Patents Pending

## Highest Grade Crystal Receiving Set

No Distortion. Perfect Reproduction of All Sounds With Extraordinary Clarity

The above illustration shows a phantom view of the NATIONAL AIRPHONE MODEL G. It is a perfect crystal radiophone of compact and rugged construction, guaranteed to receive broadcast entertainment within a radius of 25 miles, and code signals 1,000 miles and over, depending on location and cartridge tuning coils used. The NATIONAL AIRPHONE is the highest attainment in crystal radio receiving sets and is the culmination of years of work by some of our greatest radio experts and engineers.

It is built along radically different principles and embodies in its superior construction all those features which inventors and manufacturers have been striving to achieve for years. By reason of its superior scientific construction there are no electrical losses whatsoever; not a piece of wood is used—only hard rubber composition. In the NATIONAL AIRPHONE, every detail has been worked out carefully and logically. If you have ever experienced trouble with other crystal receivers and you know what an annoyance it is to fuss around with catwhis-

## Super-Sensitive Detector

Our super-sensitive detector is a revelation. It is positively more sensitive than any other crystal detector, and brings in the sounds incomparably stronger, clearer and louder than the ordinary catwhisker type. It is self-cleansing and remains sensitive practically all the time, EVEN DURING THE USUAL STATIC.

## Tuning Condenser and Tuning Coils

By means of the tuning condenser interference can be eliminated successfully by merely turning the knob. If you wish to receive a station of longer wave-length, snap into place the interchangeable cartridge tuning coil, for which purpose two coils are furnished with each outfit. It will be noted that the variable condenser is of a special design, with mica dielectric, making it one of the best radio condensers known.

## Construction

By reason of the highly-developed scientific construction of the outfit there are no electrical losses whatsoever, not a piece of wood being used, only hard rubber composition. All screws are secured with lock washers, impossible to become loose, and all necessary connections are soldered. The cartridge tuning coils are wound with enameled wire and calibrated for the right wave-lengths. Every part utilized in the manufacture of the NATIONAL AIRPHONE is rigidly tested and examined, and each AIRPHONE is separately tested under actual broadcasting conditions before shipment.

kers, crystals, sliders, springs and other fussy adjustments, the NATIONAL AIRPHONE will prove a revelation. You will know what pleasure it is to own "The little wonder AIRPHONE."

## So Simple to Operate

To operate the NATIONAL AIRPHONE, just connect the aerial and ground wires to the proper binding posts and attach the head phones. Then, if you wish to listen to a broadcasting concert, snap into place the cartridge tuning coil marked "150 to 450 meters," turn the large knob of the tuning condenser while tapping the detector wheel slightly. If broadcasting is going on, stop the pointer of the condenser knob at the point where the sounds come in loudest and clearest. Leave the adjustment at that point and then ENJOY YOURSELF.

**For Further Details See Description on Opposite Page  
If Your Dealer Cannot Supply the National Airphone Model G, Mail This Coupon Today!**

## TESTIMONIALS

Rocky Mountain Radio Corporation, Denver, Colorado: "Our organization tickled to death with AIRPHONE. What proposition are you willing to offer on distribution of AIRPHONE, Rocky Mountain Region?"

Canadian Wireless Telephone Co., Toronto, Canada: "Set satisfactory. Our engineers say your crystal set is the best seen or heard. Have arranged distribution details for Ontario and Quebec provinces, subject to your granting. Next ninety days can distribute five thousand sets or more Ontario."

Edwin A. S. Brown, Hoboken, New Jersey: "I find that the AIRPHONE is a marvel in its compactness and simplicity. The sounds brought in by the phone are clear and with no interference. It gives perfect satisfaction."

William Doniger, Cedarhurst, Long Island: "I have recently bought one of your Model G radio sets. It works wonderfully."

John Schury, Detroit, Michigan: "I have received the receiving set which I recently ordered from your firm and am pleased to advise that same is very satisfactory."

NATIONAL AIRPHONE CORP.,  
18 Hudson Street, New York City.

Gentlemen:

Please send me, prepaid, one (1) guaranteed NATIONAL AIRPHONE MODEL G, as advertised, for which I inclose  money order  check for \$12.50. If at the end of five (5) days I should not find the set to be all that you claim for it, I will return it promptly and you will refund me the full purchase price.

NAME.....  
Street Address.....  
City and State.....



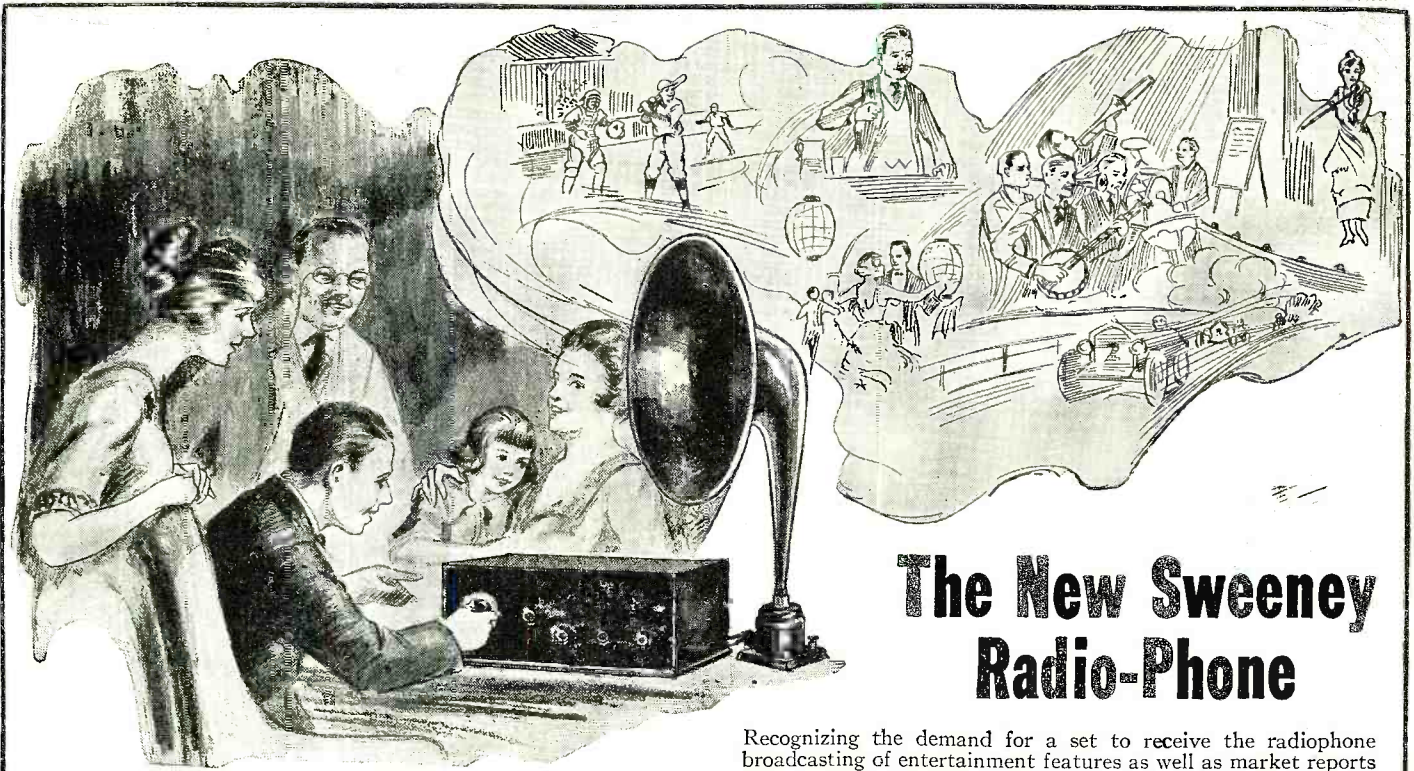

## The New Sweeney Radio-Phone

### Specifications Sweeney Radio-Phone

**Cabinet:** Genuine solid walnut, hand rubbed.  
**Circuits:** Tuning circuit consists of an antenna inductance with four taps and a series variable condensers wave lengths from 175 to 550 meters. Two audio frequency amplifying tubes.  
**Panel:** Bakelite 7x20 3/4. 3/16 inch thick **Control Knobs.** Smooth running and easily adjusted. Only two adjustments required in tuning.  
**Terminals** are in rear of the cabinet to which the aerial ground, A battery and B battery are connected.  
**Wiring** and connections substantially made with 1/16 inch brass rod with cambric tube sleeving.

Recognizing the demand for a set to receive the radiophone broadcasting of entertainment features as well as market reports and government information, our engineers have developed this receiver which incorporates simplicity of operation with its ability to receive long distance stations with clearness and sufficient volume to operate a loud speaking horn. The wave length range will cover those being used for the broadcasting of musical programs as well as the government live stock markets, grain quotations and weather forecasts. All sets are carefully constructed with the best quality of material and most careful workmanship. Each set is rigidly examined and tested before it is released. Radio frequency amplifications, one of the newest developments in radio reception, is used, which accounts for the extreme sensitivity of the instrument and enables the operator to pick up long distance stations. The audio frequency amplification increases the signal strength to such a volume that any type of loud speaking horn at present on the market may be operated. Write for special low introductory price.

### SWEENEY BROADCASTING W. H. B.

**This Is One of the Largest Inland Stations in the Country**

and sends out official Government market and weather reports every day, besides giving musical, educational and religious programs on Sundays, Tuesdays and Thursdays. Through the courtesy of C. G. Conn & Co., Elkhart, Ind., Makers of Musical Instruments, we are broadcasting some of their concerts.

This station cost \$20,000 to erect. CALL IS—WHB—360 meters for concerts and 485 for Government reports. 500 watts W. E. set provides its power. This great broadcasting station is evidence of the capacity of the Sweeney Company to serve you in the purchase of all supplies and equipment.

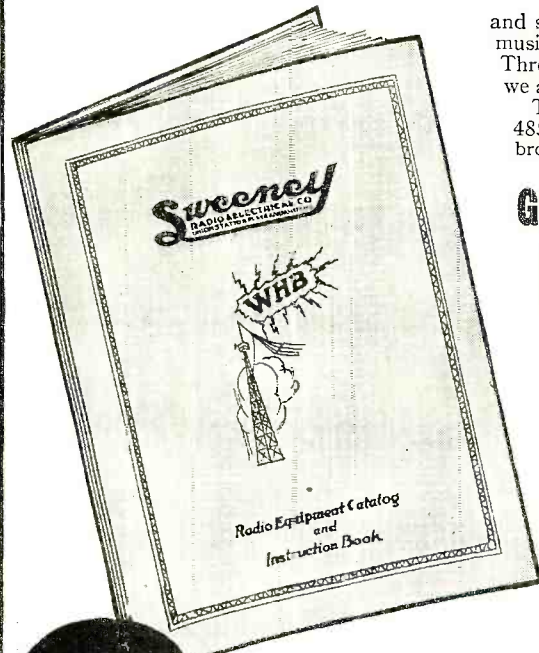

### Get This Radio Catalog and Instruction Book

Every radio enthusiast should have a copy of this valuable book which is just off the press. Contains new and interesting matter and descriptions and hints that will save you time and money, including hookups showing connections of crystal, regenerative, and high frequency amplification apparatus and give you much better results. Do not buy any radio supplies until you have seen this book as we have gone into this business on a great scale and are prepared to supply you with the best and most efficient new material at lowest prices. This book has been prepared by some of the best known electrical and radio engineers and practical instructors. Sent on receipt of fifteen cents in stamps. Get your copy today.

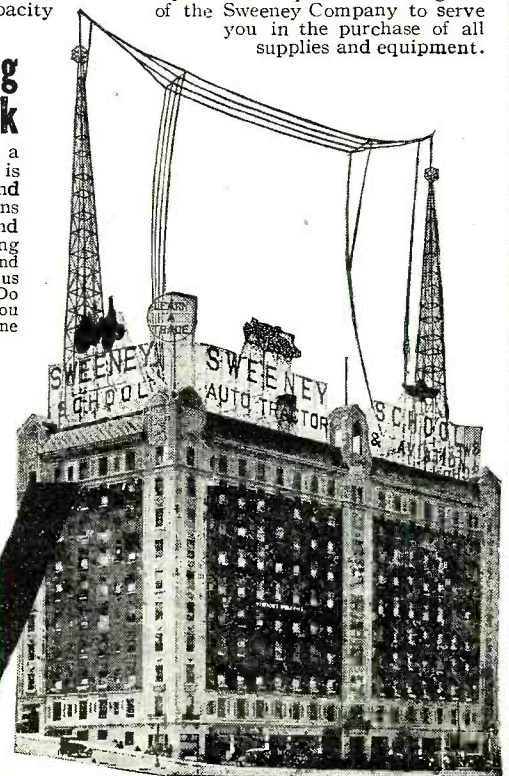

# Sweeney

**RADIO & ELECTRICAL CO**  
 1023 UNION STATION PLAZA, KANSAS CITY, MO





# RADIO NEWS

H. GERNSBACK—Editor and Publisher  
ROBERT E. LACAULT—Associate Editor

EDITORIAL AND GENERAL OFFICES, 53 PARK PLACE, NEW YORK

Vol. 4

OCTOBER, 1922

No. 4

## Needed Radio Improvements

OCTOBER marks the renewal of radio activities in this country. This time of the year, every radio amateur, every fan, is beginning to take renewed interest in his radio outfit, after the vacation period, and is trying to catch all that is going on in the air.

During the past summer broadcasters have not been asleep, either, and in a great many instances have improved their transmitting stations to a greater degree, so that broadcasted entertainment should now be of a vastly better quality than it was last spring.

We must now indulge in some straightforward talk, and must point out to our manufacturers why, after the winter and spring boom, there was such a tremendous falling off in interest on the part of the American radio public. The main reason, of course, was because too much poor apparatus was foisted upon an unsuspecting public.

Time and again, novices, buoyed up by the glowing reports they read on radio, bought poor equipment, which was promptly discarded, with the result that there was at once a man in the community who did all in his power to denounce radio. If there had been only a few of these, no great harm would have been done, but there were literally tens of thousands who were thus taken in and even now the victims have not a good word left for radio.

What the radio industry must do now, more than ever before, is to clean house, and make a clean sweep. Every instrument, every piece of apparatus that leaves the factory without giving 100 per cent. satisfaction to the user will prove a boomerang six months hence, when the public will refuse to buy. There has been too much poor equipment and flooding of the market with junk, and we cannot be too strong in our denunciation of such malpractice as was, and still is, rampant.

Another thing that has destroyed sales and taken away the confidence of the public is the loud-talker. Unless this instrument is carefully constructed, not only by radio experts, but acoustic experts as well, such an instrument will drive more prospects away than is imagined in some quarters. We have actually seen people standing in front of stores and after listening to some of these atrocities they turned away in disgust, saying, "If that is radio, I want none of it."

The fault in this case is not always in the loud-speaking device, but in the ignorance of the dealer or the man who displays the instrument, and who does not know how to get results from it. When amplification reaches beyond a certain stage, particularly where the regenerative effects are used, it becomes exceedingly difficult to avoid distortion. Even the best loud-talkers distort pretty badly, unless operated or used by an expert who knows radio from the ground up. But when the average person buys one of these instruments he very seldom gets results that are worth while and that will make for future sales. When a novice in radio operates one of these horns or loud-talkers, there is not one chance in ten that he will get the proper results, and then, when his friends come to listen to the news, music, or lectures, they may marvel at it, but as a rule they are not favorably impressed, and they do not often wish to invest their money in a similar outfit.

These conditions have killed literally a hundred thousand sales all over the country, and it is up to our manufacturers to rectify these conditions. With the exception of two or three loud-talkers, there are none that give real results.

The mischief becomes even greater when horns alone are sold, made for the purpose of attaching a headset or single receiver to them. The reason is that no two makes of receivers will work the same with such horns. The size of the diaphragm and the strength of the mag-

nets, besides a hundred other factors, contribute toward distortion, and it is impossible for a manufacturer of a horn attachment to know in advance what phone will be used with his product. Therefore, the chances are overwhelmingly against obtaining results from such a horn.

A horn that will work moderately well with a phone having a  $2\frac{1}{8}$ -inch diaphragm, will not always work with a phone that has a  $1\frac{3}{4}$ -inch diaphragm, etc. The moral, therefore, is that manufacturers of horns should not put them out alone in any case whatsoever, but furnish the phones or other electro-magnetic appliance built into the socket of the horn itself. This would be the only way to get fair results.

And while we are on the subject of horns, we want to call to the manufacturers' attention that 90 per cent. of them are not only designed wrong from start to finish, mechanically, but most of them have no acoustic properties whatsoever. The size and shape, acoustically, are wrong, and the materials themselves are ill-chosen. You cannot expect a thin, tin horn to give anything but a tinny sound, which, in fact, it does. We have seen horns when used with phones that started to vibrate at their fundamental stage, giving off a note of their own, and you can imagine the noise that issued forth from such a horn, instead of music. The materials are usually entirely too thin, and if metal is used it should never be less than  $\frac{1}{2}$  inch in thickness.

We know that to get rid of the tinny sound it would be better not to use metals at all, but try to obtain a substance that gives no rise to overtones and no bad echoes. Years ago a phonograph horn was made of a sort of cardboard substance, lined with a thin coating of felt. This horn reproduced sounds better than anything we have seen lately.

Another material which might be used is cork in some form. Even a metallic horn lined with cork would be preferable to the present-day horns.

Finally, it becomes important to dwell upon the size of the diaphragm used in connection with loud-talkers. A number of manufacturers satisfy themselves by choosing almost any type of horn and attaching it to a single telephone receiver, letting it go at that. That is not solving the problem. Even if the horn was properly constructed mechanically and acoustically, we would still have the problem of the telephone itself. We venture the opinion that the size of most of the telephone diaphragms used today is much too small. It has been found in actual practice that a telephone receiver with a diaphragm from 2 inches to  $2\frac{1}{2}$  inches in diameter gives the best results. While it is true that the telephone receiver having a diaphragm of about  $1\frac{3}{4}$  inches will, in some cases, give a louder sound, it is also, as a rule, much shriller, and does not reproduce the human voice, band concerts, etc., as well as a larger diaphragm. Always remember that for broadcasting work a diaphragm is not only called upon to reproduce the human voice, but musical instruments as well. We are of the opinion that a small diaphragm cannot do this. For this reason the Germans use much larger telephone diaphragms, the size being almost three inches. Much better results are had with such receivers for broadcast work. Our manufacturers would do well to look into this, and if they can produce something that will give perfect, or nearly perfect, reproduction they will change the whole aspect of the radio industry, and people will buy radio equipment as they have never bought it before.

H. GERNSBACK.



# Radio Equipment at KDKA

By D. G. LITTLE\*

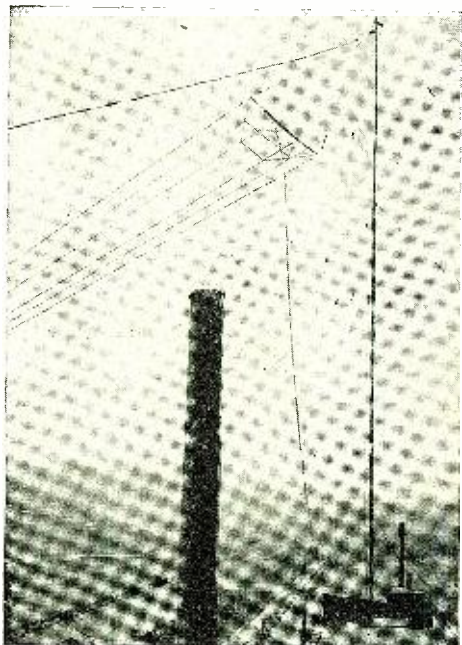

Fig. 5—Concerts and the Daily Programs Radiating from This Antenna System Have Been Received at Distant Points in Both North and South America. KDKA's Success in Broadcasting is Due Greatly to the Efficient Antenna Employed.

WITH the increasing popularity of radio broadcasting, a description of station KDKA will be of interest to the general public, a large number of whom are already acquainted with the station through their receiving sets. KDKA opened November 5, 1920, with the broadcasting of the presidential election returns that day. It is therefore believed that this station can claim the honor of being the first radio telephone broadcasting station operating regularly and exclusively for the entertainment and education of the public. Since December, 1920, daily evening programs have been broadcasted. The programs have been enlarged from time to time to include educational talks by prominent men, sporting returns, concerts from Carnegie Music Hall and other similar places, acts from theaters, and church services Sunday morning and even-

ing, with radio chapel Sunday afternoon. In addition to the above, stock and produce market reports from the local produce market and from the New York Stock Exchange, together with weather reports and relayed time signals from the Arlington radio station, are being broadcasted daily.

The power of KDKA was at first relatively small, on the order of 100 watts being delivered to the antenna. In August, 1921, the range of the station was increased by improving the height of the antenna and raising the power output first to 500 watts and subsequently to 1,000 watts.

In keeping with the growth of the station, a special studio was arranged for the artists and announcer, particular attention being given to the acoustic properties, so that echoes, reverberation and other disturbances have been largely eliminated. The quality of transmission from this station has been improved at every opportunity by means of the studio, and by improvement in the apparatus. The usual carbon microphone has been replaced by a condenser type transmitter for picking up the sound waves. Resistance coupled amplifiers are employed for increasing the relatively weak output of the pick-up transmitter to a power sufficient to control the radio set. The natural oscillating frequency of all the units in the pick-up and amplifier system has been placed, so far as possible, outside of the audio frequency range, so that the radio signal is practically a perfect reproduction of the original sound. Special filter circuits are arranged to eliminate generator hum in the power supply to the radio transmitter. As broadcasting becomes less a novelty and

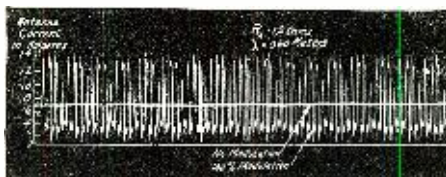

Fig. 4—Above is an Oscillogram of Antenna Current Taken When the Announcer was Speaking Loudly into the "Pick-up" Transmitter.

more a practical form of entertainment, the high quality of KDKA's programs is being greatly appreciated by the audience. After over a year of operation this audience is very exacting as to the quality of reproduction and arrangement of the programs. It is necessary to secure the very best of talent and to keep the radio apparatus in the best possible condition.

The path of the speaker's voice from the studio to the receiving station is shown in diagrammatical form in Fig. 1. The sound wave picked up by the transmitter in the studio, theater or church is amplified before it is transmitted by means of a telephone line to the radio station, where it is further amplified and used to control the output of the radio transmitter. The radio transmitting set is supplied with power directly from the work's power plant through a step down transformer for the vacuum tube filaments and through special motor generator sets, which change the 220 volts direct current to 2,000 volts direct current for the tube plates.

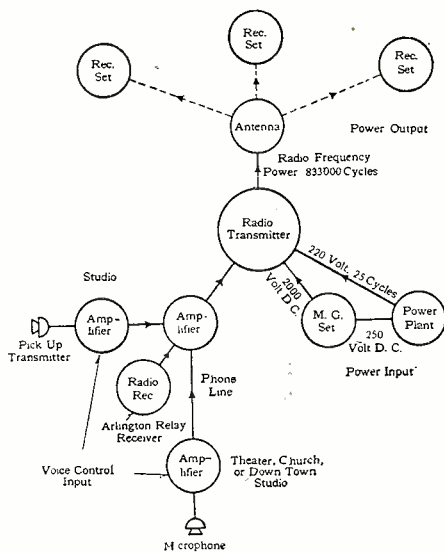

Fig. 1—Method by Which Music and Voice Pass Through the Various Sections of the Broadcasting Stations Transmitter on Their Way to the Receiver is Shown Here in Diagrammatic Form.

The radio transmitter changes this power from 2,000 volts direct-current to alternating-current power at a frequency of 833,000 cycles per second (360 meters wave length), which is supplied to the radiating system, consisting of an antenna and counterpoise. This high frequency power in the antenna system sets up waves in the ether, which travel outward in all directions and, intercepting the receiving antenna, set up voltages and currents which operate the receiving sets.

A general view of the radio transmitter now in use at KDKA is shown in Fig. 2. This set furnishes about one kilowatt high frequency power to the antenna. Fig. 3 shows the power circuit diagram. This section carries only direct current at 2,000 volts and low-voltage alternating current at 25 cycles. This 25 cycle current is used only for heating the filaments. To prevent any of the 25 cycle current being superimposed on the grid-filament and plate-filament circuit, the return of the grid circuits and the 2,000 volt circuit is connected to the midpoint of a resistor, which is shunted across the filament, each half of the resistor being shunted by a condenser for by-passing the radio and audio frequency circuits.

The four 250 watt power tubes in the upper part of the set are the oscillators, (Continued on page 668)

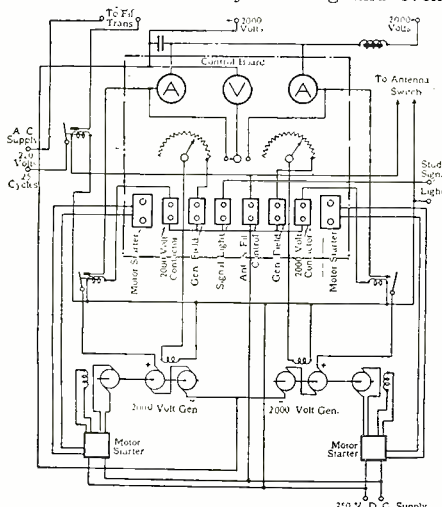

Fig. 3—Wiring Diagram of the Power Supply Unit. Plate and Filament Current for the Transmitter and Signal Light Supply are Provided. Only Direct and Low Frequency Alternating Current are Carried on This Panel. The Radio or High Frequency Energy is Limited to Its Own Switchboard.

\*Radio Engineer, Westinghouse Electric and Manufacturing Company.

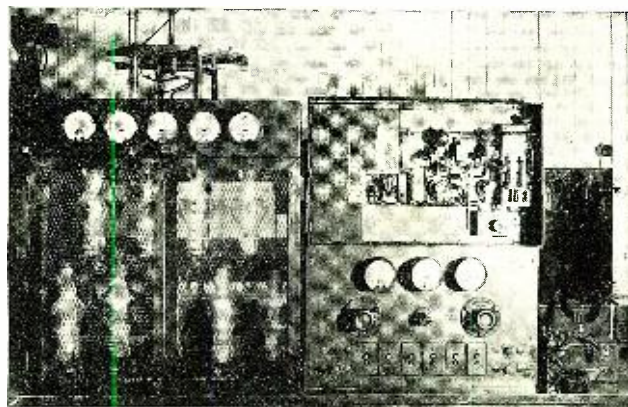

Fig. 2—A General View of the Radio Transmitter in Use at KDKA. The Meters at the Top Show the Operator How the Set is Functioning. From Left to Right They Are: Filament Voltmeter, Ground Current Meter, Plate Ammeter, Modulation Meter and Plate Voltmeter.



# The Antenna Unique

By S. R. WINTERS

ANY arrangement or device for radiating or receiving electromagnetic waves may be labeled an antenna. It is probably the most flexible term in the lexicon of radio-telegraphy and radio-telephony. Structurally, an antenna may vary in size, from a modest coil or loop with a few turns of wire to sky-climbing towers, 1,000' high, and a system embracing 10 square miles, the area covered by the high-power radio-telegraph station recently built near Port Jefferson, Long Island. The shapes of antennae are comparable to the proverbial "57 varieties." A fan, cage, umbrella, kite, inverted L, the letters T and V and a portable mast joined together like a commercial fishing rod, are among the common representations of devices for radiating or receiving electric waves.

According to a broad classification, the antenna systems resolve themselves into two classes—one serving chiefly in the capacity of electrical condensers and the other acting primarily as electrical inductances. The former classification adheres to the unmodified term of "antenna." The system acting chiefly as electrical inductances employs a variety of designations such as "coil antenna," "coil aerial," "loop," and "direction finder," when the quality of determining the direction of electromagnetic waves is uppermost for consideration. Still another distinction used is that of a "counterpoise antenna" or merely a "counterpoise," when a group of parallel wires elevated a few feet from the earth and insulated therefrom obviates ground connection. Strange formations, too, may be found in the construction of antenna systems. A device resembling a cage is especially serviceable in times of war; when the antenna is robbed of one or two of its wires it is still able to function. Trees have been employed as antennae, and in at least one instance an antenna system has invaded the wilderness, being effectively stretched across a gorge 3,000' deep.

Classification fails, however, in designat-

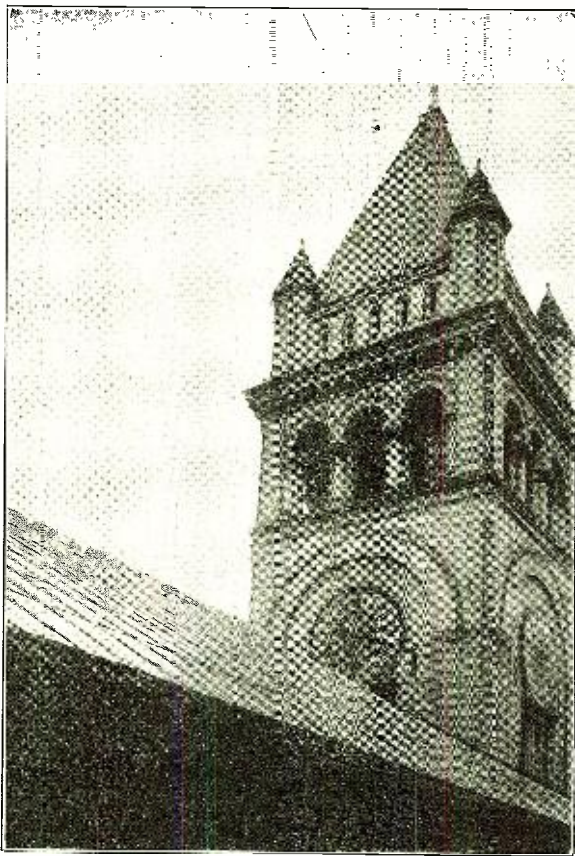

The Unique Antenna from Above. Although Erected at a Dangerous Risk to Life, No Mishap Occurred. WWX, the Washington Post Office Department, is Having Remarkable Success with the Aerial, Both in Transmission and Reception.

ing the design of the antenna system in operation by the United States Post Office Department, hence the title of this article, "The Antenna Unique." In both construction and formation, it is the only one of its kind in the world. The massive structure, quartering the administrative personnel and equipment of our national and international postal service, has been converted into a veritable base for radiating and receiving electromagnetic waves. Barring the Wash-

ington Monument, it is the tallest structure in Washington, D. C., rearing itself upward for a distance of 315'. The roof of the building and the sky-climbing tower comprise the masts for supporting the antenna, the four strands of wire converging at the pinnacle of the tower. The arrangement may be said to partake of both the features of a conventional antenna and a counterpoise, employing the roof of the building as the "ground."

The writer, in company with J. C. Edgerton, in charge of the wireless service of the United States Post Office Department, and a local photographer, by ascending devious stairways scaled the heights of the structure proper to secure the photographs illustrating the antenna system. When standing atop of the roof of the building we were then 100' or more below the top of the tower where the four groupings of wires converge. From this commanding position, the resourceful photographer tilted his camera downward to secure an image of the direct "lead-in wires" of the antenna where they obtain passage through a window to the radio-telegraph and radio-telephone apparatus on the eighth floor of the building. Then focusing the camera upward, an image of the tower, 315' above the level of the street, was for the first time visualized. The tower was a subject readily lending itself to the searching eye of the camera lens, but the antenna wires were included in the picture by adroit manipulation of the image-visualizing machine.

The Post Office Department, instead of erecting masts to a height of from 600' to 1,000' to support an antenna system, has effectively utilized existing facilities. Moreover, the same quarters which house the Postmaster General and the administrative forces employed in directing the handling of Uncle Sam's mails likewise serve as the basis for a broadcasting service in disseminating market reports and directing the operation of the air-mail stations by wireless, telephone and telegraph. This antenna system admits of both the transmission and reception of communications. The roof of the building which serves as a support for an antenna for transmitting messages also accommodates a receiving antenna. The carrying of the network of wires to the zenith of the 315-foot tower was without mishap, notwithstanding such an undertaking involved an obvious hazard to human life. The tower clears itself upward for approximately 100' from the roof of the building, this distance being gradually scaled by a portable ladder affixed to the pointed bit of architecture.

Having descended from the dizzy height, on top of the roof of the Post Office Department building at the corner of Eleventh Street and Pennsylvania Avenue, from the mission of obtaining exclusive photographs of "The Antenna Unique," the writer re-entered the radio room on the eighth floor just in time to hear a resonant voice saying, "Hello, hello, WWX is calling." It was C. A. Bauer, radio operator, beginning a real broadcasting service. The hour was 10.30 o'clock in the morning when a "marketgram" was being flung by means of radio-telephony through space to an invisible and unnumbered audience for hundreds of miles within a radius of Washington. This "marketgram," transmitted on a wave-length of 1,160 meters, is a report on the prices of fruits

(Continued on page 672)

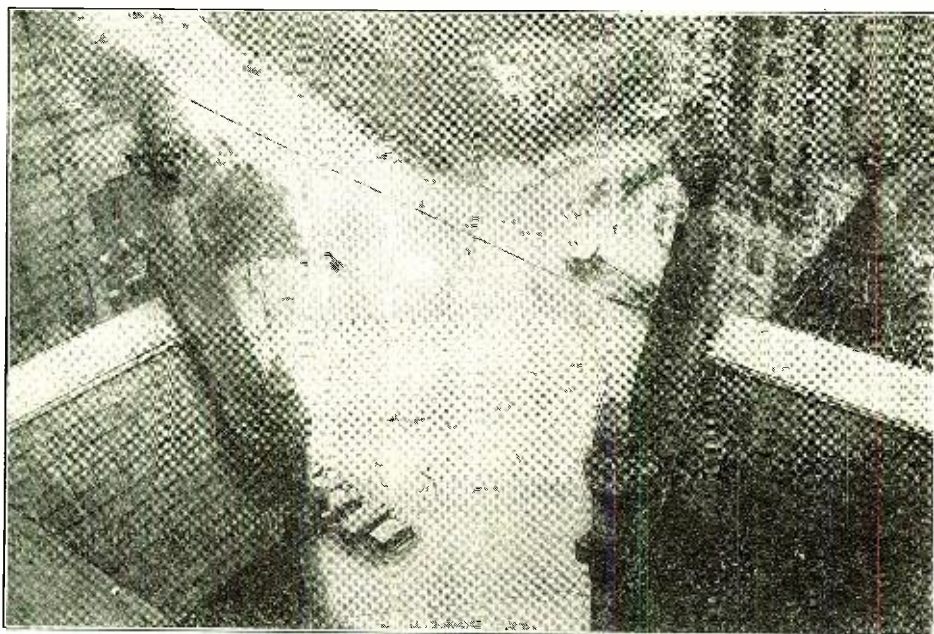

The Difficulty of Placing the Aerial in Position May Be Fully Appreciated from This View. As the Building Itself Is 315 Feet High, No Masts Were Necessary.



# Some Recent Developments of Regenerative Circuits\*

By EDWIN H. ARMSTRONG

**I**T is the purpose of this paper to describe a method of amplification which is based fundamentally on regeneration, but which involves the application of a principle and the attainment of a result which it is believed is new. This new result is obtained by the extension of regeneration into a field which lies beyond that hitherto considered, its theoretical limit, and the process of amplification is therefore termed *super-regeneration*.

Before proceeding with a descrip-

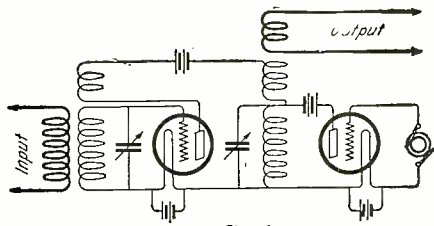

Fig. 1

tion of this method it is in order to consider a few fundamental facts about regenerative circuits. It is well known that the effect of regeneration (that is, the supplying of energy to a circuit to reinforce the oscillations existing therein) is equivalent to introducing a negative resistance reaction in the circuit, which neutralizes positive resistance reaction, and thereby reduces the effective resistance of the circuit. There are three conceivable relations between the negative and positive resistances: namely—the negative resistance introduced may be less than the positive resistance, or it may be equal to the positive resistance, or it may be greater than the positive resistance of the circuit.

We will consider what occurs in a regenerative circuit containing inductance and capacity when an alternating electromotive force of the resonant frequency is suddenly impressed for each of the three cases. In the first case (when the negative resistance is less than the positive), the free and forced oscillations have a maximum amplitude equal to the impressed emf. over the effective resistance, and the free oscillation has a damping determined by this effective resistance. The steady state is attained after the initial free oscillation dies out and continues until the impressed emf. is removed, when the current dies out in accordance with a second free oscillation. The maximum amplitude of current in this case is always finite; it reaches this maximum amplitude in a finite time, and when the impression emf. is removed the current dies away to zero. This is the action of the circuits which are now in every-day practical use.

In the second case the negative resistance is equal to the positive resistance, and the resultant effective resistance of the circuit is therefore zero. When an emf. is suddenly impressed in this case, the current in the circuit starts to increase at a rate which is directly proportional to the impressed emf.

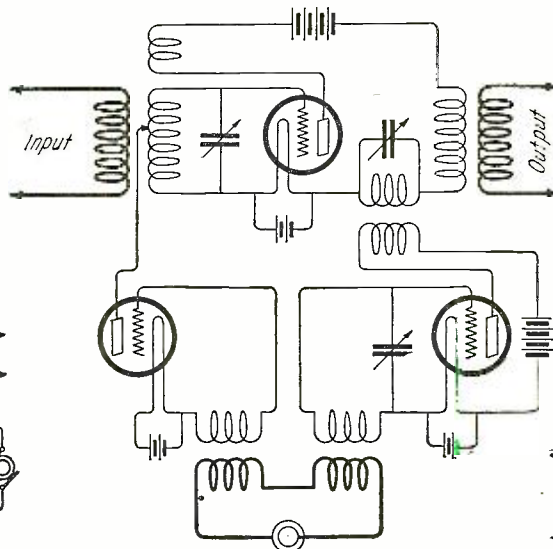

Fig. 3

These Three Diagrams Show the Three Different Methods of Producing the Super-Regenerative State by Varying the Relation Between the Negative and Positive Resistance of the Regenerative Circuit.

and to the square root of the ratio of the capacity to the inductance of the circuit (for a given impressed frequency). If the

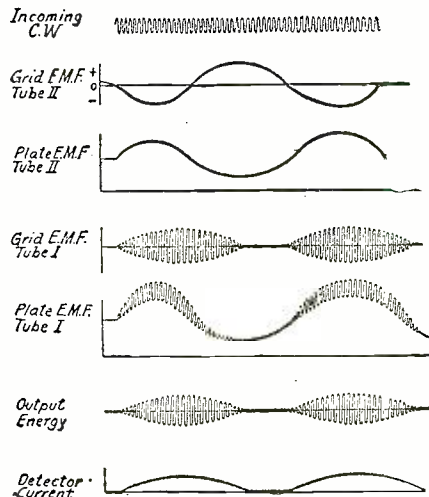

FIGURE 4

An Idea is Given Here of the Phenomena Which Occur When an emf. is Applied to the Input Circuit—in This Case, the Input of Fig. 1.

emf. is impressed for an infinite time, then the current in the circuit reaches infinity. If the emf. is impressed for a finite time, then the current reaches some finite value. When the impressed emf. is removed, the current in the circuit at that instant continues indefinitely with unchanged amplitude as a free oscillation. Theoretically, this is the limiting case for

regeneration; practically, it is always necessary to operate at some point slightly below this state at which the circuits have a definite resistance.

It is important to note here that although the circuit of this case has zero resistance, oscillations will not start unless an emf. is impressed upon the circuit; furthermore, that oscillations once started continue with undiminished amplitude indefinitely. This state cannot be attained in practice, because the negative resistance furnished by the tube is dependent on the amplitude of the current and for stable operation decreases with increasing amplitude.<sup>1</sup>

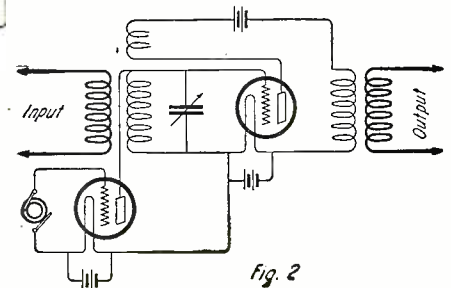

Fig. 2

In the third case the negative resistance introduced into the circuit is greater than the positive resistance, and the effective resistance of the circuit is therefore negative. When an emf. is impressed upon a circuit in this condition, a free and a forced oscillation are set up which have some interesting properties. The amplitude of the forced oscillation is determined by the value of the impressed emf. divided by the resultant resistance of the circuit. The free oscillation starts with an amplitude equal to the forced oscillation, and builds up to infinity regardless of whether or not the external emf. is removed. The free oscillation starts with an amplitude which is proportional to the impressed emf., and this proportionality is maintained throughout any finite time interval, with constant impressed electromotive force.

It is important to note that although the negative resistance of the circuit exceeds the positive, and the effective resistance of the circuit is negative, oscillations will not occur until some emf. is impressed. Once an emf. is impressed, however, no matter how small it may be, the current in the circuit builds up to infinity regardless of whether or not the external emf. is removed.

The fundamental difference between the case in which the resistance of the circuit is positive and the case in which the resistance of the circuit is negative may be summed up as follows: in the first, the forced oscillation contains the greatest amount of energy and the free oscillation

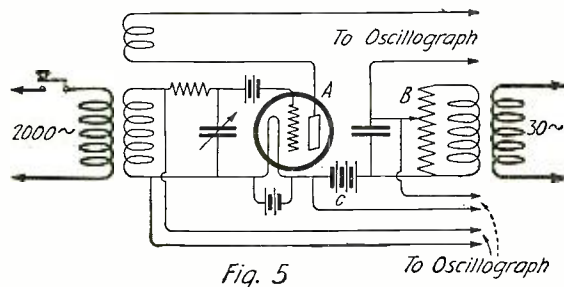

Fig. 5

The Oscillograms on the Next Page Were Obtained With the Apparatus in These Two Figures. Fig. 5, A-4 W. E. Type L Tubes in Parallel; B, AC Voltage—100 Volts; C, DC Voltage—160 Volts. Fig. 6, A-4 W. E. Type L Tubes in Parallel; B-1 W. E. Type L Tube With Grid and Plate in Parallel; C, DC Voltage—160 Volts; D, AC Voltage—30 Volts.

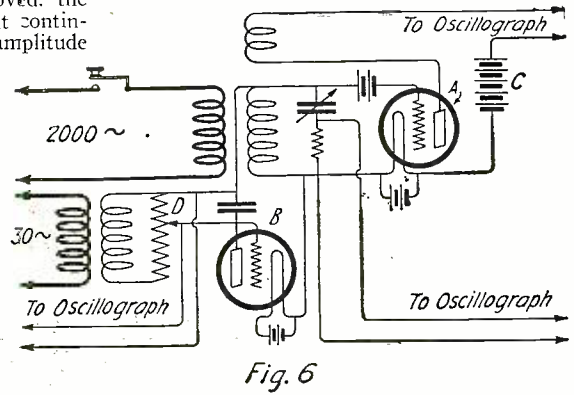

Fig. 6

\*Abstract from the Proceedings of the Institute of Radio Engineers by permission.



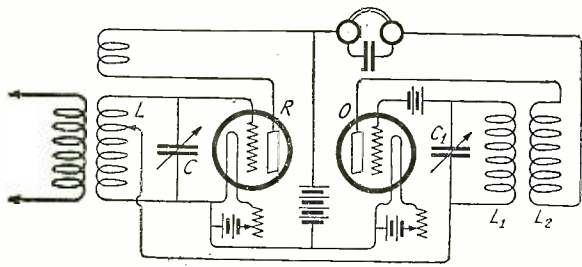

Fig. 12

is of very minor importance<sup>2</sup> (after a short interval of time); in the second, it is the free oscillation which contains the greatest amount of energy and the forced oscillation which is of negligible importance.

It is, of course, impossible with present-day instrumentalities to set up a system in which the negative resistance exceeds the positive without the production of oscillations in the system, since any irregularity in filament emission or impulse produced by atmospheric disturbances is sufficient to initiate an oscillation which builds up to the carrying capacity of the tube. It is, however, possible, by means of various expedients, to set up systems which avoid the production of such a paralyzing oscillation and which approximate the theoretical case in the use of a free oscillation to produce amplification.

It is the purpose of this paper to describe a principle of operation based on the free oscillation which is quantitative and without a lower limit. This new method is based on the discovery that if a periodic variation be introduced in the relation between the negative and positive resistance of a circuit containing inductance and capacity, in such manner that the negative resistance is alternately greater and less than the positive resistance, but that the average value of resistance is positive, then the circuit will not of itself produce oscillations, but during those intervals when the negative resistance is greater than the positive will produce great amplification of an impressed emf. The free oscillations which are set up during the periods of negative resistance are directly proportional in amplitude to the amplitude of the impressed emf. The variation in the relation between the negative and positive resistance may be carried out by varying the negative resistance with respect to the positive by varying the positive resistance with respect to the negative, or by varying both simultaneously at some frequency which is generally relatively low compared to the frequency of the current to be amplified.

These three methods of producing the super-regenerative state are illustrated respectively by Figs. 1, 2 and 3, which figures indicate the general scheme of the system and the methods varying the relation between the negative and positive resistance. Fig. 1 shows a method of varying the negative resistance produced by the regenerative system by varying the voltage of the plate of the tube by means of a

second tube, the grid of the second tube being excited by an emf. of suitable frequency.

Fig. 2 illustrates a method of varying the positive resistance of the circuit with respect to the negative. This is accomplished by connecting the plate circuit of a vacuum tube in parallel to the tuned circuit of the regenerative system and exciting the grid by an emf. of suitable frequency. Fig. 3 illustrates a combination of these two systems in which simultaneous variations are produced in both the negative and positive resistances and provision made for

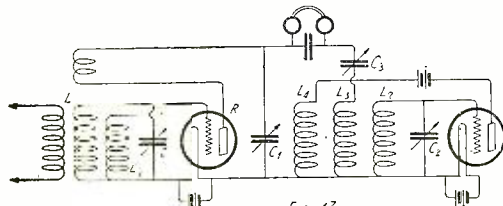

Fig. 13

When a Super-Audible Frequency of Variation is Used with the System of Fig. 1 it is Necessary to Introduce Resistance into the Tuned Circuit as Shown by  $L_1$  in This Diagram.

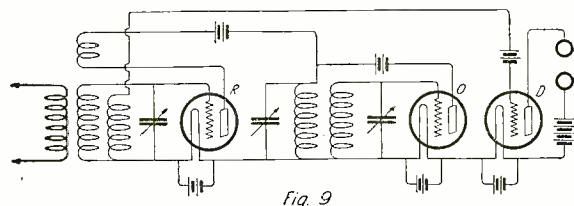

Fig. 9

Practical Application of the System of Fig. 1 for Varying the Negative Resistance. For Audible Frequency of Variation a Separate Detector Tube is Required.

adjusting the relative phases of these two variations.

A general idea of the phenomena occurring in these systems when an emf. is applied to the input circuit will be obtained from the diagram of Fig. 4 which applies specifically to the circuit of Fig. 1. This figure illustrates the principal relations existing in the system in which the positive resistance is constant and the variation is introduced into the negative resistance. It will be observed that the frequency of variation appears as a modulation of the amplified current so that the output circuit contains currents of the impressed frequency plus two side frequencies differing from the fundamental by the frequency of the variation.

Oscillograms of the essential current and voltage relations existing in the systems of the type illustrated by Figs. 1 and 2 were obtained with the set up

Right: Oscillogram of the Current and Voltage Relations Existing in the System of Fig. 1 in Which the Negative Resistance is Varied.

Left: In This Circuit, the Oscillating Tube Acts as the Detector. This Can Only Be Done When the Frequency of Variation is Super-Audible.

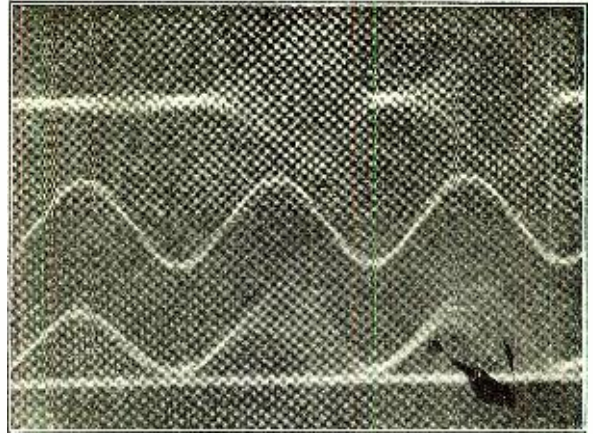

of apparatus illustrated in Figs. 5 and 6, respectively. In the arrangement of Fig. 6, in order to produce sufficient variation in the positive resistance of the tuned circuit, which was of large capacity and low inductance, it was necessary to use a two-electrode tube in series with the auxiliary emf.

Figs. 7 and 8 are oscillograms respectively for a negative resistance variation and a positive resistance variation. The signaling emf. was impressed about half way along the film, the exact point at which the key was closed being indicated by the arrow. These oscillograms show phenomena which are in accordance with the explanations already given, but, in addition, show evidence of self-excitation. It has been stated in the preceding pages of this paper that the basis of super-regeneration was the discovery that a variation in the relation between the negative and positive resistances prevented a system which would normally oscillate violently from becoming self-exciting.

An examination of the oscillograms will show that this is not strictly true, as a free oscillation starts every time the resistance of the circuit becomes negative. It will be observed, however, that this free oscillation is small compared to that produced by the signal, and therein lies the complete explanation of the operation of the system. The free oscillations produced in the system when no signaling emf. is impressed, must be initiated by some irregularity of operation of the vacuum tubes and must start at an amplitude equal to the amplitude of this disturbance. This initial value is of infinitesimal order, and hence, in the limited time interval in which it can build up the locally excited oscillation, never reaches an amplitude comparable to the oscillation set up by a signal of any ordinary working strength.

There is a second point of interest which is most evident from the curves of Fig. 7. It will be observed that there is a decided lag in the maximum value attained by the free oscillation set up by a signal and the maximum value of plate voltage (negative resistance) of the amplifying tube. This is most evident from the plate current curve. It is a point of considerable interest, and the phenomena involved will be analyzed in a later part of the paper.

(Continued on page 678)

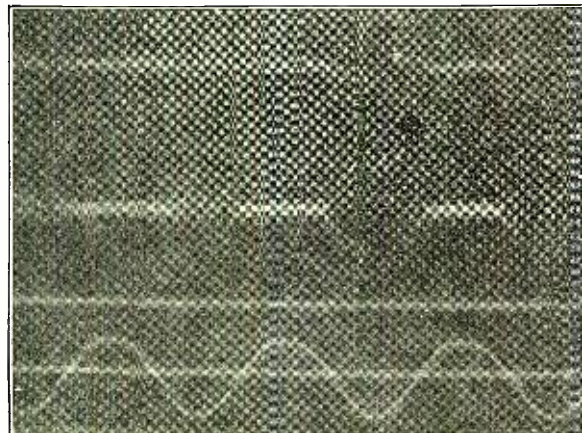

Left: Oscillogram of Current and Voltage Relations of the System in Which the Positive Resistance is Varied as in Fig. 2.

Right: Practical Application of the System of Fig. 2. The Positive Resistance of the Tuned Circuit is Varied by the Oscillations of the Second Tube.

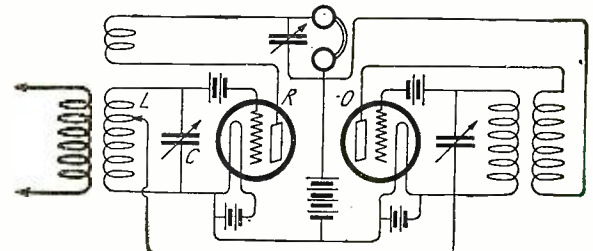
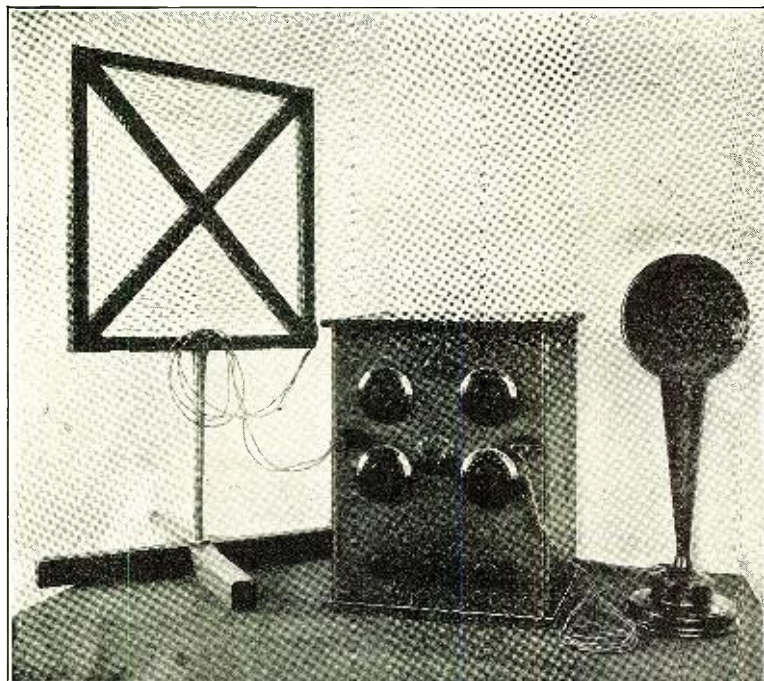

Fig. 10



# Construction of a Super-Regenerative Receiver

By KENNETH HARKNESS



Front View of the Super-Regenerative Receiver, the Construction and Operation of Which Are Described in This Article. Radio-Phone Broadcasts Can Be Received Very Loudly with Three Vacuum Tubes by Means of This Receiver.

THE theory of super-regeneration has been pretty well discussed from every possible angle. Some of us have learned—possibly for the first time—that there are several kinds of resistances, positive, zero and negative. We have read lengthy discussions concerning audible and super-audible frequencies of variation. Complicated diagrams have been flashed before us and each one seems a little different from the last and slightly more difficult to understand.

However, just as the authors of recent simplified radio text-books all seem to have separately reached the inevitable conclusion that waves are formed when a stone is dropped into a pool of water, so the various writers of articles on super-regeneration seem to agree that the same amount of amplification formerly obtained with nine vacuum tubes can now be obtained with three tubes by means of this new method of reception.

This statement is so intensely interesting to the radio enthusiast that he naturally wants to know how to build a receiver of this type.

Undoubtedly a great many super-regenerative receivers, have been constructed but, for some reason, many of these fail to operate properly. This may be on account of improper assembly or the use of incorrect material. The super-regenerative circuit is very critical and the proper values throughout are essential. Another reason for poor results may be the inability of the operator to tune the circuit, or his lack of knowledge how to approach this.

The accompanying photographs show a super-regenerative receiver which has actually worked and worked extremely well. The results are almost unbelievable. With a small loop, three tubes, 200 volts of plate batteries and a loud speaker the signals obtained with this receiver were loud enough to be heard three or four blocks away.

The writer has constructed five separate super-regenerative receivers for test purposes, each of which employed a different combination to obtain various results as recommended by Major Armstrong. The receiver illustrated in these photographs

represents the result of much experimentation in design and operation. It employs all the good features of the sets previously constructed and eliminates unnecessary controls. The set has been made as compact as possible; it only measures  $12\frac{1}{2}'' \times 16\frac{1}{2}'' \times 12''$ .

The back of the panel is shielded to assist in preventing body capacity effect while tuning and, if the proper tubes and the correct values of plate and grid batteries are used and the instructions for operating are followed, excellent results will be very easily obtained by anyone.

It is a mistaken impression that the super-

regenerative receiver is extremely difficult to operate. We have found that most instances of failure by experimenters are due to some minor fault in construction. However, one cannot expect to operate a super-regenerator in the same manner as a crystal receiver or a single-circuit tuner. Results will not be obtained by turning the dials round at random. The circuit must be tuned with care and intelligence and some knowledge of what is being accomplished by the various controls. This can best be obtained, of course, by studying the theory of super-regeneration. However, the same results can be obtained even by a novice if he follows instructions carefully.

The circuit used in this receiver is given in Fig. 1. This is based on the circuit given by Major Armstrong in his lecture to the Radio Club of America. There is one point of difference—the location of the grid battery B3. By placing the grid battery in this position a negative potential is impressed on the grids of the first two tubes. The operation of this circuit is thereby somewhat simplified. Previous arrangements of super-regenerative receivers required two grid batteries, one for each of the first two tubes as shown in Fig. 2. This has some advantage when receiving tubes are used, but as best results are obtained with power tubes, the circuit of Fig. 1 was chosen as being simpler to operate. As a matter of fact, if the plate voltage is not over 200, the receiver will operate successfully with power tubes without any grid batteries.

However, by placing the grid battery as shown by B3 in Fig. 1, a negative potential is impressed on the grids of both tubes and greater amplification is obtained. The control is also greatly simplified. The potentiometer across the A battery provides a vernier control of the grid potential and this control is very useful in finding the critical operating point.

The values of the various apparatus of Fig. 1 are indicated in the caption and the arrangement is shown in the photograph of the back view of this receiver. L1 and L2 indicate the vario-coupler which is plainly in view in the foreground. Below the vario-coupler is the condenser C1. Behind the vario-coupler, mounted on the right hand side of the panel, is the condenser C2, to the back of which is attached the coil L3. Below these is the condenser C4 which is visible in the background of the photograph. The three filament rheostats are easily recognized at the bottom of the panel. It will be noted that the panel is carefully shielded with aluminum.

A shelf is held to the front panel by means of brackets. The shelf supports the three tube sockets, the filter circuit, and the coil L5, while beneath the shelf are suspended the audio-frequency amplifying transformer Tr and the coil L4 which acts as a radio-frequency choke. The leads with clips attached are to make contact with the grid batteries. The binding posts for the filament and plate batteries are mounted at the back of the shelf.

Referring to the photograph of the front of the receiver, the loop plugs in the jack on the left and the loud-speaker on the

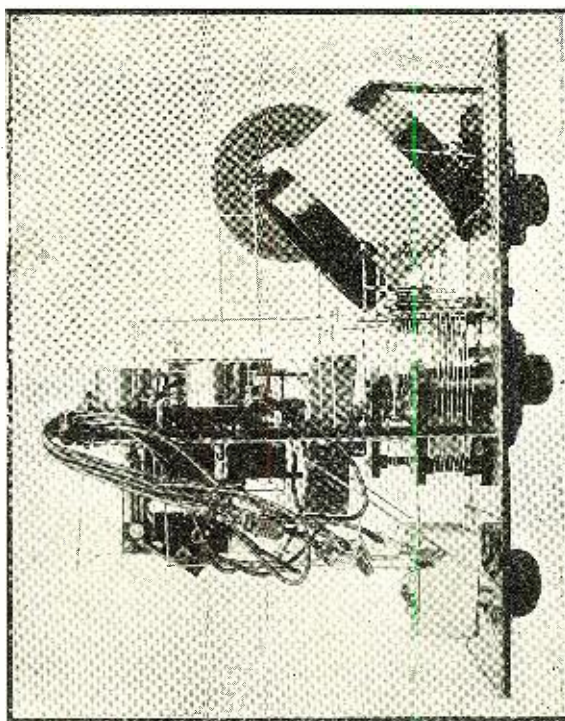

Back View of This Super-Regenerative Receiver. The Panel is Shielded With Aluminum to Avoid Body Capacity Effect.

Photos by courtesy of the Radio Guild, N. Y.



right. The lower dial on the left controls the condenser across the loop and therefore changes the wave-length of the circuit. The dial immediately above this controls the feed-back of the first tube as it varies the position of the secondary of the vario-coupler. The potentiometer is controlled by the small knob at the top center of the panel. These three controls are practically all that are required to tune this receiver, after the proper positions have been found for the other two dials controlling the oscillation and the frequency of oscillation of the second tube. The grid, plate and filament batteries are connected to the back of the receiver, leads being brought through the cabinet with clips attached.

Most of the apparatus employed in this receiver are quite familiar while the special choke coils, resistances and vario-coupler are now obtainable from radio dealers.

The best type of tubes to use are the Western Electric E tubes. These are now obtainable. The values given for batteries are intended for this type of tube. It is possible, of course, to employ other makes of 5-watt tubes or even hard receiving tubes, but the values will be accordingly changed and we do not believe as good results will be had. In any case, soft tubes should never be employed in a super-regenerative circuit—they are quite useless. The battery B1 of Fig. 1 should be 100 volts and the battery B2 also 100 volts. This amounts to a plate battery of 200 volts, all of which is connected to the plate of the last tube, while a tap is taken for the first two tubes. The grid battery B4 is 22 volts and the other

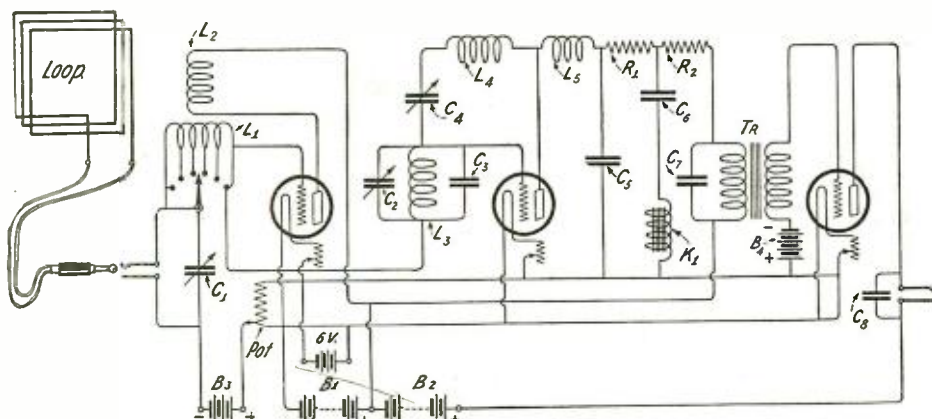

Fig. 1

This is the Hook-Up of the Super-Regenerative Receiver Illustrated in the Photographs. The Battery B3 is Used to Impress a Negative Potential on the Grids of the First Two Tubes. The Constants of the Apparatus in This Circuit Are as Follows:

L1, L2—Short-Wave Vario-Coupler, Secondary 100 Turns; C1—.0005 M. F.; L3—D. L. 1250; C2—.001 M. F.; C3—.002 M. F.; C4—.001 M. F.; L4—D. L. 250; L5—D. L. 1500; C5—.005 M. F.; R1, R2—12,000 Ohms Each; C6—.005 M. F.; K1—.1 Henry Iron-Core Choke; C7—.002 M. F.; C8—.002 M. F.

grid battery B3 is in the neighborhood of 7 volts. The latter value is variable.

**OPERATING THE RECEIVER**

When the filaments are lit a high-pitched whistle should be heard from the loud-speaker. This whistle indicates that the second tube is oscillating. If the whistle is not present the grid battery B3, the potentiometer and the condenser C4 should be varied to produce oscillation.

When the whistle is obtained, the feed-

back coil L2 and the condenser C1 are varied to produce oscillation in the first tube. This point of oscillation will be easily recognized by the usual tests for oscillation.

With the first and second tubes oscillating, if the circuit has been correctly wired, a certain unmistakable effect will be noticed. If any of the variable elements of the circuit are changed, a series of heterodynes of harmonics should be heard. This indicates that the circuit is properly connected, although these harmonics will not be heard after the circuit is adjusted.

After this state has been reached, the rest of the tuning is easy. The wave-length of the station to be received is tuned by the condenser across the loop and by tapping the number of turns on the loop itself. Voice or music should be audible. The two dials at the right of the receiver should then be varied to obtain the maximum amplification. Usually these condensers need to be at about their maximum capacity. A condition will be easily found where the whistles of the harmonics are no longer audible and the speech or music is received clearly. Final tuning with the grid battery and potentiometer will find the critical point.

No matter how explicit the instructions may be, undoubtedly the best method of operating the super-regenerative receiver is

(Continued on page 682)

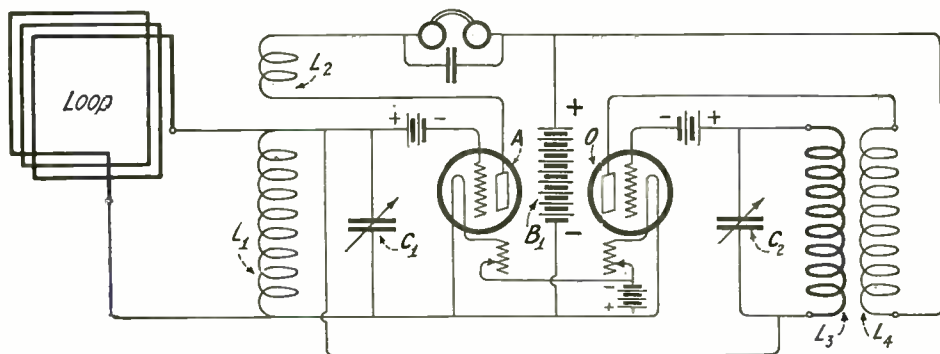

Fig. 2

In This Diagram of a Two-Tube Super-Regenerative Receiver a Grid Battery is Used for Each Tube. When Power Tubes Are Used These Can Be Omitted or the Arrangement Shown in Fig. 1 Adopted in Their Place.

## Earlier Days in Radiophone Broadcasting

By CHARLES GILBERT \*

SO much interest is being shown in the beginning of radio broadcasting, in the present awakening of public interest in the radio art, and so many inquiries are being made regarding the pioneer broadcasting of Dr. Lee de Forest that it might be well at this time to put down a few of the historical dates in the development of this notably American art.

It is interesting to know that the first broadcasting of music was not by means of the phonograph so generally used at present. The spring of 1907 saw the radio distribution of synthetic electrical music, generated and played in a building at the corner of Broadway and 37th Street, New York City. The plant itself consisted of many inductor alternators whose frequencies were those of the entire musical scale. Music furnished by this electrical organ was transmitted by wire to nearby theaters, hotels and restaurants, where one or several loud horn speakers poured into the ear this new electrical music. To connect this musical current into radio frequency and impress on the antenna, which was erected for this purpose on the roof of this building by Dr. de Forest, was

comparatively simple, and thereupon the demonstrations were made for the receiving stations in New York City. The experiment in broadcasting, however, lasted but a very short time.

The location of what may properly be described as the first actual radiophone broadcasting station of the world, however, was in the old Parker Building, 19th Street and Fourth Avenue, New York City. On the top floor of this building was the laboratory of Dr. Lee de Forest; two flag-poles on the roof of this building furnished the necessary support for the antenna. It was in the same little old laboratory that many months earlier the inventor had tested out his first three-electrode vacuum tube. Unfortunately, this historic laboratory which saw the birth of the Tiny Glass Baby, which was known as the modern Aladdin's lamp, is no longer in existence. In January, 1908, a great fire completely destroyed the Parker Building, incidentally wiping out of existence note-books and many precious samples of the earliest audion bulbs.

The first actual transmission of phonograph music, let it be known, was the re-

sult of experimental tests by Dr. Lee de Forest in 1907 on some twenty small telephone transmitters planned for installation on Admiral Evans' battleships and destroyers, prior to their historic round-the-world cruise.

The first actual application of the De Forest radiophone in reporting a news event was no doubt the reporting of the yacht races on the Great Lakes in the same summer of 1907; gramophone music was then furnished between the spoken bulletins.

In the operatic season of 1908-09, there was a temporary installation of a radiophone broadcasting station on the roof of the Metropolitan Opera House in New York City. Microphones concealed among the footlights of the stage, connected with the transmitting station, then gave the first radio opera in the history of the art. Among those who were able to listen in at that time were the radio operators on the ships in New York Harbor.

The first opera artist to sing directly into the microphone of a De Forest radiophone transmitter was Madame Mazarin, (Continued on page 684)

\*President and General Manager, De Forest Radio Telephone & Telegraph Co.



# Anacostia Naval Air Station

By S. R. WINTERS

**W**HEN radio-telephone broadcasting was in its swaddling clothes—not so many moons ago, to employ a figure of speech—amateurs in certain portions of the United States

were deluded into believing that they were copying, on abbreviated wave-lengths, long-distance communications from Nauen, Germany. Immensely gratifying it must have been to sense the thrill of such notable performance feats by radio enthusiasts whose receiving sets are to them tokens of the magical wand. And, it may be cruel, even at this late date, to prick the bubble of faith, but in doing so this writer establishes a rack on which to hang a tale!

Messages from this high-power German radio-telegraph station were really in circulation, but their avail-

costia, displacing the experimental units now in service. Perfect reproduction of all sound waves, is the appraisal made in behalf of the newly-acquired instruments. The installation was placed into service

August first, and in the future the public will be enabled to hear music and other concerts flung into space from this point in the absence of jarring notes or distorted effects of the true sounds as they are originally uttered. The experimental concerts of past months have not only afforded entertainment to an audience reckoned as being approximately 200,000, but have served as an index whereby the reliability and effective range of the radio-telephone may be considerably advanced.

As the designation implies—Anacostia Naval Air Station—"NOF" is primarily a

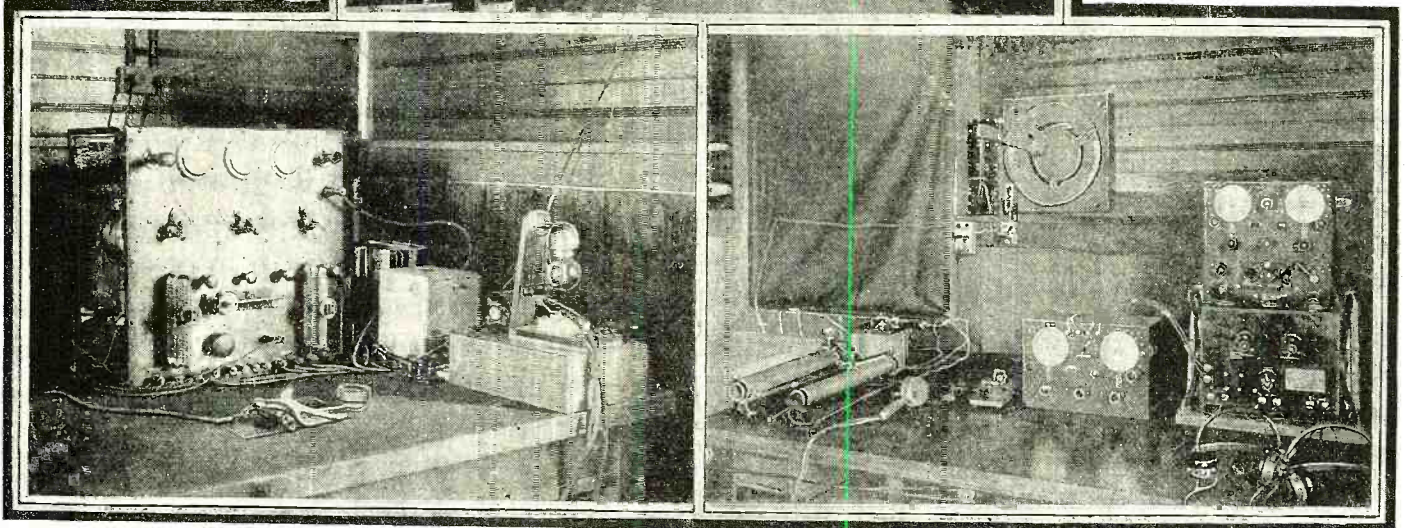
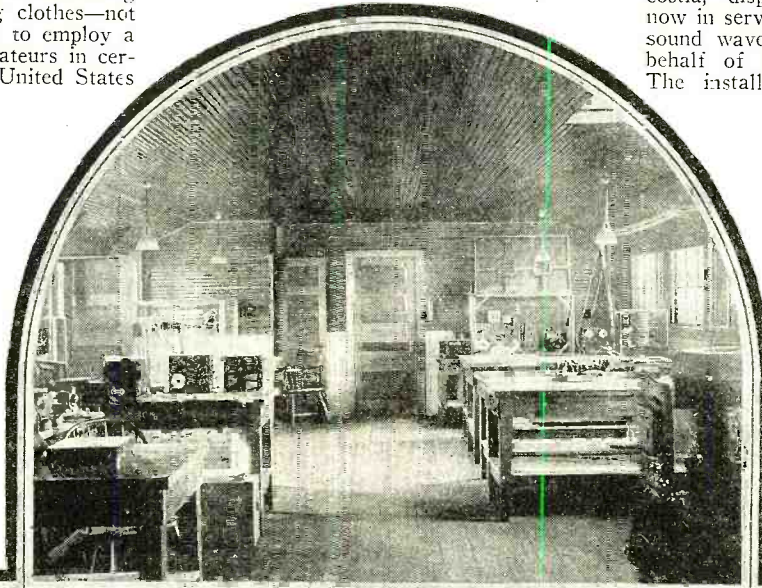

The Upper View Shows the Operating Room of NOF. Below on the Left Is the C. W. and Phone Transmitter, While on the Right Are the Receiving and Control Apparatus. NOF Sends on a 412-Meter Wave-Length.

ability to amateur stations was made possible by a rebroadcasting system in operation at the Naval Air Station, Anacostia, District of Columbia—or "NOF," to designate it by call letters familiar to the wireless fraternity. Radio-telegraph signals from Nauen, Germany, were "picked up" by "NOF" on a wave-length of 12,600 meters and distributed to amateur stations within a radius of hundreds of miles of the National Capital on a wave-length of 250 meters. This incident, heretofore disguised to those who may have credited their receiving instruments with erratic performances or superior achievements, is related as an indication that the Naval Air Station at Anacostia is calculated to spring agreeable surprises periodically. A 100 per cent. experimental radio laboratory that it is, "NOF" is not pledged to cut-and-dried performances. Unconventional ways of broadcasting are its privilege. Moreover, it is a radiating storehouse for that delightful broadcasting feature, music of the United States Marine Band.

Commander Stanford C. Hooper, chief of the Radio Division of the Bureau of Engineering, United States Navy Department, in a statement recently, indicated that the number of persons participating in the pleasures derived from the musical entertainments of the Marine Band would be swelled into an invisible audience of millions. Moreover, it is likely that the concert that is given on the grounds of the White House or in a park anywhere in the National

Capital—some distance removed from Anacostia—will be audible to the occupants of an isolated rural home or to the city-dweller many hundreds or even a thousand miles from Washington. Portable apparatus, carried from place to place with quite the facility that the peanut vender carts his parched underground product along with the floating crowds, has been acquired by the Bureau of Engineering of the Navy Department. Just as the law follows the American flag, this traveling unit, at the request of the President or Secretary of the Navy, may be installed at public exercises or other functions. Once installed, the entire performance will be relayed to Anacostia and from there broadcasted to the entire invisible audience within the transmitting range of this station. The wave-length employed will be 412 meters. Similarly the exercises will be relayed to Arlington and radiated from "NAA" through space on 2,650 meters. The system is a duplicate, in miniature, of that introduced at the dedicatory exercises of the Lincoln Memorial, whereby both visible and invisible audiences participated in the ceremonies.

"NOF" likewise contemplates the installation of equipment whose objective will be to impinge music or vocal speech on electromagnetic waves so effectually that their reproduction, in all their purity, will be assured at any point within the receiving range of this broadcasting station. Toward this end, special sound-reproducing apparatus has been purchased for installation at Ana-

research laboratory devoted to studies affecting the problems arising from the use of wireless apparatus on board air craft. With the exception of a laboratory maintained by the Air Service of the United States Army at McCook Field, Dayton, Ohio, the Naval Air Station across the Anacostia River from the War College in the National Capital is doing distinctive investigational work. It is the pioneer Government enterprise of its kind in the United States, and possibly in the world. It was established in 1918, the building being designed to serve the particular needs indicated. A squat structure, approximately 100' long and 40' wide, facilitates the movements of air craft in proximity to the building. Outside of the main structure are two or three wireless receiving stations, as well as a pretentious compass station. Commander A. Hoyt Taylor is in active charge, working under the supervision of the Bureau of Engineering of the United States Navy Department.

With the exception of "WGY," the broadcasting station of the General Electric Company at Schenectady, "NOF" is the highest powered radio-telephone broadcasting station in the United States. It was among the first stations to inaugurate a broadcasting service, and was the pioneer Government station to recognize the demands of this increasingly popular feature. At present, the Marine Band gives a concert each Wednesday evening and the Navy Yard Band performs each Friday night. Since

(Continued on page 728)



# A Radio Romance

By RAY FROST

**T**HE tremendous, world-wide interest in radio has brought to at least one man the realization of the dreams of a lifetime.

Nathaniel Baldwin, a devout Mormon, was the inventor, ten or a dozen years ago, of a highly sensitive telephone receiver, but until the advent of radio broadcasting, never experienced the least difficulty in meeting the demand for his instrument at his little hillside factory on the outskirts of Salt Lake City—that is, when he was able to raise the money for material. Now he is swamped, buried, overwhelmed with orders.

From every state in the union, every civilized country, the farthest islands of the sea, orders for Baldwin's radio headsets have poured in until there are now on file in his shanty office unfilled demands for more than 200,000 pairs.

Baldwin's modest plant lies against the base of the Wasatch Mountains, 23 over-size Salt Lake blocks to the east of the Mormon temple, and 35 to the south.

A lane, jammed with the motor cars of his employees, runs above his plant, which has been added to from time to time, until it now extends down the lot in a long row of narrow wooden buildings. A roaring mountain stream runs past the workroom windows at one side, and at the opposite windows the fragrance of peach and apple trees drifts in. One is struck with the thought that here in this clean and airy sunlight would be a good place to work.

Baldwin, the man, is a product peculiar

to the region in which he has been born and reared, modest to the point of diffidence. In his office is a drafting table in lieu of desk, and two or three plain chairs. On the table are the Book of Mormon, Doctrine and Covenants and Pearl of Great Price, standard works of the Mormon faith. The covers of these volumes harbor no dust.

Baldwin leans against the drafting table

luxurious travel or life without hard work, and all he asked was a chance to earn his way.

To some, Provo might have seemed a small and uninteresting town, even though it lay between the dimpling fresh waters of Lake Utah and the base of lofty Timpanogos, with the giant Indian figure lying flat on its back along the crest, but to young

Nathaniel it was a golden city of Baghdad. Among its enchanted streets he wandered in the heat of midday, and before the sun had set had found a place to live in exchange for a few hours of work morning and evening.

In due time he graduated from the school, and having earned and saved sufficient money to take him to Palo Alto, in California, repeated the process at Leland Stanford, Jr.

The world looked bright when, at the age of twenty-six, he returned to B. Y. as Professor of Physics, but the end of his second year in that capacity saw him dismissed and discredited in the eyes of his fellows.

Brigham Young University is a church-controlled institution, and after several warnings, the authorities had seen fit to discipline Baldwin for a lack of discretion in his discussions of a certain ancient principle which it had seemed best to abandon. The leaders of the church had declared against the continuation of plural marriages, and the instructor had failed to temper his remarks in accordance with their directions.

A period of bitter struggle followed for  
(Continued on page 724)

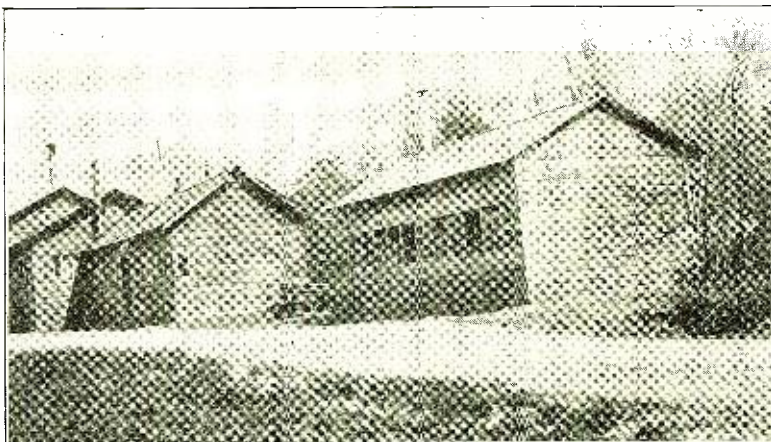

The Home of the Baldwin Phone. View of the Hillside Factory Near Salt Lake City, Where Nathaniel C. Baldwin Supervises the Manufacture of His Phones.

and smiles in a guarded, friendly fashion as he talks. He was born at Fillmore, Utah, in 1878, and as a boy set out on foot for Provo, 120 miles away, on the chance of finding an opportunity to work his way through Brigham Young University. He had no money for fare nor tuition, and was none too well clad, but the boy whose name was destined to become so well known in the future world of radio, worried about those things not at all. He knew nothing of

stitution, and after several warnings, the authorities had seen fit to discipline Baldwin for a lack of discretion in his discussions of a certain ancient principle which it had seemed best to abandon. The leaders of the church had declared against the continuation of plural marriages, and the instructor had failed to temper his remarks in accordance with their directions.

A period of bitter struggle followed for  
(Continued on page 724)

# Broadcasting From San Francisco

By OLIVER W. TUTTLE

**"K**UO"—the radiophone broadcasting station of *The San Francisco Examiner*—is the Big Brother to every radio fan in the West.

Located on top of the Hearst Building, Third and Market Streets, this station serves a multitude in the western states and brings cheer and entertainment to thousands in remote sections.

Not alone because of its power and extensive radiation is KUO a favorite with the radio public, but its popularity is also gauged by its variety and extensive programs of concerts and other data broadcasted.

Early last March this station spun into its initial activity. Previous to its birth, scant attention was given radio telephony by the general public. True, many thousands possessed receiving sets, but the wave of enthusiasm was not manifest.

*The Examiner*, realizing the possibility of serving further the public by the use of radio, established KUO. This was only after an exhaustive survey of radio and all its details, which continued over a period of many months.

A radio page was established in the newspaper with the advent of its broadcasting station, and suddenly the public pulse was awakened to the possibilities of this new scientific wonder. Practically over night the "craze," as it has been termed, swept the west and now every home and office is in the market clamoring for receiving sets.

Radio dealers frankly declare that the activity of *The Examiner* was the greatest single stroke for radio in the western states, and through the enterprise of that newspaper radio has been made a part and parcel of the life of western citizens.

Every day KUO broadcasts to its vast army of listeners-in. All anxiously await its entry on the air to get late news bulletins, baseball scores, weather and crop reports, the summary of the financial market and the extensive concert or other music.

KUO has many achievements to its credit. For instance, the following wire was sent by

C. M. Rice, Jr., Worcester Mass., and speaks for itself: "I heard KUO radiophone San Francisco on detector, without amplifiers, about April 23, four afternoons in succession and one night afterwards. The conditions were very bad, but I managed to hear the music quite clearly. My set consists of three honeycomb coils and two variable condensers and four stages of audio frequency amplification. My aerial is about 225' long. San Diego in the south, and Seattle in the north and ships 1500 miles at sea have all reported picking KUO up perfectly."

This broadcasting station conducts a service unusual in scope. On 485 meters it serves the official U. S. weather forecast three times a day. This is vital to the farming districts of the great Pacific Slope and is likewise all important during the winter season to the mariners off the Coast. On 525 meters it conducts a direct service to the pilot boat, cruising 10 miles off the Golden Gate, delivering to the navigators who board the ship entering the harbor, necessary information as to the arrival of craft, and instructions to the pilots, which is an aid to navigation. This service is looked upon as a big facility to the port of San Francisco, as well as an aid to commerce. It is likewise a safety measure in time of distress in that prompt assistance can be given craft any distance away.

Concerts, news, stock quotations and  
(Continued on page 726)

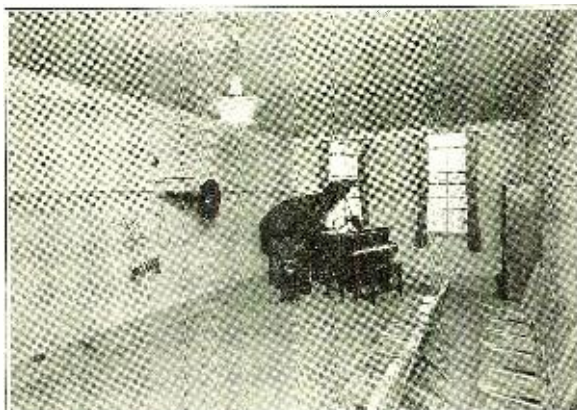

The Studio at KUO Broadcasting Station at San Francisco. Note the Signal Light Above the Microphone. This Light Instructs the Performer.



# Is the Radio Amateur Doomed?

By ARMSTRONG PERRY

UNTIL about a year ago practically one hundred per cent. of the American radio users, aside from persons in government or commercial radio services, were "radio amateurs." A radio amateur at that time was, actually or potentially, a member of the body in which the ideals of his kind took form and authority, and which, according to its own statement, is: "A national non-commercial organization of radio amateurs, bonded for the more effective relaying of friendly messages between their stations, for legislative protection, for orderly operating, and for the practical improvement of short-wave Radio Communication."

Today, the percentage of "radio amateurs" as compared with other radio users has nearly or quite lost its two ciphers, dividing it by 100. The amateur, once alone in his fascinating field, finds himself jostled and trampled upon by a horde of common folks who want to hear a concert or something—that's all. He is in about the same predicament as an aristocratic old family when a real estate operator surrounds the ancestral estate with a development full of \$4,000 houses. He is just as heroically trying to maintain the old traditions and live the old life, and with about the same chance for success.

The fact is, admit it or not, that radio communication between individual and individual is no more adapted to the new order of things than the town meeting type of government is adapted to our national affairs. A few friends could chat by radio and had a perfect right to do so while there was enough room in the ether for all who wanted to use it. But, since ninety-nine per cent. of our population cannot be expected to keep silence while one per cent. use the air for their personal pleasure, private intercourse by radio, in spite of present refinements of apparatus, will kill itself by overgrowth just as surely as the apple tree that hangs its branches so full of apples that they break.

The only possible event that can save the old order of things is the invention of a means whereby a radio message may be sent from one station to another without being heard at any station where it is not wanted. Occasionally the newspapers herald such an invention. Those who use radio would be glad to believe these reports, but few radio experts appear to place any reliance upon further increase of the traffic in the air than can be effected by enlarging the number of available wave lengths, and that increase is very limited as compared with the demands of a population of 110,000,000.

In some respects it is a pitiable situation. The radio amateur has been responsible, directly and indirectly, for developing radio to a point where all of us may enjoy it. Usually he has been a jump or two ahead of government and commercial systems because he has had more freedom. In a government system the money for experimentation comes tardily through Congress, whose first question sometimes seems to be: "What effect will this have on the election?" In a commercial system the question is: "Will it pay?" All the amateur asks is: "Will it work?", and in trying to answer this question he will hock his shirt or trap skunks or do anything else that will yield

the necessary shekels to buy one more piece of apparatus.

Government officials chuckled, it is said, when they passed a law restricting amateurs to a wave length of only two hundred meters and a limited amount of power for transmission, so that they could not interfere with government and commercial stations while sending personal messages. Officialdom thought that it would be impossible for amateurs to reach out for any great distance then, but they proceeded to develop transmitters and receivers so perfect that they soon exceeded the normal range of great plants using a hundred times their power and more effective wave lengths. Before the American public was awake to their activities, the amateurs had shot messages across the continent. Then they put a few across the Atlantic. Today some of the bunch, like Hastings of Washington, nonchalantly call up Catalina Island or any other good place on the other side of the country whenever they want to compare notes with other bugs.

The radio amateurs have fought to keep the air open for the use of the common

know nor care what message he tried to send nor where he tried to send it. They were hearing a concert and he butted in. There are thousands of them and only one of him. *Raus mit!* Let him try to listen to a distant station and his ears are filled with the voice of the phonograph in the shop down town; the admonitions of health experts to keep his head cool; the prices of white leghorn eggs and spring wheat; the frantic appeal of someone whose face he feels is even worse than her voice and who implores him for radiographic osculation, as though there could be any possible satisfaction in that. How would you feel about it? Would you get up on your hind legs and fight, or would you quietly lie down and die?

There is nothing submissive about the radio amateur except his ideal of what the other fellow ought to be when amateurs want the air. Whatever his age, he always has the spirit of youth and the way he lambasts every hostile head that comes over the horizon makes the war in Ireland seem like a Sunday-school picnic.

The "radio amateur" is as far from admitting that there is any other non-professional radio user who deserves the appellation as the Daughters of the American Revolution are from admitting Margot Asquith. A magazine that calls those who use crystal detectors for listening to concerts "radio amateurs" receives letters from small boys aged ten to ninety, who write from R. F. D. routes in forty-eight states and tell the editor for the love of Mike to cut out that stuff and learn to discriminate.

Some radio amateurs assume that the air belongs to their group, that it is theirs to give and theirs to take away. Says one of them:

"In Boston broadcasting means WGI (American Radio and Research). At the time of the convention, February, 1922, WGI had the distinction of being the oldest and worst high-power broadcaster. The Boston amateur hated WGI with all his heart and, naturally, refused to let it have the air."

In the same letter he said, after explaining that the amateurs had protested and that

WGI had improved:

"The Boston Executive Council voluntarily gave up the hours from eight to ten, exclusively, to broadcasting. This generosity can be better appreciated when one considers that 95 per cent of our interference with the broadcast listener is due to his utterly wretched receiving equipment and not at all to our transmitter."

This amateur, an adult who has been an outstanding figure in radio for many years, continues his comments on the apparatus used by the radio public in this interesting fashion:

"Most of the novice (radiophone listener) sets sold today (May, 1922) would have been obsolete in an amateur station about 1908. Their tuning ability is zero, and to quote Mr. Warner, 'in our humble opinion, they are not worth a good lively damn. . . . And in spite of these things we are making a present of the cream of the evening to these folks in Chicago, Washington, Boston and several other leading cities.'"

The league officially, with prophetic vision worthy of its strong, national leadership, has conformed to the new conditions. The

(Continued on page 740)

THIS article is one of the important of the year, as far as the radio amateur is concerned. We are glad to see that Mr. Perry has come to the same conclusion regarding the technical radio amateur as the Editor.

Time and again we have pointed out the same thoughts which are contained in Mr. Perry's article, particularly in our "Correspondence from Readers" Department.

Of course we are fully aware of the fact that the radio amateurs will let loose a war whoop that will be heard from coast to coast. We shall be flooded with letters from the old-timers, telling us, in unmistakable language, just what they think of us. We are prepared for it, and we shall be glad to publish the letters, brickbats and all, as is our custom.

If, however, the amateur will look the situation squarely in the eye, and face the emergency with spirit, and if, then, he will take Mr. Perry's excellent advice, the radio amateur will be saved.

At the present time the technical radio amateur is like a lone man standing in front of the beach, trying to stem the tide. In this case, the tide is the public. If the radio amateur does not move with the times, the public tide will surely swamp him out of existence.

Now is the time to think and organize. That is Mr. Perry's message.—Editor.

people. Long before the man on the street suspected that there was even a danger of his losing his fundamental right in the air to the far-seeing corporations that are always ready to assume control of natural resources, the radio amateur was watching Congress like a hop-scotcher watches her deadly rival, and if it stepped over the line in proposed legislation there was war until it stepped back again.

As has been said of so many other organizations and groups, the amateurs saved the country in the World War. Whatever questions may be raised about the part that others played, there can be no doubt that the radio amateurs actually did save the day. Radio was new, but vitally important. It cannot be learned in a day. The number of operators and experts in the government service was but a small fraction of the needed personnel. The ranks of the amateurs were the only source of supply. They did the job. All that is a matter of authentic history.

And now arises a situation which apparently means death to amateur radio as it has been. If he transmits as of old, the amateur is assailed by listeners who do not



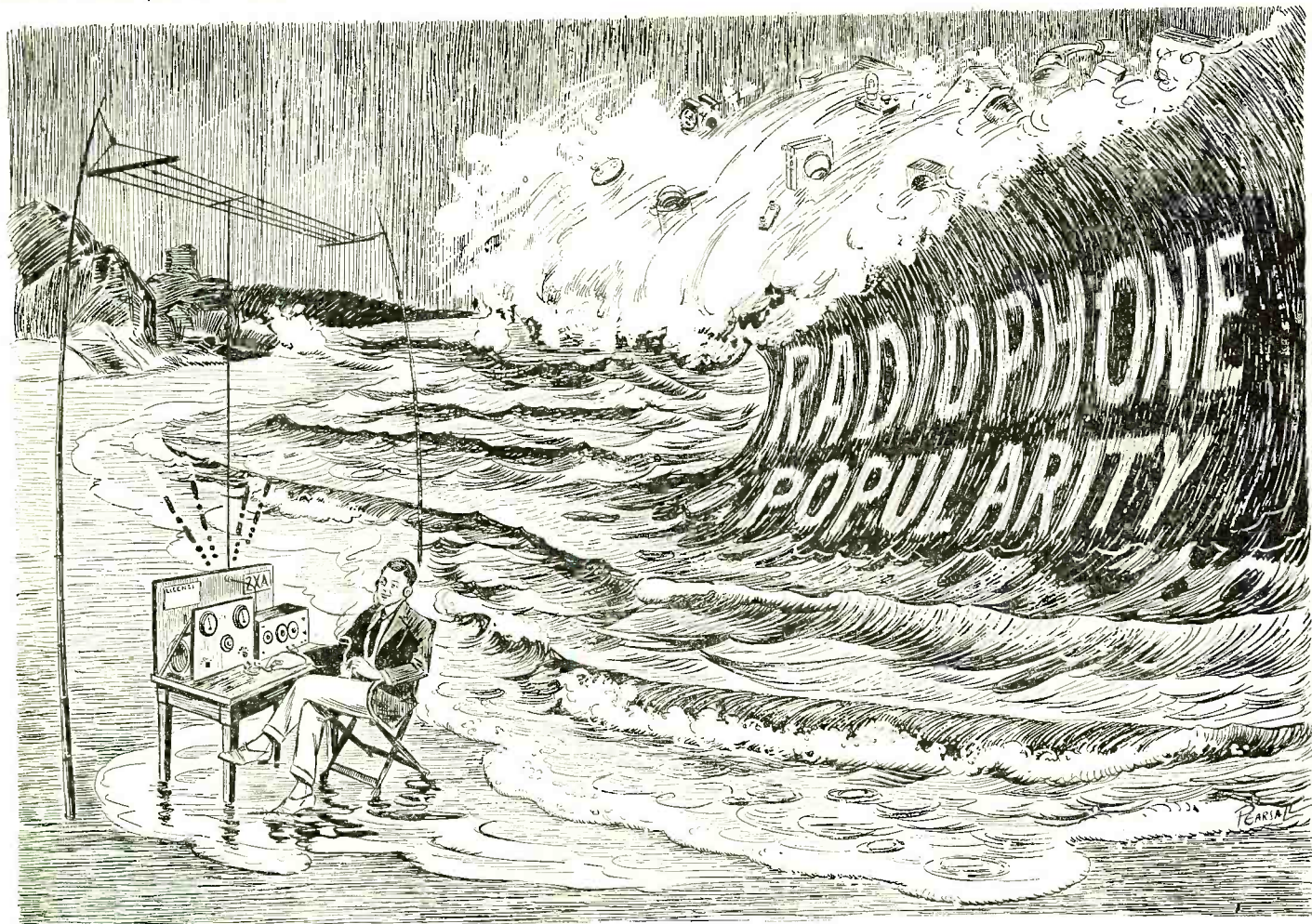

# Who Will Save the Radio Amateur?

**\$500.00 Prize Contest**  
**Radio News' Greatest Prize Contest**  
**By H. GERNSBACK**

**T**HE radio amateur and the radiophone public have arrived at the cross-roads. There is no denying that, as far as the ether is concerned today, the public has full sway. In a country where the majority rules, the radio amateur is becoming engulfed, and his very existence is threatened. If we admit that there are 50,000 radio amateurs, there are or will soon be millions of radiophone fans.

As may be known, the writer has always been with the radio amateur. Himself an amateur from the start, his sentiment, as well as his sympathy, is naturally with the amateur. Lately he has been criticized in some quarters as having changed RADIO NEWS from an amateur periodical to a radiophone publication. Whether this is true or not is left to our readers to decide. Anyone who will look through RADIO NEWS with an impartial mind can speedily convince himself whether all the articles are on radiotelephony or are for the amateur as well. We would much rather let RADIO NEWS talk for itself.

At the same time we are face to face with a condition today which is clearly brought out in the accompanying article by Mr. Armstrong Perry. *The amateur is doomed unless something is done to get him out of the present rut.* The writer has no quarrel with anyone, or any organization. He is working for the good of the amateur, and particularly the amateur experimenter, but the point he wishes to make is that *the amateur today is not recognized in the*

*community.* The public does not know him. For some reason he must be a poor advertiser. Sending messages to one another, relays, etc., which, while satisfactory to the amateurs themselves, gain the community nothing. The upshot of it is that all the present time-allocations are reserved for the broadcasting stations, and to the amateur are left the wee hours of the morning for his C. W. work. There is today no real purpose for the radio amateur. He simply

commercial or business photographers snap in a year.

Did the wave of amateur photography swamp the professional photographers out of business? It certainly did not! They are just as strong today as ever, and perhaps more so. Why? *They are rendering a distinct service to the community, for which they are getting paid.*

The writer does not mean to say in all this, it is necessary that the "professional" radio amateur should be paid for the service he renders in the community, but such a thing is not quite so unthinkable as it may be considered in some quarters. If the technically-trained amateur performs a service he should be paid for it; only if he does not perform the service in the community can he do without pay. The writer is not arguing for or against this. It is simply a thought, worthy perhaps, of consideration by our best amateurs in the country.

The writer has certain ideas of his own as to what the radio amateurs should do in order to become a great force in this country. Mr. Armstrong Perry, in his article, has expressed some such ideas.

The writer, however, believes it best to let the amateurs themselves talk, and he is willing to start the ball rolling by offering \$500 in prizes for the best suggestions as to how to bring this all about. Perhaps some of the amateurs have ideas that can be worked out, and that will do the trick, and

*(Continued on page 795)*

### \$500.00 in Gold

First Prize.....	\$200.00
Second Prize.....	100.00
Third Prize.....	75.00
Fourth Prize.....	50.00
Seventh } Prizes, each.....	25.00
Sixth }	
Fifth }	

regards radio as a sort of sport, and in many cases does not realize the great and wonderful utility of the art.

There is a parallel between the "professional" radio amateur and the amateur photographer. When photography was young photographers took pictures for pay and otherwise. Suddenly the boom of amateur photography came along with the result that there are today more pictures being snapped each day by the public than the



# German Radio Novelties

By MAURICE E. PELGRIMS

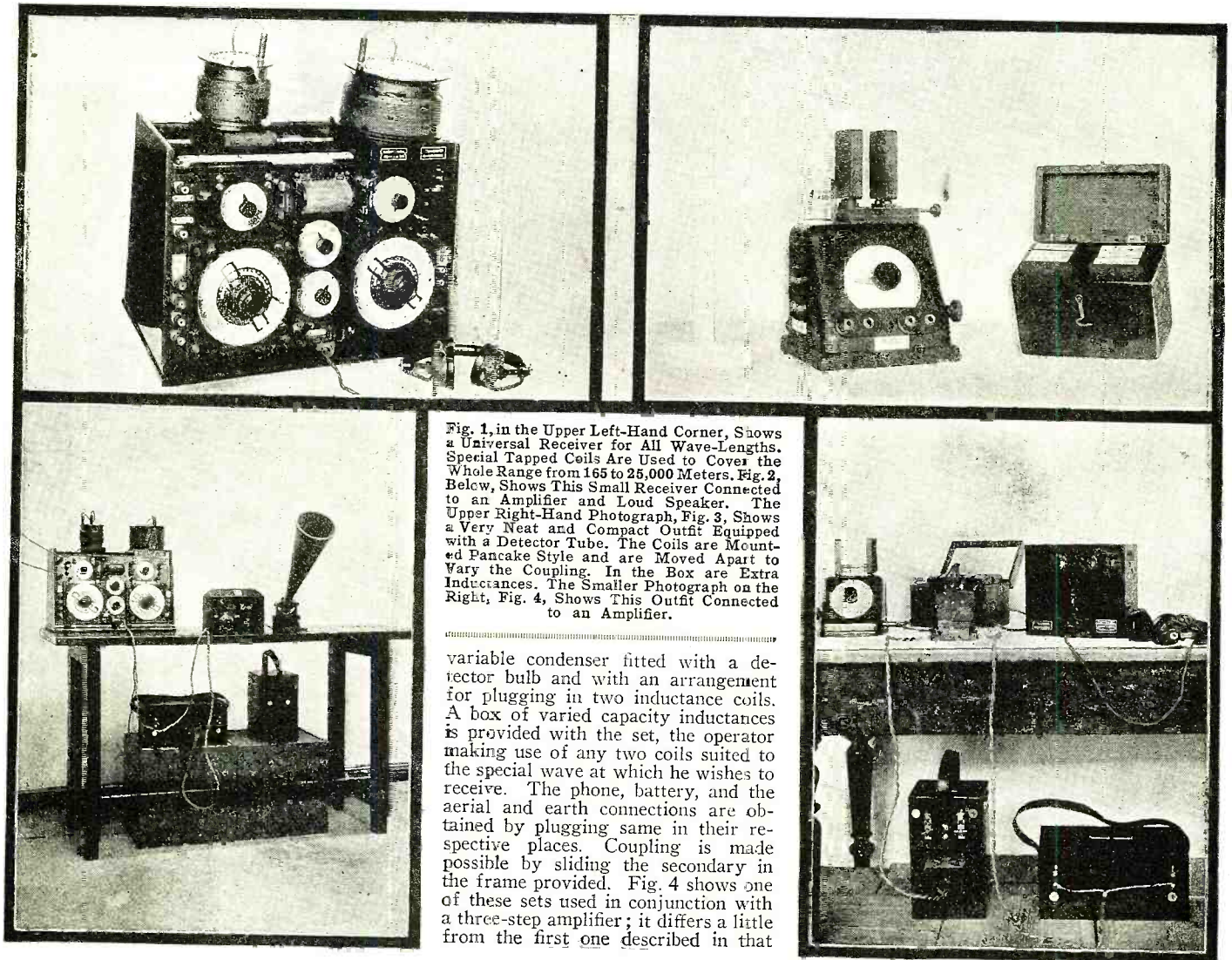

Fig. 1, in the Upper Left-Hand Corner, Shows a Universal Receiver for All Wave-Lengths. Special Tapped Coils Are Used to Cover the Whole Range from 165 to 25,000 Meters. Fig. 2, Below, Shows This Small Receiver Connected to an Amplifier and Loud Speaker. The Upper Right-Hand Photograph, Fig. 3, Shows a Very Neat and Compact Outfit Equipped with a Detector Tube. The Coils are Mounted Pancake Style and are Moved Apart to Vary the Coupling. In the Box are Extra Inductances. The Smaller Photograph on the Right, Fig. 4, Shows This Outfit Connected to an Amplifier.

variable condenser fitted with a detector bulb and with an arrangement for plugging in two inductance coils. A box of varied capacity inductances is provided with the set, the operator making use of any two coils suited to the special wave at which he wishes to receive. The phone, battery, and the aerial and earth connections are obtained by plugging same in their respective places. Coupling is made possible by sliding the secondary in the frame provided. Fig. 4 shows one of these sets used in conjunction with a three-step amplifier; it differs a little from the first one described in that

IN the accompanying photographs an unusual design of radio apparatus which is manufactured at present by the well-known German Telefunken Company is illustrated. The primary and secondary inductances consist, as may be seen, of odd-shaped wire drums provided with plug-in contacts, the latter in lieu of the customary tap switches. This type of inductance is being made for tuning on various scales of wave-lengths, in the same manner as the honeycomb coils in the United States, from 165 meters to 25,000 meters. Note the manner in which the coupling between the primary and secondary is varied (Fig. 1). The secondary coil slides in a special groove on top of the receiving cabinet and a hard rubber grip fitted thereto makes allowance for the altering of the position of the coil. A pointer indicates the degree of coupling at any time. The condensers are also of the unit-type and may be removed and replaced by others of lesser or higher capacity as may be required. The two audion bulbs are protected by a screen in the upper center of the panel. The weight of the instrument is approximately 29 pounds.

Another type of instrument which is no less interesting and noteworthy is the one illustrated in Fig. 3. This, it may be said without undue exaggeration, has a fair claim to originality. Roughly described, it consists of a

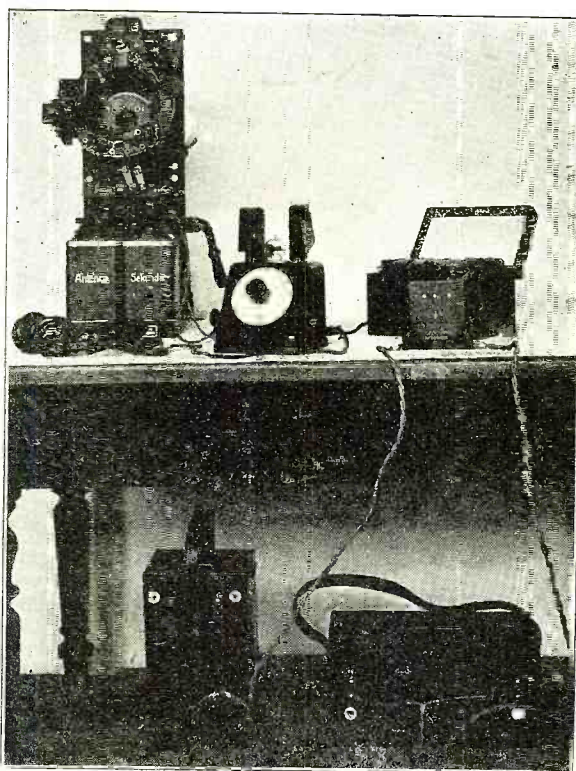

Fig. 5. A Commercial Type Receiver Connected to a Smaller Apparatus Which is Used as a Vernier for Fine Adjustment. The Detector Tube on the Small Outfit is Used with a Larger Receiver.

the ordinary inductance coils are replaced by variometer coils, both primary and secondary. Note the manner in which the variometer effect is obtained. Fig. 5 shows the same set as Fig. 4, used in conjunction with the substantially constructed commercial receiving coupler. In this case, of course, the purpose of the small set is to enable the operator to secure extremely fine adjustments, as well as to provide a larger reception wave scale.

It may prove of interest to the American amateur that the Germans are maintaining, in general lines, the mode of construction of former years. The idea of the condenser set is clever, nevertheless.

## POSTAL RADIO PLANES

While the radio work of the Department of Commerce, Public Health Service and Bureau Educational Services may be more instructive, the plans of the Post Office for aiding its transcontinental mail pilots by radio, especially in night flying, is by far the most interesting. Fourteen flying fields, stretching from Hazelhurst, Long Island, across the country to San Francisco, are already equipped with radio telegraph and telephone service for broadcasting, and all mail planes will soon be fitted out with radiophone sets capable of transmitting 125 miles. This maximum communication distance is sought in order

(Continued on page 738)



# Who's Who in Radio

No. 20.

## MARIUS LATOUR

**M**R. MARIUS LATOUR was born October, 1875, in the southwestern section of France. He was educated at the University of Paris and Parisian Ecole Supérieure d'Electricité, and was for many years consulting engineer to the General Electric Company of America; he was the author of numerous inventions in the world of electro-dynamics. Mr. Latour paid special attention to the construction of high-frequency machines, which he originally attempted to design in the shape of monophase or polyphase machines grouped in cascade. He analyzed the essential features of machines based on this principle and showed their analogy and close relationship to those of Professor Goldschmidt.

The well-known system of reception of continuous waves by beats was introduced by an original paper presented by Mr. Latour to the Technical Manager of the General Electric Company at Schenectady in 1904. In this paper he set forth the principle of this method of reception, which is in general use today.

Mr. Latour has particularly specialized in the development of low and high frequency amplifiers for radio telegraphic reception. As far back as 1905, Mr. Latour, in conjunction



MR. MARIUS LATOUR

with Weintraub, had conceived the idea of utilizing the negative resistance of a specially

designed mercury vapor tube for purposes of amplification. This vapor tube had a mercury cathode and two anodes. Under these conditions, Weintraub and Latour found, experimentally, that the potential drop between the cathode and one of the anodes for certain values of current decreased when the current increased. When the tube was introduced into a circuit containing a source of alternations, the weak current generated by the source was amplified because the negative resistance of the tube tended to balance both the positive output resistance and the internal resistance of the source. It was not until 1907 that the three-electrode tube amplifier was introduced by Dr. Lee de Forest.

Mr. Latour also perfected a system of multiple-wire telephony with high-frequency currents which was a development of the work of Maurice Leblanc in 1891-93.

During the war Mr. Latour designed the amplifiers which were used by the French Signal Corps. These were particularly of the audio-frequency type.

At present Mr. Latour is engaged in completing the work of constructing a new high-power station near Paris in which alternators of the Bethenod-Latour design will be used.

## Broadcasting to the Ships at Sea

By CLAUDE CATHCART LEVIN

**W**ILL certain Ocean liners be the broadcasting stations of the sea? Will the passengers of smaller liners dance to the music furnished by one of the big Ocean greyhounds? The prospect seems more than likely.

A few months ago, the United States Shipping Board's new passenger steamer, "Centennial State," now the "President Adams," bound from Queenstown, Ireland, for the United States, was able to entertain the officers and passengers aboard by tuning in a concert broadcasted from the S. S. "George Washington," some 200 miles distant.

The "George Washington," KDCL, after tuning his radiophone transmitter to a high degree of efficiency, announced to all within hearing that several individual selections would be sent, followed by the music of the entire ship's Orchestra.

For about an hour those listening in were entertained by the beautiful music being played aboard the "George Washington." The "Centennial State," KDRL, and the "New Amsterdam," PEB of the Holland American Line, acknowledged after each selection by radio telegraph on 450 meters. Long before the program was concluded the radio room of the "Centennial State" was crowded with an interested group of ship's officers and returning travelers and that of the "New Amsterdam" must have been the same because, after it was announced that the last selection would be given, she asked for a few more—"by special request of the lady passengers aboard."

After the selections, the leader of the Orchestra of the "George Washington" announced that it had given great pleasure to his musicians to be able to entertain the Ocean audience and that they hoped to be able to arrange for another such concert before the ship reached New York. Owing to the greater speed of the "George Washington," we on the "Centennial State" did not hear any more of the radiophone, although she may have used it when out of our immediate range or when we were busy

with telegraph traffic on another wave. The entertainment was concluded by messages of greeting and congratulations exchanged by the various ships on behalf of their commanders.

That Ocean travelers will soon begin to demand entertainment by means of radio broadcasting is a foregone conclusion. At best, an Ocean voyage is a tedious though restful affair. Only the large Transatlantic liners have orchestras aboard. Add to the number of travelers on the ships without orchestras, the men of the crews of the freighters in their lonely life of traversing the Ocean lanes and we have the population of a good sized city eagerly waiting for entertainment.

And who can deny that the value of broadcasted lectures, sermons, concerts, etc., is increased three fold in the estimation of the crew of a lonely ship bound from Australia to America or by the passengers on a slow coaster beating her way up from South America. It is a repetition of the problem of furnishing press news to the ships at sea which has been solved by radio telegraph broadcasting from high power stations throughout the world.

With ships fitted as they are at present for radio-telegraph reception, which is supposedly equal for radiophone reception, why can the people aboard not enjoy the broadcasted programs? This is possible, but not to the fullest extent. For one thing, the usual standard of commercial receiver is designed to work best on commercial wave-lengths and, with the constant increase of continuous wave telegraphy, the tendency is to design the tuners for a maximum of efficiency on wave-lengths of about 2,500 meters and upwards, rather than lower wave-lengths. At the present rate of development, spark-telegraphy will soon become only an auxiliary means of communication. Even with the present standard apparatus fitted on Shipping Board and other vessels, two receivers are usually installed, one for short waves which ranges up to approximately 600 meters and another for long-

wave work having a range of 1,000 to 10,000 meters and over.

The average ship's antenna at present is not ideally adapted to receiving on short waves, having too large values of inductance and capacity. Operators attribute to this fact the poor reception of 360 meter broadcasts.

Furthermore, on ships to-day, constant watch must be kept on 600 meters for calls and possible signals of distress. Leaving this wave-length for any reason except, possibly, to get traffic off on some other wave, is fraught with great danger. A ship sending signals of distress might not be answered by another ship in the vicinity because the operator was engaged in receiving a jazz program on another wave and did not hear the calls for help.

Passengers take their shore habits to sea with them, having a tendency to turn ships into floating hotels and cities. As the demand for the reception of radio programs becomes insistent, these problems will be speedily taken up and solved. It has already been announced that the "Leviathan" will be fitted with a radiophone receiver in each room so that the occupants may enjoy the concerts. This undoubtedly means a pair of head phones, working from a power amplifier receiving impulses from a highly sensitive tuner in the main radio room. With such equipment, and one or more receiving tuners for short-wave reception, together with suitable switches and wiring for connecting a concert to the music room, a lecture to the social hall and perhaps stock reports to the Turkish bath where the shocks can be more readily absorbed, the radio room will in reality become the telephone exchange of the sea.

Just as the "George Washington" furnished a concert for the "Centennial State" and the "New Amsterdam," so ships of the near future will be furnishing programs to their smaller fellows along the routes. Societies, which now devote their time and energy to making things pleasant and bene-

(Continued on page 728)



# Awards of the \$375 Pocket Radiophone Contest

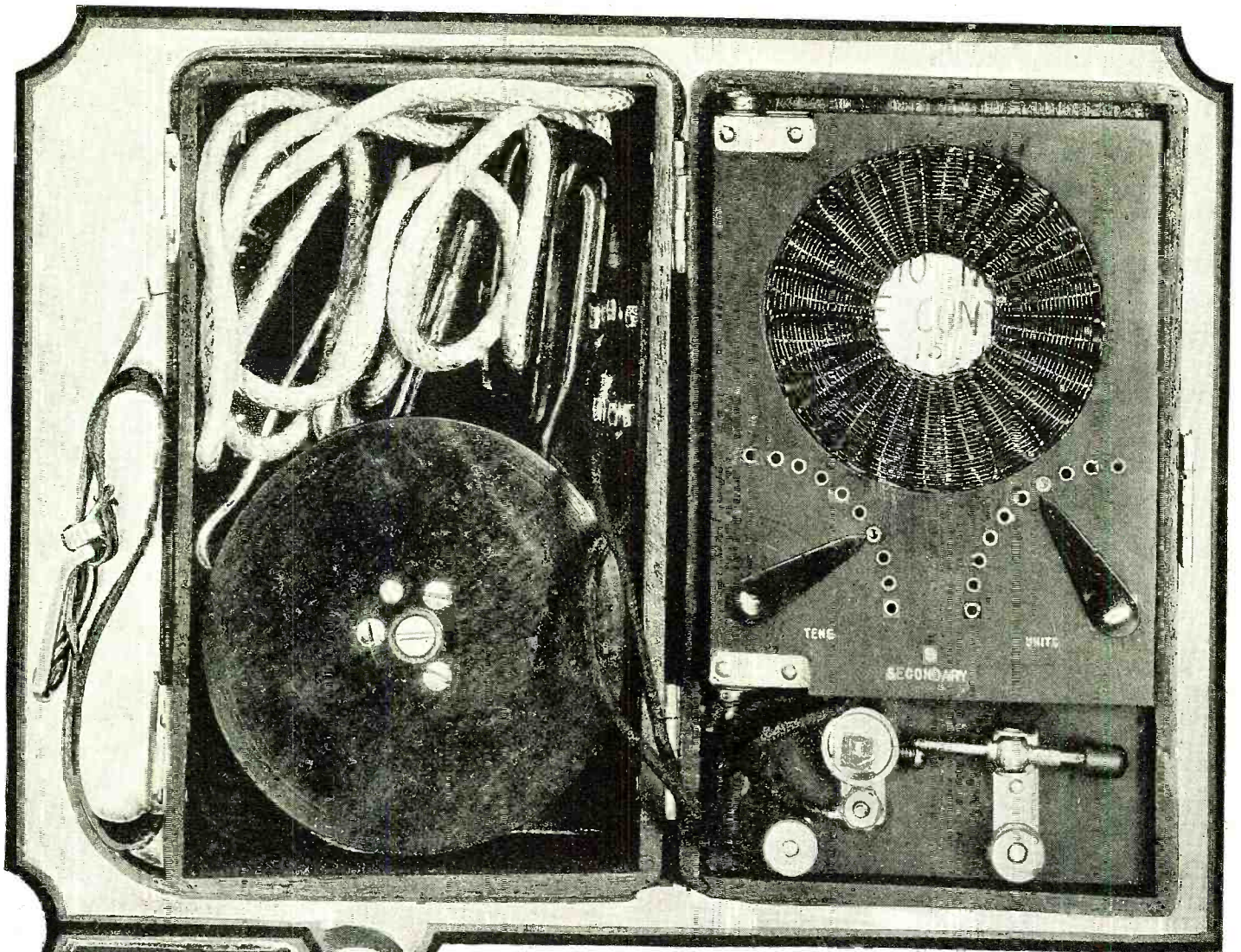

Full Size View of Receiver.

## First Prize

### A Practical Portable Receiver

By PAUL F. SHIVERS and JOHN R. STARK

**T**HE accompanying crystal pocket set was designed and constructed by us to be entered in the Prize Contest announced in your August issue, 1922.

This set, as you will see from the enclosed photos and also from the model, is complete except for the head set or phones.

The tuning coils, primary and secondary, are mounted on panels which are hinged so that the coupling may be varied. The panels carry the tuning switches, two on each panel, controlling the inductance by single turns. The coils themselves are of spider-web construction, there being two webs to each coil. Each coil consists of 100 turns tapped at each ten turns, except the last ten, which are tapped every turn.

The case, which has outside dimensions of 2" x 4" x 6½", carries the crystal detector of the cat-whisker type, the reel for the antenna, which consists of more than 150' of fine braided copper wire, the antenna insulators and the ground wire and grounding pin.

The antenna insulators are equipped to act as dead end insulators and as anchors for the antenna and lead in. The dead end

## Prize Winners

### First Prize \$150

PAUL F. SHIVERS and  
JOHN R. STARK  
% Webster Electric Company  
Racine, Wisconsin

### Second Prize \$100

J. B. ARMSTRONG  
Stop 16, Troy Road,  
Schenectady, New York

### Third Prize \$75

S. K. C. MOJEIKO  
5510 Brosser Avenue  
Cleveland, Ohio

### Fourth Prize \$50

B. HODGSON  
191 Reservoir Avenue  
Revere, Mass.

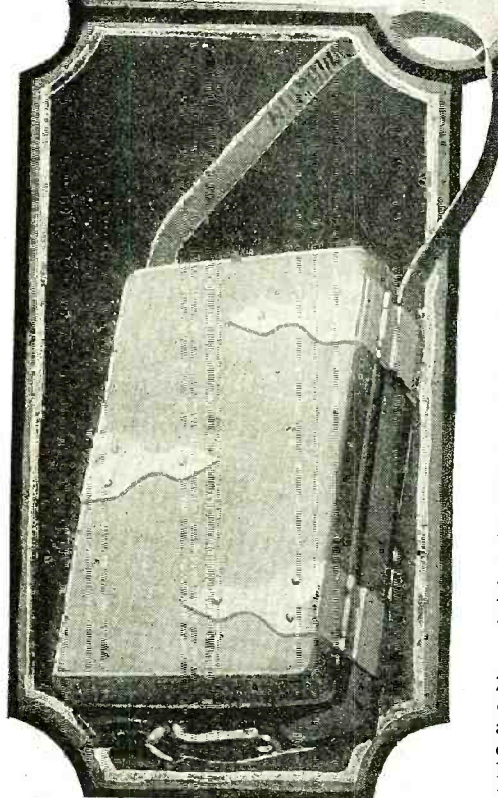

The First Prize-Winning Entry Has the Complete Aerial and the Ground Lead on One Side and Loose-Coupled Crystal Receiver on the Other. Closed, it is a Very Compact Unit and Easily Portable.



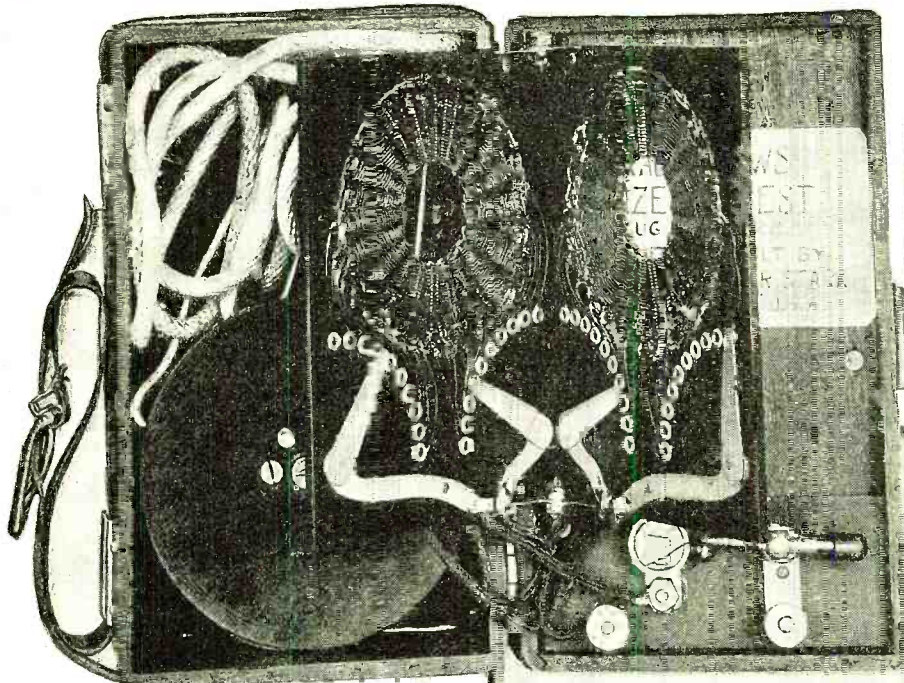

These Views Plainly Show the Exceedingly Neat Workmanship and Practical Design of This Prize-Winning Pocket Receiver. Note the Unique Method of Moving the Switch Levers. The Designers Are Shown in the Top Photographs.

insulator has a hook to attach to the antenna and a short length of heavy cord to attach to the limb or other stationary object. The anchor insulator has a clamp to attach to the antenna, the clamp being so placed that the antenna may be anchored at the proper point and the "lead in" carried down to the set.

It was found in practice that a phone stopping condenser of the smallest capacity would detract from the strength of the signals and so it has been omitted. The phone cord has sufficient capacity to pass the radio frequency and to furnish the necessary capacity in the crystal circuit.

This set, when in use with a 60' to 70' antenna raised about 40' from the ground, will give good results on phone, 25 miles from Milwaukee, where stations WAAK and WCAY are located. The signals, although faint, are distinct and the set may be considered as successful at that distance and with stations of the power represented by these two.

Owing to the very short time allowance (we have only known of the contest since August 1), we have not been able to give the set a good work-out at shorter distances.

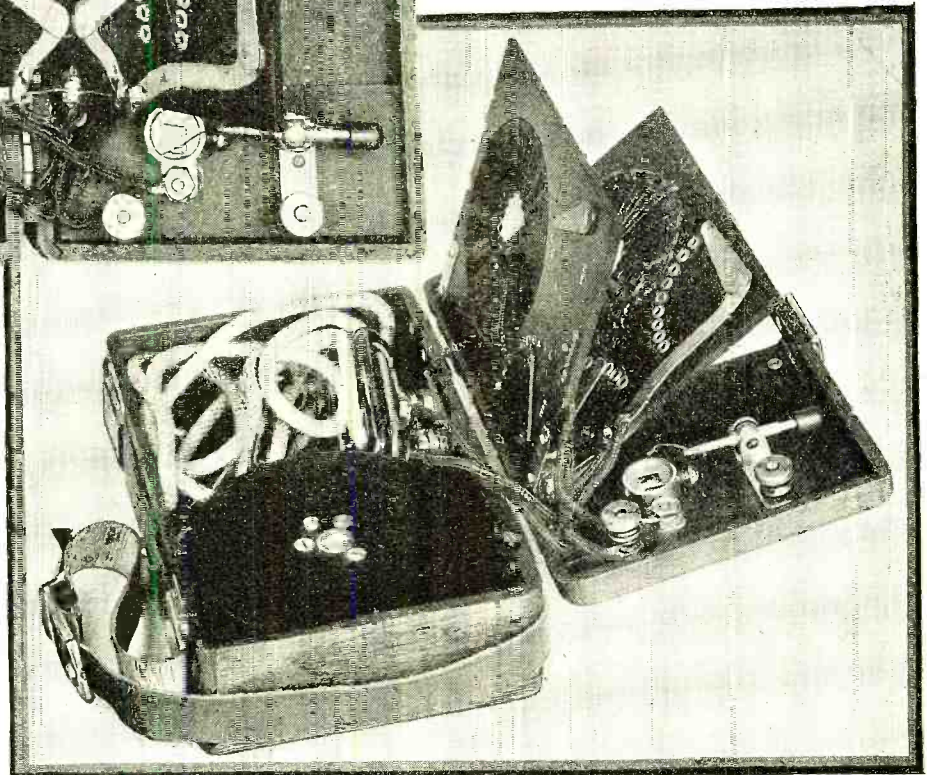

### Second Prize Pocket Radio Again

By J. B. ARMSTRONG

REFERRING to the first prize article of the "Pocket Radio" contest in the December, 1920, RADIO NEWS, the writer decided that a much smaller set could be

built that would be equally efficient. Accordingly, the set described herewith was designed and built in about two weeks' time. (Continued on page 795)

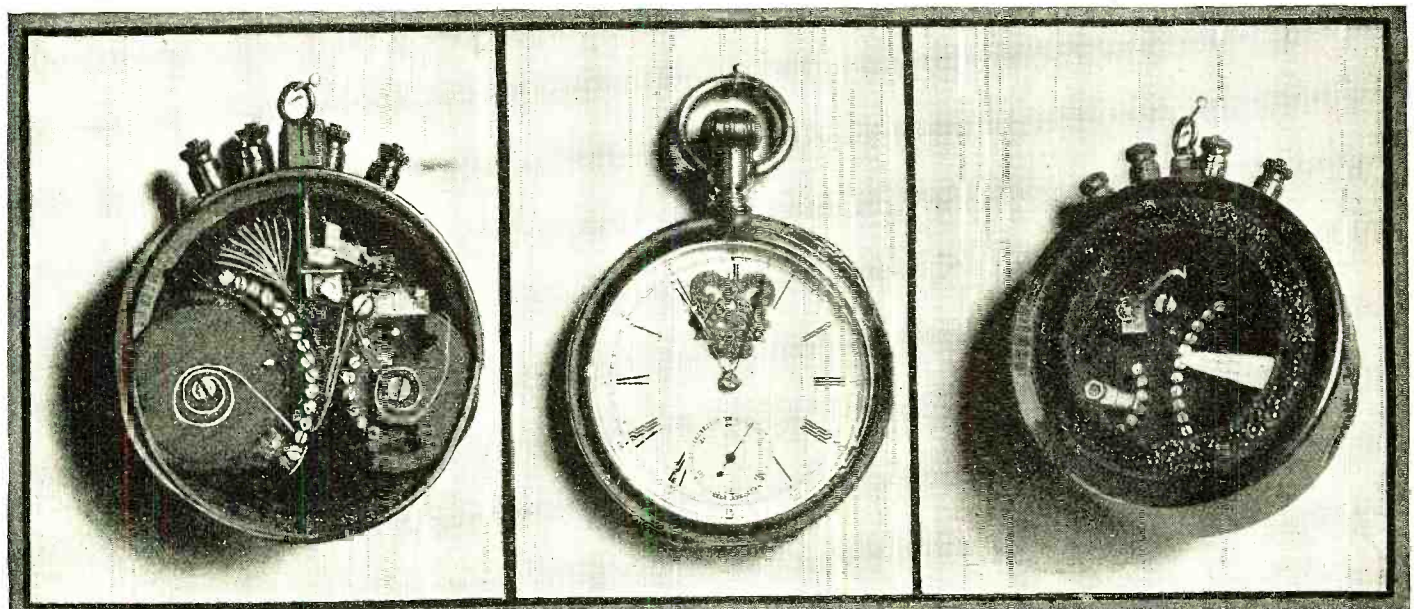

The Second Prize-Winning Model is Very Compact and Shows Excellent Workmanship. It is Enclosed in a Watch Case. The Watch Shown is on the Same Scale.



# Correspondence From Readers

## HUMOR GONE WRONG

Editor, RADIO NEWS:

I have just finished reading a certain article in your *Correspondence from Readers*, namely, that of Henry Morris. This article has given me certain mingled feelings toward you, RADIO NEWS and the writer mentioned above.

First, I experience extreme pity for H. Morris in his sad plight, for a fellow whose set finds a 3500 meter wave perched down on 210 meters. I also would compliment him on his extraordinary feat of having heard a signal of 200 meters on a wave length of 1500, a thing not hitherto accomplished.

Secondly, I regret to say that I have forever lost my trust in the Editor, as an American amateur. For several months, as the popularity of broadcasting developed, I have felt that the RADIO NEWS was slowly slipping away from the standard it once held toward the protection and encouragement of the amateur. I have fought the thought, but I realize now that I can no longer sensibly refrain from thinking so. You, by the publication of this article, which you know to contain impossible things, to show piteous ignorance of radio theory, code, or in fact anything pertaining to the amateur or radio in itself have openly deserted the amateur, cast away the friendship of those who supported your magazine, and respected you from the beginning, and thrown open your magazine to those who have destroyed, or are doing their best to destroy the art of radio, and commercialized our sport. You can no longer face the amateur and the "broadcaster" with an open, free conscience. You have made your choice and have left the sport, for the business. You would be sensible to throw open your magazine to the purpose which you have chosen and not try to hide your choice. We, the amateurs, have lost our trust in you.

As to Mr. Morris, I have no desire to antagonize him nor belittle him. However, I do not think it fair that a person with no knowledge of amateur radio, should try to do away with the amateur, who made such a thing as broadcasting possible, when the amateur should be the one protected.

Mr. Morris, Radio is our sport. If you played golf, and one day you went to the links and were told that all the links were reserved from 6 o'clock in the morning until 10.30 at night for professional players, "who played for the benefit of onlookers who didn't know anything about the game," but that you could play during the remaining time if you wished, how would you feel? You cannot read code, I am positive. Therefore you do not know that commercial stations only operate on 600 meters. You do not know that it is impossible to make an amateur transmitter operate, or even be heard on 600 meters, let alone 1500. However, if what you say is true, procure the call letters of the offenders send them to me, and I will obtain satisfaction for you.

I invite any cool-headed discussion of the subject and will answer any letter received. I would like especially to hear from Mr. Morris.

G. HAVELY HUMES.

1408 Cuyler Ave., Chicago, Ill.

*(Poor Mr. Humes! Our heart goes out to him and we feel genuinely sorry for him. When we published Mr. Morris's letter in the August issue we took it for granted that all of our readers had sufficient humor to see the obvious exaggeration of the letter, making it a really humorous epistle, with some grains of truth contained therein. In that same letter Mr. Morris says, "Some ham thinks he has to call a station 4,000 miles away," etc. Probably*

*Mr. Humes took this statement seriously, too. Fortunately, this is the only letter that was received from our readers, so probably the other 234,999 read the letter in the spirit in which it was written. We presume, in order to oblige Mr. Humes, it will be necessary hereafter to label every article "HUMOROUS" or "SERIOUS," as the case may be.—EDITOR.)*

## WHY SHOULDN'T WE BE ALIKE?

Editor, RADIO NEWS:

I am writing this letter as an answer to that of Mr. W. E. Weaver which was published in the July issue of RADIO NEWS. In this letter Mr. Weaver expressed himself to the effect that young Canadians were becoming Americanized by reason of their listening to the programs of the broadcasting stations located in the United States. I sincerely hope that I can convince Mr. Weaver and any other Canadian amateurs who think as he does that there are absolutely no grounds for their distress.

Mr. Weaver brings out two principal points in favor of his contentions. The first of these is that the Canadian amateur is learning the pronunciation common to

from what it teaches in the field of science. On this point we must all favor radio communication between the two countries if we have the best interests of mankind at heart.

Mr. Weaver also puts forth the argument that Canadians are becoming in many respects like Americans. Well, why shouldn't we be alike? We have the same tongue, the same customs and derive our laws from the same source. England is our Mother Country just as it is yours and the fact that we could not tolerate conditions during a certain period in history can never change the source from which we owe our being.

In closing I wish to say that I sincerely hope that radio communication between the two countries is on the increase and that the time is not far distant when we will listen to a Canadian broadcasting station at the same time that you are listening to one of ours.

HALL E. SHEPHERD.

Nashville, Tenn.

## MORE GALENA RECORDS

Editor, RADIO NEWS:

Having read John M. Shanner's article in the July issue of the RADIO NEWS, telling of his Galena records, I have decided to send you my record.

Using a home-made loose-coupler, with the primary winding of No. 20 S.C.C. wire on a tube 5" long, and 2 $\frac{3}{4}$ " in diameter, and with the secondary No. 32 S.C.C. wire on a tube 4 $\frac{1}{2}$ " long and 1 $\frac{1}{2}$ " in diameter, each coil was taped at every 10 turns. I can hear when the QRN is not bad, WWJ 700 miles, WDAF 160 miles, DD5 500 miles, WCM 500 miles, WHA 500 miles, 5ZA 550 miles, WAH 350 miles, 9VT, 9DUN, 9DHB, WFAY. All of these are phones. I can clearly hear the key hit on 9DUN's C. W., 30 miles distant.

I can hear all kinds of sparks, of which these are the loudest, 9ND, 5XU, 5ZA, 5ZL, 5LO, 9AFX, 9AEG, 9BZZ, 9BMW.

I was using a pair of Type "E" Baldwin phones, and no condensers. My antenna is a three wire L type 45' high and 75' long. For a while I used a single wire 120' long and 30' high. For a ground I used a water pipe.

A concert from WAH at El Dorado, Kansas, was heard from 9 o'clock until 11 one night, the cat-whisker being held in place by a drop of tallow.

Let's hear of some more crystal records.

F. P. WATTS.

Independence, Kan.

## ANOTHER GOOD ONE

Editor, RADIO NEWS:

Having read John M. Shanner's article in the July issue of RADIO NEWS concerning his Galena record, I am sending you mine.

I have heard WGY, WDM, KDKA, WWJ, WJK, and 8XJ, and small stations nearby which number about five or six. All of these stations were heard on a piece of Galena and a single slide tuning coil. KDKA and 8XJ came in very loudly, but the others were faint.

JOHN E. VALLOWE.

Homestead, Pa.

## HIS CRYSTAL IS GOOD, TOO

Editor, RADIO NEWS:

Having read John M. Shanner's letter, published in RADIO NEWS for July, reporting his Galena record and asking to hear from some more Galena records would say that on the nights of Jan. 5 and 9 I picked up music from KDKA at least five hundred miles distant, and on the nights of March 24, 28, 31, April 19, and 20, heard speech and music from WWJ at Detroit,

(Continued on page 674)

## Radio Articles Appearing in September Science and Invention

The Slot Machine Radio. By H. Gernsback.

Who Discovered Radio? By A. P. Peck.

Radio Outfit in Pickle Bottle. By Edgar I. Eisenstadt.

Tikker Reception of C.W.

Chopping Bowl Loud-Talker.

Radio Concerts from a Lamp Socket. By A. P. Peck.

Five-Stage Amplifier on 110 Volts A.C.

Radio for the Beginner. By Armstrong Perry.

Simplest Radiophone Receiver. By Frank Copman.

Radio Broadcast, Up-to-Date.

Photos of Broadcasting Stations.

Radio Oracle.

this side of the International Boundary. This is probably true, but it would only apply to a very few words and if Mr. Weaver will consult an authority he will find that either pronunciation is correct in these cases. I have spent considerable time in both Ontario and Quebec and never found any great difference in the use of English by the people who use it correctly. I know absolutely that there is less difference between the English used in Canada and the United States than there is in the English used in the different sections of this country. I think that Mr. Weaver will find this to be equally true as between the provinces of his own country. I am sure that every Canadian will agree with me when I say that a more general use of English in the Province of Quebec would be beneficial to Canada at large. Is there any greater incentive for the young men of that Province to learn English than that supplied by the broadcasting stations, whether located in Canada or in the United States?

The second point brought out by Mr. Weaver is that the Canadian amateur is learning the geography of the United States by reason of the interest created by his listening to the radio stations located in this country. I hope that Mr. Weaver is correct on this point. If radio transmission is helping to teach the young men more about the world in which we live it certainly has a far-reaching educational value aside



# International Radio Congress at Chicago

By ROSCOE SMITH

**T**HE International Radio Congress convened August 7th in Congress Hall, on the Municipal Pier which extends far out into Lake Michigan at the foot of Grand Avenue. Two celebrated figures in the electrical world, Guglielmo Marconi and Charles P. Steinmetz, gave their views as to the future of radio, one in a message sent to the Congress, the other by personally addressing the radio scientists gathered for the notable Congress.

Maj. J. O. Mauborgne, U. S. A., signal officer for the Sixth Army Corps area, and associate of Maj. Gen. George O. Squier in the Army's radio activity, was President of the Congress, and Commissioner George E. Carlson of gas and electricity of the City of Chicago, and sponsor for Chicago's Municipal broadcasting station, was chairman of the arrangement committee. Both are sanguine that the Congress will develop into a permanent organization.

A number of new inventions and improvements on radio made by the United States Army, by the U. S. Bureau of Standards, and by the engineers of the leading radio and electrical industries were announced for the first time at the Congress.

G. H. Clark, representing the Radio Corporation of America, read a paper submitted to the Congress by Signor Marconi, the keynote of which was the inventor's belief that

a great future lay in store for the short wave radio.

"Recently the long wave has been in use because it generally has been more uniform at the receiving station, but now with the directive energy on the short wave, it will be much more satisfactory, as it is essentially more punctual," Signor Marconi said. "I have found that the absorption, or fading

the Sixth Army Corps, who officiated as President of the Congress. While the Congress was in session the balance of the Pageant was listening through huge amplifiers distributed over the pier, and the middle west was also in attendance through "KYW," broadcasting station.

Visions of a powerful sheet of electric power traveling over the earth, to be used in a selective manner by all receiving stations for every purpose for which electricity is used today, were depicted in an illuminating address by Charles P. Steinmetz, consulting engineer of the General Electric Co., who spoke on the subject, "Radio."

"The successful development of radio communication by telegraph and telephone," Dr. Steinmetz said, "raises the question of the possibility or impossibility of radio power transmission. In some respects, radio power transmission exists today, for the message which you receive by radio has been carried by the power of the electro-magnetic wave

from the sending to the receiving station. However, while the sending station sends out electro-magnetic waves of power of several kilowatts or even hundreds of kilowatts, this power scatters in all directions, and it may be only a fraction of a milliwatt which we receive, that is, less than a millionth of the power sent out.

(Continued on page 732)



The Municipal Pier at Chicago in Which the International Radio Congress Was Held. Many Notable Speakers Addressed the Congress.

away is less when a directive transmitter is used, and I have been able to cover 100 miles with short waves."

Radio Day at the Pageant of Progress, so called because it was the opening day of the International Radio Congress held in conjunction with Chicago's Pageant of Progress, got well under way by the direction of Major Mauborgne, signal officer of

## The Use of Power Tubes in Radio Reception

By HERBERT E. METCALF\*

**T**HE sustained interest in radio broadcasting by the general public of this and other countries has led to a greater interest in the proper type of receiving set to use in connection with the reproduction of the wireless music and speech in the home. Not only in the home, but in many other places such as halls, auditoriums, stores, etc., radio has come to be more or less indispensable. Inasmuch as the modern receiving set costs more and more, according to the amount of volume of sound required, it is of interest to all to get the maximum volume for the minimum investment, and it is in this respect that power tubes become useful in radio reception.

A man may go to a radio store and buy a crystal receiving set with phones for perhaps \$25. This may keep him interested for a little while, particularly if he is close to a broadcasting station, but eventually, he will wish to get the music and speech a little louder. This means a vacuum tube receiving set with its accompanying storage battery, "B" battery and panel. Even then, the music will not usually be loud enough for a loud speaker, and he then adds a two-stage amplifier in hopes that he may be able to hear the music as well as he might hear music from a phonograph. Quite often he is disappointed and feels that a larger and more expensive set must be used to get

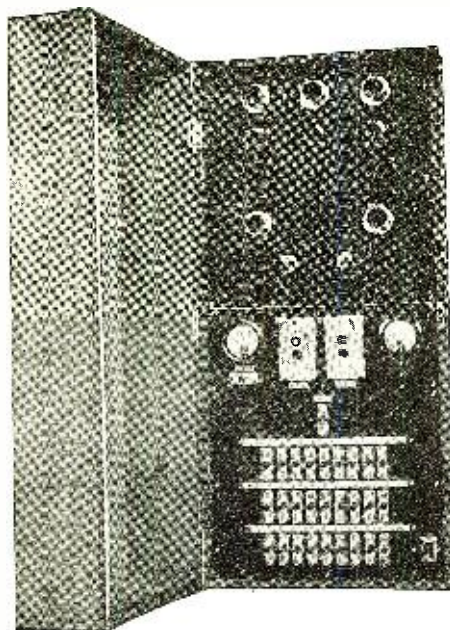

A Type of Power Amplifier Equipped with a System of Switches Permitting the Operator to Connect Several Loud Speakers Located at Different Places.

greater volume, whereas, really, by means of a proper tube selection, he may get a much greater volume from this set than he is at present receiving. When this man went to a radio store, as likely as not he knew nothing about tubes or if he did he probably thought they were all alike; consequently, the radio dealer included with the set he bought, what he, the dealer, thought was the proper tube selection. In 99 per cent of the cases the radio dealer gave him a soft gaseous content detector tube and two more or less soft amplifier tubes. On operating his set with these tubes he was immediately aware of several things: First, his detector tube was extremely sensitive in its "B" battery and filament adjustments; second, he found that he could not increase the volume of his set by increasing the "B" battery voltage of his amplifier tubes over 90 volts. If he did, his tubes choked, did not amplify, and in case he bought a three-stage amplifier, he found that the third stage did not amplify loud signals.

There is, however, one other tube which the average radio enthusiast of today has more or less ignored, and that is the power or transmitting tube. And why should he not have ignored it, because he had been taught that a detector tube was for detecting, an amplifying tube was for amplifying, and a transmitting tube was for transmitting.

(Continued on page 785)

\*Radio Engineer, The Magnavox Company.



# Radio Digest

## AN ALTERNATOR TO TRANSMIT 900 METER WAVES

By OUR BERLIN CORRESPONDENT

A new advance has been made in the field of radio engineering. In fact, Mr. Karl Schmidt, chief engineer of the Messrs. C. Lorenz, of Berlin-Tempelhof, has succeeded in raising the frequency of the current derived from an ordinary 6,000-cycle alternating current dynamo, with normal number of turns and excellent efficiency, to 360,000 cycles, i. e., waves of 900 meters are thus emitted from a machine sender.

This will open up quite new possibilities to wireless telegraphy, enabling the commercial waves, as usual in stationary and marine practice, to be generated direct from an alternating current generator, and reducing the radio sender station to a simple power plant, a result often attempted, but never yet obtained in actual practice.

The generator is connected with a speed controller, likewise designed on plans by Mr. Schmidt, which keeps the number of revolutions at such constant figures as to exclude any appreciable fluctuation even with the short waves corresponding to 360,000 cycles per second. According to a notice received from a Dutch government department, which in Amsterdam (at a distance of 600 kilometers) received the signals from a normal 1-KW ship installation, these signals arrived with perfectly constant wave-length, pure pitch and considerable acoustic intensity without any amplifier.

It is thought that high frequency generators will thus, even in the field of short waves and small outputs, which so far did not seem to be open to them, become efficient competitors to the system at present used.

## RADIO DEVELOPMENT ABROAD UNCERTAINTY AS TO BRITISH BROADCASTING PLANS. RADIO COMMUNICATION BETWEEN DENMARK AND SWEDEN

There is still much uncertainty regarding the conditions under which wireless broadcasting will be carried out in England, according to the Electrical Division of the Department of Commerce.

Differences have arisen between manufacturers and the Postmaster General, and conferences are now being held, attended by representatives of between 40 and 50 firms, including those which have applied for licenses to broadcast. The vital question is as to the erection of broadcasting stations, one group wishing to have the construction of all of them handled by one organization, and the other, composed of smaller manufacturers, opposing this office which they characterize as monopolistic.

The scheme as outlined calls for eight stations which are expected to cost approximately £20,000 each. In connection with the cost of the broadcasting program it has been suggested that the Government's "Listening in" license fee be increased and that the additional sum thereby obtained be placed in a common fund out of which the program would be provided. At present it is proposed to charge 10/6 (\$2.44 at par) for registration of receiving sets.

## RADIO TELEPHONE BETWEEN DENMARK AND SWEDEN

Reuter's Trade Service states that the radio telephone circuit between Copenhagen and Bornholm was recently opened to the public. The arc system is used for transmission and the rates charged are lower than for similar service by telegraph. This is the first public radio telephone circuit to be placed in service in Scandinavia.

## 451 BROADCASTERS OPERATE IN ALL STATES EXCEPT WYOMING

When KDKA, the first broadcasting call, was assigned nine months ago to the Westinghouse Electric & Manufacturing Co., East Pittsburgh, Pa., even the Chief Radio Inspector did not suspect that today there would be 451 stations broadcasting, one or more in every state except Wyoming. The growth has been phenomenal, but at the same time healthy, for the applications for broadcasting station licenses continue to pour into the Department of Commerce at the rate of about three a day, with very few withdrawals.

During the week ending July 29 twenty-six more stations were licensed, including the stations of the Wilmington Electrical Specialty Co., the first in the state of Delaware, which leaves but one state without a broadcasting station.

Wyoming, last of the states alphabetically, is also the last of the states to take up radio communication. There are no public service or broadcasting stations there, no experimental or technical operators and only three special or advanced amateur stations; one each at Douglass, Casper and Elk. In the

## Some of the Interesting Articles Appearing in Practical Electricians for September

- Old Time Trolley Experiences.
- Great Electric Advertising Signs.
- Electric Fountains.
- Musical Typewriter.
- High Frequency Current Experiments.  
By Leonard R. Crow.
- Spectacular Illumination for the Brazilian Exposition.
- Home Medical Coil and Violet Ray Set. By A. J. Christopher.
- Home Made X-ray Screens. By Raymond B. Wailes.

whole of the Seventh Radio District, comprising Wyoming, Oregon, Washington, Idaho, Montana, Alaska, there are only about 750 amateurs transmitting, while in other districts the number runs into two or three thousand. Evidently something must be done to awaken the great Wyoming to the call of the air, when even the smallest state, Delaware, has one broadcaster.

Naturally the greatest number of broadcasting stations are operated by electrical manufacturers and dealers, but one of the keenest interests displayed is that of the press of America: sixty-eight newspapers are broadcasting today for the benefit of their readers and the public in general. Last week five joined the throng, one each in Pennsylvania, Indiana, Iowa, Nebraska and Wisconsin.

The twenty-six broadcasting stations licensed by the Department of Commerce were the following:

- WIAN—Chronicle & News Pub Co., Allentown, Pa.
- WIAQ—Chronicle Publishing Co. Marion, Ind.
- WIAF—Gustav A. DeCortin, New Orleans, La.
- KFBE—Reuben H. Horn, San Luis Obispo, Calif.
- WJAD—Jackson's Radio Eng. Lab., Waco, Texas.
- WIAQ—Matthews Elect. Supply Co., Birmingham, Ala.
- WIAD—Ocean City Yacht Club, Ocean City, N. J.
- WHAW—Pierce Elect. Co., Tampa, Fla.
- WIAP—J. A. Rudy & Sons, Paducah, Ky.

WIAC—School of Eng. of Milwaukee, Milwaukee, Wis.

WIAL—Standard Radio Service Co., Norwood, Ohio.

WHAU—Wilmington Elec. & Specialty Co., Wilmington, Del.

WIAE—Mrs. Robert E. Zimmerman, Venton, Iowa.

WJAB—American Radio Co., Lincoln, Neb.

WIAS—Burlington Hawkeye-Home Elec. Co., Burlington, Iowa.

KPAV—Cooke & Chapman, Venice, Calif.

KFAW—The Radio Den, Ashford & White, Santa Anna, Calif.

KFBF—F. H. Smith, Butte, Mont.

WJAE—Texas Radio Syndicate, San Antonio, Texas.

WIAU—American Security & Savings Bank, Le Mars, Iowa.

WJAG—Huse Publishing Co., Norfolk, Neb.

WIAT—Leon T. Noel, Tarkio, Mo.

WJAC—Rodoll Co., Joplin, Mo.

WIAW—Saginaw Radio & Elec. Co., Saginaw, Mich.

WJAJ—Y. M. C. A., Dayton, Ohio.

## RADIO DEVELOPMENT IN FOREIGN LANDS

### WIRELESS TELEPHONY FOR THE WEST INDIES

A system of wireless telephony now connects the Turks Islands and the Caicos Islands in the West Indies, the same installations being used also for wireless telegraphy and for communication with ships. The distance covered by the radio-telephone circuit is about 12 miles.

Recent advices received at the Department of Commerce from Trade Commissioner Young, Riga, state that during May a new wireless telephone broadcasting station, located on the Kursk Railway station in Moscow, was opened by the People's Commissariat of Post and Telegraphs. The station was built by the Nizhni-Novgorod laboratory of the Government, and is designed to broadcast messages and wireless press sent out by the Government.

### WIRELESS SERVICE FROM ENGLAND TO SPAIN

The wireless traffic between England and Spain, which has been handled for some time by land wires to the Poldhu station and thence by radio, has been greatly improved by the substitution of the new Marconi station at Ongar as the transmitting agency. This station is worked by distant control from London, so that messages filed in that city are sent direct by radio without any retransmission. The same station is now working on schedule with three other continental wireless stations, according to the Daily Mail.

Poldhu, located in Cornwall, is one of the oldest and probably the best known of the European high-power radio stations. At the present time it is not being actively used and its eventual disposition is uncertain, although there has been some discussion of a plan to convert it into a radio telephone broadcasting station.

### WIRELESS SERVICE FROM EGYPT

The Egyptian Department of State Railways, Telegraph and Telephones has announced through the press that commercial wireless service is open to the public from the station at Abou Zabal, according to a report received at the Department of Commerce from Consul Maynard, Alexandria. Since 1914, when the station was completed, it has been used only for Government messages, but will now handle commercial

(Continued on page 748)



# The True Story of the de Forest Vacuum Tube

By CHARLES GILBERT\*

MUCH is being written to-day about marvels of the Audion lamp, the tiny glass bottle which has revolutionized the world of communication. The lamp itself is frequently described as a development of the two-element tube, a perfected valve, an improved incandescent light, or a rectifier to which has been added de Forest's now famous little grid. It might be of interest, therefore, since public recognition has been given radio, if we record at this time the true story of the invention of the de Forest vacuum tube.

It was in the summer of 1900 that de Forest was experimenting in his S2 a week room in Chicago when he chanced to come upon the discovery of what he, at first, thought was only a strange phenomenon. On this memorable night, he was working on an electrolytic detector. His wireless apparatus was placed on a table beneath a Welsbach gas burner. The spark coil he was using as a source of oscillations was located in a closet about ten feet distant.

On one occasion, when he closed the switch of the spark coil by means of a string running across the floor from his table, he observed there was a decided change in the illumination from the Welsbach burner. As soon as the sparking ceased, the light from the gas mantle increased very perceptibly, resuming its normal brilliance. This phenomenon continued and impressed itself strongly upon the attention of the youthful investigator.

Further experiments with the gas mantle soon convinced de Forest that "heated gas molecules were sensitive to high frequency electrical operations," but it was not until three years later that he returned to the development of his gas mantle idea.

Dr. de Forest did considerable work, then, with various types of Bunsen burner arrangements, and set up a laboratory type of flame detector which was actually used in 1903 for receiving signals from ships in the harbor of New York. The inconvenience of supplying a source of gas for the new detectors was of course obvious, and de

\*President and General Manager, de Forest Radio Telephone & Telegraph Co.



While Experimenting With a New Detector in 1900, Dr. de Forest Discovered That the Light of a Gas Burner Was Affected by the Discharges Produced by a Spark Coil.

Forest sought for other means of obtaining the necessary heated gas and heated electrodes. The next experimental step was an electrical arc, but an arc was found to be very irregular and noisy in the telephone receiver.

After the arc came the idea of an incandescent filament in an enclosed chamber. And, thereupon, de Forest put his "Jinn in the Radio Bottle." Thus it will be seen that de Forest developed his audion from an entirely different angle from that commonly supposed to-day, not from the incandescent light, the rectifier or the two-element valve, but directly from the heated gases which he himself introduced into the lamp.

There is no mistaking the fact, either, that even at the time when the first audion patents were issued, June 26, 1906, de Forest realized the true importance of his discovery. He then said:

"The audion, the most sensitive and closely tuned receiver in the world today, I consider to be my greatest achievement."

The audion used an absolutely novel principle, that of the sensitive hot gas as distinguished from the cruder, solid and liquid, receivers employed by others.

Almost immediately following the granting of the first audion patents as a wireless receiver, came the discovery by de Forest that his audion bulb could be used as a telephone relay. Some kind of a telephone relay had been long sought in vain by the leading telephone engineers of the country. It was not until several years later, however, that de Forest was invited to demonstrate his audion relay to the engineers of the American Telephone & Telegraph Company.

Considerable discussion has arisen as to the first use of the audion as an oscillator, or source of alternating current. It was in the summer of 1912, when at work in his Palo Alto Laboratory in California, that de Forest discovered that his audion could be made to oscillate or to generate sustained alternating currents of any frequency, still the same audion upon which is based the modern evolution of the radio art.

Another activity of the audion on the development of which de Forest has been working for many years was the production of synthetic music. Demonstrations of the musical audion were made publicly before the New York Electrical Society in December, 1915, and proved of great interest to musical as well as scientific circles.

It was the hope of the inventor, at that time, to perfect his audion musical apparatus, but still another more inviting phase of audion activity led him in the direction of what may now be regarded as another notable achievement with his audion lamp, namely, the invention of the talking motion picture film, or as he himself describes it, the phonofilm. As in the case of our present

(Continued on page 692)

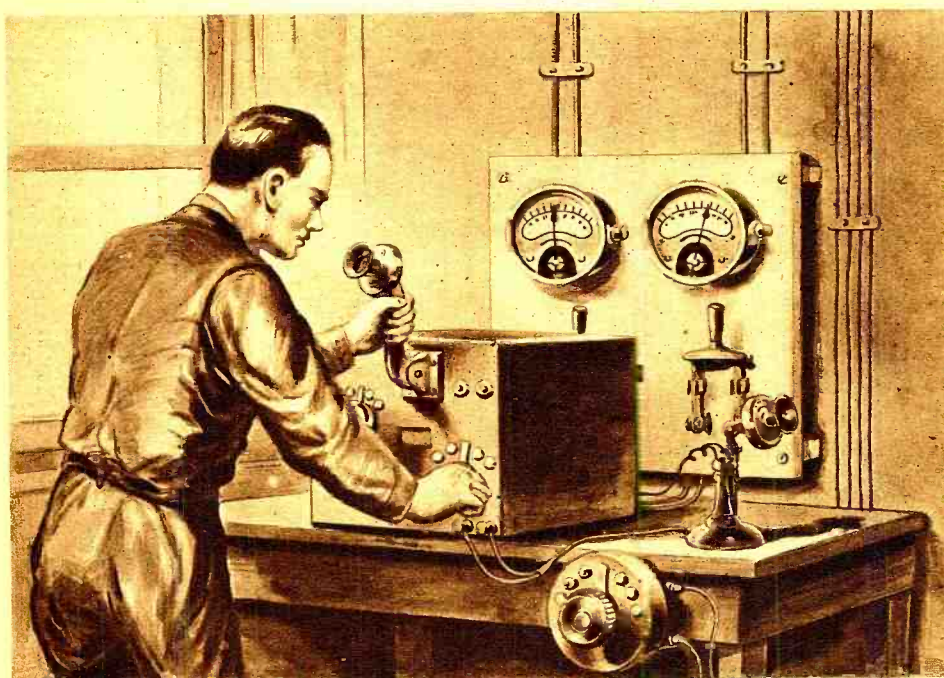

In His Early Radiophone Experiments de Forest Used an Arc Transmitter Which Was Soon Replaced by Vacuum Tubes. He Installed a Radiophone Station on the New York Opera House in 1908 to Broadcast the Performances.



# New Developments in German Radio

By DR. ALFRED GRADENWITZ  
Berlin Correspondent of Radio News

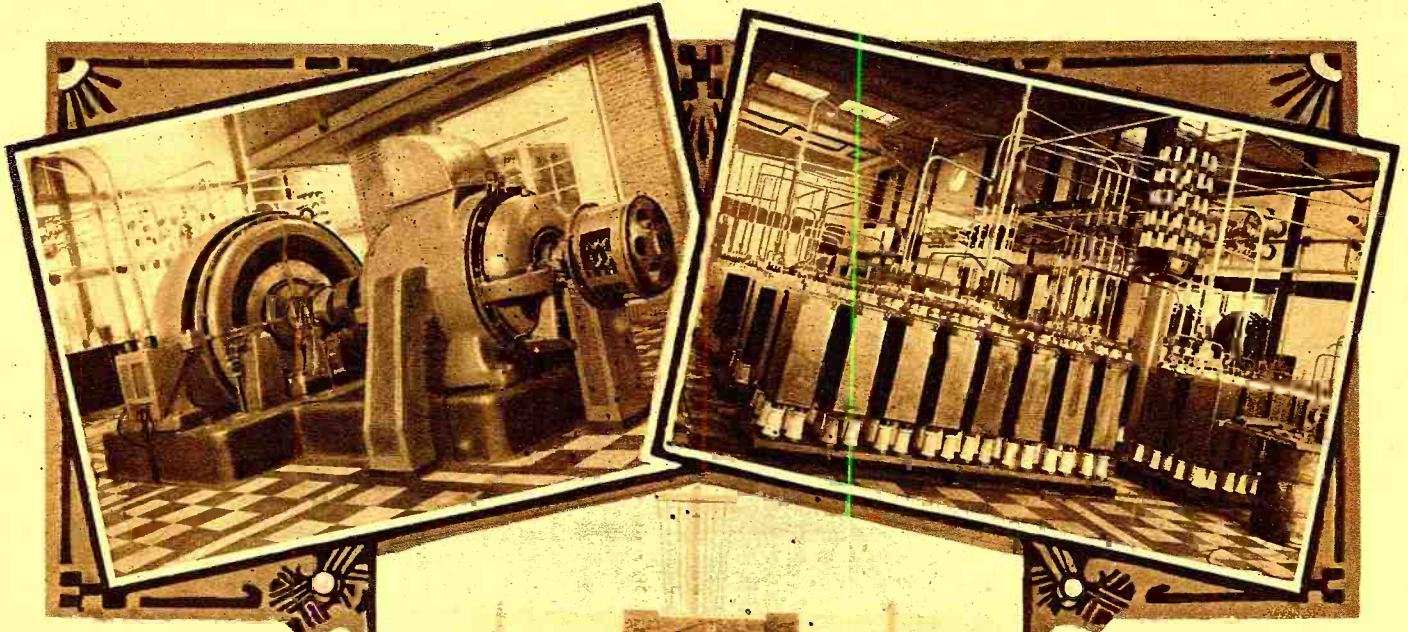

Above—High Frequency Alternators at the Nauen Station.

Below—Enormous Loop Used in Tests for Transmission and Reception at the German Transatlantic Station.

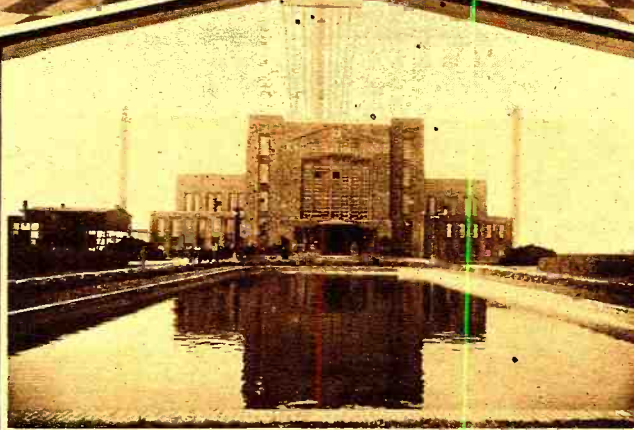

Above—A Section of the Transmitting Set at the Nauen Station with a View of the Condensers.

Left—General View of the Station.

Below—The Transmitting Inductances at the Nauen Station.

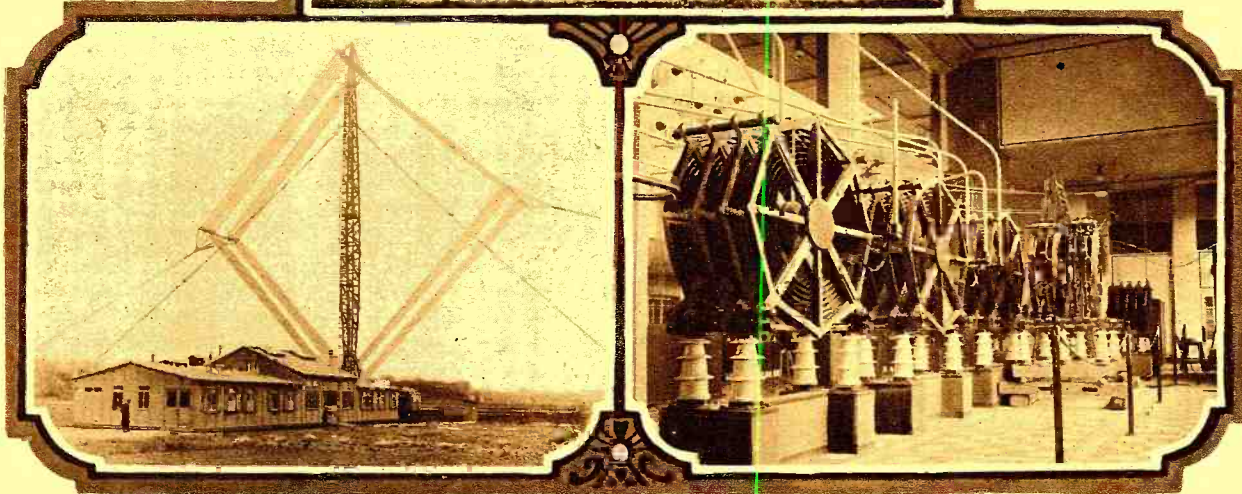

THE unprecedented strides made by American radio are, of course, watched with great interest in Germany where the drawbacks of the present State monopoly are keenly felt. Before long, it will doubtless be possible for the common run of mortals in Germany, as abroad, to own and operate private radio stations, though, under present economic conditions, progress in this respect will be slow. In the meantime, the interest of radio engineers centers around the public wireless telegraph service and the broad-

casting of economic news to subscribers. The latter subject will be taken up in another article. In this present article I wish to discuss the recent improvements in the European and Transatlantic Wireless Telegraph Service.

Being invited to the opening of the new Transradio Central Station, at the premises of the Oranienburgerstrasse Main Telegraph Office, the writer and a small circle of scientific journalists, Government officials and business men were entertained with a series of addresses on the various aspects of

German radio-telegraphy. We found ourselves in a building where invisible threads communicating with all parts of the world are now combined and connected with the wired and wireless telegraph systems of Germany and the rest of Europe,—where the limitations of space and time are overcome on a grandiose scale.

Count Arco, director of the German Wireless Telegraph Company ("Telefunken" Company) first drew attention to the importance of recent technical improvements, (Continued on page 684)



Right—These Loops at the Gellow Receiving Station are Used for Receiving from Different Stations all Over the World. Each Loop is Connected to a Receiving Set and the Signals Relayed to the Central Station at Berlin.

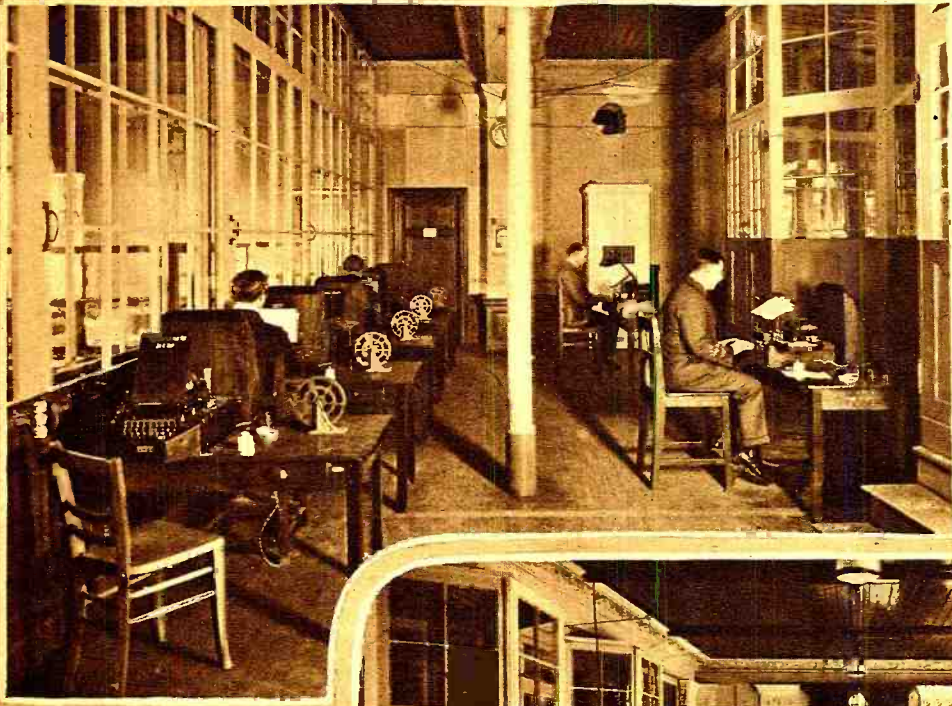
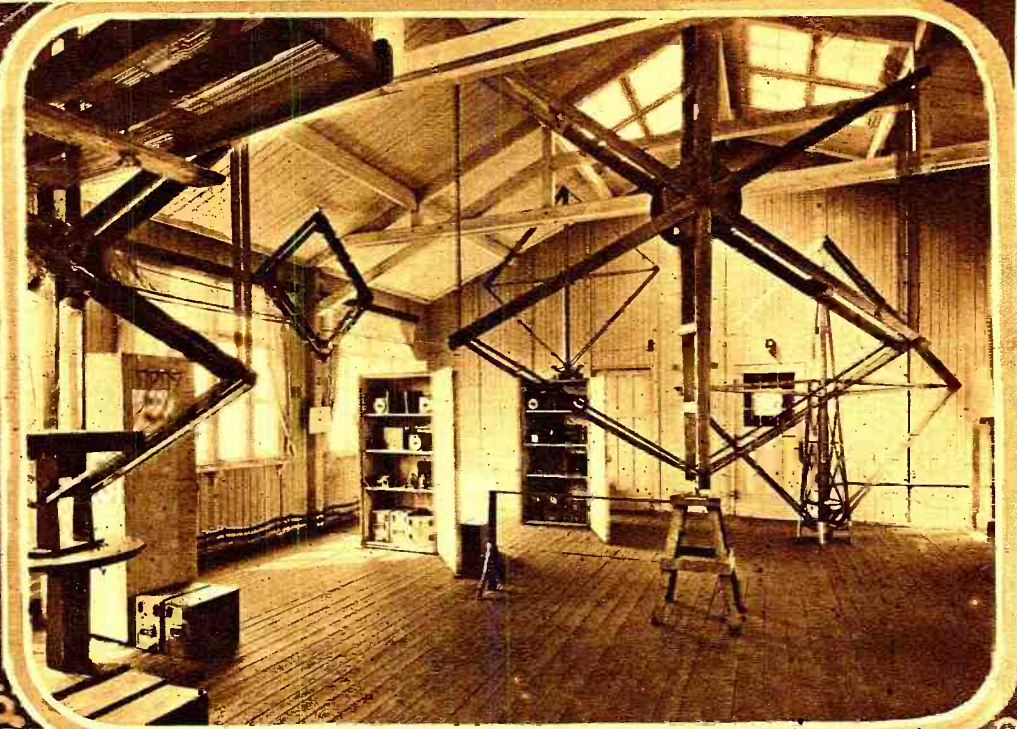

Above—Punching the Tape for Automatic Transmission from Radio Central Station at Berlin. The Newer Stations Operated by Remote Control.

Right—These Operators at the Berlin Central Station Control the Transmission of One Station and Receive from Another Station. Transmitting and Receiving Operators are Seated Side by Side. Duplex Operation is Conducted.





# New Broadcasting Station at Denver

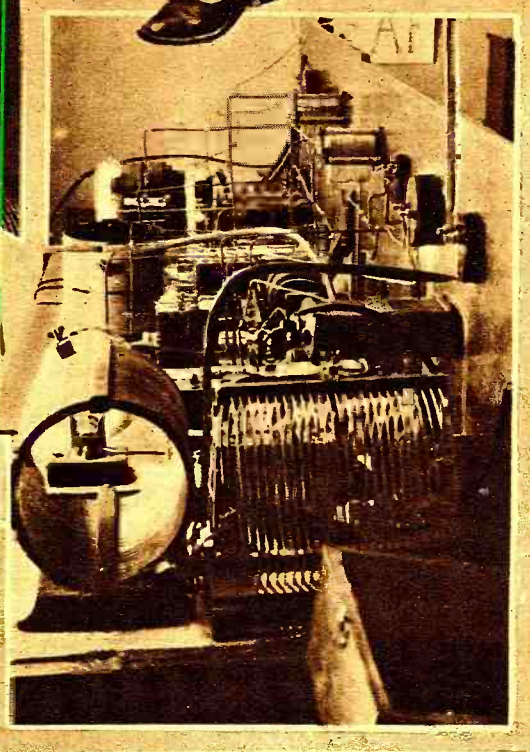
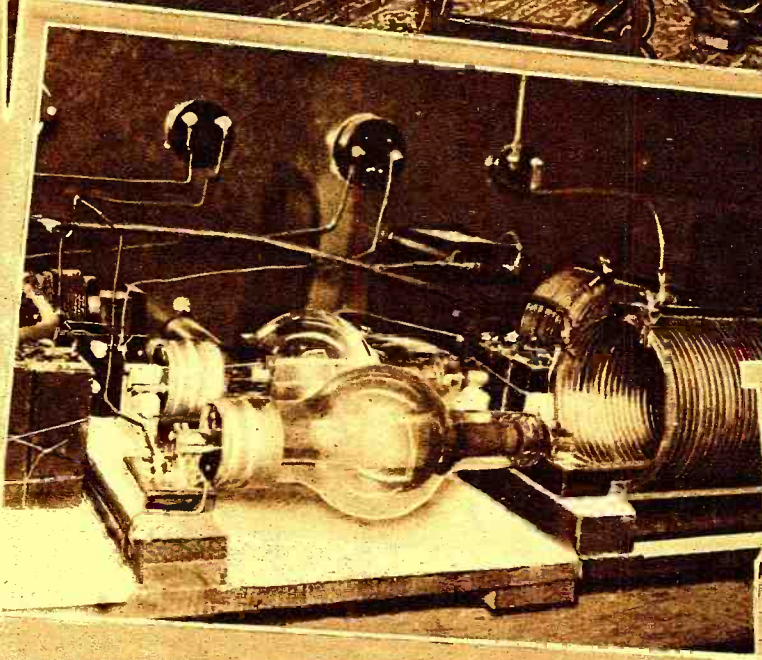
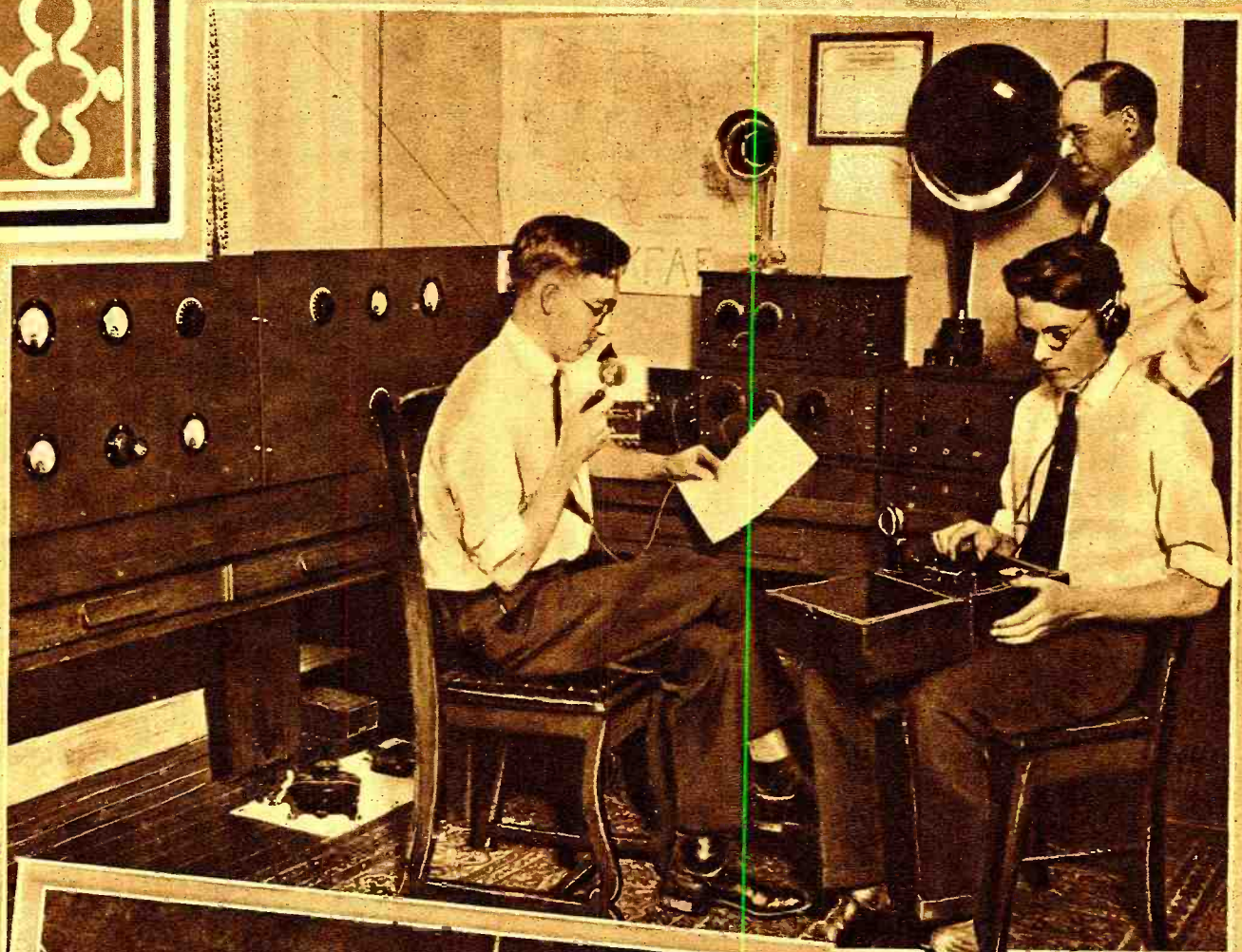
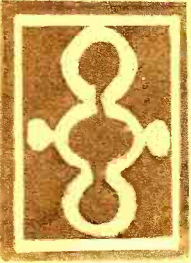

The Above Photographs Are of the New Broadcasting Station KFAF of the Western Radio Corporation at Denver, Colorado. At the Top is the Broadcasting Room and Below Two Views of the Transmitter, Showing the Two 250-Watt Tubes. This Station is Now the Most Powerful Broadcasting Station West of Chicago. It Has Been Built in the Belief That Radio is Here to Stay, and Working in Conjunction with the Denver Post Will Provide News and Entertainment Over a Large Radius.



# With the Radio Kids



Above: This Receiving Set Was Built and Designed by These Kiddies. They Are Enthusiastic Over Radio and Are Budding Amateurs. They Use the Clothes-Line Antenna.

Photo © K & H

Right: Two Pupils of an English School Practicing Code on the Receiver Which They Constructed. This is One of the First Receivers to be Installed in an English Elementary School.

Photo © P & A

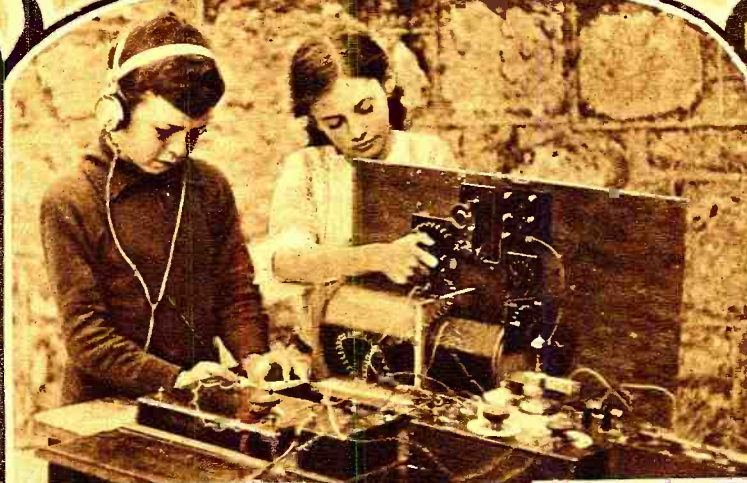

Above: These Boys Set Out to Fool the Landlord and Succeeded. They Disguised Their Antenna to Look Like a Clothes-Line by Running Copper Wire Through the Center. It Acts Just as Well as the Ordinary Aerial and Can Still be Used for the Clothes.

Photo © K & H



Right: The Old Aerial Listeners Used in England During the War for Detecting Air Raiders Are Now Being Employed as Radio Horns.

Photo © K & H

Left: This Lad Has Fitted His Bicycle With a Radio Set and Rides Around Washington Listening in. He Carries the Flashlight Batteries in His Pocket.

Photo © U & U

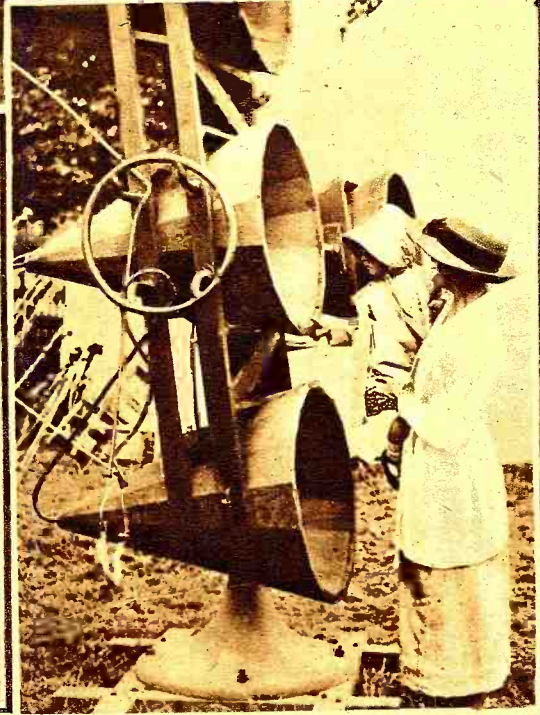



# Radio Developments at New York City College

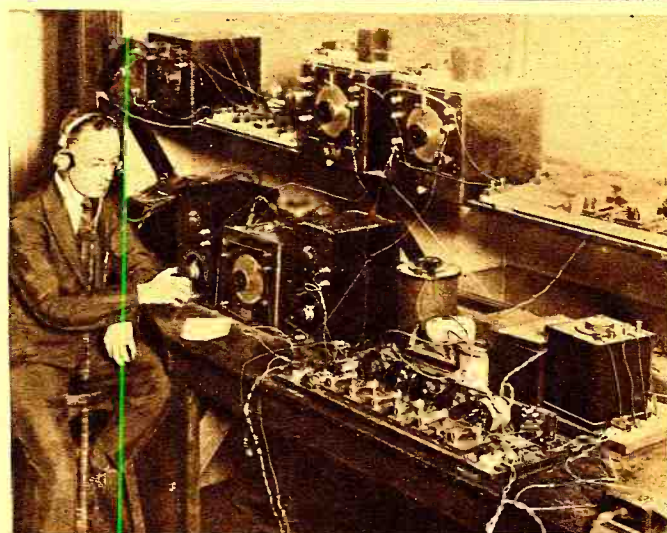
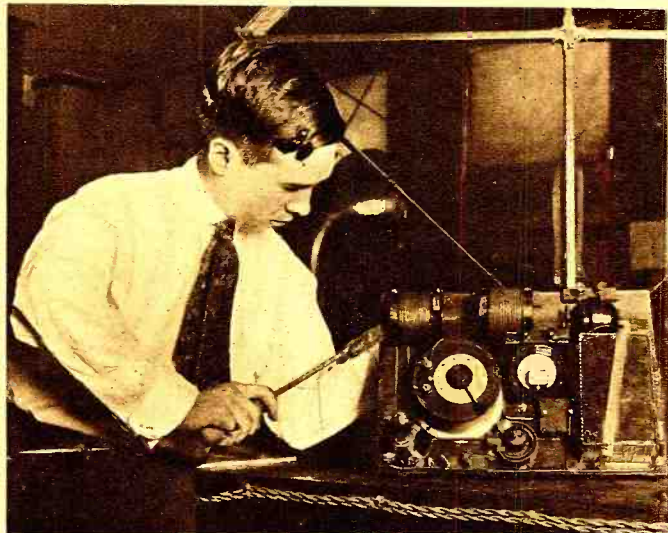

Above: A New Low Power Transmitter Which Operates on 50 Meters. Tests Will Probably be Made With Super-Regenerative Receivers Which Amplify Short Waves Enormously.

Below: Dr. Goldsmith of the City College With a New Compact Uni-Control Receiver. It Comprises a Complete Tuner, Detector and Two-Stage Amplifier With the Necessary Filament and Plate Batteries. Peanut Tubes Are Employed.

Photos © K & H



Above: Radio Set for Research Work on Long Distance Reception at the New York City College.

Left: The Large 250-Watt Transmitter tube of the Western Electric Company, Compared With a J Tube. Some Tube!

Below: A New Circuit Used in Receiving High Speed Transoceanic Radio Telegraph Messages. The Single Control Adjusts Six Different Circuits at the Same Time.

Photos © K & H

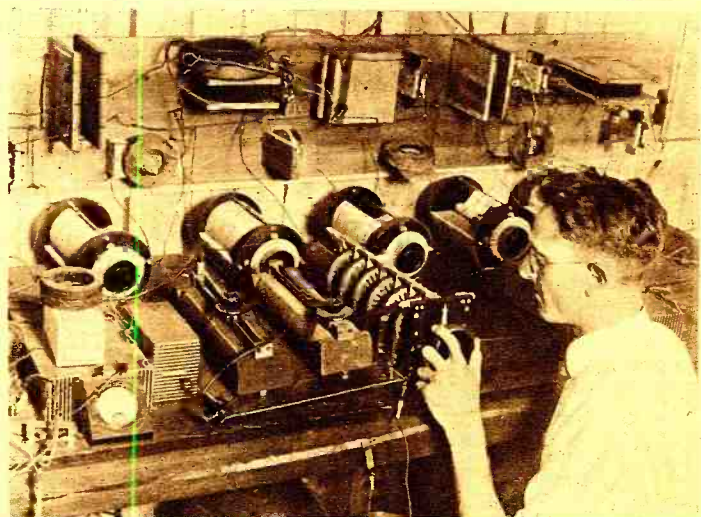
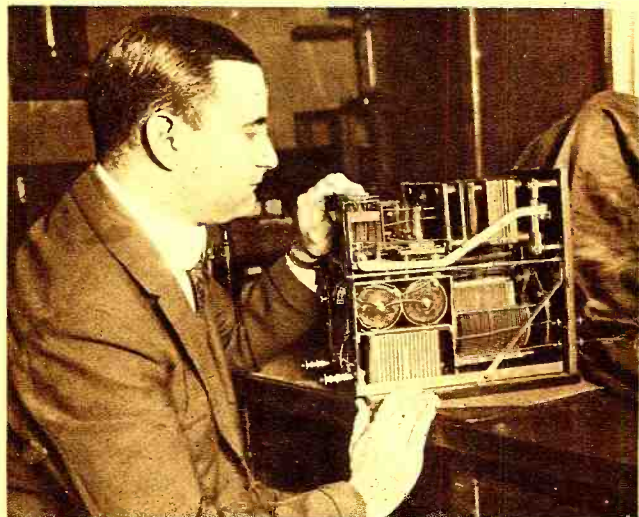



# French Amateur Activities

The Pre-War and Post-War Stations of a French Amateur

By MARIUS THOUVAIS

(Editor's Note.)—These photographs of French amateurs' stations are indications of the progress that has been made since the severe restrictions on amateur transmission have been removed by the French Government. The interest in radio is rapidly growing in all parts of Europe and we trust that the action of the French authorities is a forerunner of better days for the European amateur. Although the number of stations in France is limited, they are well equipped with modern apparatus. We hope, in the near future, that it will be possible for exchange of traffic to be conducted between the French and American amateurs. The possibility is not remote as recent tests proved, and now that the restrictions on transmission in France are removed, we may expect early attempts to be made.

It may be interesting to compare side by side the two accompanying photographs: My earliest crystal set and my latest valve station. Many improvements have taken place since the galena days and there is a marked advance between the two sets. Look at the pictures: It is the same table, the same lead-in with its same aerial-earth switch, also the same operator—only some years older! But nearly all the apparatus that was in use in the first crystal set has become useless, except the phones and the condenser and plug board.

All the apparatus is home-made with the exception of two galena detectors, phones and audions, and although not quite of professional appearance, it has proved very efficient.

The aerial in use now is exactly the same as that used the first time; it is a three-wire type, 37 meters long, average height eight meters—with a seven-meter lead-in. Its fundamental wave-length is in the neighborhood of 230 meters. It is fastened at one end to the higher chimney of my house and the other end to a wooden mast in the garden, quite well insulated by a chain of porcelain pulleys. Its reception of spark stations with the original galena receiver has been excellent.

A glance at the first photograph will show that there were six galena detectors, any of which could be selected by the six-way switch standing in the middle of the panel; these detectors are each upon separate holders fixed to the wall, thus ensuring efficient protection against shocks. In fact any detector could keep its sensitive point over several months. Tuning is done by a two-slide coil (left hand), and a fixed loading coil (right hand, behind the operator's arm). Although it was an "oudin" hook-up, there were two variable condensers, one on the "primary"

with a series parallel switch, and the other across the "secondary" side. These two condensers shunting across the same inductance were not very useful, but they permitted an increase of the wave-length range and became much more useful when I progressed to valve reception.

After the war, when I succeeded in ob-

tephony experiments were heard on single galena without any amplification, clearly enough, but not very strong.

About a month later I (at last!) got my first audions and immediately started building up a three-step high-frequency (resistance capacity) amplifier with reaction coil in the last plate circuit, coupled to the aerial tuning inductance for regeneration and the reception of continuous waves. I was surprised at the results obtained with this new piece of apparatus, leaving the crystal detectors a long way behind the times. Most high power European stations spark as well as C.W., could be heard all over the room and every station on the Continent could be well received, including the Russian ones, whose M S K and S E W sparks were quite loud on their true note. Annapolis NSS time signals were also clearly received daily. As I had no means of charging my accumulators at that time, I soon tried a single audion reaction set (an audion detector with a tickler coil), in view of saving filament current consumption.

This single audion set gave me fairly good results, nicely readable signals from all European stations and from three American ones (NSS, WSO and WII). My tuner consisted of six fixed loading inductance coils (cylindrically wound), in addition to the old two-slider coil, but all these bulky coils were not yet sufficient and I had to add a fixed condenser across the variable ones to reach the longest waves, which somewhat lowered the efficiency.

The German telephony from Koenigwusterhausen (LP) was received with the phones on the table with the three-stage amplifier, while it was still nicely understandable with the single audion detector (with the phones "on" of course!) The Dutch concerts from The Hague (PCGG) were also received with but one bulb, but much more weakly as, unfortunately, at this relatively short wave-length, the resistance capacity amplifier did not work well.

Last year I decided to dismantle my already out-of-fashion amplifier and to build another amplifying board capable of working well on all wave-lengths, from the shortest up to the longest, and allowing one, two or three stages to be used at will. For the tuner of this new set I tried all the known methods of winding: single layer, pile-wound, honeycomb and duolateral coils, but I kept two types only: Basket coils for waves shorter than 2,500 to 3,000 meters and "slab pancake" inductances for the longer ones up to 24,000 meters. I now have a set of six basket coils and eight slab coils. Such a number is unnecessary, but is found useful, as it gives large "overlaps" allowing



A Typical French Amateur Station with a Universal Wave-Length Receiver. This Picture was Taken Recently and Shows that Mr. Thouvais Keeps Well Posted Regarding the Progress of Radio, through the Numerous Radio Magazines.

taining a receiving license, I re-erected my aerial and for some time had to receive on galena again as audions were not, at that time, easily obtainable.

Here are some of the distant spark stations I was able to read regularly with the good old galena; MPD (Poldhu) and BYB (Cleothorpes), quite strong, BYO, BVY, GNI, BYY, BWW (Gibraltar), and BYZ (Rinella Bay, Malta). This last station, 1,000 miles away, has even been read through MPD and BYB jamming. Other stations such as IQZ, IDC, ICI, HB, OHD, POZ, KAV, OST, PCH, SAJ, SAB, EGC, EAA, etc., came in quite well as did also numerous ship and coast stations. I may state that even in February-March, 1920, the first Chelmsford

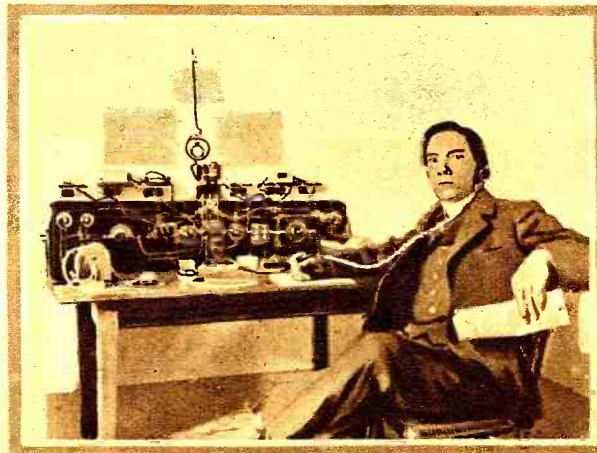

The Simplified Station as It Was Before the War. At That Time Crystal Detectors Only Were Used.



a lower capacity to be used to tune in on the whole wave-length range, further increasing the efficiency.

Every coil has been calibrated against the well-known calibration waves sent out regularly by FL, YN, UA, LY, LO, GFA, QMT, etc. Each coil has its curve with condenser readings as regard wave-length and stations usually received.

In the larger photograph the new set may be seen standing in the middle of the table. It consists in the main of two similar wooden boxes, each holding an audion and a tuning stand (coil holder and the usual large and vernier condenser). The adjusting knobs of the condensers and rheostat stand on the front panel, near at hand.

This set is rather an uncommon one, as it is composed of two separate single audion sets; each one is in itself a complete receiver. I will not now venture into a detailed description of this special arrangement, as this would need much space, however, I hope to deal with it more fully at a later date. I shall only say that the first box acts as a usual single tube regenerative receiver, while the second set may be operated as a further heterodyne, interfering with the incoming waves which are rectified and amplified by the first box working then just off the oscillating point, thus providing an astoundingly loud and selective reception of long-wave stations. The second box may also be used as a detector and second-stage

can be read at all times, being never too much jammed.

I find the best time to listen to the Transatlantic transmissions is in the morning, between 5 and 9 A. M. and better still on Sunday morning, when local and European stations seem to be quiet. As previously stated, these results are obtained with a single audion de-

Below is a View of a French Amateur Station Equipped with a Radiophone and C.W. Transmitter; It is One of the First Amateur Transmitting Stations of that Country. On the Table are a Short and Long Wave Set with Radio and Audio-Frequency Amplifiers. On the Right is a Close-up of the Transmitters. The C.W. Set is Above and Consists of Two Tubes in Parallel as Oscillators.

The Radiophone Below is a Combination Transmitter and Receiver Such as Used by the Signal Corps of the French Army.

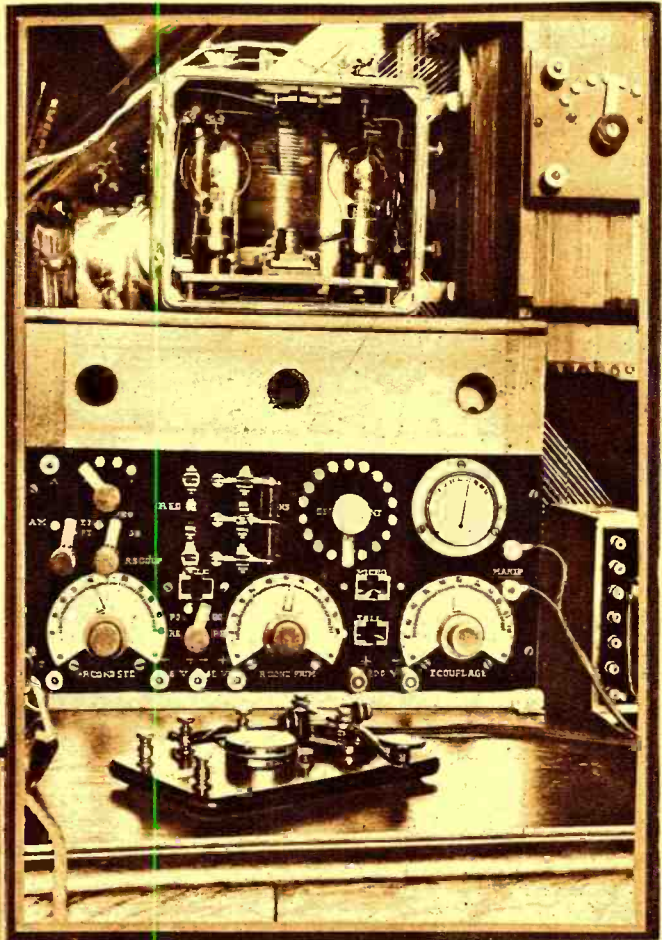

## French Amateur Station, 8BB, at Paris

THE accompanying photograph is of the apparatus used at 8BB, owned by James Bachollet, 61 Avenue de la Republique, Paris 11, France, and operated by Paul L. Barralon.

On the left is the first radiophone transmitter. This set uses three 10-watt tubes and the second (portable set) uses two 10-watt tubes, one as oscillator and one as modulator. This small set gives wonderful results and we have improved its range from 49 miles last month to 60 miles this month. Our present radiophone transmitter is equipped with French sending tubes and a dynamo furnishing 12 and 800 volts for the filament and plates. Best results have been obtained with Western Electric V.T. 2 tubes.

On the right are the receiving sets, one for short waves, from 180 to 800 meters, and one for long waves, from 800 to 29,000 meters. The second apparatus is regenerative, four radio frequency tubes and two radio frequency tubes. We are using Baldwin, Brown and Sullivan phones.

Reception is accomplished at any time of the day or night, without trouble, with the large loop aerial. We receive all the big stations of Europe and America, Annapolis, Rocky Point, Tuckerton, Marion, which come in loudly enough to be heard all over the large room when the aerial is used with the loud talker. The antenna is an L inverted type, four wires 100' long and 4' apart, at a height of 60'.

Those who gave us the first information and data for the construction of a set were American soldiers in 1918. We became acquainted with some of the boys and now we have several friends in the good old United States

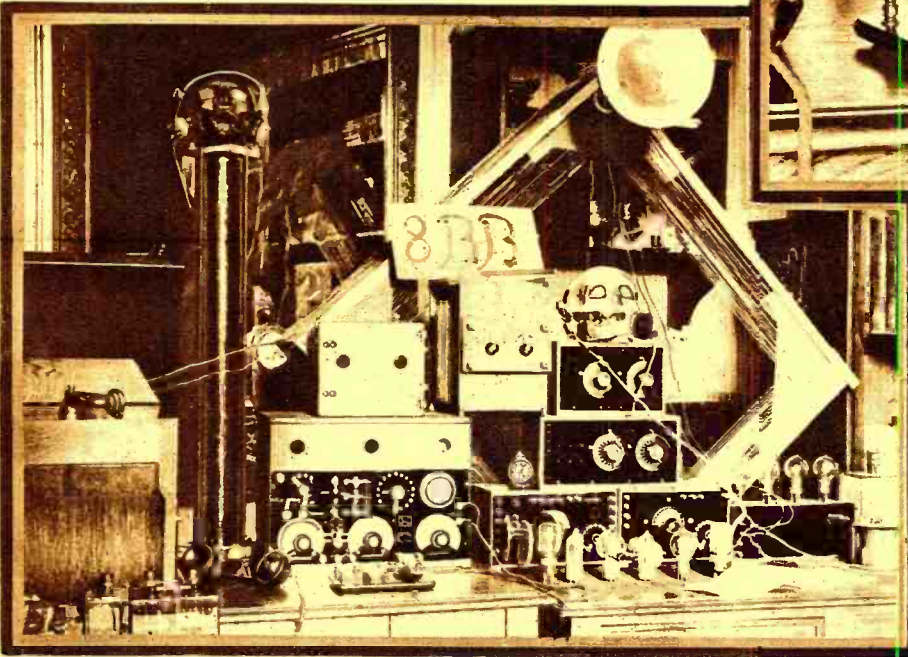

amplifier, with or without tickler coil, the first set acting then as a high frequency tuned amplifier, giving thus an excellent and extremely selective amplification on all wave-lengths.

I must say, however, that the two boxes working together, as the tuning is exceedingly sharp, the complete set is rather difficult to manage and will, in the hands of a beginner, give beautiful howlings!

The third tube, which may be seen in the photograph, on right-hand side, operates either as a short-wave receiver, when combined with the small loose coupler, or as an audio frequency amplifier when connected up to the output side of either boxes through the usual iron-core transformer.

Some of the results obtained will doubtless interest readers; using one tube only, (the first box alone) such high power stations as FL, UA, YN, LY, YG, MUU, BYC, GBL, IDO, POZ, OVI, etc., can be read with the phones lying on the table, simply by putting a phonograph horn upon one of the earpieces. When QRN and QRM are not too bad, five American stations may easily be read: NSS, WGG, WSO, WII and WQK. Even on account of its longer wave-length the latter

ector; when I use the first two tubes, such stations as POZ (over 600 miles away) can be read, all doors open, over 30' from the operating room, while American stations, when well tuned up, come in quite clearly, at all times, in spite of any jamming.

The audio-frequency amplifier is used for weak telephony only, for instance to magnify PCCG, the Dutch concerts, or QMT, the English broadcasting. Of course this is not necessary for FL broadcasting and St. Assise telephony and concerts.

A word may be said regarding the tubes used; the first I had were FOTOS; they were of the French Army type, and were the best I ever had, as they have been in continuous use for over two years and still remain quite good. Later I tried other French tubes (metal ones) which gave satisfactory results also; unfortunately I was unable to test any American tubes which are not on sale in this country. I am now trying the new low-consumption bulb. (French W type). This new kind of tube takes about a third of the filament current usually required, which is from 0.15 to 0.2 amp. under four volts only. They give

(Continued on page 692)



# Eiffel Tower Station at Paris

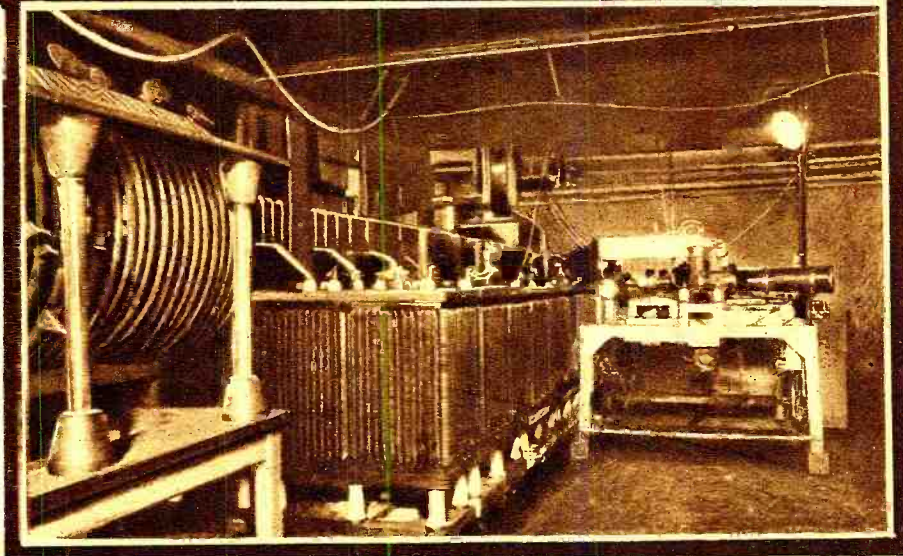
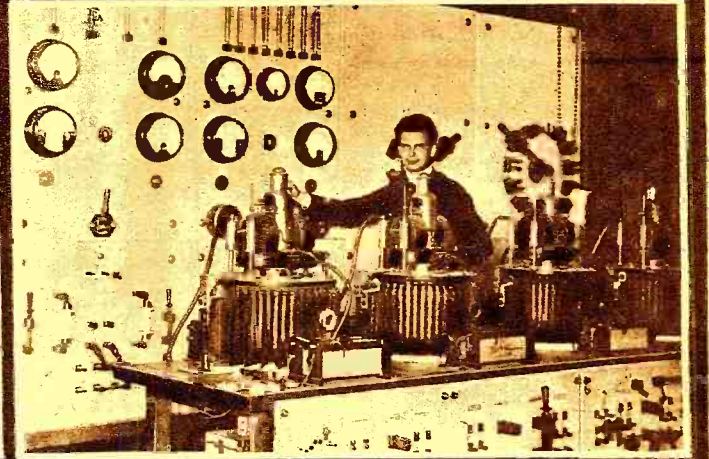
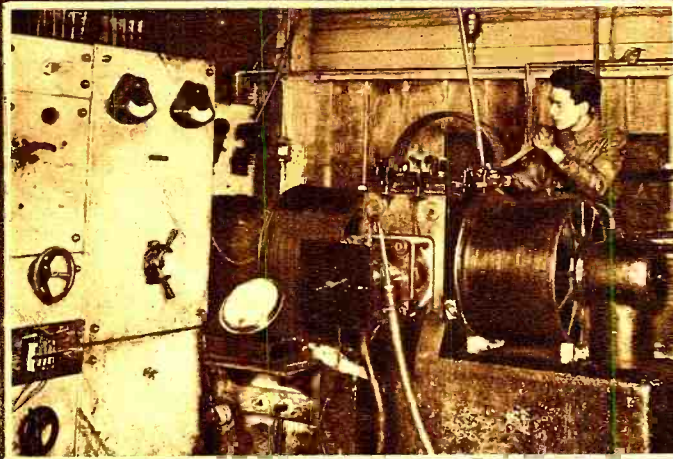
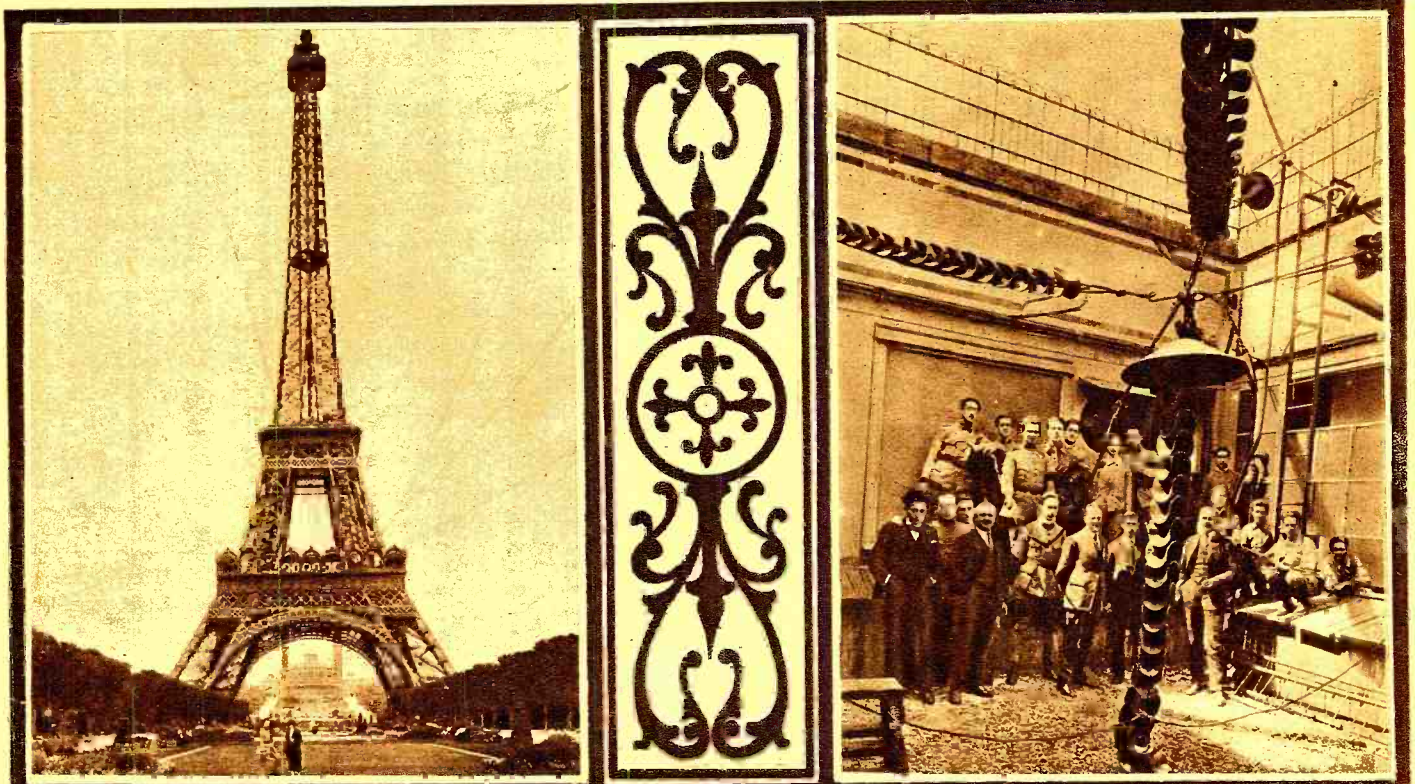

Above—View of the Eiffel Tower, at the Base of Which is the Radio Station. The Antenna is Suspended from the Top of the Famous 1,000-Foot Tower.

Above—The Poulsen Arc Used at FL for Undamped Wave Transmission.

Above—The Station Personnel Are Grouped Near the Huge Lead-in Wire and Insulators.

Above—The Mercury Turbines for Manipulating the Arc. Behind is the Control Switchboard of the Arc Transmitter.

Left—The High Tension Room of the Old Spark Transmitter. In the Foreground is the Inductance Installed When FL was First Opened.





Wanda Hawley, Well-Known Star of the Movies, Invites You to Listen In on Her New Receiving Set.



Interesting Tests Were Recently Made at Brocklands, England, to Keep in Touch by Radio with an Automobile Racer Attempting to Break the Endurance Test by Traveling for 12 Hours.



The Government, Through Its Radio Service in the Post Office Department, is Using Radio Instead of Telegrams Wherever Possible. The Telegraph Messenger Boy Will Soon Be Out of a Job if the Progress of Radio in the Post Office Department Continues.

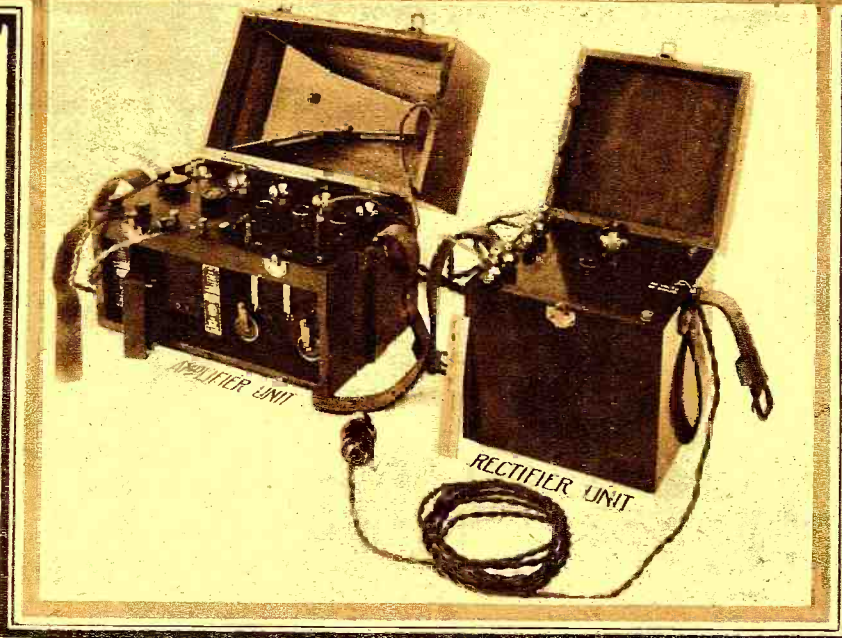

Above: Dr. S. W. Stratton, Director of the Bureau of Standards, Receiving on a 9-Inch Loop Antenna. Left: This Complete Rectifier and Amplifier Has Just Been Developed by the Bureau of Standards and Permits Reception Without Any Plate or Filament Batteries, the Necessary Power Being Obtained from the A. C. Light Lines. The Circuit Used in This Apparatus Was Given in the September Issue of RADIO NEWS.



# One Way or Another

A Play in One Act  
By ERALD A. SCHIVO



While the Captain's Back Is Turned, Sears, Throwing in the Switch for Sending, Speaks Into the Transmitter: "Boys, Police Have Secret Code. Make Your Getaway the Best Way You Can and Disregard All Instructions From This Station."

## CHARACTERS:

POLICE CAPTAIN MATHEW BRADY  
JOHN SEARS  
TWO DETECTIVES

The scene is the wireless station at police headquarters. Necessary radio apparatus for receiving and transmitting is located in the rear of the room on a table. A half-dozen red books, each about the size of a pocket dictionary, are on the receiving cabinet, which is to the left of the radio telephone. A door on the left side of the room leads to another room which is for the convenience of the police wireless operators. A door to the right leads to the corridor and elevators. Near the door is line telephone attached to wall, and above the door is a clock on wall indicating 9 o'clock, running throughout scene. Simultaneous with the lifting curtain, the door on left side of room opens and Police Captain Mathew Brady enters. He walks to the wireless apparatus and seats himself in a comfortable chair. He then puts on the head set and throws aerial switch to receiving position.

There enters through corridor door John Sears.

Mathew Brady is a successful police captain in the early forties, while John Sears is a criminal, suspected by the police of many crimes for which the evidence is lacking. He is about 30 years of age.

Captain (*surprised*)—I thought, Sears, that you were to "pull off" a highway robbery to-night?

Sears (*nonchalantly seating himself in a chair near the wireless apparatus*)—What makes you think so, Captain?

Captain—Didn't you send this?

(*He takes a sheet of paper from the table and places it in Sears' hand.*)

Sear (*reads*)—Captain, you think you can get us fellows by such a foolish thing as radio, but I'll prove that the wireless will never get us. Here's your chance. Watch for an auto robbery tonight at 9:15. (*He hands the sheet to the Captain.*) Do you think I would admit sending that note?

Captain (*replacing sheet on table*)—You never know what a crook may do.

Sears (*angrily*)—Don't call me a crook, Brady. I have never been convicted of any crime yet.

Captain (*grimly*)—Nevertheless, you were implicated in many, but we lack the evidence. Sometime, somewhere, I will get you, and I will have the evidence!

Sears (*smiling*)—Come, come, Captain, let's be friends tonight. I have come to watch you operate the radio set. It will please me to see how you fail to capture the auto bandits. (*He laughs.*)

Captain (*with determination*)—While I operate this radio set no highwayman will get out of this city in an automobile, not if the robbery is reported in time.

Sears (*laughing*)—And how will you prevent them, may I ask?

Captain (*thoughtfully*)—Well, I might indiscreetly tell you now, but I think not,

although all the radio magazines will soon be explaining the different methods; however, I don't mind giving you a case we had the very first day we used the apparatus. A couple of burglars robbed a house on Frederick Street and made their getaway in an automobile. A pedestrian saw the burglar come through a window and then get into a waiting machine in which another man was seated. The couple headed for the ocean beach. The witness phoned me and gave me a description of the machine and also the license number. After getting the important information I immediately threw my aerial switch to the transmitting side. (*He thrusts aerial switch to sending position.*) It is very simple, I turn this handle and this rheostat— (*He adjusts radio telephone transmitter.*) The set is now ready for sending. All I did was to call certain police automobiles near the beach. I then gave them all the information necessary. The burglars were arrested on Lincoln Way. (*He throws switch into receiving position and turns off transmitting current.*)

Sears (*sarcastically*)—Suppose, Captain, that the bandits' machine also has a wireless receiver and intercepts your orders. It is not very likely that they will continue to head toward the beach. You have a lot to learn yet, Captain. Didn't think of that, did you?

(Continued on page 692)



# The Newspaper Radio Editor

By S. P. WRIGHT

**T**HE little boy who used to be called "queer" because of his mania for radio, is now the most admired and respected young man in his community. Radio is quite the thing now; static is torturing the tympanic membrane of some of Society's (with the well-known capital S) biggest bugs, and the modulated continuous wave is rapidly becoming more popular than the Marcel wave. The dim lights of audions are proving a greater lure than the bright electrics of the White Way. All of which is merely an introduction.

When radio sky-rocketed from obscurity to its present prominent place, every newspaper in the country with a circulation of over 347 started a radio page. Papers under this circulation merely had a radio column or two. It is these outbursts in the daily sheets that are the cause of this—which, by the way, is another black mark against them. Judging from results, it must have happened something like this:

lightning protection than for operating the set. The ground switch should have an amperage of at least 500 volts, in order to conform with the Undertaker's Rules." The electrical industry has long maintained that the Underwriters Laboratory was composed of a bunch of dead ones, but—well, let's go on.

His article on detectors is really good. "The property of unilateral conductivity" (fine words, those, to roll under your tongue, eh? Like "Logarithmic decrement" and "Internal impedance"), we are informed, "is peculiar to certain metallic ores such as silicon, galena and perikon. If it were not for this property, radio communication would be impossible, as we would hear both sides of the cycle at once." Simple, isn't it?

Audion tube theory has balled up many a good man, but not our doughty Radio Ed. Far be it from such—listen:

"The theory of the action of the audion can be briefly explained by saying that it

reader" of his "very interesting column, and would like to ask a question to settle an argument." It appeared that she could have asked a cousin of hers by the name of Theodore (not named after the late Teddy, but in honor of an uncle on her mother's side,) but Theodore was in a town in Montana, she forgot the name, but it was somewhere in the northern or northeastern part. He was on his vacation, and was learning to ride horseback like a regular cowboy, or so he said, although she couldn't imagine his doing that, but Theodore was so far away and not very obliging anyway, and probably wouldn't know, at that, so she was, as has been said, asking the Radio Editor. Having thus come directly to the point, she inquires whether or not Marconi invented the audion.

"ANSWER: Audions cannot be said to have all been invented entirely by one man. The vacuum used in modern tubes was discovered some time ago; the first two elements were invented by Flemming and the last one by DeForest.

It is not known who invented the prices now in vogue, and for safety's sake, he will probably always remain in cog." He comes nearer to it this time than ever before.

"Please give me a hook-up for the fol-

The Article on the Radio Page About Detectors is Really Good. "The Property of Unilateral Conductivity," We Are Informed, "is Peculiar to Certain Ores. If it Were Not for This Property Radio Communication Would be Impossible, as We Would Hear Both Sides of the Cycle at Once." Simple, Isn't it?

lowing instruments," "Johnny R." requests, "Three dry cells, a galena detector, a telegraph key, a tuning coil, two spark coils and a headset." We couldn't do it, right offhand, but that just shows how sadly lacking we are in an understanding of

things radio. The new Radio Editor gives him a hook-up, and it works—splendidly!

As Johnny himself says, "I can hear the spark fine in my phones every time I press the key." You see what education will do, don't you?

It isn't long before the Radio Editor begins to blossom out in regular style. He starts to illustrate his page. Know what we mean?

There are two kinds of radio pictures; one runs largely to feminine pulchritude, especially of the lower section (and sometimes not so low as that!) of the pedal extremities, and the other illustrates scarf-pin sets that have brought in stations from all over the country at the owner's home in Wattown, N. J., said owner appearing bashfully (?) in background. Of course, they are not all scarf-pin sets; there are garter, ring, button, stud, watch-case, lead pencil, fountain pen, tooth brush, and other kinds, but—well, you've seen 'em yourself, so why enumerate them?

What we are driving at, though, is that  
(Continued on page 696)



When the time was ripe, the editor of the paper decided that there must be a radio department, a "Question and Answer" column, "How to Make It" article,—in fact, the whole works. A little investigation proved that the cub reporter who was covering the police court had a cousin who once operated a galena detector set belonging to a friend. This expert was, therefore, given the title of "Radio Editor," a book on "Elementary Radio" published in 1912, and a three-dollar-a-week raise; that made fifteen.

His first article was something of a masterpiece—perhaps you read it. "The aerial," he stated, "should be composed of strands of wire not more than 200 meters in length, and should be insulated on both ends to prevent the capacity from exceeding the resonance." So far, so good, but he gets tangled up a bit on grounds—something on this order:

"The set should be grounded when not in use," one learns, "to separate a ground. When in use, another ground is used, as a much heavier ground is needed for

acts like a valve. The filament is constantly throwing off large numbers of minute particles called electrons which strike the plate with considerable force. When a signal comes in, it acts in such a way as to increase the speed of these particles, thus making them strike the plate a harder blow. This produces the sound in the receivers." And to think that it took DeForest so long to work out such a simple thing as that!

After all, it is in the "Questions and Answers" column that he is at his best. "A. F. G." wants to know why his audion wouldn't work with a dry cell for a "B" battery—"this cell is much larger than the 'B' batteries in the store," he claims, with some degree of truth. Don't think that this query stumps Ye, Ed. Far from it:

"ANSWER: The wave-length impressed upon the plate circuit by a dry cell is not sufficient to cause the tube to oscillate. Naturally, then, it would not operate at its maximum characteristic." Which we contend is the truth, too!

Little "M. M. L." is "a high school girl



# Radio Humor

## MUTT AND JEFF—And as a Radio Salesman, Jeff Is the Robin's Raincoat . . . By BUD FISHER

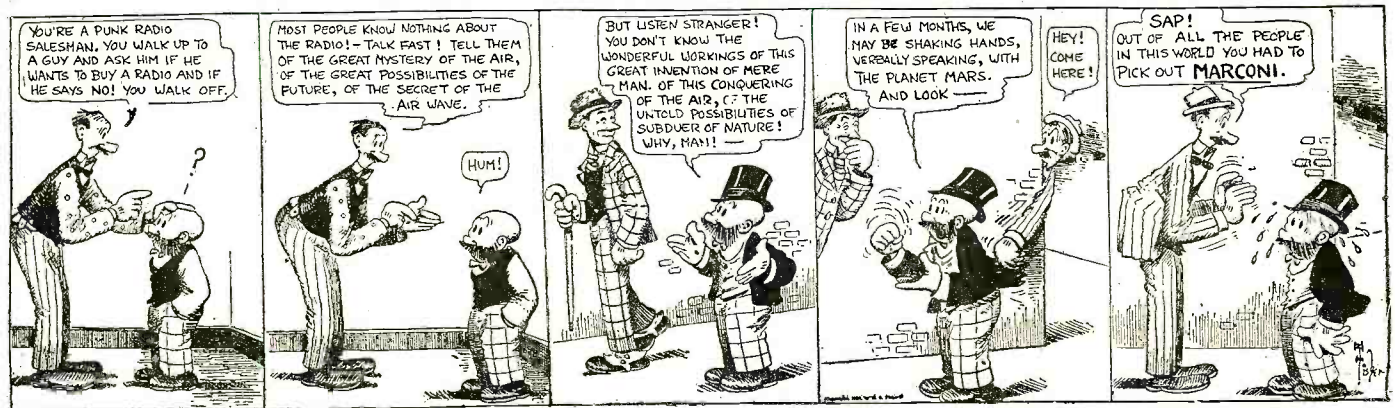

From the N. Y. World

### Radio Rhymes

#### The "Shoestring" Enterprise

By ROBERT STEWART SUTLIFFE

Bill Jones for many a year had slaved, and had through self-denial saved, until he saw his balance grow, up to five thousand "plunks" or so. And while thus saving made a plan, for using every "iron man"; no flivver 'd ever tempt this sage, the fund should serve in his old age.

His spouse, the type the small town knows, has shared with him his joys and woes; had skimped herself in many ways, for that good fund for future days. And day by day the years rolled by, with many a tear and many a sigh; but when a thing became the rage, she gloried in her "snug old age."

Then came along the Radio, and Bill and Mary came to know the marvels of this "people's friend," with entertainment without end. They heard its concerts, its advice, its what to do and how to price; into their humble lives it seemed, to bring the joys they'd only dreamed.

One day unto their home town came, through Radio, a bid for fame; a neighbor's boy a patent won, was dubbed "The Local Edison." Promoters then, with pockets lean, appeared to paint a brilliant scene, of factories and wealth to be, of work for all;—prosperity. Why hesitate when circumstance, had brought their town this splendid chance! Why. fortune perched within their reach, a life-time opening for each!

And then they dwelled upon the theme of funds to carry out the scheme; announced that in the big Town Hall, a chance for stock should come to all. And Bill and Mary as of old, with visions of a rain of gold, despite of warnings of the wise, invested in the enterprise.

From prehistoric days, alas! this same old game has come to pass; the fools rush in where fear to tread, the wise; and soon the news is spread, of bursted bubble, crash and fall; so Bill and Mary lost their all.

Perhaps some time experience will give our saving folks more sense; folks like Bill may be more rare; but more than likely they'll be there, slaving, skimping—early, late—to meet at last the same old fate.

### Program of Station P. D. Q.

The Dumb-Bell Broadcasting Station will at 6:00 P. M. Monday broadcast the following program on a wave-length of 1,000,000 Comets.

If bugs at distant points fail to hear some of these selections they should throw their sets away; they can't be any good.

Inter Ference, personally known to most of you radioists as "Static," will at intervals during the evening give a few selections on the snare drum: "Boilermakers' March," "Machine Shop Blues" and others. He will also, at 9:00 P. M., give an imitation of a freight train wreck.

6:00 P. M. Soup-eating contest between six qualified patrons of Carl Goodman's restaurant.

6:30 P. M. We will be favored by a talk, subject "Burnt Gases" by Exhaust Pipes.

7:00 P. M. The United Brothers of the Gasmen's Association will render a gas-house explosion; this number will require no loud speaker. If operators at a distance of 5,000 miles do not hear this selection, let us know and we will call the city powder plant and have the explosion repeated.

7:20 P. M. The poultry house quartet, Brown Leghorn, and Brother "Red" Leghorn, "Hardboiled" Egg, and Will Cackle, will favor us with a selection entitled, "Can a Battleship Hatch?"

7:40 P. M. Shooting of noiseless fire

crackers for the benefit of the Deaf and Dumb institutions at various points.

8:00 P. M. Talk "How to transmit with a Ford coil." Beginners are urged to turn out their filaments.

8:30 P. M. We are sorry to say this number will have to be omitted, as Mollie Cule has the flu and can not be seen. Bed-time stories will be transmitted instead. Stories by Goose Down, and "Red" Quilt.

9:00 P. M. There will be a reading by Millie Ameter.

9:30 P. M. If the Moon shows up we will have a man in the moon story.

9:45 P. M. Mag Neto will give a few shocking remarks on "Spark Plugs"; Dyna Mo will also endeavor to throw some light on the subject.

9:55 P. M. At 9:55 P. M. and lasting until 10:00 o'clock, we shall relay the Arlington time signals directly from the Arlington Squeak Box.

10:01 P. M. Market reports by Bull Durham.

11:30 P. M. Whistling solo by Callie Ope.

12:01 A. M. The barn yard trio, Kittie Catwhiskers, soprano, Tow Eeyow, basso, and Maui T. Highback, bass, will give a rousing selection entitled "Chase me, kid, chase me."

12:14 A. M. P. D. Q. Signing off.

12:15 A. M. Good Night.

Contributed by G. S. DOZIER.

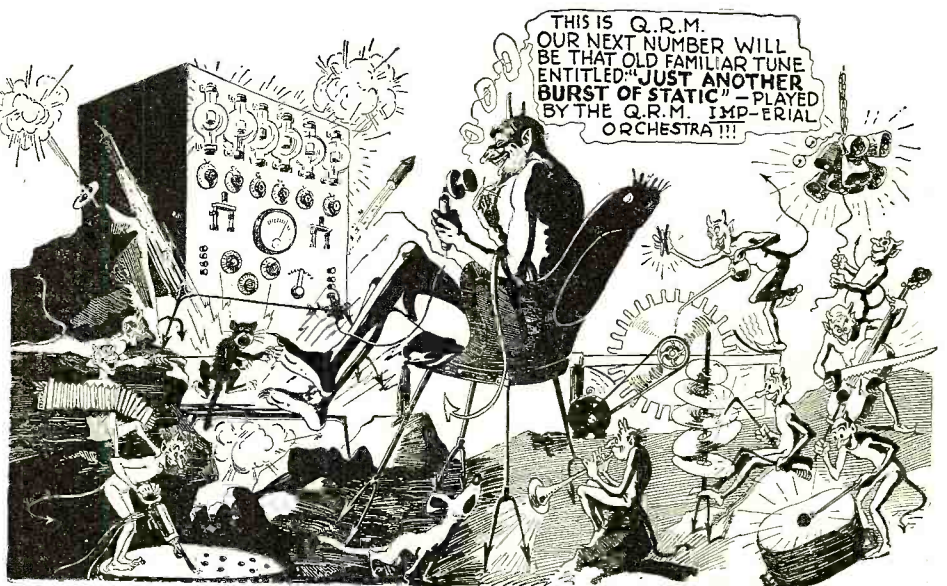

One Station We Have All Heard—By G. B. ASHTON



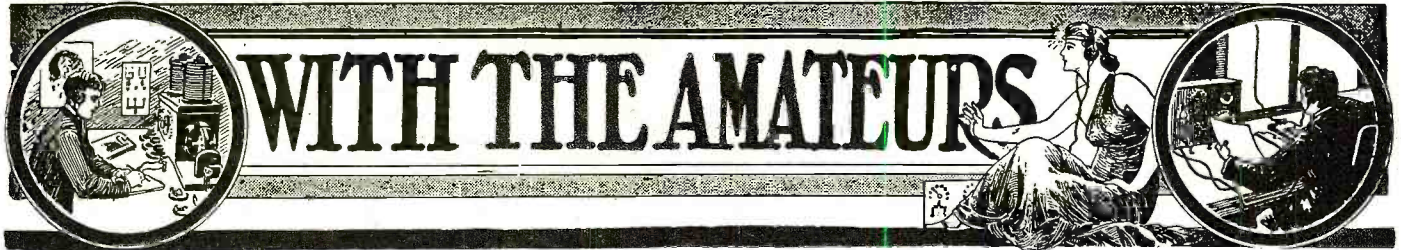

**T**HIS Department is open to all readers. It matters not whether subscribers or not. All photos are judged for best arrangement and efficiency of the apparatus, neatness of connections and general appearance. In order to increase the interest in this department, we make it a rule not to publish photographs of stations unaccompanied by a picture of the owner. We prefer dark photos to light ones. The prize winning pictures must be on prints not smaller than 5 x 7". We cannot reproduce pictures smaller than 3½ x 3½". All pictures must bear name and address written in ink on the back. A letter of not less than 100 words giving full description of the station, aerial equipment, etc., must accompany the pictures.

**PRIZES:** One first monthly prize of \$5.00. All other pictures published will be paid for at the rate of \$2.00.

## Walker L. Wellford's Station 5DO at Memphis, Tenn.

### THIS MONTH'S PRIZE WINNER



**H**EREWITH is a picture of my station, Radio 5DO, which I would like to enter in the Amateurs' Contest. The following is a description of it.

My transmitting set consists of a 20-watt C.W., using either straight or chopper C.W. All of the transmitting equipment is Radio Corporation except the meters, which are Jewell. The electrolytic rectifier, however, is homemade and the key is a Clapp-Eastham. The rectifier consists of 10 porcelain jars which may be seen in the corner. They

**A Very Compact Station Equipped with Modern Apparatus. Note the C.W. Set Above the Receiver.**

supply about 500 volts to the tubes. The chopper consists of a 16-electrode disc revolving at about 2,300 R.P.M. It gives a note somewhat like a spark set.

The receiver is a Grebe CR8 and two-step amplifier, using Baldwin phones, and a Magnavox which may be seen at the right of the picture. I use 100 volts on the plates of the receiving tubes. In order to keep my battery charged I use a tungar rectifier.

I have been heard 1,300 miles on my transmitting set and so far I have worked about 1,000 miles.

(Continued on page 790)

## Raymond Whitcomb's Station 7AAR AT PORTLAND, OREGON

**T**HE antenna at 7AAR is a 35' cage type, 50' high at one end and 40' high at the other. It is composed of six wires of heavy stranded copper cable separated by star-shaped wooden forms. The lead-in is also a six-wire cage, but is only 1' in diameter while the aerial is 2' in diameter. The city water mains are used for a ground.

For the reception of the arcs, a long, single, 350' cable is used.

The receiving equipment is all designed and constructed by the owner, and is fully described and illustrated in another part of this issue. Much experimenting has been done at this station with radio frequency short wave amplification, and of all the tubes tried, which include Mooreheads, Radiotrons, Myer's, Western Electric, Westinghouse, and a war-time French valve, the little British V-24's obtained at Vancouver, B. C., surely win the hand-brothered high-top boots. They seem to be made just to order.

For A. F. amplification, Type C-W 933  
(Continued on page 790)

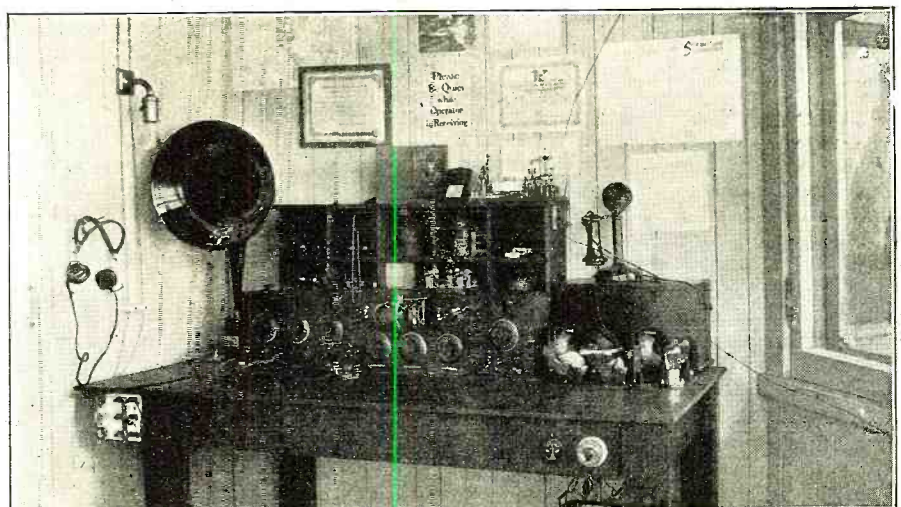

**A Very Neat Receiving Station Which is Entirely Homemade. The Apparatus Used at 7AAR are Described Elsewhere in This Issue.**



# Station 8 BAH at Cleveland, Ohio

I SUBMIT herewith a photo of Station 8 BAH, West Y. M. C. A., Cleveland, Ohio. The transmitter consists of a  $\frac{3}{4}$ -K.W. 25,000-volt, Thordarson transformer, glass plate, oil-immersed condenser, "Amrad" quenched gap, and heavy copper O.T. The O.T. is specially built to have a very fine adjustment, which is necessary with a quenched gap.

The receiving set consists of a Regenerative receiver, detector, three-stage amplifier and Magnavox. The coupler at the left increases the efficiency of this set about 25 per cent. It is of the flop-coil type and nearly all of the regeneration adjustment is done with it and the condenser in series with the ground.

The transmitting antenna is a six-wire flat top, inverted "L," 60' long and suspended 20' above a four-story building. The lead-in, consisting of six bunched wires, is about 25' long. The ground, which is not very efficient, but the best obtainable, consists of the water and steam pipes of the building, all the copper cave spouts, and a steel fire escape. Despite this inefficient ground, the transmitter will put from 3 to 6 thermo amps. into the antenna.

Perhaps the most novel feature about this station is the lack of switches in transmitter and receiver, especially the antenna change over switch. Instead a separate, single wire antenna is used for receiving and the transmitter is then connected directly to its antenna and in series with an anchor gap to the ground. This does away with the losses sometimes caused by a change over switch. The switch in the photo is used only to start

.....  
 This Station Uses Two Antennae, One for Transmission and the Other for Reception. The Transmitter is a  $\frac{3}{4}$ -K. W. Spark.  
 .....

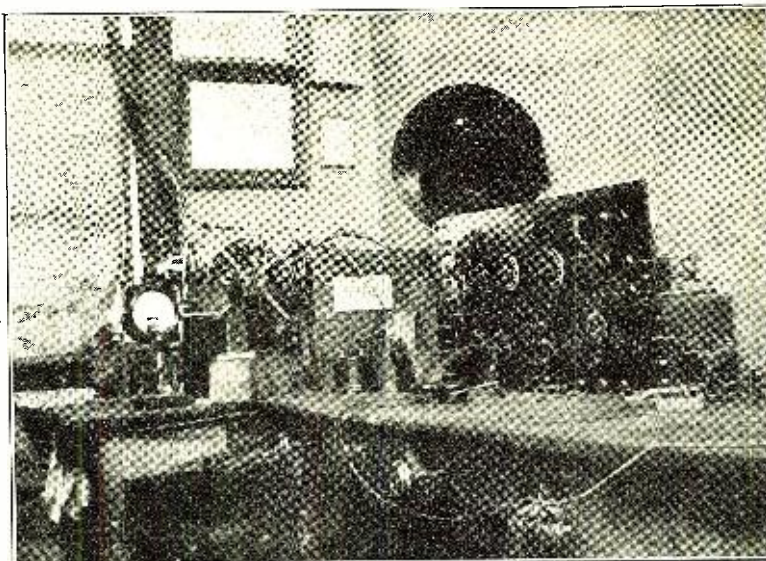

the fan for cooling the gap, and to close the primary circuit to the transformer.

Due to transformer trouble this station was not in operation during the winter, but in the time of actual operation since April the set has really shown its worth. Regular communication has been carried on with stations 800 miles distant and a record of 1,500 miles has been attained. Reports state the signals

are QSA with slight QSS and break right through the QRM and QRN.

A C.W. set and radio frequency amplifier are now being built and are expected to be in operation very soon. Reports on either the spark or C.W. signals of this station will be greatly appreciated and acknowledged.

HARRY TUMMONDS (SM),  
 HOWARD ROWE (LM).

## Amateur Station at Pernambuco, Brazil

Owned by G. G. GATIS

THE accompanying is a photo of my radio set which is considered out here as the best amateur set in the north of Brazil. I may state that all the apparatus was made and constructed by myself. This includes the panel, receivers, switches, contacts, loading coils, detectors,  $\frac{1}{2}$ -K.W.

and ammeters were purchased with great difficulty out here from friendly OP's whose ships put into this port.

### AERIAL

I have two aerials in use. The first consists of an inverted L, four wire, 20 meters

### RECEIVER PANELS

Three types are used; regenerative panel mounted with bulb and tuned to 150-7,000 meters and 20,000 meters with loading coils connected. In this set, primary, secondary and tickler are all adjustable. The second is a small regenerative set tuned 100-600 meters used by the hams here. The third is a honeycomb tuner with separate valve panel. This valve panel is fitted with amplifying transformers and may be used as a one step or detector with another set. Phones are Western Electric and Fosters and are both excellent receivers. Tubes used are Navy J tubes and Moorheads. Stations on spark and C.W. have been heard many thousands of miles. These sets are all fitted with crystal and may be changed in a moment to either. A double slide tuner may be seen and is used as a loader for tickler and answers its purpose splendidly. A two-way switch is fitted on the aerials so that either may be used as desired. Everything is mounted on ebonite and thoroughly insulated and works O. K. Time signals from sundry stations come in very clearly and well.

### TRANSMITTER

A  $\frac{1}{2}$ -K.W. 220-V. transmitter, closed core, with three taps (which took me eight months to make) is used and may be seen enclosed in a teak box at right hand corner with H. T. condenser, helix, plain gap, quenched gap and rotary, these being used as desired: the rotary is driven by a small step-down transformer, 220 to 300 V., seen above, which also serves the rectifier to charge my A battery. The note produced by rotary and quenched is high and pleasant, and friendly OP's on board ships say that they can read my signals on  $\frac{1}{2}$ -K.W. 100 miles or more out at sea. It took me nearly three years to complete this set and I may state I own it with pride considering the hardships I encountered while constructing same.

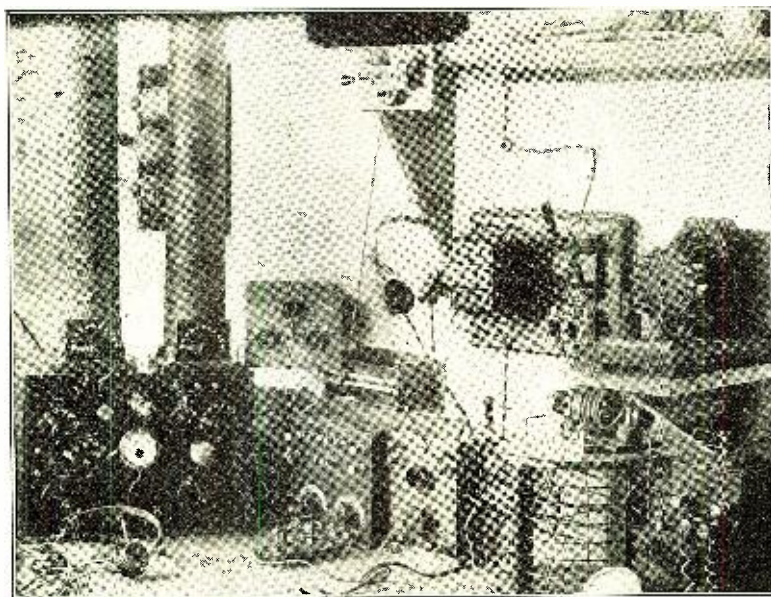

.....  
 This Station is Considered to be One of the Finest Amateur Stations in North Brazil. The Apparatus is Nearly All Home-Made.  
 .....

transformer, spark gaps, rotary gap, H. T. condenser, helix, charging rectifier. A battery, B battery (these being made up of small vaseline pots, dry cell principally), and amplifier transformers. The honeycomb coils were also wound by myself, but do not appear in this photo, yet the panel can be plainly seen, next to the regenerative set. The transformer for rectifier, phones

long, 12 meters high, which is used to chat with my fellow hams out here (we are now permitted to send), tuned down to 200 meters. The second is of the same type, but is 90 meters long, 20 meters high, slung on masts fixed on trees and used exclusively for long wave and distant reception. Earth consists of the water pipe and plate sunk in well.



# That Short Wave Set

By C. H. WARD

ARTICLES to help the beginner in radio are appearing in countless numbers in the radio publications, newspapers and elsewhere, and rightly so, for the number of newcomers in the radio art is legion. There are also discussions of the niceties, theories of operation, and more or less complicated and unique layouts of apparatus for the advanced amateur—the fellow who has the inclination, time and apparatus to go into the theory of radio for its own sake and to help in the development of the art. Personally I feel that I belong to neither class and have often heard the same comment from other amateurs.

Let me speak for these other fellows when I say that we understand the principles involved in a practical way, that we usually want to have a hand in the construction and installation of our apparatus and that we have the habit of periodically changing our apparatus and circuits for better or for worse—sometimes to the intense displeasure of our listening family and friends. Foremost in our minds, though, are good results—we find it necessary to know the theory of radio, but we are more interested in the doing than in the knowing.

If our radio experience began before the war, its history is probably about as follows, up to the introduction of phone broadcasting:

Loose coupler and crystal.

Loose coupler and audion.

A "tickler hook-up" using the old coupler and honeycomb coils.

Finally the climax in a "short wave set." The latter seems like an indefinite term, but to the amateurs of a short time ago it could only mean one thing—a regenerative

set consisting of three tuned circuits using a variocoupler and two variometers.

If we were to carry our history a little way into the future, it would probably have something to do with a radio frequency amplifying system and a loop aerial. However, most of us still look on that short wave set with awe, for we remember those dots and dashes from low power, far distant stations that other "radio bugs" could

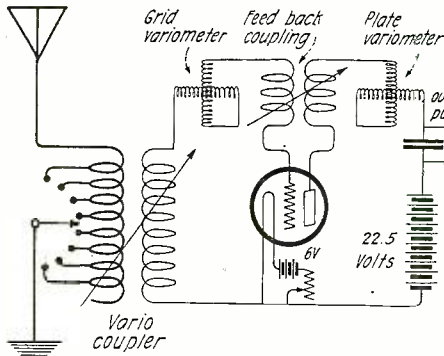

This Regenerative Hook-up is Very Efficient and is Particularly Useful for the Longer Wave Lengths

only hear in their imaginations. And when broadcasting started, there were nights when it seemed that the program was in the same room and the sound details of the announcer's voice were almost uncanny. One could hear him draw his breath and make the other little noises incident to speech that remind us of the wonderful reproductions of Harry Lauder's voice on the phonograph. But unfortunately there were nights

when programs did not measure up in tone quality to even the cheapest phonograph—especially when our friends dropped in to listen for an evening. Yes, there have been nights when even the sound of a voice of any kind would have been welcome to our ears, and others when signals started, to swing and our nerves were so shattered trying to keep in tune that we swung up and copied Navy press just to be sure of something. To make matters more embarrassing, possibly, we stopped in to hear the neighbor's set—one of the new broadcasting receivers—an immaculate little thing with two knobs to play with and possibly a set of dry cells to light its filament, and behold, we hear the whole concert through. Of course, the tone quality isn't in the same class as that from our three-circuit set when it decides to perform, and static is pretty strong, but still we have to hand it to our neighbor for he always gets something and sometimes we get nothing.

From here on I must stick to personal experiences. Possibly they will be repetitions of other fellows' experiences, but they may help others to get the results I am getting now—good results. When I saw my neighbor's set and others like it, I at first decided that the refinements introduced in large scale manufacture of receiving sets for concert reception made possible a set that could not be duplicated by the home workshop except by chance, and we should all remember that this is true, no matter how good our results may be. Later, however, when I found the boys turning out one and two circuit sets that performed almost as well as manufactured ones, and some of

(Continued on page 718)

## A Paper-Pulp Loudspeaker Horn

By GEO. A. IRLAND

IN looking over the advertisements of any of the radio magazines it will at once be noticed that one instrument which receives considerable space is the horn to which the ordinary head phones may be attached, either a single phone on the end, or two phones, one at each side of the end. These horns are usually made of metal and consequently have a metallic sound which is similar to the sound of the old-fashioned phonograph with a metal horn, and is not agreeable to the listener. The prices of these horns range from \$5 to \$12. The photograph shows a horn which anybody with the patience to spend a little time on it can make. It will give a good clear reproduction of the sound in the receiver.

The material used is paper; old newspapers are just the thing. These are soaked in water for about three days, one half pound in three quarts of water, and are torn into small pieces and stirred until they make a pulpy mass. To this mass is then added either one tablespoonful of powdered alum and one quart of wheat flour, or one-half pound of ground glue. The mixture is then boiled for about an hour, or until it becomes almost as stiff as bread dough. It is then allowed to cool. As soon as it becomes cool enough to handle comfortably it should be formed into the proper shape.

To shape the horn properly, a pasteboard form must first be made by twisting a large piece of pasteboard to the size of the inside of the finished horn. The one in the photograph was 6" in diameter at the large end and 18" long. The small end of this pasteboard should be placed into a 1/2" hole in a wood block about 2" square, and the horn

held in shape by sewing up the side where it is joined. After sewing, the horn should be cut off squarely at the large end, so that when standing up on that end it is straight and touches the flat surface of a table at all points.

The pasteboard horn should then be placed on a board about 2' square so that there are

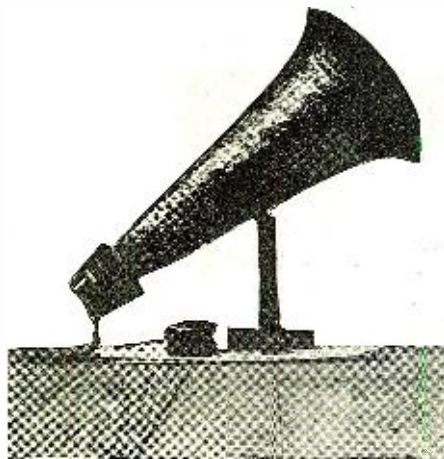

A Horn May Be Made Cheaply by Using Some Paper Pulp Moulded Over a Form

at least 6" of margin on each side of the large end of the horn. The pulp is then stuck on the outside of the horn about 1" thick, beginning at the bottom, either using the hands or a large spoon. After covering

the entire horn with pulp the remainder may be placed around the bottom to form the bell. Care should be taken to get the pulp evenly distributed over the pasteboard horn and to make the bell into a good shape.

After the horn has been formed it must be allowed to dry. As it is very thick, this requires a good deal of time. About a week in the sun is necessary for it to become quite dry and hard. After it is hard on the outside it may be removed from the board with a knife and allowed to dry on the inside. When dry, the inside of the bell should be hollowed out so that the wall is the same thickness throughout the length of the horn.

A block must be made for the attachment of the receiver to the small end of the horn. The block which was used to form the end must be removed and a different kind of block put on in its place. This may be either square or round, a little larger than the receiver to be used. A 3/4" hole is bored through the center into which a tube of wood is made to fit; this also has a hole through its center 1/2" in diameter. This tube is glued into the block and the horn is cut out with a sharp knife to allow the tube to fit into it. It should extend into the horn about 1" and glued to it. The side of the block away from the horn should be rounded to fit the receiver used and should be covered with felt having a hole in the center opposite the hole in the block. An old felt hat is just the thing for this washer. A guide for holding the receiver in the proper place should be provided; some small nails will answer the purpose. The receiver

(Continued on page 790)



# The Construction of a Crystal Amplifier

By MAURICE B. O'NEIL

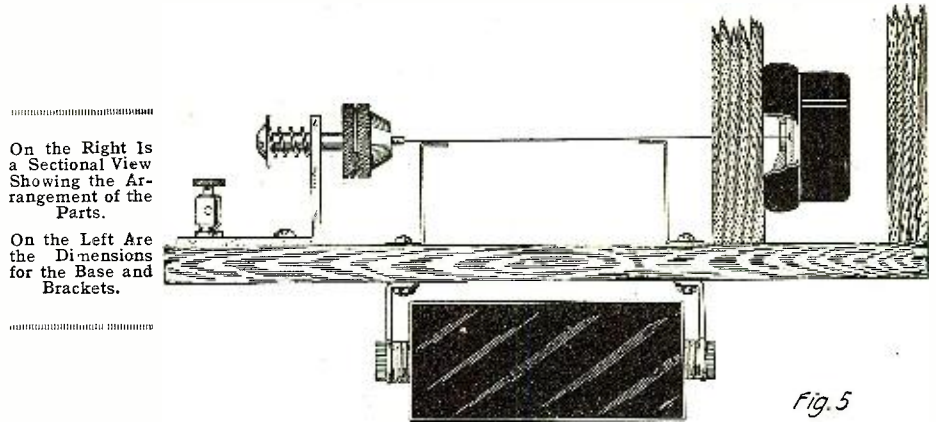
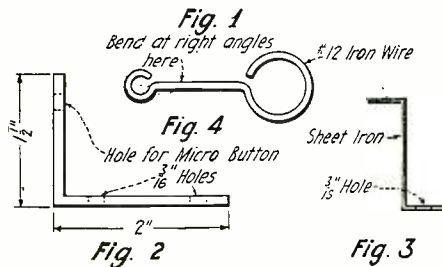
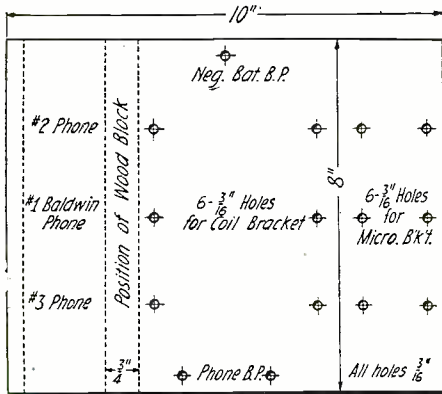

for holding coils to base, bent as shown in Fig. 4.  
 Three telephone transmitter buttons.  
 Two mandolin "E" strings.  
 One piece 3/4" wood, 8" long by 3" wide. (Not shown in drawings, is used in back of telephone receivers.)  
 Wood base 8"x10", 3/8" thick.  
 Wood case 3" deep and 8" x 10" (inside measurement).  
 The three Ford spark coils are taken out of the coil boxes, care being taken not to break any of the secondary wires. The compound in the coil boxes need not be melted nor the secondary sections taken apart. After the box has been broken away,

for adjustment of the tension on the steel wire to the telephone receiver diaphragm, see Fig. 5.  
 The brass brackets are mounted on the wood base after having been bent and drilled as shown in Fig. 2. The binding post at the end of the base passes through the hole in the brass bracket serving as a connection to it and at the same time to secure it to the base. A small wood screw is used in the second hole in the foot of the brass bracket to prevent side motion of the latter. A hole large enough for the shank of the transmitter button to pass through is drilled in the top of the bracket at a point where it will be in line with the center of the telephone diaphragm when it is in place. These will vary with the different types of receivers.

**T**HE amplifier here described, to be used with a crystal detector, has worked more successfully than more than a dozen different types recently designed and tested. After numerous unsuccessful attempts to perfect a more delicate microphone type of amplifier, using sharp edges in microphonic contact with pencil leads, etc., they were all discarded for this one.

When once adjusted this instrument will not jar out easily. I do not mean that it can be thrown about in a careless manner which will of course disturb the most sensitive position of the carbon grains in the transmitter buttons, but it is not as annoying as the more delicate microphone types of crystal amplifiers.

For the construction of a three-step amplifier, the following parts are needed which are easily found in any amateur or experimental station.

- Three telephone receivers.
- Three Ford spark coils.
- Six binding posts.
- Three pieces of brass, 3/4" wide, 3 1/2" long and 1/8" thick.
- Six pieces of thin sheet iron, bent as shown in Fig. 3, 1/4" wide.
- Six pieces of No. 12 galvanized iron wire

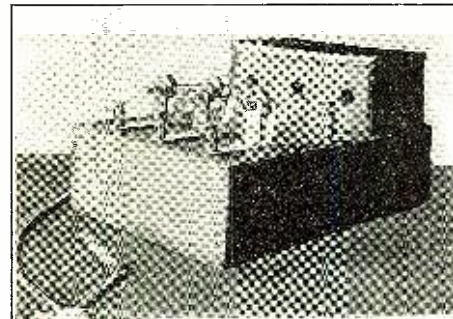

The Complete Unit.

the primary and core are pulled out and primary wire removed. The core is then wound with six layers of No. 24 D.C.C. magnet wire. The six layers allow a snug fit of the primary into the secondary after the extra two or three layers of waxed paper in the tube have been removed; the three coils are made alike.

The telephone transmitter buttons are drilled and tapped in the shank to allow

The small sheet iron standard shown in Fig. 3 is held to the base by the same screw that holds the No. 12 iron wire to the bottom of the base for the purpose of supporting the coils. They should be clamped with an iron bolt. The purpose of this piece of sheet metal is to give an increased magnetic pull on the steel wire between transmitter button and receiver, helping to give a stronger pull on the button and allowing more current to pass through the primary of the spark coils which increase the signal strength from step to step.

The telephone receiver diaphragms are marked at their center and a small hole punched through with a phonograph needle. The mandolin "E" string is passed through and a very small hook made at the end of the wire, which is then soldered with as small an amount of solder as possible. At the outer edge of the diaphragm, a small wire is soldered and connected to the primary of the spark coils as shown in wiring diagram.

The receivers are placed behind the wooden block and wedged there between the block and wood end-piece shown in Fig. 5.

The other details may be easily understood from the drawings furnished and should present no difficulties to the average electrical experimenter.

Greater amplification may be obtained by the use of higher voltage through the amplifier, but I have obtained best results with a small resistance in series with the negative binding post which will prevent the passage of too great a current, resulting in the heating of the transmitter buttons.

The first step is adjusted until best signal strength is obtained, then the second and third. The batteries may be dry cells. Five cells give good results. The amount of voltage for each step is found by experiment and adjustable clips are used from the three binding posts at the end of the instrument.

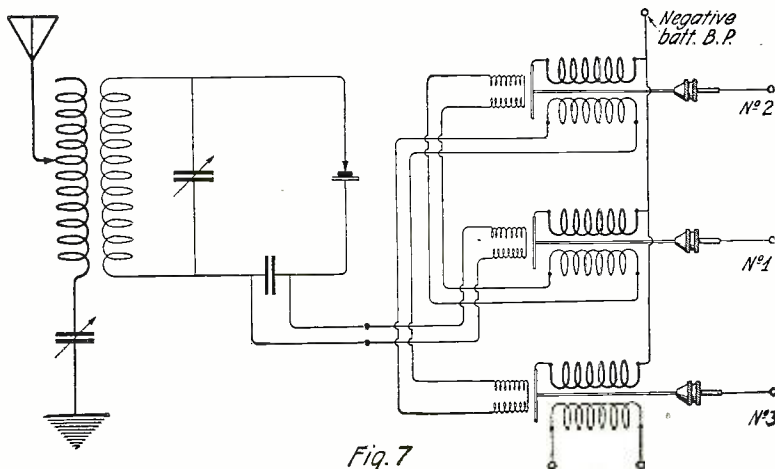

Hook-Up of the Crystal Amplifier. The Batteries Are Connected to the Binding Posts on the Right.



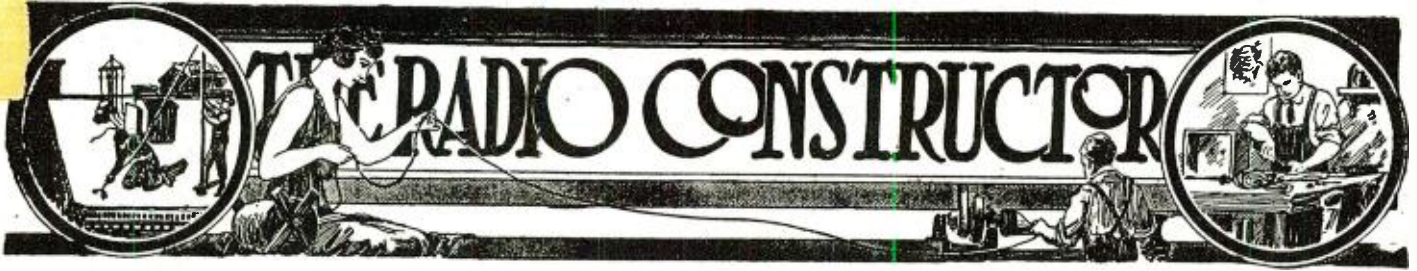

# A Novel Short-Wave Regenerator

By ARTHUR W. LAMBERT, Jr.

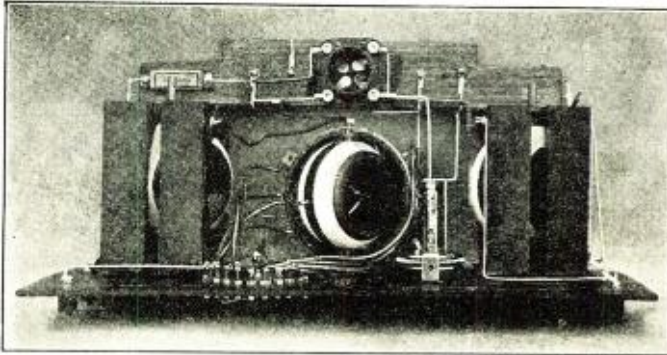
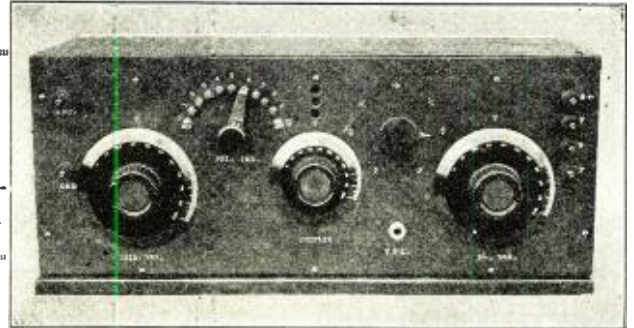

Fig. 1 to the Right and Fig. 5 to the Left Show Front and Back Views of the Completed Short-Wave Set Described in This Article.



WHEN the daily papers and other periodicals first began to broadcast news about radio the general public paused to look at the pictures, possibly read the headlines, then muttered something or other about the "bug-house" and passed on to scan the other items which made up the news of the day.

But when "Mutt" and "Jeff" put in a radio set and Goldberg began to illustrate contraptions like those designed by "Fips" of ancient *Modern Electrics'* fame and the hallucinations of the present Col. G. Ridleak, the public, "always eager for something new," swallowed the bait, hook, sinker and all, and a regular bargain day rush assaulted the radio counters.

Some of the good old crystal detector sets and numerous loose-couplers of pre-war popularity were resurrected from their resting places and after a thorough dusting were exchanged for honest-to-goodness dollars by those who desired to "listen in on the news of the world" at a minimum price.

New manufacturers sprang up overnight, and it was rumored that the lead mines worked overtime to supply the enormous demand for crystals.

It was not long, however, before the buying public learned that a galena garage and a tin horn might be all right for Underwood and Underwood to take pictures of (particularly if operated by a sweet young thing with shapely ground connections), but it was a mighty poor outfit as compared to a two-stage amplifier and loud speaker, for supplying music for a radio dance.

In addition to its pictorial value, the crystal detector, like the velocipede, has its place; but, as Shakespeare might have said, "The tube's the thing."

"Yea, verily," responds the would-be radio fan. "But think of the expense!"

Yes, a tube set costs more, but if Mr. Radio Fan will keep the cost of his outfit down to the minimum, he may assemble his own and double the purchasing power

of his little tin bank. And the recent boom in radio interest, we think, has cleared up another point. The novice who cares nothing for expense, and who buys the most expensive installation obtainable, tires of it within a few days. Then he has the nerve to broadcast information in his own way to

purchased a few bits of "junk" and finally succeeds in actually hearing signals—he has a different story. He tells what he has accomplished through his own efforts. He is the fellow who radiates the real enthusiasm of radio.

And he progresses, building and rebuilding his outfits, until before long he hears distant signals that his moneyed contemporary never could bring in.

And then the fun commences. "Faker" wails the purchaser of the hand-rubbed, nickel-plated beauty to the dealer who sold him his set. "I paid over two hundred dollars for my outfit, and I can't hear a thing; yet the kid down the block who made his own set has no trouble hearing Catalina Island and Pittsburgh."

As George Ade would say: "MORAL—Build your own."

The accompanying figures and illustrations show how any amateur or novice, with the aid of very few tools and little constructive ability can construct a complete receiver of the good old variometer type. And he will find that it not only works as well as the most expensive similar outfit that money can buy, but that it will grace the operating table at any station and be a source of pride to the builder.

Although this tuner and detector unit is a complete receiver, the set is designed as the first unit of a series of units. It can be simply and quickly connected to an external detector and amplifier, of audio or radio frequency design.

Fig. 1 shows the receiver in its cabinet. Used as shown, with but a single detector tube, the writer, at Arcadia, Mo., one hundred miles south of St. Louis, listened to the St. Louis Municipal Opera as broadcast by KSD, hearing the lines and music far better than could the audience in the seventy-five cent seats at the theater itself. With external detector and two stages of amplification we let her run at home and listened to the entire programs of *Sari, Yeoman of the Guard, Spring Maid* and  
(Continued on page 698)

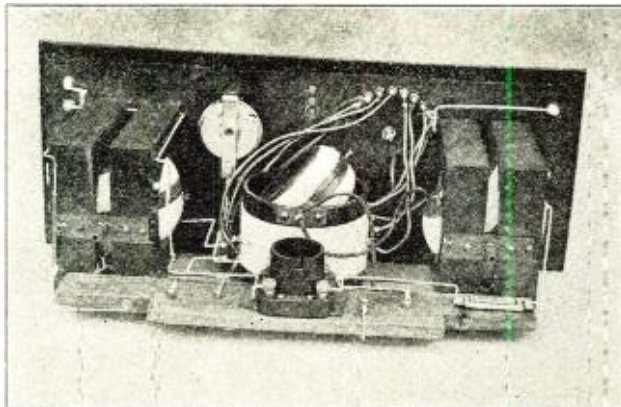

Fig. 6. A Full Back View of the Finished Receiver Which Clearly Shows the Wiring.

the effect that radio music is scratchy, radio speeches and lectures poor, and that radio in general is still far from perfect, impracticable, and not what it is cracked up to be.

But, on the other hand, the fellow who has saved his dimes and nickels with an eagerly anticipated variable condenser or additional amplifying tube in view, has

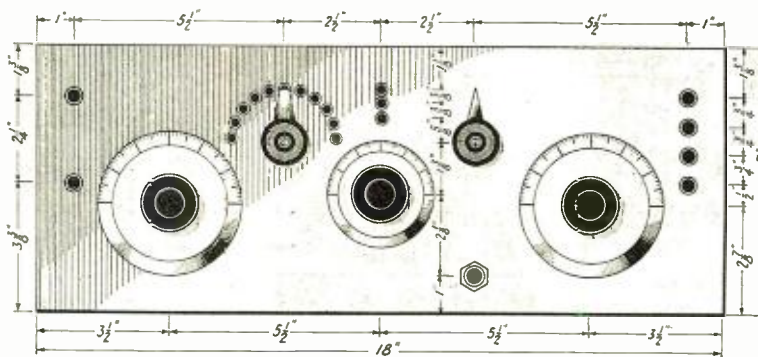

Fig. 2

Front of the Panel with All the Distances Between Holes for the Apparatus Indicated.



# Details of an Efficient Universal Receiver

By RAYMOND WHITCOMB

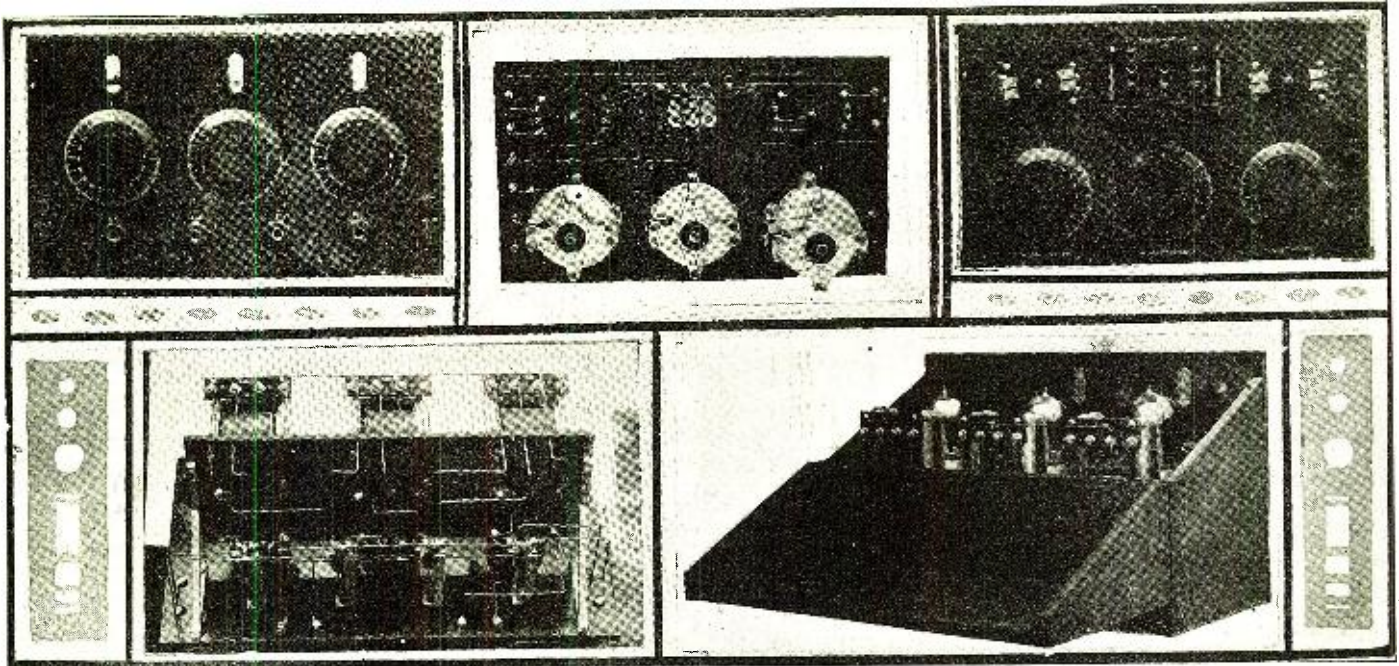

Above Are, from Left to Right, a Front View of the Three-Stage Amplifier, and a Back and Front View of the Tuner. The Lower Pictures Show Two Inside Views of the Amplifying Unit, Which Is Well Designed. Below, the Diagram Illustrates How a Separate Circuit May Be Compared with the Tuner.

THE radio receiver described and illustrated in the following article was designed and constructed by the writer and has been in use at 7AAR since June, 1921. It has given splendid results and is proving entirely satisfactory from the standpoints of efficiency, convenience and appearance.

As may be seen from the photographs, it is in three separate units, viz., a honeycomb coil universal tuner, an audion detector and a three-step amplifier. In the original plans was included a variometer short wave set, but the honeycomb coils gave such satisfactory results when properly handled that the fourth unit was never constructed.

For test purposes, a three test-circuit regenerative variometer set was connected in and both tuners were tuned separately to a long-distance station. Using the "zero beat" adjustment of the honeycomb coil set, and using regeneration on the variometer set at a point where the signals were almost mushy, no difference in the signal intensity given by the two sets could be detected, as the tuner master switch was shifted first to one side and then to the other. If anything, the honeycomb coil set was the more selective of the two.

The master circuit switch is very handy in testing out new hook-ups (radio frequency amplification, etc.) and comparing them directly with the standard tickler circuit. The writer usually has some test circuit

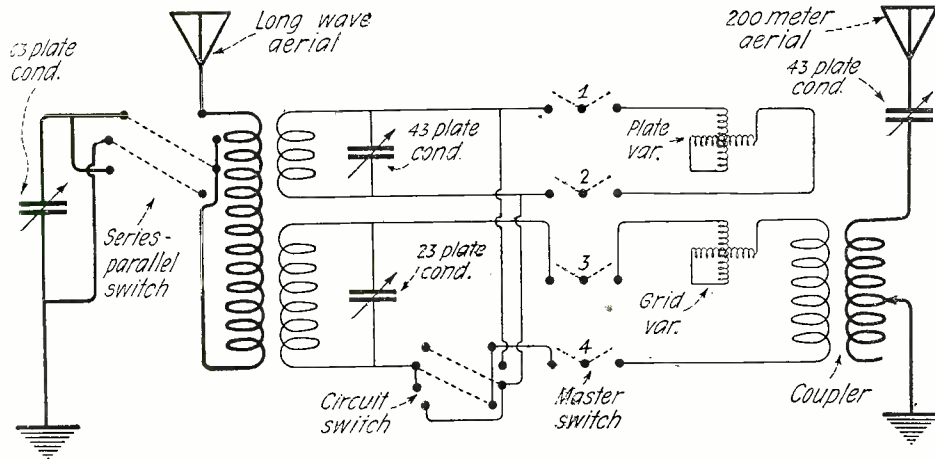

hooked onto it and would not be without it for a great deal. The special three-circuit switch also adds flexibility to the set by allowing a tickler regenerative, an ultraudion, or a straight audion circuit to be used at will.

Another switch permits the use of the primary condenser in series or shunt with the primary coil, or short circuits it entirely, while two others make and break the filament and plate circuits. A variable condenser shunted across the tickler coil gives a sort of vernier control of the regeneration

reception of speech and music and give spark an unnatural tone.

I believe that the photographs are sufficiently clear to illustrate the general construction of the set without a detailed explanation, and exact measurements of the panel layout are not given for the reason that each one will want to use different types of apparatus in its construction and lay out the panels in order to accommodate them. A cardboard template should be made before drilling the panel.

The panels are of 1/4" bakelite, and each unit is mounted entirely and rigidly on its panel so that it may be removed from its cabinet for inspection or change. The coil mounting is a De Forest, the variable condensers are Clapp-Eastham balanced type, the transformers are Acme, the rheostats are Paragon, the jacks are Western Electric, the grid leak is an R. C. and the fixed grids and phone condensers are Grebe.

These types need not  
(Continued on page 746)

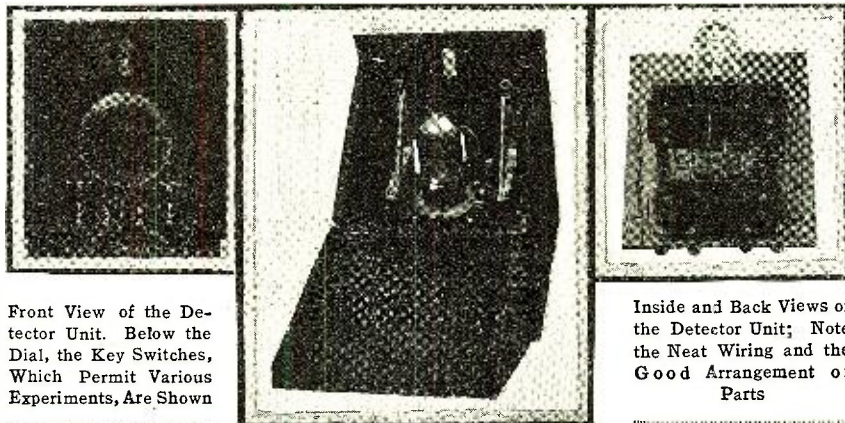

Front View of the Detector Unit. Below the Dial, the Key Switches, Which Permit Various Experiments, Are Shown

Inside and Back Views of the Detector Unit; Note the Neat Wiring and the Good Arrangement of Parts



# A Compact Radio Receiving Set

By PAUL G. WATSON

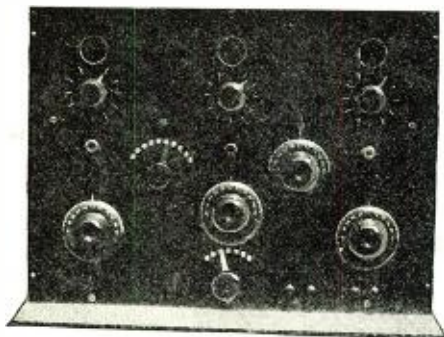

Front View of the Regenerative Receiver with Detector and Two Stage Amplifier.

THE receiving set described here was designed to meet the requirements of a store, where the loudest possible signals could be had with the apparatus taking up as little room as possible. There are numerous other designs of sets containing the tuner, detector and amplifier in one cabinet, most of which are great long cabinets, measuring up to 40" in length. The set described here was designed to be placed on the top of a roll-top desk, and could not, therefore, take up very much space. The space required for this set is about 10" by 20", with a height of 16", the extra height making up for the short length.

The general construction may be seen in the photos. The circuit of the tuner element is that given by the writer on page 1188 of the June, 1922, issue of RADIO NEWS, and is included in the diagram. The spacing of the various pieces on the panel is shown in the detail drawing of the panel.

The variometers and variocoupler used in this set are the "Simplex" type, selected for their high efficiency and selectivity of tuning. The necessity for a good contact to the moving elements cannot be exaggerated, and is well taken care of in this type of apparatus. No sounds are heard in the phones when tuning with these variometers, as there are no brushes to cause them. In wiring the coupler primary only the large steps are used, the short wave condenser will handle the close variation of the primary more efficiently than the single taps. The short wave condenser is a 43-plate condenser, of .001 Mfd. capacity. The proper use of the condenser and taps will give a very closely tuned circuit.

The only variable elements in the secondary circuit are the variometers. The grid variometer should have shielding placed on the back of the panel and connected to the ground terminal of the tuner. This shielding is nothing more than a piece of tinfoil about seven inches square, fastened to the back of the panel with shellac, and insulated from the variometer. This shielding will

remove the capacity effect of the hand while tuning. The grid condenser is a fixed one of .0005 Mfd. and a grid leak is shunted across it. The "B" or plate battery for the detector is a battery having variable voltage. Variation is made by the upper switch on the panel. In connecting the points of this switch only alternative points should be used, thus avoiding a short circuit of sections of the battery as the lever passes from one contact to the next. The detector tube used in this set was a pre-war "Audio-tron" and required a maximum voltage of 45; if the "Radiotron" UV 200 is used, a 22 volt maximum is sufficient. The rheostats used were the "Paragon" type, and give a close, smooth regulation of filament current. The three tubes are connected in parallel in the filament circuit, and are brought to two binding posts on the face of the panel where the storage battery is connected. Extreme care should be used to have soldered connections throughout the set, so that no noise can come from the poor connections and joints in the connecting wires. "Federal" jacks were used in the detector and amplifier circuits, as they give

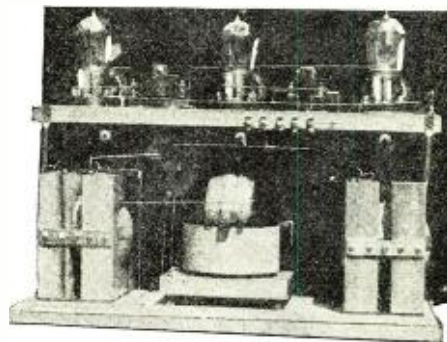

Inside of the Complete Receiver. Note the Connectors for A and B Batteries.

amplifier, since it has two stages of audio frequency amplification. "General Radio" transformers were used in this case and worked extremely well. Howling is eliminated completely by mounting the transformers as far apart as possible and at right angles to each other. In connecting the transformers of any make, care should be used

to see that the out turn of the secondary is connected to the grid terminal of the tube. Three "General Radio" sockets were used in this set, the contacts being secure and the ability to resist the action of heat being the points considered in the selection.

The manner in which the "B" or plate batteries are connected is one taken from several types of commercial apparatus. "Fahnenstock" spring binding posts are used to connect all the plate batteries. The two large size posts are the terminals for the amplifier plate battery. The opposite variometer has one spring binding post which is the negative post of the detector plate battery. The five small spring posts placed along the edge of the upper board are the connections for the taps of the variable battery which has been men-

tioned previously. This method of connecting both batteries assures a firm contact at all times, and removes the possibility of noise from this source.

All wiring in the set is to be done with No. 14 bare wire, using spaghetti insulation when necessary. The use of wire as large as this may seem unnecessary to the layman, but it can be pointed out, as examples of this point, that all commercial and military apparatus is thus wired, and again a comparison of the tuner wired with small wire and then re-wired with the larger, will convince the experimenter of the necessity of the large wire. The possibility of short circuit is lessened by the fact that No. 14 wire is stiff enough to remain in position when once placed.

The lower board or base of this tuner is about 19" long. On it are

(Cont. on page 790)

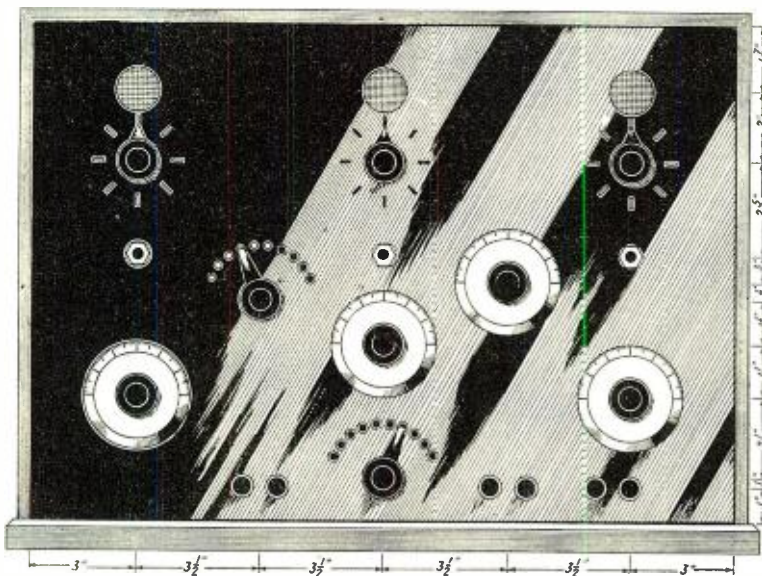

Layout of Front Panel with Distance of Holes to be Drilled.

good tight contact when the plug is removed. Poor contact in the jacks will give an unlimited amount of trouble, and cannot be overlooked as a point where trouble can start. Two double circuit jacks and one single circuit jack are needed, the single circuit being used in the last step of the amplifier. In soldering the connections on the lugs of the jacks, care should be taken to keep the soldering paste out of the insulation.

Two transformers are required for this

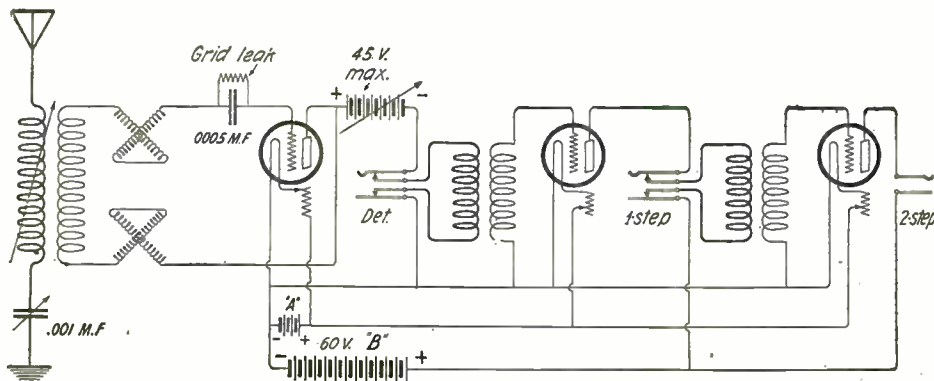

The Hook-Up Used by Mr. Watson in His Receiver.



# The Construction of a Loop

By FREDERICK RUMFORD

**A** COMPLETE description of a simple and efficient loop aerial is set forth in this article.

The use of a loop is to be recommended if heavy static or local interference is experienced. Static may be reduced to a minimum and by revolving the loop it is possible to eliminate interfering stations. Although for best results on one tube an outdoor aerial is a necessity, a loop is quite efficient if used in conjunction with the proper apparatus.

Only one control, a shunt variable condenser, is required for tuning. This simplifies the circuit and is, therefore, of special value in a portable receiver.

If the loop is revolved over a 360-degree scale while listening to a distant transmitter, two points of maximum audibility will be heard and likewise two settings will bring in the station with the minimum signal strength. The minimum setting is more accurate than the maximum and is generally used. The direction of the transmitter is in a line with the plane of the wire, when the minimum signal strength is found. This is the bilateral method and has the disadvantage of not permitting the determination of the true or absolute direction of the transmitter. By co-ordinate operation of two or more coil stations, this defect may

be partially overcome. The unilateral method employing a vertical non-directional aerial in conjunction with the bilateral loop is used at most direction-finding stations on the coast.

When a ship asks the direction-finding station for a position report, the direction-finding loops at the two or three sub-stations are maneuvered until each sub-station has a "line" on the ship. The degree of each sub-station "line" is telegraphed to the direction-finding station and thence by radio to the ship.

An interesting experiment is to obtain a bearing on the ship while it is transmitting and check the results obtained with those of the direction-finding station. In most cases, they will be found to coincide, especially so after the amateur has gained some experience in this work.

It is possible to locate an unlicensed or interfering station, if three or more amateurs, equipped with loops, take bearings and combine them. For inter-city and short distance work loop reception at wave-lengths of from 150 to 200 meters makes it possible to almost entirely eliminate interference.

In Figs. 1, 2 and 3, the complete construction details are clearly shown. The hub, spreaders and supporting rods are cut, drilled, finished off and joined. The hub is a 1" cube with four 1/2" holes bored into it part way. The spreaders are 6" long cut from 1" square stock. Grooves are cut into the outer side of each spreader to hold the wire in place. A space of 1/4" should be left between grooves. If desired, bakelite or fiber may be used for the spreaders.

For the support rods either 1/2" wood rod, bakelite rod or aluminum may be employed. On all

(Continued on page 720)

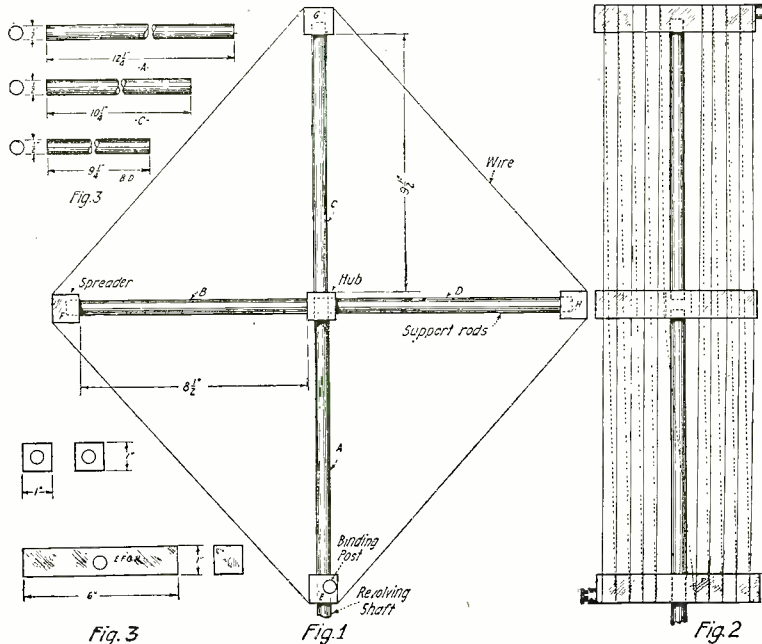

This Loop Can Easily Be Constructed. It is Very Light and Portable and Will Be Found Useful for Many Purposes.

# Receiving Broadcasting with A. C.

By Prof. M. MOYE

**T**HE new methods of broadcasting give a distinct revival to the use of crystal detectors, the chief advantage being avoiding the bulky and costly "A" and "B" batteries, especially the former. But crystal reception is not very sensitive for moderate or long distance work and some amplification is always welcome. For the benefit of experimenters provided with A. C. lighting mains, we devised a mixed hook-up (V. T. and

galena), which works cheaply and efficiently for wireless telephony or telegraphy.

The set is simply a development of that already described in RADIO NEWS for June, 1921, page 863, with a few adjuncts, especially the coming-down, through a potentiometer, of the return wires of the filament-grid circuits, according to the method of Mr. Reed (RADIO NEWS, January, 1921; page 447).

Perhaps readers may be reminded that the basic principle of the elimination of the humming of A. C. is the use of a tuned circuit in the plate circuit of the last V. T. of the set. This circuit allows a ready path to the very low frequency of A. C., while acting practically as a rejector for any radio frequencies. Those are rectified and made audible, in the ordinary way, by a crystal, as per diagram. The diagram needs only a few explanations: A and A' are V. T. coupled by a radio-frequency transformer and working as radio-frequency amplifiers. They are lighted by A. C. reduced to six volts, a rheostat giving the correct heating. The potentiometer is of any value, between 400 and 1,000 ohms. It does not need to be variable, a middle tap doing as well.

A third V. T., fed by five volts A. C., works as a two-electrode rectifier, grid and plate being connected together. C is a fixed condenser of about one microfarad value, helping to smooth out any ripples of the rectified A. C. If preferred, rectifier and condenser may be dispensed with and a "B" battery connected as usual. It is chiefly the "A" battery which is troublesome to keep in working order and needs a substitute.

The dotted connection and variable vernier condenser C" is not necessary, but it is useful for further amplification and, eventually, C. W. reception.

With the filter circuit L. C. tuned to the on-coming wave-lengths, broadcasting comes quite loud, without any distortion or humming, exactly as when storage-cells are used.

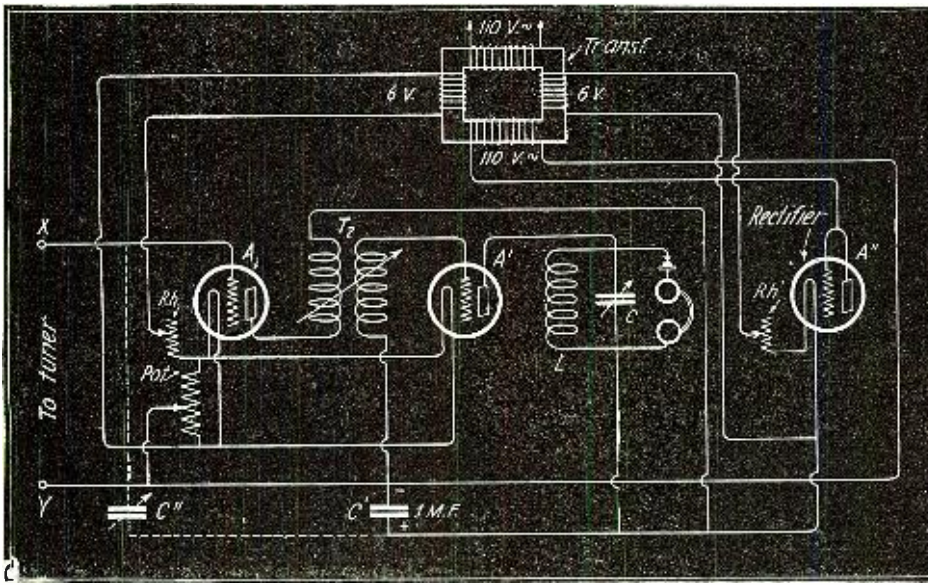

A Two-Stage Radio-Frequency Amplifier Entirely Supplied with A. C. A Rectifier Tube is Necessary and a Crystal Detector is Used, as it is Not Possible to Use a V. T. Detector.



# Handy Tools for the Radio Workshop

By G. A. LUERS

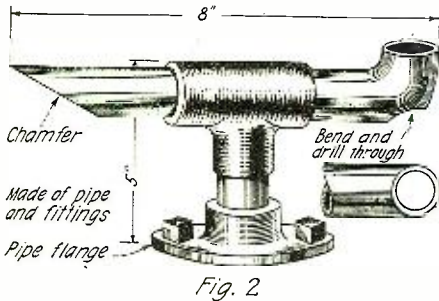
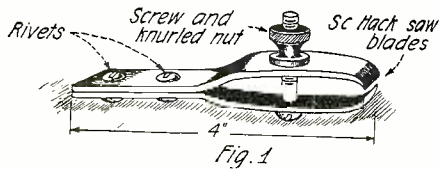

Fig. 1 Shows a Pair of Tweezers Made from Saw Blades. Fig. 2, a Small Anvil Useful for Light Work.

**N**EATNESS in the construction of radio equipment depends greatly upon the facilities for handling the metal parts, panels and wiring and correctly shaping each instrument or wire. By making the tools shown in the accompanying sketches the amateur will be greatly aided, by their use, in building his set.

Eight types of tools are shown, the material for which may be readily obtained or found among the contents of the tool box. Each tool will prove indispensable after its use has been learned and mastered.

No. 1. The small tweezer tongs, as shown, are made up of saw blades and a screw terminal. Obtain two lengths of hack saw blades, bend them to shape, drill for the screw terminal and rivets, then assemble. Small machine screws and nuts may be used instead of rivets, if desired. The tongs will prove very useful when soldering or assembling light apparatus. A wing nut may be used for faster and easier action.

No. 2 is a small stake anvil of light construction. All parts are made from pipe or pipe fittings. As is clearly indicated, the

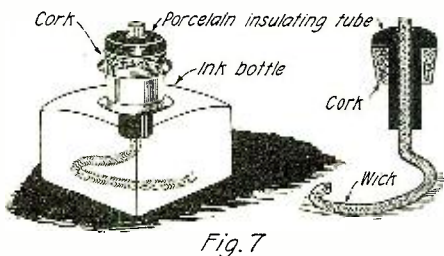

A Little Alcohol Lamp Which May Be Used as a Blow Torch is Useful to Make Apparatus.

base is made from a pipe flange, into which is screwed a small pipe upright, to the top of which is fitted a T joint. The cross pipes are cut and drilled, screwed into the T joint and the instrument is finished. I have found that a height of 5 inches and a length of 8 inches is to be preferred. In building up rheostats, coils, placing rivets and soldering, this tool finds a useful place.

No. 3. The cutter and trimmer is made from two steel blades and a handle, suitably fastened to a wooden base. A graduated scale should be marked upon the base, one blade screwed to the side, the other blade bolted in place with a handle to operate it, and the whole instrument finished up neatly.

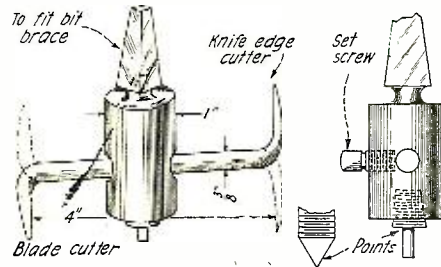
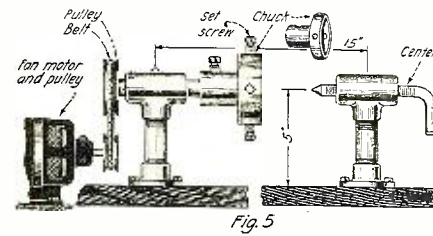

Above is a Coil Winder Which May Be Built with Pipe Fittings. Below is a Disc Cutter for Making Dials, Condenser Plates, Etc.

This tool will prove handy in cutting condenser plates, shearing iron core stock and other light material.

No. 4. This is a combination saw and file holder. A piece of  $\frac{1}{2}$ " steel pipe is cut and bent to the proper size and slotted for the blade ends as shown. This holder will enable a firm hold to be had on saw blades or any type of file, either flat or circular.

No. 5. A very simple and easily constructed coil winder may be made as follows: Two end supports should be made first. They consist of a pipe flange, a short length of pipe and a T joint. The supports are separated 15" and securely fastened to the bench, making sure that the openings are in line. One support is equipped with an axle on to one end of which is fastened a pulley. The chuck is fastened to the other end with a set screw. The axle may be

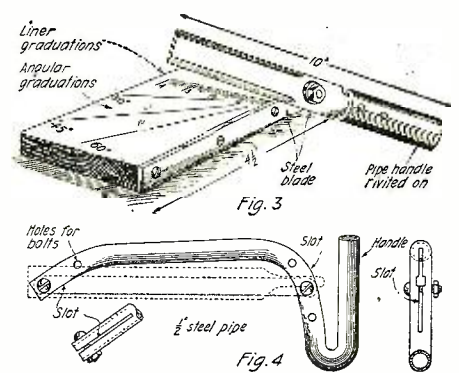

The Cutter, Fig. 3, May Be Used to Cut Condenser Armature of Cardboard; the Tool Shown in Fig. 4 May Support a Saw or a File.

turned with an electric motor, or the fan may employ the ever-present sewing machine for power. This instrument will aid greatly in winding all forms of coils and may also be used for drilling if desired.

No. 6. The disc cutter shown enables one to cut dials, condenser end plates, etc., from sheets. Bar stock is used throughout, the arrangement being very simple. This tool will fit the bit brace, and, if the size shown is adhered to, will give satisfactory service.

No. 7. This alcohol torch is a necessity in every station, and its construction is so simple that every amateur should make one and derive the benefits therefrom. An ink, or other bottle which will not readily upset, is employed. Drill the cork for a short length of insulating tube, which should then be inserted as shown. The wick may be purchased at any drugstore. Wood or real alcohol, if you can get it, may be used. For every purpose where heat is desired this small necessity will prove of value.

No. 8. The hand knurl and tube cutting tool shown consists of a handle with an adjustable elbow. When using the knurling disc it is possible to tighten up the numerous thumb screws and adjusting pieces. The cutting disc will allow easy grooving or cutting off of metal tubing or solid insulating rod. This device will be found very handy in a large assembling room, and the amateur will never regret the time spent in making this, or any of the other tools described in this short article.

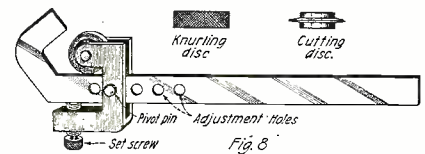

To Cut Grooves and Knurl Knobs Such a Mounting is Convenient.

## How to Wire a Radio Set Correctly

The reason so many constructors make bad jobs of their sets in regard to wiring them is often because they can't solder connections. Soldering is easy once the fundamental secret is learned. The two surfaces to be soldered must be scrupulously clean. They should be bright and lustrous, so that the solder may join them together into a solid unit. However, the least amount of solder compatible with efficiency should be used. A good soldering flux is a necessity. Zinc chloride solution, formed by dropping a few pieces of commercial zinc into a dilute solution of muriatic acid, can be used, or any other of the numerous pastes and

solutions on the market. If a paste is used, be careful not to use too much, since it neither aids soldering nor makes a neat appearance. In fact, if the melted flux flows to another connection, a high resistance will be shunted across the two, thus materially affecting the efficiency of the set. A little practice will show just how much flux is best. The paste should be applied so that just a thin coating covers the work, the thinner the better. The "killed acid," zinc chloride, should barely wet the connection. As to the soldering iron, which, by the way, is made of copper, be sure it is hot enough to make the solder

flow freely. If it has been heated in a bunsen burner flame, do not heat the iron so much that the flame is colored green by the copper, since this pits the iron and gradually deprives it of its power to retain heat. Moreover, the iron should be "tinned," that is, it should have a thin coating of solder, one-half inch, at the tip. To apply this, file the end of the iron on all sides, exposing the bright metal beneath. Then heat the iron to its usual heat, and apply a small amount of flux to the iron itself; wire solder should then be applied so that it coats the instrument all along the tip. This coat-

(Continued on page 791)



# Practical Home-Made Condensers

By S. B. HOOD

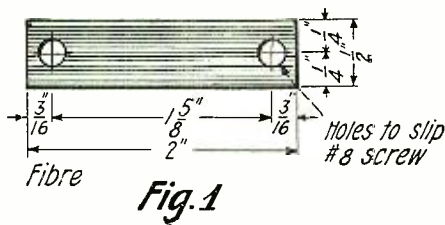
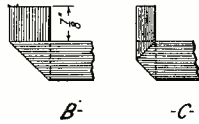

Fig. 1



B

C

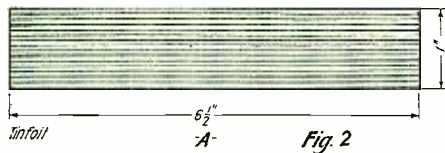

Fig. 2

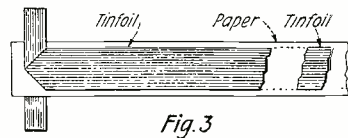

Fig. 3

Showing How the Fixed Condensers are Made with Strips of Paper and Tinfoil.

**T**HE amateur who has graduated from his first crystal set delights in trying every new hook-up he hears about. Since many of these show various forms of fixed and variable condensers, and the hook-up may not work as well as others he has tried, it does not pay to purchase ready-made condensers.

The condensers shown in the accompanying sketches are very inexpensive to make and require only the simple tools to be found in any real amateur mechanic's workshop, and a reasonable amount of mechanical skill, to construct.

The fixed condensers should not cost over five cents each for the material, and the large variable condensers can be built for less than two dollars. Any of them will work as well, or better, than the "bought" variety and the exposed parts will look neat enough to grace any panel.

It will be noted in reading the description that the variable condenser is in reality a combination of a bank of fixed units controlled by a dial switch. The fine tuning is done by a vernier rotating variable unit that bridges the steps of the dial units. The units combined to make the larger variable one can just as well be used individually. Having this in mind the entire condenser requirements for a most elaborate set can be constructed as described.

For the complete large variable condenser as shown, having an approximate capacity of .002 M.F., the following material will be required:

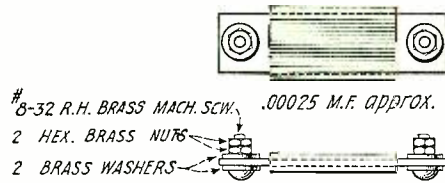

Fig. 4

The Finished Fixed Condenser.

One piece of vulcanized fibre panel stock 1/8" or 3/16" in thickness. (Bakelite or hard rubber will prove equally as good.)

Two inductance switch knobs with shafts and bushings.

Nine switch buttons with nuts.

One switch stop with nuts.

Sixteen 1/2" No. 8/32 R.H. brass machine screws with two hexagon brass nuts and two washers each. (It is advisable to get some extras for stock fixed condensers while you are about it.)

Two 1" No. 8/32 R. H. brass machine screws with nuts, and about two dozen washers.

Two binding posts with screws and washers.

A small piece of hard sheet brass not over 1/64" thick.

Small sheet of 1/16" fibre, fuller board or press board. (Stiff cardboard will do in a pinch.)

A few sheets of tinfoil. (Save the wrappings from tobacco, cigars and cigarettes and you will always have a stock of this.)

About one-half pound of paraffin wax.

A sheet of paraffined paper. (Tracing paper is ideal.)

A few feet of wire for connecting. No. 14 bare wire is best, as it is stiff enough to stay where it is put; insulated bell wire may be used. If a fancy job is desired cover the bare wire with spaghetti tubing.

The first parts to make are the fixed condenser units. These are shown as approximately .00025 M.F. Their capacity may be

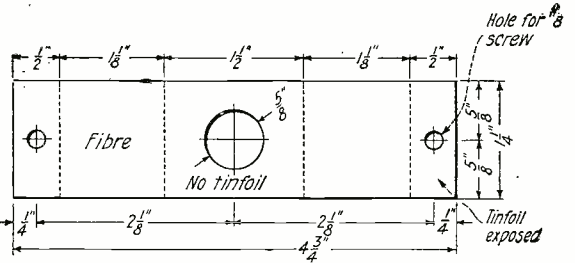

Fig. 5

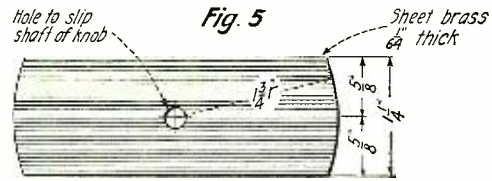

Fig. 6-a

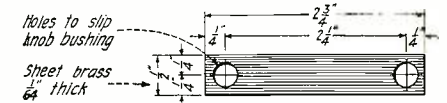
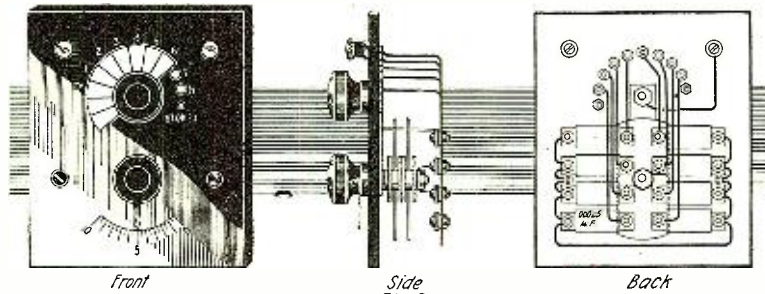

Fig. 6-b

The Elements of the Variable Unit May be Made to the Sizes Given in This Drawing.



Here are Three Views of the Complete Unit. Such a Variable Condenser is Cheap to Make and Will Prove Most Useful for Sharp Tuning.

varied to suit. While making them, it is better to have a collection varying from .0001 to .001. In figuring these capacities allow one square inch of tinfoil for each .00005 M.F. To this add 1 1/2" to allow for the turned over end that is not active.

From the sheet fibre cut the necessary number of pieces to size, shown in Fig. 1.

Cut two pieces of tinfoil for each, of the size shown in "A" of Fig. 2. Fold one of each first as shown in "B" and finally as in "C." This forms the lug for connecting and does not require fancy cutting of the sheet or waste of foil. Next cut strips from waxed paper, making them 1/4" wider than the tinfoil and about 1 1/2" longer.

Stack alternately paper and foil, as shown in Fig. 3. Lay one of the fibre plates on this at the lug end and wrap tightly around it, being careful to see that the paper and foil do not slip and short-circuit the unit. Before wrapping, cut some strips of writing paper the same width as the waxed strips. For this use an envelope cut so that the gummed flap forms one edge of the strip. These need to be only about 2" in length. Wrap one of these around each condenser

and seal the flap, thus holding the unit tightly in place.

Finally bend the connecting flaps around the end of each fibre plate and punch holes for the binding screws. Place the screws in position, with a washer against each side of the strip, and put two nuts on each screw.

The resulting condenser is like that shown in Fig. 4, and is as good as any which can be purchased. But it is not good enough for permanent use, as it is not impregnated and will collect moisture.

To guard against this, place the paraffin wax in a glass jelly-tumbler, in a pot of water to boil until all the wax is melted and the glass is about two-thirds full. Immerse each condenser in the melted wax and allow it to remain there until all the air bubbles disappear. Then withdraw and allow to cool.

Before immersing, mark the approximate capacity on the wrapper in pencil or ink for future identification purposes.

To use one of these small units as a combination condenser and grid leak simply place a blank fibre plate on top of the finished condenser unit. Under each washer, and extending a short distance beyond it toward the center of the strip, make a circle with a soft lead pencil. Connect these two circles with a pencil line and the leak is completed. By widening the pencil line the amount of leak can be increased at will.

(Continued on page 782)

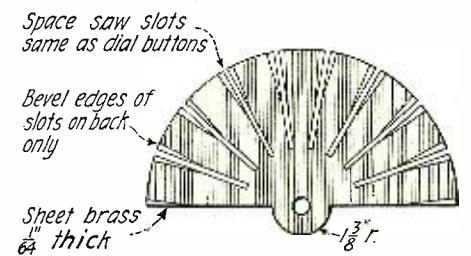

Fig. 6-b

Detail of the Fan Switch by Means of Which Several Capacities May be Connected in Parallel.



# Construction of a High-Voltage Storage Battery

By E. L. HALL and J. L. PRESTON

THE purpose of this paper is to give some information in regard to a high-voltage storage battery which has been used by the Radio Laboratory of the Bureau of Standards for over four years and has given excellent service. There have been many calls for information upon this subject and it is hoped that this paper may answer some of these inquiries. The present apparatus is subject to further improvements. At the close of the paper are given recommendations for several changes which seem desirable. The particular batteries to be described are used to furnish plate current for a generator of

undamped radio-frequency currents. The electron tube used is either a Western Electric VT-2 or a General Electric Type P plotron, or their equivalents. The current for the first tube may range from 5 to 30 milliamperes while for the latter tube it may be 15C milliamperes depending on the plate voltage used. It is necessary that a constant current of small value be available.

The individual elements composing this battery are made by The Electric Storage Battery Company, being their type LT Chloride Accumulator. The following data are taken from the catalog of the above company:

Type	Size of Plate	Number of Plates	Discharge in Amperes		
			For: 8 Hrs.	5 Hrs.	3 Hrs.
LT.....	3½"x1"	2	1/5	¼	2/5

Normal Charge Rate Amperes	Dimensions of Glass Jar			Weight in Pounds	
	Length	Width	Height	Electrolyte	Cell Complete
1/5	1½"	1¾"	4½"	1/5	¾

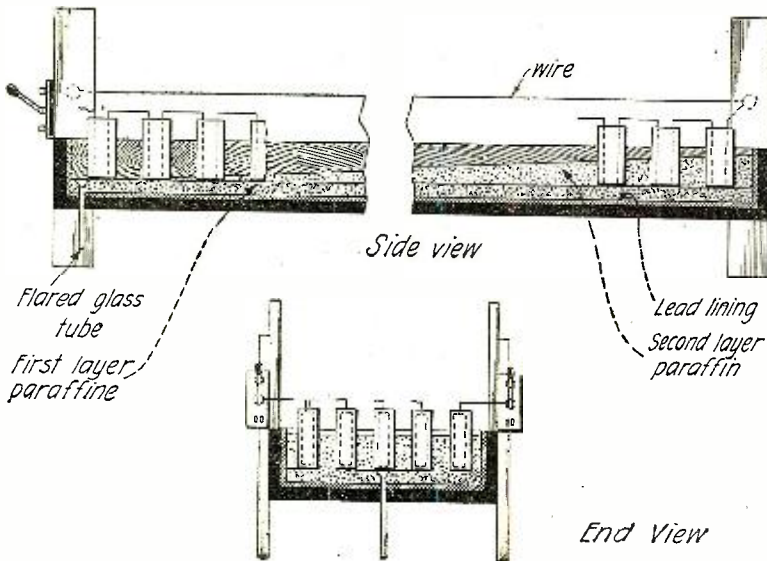

This Storage Battery Provides a Voltage of 100 V. and Can Be Used in Reception or Low Power Transmission. The Sloping Layer of Paraffin Permits Overflow of Acid to Run Down to the Drain and Prevents Damage

The batteries were made up using twelve cells per row and four rows to the tray, giving about 100 volts when charged. Fig. 1 shows the arrangement as employed at present with one exception which will be mentioned later. Wooden trays were made up of ¾-inch lumber measuring 11¼ by 19 by 4 inches deep. Legs 1¾ inches long were placed at each corner. Vertical supports 12 inches high were fastened at each corner of the tray so that the trays might be built up in stacks if desired, thus occupying a minimum of floor or table space. The trays were given two coats of black insulating varnish, allowing plenty of time for drying between coats.

Melted paraffin was poured into the tray and allowed to harden. The glass jars, the tops of which had been dipped in paraffin for about an inch down the side, were then put in place and one end of the tray blocked up about two inches. More paraffin was poured in until it came within about one inch of the top at one end and about three inches from the

(Continued on page 704)

## An Amplifier for Direct Current

By H. A. SNOW

IN various fields in electrical work, particularly in radio work, it is important to have a relay possessing negligible time lag, capable of operating on small impressed currents, of the order of 10 milliamperes. Such a device may be found useful, for example, in recorders for registering telegraphic or radio signals, in apparatus for remote electrical control, in railway signaling work, and for operating an oscillograph from a source of very small current.

The following paper describes a resistance coupled electron tube amplifier designed to amplify a direct or alternating current of 10 to 20 milliamperes to 110 to 200 milliamperes to take the place of a special type of polarized relay at present used for this purpose. The conditions under which the relay operates and which are imposed on the amplifier follow:

### CONDITIONS

The current operating the relay is either an alternating current of 10 to 20 milliamperes at a frequency of about 40 cycles or a direct current of the same magnitude in either direction, both of which are applied intermittently from a high impedance source. The input impedance of the relay is about 750 ohms with an allowable increase to 1000 ohms. The impedance of the output circuit is 50 to 100 ohms. When a direct current in a given direction is supplied to the input of the amplifier, an amplified direct current will be produced in the output circuit. When a direct current in the opposite direction is supplied to the input, an amplified direct current in the opposite direction will be produced in the

output circuit. The amplifier will amplify alternating currents of either low commercial frequencies or high radio frequencies with very little distortion.

### TUBES

The electron tubes selected for the amplifier tests were UV-202 Radiotron 5-watt power tubes, because of their high filament emission and steadiness of operation with a high plate current.

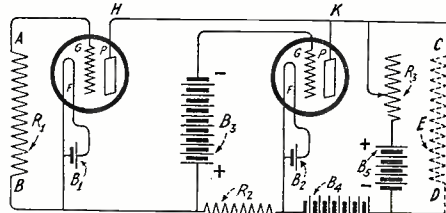

By Means of This Circuit No. 1, a Direct Current or Alternating Current Can Be Amplified With Vacuum Tubes.

### CIRCUITS

Since the electron tube amplifier is essentially a voltage-operated device of high impedance, it is not readily adapted for efficient current amplification. For highest efficiency the highest possible voltage should be produced from the input current it is desired to amplify. The type of amplifier circuit that may be used is limited by the fact that the input consists partially of direct current, to a resistance-coupled circuit em-

ploying the voltage drop across a resistance for the input to each stage, so the maximum voltage available with 10 milliamperes flowing in the input circuit is the drop across a resistance in the input circuit. The resistance being limited to 1000 ohms, the maximum voltage available is 10 volts. This requires more than one stage of amplification for efficient use of the tubes.

### CIRCUIT DESCRIPTION

Two circuits each having two resistance-coupled stages were set up and adjusted for maximum current amplification. These circuits are shown diagrammatically in Fig. 1.

In both circuits 1 and 2 of Fig. 1: A and B are the input terminals. C and D are the output terminals. E (in dotted lines) represents the impedance of the output circuit. In these tests E was a resistance of 50 ohms.

(Continued on page 720)

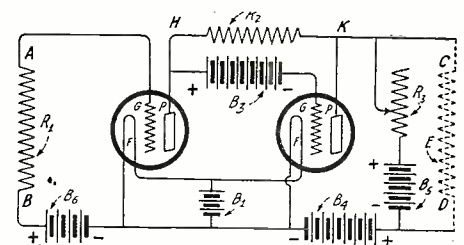

Circuit No. 2 Performs the Same Function as No. 1, but Requires More Tubes. The Difference in Amplification is Due to the Manner of Connecting R-2.





## Monthly Laboratories Report

By L. G. PACENT, Director

THE readers of RADIO NEWS were, no doubt, very gratified to read Mr. Gernsback's editorial announcing the establishment of the RADIO NEWS laboratories to encourage the manufacture of better radio apparatus. It is realized that a number of radio manufacturers are putting equipment on the market which is not up to standard but which could be improved with slight modifications and by following the best principles of modern radio engineering. A short time after this editorial appeared, Mr. Gernsback, whom I have known for a number of years, asked me if I would act in the capacity of director of this laboratory. After several conferences, in which he assured me it was to be a national and not a local laboratory, and that the issuance of certificates would be left in the hands of Mr. Lacault, Mr. Clement and myself, I accepted the directorship. The laboratory is now well under way.

Before going into the details of the work which the laboratory is accomplishing, the personnel of the laboratory staff will be outlined.

Mr. R. E. Lacault, Laboratory Director: Mr. Lacault's work in radio is practically unknown in this country but he was in the Radio Service of the French army during the war. He was engaged in experiments in the same research laboratory in which Major Armstrong, at that time with the American forces "over there," performed such wonderful work, including the original development of the super-heterodyne receiver. He has been connected with radio since 1912 and has carried on experiments in its various branches.

Mr. L. M. Clement, Technical Director, is well known to radio engineers, experimenters and amateurs in this country, owing to his long radio experience as an amateur on the Pacific Coast, as engineer for Marconi Company and as radio engineer in charge of Commercial Design for the Western Electric Company, which position he now holds. Mr. Clement was in charge of the installation of the Catalina Island radio link which set the standard for radio communication, both for speed of erection and constancy of operation. Mr. Clement designed a number of instruments during the war while employed by the Western Electric Company and is considered one of the best all around engineers in the country.

Mr. A. F. Toth, formerly of the Western Electric Company, is in charge of the practical work.

The laboratories, although recently established, have received a great deal of equipment for testing the various apparatus submitted. The remainder of the equipment is expected daily. For the testing of radio headsets, we are having especially made for us an oscillator with a range of frequencies from 100 cycles to 10,000 cycles. It will be completed shortly and we ask the telephone manufacturers who have submitted headsets to kindly refrain from wiring us requesting that we rush the test, because we are unable to do so until we get the proper apparatus. We have a standard capacity bridge for measuring capacities of almost any value and hope that the condenser manufacturers

will take advantage of this and send in condensers, on which we are ready to issue reports in rotation without a great deal of delay. We expect shortly to receive a standard wavemeter with which we will be able to measure inductances, both variable and fixed. For insulation and other tests, we have ordered a high voltage outfit with A. C. motor generator, together with thermocouples, thermogalvanometers, electrostatic voltmeters and high tension transformers for breakdown tests.

Laboratories for testing various equipment have been in existence for many years, but in the writer's estimation never before has a laboratory of this nature been started for the sole purpose of helping manufacturers. Private reports with constructive criticism and suggestions for improvement will be made to each manufacturer who submits apparatus for test. The weaknesses of the apparatus will be outlined from engineering, operative and salability standpoints. It has never been done before. We have started with this end in view and we will accomplish it. With this in mind, we do not intend to issue a standard certificate for all pieces of apparatus. The certificate will have stamped on the seal the percentage which the particular piece of equipment deserves, as determined by the laboratories. On the back of the certificate the percentage will be enumerated and divided into five classes: mechanical, electrical, salability, serviceability and operation. The totals of each will be shown and also the total percentage. The various percentages are divided as follows:

	Per Cent
ELECTRICAL CHARACTERISTICS.....	25 (total)
Subdivided: Design.....	5
Efficiency.....	5
Accuracy.....	5
Operation.....	5
Construction.....	5
MECHANICAL FEATURES.....	25 (total)
Subdivided: Design.....	5
Accuracy.....	5
Operation.....	5
Construction.....	5
Ruggedness.....	5
SERVICEABILITY.....	25 (total)
Subdivided: General Ruggedness.....	5
Material.....	5
Packing for Shipment.....	5
Life—Probable.....	10
OPERATION.....	10 (total)
Subdivided: Material.....	5
Finish.....	3
Arrangement of Parts.....	2
SALABILITY.....	15 (total)
Subdivided: Operation.....	5
Packing for Shelves.....	5
Novelty of Design.....	5

In cases where the equipment submitted is subject to certain laws or regulations made by the Department of Commerce, the National Board of Fire Underwriters, or other authoritative agency, and it is found that either the apparatus or the accessories do not meet with these laws or regulations, 20 per cent will be deducted from the total percentage. In order to be awarded the certificate, all pieces of apparatus must be awarded at least 60 per cent, the percentage in each class being determined by the Directors, and based upon each piece of equipment after the tests have been carefully made.

In order to facilitate our work we request manufacturers submitting equipment to

enclose with the apparatus all literature which they have concerning it, in order that we can make suggestions regarding the description of the goods as well as on the apparatus itself.

The laboratories are entirely controlled by the director and technical director and not connected in any way with the magazine, except that they are financed by RADIO NEWS and that a space is devoted each month to the description of the instruments tested. These descriptions are published for the benefit of the buyers, who are thus informed of the performance of the apparatus which are awarded certificates. Although at present the laboratory is temporarily located in the magazine office, we are looking for a space in a proper location where it will be separated entirely from the RADIO NEWS office.

During the last few weeks, various instruments were submitted for which we cannot award certificates. These are not in themselves radio apparatus, but merely accessories, the functioning of which depends upon the kind of apparatus with which they are used. Several of these, although well-made and working well, cannot be tested. Horns are in this category. These are used in conjunction with telephone receivers as loud speakers, but are not in themselves complete units, and will not give the same results under all conditions. For instance, if a good telephone receiver is attached to one of these horns and functions well when connected to a two-stage amplifier, it cannot necessarily be said that the horn is good, for if the latter is used with a poorly constructed headset attached to a regenerative receiver with only one detector tube, the signals will not be loud enough and will probably be distorted, thus rendering the horn practically useless. It is our advice that such amplifying devices, based on acoustics, should be furnished with a reproducer of some sort and accompanied by a pamphlet stating under what conditions the best results will be obtained. If they were so constructed they would be in themselves loud speakers, which we could test, and would be awarded a certificate, if they would work satisfactorily under the conditions mentioned by the manufacturer.

Among the other pieces of apparatus that were rejected were some varicouplers and coils which were not provided with any means of mounting, either on a panel or a table. On some others the taps were entirely too short to permit the soldering of connections, or the windings were loose and not protected from moisture by any kind of insulating varnish. In some couplers the bearings were loose and no stops provided, so that the secondary could be turned indefinitely, making possible the breaking of the connections attached to the stator.

All these points should not be overlooked by the manufacturers, as every poor piece of apparatus put on the market means a dissatisfied customer. It is, therefore, highly desirable that these various pieces of apparatus be manufactured to conform with modern engineering design. It is for this purpose that the laboratories have been installed, and we hope that all manufacturers will take advantage of them for their own benefit.



# Apparatus Awarded Certificates

## THE BRADLEYSTAT

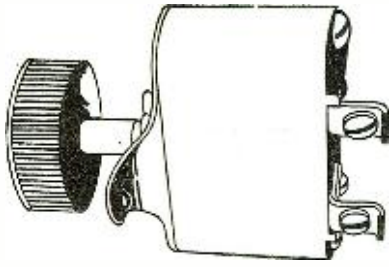

The Bradleystat, a carbon compression type of rheostat, is manufactured by Allan-Bradley Company of Milwaukee, Wisconsin.

It provides a close regulation of current by tightening or loosening the contact between the carbon discs which conduct the current. This is accomplished by turning the knob clockwise to increase the current and counter-clockwise to decrease it. By turning to the extreme position, the current can be entirely cut off.

The rheostat is well-constructed and is fool-proof, the working parts being enclosed in a porcelain container. An enclosed instruction sheet gives directions for mounting on a panel. Screws are provided for panel mounting.

Approximate size  $2\frac{3}{4}'' \times 2\frac{1}{2}'' \times 2\frac{1}{8}''$  over all.

Tested for 1 hour at  $2\frac{1}{2}$  amperes.

Received in good packing.

AWARDED THE RADIO NEWS LABORATORIES CERTIFICATE OF MERIT No. 8.

## KLOSNER VERNIER RHEOSTAT

Vernier rheostats are desirable to regulate the current through the critical filament of a gas content vacuum tube. The Klosner Improved Apparatus Company of 2024 Boston Road, New York City, offer their Vernier Rheostat to fill this need. There is but one knob to control both coarse and fine adjustments. The vernier consists of a single turn of bare resistance wire wound on the periphery of the moulded, heat-resisting base, over which the auxiliary arm moves. To change from coarse to fine adjustment, the knob is pulled outward, disengaging the main arm. When the knob is pushed back into the normal position, a pin engages in one of four slots on the main spindle, allowing both arms to rotate. During this movement, the auxiliary arm slides off the vernier wire and runs idle on the rim of the base. Two nickel plated filister head machine screws are provided for panel mounting.

The rheostat is well-constructed mechanically. Total resistance of samples tested was 5.53 ohms.

Tested for 2 hours under 1.25 amperes.

Received in excellent packing.

AWARDED THE RADIO NEWS LABORATORIES CERTIFICATE OF MERIT No. 9.

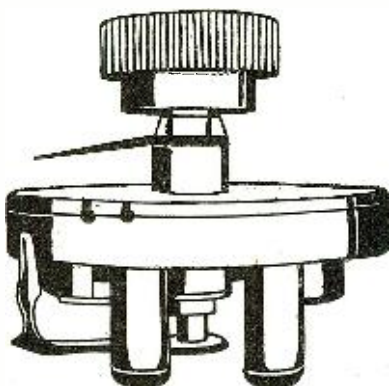

## KING RHEO-SOCKET

As its name implies, the King Rheo-Socket is a combination of vacuum tube socket and rheostat upon the same base.

It is manufactured by the American Pattern Foundry and Machine Company, 82-84 Church Street, New York City.

The whole unit is very compact and is made of moulded condensite with metal parts nickel plated. Provision is made for mounting on a panel or table. A neat knob with an arrow in relief controls the rheostat resistance of 5.21 ohms.

Tested for  $2\frac{1}{2}$  hours at 1.25 amperes.

Received in excellent packing.

AWARDED THE RADIO NEWS LABORATORIES CERTIFICATE OF MERIT No. 10.

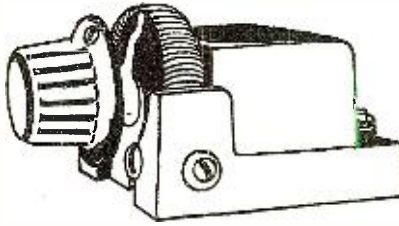

## NELSON'S IMPROVED V. T. SOCKET

This sturdy vacuum tube socket made of moulded bakelite is manufactured by I. R. Nelson Company, Inc., of Newark, New Jersey, and is one of the "Reel Easy Products." The socket measures  $3'' \times 1\frac{1}{8}'' \times 1\frac{1}{8}''$ . The terminals are clearly marked on both top and bottom of the base. A heavy web is moulded across the inside of the socket with four holes to allow the prongs of the tube to touch on the spring contacts. Metal parts are nickel plated. A well-made socket in every respect.

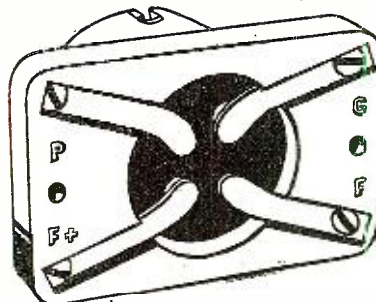
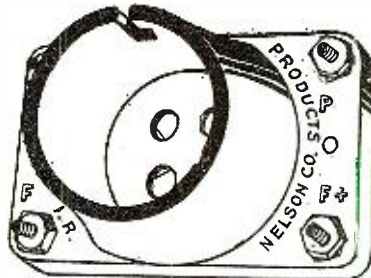

AWARDED THE RADIO NEWS LABORATORIES CERTIFICATE OF MERIT No. 11.

## CHELSEA VARIABLE AIR CONDENSER No. 1

In this condenser, made by the Chelsea Radio Company of Chelsea, Massachusetts, the moulded construction insures the maintenance of the correct separation between the medium gauge aluminum plates. Three cast pillars hold the semi-circular stationary plates while the movable ones are rigidly held by an auxiliary casting around the steel shaft, all castings being made of soft metal. The bearings are of brass, moulded into the bakelite ends. Contact to the moving plates is made by a brass strip held

against one end of the steel shaft by a set screw which regulates the degree of pressure on the friction con-

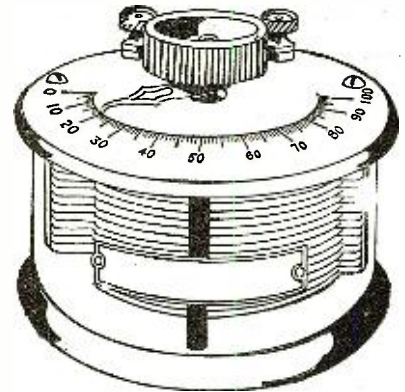

tact. The separation between the plates is about .084 inch. A transparent celluloid case surrounds the entire condenser, excluding dust and allowing the inside to be seen.

Over a 100 degree scale moulded on the top of the condenser and filled with whiting, a nickel plated pointer gives the relative capacity in the circuit. As measured on a capacity bridge, the maximum and minimum capacitance of the sample submitted for test were found to be 1086 micromicrofarads (.001086 Mfd.) and 29.8 mmf. (0.000029 mfd.), respectively. Two heavy nickel plated binding posts are provided for connections as the condenser is not intended for panel mounting.

Overall dimensions are  $4\frac{3}{8}''$  diameter and  $3\frac{3}{8}''$  high.

Received in good packing.

AWARDED THE RADIO NEWS LABORATORIES CERTIFICATE OF MERIT No. 12.

## CHELSEA VARIABLE AIR CONDENSER No. 3

This condenser, made for panel mounting, is provided with a counterweight to balance the movement of the movable plates about the shaft. It is manufactured by the Chelsea Radio Company of Chelsea, Massachusetts. The end plates of ample proportions as well as the dial and knob furnished with the instrument are of moulded bakelite. By means of a soft metal casting, the plates are secured to a steel shaft running on brass bearings. The inside is of the same moulded construction as the No. 1 type Chelsea condenser.

Three threaded brass inserts are moulded into the end plate for the purpose of mounting on the panel. Overall dimensions are  $4\frac{1}{2}'' \times 4'' \times 4\frac{3}{8}''$ . The dial which accompanies the condenser reads from left to right and bears 100 divisions, filled with whiting. The capacitance, as measured on a capacity bridge, was as follows:

Maximum 1136.6 micromicrofarads (0.0011366 mfd.).

Minimum 20 mmf. (0.000020 mfd.).

Received in good packing.

AWARDED THE RADIO NEWS LABORATORIES CERTIFICATE OF MERIT No. 13.

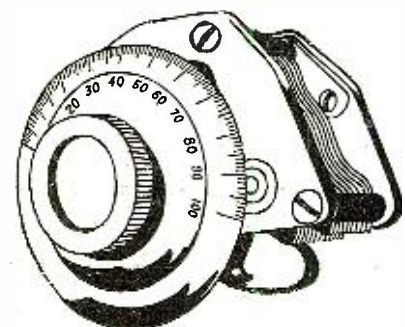



# THE BEGINNER

## A Set for the Radio Novice

By **RODNEY ROACH**

**T**HE broadcasting of news, weather reports, music, and even plays by the large radiophone stations of this country, such as WJZ, has turned many people to radio as a form of entertainment. Boys as young as ten and men as old as seventy have become interested in the greatest hobby of the times. There is a need for an inexpensive and good audion set for these enthusiasts. Many are using crystal sets for the reception of broadcasted music, but an audion set is far better. The chief drawback, though, is the high cost of such a receiver. It is to an inexpensive regenerative set for the radio novice that this article is devoted. This set is an excellent receptor of music, is of simple construction, and lastly, is of low cost—\$13 in all. By building this receiver the constructor will save money, give himself a good set, and gain much valuable experience.

**A LIST OF MATERIALS NEEDED**

1 tube socket.....	\$1.00
1 rheostat.....	1.00
Variable condenser.....	2.15
2 dials.....	2.00
2 switches.....	.80
20 switch points.....	1.00
8 binding posts.....	.80
Cardboard tubing.....	.40
1 grid condenser.....	.35
Wire .....	1.50
Wood .....	2.00
<b>Total</b>	<b>\$13.00</b>

**THE CIRCUIT**

Fig. 1 shows the circuit employed. A is the aerial and G is the ground. LP is the primary and LS the secondary of the vario-coupler employed. L is a secondary loading coil, while VC is a 13-plate variable condenser. X is a grid condenser such as is on the market today. C is a fixed condenser of special construction. B is the high voltage battery and A the filament or so-called storage battery. PH designates the phones.

**CONSTRUCTION OF THE COUPLER**

The coupler used in this set is a sort of vario-coupler and is of very simple construction.

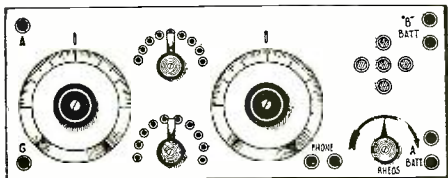

Fig. 3

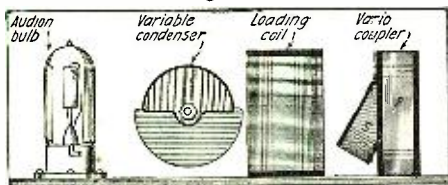

Fig. 4

Front and Back Views of the Receiver Showing Location of the Apparatus.

The primary is made from a cardboard or formica tube  $4\frac{1}{2}$ " in diameter by  $2\frac{1}{2}$ " in length. If a cardboard tube is used, it should be shellacked well (before winding on the wire) to prevent it from shrinking; 27 turns of No. 24 double cotton covered wire are wound tightly on the tube. Taps are taken out every third turn and brought out to the 9 point switch on the panel as seen in Fig. 3. The set functions better without shellacked windings, but if the wire will come loose without it, apply a very thin coating of shellac.

The secondary is wound on a tube  $3\frac{1}{2}$ " in diameter by  $1\frac{3}{4}$ " in length, and is wound with 30 turns of No. 26 double cotton covered wire; no taps are taken off.

Fig. 2 shows the method of mounting the coupler. As is seen, the primary is fastened to the panel and to the base by screws. A disc of  $\frac{1}{4}$ " wood is fitted inside the secondary tubing of the coupler and to this a copper arm is fastened by means of screws. As the dial controlling the coupler is moved, the arm moves, thus drawing the secondary in and out of the primary.

**THE LOADING COIL**

The loading coil L in Fig. 1 is made on a tube  $4\frac{1}{2}$ " in diameter by 5" long. It is wound with 100 turns of No. 26 double cotton covered wire and taps are taken off every ten turns and brought out to the ten point switch on the panel. In Fig. 1 is shown a wire connecting the last tap of the loading

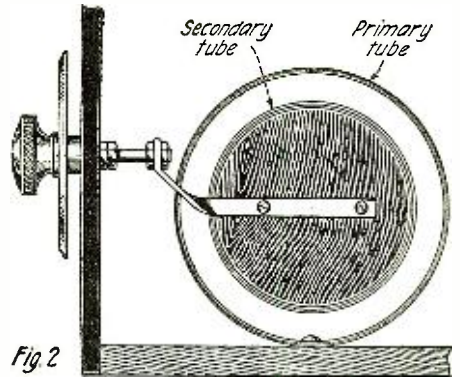

Fig. 2

The Method of Coupling the Secondary Coil to the Primary is Shown Above.

**ARRANGEMENT OF THE SET**

In Fig. 3 is shown the arrangement of the panel; this may be made of wood or of bakelite—bakelite making a neater and better insulated panel. At the left is the dial controlling the vario-coupler, while at the right is the dial for the variable condenser. There are two switches between the dials, the upper one is for the coupler and the lower one for the loading coil. Fig. 4 shows the arrangement of the back of the panel, the way in which the set is laid out. Since every builder will use parts different in size, no dimensions are given for the panel or cabinet. This may be worked out easily.

**OPERATION OF THE SET**

The next and very important point to consider is that of operating the set. A good receiver is worth little to its owner if he knows nothing about operating it. The kind of tubes (or bulbs or audions or detectors) to use with this set are the soft tubes, such as the double filament Audiotrons, the Radiotrons, and Moorhead Electron Relay tubes. The writer has used all of the makes named and has found that the last named tube is the best, but it has a very critical adjustment. The Radiotron, while not bringing in distant signals as well, is easier to operate. When working a set, always adjust the plate voltage and filament rheostat carefully until the set oscillates; this is indicated when a click is heard in the phones. The oscillating of the set described in this article is controlled by the dials of the coupler and of the variable condenser. Also, the operator will find that the coupler has a great effect on the strength of the received signals.

The writer can guarantee success if the foregoing specifications are followed with some degree of care. He has built three of these receivers for his friends and has given others the plans for it. On one tube 9EB of Colorado, 6EN of California, and hundreds of eights have been heard. If a two-step amplifier is added to this set, it will bring in music which can be heard at a great distance from the phones. The writer will be glad to answer any questions about this set.

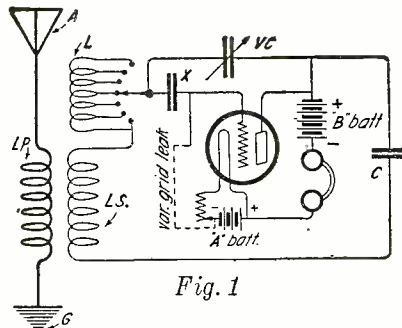

Fig. 1

Wiring Diagram of the Simple Regenerative Receiver Described in This Article.

coil with the switch. This is a device that eliminates the "dead-end" effect.

**THE CONDENSERS USED**

The variable condenser used in this circuit is of small capacity. It is a 13-plate panel type condenser. The writer uses a 13-plate "Illinois" condenser, which can be purchased for \$2.15, and is of good construction.

C in Fig. 1 is a fixed condenser. This is made by covering a piece of mica  $2" \times 3"$  on each side with tinfoil. A wire is soldered to each of the two pieces of tinfoil and serves as terminals of the condenser. The whole thing is soaked in paraffine, which makes a very neat and efficient condenser.



# The Universal Receiver

By JOHN R. MEAGHER

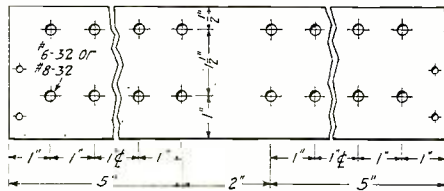

Fig. 1 Shows the Layout of the Special Sub-Terminal Panel Incorporated in This Receiver. Details of the Honeycomb Coil Rack Appear in the Second Figure.

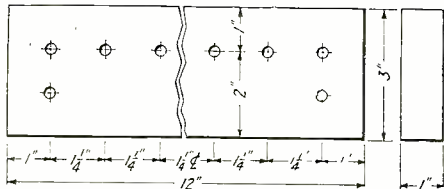

Fig. 1 Shows the Layout of the Special Sub-Terminal Panel Incorporated in This Receiver. Details of the Honeycomb Coil Rack Appear in the Second Figure.

**T**HE following description is intended for the advanced novice and amateur who desires to build a receiver which will incorporate the good features of the best types of sets and, at the same time, be easy to construct and low in cost. Even after the thrill of receiving distant broadcasting has somewhat diminished, this set will provide entertainment from the great number of amateur phone stations which may be picked up; it is very efficient on 200 meters. Additionally, it is possible to receive foreign high-powered stations, which is surely just as interesting as receiving a concert. By building and operating this set a great deal will be learned about reception and, though starting as a broadcasting fan, the constructor will probably end up as an accomplished radio bug.

### THE TERMINAL SUB PANEL

Often the owner of a "cabinet" receiver wishes to try out a new improvement in the circuit, but, after taking a look at the interior wiring, he generally leaves it as is, for it would not be an easy task. In this set, however, provision is made for a sub panel inside the set at the top, on which are mounted the terminals of each instrument. By centering the terminals in this manner it is possible to wire up almost any circuit. The hook-up best adapted for a certain tube or special exterior conditions can be readily found. The sub panel in no way detracts from the appearance of the receiver. It is a much neater method than spreading the instruments all over the table and will give just as good results.

### THE MATERIAL NECESSARY

- One main panel, size 14"x12"x3/16".
- One sub panel, size 12"x3"x1/8".
- Two forty-three plate variable condensers.
- One twenty-three plate variable condenser.
- One rheostat and vacuum tube socket.
- One single-gang filament switch.
- One three-coil mounting.

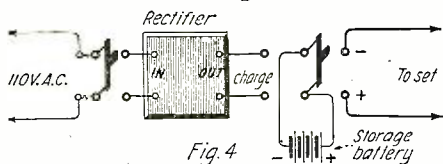

The Correct Circuit for a Battery Charger is Shown Here. This Wiring Method Prevents Possible Damage to the Receiver.

Wire, forms and plugs for short wave coils. Dials, tinfoil, wire, cambric tubing, etc.

When buying the condensers see that they meet these specifications. The plates must be rugged with fairly wide spacing. Shaft ends must be solid so that continual wear will not affect them. Most important, either the movable plates must have a flexible wire connection or the spring connection must be very good so that constant contact is assured. The socket recommended for this set is a Paragon for panel mounting. About seven makes of three coil mountings have been advertised in RADIO NEWS but the mountings which have the small knobs on top for adjusting the coupling are not suited for this set. The Remler or Cotocoil will serve. These mountings have an extension handle and when the handle is removed the detuning experienced with other mountings is minimized. Besides, the knobs on the usual type of mountings are very hard to adjust because they are in an awkward position. With the Remler or Cotocoil, the wrist can be at rest on the table while tuning. If the reader has a de Forest or similar type, I would advise purchasing two Remler extension handles and fitting them on the two outside movable plugs.

### THE PANEL

Fig. 1. is a detailed plan of the main and sub panels. Either condensite celeron, bakelite XX, hard rubber or fibre may be used. Of these four, rubber is the easiest to drill

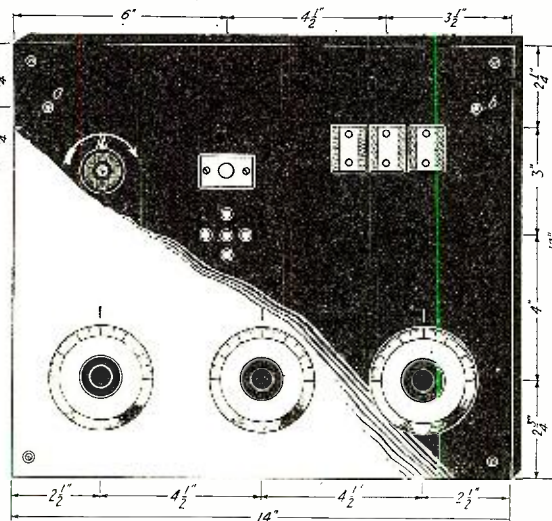

Front View of the Universal Receiver Showing the Disposition of Controls and General Panel Layout.

but bakelite is much sturdier and can be given a nicer finish. The main panel is three-sixteenths of an inch thick, while the sub panel is only one-eighth inch.

As the placing of the supporting screw holes in different types of condensers varies, only the shaft holes are shown in Fig. 1. It will be necessary to lay out the extra holes to fit after the variable condensers have been purchased. This also holds true for the coil mounting. The first step in the actual construction after buying the material is to drill the holes. These should be drilled carefully or a few panels may be spoiled in the attempt.

The position of the holes should be laid off directly on the face of the panels. Obtain the exact location and with a soft, sharp pointed lead pencil mark the points to be drilled. Place a center punch or sharp nail on these spots and tap hard enough to make a distinct indentation. Now proceed with the drilling, using the dents as a guide. It will be necessary to have three sizes of drills. One large size to cut half-inch holes for the condenser shafts, one to pass eight

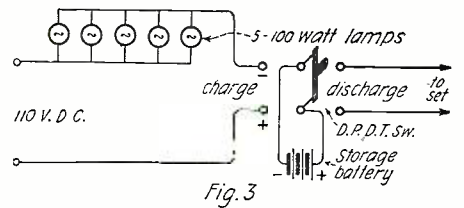

If Direct Current is Available, the Diagram Above May Be Employed to Charge the Radio Storage Battery. The Charging Rate Depends Upon Total Lamp Wattage in the Circuit and May Be Regulated by Adding or Removing Lamps.

thirty-second screws and the other to pass six thirty-second screws. When drilling, secure the panels firmly to the work table, so that both hands are free.

The indicating scratch marks are made by a vertical line from each shaft hole and on this is marked off a sector starting at a point one and one-quarter inches above the hole to a point two inches above the hole. This three-quarter inch sector is to be scratched out and later filled in with white lead. When scratching, go lightly at first and then press harder until the scratch is deep, solid and clean cut. A hard, sharp pointed instrument will be necessary. This mark is for three-inch dials as these should be used. Four-inch dials will look out of place on a panel of this size.

It will now be necessary to finish off and polish the panel. A very simple method is to get a handful of steel wool, spread a few drops of olive oil on the panel, and rub steadily until all trace of scratches vanish. Use plenty of oil and rub in the same direction always. The finished results will be surprising. To retain this clean and neat appearance the panel will only require to be cleaned regularly with an oily rag. The main panel need be polished on one side only as the rear is shielded. The sub panel should be polished top and bottom.

White lead should then be rubbed into the scratches or indicating marks. Use only a small amount of it and rub off the excess with a clean, dry rag. After it has dried over night rub again with an oily rag, to remove the thin white coating about the mark.

### SHIELDING

Shielding is next in order. If the main panel is not shielded the body capacity effects will prove very annoying. By lining the rear of the panel with tinfoil or other metal sheet and connecting it to the ground, moving the hands away from or near to the set will not change the signal. In some sets

(Continued on page 708)

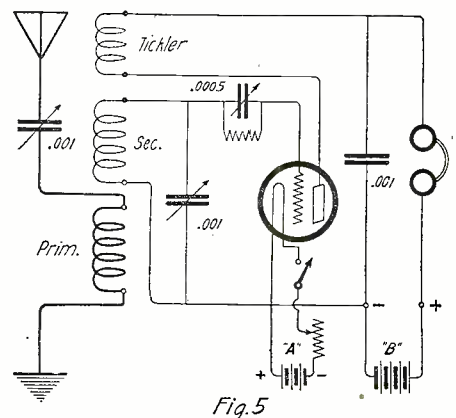

Standard Three-Coil Regenerative Circuit; This is One of Many Hook-Ups Which May Be Used with the Receiver Described in the Accompanying Article.



# Awards of the \$50 Radio Wrinkle Contest

## First Prize

### A DOUBLE VERNIER

By LEO COHEN

WHILE tuning in phone signals and C. W., I experienced considerable trouble in adjusting the secondary condenser. The following is a method I devised and have used for some time with good results.

Taking an ordinary 43-plate condenser out of its casing I mounted a large gear wheel on its shaft; the condenser in turn was mounted on the back of the receiving panel in the usual manner with the exception that no shaft protruded. A small gear wheel was mounted on a brass shaft and fitted through the panel so as to mesh with the large gear. This shaft may be centered on the cover of the condenser or other arrangements made for its rear bearing, the panel acting as front bearing. Upon this shaft a 3-inch dial and knob was attached. At the present stage it may be used and an adjustment of 5 to 1 secured. The gears were obtained from a telephone bell ringer, which served the purpose admirably owing to the numerous teeth on the gears.

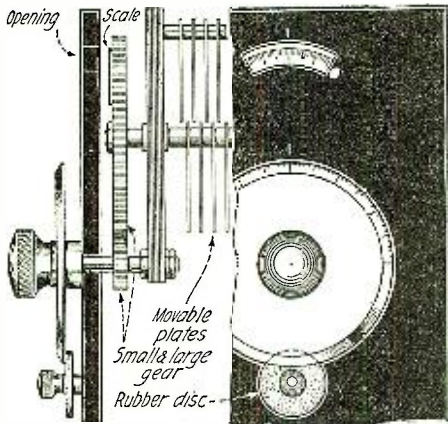

This Prize-Winning Suggestion for a Double Vernier Control is Very Practicable and Well Described.

For much finer adjustment, I fitted another shaft in vertical line with the condenser and dial centers, upon which was mounted a piece of rubber packing in such a manner as to bear friction against the under side of the dial. A small binding post knob was attached to this shaft which further allowed close adjustment, similar to the vernier attachments on the market today. You realize that the dial will turn several times before the condenser has made half a revolution and in order to know how your condenser is setting, a 180-degree scale is mounted on the large cog wheel and an opening cut in the panel to view the scale.

An illustration is herewith attached to make this description clearer and from the general plan the amateur may devise his own means for mounting the gears and condensers he may have on hand.

## Second Prize

### DETECTOR STAND OF NOVEL DESIGN

By R. E. GERHARDT

I present, in this article, an interesting wrinkle which has proved so satisfactory in actual use that I have decided to enter it in the contest.

Essentially designed for galena or silicon, this stand provides close regulation of the degree of pressure on the crystal. The importance of this feature is not to be overlooked if maximum efficiency is desired.

## PRIZE WINNERS

First Prize, \$25

Mr. Leo Cohen  
310 West 14th Street  
New York

Second Prize, \$15

Mr. R. E. Gerhardt  
Hoquiam, Washington

Third Prize, \$10

Mr. W. S. Mayers  
234 Watson Avenue  
Fairmont, W. Va.

When completed, the stand is placed on a solid base out of the way so that when once adjusted, movement of the receiver or accidental jars will not affect the adjustment. It would be well, in building a crystal receiver, to keep this point in mind.

As may be seen in the diagram, a compass or divider is used as the movable arm and pressure regulator. Secure a good compass; cut off one leg at the point indicated and bore two holes for the insertion of the pivot-contact. The arm may be cut off with a good hack-saw or sharp file and should be rounded off to avoid accidentally scratching oneself. The holes are to be cut with sufficient diameter to pass an 8/32 round-headed nickel machine screw. For a crystal cup I have used an old battery carbon terminal, although a purchased cup will not cost much and presents a neater appearance. If desired, the holder may be made after the builder's own ideas. A clip is sometimes employed with good results.

As the size of the compass will vary from that which I am using, the exact distance between the swivel and cup cannot be given;

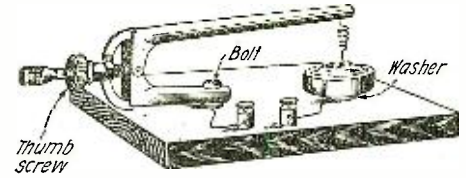

An Excellent and Exceedingly Simple Crystal Detector. Easy and Universal Control is Afforded.

however, the correct space is easily ascertained and should be marked on the base for drilling. Hardwood, fibre, bakelite, rubber or other good insulating material may be used for the base, the size of which will depend upon the type of compass employed. Secure a heavy piece and after the stand is assembled, it would be well to glue a thick layer of soft felt to the under surface. The felt will serve the dual purpose of preventing harm to polished tables and will allow the absorption of slight shocks and jars. I have used a piece of old storage battery jar for the base and after shining it up, was very pleased with it.

To assemble the instrument, it is necessary to drill two holes at one end for binding posts and two holes for the detector cup and adjusting arm. Use a good grade of well-insulated wire for connections and be sure that all points are soldered. For the cat-whisker, a No. 28 bare copper wire will give as good results as any. In actual use, the end of the wire touching the mineral should always be clean.

It is not necessary, contrary to our newspaper radio editor's opinion, to wash the crystal every week or so, or to wash it every day as advised by some. The daily tub in no way adds to the efficiency of the detector, as a trial will conclusively prove. If the dust is blown from the mineral surface every day, the unit will function satisfactorily.

If it appears as though the sensitivity of the mineral has faded, a new surface may be scratched with a knife. Either unmounted or mounted crystals give satisfaction with this stand. In general, keep the mineral as small as possible to allow only a short separation between the point of cat-whisker contact and the holder. This is said after the fact has been learned that most large crystals are "sensitive" near the edge. The stationary contact should be made to cover as large a portion of the unused surfaces as possible.

I am confident that anyone constructing this stand will find it entirely satisfactory.

## \$50 in Prizes

The special prize contest for radio amateurs and beginners is held each month. There are three monthly prizes as follows:

First Prize	\$25.00 in gold
Second Prize	\$15.00 in gold
Third Prize	\$10.00 in gold
Total	\$50.00 in gold

What we desire are simple ideas exclusively for the beginner and the novice, the simpler the radio idea the better the chance to win the prize.

There are lots of valuable little stunts that you amateurs run across every month, and we mean to publish these for the benefit of the entire Radio fraternity.

If possible, a clear photograph should be sent with the idea, but if that is not possible, a good sketch will do.

This prize contest is open to everyone. All prizes will be paid upon publication. If two contestants submit the same idea, both will receive the same prize. Address all manuscripts, photos and models to *Editor Radio Wrinkle Contest*, care of this publication.

## Third Prize

### VARIABLE CONDENSER MADE FROM PHOTO PLATE HOLDER

By W. S. MAYERS

An old 5"x7" photographic dry plate holder, which has been discarded in favor of the newer film holder, may be used in the

(Continued on page 794)

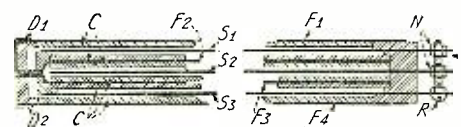

F1, F2, F3, F4 - Fixed Plates. S1, S2, S3 - Sliding Plates. C - Cardboard. D1, D2 - Fixed plate connectors.

A Good Idea. Use an Old Photographic Plate Holder as a Variable Condenser.



# Practical Hints for Amateur Constructors

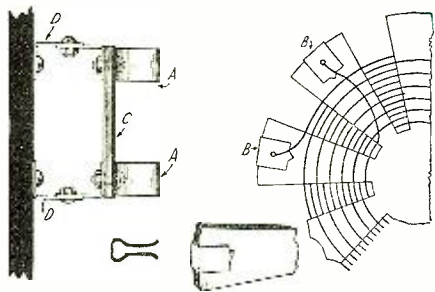

A Very Simple and Convenient Manner of Mounting Honeycomb Coils is Shown Above.

## MOUNTING FOR SPIDER-WEB COILS

Spider-web coils are very easily constructed and because of their efficiency they have found favor in many amateur receiving sets. The difficulty in mounting these coils has presented a stumbling block to beginners and, I believe, has retarded their general adoption.

With this in mind, I have designed the simple mounting shown and described in this article. First obtain some fairly thin sheet brass, cutting it to size and shape as required. For a movable or coupling mounting, two right-angle brass strips are fastened to the panel as shown. They may be 1/2" wide, the length depending upon the personal wishes of the builder. Two more strips of almost the same size, except for the flanges which are set as shown to clasp the coil terminals, are cut and pivoted to the first angles. Use 6/32" machine screws and hexagon nuts for pivots and for clamping the angles to the panel. To each coil affix the small brass strips cut to the shape indicated, driving the pointed tips into the coil form securely. The strips are spaced the same distance as the clasps on the panel to permit contact. (The wire leads are soldered to their respective brass strip.)

A stationary coil mounting may be designed in the same manner so that, if it is ever desired, it, too, may be varied. Be certain that the clasps have sufficient spring to securely hold and make good electric contact with the coil terminal strips. It is not necessary to have the coils running in a certain direction as they may be inserted in the holder in either direction, an important feature.

Possibly a word concerning the spider-web coils themselves would not be out of place here. Use No. 24 D. C. C. throughout. This wire is good for all coils in receiving sets and manufacturers and amateurs would do well to standardize on it. The forms may be made from two or three circular discs of stiff manila board glued together under pressure. To the top and bottom, glue a strip of varnished cambric sheet or empire cloth. Nine or 11 radial slots are cut in the form and the wire carefully wound on till the desired inductance is obtained. A number of these coils, of varying

turns, may be made and will prove satisfactory in the reception of different wavelengths.

Contributed by S. LITCHINSKY, Drumheller, Alta., Canada.

## SWITCH FOR POCKET SETS

Many amateurs are beginning to make pocket sets, but they sometimes experience difficulty in the selection of a proper switch lever and become quite puzzled because of the fact that the ordinary switch is too big for the small space allotted to it. A suitable switch for such work can be made from a binding post. The style with the rubber knob and threaded washer is best. A piece of brass 1/2" high and 1/32" in thickness should be bent and made to fit the threaded screw and a steel spring which will fit loosely over the brass sleeve will have to be procured. It will be best to cut the lever out of a springy piece of brass. On tightening the washer, the switch will never become loose.

Contributed by J. POLAK, N. Y. C.

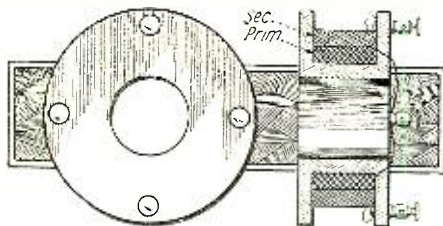

A Ford Spark Coil Spool Can Be Used as the Winding Form of a Radio Frequency Transformer.

## A RADIO FREQUENCY TRANSFORMER

I have found by experiment that the home-made radio frequency transformer is the only kind for the experimenter who wishes to build an efficient and selective radio frequency amplifier using from two to three or four stages of amplification.

Eight or ten such transformers as here described may be constructed in a short time at the work bench and will cover a large band of wave-lengths.

No. 40 cotton or silk covered wire may be used for both primary and secondary. Ford coil secondary wire may be used satisfactorily with ratio of primary and secondary windings 1-2, on short wave-lengths.

The winding forms are made from a Ford spark coil secondary spool, the wire first being removed and then the individual spools, used originally for winding the pies on the secondary, sawed out. They may be sandpapered and shellacked to improve appearance.

The primary is first wound on and the terminals fastened to binding posts, as shown in the drawing, this winding being covered with some insulating paper or cloth. The secondary is wound over this and the terminals fastened to the other pair of binding posts. The exposed secondary winding should be covered with paper or tape for protection.

Such transformers are easily constructed and serve well for amateur use.

Contributed by CECIL E. RHODE, Eureka, Kansas.

## A LIGHTNING SWITCH BLADE OF GREATER ELECTRICAL EFFICIENCY

In the design of radio installations, one of the simplest and best methods to increase efficiency in both transmission and reception is to eliminate, as nearly as possible,

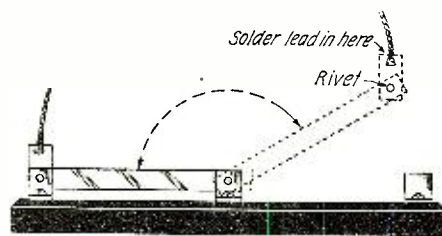

This Type of Lightning Switch Prevents Any Loss in Poor or Dirty Contacts.

all unsoldered joints. In going over my own set to get rid of unnecessary joints I found one stumbling-block in the joints of the lightning switch. Since the switch was out of doors, these joints, because of the action of the weather, were of very high resistance and a test showed that the chief trouble was at the point where the blade was pivoted. The pivot to work freely had to be loose, allowing dirt and oxide to collect, while at the jaws the clipping action made a fairly good self-cleaning contact. It is remarkable that reception is not entirely blocked at times by the poor contact at the middle support. Such a joint is particularly harmful to C. W. transmission with its low potential. A temporary solution of the problem was found by dispensing with the switch, but of course this could not be tolerated.

In designing a new blade the first consideration was to afford the same or even better protection from lightning and after that to increase electrical efficiency and maintain mechanical strength, economy, and ease of operation. The design evolved can be applied to any standard switch, is easily made by amateurs and can be standardized by manufacturers. It requires no changes in the switch except the blade, and, in the case of an entire switch being manufactured with this feature, would be cheaper. Several of these switches have been in use for almost a year and have given excellent results.

### CONSTRUCTION

The blade proper is made of Bakelite 1/8"x1" (the length of old switch blade, nearly always 6"). A strip of copper is needed 1/16"x1"x4 1/8", bent as shown in the drawing, and drilled one half inch from the ends with a 1/8" drill or larger and countersunk. The Bakelite strip is also drilled to accommodate the pivot at one end and with the 1/8" drill at the other. All four corners should be rounded. The copper strip is then riveted to the Bakelite and the rivet filed off flush on each side. The copper must be allowed to turn freely. The lead-in is then soldered to the copper strip and the switch reassembled for use.

### ACTION

The Bakelite forms an insulating handle for throwing the switch and also increases the insulation of the parts from the base. Only one unsoldered contact remains, and several sharp turns are eliminated, which

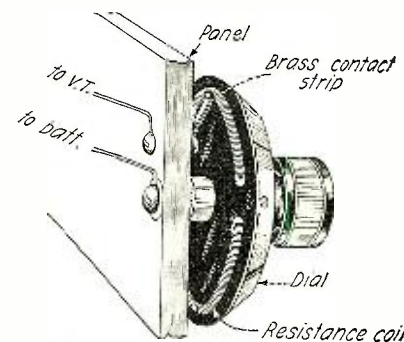

This Compact Rheostat Can Be Easily Made and Looks Well on the Set.

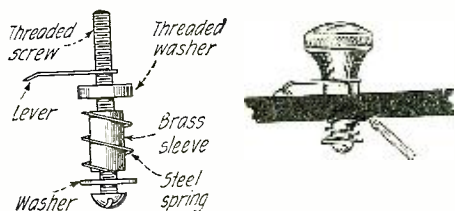

This Shows the Best Way to Make a Switch Lever for a Pocket Radio Set. The Knob is a Small Binding Post.



reduces brush discharge. As the copper strip swivels the lead-in is not kinked or twisted in any way.

The switch may be considered merely as a modification of the plug and jack system having an insulating handle, and a guide to direct the plug and keep it always at hand.

Contributed by E. P. TALBOT,  
Indianapolis, Indiana.

**A COMPACT RHEOSTAT**

The materials needed to make this rheostat are a composition dial, some resistance wire, a small strip of brass, and some screws and mica disc. Wind the resistance wire on a 3/16" rod; when the coil is wound on connect one end to the brass backing inside of the dial and cut the other end off about 1/4" from the set-screw that runs from the top of the dial to the bushing. Cut out a round piece of thick mica large enough so that the wire will fit tightly on it, and then groove the mica. Cut out a hole in the center of the disc so it will fit snugly over the bushing, and drill a hole the size of this set-screw parallel with the disc. Put the set-screw in and this will hold the disc on the dial. Punch two holes in the disc where the two ends come and connect one end to the bushing. This serves as one contact and the other contact is made by the small brass strip that is fixed on the panel.

Contributed by LONDON CORRINGTON,  
Memphis, Tennessee.

**A UNIVERSAL CRYSTAL DETECTOR**

I have not yet seen in RADIO NEWS a really good detector, from my point of view, that the beginner can construct easily from materials at hand in the workshop. My idea of a good detector is one with which

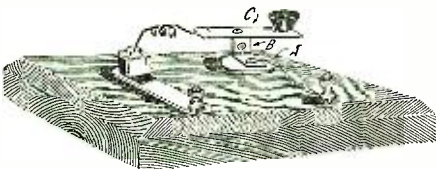

A Universal Joint Crystal Detector Which is Simple to Construct.

a fine adjustment may be made on any point of the crystal. The detector described here has a form of universal joint which allows such an adjustment.

It is mounted on a wood base, 6x3x3/4". The materials required are, a base, two binding posts, a strip of spring brass 2 1/2 x 1/2", a wooden pot-lid knob, three small lock washers, and several pieces from a structural toy set such as "Erector" or "Meccano."

To make the universal joint first get a 2 1/2" strip, three small angle pieces, and several nuts and bolts from the toy set. These are assembled as shown in the diagram with lock washers under the nuts at the points B and C. A round-head wood screw with a lock washer under the head is used to hold the joint to the base at A. A plain washer is placed between the wood and the angle piece to make it turn easily. The knob is put on one end of the horizontal arm and

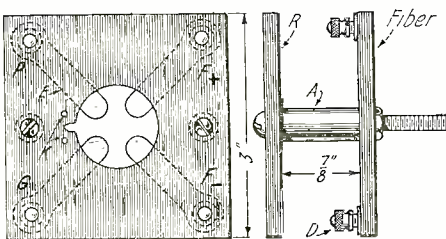

A Tube Socket Can Be Made from Pieces of Scrap Bakelite.

the cat-whisker on the other. A wire is soldered near the middle of the arm and a pig-tail lead is made over to one binding post.

The screws at points A, B, and C should be adjusted to give the desired stiffness of operation.

The crystal holder is shaped from the strip of spring brass. This is bent hair-pin shaped as shown and an angle piece is soldered on one side. A wood screw is used to fasten it solidly to the base. This holder is connected to the other binding post. The holder should be made so that it closes all the way when the crystal is not in it.

If lock washers are not to be had, small stiff springs may be used in their place.

By careful workmanship this may be made a very neat and efficient instrument.

Contributed by JOHN W. DIXON.

**A TEN CENT V. T. SOCKET**

In the accompanying sketch I show a home-made V. T. socket which I have made for about ten cents.

Believing that a socket of this type will be of interest to many amateurs, the complete details are given here.

The socket consists essentially of two pieces of fibre (R) or other insulating material cut 3" square. In the center of each piece drill a 1 3/8" hole. Drill four holes in the corners of the bottom piece and two extra holes for the supporting collar and screws.

From spring brass cut four springs as indicated (E). Secure the springs firmly to each corner of the bottom insulating strip, using binding posts, as shown (D). The two collars (A) are 7/8" long and may be cut from either solid stock or tubing.

Drill two holes in the upper spring and assemble the parts to form the completed unit.

The position of the slot for the tube pin should be carefully placed. Small studs (K) are driven into the upper strip on each side of the slot in order to prevent the tube from moving more than it should.

A row of these sockets may be made for an amplifier.

For the strips I have used the material on old storage battery jars with great success.

Contributed by EUGENE SCHMIDT,  
Utica, N. Y.

**SNAP FASTENERS AS CONNECTORS**

The small snap fasteners for dresses that are sold in all ten cent stores for five cents a dozen may be put to a great many uses by the radio experimenter.

The accompanying sketches show a few of the uses to which they can be adapted. These fasteners make very neat binding posts and by using different sizes and different halves of the fastener the set can be made so that it is impossible to connect it up wrong. By soldering one half of the fastener on the phone cord and the other half on the panel with a common pin as shown, the phones may be plugged in quickly and if the cord gets a strong pull they will release and not pull the set off the table. A very good multi-point switch may be made by pinning to the panel as many points as wanted in a circle and also one at the center of the circle, and then with the two halves of the fastener soldered on to a strip of copper at a distance equal to the radius of the circle a switch arm can be made. The fastener in the center makes a good swivel and when the right point of the switch is found in tuning the other fastener can be pushed home making almost a positive contact.

Another use I have made of them is in mounting home-made honeycomb or spider web coils. I fasten one part of the fastener on both top and bottom of the coil form and

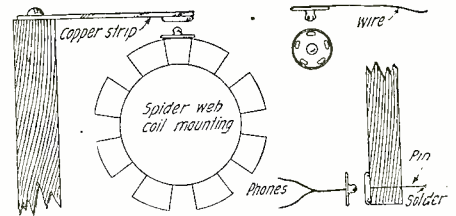

Snap Fasteners Are Very Useful as Connectors and in Many Other Ways.

solder the ends of the coil to them. The other half is soldered to a strip of copper or brass that acts as the arm to swing them on. This form of mounting is very handy if much changing of the coils is made for it works so quickly. A good connection to the end of the variocoupler or variometer rotor shaft may be made by soldering a fastener on the end and the other half to a flexible wire.

No doubt other uses will occur to the experimenter. They are certainly cheap enough and always make a good contact and provide a neat appearance.

Contributed by FRED. W. TEMPLE,  
Lenwood Hospital, Augusta, Ga.

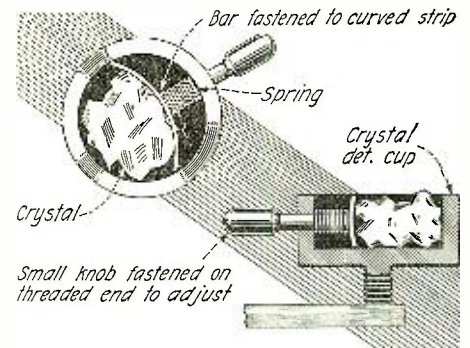

This Spring Clamp for a Detector Cup Permits Any Size of Crystal to be Firmly Held.

**SPRING CLAMP FOR CRYSTAL**

Here is a little idea that is very practical. It is a simple spring clamp to hold your crystal securely in its place. Anyone can make it from an old crystal cup and a narrow bar. The spring is an easy factor to obtain and the small knob can be found anywhere in the experimenter's "junk box." Solder a curved brass strip to the brass bar, which latter should fit your set screw hole, put a spring between the strip and the body of the cup on the bar so that when the latter is pulled out the spring contracts. Tap the end of the bar on the outside and screw a small hard rubber knob on it to adjust the clamp. Thus on pulling the knob out the clamp contracts the spring and the crystal, which is then set in the clamp, is freed, thus holding the crystal securely in place.

Contributed by JACK KAHN,  
New York City.

**MAKING HOLES IN GLASS PANELS**

In making holes in glass, one often experiences difficulties through the chipping of the glass. A very simple way to overcome this is to procure some sand, wet it, and place about a teaspoonful on the spot where the hole is to be made. A lead pencil or any piece of round wood the size of the hole desired is then pressed in the sand, making a cast of the hole. Melt some lead or solder and pour into the impression, and the glass falling out leaves a fine hole. Glass will prove to be a serviceable panel and in the way described may be made cheaply.

Contributed by EMMETT VANCE,  
Oak Park, Ill.





**T**HIS Department is conducted for the benefit of our Radio Experimenter. We shall be glad to answer here questions for the benefit of all, but we can only publish such matter of sufficient interest to all.

1. This Department cannot answer more than three questions for each correspondent.
2. Only one side of the sheet should be written upon; all matter should be typewritten or else written in ink. No attention paid to penciled matter.
3. Sketches, diagrams, etc., must be on separate sheets. This Department does not answer questions by mail free of charge.
4. Our Editors will be glad to answer any letter, at the rate of 25c for each question. If, however, questions entail considerable research work, intricate calculations, patent research, etc., a special charge will be made. Before we answer such questions, correspondents will be informed as to the price charge. You will do the Editor a personal favor if you will make your letter as brief as possible.

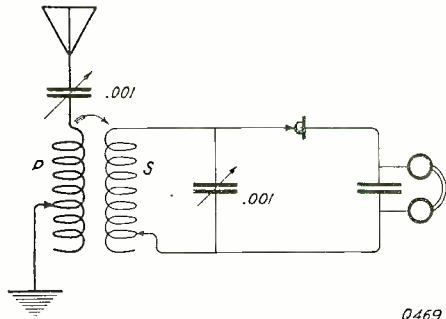

**A Crystal Circuit of High Selectivity. Additional Information on Crystal Receivers and Their Construction May Be Found in the Answer to This and Other Questions in the Column.**

**SEARCH FOR AN EFFICIENT CRYSTAL**

(468) Mr. R. C. Crowe of Chicago, Illinois, asks:  
 Q. 1. I would greatly like to find a crystal which will give the best results in my set; is there any special one superior to all others?

A. 1. Many types of crystals will operate equally well, though occasionally a specially good piece may lead one to believe that that type is best. The design of the detector stand will greatly influence the results. Galena is the favorite but silicon will be found to be almost as good and retains a good spot for long periods at a time. A graphite contact instead of the usual copper cat-whisker will sometimes give surprising results when used in conjunction with galena. Carborundum has the advantage of eliminating fine adjustments and is very rugged. Molybdenite, zincite or zincite in combination with bornite, iron pyrites and others have been successfully used. A block of galena may be purchased and broken into small pieces. Some good crystals will most likely be found.

**BEST CRYSTAL CIRCUIT**

(469) Mr. R. Irvin of Salmon, Idaho, wishes to know:

Q. 1. Of all the crystal circuits which will give the most satisfactory results?

A. 1. The double circuit crystal receiver shown in this column will provide the most efficient method of crystal reception.

Q. 2. What form of inductances will be best and how should they be constructed if the range is to be from 200 to 600 meters?

A. 2. It is necessary to have two tapped inductances for which purpose tapped single layer coils, tapped honeycomb or duolateral coils, tapped spiderweb coils or other special forms will be suitable. A small and efficient loose coupler may be made by having a primary tube 3" in diameter wound with 100 turns of No. 24 D.C.C. wire. Tap this coil at every 25th turn. The secondary may be wound on a 2 1/2" tube with 70 turns of No. 24 D.C.C. wire tapped every 15th turn. The coils may be coupled by sliding the secondary into the primary. If honeycomb coils are used, secure a DL 100 for the primary and tap it at each layer if possible; the secondary may be a DL 75 tapped at each layer. Spiderweb coils of the same number of turns tapped every 25th for the primary and every 15th turn for the secondary may be used. Two variable condensers are connected as shown in the diagram. To vary the coupling of these coils, three methods are in common use. The secondary or primary can be secured to a sliding rod

and moved to or away from the other coil, or one coil may be slid over the other; the third method, which is most used, is to have one coil on a hinge so that the coupling may be varied by changing the angle of windings. In all coils No. 24 D.C.C. may be used to good advantage.

Q. 3. Does it matter greatly in which direction you connect the crystal stand?

A. 3. No difference is noticeable in reversing connections to the crystal stand.

**CIRCUIT OF MARCONI TYPE 106 RECEIVER**

(470) Mr. R. E. Ciever of Chicago, Illinois, writes:

Q. 1. Please publish a hookup of the Marconi 106 tuner.

A. 1. The diagram you request is shown on these pages.

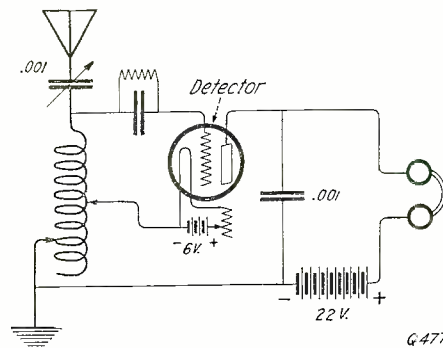

**There Is No Necessity for Throwing Away the Old Two-Slide Tuner. This Circuit Works Very Well When Properly Connected.**

**SELECTION OF APPARATUS**

(471) Mr. W. O. Rondolf of Rochester, New York, writes as follows:

Q. 1. What transformers would you recommend for audio and radio frequency work?

A. 1. By reading the "Certificate of Merit" page in this and other issues of RADIO NEWS, you may be guided in the selection of efficient and high grade apparatus.

Q. 2. If jacks are used to plug in the tuner on any number of radio frequency amplifiers will the efficiency be greatly decreased?

A. 2. Unless the jacks have an exceptionally low capacity, the efficiency will be greatly impaired. A hookup is shown on these pages in which switches are used for this purpose. Remember to keep the leads as short as possible and the capacity at a minimum.

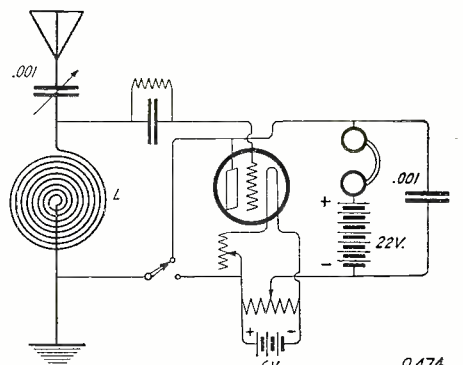

**A Spiderweb Coil Is Employed in the Single Audion Ultraudion Circuit Shown Above.**

**450 AMPERE HOUR STORAGE BATTERY**

(472) Mr. John Flynn of New York desired the following information:

Q. 1. Where may I obtain a fully-charged 450 ampere storage battery?

A. 1. If a voltage of 6 is desired, you may place 4 or 5 standard 100 ampere hour batteries in parallel to obtain the amperage you desire. 100 ampere batteries may be secured from any storage battery manufacturer. We do not know where a single battery of such large capacity may be obtained.

Q. 2. Please publish hookup of a Marconi crystal receiver.

A. 2. A diagram of a Marconi receiver is shown on these pages.

**ARMSTRONG SUPER-REGENERATOR**

(473) Mr. A. Woehr of Geneseo, Illinois, writes:

Q. 1. In the Armstrong super-regenerative circuit is it necessary to change the size of the grid and plate inductances of the second tube when the other inductances are changed for different wavelengths?

A. 1. The grid and plate coils of the second tube in the circuit employing two tubes remain constant. Only the tuning inductances of the first tube and the aerial inductance need be changed when the wavelength is to be varied.

Q. 2. Will two detector tubes give good results on this circuit?

A. 2. No, we would advise that you employ either hard amplifying bulbs or low power transmitting tubes.

Q. 3. What plate voltage may be used with the tubes?

A. 3. With small 5 watt transmitting tubes, 200 to 300 volts may be placed upon the plates. Use 80 to 100 volts on amplifier tubes.

**SINGLE COIL V. T. RECEIVER**

(474) Mr. G. T. Payson of Macon, Missouri, requests:

Q. 1. Please publish an efficient hookup for one spiderweb coil, one variable condenser and a vacuum tube control unit.

A. 1. The diagram you request is shown on these pages. Either straight audion or ultraudion connections may be used. If desired, another spiderweb coil may be connected in series with the plate and positive pole of the B battery to be coupled back to the main inductance for regeneration.

Q. 2. Will a potentiometer

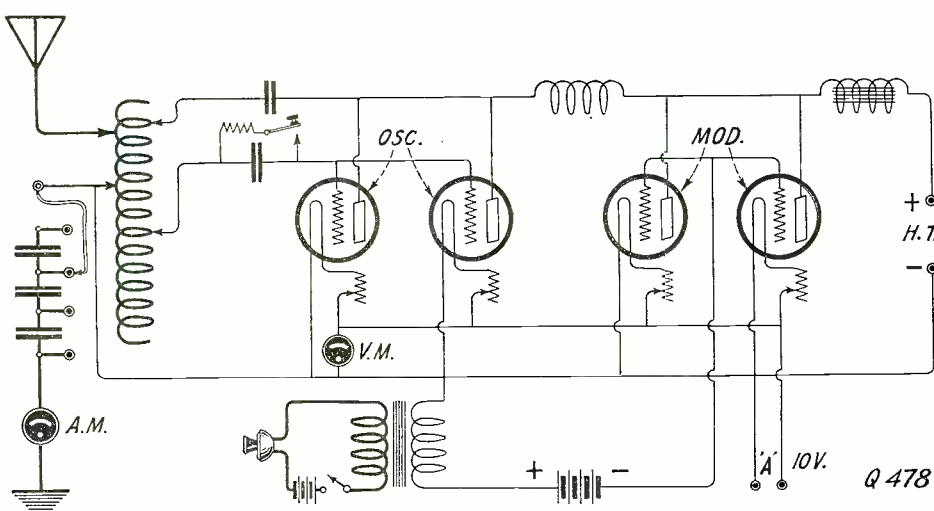

**Four Tubes, Two Modulators, Two Oscillators, Are Employed in This Circuit Combination Phone and C.W. Transmitter. When It Is Desired to Use I.C.W. a Buzzer May Be Placed in the Position the Microphone Is Connected.**



meter across the A battery be of any aid in reception?

A. 2. The A battery potentiometer will be of some benefit if properly adjusted. A tapped B battery could be used instead but the plate voltage control would not be as accurate. The potentiometer connections are shown in the diagram.

**GROUNDING THE METALLIC RADIO MASTS**

(475) Mr. H. J. Simpson of the Bronx, New York, writes:

Q. 1. Will there be any loss in efficiency if the metallic masts supporting an aerial are grounded?

A. 1. A small amount of absorption will result if the masts are grounded but we do not believe that the loss will be very great.

Q. 2. Why is it possible for the antenna voltage to reach a value higher than the secondary current?

A. 2. The step-up action of the oscillation transformer will explain this.

**ANTENNA CONSTRUCTION**

(476) Mr. H. Reynolds of San Francisco, California, requests:

Q. 1. In what direction shall I place my inverted L aerial so that I may obtain best results from all points in the United States?

A. 1. If your aerial lies in a line extending from east by north to west by south with the lead-in at the eastern end, you will obtain the desired effect. An inverted L aerial is directional in a direction opposite to that of the free end. For efficient all-round reception in the central United States, amateurs in that district should employ T aeriels about 150' long placed in an east and west direction. By applying the principle of the directional effect of different Types of aeriels, anyone may arrange his aerial for either the best all-round reception or maximum signal strength from some particular station.

Q. 2. Is the insulation in the receiving aerial very important?

A. 2. The best possible insulation should be employed in any aerial if maximum results are desired.

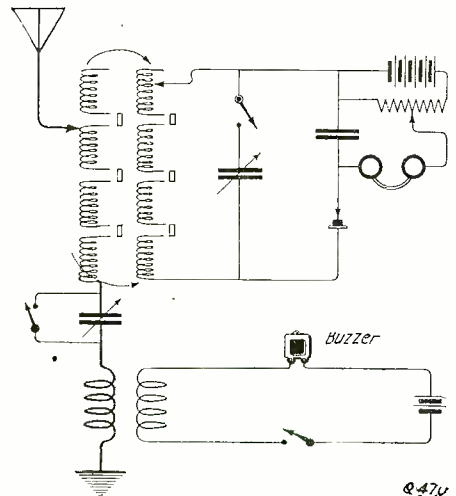

The Hookup Employed in the Marconi Type 106 Tuner Is Shown Above. The Battery and Potentiometer Are Used in Conjunction with a Carborundum Detector.

**DOUBLE SLIDE TUNING COIL**

(477) Mr. Dill of Hazleton, Pa., asks:  
Q. 1. Please show a diagram of a two-slide tuner and vacuum tube detector?

A. 1. The diagram you request is shown in these columns.

Q. 2. Please give all details.  
A. 2. The constants are shown in the diagram. You will need a two slide tuner, a variable condenser, a grid condenser, a socket, a rheostat, a B battery, a detector tube, a headset, a fixed phone condenser, wire, etc. By carefully adjusting the slider it is possible to obtain very good results with this simple outfit. The slider connected to the negative side of

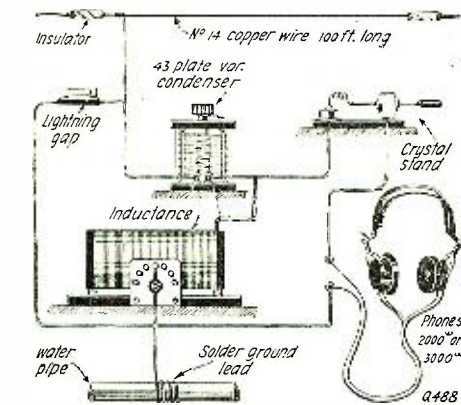

Here Is a Sketch of a Single-Circuit Crystal Receiver, Data for Which Will Be Found in the Answers to Question 488.

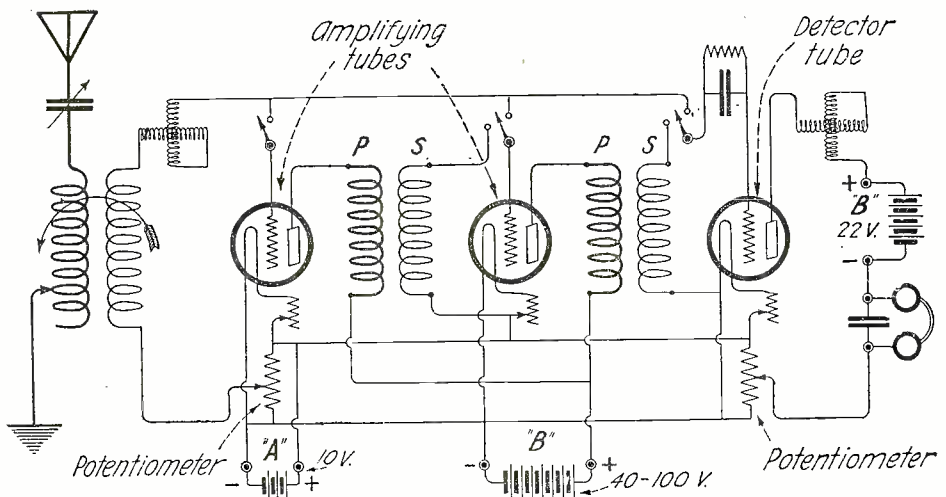

Q. 471—A Switching Arrangement for a Radio Frequency Amplifier.

the filament controls the regeneration, while the ground slider and aerial series condenser constitute the wavelength control.

**TRANSMITTING CIRCUIT**

(478) Mr. E. J. Seyfried of Flushing, New York, wants to know:

Q. 1. Please publish a hookup for a C.W., I.C.W. and telephone transmitter using four 5-watt tubes.

A. 1. A suitable circuit is shown on these pages for the set you desire to employ.

Q. 2. Where may I obtain "peanut" tubes?

A. 2. "Peanut" tubes or Aerotron bulbs are manufactured by the Westinghouse Company, but are not on the market at the present time.

**WAVEMETER FOR 150-250 METERS**

(479) Mr. Jack Dempsey of New York, asks:

Q. 1. Please give me some constructional data on a short wave wavemeter.

A. 1. Wind a coil of 25 turns No. 18 D.C.C. wire on a well-seasoned and shellaced wooden form. Shunt this coil with a good make of 43 plate variable condenser; the condenser is the determining factor in the wavemeter and great care should be exercised in its purchase. Mount the coil and condenser in a box on a fiber panel; make connections direct (avoid all bends). The dial should be riveted or otherwise firmly attached to the shaft and should be set so that when zero is registered on the scales, the capacity is lowest. Write the Bureau of Standards for shipping instructions and if you follow them out carefully they will calibrate your wavemeter. The range of this meter will be rather large but use only the portion of the 180° scale between 20° and 60°. In this manner the curves at the maximum and minimum setting are avoided. In asking the Bureau to calibrate the meter, request that one point be taken at 200 meters so that there will be no discrepancy in the finished curve. If you desire a D.C. 25 honeycomb coil could be used instead of the inductance mentioned.

**AMPLIFIER TROUBLE**

(480) Mr. T. Borden of New York wishes to know:  
Q. 1. I have a one stage amplifier and am unable to secure proper operation; what would you advise?

A. 1. The general trouble with amplifiers may be traced to improper connections at the amplifying transformer. It would be advisable to reverse the primary connections to make sure they are properly connected. Try reversing the storage battery leads to the amplifier. Use a plate power up to 100 volts if regular amplifying tubes are used. It will be well to place a fixed condenser of .001 M.F. across the primary of the first transformer to pass the radio frequency currents in the plate circuit of your regenerative set.

Q. 2. What size honeycomb coils should I use for 1500 meters reception?

A. 2. DL 200 primary, DL 150 secondary, DL 75 or 100 for tickler.

**CORRECT SIZE WIRE FOR RADIO WORK**

(481) Mr. Kidd of New York inquires:  
Q. 1. What size wire should be used in the different parts of a radio receiving set?

A. 1. No. 14 copper or copper-clad may be used for the aerial, ground and connections. No. 18 may also be used for the connections. No. 24 double cotton-covered can be used for coils and couplers. No. 16 is a safe size to carry the filament current

although a heavier wire will be better when using more than one tube.

Q. 2. I have often seen the terms D.C.C., S.S.C., S.S.C., and at times, E.C.—what do they mean?

A. 2. D.C.C. means double cotton-covered; S.S.C. means single cotton-covered; S.S.C. means single silk-covered; E.C. means enamel covered.

Q. 3. What determines the size covering on wire to be used in making turning coils?

A. 3. If distributed capacity is to be kept low for efficiency in operation, D.C.C. is generally used. If small size is required, S.S.C. or E.C. may be used with a slight loss in efficiency.

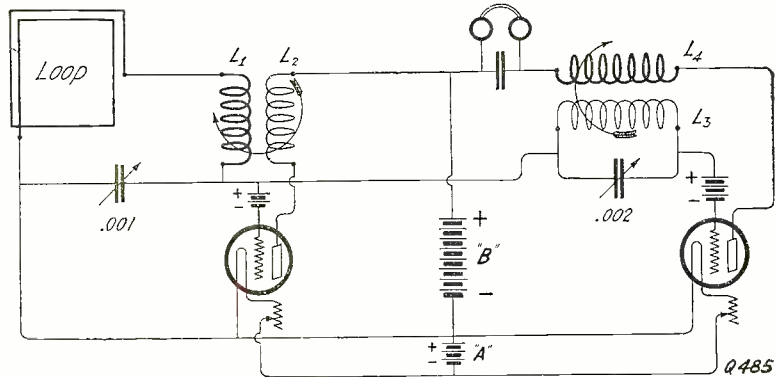

The Armstrong Super-Regenerative Receiver, When Properly Adjusted, Is Capable of Extreme Amplification.

**STANDARD HONEYCOMB CIRCUIT**

(482) Mr. N. Dow of Philadelphia, Pa., asks:

Q. 1. Please show a honeycomb hookup with V.T. detector.

A. 1. The diagram you request is published on this page.

Q. 2. Is such a circuit suitable for damped and undamped waves?

A. 2. This circuit will respond to all types of waves when properly tuned.

Q. 3. What will give best results as a receiving ground, the water pipe, gas pipe, radiator, fire escape or counterpoise?

A. 3. The water pipe will generally prove more efficient than the other ground you mention, though a combination of two or more of the others will be satisfactory.

**2500 METER LOOSE COUPLER**

(483) Mr. Stephen Morton, Jr., of Elizabethton, Tenn., writes:

Q. 1. Please give me instructions for building a loose coupler to tune up to 2500 meters.

A. 1. Use No. 24 D.C.C. on both primary and secondary; wind 400 turns on a 4" tube for the primary with taps every 25 turns. The secondary tube should slip inside the primary and is wound with 200 turns

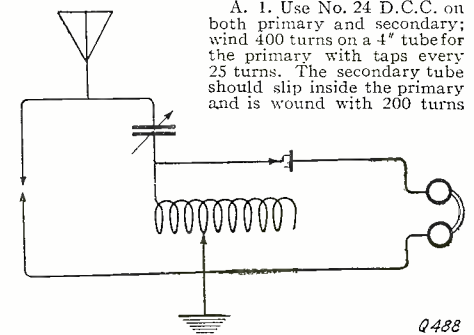

This Circuit Is the Same as That Shown in the Cut on the Opposite Side of the Page. In This Diagram Symbols Are Used to Denote Each Instrument. As an Aid to Beginners the Other Cut Has a Sketch of Each Part.



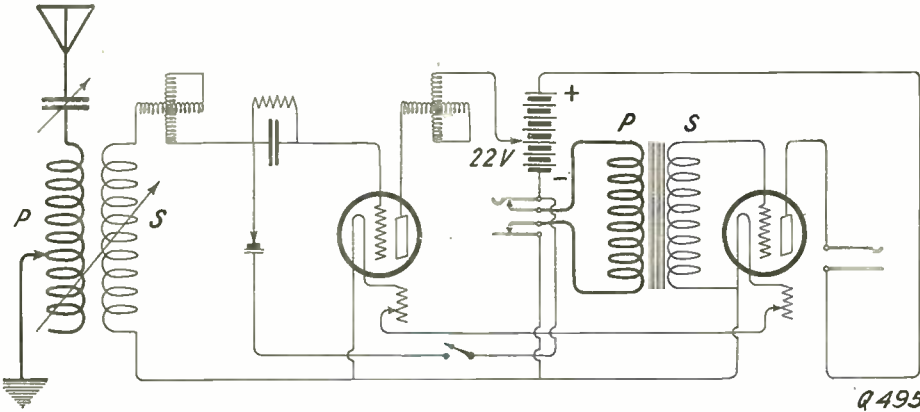

Either a Crystal or Vacuum Tube Detector May Be Used with This One-Step Amplifier.

tapped every 25th turn. A series condenser of .001 M.F. is used in the primary and a similar condenser to shunt the secondary.

Q. 2. What is the average phone and C.W. range of a 5-watt transmitter?

A. 2. With an efficient transmitter and a good receiving set, the phone range should be about 20 miles, the C.W. range about 50 miles.

**CHOKO COILS FOR POWER AMPLIFIER**

(484) Mr. N. Michel, Union Hill, New Jersey, asks:

Q. 1. How may I construct the choke coils for use in the power amplifier described on page 971 of the April-May issue of RADIO NEWS? Can I purchase them?

A. 1. A suitable choke coil may be purchased at

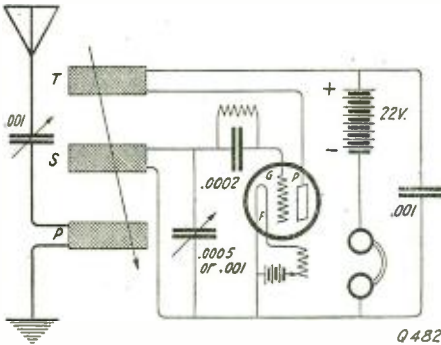

A Standard Three-Coil Honeycomb Set Is Shown Here. The Fixed Condenser Across the Phones and B Battery Will Prove of Benefit with Almost All Regenerative Receivers.

any electrical store as the primary of the small size of Wayne bell-ringing transformer is satisfactory for this purpose.

**ARMSTRONG SUPER-REGENERATOR**

(485) Mr. Jason Crain, Elnio Mayer, P. Rabito and others, ask:

Q. 1. Please publish a hookup of the new Armstrong Circuit employing two tubes.

A. 1. The hookup you request is published on these pages.

Q. 2. How many volts should be used on the plates?

A. 2. The plate voltage will depend upon the tubes employed. For amplifier tubes, 100 volts will be satisfactory. For transmitting tubes, use about 200-300 volts. Transmitting tubes have proven satisfactory with this circuit.

Q. 3. What value should the different coils have for 360 meter reception?

A. 3. The coil L1 is the primary of a variocoupler and L2 the secondary of the same, rewound with 90 turns; L3 is a 1,250 duolateral coil and L4 a 1,500 duolateral coil. The phone condenser should have a capacity of .005 M.F. Some difficulty may be found in tuning this circuit until the proper control is mastered.

**MAKING A REGENERATIVE SET REGENERATE**

(486) Mr. W. E. Dougherty of Ault, Col., asks:

Q. 1. What must I do to make my regenerative set oscillate without forcing the filament.

A. 1. If the resistances of all circuits and contacts are reduced to a minimum, the receiver will operate correctly with lowered filament current. It would be advisable to go over the wiring carefully; use at least No. 18 wire for connections. Soldering all contacts will be of great benefit. Make certain that the vacuum tube makes positive contact with the socket prong. It may be that a cell in your B battery is dead; try a new battery. Shunt a condenser of .001 M.F. across the phones and B battery to allow a bypass for the radio frequency oscillations. Your ground may be of high resistance, try improving it or use a counterpoise in conjunction with it. The number of turns on your tickler is correct but perhaps closer coupling between tickler and secondary would help. Keep the secondary condenser as near zero as possible, using the inductance to increase the wavelength. Make a grid leak from the grid to the positive side of the filament.

**CONSTRUCTION OF CRYSTAL STANDS**

(487) Mr. J. R. Jones of San Francisco, Cal., asks:

Q. 1. Would you advise me to place my crystal stand directly upon the receiver panel or will I have better results by making it entirely separate?

A. 1. It would be advisable to construct the crystal stand independent of the tuner. The reason this is preferable is primarily due to the fact that when a small crystal set is tuned, the cat-whisker is apt to be jarred out of adjustment, necessitating another bothersome search for a sensitive spot. By placing the stand, or better still, two or more stands controlled by a switch, upon a firm base, connecting them correctly to the tuner and locating the best position for the cat-whisker, you may tune or move the receiver without fear of knocking out the light contact.

Q. 2. What are the requirements for a good galena stand?

A. 2. Galena requires a light contact and is not sensitive all over, therefore you should design the stand so that the cat-whisker will be able to touch all points of the crystal and with any degree of pressure. A No. 28 copper wire will prove satisfactory for the cat-whisker.

**CRYSTAL RECEIVER DATA**

(488) Mr. H. S. Brown, New York, wishes to know:

Q. 1. Please publish a sketch of a good single circuit crystal receiver giving information relative to its construction.

A. 1. We publish on these pages, two diagrams of a single circuit crystal receiver. The inductance is formed on a tube 3 to 4" in diameter. It consists of 100 turns of No. 24 D.C.C. tapped every 10 turns. The inductance may be mounted on a board or a panel may be employed. In tapping, the best method is to leave a loop of wire at each point from which a tap is to be taken. Bring the end of the loop to the switch tap and solder. If desired, you may use cambric tubing to finish off the instrument neatly. The variable condenser is of .001 M.F. Connections between instruments may be made with No. 18 copper wire. Connect the lightning arrester as shown. Information on crystal stands and other simple apparatus will be found elsewhere in this column.

**RECEIVER RANGE**

(489) Mr. W. J. Pormba of Chicago, Illinois, wishes to know:

Q. 1. What is the range of a regenerative receiver, employing two variometers and a variocoupler?

A. 1. It is very difficult to state the distance over which a receiving set will function. Under favorable condition with a good set carefully tuned it is possible to hear phone stations of high power up to one or even two thousand miles. This, however, could not be accomplished every day. The average range is about 200 miles lower in summer and generally greater in winter. The time of day, the skill of the operator, the power and efficiency of the transmitter will all determine the distance which may be covered.

Q. 2. In what manner does audio frequency differ from radio frequency?

A. 2. Audio frequency is audible to the ear while radio frequency is inaudible. Frequencies below 10,000 are usually called audio, above 10,000 they are radio frequencies. Some ears can respond to vibrations above 10,000 but the average person cannot hear such sounds. For that reason the distinction is drawn at a frequency of 10,000 cycles per second.

**AMPLIFYING V. T. AS DETECTOR**

(490) Mr. H. Smith of Springfield, Mass., writes: Q. 1. Which type of bulb would you advise me to use with the set described on page 1214 of the June issue of RADIO NEWS?

A. 1. Mr. H. S. Pyle, the writer of the article you mention, recommends a hard or amplifying tube as it does away with critical filament control. You may employ either a hard or soft (detector) tube with good results.

Q. 2. With a loop aerial should I be able to receive stations ten mile away with this set?

A. 2. It would be possible to cover such a range with a loop, but the set Mr. Pyle described will function much better with the regular aerial and ground.

**PHONE POLARITY**

(491) Mr. J. Young, Honolulu, writes: Q. 1. Is it necessary to have the polarity of the phones correct when using a plug and jacks in a vacuum tube set?

A. 1. It is not absolutely necessary to have the polarity correct but most phones work best when connected in the proper direction. One manufacturer gives the correct polarity with each headset, a procedure others would do well to copy. Information on the correct polarity of phones when used in vacuum tube sets has appeared in previous copies of RADIO NEWS.

**BEVERAGE ANTENNA**

(492) Mr. J. Thomas of Tiffin, Ohio, wishes to know:

Q. 1. What is "Beverage" antenna?

A. 1. This form of antenna is named after its originator and essentially consists of one or more wires relatively low and either 1/2 the wavelength to be received, exactly the same, or double. In the one wire type, the far end is connected to the ground through a variable resistance, though in some other forms the resistance may be at the near end. This type of aerial is very directional and while it does not eliminate static, it reduces it to a much lower degree. The Beverage antenna has been used successfully for both long and short wave reception. Most of the transatlantic receiving stations are equipped with this form of antenna. The Beverage loop at Chatham, Massachusetts, is seven miles long, consists of 4 very heavy copper wires in the form of a square supported on ordinary telegraph poles. It points in

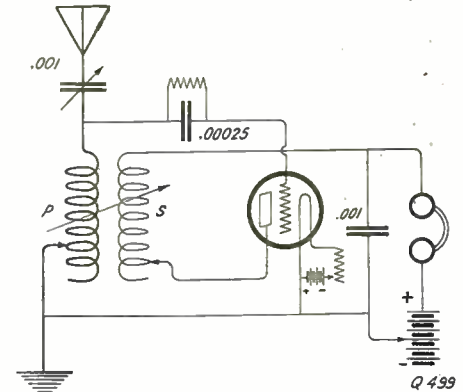

A Loose Coupler Provides a Good Tuning Element for a Single-Circuit Receiver, if the Above Circuit Is Employed.

a west by south direction with the lead-in at the eastern end. Reception from POZ and OUI in Germany and LCM in Norway is extremely successful while NPL in California which formerly had caused heavy interference, is barely heard. Mr. Godley (Continued on page 778)

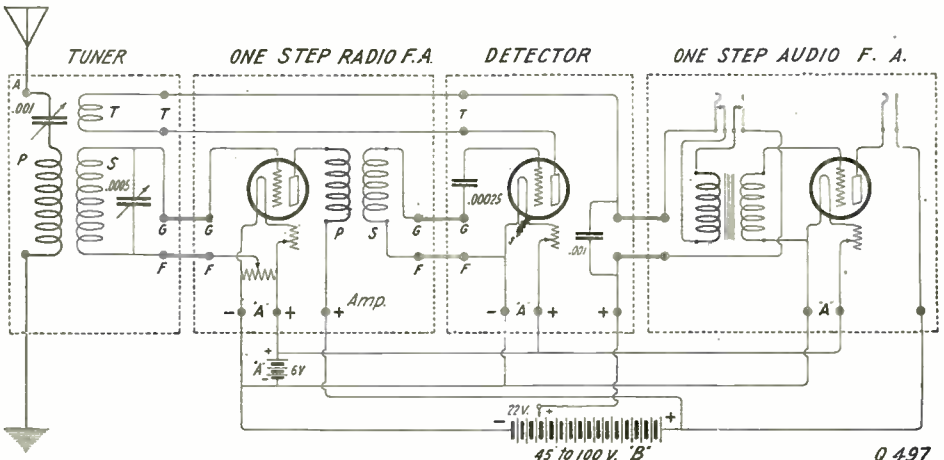

A Method of Panel Construction Which Allows Unlimited Expansion. This Is Especially Suited to the Amateur Who Is Unable to Purchase a Large Set at One Time.



---

M

# MURDOCK RADIO

**W**ITH less adherence to quality, we could make many more Murdock Phones.

Murdock quality has sent the demand for Murdock apparatus far beyond our expectations.

Examine Murdock apparatus at your dealer's. There are no other phones so good at so low a price. *After you have bought*, a 14 day trial privilege assures satisfaction with your purchase.

## WM. J. MURDOCK CO.

344 Washington St.,  
1270 Broadway,  
509 Mission St.,

Chelsea, Mass.  
New York City  
San Francisco, Cal.

No. 56-2000 ohm—\$5.00

No. 56-3000 ohm—\$6.00

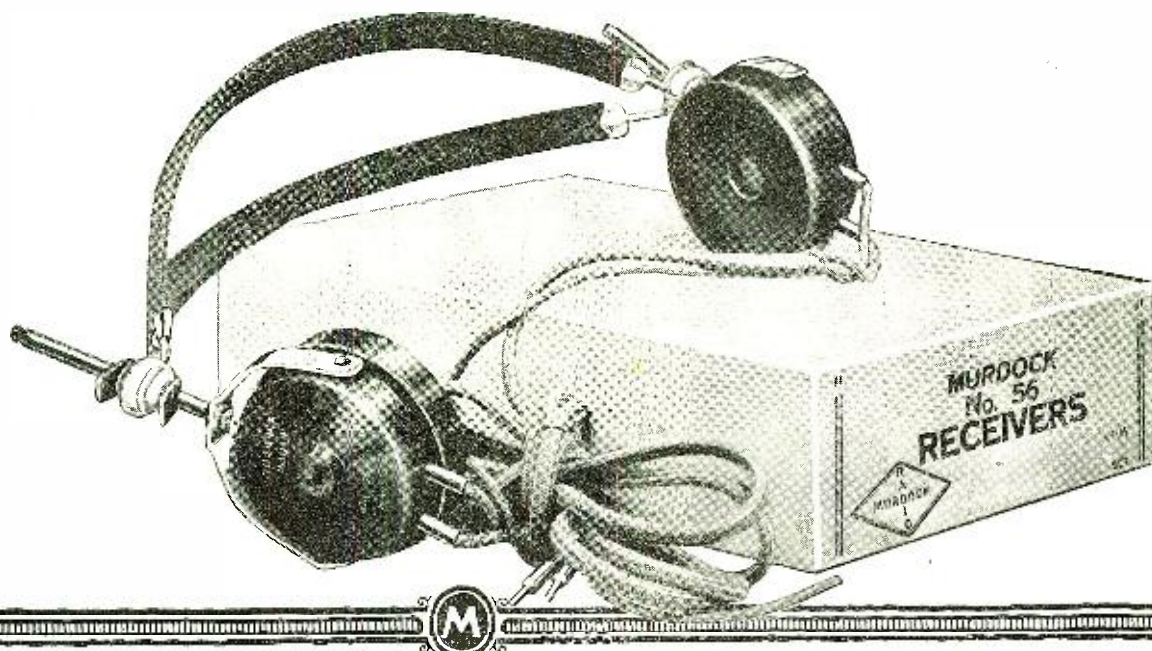



**RADIO HEADQUARTERS**

**Quality—Price Prompt Service**

We list below a few popular items from our large stock of standard Radio Supplies. Play safe—buy standard equipment. Order from this list.

Westinghouse RC Receiver	\$132.50
Westinghouse RA Tuner	88.00
Westinghouse DA 2-Stage Amplifier	70.00
Clapp-Eastham RZ Receiver-Amplifier	100.00
Clapp-Eastham HR Regenerative Receiver	40.00
Clapp-Eastham HZ 2-Stage Amplifier	40.00
Grebe CR-9 Receiver-Amplifier	130.00
Grebe CR-5 Receiver	80.00
Grebe HORK 2-Stage Amplifier	55.00
Tubes, Batteries and Phones are extra, except as noted.	
Remler No. 330 Detector Panel	8.50
Remler No. 331 Amplifier Panel	6.00
Remler No. 333 Same with Cam Switch	9.00
Remler No. 505 Panel-mounted Variable Coupler	12.00
Remler No. 502 Panel-mounted Variometer	9.75
Remler No. 500 Moulded Variometer	6.50
Remler No. 501 Same with No. 100 Knob and Dial	7.50
Remler No. 503 Variocoupler	5.40
Remler No. 504 Same with No. 100 Knob and Dial	6.40
Clapp-Eastham F-755 43-Plate Var. Condenser	4.75
Clapp-Eastham F-774 17-Plate Var. Condenser	4.25
Chelsea No. 1 43-Plate Var. Condenser, mounted	5.00
Chelsea No. 2 23-Plate Var. Condenser, mounted	4.50
Chelsea No. 3 43-Plate Var. Condenser, with Dial	4.75
Chelsea No. 4 23-Plate Var. Condenser, with Dial	4.25
Murdock No. 367 43-Plate Var. Condenser, in case	4.50
Murdock No. 368 23-Plate Var. Condenser, in case	4.00
Murdock No. 3660 43-Plate Var. Condenser, no case	4.00
Murdock No. 3680 23-Plate Var. Condenser, no case	3.25
ABC No. 650-1 11-Plate Var. Condenser	3.00
ABC No. 650-3 3-Plate Var. Condenser	2.25
Radion 3-inch Dial	.75
Radion 4-inch Dial	1.00
Moulded Bakelite 3-inch Dial	.75
Cunningham C-301 Radiotron UV201 Amplif. Tube	6.50
Cunningham C302, Radiotron VV202 Power Tube	8.00
Jefferson No. 48 Tube Socket	1.00
R.C. UV-541 Porcelain Tube Socket	2.50
Signal R-75 Tube Socket	1.42
Clapp-Eastham HT Bakelite Panel Socket	1.00
Remler No. 810 J <sub>1</sub> Filament Rheostat	1.00
Remler 1 1/2-Amp. Panel Rheostat No. 811	1.75
Remler 3-Amp. Panel Rheostat No. 813	1.75
Paragon No. 1023 Panel Rheostat	1.50
Bradleystat Filament Controller	1.85
R.C. PR-535 Rheostat	3.00
Cutler-Hammer H-1 Vernier Rheostat	1.50
Cutler-Hammer H-2 Plain Rheostat	1.00
R.C. PR-536 "A" Battery Potentiometer	2.00
Batteries	See our Catalogue
Frost Fones No. 162, 2000 ohms	5.00
Frost Fones No. 163, 3000 ohms	6.00
Murdock No. 56 Phones, 2000 ohms	5.00
Murdock No. 56 Phones, 3000 ohms	6.00
Baldwin Type C Phones	16.00
Baldwin Type F Phones	16.00
Baldwin Type G Phones	16.00
Western Electric Phones	15.00
Westinghouse Vectors	30.00
Magnavox R-3, 14-Inch Horn	45.00
Acme A-2 Amplifying Transformer, mounted	7.00
Acme A-2 Amplifying Transformer, semi-mounted	5.00
Jefferson No. 41 Amplifying Transformer	4.25
Jefferson No. 45 Amplifying Transformer	7.00
R.C. UV-712 Amplifying Transformer	7.00
Murdock No. 358 .0007 Mfd. Fixed Cond.	.70
Federal No. 15 Universal Plug	1.75
Frost No. 132 Plug	1.00
Frost No. 137 Plug	1.25
Frost No. 131 Jack	.90
Frost No. 133 Jack	.65
Frost No. 134 Jack	.75
Frost No. 135 Jack	1.00
Frost No. 136 Jack	1.25
Rotary Lever Switches	See our Catalogue
Remler Standardized Switch Parts	See our Catalogue
Cabinets and Panels	See our Catalogue
Brach No. 223 Outdoor Vacuum Gap Protector	3.00
Brach No. 200 Indoor Vacuum Gap Protector	2.50
Keystone Radio Lighting Arrestor	2.00
Antenna Insulators, Magnet Wire, Cardboard Tubing, Bakelite Tubing, Fiber Tubing, Spaghetti, Radio Books, Crystal Detector Supplies, Battery Charges, Loading Coils, etc.	See our Catalogue

**FREE CATALOG** illustrated, sent on request.

Dealers—Buy reliable equipment from a house of established reputation. Send for catalog of tested and approved apparatus and our discount sheet.

**IN BUSINESS SINCE 1860**

**JULIUS ANDRAE & SONS CO.**  
117 MICHIGAN ST. MILWAUKEE, WIS.

**Radio Equipment at KDKA**

(Continued from page 616)

which, in conjunction with the condensers and oscillation transformer, change the 2,000 volt direct-current power into alternating-current power at 833,000 cycles, thus generating the carrier wave, which is impressed on the antenna through a remote controlled double throw switch, which allows the same antenna to be used for receiving when the station is not broadcasting. The amplitude of the radio frequency wave thus generated is constant as long as the plate voltage remains constant, and fluctuates with the plate voltage when the latter is varied.

The function of the five modulator tubes, also rated at 250 watts each, is to vary the voltage on the plates of the oscillator tubes according to the voice frequency impressed upon their grids by the speech amplifiers. This system is known as power modulation, the modulation being accomplished by means of the constant choke coil in series with the positive lead to the modulator and oscillator tube plates. The grids of the modulator tube are held at a static potential of 80 volts negative with respect to their filaments by means of a battery. The audio frequency from the speech amplifier then adds to or subtracts from this 80 volt grid potential. At an instant when the modulator tube grids have impressed upon them by the amplifiers a low negative, or zero potential with respect to their filaments, the tube impedances from the plate to the filament are low and a large plate current flows in the 2,000 volt direct-current circuit to the modulator tube plates. Because of the very large inductance (50 henries) of the audio frequency choke coils in series with the plate supply, the total generator current can change very little in a brief interval of time. Hence, part of the generator voltage occurs across the choke coils, thus lowering the voltage impressed on the oscillator tube plates and hence the radio frequency output of the set. The next instant when the modulator tube grids have a high negative potential with respect to their filaments, the plate impedances are high and little or no current flows through the modulator tubes. The choke coils, tending always to keep the total generator current constant, create a voltage which adds to the generator voltage and thus forces most of the current into the oscillator tubes, which increases the radio frequency or antenna output accordingly. In this way the audio frequency choke coils cause the voltage applied to the oscillator tube plates to fluctuate in proportion to the speech voltage impressed on the grids of the modulator tubes by the speech amplifier. As the amplitude of current in the antenna varies directly with the plate voltage on the oscillator tubes and as this voltage varies from nearly zero to 4,000 volts, the antenna current varies accordingly. Fig. 4 shows an oscillogram of rectified antenna current taken when the announcer is speaking loudly into the pickup transmitter. It is seen that the antenna current varies from nearly zero to nearly twice its no talk value. This variation in antenna current at voice frequency is known as modulation.

The radio frequency choke coils in series with the oscillator tube plates serve to stop any radio frequency from entering the modulator and power supply circuits. These choke coils are of air core construction and are about five millihenries inductance each. They thus offer a high impedance to the radio frequency, but negligible impedance to the audio frequency.

In order to indicate the amount of modulation, a so-called modulation meter has been developed. This consists of a current trans-

**U.S. PATENTS**



**SEND FOR THIS FORM**

**Don't Lose Your Rights**

Before disclosing your invention to anyone send for blank form "Evidence of Conception" to be signed and witnessed. A sample form together with printed instructions will show you just how to work up your evidence and establish your rights before filing application for patent. As registered patent attorneys we represent hundreds of inventors all over the U. S. and Canada in the advancement of inventions. Our schedule of fees will be found reasonable. The form "Evidence of Conception" sample, instructions relating to obtaining of patent and schedule of fees sent upon request. Ask for them, a post card will do.



270 OURAY BLDG., WASHINGTON, D. C.

"Originators of form Evidence of Conception"

**TUNIT The Real Tuner**

(Patent applied for)

\$15

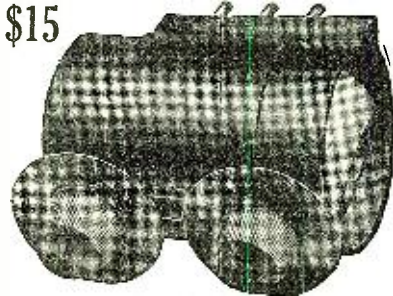

160-600 Meters

**D**UPLICATES the performance of the most expensive short-wave sets at a price anyone can afford. Fits the standard 3-coil mounting.

Ask your dealer to demonstrate. If he cannot supply TUNIT send him name for descriptive circular.



80 Washington St., New York, N.Y.

Write For Our FREE BOOKS On

**PATENTS MUNN & CO.**

631 Woolworth Bldg. NEW YORK  
Scientific American Bldg., WASHINGTON, D. C.  
Tower Bldg., CHICAGO, ILL.  
611 Hanna Bldg., CLEVELAND, O.  
Hobart Bldg., SAN FRANCISCO, CAL.

**PATENTS**

**C. L. PARKER**  
Formerly Member  
Examining Corps,  
U. S. Patent Office.  
PATENT - LAWYER  
McGill Bldg., Wash., D. C.

Patents, Trade Marks, Copyrights, Patent Litigation  
Handbook for Inventors, "Protecting, Exploiting and Selling Inventions," sent upon request.

**PATENTS Secured**

Prompt service. Avoid dangerous delays. Send for our "Record of Invention" form and Free Book telling How to Obtain a Patent. Send sketch or model for examination. Preliminary advice without charge. Highest References. Write TODAY.

**J. L. JACKSON & CO.**  
361 Ouray Bldg. Washington, D. C.



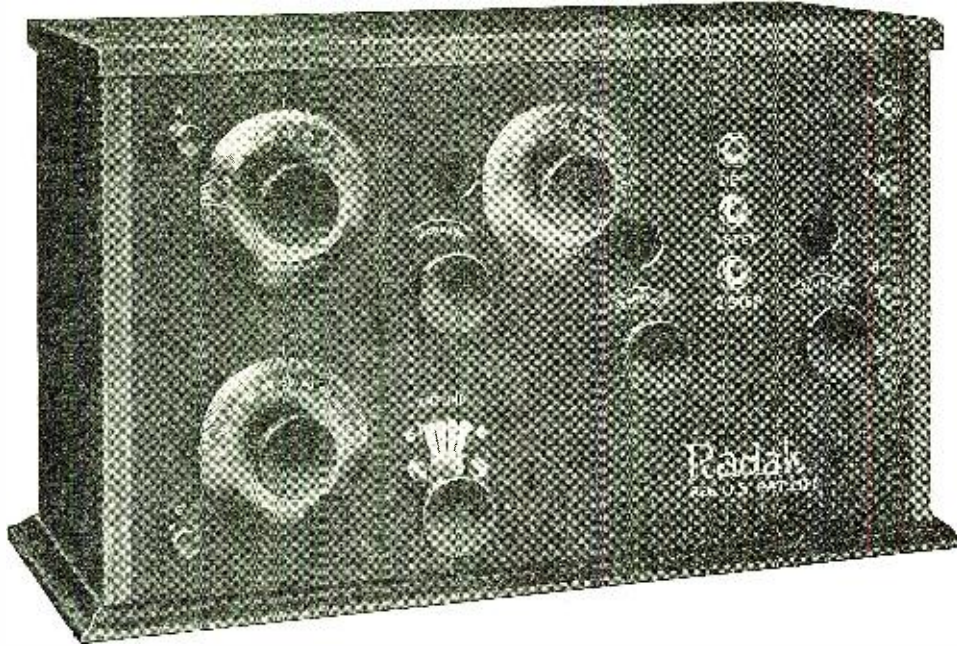

*Model R Z Radak Receiving Set.*

*(Licensed under Armstrong U.S. Pat. 1,113,149)*

# THIS LATEST RADAK SET A BIG ADVANCE IN SIMPLIFICATION

Regenerative receiver and two stages of amplification "hooked up" in one complete unit—

Telephone jack connections, in place of binding posts—

A range of response to wave-lengths as high as 3000 meters—

An ease of tuning that surprises even the hardened radio "fan"—

A handsomely finished cabinet that harmonizes with home surroundings—

These are only a few of the separate improvements which contribute to this new set's success.

But even the enumeration of all the separate advantages can give you no idea of the surprising results you will obtain in using it. Distances seem to melt like mist—you hardly believe your ears until you verify the published programs.

The loudness of signals—especially when used with a loud speaker—the clearness and lack of distortion, continue to amaze you.

## SPECIFICATIONS

### MODEL R Z RADAK

*Cabinet:* Solid mahogany, dull finish. Hinged cover. Compartment for B battery.

*Panel:* Condensite, dull finish black; white lettering.

*Dials:* Indestructible metal, black with white lettering.

*Binding Posts:* Hard rubber composition.

*Condensers:* Balanced type, built as a Vernier; two rotary, three stationary plates.

*Antenna Inductance:* Wound on formica tube.

*Plate Inductance:* Wound on molded bal.

*Switch:* Fan blade.

*Rheostat:* Clapp-Eastham type H-400.

*Circuit:* Single circuit regenerative.

*Price:* \$100, complete as above.

Only the experience of over sixteen years' exclusive specialization in radio could produce such a set as the Model R Z Radak Receiver. Ask to hear it at the store where you usually buy electrical goods. If the dealer doesn't now carry Radak radio equipment, his jobber can supply him.

Radio Catalog describing this set and other Radak equipment by mail 6c.

## "MORE THAN YOU RECOMMEND"

Marshall, Missouri.

"About three weeks ago I purchased your HR Tuner Unit \* \* \* I want to say right here that it is more than you recommend in your advertisements in the radio papers. It is a wonder! \* \* \* I get the following stations so far: Pittsburgh, Pa.; Schenectady, N. Y.; Detroit, Mich.; Chicago, Ill.; Tulsa, Okla.; Guthrie, Okla.; Columbia, Mo.; Slater, Mo.; Carrolton, Mo.; Kansas City, Mo.; Denver, Col.; and several other places. \* \* \* I heard a great concert last night in Convention Hall at Kansas City, Mo., which is over a hundred miles from here. Every member of the orchestra and voice numbers came in plain, and my neighbors were astounded at the clearness of the music."

FRANK Q. T. UTZ.

# CLAPP-EASTHAM COMPANY

107 MAIN STREET, CAMBRIDGE, MASS.

*Oldest, Largest Manufacturers of Radio Equipment Exclusively. Established 1906.*





**PRICE**  
**\$7.50**

### The Delights of Radio

are greatly increased by the use of first-class apparatus. Convenience in operation—excellence in results are characteristics of equipment fitted with

## Stromberg-Carlson Radio Parts

Standard for high efficiency in commercial and amateur service.

STROMBERG-CARLSON "Radio Head Sets" are designed especially for **comfort** and **adjustability**, with **tonal qualities** unexcelled in reproducing accurately faint long distance signals. In addition, the construction permits the separation of the receivers so that two observers may "listen in" simultaneously.

STROMBERG-CARLSON "Universal Radio Plug" should be attached to every Head Set. It fits any standard jack, takes any type or size of conductor, and takes wire loops, tinsel loops, pin tips or spade tips.—No. 60—Universal Plug. \$1.25.



STROMBERG-CARLSON "Radio Jacks" are adapted to all standard Radio Plugs. They mount neatly, without washers, on panels varying in thickness between 1/8" and 1/4". No. 147 Radio Jack, \$0.85.

STROMBERG-CARLSON Radio Parts are made by a company with 28 years' experience in designing and manufacturing radio and telephone apparatus.

You may order Stromberg-Carlson apparatus from your electrical merchandise dealer, or a postal will bring you free Bulletin No. 1029-R, which fully describes the exclusive Stromberg-Carlson features.

**STROMBERG - CARLSON TELEPHONE MFG. CO.**  
ROCHESTER, N. Y.  
Kansas City Chicago Toronto  
Address nearest office

former, the primary of which is connected in series with the direct-current supply to the oscillator tube plates and the secondary of which is connected to a thermo-ammeter. The transformer ratio is such that an audio frequency variation in the direct-current from zero to twice its normal value gives full scale deflection. An air-gap is provided in the transformer core to prevent saturation due to the direct-current component of the plate current. The meter has a current scale marked from 0 to 100 per cent modulation. When the announcer is speaking into the transmitter, the modulation meter averages about 40 per cent with maximum between 70 and 80 per cent. Piano solos average about 30 per cent, violin solos 20 to 30 per cent and vocal numbers 40 to 50 per cent with maximum of 100 per cent. Of course the modulation meter indicates only the average volume of sound. While the meter may read only 30 per cent in case of piano music, the individual notes at the instant of striking may reach 80 to 90 per cent. Allowing for the kind of sound being transmitted, that is, piano, speaking voice, solo, etc., the modulation meter provides a convenient means of finding the correct distance to place the artist from the pick-up transmitter and accounts to a large extent for the uniform volume of sound received from KDKA. The instruments at the top of the transmitter panel, Fig. 2, are from left to right, filament voltmeter, ground current meter, plate ammeter, modulation meter and plate voltmeter. The antenna current meter is mounted on the wall with a series condenser and discharge resistance and is not shown in the photograph.

The antenna at KDKA consists of six wires, 190 feet in length on 20 foot spreaders. This antenna is supported 210 feet above the ground by a brick smoke stack at one end and by a 100 foot pipe mast on a nine-story building at the other end. The operating room and studio are located on the ninth floor of this building. Fig. 5 shows the mast end of the antenna with the operating room directly below. A counterpoise which is a duplicate of the antenna in construction is placed 110 feet beneath the antenna. This brings the counterpoise about 15 feet below the transmitting set. The down lead from the antenna and the counterpoise lead are made up of eight strands of No. 14 copper wire equally placed around 1.5 in. diameter wooden spacers. The natural period of this aerial system is approximately 412 meters. A series condenser of 0.0005 mf. capacity is used in series with the antenna and sufficient loading inductance added to obtain the desired wave length of 360 meters. The series condenser is shunted by a radio frequency choke coil of 10 millihenries inductance in series with a one megohm resistance, to drain off any static charge that might accumulate on the antenna when insulated from ground by the series condenser. The high frequency resistance of the antenna system at 360 meters wave length is approximately 12 ohms, a large percentage of which is radiation resistance. The antenna current at 500 watts is 6.5 amperes; at one kilowatt it is 9 amperes.

The power equipment consists of two 2-kw. motor generator sets with 250 volt direct-current motors, the current employing two armature windings and two commutators permanently connected in series. Normally the motor generator sets are used with the generators parallel. Either set may be used alone with the radio set at reduced power. There is also a third motor generator set with a 220 volt 25 cycle motor which can be connected to the radio set in case of failure of the direct-current supply. This set is provided with an exciter to supply the field of the high voltage generator. A filter consisting of a 50 henry inductance and 32 microfarad condenser reduces the generator hum to a negligible amount. The panel beneath the speech am-

## We Save You Money on RADIO CABINETS

Assemble your set in one of these handsome cabinets equal in appearance to the most expensive, yet priced unbelievably low. Everyone can afford them. Made of selected Oak, cover splayed, will not warp; shipped knocked down, with full instructions for easy assembling and staining. Order today, cash or money order.

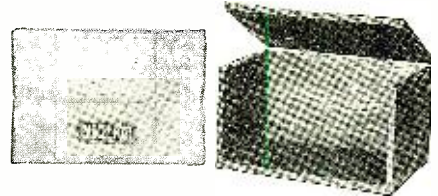

Panel Size	Price	Panel Size	Price
6x7"	\$1.50	9x14"	\$2.75
6x10"	2.00	12x14"	3.25
6x14"	2.00	12x21"	3.65
6x21"	2.50		

Above sizes 7" deep inside. Above sizes 10" deep inside

## RADIO SET

**\$3<sup>95</sup>**



Parcel Post Order Today

Equal to sets at several times the price. Dust-proof Detector, Insulated Sliders. Coil wound, wood parts machined and finished. Neat. Shipped knocked down with instructions for easy assembling. Aerial wire included.

Above Set with 1500 Ohm Double Phones Complete, Ready to Listen In, \$9<sup>65</sup>

Double Head Phones, Without Set \$5<sup>75</sup>

Radio Cabinet Co. of 1460 Hubbard Ave. Detroit, Mich.



## 2 K L Announces PARAGON SETS

RA-10 - \$75 RA-Special \$50  
160-1000 Meters 160-500 Meters

DA-2 Detector and 2 Step \$65

Immediate delivery. Satisfaction guaranteed. Everything in radio. A real service. Try it. Send 25 cents for 208-page catalog.

**A. V. Gregory**

42 Broad St., Red Bank, N. J.

## LEARN WIRELESS

WIRELESS TELEGRAPHY AND TELEPHONY SIMPLY EXPLAINED—By Alfred P. Morgan, 151 pages. Price \$1.50 postpaid. This book contains one of the most comprehensive treatises on the subject, explains in simple language the theory and practice of wireless telegraphy and telephony, illustrated by 150 photographs and drawings. RADIO EXPERIMENTERS HANDBOOK—By M. B. Sleeper, 16 chapters, fully illustrated. Price \$1.00 postpaid. Explains the how and why of radio in simple terms and answers the practical questions of the beginner and advanced student. Chapters on construction, operation, sending, receiving, radio rules and regulations. RADIO HOOK-UPS—By M. B. Sleeper. Price \$0.75 postpaid. Contains wiring diagrams of 86 different wireless circuits, suitable explanations accompany every diagram, and space is left for the experimenter to enter notes.

SCIENTIFIC BOOK AND SUPPLY CO.  
1512 Logan Ave. Youngstown, Ohio

## "IMPROVED" RADIO PRODUCTS

RADIO IMPROVEMENT COMPANY  
29 West 35th Street New York



**CHEMISTS PREDICT STARTLING NEW ERA**  
Sun's Rays, Earth's Rotation and Atomic Energy in Matter to Be Used.  
SEE REVISING OF BIBLE  
Light Like Firefly's May Be Produced by Chemistry, American Society Hears.  
New achievements in physics and physical chemistry—developments that will no doubt result in the great destruction of the World War, but will open the way to the sun's light energy in which the sun's light energy in ordinary matter will be converted into an energy that is limited to an extent little dreamed of by chemists.  
The American Chemical Society, at the International Meeting of the American Chemical Society, held in Washington, D. C., in 1921, discussed the possibility of utilizing the sun's energy to supplement the world's supply of coal, petroleum and other sources of energy.

**DEMAND FOR INDUSTRIAL CHEMISTS INCREASING**  
It is probably not far from the mark to assert that there are more than 25,000 chemists employed in the United States today and the demand for them is constantly increasing. The American Chemical Society, at the International Meeting of the American Chemical Society, held in Washington, D. C., in 1921, discussed the possibility of utilizing the sun's energy to supplement the world's supply of coal, petroleum and other sources of energy.

**SAUSAGE GETS ATTENTION OF CHEMISTS**  
Is One of Many Topics in Pictures Drawn by Experts.  
The product of the distillation of alcohol is a pure one, but it has been found that it is not so pure as it is supposed to be. The chemists have discovered that it contains a small amount of water, which is not only harmful to the health, but it also makes the alcohol more difficult to use.

**URGES USE OF CHEMISTRY AS BUSINESS AID**  
Shows Traces of Hardship From Linen and Makes Student a Real Laundryman.  
How to remove all traces of the stains of life in a big city from the laundry is a problem that has long troubled the housewife. The chemist has now revealed the secret of the action of the stains on the fabric and has shown how to remove them. The student who has learned this lesson will be able to remove all traces of the stains of life in a big city from the laundry.

**Chemistry in the Home**  
One of our great-grandmothers' recipes were handed down to her daughter or passed back to her mother. No one thought of calling it chemistry. The chemist has now shown that the recipes are really chemistry. The chemist has shown that the recipes are really chemistry.

**AMERICA'S FUTURE BEFORE CHEMISTS**  
Dr. E. F. Smith Urges Upon Associates Recognition of Nation's Claims.  
Described That Miles to a of Gasoline.  
E. EYE SHOWN  
Side on American  
in of S  
F

**CHEMICAL SCIENCE MAY CUT SHOE PRICES**  
New Methods in Tanning to Be Discussed by Experts at Meeting of American Society.  
4,000 EXPERTS TO ATTEND  
Sessions Will Be Held at Columbia University—Next Month—Scientists to Speak.  
Shoe prices may trend downward as a result of new processes of tanning based on studies of electrical discharge and used by the American Chemical Society, which will meet at Columbia University Sept. 10-12.

**CHEMISTS CHANGE ALCOHOL INTO HIGH QUALITY SILK**  
Government Experiments Set Pace for New Industry Already Under Way and Patent Silk Worm May Lose Popularity  
The product of the silkworm is a natural silk, but it is not so pure as it is supposed to be. The chemists have discovered that it contains a small amount of water, which is not only harmful to the health, but it also makes the silk more difficult to use.

**CHEMISTRY EXPERT HEADS 'CLEAN CLOTHES' COLLEGE**  
In Eleven Weeks He Teaches How to Remove All Traces of Hardship From Linen and Makes Student a Real Laundryman.  
How to remove all traces of the stains of life in a big city from the laundry is a problem that has long troubled the housewife. The chemist has now revealed the secret of the action of the stains on the fabric and has shown how to remove them. The student who has learned this lesson will be able to remove all traces of the stains of life in a big city from the laundry.

**CHEMISTS IN MONTREAL LEARN OF NEW GLASS**  
Said to Admit Unlimited Light and Bar All Heat.  
MONTREAL, Aug. 28.—(AP)—Chemists here have discovered a new kind of glass which is said to admit unlimited light and bar all heat.

# Chemists Are Badly Needed To-day In Every Branch of Industry

All industry today is three-fourths chemical. Every day brings new announcements of new ways in which chemistry is employed in business and industry. The sudden and almost unbelievable expansion of the chemical field in the United States has increased the need for trained men in our country. Industrial plants of all kinds pay tempting salaries to get good men—salaries of \$10,000 to \$12,000 a year are not unusual for those who have proven their abilities. If you want a profession that offers unlimited possibilities—if you are looking for more money—if you like fascinating work—take up chemistry. No other vocation offers such splendid opportunities for real money and rapid advancement. Chemistry is now recognized as the coming great science and the demand for trained men is increasing every month.

**Learn Chemistry at Home** **Dr. T. O'Connor Sloane Will Teach You**

We will teach you Chemistry right in your own home, and in your spare time, in a practical and intensely interesting way. Our home study course written by Dr. T. O'Connor Sloane is practical, logical and remarkably simple. Endorsed by leading scientific and educational authorities. The entire course is illustrated by so many experiments that are performed right from the start that anyone, no matter how little education he may have, can learn and thoroughly master every lesson. Dr. Sloane teaches you in your own home with the same individual and painstaking care with which he has already taught thousands in the class room. And Dr. Sloane personally examines and corrects all examination papers, pointing out your mistakes and correcting them for you. His personal training will be of inestimable value to you in your future career. If you really want to learn Chemistry and will honestly apply yourself to our lessons, our course will give you just as thorough and just as complete an education in general chemistry as you would have received had you been able to attend College.



## Easy Monthly Payments

You can pay in small monthly amounts as you go along. The price of our course is very low and includes everything, even the chemistry outfit—there are no extras to buy with our course. Our plan places a chemical education within the reach of everyone. No matter what your income is, you can meet our low terms, and you do not have to give up your present employment while learning.

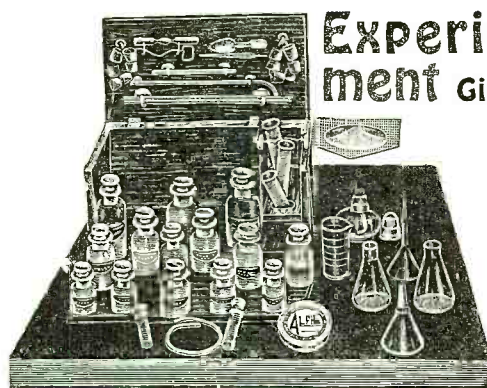

## Experimental Equipment Given Free To Every Student

We give to every student, absolutely free of charge, this chemical equipment including everything you need for the entire course with the exception of a few pieces of apparatus which we teach you how to make. You couldn't buy so complete an outfit anywhere for one cent less than \$20.00. There are forty-two pieces of laboratory apparatus and supplies and eighteen different chemicals and reagents all enclosed in a fitted heavy wooden box with hinged front and cover. This hand-finished box serves not only as a case for the outfit but, as a laboratory accessory for performing countless experiments.

## Special 30 Day Offer

Besides furnishing the student with his Experimental Equipment as described above, we are making an additional special offer for a short while only. You owe it to yourself to find out about it. Write today for full information and free book "Opportunities for Chemists." Send the coupon right now while it is fresh in your mind. Or just write your name and address on a postal and mail it to us. But whatever you do, act today before this offer is withdrawn.

**Chemical Institute of New York, Inc.**

Home Extension Division 10 140-R LIBERTY STREET, NEW YORK CITY

Dr. Sloane, Educational Director of the Chemical Institute of New York, is one of this country's foremost authorities on chemistry. He was formerly Treasurer of the American Chemical Society and is a practical chemist with many well-known achievements to his credit. Not only has Dr. Sloane taught chemistry for years, but he was for a long while engaged in commercial chemistry work.

Many people would pay big money to have Dr. Sloane teach them chemistry. You can secure his services and personal training without one cent of extra expense by enrolling with the Chemical Institute of New York.

CHEMICAL INSTITUTE OF NEW YORK, Home Extension Division, 10, 140-R Liberty St., New York City.

Please send me at once without any obligation on my part, your free Book "Opportunities for Chemists," and full particulars about the Experimental Equipment given free to every student. Also please tell me about your plan of payment and your special 30 day offer.

NAME .....  
 ADDRESS .....  
 CITY .....  
 STATE .....  
 R. N. Oct., '22.



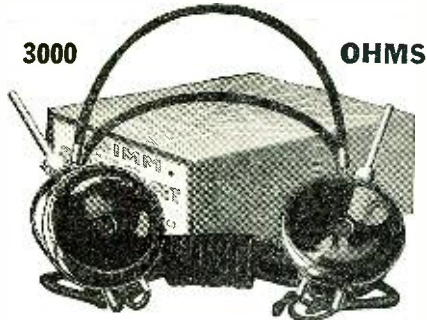

# ONE-YEAR GUARANTEE

Just what you have been waiting for—a strictly high-grade head set that you can buy and sell with absolute confidence because backed by a binding one-year guarantee of satisfactory service.

## TRIMM Professional Head Set

At last! Perfect reproduction and articulation at any range with the new approved TRIMM professional Head Set. Designed and built expressly for radio work by highly skilled experts of long experience.

One-piece magnet formed (not punched) guarantees uniform tempering and magnetizing. Cases and caps made entirely of high-grade Phenol compound, free from sulphur and corrosive gases; odorless and warp-proof. New type head band insures perfect comfort.

### Shipped on Approval

Absolute Satisfaction Guaranteed;  
Your Money Back on Request

Special Introductory Price, only \$19.00, with privilege of five days' trial. We prepay charges. Your money back if you return it. See below how to order.

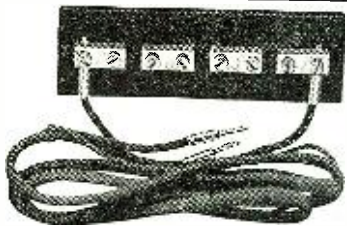

## TRIMM MULTI-PHONE Connectors

For connecting 2, 3, 4 or 5 additional head sets to audion tube or crystal detectors. Type "A" (illustrated above) for connecting head sets in series—the only proper method for lamp detector sets. Does not diminish the sound or tone by dividing it between the extra head sets. Type "B" (not illustrated) for connecting head sets in multiple—the only proper method for crystal receiving sets.

Prices: For 2 head sets, \$1.00; for 3 head sets, \$1.25  
For 4 head sets, \$1.50; for 5 head sets, \$1.75  
Order any TRIMM product on 5 days' trial. Your money back if you return it. We ship direct or through your dealer. Write today for folder. Or mail your order at our risk.

## TRIMM 2-Way PLUGS



Style "A" for connecting two head sets in series. Intended expressly for and the only correct plug for use with lamp (vacuum tube) detector sets. Style "B" for connecting two head sets in multiple. For use only with crystal detector sets.

Price, each, either style, \$1.50, postpaid. Be sure to state style wanted.

**DEALERS:** Trimm Radio specialties have no real competition. Our wholesale and retail distributors are fully protected. Write for quantity discounts and full particulars. We ship your first order on approval.

**TRIMM RADIO MANUFACTURING CO.**  
Dept. 30, 24-30 S. Clinton St., Chicago

plifier on the right in Fig. 2 controls the power equipment. Here are mounted generator field switches and rheostats, generator paralleling switches, generator voltmeter and ammeters, voltmeter switch, antenna switch control and studio signal light button to show the announcer in the studio when the transmitting set is in operation.

The engineer in charge of the station tests all filament and plate batteries before each program. He next starts the transmitting set and checks the wave length by means of a wave meter. He then lights the signal light in the studio notifying the announcer that the transmitter is in operation. The announcer turns on the studio amplifier which lights a signal light in the operating room notifying the engineer that the audio circuits are in operation. The engineer then watches the modulation meter and adjusts the amplification of the speech amplifier to give the desired amount of modulation. A loud speaking receiver in the operating room serves as a check on the quality of the transmission. When programs from local churches or from the downtown studio are to be transmitted, the telephone line is tested beforehand. Orders and any special arrangements are made over a supplementary order wire or phone line between the radio station and place of performance.

## The Antenna Unique

(Continued from page 617)

and vegetables, information calculated to be of particular benefit to farmers and fruit-growers in the District of Columbia, Maryland, Virginia, West Virginia, and Pennsylvania. This "marketgram" gives the prices on fruits and vegetables in wholesale quantities on the Washington, D. C., market. Forecasts of weather conditions had already preceded the "marketgram," the hour of ten o'clock being allotted for this purpose. The conditions of the upper atmosphere are again being made known by radio-telephone at 9.50 p. m., the wavelength in both instances being 1,160 meters.

The government radio station operated by the United States Post Office Department is not only equipped for both sending and receiving of communications, but both radio-telephony and radio-teleggraphy are employed in its broadcasting service. Originally, when this radio station was established, only a two-kilowatt arc-transmitter, modified to increase its strength to four kilowatts, was employed. The original purpose of wireless installation in the Post Office Department was to facilitate the use of the aircraft-mail service, then transporting 200,000 letters daily by air-going machines. At one time, 15 air-mail stations were in operation, radio-teleggraphy being the means of communication between them and Washington headquarters. With the introduction of the radio market news service on April 15, 1921, the station was automatically expanded. A radio-telephone transmitting outfit, capable of putting 14 amperes in the antenna at 1,160 meters, was subsequently installed. For a time, radio-telephony displaced radio-teleggraphy, but in the plans of broadening the range of operations, more recently, both of these instruments of rapid-fire communication are being employed.

A continuous-wave tube transmitter, operating at a wave-length of 1,980 meters, is pressed into service at 12.30 daily, with the exception of Sundays and holidays. At this hour, the live-stock market reports from Chicago and St. Louis are given wide circulation through the medium of electromagnetic waves. Again, at 2.15 o'clock p. m., the conditions of the live-stock markets at Chicago and St. Louis are made known by radio-teleggraph, the wave-length used being 1,980 meters. The prices of fruits and vegetables are broadcasted by the use of the tube transmitter at 3.30 p. m. At 5 o'clock p. m., the prices of dairy products

"East and West, the Globe is Best"

# GLOBE RADIO HEAD PHONES



Highly sensitive  
Matched receivers  
Natural in tone  
Each receiver tested by radio  
Lightweight (11 oz.)  
Comfortable to wear  
Will not distort signals, when amplified  
Articulation perfect

2200 ohms List price only \$9.00

There are many types of head sets on the market, but not too many good ones. The GLOBE RADIO HEAD SET incorporates a knowledge of acoustics based on nearly fifteen years of experience in making high grade sound producing and receiving instruments. It embodies correct design with the best of materials. The Globe Phones are for those who discriminate.

Ask about the Globe Antenna Attachment Plug for connecting your radio set to your electric light circuit.

Buy from your local dealer, or write us direct.

We are also the sole distributors of the Globe Vactuphone, invention of Earl C. Hanson, the only hearing device made for the deaf using the vacuum tube amplifier.

**GLOBE PHONE MFG. COMPANY**  
READING, MASSACHUSETTS, U. S. A.

## EINSTEIN

Has the dope on **RELATIVITY**  
We have the dope on **RADIO**



Longer Distance  
Clearer Signals  
Thru More Interference  
Non-infringing Apparatus

Are you from "Missouri"?  
Write us today!

**SCIENTIFIC ENGINEERING ASSOCIATION**

817 MAIN STREET CINCINNATI, OHIO



## HOWARD VERNIER RHEOSTATS

Base made of special heat-resisting composition. Total resistance 6.8 Ohms. Carrying capacity 1.5 Amperes. Diameter of base 2 3/8 inches. All sliding contacts of phosphor ground springs. Price \$1.75. Rheostat without vernier adjustment \$1.10. Order now.

\$1.75

TESTED EQUIPMENT

Write, wire or call for our list of tested radio apparatus.

**APEX RADIO COMPANY, INC.**  
1105 W. 69th St., Dept. R., Chicago, Illinois



**SOME OF THE NEW ORIGINAL and BETTER PRODUCTS OF THE MAZDA RADIO MFG. CO.**

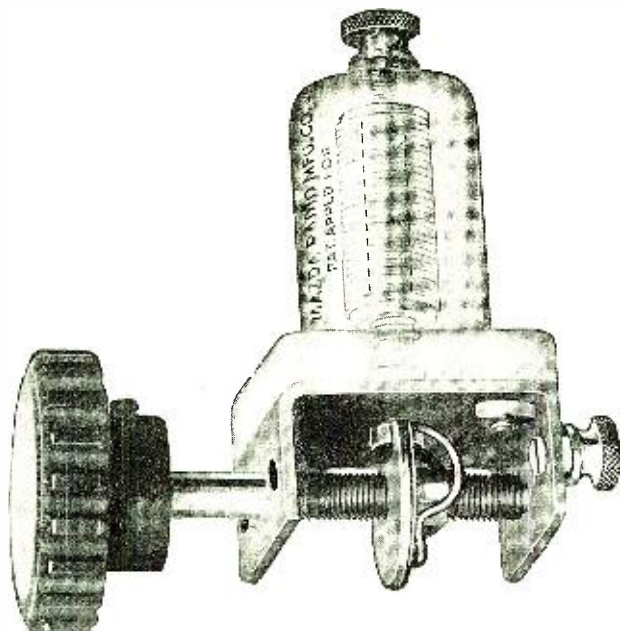

**Rheostat.**—Carbon pile. Will handle with safety three detector amplifier tubes. Gives extremely delicate filament control over critical range. Price \$1.75

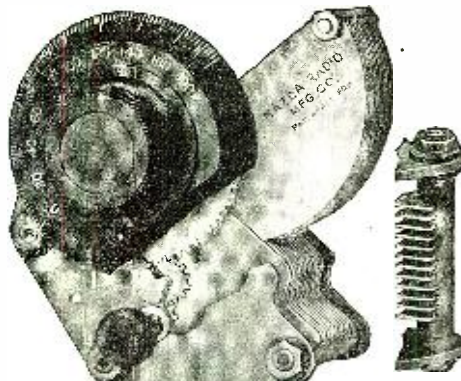

**Variable Condenser.**—Vernier control without separate vernier, produced by improved plate design. Micrometer adjustment obtained by 12 to 1 built in gear drive. Entirely new plate spacing construction throughout insures positive alignment. Prices: 3 Plate \$3.00, 23 Plate \$5.50, 43 Plate \$7.00.



**Senior Plug.**—A handsome, highly finished standard plug. Price \$1.00.

**Junior Plug.**—A popular priced, fool proof plug. Easily connected. Price \$.60

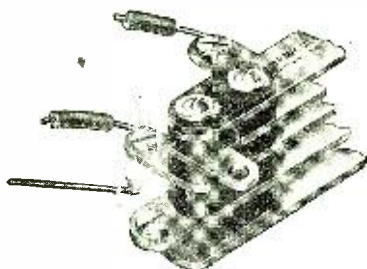

**Jacks.**—Suitable for all plugs. Ears designed for accessibility and equipped with screw, nut and fusible washer. Solder with a match. Prices: Open Circuit \$.35, Single Circuit \$.75, Double Circuit \$.90, Filament Control—Single Circuit \$1.00, Filament Control—Double Circuit \$1.25.

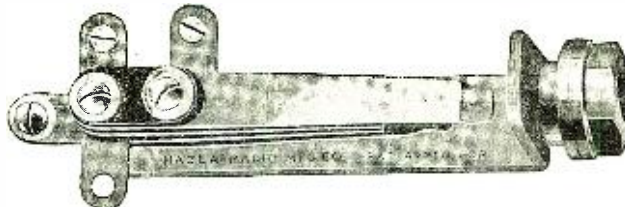

**Socket.**—Heavily GILD plated, non corrosive contact springs. Separate side and bottom positive contact for each tube prong. Prices: Composition Style \$1.00, Composition Base, Metal Shell \$1.25.

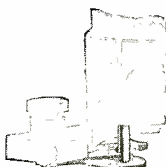

**Variable Fixed Condenser.**—Designed to insure rated capacitance. Made in four sizes. Prices: .00025 Mfd. \$.30, .0005 Mfd. \$.30, .001 Mfd. \$.40, .002 Mfd. \$.50.

The above articles are only a few of those being marketed, all of which contain unusual features, provide for accessibility, ease of assembly, and are correct in their electrical and mechanical design. We manufacture everything for the radio fan except tubes and batteries, each article being produced and tested in several styles and sizes, and sold at prices surprisingly low for the high quality of our product.

*Most Complete Line of Radio Parts*

**THE MAZDA RADIO MANUFACTURING COMPANY**

1830-40 E. 35th STREET, CLEVELAND, OHIO

Subsidiary of The Simmons Mfg. Co., Largest Independent Manufacturers of Automobile Replacement Parts in the World



## Radio Frequency Amplifying Transformers

### What is Radio Frequency Amplification?

Radio Frequency Amplification is the increasing of the strength of radio signals or waves before they are applied to the detector tube, where they are made audible.

### What results will I get by adding Radio Frequency Amplification to my set?

Louder signals with less noise in your set; distant stations which your detector alone cannot pick up. Less interference and less static disturbance, particularly if you use a loop indoor aerial.

### Can Radio Frequency Amplification be added to any standard make of tube set to advantage?

Yes.

### What must I add to my set to use Radio Frequency Amplification?

One radio transformer, one tube socket and one amplifier tube must be added for each stage desired. A 200 ohm potentiometer, irrespective of the number of stages, is an advantage, although not necessary.

### How should a Radio Frequency Transformer be constructed to insure maximum efficiency?

An efficient radio frequency transformer is preferably built with a closed magnetic circuit to prevent undesirable oscillations or whistling sounds and should, therefore, employ an iron circuit and iron shielding to eliminate stray magnetic fields.

### What Radio Frequency Transformer is built that way?

The transformer manufactured by the Radio Service Laboratories, Inc., is built on this engineering principle. The laminated iron closed core (a special form of divided magnetic material) completely encloses the bobbin or transformer windings thus broadening the wave-length range, increasing the amplification per stage, shielding from stray magnetic fields, and eliminating capacity and leakage effects.

### Where can I obtain this transformer?

At any electrical shop or store where Radio supplies are sold. If your nearest dealer does not carry it, write to the Rasla Sales Corporation, national distributors, 10 E. 43rd St., New York City, giving us the dealer's name and we will see that you are promptly supplied.



## ATTENTION RADIOTICS



If you use Amplifying Tubes you can make your Victor talking machine a **RADIO LOUD SPEAKER**, with a

**"BEEKO"**

Radio-Phone attachment

Liberal Discount  
in Quantities

**J. H. Bunnell & Co.**

Department X

32 Park Place, New York

in New York and Chicago are sent out by radio-telephone, operating on 1,160 meters. The condition of the grain market is revealed to the public at 5.30 p. m. by radio-telegraph, the wave-length employed being 1,980 meters. Again, the radio-telephone is pressed into service at 7.30 and 8 o'clock p. m. when the fluctuating tendencies of the prices of livestock, grain, fruits, and vegetables are scattered through the medium of electrical waves. Weather reports are broadcasted in conclusion of the daily broadcasting program at 9.50 and 10 o'clock p. m. by radio-telephone.

Contingent upon the will of Congress in appropriating the requested \$500,000 for establishment of a "Bureau of Communication," the wireless service will be extended in its reach as well as expanded in nature. Isolated areas as well as frequented points in the United States, will be visited by this hurry-up method of spreading the news. At present, there are eight wireless stations, originally established in conjunction with the transportation of mail by airplane, used as distributing agencies of market and weather reports. These are located at Washington, District of Columbia; Cincinnati, Ohio; Omaha and North Platte, Nebraska; Rock Springs, Wyoming; Elko and Reno, Nevada. Radio-telephone stations, in prospect, by reason of the expansion of the service, will be located in Georgia, Texas, California, Montana, Illinois, and at some point in the New England States. A survey being conducted by the Post Office Department will determine the exact locations of these information-distributing stations.

The Post Office Department voices the belief that the widespread dissemination of government knowledge will not only prove of economical value to a varied citizenry of the United States but will serve as a leavening process in Americanizing the increasing element of foreign population within our midst. The Post Office Department will not only give circulation to market news and weather forecasts, in the event that Congress sanctions an enlargement of the service, but the different government bureaus will be drawn upon for facts pertaining to discoveries and developments that will serve the diverse interests of the farmer, miner, rancher, fruit-grower, forester, and lumberman. Then, too, the public in general can appropriate to advantage much of the information circulating through space by reason of its practical value and entertaining quality.

## Correspondence from Readers

(Continued from Page 630)

speech being easily understandable, but—that's not all. On the night of March 28, I distinctly heard a concert in progress at Schenectady, N. Y., broadcasted by WGY. His speech was easily understandable. I have heard him a few times since. All this was on Galena using a double slide tuner in connection with a four-wire aerial hung very low, about twenty-five feet above ground. I've also copied regularly NAA since Dec. 12, 1921. In the winter he was readable with the phones three inches from the ears. I agree with G. W. Perkins as to broadcasting stations signing more often, as it has been my own experience to fuss around part of an evening just to catch a station's call.

SHIRLEY C. NEIS.

Lodi, Wis.

## DEALERS

We are now making prompt deliveries on the following lines:

Acme, Grebe, Baldwin  
Phones, Murdock, Fada,  
Federal and many other  
lines including the well  
known Radio Shop  
Products.

Write for our Discount Sheet.

## THE RADIO SHOP OF NEWARK

41 S. Orange Ave.,  
Newark, N. J.



## "True-Tone" Phones

Perfection in  
Performance  
and Appearance.  
Embodying every  
factor of scientific  
design.  
3000 Ohms  
resistance.

Worth More, Yet Costs Less

"True-Tone" Phones—Just \$5.00  
what the name implies.  
Clear and Loud with all  
types of apparatus.

Backed By A Real Guarantee

If your dealer can't supply you, send us his name and address with price and we will ship at once.

Jobbers, Dealers: Write or Wire—NOW.

"True-Tone" RADIO MFG. CO.  
188 No. LaSalle Ave., CHICAGO, ILL.

# NEW ORLEANS

## RADIO

### APPARATUS and SUPPLIES

ROSE RADIO SUPPLY

129 Camp St., New Orleans, La.

Send 10c for Latest Catalog

## The RADIO-PHONE SALES CORP.

Announce

Long Range Receiving Sets  
All Units in One Cabinet

TERMS TO DEALERS

Dept. 7-S, 308 S. Green St., CHICAGO, ILL.



# The M & M Co

## RADIO MFG. DIVISION

M & M Radio Products sell and stay sold because, in addition to being finished to the last detail, every item is designed and constructed with a thorough knowledge of the duty it is to perform. Therefore, it is no wonder that M & M superiority is instantly recognized by the leading jobbers.

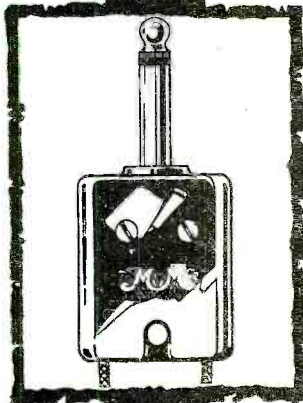

### M & M Radio Plug

At last. A phone plug you don't have to take apart or unscrew to make connections; no tools of any kind necessary. Simply insert phone cord tips in holes and connections are made. Strong, phosphor-bronze springs make positive and strong contact. Tips are released by slight upward pressure. Hole is provided for anchoring cord tie.

Price..... **\$1.50**



### M & M RadioVar

A hard, quick-drying varnish for coating radio coils of any kind, without increasing capacity effects between turns. Is far superior to shellac and protects the windings against moisture or becoming loose. Do not use on enameled wire as it removes the enamel. If it becomes thick, thin with grain alcohol or ethyl acetone. Keep fire away.

Price, 8-oz. jar..... **50c**

### M & M Head Phones

They are unusually sensitive; special attention being given to matching perfectly the tone in both receivers. The magnets are made of finest grade of magnet steel and properly aged before assembly. The receivers have aluminum cases and the earcups are of moulded Bakelite. A rear cap prevents connections from being jerked loose. All metal parts heavily nickel plated. Shipping weight, 1 pound.

Price..... **\$10.00**

### Variable Condensers

This variable air condenser is for all-round amateur or commercial use and is die cast with a special metal containing a minimum of lead, thus assuring positive accuracy without danger of buckling or distortion of plates. The ends are of special hard rubber and the plates of aluminum.

Type A .0095 mfd..... **\$3.75**  
Type B .001 mfd..... **\$4.25**

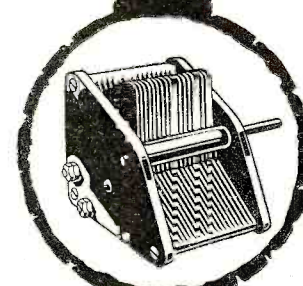

### 180° Vario Coupler

Designed primarily for use in the popular single circuit tuner. The secondary coil is two-layer bank wound so it will respond to any wave-length covered by the primary; furnished also with single layer winding, if desired. The secondary leads are brought out thru spring contacts on the shaft, insuring positive connections at all times. All metal parts nickleed. Wave-length 170 to 600 meters. Shipping weight, 1 pound.

Price..... **\$5.30**

### M & M Variometers

This special design with the skeleton rotor and stator reduces the usual losses found in most other variometers. The coils are form wound, the turns being held together with RadioVar. The skeleton frames are made of 1/16" black fibre securely cemented together; the windings are secured to the frames at eight different points. Metal parts are nickel plated brass. Wave-length 170 to 500 metres. Price..... **\$5.00**

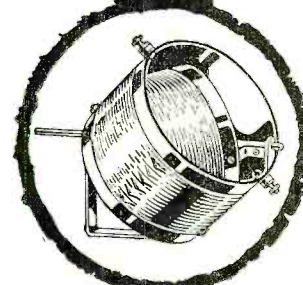

### Lead-In Insulators

A simple, efficient device for bringing the lead-in through the window or wall. Made of moulded hard rubber compound, possessing high insulation properties. Easily installed: simply drill one "x" hole through the window or wall, insert insulator and tighten the nuts. Beautiful in appearance; light in weight. Price—4-inch size, **60c**;  
9-inch size..... **\$1.00**

### Vacuum Tube Socket

Made for standard detector, amplifier or 5-watt power tubes. Shell is of heavy brass, nickel plated and highly polished; hard rubber moulded base with connections plainly marked. Contacts made through phosphor bronze springs, assuring positive connections at all times. Mounting holes provided.

Price..... **60c**

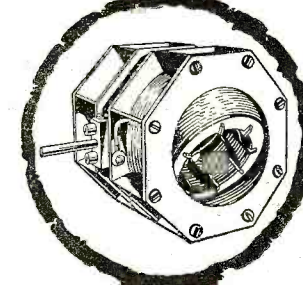

### Also Manufacturers of

McLean Radio Batteries, M & M Audio Frequency Transformers, M & M Radio Frequency Transformers, M & M Rheostats, Bestone Loud Speaker and M & M Dials.

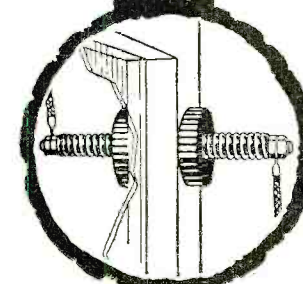

RADIO MFG. DIVISION



500 PROSPECT AVE. CLEVELAND, O.

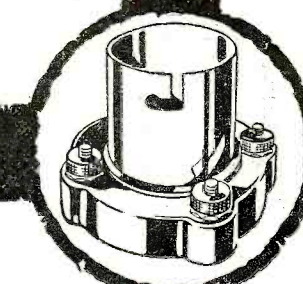

Jobbers—Write for Catalog and Discounts



# 4 of our many big bargains

## RHEOSTAT

Highly finished hard rubber. A beautifully designed piece that is a decided ornament to any Radio Set.



RHEOSTAT with DIAL **\$1.35** With POINTER **\$1.10**



## VARIOMETER

No wood! No composition! Rotor and Stator of hard rubber, best insulator known! Nickel-plated hardware.

Beautiful design. Shape of Stator conforms with that of Rotor, saving space on panel board. **\$5.00**

## VARIOCOUPLER

Fiber tubing, hard rubber Rotor. Green covered wire. Nickel-plated hardware. Large Size, 180° adjustment. **\$4.50**

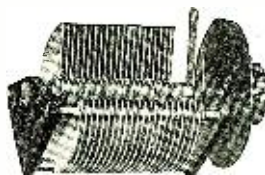
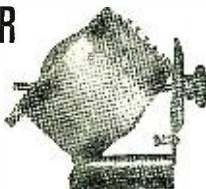

## Variable Condenser

21 Plates Capacity .0005 M.F.D. **\$3.50**  
43 Plates Capacity .001 M.F.D. **\$4.50**

## UTILITY ELECTRICAL PRODUCTS COMPANY

4550 Congress St.



CHICAGO

DEALERS: write for proposition

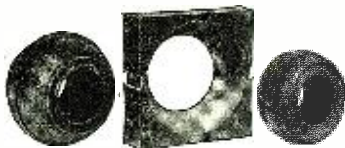

Variocouplers, Rotors, Winding Forms. Stators, in Genuine Mahogany.

Quick Deliveries. Write for prices.

ARTISTIC WOOD TURNING WORKS

519 No. Halsted St., Chicago, Ill.

## RADIO HEAD SET CORDS

R. W. LILLIE CORPORATION

50 Church St. NEW YORK CITY

176 Federal St. BOSTON, MASS.

### SIGN OFF MORE CAREFULLY

Editor, RADIO NEWS:

As a subscriber to your RADIO NEWS magazine, I take this privilege of calling your attention to a matter which I consider of great importance.

Out in this country there seem to be a number of broadcasting stations which fail to make a good job of signing off. I have been wondering if you could reach these stations through your magazine and make it impressive to them by publishing an article requesting them to be more careful in signing off, as we radio fans would like to know who we are listening in on and would be glad to write to them as per their request.

C. M. STENBERG,  
Genoa, Neb.

### CONSTRUCTIVE CRITICISM

Editor, RADIO NEWS:

In the August issue of RADIO NEWS there appeared on page 235 a letter by Mr. Henry Morris of Monrovia, California. Because the short-sighted letter was made still more misleading by the heading "When, Oh when will it stop?" I wish to answer that communication.

There is a remote possibility that conditions are as bad as Mr. Morris paints them. At present California, especially near San Diego, holds the unpleasant distinction of being a center of radio anarchy. As in municipal affairs, so also in radio, the conditions of a city are always a direct reflection of the citizen mind. Where the population takes an active interest in governmental affairs, joins in citizen's meetings and becomes directly acquainted with those in power, there will be an intelligent understanding of the evils of government and because the law-abiding citizen is acquainted with others of his kind, they can, by force of united action and opinion, cure those evils without a civil war.

On the other hand, if the citizen stays away from public meetings and writes appeals to the National Government and to the magazines (however eminent the latter may be) he will continue to endure the same conditions with only himself to blame.

But are things really as stated, Mr. Morris? Are you not one of those who uses a crystal receiver or perhaps single circuit tube set?

Whatever may be the merits of those devices they are admittedly unable to do away with local spark interference as well as the coupled tuners. True, the single circuit attains selectivity when the tube is made to oscillate, but it is not so used by the broadcast listener.

Wherever the user of the single circuit is situated near a strong spark or arc station there will be discontent on his part as to the interference conditions, and only too often he is blaming the amateur for that interference when the call of the "rock crusher" in question begins with an "N" or a "K" or a "W."

Therefore, I wish to suggest to Mr. Morris and to others who write similar letters that he first go over his own receiver in a highly critical frame of mind, then (if the set passes inspection) that he go out and join a radio club, become active in its ranks, learn to know the men who create the interference and by force of education, club opinion and just possibly by law cure those men of the practices in question.

The National Government cannot be expected to settle these local quarrels, nor has it any such intentions, as is shown by the provisions of the new law which, in contradiction to the impressions of Mr. Morris, is designed to restrain the broadcast station rather than the amateur.

S. KRUSE,  
New Orleans, La.

### Recognized as best by largest Radio Manufacturers



BUY IT IN CARTONS

### COPPER CLAD STEEL COMPANY

New York Chicago  
Braddock, P. O., Rankin, Pa.

### A Broadcast From the Far West

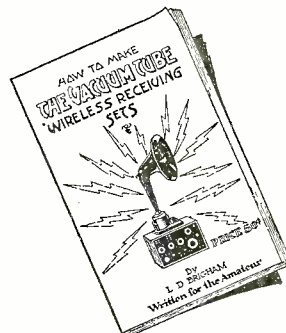

The Radio Book of Books **50c**

CONTENTS: 12 Diagrams, including The Armstrong Regenerative Hookups, Detector, Two-Stage Amplifier, Radio Amplifier, Radio Audio Amplifier, Armstrong Regenerative, same with Amplifier.

If your Radio Dealer does not have it, order direct

How to make a (crystal) wireless receiving set. By L. D. Brigham. For city use only. **25c**

### ARCHWAY BOOKSTORE

224 Pike Street Seattle, Wash.

### CARDBOARD TUBING

Seamless—Grey	Per Inch or Fraction	Per Ft.
2½, 3 and 3½ in. O. D.	3½c	30c
4, 4½ and 4¾ in. O. D.	4c	35c
5 in. Outside Diameter	4½c	42c
5½ and 6 in. O. D.	5c	50c

Postage Extra—Shipping Weight, 1 lb. per ft.

Dealers Write for Discounts

### MICHIGAN RADIO CO.

2173 Hillger Ave. Detroit, Mich.

THE crystal receiving set

## PINK-A-TONE

DETECTOR of the air

Manufactured by PINKERTON ELECTRIC EQUIPMENT CO. National Service Co., General Sales Agent 1834 Broadway, New York



# Announcing The New **WORKRITE CONCERTOLAS**

\$12<sup>00</sup>

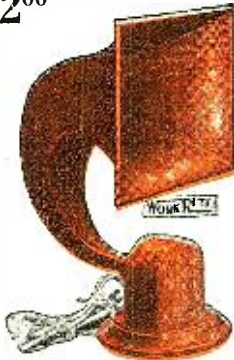

**CONCERTOLA JR.**

A graceful, beautifully constructed instrument, harmonizing with your house furnishings.

**H**ERE they are—the loud speakers produced by the WorkRite engineers—Concertola Sr. and Jr. Perfected until they are worthy of the name WorkRite. Hundreds of thousands of radio fans who have used WorkRite Radio Products know that “WorkRite” means perfection.

WorkRite Concertolas accurately reproduce music or voice from the broadcasting station without the slightest distortion. On still nights they can be heard two city blocks away.

The sound chamber in both these instruments is made from our specially developed material. Why listen to music through a “tin-panny” metal horn that loses all the beautiful tones of the artists, when you can buy a WorkRite Concertola that will give you perfect reproduction of voice and music?

\$24<sup>00</sup>

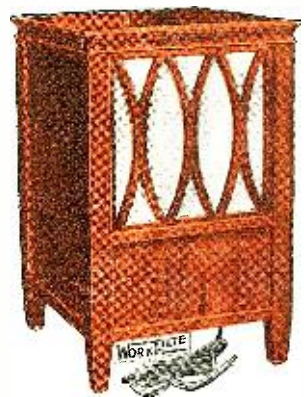

**CONCERTOLA SR.**

Made from the finest grade mahogany with handsome rubbed finish.

EXCEPT FOR THE PHONE

**There Is Not the Slightest Metal Used In Either the WorkRite Concertola Senior or Junior**

**IMPORTANT!** The best sound amplifier will not get results with an ordinary head phone. Our engineering department has developed the WorkRite Concert Phone for just one purpose—to be built in the WorkRite Concertola Sr. and Jr., making a combination that is unequalled. This special 5,000-ohm phone is not sold separately from the Concertola. Phones and cord are built in each instrument.

WorkRite Concertola Jr. \$12.00

**FREE TRIAL** The WorkRite Concertola Sr. and Jr. are sold on an absolute money-back guarantee. After three days' trial, if you do not find this the most wonderful loud speaker in every way for home use, return it and your money will be refunded. If your dealer cannot fill your order, we will ship by Express, prepaid, upon receipt of the price.

WorkRite Concertola Sr. \$24.00

**BEFORE BUILDING A SET WRITE FOR OUR FREE CATALOG!**

WorkRite Vernier Super Rheostat



Here is a real Rheostat—something entirely new and very much needed. Can be instantly changed from 6½ ohms resistance to zero by simply pushing in the knob, or you can have fifty thousand different adjustments by turning the knob. The WorkRite Rheostat will usually double the audibility of distant concerts. Screws for mounting on panel furnished. The WorkRite Rheostat is really remarkable in its performance and is easily worth twice the price asked. No set should be without it. Price.....\$1.50

**JOBBERS and DEALERS**  
Write or wire for discounts

WorkRite Super Variometer

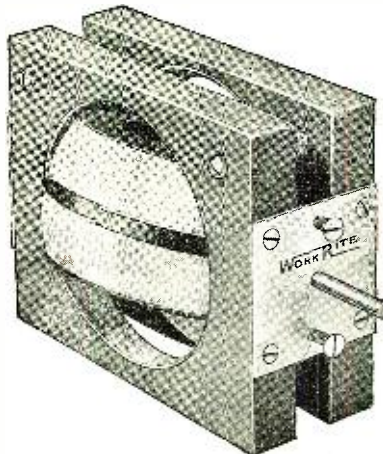

**THE WORKRITE VARIOMETER** is made from finest quality mahogany. All windings are perfectly made, and connections cleverly concealed. Substantially built throughout. **WORKRITE VARIOMETER** packed in attractive box.....\$5.25  
With WorkRite Dial..... 6.00

WorkRite 180° Super Variometer

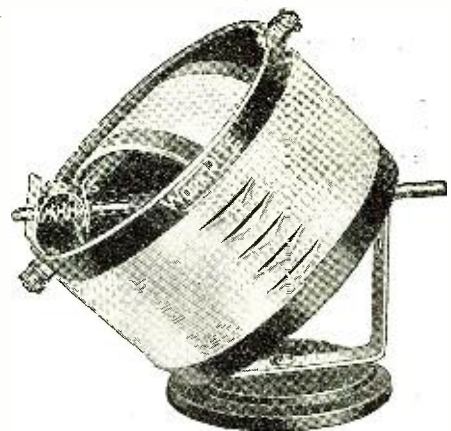

**THE WORKRITE VARIOCOUPLER** represents perfection in getting all dimensions and number of wire turns just right. Tunes twice as sharp as the ordinary 90-degree coupler. **WORKRITE VARIOCOUPLER** packed in attractive box.....\$5.00  
With WorkRite Dial..... 5.75

**THE WORKRITE MFG. CO.,**

5525 Euclid Avenue, CLEVELAND, OHIO

Branch, 2204 Michigan Ave., Chicago, Ill.

R-N. 10227



## Some Recent Developments of Regenerative Circuits

(Continued from page 619)

**“PROFCO”  
RADIO SETS**

HAVE  
*Quality in Workmanship  
Excellence of Design  
Neatness of Appearance  
Simplicity of Operation*



**\$85.00**

**TYPE R-D-2**  
(Receiver, Detector, and 2-Stage Amplifier)

Detector and Two-Stage Amplifier... \$55.00  
Receiver and Detector..... 42.00

Write for Latest Bulletin

**PROFCO RADIO MFG. CORP.**  
138 WEST BROADWAY, NEW YORK CITY

The rate of variation in the relation between the negative and positive resistance is a matter of great importance. It may be at sub-audible, audible, or super-audible frequencies. In radio signaling, for the reception of telephony, the variation should be at a super-audible frequency. For modulated continuous wave telegraphy and spark telegraphy, to retain the tone characteristics of the signals, it must be well above audibility; for maximum amplification a lower and audible rate of variation should be used. In continuous wave telegraphy, where an audible tone is required, the variation is at an audible rate; where the operation of an

duced into the tuned circuit of the amplifying tube. In this case the amplifying tube serves also as the detector for any frequency of variation, as the tuned circuit forms a sufficiently good filter even for an audible frequency to prevent a disturbing audible tone in the telephones.

Figure 11 illustrates the case of a simultaneous variation in both positive and negative resistances. This is accomplished by providing the amplifying tube *R* with a second feed-back circuit  $L_1C_1$  and  $L_2C_2$  adjusted to oscillate at some lower frequency, thereby introducing a variation in the negative resistance through the variation of the plate potential of the amplifier and a variation in the positive resistance by means of the variation of the grid of the amplifier. The proper phase relations between the negative and positive resistance are obtained by adjustment of the capacity of condensers  $C_1$  and  $C_2$  and the coupling between  $L_1$  and  $L_2$ . In operation this system is very critical, and extreme care is necessary in order to obtain the super-regenerative state.

In each of the preceding cases the detecting function has been carried out either by a separate tube or by means of the amplifying tube. When a super-audible frequency of variation is employed, it is sometimes of advantage to perform the detecting function in the oscillating tube, and a system for carrying this out is illustrated in Fig. 12. The operation of this system is as follows: incoming signals are amplified by

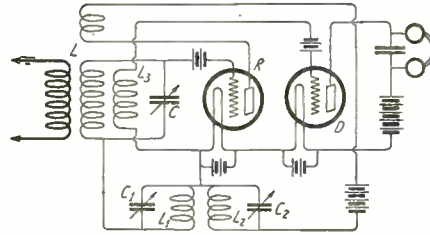

Fig. 11

This is the Method Employed for Simultaneously Varying the Positive and Negative Resistances of the Regenerative Circuit. A Separate Detector Tube is Used.

indicating device is required, a sub-audible frequency may be best. The choice of frequency is a compromise, particularly in telephony, since obviously the lower the frequency the greater the amplification, and the higher the frequency the better the quality.

Some practical forms of circuits are illustrated by Figs. 9, 10 and 11, which illustrate respectively the three types of variation. Fig. 9 shows a method of varying the plate voltage coupled into the plate circuit. In this arrangement a third tube acts as a detector. This is essential when an audible frequency is employed; when a super-audible frequency is used the telephones can be placed directly in the plate circuit of the amplifying tube.

Fig. 10 shows the second case in which the variation is introduced into the positive resistance of the tuned circuit. This is done by means of an oscillating tube *O*, the grid circuit of which is connected through the tuned circuit  $LC$  of the amplifying tube *R*. The variation in the resistance of the circuit is effected through the variation in potential of the grid of the oscillating tube. During that half of the cycle, when the grid of the oscillating tube is positive, energy is withdrawn from the tuned circuit in the form of a conduction current from the grid to the filament of the oscillating tube, thereby increasing the effective resistance of the circuit. During the other half of the cycle, when the grid of the oscillating tube is negative, no conduction current can flow through the grid circuit of the oscillating tube, and hence no resistance is intro-

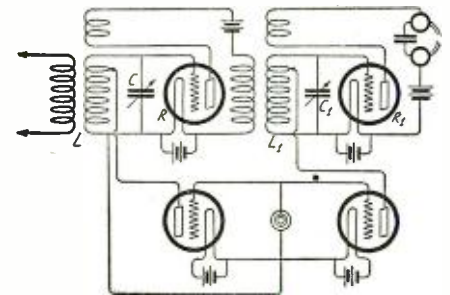

Fig. 14

In Using Cascade Amplification with the Super-Regenerative, Complications Arise. A Simple Manner of Overcoming These is to Amplify the Second Harmonic of the Output.

means of the regenerative action of the amplifier tube *R* and the variations of potentials across the tuned wave frequency circuit  $LC$  impressed upon the grid of the oscillating tube *O*. These oscillations are then rectified, and two frequencies are produced in the circuits of the amplifier tube. One of these frequencies corresponds to the frequency of modulation of the signaling wave. The other corresponds to the frequency of the variation and contains a modulation in amplitude corresponding to the modulation of the transmitted wave. This second frequency is then impressed upon the circuits of the oscillating tube

### APPARATUS FOR THE New Armstrong Circuit

Ward Leonard Resistances, 12,000-ohm. Each.....	<b>\$3.50</b>
.1 Henri—Choke Coils. Each.....	<b>3.50</b>
DL—1500 Honeycomb Coils. Each.....	<b>3.85</b>
DL—1250 Honeycomb Coils, Each.....	<b>3.30</b>
DL—300 Honeycomb Coils. Each.....	<b>1.93</b>
Mica Condensers—.001 Mfd. Each.....	<b>.35</b>
Mica Condensers—.002 Mfd. Each.....	<b>.40</b>
Mica Condensers—.005 Mfd. Each.....	<b>1.00</b>

Complete sets and parts to make your own sets. Write for catalogue.

**DAVID KILLOCH CO.**

57 Murray St., New York

WHOLESALE RETAIL

### RADIO FOR THE NATION

Stores in five large cities enable this organization to supply radio equipment, both wholesale and retail, with the greatest speed and economy.

**20th Century Radio Corporation**

565 Fifth Avenue, New York City  
Straus Bldg., Suite 710

Stores in Norwalk, Conn., Detroit, Mich., Newark, N. J., Brooklyn, N. Y., White Plains, N. Y.

Wood Variometer Turnings, Rotor and Two Stator Blocks, with axles and brass plates. Largest size, complete, \$1.55. Our 43 plate condenser for panel mounting, \$4.50; with 2½ inch knob and dial, \$5.25. Try us for brass rod, brass machine screws, sheet fibre, etc.

**ANGIERS, U. S. A.**  
Bruce St. Plant Streator, Ill.

Continuous Oscillations Occur When it is Attempted to Use Tuned Circuits Between the Antenna and the Amplifier. These Can Be Avoided by the Super-Heterodyne Method of Amplifying a Different Frequency.

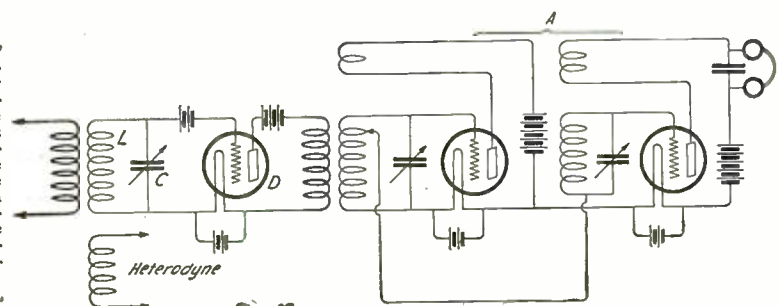

Fig. 15



# no ground aerial

The Oard **PHANTOM** no ground circuit  
used in -

## The A-P Special RECEIVING SET

One of the most important, most revolutionary developments since the discovery of radio. The receiving set thousands have been waiting for. A set that requires no ground, no aerial. For general use a single wire not exceeding 15 feet in length, concealed in the picture moulding, laid on the floor, or, if out-of-doors, placed on the ground, is all that is necessary. Stations 400 miles distant have been heard under these conditions. For distant service a wire not over 50 feet long will produce better results than can be obtained with the elaborate 150 to 200 foot aerial and ground, or loop system required by other types of receivers.

The A-P Special has the apparent advantages of radio frequency amplification without its delicate and complicated adjustments. It is remarkable for its simplicity of control and marked selectivity, and ideal both as a home set and for use as a portable in camping or outing.

*Bulletin B contains complete information on this wonderful set. Write for it and name of our nearest dealer. We are now in position to make prompt shipments.*

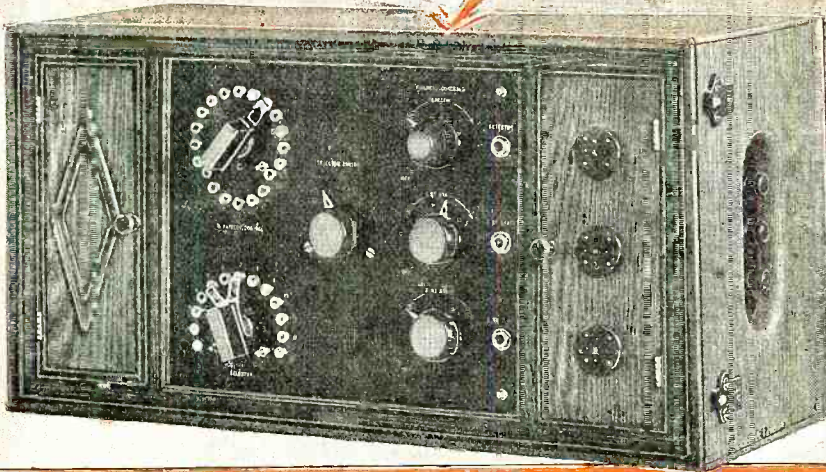

U.S. AND FOREIGN  
PATENTS PENDING

**Atlantic-Pacific Radio Supplies Co.**  
Operating K.Z.Y. Broadcasting Station      646-650 Mission St.      Radio Supplies  
San Francisco, Cal.



The Hit of **SE-AR-DE** New England



Radio

Products



SE-AR-DE Variometers are made of genuine molded bakelite, wave length range 180 meters to 580 meters, stator wound with single cotton covered wire, rotor with single green silk wire, mid point of stator winding brought out for first tap in single circuit tuner. The only variometer to which a bank wound inductance can be conveniently attached. It has lower dielectric losses and higher efficiency than any similar article on the market. No friction contacts, the rotor connections are pig-tailed to two binding posts on the rear.

Retail price \$8.00 (Design and construction patents pending)



SE-AR-DE Switches are made in  $1\frac{1}{8}$ "- $1\frac{1}{2}$ "- $1\frac{3}{4}$ " radius—Single contact and  $1\frac{3}{4}$ " radius Dead Ending types—with Thermoplox knob (no shellac), all parts nickel plated, contact arm and bushings nicked and hand buffed—Each switch is packed in individual box.

Retail price

Single Contact \$0.60

Dead End \$0.75

Jobbers and Dealers write for discounts on the above. Also knob and dial, bakelite socket, vario coupler, bank wound inductance, variable condenser, insulated binding posts, contacts, C.W. Inductances, choppers and phonocaps.

**R. MITCHELL & CO.**

255 Atlantic Ave.

Boston, Mass.

For 47 yrs. Mfrs. of Scientific and other equipment.  
Look for trade mark on every piece.

**CANADIAN AMATEURS!**

**HEADQUARTERS FOR THE BEST  
RADIO EQUIPMENT**

Write for Price List

**SCIENTIFIC EXPERIMENTER, Limited**

33 MCGILL COLLEGE AVENUE

MONTREAL

Get a Handy Binder for your RADIO NEWS. Holds and preserves twelve issues, each of which can be inserted or removed at will. Price 65c. Experimenter Pub. Co., Inc., Book Dept., 53 Park Place, New York.

with which it is in tune, amplified by the regenerative action of the system  $L_1C_1L_2O$  and then rectified. The amplification obtainable with this form of system is considerably greater than that of the single amplification circuits, but is naturally more complicated to operate.

When a super-audible variation is employed in a system such as illustrated in Fig. 1, it is generally necessary to introduce a certain amount of resistance in the tuned circuit to insure the dying out of the free oscillation during the interval when the resistance of the circuit is positive. This is most effectively carried out by means of the arrangement illustrated in Fig. 13, in which a secondary coil  $L_1$  of large inductance and high resistance is coupled to the tuned circuit  $LC$  and the energy withdrawn thereby from the oscillating circuit stepped up and applied to the grid of the tube. In the operation of this system, a curious phenomenon is encountered. This is the manifestation of an inductive reaction by the plate circuit of the amplifying tube to the auxiliary frequency emf. supplied the plate circuit by the oscillating tube. This comes about in the following way. When the auxiliary emf. is impressed upon the plate of the amplifying tube, a current is produced in this tube in phase with the emf. across the tube. Now suppose the plate voltage is at its maximum positive value. This means that the negative resistance of the circuit is a maximum in amplitude. This in turn means that the average value of the grid is becoming more positive and the current in the plate circuit is likewise increasing. Since the free oscillation in the system will increase in amplitude as long as the resistance of the circuit is negative, it will reach its maximum amplitude after the maximum positive voltage is applied to the plate. Hence the component of current corresponding to the frequency of the variation set up in the plate circuit by the rectification of the radio frequency oscillations lags in phase behind the auxiliary emf. impressed on the plate. Hence the plate circuit of the tube manifests an inductive reaction to the auxiliary emf. It was found that this inductive reaction could be tuned out by means of the parallel condenser  $C_1$  with great improvement in the stability of the operation of the system and increase in the signal strength. The resonance point is pronounced, and once the other adjustments of the system have been correctly made, is as readily found as any ordinary tuning adjustment.

The problem of cascade amplification with these systems is a rather involved one on account of a great number of effects which are not encountered in ordinary methods of cascade amplification. The principal trouble is the reaction of the second amplifying system on the first, and the difficulty of preventing it in any simple way on account of the high amplification per stage. While this difficulty is not insuperable, a simple expedient may be employed which avoids it. On account of the large values of radio frequency energy in these amplifying systems, the second harmonic is very strong in the plate circuit of the amplifying tube and is of the same order of magnitude as the fundamental if the tube is operated with a large negative voltage on the grid. Hence by arranging the second stage of a cascade system to operate at double the frequency and to amplify this harmonic, the difficulty is avoided. The general arrangement of such a system is illustrated by Fig. 14, in which the positive resistance of the circuits  $LC$  and  $L_1C_1$  of a two-stage amplifier are varied synchronously by a single oscillator. The circuit  $L_1C_1$  in this case is tuned to the second harmonic of the circuit  $LC$ , but the combinations of circuits which may be arranged on this principle are very numerous.

One of the curious phenomena encountered with the super-regenerative system is



# Regal Radio Products

*Regal*  
CONDENSERS  
PRECISION MADE



43 PLATE .001-MF \$ 4.50  
23 " .0005-MF 3.50  
11 " .00025-MF 3.00  
3 " VERNIER 2.50

*Regal*  
TUBE SOCKET



\$0.75

*Regal*  
MULTIPLE TELEPHONE  
CONNECTORS



FOR PANEL MOUNTING \$1.50  
WITH PLUG AS SHOWN 2.50

*Regal*  
TAPERED KNOB  
NEW DESIGN  
HANDSOMELY FINISHED



1" DIA., 1" HEIGHT \$0.40EA  
1/4" " 1" " 0.45 "

*Regal*  
VARIO-COUPLER

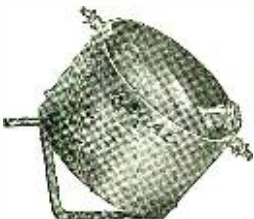

PERFECT ALIGNMENT  
AND CONTACT  
\$ 5.00

## This is a "Regal" Year Here Are Five Big Reasons for the Enormous Sale of "Regal" Receivers

1. Designed by our own radio engineers and a scientific precision instrument simple and easy to operate. 2. Built entirely in our own factory with all "REGAL" parts. 3. Has a guaranteed wave length from 150 to 1800 meters. 4. Backed by our thirty years' experience in the manufacture of precision instruments. 5. Priced at \$40.00 instead of \$100.00—reason, we build it ourselves.

(Under actual test in our testing laboratory in Bridgeport, Conn., on the evening of July 12th, we brought in a very beautiful concert from station WOH, Indianapolis; concert and base ball scores from station KDKA, Pittsburgh; Marine Band concert from station NOP, Washington, D. C.; Concert, weather and market report from station WJZ, Newark, as well as several other stations. This test was with one tube and without the use of the Regal Two-stage Amplifier.)

*"Regal"*  
Vacuum Tube Receiver \$40.00      *"Regal"*  
Two-Stage Amplifier \$35.00

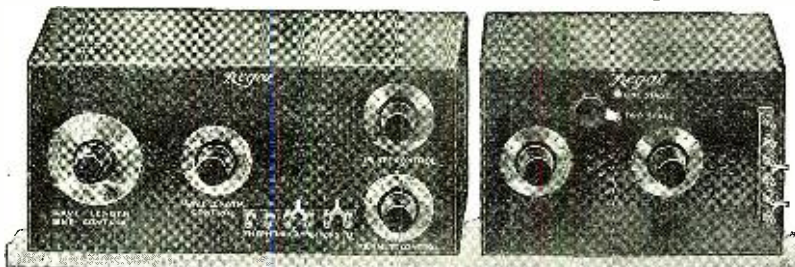

Can be added to "Regal" Receiver to triple range and audibility.

### Some Excellent Features of the "Regal"

Minimum number of controls, all clearly marked, with taper knobs and etched silver dials. Unique Regal Telephone Connector, permitting use of three pairs of head phones (doing away with all jacks and plugs) Fine Regal Potentiometer Plate control—so necessary to efficient tuning of modern vacuum tube detector. New Regal Rheostat (6 Ohms—2.2 amperes) New Regal Inductance switch, doing away with all unsightly switch points and levers and insuring fine electrical connections. Regal 43-Plate Condenser. Regal Tube Socket. Mahogany piano finished cabinet with satin finish panels. Rear panel connector, for antenna, ground, batteries, etc., doing away with all crude looking wires in front of cabinet.

*"Regal"*  
Inductance Switch with  
Knob and Dial

A quality instrument that is 100 per cent efficient. 15 point switch complete in one unit. Does away with usual awkward and unsightly job of single threaded switch points bolted to panel. Requires but one hole to mount on panel. Smooth wiping contact over heads machined to same height on one piece contacts. Complete soldered assembly attached, or removed from panels by means of one threaded shaft bushing. Gives inductance regulation by dial contact. THE BIGGEST HIT IN RADIO. Complete with Knob and Dial.

Price \$2.50

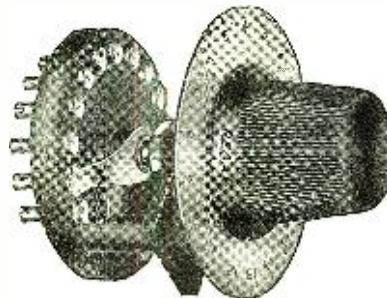

Patent Pending

*"Regal"*  
Filament Rheostat

Your Receiving Set is worthless without a good Rheostat. The "REGAL" is mechanically perfect. Has full exposed resistance wire, giving critical adjustment so necessary to the efficient operation of a vacuum tube. Fine, smooth working control. Handsome knob, heat resistance base and highly nickel plated parts. 6 ohms resistance—2.2 amperes.

Price \$1.25

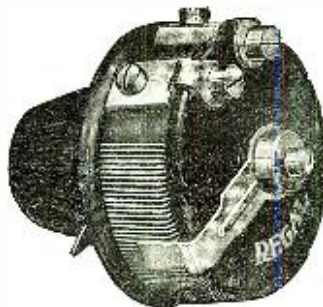

Patent Pending

HOME OF REGAL RADIO PRODUCTS

Attractive  
Proposition  
for  
Jobbers  
Dealers and  
Distributors

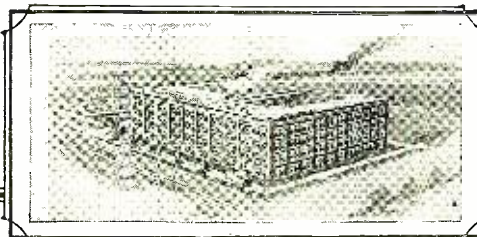

Ask for Our  
Handsome  
New  
Catalog  
No. 20

GENERAL OFFICES 145-195 HOLLAND AVE.  
FACTORIES HOLLAND AVE. AND ASH STS.

*Regal*  
HEAD SETS  
SUPER-SENSITIVE  
BACKED BY OUR GUARANTEE



2000 OHMS \$ 7.50  
3000 " 10.00

*Regal*  
KNOB AND DIAL



3" DIA. ~ \$1.00  
4" " 1.25

*Regal*  
CRYSTAL DETECTOR.  
UNIVERSAL ADJUSTMENT  
A DISTINCT REGAL PRODUCT



\$ 1.25

*Regal*  
LIGHTNING SWITCH  
HAS 5" BREAK  
COPPER PARTS 100AMP.



\$ 3.00

*Regal*  
VARIOMETER  
PRECISION  
WOUND



GUARANTEED  
PERFECT

\$ 5.00



# "How to make your radio set work best"

**I**N ORDER to make your radio set work, let us briefly consider the requisites necessary and then apply a definite method to achieve this end.

To receive signals of maximum intensity, the open and closed circuits of the receiver *must be accurately tuned to each other and to the frequency of the incoming wave.* Tuning in the circuits of a radio receiver is accomplished by means of the variable elements of inductance and capacity.

The best results in tuning to a wave length are obtainable by means of a variable condenser, always providing that this instrument has been constructed with *micrometer exactness* as is the Westwyre Variable Condenser.



Not only does this instrument enable you to more readily *select the station you desire* where two or more are broadcasting at approximately the same wave length, but it *tends to increase the strength of incoming signals and eliminate interferences* from near-by stations which ordinarily drown out those farther off.

In a weighing operation, weights of several pounds are first placed on the scales, while the delicate balancing is accomplished by a sliding beamweight. So in a radio set the inductance may be varied in rather large steps while the finishing off is left to one or more Westwyre Variable Condensers which are capable of exceedingly fine wave length adjustment.

43 plate, .001 mfd. with dial..... \$5.00    11 plate, .00025 mfd. with dial..... \$3.50  
 23 plate, .0005 mfd. with dial..... 4.00    3 plate, vernier with dial..... 3.00

## Westwyre Variable Condensers

THE WESTWYRE RADIO COMPANY, Westfield, Mass., U. S. A.

I am attaching money order check for..... Plate, Westwyre Condenser, shipped by parcel post. Please send radio catalog.

Name.....

Street.....

City.....

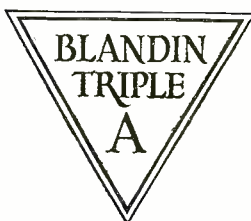

Radio Cabinets

If you are merchandizing high, grade apparatus—

And want your quality reflected in the cabinet that helps sell it—

Specify "Blandin Triple A" equipment exclusively.

This mark guarantees you the first and highest quality—and within the popular price range.

Send your specifications now if you want deliveries.

BLANDIN PHONOGRAPH CO., Inc.  
 1200 16th St. Racine, Wis.



**MONEY for You**—Add to your Salary—Make extra Pin Money. Start a lucrative business of your own. Spend an hour each day taking subscriptions for the "Radio News." We'll pay you well and you'll enjoy the work. Write for full particulars. Circulation Dept., RADIO NEWS 53 Park Place, N.Y.C.

found when it is attempted to secure sharp tuning by the use of tuned circuits placed between the antenna and the amplifying system. The free oscillations set up in these circuits by the reaction of the amplifying system continue in these circuits during the interval when the resistance of the amplifier circuit is positive, re-excite the amplifier when the resistance becomes negative, and hence the entire system is kept in a continuous state of oscillation. The effect is most critical, and may be produced with most extremely weak couplings between the amplifier circuit and the second tuned circuit. The simplest solution of the difficulty is to perform the function of tuning at one frequency and amplification at another, and this is best accomplished by means of the super-heterodyne method illustrated by Fig. 15. This may be adapted to work on either the sum or difference frequencies, but when the higher frequency is used, care should be taken that it is not near the second harmonic of the local heterodyning current. In the particular arrangement illustrated, LCD represents, together with the heterodyne, the usual agency for changing the incoming frequency, and A represents the super-regenerative amplifier which may be of any suitable type.

<sup>1</sup>It is very important at this point to distinguish between this purely theoretical state and the state which exists in oscillating tube circuits. In the various forms of self-heterodyne circuits a free oscillation of constant amplitude is maintained in the system and the circuit may be considered as having zero resistance, but only for that particular amplitude of current. An external emf. impressed on the circuit always encounters a positive resultant resistance, assuming, of course, that the existing oscillation is stable. This is due to the non-linear characteristic of the tube.

<sup>2</sup>This is strictly true when dealing with continuous waves which we have been considering. It is not true in the regenerative reception of spark signals, particularly of short wave length, large damping and low spark frequency. In this case the energy in the free oscillation exceeds the energy in the forced oscillation.

### THUNDER STORMS

Hoboken, N. J. What has been the cause of all the lightning and thunder storms the last month or more?

I have an idea there is too much electricity in the air due to the many radiophones now being used. Isn't there some one who can tell if this is the cause?

WILLIAM COLLIER.

(The above item picked from the New York "News" attracted our attention. No doubt the weather has troubles of its own and is pretty much peeved with all the aerial noise going on at the present time. There is no doubt that it has convulsions and fits when it listens to some of our pseudo singers. Can anyone blame the weather for turning to lightning and thunder storms at such exhibitions of "art"?)

### Construction of a Super-Regenerative Receiver

(Continued from page 621)

learned by practice. After a little experience, it is not difficult to find the different effects and learn to recognize the sounds which accompany them.

The receiver is well worth constructing. It does not cost much more than an ordinary regenerative receiver and there is no comparison in the results.

An aerial should not be employed with one of these receivers. For one reason, it is hardly necessary, as a loop is all that is required to receive. For another reason, if these receivers become common, they will interfere considerably with each other if they are used in connection with aerials. If a super-regenerative receiver becomes out of adjustment it radiates strongly. This effect is not so noticeable on a loop which will not radiate any great distance,



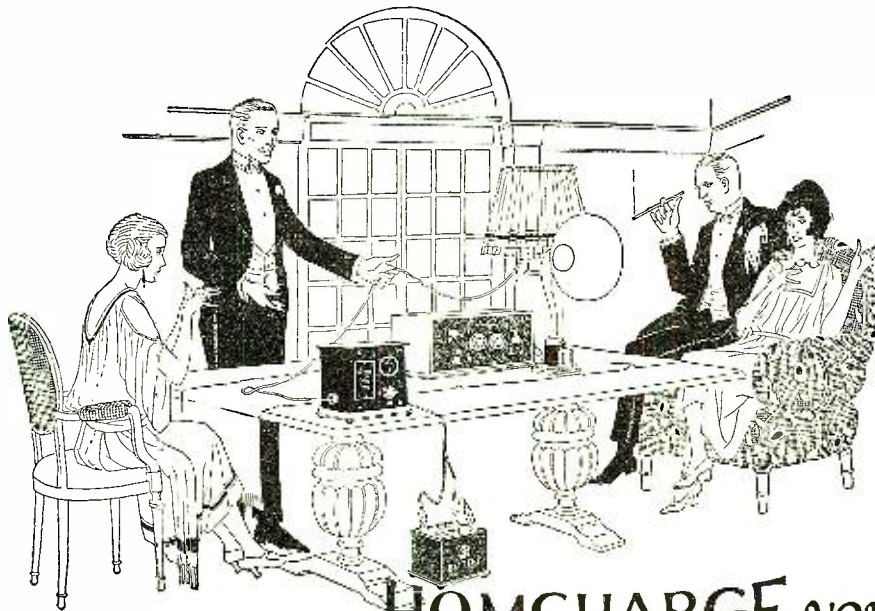

## HOMCHARGE your Radio Battery for a nickel!

Enjoyable Radio Concerts and maximum receiving range are obtained only when your battery is fully charged.

Don't be bothered with the inconvenience and expense of taking your battery to a service station every few days for recharging.

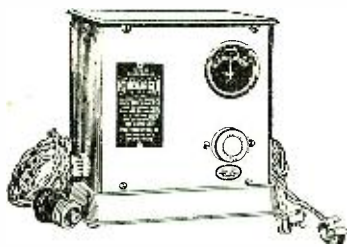

Type "R" (Portable)  
Radio Homcharger De Luxe

### RADIO HOMCHARGER DE LUXE

has been designed especially for this purpose. It charges your "A" or "B" battery over night without removing it from your living room. The Homcharger is silent and clean in operation—no muss—no trouble—no dirt—requires no watching.

Simplicity itself. Attach to any lamp socket and connect to battery. Fully automatic in operation—cannot overcharge or injure your battery.

Constructed of the best materials—moulded Bakelite Base—Jewell Ammeter—Oversize Silicon Steel Transformer. No castings to break—only the finest stampings used thruout.

SAFE—all parts entirely enclosed—no danger from fire—approved by Fire Insurance Underwriters everywhere. Unconditionally guaranteed—lasts a lifetime.

#### An Ornament For Your Living Room

Beauty has been combined with utility in the NEW RADIO HOMCHARGER DE LUXE. The body is beautifully finished in rich Antique Mahogany—the base and fittings in a handsome dull gold. Equipped with rubber feet, it cannot mar polished surfaces. It harmonizes with the finest living room.

#### Over 50,000 HOMCHARGERS IN USE

50,000 users have heartily endorsed the HOMCHARGER. Beware of imitations when buying as *there is only one HOMCHARGER. Insist on the genuine which bears our registered trade name, HOMCHARGER.*

Furnished complete with attachment cord and plug, charging cable and battery clips. No extras to buy. Price at all good radio, accessory and electrical dealers, \$18.50, or shipped prepaid upon receipt of purchase price, if your dealer does not carry it.

*Booklet illustrating the NEW RADIO HOMCHARGER DE LUXE in actual colors is FREE for the asking. Send for your copy today.*



Type "W" Homcharger for  
Wall Mounting  
Over 50,000 in Use

## The Automatic Electrical Devices Co.

118 West Third Street

Cincinnati, Ohio

*Largest Manufacturers of Vibrating Rectifiers in the World*

BRANCH OFFICES: New York - Chicago - Pittsburgh - Detroit - Dallas - Philadelphia  
Los Angeles - Baltimore - Minneapolis - Kansas City - St. Louis - Atlanta.



## New York Coil Company Radio Products Are Built to Work—Not Just to Sell

THE leadership they enjoy is due to correct design, exceptional workmanship and eighteen years' experience in the manufacture of wireless and precision electrical devices. Two especially equipped factories and quantity production is responsible for our low prices.



Price \$4.00



Price \$4.00

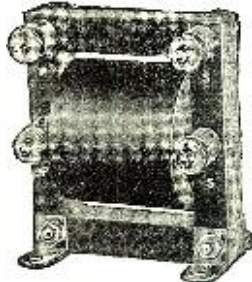

Price \$4.00



Mounted Variocoupler for Panel or table use, but three holes used in panel saves all laying out, drilling and soldering—nothing else like it. Price \$8.00

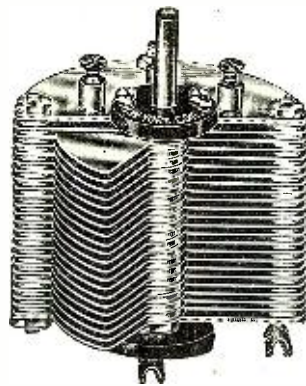

11 Plate. . . . .	\$1.50
23 Plate. . . . .	2.00
43 Plate. . . . .	3.00
3 Plate. . . . .	1.25

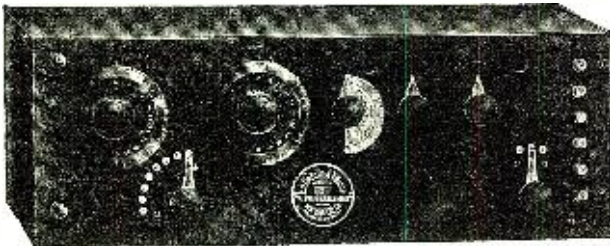

Receiving Set consisting of Tuner, Detector, Two stages of Amplification. Guaranteed to bring in more clear speech, music and entire satisfaction. Complete \$50.00

## NEW YORK COIL COMPANY

338 Pearl Street

New York City

## Earlier Days in Radio-Phone Broadcasting

(Continued from page 621)

Oscar Hammerstein's dramatic soprano, who sang at special performance at the De Forest laboratory at 103 Park Avenue, New York City.

Radio news and music was first furnished on a regular program in the fall of 1916 at the De Forest laboratory in Highbridge, N. Y. In connection with the New York American, election returns were supplied to the radio amateurs of the Eastern States in the 1916 campaign. Music for a radio dance was supplied by the De Forest Highbridge laboratories on the evening of December 30, 1916, for a house party given in Morristown, New Jersey.

After several experimental tests, the *Detroit News* on Wednesday September 1, 1920, reported the fact that the *Detroit News* Wireless Service "for the benefit of the Detroit devotees of the radiophone will be a regular part of the news to the public."

It should not be forgotten that the year 1920 also saw the broadcasting of orchestral music on a large scale from the California Theatre in San Francisco, California, where a daily musical program was furnished to the music lovers on the Pacific Coast.

Following the installation of the *Detroit News* service, came the broadcasting service furnished by the Westinghouse Company at Pittsburgh, later on at the Newark station and other stations with which the public is now more or less familiar.

## New Developments in German Radio

(Continued from page 634)

as embodied in the new central station, for the news service of the world, after which Dr. Rukop, director of the vacuum tube laboratory of the Telefunken Company, gave a short account of recent advances in the field of vacuum tubes, the adoption of several new types of filaments constituting another turning point in the development of these. After its invention, in 1905, by Robert von Lieben, the cathode amplifier tube was, a year later, in the form of Lee de Forest's audion, first adopted in general wireless practice. The successes thus obtained induced the leading companies of the world in their laboratories to undertake the investigation of the more important problems connected with the use of vacuum tubes, the work done by the Telefunken people being remarkable in many ways. During the war, the German Wireless Company was, of course, shut off from the rest of the world, but at present, there is a lively exchange of experimental results between it and the other leading concerns of Europe and America.

Some remarkable improvements have, during the last few months, been devised at the Telefunken laboratory, the heating current being reduced and the life of the filament lengthened considerably, while the troublesome noises of the tubes have been reduced to a minimum. These results were obtained by designing some new types of filament for the incandescent cathode, primarily a new and most efficient oxide filament which only uses up about one tenth of the electric energy required by tungsten filaments, while possessing a remarkably long life (in many cases up to 10,000 hours). Two other types of cathode filament were

"Spirola Speaks"

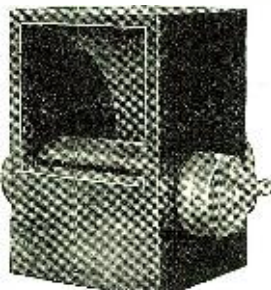

PAT. PENDING

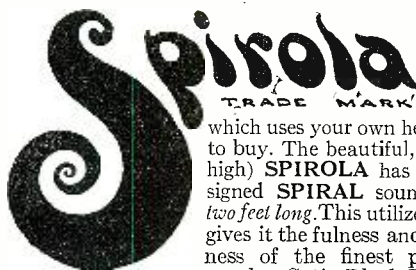

Only CABINET LOUD SPEAKER

which uses your own headset—no "units" to buy. The beautiful, compact (8 inches high) SPIROLA has a scientifically-designed SPIRAL sound chamber nearly two feet long. This utilizes all the sound and gives it the fulness and richness of the finest phonographs. Satin Black Finish. **\$3.85**

SPIROLA DELUXE model, either mahogany finish with bronzed throat or dark oak finish with silvered throat—\$4.85. At dealers, or postpaid direct—money back guarantee.

L. H. DONNELL MFG. CO., Box 70, Ann Arbor, Mich.

Insure your copy reaching you each month. Subscribe to Radio News—\$2.50 a year. Experimenter Publishing Co., 53 Park Place, N. Y. C.



# ---stop *this* interference

**T**HERE'S one kind of "interference" that you can definitely eliminate. That's the "interference" from poorly constructed and unskillfully designed instruments. In putting our Teagle radio apparatus on the market, we are giving the radio fraternity the results of years of radio engineering experience. In addition, we are giving the guarantee of The Newman-Stern Co., pioneers in the radio field.

N.B.—Any item on this page at your dealer's, or sent direct from us, prepaid, on receipt of price.



**Teagle Filament Rheostat**

For panel or table use. Smooth action.  
No. T-100. Price..... \$1.00



**Teagle Stopping Condenser**

Mica dielectric. Brass plates; .0005 Mfd.  
No. T-102. Mounted. Price..... \$0.75  
No. T-102-U. Unmounted. Price..... .60



**Teagle Grid Leak and Condenser Unit**

The only moisture-proof variable grid leak. Screw thread caps. Mica condenser. Brass plates.  
No. T-103-4. Price..... \$1.00  
No. T-104. Grid leak only. Price..... .60  
No. T-103. Grid condenser only. Price..... .40



## The socket that will get your enthusiastic O.K.

**T**HIS Teagle socket is, in the judgment of experienced radio engineers, *the best instrument for the purpose that has ever been devised.* That's a strong statement, but the Teagle socket, when put into use, proves that it deserves just such an unqualified endorsement. When you make it a part of *your* radio equipment, you'll promptly join the army of those who are praising it without stint. *It's a better socket.*

The Teagle socket has a genuine Bakelite sub-base, with four substantial binding posts, and tempered German silver contact springs. The socket itself together with the panel bracket and table lugs, are stamped as one unit from a single piece of brass. This results in a rugged simplicity never hitherto achieved in socket construction. The Teagle socket can therefore be used with equal facility for both panel and table mounting. And the matter of appearance has not been overlooked; the metal parts are highly nicked and polished. This socket is designed to fit detector, amplifier and transmitter tubes. In common with the other carefully-worked-out items in the Teagle line, you can absolutely bank on this radio instrument giving you efficient service and gratifying results. And last but not least, *the price is less.*

Ask your dealer, or send direct to us, for No. T-101 V. T. Socket (shipping weight 1 lb.). Price **75c**

**The Newman-Stern Co**  
Teagle Radio Division  
Newman-Stern Bldg.  
Cleveland, Ohio



**Teagle Receiving Set**

A high-grade crystal receiver. Splendid design.  
No. T-1070. Price.... \$10.00  
No. T-107, with "Red Head" phones. Price.. 16.00



**Teagle Crystal Detector**

Fully adjustable. A better detector.  
No. T-105. Price..... \$1.00



**Teagle Adaptafone**

Converts phonograph into loud speaker. Fits all standard receivers and phonographs.  
No. T-106. Price..... \$1.00

### N-S "Red Head" Radio Receivers

These 3,000-ohm receivers are truly "a triumph in radio receiver design." They possess ruggedness and beauty of appearance, combined with that most important of all features—extraordinary sensitiveness. At the new record-low 1922 price of \$6.50, "Red Heads" are beyond all doubt the best receiver "buy" on the market today.



No. RH Double Set with six ft. cord and military head band, Price.. \$6.50

No. RH-1 Single Receiver, 1,500 ohms, (without cord or head band), Price..... 2.50

### "NAA" Detector Crystals

*"Known and used the world over"*

These are the original tested detector minerals. There are many imitations, but they only mean "interference" with good results. The genuine "NAA" are distinguished by their tested sensitiveness—remember that!—and by the name, "J. S. Newman" on each little lithographed tin container. Demand the "real article."

NAA Galena, Silicon or Goldite, Price per crystal..... \$0.25

Mounted, set in Wood's metal in brass cup, Price per crystal..... .40





**SECOND EDITION ENLARGED AND ELABORATED— WITH NEW DATA**

## The New ARMSTRONG Super-Regenerative CIRCUIT

*The Circuit That Will Solve Your Loop Antenna Problem*

By means of Major Armstrong's new epoch making invention it is now possible with two vacuum tubes and an indoor loop antenna to receive broadcasted music up to 100 miles distant.

Our engineering department has compiled a pamphlet that gives an exposition of the theory of operation with full working directions, etc. A large blueprint is included with this pamphlet. Our engineering department has actually operated the new circuit, of which little is known as yet. In this pamphlet will be found the correct circuits, as well as the proper instruments, inductances, etc. In most instances, it is possible that with your present instruments you can achieve these wonderful results.

**25c**

Order from your local dealer, or direct from us.

**The E. I. Co.**  
233 Fulton Street  
New York City

ARMSTRONG  
"SUPER-REGENERATIVE"  
RECEIVER

next demonstrated, consisting of special alloys and possessing similar characteristics to the oxide filament, while being especially satisfactory by the absence of disturbing noises.

In accordance with a scheme first devised by Dr. Meissner, cathode tubes are, of course, used also for generating electric waves, i. e., as radio transmitters, especially for telephone purposes. Even high power stations are designed on this principle. Recent improvements in this connection, apart from a lengthened life and reduced dimensions, enable the working tension to be increased. Dr. Rukop demonstrated three new types, viz., two for 10,000 volts and 1 and 2½ kilowatts respectively, and one for 20,000 volts and 5 kilowatts. These new sending tubes afforded an opportunity of demonstrating the familiar Tesla tests, especially the radiating coil experiment, in an especially striking form with cathode tube vibrations.

Dr. Esau, director of the high power station receiver laboratory, then gave an account of his results in connection with receiver tests in South America. The use of amplifier tubes in receiving, of course, enables the huge receiving aerials formerly used to be replaced by transportable loop antennae, which have been found to work satisfactorily even over distances up to 20,000 kilometers, i. e., half the circumference of the earth. A loop area of only 0.04 square meter, under satisfactory conditions, is sufficient to obtain this effect. On account of the growing number of wireless sending stations, receivers must comply with more stringent requirements to obtain freedom from interference. In this connection the use of amplifier tubes has likewise proved of great advantage. A number of receiving tests were carried out in Argentina, which are to afford a basis for the wireless service between Berlin and Buenos Aires to be opened in the near future, when the new high power station, the construction of which was commenced about a year ago, will begin to operate. In connection with these tests an opportunity was afforded of investigating conditions in the case of stations receiving from transmitting stations situated on the opposite pole of the globe, i. e., in the vicinity of the antipodes. Just as the magnetic needle at the magnetic north pole ceases to point in a given direction, the receiver loop under such circumstances no longer shows any directive effect. Moreover, wireless signals then frequently become unreadable, though the necessary intensity is by no means wanting. These striking phenomena, here observed for the first time, were perfectly elucidated by Dr. Esau, who thus succeeded in providing a theoretical basis for ascertaining the receiver energy at the antipodes. In the neighborhood of the antipodes the ordinary loop antenna fails to work and should be replaced by a unilateral loop frame, receiving only from one direction, while the opposite direction is made inactive. The phenomena above referred to were due to the more or less considerable superposition of Morse signals, depending on the time difference of the two trains of waves arriving from opposite directions. This interference could only be avoided by receiving the waves from one direction alone.

The time is no longer distant when we shall be able not only to receive at the antipodes, but to receive signals which travel completely round the earth. Inasmuch as the time required for this effect, which is about one-seventh of a second, can be ascertained most accurately, the circumference of the earth may be calculated and trigonometrical measurements checked by this means.

Mr. K. Solff, director of the Transradio Company, finally proceeded to describe the arrangements of the Transradio Central Station. He first gave a short historical survey of the development of the Nauen-North America Transatlantic service,

**BAKELITE**  
**RADIO PARTS**

Moulded To Your Design

Northern Industrial Chemical Co.  
11 Elkins St. Boston, Mass.

Moulders of Electrical Insulation

**Firco Radio Apparatus**

For sale by all prominent dealers

**JOHN FIRTH & CO., Inc.**  
*Pioneers since 1901*  
709 Sixth Avenue New York





# RADIO ESSENTIALS

**PLAY SAFE! LOOK ~ FOR ~ THE PACENT TRADE MARK**



PACENT Universal Plug



PACENT Radio Jack



PACENT Twin Adapter

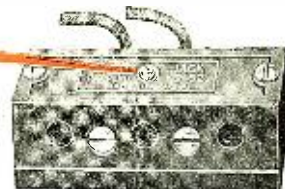

PACENT Multi-Jack

## The PACENT Trademark Solves Your Radio Problems

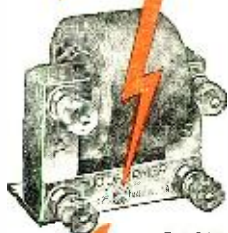

PACENT Audicformer

PACENT Universal Detector Stand

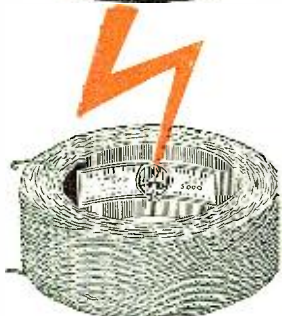
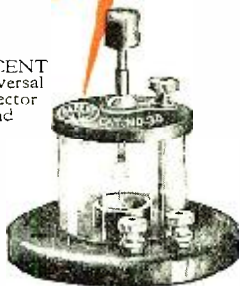

PACENT Duo-lateral Coil

**THE PACENT UNIVERSAL PLUG** is the *original* radio plug. It gives perfect contact, fits all standard jacks and is approved by all radio authorities.

Cat. No. 50.....Price, \$1.25

**THE PACENT TWIN ADAPTER** is a device which enables you to connect two plugs into one jack. It is the only device which meets this frequent radio need.

Cat. No. 51.....Price, \$1.50

**THE PACENT AUDIO-FORMER** meets the need for a transformer which gives perfect amplification of music and speech at all audio frequencies.

Cat. No. 25.....Price, \$5.00

**PACENT RADIO JACKS** are used as standard equipment by the largest leading radio manufacturers. This in itself is sufficient assurance that these Pacent Essentials perform perfectly.

Cat. Nos. 61-66.....Prices, .70-\$1.20

**THE PACENT MULTI-JACK** is a moulded unit of three jacks and enables you to connect three 'phones to a single pair of binding posts.

Cat. No. 52.....Price, \$1.50

**THE PACENT UNIVERSAL DETECTOR STAND** incorporates every possible modern feature for a device of this kind. It is an extreme offering of quality at the right price.

Cat. No. 30.....Price, \$1.50

**PACENT DUO-LATERAL COILS** are generally conceded the "last word in inductances." Besides being used in standard sets of wide distribution they were approved and used by Major Armstrong as important elements in his new super-regenerative circuit.

Sizes US25 to US1500

### DON'T IMPROVISE—PACENTIZE

SEND FOR DESCRIPTIVE BULLETINS

DEALERS AND JOBBERS—The Pacent Sales Policy is to a great extent responsible for the popularity of Pacent products. Write for outline of our Sales Plan.

## PACENT ELECTRIC COMPANY

I N C O R P O R A T E D

Manufacturers and Distributors of Radio and Electrical Essentials

Executive Offices:

22 PARK PLACE  
NEW YORK, N. Y.



Branch Offices:

PHILADELPHIA, PA. CHICAGO, ILL.  
Bourse Bldg. 33 So. Clinton St.

WASHINGTON, D. C.  
Munsey Bldg.

Member Radio Section, Associated Mfrs. of Electrical Supplies



# KENNEDY EQUIPMENT

*The Standard by which to judge Radio Equipment*

SO careful has been the manufacture of Kennedy Equipment since its inception that radio enthusiasts everywhere proclaim it the standard by which to measure all radio receiving apparatus.

## KENNEDY

*Short-wave Regenerative Receiver Type 281*



is a sturdy example of the quality which has made the name Kennedy synonymous with good radio equipment everywhere. Type 281 possesses selectivity and efficiency to a high degree, these features being insured by the correct use of inductively coupled circuits.

*All Kennedy Regenerative Receivers are licensed under Armstrong United States Patent No. 1,113,149.*

KENNEDY RADIO EQUIPMENT IS SOLD BY GOOD DEALERS EVERYWHERE

*Write for Latest Bulletin C-3. Address our nearest office.*

### THE COLIN B. KENNEDY COMPANY

INCORPORATED

SAN FRANCISCO

U. S. A.

SAINT LOUIS

which, as far back as at the end of 1914, as a simple alternate service with one antenna at either end, gave quite satisfactory results. This was due primarily to the fact that the two stations engaged in this service, Nauen and Sayville, were set apart for it exclusively and could accordingly avail themselves of the most suitable hours of the day for sending and receiving. When, in 1919, the U. S. Government station at Annapolis resumed communication with Nauen, only a few hours daily could be spared for this service. Full advantage had, therefore, to be taken of the limited time available by the adoption of a duplex service, i. e., by simultaneous sending and receiving in either direction. The arrangements required to obtain this duplex operation were, in the case of Nauen, temporarily installed at Geltow and a satisfactory commercial service was established. The private station at Marion, owned by the Radio Corporation of America, was eventually substituted for the Government station at Annapolis.

The continually increasing radio business on this line soon called for another improvement of the duplex service, which was effected by connecting the sending and receiving stations at the German end not only by telephone, as formerly, but by distant control. This allowed the Nauen transmitter to be controlled from the Geltow receiving station. While this was an undoubted progress, it was far from affording ideal conditions. This was only made possible by further advances in the amplifying and selecting possibilities at the receiving end, which enabled even the weakest received signals to be transmitted a considerable distance over simple telephone lines. Inasmuch as the distant control of the sender over a long telegraph line did not raise any difficult engineering problems, the ideal solution was obtained by a combination of the sender and receiver services at a central station situated in the immediate proximity of the main telegraph office. This is how the idea of the present Transradio Central Station originated. It constitutes the cerebrum brain, as it were, of the combination of three senders and seven receivers, of which the present Nauen-Geltow high power radio station is composed. At the same time, it communicates closely with the main telegraph office and, through this, with both the general telegraph wire and with the German and foreign radio systems.

This arrangement does away with those causes of delay and errors which were unavoidably connected with the re-telegraphing between the main telegraph office, Geltow and Nauen. Radio messages now handed in at the Transradio Transatlantic Counter of the Berlin Post Office No. 24 are, in a twinkling, by pneumatic post, transferred to the main telegraph office situated in the same building as the counter, together with the distant-control radio station. The message, therefore, goes immediately to the Morse keys actuating the Nauen senders. Each signal, in a fraction of a second, reaches the New York central station of the Radio Corporation of America, which is arranged in a similar manner.

German Transatlantic messages coming from places outside of Berlin, as well as those coming from other parts of Europe, are, if destined for transmission by "Transradio," first transmitted by wireless to the Berlin main telegraph office, in order thereafter to be handled in the same way as those originating from Berlin.

The advantages of this centralized service are clearly seen in the continually growing European and Transatlantic radio business dealt with from Berlin. Nauen and its sister station Eilvese are, in the Berlin-America service, dealing with about one-half million words per month, while the number of words dealt with from Nauen on

IF YOU WANT CLEAR-TONED RECEPTION AND FULL SERVICE, USE



## BRIGHT STAR "B" BATTERIES

Noiseless Long Service  
Strong Recuperation  
Binding Post Terminals  
Send for Circular to Dept. R.

BRIGHT STAR BATTERY CO.,

New York 310 Hudson Street  
Chicago 9 So. Clinton Street  
Portland 26 No. Broadway  
San Francisco Furniture Ex. Building



Gould Radio "A" Batteries are used by the various Radio Branches of the U. S. Government. Built for dependable, continuous service. Made in sizes from 60 A. H. to 150 A. H.

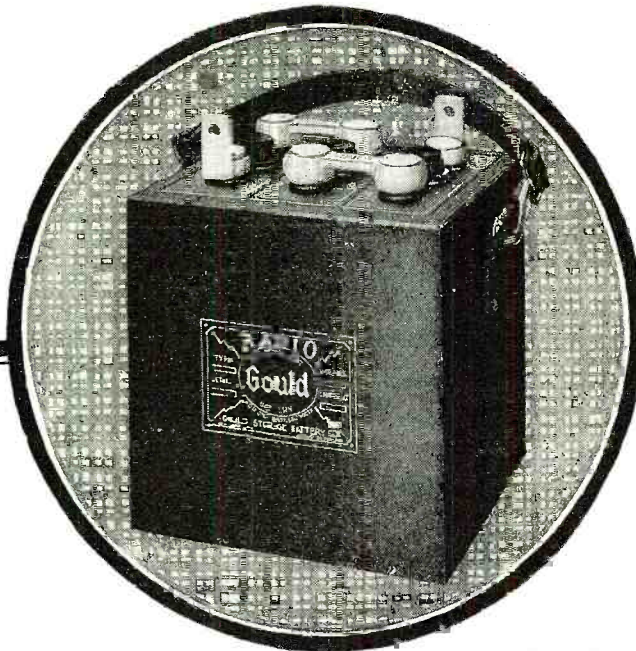

Retail Prices  
\$17 to \$29  
(f. o. b. factory)

# A Fine Radio Receiving Set Deserves these Quality Batteries

THESE newest additions to a Famous Battery Family—the Gould "A" and "B" Radio Storage Batteries—are designed and built for Radio work by a manufacturer with over a generation of experience in making railroad, submarine, central station and automobile batteries.

Gould Radio Batteries are built by the same men who build the Gould Automobile Battery, known for "Longest Life by Owners' Records." They are equipped with the same

rugged Dreadnaught Plates and Armored Separators. No finer Batteries can be produced.

Gould Radio "B" Batteries are exceptionally compact owing to the unique insulating features of their design—require no more shelf space than a dry battery—provide a steady, continuous, noiseless service—are easily recharged and if given proper care will last many years.

On sale by Radio Dealers and  
over 3000 Gould Service Stations

# Gould

GOULD STORAGE BATTERY COMPANY  
30 East 42nd St., New York Works: Depaw, N. Y.

Patents Applied For

Retail Price  
\$8.50 (f. o. b. factory)

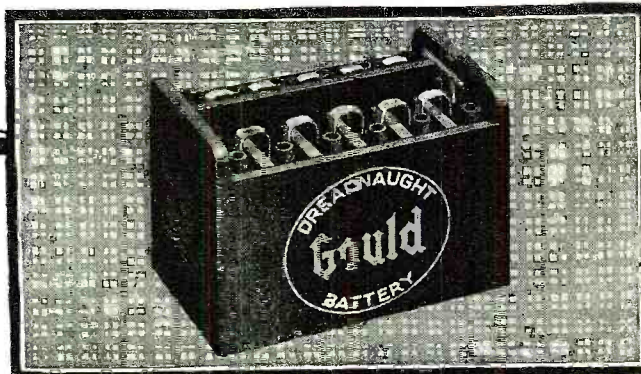

The Gould Radio "B" Battery is uniquely designed, compact and attractive. Provides 24 volts variable in 2-volt steps. Non-slipping hard rubber case. A battery that does not detract from the appearance of the finest set and assures a steady, continuous, noiseless service. Ask any Radio Dealer.



# FRAMINGHAM

"The Rheostat with the Panel Bushing"

Merits the  Guarantee

THE Ship Owners Radio Service, Inc., has for some time been looking over and testing filament rheostats in order to find one which would permit fine adjustments and at the same time stand up under the hard test of service.

In the Framingham Rheostat we have found these advantages together with a unique and exclusive feature—the panel bushing. This bushing simplifies the mounting of the Framingham, and once set in place gives it extreme rigidity.

The Framingham is a rheostat we are proud to guarantee as to service and dependability.



**FRAMINGHAM \$1**  
RHEOSTAT  
For Table or Panel Mounting



The Sign of the Reliable Radio Store. Watch for it.

THE Framingham Rheostat sells for One Dollar. If your dealer hasn't put in his stock, send us his name and receive free descriptive circular.

**SHIP OWNERS**  
RADIO SERVICE  
INC.

80 Washington St., New York

Boston Chicago Baltimore Kansas City Norfolk  
Savannah New Orleans San Francisco Seattle  
Portland (Ore.)

the four European lines, is about the same. In fact, high power radio stations are dealing with a considerable percentage of the whole of the German foreign service. Inasmuch as this business is increasing continually, the growing requirements must be accounted for by a provident extension of existing radio stations. Nauen is accordingly being submitted to an extension by which its sending output will be trebled and its communicating possibilities multiplied. In the place of the present three antennae and three senders, four antennae, each with a self-contained, high frequency generator set, i. e., four independent sending stations, are provided, which, either simultaneously or in different combinations, will account for all requirements of radio communication with the North as well as the South of America. Moreover, by "tapping" the large senders, four small senders for the European service will be provided. In a similar manner, Eilvese station is to be converted into a two-way station.

Following these addresses, an inspection of the new and interesting installations of the Transradio Central Station was made. The sending and receiving services are combined not only in the same room, but, in the case of each pair of corresponding radio stations, around the same table, the sending and receiving telegraphists being seated in front of one another. There is a "Europe Hall" and an "America Hall." In case of doubt as to the exact wording of a message, the receiving telegraphist simply stops his apparatus and asks his partner to request a repeat. An answer is immediately received from the other end. Some of the radio business is still dealt with by hand, while



The World Time Clock at the German Radio Central Which Shows the Time at All Parts of the World.

automatic high-speed operation is resorted to on an ever increasing scale. The maximum rate, in the former case, is 20 words, and in the latter, 130 words per minute. In the case of automatic operation, the message is transcribed on a special typewriter, turning out a punched tape which, on being run through a Siemens and Halske high-speed telegraph, automatically sends out a sequence of dots and dashes over the transmission line to the Nauen sending station. From there, in the form of ether waves, they are automatically radiated into space and, at the New York end, received by high-speed Morse recorders at the premises of the Radio Corporation of America. The only difference in the installations of the New York central station is that there is no special punching hall there, the punching operator being seated at the same table with the sending and receiving telegraphists.

An especially interesting feature is the installation in the two halls of "World Time Clocks" of a new system on which the considerable differences of time between the sending and receiving stations are recorded direct, thus enabling the most suitable hours of the day in each case to be chosen for radio transmission.



"PRECISION"

### GRID LEAKS AND MOUNTINGS

Resistance Ranges from .05 Megohms to 5 Megohms. Carefully Calibrated and Accuracy Guaranteed

GRID LEAKS.....75c  
MOUNTINGS.....50c

**RADIOPHONE EQUIPMENT CO.**  
49 NEW STREET, NEWARK, N. J.

## MICO Wires for Radio

COTTON AND ENAMEL  
WIRE ON 1/4-1/2-1 LB. SPOOLS  
Antenna Wire Ground Wire  
BULB LIGHTNING ARRESTER  
Specialists 40 Enamel

**Metals & Insulation Co. of America**  
200 Fifth Avenue - New York City

Get a Handy Binder for your RADIO NEWS. Holds and preserves twelve issues, each of which can be inserted or removed at will. Price 65c. Experimenter Pub. Co., Inc., Book Dept., 53 Park Place, New York.



# Receive Broadcasts on a Loop

## With THIS Super-Regenerative Receiver

Price complete,  
unassembled,  
**\$75<sup>00</sup>**  
No. RG600

Includes all necessary parts, with drilled and finished Eakelite panel, filter unit and choke coils of correct values especially designed and manufactured by us. Loop and loud speaker extra.



Price, completely assembled in attractive solid mahogany cabinet, ready for wiring,  
**\$95<sup>00</sup>**  
No. RG601

Harkness Booklet free with each set. Loop and loud speaker not included.

Described by Kenneth Harkness in his new booklet on

# The Construction of Super-Regenerative Receivers

Approved by the New York Evening Mail Radio Laboratory and Leading Radio Experts throughout the Country

**Literary Digest** says: "full instructions are given by Mr. Harkness for the home construction of various Super-Regenerative circuits."

**N. Y. Evening Mail** says: "these sets have been examined by a representative of the *Evening Mail*, and bear out exactly the statements made in the booklet."

**Washington Herald** says: "The booklet is authoritative, fully illustrated and well arranged. It . . . is comprehensible by the radio expert and the experimental novice as well."

**Atlanta Journal** says: "One of the most complete sources of information . . . in which Kenneth Harkness gives a detailed description of the Armstrong Circuit."

This new and improved edition of the popular Harkness booklet describes the construction and operation of two different Super-Regenerative Receivers, with full and detailed mechanical drawings, wiring diagrams and numerous photographs. It also describes the theory of super-regeneration in detail, with four diagrams.

**Price of Booklet 50 Cents**  
from your own dealer or direct

**Radio Frequency Specialists**

**The Radio Guild, Inc.**  
256 West Thirty-fourth Street, New York City

Designers and Manufacturers of the "Vox Humana" the Receiver with the Living Voice





# CONTINENTAL

"New York's Leading Wireless House"

## STOP! LOOK!! LISTEN!!!

### PARAGON RECEIVER

RA-10 Receiver, DA-2 Amplifier, R-3 Magnavox. Clear tone, no distortion. Uniform in size and oak finish. Micrometer Adjustment Control on Coupling, Secondary- and Wing Circuits. Great selectivity possible. Instructions for connections and operation with each receiver.

Price Complete

**\$273<sup>00</sup>**

With Aerial, Tubes and Batteries

2008-Q

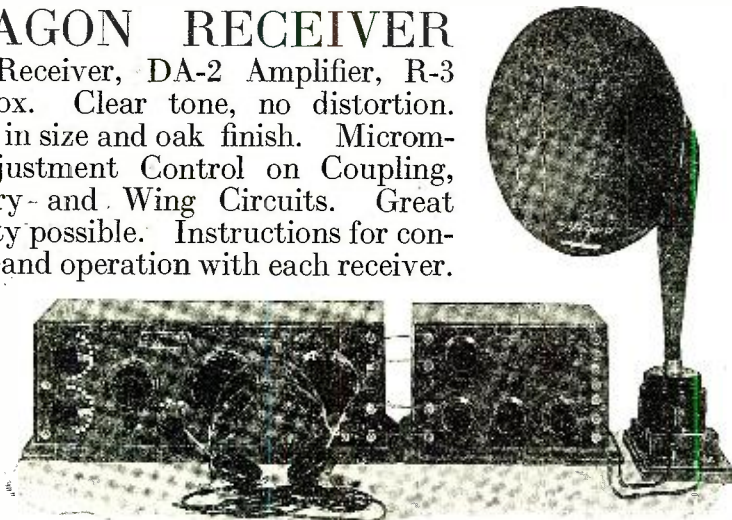

"Modern Radio"—a new two hundred and eight page catalog of our wireless equipment, supplies and apparatus sent for thirty-five cents.

CONTINENTAL RADIO and ELECTRIC CORPN.

SIX and FIFTEEN WARREN STREET, NEW YORK, U. S. A.



**"SECO" PERFECTION PRODUCTS**  
 Seco Audio-frequency Transformer is a highest grade instrument, heavily shielded in special Aluminum Alloy Case against eddy currents. Noiseless. Highest efficiency. Lowest "B" battery power required.  
 SECO type A.F. 500 (enclosed). List Price.....\$6.50  
 SECO type A.F. 501 (open). List Price.....\$5.50  
 SECO type A.F. 502 (unmounted). List Price.....\$5.00

**SECO 2200 Ohm HEAD SET**  
 A receiver set designed and built to obtain maximum clarity and volume of tone without sacrifice of either quality. The result is a sweeter toned receiver than other makes.  
 SECO 2200 Ohm Head Set. List Price \$8.00  
 Prices postpaid U. S. and Canada.

**Scientific Equipment Co.**  
 Ridgewood, N. J.



**SPALDING Fibred PRODUCTS**

**PANELS WASHERS AND BUSHINGS**

*Sheets, rods, tubes, everything in Fibre for the Radio Mfr.*

**J. SPAULDING & SONS CO., INC.**

NEW YORK.....484 Broome Street  
 BOSTON.....15 Elkins Street  
 PHILADELPHIA.....141 North 4th Street  
 CHICAGO.....659 W. Lake Street  
 TONAWANDA.....New York

Old 9ZAF **DENVER** New KLZ

Oldest and Largest

**RADIO DEALERS**

RETAIL and WHOLESALE  
 DISTRIBUTORS—A Complete Line

Our latest BULLETINS show every new practical development in Radio. Our New Building is most up-to-date RADIO plant and store in the West.

**REYNOLDS RADIO COMPANY—INCORPORATED**

1534 Glenarm St. DENVER, Colo.

## The True Story of the de Forest Vacuum Tube

(Continued from page 633)

radio development, the audion is the keystone to the arch upon which the phonofilm is built. Dr. de Forest is now engaged in perfecting the audion camera and projector which he has predicted will shortly revolutionize the world of motion picture art.

As indicative of the audion art, the number of patents issued on various devices and circuits dependent thereon, gives a pretty fair key. Up to 1912, there had been issued over 20 patents, all filed subsequent to 1904. Today there are over 100 U. S. patents on the Audion Art, and the number is very rapidly growing. Regardless of what name may be applied to the device patented, practically every one of these patents since 1906 shows the de Forest three-electrode bulb.

"An epoch-making advance," is the way in which the engineers of the American Telephone & Telegraph Company recently described the audion. Personally, I cannot help but feel that the benefits that will come to humanity from this single invention are unlimited.

## French Amateur Activities

(Continued from page 640)

quite satisfactory results, being nearly as sensitive as the regular audions on weak signals, although the sound produced for strong reception is not as loud as with the usual type. However, this does not matter in most cases, except when it is required to demonstrate a loud speaker, as strong signals are often too loud to be comfortable when the phones are worn.

A last word which, although not of wireless, may interest amateur photographers: The part of the room in which my wireless set is situated is very dark and I was afraid that it would not be possible to get a good photograph of it. The two accompanying pictures were taken by a friend of mine, Mr. Maurice Clochard, who is a keen amateur photographer; he took special precautions to get a satisfactory picture. First he placed a white reflector which was hung from the ceiling at the right of the camera in order to lighten the shadows on the table, also a big mirror was placed so as to give a luminous reflex on the darkest part of the set. It was about 10 A. M. when the photo was taken; the sun was then fairly bright outdoors, but the muslin across the window softened the light. The speed number of the plates used was 570 H & D, and the aperture chosen was F32; the exposure was 20 seconds; another attempt which was made with F16 and 10 seconds exposure gave much less satisfactory results.

## One Way or Another

(Continued from page 643)

(The telephone bell rings. The Captain removes the head-set and goes to answer phone on right side of room.)

Captain (lifting receiver to ear and speaking into transmitter)—Hello . . . (pauses) . . . Yes . . . (pauses) . . . I'll have him stopped; we must take no chances. Repeat that license number again. (He takes pencil from pocket of uniform and writes on pad of paper.) That's good Marsh, good-night.

(The Captain puts receiver on hook and crosses room. He seats himself before the radio apparatus and puts on the head-set.)

Sears—Well, you didn't make a reply to what I said last.

Get a Handy Binder for your RADIO NEWS. Holds and preserves twelve issues, each of which can be inserted or removed at will. Price 65c. Experimenter Pub. Co., Inc., Book Dept., 53 Park Place, New York.



# DOUBLE PROTECTION

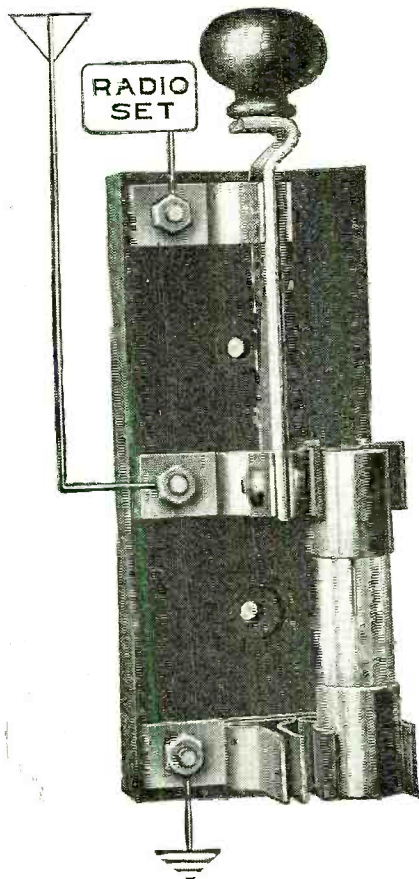

Cat. No. 602  
Price \$3.50

This is the Barkelew Lightning Arrester Switch, the most compact and efficient protective device on the Radio market.

### To Radio Distributors and Dealers

Trade Discounts to Radio Distributors and Dealers who have established standing or can prove their status.

Local distribution is through Dealers where available.

Ask for our new Window Display Card designed to boost sales and featuring our Four-Phone Plug.

## The Barkelew Radio Lightning Arrester Switch

### Continuous Vacuum Tube Arrester Protection with a Positive Ground When Desired

(Approved and Listed by The Underwriters Laboratories)  
*Patents Pending*

Two separate devices have been developed for protecting antenna circuits from lightning—a Radio Ground Switch and a Vacuum Tube Arrester. *Each has advantages and disadvantages.* We have combined the two on one base, multiplying efficiency and protection, and overcoming the disadvantages of using either type by itself.

Here then you have one compact Lightning Protection device which insures to you the *combined merit* of the Radio Ground Switch and the Vacuum Tube Arrester. Send for *Bulletin No. 30*, telling of the merits and disadvantages of both types, and how by combining the two on one base we have solved the lightning protection problem.

## The Barkelew Four-Phone Plug

Full Size

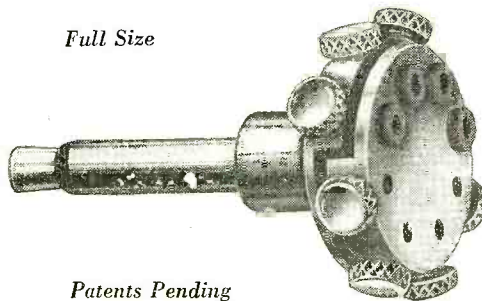

Patents Pending



Cat. No. 614—Price \$1.50

Let the family "listen in" with this small, simple and inexpensive Phone Plug which permits the use of four phones or less, on any set using a telephone jack. There is ample room for all the phone tips and they are easily adjusted without removing the plug. *Send for Bulletin No. 29.*

## The Barkelew Electric Manufacturing Co.

15 S. Clinton St., Chicago  
75 Fremont St., San Francisco

MIDDLETOWN, OHIO

7-9 W. Canal St., Pittsburgh  
365 W. 23d St., New York

# BARKELEW



*What Part of the*  
**\$300 in Prizes**  
*Do You Want to Win?*

How would you like to receive \$100 in gold in return for spending an hour or so in pleasure—helpful, profitable pleasure? We believe RICO receivers are the finest on the market. We know they are one of the fastest selling. That's why we're willing to spend a few hundred dollars in order that you may learn the superiorities of RICO Telephones.

**GOLD!**  
**Six Prizes, \$300:**  
 First Prize . . . \$100 in Gold  
 Second Prize . . . 75 in Gold  
 Third Prize . . . 50 in Gold  
 Fourth, Fifth and Sixth Prizes (each) . . . 25 in Gold

**Hurry! The Contest Closes October 20th.**

But there is still time for you to swoop in one of the six wonderful prizes. The idea of the contest is very simple. We are going to give prizes to those who originate some new idea or a new stunt with RICO Receivers. In order to make plain what we want, we have shown four examples on a circular which we will gladly send you with our compliments.

**Why You Will Find RICO The Best**



RICO marks a new advance in telephone receivers. These receivers are built on a radically different plan than all other receivers. The pull on the diaphragm is where it should be—in the mathematical center of the diaphragm.

Other Outstanding Mechanical Features make RICO the Choice of experts who know the best and demand it:

Lightness, Stability, Aluminum shells. Non-rusting diaphragms. Guaranteed tungsten magnets. Neat, black mercerized cord. Headband adjustable not

only to every size head, but the two bands are adjustable as well; the only headband made in this manner. Sanitary soft rubber covering that can be washed and will not catch the hair—especially appreciated by ladies.

**What Part of the \$300 Will You Win?**  
**Send TODAY For Full Particulars FREE**



131 Duane Street

New York City

**States Radio Corporation**



501 So. Jefferson St.  
 Chicago  
 Manufacturers of  
 High Grade Equipment

**Immediate Delivery**

Radio Frequency Detector, and 2 Stage Amplifier. In attractive mahogany cases, simple, reliable, tunes to all broadcasting, giving clear reproduction—local and long range. No wiring to do. Ask for STATES RADIO and get the best.

**Everybody Wants  
 a Radio Research  
 Lapel Button**



Worn by radio fans from coast to coast who have built their own sets. Gold plated 50c; Solid 14k Gold \$5.00. Artistic, high grade. No enamel to chip off. By mail postpaid if your dealer is out of stock.

**RADIO RESEARCH GUILD**  
 9-15 Clinton St., Newark, N. J.

Mounted 12 on a display card. Jobbers and dealers write for discounts. **EASY SALES—GOOD PROFITS.**

**RICO**  
**TRI-POLE DOUBLE HEAD PHONES**

**TESTIMONIALS**  
**CAPITAL RADIO COMPANY,**  
 2041 K Street, Lincoln, Neb.  
 Gentlemen:—In regard to your RICO tri-pole phones, we wish to state that we have tested them out in our laboratory and find them equal in sensitiveness, and in several instances far superior to phones selling at higher prices. We also wish to commend you on the construction of the headband which is exceedingly comfortable.  
**CAPITAL RADIO COMPANY,**  
 Paul C. Rolwer, F. Bradden.

**PHILIPSBURG FOUNDRY & MACHINERY COMPANY,**  
 Philipsburg Penna.  
 Gentlemen:—Relative to the RICO Tri-pole phone, which we received from you some time ago, please be advised as follows: We have found this phone very sensitive, especially in conjunction with its use with our sensitive Receiving apparatus, the Bakigil Grand, of our own manufacture.  
 R. I. GILLAND,  
 General Manager.

**TESH RADIO COMPANY,**  
 High Point, N. C.  
 Gentlemen:—We have tried out the RICO Tri-pole phone which we received from you; we find it equal in every respect to the highest priced phones we handle. Just as soon as we work off some of our present stock, you may expect a quantity order from us.  
**TESH RADIO CO.,**  
 J. Fred. Tesh.

**THE LOW PRICE LIST**

DOUBLE HEAD SET	
No. 20	2000 ohms. . . . . \$6.50
No. 30	3000 ohms. . . . . 7.50
No. 40	4000 ohms. . . . . 9.50
No. 50	5000 ohms. . . . . 12.50
No. 60	6000 ohms. . . . . 15.00
No. 75	75 ohms. . . . . 6.50
No. 5	5 ohms. . . . . 6.50
SINGLE HEAD SET	
No. 10	1000 ohms. . . . . 4.00
No. 15	1500 ohms. . . . . 4.50
RECEIVER ONLY	
No. 2	1000 ohms. . . . . 2.50
No. 075	75 ohms. . . . . 1.00
No. 3	1500 ohms. . . . . 3.00
No. 05	5 ohms. . . . . 2.50

Captain—No, but I will show you how the radio set works. A mounted policeman just phoned me that a speeding automobile passed him, disregarding his hand signal to stop. The machine is going out Nineteenth Avenue. There have been quite a few robberies in that district lately, and the man driving the automobile is going fast enough to be suspected of something worse than speeding. I will instruct the police machine patrolling Nineteenth Avenue to stop the autoist, and arrest him for speeding if for nothing else. Something might come up in the meantime.

(He throws in aerial switch to transmitting position and manipulates apparatus.)

Sears (smiling)—Bet you don't get them, Captain.

Captain (speaking into hand transmitter)—Auto two, auto two, auto two, ready. Stop machine going out Twenty-ninth Avenue, Dodge number 612122A, and arrest for speeding if there is nothing more suspicious about the men. Good luck.

Sears (somewhat ill at ease)—You gave the wrong street, Captain.

Captain (throwing switch to receiving position and turning off transmitting current)—That's not the only thing I gave wrong. The name of the car and the number are also incorrect. We have a code for all automobiles, license numbers, and names of the different streets in the city, to say nothing of a few other things. You see, it will do no one any good to listen in on what we say. Bandits with a receiving set in their machine might get my instructions, but if the instructions were about them they would never know. Here are some of the code books; I have to give out a few tomorrow. (He points to the little red books on the receiving cabinet.)

Sears (looking at the clock)—Your clock is right?

Captain—No, the janitor forgot to set it correctly, it is about eight minutes slow!

Sears (turning pale)—Then the fellows who sent the note have already committed highway-robbery.

Captain (looking at clock)—Um, five minutes have passed, if they pulled it off the time they said in the note. The correct time is now 9:20 o'clock. Maybe they were a few minutes late. A report should come in any moment now.

(The telephone bell rings. The Captain removes head-set and goes to answer phone.)

Sears (very pale)—Maybe—  
 Captain (ready to lift receiver)—Yes, maybe your friends were a little late and this is the report.

(The Captain takes the receiver from hook.)

(Sears quickly takes one of the little red code books and slips it into his inside coat pocket while the Captain's back is turned.)

Sears (grasping wireless hand transmitter with one hand and with the other throwing in aerial switch for sending)—Boys, police have secret code. Make your getaway the best way you can and disregard all instructions that come from this station.

Captain (into line telephone transmitter)—Wait a few moments, please. (He laughs.) I could have shot you, Sears, before you finished the first three words, but, you forgot in your excitement that it takes electricity to transmit the voice. Next time don't forget the current. Take a look at this.

(The Captain draws a revolver from under his coat. He stands with mouth to side of line telephone while one eye watches Sears.)

Sears (sitting down)—I'll learn all about these wireless sets yet.

Captain (speaking into transmitter)—Hello... (pauses)... What, highwaymen have robbed an autoist on Judah Street?... (pauses)... At 9:15 o'clock; they headed out Nineteenth Avenue? Give that number again... (pauses)... Thank you, we'll get

**MONEY for You**

Add to your Salary—Make extra Pin Money. Start a lucrative business of your own. Spend an hour each day taking subscriptions for the "Radio News." We'll pay you well and you'll enjoy the work. Write for full particulars. Circulation Dept., RADIO NEWS, 53 Park Place, N. Y. C.



# Broadcasting a Message of Radio Reliability

# Cotoco

TRADE MARK REG. U. S. PAT. OFF.

## Buy by This Name and You Buy Right

COTO COIL CO. is not a mushroom growth in the Radio Field. We were winding electrical coils long before the radio boom. We are here to stay. Our products are right to hold their own in any comparison for quality. Electrically correct and mechanically accurate. Even the Cotoco Dial is a better product—practically unbreakable, with metal insert to make it run true.

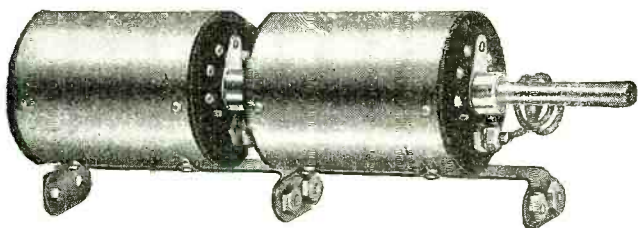

**Cotoco Amplifying Transformer  
for Radio Frequency Makes  
Loop Aerials Practical**

The advantages of all-in-the-room Loop Aerials are obvious. Greater selectivity, of course. Users report twelve and more stations received one night. Now ample range is secured. You will want our Connection Diagrams for two stages (as illustrated), or three stages of Radio Frequency Amplification.

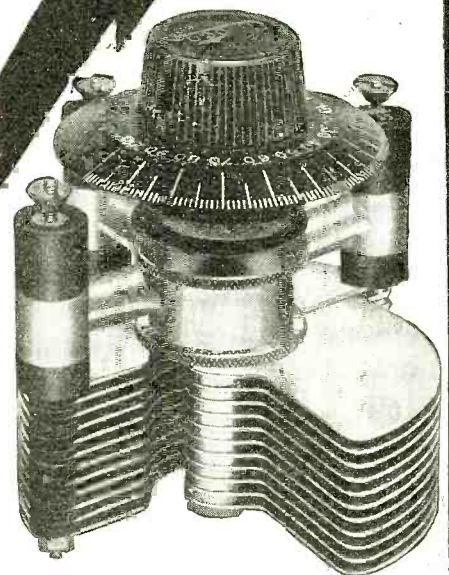

Above, the COTOCO VARIABLE AIR CONDENSER, scientifically correct for minimum of electrical losses. A fine machine product that is as superior as it looks. At left, below, the COTOCO AMPLIFYING TRANSFORMER FOR AUDIO FREQUENCY. Allows you to forget distortion. Whether through head phones or loud speaker, music or speech comes clear and true. At right, below, the COTOCO HONEYCOMB COIL, yet to find its equal as a compact, neat and remarkably efficient inductance unit.

**Send Us Your  
Dealer's Name**

if he does not carry Cotoco Products. We will mail you FREE Connection Diagrams for Loop Aerial set and see that he can supply you.

**COTO-COIL  
CO.**

87 WILLARD AVE.  
PROVIDENCE, R. I.

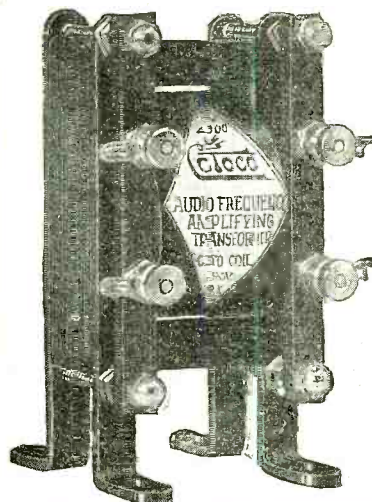

*Scientifically Correct—Mechanically Accurate*

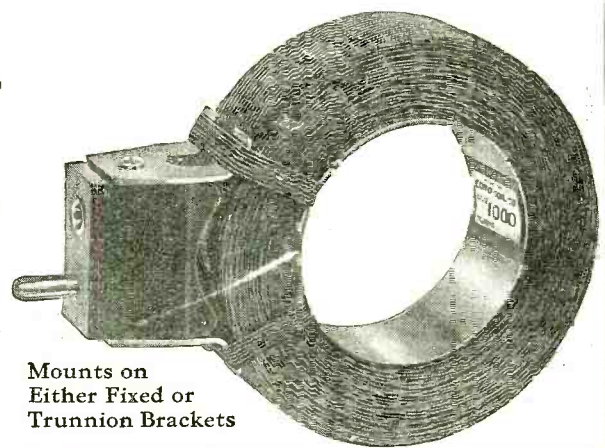

Mounts on  
Either Fixed or  
Trunnion Brackets



# DX RADIO FREQUENCY

## Amplifying Transformers are a Radical Departure in R F Transformer Design

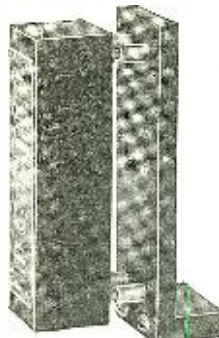

Patents Pending

Nation-wide tests have proven beyond a doubt the superior qualities of the DX Transformers

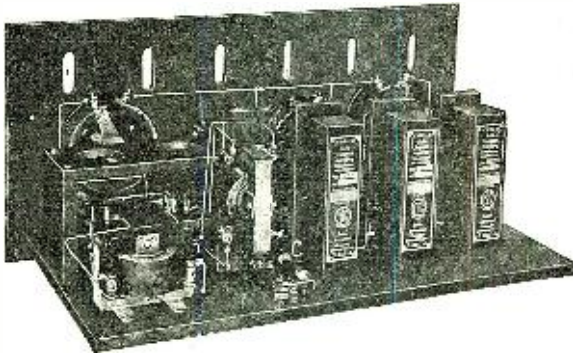

Manufacturers who demand the highest quality product obtainable are standardizing their sets, using DX - R F transformer.

Make comparative tests to prove you are getting **THE BEST**

Send for Literature

	Wave length Range	Price
DX-1	170—450	\$8.00
DX-S	400—1200	8.00
DX-2	900—3000	8.00
Standard Plug Mounting		1.00

DX RADIO FREQUENCY TRANSFORMERS SOLD THROUGH RELIABLE DEALERS AND JOBBERS. Write for details. It PAYS to carry the BEST.



(If your dealer does not have DX RADIO FREQUENCY TRANSFORMERS write us.)

### PRECISE VARIABLE CONDENSERS

Vernier Adjustment  
Maximum Efficiency  
.0002 Mfd.  
.0005 "  
.0012 "  
Capacity



Model No. 265  
Of Interest to Dealers

PRECISE MANUFACTURING CORPORATION  
ROCHESTER, - - N. Y.

EVERYTHING IN

## RADIO HARDWARE

FRANK WHEELER and SON  
MERIDEN, CONN.

them. (The Captain puts receiver on hook and crosses over to wireless apparatus.) Yes, Sears, we'll get them, your pals!

Sears (lighting a cigar)—Interesting evening I had with you, Captain. Guess I'll be going now. (He rises and walks to corridor door.) Good-bye till we meet again.

(Exit Sears.)

(The Captain pushes a button on the table. He then adjusts the wireless telephone transmitter and thrusts switch to sending position. He takes up the wireless hand transmitter, while he looks expectantly at the corridor door.)

Captain (into wireless hand transmitter)—Police Captain Brady speaking. All police automobiles be on watch for Dodge car license number 612122A. Stop them and arrest all in machine.

(There are sounds of scuffling outside, in the corridor. It continues for a few seconds. Enter Sears, handcuffed, with two detectives, one on each arm.)

Sears (angrily)—What is the meaning of all this? I have nothing to do with the auto-bandits. You have nothing on me. What is the charge?

Captain (to detectives)—Search him. I believe he stole a little red book from the top of the receiving cabinet.

(Detectives search Sears and find code book in his inside coat pocket.)

Captain—Do you know the charge now, Sears? One way or another I knew I would get you.

(CURTAIN.)

### The Newspaper Radio Editor

(Continued from page 644)

the page now bursts forth in a blaze of half-tone glory. Listening to sweet music while fishing, bathing, swimming, eating, drinking, playing ball, walking, riding, standing, sitting and even sleeping, is the motif of nine-tenths of them; the rest, as has been said, are largely—er, well, look at your OWN radio page next Sunday!

This is bad enough, but about this time the press agents and "publicity men" start in. The Radio Editor is given permission to publish long articles on what a "wiz" a certain engineer employed by a big radio company is; he is offered, "for immediate release," exciting articles on the construction of a certain radio storage battery. The only press agent stunt that is pulled that makes a real hit with him is that of the publishing houses that send him radio books with requests for reviews. He keeps the books.

The newspaper radio page is going somewhere very fast. It is now about one-fourth program, one-fourth drivel, one-fourth idiotic pictures, and the rest press agent dope. Which is the least interesting, it is hard to determine, but the radio editor is doing his best, and is working hard—next winter, he has been promised, he will receive three dollars a week more. That'll make eighteen.

### RADIO TO LINK ISLANDS OF JAPANESE EMPIRE

Telephone communication by radio will soon be opened across the Chosen Strait. The stations at Fukuoka and Fusan contain the necessary equipment and it is expected that the shipping along the coasts of Kiushu and Chosen will take advantage of this service.

This particular installation is a unit in the Government plan for linking up the various islands of the empire by wireless telephone and telegraph.

HAVE YOU SOMETHING TO SELL OR EXCHANGE?  
A classified ad in Radio News will reach over 235,000 at a cost of only fifteen cents a word





All Radio Sets installed FREE in the homes of the winners anywhere in the U. S. A.



Cabinet Closed

**1st Prize**

This cabinet type complete Radio Receiving Set is one of the finest and most complete sets on the market. It is designed and manufactured by the Colin B. Kennedy Company of San Francisco, makers of the finest type of radio receiving sets. The cabinet is walnut and stands 58 inches high—a masterpiece of cabinet making. The receiving set is regenerative, having an effective range from 175 to 25,000 meters—400 to 600 miles on “broadcasting.” Contained within the cabinet are all batteries, and a most efficient loud speaker. Value complete, \$725.00.



**2nd Prize**

It consists of the Westinghouse R. C. Receiving Set and the famous distortionless Western Electric Loud Speaker, “Tunger” Battery Charger, Storage Battery, 9 “B” Batteries, one Manhattan 3,000 ohm Headset, 3 vacuum tubes, 2 telephone plugs, and complete antenna equipment—a total value of \$408.50.

**3rd Prize**

A complete receiving outfit made up of the well known Grebe CR No. 9 Regenerative Receiver and 2 stage amplifier, Magnavox Loud Speaker, Storage Battery, “Homcharger” Battery Charger, “B” Batteries, one Manhattan 2,000 ohm Headset, 3 vacuum tubes, 2 telephone plugs, and complete antenna equipment—a total value of \$256.50.

**50 Other Prizes**

To 50 other contestants, whose answers the judges decide are most meritorious will be given one of the famous Manhattan 2,000 ohm Radio Headsets. These headsets are built with the precision of a watch and have great sensitiveness and high amplifying qualities.

## Win this \$725.00 Radio Set FREE

*Only a rich man could buy it  
but a poor man may win it FREE*

**S**IMPLY obtain a free “Red Seal Battery” contest blank between November 1st and November 15th from stores that show the Window Display pictured below. Each contest blank gives full simple instructions to help you write your answer and full rules of the Contest.

**“Finish the Sentence”**

The prizes will be awarded for the most appropriate answers for completing *in your own way* in not more than ten words, the following sentence:

- “The Red Seal Dry Battery is best  
(1) because it is the All-Purpose Battery and  
(2) because.....”

**Examples**

Your answer may be descriptive of the Red Seal Dry Battery or it may describe some use. For example: “It never fails on land, air or sea.” Another: “It never starts what it can’t finish.” Another: “it rings bells and buzzes buzzers.”

**Judges**

The judges of the Contest are: Mr. Llew Soule, Editor of “Hardware Age,” New York; Mr. Howard A. Lewis, Manager of “Electrical Merchandising,” New York,

and Mr. Joseph A. Richards, President, Joseph Richards Co., Inc., Advertising Agents, New York.

**Awarding the Prizes**

Prizes will be awarded to those who conform to the rules of the Contest and whose answers, in the opinion of the judges, are most appropriate. In case two or more persons submit winning answers, prizes identical in character with those offered will be given to each successful contestant.

**Announcing the Winners**

As soon as possible after the judges have rendered their decision, the names of the prize winning contestants will be announced in the Saturday Evening Post.

**Contest Opens Nov. 1 — Closes  
Midnight Nov. 15.**

All answers must be written *only on contest blanks* supplied by dealers displaying Red Seal Battery Contest window display. Send as many answers as you like to:

Red Seal Battery Contest  
**Manhattan Electrical Supply Co., Inc.**  
17 Park Place  
New York City, N. Y.



Look for this Window Display in Dealers' Windows Nov. 1 to 15. It identifies all stores that have free contest blanks.



**MANHATTAN**  
ELECTRICAL SUPPLY CO., INC. NEW YORK  
*Makers of the Famous Red Seal Dry Batteries  
and Manhattan Head Sets*





View of Our  
St. Louis  
Retail  
Department



# Get Ready for Fall!

This fall is going to be the greatest in the history of wireless! Dozens of new broadcasting stations are opening—and each one will cover a wider radius as soon as the summer static clears up. Radio enthusiasts will want better equipment—dealers will need better stocks—and the Benwood Co. is ready to take care of you RIGHT NOW! Order what you need TODAY!

## IMMEDIATE DELIVERY

<b>ANTENNA WIRE</b>		<b>CONDENSERS</b>	
Braided	Per 100 ft. \$0.50	23 Plate Signal	\$3.80
No. 14 solid copper	.45	43 Plate Signal	4.70
No. 22 7 Strand tinned	.85	43 Plate Tucker	5.00
<b>LOUD SPEAKERS</b>		43 Plate Benwood	2.95
Arkay Horn	5.00	<b>REGENERATIVE RECEIVERS</b>	
R-3 Magnavox	45.00	Meter	
Western Elec.	161.00	Grebe C R-3	170-680 \$65.00
<b>AMPLIFYING TRANSFORMERS</b>		Grebe C R-5	175-3000 80.00
Benwood Shielded	4.00	Grebe C R-8	175-1000 80.00
Acme Semi-Mounted	5.00	Grebe C R-9	175-3000 130.00
Jefferson	7.00	DeForest MR-6	150-3000 112.00
<b>RHEOSTATS</b>		Paragon RA-10	175-1000 69.50
Paragon	1.50	Kennedy 220	175-3100 125.00
Murdock	1.00	Kennedy 281	175-620 80.00
Fada Newtype	1.00	Super-Radio	175-600 125.00
Fada Power	1.35	<b>AMPLIFIER AND DETECTOR</b>	
Howard	1.10	<b>PANEL UNITS</b>	
Tucker	.85	Benwood Detector	9.50
<b>TELEPHONES</b>		Benwood Amplifier	13.00
Army & Navy 2500 Ohm	10.00	Acme Amplifier	13.00
Federal 2200 Ohm	8.00	<b>VACUUM TUBES</b>	
Frost 3000 Ohm	6.00	No. UV 200 Detector	5.00
Frost 2000 Ohm	5.00	No. UV 201 Amplifier	6.50
Murdock 3000 Ohm	6.00	No. UV 202 5 Watt Transmitter	8.00
Murdock 2000 Ohm	5.00	No. C-300 Detector	5.00
Manhattan 3000 Ohm	6.50	No. C-301 Amplifier	6.50
Manhattan 2000 Ohm	5.50	No. C-302 5 Watt Transmitter	8.00
Type C Baldwins	12.00	<b>6 VOLT "A" STORAGE BATTERIES</b>	
Type F Baldwins	13.00	Benwood 60 Amperehour	15.00
Type C Baldwin units	14.00	Kece Combination Battery and Charger	35.00
Tucker	6.00	<b>VARIOMETERS</b>	
<b>B BATTERIES</b>		Benwood	5.00
Bright Star—22½	1.00	Benwood Knock Down	4.00
Burgess No. 763	2.00	Atwater Kent moulded	8.00
Burgess 2156	3.00	<b>VARIOCOUPERS</b>	
<b>V. T. SOCKETS</b>		Benwood	4.50
Benwood Panel Mount	1.00	Benwood Knock Down	4.00
Murdock	1.00	Workrite	6.00
Socket nickel holders	1.25	Atwater Kent moulded	8.00
<b>DIALS</b>			
Benwood 4 in.	1.50		
Benwood 3½ in.	1.25		
Paragon 4 in.	1.75		

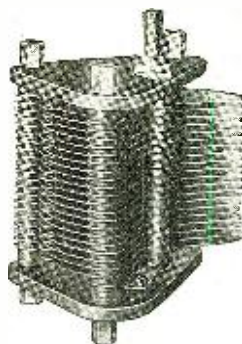

Benwood  
Variable Condenser

Note the improved stationary plate design—this condenser has the greatest capacity for overall size of any variable condenser made. Single bearing wiping contact assures positive connections. Heavy aluminum plates will not bend or buckle. Bakelite ends. 43 plate. .0011 Mfd. Each **\$2.95**

other delightful renditions.

In the middle of summer, while at Arcadia (which is close to the lead belt section of Missouri, and also surrounded by hills) with the receiver shown in Fig. 1, we heard broadcasts from Madison, Wis.; Detroit, Mich.; Memphis Tenn.; St. Louis, Mo.; Indianapolis, Ind.; Kansas City, Mo.; and Atlanta, Georgia; to say nothing of numerous distant amateurs and 600 meter stations sending in code.

The following materials were used in this receiver, and the cost of each is given. Standard apparatus of other makes than those named can no doubt be substituted with equally good results.

- 1 Cabinet, oak, mission finish .....\$5.00
- 1 Hard Rubber 7"x18"x3/16" (New U. S. Rubber Co.) Material for radio panels ..... 2.00
- 2 \*Heard Co. Variometers @ 4.35 .. 8.70
- 1 ‡Heard Co. Variocoupler ..... 4.25
- 1 Kellogg Vacuum Tube socket..... 1.00
- 1 Cutler-Hammer filament rheostat... 1.00
- \*Wound with 56 turns No. 20 D. C. C. on Stator and Rotor.
- ‡Primary consisting of 50 turns No. 22 D. C. C. tapped every 5 turns. Rotor ball wound with 36 turns same wire.
- 1 No. 131 Frost Jack ..... 90
- 2 4" bakelite dials ..... 2.50
- 1 3" bakelite dial ..... 1.00
- 1 1½" radius switch lever ..... .35
- 11 Contact points ..... .55
- 1 Gridleak and Condenser, home-made—
- 10\*Binding-posts ..... 1.00
- 1 Oz. tinfoil ..... .10
- 12 Feet spaghetti ..... 1.20
- 20 Feet No. 14 aerial wire ..... .10
- 10 Feet No. 20 D. C. C. (used scrap)—
- 5 Feet flexible lamp cord (used scrap) .10
- 1 Wood board 2"x14"x½" ..... —
- 4 Cigar-box wood spacers 1"x3½"..... —
- 1 piece brown wrapping paper ..... —
- ½ pint orange shellac ..... .15
- 3 dozen ½" No. 4 R. H. brass woodscrews.
- 1 dozen No. 6. brass washers.
- 2 only 2" No. 6 flathead woodscrews.
- 8 only 1" No. 8 flathead woodscrews.
- Total screw cost about ..... .25

\$30.15

\*Binding-posts have 1" No. 8-32 machine-screws with brass base-lug and thumb nuts tapped clear through. This makes it unnecessary to fit binding-posts to any special panel thickness, and leaves plenty of room for heavy interunit connections.

It is readily seen that should the builder of this set desire to economize he can make his own cabinet, wind his own variometers and variocoupler, use less expensive dials, etc. By doing this, it should be possible to build the set for about \$18.

The tools necessary to construct this unit are found in nearly every amateur workshop or can be purchased at any hardware store for very little. About the only tools used by the writer were: 1 hand-drill and drills, small soldering iron, ten cents worth of solder, ten cents worth of paste, pliers, hammer and screw-driver. The entire set was constructed on the back porch of a summer home, using the dining-room table (between meals) for a work bench.

We will now describe the assembly, step by step.

### SEND FOR CATALOG

Send 10c in stamps for the Benwood Catalog and price list, also complete catalog and price list of DeForest Radio Equipment.

### DEALERS—WRITE OR WIRE!

New price and discount sheets have just been issued. Write or wire for our attractive proposition on radio apparatus we manufacture. Immediate shipment.



"WORLD-WIDE MAIL ORDER SERVICE"

1111 OLIVE STREET

ST. LOUIS, MISSOURI

## Thornton Audio Frequency Amplifying Transformer

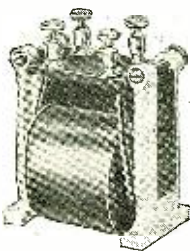

"The Transformer Supreme"

We still have territories open for Jobbers  
Write for particulars

Thornton Transformer Co., Inc.  
30 Church St., New York

## Complete Receiving Set for \$20.00

Material mounted on panel but unwired. Hook up yourself. Book of wiring diagrams furnished with each set.

- Set consists of
- 1 Hard Rubber Panel 7 x 21"
  - 3 "Dials 3"
  - 2 Variometers
  - 1 Variocoupler
  - 2 Inductance Switches
  - 1 Socket
  - 1 Rheostat
  - 1 Comb. Grid Leak Condenser
  - 1 Phone Jack
  - Wire, Tubing, Terminals, etc.

The above, combined with two-step amplifier, \$35.00, unwired.

Send for price list of our complete line.  
**C & K RADIO MFG. CO.**  
299 SEVENTH ST., BROOKLYN, N. Y.

MONEY FOR YOU—Add to your salary—Make extra pin money—Start a lucrative business of your own. Spend an hour each day taking subscriptions for the Radio News. We'll pay you well and you'll enjoy the work. Write for full particulars. Circulation Dept., Radio News, 53 Park Place, New York City.



# Each Instrument Guaranteed



**AIR-WAY MODEL "C" RECEIVING SET**  
 Here is a sound, practical set with detector and two stage amplification. It is remarkable for its long-range reception and its fineness of tuning.



**AIR-WAY MODEL "B" RECEIVING SET**  
 This set contains so many outstanding features that radio enthusiasts have wondered at the range and accuracy of reproduction. Detector and one stage amplifier with typical "AIR-WAY" fineness of workmanship.

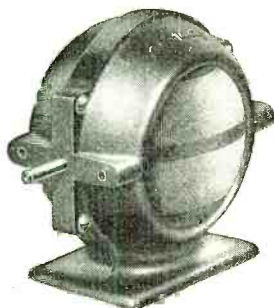

**AIR-WAY MOULDED VARIOMETER**

A combination of the finest known insulating material with precise assembly and accurate winding—careful AIR-WAY manufacture doubles effectiveness and reduces interference.

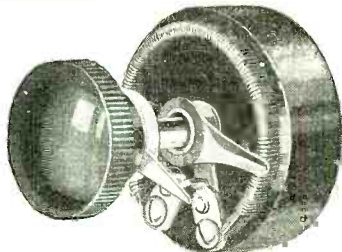

**AIR-WAY GREEN SEAL FILAMENT RHEOSTAT**

A compact Rheostat wound with non-corrosive resistance wire over a substantial insulating ring. Trim, workmanlike, effective and durable.



**AIR-WAY genuine molded rubber composition with neat white accurate graduations and numbers.**

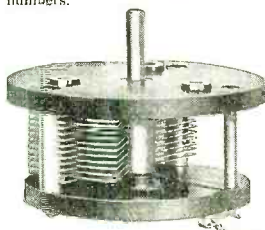

A sturdy frame with molded hard rubber endplates; uniformly mounted to assure maintained accuracy.

## Air-Way GREEN SEAL RADIO EQUIPMENT

The aim of the Air-Way engineers and the policy of the Air-Way Corporation are united in the production of Radio equipment which bears the unmistakable imprint of intelligent design, expert craftsmanship, and genuine quality throughout. In the Air-Way factory there is no compromise between quality and cost. Scientifically organized production by men skilled in volume manufacture of fine electric instruments and equipment is entirely responsible for the attractive prices at which Air-Way Radio parts and complete receiving sets are offered to the public. The Air-Way Green Seal Guarantee Tag attached to each Radio instrument is a symbol of quality that is known and preferred by experienced Radio buyers.

**Air-Way Electric Appliance Corporation**  
 TOLEDO, OHIO

Air-Way instruments appeal most to those dealers who are wisely preparing to merit a successful and growing radio business by selling products of reputation at genuine quality at fair prices. Write for Air-Way Radio Bulletin.



No professional operator would ask for a more precise and enduring instrument than the AIR-WAY Green Seal Variocoupler. It is built right and stays right.

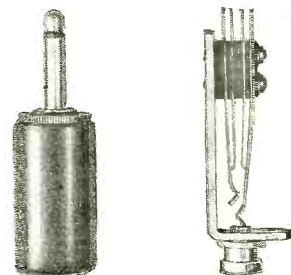

AIR-WAY Jacks and Plugs are built especially for the finer radio apparatus to do away with the loose connections for which plugs and jacks are frequently responsible.



AIR-WAY new, light-weight, positive contact tube sockets save bulbs and maintain perfect connections. New design.

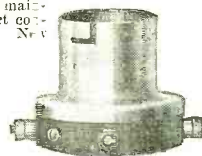

AIR-WAY Amplifying Transformers do more to eliminate the whines and shrills than any other similar piece of radio equipment. They prove their own merit by comparison.



# BRACH vacuum LIGHTNING ARRESTER



**Guards Your Radio Like a Sentinel, Day and Night**

If you seek protection for your radio, if you wish freedom from interference by static, if you desire clear signals and beautiful voice and music receptivity, you should by all means install the Brach Vacuum Lightning Arrester, for many years recognized by skilled engineers of the great railroad and telegraph companies as the highest development in lightning protection.

The Brach Arrester is an unflinching sentinel—alert, awake ready for every attempted invasion—it works automatically like a valve on a steam system. It is made in two types—No. 200 for indoor use; No. 223 for outdoor service—both types “Built Up to a Standard—Not Down to a Price.”

Listed by the Underwriters' Laboratories  
SOLD BY LEADING DEALERS

## safe radio

**L. S. BRACH MFG. CO., NEWARK, N. J.**

16 Years Specialists in Lightning Protective Apparatus. Also Makers of SOLDERALL  
Coast Representatives: Pacific States Electric Co., San Francisco, Cal.

**FIRST STEP, PANEL PREPARATION**

(1) Lay out the panel as shown in Fig. 2. It is best to lay out this design on a piece of paper. The paper pattern may then be on the panel front and the various holes marked with a center-punch.

The layout given shows dimensions for the instruments used in the set built by the writer. If other makes are used, although the panel layout is practically the same, the various holes should be checked and placed in proper position.

Holes for the screws that are to attach the panel to the cabinet are not shown. In any case it is best to wait until mounting the panel before locating these.

(2) Drill the holes. Take care to see that you do not drill a small hole-mark for a 1/4" shaft by mistake. The writer prefers to drill the large holes first, and before drilling each hole he checks and rechecks the same.

(3) Ream out the shaft holes slightly larger than the relative shafts. This allows for any slight irregularity in drilling holes for the attachment screws and keeps the shafts from binding.

(4) Countersink all holes for flathead attachment screws.

(5) Engrave the panel. If bakelite is used, it is best to have a professional engraver do the job. However, if hard rubber or black fibre is used the letters may be stamped in.

The panel shown in the photographs was a hard rubber panel. The letters were stamped in with a set of steel dies borrowed for the occasion. (Ordinary printers' type has also been used with fair success. Good, sharply cut block letters should be used, however, as such type is rather soft.)

(6) Give the back of the panel and also one side of a sheet of tinfoil a good coat of shellac and let dry. In shellacking the panel be sure to hold face up. This will prevent the shellac from running through the holes onto the face.

(7) When the above coats are dry, re-shellac the panel and tinfoil. Wait until the second coat has become gummy. Then stick the tinfoil on the back of the panel and let dry. (If desired, copper-sheet may be used in place of the tinfoil, but it is harder to work.)

(8) After giving the tinfoil shield a little time to set, take a sharp knife and cut away the shielding from about the shaft-holes, switchpoints, binding-posts, etc. However, the shield should not be removed from around the ground connection binding-post hole.

(9) When the tinfoil shielding has had time to set firmly in place, give it one or two coats of shellac and stick a sheet of brown wrapping paper over it. This protects the shielding and acts as an insulator to prevent accidental grounds. It should also be given an outside coat of shellac.

The panel should then be put away for at least 24 hours to dry.

(10) Punch out the holes through the paper. This is done quickly and easily with a red-hot ice-pick.

The panel is now ready for the mounting of the instruments.

**SECOND STEP, MOUNTING THE INSTRUMENTS**

Fig. 4 shows the panel assembly; all the instruments are mounted either directly or indirectly to the panel. This makes the entire assembly a unit which may be removed at will from the cabinet and turned in any position for soldering or repairing.

The use of the brace across the back of the variometers is a novel wrinkle, which the writer believes to be the best mounting method for such an outfit ever tried. Besides providing a convenient mount for the tube-socket, it aids greatly in securing rigidity. It serves as a convenient support for

## STA-JUST DETECTORS

Patented Ball Joint  
All Metal Parts Nickel Plated

\$0.40                      \$0.65

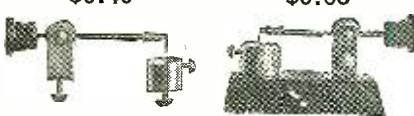

If Dealer cannot supply will send Parcel Post Prepaid upon receipt of Price

**McCLOY ELECTRIC COMPANY**  
7131 KELLY STREET                      PITTSBURGH, PA.

**Wireless Operators Wanted**

**LEARN WIRELESS** AT HOME IN SPARE TIME

The demand for experts exceeds supply. Pays big salaries, \$125 to \$250 a month to \$10,000 a year. Our home course will make you an expert operator in shortest possible time. Instruction by radio experts. We give you Best Theory, Text-Books, and Two Instruments Free, the wonderful Omnigraph and

**FREE VACUUM TUBE** Wireless Phone AND CODE SET

Given Free with Professional Course.

Special Low Cost, Quick, Simple

**AMATEUR WIRELESS COURSE**

Qualifies For Amateur License

Write for booklet "How to become a Wireless Operator."

**FREE** Learn-O-Graph Code Sender given with Amateur Course.

**NEW YORK WIRELESS INSTITUTE**  
154-V Nassau St.                      New York City

**WANTED:** Back numbers of Radio News, Sept., Oct., Nov. and Dec., 1921; Jan. and Feb., 1922.  
EXPERIMENTER PUBLISHING CO., Inc., 53 Park Place, New York City



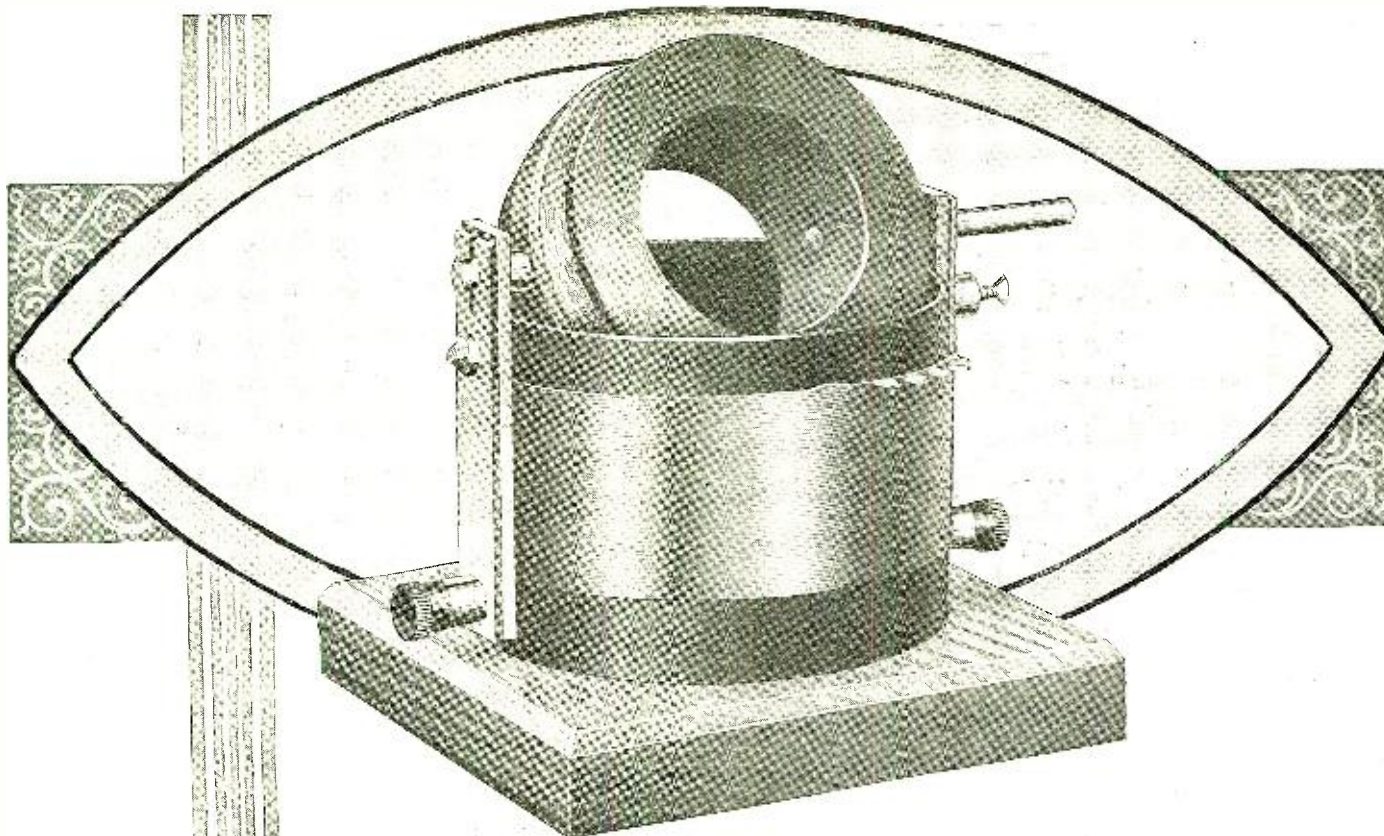

## The Thoroughbred Vario-Coupler

*An essential to every worth  
while radio set*

**I**T IS an interesting thing to observe that A. Frederick Collins, inventor of the wireless telephone, in "The Radio Amateur's Handbook" (Thomas Y. Crowell Co., New York) places the vario-coupler first in the list of parts essential to a successful regenerative receiving set. This only serves to emphasize the importance of a proper vario-coupler as essential to every set.

The Thoroughbred Vario-Coupler because of its exclusive features is chosen by experienced amateurs to complete their sets. The Thoroughbred Vario-Coupler is of the all-moulded type which reduces losses and is not subject to dampness. The first seven taps on the primary are tapped one turn at a time and the last seven, a tap at each seven turns. The user is thus able to *tune in one turn at a time*—a feature not found on any other vario-coupler.

The amateur can use it with base on a table or he can mount it on a panel merely by removing this base.

The secondary of the Thoroughbred Vario-Coupler is wound with fine wire in order that it may be used for plate and tickler, thus doing away with the need for a variometer. On the average aerial it has a wave length of 200 to 700 meters. You can buy it at good radio and electrical stores for \$5.00.

The Thoroughbred Vario-Coupler is but one of fifteen radio products manufactured by the Marshall-Gerken Company in their new and larger plant at Toledo, Ohio.

Write for interesting literature.

THE MARSHALL-GERKEN CO.

Jackson and N. 12th St.

Toledo, Ohio

## *Thoroughbred Apparatus*





Run-down batteries need not be the reason for missing any broadcast programs

## No Concerts Missed Because of Run-Down Batteries

With a Tungar Battery Charger you can easily keep your batteries up to full voltage. It enables you to recharge batteries from any a-c. lighting circuit at your convenience and at a minimum cost. The battery doesn't have to be taken out of the house. "B" storage batteries, also, can be charged by means of a simple, inexpensive attachment.

The Tungar Battery Charger requires no attention while operating and is so designed that there isn't the slightest danger of injuring the battery. And its first cost is very low.

Tungar has kept other people's storage batteries in condition for years—why not yours? Of course, it is equally good for your automobile battery.

Our new booklet on the application of Tungars to radio batteries will interest you. Send to us for booklet B-3640, if your dealer cannot supply you.



Tungar Battery Charger—saves disappointments and annoyance

**Tungar**  
BATTERY CHARGER

long bits of wiring and makes a convenient place to put the "sub-terminals" for the "A" and "B" battery connections.

The photos show the method of mounting. However, the writer recommends the following procedure:

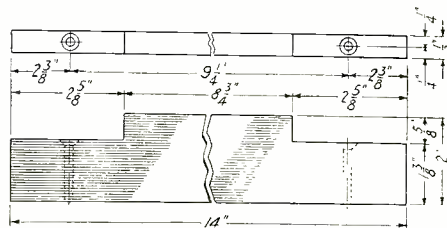

Fig. 3

Dimensions of the Back Support Which Holds the V. T. Socket Are Given in This Diagram.

(1) Mount the switchlever and each switchpoint fully before proceeding to the next; this gives plenty of room for the pliers in tightening the nuts. (Two little stops should be cut from a strip of brass or tin for the two end points.)

(2) In mounting the variometers, secure them to the panel with four 1" No. 8 flat-head wood screws. The front of the variometers should be spaced away from the panel about 1/8" to prevent accidental grounding to the panel. Two wood-spacers 1"x3 1/2", of cigar-box or other thin wood, shellacked, should be employed. Care should be taken to drill holes to pass the 1" assembly screws.

(3) Mount the variocoupler.

(4) Mount the filament rheostat. If Cutler-Hammer is used, it is best to mount with the terminals down.

(5) Mount jack.

(6) Mount binding-posts.

(7) Mount the wood-brace that serves also as a socket mount. The dimensions of this piece are shown in Fig. 3. This brace should be mounted 1/2" above the variometer base and care should be exercised to see that it is mounted square. Use 2" No. 6 flathead woodscrews and take care they do not penetrate the stator windings.

Now test for accidental panel grounds. If none are discovered, the unit is mounted and all is ready for the wiring.

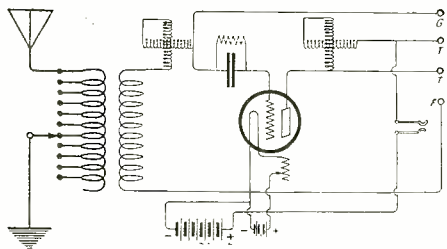

Fig. 4.

Wiring Diagram of This Short-Wave Receiver. The Same Tuner Can Be Used With Another Detector.

### THIRD STEP, WIRING

The hook-up used in this set is shown in Fig. 4.

Figs. 5 and 6 show photographic views of the wiring. The circuit is the good old standard two-variometer circuit. The diagram of connections shows the proper order in which to make the connections if convenience in soldering is desired. The "inside" and "close-to-the-panel" connections are made first. The arrowheads show the beginning and end of each wire. Using the pictured views in Figs. 5 and 6 and taking a little care in making right-angle bends and using straight wire will produce a remarkably neat and workmanship looking outfit.

Connections (2), (17) and (18) should be made of flexible lamp cord. Connections (3) should be made of No. 20 bare or D.C. C. All other connections should be made

**General Electric Company**  
General Office Schenectady, N.Y. Sales Offices in all large cities. 35-A 77

We are Distributors for



The Recognized Symbol of Superior Performance

ALSO CHELSEA, FADA, DUBILIER, FEDERAL, GENERAL APPARATUS  
Complete stock of accessories and diagrams for Armstrong Regenerative Circuits

Mail Orders Filled

**ELECTRIC SERVICE ENGINEERING CO.**  
105 West 47th Street NEW YORK CITY



# This is station K.S.&S.C.

## ANNOUNCING Better Radio Equipment Kellogg Built Throughout



No. 69A  
Head Set



No. 21 Microphone



No. 2  
Tube Socket



No. 501 Dial

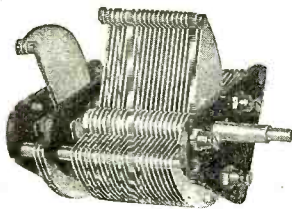

No. 505 Variable Condenser

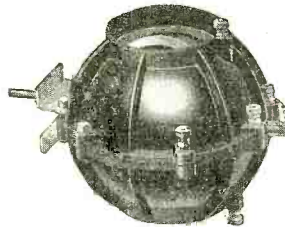

No. 501 Variometer



Grid Condenser with No. 502 Mtg.



Air Choke Coil



No. 501 Four Conductor Jack



Grid Leak and Condenser  
with No. 503 Mtg.



Iron Core Choke Coil



No. 501 Plug



No. 4 Insulator

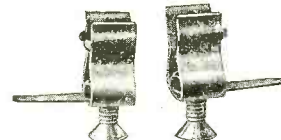

Set of 501 Condenser Mtg. Clips

### KELLOGG STANDARD RADIO APPARATUS

is made in standard resistances and ratings. Only the highest grade material is used, and first-class workmanship assures a product that guarantees high efficiency and durability.

*Send for our latest radio Bulletin.*

**Kellogg Switchboard & Supply Co., Chicago**

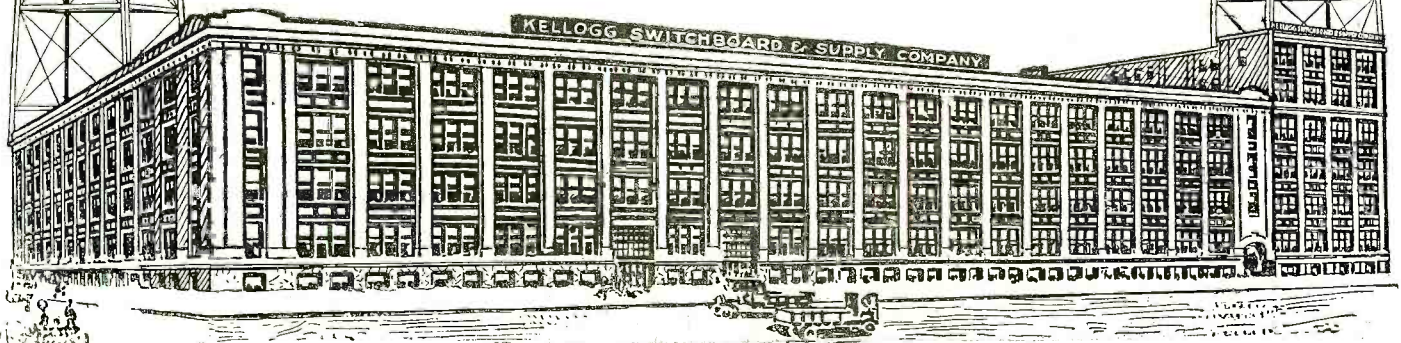



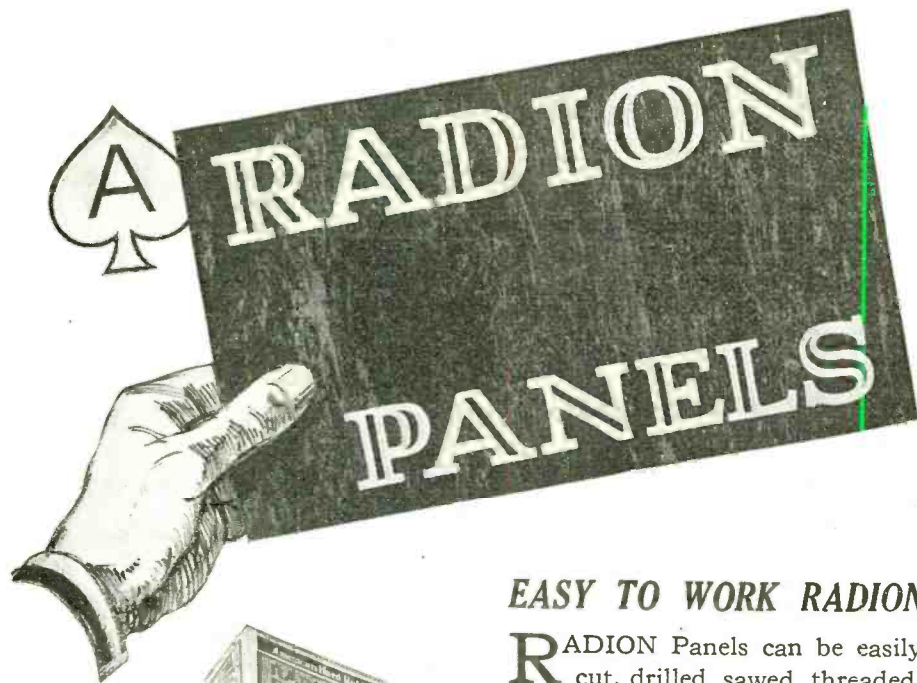

**EASY TO WORK RADION**

**R**ADION Panels can be easily cut, drilled, sawed, threaded, tapped, sanded, stamped and engraved by the amateur without incurring the danger of chipping or of leaving rough edges. No other panel combines the same high dielectric strength and beauty with these ideal working qualities.

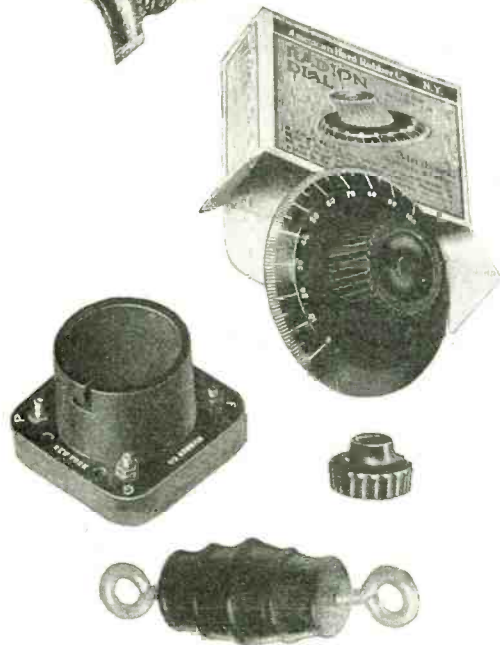

Send for complete Radion Catalog listing stock sizes of Black, Brown and Mahogany (mahogany grain) Panels, together with complete list of Moulded Radion Parts.

**AMERICAN HARD RUBBER COMPANY**  
 11 Mercer Street.....New York, N. Y.  
 Chicago Office.....Conway Building

of No. 14 bare copper or larger. Connections (3) should be covered with spaghetti, which should also be used to cover any wires which are in danger of touching others.

When the connections shown in Fig. 4 are completed, they should be tested for misconnections. If none are found, the unit is ready to be placed in its cabinet.

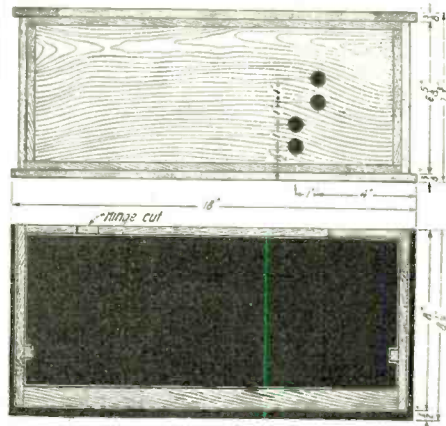

Fig. 7

Dimensions and Details of the Cabinet Which Encloses the Receiver Are Given Here.

**FOURTH STEP, PLACING IN CABINET**

The cabinet shown in Fig. 7 was made of 3/8" oak, with mission finish, measuring 7"x18" by 8 1/2" deep.

"A" and "B" batteries are connected to binding posts at the rear of the cabinet. Their location is shown in Fig. 7.

Fig. 7 gives the dimensions and layout. You will notice that the cabinet is of the flush panel type. Only the over-all and a few odd dimensions are given.

The binding posts for "A" and "B" should be connected to the sub-terminals on the socket-mount board by one-foot lengths of lamp cord. This makes it easy to remove the wired tuner-detector unit from the cabinet, to get at any part of the set. As soon as the "A" and "B" connections mentioned are made, the unit should be placed in the cabinet and the screws that hold it in place put in. The letters should then be whitened. The writer used white shoe-polish and a steel pen. This fills in the indented letters and soon dries.

The dials should be put on last, and when they are in place it is only necessary to connect the antenna and ground wires and attach the batteries, when the outfit is ready for work.

The four binding-posts G, T, T, F enable an external detector to be connected. The next article will describe a detector and two-step audio frequency amplifier unit that matches up with this one.

The writer will be glad to answer any questions regarding this set if a self-addressed and stamped envelope is sent him.

**Construction of a High-Voltage Storage Battery**

(Continued from page 656)

top at the other end. After the paraffin hardened and the tilting blocks were removed a sloping surface resulted which is convenient for washing out any acid or dirt. A flared glass tube was put through the bottom of the tray at the lower end to drain off any water or acid.

The plates for the battery come in pairs consisting of one positive and one negative plate joined by a lead link, the plates going in adjacent cells and being supported by the lead link. The battery was made up in such a

# MARKO



*for* **RADIO**

## ALWAYS DEPENDABLE

Made in All Sizes and Capacities      Guaranteed Two Years

**Marko Storage Battery Co.**

213 W. 64th Street      Jefferson Ave. at Bedford  
New York      Brooklyn, New York



# "It's a Super-Rheostat for Your Radio Set"



No *Wire* Rheostat can produce the amazing results of the Bradleystat

If you want the finest results from your radio set, install a Bradleystat in each vacuum tube circuit. Our customers have found that by using Bradleystats, instead of wire rheostats, they get

1. *Clearest and Loudest Reproduction*, because the Bradleystat stepless control locates the precise filament current for greatest amplification or detection.
2. *Quickest and Easiest Tuning*, because one knob, without vernier, does the work. There are no interfering noises, no loss of time, and no worry as with complex wire rheostats.
3. *Greatest Receiving Range*, because noiseless control detects weak radiophone waves and by locating exact filament current, amplifies the waves to fullest extent.

That is why the Bradleystat is known among radio experts as the Super-rheostat. Don't hamper your vacuum tubes with inadequate wire rheostats. Use the Bradleystat.

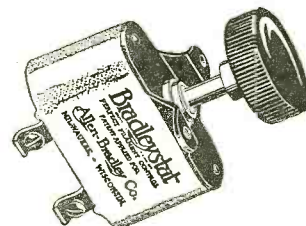

**Bradleystat**  
REGISTERED U. S. PAT. OFF.  
PERFECT FILAMENT CONTROL

Two columns of graphite discs (not loose carbon grains) provide the delicate control so vital and essential for vacuum tubes in radio sets.

A single adjusting screw gradually applies or removes pressure from the discs, thereby changing the filament current in such a smooth and stepless manner that you quickly find the loudest and clearest reproducing point of your tube.

The Bradleystat is so simple and efficient that thousands of radio enthusiasts are using them to the exclusion of all wire rheostats. Twenty years of experience and research have made such perfection possible.

**Allen-Bradley Co.**  
Electric Controlling Apparatus  
287 Greenfield Avenue  
Milwaukee, Wis.



INSIST ON THE CHECKERED BOX

Retail Price

**\$1.85**

Postage 10c extra

MAIL

Coupon for  
**FREE BOOKLET**  
on V. T. CONTROL

**Allen-Bradley Co.**  
Electric Controlling Apparatus

287 Greenfield Av., Milwaukee, Wis.

Please send me latest bulletin on  
Bradleystat Perfect Filament Control,  
explaining how it will improve my radio set.



# AMPLIFICATION WITHOUT DISTORTION

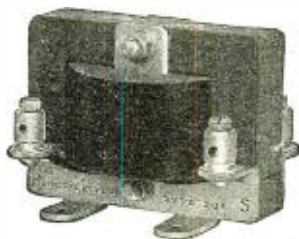

TYPE 231A

## AMPLIFYING TRANSFORMER

Price - \$5.00

The GENERAL RADIO CO. type 231A audio frequency amplifying transformer is correctly designed. It amplifies without the distortion and disturbing noises so frequent in amplification.

### CONSTANTS OF THE TRANSFORMER

	Primary	Secondary
Direct current resistance - - -	1,100 ohms	5,500 ohms
Resistance at 1000 cycles - - -	11,000 ohms	130,000 ohms
Reactance at 1000 cycles - - -	66,000 ohms	700,000 ohms

## GENERAL RADIO COMPANY

Massachusetts Ave. and Windsor St.

CAMBRIDGE 39 . . . MASSACHUSETTS

*Standardize on General Radio Co. Equipment Throughout!*

BULLETIN 911N WILL BE SENT ON REQUEST

Do not confuse the products of the GENERAL RADIO CO. with those of other concerns using the words "General Radio." It has no affiliations with any other companies.

## COPPER FOR BEST RESULTS

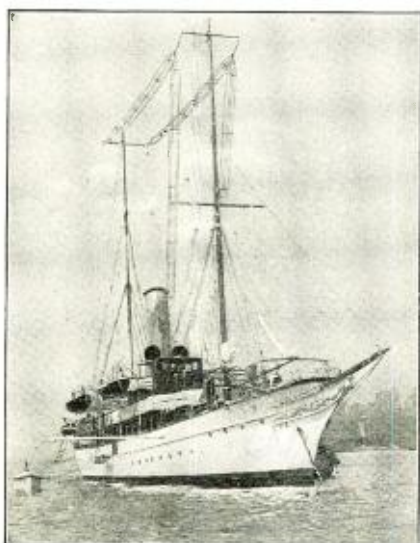

Signor Marconi's Yacht  
"Elettra"

THE world was set agape not long ago by a report that mysterious radio signals had been received from the planet Mars by Signor Marconi. The delicate sensibilities of the Copper wires with which the *Elettra* is equipped apparently had detected and defined sound waves that had received their initial impulse millions of miles away.

Whether or not in this instance Mars was no further than Schenectady, the fact remains that Copper does its job so well that those who want the best radio results are taking no chances with substitutes.

Be sure it's Copper, pure Copper, if you want good service.

## COPPER & BRASS RESEARCH ASSOCIATION

25 Broadway - New York

way that its terminals were at the opposite end from which the tray is drained.

Chemically pure sulphuric acid is diluted to bring the specific gravity to 1.210. Directions for mixing the electrolyte may be found in any handbook on storage batteries. The electrolyte in the jars should come about one-fourth inch above the top of the plates.

Paraffin covers were made for the cells. The majority of covers in use consist of one long cover for each row of cells. The paraffin was poured into a wooden mold or trough about  $1\frac{1}{2} \times 18\frac{1}{4}$  inches forming a piece about  $\frac{1}{4}$  inch thick. While the cover was still warm, it was removed from the mold and placed on top of the row of cells where it was pressed down and conformed to the tops of the jars and lead links. In the center above each jar a considerable depression was made and a small hole made for gases to escape. This method gives a convex surface to the under side of the cover so that the spray forming when the cell is charging collects on the cover and forms droplets which are returned to the electrolyte. As would be expected the covers have reduced the evaporation greatly in addition to keeping dust out of the cells. When the batteries are on charge no spray or fumes are noticeable in the room.

Each terminal of each battery comes out to the blade of a single-pole double-throw switch mounted on the vertical supports of the tray. The lower terminals of all positive terminal switches are connected together, the same being true of the negative terminal switches. By throwing all of the switches downward, the batteries are placed in parallel either for obtaining 100 volts or for charging from the 110-volt direct current mains. The batteries are connected directly to the 110-volt mains through small fuses when charging. The upper terminals of the switches are connected in series, positive to negative, and have suitable binding posts attached to each pair of switch terminals for the wires from the radio-frequency generator. By a suitable throwing of switches any voltage from 100 to 600 may be obtained with these batteries. The voltage obtained of course depends on the number of trays. When operating the larger electron tube, three of the batteries may be in use while the other three are being charged.

Quite a number of these batteries have been used by the Radio Laboratory of the Bureau of Standards and they have been entirely satisfactory for supplying a small constant current such as is necessary for electron tube generators. To obtain best results the batteries must be given some attention to see that the jars are kept filled with distilled water to a height somewhat above the top of the plates and are charged from time to time. How often the batteries are charged depends on how much they are used. It is preferable to charge them oftener and keep them well charged than to use them to the limit, charging them only at wide intervals or when nearly run down. The trays should be washed out once in two or three weeks with clean water to remove any collected acid or dirt.

As has been previously stated, storage batteries of this general type (using same type of element) have been in use in the Radio Laboratory for over four years. While no definite data have been collected to show the useful life of such high-voltage batteries some very conservative estimates may be given. The life of such batteries is greatly influenced by the care afforded them. Good care includes keeping the jars and wax free of acid spray and dust; keep jars properly filled; keep within the proper ampere-hour charge and discharge rate; and if batteries are not normally used at the specified discharge rate, they should be exercised about every two weeks by discharging, through a resistance, at the proper discharge rate and then recharged. Batteries of this type which have been given proper attention have been in use for over four years and are yet quite serviceable. Others have gone to ruin in six months for want of care.

Get a Handy Binder for your RADIO NEWS. Holds and preserves twelve issues, each of which can be inserted or removed at will. Price 65c. Experimenter Pub. Co., Inc., Book Dept., 53 Park Place, New York.





## A Word About Price!

*Something that everyone interested  
in Radio should know*

**T**HE Automatic Electric Head Set has been developed and completed to give a maximum loudness and clearness under all conditions.

Some of the outstanding features have been discussed in these pages. Price has been quoted at \$10.00, with plug attached \$11.50. This is a fair price. It covers development and manufacturing costs plus a reasonable profit.

On account of the widespread demand for Radio equipment, it is difficult to judge real values by the various prices you see quoted. High price may not necessarily mean commensurate quality. That is why it is safer to buy a product whose origin you *know*.

Automatic Electric Company has been making high class telephone apparatus for over thirty years. This perfected Radio Head Set is the result of years of experience and technical knowledge, backed by the reputation of this house. And it is our aim to give you the best Head Set ever produced, to fit all requirements.

### Some of the Important Points of Superiority of the Automatic Electric Head Sets are:

**Single pole construction** — (a single powerful electro-magnet which takes effect at the exact center of the diaphragm).

The **soft iron magnetic path** assures minimum loss of strength and character to the diaphragm vibrations.

The **coil design** — a single coil wound on a cylindrical core. No sharp corners. The core of the coil is very small and the electric resistance per average turn is correspondingly low.

High resistance, as you know, sounds impressive but means practically nothing. The thing that counts most is PROPER effective impedance. This is governed chiefly by the number of turns of wire, amount of iron in the magnetic circuit, and its construction.

If your dealer sells high class Radio apparatus, he can tell you all about Automatic Electric Head Sets. Ask him. If he cannot supply you, order from us direct. Price is \$10.00, postpaid—with plug attached \$11.50.



## Automatic Electric Company

ENGINEERS, DESIGNERS & MANUFACTURERS OF THE AUTOMATIC TELEPHONE IN USE THE WORLD OVER  
HOME OFFICE AND FACTORY: CHICAGO, U. S. A.

This is the high grade plug that comes attached, when desired, to *Automatic Electric Head Sets*. It will take care of any kind of cord terminals, will fit any kind of jack and will accommodate two head sets. With this plug attached to our head set you can be sure the head set is properly "poled."

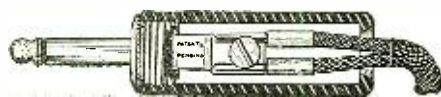



# Radio

The Greatest Radio Offer of the Year—Absolutely Complete, \$49.50

This special receiving outfit will give as good results as any outfit of this improved type on the market. It is absolutely complete, there is nothing extra to buy. We include everything—you simply put up the aerial, connect the instruments, which is easy to do, and in less than half an hour you can be receiving signals, radio music, lectures, stock reports, market reports, or any other radio program sent out. In making tests with this set in Chicago we regularly heard Detroit, Pittsburgh and other stations were often tuned in. Of course, atmospheric conditions affect the range of this or any other receiving set made.

## Highest Development in Radio Receiving

This outfit will equal in results any outfit of this type regardless of price. It is especially made for us and has behind it the fifty year old guarantee of Montgomery Ward & Co.: "Satisfaction guaranteed or your money back." You take no risk whatever in ordering this set.

## Long Distance Vacuum Tube Receiving Set

The complete outfit includes our special Combined Tuner and Detector; Special 2000 ohm Double Head Set; Radio Storage Battery; one Detector Tube, one "B" Battery; and complete antenna and connecting equipment including 150 feet bare copper wire and 25 feet insulated wire, porcelain tube, double throw switch; 2 antenna insulators; lightning protector; ground clamp, 2 screw eyes and 25 feet of wire for instrument connections.

Order this set at our risk. It will be packed carefully and shipped immediately from our nearest house. Shipping weight 40 pounds.

563Z59—Complete Outfit..... \$49.50

Order this outfit today and start at once enjoying in your home the most marvelous invention of the age.

Price of receiving Set without batteries, head piece, switch and aerial, shipping weight 8 pounds: 563Z598—\$27.50.

Send money order or check to the one of our five houses that is nearest to you.

MONTGOMERY WARD & CO., Dept. 2-R  
Chicago Kansas City Saint Paul Fort Worth Portland, Ore.

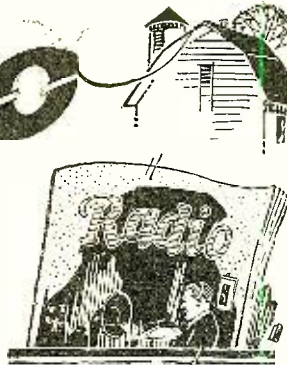

## RADIO CATALOG FREE

This FREE catalog tells you the kind of Wireless Equipment to own, so that you receive in your own home all the latest news, music, Church services, lectures—everything that is broadcasted. Every home should have wireless telephone outfit. We now offer complete outfits from \$12.95 up. Everyone interested in radio should see our low prices on parts and accessories. Write for this book. Learn about the miracle invention of the age. Easy to install, simple to operate.

One copy of this booklet is yours, FREE. Write for your copy.

COMPLETE OUTFIT \$49.50

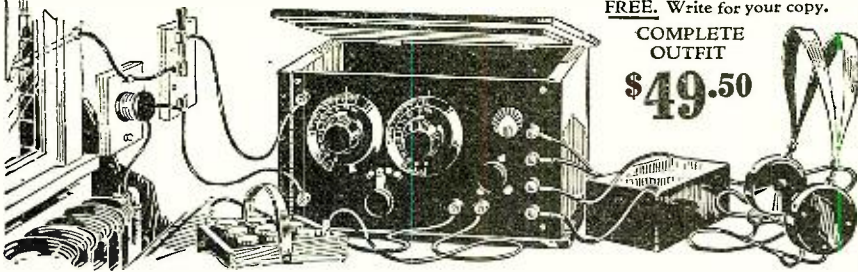

# Montgomery Ward & Co.

The Oldest Mail Order House is Today the Most Progressive

## Service

"I had six honest, serving men;  
(They taught me all I knew):  
Their names are WHAT and WHY and WHEN,  
and HOW and WHERE and WHO."  
(Kipling)

WHAT was the Declaration of London? WHAT are consols?  
WHY does the date for Easter vary from year to year?  
WHEN and by whom was the great pyramid of Cheops built?  
HOW can you distinguish a malarial mosquito?  
WHERE is Canberra? Zeebrugge? Delhi?  
WHO was Mother Bunch? Mill boy of the Slashes?  
Are these "six men" serving you too? Give them an opportunity by placing



## WEBSTER'S NEW INTERNATIONAL DICTIONARY

in your home, office, school, club, shop, library. This "Supreme Authority" in all knowledge offers service, immediate, constant, lasting, trustworthy. Answers all kinds of questions. A century of developing, enlarging, and perfecting under exacting care and highest scholarship insures accuracy, completeness, compactness, authority.

The name Merriam on Webster's Dictionaries has a like significance to that of the government's mark on a coin. The NEW INTERNATIONAL is the final authority for the Supreme Courts and the Government Printing Office at Washington.

Write for a sample page of the New Words, specimen of Regular and India Papers, also booklet "You are the Jury," prices, etc. To those naming this magazine we will send free a set of Pocket Maps.

G. & C. MERRIAM COMPANY, Springfield, Massachusetts, U. S. A.

Established 1831

Name \_\_\_\_\_ Address \_\_\_\_\_

DIMENSIONS OF TRAY

Approximate Voltage	Rows	Cells per Row	Distance between Rows	Distance between cells	Tray inside Dimensions	Remarks
100	4	12	1	0	11 1/4 x 19	Present tray suggested size rather unwieldy
100	4	12	1	3/8	11 1/4 x 24 1/4	
50	3	8	1	3/8	8 1/2 x 16 3/4	Suggested size too low voltage.
100	5	10	1	3/8	13 1/4 x 20 1/2	Suggested size

(Abstract from Journal of Optical Society of America)

## The Universal Receiver

(Continued from page 66)

aluminum or copper sheeting is used but it is more difficult to attach and tinfoil is just as efficient. Get a heavy grade, smooth it out as flat as possible and cut it one-half inch smaller, all around, than the main panel. The sub panel does not need shielding. Shellac will be fine for holding the tinfoil, if, after coating the rear of the panel with it, it is allowed to become tacky before placing the foil. Press the foil on heavily so that there will be no air bubbles to blister.

(Continued on page 713)



# KNOW WHO IS SENDING

Get twice the pleasure and usefulness out of your receiving set. Look up the name and location of any ship or land station whose messages you pick up—learn the name and address of that amateur whose sending set you just heard.

**Now Ready!** 4th Edition  
of the

## CONSOLIDATED RADIO CALL BOOK

In a new large size—280 pages—88 more valuable pages than the 3rd Edition and featuring

### 7 Two-Color Radio Maps

Five of them are Continental Maps showing all stations throughout the world handling commercial traffic, with their calls; one showing the amateur radio districts of the United States and the principal radiophone broadcasting stations with their calls; and a map of the United States Weather Forecast Zones. Seven wonderful, two-color radio maps with a wealth of information that will give you a great deal of pleasure and knowledge.

#### Every Amateur Call in the U. S. and Canada Is Listed!

All Amateur Radio Calls of the United States and Canada; Every Vessel, Coast Station, and Radio-Compass Station in the World; Radiophone Broadcasting Stations of the United States; Every High-Power Station in the World; Special Land Stations of the United States; Time Signals, Hydrographic and Weather Reports of the United States and Principal Foreign Countries; International Abbreviations; Assignment of International Calls; Press Schedules; Radiogram Rates; Cable Rates; International Morse Code and Continental Signals; and Complete General Information covering Distress Calls, International Safety Signal, Use of 800-Meter Wave Length, Amendments and Changes in Various Governmental Regulations, How to Determine Charges on Radiograms, Free Medical Advice by Radio to Vessels, and much other useful information.



#### Some of the Valuable Information Contained in This New Book:

And every vessel and land station in the world is represented and listed alphabetically, according both as to name of vessel or land station, and to call letters.

The Consolidated Radio Call Book is the only book in print officially listing all the Radio calls as issued by the Bureau of Commerce. And the New Radiophone Broadcast Section is particularly complete and gives all available information concerning calls, wave lengths, PROGRAMS, etc.

The third edition of 10,000 copies was exhausted in two weeks. The fourth edition is selling just as quickly. Don't wait until it is all gone. Order at once, either direct from us or from your favorite dealer.

Published by

**Consolidated Radio Call Book Co., Inc.**  
96-98 Park Place, New York City

## Great 38-page Supplement FREE to all who have the 4th Edition Call Book

As a special service to the readers of the Fourth Edition of the Radio Call Book, we have printed, at great expense, a 38-page supplement containing the latest amateur radio calls of both the United States and Canada, and other calls issued very recently. It is absolutely free to all those who write for it, provided you have bought a copy of the fourth edition of the Consolidated Radio Call Book. This wonderful supplement brings the call book up to the very last moment and on account of the many changes that have taken place and which are fully covered by this supplement, every radio amateur or professional is urged to send for his free copy of this supplement today.

Send to us direct or get it from the dealer from whom you bought the 4th Edition Call Book





# BUILD YOUR SET WITH BARAWIK STANDARD

## PLATE CIRCUIT "B" BATTERIES

You can make real savings on these batteries. Don't pay more. We guarantee them to equal any on the market regardless of price. Absolutely uniform. Extra long life.

160 Signal Corps type, small size, 15 cells, 22½ volts. Each... \$5c

J182 Large Navy size, 6¼x4x3, 15 cells, 22½ volts. Each... \$1.75

J184 Variable Large Navy size, 5 taps, giving range from 16½ to 22½ volts in 1½ volt steps. Each... \$1.80

J188 Double Navy size 6¼x4x6, 30 cells, 45 volts. Suitable for amplifier circuits and power tube use. Two or more of these units in series may be used in C. W. and radiophone circuits. Each... \$3.40

J188 Combination Tapped 45 volts, 30 cell, 6¼x4x6 battery. Tapped to give 45, 22½, 21, 19½, 18, and 16½ volts. Handles both detector and amplifier tubes. Each... \$3.55

**4½ VOLT "C" BATTERY UNIT**  
For use in grid circuit. Also can be used to make up "B" batteries.  
J189 Each... 39c

**WILLARD "B" STORAGE BATTERY**  
Better results. No battery noises. Cheaper in the long run. Easily recharged by our Battery Charging Rectifier. Leak proof glass jars. Will last for years.  
J205 Price... \$9.00

**BATTERY CHARGING RECTIFIER**  
Charge your battery at home overnight for a few cents. Simply connect to any 110 volt 60 cycle light socket, turn on current and rectifier does the rest automatically. Will work for years without attention. Simple connections. Gives a tapering charge which batteries should have. You can make it pay a profit charging your friends' auto batteries. Long connecting cords with pair of battery clips.

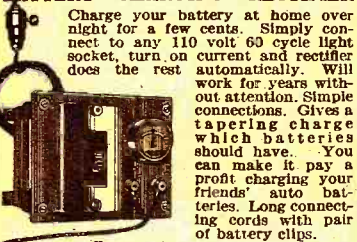

Prices are Transportation Paid

J201 For 6 volt battery... \$13.95  
J203 For 12 volt battery... 13.85

**STORAGE BATTERY**  
A very high grade battery made especially for radio service. Guaranteed. Properly cared for will give years of service for filament lighting.

J184 6 volt, 40 ampere size. Each... \$10.00  
J186 6 volt, 80 ampere size. Each... \$12.50

**BATTERY CLIPS**  
J188 Two for... 28c  
Clip onto storage battery terminals. Lead coated. Make positive non-corrosive contact at all times.

**WIRE CONNECTING CLIPS**  
J189 Per dozen... 30c  
Small connecting clips for fast-acting leads onto binding posts, etc. Handy and useful. Every experimenter should have at least a dozen.

**PORCELAIN BASE SWITCHES**  
Fine white porcelain bases. Copper contacts and blades. Can be used as antenna switches.

J385 Single Pole Switch Throw. Each... 20c  
J387 Single Pole Double Throw. Each... 32c  
J384 Double Pole Double Throw. Each... 50c

**FILAMENT CONTROL RHEOSTATS**  
Cresley Wound on vulcanized fiber. Adjustable to any panel. Complete with knob.

J130 Each... 54c

Best grade. High heat resisting base. Diam. 2½ in. cap. 1¼ amp. Resist. 6 ohms. 1¼ in. Knob with pointer.  
J132 Each... 70c

**POTENTIOMETER**  
Same style as above rheostat. Gives fine "B" battery adjustment. Resistance 100 ohms.  
J133 Each... \$1.18

**VERNIER RHEOSTAT**  
Gives exceedingly fine control of a battery current. A necessity for best receiving results.  
J135 Each... \$1.19

**QUICK ACTING VERNIER RHEOSTAT**  
Gives very fine control of current and can be switched on or off instantly at any desired point.

J124 Each... \$1.27

Porcelain Base Rheostat for table mounting. Resist. 10 ohms.  
J138 Each... 78c

## WE PAY TRANSPORTATION CHARGES EAST OF THE ROCKIES

THE PRICES QUOTED DELIVER THE GOODS TO YOUR DOOR FAST SERVICE—TRY US AND BE CONVINCED

THIS GUARANTEE PROTECTS YOU—Examine the goods we ship you. They must suit you in every respect. If you are not satisfied with your purchase return the goods at once and we will refund the price you paid.

### SPECIAL OFFER ON TWO HIGH GRADE RECEIVING INSTRUMENTS



**Regenerative Tuner and Detector—Two Step Amplifier**

J220 The two for... \$67.50  
This is a combination unequalled for clear long distance radiophone receiving. With a good aerial the range is only limited by the power of the transmitting set. Send for complete descriptive circular.



**DETECTOR-TWO-STEP AMPLIFIER**

J222—Price \$35.00  
A very sensitive high grade instrument. Signals that cannot be heard with detector alone will be brought in strong. Has one detector and two amplifying circuits. Standard tube sockets, grid condenser in detector circuit two amplifying transformers, 3 jacks and a plug. Satin finished Formica Panel. Fine Mahogany finish large size cabinet. Hunged top. Interior easily accessible. Binding posts for all necessary connections.

### REGENERATIVE TUNER

J224—Price \$37.50  
This is a standard make Armstrong licensed set. Range from 180 to 600 meters. Will tune sharply and bring in signals strong even under difficult conditions. Fine Mahogany finished large size cabinet. Satin finished Formica Panel. Two high grade variometers, with variable coupler for closest tuning. Engraved dials, knobs, switches, binding posts for all necessary connections, etc. A high grade outfit worth much more than we ask.

### VACUUM TUBE

Standard Brands—Cunningham Radiotron. Every one guaranteed new and perfect. We will ship brand in stock unless you specify otherwise.

J105 Detector. Each... \$5.00  
J110 Amplifier. Each... 6.50  
J115 5 Watt Transmitter. 8.00



### MYERS TUBES

These tubes have many desirable characteristics that have made them great favorites. No critical adjustments. Low battery consumption. Clear signals. Great sensitivity on long distance reception. Small size. Rigid construction. No tube noises due to mechanical vibration. Perfect oscillator. Excellent as audio or radio frequency amplifier. Especially satisfactory on Armstrong super regenerative circuits. Can be used in Myers receptacle or in any standard socket with adapter listed.

J111 RAC-3 Audion. Each... \$3.50  
J113 High-Mu Audion. Has 5 times amplification of ordinary tubes. Oscillates anywhere from 2 to 300 volts or plate. Each... \$5.00  
J118 Receptacle for above. Each... \$1.00  
J117 Adapter to adapt Myers tubes for use in any standard socket. Each... \$1.05

### MYERS CHOKE COIL

For Audio Frequency Amplification. Designed to work with Myers tubes. Brings in loudest possible signals. Flexible over a broad band of wave lengths. Free from amplifier noise. Free from distortion. Mounts in Myers special receptacle.

J119 Each... \$3.50

### VACUUM TUBE SOCKETS

Our Special Socket. A wonderful value. Moulded entirely of bakelite. Four binding post connections. Right angled contact springs.

J140 Each... 39c

**PORCELAIN BASE AND TUBE**

J144 Cresley for either panel or table mounting... 42c

High Grade combination type for panel or table mounting. Metal tube. High insulation base.  
J146 Each... 69c

Paragon combination type for panel or table mounting. One of the best designed and best made sockets on the market. Metal tube bakelite base.  
J148 Each... \$1.10

### TWO AND THREE GANG SOCKETS

These sockets make it easy to build detector and amplifier units and make a neat, compact, workman-like job. Perfectly made of high grade materials. Metal tubes mounted on fiber base. Quickly mounted on panel or base.

J147 Two gang socket... \$1.20  
J149 Three gang socket... \$1.85

### FIXED CONDENSERS

Moulded cases, nicked binding posts.  
J862 .005 Mfd. Each... 49c  
J864 .01 Mfd. Each... 59c

### CARBON PRESSURE DISC VERNIER RHEOSTAT

Current regulation is obtained by changing of pressure on carbon discs. This permits of infinitely fine variation of current. Very durable. Resistance 15 ohms. Capacity 2½ ampere.  
J131 Each... \$1.48

### VARIABLE GRID LEAK

Pencil mark type. Resistance may be varied exactly as needed.  
J180 Each... 24c

### GRID CONDENSER

J182 Mounting holes spaced to fit lugs of above leak. Cap. .0025 MF. 19c  
J183 Same as 182 but higher grade. Enclosed in metal case... 39c

### PHONE AND GRID CONDENSERS

A compact, inexpensive style of condenser that is very satisfactory and durable. Conducting sheets and dielectric are wound on fiber strip with eyelets for mounting and connections.

Price, each... 12c  
J170 Phone Condenser. .001 Mfd.  
J172 Phone Bridging Condenser. .0005 Mfd.  
J174 Grid Condenser. .00025 Mfd.

J176 Grid Condenser .00025 with pencil mark leak. Each... 24c

### TUBULAR GRID LEAKS AND CONDENSERS—MOUNTED STYLE

Very convenient. Permits quick change of leaks or condensers of varying capacities.

Grid Leaks. Price, Resistance, 87c

J850 .5 Meg. J855 2 Meg.  
J851 1 Meg. J857 3 Meg.  
J853 1.5 Meg. J859 5 Meg.  
Grid and Plate Condensers. Price, each... 55c  
J830 .00025 Mfd. Correct for Myers Tubes.  
J832 .001 Mfd. For special circuits.  
J834 .00025 Mfd. For U. V. 201 and Cun. 301.  
J836 .0005 Mfd. For U. V. 200 and Cun. 300.

Mountings. Bakelite base. Spring clip contact.

J840 Single mounting. Each... 38c  
J842 Double mounting. Each... 57c  
J844 Triple mounting. Each... 78c

### INDUCTANCE "HONEY COMB" COILS

Carefully made—fine looking coils. Highest efficiency. Low distributed capacity effect, low resistance—high self inductance. Very firm enamel impregnation. Range given is in meters when varied with .001 variable condenser.

Mounted coils have standard plug mountings.

Turns	Range	Art. No.	Price
25	120-250	J301	\$9.38
35	175-450	J302	.42
50	240-720	J303	.49
75	390-910	J304	.54
100	500-1450	J305	.58
150	600-2000	J306	.63
200	800-2500	J307	.72
250	1200-3500	J308	.72
300	1500-4500	J309	.82
400	2000-5000	J310	.97
500	2800-6100	J311	1.12
600	4000-10000	J312	1.27
750	5000-12000	J313	1.43
1000	7000-15000	J314	1.70
1250	9750-19500	J315	1.92
1500	14500-26500	J316	2.18

### COIL MOUNTINGS

J340 Three coil mounting... \$2.95  
High grade fine looking mountings. Polished black composition. Center receptacle stationary, two outer ones adjusted by knobs. Takes any standard mounted coil.

### COIL PLUGS

Made of moulded bakelite. Fits any standard plug. Mounts any standard honeycomb coil.  
J344 Each... 50c

### RADIO FREQUENCY AMPLIFYING TRANSFORMER

J995 Each... \$4.50  
This transformer will get the long distance stations loud and clear. Permits of easy sharp tuning. Helps cut out static and interference. Makes your set sensitive enough to use a set loop aerial. Enclosed in metal case affording perfect shielding. Suitable for panel or base mounting. Because of its special design can be mounted in tube. Wave ranges 150 to 550 meters. Wiring diagrams included.

### OUR SPECIAL AUDIO FREQUENCY AMPLIFYING TRANSFORMERS

We believe these transformers to be the best on the market. We offer them with two winding ratios—the 10 to 1 for Radiotrons and Cunningham—the 3 to 1 for A. P. Models. These two types of tubes have entirely different characteristics and therefore require transformers of different winding ratios. As high as three proper impedance ratio, minimum distributed capacity, low core losses and proper insulation. Mounted style has bakelite panel with binding post connections. Unmounted has core and coils assembled with two holes in tube for fastening to apparatus.

J231 10 to 1 Mounted. Each... \$3.95  
J235 10 to 1 Unmounted. Each... 3.20  
J238 3 to 1 Mounted. Each... 3.90  
J237 3 to 1 Unmounted. Each... 3.10

### THORDARSON AUDIO FREQUENCY AMPLIFYING TRANSFORMER

An especially high grade transformer with correct characteristics for Cunningham, Radiotron or A. P. Tubes. Wonderful results without distortion on one, two or three steps. Low distributed capacity. Fully mounted bakelite panel.  
J232 Each... \$4.00

### RADIO CORPORATION TRANSFORMERS

Audio Frequency Amplifying Transformer. Especially designed for Radiotron tubes. 9 to 10 winding ratio.  
J172 Each... \$7.00

### RADIO FREQUENCY AMPLIFYING TRANSFORMER

Range 200 to 5000 meters. For long distance reception.  
J174 Each... \$6.50

### OUR COMPETITOR AUDIO FREQUENCY AMPLIFYING TRANSFORMERS

While these are very low priced transformers, never the less they will give excellent results. They are carefully designed and carefully made. Quantity production and small profits make the low price possible. Will equal in results many transformers selling at much higher prices.

J238 Unmounted, with wire leads... \$2.00  
J239 Mounted, with binding post connections... \$2.76

### BARAWIK SPECIAL PANEL MOUNTING VARIABLE CONDENSERS

J812—43 plate .001 Mfd. \$2.95  
J813—21 plate .0005 Mfd. 2.55  
J814—11 plate .0025 Mfd. 2.15  
J815—3 plate Vernier. 1.48

These are especially high grade condensers and we guarantee them to be mechanically and electrically perfect. Fine polished end plates of high dielectric and great mechanical strength. Sturdy aluminum alloy plates perfectly spaced to insure smooth, even reliable capacity. Our low prices save you money. These condensers are of the very best make and are not to be compared with many inferior cheap condensers offered. We guarantee them to please you or your money back.

### COMBINATION VERNIER VARIABLE CONDENSERS

J824—23 plate .0005 Mfd. \$4.30  
J826—43 plate .001 Mfd. \$4.95

The latest improvement in condensers consists of regular variable condenser controlled by large knob and dial. Separate small knob mounted above dial controls a three plate vernier condenser. This arrangement permits of very fine tuning. High grade design and construction. Finely finished. Suitable for table or panel mounting.

### ENCLOSED VARIABLE CONDENSER

One of the best made condensers. Rigid, accurately spaced aluminum plates. Formica ends. Engraved scale. Knob and pointer. Clear transparent case.  
J808—43 plate .001 Mfd. \$3.94  
J809—21 plate .0005 Mfd. \$3.25

### KNOCKED DOWN VARIABLE CONDENSERS

You can save money by assembling your own condensers. Formica top and base. Complete with all parts not assembled. Go together easily and perfectly. Panel mounting type.  
J820—41 Plate .001 Mfd. \$2.48  
J821—21 Plate .0005 Mfd. 1.88



# RADIO GOODS—BEST QUALITY—REDUCED PRICES



**ARLINGTON RECEIVING TRANSFORMER**  
Will tune in all stations up to 3,500 meters. Very efficient on short waves and for radio-telephone reception. Used with our Detector Two Step Amplifier it produces very excellent results. Also does good work with crystal detector. Silk covered windings on formica tubes. Very fine mahogany finish wood work. Base size 6x18 inches. Slider controls primary. 12 point switch on secondary. Can be tuned very close. A wonderful value at our price. J720 Price... \$8.95



**TUNING COIL**  
Range up to 850 meters. Wound with bare copper wire, machine spaced. Ends of mahogany finished hard wood. Two easy binding contacts on polished brass rods, four binding posts. Substantial, efficient, attractive. Length 8 3/4 in. J722 Price... \$2.45



**VARIOMETER**  
J110—Completely assembled, price \$2.97  
J111 Not assembled but all parts complete, including winding form, \$1.90  
Perfect in design and construction. Accurate work forms. Correct inductive ratios. Solid baked windings. Have contacts. Highest efficiency.



**VARIO-COUPLER**  
With this loose coupler and two variometers, together with the necessary other parts, a highly efficient tuning set can be made. Easily mounted on panel. Primary winding on formica tube. Inductively coupled for 130 to 600 meters. Multiple taps permit fine tuning. J415 Price, completely assembled, \$2.95  
J418 Not assembled but all parts complete. Price \$1.35  
J417 Rotor ball only. Each 29c

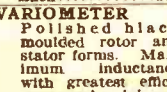

**MOULDED VARIOMETER**  
Polished black moulded rotor and stator forms. Maximum inductance with greatest efficiency and minimum distributed capacity. A high grade durable instrument that will make up into a set you will be proud of. Results. Wave length 180 to 600 meters. 3/4" square. 1 1/4" thick. Shaft threaded 8-32. J412 Price... \$4.35  
J413 Brackets for panel mounting, pair 29c  
J412-3" Dial and knob to fit. 65c



**MOULDED VARIO-COUPLER**  
This coupler is designed to work with the above variometer. The stator and rotor forms are of polished black moulded composition. Primary has seven taps to enable finest tuning. Wave length range 180 to 650 meters. Fitted with panel mounting bracket. Shaft threaded 8-32. J410 Price... \$4.25  
J410 Moulded dial with 90° scale to fit. 65c



**180° VARIO-COUPLER**  
J418 Price... \$3.90  
The most efficient type of coupler. Insures sharper tuning and louder signals. Primary and secondary wound on genuine bakelite tubes. Secondary connections through soldered flexible cables eliminates contact noises. Primary has 7 taps. Can be panel or table mounted. Range 180 to 650 meters.



**BRASS ROD**  
Supplied only in 12 inch lengths.  
J981 Threaded 6-32, per length... 8c  
J982 Threaded 8-32, per length... 10c  
J985 Solid 3-16 inch, per length... 10c  
J987 Solid 1/2 inch, per length... 12c

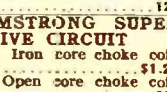

**SPAGHETTI**  
For covering connecting wires in sets. For size 12 and 14 wires.  
J985 Finest quality braided and saturated with best baked lacustrous transparent insulating varnish. 3 feet for... 25c  
J986 Best quality braid and covered with good grade insulating compound. 3 feet for... 12c

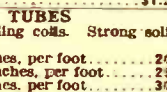

**PARTS FOR ARMSTRONG SUPER REGENERATIVE CIRCUIT**  
J335 100 Millihenrie Iron core choke coil. Each... \$1.20  
J354 10 Millihenrie Open core choke coil. Each... 8c  
J357 12,000 ohm Non-Inductive wire wound resistance. Each... \$1.58  
J358 12,000 ohm Moulded resistance. Each... 45c  
J358 5 Millihenrie Open core choke coil. Each... 9c  
J359 1 Henrie Iron core, choke coil. Each... \$1.20



**FIBER TUBES**  
Fiber tubes for winding coils. Strong solid material.  
J950 Diameter 3 inches, per foot... 27c  
J951 Diameter 3 1/4 inches, per foot... 25c  
J952 Diameter 4 inches, per foot... 30c

**EVERYTHING FOR THE COMPLETE SET**  
PRESERVE THESE PAGES  
ORDER FROM THEM AND SAVE MONEY  
FAST SERVICE—TRY US AND BE CONVINCED  
THE PRICES QUOTED DELIVER THE GOODS TO YOUR DOOR



**BARAWIK QUALITY HEADSETS**  
These headsets have proven on rigid tests to be one of the very best on the market. The tone quality is excellent with an unusual volume. Skilled workmen make them from only the best selected materials. The receiver cases are brass in fine polished nickel finish. Polished black ear pieces. Fabric covered head band comfortably and quickly fitted to the head. Supplied with 5-foot cord. These sets were designed to sell for \$5.00 and \$9.00 each and at our price are a wonderful bargain. We guarantee that you will be pleased with them and agree that they are the best value by far yet offered. If they don't suit you we will cheerfully return your money.  
J770—2000 ohm... \$4.00 J772—3000 ohm... \$5.00

**OTHER STANDARD BRAND HEADSETS**

J751	Murdock 56, 2000 ohm	\$4.45
J752	Murdock 56, 3000 ohm	5.40
J764	Frost, 2000 ohm	4.45
J768	Frost, 3000 ohm	5.40
J758	Red Head, 3000 ohm	5.85
J758	Western Electric, 2200 ohm	10.80
J754	Baldwin Type C with universal jack	

plug \$16.00  
J755 Baldwin Type C unit with attaching cord... \$7.75  
J768 Brandes, 2000 ohm... 7.20  
J769 Holzer-Cahot, 2200 ohm... 7.20  
J770 Kelllogg, 2400 ohm... 9.75



**ENCLOSED DETECTOR**  
One of the finest crystal detectors on the market. Supersensitive galena crystal enclosed in heavy glass shield. Quick, positive adjustment. Brass parts polished nickel finish. J730 Each... \$1.48



**GALENA DETECTOR**  
Easy fine adjustment. Crystal mounted in cup. Moulded base and knob. Brass parts polished nickel finish. J732 Each... 85c

**DETECTOR CRYSTALS CAREFULLY TESTED**

J738	Galena, Arlington tested, per piece	18c
J738	Silicon, Arlington tested, per piece	18c
J735	Buzzer tested, Galena, per piece	12c
J737	Buzzer tested, Silicon, per piece	12c



**DETECTOR PARTS**  
J725 Price set. 32c  
All metal parts for crystal detector. No base included. Easily assembled. Polished nickel finish.  
J727 Detector Crystal Cup. Each... 6c  
J728 Cat Whisker Wire. 5 feet for... 5c



**BAKELITE DIAL AND KNOB**  
Neat, clean cut design. Clear, plain engraved scale, with enameled white letters contrasting with polished black finish of dial. Fluted knob. Diameter three inches.  
J902—For 3-16 inch shaft. Each 89c Dozen \$7.20  
J903—For 1/2 inch shaft. Each 89c Dozen \$7.20

Same design Dial and Knob but made of polished black composition. Looks just as well as the bakelite when new but does not retain finish as well and is more fragile.  
J908—Three inch 3-16" shaft... Each 30c  
J909—Three inch 1/2" shaft... Dozen \$3.00



**ONE PIECE DIAL AND KNOB**  
A fine looking knob and dial moulded in one piece. Neat clean cut design. Polished black finish. Clear plain engraved scale with numbers and lines in contrasting white enamel. Ribbed knob that fits the hand. The three sizes used on the same panel can be arranged to produce a very attractive effect. Three and four inch sizes are marked 0 to 100 over 180° of the scale. 2 1/4 inch size is marked 0 to 3 over 270° of scale.  
J900—2 1/4 in. Diam. for 3-16 in. shaft. Each 45c  
J901—2 1/4 in. Diam. for 1/2 in. shaft. Each 45c  
J904—3 in. Diam. for 3-16 in. shaft. Each 45c  
J905—3 in. Diam. for 1/2 in. shaft. Each 45c  
J906—4 in. Diam. for 3-16 in. shaft. Each 75c  
J907—4 in. Diam. for 1/2 in. shaft. Each 75c



**ELECTRIC SOLDERING IRON**  
J987 Price... \$5.75  
Especially adapted to radio work. Will enable you to do neat clean work quickly. Simply attach to any light socket 100-120 volts. Complete with six foot cord and attaching plug. Renewable solder point. Will last a lifetime for ordinary home or light shop work. A wonderful value at the price.



**ROSIN CORE SOLDER**  
J958 Per Coil... 22c  
Self fluxing. Especially designed for soldering electrical connections. Fine for use with above electric iron. Coil will last a long time.



**TINOL**  
J959 Per tube... 22c  
With this preparation you can solder your connections with the heat of a match. Works fast. Makes a perfect electrical and mechanical joint. Self fluxing.

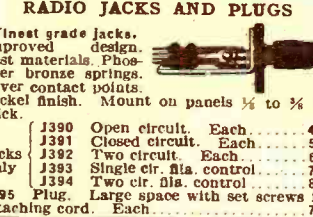

**RADIO JACKS AND PLUGS**  
Finest grade jacks. Improved design. Best materials. Phosphor bronze springs. Silver contact points. Nickel finish. Mount on panels 1/2 to 3/4 in. thick.  
J390 Open circuit. Each... 45c  
J391 Closed circuit. Each... 52c  
J392 Two circuit. Each... 83c  
J393 Single cir. dia. control... 70c  
J394 Two cir. dia. control... 85c  
J395 Plug. Large space with set screws for attaching cord. Each... 78c



**COMPETITOR JACK AND PLUG**  
Well made, durable, smooth working. Interchangeable with any standard Jacks and Plugs. Solder connections. Nickel finished metal parts. Fiber barrel on Plug.  
J388 Two Circuit Jack. Each... 48c  
J389 Standard Plug. Each... 48c



**STANDARD FLAT PLUG**  
J398 Each... 74c  
Black polished case with polished nickel insert. Fits any standard Jack. Quick solid connections.

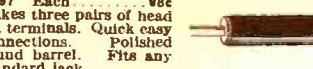

**THREE-WAY ROUND PLUG**  
J397 Each... 88c  
Takes three pairs of head set terminals. Quick easy connections. Polished round barrel. Fits any standard Jack.



**BINDING POSTS**  
Brass, polished nickel finish. Washer and 6-32" screw extending 1/2".  
J370 Large size—barrel and knob 1/2" long, dozen... 95c  
J372 Smaller size—barrel and knob 9-16" long, dozen... 84c  
J374 Large size with composition knob, dozen... 50c  
J376 Large size with hole for phone tip or wire, dozen... 95c  
J378 Small size with hole for phone tip or wire, dozen... 38c



**SWITCH CONTACT POINTS**  
Brass, polished nickel finish. All have 1/2" long size 6-32 screws. All prices the same.  
Dozen 20c Hundred \$1.40  
Order by Article Number.  
J369 Head, 3/4" Diam. 1/4" High  
J369 Head, 3/8" Diam. 1/4" High  
J363 Head, 3-16" Diam. 1-16" High  
Solder Lugs to Fit Contact Points  
J385 Dozen 12c—Hundred 60c



**SWITCH LEVERS**  
Moulded composition knob. Exposed metal parts polished nickel finish. Fitted with panel bushing, spring and two set nuts. A high grade switch.  
J380—1" Radius... Each  
J381—1 1/4" Radius... Each  
J382—1 1/2" Radius... 22c

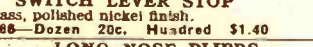

**SWITCH LEVER STOP**  
Brass, polished nickel finish.  
J386—Dozen 20c. Hundred \$1.40



**LONG NOSE PLIERS**  
J970 Price... \$1.25  
The handiest pliers for radio work. Made of fine hardened steel. Length 5 inches. Fine clean finish.

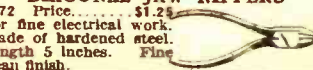

**DIAGONAL JAW NIPPERS**  
J972 Price... \$1.25  
For fine electrical work. Made of hardened steel. Length 5 inches. Fine clean finish.



**FOUR-IN-ONE SCREW DRIVER**  
J974 Each... 55c  
Especially suitable for radio work. Will handle any size screw used. Smaller drivers nest inside larger one and are held in place with screw cap. Made of steel, nickel finished.



**CABINETS**  
Fine looking cabinets solidly built. Made of genuine solid mahogany in elegant hand rubbed finish. You will be proud of your set mounted in one of these cabinets. Hinged tops. Front rabbeted to take panels. Panels not included. Prices are transportation paid.

Panel Size	inside Dimensions			Art. No.	Price Each
	High	Wide	Deep		
6x 7 1/2"	5 1/4"	6 1/2"	7"	J420	\$2.48
6x10 1/2"	5 1/4"	10"	7"	J422	2.75
6x14"	5 1/4"	13 1/2"	7"	J424	3.30
7x14"	6 1/2"	13 1/2"	7"	J423	3.60
7x18"	6 1/2"	17 1/2"	7"	J426	3.90
8x21"	5 1/2"	20 1/2"	7"	J425	3.90
9x14"	8 1/2"	13 1/2"	10"	J428	3.70
12x14"	11 1/2"	20 1/2"	10"	J430	4.40
12x21"	11 1/2"	20 1/2"	10"	J432	5.25

**SOLID GENUINE CONDENSER CELORON PANELS**  
Notice our very low prices on this fine quality grade 10 genuine solid sheet Condensers Celoron (a product with mechanical, chemical and electrical properties like formica and bakelite). Machines well without chipping. Won't warp. Waterproof. Highest mechanical and dielectric strength. Attractive natural polished. Black finish which can be sanded and oiled for extra fine work.

Panel Size inches	1/2" thick		3-16" thick		1/4" thick	
	Art. No.	Price	Art. No.	Price	Art. No.	Price
6x 7	J450	\$0.50	J460	\$0.75	J470	\$0.98
6x10 1/2"	J451	.75	J461	1.15	J470	1.47
6x14	J452	1.05	J462	1.55	J472	2.05
7x14	J458	1.20	J468	2.65	J478	2.40
7x18	J453	1.55	J463	2.30	J473	3.10
7x21	J457	1.75	J467	2.85	J477	3.60
9x14	J454	1.80	J464	2.30	J474	3.10
12x14	J455	2.10	J465	3.15	J475	4.15
12x21	J456	3.15	J466	4.65	J476	6.20

**TRANSFER PANEL MARKERS**  
J501 Per set... 27c  
A complete set of decalcomania transfer markers that can be quickly and easily applied to any part of any panel to mark binding posts, dials, knobs, etc. Very attractively lettered words on neat gold background. Following captions included:  
Aerial  
Pri. Condenser  
Sec. Condenser  
Grid  
Primary  
Secondary  
Plate Var.  
Grid Var.  
Coupling Detector  
1st Step  
2nd Step  
3rd Step  
Input  
Output  
Phones  
B Battery  
Landing coil  
On... Off  
(3) Increase  
Series (2) + G  
A G  
A Battery  
Phones  
TICKLER

**ETCHED METAL NAME PLATES**  
Made of brass. Silver plated characters and border on black background. All plates are 1 inch long and 3/4 inch wide, except "INCREASE CURRENT" which are quarter circle 1 1/2 inch over all, and "ON" "OFF" which are 3/4 inch long. Attaching holes pierced.  
J503 Per Dozen... 35c  
Not less than one dozen assorted sold. Specify marking wanted as follows:  
Plate Variometer  
Grid Variometer  
Vacuum Tube  
Primary Condenser  
Secondary Condenser  
Increase Current  
Increase Current (to right)  
Increase Current (to left)  
Secondary Aerial  
Ground  
Phones  
TICKLER  
Load'g Coil  
Coupling  
Output  
Parallel  
On  
Off  
Detector  
1st Step  
A Battery  
2nd Step  
B Battery  
3rd Step

**PHONES**  
Insulated copper wire. Best quality even drawn wire, one piece to a spool. Prices quoted are for 8 oz. spools.  
Double Cotton Covered Insulation  
Enameled Insulation  
Number 1990  
Number 1992

Gauge	Price	Gauge	Price
18	50c	20	45c
20	80c	22	55c
22	75c	24	61c
24	85c	26	85c
26	95c	30	76c
28	\$1.15	32	76c
30	1.65	36	90c

**MAGNET WIRE**  
Insulated copper wire. Best quality even drawn wire, one piece to a spool. Prices quoted are for 8 oz. spools.  
Double Cotton Covered Insulation  
Enameled Insulation  
Number 1990  
Number 1992

Gauge	Price	Gauge	Price
18	50c	20	45c
20	80c	22	55c
22	75c	24	61c
24	85c	26	85c
26	95c	30	76c
28	\$1.15	32	76c
30	1.65	36	90c

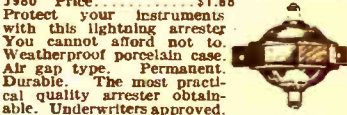

**OUTDOOR LIGHTNING ARRESTER**  
J980 Price... \$1.85  
Protect your instruments with this lightning arrester. You cannot afford not to. Weatherproof porcelain case. Air gap type. Permanent. Durable. The most practical quality arrester obtainable. Underwriters approved.



**ANTENNA INSULATORS**  
J260 Six 1x3 1/2... 19c  
J262 Size 2 1/4x3 1/4... 58c  
Two for... 58c  
J264 Size 1 1/4 x 4... 80c  
Two for... 80c  
J266 Size 1 1/2x10 1/4... \$1.35  
Two for... \$1.35

**SOLID BARE COPPER WIRE**  
Solid bare copper wire for aerials, leads or wiring instruments.  
Solid Bare Copper Wire, size 14  
J240—100 ft. coil 45c J242—500 ft. coil \$2.15  
Solid Bare Copper Wire, size 12  
J244—100 ft. coil 61c J248—500 ft. coil \$2.75

**STRANDED ANTENNA WIRE**  
Cabled of fine copper strands. Very flexible. High tensile strength. Best for aerials.  
J246—100 ft. coil 65c J249—500 ft. coil \$2.95



# Two New Ones Your Choice **25c** Postpaid for the Amateur

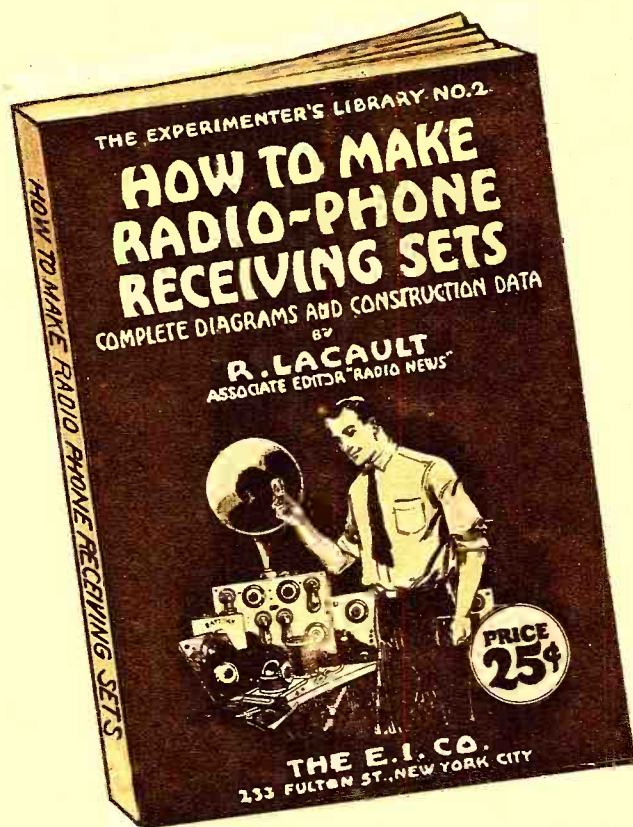

## HOW TO MAKE A RADIO-PHONE RECEIVING SET

By

**ROBERT E. LACAULL**

Associate Editor RADIO NEWS

A NON-TECHNICAL book for the beginner. Gives complete constructional data on the building of a complete Crystal Detector Set, Tuning Coil, Loose Coupler and a Single Audion Tube Set with Amplifying Units. It furnishes all dimensions and working drawings of every part that must be constructed by the amateur. Written in plain, simple language that anyone can understand. The opening chapter gives a complete description of the theory of radio and tells what it's all about, teaching the principles of wireless so that the constructor knows what he is doing.

48 Pages, 26 Illustrations

Bound in Beautiful Two-Color Cover

Size, 5½ x 7½ inches

Prepaid, 25 Cents

## RADIO FREQUENCY AMPLIFIERS

AND HOW TO MAKE THEM

By

**JOHN M. AVERY**

THIS book is for the more advanced amateur, showing the construction of the Radio Frequency Amplifying Transformer and giving complete constructional data. It shows the application of Radio Frequency to amplifying units that the amateur may already possess and gives 15 hook-ups showing practically every use Radio Frequency Amplifying Transformers can be put to.

32 Pages, 15 Illustrations

Bound in Beautiful Two-Color Cover

Size, 5½ x 7½ inches

Prepaid, 25 Cents

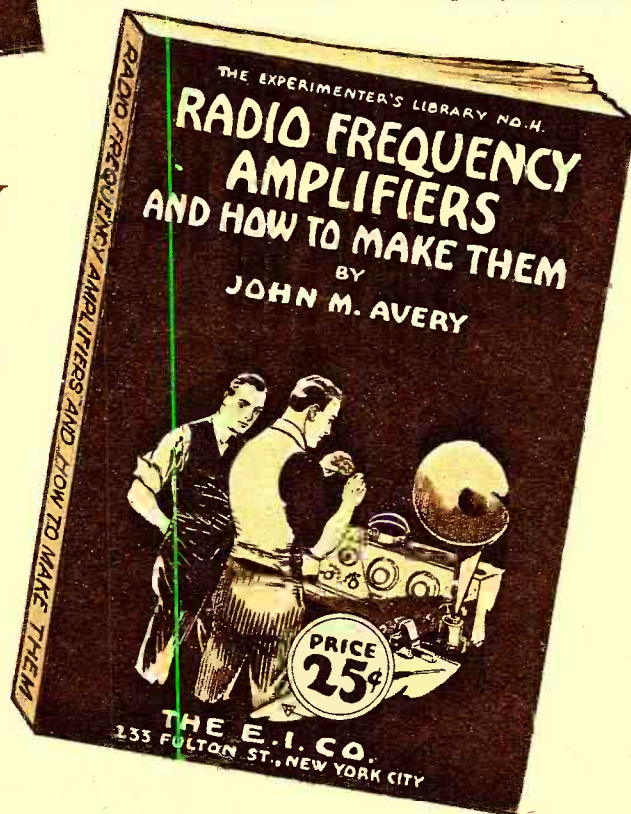

**THE E. I. COMPANY** 233 FULTON STREET  
NEW YORK CITY, N.Y.



(Continued from page 708)

After squaring it up and allowing it to dry thoroughly, scrape the tinfoil away from all the holes so that the shafts and connections will not short. If you wish, and it would be a good idea, get a sheet of cambric (empire) insulating cloth, cut it to the same dimensions as the tinfoil and shellac it over the foil. This will eliminate the crude appearance of the tinfoil and lessen the danger of shortage. Cambric sheeting is rather difficult to obtain, although it is a very handy article to have about the station.

**ASSEMBLING**

Mounting the apparatus is the next consideration. The variable condensers should be securely attached to the panel, using flat-headed nicked screws, which are generally supplied with each instrument. The smaller condenser of twenty-three plates occupies the center space, with the two forty-three plate condensers at either side. The vacuum tube socket is mounted in a novel manner; the bakelite end piece of the twenty-three plate condenser serves as a special sub panel. It will be necessary to drill two holes in this end plate, to which the socket is firmly held with two machine screws. The filament switch is the ordinary single-gang switch. It will be found useful as it saves wear on the filament rheostat. It is better also, as it allows the filament to light instantly, thereby prolonging its life. This switch is located at the top, center, the audio prep hole being directly below. If a large sized drill is not available, the hole for the switch should be made by drilling a ring of small holes and knocking out the center.

The sub panel is mounted flush up against the main panel near the top. Cut two pieces of hard wood two inches long by one-half inch square and fasten them to each edge of the sub panel with machine screws, using the two holes at either end as shown in Fig. 1. The sub panel, in turn, is held to the main panel by two flat-headed wood screws, nicked, one inch long. Finally, place the dials and knobs on the shafts. When the zero mark on the dial and the indicating mark on the panel are in line the movable elements of the condenser should be all the way out; i. e., the least value of capacity.

**WIRING**

The last step toward the completed instrument is the wiring. The terminals on the sub panel may be ordinary six thirty-second machine screws, or regular binding posts. There are twenty of them on this sub panel. Six are connected to the posts of the three condensers, six to the coil mounting, four to the vacuum tube socket and two each to switch and rheostat. Use No. 18 hard drawn copper wire for connecting the instruments to the sub panel. Run the wire in cambric tubing, keeping the leads as far as possible from the panel. Be very sure that these connections are good. Solder all of them and make a good mechanical connection besides. One loose connection will give an extraordinary amount of trouble. Make them as short as convenient. If the wire is run up against the panel, the tinfoil, being so close, will introduce objectionable capacity effects.

**SUPPORT**

The panel may be mounted by means of brass angle braces or set in a suitable sized cabinet. Whichever method is used some means of keeping out the dust should be provided. If a cabinet is used the leads from the aerial, ground and other exterior parts may be brought to the sub panel by drilling a few quarter-inch holes in the back near the top and bringing the leads in through them. This places all exterior connections out of sight. Room has been left on the panel for either angle brass or cabinet mounting.



If all the Manhattan Radio Headsets that have been manufactured and sold since the first one was produced on March 20th, 1922, were placed side by side, they would stretch in an unbroken line eleven miles long.

This means quantity production—and quantity production assures you of four things :

1. **Uniform Quality of Product.** Quantity production demands absolute uniform quality of raw materials. Only the very best materials are uniform in quality.

2. **Rigidly Tested Product.** Quantity production necessitates rigid tests at every stage of manufacture. Rejection of a finished headset is costly.

3. **A Correctly Designed Product.** The proper design of the Manhattan headset and the use of special tools, only possible in quantity production, enable us to add refinements and extra features at no increased manufacturing cost.

4. **A Quality Product at a Quantity Price.** Quantity production cuts labor costs. This enables us to offer Quality Headsets at Quantity Price.

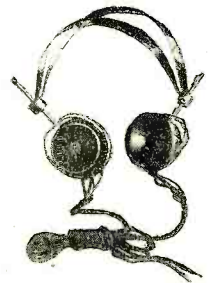

No. 2500, 2000 Ohms  
\$6.00

No. 2501, 3000 Ohms  
\$7.00

Manhattan Radio Headsets are on sale by all reliable radio dealers. If he hasn't them in stock he will get them for you.



NEW YORK  
17 Park Place

CHICAGO, ILL.  
114 So. Wells St.

ST. LOUIS, MO.  
1106 Pine St.

SAN FRANCISCO  
604 Mission St.



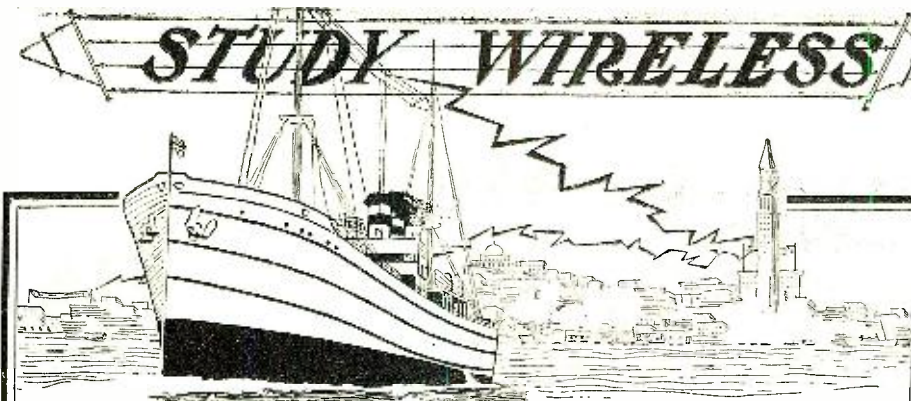

## Positions Guaranteed Our Graduates

For actual classroom use our equipment includes a

**U. S. NAVY  
STANDARD  
SHIPPING  
BOARD SET**

and 5 latest type complete commercial transmitters—the largest and best equipment of any school of this kind in New England.

ON ACCOUNT of the unequalled high standing our school has established in New England in qualifying men for First-Class Commercial License, we are able to place our graduates at once in good paying positions at sea, in land stations or in industrial Radio work.

This school not only holds a record for the number of graduates qualifying for the First-Class License, but has graduated and placed more men in positions in the last two years than any other Radio School in New England.

*Details of courses of instruction methods, faculty and equipment given in our new Catalog—sent free. Write for it today.*

Mr. Theodore J. McElroy, holder of the World's Championship in Radio Receiving, is a graduate of this school

**MASS. RADIO and TELEGRAPH SCHOOL**

18 BOYLSTON ST.,

COR. WASHINGTON ST.,

BOSTON

Oldest Radio School in New England—Estab. as Telegraphy School 1903

**TELMACO**

## TELMACOPHONE

*Why Is the Telmacophone the Greatest Value on the Market?*



Because it is the result of exhaustive tests and research, expert knowledge of acoustics, and the finest detail of construction.

Complete in every detail. Inverted horn. Reflected tone. Equal in volume to any other horn twice its length. No extras to buy. Nothing to get out of order.

The money you invest in a Telmacophone will give you the utmost in satisfaction. Insist on the best—the Telmacophone.

Price, Complete, \$20.00, Fully Guaranteed

RADIO DIVISION

**TELEPHONE MAINTENANCE CO.**

20 So. Wells St. Dept. B., Chicago, Illinois

DEALERS! We are distributors for many standard, reliable lines. Full discounts on the Telmacophone. Write for proposition on our complete line.

### SHORT WAVE COILS

The only parts actually home made are the coils for short wave reception. Four will be necessary for the band of wave lengths from 200 to 800 meters, using either single or double circuit. The forms may be made of stiff cardboard tubing, one inch wide and three to four inches in diameter. Give each a good coat of shellac and let them dry. If necessary, a few more coats may be applied to give them the necessary stiffness. Bakelite or micarta tubing will be better and make a nicer job. Near the edge of each coil drill a small hole, to which the wire is to be fastened. One coil is twenty turns, the others thirty, forty and sixty. Wind the wire on evenly and tightly. The twenty turn coil is wound with No. 20 double cotton covered, the thirty turn coil with No. 24 D. C. C., the forty turn one with No. 26 D. C. C., the sixty turn coil with No. 32 D. C. C. The wire may be given a very light coat of shellac or, better still, a coat of collodion, which may be purchased in the drug store. If neither shellac nor collodion is used, it will be necessary to band the coil at regular intervals with silk thread to prevent the wire from slipping off the form. The last method is to be preferred. Make each coil alike in the direction of winding and when mounting them on the coil plugs be sure that the connections are similar; i. e., that each coil is poled the same as every other. Attach the coils to plugs with some form of tough strap. If any of the cambric sheeting is left it will serve. Regular straps may be purchased or stiff glazed manila paper or sheet celluloid will answer the purpose. Solder the leads to the plug and make the strap firm so that the coil will stand some knocking about. For waves above 800 meters multilayer coils may be made with taps. Only a few will be necessary to cover the entire range.

### ACCESSORIES

It is very unworkmanlike to leave the coils scattered about the table and floor and not conducive to their long life to have them stepped on. Therefore a small but necessary accessory is a coil rack. This rack should be mounted on the wall in a convenient position. The simplest type of rack consists of a piece of wood a foot long, three inches wide and an inch thick. On a line one inch from the top drill a series of holes one and one-quarter inch apart. The holes should be just big enough to tightly hold the plug. Fig. 2 makes everything clear.

The storage battery has to be charged and the cheapest and best way is to do this at the owner's station. Fig. 3 gives the correct hook-up for charging with D. C. If only alternating current is available it will be necessary to buy a rectifier. The rectifier can be either mechanical or the Tungar type. Fig. 4 shows the proper connections. This switching method is fool proof and there will never be any danger of blowing the bulbs or burning the set. Use No. 14 rubber covered wire and the ordinary battery double pole, double throw switch.

The aerial for this set, if one is not already erected, should consist of a single wire from 75 to 150 feet in length. The lead should be taken off at one end and soldered. The lead-in wire may be the same as the aerial, No. 14 copper or copper-clad.

The phones are connected to a phone block, consisting of a piece of bakelite and a pair of binding posts, or two pairs, if more than one headset is to be used. The telephone block should be screwed to the left-hand side of the operating table. The cord will then be out of the way when tuning. The connections from the block to the sub panel can be made with bell wire.

### TUNING

Assuming that the set is complete, the aerial erected and the extras on hand—wire



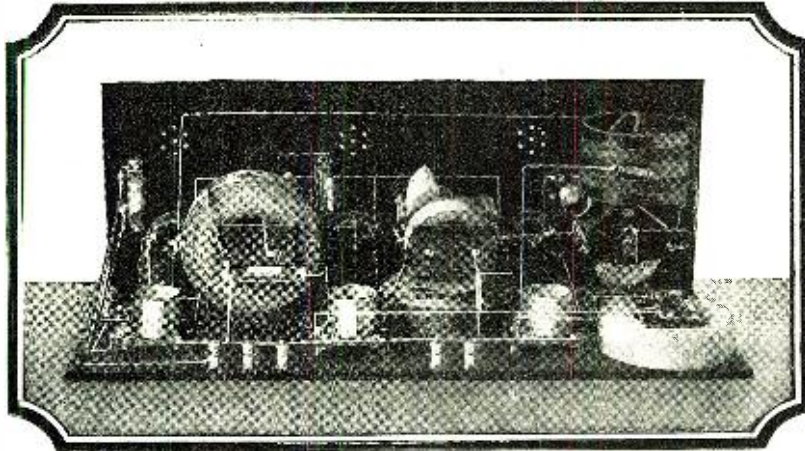

# Opening a *new and absorbing* field for radio exploration—

**T**HE Armstrong Super-regenerative Circuit opens a great new field for radio exploration and valuable experimentation. This circuit is sufficiently complicated beyond that of the ordinary hook-up to whet the appetite of the radio amateur. Experimentation has already shown this circuit to afford almost limitless possibilities for development by radio enthusiasts. Who knows but that you, yourself, may be the one to hit on the next great step forward!

Here is the way to start. The Sleeper Radio Corporation, makers of the many Sleeper Construction Sets, has just completed the successful development of a set embodying the super-regenerative circuit that can be built in the home workshop. By constructing this receiver yourself from the specially designed and selected parts you gain the fundamental knowledge necessary before commencing

your own experimentations. This set was designed by M. B. Sleeper, Editor of "Radio and Model Engineering" published by the Sleeper Radio Corporation. Included with the set are clear, concise specially-prepared instructions. You can build this Sleeper Construction Set for a fraction of the cost of a finished set.

The only tools you need are pliers, screw driver and soldering iron. The set includes a small loop antenna to replace the cumbersome outdoor aerial—just one example of its many advanced features. This new Sleeper Construction Set is now on sale at most radio and electrical stores. If your dealer has not already been supplied send us his name and we shall be glad to supply you both with further interesting information. Ask also for complete catalog of Sleeper Radio Products. **THE SLEEPER RADIO CORPORATION, Dept. 9, 88 Park Place, New York City.**

## *Sleeper Radio Construction Set—Type 3,000*

PRICE \$59.65. The super-regenerative receiver. A construction set which promises to revolutionize short wave reception. Consists of special vario-coupler, completely assembled; special high resistance units, four concentrated inductances, three variable condensers, a vernier condenser, panels drilled and engraved and all necessary incidental parts. Packed complete with instructions in neat display box. *Ask your dealer.*

# SLEEPER

*Radio*

## CONSTRUCTION SETS



# Carter *TU-WAY* Radio Plug

PRICE

**\$1.50 EACH**

Special designed terminal permits TWO phone sets to be connected at the same time. Positive contact made with ALL types of tip cord terminals or wires.

CUT EXACT SIZE  
Insulation undercut.  
Tip properly shaped to engage all jacks.

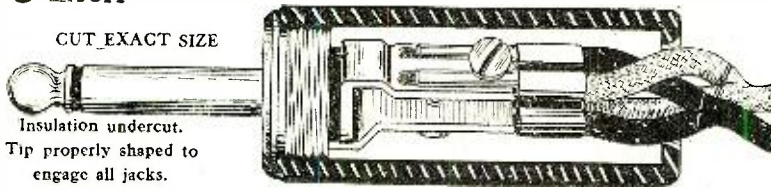

Black finish, non-breakable, round, one piece handle not affected by body capacity; no screws used to hold handle in place.

# Carter *HOLD-TITE* Radio Jack

CUT EXACT SIZE OF No. 105 AUTOMATIC FILAMENT CONTROL JACK

Wide tapered frame shaped to eliminate usual insulation stack-up between frame and springs.

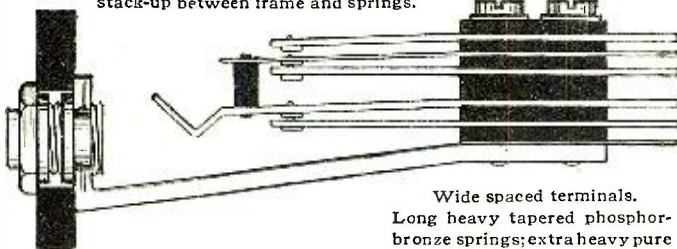

Wide spaced terminals.  
Long heavy tapered phosphor-bronze springs; extra heavy pure silver self-cleaning contacts.

The only jack which mounts on 1/8-in. to 1/4-in. panels without spacer washers or screws. Adjustable lock-nut feature prevents improper mounting.



THESE AND OTHER CARTER PRODUCTS SOLD BY THE BEST KNOWN ELECTRICAL AND RADIO JOBBERS

PRICE  
**\$1.10 EACH**

Other Combinations, 1 to 4 Springs,  
**70c to \$1.00 EACH**



Insist on Getting **THE BEST CRYSTALS ON THE MARKET**

**U. S. EAGLE GALENA, 25 Cents**

**U. S. EAGLE GOLDENA, 35 Cents**

**MOUNTED U. S. EAGLE GALENA AND GOLDENA, 2-in-1, 50 Cents**

Patent Applied

Each U. S. Eagle Crystal is Packed with the following guarantee

**GUARANTEE**

We guarantee that each U. S. EAGLE crystal is tested and sensitive. If any U. S. EAGLE crystal is not satisfactory, return this slip with your address, and the address of your dealer direct to us, and receive another crystal free of charge by return mail. The U. S. EAGLE trademark is your protection.

U. S. RADIO OF PENNA., Inc.  
Distributors of Domestic and Imported  
Radio Telegraph and Telephone Apparatus  
Cor. FERRY & DIAMOND STS., PITTSBURGH, PA.  
Name \_\_\_\_\_  
Address \_\_\_\_\_  
Dealer's Name \_\_\_\_\_  
Address \_\_\_\_\_

Attractive proposition for dealers and jobbers.

EVERYTHING IN RADIO SUPPLIES SEND 10 CENTS FOR CATALOGUE

**U. S. RADIO CO. of PENNA., Inc.**

Distributors and Manufacturers of Radio Apparatus  
Corner of Ferry and Diamond Streets  
Pittsburgh, Pa., U. S. A.

up the sub panel to the circuit of the usual three coil mounting in Fig. 5 and the set is ready for a trial. The sub panel terminals are connected with No. 18 copper run in cambric tubing. It is easy to remember to what instrument each pair of terminals is connected, but, to be sure, either engrave the sub panel, use the small name plates advertised in this magazine or make a drawing of the sub panel, label the terminals and paste the drawing on the inside of the hinged top. When the circuit in Fig. 5 is used, the left-hand coil socket is the primary, the stationary socket is the secondary and the right-hand socket is the tickler. The left-hand condenser is the primary, the center condenser is the variable grid condenser and the right-hand condenser is the secondary condenser. By this arrangement the controls most used are placed nearest the right hand. Insert a twenty turn coil in the primary socket, a thirty turn coil in the secondary and the sixty turn coil in the tickler socket.

Now insert the bulb, making sure that the prongs of the tube socket make positive contact with the studs. Turn the rheostat knob, decreasing resistance till the tube lights brightly, and some sign of life is heard in the phones. Bring the primary coil close to the secondary, place the tickler at a thirty degree angle to the secondary and place the variable grid condenser (center) at about one hundred degrees. Now move both primary and secondary condensers.

Let us suppose that a faint phone station is heard, move both primary and secondary condensers till the loudest signal is obtained. Light the bulb still brighter, but not enough to distort the voice. Vary the tickler coupling, and at the same time the secondary condenser, in order to keep the station in tune. Now, when the station is loudest decrease the primary coupling, and turn the primary condenser. Readjust the primary coupling. Only when the station is as loud as possible should the rheostat and grid condenser be touched. Move both till maximum response is had in the phones. You will see that the tickler and secondary condenser are used most and that is the reason why they are at the right-hand side of the panel. If spark stations are heard, proceed in the general manner indicated above, but conclude by varying the primary and tickler coupling and secondary condenser. If the receiver does not oscillate reverse the tickler leads. This circuit is typical of the ordinary receiver and after a little experience the knack of adjusting the controls will become second nature to the operator. It is not the purpose of this article to give a list and description of all the circuits which may be used on this receiver. Buy a good book on vacuum tube circuits and find the relative merits of each one by actual trial. A few may be found in this issue and back copies contain descriptions of nearly all of them. The newest of Armstrong circuits, or any other one which calls for more apparatus, will necessitate the construction of another panel the same height as the one described and equipped with a terminal sub panel also. Connections from one sub panel to another can be done neatly. Fixed condensers are introduced to the set by wiring them in at the sub panel. The grid leak can be drawn directly across the terminals on the sub panel. Equip the vacuum tube with fuses. Only after blowing out a few perfectly good tubes can the importance of this last statement be fully appreciated.

**CONCLUSION**

The cost of such a set is very low when the results are considered. Very little work is required, as there are no movable home-made parts to bother with. Calculating from prices advertised in a daily paper the set without extras should cost no more than \$25. The extras mount up to \$30 more, and if a rectifier is needed add \$15. So the set complete will cost either \$55 or \$70 at the most.





*"Comin' In Great!"*

# At Last! — High Efficiency Receivers at a Down-to-Earth Quick-Sale Price

**ELEVEN** years in the manufacture of delicate electrical units and apparatus—eleven years concentrated in the production of one line of equipment—all electrical, means something in accumulated experience and facilities.

That's the answer to how we have been able to place on the market this super-sensitive radio head set for \$6.00.

## **BASCO** RADIO Receivers "Hear" More and Cost Less

All the high-priced qualities—extreme sensitiveness, perfect balance, natural voice pitch, no scratching—are all Basco Receiver refinements. Light weight, aluminum case—solid horse shoe type magnet, no laminations—bus-bar connections, no loose, hairlike wires.

Light, extra sensitive diaphragm, set to thousandths-of-an-inch accuracy from magnet poles. Clean cut, rugged design throughout—easy on the head—comfortable on the ears and good to look at. Compare them with any other head set, irrespective of price—then you'll be convinced they're what you want, for quick turnover.

*Write for exceptional dealer proposition and list of Basco Radio Equipment*



**\$6.00**

Put up in attractive orange colored cartons

## Briggs & Stratton Co. **BASCO** PRODUCT Wisconsin Milwaukee

- 2000 Ohm \$6.00
- 3000 Ohm \$7.50

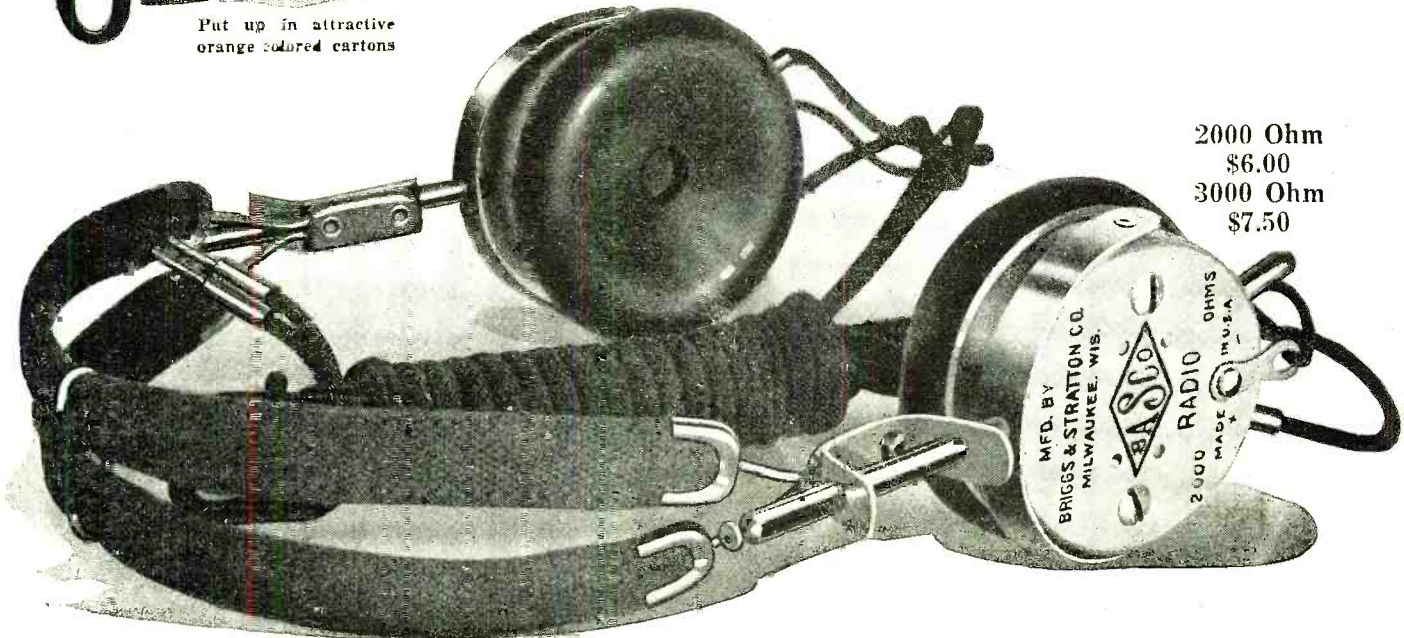



# ATWATER KENT

## 2-STAGE AMPLIFIER

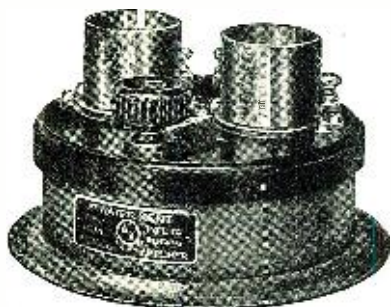

Price \$16<sup>00</sup>

THE LOW PRICE IS MADE POSSIBLE AS A RESULT OF  
20 YEARS' EXPERIENCE IN QUANTITY MANUFACTURE  
OF SCIENTIFIC ELECTRICAL INSTRUMENTS

*An Excellent Merchandising Proposition*

ATWATER KENT MANUFACTURING COMPANY  
4943 STENTON AVE. Radio Dept. PHILADELPHIA, PA.

THE OUTSTANDING

### *Advantages*

OF THIS INSTRUMENT are

- § Excellence of reproduction.
- § Amplification regulation by small steps.
- § A complete instrument in itself.
- § Compactness.
- § Regulation entirely by knob, no jacks to equip.
- § Transformers protected by steel housing.
- § Short wiring connections eliminate capacity effect.
- § Hermetically sealed, absolutely no moisture troubles.

This set will certainly give the utmost satisfaction if made fairly close to specifications. As an all-round receiver it is unexcelled and has the added advantage of containing many circuits in one set.

## That Short Wave Set

(Continued from page 648)

them very crude in construction, it seemed to be up to me to junk the old short wave set and build something new.

While planning the new set it occurred to me that all such sets differed from the conventional three-circuit tuner in having a direct inductive coupling between the plate and grid circuits. In other respects they varied widely and it was difficult to select the best arrangement. I never did decide which one to built but instead of simplifying my circuit, I complicated it.

It is hardly necessary to state that tone quality, selectivity and relief from static are attained to a greater degree with three-tuned circuits than with the simpler arrangements, and the addition of means for coupling the grid and plate circuits has proved to provide what the conventional three-circuit tuner lacks, stability and ease in tuning. Of course considerably more time is consumed in tuning the three-circuit set when first put in operation, but this has never been a serious matter if results could later be duplicated using the same adjustments for the same stations. This has been found possible with the set stabilized by direct feedback coupling, while in the ordinary three-circuit tuner adjustments for good phone reception vary from day to day.

The first means of coupling which was devised consisted in splitting up the plate variometer stator winding into two halves. One half was left in the plate circuit and the other connected in series with the secondary of the variocoupler and grid variometer. The operation of the set connected in this way proved that the coupling provided was a decided stabilizer—or, in other words, that the idea was good. Stations were tuned in with practically the same adjustments day after day; the set remained in operation without further adjustment for as long as desired, and the tone quality was equal to the best results obtained with the usual connections.

Two of the broadcasting stations regularly heard, however, and many familiar amateur C.W. stations could not be heard. These stations were all brought back by changing to the arrangement shown in the accompanying diagram, where a separate coupler is used for grid-plate coupling and the plate variometer left intact. The coupler used was made up on the common variocoupler forms with 30 turns of No. 22 cotton-covered wire on both stator and rotor. The stator is in the grid circuit and the rotor in series with the plate variometer. I consider the resulting set the last word in regenerative receivers, barring the refinements in design and manufacture that could well be introduced, and I believe others will find it so until they are able to bid Old Man Static farewell with a loop and R. F. amplifiers.

The coupler used in this set is 3 1/2" in diameter and the stator is 4" long, but it is obvious that slight changes in dimensions and winding will not affect the results obtained, as both circuits concerned are separately tuned.

### BROADCASTING LUNCH

One of the best ways to get Congress down to business is to start broadcasting the daily proceedings, including the three-hour intermission for lunch.

## The Ideal Tuner for Popular Broadcast Reception

AN INTIMATE and extensive experience with the conditions that make for real use and enjoyment of radio programs, has produced the new ABC Tuner No. 5750, as illustrated.

This inexpensive yet expert apparatus is constructed especially for receiving broadcasting sent out on 360 meter wavelength.

The ABC Tuner No. 5750 is compact, accurate, selective, and comes complete in beautiful kodak-finish cabinet making one more of the famous ABC Standardized Radio Sectional Receiving Units.

Write today for full information and price of No. 5750 and the other ABC Units illustrated—a complete receiving set at very moderate cost.

### Jewett Manufacturing Corp.

342 Madison Avenue (Dept. R) New York City



ABC Radio Tuner  
No. 5750

ABC Detector  
and One Step Amplifier  
No. 5013

ABC Two Step Amplifier  
No. 5014



ABC  
Loud-  
Speaker  
No. 5500



# When You Want Amplification Buy

## ALL AMERICAN TRANSFORMERS

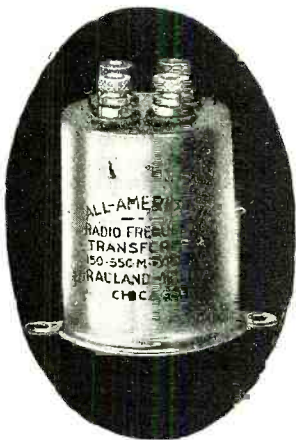

Radio Frequency  
Type R-10 \$4.50  
150 to 550 Meters

Your  
Local Dealer  
Has Them

Bulletin 22-B  
Containing Valuable  
Information on  
Amplification  
Sent on Request

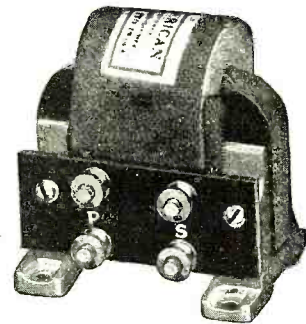

Audio Frequency  
Type R-2—ratio 3 to 1  
\$4.25  
Type R-3—ratio 10 to 1  
\$4.50

# RAULAND MFG. CO.

35 So. Dearborn St., Chicago, Ill.



## SATISFACTION!

**T**HE MOON LOUD SPEAKER was designed by an Acoustician, an artist and a hard-boiled Business Man. The Acoustician (student of sound) gave the MOON its beautiful, full round tone and freedom from tone distortion. The Artist contributed the splendid beauty of design and and quiet dignity which characterizes the MOON and the Business Man used his experience and common-sense to manufacture them at a price which puts the MOON within reach of the slimmest purse.

The MOON is made of heavy aluminum, highly polished and built to last a lifetime. The horn is seamless, spun like silver-ware all in one piece, 10½ inches in length. The complete instrument stands 15½ inches high. To own one solves the Radio Home Concert Problem.



**MOON**  
LOUD SPEAKER

## A Big, Pure, Clear, Round Tone!

### JOBBER'S PLEASE READ:

**L**OUD speakers cost too much! Manufacturers who made them "milked the market" last winter and spring. There was no excuse for it either. The result was that the public bought sparingly. What you want and what we want is turnover and volume. The MOON LOUD SPEAKER gets it! The discount is not as big as some, but the turn-over of your capital is multiplied many times.

### DEALERS PLEASE READ:

You've read our sentiments directed to the jobber. They apply twice as strong to you.

These MOON LOUD SPEAKERS make your window display look like a million dollars. Efficiency comes first naturally but beauty of line, design and finish is what attracts attention, creates interest and "puts over the sale."

See your local jobber first. If he hasn't them, write direct to us.

Only  
\$7.50

**Users, Attention:** We want you to buy from your local dealer. If he hasn't the MOON LOUD SPEAKER send us his name and we will see to it that you are taken care of.

**WILSON UTENSIL CO.**  
Dayton, Ohio

## The Construction of a LOOP

(Continued from page 653)

wooden parts a thorough coat of good varnish is necessary. Glue may be used for assembling the supports, hub and spreaders.

When the frame is dry and entirely finished, the wire should be wound on. Either No. 22 (the smallest allowable), No. 20, 18, or larger copper, copper clad or stranded wire should be used. As most dealers stock the even number sizes in copper wire there should be no difficulty in securing same. Fasten one end of the wire to a binding post on the bottom spreader and, with care, proceed to wind the ten turns on the frame. The wire must be stretched taut enough to prevent slack. A space is to be left at the center, as shown, for the revolving shaft.

While no stand is shown, it is desirable to use one. It should be made to match the frame and should be capable of a 360-degree rotary movement. An old flywheel from a sewing machine used as a control wheel and a large 360-degree dial will finish the unit.

Clips may be used to vary the inductance. In actual operation, the loop is connected to the grid and filament, or input terminals, of the detector with a 23-plate variable condenser shunted across it. A variometer may be used in the plate circuit for regeneration or three connections may be taken from the loop. One connection goes to the grid condenser, the central connection to the negative side of the "A" battery and the third tap to the negative side of the "B" battery, the positive side of the "B" battery going through the phones to the plate. Shunt a .001 M. F. condenser across the phones and "B" battery. The tap going to the "A" battery regulates regeneration. This loop will work well with one or two stages of radio-frequency amplification. It is to be recommended for use with the Armstrong super-regenerative circuit. Unsatisfactory results will be obtained if a crystal detector is used without amplification.

It is sometimes possible to increase the signal strength by connecting the ground to either the "A" battery or a section of the loop. If a high-powered spark station is located in the immediate vicinity, a good method which will greatly reduce, if not entirely eliminate interference, is to erect an aerial and tune it with a variable inductance connected to the ground to the wave-length of the interfering station. This will balance out the unwanted signals. The loop may then be tuned to any desired wave-length.

I am confident that anyone constructing this aerial will be well repaid for the small amount of time and energy expended.

## An Amplifier for Direct Current

(Continued from page 656)

*F*, *G*, and *P* are respectively the filaments, grids and plates of the tubes.  
*I* = First stage.

*K* = Second stage. For simplicity only one tube is shown in each stage, although several connected in parallel were used.

*B*<sub>1</sub> and *B*<sub>2</sub> = 8-volt batteries of sufficient capacity to supply the filaments connected to each battery. Each tube requires 2.3 amperes.

*B*<sub>3</sub> = Source of grid voltage of 22 to 110 volts, according to tubes used, capable of carrying about 40 milliamperes in a direction opposite to the voltage of this source.

*B*<sub>4</sub> = Source of plate voltage, 220 volts, capable of delivering 0.5 amperes.

## MIRACO Radio Frequency Broadcast Receiver

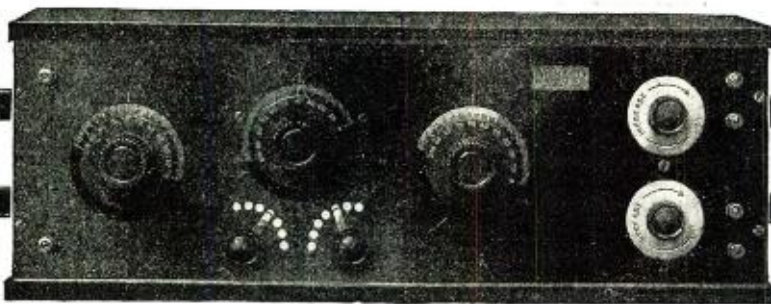

REPRESENTING THE LATEST DEVELOPMENT IN LONG DISTANCE RADIO RECEIVING SETS

Provides sharper tuning, with less controls, eliminates interference.

AMPLIFIES BEFORE IT DETECTS which makes it capable of bringing in concerts and signals from extremely long distances.

\$55.00 PREPAID—Less tubes, phones, and batteries.

DEALERS WRITE NOW

Send for literature descriptive of this and other "MIRACO" Products.

**MIDWEST RADIO CO.**

804 MAIN STREET,

CINCINNATI, OHIO





Scene from the Opera "Faust"

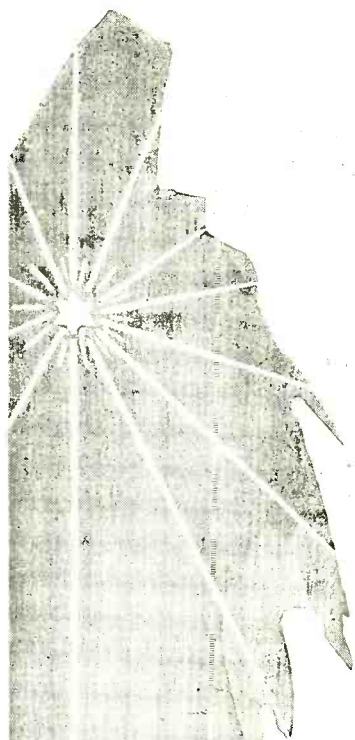

The New  
Star in  
the Radio  
World

*M*OMENTOUS events in the arts and sciences are the result of rising above out-worn principles, independent of the tools of mediocrity. Beginning where others have been content to finish, a forward-looking group of radio engineers, comprising the Mu-Rad Laboratories, have designed and successfully constructed radio apparatus which is as advanced as the twenty-one-jewel watch is over the key-winder. Prices of this apparatus insure that great numbers will benefit from their achievements. Descriptive literature upon request.



**MU-RAD**  
**LABORATORIES**  
INCORPORATED  
ASBURY PARK  
NEW JERSEY

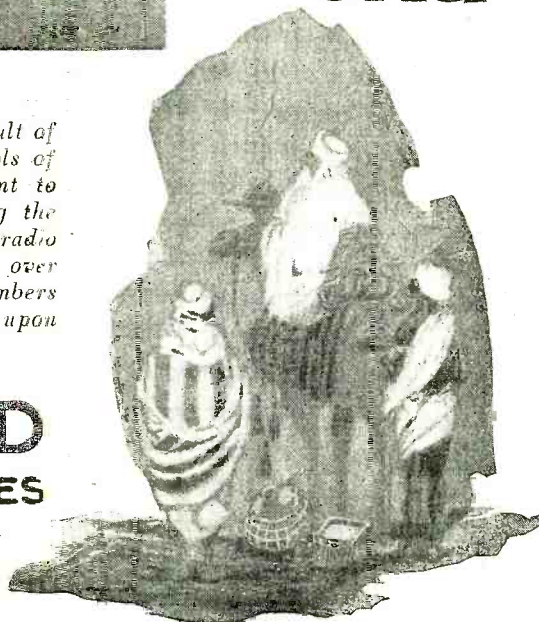



# Radio Music Perfectly Reproduced Through Your Phonograph

*Cleveland Dulce-Tone Junior.*

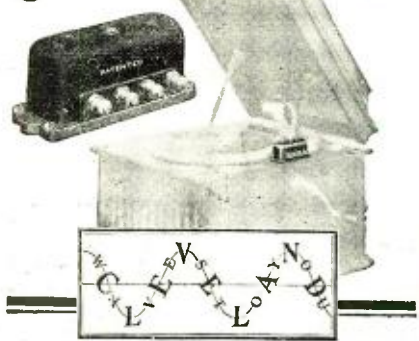

The Dulce-Tone Junior converts your phonograph into the finest of loud talkers without detracting in the least from its power to play phonograph records.

The radio music comes to you with cello-like sweetness, even more clearly than that reproduced from your records.

The Dulce-Tone Junior is adaptable to any phonographic instrument. When you consider that you are using the wonderful sound-box, tone-arm and even the needle which has been perfected only after years of experimenting, you can realize the QUALITY and SWEETNESS of the tone which is so faithfully reproduced through the Dulce-Tone Junior.

Any one can attach the Dulce-Tone Junior in a few minutes. To operate, simply swing the tone-arm, allowing the needle to rest on the small center element of the Dulce-Tone Junior. This ingenious instrument eliminates the necessity of numerous expensive head-phones when entertaining a roomful of people—is a true economy.

The Dulce-Tone Junior is the instrument of the century—an instrument that will improve any radio set. Put one on your phonograph today and realize the possibilities of radio music for quality of tone.

RETAIL PRICE ONLY . . . \$15.00 (\$17.50 West of the Rockies)

If your dealer does not handle the Dulce-Tone Junior, fill out the coupon below, mail it with one dollar, and we will forward this wonder instrument to you C. O. D. at \$14.00.

COUPON

THE CLEVELAND RADIO MFG. CO.  
234 St. Clair Avenue N. E., Cleveland, Ohio

Enclosed find one dollar for which send me a Dulce-Tone Junior (\$14.00 balance due C. O. D.) Send me your folder entitled "Waves to You Through Your Phonograph."

Name.....  
Address.....  
Town and State.....

**The Cleveland Radio Mfg. Co.**  
234 ST. CLAIR AVENUE, N. E. CLEVELAND, OHIO

SOLE LICENSEES UNDER KAEHNI CIRCUIT INVENTIONS AND PATENT APPLICATIONS

BEING AMONG THE

*First*

—to blaze the trail in the Radio business, the Phila. Wireless Sales Corp. is today recognized by the manufacturers and dealers as a leader.

Our entire personnel are practical Radio men, devoting their time to giving a "real service."

We handle only standard Radio Products showing merit.

Our approval stamps it a worthwhile product.



Trade Mark Registered

**PHILADELPHIA WIRELESS SALES CORPORATION**

Formerly Philadelphia School of Wireless Telegraphy

1533 PINE STREET

PHILADELPHIA, PA.

$B_1$  = 40-volt battery to supply 200 milliamperes.

$B_2$  = (circuit 2 only) 12-volt battery to supply 20 milliamperes.

$R_1$  = Input resistance of 1000 ohms. The sensitivity of the amplifier can be controlled completely by varying this resistance. Increasing the resistance increases the current amplification and reducing the resistance decreases the amplification.

$R_2$  = Coupling resistance of 10,000 ohms to 55,000 ohms, according to number of tubes used. Both  $R_1$  and  $R_2$  should have a current capacity of 30 milliamperes.

$R_3$  = Resistance which must be variable by small steps from 150 to 300 ohms, such as a slide wire rheostat. Current carrying capacity 200 milliamperes.

**TESTS**

With the two circuits shown in Fig. 1 adjusted to give the highest amplification, measurements were made of the output current for an input voltage of 10 volts positive and negative which corresponds to an input current of 10 milliamperes through the input resistance of 1000 ohms. The current amplification, that is, the ratio of the output to the input current, is obtained by dividing the measured output current by the 10 milliamperes input current.

**RESULTS**

The following table shows the amplification obtained with both circuits, using the tubes as indicated in the first three columns and also gives the values of coupling resistance and grid voltage ( $R_2$  and  $B_1$  respectively of Fig. 1) required for best operation in each case:

TABLE 1  
Circuit 1

Number of Tubes			$R_2$ Ohms	$B_1$ Volts	Output Current with 10 M. A. input	Current Amplification
Total No.	1st Stage	2nd Stage				
2 <sup>1</sup>	1	1	46 000	100	60	6
3 <sup>1</sup>	1	2	46 000	100	100	10
4	1	3	50 000	88	120	12
5	2	3	14 000	110	130	13
6	2	4	14 000	110	160	16

TABLE 1  
Circuit 2

Number of Tubes			$R_2$ Ohms	$B_1$ Volts	Output Current with 10 M. A. input	Current Amplification
Total No.	1st Stage	2nd Stage				
3 <sup>1</sup>	1	2	12 000	45	70	7
4 <sup>1</sup>	2	2	8 000	35	90	9
5	2	3	5 000	48	110	11
6	2	4	5 000	66	140	14

<sup>1</sup> Does not fulfill requirements

**DISCUSSION**

Table 1 shows that in order to fulfill the conditions that the input current of 10 to 20 milliamperes will be amplified to 110 to 200 milliamperes, the minimum number of tubes that can be used is four tubes in circuit 1 and five tubes in circuit 2. Circuit 1 should therefore be the more economical to use even though two separate filament batteries are required, because less tubes are required and the total current capacity of both batteries required to supply the filaments in circuit 1 is less than the capacity of the single battery required in circuit 2. Circuit 2 also requires an additional grid battery ( $B_2$ , Fig. 1) of 12 volts.

The difference in amplification of the two circuits is due to the manner of connecting the coupling resistance ( $R_2$ , Fig. 1). In circuit 1, the grid current of the second stage tubes acts as a regenerator, to increase the amplification for a given input current, while in circuit 2 the amplification is decreased by the grid current.





**Eveready "A" Batteries**  
 —hardwood box, mahogany finish  
 —convenient handle, nickel plated  
 —rubber feet protect the table  
 —insulated top prevents short circuits  
 —packed vent caps prevent spilling  
 No. 5860—90 Amp. Hrs.—45 Lbs.—\$18.00  
 No. 6880—110 Amp. Hrs.—52 Lbs.—\$20.00



**Eveready "B" Battery No. 766**  
 Equipped with 5 positive voltage taps ranging from 16½ to 22½ volts. Fahnestock Spring Clip Binding Posts—an exclusive Eveready feature. Price \$3.00

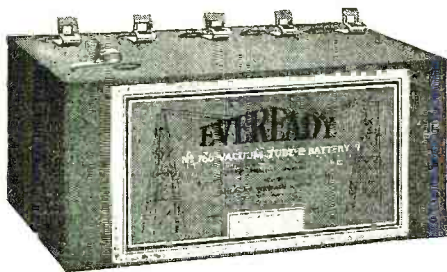

**Eveready "B" Battery No. 774**  
 Equipped with 6 positive voltage taps at 4½ volt intervals ranging from 18 to 43 volts. Fahnestock Spring Clip Binding Posts—an exclusive Eveready feature. Price \$4.00



**For Better  
 Results  
 USE**

**EVEREADY**  
**"A" and "B" BATTERIES**

*with your radio set*

For sale by the better radio supply dealers everywhere

Send today for descriptive booklets

**NATIONAL CARBON COMPANY, Inc., Long Island City, N. Y.**

Atlanta

Chicago

Cleveland

Kansas City

San Francisco



# Wimco Announces

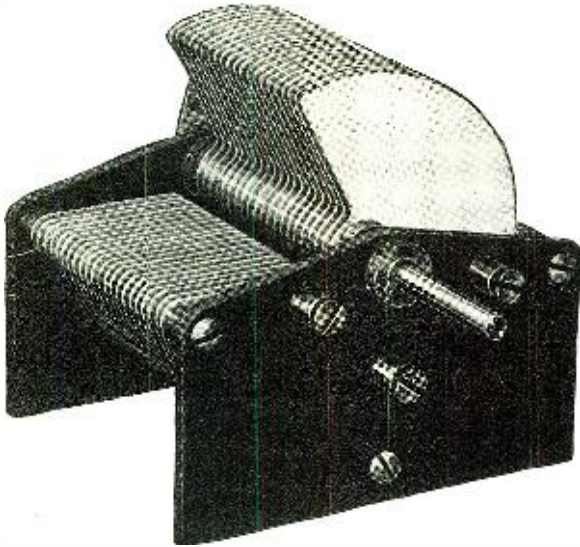

## THE WIMCO VARIABLE CONDENSER

After months of experimentation to produce a really good Variable Condenser, we take pleasure in introducing to the trade The Wimco Variable Condenser, which will be furnished in 43, 23, and 3 plate type. Tests Conducted by the Washington Radio Laboratories show that The Wimco Variable condenser of the 43 plate type has a resistance, at maximum capacity, of but .018 ohms, and the capacity at zero on the scale is but 15 micro-microfarads. These values we believe, are lower than in any other condenser manufactured for general amateur use.

Deliveries on The WIMCO Variable Condenser will begin September 15th and we are now accepting Jobbers' and Dealers' orders. We have a very attractive proposition for the Jobber, and solicit your inquiries.

**THE WIRELESS MANUFACTURING CO., MANUFACTURERS** Canton, Ohio  
**DISTRIBUTORS**

### ADJUSTMENTS

The necessary adjustments to put the amplifier in proper operating condition are:

(1) Filament Current: The filament current is adjusted by means of a series rheostat to 2.3 amperes per tube, or the filament voltage to 7.4 volts. With an 8-volt storage battery and low resistance leads no external resistance is necessary.

(2) Output Current: With no input current flowing, the resistance  $R_3$  of Fig. 1, is adjusted until the output current is reduced to zero. The amplifier is now ready for operation.

If changes occur in the plate voltage supply or a tube is replaced, it may be necessary to readjust  $R_3$  to reduce the output current to zero with zero input current.

### GENERAL

The plate supply ( $B_4$ , of Fig. 1) may be of any voltage between 200 and 250 volts. A 220-volt D. C. light or power line may be used provided that the voltage does not vary more than about 10 volts.

With a plate supply of less than 200 volts the amplification decreases rapidly, while voltages in excess of 250 overheat the tubes and make their operation unsteady.

The above tests were all made using UV-202 Radiotron 5-watt power tubes. Other tubes suitable for current amplification are Western Electric type E tubes. With these tubes somewhat less amplification was obtained, and not as steady operation because of heating.

### SUMMARY

Two resistance-coupled amplifier circuits were constructed to amplify both a direct and alternating current of 10 milliamperes to 110 to 200 milliamperes magnitude, and tests made to determine the amplification for best adjustments of the circuit constants.

*(Abstract from The Journal of the Optical Society of America)*

## Stahl Insulated SHORT PROOF Variable Condenser

Impossible to short circuit.

Every condenser given 1,000-volt breakdown test before leaving factory.

This is because we use non-conductor composition plates, with one surface of each plate electrically copper-plated.

Copper and non-conductor always face each other. Insulation is complete. Climate and weather conditions cannot affect it.

This enables us to use smaller plates, closer together, making the condenser more compact.

Furnished in all standard capacities with or without dial and knobs.



**PRICES WITHOUT DIAL OR KNOB**

11 Plates.....	\$4.50
23 Plates.....	\$4.75
45 Plates.....	\$5.00

Dealers, write for sample and discounts.

Manufacturers of Radio Sets are invited to arrange with us for the adoption of the Stahl Insulated Condenser as standard equipment.

WRITE FOR BULLETIN

## STAHL RECTIFIER CO.

1457 W. Congress St.

Chicago, Ill.

## A Radio Romance

*(Continued from page 623)*

young Professor Baldwin, who had a wife to support now, and he was reduced to the necessity of gaining a livelihood as best he might in a community where few dared befriend him. His credit at the grocery store had mysteriously been cancelled, and he was compelled to accept whatever employment he could find that he might earn money to live. He dug post holes and he cleaned flues—but he did not change his mind about what he regarded as his right to freedom of speech.

A position as operator of a hydro-electric plant, for which he was well qualified, was offered him at Mountain Lake, 20 miles in the mountains. He took the job, but his tenure was short.

A similar place was open with the Progress Co., a small concern with a powerhouse in Mill Creek canyon, 50 miles away, in the mountains adjacent to Salt Lake City. Into this secluded canyon Baldwin took his family, and there he perfected and patented his receiver.

With money he saved from his salary he purchased the lot where his rambling plant stands, and put up the first diminutive unit of his factory.

From that time onward his progress was marked by the experiences usual to the making and marketing of patented devices in competition with long-established articles. His receiver was a practical one, and certainly was more sensitive than those in

### Genuine GANAERITE Crystals

Individually Tone Tested.  
Most Sensitive Mineral Rectifier Developed.  
Mounted Crystals, Postpaid, 50c.  
Trade Discounts to Dealers and Clubs.  
Now Delivering Promptly on Large Orders.

**THE HARRIS LABORATORY**  
26 Cortlandt Street New York City.

## CONNECTICUT RADIO EQUIPMENT

Variable Condensers, Variometers,  
Head Phones, Etc.

**CONNECTICUT TEL. AND ELEC. CO.**  
MERIDEN, CONN.



# ERLA

# DEPENDABLE RADIO PRODUCTS

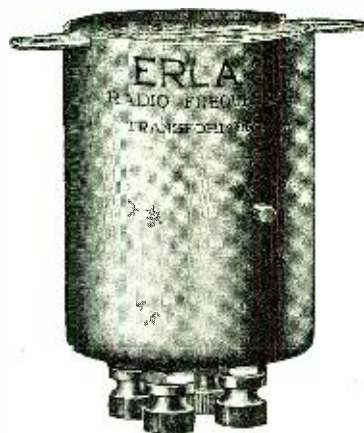

List Price } Type AB1 } \$6.00  
 Price } Type AB2 } each  
 Type AB3 }

## RADIO FREQUENCY TRANSFORMER

**T**HE superior efficiency of the ERLA radio frequency transformer is winning recognition everywhere. Experts who have tested it are unanimous in declaring that it gives results far surpassing their best previous experience.

It is the first transformer successfully to overcome the high capacitance effects of domestic vacuum tubes. Likewise, the capacitance effect of the transformer itself has been reduced to a degree heretofore unattained, enabling its successful application to as many as three stages of ampli-

fication, with a uniform and high step-up ratio between each stage.

The addition of even one stage of ERLA radio frequency will work an amazing improvement. Range and tone volume are greatly increased; tone quality and definition much improved, with a minimum of interference, tube noises and other disturbances.

Even though you are now using other transformers, it will pay you to install the ERLA. Diagrams of circuits using one or more stages of ERLA radio frequency are available on request.

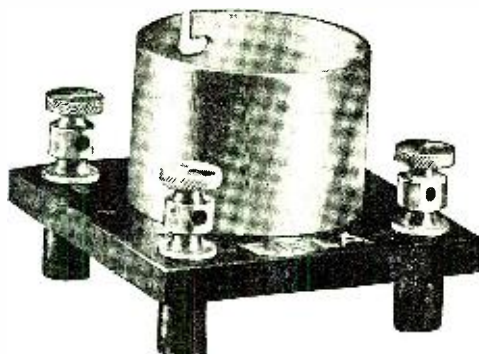

List Price: \$1.00 each

### V. T. SOCKETS

The strongest and most beautifully finished socket on the market. Heavily nickeled brass shell on polished Radion base. Insulated hard rubber feet. Special binding posts for quick wiring. Rugged contact springs will not arc under filament current of five-watt transmitting tubes. Fits any American four-prong tube. Greatly improves the appearance of any set.

### BEZELS

Beautifully made of heavily nickeled brass, these screened bezels will add 100% to the neatness and attractiveness of any receiving set. Telescoping rim gives perfect fit of 1 1/2" hole in any 1/8" to 1/4" panel. Screen provides full view of tube filament, at the same time furnishing ample ventilation. No well made receiving set should be without this latest improvement.

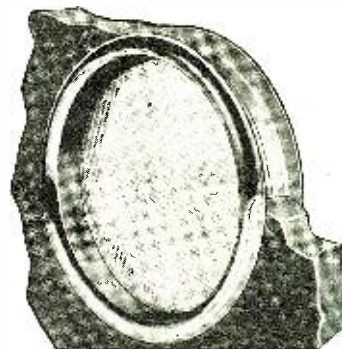

List Price: 20c each

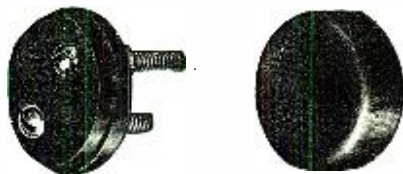

### ERLA GRID LEAK

Built to ERLA quality standards. Hard fibre base; brass cap with durable hard rubber finish. Screws and nuts heavily nickeled. Pencil mark type; resistance varied as required. List Price: 50c each.



### GRID CONDENSER

The holes of this condenser are spaced to fit the lugs of the ERLA grid leak, making it quick and easy to mount and unmount. This is Type 3, .00025 mfd. capacity. List Price: 25c each.



### ERLA TELEPHONE PLUG

The greatest value in a telephone plug ever offered, embodying every improvement and refinement. Instantly connected or disconnected without tools. No need to cut or change phone tips in any way. Securely fits any standard jack. Handle of polished fibre, with all parts heavily nickel plated. List Price: \$1.00 each.

*If your dealer cannot supply you, send us your order direct, with your dealer's name.*

**SPECIAL PROPOSITION TO JOBBERS**

## ELECTRICAL RESEARCH LABORATORIES

Dept. D, 2515 Michigan Ave.  
 CHICAGO



# Which?—

Indifferent Results and Short Life for Your Tubes—or a

“The Watch Dog of the TUBE”

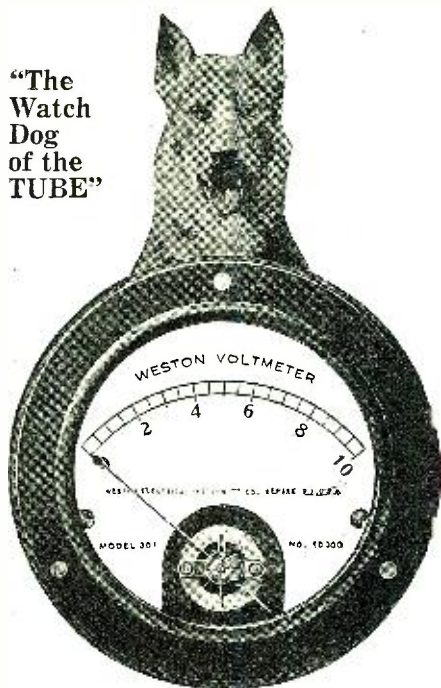

## Weston Filament Voltmeter

The length and quality of service received from a TUBE depends almost entirely upon your regulation of the filament voltage. To endeavor to judge this voltage by the degree of illumination of the filament is GUESSWORK and is certain to mean the loss of many tubes prematurely.

The Weston Filament Voltmeter indicates positively the voltage being used, making it possible to prevent many unnecessary burn-outs and to easily keep within the voltage limits that insure best results.

This voltmeter costs but little more than one tube. It pays for itself quickly in tubes saved. Make it part of your regular equipment at once.

Write to-day for Circular “I” describing this and other Weston Instruments composing the complete RADIO Group. If your dealer cannot supply your needs from stock we will gladly do so.

**WESTON ELECTRICAL INSTRUMENT CO.**  
173 Weston Ave., NEWARK, N. J.  
Branches in All Large Cities.

Model 301—One of a Group of Weston Instruments especially designed for RADIO use.

general use by telephone companies. It may have been too sensitive for the average ear, or it may have been that its greater cost kept down the volume of its sales.

At any rate, until the advent of radio telephony, Baldwin's factory, with the addition of another small building from time to time, was adequate for the manufacture of all the receivers he could sell.

Then came the tremendous interest in radio, and with it came the avalanche of orders that since November has exceeded the capacity of his plant by the enormous total of 200,000 sets.

An idea of what it may mean when an inventor's dream comes true may be had when it is stated that the filling of these surplus orders has been contracted on the basis of a royalty, said to be two dollars on each set.

Meanwhile Baldwin will go on supervising his little factory, helping to get out its normal production of 150 sets each day.

Nathaniel Baldwin is a modest and unassuming man. With flannel shirt open at the neck he stands with his elbow on the drafting table in his little office, smiling in a dazed sort of way as he talks. One could wish he were not quite so modest; then he might have been persuaded to pose for an unconventional picture.

## Broadcasting from San Francisco

(Continued from page 623)

market advice are broadcasted on 360 meters from 3 to 3:30 P. M. and 5:30 to 6:45 P. M. daily and on Sundays between 5 and 6 P. M. Personal talent rather than “canned” music is broadcasted. A special radio studio, the first of its kind, erected west of Chicago, and constructed especially for radio activity, was built on top of the building. In this house of magic is staged the concerts. The building is constructed of trantelate, an asbestos composition, fire-proof though non-metallic and the acoustics of the room are particularly good. Adjoining the studio is the operating room, where two transmitting sets are located. A special room adjoins the operating room, where the batteries and motor generators are located. In the studio every appliance known to radio engineers as an aid to transmission has been installed. Pilot lights guide the artists and special effects are arranged for various classes of musical selections.

The “T” type antenna is 300' high and 85' long with an 80' lead in.

Many novel stunts have been staged as radio experiments by KUO. During the great Shriner parade, an army signal corps vehicle with a transmission telephone set traversed the line of the parade and the radio editor of *The Examiner*, sitting in the vehicle, was able to talk direct to the operator of the station on top of the Hearst Building. For one hour and forty-five minutes a steady conversation was maintained by voice, in which the radio editor described the features of the parade as a news story, which was copied by stenographers in KUO's operating room. Likewise, the description of the parade with all its colorful effects, as spoken into the transmitter by the radio editor in the moving vehicle was audible to thousands of persons confined to their homes or in their offices, both in the city and in the country, who were unable to witness the great spectacle.

KUO is the official broadcasting station of the State Board of Health, State Board of Education and the San Francisco Bar Pilots. Each week the bulletins of interest to the general public from the Health De-

Made of High Grade Material

No moving contacts; connections made through hollow shaft to patented clips.

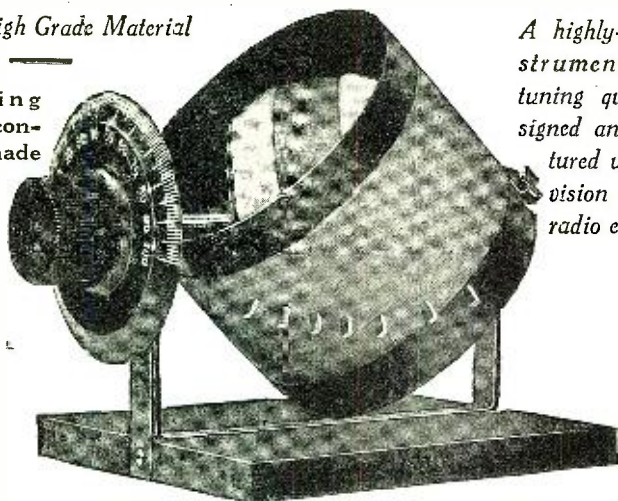

A highly-efficient instrument with fine tuning qualities—designed and manufactured under supervision of expert radio engineers.

**AMPCO VARIO-COUPLER—Price \$7.50**

Mounted on Mahogany Base



**AMERICAN**  
PATTERN, FOUNDRY  
AND MACHINE CO.  
82 Church St., New York



## KEYSTONE VARIABLE CONDENSERS

21 Plate, \$3.55

43 Plate, \$4.50

Our selection of materials and built-up type design give assurance of low energy loss and high efficiency

Agents and Jobbers write for information

**KEYSTONE MOTOR COMPANY**  
OAKS, Montgomery County, PENNSYLVANIA



## VACUUM TUBE RECEIVERS

### Clapp-Eastham Type HR

Compact, efficient, and very sensitive. Range up to 1500 meters. In nicely finished mahogany cabinet. **\$40**

2-Stage Amplifier to match. **\$40**

### 45V VAR. UNIT "B" BATTERIES

With phosphor bronze jiffy connectors. Unusually big value at **\$3.60**

### KEYSTONE ARRESTERS

Reduced **\$1.20** to.

### 600V-100 AMP. LIGHTNING SWITCHES

15 inches long, with ebony asbestos base. Regular price of this switch **\$2**

#### Special

### CRYSTAL DETECTOR RECEIVERS

Biggest value on the market. Has Variable Condenser, Vario Coupler, Tapped Primary, Buzzer Test, Cord Tipped Jacks, Bake-lite Panel. **\$20**

### ADAPTERS for WD-11 TUBES

—make it possible to use Westinghouse Senior Tube in any Standard Socket. **\$1.50**

**We carry a full line of Frost plugs and jacks**

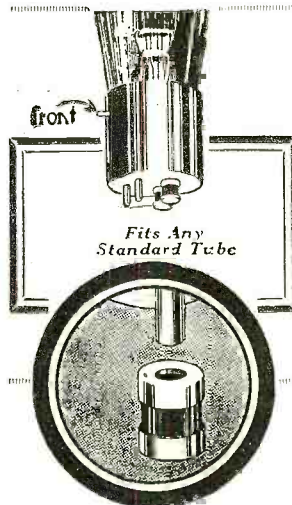

## —bulb insurance

The moment you slip the Radeco Safety Fuse on the filament terminals of your vacuum tube, it's the same as if you covered that tube with a "burn out" insurance policy. It is impossible, even by accident, to "burn out" a bulb protected with the

## RADECO SAFETY FUSE

(PAT. PENDING)

for VACUUM TUBES, METERS and other DELICATE INSTRUMENTS

Absolutely without affecting the efficiency of your set, this tiny protector, attached in a second to any standard bulb used in any standard socket, positively ends "burning out" and makes a tube last a lifetime.

Right now when tubes are not only expensive, but hard to get, you *cannot afford* to be without the Radeco Fuse. It means time, worry, money and trouble saved at trifling cost.

Come only in packages of four

**4 for \$1**

Order by mail or from your dealer

We can make immediate delivery on sizes for the following tubes:

ELECTRON RELAY, A-P AMPLIFYING TUBE, DOUBLE FILAMENT AUDIOTRON, CUNNINGHAM C-300 AND C-301, RADIO CORP. UV-200, UV-201, UV-202 AND WESTERN ELECTRIC VT-1 AND VT-2.

**When you order state WHAT tube fuses are for!**

**CAUTION:** On many of the new tubes the solder on the contacts of the filament terminals is irregular. Before attaching the Radeco Safety Fuse file or sandpaper the solder off the SIDES of the terminal so that the fuse will slip on easily.

WE CARRY A COMPLETE STOCK OF PARTS AND SETS AT STANDARD PRICES. ORDER FROM ANY STANDARD CATALOG

Reliable Goods at Right Prices

## RADIO EQUIPMENT CO.

630 Washington Street, Boston, Mass.

New England's Oldest Exclusive Radio House

We Carry Only the Best Radio Goods



# RADIO MEN WANTED

THE world's new industry is radio, which is progressing at a pace that has outstripped all records. Today everyone is concerned with wireless development, from the youngest boy, building his own crystal receiving set, to the largest electrical corporation, making expensive commercial apparatus. Radio is the world's safeguard of the seas. It spans the oceans, links the continents together, and brings to the smallest hamlet the intelligence of the world. Radio is the latest means of communication, a public, world-wide utility, romantic in its operation and as unlimited in possibilities as is the mind of man.

Get in this new industry today, while it is still in the growing period, while the greatest opportunities are offered to men of intelligence and initiative. Today there are not enough trained men to go around.

The one best way in which to touch this industry at its very center is through the course of study of the Radio Institute of America, a course that has been developed steadily with the industry during the past fifteen years, and has turned out over 6,500 trained men, 95 per cent. of whom have engaged successfully in this new branch of science and industry.

The graduates of the Radio Institute of America enjoy an exclusive advantage because of the close relation existing between it and the Radio Corporation of America, the world's largest wireless organization, operator of the Long Island Station, that is heard round the world.

Among the thousands of Radio Corporation employees, on ships and ashore, in offices, factories and laboratories, are many former students of the Radio Institute. Think what an advantage it gives you to be able to say: "I am a graduate of the Radio Institute of America."

The Radio Institute of America offers two courses of instruction, one in classrooms and laboratories, to those who can attend personally in New York, and the other by mail. The mail course is skillfully worked out and exactly parallels the personal course. Each student of the Home Study Division has personal attention given to his progress by the experts of the Institute. Code instruction at home is rendered possible by an ingenious automatic transmitting device, variable in speed, so that the beginner learns the code as fast as he is able, exactly as if an instructor sat at his side.

A three weeks' Post-Graduate Course in our New York City School is given, with no cost whatever, to any student in the Home Study Division desiring it.

There is a booklet which we send free to you: "Radio, the New Field of Unlimited Opportunity." Send for it and learn more about the extraordinary things that Radio offers to all men of energy and ambition.

HOME STUDY DIVISION

## Radio Institute of America

(Formerly Marconi Institute)

324 Broadway, New York



*Why  
by sorting, dusting and cutting  
our own rags we make better fibre*

You see if we didn't make sure that the rag stock were free of foreign substances, a piece of wire or perhaps a pin or nail might show up after you had spent some time in machining or finishing a piece of fibre. This would mean costly labor wasted.

We are always glad to guarantee Vul-Cot Fibre to be free of foreign substances. Incidentally, this care which we take in making the paper used in Vul-Cot Fibre increases its dielectric strength and lowers dielectric losses.

We'll be glad to send you a piece of Vul-Cot Fibre. And then if you want, we'll machine Vul-Cot Fibre to your specifications, or you may purchase it in sheets, rods and tubes.

**AMERICAN VULCANIZED FIBRE CO.**  
503 Equitable Building, Wilmington, Del.

**SALES OFFICES**  
BOSTON PHILADELPHIA CLEVELAND CHICAGO  
NEW YORK PITTSBURGH DETROIT ST LOUIS  
Complete Stock for Immediate Shipment at Chicago  
Western Agents Canadian Agents  
Western Electric Company Northern Electric Company  
SAN FRANCISCO SEATTLE MONTREAL TORONTO WINNIPEG  
PORTLAND OAKLAND LOS ANGELES OTTAWA HALIFAX CALGARY  
REGINA VANCOUVER



partment of California, as well as from the State Board of Education, are transmitted by this station.

## Broadcasting to the Ships at Sea

(Continued from page 628)

ficial for the men at sea, will do well to turn their attention to this new practical method of both diversion and education. One can even imagine the designation of certain ships as travelling Ocean broadcasting stations. And if directional and secret radio ever becomes a possibility, one can visualize the flagships of certain lines sending exclusive little chats to their own ships. But the sea is too big a brotherhood for that to become a possibility for other than purely commercial messages.

Practical observations show that broadcasted radiophone signals travel greater distances over sea than over land. Operators on the Transatlantic routes, who occasionally go down to the short-wave schedules, report hearing Newark clearly at distances of 1,700 miles and over, to the eastward. He has several times been picked up by vessels on the west coast of South America, or the coast of Peru. Vessels in the Gulf and West Indian waters hear him occasionally. An operator of our acquaintance coming aboard his ship in Tampico with a cargo of the product of Mexican distilleries in his system, happened to pick up the receivers and, hearing a lecturer in some northern city saying, "You must try it again and yet again" promptly went ashore and took the good man's advice.

With radiophone broadcasting at sea for purposes of entertainment will come radiophone conversations between ships for commercial and other purposes. It will be extremely interesting to watch the evolution of the use of radiophone for and by the ships at sea.

## Anacostia Naval Air Station

(Continued from page 622)

the band from the Marine Corps of the Navy Department introduced its concerts, on May 31 of this year, in excess of 2,000 voluntary letters have drifted into Washington complimentary to the character of its musical renditions. These communications have originated in 16 States, from Maine to Florida, with scattering testimonials from Ontario and Quebec, in Canada. The weekly program, invariably given on Wednesday evening, begins at 8:30 and continues for one hour. Fittingly, its renditions conclude with "The Star Spangled Banner." Thus the national anthem is broadcasted through space for a radius of hundreds of miles of Washington, the melodious strains drifting into the isolated farm home as well as that of the city-dweller.

Structurally, what manner of radio station is 'NOF'? This question, in perhaps different language, has been pondered in the minds of thousands of radio amateurs who have so frequently tuned their receiving sets to 412 meters. Therefore, a brief description of this 100 per cent. radio laboratory is not amiss. Its multiple-tuned antenna is of outstanding note, admitting of a variation in wave-length from 190 to 3,000 meters.

**Sidbenet**

RADIO EQUIPMENT MFG. CO.  
1663 JEROME AVENUE  
Send for catalog of parts and equipment.  
COMPLETE SETS \$10.00 UP



### Save Money

Build Your Own At Home  
Complete Standard Parts for Long Distance Radio Outfits. We do all machine work; you do the hand work; we tell you how. Immediate delivery. Also complete Radio Sets—all sizes at bargain prices. Write now for our big bargain catalog.

Colonial Radio Equipment Co., 4759 Calumet Avenue, Dept. 11, Chicago, Ill.



RADIO APPARATUS

# CROSLEY

RADIO APPARATUS

**Better—Cost Less**

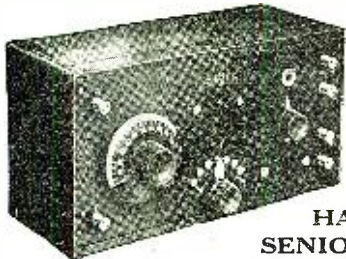

**HARKO SENIOR NO. V**

This instrument is a combination tuner and Audion detector, recommended for receiving broadcasting stations up to fifty miles. Under favorable conditions, ships and stations on the Atlantic Coast are easily copied in Cincinnati. Minnesota hears Newark. Denver hears Schenectady and other distant points are brought in except under adverse conditions. Formica panel, Adam brown mahogany finished cabinet, price as shown without tubes, batteries or phones, \$20.00. Crosley Harko Senior No. V is equivalent to Crosley Crystal Receiver No. 1 and Crosley Audion Detector Unit.

**E**FFICIENT, satisfactory and economical, Crosley Radio Units have become well and favorably known to the trade. Several of the Crosley early units, greatly refined in finish and detail, are illustrated here, together with several new models which have recently been perfected. Crosley prices are remarkably low. These prices are made possible by quantity production and up-to-date methods employed in our factories. Everywhere Crosley "Better—Cost Less" Radio Units are meeting with success.



**CROSLEY RADIO FREQUENCY TUNED AMPLIFIER (R. F. T. A.)**

This unit can be used in connection with the Crosley Crystal Receiver No. 1 and Crosley Audion Detector Unit or with the Crosley Harko Senior No. V. It can also be used with practically any other type of Audion detector outfit. The tuning feature means selectivity, elimination of static and great increase in volume of signals. In combination with the above-mentioned units, the Crosley R. F. T. A. adds at least six times the volume and range. Price without tube or battery, \$15.00.

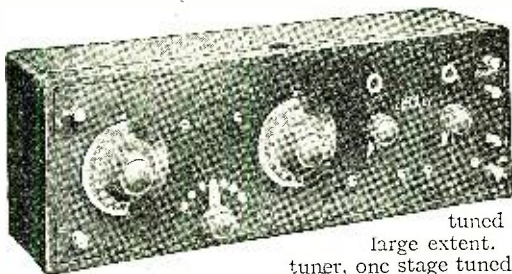

**CROSLEY RECEIVER No. VI**

This Unit has approximately six times the range and volume of the Harko Senior. With it, distant broadcasting stations are brought in loud and clear-tuned sharply. It also eliminates static to a large extent. The Crosley Receiver No. VI consists of tuner, one stage tuned radio frequency amplification and audion detector. Mounted on formica panel, Adam brown mahogany finished cabinet without tubes, batteries or phones, \$30.00. Crosley Receiver No. VI is equivalent to the Crosley Crystal Receiver, Crosley Audion Detector Unit and Radio Frequency Tuned Amplifier or Crosley Harko Senior No. V and Crosley Radio Frequency Tuned Amplifier.



**CROSLEY TWO-STAGE AUDIO FREQUENCY AMPLIFIER**

With this unit, two stages of audio frequency amplification can be added to any type of radio apparatus. Can be used in conjunction with the Crosley Crystal Receiver No. 1 and Crosley Audion Detector Unit, Crosley Harko Senior No. V, Crosley R. F. T. A. or Crosley Receiver No. VI. This unit increases the volume about one hundred times. Designed to match up uniformly with the above-mentioned units, without tubes, batteries or phones, \$25.00.

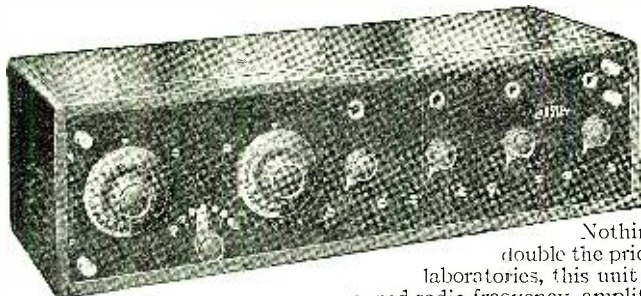

**CROSLEY RECEIVER NO. X**

In placing this receiver upon the market, we are offering you a unit whose range, volume and selectivity are remarkable. Nothing can be compared with it at double the price. Developed in the Crosley laboratories, this unit combines tuner, one stage of tuned radio frequency amplification, audion detector and two stages of audio frequency amplification. As shown, without tubes, batteries or phones, solid mahogany cabinet, \$55.00. Crosley Receiver No. X is equivalent to Crosley Receiver No. VI and Crosley Two-Stage Audio Frequency Amplifier.

**CROSLEY SHELTRAN**

Incorporated in the design of the Crosley Sheltran, are all the characteristics so essential and necessary to obtain maximum amplification from the modern vacuum tubes used in radio work. These tubes, with their high amplification constant, operate most effectively at large fluctuations of the grid potential. The Crosley Sheltran is designed to accomplish these results and tests have shown that the design is correct to insure maximum efficiency. Completely shielded—9 to 1 ratio. "Better—Cost Less," \$4.00.

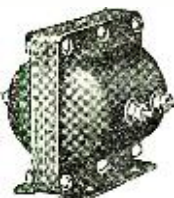

**CROSLEY V. T. SOCKET**

This socket has been pronounced by many radio engineers the best socket on the market. Ever since its announcement, its success has been phenomenal. Although the success has been largely due to the price, its real popularity is based on its high quality, efficiency, service and practical unbreakability. Patents pending. Beware of imitators. Made of porcelain for base or panel mounting, \$ .50.

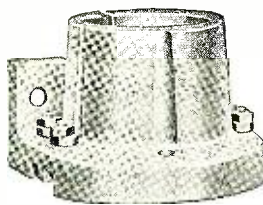

**CROSLEY RHEOSTAT**

This rheostat permits exceptionally accurate and delicate variations of the filament current. With it, the best possible results are received from expensive vacuum tubes. Unique construction allows the Crosley Rheostat to be mounted on a panel of any thickness up to and including 3/8 inch. A special grade of non-corrosive wire forms the resistance and results in highly efficient service. Furnished complete with newly designed tapering knob, pointer, etc.—"Better—Cost Less," \$ .60.



**WRITE FOR CATALOGUE**

*Dealers and Jobbers Who Handle Crosley Apparatus, Handle the Best*

**CROSLEY MANUFACTURING COMPANY**  
DEPT. R. N. 1 CINCINNATI, OHIO



# RADIO SERVICE PRODUCTS

The Acknowledged Standard of the Radio Amateur  
The

## AMPLITRON

(A Real Loud Speaker)

The Amplitron is a product of the Radio Service Laboratory and has been designed and constructed especially for radio work. This instrument fills the need for a moderate priced loud speaker. It reproduces radio phone speech and music without distortion—equally good for code. No exciting batteries or adjustments necessary. Uses a Baldwin Type "C" single phone.

Price (as illustrated).....\$10.00  
Price WITH BALDWIN PHONE AND CORD.....\$16.50

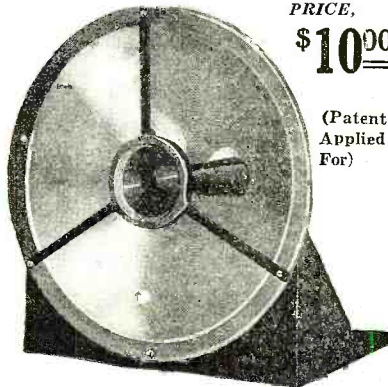

PRICE, \$10.00

(Patent Applied For)

### OTHER RADIO SERVICE PRODUCTS

#### Single VT Socket

\$1.00

Type S10



- Triple VT Sockets Type S4.....\$3.00
- 23 Plate Variable Condenser without dial.....\$3.00
- 43 Plate Variable Condenser without dial.....\$3.75
- Grid Condensers .0005 mf. Type S15......35c
- Phone Condensers .002 mf. Type S16......35c
- Grid Leak Condensers Type S30......50c
- Variable Grid Leak Type S40, 1/2 to 3 megohms..75c

#### Double VT Socket

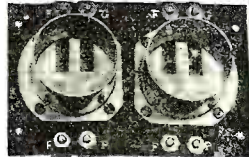

Type S3 \$2.00

We carry numerous other types of interest to Radio dealers and wireless men. Radio Service Products are for sale by all reliable dealers.

## RADIO SERVICE & MFG. CO.

Sales Office: 110 W. 40th St., New York City  
Factory: Lynbrook, Long Island

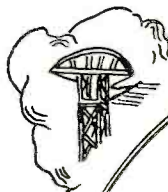

There are all kinds of insulations; nearly all vary as to quality. There is one sure way of obtaining the best.

Specify

# Condensite

A standardized material of known composition, possessing all the properties essential to radio insulation.

Condensite Company of America  
BLOOMFIELD, N. J.



The antenna is comprised of half a dozen wires, spaced 3' apart and 235' long, supported by two 100-foot guyed masts. The "down leads" are five in number, contrary to the conventional antenna with only one. These are equally spaced, one at each end, another in the center, and one on each side half-way between the center and end. Variable inductances are found in each "lead" at the end reaching the ground, these being protected from unfavorable weather conditions by inconspicuous wooden boxes surrounding them on the earth. Each "down lead" is "grounded" through its inductance to a copper-screen interred in the soil to a depth of five feet. The electric current in each of these "down leads" is of uniform capacity in so far as possible, a condition insured by careful tuning.

The radiation at Anacostia, comparatively of a high value, is obtained on low-power consumption—not exceeding one and one-half kilowatts. The multiple-tuned antenna vouchsafes this virtue. The transmitting unit employs the master-oscillator power-amplifier system. The latter involves the use of three 250-watt pliotrons, actuated by 1,500 to 1,600 volts on the plates. The electric strength for the filaments, at present, has its source in 24-volt batteries, but a transformer is in the course of construction whereby the filaments will be lighted from the commercial 25-cycle alternating current supply in the research laboratory. The master-oscillator is a 50-watt filament tube and the master-modulator is of similar caliber. The oscillator is linked to the grids of the power-amplifier tubes with reasonable loop-coupling, a provision which prevents the amplifier tubes themselves oscillating. A 5-watt speech amplifier precedes the modulator tube.

Power for the "NOF" transmitting apparatus has its source in a three-phase, 60-cycle motor directly coupled to a generator whose complete load ranges from 700 to 1,600 volts. A half-way tap is accessible on the generator, affording a means of dividing the voltage for operating the master outfit. Filters are placed in the three lines extending from the generator so as to minimize commutator and slot ripples. The transmitter at Anacostia is subject to remote control from the building of the Navy Department in Potomac Park. When a remote telephone station is thus employed, the operation of the transmitting outfit involves the use of an additional five-watt tube amplifier between the incoming speech over the telephone line and the speech amplifier tube in the laboratory.

The transmitting range of Anacostia at night has been variously estimated to be from 300 to 1,000 miles radius of Washington. Speaking in terms of its maximum radiating distance, its radio-telegraph signals have been heard and acknowledged in far-away Hawaiian Islands, on the Pacific Coast of the United States, and off the mouth of Orinoco River in South America. The daytime range of its radio-telephone broadcasting would doubtless be limited within a radius of 150 miles of the National Capital, in the event that daylight hours were employed for this form of transmission. Verily, "NOF" is a government radio station whose programs of performance are novel in character and surprisingly efficient.

### Correction Notice

We regret that, through an oversight, in the August issue of RADIO NEWS, the conclusion of the article entitled "A. C. Rectification for C. W.," which commenced on page 234 and was partly concluded on page 338, was not continued on the proper page. The continuation from page 338 will be found on page 330.

#### C-B RECEIVING SETS

1-2-3 Steps

#### RADIO FREQUENCY

Loud Speaker on 6 in. Loop... Fits Phonograph Cabinet

Cooper-Byron Radio Electric Corp.  
507 Summit Ave., Jersey City, N. J.

#### VULCANIZED

# FIBRE

Be sure and specify

#### "WILMINGTON FIBRE"

Sheets, Rods, Tubes, Washers, Etc., Specialties

Wilmington Fibre Specialty Co., Wilmington, Del.  
Branch Offices "Everywhere"





The Willard Radio "B" Battery with glass jars and Threaded Rubber Insulation is the most practical insurance against leakage noises and leakage losses.

# Why Gamble on "B" Batteries?

You're careful in soldering connections. You spend good money for additional stages of amplification. You give special attention to insulation of aerial and lead-in.

If you've gone that far, you simply can't afford to take a chance on having a leaky "B" Battery spoil it all with a bombardment of leakage noises. *You can't afford anything less than a leak-proof Willard "B" Battery.*

Every cell of a Willard "B" Battery is an individual glass jar. Jars are

well-spaced to prevent leakage from cell to cell. Threaded Rubber Insulation protects the plates and thus guards against inside leaks.

Because of the leakproof feature Willard "B" Batteries are unusually quiet and hold their charge for long periods.

Ask your radio dealer or the nearest Willard Service Station to show you the Willard 6-volt Radio "A" Battery and the Willard 24-volt Radio "B" Battery.

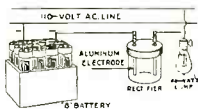

This rectifier will keep your "B" Battery charged at a cost of a few cents a month.

**WILLARD STORAGE BATTERY COMPANY**  
Cleveland, O.

*Made in Canada by the*

Willard Storage Battery Company of Canada, Limited, Toronto, Ontario

# Willard

THREADED RUBBER BATTERY





**HESLAR Improved**  
Equa-Tone Phones  
2200 Ohm... \$10  
3200 Ohm... \$12

**READY!**  
for immediate  
delivery

HESLAR Improved Radio Equipment is the product of engineers with FOURTEEN years of experience. It is designed on the formula of positive knowledge gained from countless experiments. Every HESLAR product shows exclusive features that are two jumps ahead of the times.

Go to your dealer NOW! Ask for HESLAR Radio Equipment or  
**Send for catalogue**

**HESLAR Improved**  
Variable Condensers  
23 Plate... \$3.60  
43 Plate... \$4.50

**HESLAR Improved**  
V. T. Sockets  
Price ..... \$1.25

**HESLAR**  
RADIO CORPORATION  
INDIANAPOLIS, IND. U.S.A.

## International Radio Congress at Chicago

(Continued from page 631)

"Hence, the problem of radio transmission," Dr. Steinmetz continued, "is that of directing the radio waves so closely that a large part of their power remains together so as to be picked up by the receiving station. Much successful work has been done in directing radio waves, and, for instance, our trans-Atlantic stations send out most of their power eastward. However, even as directed, the power scatters over the coasts of Europe from Norway to Spain, so that it is impossible to pick up any appreciable part of it.

"Suppose we have a very large station sending out electro-magnetic waves not of hundreds, but of hundred thousands of millions of kilowatts, and suppose we could find a wave-length where the absorption in the passage of the wave through space is sufficiently small so as to be negligible compared with the amount of power. Suppose we now erect a second station, tuned for the same wave-length as the sending station. It would resonate with the standing electro-magnetic wave issuing from the sending station, thereby stopping its passage by absorbing its energy. It would, as we may say, punch a hole in the standing wave sheet coming from the sending station. Power would then flow into this hole, the sending station would begin to send out additional power to maintain the wave sheet, and this power would be received by the receiving station. This would give a real radio power transmission. Any receiving station of suitable design would then be able to pick up power from the universal power supply carried by the standing wave sheet covering the earth. It would have to be economically permissible, and feasible. It would have to be an international development. Even if such radio transmission by a stationary electro-magnetic wave sheet were possible, its realization at best is rather distant and the present outlook for radio power transmission somewhat remote."

A number of engineering clubs gave Dr. Steinmetz a dinner recently at the Hotel Morrison, the guests numbering fully 200 radio and electrical representatives from the middle western territory.

R. H. G. Matthews of the American Radio Relay League read a paper on "Amateur Radio." Lieutenant Colonel Louis R. Krumm, superintendent of radio operations of the Westinghouse Electric and Manufacturing Co., took up the subject of broadcasting operations, present and future. Francis W. Dunmore, radio laboratory, Bureau of Standards, Washington, gave his views on relay recorders for remote control by radio.

John Mills, one of America's leading electrical engineers and the author of several technical books of merit, dealing with the development of the present system of radio and telephonic communication, entertained the Congress with his widely known talk, "The Human Voice and Its Electrical Transmission." Mr. Mills was educated in Chicago, graduating in 1901 from the University of Chicago, having the distinction of being the first person whose voice was carried through the ether across land and sea from Washington to Honolulu when radio reached an advanced stage in 1915. He is at present with the Western Electric Company at New York City. Other members of the Western Electric research departments present at the Congress were R. A. Heising, and H. W. Nichols.

T. R. McElroy of Boston, an employee of the Western Union Telegraph Company, won the Carlson diamond medal for speed and accuracy in a radio receiving contest held as one of the principal practical features of the Congress.

Surrounding McElroy was a field of radio wizards from all points of the com-



## Wilmaco 180° Variocoupler

All parts nickel plated; fibre tubing; 175 to 700 meters wave length; green silk wire on primary and secondary. This is the best value on the market.

**Price \$5.25**

We also make a complete line of radio equipment, including the famous Wilmaco Receivers at \$40.00.

If your dealer can't supply you, write to us direct.

**DEALERS: Write us for an excellent proposition.**

**WILSON, McGUIRE CO., INC.**

1004 TREAT AVE., SAN FRANCISCO, CAL.

## MANUFACTURERS AND JOBBERS

We have a new device for use on every tube set. Descriptive bulletins will be ready for distribution by the time this issue reaches you. Write for particulars.

Wireless Appliances Company  
Old Colony Bldg., Chicago

## WANTED

Reliable JOBBERS for our bakelike variocouplers. Double green silk covered wire wound securely upon a moulded stator and rotor tapped so as to obtain a one-turn variation over its entire range. No shellac used!

**\$5.00**

Attractive discounts to dealers and jobbers

**Ridgewood Radio Shop**

1603 Myrtle Ave.

Ridgewood, L. I.



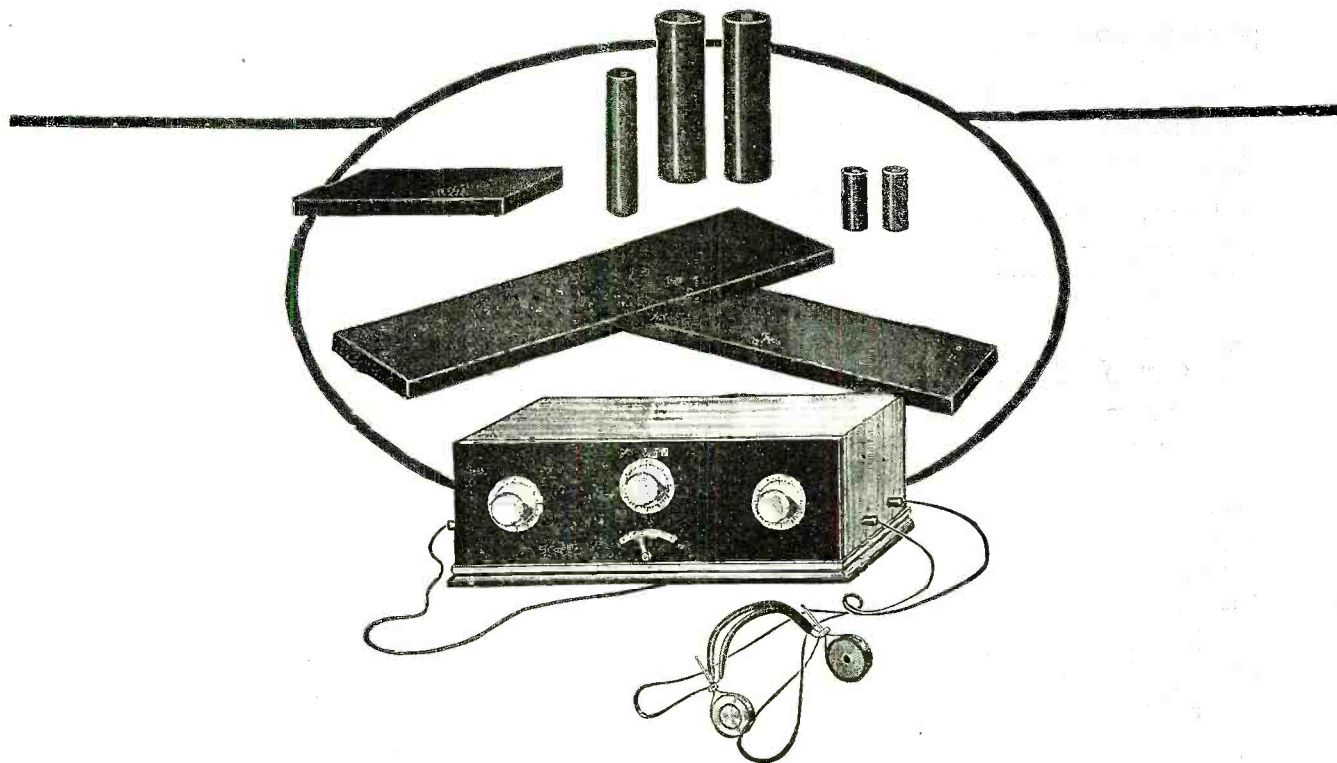

## Why *Formica* Is the Best Radio Insulation

**F**ORMICA practically absorbs no moisture. Hence it never warps or develops current leaks.

Fumes, steam, heat and most chemicals do not affect it.

It is not brittle and will not crack.

The finish is a handsome brown or black, perfectly uniform and glossy unless it is sanded. It makes a panel of splendid appearance and one that never loses its good looks.

Formica manufacturing methods make Formica what it is—the most popular and widely used radio insulation.

The cotton rag Filrous base which is

the base material of the radio grade has been developed scientifically for use in Formica only. This is thoroughly soaked in Redmanol resins, cut in sheets and fused or vulcanized under great heat and pressure into a solid piece of Formica.

The resin is handled with the greatest accuracy so it will be always perfectly uniform and aged just right when it is used. Temperature control is most exact.

Don't believe that all radio insulation is alike. Only Formica is like Formica. Insist on it.

DEALERS: Formica probably has the "call" in your territory as it has nearly everywhere. We have recently doubled our capacity and can now deliver your orders promptly.

### THE FORMICA INSULATION COMPANY

4618 SPRING GROVE AVENUE  
CINCINNATI, OHIO

#### SALES OFFICES

50 Church Street, New York, N. Y.  
9 South Clinton Street, Chicago, Ill.  
414 Finance Building, Cleveland, Ohio

1042 Granite Bldg., Rochester, N. Y.  
422 First Avenue, Pittsburgh, Pa.  
Sheldon Building, San Francisco, Cal.

932 Real Estate Trust Bldg., Phila., Pa.  
321 Title Building, Baltimore, Md.  
415 Ohio Building, Toledo, Ohio

# FORMICA

Made from Anhydrous Redmanol Resins  
SHEETS TUBES RODS



# MEMORIZE CODE IN ONE HOUR

TRADE MARK **BKUMA YRLSBUG** REG. AP. FOR

**BEGINNERS HAVE REPORTED**

**Memorized Code in 30 Minutes**

and by limited evening practice

**Qualified for Exam in One Week**

**OUR HONOR ROLL**

Names Beginners in 10 Radio Districts

*Who Quickly Became*

**LICENSED OPERATORS**

and to encourage others reported their success, stating time required to memorize the Code

**DON'T BE CONTENT TO LISTEN IN  
KNOW THE CODE AND GET IN**

*Investigate—Save Time and Expense—Get Results*

Send ONE dime for HONOR ROLL or send TWO dimes for Reports from 300 successful Beginners. Learn what others have done. Realize what you may do.

**ATTENTIVE BEGINNERS WHO USE**

**DODGE ONE DOLLAR RADIO SHORT CUT**

**DO ARRIVE**

**C. K. DODGE BOX 200 MAMARONECK, N. Y.**

ASK FOR A **"PRAMCO" UNIT**

TRADE MARK

**Includes All Necessary Panel Mountings for  
a Complete Crystal Receiver**

**CONTENTS**

- |  |                                       |
|--|---------------------------------------|
| 18 Switch Points with Nut                    | 2 Small Posts for Telephone Receivers |
| 4 Switch Stops with Nut                      | 2 Switch Levers, 1½" Radius           |
| 1 Detector Post, Universal Joint             | 1 Crystal Cup                         |
| 2 Large Binding Posts for Antenna and Ground | 1 Phosphor Bronze Cat Whisker         |

**All Parts Polished and Nickel-Plated with Our  
Unequaled Finish.**

**Put Up in a Box Complete for \$2.00**

*From Your Dealer or Direct Postpaid*

**PREMIER DENTAL MFG. CO.**

Switch Points, Switch Levers, Binding Posts, Crystal Cups, Detectors, Etc.

*Our New Literature Now Ready for Dealers*

**1900 North Sixth Street**

**Philadelphia, Pa.**

**JAXON**

STORAGE "A" and "B"  
**BATTERIES**

Fully Guaranteed—High Quality—Fair Prices

*Write for Radio Supply List.*

**Jackson Battery Company**  
1124 R. Jackson Blvd. Chicago, Illinois

**WHOLESALE ONLY**

**Complete Line of RADIO PARTS**

Also Crystal Sets, Tube Sets and  
All Necessary Parts

**IMMEDIATE DELIVERIES**

Domestic and Foreign Shipments

**AJAX PRODUCTS CO.**

154 NASSAU STREET, NEW YORK CITY

pass. The medal was awarded by George E. Carlson, Commissioner of Gas and Electricity of Chicago, McElroy copied 55.01 words per minute without a single error. The Continental code was used by the entrants and the speed was started at 40 words per minute, gaining at short intervals until well over the 50 mark was scored.

Benedict D. Brankey of the Chicago Western Union office dropped out after reaching a speed of 46 words per minute. M. Swartz, assistant radio inspector of the Chicago district, quit when he attained a speed of 48 words, and this defection left B. J. Scutter as the champion's only competitor. Scutter reached 52 words per minute with four errors in his copy. McElroy, however, sped on unmindful of his competitors, reaching the 55 word mark without making a copy error.

Benjamin Miessner in outlining "A Secrecy System for Radio Communication," and Samuel Kintner of the Westinghouse company speaking on the technique of broadcasting, closed the speakers' forum.

Guglielmo Marconi's paper, read by G. H. Clark, because the famous Italian inventor of wireless was unable to be present, proved to be the most noteworthy scientific opinion along practical lines of realization. "Since the beginning of radio activities," the paper read, "the wave-lengths have been getting longer and in every case non-directive, or 'broadcast' transmission has been used, that is, the radio signals have been radiated in all directions into space, that one particular receiving station out of the millions of possible receivers may gather in the signal. Only in the last year when broadcasting of general information has become popular, have the 'radial' features of modern radio communication really been utilized at all.

"One of the reasons that short waves have been neglected so long is that there is far greater 'fading' experienced with their use. That is, signals might be extremely strong at one moment and the next moment might die to inaudibility, a characteristic which is by no means so marked when the wave-length is made greater.

"It has long been appreciated that, apart from fading, short waves were much more efficient than long, as, for instance, the recent achievement of the American amateurs in reaching England with only a few hundred watts on a short wave-length, whereas commercial stations on wave-lengths hundreds of times longer must use powers of several hundred kilowatts.

"The point to be noted here, however, is that the amateurs happened to 'get through' once, out of thousands of times of failure, and succeeded that once because 'absorption' or 'fading' happened to be noticeably absent for a brief period, whereas the commercial stations get through practically all the time.

"Now, directional transmission offers a further possibility for getting messages through with low power because all the power that is available is concentrated over a few degrees of arc rather than sent, uselessly, in every direction in order to be utilized in one only. Directional transmission means reflection of the created energy by local reflectors so as to catch and send back energy that otherwise would go in the wrong direction, and since reflectors must have comparable dimensions to their reflected waves, it is not today practicable to reflect wave-lengths of thousands of meters in length, but with waves of 50 meters it is another question. Directional transmission is, therefore, possible on short wave-lengths.

"Direction reception, or picking up a message that is coming from one given direction and not picking up others from sources of different locations, has been with us for some time, so that we can directly make use of this for the new development of radio.

"We have, therefore, the well known fact





24 RB 2 SERIES  
Hard Rubber Case



R 6 EA SERIES  
Hard Rubber Case



6 EA SERIES  
Black Wood Case



V 6 EA SERIES  
Finished Maple Case

PRICES		
No.	Amp. Hrs.	Prices
6EA 5	60	\$17.50
6EA 7	80	20.00
6EA 9	100	23.00
V 6EA 7	80	21.50
R 6EA 9	100	28.00

Vesta six-volt Radio Batteries are made in three styles and three sizes. The ampere draw of a vacuum tube is approximately one ampere—24 RB 2, "B" type, \$9.00.

# Any Radio Set Is a Better Set With Vesta Batteries

The name Vesta on your radio battery is absolute assurance of long, dependable service, free from the vexations of having the current output drop at the critical moment.

No need to run back and forth constantly to the service station for recharging with Vesta "A" storage batteries. The extra heavy plates retain their charge over long periods.

Vesta "B" Batteries eliminate the "frying" noises made by dry cells (sometimes mistaken for static) and greatly increase the audio efficiency of your tubes. Moreover, an accidental "short" will not put them out of commission permanently, because they can be recharged. This is not possible in the case of a dry battery. Those using the "soft" type of detector tube prefer Vesta "B" Batteries to all other makes.

Vesta Radio Batteries are made in the styles illustrated. Two or four years' service may be expected from these batteries if kept watered and recharged when gravity falls below 1200°.

Vesta Service Stations catering to the automobile trade and radio dealers are supplying these batteries. Consult your phone book or write us if you are unable to find a local Vesta dealer.

VESTA BATTERY CORPORATION  
2100 Indiana Avenue, CHICAGO, ILL.

# VESTA

**COSTS LESS PER MONTH OF SERVICE**





TRADE **ESCO** MARK

THE THINGS THAT HAVE ENDURED FOR AGES  
WERE MADE OF QUALITY—THE CHEAP THINGS  
HAVE PASSED ON—AND ARE FORGOTTEN

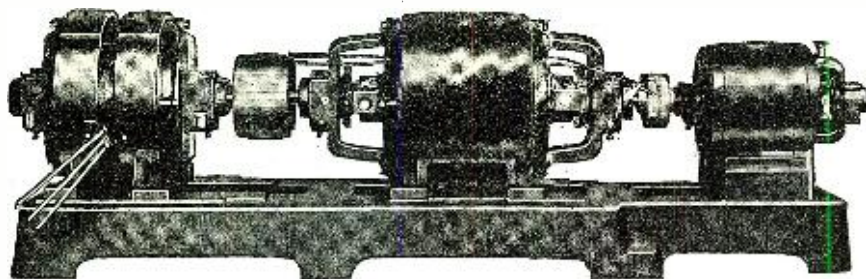

**ESCO**

**HIGH VOLTAGE MOTOR-GENERATORS STAND PRE-EMINENT**

Used by Leading Educational Institutions, U. S. Army and Navy Academies,  
Research Laboratories, Newspapers, Dept. Stores and Broadcasting Stations

BULLETIN 237 LISTS OVER 200 COMBINATIONS

SPECIAL APPARATUS DEVELOPED FOR SPECIAL REQUIREMENTS

**MOTORS—DYNAMOTORS—GENERATORS—MOTOR-GENERATORS**

SOLD BY PRINCIPAL DEALERS EVERYWHERE

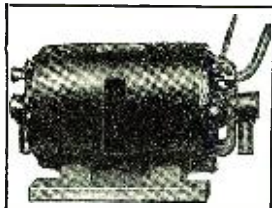

**ELECTRIC SPECIALTY CO.**

211 SOUTH STREET

STAMFORD, CONN., U. S. A.



## Radio Enthusiasts Here's the Marshall Variable Condenser

**A Precision Instrument**

designed to suit the capacity requirements  
of every set; mechanically and radio-electrically correct.

**A Quality Product, Reasonably Priced**

**Build It Yourself To Suit Your Own Capacity Requirements  
FOR FUN AND FOR SATISFACTION**

A new idea of proven popularity both with amateurs, experts and schools. Construct a condenser which tunes instantly and accurately; which cuts out static, interferences, etc., by a twist of the wrist, and which brings in the signals as clear as a bell. And save money.

Plates cannot get out of true. Hair-breadth accu-

racy maintained throughout. High oscillative power factor, minimum interference guaranteed.

Full directions and special tools accompany every outfit.

And should you wish to increase the capacity of your set at any time, you may obtain just the parts you need from your dealer or directly from us. A sound, economical principle to build on.

### SIZES AND PRICES

Write Now for Special Christmas Order Proposition—Very Profitable

No. of Plates	Price, Assembled	Price, Ready to Build	No. of Plates	Price, Assembled	Price, Ready to Build
3	\$2.50	\$1.90	23	\$5.25	\$3.80
5	2.75	2.10	35	6.00	5.15
9	3.50	2.55	43	6.50	5.60
17	4.25	3.35	67	10.00	8.40

Special Outfit for Radio Service Experts—contains parts for five complete 23 plate condensers. Makes a fine, profitable spare parts box for store.

**RETAILERS**—You will be interested in our novel Xmas selling plan, which assures fast turnover, liberal profits and repeat customers. Original and attractive window display backs up our national advertising and attracts customers to your store.

**NEW HAVEN RADIO CO., Manufacturers, Chapel & Hamilton Sts., New Haven, Conn.**

Everything  
in  
Insulation

## "SPAGHETTI"

PAPERS, WAXES, COMPOUNDS, PAPER TUBES, VARNISHES  
FOR IMPREGNATING AND FINISHING, ETC., ETC.

ESTABLISHED 1889

MITCHELL-RAND MFG. CO., 21 VESEY STREET, NEW YORK

that short waves are ideal from the standpoint of energy; we have the possibility of sending these waves in one direction; we can also sharpen the eyes of our receiver so it is blind in all but one direction and especially keen in that one. There still remains the problem of intermediate absorption. Distances of 50 miles have been reached already on this short-wave directive work, using radio-telephony, and experiments on far greater powers are now in progress.

"Further application is with radio-lighthouses. A radio transmitter is rotated constantly, sending out a beam of radio waves just like beams of light. A different Morse character is sent out automatically for every major position of the beam around a circle, and by this means a ship can tell exactly her position with respect to the lighthouse. This is being tried in England."

Below is given the program of the exposition:

**SUNDAY, AUGUST 6th, 10 A.M.**

Radio Marathon. Diamond medal speed contest for radio operators.

Diamond medal donated by Mr. Geo. E. Carlson, Commissioner of Gas and Electricity of the City of Chicago.

The test was conducted by Mr. Lawrence R. Schmitt, former U. S. Radio Inspector, 9th district.

**MONDAY, AUGUST 7th, 10 A.M.**

A.M.

10:00 Opening remarks by the President of the Radio Congress, Major J. O. Mauborgne, Signal Officer of the 6th Army Corps Area.

10:05 Mr. Benj. Miessner on "A Secrecy System for Radio Communication."

10:50 Mr. Samuel M. Kintner, General Radio Engineer, Research Dept. of the Westinghouse Electric & Mfg. Co. on "The Technique of Broadcasting."

11:35 Mr. John Mills, Research Engineer of the Western Electric Co., on "The Human Voice and Its Electrical Transmission," illustrated by motion pictures.

**MONDAY, AUGUST 7th, 2 P.M.**

P.M.

2:00 Dr. Louis Cohen, Consulting Engineer, Signal Corps, U. S. Army, Washington, D. C., on "Wired Wireless and Its Application to Broadcasting on Power Lines."

2:45 Mr. R. A. Heising, Research Engineer of the Western Electric Co., on "How Speech Is Carried."

3:30 Dr. J. H. Dellinger, Physicist in Charge of Radio Laboratory of the Bureau of Standards, Washington, D. C., on a subject to be announced later.

4:15 Senatore Guglielmo Marconi on "Radio Telegraphy." Discussion.

**TUESDAY, AUGUST 8th, 10 A.M.**

A.M.

10:00 Mr. A. A. Hebert, Treasurer of the American Radio Relay League, on "Amateur Radio."

10:45 Lt. Col. Louis R. Krumm, Superintendent of Radio Operations of the Westinghouse Electric & Mfg. Co., on "Broadcasting Operations, Present and Future."

11:30 Dr. H. W. Nichols, Research Engineer of the Western Electric Co., on "Radio Communication."

**TUESDAY, AUGUST 8th, 2 P.M.**

P.M.

2:00 Mr. Francis W. Dunmore, Radio Laboratory, Bureau of Standards, Washington, D. C., on "A Relay Recorder for Remote Control by Radio."



# When Marconi heard the AERIOLA GRAND



© UNDERWOOD & UNDERWOOD



Look for this  
trademark at  
your dealer

**I**T comes closest to the dream I had when I first caught the vision of radio's vast possibilities. It brings the world of music, news and education into the home, fresh from the human voice. It solves the problem of loneliness and isolation.

"The Aeriola Grand is at present the supreme achievement in designing and constructing receiving sets for the home—a product of the research systematically conducted by scientists in the laboratories that constitute part of the R C A organization."

*G. Marconi*

## The importance of the Symbol R C A

**C**RUDE radio apparatus of a kind can be made even by embryonic organizations. But the vitally important inventions that have made radio the possession of every man, woman and child are those protected by patents owned by the Radio Corporation of America and developed as the result of costly research conducted in the engineering laboratories of the Radio Corporation of America.

The name-plate of a Radio Set is all-important in the purchase of radio apparatus. If it bears the letters "R C A" the public and the dealer are assured that at the time of its introduction it is the highest expression of the advancing art of radio.

In tone quality, in simplicity of manipulation the Aeriola Grand is unrivalled. A child can snap the switch and move the single lever that tunes the Aeriola Grand and floods a room with song and speech from the broadcasting station.

Any R C A dealer will be pleased to show you the Aeriola Grand and to let you judge its wonderful tone quality for yourself.

There is an R C A set for every purse — Prices range from \$18 to \$350.

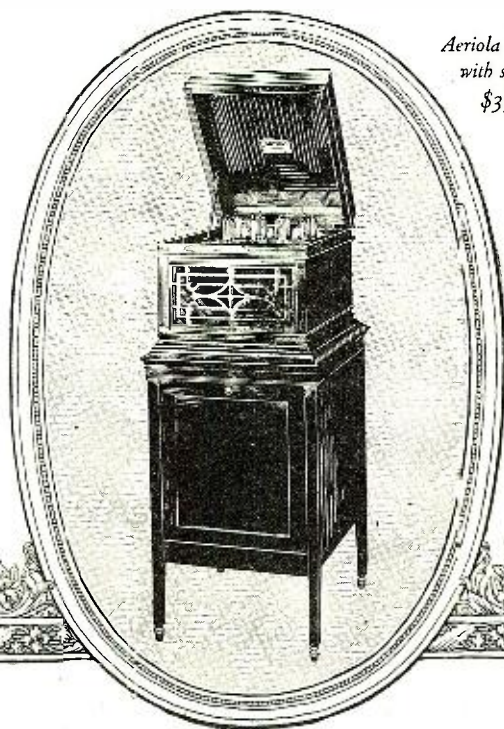

Aeriola Grand  
with stand  
\$350

**Radio Corporation**  
of America  
WORLD WIDE WIRELESS

Sales Dept. Suite 2065  
233 Broadway  
New York City

District Office  
10 South La Salle St.  
Chicago, Ill.



# What's in Your Phones?

It is an electrical principle that the greatest effect will be produced in a magnet when there are the greatest number of ampere turns within a given space.

It is this magnetic effect, and not the resistance caused by the great length of fine wire, that makes for sensitivity in receivers. Remember, when making a purchase of Elwood Head Sets, you are obtaining receivers with not only full ohmage capacity, but with this scientific standard correctly worked out.

We have been manufacturers of Electrical and Radio apparatus since 1905.

Above is an interesting sales point that radio enthusiasts may mention to you.

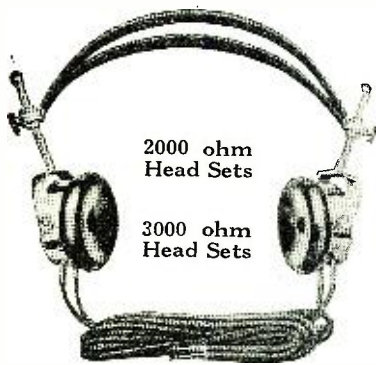

We make 3 different types in 2000 and 3000 ohm sets

## Elwood Electric Company

Incorporated

2-4 Randall Ave. Bridgeport, Conn.

### THE CHART TELLS THE STORY OF

# THE AMERTRAN

## A BROAD BAND AUDIO FREQUENCY SUPER-AMPLIFYING TRANSFORMER

which has been recently developed to meet the critical demand of discriminating radio engineers.

NOTE the amplification curve in the chart below compared with musical scale frequencies—plotted from actual and authentic tests.

Highest Amplification Constant Over Broadest Band of Frequencies—Absolutely Without Distortion or Resonance Peaks.

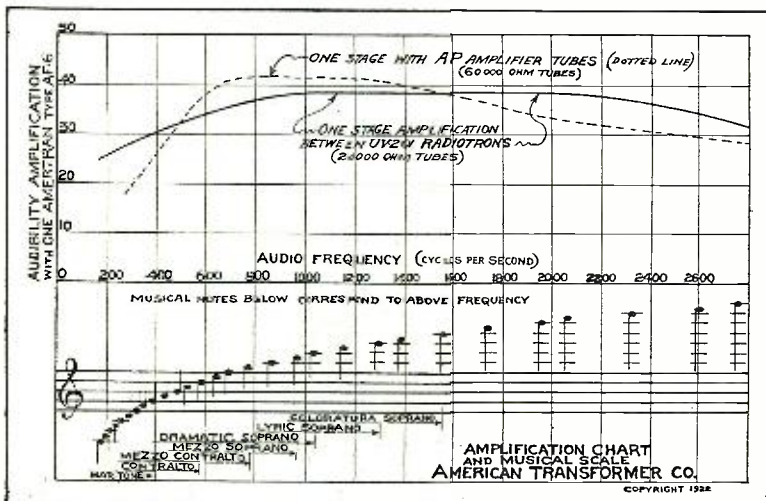

UNEXCELLED IN OPERATION—UNIQUE IN CONSTRUCTION  
LIST PRICE—\$7.00, F. O. B. NEWARK, N. J.

Made by the  
**AMERICAN TRANSFORMER COMPANY**  
NEWARK NEW JERSEY

P.M.  
2:45 Major General George O. Squier, Chief Signal Officer, U. S. Army, Washington, D. C., spoke on the subject concerning "Line Radio."  
3:30 Dr. Chas P. Steinmetz, Consulting Engineer of the General Electric Co., on "Radio."  
Discussion.  
Report of Radio Committee, Pageant of Progress, Mr. George E. Carlson, Chairman.

### NEW BROADCASTING WAVE PLANNED

The Department of Commerce contemplates inaugurating a new class of license for broadcasting stations which can meet certain requirements. These stations will be known as Class "B" stations and will be authorized to use the wave length of 400 meters. The qualifications necessary for obtaining this class of license will be ready for distribution within a few days, and will also be published in the September issue of the Radio Service Bulletin.

The new wave length may be used only with specific authority of the Department in special cases recommended by the District Radio Inspectors, where interference is at a maximum. This action on the part of the Government Radio Officials, pending the passage of the new Radio Bill, will aid broadcasting materially, especially in cities and sections where numerous broadcasters are located.

### Postal Radio Planes

(Continued from page 626)

that a plane can always be in contact with at least one field, and the fields approximately 250 miles apart.

The safety of the pilots is essential and so is the transit of the mail; therefore when a plane is damaged or delayed, radio advises of the predicament, specifying what aid is needed and the disposition of the mail. In some instances the mail is carried only part way across by plane, trains acting as relays between flights. By this method at least two days' time has been saved between New York and San Francisco, and an experimental letter reached Salt Lake in two days.

Night flying will speed up the mails materially and night flying is planned with the aid of radio. In working out the problem of a light and compact phone transmitting set, Superintendent J. C. Edgerton and Assistant Superintendent Charles I. Stanton have been testing out a mail plane in Washington, equipped with a Naval SE 1370 transmitting set and a special six-stage amplifier. The DH4, B plane so equipped flew about Washington, maintaining constant communication with the air mail and radio headquarters in the Post Office tower and Bolling Field. From distances up to about fifteen miles the set worked well, and messages were transmitted over a distance of twenty miles, although the words were barely audible. Improvements are being made which it is hoped will improve the set and secure an approximate 125-mile radius and cut the weight 100 pounds. The set is capable of tuning to four waves, 507, 600, 800 and 975 meters, but to date only 507 Naval Air phone wave has been used. The tests, begun last week Thursday, are conducted each day from 4 to 5 P. M. and will go in an effort to eliminate "bugs," but new and improved apparatus is being designed on a lighter and simpler basis. When maximum distance and audibility are secured, a number of sets will be built for the long distance mail planes in use.

When the phones are installed it is expected that a night pilot can get his position from two radio stations, just as a marine gets his bearings from radio compass



# Ask Uncle Sam He knows!

## BY FAR THE BEST FOR RADIO PANELS

Uncle Sam has used Bakelite-Dilecto XX on electrical and wire-  
less equipment in the Navy and Signal Corps for over *eight years*.

That's proof this unique material outdoes hard rubber, wood or  
marble. Uncle Sam does not adopt anything until he has tested  
everything!

# Bakelite-dilecto!!

Amazingly adaptable for RADIO panelling and insulation. Gives  
positive and permanent insulation and utterly eliminates vibration.  
Imparts a professional finish to any home-made set.

Tests highest in every particular. Unheard-of dielectric strength  
(proved constant 5.2). Resists water, heat and milder acids.  
Cannot warp or swell. Finished a sleek, everlasting black. Tough  
and hard; yet *easily machined*.

Tell us who your electrical supply man is and we will write you  
where to get Bakelite-Dilecto X X cut to your exact requirements.

### THE CONTINENTAL FIBRE CO.

Factory—NEWARK, DELAWARE

*Dealer service from*

NEW YORK . . . 233 Broadway	PITTSBURGH . . . 301 Fifth Av.
ROCHESTER . . . 85 Plymouth Ave., S.	SAN FRANCISCO . . . 75 Fremont St.
CHICAGO . . . 332 S. Michigan Av.	LOS ANGELES . . . 411 S. Main St.
SEATTLE . . . . . 91 Connecticut St.	

# bakelite dilecto GRADE XX



# COLUMBIA RADIO PARTS



Price, \$5.50  
With Dial, \$6.50

## COLUMBIA 180° MOULDED VARIOCOUPLER

A MOST efficient 180° coupler designed for sharp tuning from 150 to 650 meters. Stator made of a highly dielectrical composition. Rotor of moulded hard rubber; both wound with green silk covered wire. All metal parts nickel plated and mechanically correct. Ten taps are provided. Has 3/16" shaft with spring tension to insure electrical contact; base and panel mounting.

## COLUMBIA MOULDED VARIOMETER

A superior instrument with the Stator and Rotor of moulded hard rubber. Accurate electrical and mechanical construction throughout; designed for best values of maximum and minimum inductance and minimum distributed capacity. Has 3/16" shaft, with spring tension to secure electrical contact. Adapted for both base and panel mounting. All metal parts highly nicked. An essential radio instrument of beauty and efficiency.

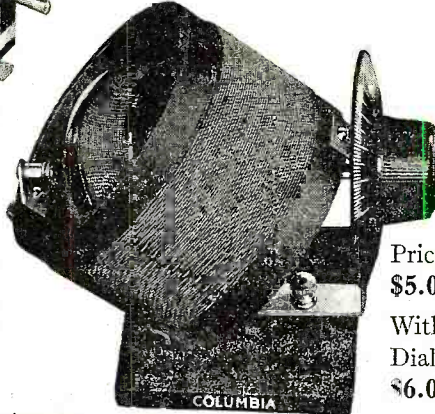

Price \$5.00  
With Dial \$6.00

Columbia Apparatus will add beauty and efficiency to your outfit. Variable Condensers, 23 plate, \$3.50; 43 plate, \$4.50. Bakelite or Hard Rubber Dial and Knob, \$1.00. If your dealer does not stock our items, send your order direct.

# COLUMBIA RADIO CORPORATION

2756 Diversey Avenue  
Chicago - Illinois

## Buy Your Radio Parts Direct from the Factory - PRICES SLASHED -

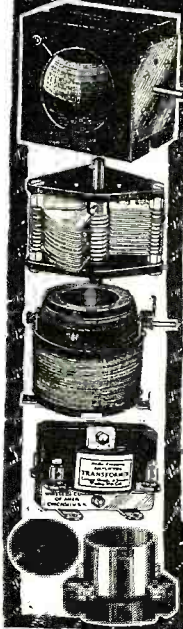

**Make Your Own Radio Set:** Buy your parts direct from the factory. Satisfaction guaranteed or money refunded. Every part carefully tested and inspected by radio experts.

This is your opportunity to make your own, efficient radio receiving set at small cost. Send full payment with order, or if you prefer, you may send deposit, and pay balance C. O. D., and we will ship any of the following radio parts at the bargain prices quoted:

	Regular Price	Special Price
Variometers.....	5.00	3.00
Vario Couplers.....	5.00	3.00
Transformers.....	5.00	3.00
23 Plate Condensers.....	3.60	2.25
43 Plate Condensers.....	4.50	2.75
Vacuum Tube Sockets.....	1.00	.65
Dials and Knob.....	1.00	.65

**FREE** Wiring diagram and blue print with every order. This special bargain price offer is for a limited time only. Act at once! Remember—we guarantee satisfaction or refund your money. Circular mailed on request.

**METRO ELECTRIC CO.**  
1422-1438 RANDOLPH ST. CHICAGO

### VACUUM TUBE REPAIRING

MARCONI MOORHEAD  
RADIOTRON U. F. 300-201  
CUNNINGHAM Q-300-301  
ELECTRON RELAY  
Amplifiers, \$4.50 Detectors, \$3.50

Satisfaction, prompt deliveries assured  
GEORGE H. PORELL CO., Inc., 364a Somerville Avenue, SOMERVILLE, MASS.

### RELIABLE RADIO SUPPLIES

We carry a complete line. Made by well known manufacturers. OUR CATALOG MAILED FREE EVERYWHERE

**H. GOLDBERG**

Established 1894  
1373 Third Avenue (Near 78th St.) NEW YORK

stations at sea. Radio would also advise the pilot of weather and ground conditions while he was en route between stations, eliminating the possibility of accidents in landing in fog or on washed-out fields. The radiophone is used so that the pilot need not learn the code and so he can talk directly into a transmitter and not have to take his hands from the "wheel" to "send"—he talks as he drives, so to speak, and hears as well.

## Is the Radio Amateur Doomed?

(Continued from page 624)

traffic manager says, in his preface to the rules and regulations of the Operating Department: "With the coming of high-class radiophone broadcasting we must heed the demand of citizens who desire to listen to such broadcasts. Consideration must be accorded those who desire the broadcast service and our relay work will find its periods confined to the later hours of the night. We must not encroach upon the rights of others with our relay message traffic. There were times when we could start our relay message traffic at any hour of the day or night, but with the coming of thousands of new men we had to adopt working schedules whereby each and every one was given a chance to carry on radio communication. Just so with the hundreds of thousands of citizens who find their radio pleasure in listening to concerts, lectures, etc.—we must not interfere with their sport and pleasure." With such a spirit, plus its technical ability and its long, successful experience, it would seem that the league might lead the radio public as it has the technical amateurs if it would broaden its scope.

But the rank and file are usually a few strides behind their leaders, and the preceding quotations express, I believe, the attitude of a considerable part of the radio amateur fraternity. They claim the air as Spain, England and other old world countries claimed America, by virtue of first discovery. The sad part of the story lies not in any criticism that may be made of this attitude, favorable or unfavorable, but in the fact that the great radio public cares less and less what their attitude is. The radio public wants to hear what it wants when it wants it, and every amateur who, though acting within his rights as he understands them, opens up and spoils a concert for the people in his town, hastens the day when there will be enough irritated radio users in Congress, and represented there, to consign him and his friends and his game to the pages of ancient history. It may seem unjust, but how are you going to help it, in a republic where majorities rule?

The American Radio and Research Corporation announced that it was considering suspending operation for a portion of each evening, in order to permit New Englanders to listen to New Yorkers and that kind of people. They asked for an expression of opinion from listeners and less than 10 per cent who replied thought the idea had any merit whatsoever. Those who "hated WGI with all their hearts" were strangely reticent about expressing themselves over their signatures. What is to be done in a case like that when a broadcaster, anxious to please the radio public, finds it overwhelmingly in favor of a whole evening's local program? Shall the radio public, even if its receivers are of the vintage of 1904, as alleged, be deprived of its entertainment for the sake of a comparatively small group of "radio amateurs"? Shall the decision be left to the amateurs?

In the matter of apparatus, the amateurs themselves are no more unanimous than the country is on prohibition. In the radio telephone conference in Washington one ama-



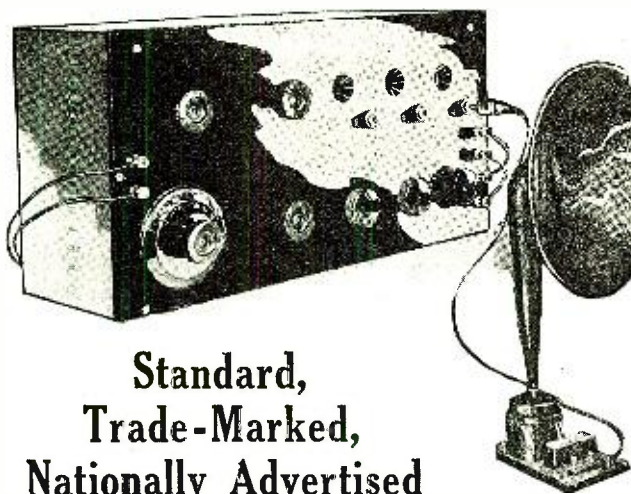

**Standard,  
Trade-Marked,  
Nationally Advertised**

# RADIO MERCHANDISE

**Will Help You Establish a Substantial Business**

**R**ADIO business will be brisk this fall and Christmas, but the radio buyers will carefully pick and choose. They will read more advertising and insist upon products of recognized merits.

The services of the Wholesale Radio Equipment Co., will be of incalculable help to you in holding this trade and firmly establishing your business. You can draw upon our never-exhausted stocks of radio products of 16 or more important, nationally known manu-

facturers and always depend upon delivery to the promised minute. Advantageous discounts.

Drop us a line now while it is fresh in your mind. Let us help you plan your business for the next six months.



**Get Your Share of the Fall and Christmas Trade. In-  
sure Ample Stocks of Standard Parts by Ordering NOW!**

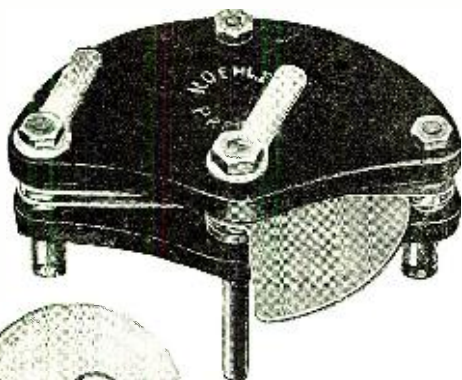

## Two Very Profitable SPECIALS

### Koehler 3-Plate Vernier Variable Condensers

Heavy aluminum plates, thick Bakelite ends, other parts of brass, nickel plated. .000075 MFD capacity. Accurately manufactured and carefully tested. Koehler Condensers have made good. Also made in other sizes.

LIST  
**\$1.50**

### GREWOL Crystal Detectors

No trouble selling this fixed detector. Stays adjusted. Guaranteed tested crystal in dust-proof glass cup.

LIST  
**\$2.00**

- DISTRIBUTORS FOR**
- Acme
  - Baldwin
  - Bradleystat
  - Chelsea
  - De Forest
  - Eveready
  - Federal
  - Homcharger
  - Jefferson
  - Klosner
  - Magnavox
  - Murdoch
  - Paragon
  - Thordarsen
  - Tuska
  - Western Electric
- WHOLESALE ONLY**

*Test Our Service With a Trial Order of These Two Standard Sellers*

*Write for Attractive Discounts on Our Complete Line*

**Wholesale Radio Equipment Co.**  
24 WILLIAM STREET, NEWARK, N. J.



# ARKAY UNIVERSAL CAM SWITCH

(PATENT APPLIED FOR)

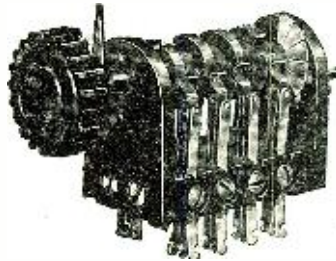

PRICE \$5

## Gives Absolute Control of Any Amplifier

There is no switch on the market superior to the ARKAY. It is built of highest grade condensite; contacts of sterling silver, set in nickel silver springs. Superior workmanship throughout—and backed by the Arkay guarantee. Takes the place of jacks and plugs in amplifier circuits. Rotary action gives instant change-over from detector to amplifier or succeeding changes of amplification, at the same time providing filament control. Can be used as a send-receive switch or short and long wave change switch, by merely shifting position of cams on shaft.

### ARKAY LOUD-SPEAKER RADIO HORN...\$5.00

The Arkay Horn fits any make of receiver, works on one or two stages of amplification, amplifies your signals, speech or broadcasted concerts without the slightest distortion. You get wonderful results through the Arkay. Black enamel, \$5.—Polished nickel, \$6.

**ARKAY CRYSTAL DETECTORS 75c**  
A detector with universal adjustment, permitting the whole face of the crystal to be searched for sensitive spots. Cannot be jarred out of adjustment. Takes either mounted or unmounted crystals.

**ARKAY VERNIER ADJUSTERS \$1.00**  
You can tune closer and sharper if you will attach this adjuster to your dials. Spring keeps the adjuster pressure constant.

### ARKAY PHONOGRAPH ATTACHMENTS \$1.50

### ARKAY VARIABLE CONDENSERS

Arkay Variable Condensers increase the sensitivity of your tuning set; afford a delicate adjustment on low capacities and insure positive operation throughout the range; made with hard aluminum plates. Cannot warp.  
15 Plate—.0005 Mfd. Capacity \$3.75  
23 Plate—.001 Mfd. Capacity \$4.75

Unmounted, no dial or knob.

Manufacturers, Jobbers and Dealers Will Be Given Liberal Discounts

**RILEY-KLOTZ MANUFACTURING CO.** 17 MULBERRY STREET  
NEWARK, - - N. J.

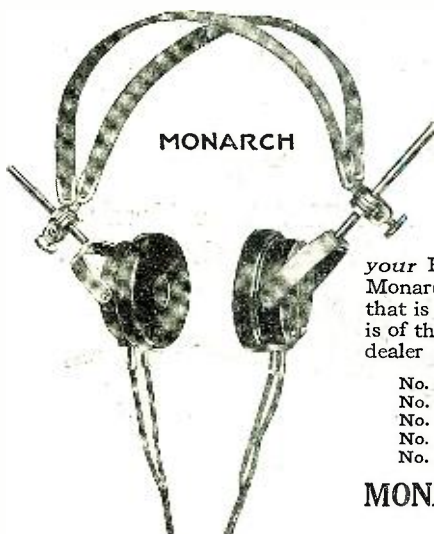

# MONARCH Radio Head Sets

have been designed and are produced under the supervision of Engineers who have been designers of high quality communication equipment for the past quarter of a century. *It pays to know* who makes your Radio Equipment. The reputation of the Monarch Company is behind *this* equipment, and that is your *guarantee* that Monarch apparatus is of the highest quality in *every respect*. If your dealer cannot supply you, order from us direct.

- No. 1-A-2000 Ohms—BAKELITE - - \$8.00
- No. 1-B-2500 Ohms—BAKELITE - - 10.00
- No. 1-C-3000 Ohms—BAKELITE - - 12.00
- No. 2-A-2000 Ohms—COMPOSITION - - 7.50
- No. 5-A-1000 Ohms—SINGLE SET - - 4.50

**MONARCH TELEPHONE MFG. CO.**  
Fort Dodge, Iowa, U. S. A.

# "ILLINOIS" THE RELIABLE CONDENSER THAT IS MADE RIGHT AND STAYS RIGHT

	Panel	Cased		Panel	Cased
67 Plates.....	\$7.00	\$8.50	23 Plates.....	\$2.75	\$4.00
43 Plates.....	3.50	4.75	13 Plates.....	2.25	3.50

Vernier with single movable plate applied to 13, 23 or 43 sizes, \$3.00 extra.

Above list is for our Regular Style with Knob, Pointer and Scale. We also furnish the Condenser with smooth 3-16 inch staff suitable for Dial at 15c off list.

A 3-inch Bakelite Dial with Condenser, add 75c to list.

A very beautiful 3½-inch Metal Dial with Condenser, add 50c to list.

Fully Assembled and Tested.

Money back if not satisfied. Just return within 10 days by insured Parcel Post.

Sent Prepaid on Receipt of Price, Except: Pacific States, Alaska,

Hawaii, Philippines and Canal Zone, add 10c. Canada, add 25c.

No Discounts except 5 per cent. on orders of 6 or more. Send for Bulletin.

**G. F. JOHNSON, 625 Black Ave., Springfield, Ill.**

teur assailed a type of apparatus made by another. He said it transmitted radio waves while being used as a receiver and thereby caused interference. An expert of equal standing told me after the meeting that the man who spoke had better look out, for the outfit the speaker was manufacturing himself did the same thing and he did not seem to know it. And that leads to the fact that a good many of the radio amateurs are manufacturers or dealers. Our leading organization strives to keep itself free from all commercialism and does it very well, I believe, but a number of its prominent members are about as amateurish in radio as A. G. Spalding & Co. are in baseball. A man who derives an income from a sport or pastime may be in it for the love of the game, but when his argument runs altogether to more expensive apparatus, can he expect the public to ignore the fact that he appears to derive a better profit from the higher-priced stuff?

In some ways the "amateur" idea is hindering the radio business. I speak now from observations brought up to date by a recent trip through five states, during which I talked with a lot of folks who represent the radio public. As a business radio has developed in a peculiar way. Before the broadcasting stations turned the technical sport to a popular craze, it was in the situation that the automobile business would have been in if its early promoters had been so interested in gear cutting and the chemistry of rubber that they had tried to make technicians of their customers and overlooked in their selling arguments the fact that a man with a car can take his family, his best girl, or the man he wants to sell a bill of goods to, out for a ride.

The radio amateur, even though he may have graduated into the business of radio, seems to carry with him the conviction that there is no fun for anybody in radio except that of experimenting. What he wants when he is operating a set is distance. He cares little what sort of a message he gets if it comes far enough. He cannot seem to understand why anyone should do what I did last winter, install a \$25 receiver that would bring in reliably half a dozen local broadcasting stations, and just let it work, supplying the household with concerts, lectures, news, addresses and all manner of entertainment with little or no interference.

Dealers possessed of the amateur's enthusiasm for highly developed apparatus recommend complicated sets to men who have had no instruction in radio and who do not want to spend the time to learn it. Some of them have killed prospect after prospect, influential men, whom I took to them for demonstrations. The demonstration was sometimes 50 per cent unintelligible sounds from the receiver and 50 per cent stories from the operator about the wonderful results he got last week.

There were second-hand sets for sale by disgusted customers almost immediately after the summer atmospherics added their interference to the bunch of trouble that the radio public was already having, and families are giving up radio because the amateur who operated the set was the only one who had any fun at all. In that situation it was, of course, the amateurs' buying and their ability to interest others in technical radio that saved the business from a total slump.

The percentage of the public that will ever catch the amateur's enthusiasm for things technical is as small as the percentage of doctors, lawyers and school teachers in the average town. The big fellows in the business know this and the amateur is bound to lose importance in their estimation as his purchases grow smaller and smaller in proportion to those of folks who want to use, not study, radio. It still seems to be necessary for persons living far from a broadcasting station to own and operate expensive and complicated sets if they are to



Unlimited resources of entertainment with the Magnavox Radio



IT is the Magnavox Radio which is invariably selected for demonstrations of technical or public interest. The two sizes of Magnavox Radio meet every requirement of volume and range—from the home gathering to the largest public audience.

R-2 Magnavox Radio		Model C Magnavox Power Amplifier
with 18-inch horn . . .	\$85.00	2 Stage—AC-2-C . . . \$ 80.00
R-3 Magnavox Radio		3 “ —AC-3-C . . . 110.00
with 14-inch horn . . .	45.00	

*The Magnavox products may be had of good dealers everywhere.  
Our interesting new booklet (illustrated in 3 colors) sent on request.*

THE MAGNAVOX COMPANY, Oakland, California; N. Y. Office, 370 Seventh Avenue

# MAGNAVOX RADIO

*The Reproducer Supreme*



## GET ACCURATE BATTERY READINGS

### DON'T RUIN YOUR BATTERY BY USING INACCURATE BATTERY TESTERS

**THE READ-EASY INSURES ACCURACY**

Frequent inspection is your only insurance against heavy repair bills, loss of time and untold inconvenience. But a test tells you nothing unless your readings are absolutely accurate. Know the truth about your battery. Read-Easy will tell. Order yours today.

*No Spilling or Splashing of Acid*  
**A Protection for Your Clothing and Rugs**

**DEALERS AND JOBBERS**—Our proposition means quick turn-over and volume sales. Our attractive counter display moves our goods off the dealers' shelves. We can give immediate delivery now in quantity lots.

Read-Easy is a quality, precision product.  
Handle the best hydrometer and you'll sell the most.

## ALA MANUFACTURING CO.

Radio Dept. No. 12  
401 to 419 S. Sangamon Street Chicago, Ill.

Sold on a strict Guarantee Adopted by Leading Battery Manufacturers

RADIO FANS—If your dealer can't supply you, send \$1.25 direct to us and we will send a "Read-Easy" at once parcel post prepaid insured.

# LEARN THE CODE AT HOME

*"Just Listen—The Omnigraph will do the teaching"*

## with the OMNIGRAPH

THE OMNIGRAPH Automatic Transmitter will teach you both the Wireless and Morse Codes—right in your own home—quickly, easily and inexpensively. Connected with Buzzer, Buzzer and Phone or to Sounder, it will send you unlimited messages, at any speed, from 5 to 50 words a minute.

THE OMNIGRAPH is not an experiment. For more than 15 years, it has been sold all over the world with a money back guarantee. The OMNIGRAPH is used by several Depts. of the U. S. Govt.

—in fact, the Dept. of Commerce uses the OMNIGRAPH to test all applicants applying for a Radio license. The OMNIGRAPH has been successfully adopted by the leading Universities, Colleges and Radio Schools.

Send for FREE Catalog describing three models, \$14 to \$30. DO IT TODAY.

## The Omnigraph Mfg. Co., 20 Hudson St., New York City

*If you own a Radio Phone set and don't know the code—you are missing most of the fun*

# HAYNES RADIO

New York's Oldest Exclusive Radio Store

## Haynes Precision Variable Condensers

Need no introduction, they are used universally today by the intelligent radio men who appreciate the value of a REAL Variable Condenser.

<p>Add Postage Shipping Weight, 2 lbs.</p> <table border="0"> <tr> <th style="text-align: left;">Capacity</th> <th style="text-align: left;">Price</th> </tr> <tr> <td>.001 mfd.</td> <td>\$5.75</td> </tr> <tr> <td>.0005 mfd.</td> <td>4.75</td> </tr> <tr> <td>.00025 mfd.</td> <td>3.90</td> </tr> </table>	Capacity	Price	.001 mfd.	\$5.75	.0005 mfd.	4.75	.00025 mfd.	3.90	<table border="0"> <tr> <td>1 henry Impedance Coils</td> <td>..... \$1.25</td> </tr> <tr> <td>12000 ohm Resistances</td> <td>..... 1.00</td> </tr> <tr> <td colspan="2"><small>(above for Armstrong Super-regenerative circuit)</small></td> </tr> <tr> <td>Genuine De Forest Type A-400 Audio-frequency Amplifying Transformers, fully mounted; regular list price \$6.50, at.....</td> <td><b>\$4.00</b></td> </tr> <tr> <td>Western Electric, Signal Corps released VT-1 Detector and Amplifier Tubes.....</td> <td><b>\$7.00</b></td> </tr> <tr> <td>Western Electric Signal Corps VT-2 Transmitter and Amplifier. (Ideal for Super-regenerative circuit.)</td> <td><b>\$9.00</b></td> </tr> </table> <p style="text-align: center;"><i>These tubes are not "rejects"</i></p>	1 henry Impedance Coils	..... \$1.25	12000 ohm Resistances	..... 1.00	<small>(above for Armstrong Super-regenerative circuit)</small>		Genuine De Forest Type A-400 Audio-frequency Amplifying Transformers, fully mounted; regular list price \$6.50, at.....	<b>\$4.00</b>	Western Electric, Signal Corps released VT-1 Detector and Amplifier Tubes.....	<b>\$7.00</b>	Western Electric Signal Corps VT-2 Transmitter and Amplifier. (Ideal for Super-regenerative circuit.)	<b>\$9.00</b>
Capacity	Price																				
.001 mfd.	\$5.75																				
.0005 mfd.	4.75																				
.00025 mfd.	3.90																				
1 henry Impedance Coils	..... \$1.25																				
12000 ohm Resistances	..... 1.00																				
<small>(above for Armstrong Super-regenerative circuit)</small>																					
Genuine De Forest Type A-400 Audio-frequency Amplifying Transformers, fully mounted; regular list price \$6.50, at.....	<b>\$4.00</b>																				
Western Electric, Signal Corps released VT-1 Detector and Amplifier Tubes.....	<b>\$7.00</b>																				
Western Electric Signal Corps VT-2 Transmitter and Amplifier. (Ideal for Super-regenerative circuit.)	<b>\$9.00</b>																				

NOTE—We do not make a practice of cutting prices, but are occasionally able to offer a few extraordinary Values such as the above, due to unusual purchasing facilities. The quantities at these prices are limited.

## HAYNES RADIO CO., Inc.

629 LEXINGTON AVENUE NEW YORK CITY

enjoy radio at all, but the spread of broadcasters puts radio nearer and nearer to the masses. Already the bulk of our population can have an entertainment any evening with crystal detector or single-tube sets. The amateurs can break up the show if they will, but unless they all read the signs of the times as their far-sighted leaders have and keep out of the public's way, their finish is in sight.

There is a more cheerful aspect to the matter, if the amateurs can see it. There is a great, unoccupied field in radio which they could occupy and in doing so make themselves so obviously necessary to their communities that they would receive support and assistance instead of increasing repression. The public is not yet awake to radio as a utility. It knows radio as a commercial proposition like the telegraph and as a partially successful home entertainer, but it does not realize that the air is full of valuable information and that government stations could be utilized for supplying exactly what any section needed if a request should be made through the proper channels to Washington. If radio amateurs should be the first to give the public an organized radio service, receiving and publishing all information that their respective communities should have, it would be as easy for them to get quiet air for tests and relays on occasion as it is for the school teacher to get a vacation, for they would have the public with them.

One thing that stands in the way is the fact that the technical amateur does not enjoy such service nor seem to appreciate that it is worthy of his attention. If it is brought to his notice he sometimes passes the buck or finds fault about the transmission of the broadcasts. "The establishment of a copying station is always the hardest thing in amateur radio," says the man whom I have quoted so often for the reason that he so well typifies the highly developed amateur, "because it is unutterably dreary, unrewarded and unrecognized. The public accepts success as a matter of course and sneers at the occasional failures that mark all radio work." His is typically the attitude of the laboratorian toward the practical application of the very things that he develops. There should be no quarrel with that. The world needs different types of workers. But should the small percentage of men so constituted attempt the impossible task of running the whole radio public into the same mold or look down upon the rest of us?

For every one of these specialists there are a hundred potential operators who for a year or longer would handle a copying service with enthusiasm and without thinking of any other reward than the high honor of being appointed to take charge of a community receiving station provided by the Chamber of Commerce, the Rotary Club or some other public-spirited organization. Thousands of older Boy Scouts would jump at the chance. The technical amateur does not need to carry the whole load. He could offer his technical ability to help in getting things started and thereafter lend a hand only when specially needed.

The technical amateur is always ready to help anybody who wants to learn about radio. It is not generosity that he lacks. The league offers its members' services to novices, and urges amateurs to assist local jewelers in installing radio receivers to bring in time signals. The A. R. R. L. has brought about the organization and enforcement of schedules designed to give everyone a share of the time. But the man who will sit up nights and strain his ears and adjust his apparatus hour after hour to add a hundred miles to his range is not the man to initiate a service which would take him away from his experiments, unless there are strong reasons for doing so. The A. R. R. L. handles a thousand citizen messages a day free of charge as material for its relay experiments,



# Radio Merchandise

**F. D. PITTS CO.**

INCORPORATED

219 Columbus Avenue

BOSTON, MASS., U. S. A.

*ANNOUNCES A CHANGE OF POLICY*

**WHOLESALE ONLY**



## DISTRIBUTORS FOR

A. H. GREBE & CO. (New England)  
RADIO CORPORATION OF AMERICA  
GENERAL ELECTRIC COMPANY  
WESTINGHOUSE ELECTRIC & MFG. CO.  
WIRELESS SPECIALTY APPARATUS  
COMPANY  
MAGNAVOX COMPANY  
CLAPP EASTHAM COMPANY  
WESTERN ELECTRIC COMPANY  
ACME APPARATUS COMPANY  
DEFOREST RADIO TEL. AND TEL.  
COMPANY  
FEDERAL TEL. AND TEL. COMPANY  
WM. J. MURDOCK COMPANY  
ADAMS MORGAN COMPANY  
PACENT ELECTRIC COMPANY  
CHELSEA RADIO COMPANY

REMLER RADIO MFG. COMPANY  
FRANK A. D. ANDREA  
HERBERT H. FROST  
ELECTROSE MFG. COMPANY  
SIGNAL ELECTRIC MFG. CO.  
GENERAL RADIO COMPANY  
AMERICAN RADIO AND RESEARCH  
CORP.  
JOHN FIRTH AND COMPANY  
GENERAL APPARATUS CO.  
C. D. TUSKA COMPANY  
AMERICAN EVER READY WORKS  
WIRELESS PRESS  
MURAD LABORATORIES  
DUBILIER CONDENSER COMPANY  
WESTON ELECTRICAL INSTRUMENT  
COMPANY

AND OTHERS

*Dealers are urged to send for our latest stock sheets, listing desirable radio merchandise for immediate delivery at attractive discounts*

---

The retail and mail order business formerly conducted by the F. D. Pitts Co., at 12 Park Square, Boston, Providence, R. I., and Springfield, Mass., is now operated by the "Pitts Radio Stores, Inc.," at the same addresses



# LEICH "NON TUNE" RADIO RECTIFIER

**A Rectifier for Charging "A" Batteries in the Home  
SAFE - RELIABLE - EFFICIENT**

The battery circuit is automatically opened if the power current fails.

The vibrator of the "Non Tune" Rectifier is shaft mounted and will operate over a considerable range in frequency.

The charging rate is two amperes. This does not over-rate the rectifier and is of a sufficient charging rate for the batteries.

This rectifier is equipped with ammeter showing rate of charge and may be used to charge any 6-volt battery

Used by the largest railroad systems for charging signal batteries.

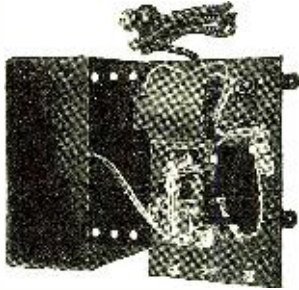

*Ask Your Dealer. If He Cannot Supply, Write Us*

**LEICH ELECTRIC CO.**

*Telephone Manufacturers*

GENOA, ILLINOIS, U. S. A.

## Get in Touch with Headquarters

To be sure of obtaining the greatest value for the money and GUARANTEED RELIABILITY in a

# RADIO RECEIVING SET

which will keep you in touch with the world's news and amusements—write, for full information—"Radio Recommendations"—and prices DIRECT to

RADIO HEADQUARTERS

## RAY-DI-CO ORGANIZATION INCORPORATED

*Designers and Constructors of only High-Class Radio Equipment*

*General Offices, Laboratory and Salesroom, 1215-1217 Leland Ave., Chicago*

*Retail Store and Shipping Department, 1547 North Wells St., Chicago*

**SPECIAL** *We are ready now to make arrangements with dealers throughout Illinois, Iowa and Wisconsin. Write for information.*

but only, in the language of my correspondent, "Some small towns now obtain bulletin service from amateurs."

QST, the mouthpiece of the league, finds great encouragement in the fact that the number of amateurs is rapidly increasing, yet can it be doubted that every amateur who gets into the game and operates a transmitting station brings the ether nearer the saturation point and the public nearer to the point of forcing the amateur transmitters all out of the air during the time when it is most convenient for them to work?

To sum the matter up, as I see it, the radio public is in control and is no more likely to give the radio amateur the air when common folks want to listen in than it is to give the speed specialist the road. The technical amateur may do much for radio as he has in the past, but his work probably will never be fully appreciated by the public because it is technical and because eventually it is almost sure to be exploited by commercial concerns whose interest is in promoting their own business rather than the reputations of amateurs.

Amateurs may succeed in forcing changes in the transmitters of government and commercial stations, as they have in the past, and may even change the radio public's receiving apparatus, but in doing so they are more apt to be classed as meddling busybodies than as public benefactors unless they use more tact than usually comes to the surface when we ride our hobbies.

If the technical amateur sticks to the silence of his radio den, hating the home folks whose normal activities interfere with his sport, his troubles are going to multiply. But if he will spare the time to come out and mingle with the common herd, organize us and lead us until we have a unified system of government and commercial broadcasts and a receiving end in every neighborhood so that we will get the really important information from Washington, Chicago, New Orleans and San Francisco daily, before, after or between the radio shows, he is going to be a guest of honor at many a banquet and a citizen whom everybody knows and likes. And he is going to have the consciousness of leading the greatest movement of the most important period in the history of the world.

## Details of an Efficient Universal Receiver

*(Continued from page 651)*

necessarily be adhered to in assembling the set, as there are several brands of reliable apparatus on the market which will prove equally as good. Much trouble was experienced in building previous sets in obtaining dials that would run true. The molded dials then available warped discouragingly. The dials on this set were turned from 1/4" sheet bakelite and engraved on a machine. They are the product of a manufacturing company in Portland, Ore., and have given complete satisfaction, as they are absolutely true.

As much or more pains should be taken with the wiring as with the other details of construction. Use bare wire and make all connections rigid and neat. Be sure to solder all joints. It is in the wiring that so many home-made sets fall short of the commercial standard which they often approach, and sometimes surpass in other details of construction.

If carefully made, this set will give unfailing service and amply repay the builder for his pains. The amplifier may be limited to two stages, but I personally find three of good use with the Magnavox.

Any questions regarding this set will be gladly answered by mail, if the person desiring the information will enclose a stamped, self-addressed envelope with his request.

The address is 597 Montgomery Drive, Portland, Oregon.

*Service*



*Satisfaction*

### RADIO ESSENTIALS

Radiotron UV-200 .....	\$5.00	Clapp-Eastham RZ Set.....	\$100.00
Radiotron UV-201 .....	6.50	Clapp-Eastham HR Set.....	40.00
Radiotron UV-202 .....	8.00	Clapp-Eastham HZ Set.....	40.00
Radiotron UV-203 .....	30.00	Westinghouse RC Set.....	132.50
Brach Arresters, inside .....	2.50	Westinghouse Aeriola Sr.....	65.00
outside .....	3.00	Klesner Rheostats, vernier .....	1.50
WECO Moulded Sockets .....	.75	Western Electric Phones .....	12.00
WECO Dials, rheostat .....	.90	Murdock Telephones, 2000 ohms .....	5.00
WECO Dials, 3", 1/4 or 3/16.....	1.00	Murdock " 3000 " .....	6.00
WECO Dials, 4", 1/4 or 3/16.....	1.45	Frost Telephones .....	Same Price

We are distributors for Radio Corporation, Clapp-Eastham, Murdock, Frost, Remler, Signal, Federal, Acme, Bristol, Everready, Willard, and many others.

*"You will like trading with us"*

**WHITALL ELECTRIC CO., Westerly, R. I.**





# The Recognized Symbol of Superior Performance



Ampliformer 2620. As illustrated, \$6.00. Unamtd., \$3.75

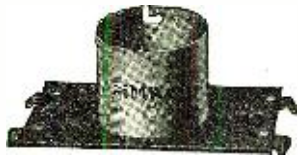

Tube Base 2154. Navy Type Design. Price \$1.00



Vernier Variometer 2610. A Miniature Variometer. Price \$2.50

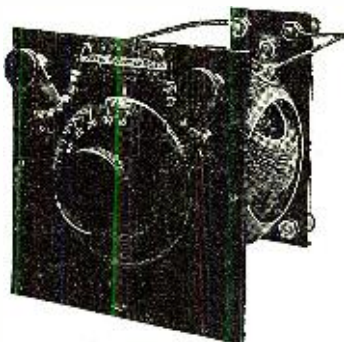

Basketball Vario-Coupler 2612 \$7.75, \$8.50 or \$14.50, according to type  
Basketball Variometers \$6.50, \$7.25 or \$11.50, according to type

## Use PROVEN Parts In Your Detector and Amplifying Panel

Thousands interested in Radio prefer to build their own equipment. The Amrad line offers the man of mechanical mind numerous receiving specialties of known value—products resulting from research and engineering experience in Radio antedating the late War.

For amplification, it's the Amrad RADI-FORMER for radio frequency and the Amrad AMPLIFORMER for audio. These transformers were specially designed for Radiotron tubes. Comparative tests have proved conclusively 25 to 50% greater amplification *without distortion* than can be obtained in conventional designs. Bulletins R and N, sent on request, detail the exclusive features of Amrad design which make this possible. Ask your dealer for these Bulletins or write our nearest office.

Amrad Grid Leaks and Fixed Condensers are useful necessities extremely popular with the radio man who builds. The Grid Leaks are furnished in six values while there are seven capacities available among the cartridge Condensers.

All Amrad Parts are standard equipment in Amrad Receiving Sets—Radio Products born of experience in manufacturing nearly a million dollars' worth of radio equipment to government specifications and more than as much again for the radio public. You can purchase them with full assurance of satisfaction provided they are identified as AMRAD.

## Amrad Basketballs

Basketball Variometers and Couplers are endorsed by radio engineers everywhere. But what we like best are letters from enthusiastic Amrad Basketball Fans in representative sections of the country—letters paying glowing tribute to the patented basket-weave windings guaranteeing low dielectric losses and maximum signal strength. There are SIX styles of Amrad Variometers and Couplers—each a BASKETBALL. Inspect the Basketball at your dealer's. Ask for descriptive Bulletin O.

For extra fine tuning the Amrad Vernier Variometer is the answer. This is a new wrinkle for tuning and "holding" C.W. It eliminates all shunt capacities. Described in Bulletin N.

Complete Amrad Catalog listing over 80 radio products 10 cents



Radiformer 3057-1. Price \$5.00 (The new Radio Frequency Amplifying Transformer)



Amrad Grid Leaks, 1/2, 1, 2, 3, 4 and 5 megohms. Price, each, 80c

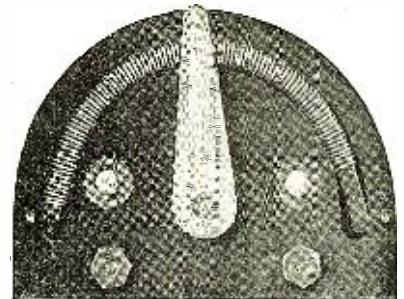

Rheostat 2621. Rugged. Ample Capacity. Price \$1.00



Fixed Condenser, 4-11 Capacities, Each, 45c

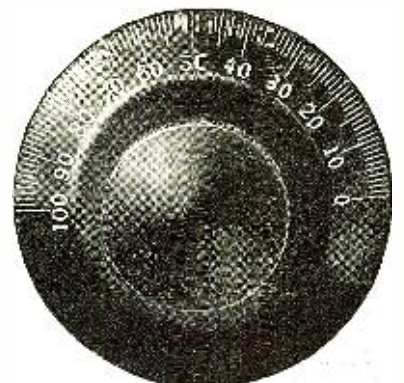

Knob and I al 2608. Price 75c Also in 50 Divisions. Shaft Diameter, 3/16"

# AMERICAN RADIO AND RESEARCH CORPORATION

New York District Office  
21 Park Row

General Office, Factory and Laboratory  
203 College Avenue, Medford Hillside, Mass.

Chicago District Office  
220 So. State St.



# Warren Head Sets



THE product of a *successful designer of Receivers.*

All WARREN Head Sets are thoroughly tested and toned alike. A guarantee covers every instrument.

Case—solid aluminum.  
Cap—hard rubber.  
All parts highly nickel-plated.

If after two weeks' trial you can show us a *better* Head Set than the WARREN, we will gladly refund your money!

Ask your Jobber—or write us.



Specialists in Head Sets and Loud Speakers

**WARREN RADIO PHONE MFG CO. Inc.**  
WARREN, RHODE ISLAND U.S.A.

## Radio Digest

(Continued from page 632)

traffic through the State offices. Wireless messages to Great Britain and Ireland will be accepted subject to the same rules as ordinary telegrams.

### RADIO SHOWS IN THE SOUTH

The first of a series of Radio Shows in the Southwest is scheduled for Houston, Texas, from September 18 to 23, inclusive. Other shows will be held at San Antonio, Texas, October 9 to 15, and New Orleans, Louisiana, November 13 to 19. It is the intention of the producers to stage additional shows throughout the territory during the fall and winter.

The co-operation of the manufacturers is being asked for to make up the most extensive and up-to-the-minute exhibits and demonstrations of radio apparatus possible. Besides many novel and entertaining features within the exhibition buildings, a program as diversified and elaborate as money will buy, will be broadcasted during each exhibition week. Professional artists only will be engaged for this work.

It is also planned to set apart certain hours, during which lectures and demonstrations will be given by famous experts in radio work.

The southwest is regarded as practically a virgin field for the radio manufacturer, and, while there are thousands of fans, in the main, they are floundering about in a sea of doubt and experimentation.

The radio show is expected to not only stimulate interest in radio and open up immense selling possibilities for the dealer, but to serve as a school for the amateur as well.

### APARTMENT HOUSE RADIO INSTALLATION

A choice of "listening in" to either of two programs being sent out by the big broadcasting stations will be a feature of a unique radio system being installed in a 72-family apartment house in Newark, N. J., by an electrical company. Two complete receiving sets will be installed, each with a large loop or directional aerial, pointed to a particular broadcasting station and the program received without interference from whatever may be coming in on the other loop.

A special radio room in charge of a licensed operator will house the equipment. From this room will emanate two complete circuits connected to each of the seventy-two apartments and so arranged that the tenant may plug in his receiving set to whichever of two programs he may prefer. The apartment operator will tune in each evening to the two stations that offer the best programs or are heard the clearest and in this way the tenants will be able to enjoy the best in the ether each night with the least of trouble.

Two complete receiving sets of the R. C. A. type, each equipped with a detector tube, two stages of audio and two steps of radio frequency, will be installed.

### RADIO IN THE PRISON

"Trustees" and officials at the Ohio State prison farm at London, Ohio, are now able to keep in touch with the outside world through the installation of a radio receiving set, purchased from the entertainment funds of the institution. The set, which has just been installed, will be enlarged within a few months by the addition of a transmitting set, through the use of which prison authorities hope to be able to bring about recapture of escaped convicts more quickly. The news of escape will be broadcasted immediately, to be picked up by amateurs in the vicinity,

## Manufacturers ! Send your Radio Jobbers Dealers • Needs to Us

**LARGE COMPLETE STOCKS — IMMEDIATE DELIVERIES**

*order anything you need*

If our stock does not include all you need, as a matter of service we will advise you where you can get it.

*Send for our New Fall Price and Discount Schedule*

Distributors For	RADIO CORP.	WESTERN ELECTRIC	DEVEAU
	WESTINGHOUSE	EVEREADY	FEDERAL
	CLAPP-EASTHAM	EXIDE	DEFORREST
	GENERAL ELECTRIC	BRACH	BRANDES
		AND OTHERS	

**TIMES APPLIANCE CO., Inc.**

145 West 45th St.

Wholesale Only

New York City

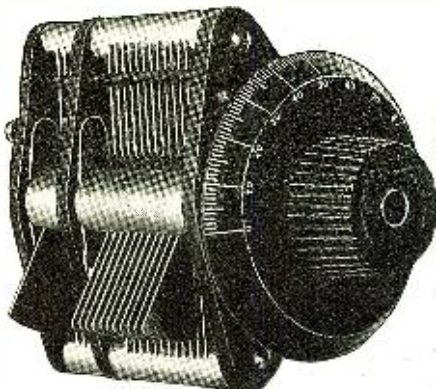

Niagara "Vernier" Variable Condensers Tune Sharply and Reduce Interference

Laboratory Quality—Commercial Prices  
 43 plate VERNIER, without dial.....\$7.00  
 23 plate VERNIER, without dial..... 6.25  
 3 plate VERNIER, without dial..... 2.25  
 43 plate Regular, without dial..... 4.75  
 23 plate Regular, without dial..... 4.00  
**JOBBERS AND DEALERS—Write for Discounts**  
 NIAGARA SALES CORP., 3 Waverly Pl., New York, N. Y.



Variometers } \$3.00  
 Variocouplers } each

Variotuners \$5.50

Wave Length 150-1600 Meters

Completely Assembled and Guaranteed

SEND FOR BULLETIN

**FREDERICK WINKLER, Jr.**

304 Columbus Ave., New York, N. Y.



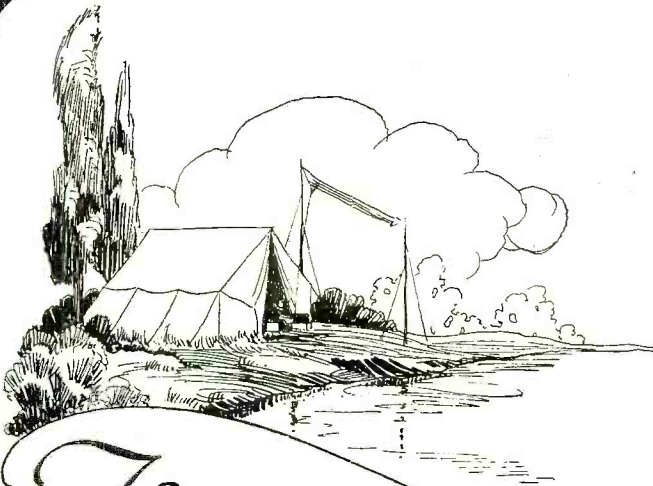

*The ideal combination for VT control without the use of jacks or plugs.*

*We are the inventors and sole manufacturers of the famous Klosner Vernier Rheostat Model 100, still being sold for \$1.50.*

*Write for interesting literature on the "Amplitrol" and the Klosner Rheostats. Address Dept. OA.*

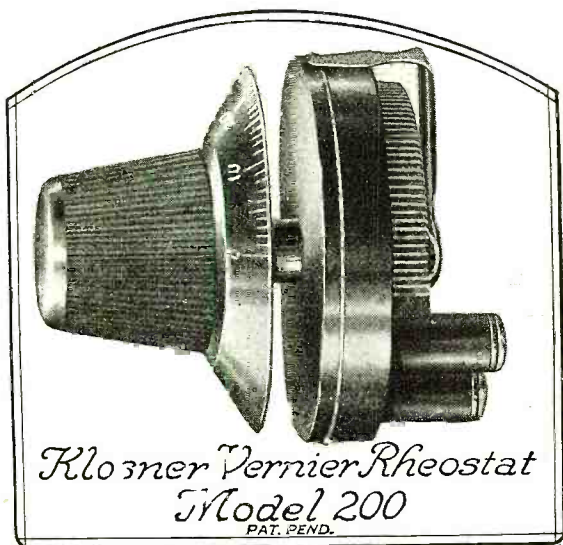

*Klosner Vernier Rheostat Model 200*  
PAT. PEND.

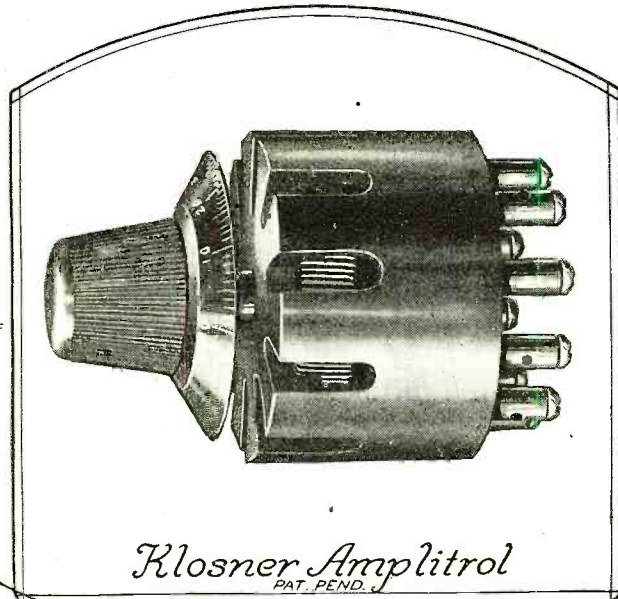

*Klosner Amplitrol*  
PAT. PEND.

THE long looked-for has at last arrived. The new Klosner "Amplitrol" fills that long-felt radio want—that of controlling the vacuum tube circuit without the use of jacks, plugs or any additional switches. A real radio necessity. Each of your amplifier tubes deserves one. No more plugging in from one stage to the next. Simply attach your phones or loudspeaker to binding posts and turn on any stage at will.

The "Amplitrol" not only adjusts the filament to its maximum efficiency, but it automatically controls the plate circuit at the same time, thus eliminating an extra operation. Unlike an automatic filament control, the "Amplitrol" does not put a sudden strain on your filament. It provides a gradual current increase for the filament, thus prolonging its life.

Made of moulded condensite. Contacts of phosphor-bronze. Exposed metal parts highly nickel plated. New style tapered knob, and dial correctly numbered in white lettering. Price...\$4.00.

What the "Amplitrol" is to the amplifying tube, so the Klosner Rheostat is to the detector tube. The new improved Rheostat Model 200, embodies some vast changes and improvements. These are too numerous to list, but your inspection will immediately win your approval. The "Amplitrol" and the new improved Klosner Rheostat are the ideal combination for your vacuum tubes. Klosner Rheostat Model 200. Price.....\$1.80.

The "Amplitrol" and the Rheostat do not employ the graphic-disc principle, but that of wire wound. This feature insures perfect contact at all times, making tuning quicker and louder and giving greater range. See them at your dealers or write for literature.

**Klosner Improved Apparatus Co.,**  
2024 Boston Road  
New York City



# BERWICK SUPREME

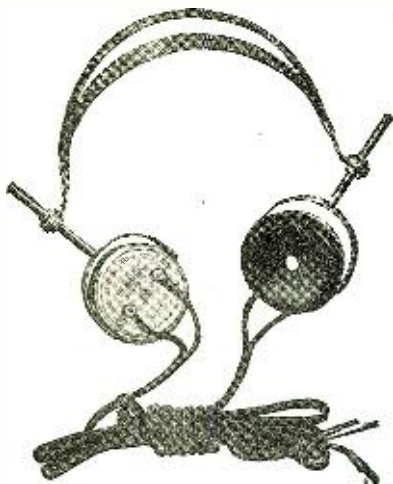

Aluminum Cups—2200 Ohms.

## A Reliable Head-set

THIS carefully manufactured and adjusted instrument invites comparison with your favorite make for clearness of tone, volume of sound, rigid construction, lightness and neat appearance.

We are satisfied to go by *your judgment—on your own test.*

The concern that is prepared to produce quality and deliver it at a price, gets the business.

**List \$8.**

*Awarded certificate of excellence by N. Y. Evening Mail. Sample set and discounts upon request.*

TRIANGLE ELECTRO TRADING CO., Inc.

632-34 Broadway

New York, N. Y.

Manufacturers

**BERWICK SUPREME RADIO TELEPHONES**

# Moulded-RADIO-Accessories

*Manufactured of Approved Material*

Specifications Solicited

**Knobs  
Couplers**

**Dials  
Panels**

**Rotors  
Stators**

## International Insulating Corporation

Radio Dept.  
25 West 45th St.  
New York City

Factory  
Springfield,  
Mass.

## LOOK AHEAD!

Men who understand and can operate radio apparatus are in increasing demand as operators and salesmen at good salaries.

We have trained thousands of successful radio men. Let us train you. Complete course covers

**Arc, Spark and Vacuum  
Tube Systems**

Send for free illustrated booklet

**Y. M. C. A. RADIO SCHOOL**  
158 East 86th St. - - New York City

"The Best Radio School in the East"

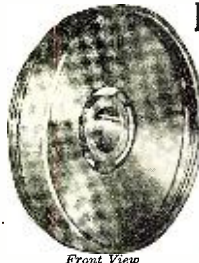

## REDUCE STATIC INTERFERENCE

Equip your head set with the **Wonderful Clariphone Attachment**

This simple device adds efficiency to the receivers and allows maximum results with no complicated horns or circuit arrangements—every word modulation and tone distinction easily heard—particularly effective for music receiving. Easy to hook up—no adjustments necessary.

Front View

Made for Western Electric and Stromberg-Carlson Receivers  
Price \$3.00 set of two postpaid.  
Stromberg-Carlson receiving sets completely equipped with Clariphones \$10.50

Order direct or through your dealer.  
Sole Patentees and Manufacturers

**THE COLYTT LABORATORIES**  
(Engineering) 565 West Washington St., CHICAGO

who in turn will advise the proper authorities.

The set has been installed in the reading room of the institution, but it is the plan of the officials to install additional aerials over the other structures at the institution, so that the receiving set may be moved from place to place as the occasion demands.

### 17 LIMITED COMMERCIAL OR BROADCASTING STATIONS LICENSED BETWEEN JULY 29 AND AUGUST 4, 1922

WIAX, Capital Radio Co., Lincoln, Neb.  
KFBB, First Presbyterian Church, Tacoma, Wash.

WIAV, New York Radio Laboratories, Binghamton, N. Y.

WKAA, H. F. Paar and Republican Times, Cedar Rapids, Iowa.

WKAC, Star Publishing Co., Lincoln, Nebr.

WJAK, White Radio Laboratory, Stockdale, Ohio.

WIAY, Woodward & Lothrop, Washington, D. C.

WJAM, Central Park Amusement Co., Rockford, Ill.

WIAZ, Electric Supply Sales Co., Miami, Florida.

WJAP, Kelly-Duluth Co., Duluth, Minn.

WKAD, Charles Loeff, East Providence, R. I.

WJAR, The Outlet Co., Providence, R. I.

WJAN, Peoria Star and Peoria Radio Sales Co., Peoria, Ill.

WJAX, D. M. Perham, Cedar Rapids, Iowa.

KDZT, Seattle Radio Ass'n, Seattle, Washington.

WJAL, Victor Radio Corp., Portland, Maine.

WKAJ, W. S. Radio Supply Co., and Wm. Schack, Wichita Falls, Texas.

### RADIO TELEPHONY IN ARGENTINA

No laws have yet been passed to govern wireless telephony in Argentina, but a bill is being drafted for presentation to the next Congress to regulate the use of radio sets.

No regulations at the present time in effect prevent the sale of broadcasting and receiving sets. The latter are being manufactured to some extent locally, but of very inferior quality and sell at from 200 to 700 pesos.

### NEW BROADCASTING STATION

The Radio Electric Company of Pittsburgh has recently been assigned call letters WHAF for its broadcasting station. Scheduled programs will begin about September first.

This broadcasting station will be under the direction of Mr. Parker E. Wiggin, Chief Engineer of the Radio Electric Company.

Weather reports, news broadcasts, educational features and musical programs summarize the work to be accomplished by this station.

### THE BROADCASTING SITUATION IN ENGLAND

Radiophone broadcasting in England will soon become as popular as in the United States.

The last few months have been spent by the various wireless instrument manufacturers in coming to a practical working scheme, the object of which is to cover the whole of the British Isles with broadcasting areas, and at the same time endeavor to keep mutual interference at a minimum.

The following towns have been selected and stations of a 1½-K.W. rating will be shortly opened and operated. The centers



Mt. Tamalpais, California, whose rugged slopes and lofty summit are plainly visible from the plant where Parkin Parts are made

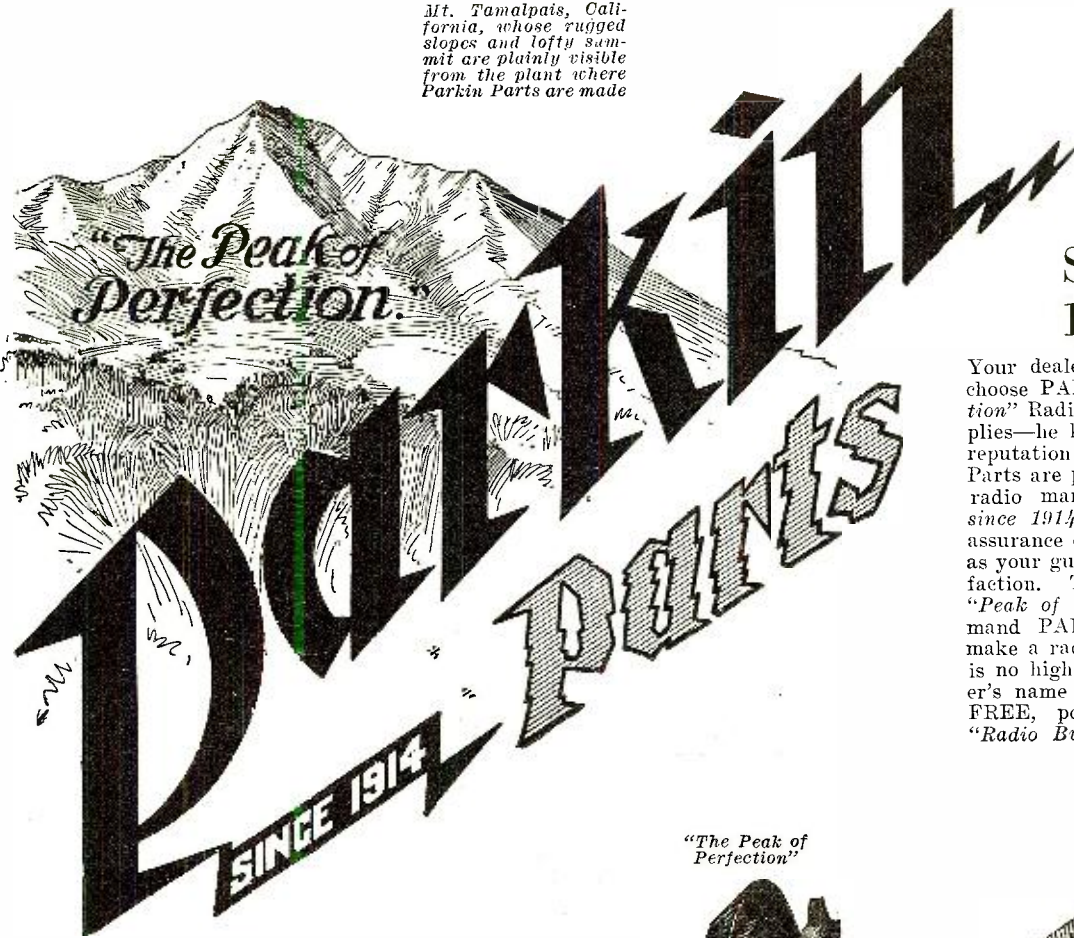

SINCE  
1914

Your dealer is glad to have you choose PARKIN "Peak of Perfection" Radio Parts and Radio Supplies—he knows he can stake his reputation on them. For PARKIN Parts are produced by experienced radio manufacturing—PARKIN since 1914. This is the dealer's assurance of dependability as well as your guarantee of perfect satisfaction. To be sure of getting "Peak of Perfection" quality, demand PARKIN every time you make a radio purchase. The price is no higher. Send us your dealer's name and we will send you FREE, postpaid, the PARKIN "Radio Buyer's Guide" (No. 7).



\$1.00

**PARKIN VT SOCKET**  
panel or table mounting

—for maximum insulation. Moulded of genuine Bakelite, highly polished; contact fingers, binding posts, screws, and washers nickel plated. Base 2 1/4" by 2 3/4", marked for proper connections. Price includes screws for panel mounting, and holes drilled for table mounting. Order No. 78—price \$1.00.



\$1.75

**PARKIN Dial Type RHEOSTAT**  
(Patented)

The resistance element is mounted in a recessed groove in the back of a 3-inch moulded Bakelite dial, which saves you the cost of an extra part, gives you more cabinet space, and eliminates resistance heating from inside of cabinet. An off position is provided and a stop on the dial engages the stationary contact at the extreme positions. 360° rotation insures fine adjustment, and a brass bearing insures true running. Figures and graduations filled with brilliant white enamel. Brass parts nickel plated. Dial and knob both of die-moulded Bakelite. Resistance 5 ohms, carrying capacity 2 amperes. Only two panel holes required for mounting. Instructions with each instrument. Order No. 77—price \$1.75.

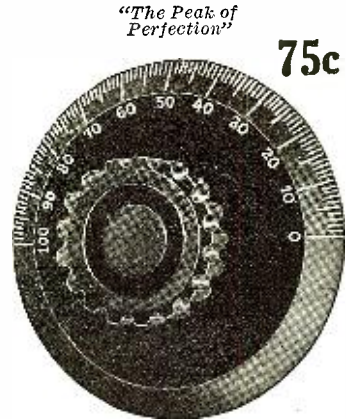

75c

**The PARKIN Bakelite Dial**

A dial whose easy action, smooth running and positive accuracy make tuning a real pleasure. A dial which we believe is worthy the name of PARKIN and the years of radio manufacturing behind it. A standard dial of moulded Bakelite highly polished. Graduated from 0° to 180°. The graduations read from right to left for clockwise rotation, and are filled with brilliant white enamel for easy reading. The knob is of moulded Bakelite. The brass bushing is moulded into the dial to insure easy action and true running. The set screw penetrates both the bushing and the knob. Drilled for either 3/16 or 1/4 inch shaft. Order No. 76—price 75c.



70c

**PARKIN Fixed Receiving CONDENSER**

Regulation type for use with receiving circuits. The binding post screws are soldered to the unit, and with the unit moulded solidly into an unbreakable Bakelite base, making a sturdy and attractive one-piece instrument. Order No. 53—price 70c.

**DEALERS and JOBBERS:** We want to hear from every radio dealer who has the foresight to realize that he must sell quality and give service to build a profitable business. If you are that kind of a dealer, write us, we have something for you. Ask for Catalogue No. 7.

**Parkin Mfg. Co.**  
San Rafael, California



OCTOBER **EMPIRE RADIO** BULLETIN

**A NEW EMPIRE PRODUCT**

*Built up to a standard, Not down to a price*



**Price only 95c**

**Description:** Resistance unit of 6 ohms, carrying capacity  $1\frac{1}{2}$  amperes, firmly secured in high heat insulation base. The action is absolutely smooth and noiseless. Contact lever is of phosphor bronze, pointer is hand polished nickel. Knob is of polished bakelite, knurled and tapered. Shaft takes any thickness panel.

**NOTHING BETTER CAN BE HAD IN RHEOSTATS**

*Dealers and jobbers write for attractive proposition  
Amateurs send 10c for our new and complete catalog*

**EMPIRE RADIO CORPORATION**  
Manufacturers and Distributors of Radio Apparatus

271 West 125th Street New York City



*Mr. Maker of Radio Apparatus Try*

**NATIONAL SEAMLESS TUBING**  
in Large Diameters

For Vario-couplers, Variometers, Tuning Coils and wherever you use large diameter fibre tubing, this tubing is less expensive and infinitely superior.

It is a fibre tube built especially for radio work. Will not warp, shrink or swell. Exact dimensions, high dielectric. Sizes from 3" to  $4\frac{1}{2}$ " ID, any thickness of wall from  $\frac{3}{32}$ " up. Comes in Dark Gray, Black, or dipped in insulating varnish. *Samples and prices on request.*

**Use National Fibre for Panels**

Hard, black stock, for condenser tops and bottoms, rheostat bases, bushings, etc. Let us quote on the stock, or completed parts machined to order.

**Ask for Peerless Insulation**  
The Standard thin weight fibre or "fish paper."

**NATIONAL FIBRE & INSULATION CO.**  
BOX 472    --    --    --    YORKLYN, DELAWARE

**"NENCO" "B" Batteries**

THE MOST EFFICIENT MADE

Last Longer—Serve Better—Cost Less

Made In  
All Standard Sizes and Voltages

**National Electric Novelty Co.**  
53 Walker St. New York, N.Y.



are: London, Cardiff, Birmingham, Manchester, Plymouth, Newcastle, Edinburgh and Aberdeen.

The manufacturers, it is understood, have approached the British Government with the object of obtaining protection for British-made wireless sets. They argue that hardships will be involved, if after a heavy outlay has been made in the erection of the broadcasting stations, foreign manufacturers, especially Germans, are allowed to flood the market with cheap receiving sets. The necessary protection, it is believed, will be forthcoming.

The estimated cost of a broadcasting program is something like \$100,000 a year for each of the eight stations, and several suggestions have been made whereby the manufacturers may be aided financially. At present a proposal that the price of the Government "listening in" license, which all possessing wireless sets have to obtain and which at the moment is approximately \$2.50 a year, should be increased and that this increase should be reserved solely for providing a broadcasting program, is being considered by the authorities.

Considerable interest is now being shown in the enterprising action of the London *Daily Mail*. The publishers of this paper have undertaken the continuance of the wireless concerts from The Hague, which would soon have ceased owing to lack of funds. It is intended at present to transmit concerts every Sunday and Thursday evening between 7 and 8 o'clock British summer time. The wave used will be 1,050 meters and the power will shortly be increased to  $1\frac{1}{2}$  K.W. With this power the promoters are hopeful of attaining a radius of from 1,000 to 2,000 miles.

Contributed by J. E. DAVIES.

#### SHORTHAND STUDENTS USE RADIO SETS TO GAIN SPEED

A novel aid in the study of shorthand, the taking of dictation from wireless speeches and programs, is the latest means of utilizing radio receiving sets in Pittsburgh.

Ruth Baker, who lives at 118 East Ohio Street, Pittsburgh, Pa., listens in and transcribes the text of speeches into shorthand notes while enjoying the radio program broadcasted from KDKA, radio broadcasting station at East Pittsburgh, Pa., and thus finds unlimited opportunity for practice.

"It's really fun," Ruth declares. "I like to hear the wireless program and I just take down shorthand notes while I am listening to the speakers. Then, instead of having to study my shorthand after the entertainment, all I have to do is to transcribe my notes for practice. It makes study a pleasure."

The method is recommended as an excellent one by Prof. O. B. Hughes, head of Park Institute, Pittsburgh, which Ruth attends. Many other schools are advising their pupils to employ the radio in similar fashion.

Difficulty often has been found by pupils in finding members of their household to dictate to them. Now, instead of coaxing a brother or sister into serving as unwilling dictators, or separating "Dad" from the sporting sheet, the shorthand student finds almost unlimited dictation in the eloquence of week-day speakers or the quiet Sunday morning sermon over the home radio set.

#### FEDERAL RADIO ACTIVITIES INCREASING

Since the establishment of the Inter-Departmental Radio Board, radio activities in several of the governmental departments and bureaus have been increasing rapidly. The Army and Navy are constantly going full tilt and increasing their official and public service almost daily, while the Post Office, with fifteen stations, is perfecting radio-



# RASCO GIVES \$250.00 IN PRIZES TO RADIO AMATEURS

## \$250.00 IN PRIZES FOR RADIO AMATEURS

**T**HE Radio Specialty Co. today is the only radio supply house in the United States specializing exclusively in radio parts. With one or two exceptions we manufacture no complete apparatus whatsoever.

The Radio Specialty Co.—RASCO for short—manufactures some three hundred specialties which are advertised in their catalog and which have been advertised in these pages for a long period. The Radio Specialty Co. is always on the look-out for new ideas. Hence, this prize contest. There is hardly a radio instrument that cannot be built with our parts, and to prove this we are willing to give away prizes to show the other amateurs what can be done with our multiplicity of radio parts. What this apparatus or instrument will be we leave entirely to the amateur radio fraternity. Look over our catalog carefully and select the parts and pieces that you think are necessary for building the instrument or apparatus. It may be a complete receiving set or it may be any other single instrument that you may choose.

The first prize will go to the amateur who constructs a complete set or instrument using the greatest amount

RASCO parts are used the better chance the contestant has to win a good prize.

\$250.00 IN GOLD	
First Prize .....	\$100.00
Second Prize .....	75.00
Third Prize .....	25.00
Fourth Prize .....	20.00
Fifth Prize .....	15.00
Sixth Prize .....	10.00
Seventh Prize .....	5.00

Bank Reference: Irving National Bank (Aetna Branch), New York.

of "RASCO" parts illustrated in the RASCO catalog. The next greatest number of "RASCO" parts used will win second prize, etc. It is, however, permissible for the builder to buy cardboard tubing, baseboards or cabinets, nails, etc., from other sources, as some of these parts are not listed or sold by us. Naturally, the more

Rule 1: In order to compete, it is necessary that all parts are bought from Radio Specialty Co. Keep your receipts as proof. Also the date and amount of your order.

Rule 2: The complete instrument, which shall remain the property of the owner, is to be sent to the Radio Specialty Co., and the instrument will be returned to the owner as soon as the prizes have been awarded.

Rule 3: As the Radio Specialty Co. does not build telephone receivers, vacuum tubes and vacuum tube sockets and other apparatus, these may be bought from other firms and incorporated in the outfit if the builder so chooses.

Manuscripts accompanying models should not be longer than one thousand words.

All prizes will be paid immediately upon the close of the contest and as soon as our engineers have completed the tests which will be within eight days of the closing of this contest.

In the event of ties for any of the prizes offered, the full amount of the prize tied for will be awarded to each of those contestants so tying.

This special contest closes in New York City at our offices on November 25th and the prize winners with full description of the ideas submitted will be announced in the February, 1923, issue of this publication. Address all models, etc., to Manager, RASCO Parts Contest, care of this company.

## "RASCO" JACKS AND PLUGS

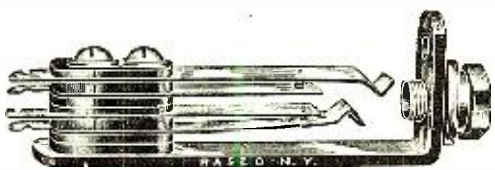

No. 1000 Jack, \$0.75



No. 1001 Jack, \$0.80



No. 1002 Jack, \$1.00

We introduce herewith to the radio fraternity the RASCO line of plugs and jacks. After having studied all the other plugs on the market, we have eliminated all the disadvantages of the poor ones and have incorporated in ours all of the good points of the best plugs, and have added several improvements of our own. By having our own metal factories, we are in a position to sell these plugs and jacks at a considerably lower price than those offered by other reputable concerns.

Our factory which has for twelve years made plugs and jacks for the Postal Telegraph Co. is now making these radio plugs and jacks, which although somewhat different, embody the same principles as the ordinary telephone jack. The long experience of our factory is your guarantee.

Note particularly, and we lay special stress on this, that all of our jacks are equipped with **PURE SILVER CONTACTS**. When buying plugs whether it be ours or other makes always insist upon silver contacts. Some concerns are selling jacks without silver contacts, which are of course worse than useless, because such contacts give rise to microphonic action, which in turn produce noises in the telephones or rooms and squeals in the loud talker.

RASCO jacks are made of the best material that money can buy, and the construction is correct, behind it being the soundest engineering practice. The springs are very heavy and the tension is right. The jacks are rugged,

have positive action at all times while the silver contacts are very large, insuring absolute electrical contact. The construction of the bracket is brass, heavily nickel-plated and buffed.

Specify RASCO plugs and jacks and avoid disappointment. We are manufacturing three types of jacks which have proven to be the best sellers.

- No. 1003 Rasco Plug .....Price \$0.75
- No. 1001 Rasco Jacks, 3 springs...Price 0.80
- No. 1000 Rasco Jack, 4 springs, double circuit.....Price 0.75
- No. 1002 Rasco Automatic 5 spring Jack .....Price 1.00



No. 1003 Plug, \$0.75

## THE "RASCO" CATALOG

CONTAINS 50 VACUUM TUBE HOOK-UPS

Complete hook-ups of all important vacuum tube circuits are given in clear diagrams with complete explanation. Just to name a few.—The V.T. as a detector and one-step amplifier; regenerative circuit; De Forest ultratrouble; V.T. to receive undamped and spark signals; Armstrong circuits; one step radio frequency amplifier and detector; three stage audio-frequency amplifier; short wave regenerative circuits; V.T. radio telephone; 4-stage radio frequency amplifiers; radio and audio frequency amplifier, inductively coupled amplifier; Armstrong superautodyne; radio frequency amplifier and crystal detector; etc., etc. The catalog contains 200 illustrations. On account of its great cost, it cannot be distributed free of charge. Mailed only upon receipt of



This business was originated with the sole purpose to cater to the amateur who has small orders. ALL OF OUR ORDERS ARE SMALL and that is why your small order will never be side-tracked by us. A trial order will make you a life customer. Order from the above illustrations. "We can only stick you once." Try us with a small order. ALL GOODS PREPAID.

### DEALERS

Get Our Special Proposition

98 PARK PLACE, NEW YORK CITY

Factories: Brooklyn, N. Y.—Elkridge, Md.

15c in stamps or coin.



## THE STORM-LEE MULTIPLEX ROTARY SWITCH

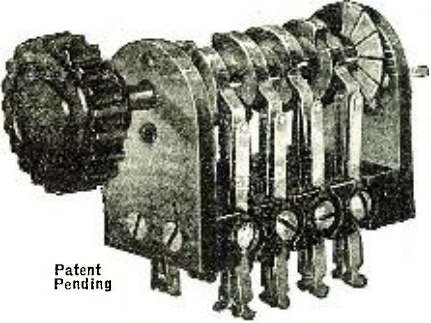

**The Perfect Amplifier Switch, Gives Complete Control of Detector and 1, 2 or 3 Stage Amplifier, Including Automatic filament control.**

The MULTIPLEX ROTARY SWITCH takes the place of filament control jacks in the vacuum tube control panel, giving much greater convenience at lower cost. With this switch you may change from detector to any desired stage of amplification by merely turning one knob. Filaments of unused stages being automatically extinguished.

**UNIVERSAL IN USE**

This switch is adjustable; by loosening one nut the cams may be adjusted to meet practically any switching requirements.

**SPECIFICATIONS**

INSULATION—BAKELITE  
SPRINGS —NICKEL SILVER  
CONTACTS —STERLING SILVER

**PRICE - - - - \$5.00**

If your dealer cannot supply you write us, giving his name.

**DEALERS - MANUFACTURERS**  
WRITE FOR DISCOUNTS  
**STORM-LEE RADIO APPARATUS CO.**  
742 HIGHLAND AVENUE  
NEWARK, N. J.

Patent Pending

**BEWARE!** of imitations of our Switch. We are the originators of this type universal cam switch, protected by Patents Pending.

## An important announcement concerning THE NEW EASTERN CLASSIC—EDA-4

**A** COMPLETE receiving unit equipped with three stages of amplification, set up in a beautiful mahogany cabinet similar in construction and design to the talking machine.

**O**NE of the radical improvements made is a loud speaker within the cabinet, thus keeping the entire unit intact. The New Eastern Classic will make a beautiful and practical addition to the home, and the price is well within the reach of all. **\$125 00**

*Attractive discounts to dealers and jobbers*

Manufactured by  
**EASTERN RADIO MANUFACTURING COMPANY**  
122-124 Fifth Ave. New York, N. Y.

## DEPEND ON CRAMER RADIO



**SPECIAL**  
**For 30 Days—This \$80 Receiver for Only \$45**

The CH5 receiver needs no introduction. Judged by any standard it is without equal anywhere. Simple in control; handsome in appearance; super-efficient in operation. Includes in its 150 to 2000 meter range, amateur, commercial and Navy waves, special band stations, ship stations and Arlington "Time." Employees' latest inventions. Especially efficient for radiophone concert reception. Guaranteed in writing for one year. Regular price \$80—and worth it. **SPECIAL PRICE ONLY \$45.**

**ORDER ONE NOW!**  
Send cash only—no CODs. Only one sold to a customer.

**W. R. Cramer Co., Dept. 2, Omaha, Nebr.**  
"Pioneer Radio Manufacturers"

## BE A RADIO WIZARD

Have your set the best. Make the other fellows look up to you as a radio expert.

It's easy when you have the Standard Radio Encyclopedia, by A. Howland Wood, Ex-Navy Instructor and Radio Engineer. Explains every instrument plainly. Tells how they work. Shows how to build, hook-up and operate. Nearly 100 illustrations, wiring diagrams etc. Written in plain English that clearly explains the most difficult technical terms.

You need this book to really know radio. It only costs \$2.00 postpaid. Your money gladly returned if you are not *absolutely satisfied*. Order today from **Perry & Elliott Co., 146-D Summer Street, Boston, Mass.**

--- EASY ORDER BLANK ---

**PERRY & ELLIOTT CO.**  
146-D Summer Street, Boston, Mass.

Enclosed is \$2.00. Send me the Standard Radio Encyclopedia. If I'm not absolutely satisfied, I can return it and get my money back.

Name \_\_\_\_\_

Address \_\_\_\_\_

phone broadcasting and planning control of its cross country air mail planes. The Public Health Service and the Bureau of Education now expect to open broadcasting services for the dissemination of information and educational matter.

A little while ago the Veterans' Bureau began weekly broadcasting of want ads.; Secretary Davis wants a labor radio news service, and the Department of Commerce has just authorized its thirty-three co-operating offices to arrange with local broadcasting stations to release all cable and radio information on foreign markets in the form of a daily world survey.

Shortly you may expect to hear interesting items on foreign trade and commerce emanating from broadcasting stations at Akron, Atlanta, Baltimore, Boston, Bridgeport, Chattanooga, Chicago, Cincinnati, Cleveland, Columbus, Dallas, Dayton, El Paso, Indianapolis, Los Angeles, Milwaukee, Newark, New Orleans, New York, Norfolk, Omaha, Pensacola, Philadelphia, Pittsburgh, Portland, Richmond, Rochester, San Francisco, St. Louis, Seattle, Syracuse and Manila.

The Inter-Departmental Committee, which acts on government priority in broadcasting, when the Naval stations are used, has before it a large number of requests, as practically every governmental department has found radio beneficial to its operation, if not essential.

On August 4 the Assistant Secretary of the Treasury will employ the Naval Radio Station at Anacostia to broadcast a message to the U. S. Coast Guard on the 132nd anniversary of its creation.

### GOVERNMENTAL BROADCASTING COMMITTEE

A recently organized Inter-Departmental Committee now advises Secretary Hoover regarding the priority of Government material to be broadcasted and submits schedules of operation.

The committee recognizes the principle that radio must be used primarily for types of service that cannot be as satisfactorily conducted by other means of communication, and therefore radio broadcasting should not be used in general where wire telegraphy or telephony or printed publication would be as satisfactory. The scope of the committee's activities may be extended in an advisory capacity to the Secretary of Commerce in matters of Government radio regulation and considering all radio questions of inter-departmental interest.

Eight existing governmental stations designated as primary stations for the transmission of daily news and information include Naval stations at Arlington and Great Lakes, Post Office stations at Washington, Omaha, North Platte, Rock Springs, Elko and Reno. The material sent out may be re-broadcasted by other stations licensed as "limited commercial."

The personnel of the committee follows: Agriculture, W. A. Wheeler; Commerce, Dr. S. W. Stratton, Chairman; Interior, O. P. Hood; Justice, S. Ely; Labor, A. E. Cook; Navy, Com. D. C. Bingham; Post Office, J. C. Edgerton; State, W. S. Rogers; Treasury, L. J. Heath; War, Maj. Gen. G. O. Squier; Bureau of the Budget, E. P. Perill; the Shipping Board, F. P. Guthrie; and Dr. J. H. Dellinger, Bureau of Standards, Secretary.

### PUBLIC HEALTH BROADCASTS

The Public Health Information Service by Radio, the only national education by radio in the world, was back on the air through NOF, the Naval Radio Station at Anacostia, D. C., at 7.45 o'clock August 8. This service, together with all voice broadcasting through Naval stations, was temporarily suspended on April 15 in order to effect a reduction in interference pending



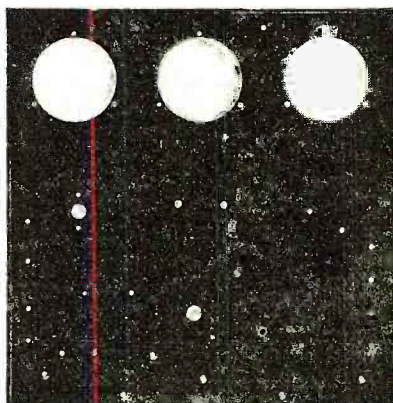

# CONDENSITE CELORON

## Sets a New Standard in Radio Panels and Parts

This strong, handsome, jet black, insulating material gives you a surface and volume resistivity greater than you will ever need and a beauty that will make your set the envy of your friends. It is the ideal material for making radio panels because it machines readily—engraves with clean cut characters and can be finished with a high natural polish or a rich dull mat surface.

If you want the highest type panel you can obtain—a panel made from a material approved by the Navy Department Bureau of Engineering—a panel that will give you continued satisfactory service—insist upon a Condensite Celoron Panel.

### Make Your Next Panel of Condensite Celoron

If your local radio dealer cannot supply you with a genuine Condensite Celoron Panel get in touch with us direct. We'll see that you are supplied.

### An Opportunity for Radio Dealers

Condensite Celoron Radio Panels offer a sales opportunity unequalled to the live wire dealer who is keen on building business on a quality basis. Write us today for our special Dealers Proposition and let us give you all of the facts.

### Diamond State Fibre Company

Bridgeport (near Philadelphia), Pa.

Branch Factory and Warehouse, Chicago

Offices in Principal Cities

In Canada: Diamond State Fibre Co. of Canada, Ltd., Toronto





## "CHI-RAD" APPARATUS

### New Storage "B" Battery

At last a real Storage "B" Battery for your radio set. Can be used on receiving apparatus as source of plate voltage on both Detector and Amplifier tubes. Ideal as plate potential on small Radio Telephone or C.W. Transmitters. When discharged do not have to be discarded as with ordinary "B" Batteries, but can be recharged again and again exactly like your "A" Battery.

**SPECIFICATIONS**

Cut one-half natural size.  
Voltage per cell, 2 volts.  
Pasted plates, ready formed for use. This means long life, battery ready for use upon the first charge given.  
High ampere hour capacity—will operate one detector tube over 1000 hours with one charge. Shipped dry with simple directions for preparing the electrolyte.  
NOTE:—A 22-volt battery of these cells costs but \$6.00 complete with base.

**"GIVE US YOUR BUSINESS—  
WE'LL GIVE YOU SERVICE YOU WILL LIKE"**

**DEALERS**

Write for discounts and territory on this new item—the demand will be heavy. Chicago Amateurs:—Come and inspect this battery and our general stock of Radio Apparatus—largest in the Middle West.

**CHICAGO RADIO APPARATUS CO., Inc.**  
415 So. Dearborn St. CHICAGO, ILL.

Price per cell, \$0.40  
Add PP on 1/2 lb. per cell

decision on a government radio telephone policy. The development of a radio policy progressed to a point where it was possible for the Public Health Service broadcasts to be resumed. After this educational service was suspended, hundreds of letters were received from operators all over the eastern half of the United States asking that the public health broadcasts be continued.

"While we regret the temporary suspension of this service since April 16," an official of the Public Health Service said, "we realized the necessity for a government radio policy and appreciated fully the wisdom of suspending service until a government policy could be established and a program for avoiding interference devised. The letters received indicate that the broadcasting of educational material for the consumption of the general public has met with popular approval."

With the resumption of broadcasting public health messages through NOF, the station through which the Public Health Information originally began, stations co-operating with the Public Health Service in spreading the "gospel of health" number seven, including WGI, at Medford Hillside, Mass.; CKAC, Montreal, Canada, releasing in both French and English; KDKA, East Pittsburgh, Pa.; WRK, Hamilton, Ohio; 7XF, Portland, Oregon; and KFC, Seattle, Washington.

Commencing August 8th, these Public Health broadcasts were released through NOF, on Tuesdays and Thursdays at 7.45 p. m. Eastern Standard Time, on a wavelength of 412 meters. A lecture on Cerebro Spinal Meningitis or Spotted Fever by Louis Jay Heath was broadcasted from KDKA recently and will soon be put on at the other stations.

## By All Means Use a GOOD Horn— Standard Radio Horn

Patent Applied For

The Horn Illustrated

7" Bell, 19" High

Rubberoid finish only. Will take all makes of receivers. No air pocket. No. 17  
Designed to give proper amplification. Price \$7.50  
Heavy material to avoid blast.

SPECIALLY DESIGNED TO FIT ANY RECEIVER—HEAVY MATERIAL, NO BLAST—RUBBEROID ENAMEL FINISH

Your Dealer Will Supply You.

**Other Horns:**

14" bell, 23" high—No. 114 } \$12

5" bell, 14" high—No. 15 } \$5

**Standard Metal Mfg. Co.**

237 Chestnut St.  
Newark, N. J.

**MANUFACTURERS!**  
Let us quote you prices on special horns to meet your requirements.



### DISABLED VETERANS AT CAMP LOGAN HOSPITAL ENJOY RADIO

Mrs. H. D. Morse, president of the Houston War Mothers, visiting the United States hospital for disabled war veterans at Camp Logan recently with Congressman Dan Garrett, came upon a boy in ward No. 1 sound asleep with radio phones securely clamped on his head.

"What's this?" said Congressman Garrett. "Why, they have the sick ward radio-phones working," said Mrs. Morse.

A few minutes later while Mrs. Morse and Congressman Garrett were still at the bedside, the disabled soldier boy stirred, a smile spread over his face as sleepy eyes opened.

"What are you doing, going to bed with the radio nowadays?" asked Mr. Garrett.

"Sure I am. I didn't want to miss the afternoon concert. Thought I would like to take a little nap, but just to make sure that I wouldn't sleep too long, put on the ear phones, thinking the music, when it came in, would awaken me. This thing sure is great, I'll tell the world," the boy continued.

And as Mrs. Morse and Congressman Garrett went on through the ward they found other boys with phones at their ears listening in.

Mrs. Morse and Mr. Garrett, inspecting the hospital, in ward No. 1, where the patients from the surgical rooms are taken, and in ward No. 20, in which the boys are confined to their beds with tuberculosis, found wires strung along the walls with binding posts placed at the head of each bed. Here radio ear phones could be hooked in for the soldier boy who might be occupying the bed. There were 50 ear phones in use. The wires extended out into the wards from the nurses' room at one end of the ward. In this room was found a nurse tuning a receiving set for the entertainment of the bed patients.

The receiving sets are one tube Carona detectors, to each of which is added a two-

Our Radio Department is conducted by electrical engineers, which assure you dependable and highly efficient Radio equipment, either in complete sets or separate units, such as Head Receivers, Variocouplers, Variometers, Cabinets, Detectors, Antennas, Rotary Spark Gaps, Sliders, Panels, Dials, Knobs, Condensers, Grid Leaks, Contacts, Galena Crystals, etc. We especially recommend our popular Receiving Set, RESODON, which is one of the most desirable outfits for the home, club, etc. This set comes in a beautiful mahogany finished cabinet. Write for literature.

**PAUL G. NIEHOFF & CO., Inc.**  
Electrical Laboratories and Manufacturers  
238 E. Ohio Street, Chicago, Illinois



**Detector and Two-Stage Amplifier } \$22.50**

**Detector Panel and Cabinet - - \$5.50**  
(Less batteries and tubes)  
2000 Ohm Receivers, \$5.00  
Superior Crystal Receiving Set, \$4.75  
Attractive dealers' proposition

Steinmetz Wireless Mfg. Co., Inc., 5706 Penn Ave., Pittsburgh, Pa.



stage amplifier. That this detector and amplifier "will carry the load" was proven.

It was a nice job of radio engineering that was done. M. R. Snapp, radio engineer, did the work, and to say that he is proud of the job is putting it mildly. The telephone receivers are hooked up in series and so arranged that all will get the music, those farthest away from the detector as well as those nearest to it, with the same clearness and volume.

The fact that one of the boys, unable to sleep one night, caught a broadcast message from Los Angeles, Cal., proved the possibilities of the arrangement. This message was caught about midnight. One of the patients in ward 20, who is able to be up and about a little, was unable to sleep, so the nurse let him go into the room where is installed the detector, to see what he could pick up. He had had some experience with radio and was able after a little to pick up far away messages. After listening for some time, he discovered that messages were being broadcast by the Bell Telephone station at Los Angeles to its receiving station on Catalina Island. The air that night and at that hour, for the summer time, was unusually free of static.

And that is just one little incident of the first week's use of the radiophones in the two-bed patient wards. Every afternoon and evening the concerts, the news and the baseball scores that have been sent out from Houston stations have been caught.

Those who have been to Camp Logan and have seen the terrible tiresomeness of nothing to do all the day through know what that means to the poor disabled boys lying there. The other many thousands who have not been there possibly will never realize how wonderful the radio installation is.

"I wish," said Mrs. Morse, "that I could get over to the people generally what this means to the poor fellows lying out there bedridden.

### CABINETS FROM WALL-BOARD

I have just completed a radio receiving station and I wish to describe the manner in which I made a cabinet for my set.

My instruments are all mounted on a wooden panel, although I think a composition panel could be used as well by using a little smaller screw.

There are four good reasons for using wall-board in making cabinets.

1—It finishes just as well as a piece of wood.

2—It is much lighter than wood.

3—It is easily assembled and disassembled, making the rear of the panel readily accessible for inspection or repairs, by removal of several small screws.

4—It is much less expensive than wood, especially if the panel is of an odd size.

Wall-board is generally sold in large sheets, but I picked up several odd pieces in a hardware store for a few cents. I cut two pieces of board the height of the panel and as wide as the base for the two end pieces, and then secured these two pieces with small brass flat head screws.

In cutting the board, I very carefully cut it entirely through, otherwise it would have left a rough edge. I then cut a piece for the back, measuring from the outer edges of the end pieces, and screwed it fast; I also cut a piece for the top, large enough to cover all edges. To finish the cabinet, I applied a coat of Jap-A-Lac combination stain and varnish, mahogany color. When this first coat had dried thoroughly, a second coat was applied and left to dry.

With a piece of very fine sandpaper I smoothed the rough spots and rubbed the cabinet down with pumice stone powder on a damp cloth.

After another coat of the same Jap-A-Lac had been applied, the cabinet was complete.

Contributed by EDWARD H. BUCHER,  
Harrisburg, Pennsylvania.

### DUO CONDENSERS

Duo condensers are made for those who appreciate better apparatus. They are made in the following sizes and styles:

DUO—3—Pancake . . . .	\$2.25
DUO—5—Pancake . . . .	2.50
DUO—13—Pancake . . . .	3.00
DUO—23—Pancake . . . .	3.50
DUO—23—Straight . . . .	4.50
DUO—43—Straight . . . .	5.75
DUO—23—Vernier . . . .	6.00
DUO—43—Vernier . . . .	7.50

Larger condensers made especially for use in the Super-Regenerative circuit.

Sold through dealers or direct

**H. F. GELDMEIER CO.**

1008 French Street - - Erie, Pa.

Send two cent stamp for circular

Dealers Note—If your jobber cannot supply you order direct

### The Radiobat Storage "B"

contains the first successful semi-solid electrolyte. It is a real rechargeable 22-volt storage battery that eliminates "B" battery replacement expense. Write for information to—MULTIPLE STORAGE BATTERY CORP., 350 Madison Ave., New York City.

### Dealers—Everywhere Please Note

Very many dealers have been agreeably surprised to find that they are more than paying their "overhead" expenses through taking subscriptions to **Science & Invention** and **Radio News**.

The increasing demand for these magazines has been steadily growing for many months, and your patrons will appreciate the privilege of leaving their subscriptions with you.

For details and subscription blanks write Mr. C. J. Wolfe, Experimenter Publishing Co., 53 Park Place, N. Y.

## Radio Company FOR SALE

**W**ELL-KNOWN and long established Radio Corporation, manufacturing a line of popular instruments and owners of a number of patents, tools, dies, trademarks, etc., as well as a large stock of goods, is for sale. This is an opportunity to acquire a going business that can be easily and quickly developed into one of the biggest of its kind in the industry. Write for full particulars.

Box 800, care of *Radio News*, 53 Park Place, N. Y.



# Battery-Charging Motor-Generator

## \$35<sup>00</sup>

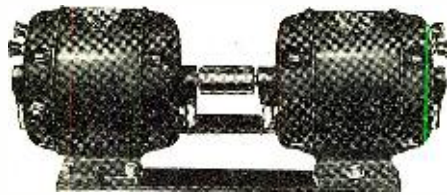

For charging 6-volt "A" Batteries. Has 1/4-horse-power, 110-volt, 60-cycle A. C. Motor, which we guarantee for one year. Best value ever offered for..... **\$35.00**

### Other Bargains f. o. b. Chicago

Synchronous Motor for operating spark-gap, 1/8 horse-power, 110 volt, 60 cycle, A.C.—guaranteed for one year..... **\$20.00**

Combined Motor-Generator, with low voltage for charging "A" Batteries and 500 volts for broadcasting. Motor is 1/2 horse-power, 110 or 220 volt, 60 cycle A.C. Generator, 1/2 horse-power D.C. Guaranteed for one year..... **\$100.00**

General Purpose Motor for operating machine tools, ventilating fans, etc., 1/4 horse-power, 110 volt, 60 cycle, A.C. operating at 1740 R. P. M. Guaranteed for one year..... **\$13.50**

Grinder and Buffer, with 1/4 horse-power motor, 6-inch abrasive wheel and 7-inch cotton buff..... **\$25.00**

**Immediate Shipment from Stock**

Send cash with order, as these low prices do not permit of bookkeeping or collection expense. If not satisfied, money will be refunded on return of purchase within 30 days.

## NORTHWESTERN ELECTRIC CO.

412 S. Hoyne Avenue, Chicago

# Don't Growl—

If you've used inferior equipment, and can't get results. It's not too late to throw it out and start over—with *Ace* material. If you have put up with poor service the past season—get started right this fall with *Ace* apparatus. Our socket illustrated herewith is a suggestion. Not a molded proposition to melt at the first touch of a soldering iron, but a base of 1/4" solid sheet Formica, with die cast shell and absolutely guaranteed. Grid leak incorporated in socket base—adjustable to suit tube—and the price as low as consistent with highest quality. We make complete receiving sets and numerous small parts—literature on request.

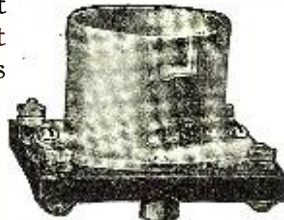

Type T-S VT Socket **\$1.50 with Grid Leak**

ADDRESS DEPT. H-P

## The Precision Equipment Company

2437-2439 GILBERT AVENUE, CINCINNATI, OHIO

# RADIO PARTS

Quantity production enables us to supply the following radio parts at the lowest possible prices:

- VARIOMETERS
- VARIO-COUPERS
- VARIABLE CONDENSERS
- SOCKETS
- TRANSFORMERS
- PHONE JACKS
- DIALS
- PANEL SWITCHES
- BINDING POSTS
- SWITCH POINTS

GET OUR PRICES

**THE SYPPER MANUFACTURING COMPANY**  
Dept. R Toledo, Ohio

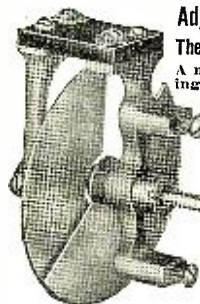

### Adjustable Vernier Condenser

#### The New "WHITE" Type 1VC

A necessity for the sharp tuning of amateur and broadcast receiving sets. Absolutely noiseless. Highest grade, electrically and mechanically. Superior features, special bearing, adjustable air gap, no contact springs, all non-magnetic materials.

Price, post-paid, **\$2.50**

Special proposition for Dealers and Jobbers. The best selling device now on the market.

**The O. C. WHITE COMPANY**  
15-21 Hermon Street, Worcester, Mass.

"The installations we have made have cost us more than was first anticipated. We now have a receiving set with loud speaker in operation in Red Cross Hall for the boys who are able to be up and visit there; then there are the two receiving sets just installed, one in ward No. 1, surgical ward, and the other in ward No. 20, one of the two tubercular wards. With the wiring that had to be done, and an ear phone for every bed that had to be procured, the cost of the receiving set was a small part. However, there is still some money left in the fund that Houston people so generously gave to the War Mothers for this purpose, and with other money, which we feel sure we can get, we plan eventually to have every ward where there are bedridden patients fitted up as we now have the surgical and tubercular wards."

Every one at the hospital is enthusiastic about the radio sets installed. The nurses say it is the greatest thing that could be done for the boys.

Colonel R. L. Cook is enthusiastic. Ever since he has been in command at Camp Logan he has made a specialty of trying to provide for the comfort of the disabled men as well as to give them the best treatment that medicine and surgery render.

"And this thing will add wonderfully to their contentment out here," he said, referring to radio.—*From the Houston Post.*

## RADIO AND THE WHISTLING LANGUAGE OF THE CANARY ISLANDS

American manufacturers of radio broadcasting or receiving devices might just as well pass up the Canary Islands as a market for their instruments, in the opinion of American Consul F. A. Henry at Teneriffe. There is not a chance, says the consul, particularly on the remote island of Gomera, to compete with the "whistling language" of the natives. The inhabitants of this island by use of a system of whistling signals can convey bits of news and information over considerable distances with great rapidity. The system dates back hundreds of years, says the consul's report, consequently radio telephony is practically unknown.

## KILLED WHILE ERECTING AERIAL

Recently in Cleveland, Ohio, a father, 48 years of age, and his son, 15 years of age, were killed in a tragedy brought on when an aerial touched a 2,200-volt wire. In a hurry to set up a receiving set to hear a concert the young son, with the aid of another boy, who was seriously burned, had attached the aerial to the chimney of his house, and in doing so threw it over a high-tension wire. Not heeding the caution of other persons to tie a rope to the aerial, the young men clutched it. In the meantime friction of the aerial had rubbed off the insulation of the electric wire, a flash, the youth was killed instantly, and his father, who rushed to save him, died within a few minutes. This fatality should serve as a warning to others to be extremely careful in avoiding high-tension wires, and for that purpose this narrative is published.

—*Radio Service Bulletin.*

## JACKIE COOGAN MADE HONORARY MEMBER JUNIOR RESERVE POST

A Junior Naval Reserve Post is being organized in Boston to which has been given, with the Mayor's consent, the name, James M. Curley Post. To this Post Jackie Coogan, the juvenile star of moving pictures, has been elected an HONORARY CADET member, and has been so notified. A telegram received at National Headquarters, 2180 Broadway, New York City, from Jackie Coogan, himself, rings true in the following words:

Insure your copy reaching you each month. Subscribe to Radio News—\$2.50 a year. Experimenter Publishing Co., 53 Park Place, N. Y. C.



"You bet I accept, and I will do my level best to be as brave and true an American as the rest of the members of the James M. Curley Post. Yours awaiting orders, Jackie Coogan."

To Lieut. Minor M. Farleigh, Radio Engineer, Headquarters Staff, U. S. Junior Naval Reserve, is due the credit of erecting the first loop type aerial and one of the first amateur aerials in the United States.

In 1903 when a mere boy he was greatly interested in wireless telegraphy and in June of that year erected a loop aerial planned in 1902. He was at that time a resident of Indianapolis and connected with the Hercules Electric Co. There were no amateurs in that city or in that part of the country. The best to be heard through the ether was atmospheric electricity. Young Farleigh was laughed at for his efforts to pick up signals from the steamers operating on the Great Lakes with his coherer detector and particularly so when he built a sending outfit and sent signals a distance of one hundred feet to prove his receiving set was functioning properly.

As many Boy Scouts gravitate into the Junior Naval Reserve, when they reach their 14th year, the Executive Board of the Reserve has recently decided that Boy Scouts who have attained the rank of Eagle Scouts, will be commissioned as Ensign, on enlisting in the Reserve. They will be assigned to Post units where they will have the opportunity to develop their "office material."

### Naval Submarines to Have Long Range Radio Sets

By CARL H. BUTMAN

Radio engineers of the Navy Department have been so successful in the development of a special radio telegraphic transmitting and receiving set for submarines, that 59 new sets have been ordered. They will be improvements on the experimental set installed on the S-50 which paid a visit to Washington recently, and was said then to be one of the best equipped submarines in the world. The sets will be constructed on confidential specifications drawn up by the Radio Section of the Bureau of Engineering, based on experimental sets building at the Washington Navy Yard.

Approximately \$300,000 has been saved on paper—not an actual saving because the Navy did not have the money to save. What the radio experts accomplished, however, is a remarkable saving, because practically new and very excellent long-distance sets will be available for all the big submarines at a very small cost. By redesigning and remodeling old apparatus, barring a few small innovations and parts, the naval radio experts have built up an entirely new standard submarine radio set, better than that on the S-50.

The results in radius of action, Rear Admiral Robison, Chief of the Bureau of Engineering, says, are twice what the radio men hoped for when they began the experiments some months ago. In other words, instead of a radius of about 100 miles, the U. S. N. subs will have a radius of radio transmission better than two or three times that distance in ordinary day-time communication.

The first set was installed on the R-22 and the resulting experiments proved that an excellent practical submarine set had been evolved by remodeling surplus apparatus and scraps of present equipment. New apparatus manufactured by commercial concerns along the lines of the perfected specifications would have cost the Navy in the neighborhood of \$5,500 per set, instead of \$500, the estimated cost of remodeling and assembly. Fifty-nine times the difference is \$295,000—saved.

Another remarkable feat accomplished by the Navy was the perfection of the details



## Putting the "howler" to sleep

**T**HERE'S more than one "howler" to put to sleep these days. Your radio set can put on the greatest squalling and howling demonstration you ever dreamed of. The surest way to stop this howling and keep it peaceful is to add an Acme Audio Frequency Amplifying Transformer.

Most any amplifying transformer can magnify the incoming sounds, but it also amplifies the howling and distortion of stray fields in the circuit. Acme Transformers with their specially constructed iron cores and coils eliminate this disagreeable feature and it only takes five dollars to buy one.

Acme assures your receiving a large volume of

sound that possesses the natural tones so lacking in the ordinary receiving set. Then, too, you will want the Acme Radio Frequency Transformer which costs the same as the Acme Audio Frequency Transformer. It can be used on both crystal detector and vacuum tube sets. It greatly increases the range of either.

You can buy either transformer at your nearest radio store or write the Acme Apparatus Company (pioneer transformer and radio engineers and manufacturers), Cambridge, Massachusetts, U. S. A. (New York Sales Office, 1270 Broadway.) Ask also for interesting and instructive booklet on the use and operation of amplifying transformers.

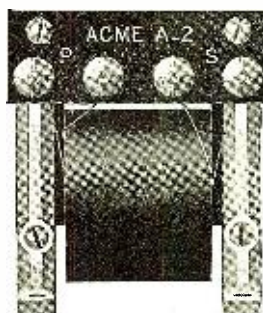

Type A-2 Acme Amplifying Transformer  
Price \$5 (East of Rocky Mts.)

# ACME

for amplification



# ARMSTRONG'S SUPER-RECEIVER

## More Parado Offers

Operators who take advantage of Parado Offers save in original cost of apparatus and always get equipment that is "First Tested—Then Sold."

We carry complete stock of apparatus for any ARMSTRONG SUPER RECEIVER HOOK-UP. This includes the "Flivver," the "2-Tube" and the "3-Tube."

Before you buy, get our Special Bulletins on the SUPER-RECEIVER and other Radio Apparatus.

## Parado Offers Save You Money

### Guaranteed Apparatus



**Peoria Radio Sales Co.**  
Dept. B  
PEORIA,  
Illinois

## Special Dealer Plan

**Dealers:**—Write for our new plan on distribution. We are taking orders on monthly allotment basis. Our dealers and agents get the best lines of equipment. We distribute these lines:

Acme Clapp-Eastham Grebe  
Adams-Morgan DeForest Moorhead  
Baldwin Jewell Murdock  
Brandes Federal Pacent  
Westinghouse Radio Corporation

Write today for New Dealers'  
Discount Schedule No. 8

**KLAUS RADIO CO.**  
Dept. 200  
Eureka, Ill.



**FIRST TESTED—THEN SOLD**

## The New "ALL WAVE" Coupler

COMBINATION FLAT AND BANK WOUND

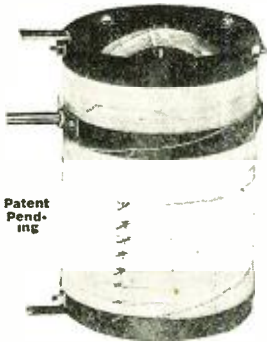

Patent Pending

Entirely Eliminates the use of All Variometers, Variocouplers and Loading Coils

Permits the building of the most compact and efficient receiver at a considerably lower cost.

**Guaranteed Wave Length, 150 to 3000 Meters**

Every dealer is authorized by us to sell the "ALL WAVE" Coupler (with a money back guarantee) to give maximum results for long or short wave long distance selective reception **List \$9.00**

If your dealer cannot supply you, send us his name and your order. We will supply you direct or through him.

MANUFACTURED BY

**Capitol Phonolier Corporation**  
54 Lafayette St. New York, N. Y.

**WARNING:** Don't permit unscrupulous dealers to urge you to buy something nearly as good for less money. Insist on the six hook-ups which accompany each genuine "ALL WAVE" Coupler and look for the trade mark on the Rotor.

## Startling Price Reduction

Handsome hardwood Cabinets, satin mahogany finish, hinged lid, front rabbeted to take panel.

**You Will Be Proud of Your Set in This Cabinet**

Prices—Postpaid in U. S., Delivery guaranteed. Cash with order. Panels not included in price.

Panel size	Inside dimensions			Price
	High	Wide	Deep	
6x 7"	5 1/2"	6 1/2"	7"	\$1.50
6x10 1/2"	5 1/2"	10"	7"	1.70
6x14"	5 1/2"	13 1/2"	7"	1.95
7x18"	6 1/2"	17 1/2"	10"	2.20
9x14"	8 1/2"	13 1/2"	10"	2.70
12x14"	11 1/2"	13 1/2"	10"	2.95

**The Southern Toy Company**  
HICKORY, N. C.

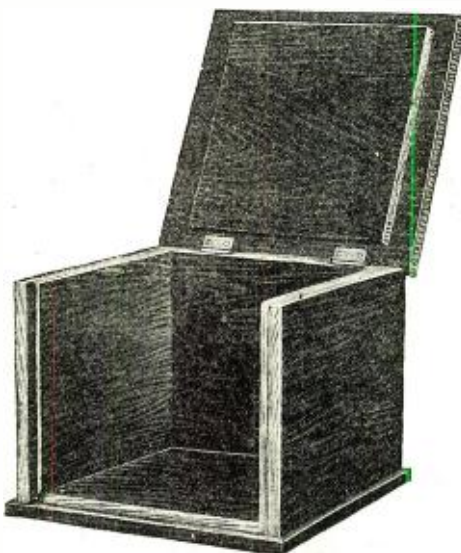

of the set within six month. The original submarine set developed and built by a commercial concern required two and a half years, it is said, or five times as long. When all the subs are equipped, naval experts believe that these craft of the American Navy will be just a bit better equipped than those of any other navy in the world.

Very few details of the new sets are revealed, but it is known that they are vacuum-tube sets developed along original American lines. Late in the war, German submarines lying on the surface succeeded in sending messages during the night as far as 800 or 1,000 miles to their bases by using short wave-lengths of about 300 meters. Spark sets were used until the last few months of the war, when vacuum tubes were introduced in sending, although they had been used in receiving for about a year. The German spark was operated on a 500-cycle frequency about 2-k.w. capacity. Much of their equipment they considered very confidential and after an unsuccessful engagement they threw the important parts overboard or into the bilges. Although arc transmitting sets are said to be dangerous for submarine use on account of the gases given off by the many electrical storage batteries, 2-k.w. arc sets were used in British subs successfully. In American submarine practice a grounded loop is used. This aerial is very efficient and consists of a highly insulated wire grounded at the extremities of the hull and running to a mast amidships. Two down leads of the loop pass through watertight insulators into the hull, where the primary of the circuit is connected in series. The loop is connected with the standard naval radio equipment by the ordinary means, except that a condenser in series is used when transmitting.

Owing to the ability of the undersea craft to submerge with the aerial in place, it is possible to receive long-wave signals under water to a depth of about 20', and short-wave signals to a lesser depth. In 1919, a submarine 16' under water off New York picked up signals sent out from Arlington, 200 miles away, and while submerged at 8', heard Nauen, Germany, 4,000 miles distant, and also San Diego.

On underwater transmission little is available for publication, but it is understood that transmission as well as reception is practical.

The aid radio brings is interesting: Recently the S. S. *Wassaic*, whose call is KROO, experienced boiler trouble about 350 miles southeast of New York. Her SOS was answered by KEFT, *The City of Eureka*, another Shipping Board vessel, which towed her into New York safely. When WDOO, the S. S. *Federal*, stripped her turbines and sent out a distress call 200 miles northeast of the Bahamas, the *City of Weatherford* soon hove alongside and arranged to tow the disabled *Federal* to Mobile. Another Shipping Board vessel was towed from off St. Nazaire, France, over 2,000 miles to an American port in response to a radio message to sister ships bound west—thus saving tremendous salvage payment. Without radio she might have awaited assistance for months.

Lack of radio facilities shows its value best, perhaps: When the *Western Hero's* radio got out of order on one cruise, she was literally "lost" for two weeks, but "found" when it was repaired. A cargo ship whose radio officer died, sailed without waiting his replacement, and in endeavoring to pursue the northern trans-Atlantic route without radio, ran into icebergs and damaged herself to the extent of about \$10,000—she could not pick up the Naval Hydrographic Office warnings nor the messages of the revenue cutter on ice patrol.

Today the activities of the Shipping Board are less than a year or two ago, there being only about 400 vessels in commission. Radio maintenance on the many laid-up ships has been reduced materially and a saving of



approximately \$130,000 achieved, by the assumption of the upkeep by the Board and the elimination of repair shops maintained by outside radio contractors in seven ports. For radio messages transmitted the Board collected about \$30,000 during the past year.

Business is expedited greatly by the operation of a special radio station established at London, which, in co-operation with the Naval Communications Service, handled all trans-Atlantic radio messages for London officials direct from Annapolis. Frequently, messages filed in Washington at the close of business on one day are answered by the time the Washington office opens on the next. The London radio supervisor estimates that a saving of over \$11,000 a year is effected by using radio for trans-Atlantic dispatches. Radio messages to Panama, Manila and the Orient are also handled through naval co-operation, saving almost \$5,000 per annum over cable charges.

In technical development, the Shipping Board has experimented with a 2-k.w. arc set, installed on the S. S. *President Adams*, which succeeded in communicating with American stations while the vessel was in the English Channel. The operation of this set is said to be almost entirely automatic, being a new departure in the construction of sets. The S. S. *Eastern Admiral* and *President Polk* were also equipped with 2-k.w. Federal arc sets with good results after a direct comparison with spark sets.

### Radio Protects Sea Travelers

By CARL H. BUTMAN

Due almost entirely to the use of radio on the Shipping Board's fleet, not a single ship has been lost without trace during the past three years, according to F. P. Guthrie, head of the Radio Section. Whatever hard knocks the Board may receive, little can be said against its radio equipment and its operation. Practically all Shipping Board vessels are now equipped with audion-tube detectors, which have also been made available for general marine use through the insistence of the Board, making for greater safety in sea travel. Ships, lives and money have been saved, and in general radio has a fine record in all the government services.

These days we seldom hear of mysterious losses at sea—ships which disappear or return crewless, as did the *Marie Celeste*—due chiefly to radio, the safeguard enabling ships to converse together freely and communicate with one port or another every day. The naval collier *Cyclaps* is practically the only "missing" vessel recorded since the advent of the radio law at sea in 1912, except during the war.

The Coast Guard, Navy and Bureau of Navigation of the Department of Commerce all indorse radio highly, yet no bureau keeps a record of what radio actually does toward life and property saving at sea. Lost ships are recorded to the number of 380 from all causes for the year 1921, but the number saved, thanks to the SOS, is undetermined. A year ago the Shipping Board reported that approximately 500 vessels in distress or temporarily disabled were reported by radio, and that about 190 were towed to port through arrangement made by radio. This assistance rendered by the radio of Shipping Board vessels, augmented by other radio warnings in all parts of the world, protected hundreds of thousands of lives and billions of dollars' worth of property—but no adequate estimate can be reached.

### The National Co-operative Radio Society

By ROY A. ANDERSON

The National Co-operative Radio Society is the name to be given to a national society which is now being formed. The purpose of this society is,

# Burgess, the Radio Battery

## —construction fully patented

When you buy a Burgess "B" Battery you get more than long life, noiselessness, high capacity and moderate price. You get also Burgess special radio construction, perfected by wireless specialists and fully patented! This exclusive *radio* construction is found in no other battery on the market today.

What does this mean to users of radio batteries? It means clear receiving. It means lowest cost per hour of service. It means long shelf life and highest current capacity. It means that Burgess "B" Batteries are the best radio batteries it is possible to produce. Don't take our word for it—ask any radio engineer.

Leading manufacturers of radio equipment specify "Burgess." Burgess "B" Batteries are handled by all progressive jobbers and dealers. "Look for the Black and White Stripes." And if your dealer doesn't handle Burgess "B" just address:

### BURGESS BATTERY COMPANY

Engineers—Dry Batteries—Manufacturers

Offices and Warehouses at:  
 CHICAGO, ILL., 111 W. Monroe St. KANSAS CITY, MO., 2109 Grand Ave.  
 ST. PAUL, MINN., 2362 University Ave. BOSTON, MASS., 136 Federal St.  
 NEW YORK, N. Y., 50 Church St. MADISON, WIS., Main and Bready Sts.

In Canada: BURGESS BATTERIES, Ltd.  
 Winnipeg, Toronto, Montreal

# BURGESS

## "B" BATTERIES

"ASK ANY RADIO ENGINEER"

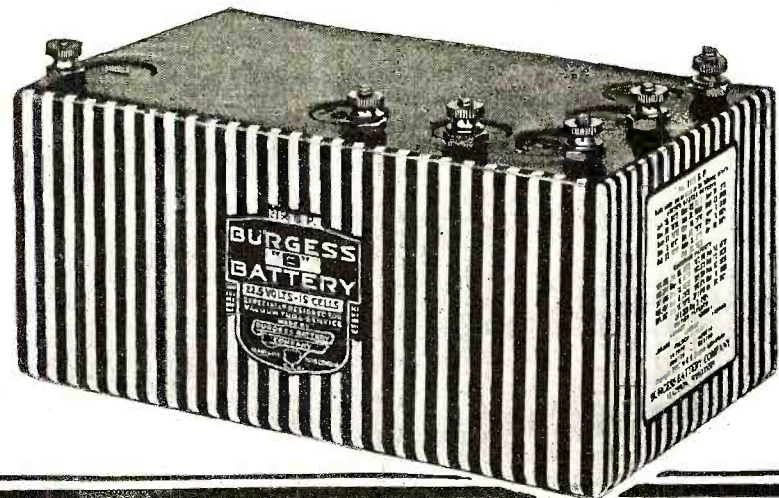





## Cuts "A" Battery Costs in Two

The Magno Storage Battery is the most economical "A" Battery on the market today. It is of practically unlimited ampere hour capacity because it can be

**Recharged at Home in 1 Minute**  
Simply unscrew cover and insert "spare" charged electrode. "Spares" are exchangeable at your dealer's or from us at 25 cents each.

**No Charging Equipment Needed**  
"Spare" charges can be kept indefinitely. They will not "run down" prior to insertion in the battery. They need no more care than a hammer. By keeping "spares" on hand your concert will never be interrupted.

Each Magno Battery is a 2-volt unit. Two in series is sufficient for the new 4-volt tubes. Three in series for the 6-volt tubes. Each positive electrode is rated at 30 ampere hours, but because of their unusual recuperative power they last much longer than their rated capacity.

You can get a greater ampere hour capacity with Magno batteries and a few "spares" per dollar invested than from any other battery.

Write for descriptive folder R1.  
Price per battery ..... \$6.00  
Price per positive electrodes... 1.00  
Positive electrodes exchanged... .25

Dealers, write for discounts today  
*Every Battery Its Own Service Station*  
**MAGNO STORAGE BATTERY CORPORATION**

AEOLIAN BLDG. NEW YORK

# STORAGE BATTERY MAGNO

**JOY-KELSEY CORPORATION**  
Manufacturers  
**RADIO EQUIPMENT**  
4021 West Kinzie St. Chicago Ill.

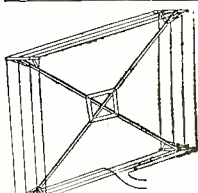

### It's easy, make your own INDOOR COIL AERIAL

Drawing, R. F. amplifier circuit, chart and tables giving proper number of turns to put on coil for any wave length. Complete data covering 0 to 24,000 meters on three large sheets, \$1.00. Stamps not accepted.

C. A. DAVIS & CO.  
2371 Champlain St., Wash., D. C.

**Buy From Reputable Manufacturers**  
Our 3 factories are devoted to the manufacture of reliable, guaranteed complete radio receiving sets and parts.  
**FREED EISEMANN RADIO CORPORATION**  
255 FOURTH AVENUE NEW YORK, N. Y.

generally speaking, for the betterment of the radio broadcasting entertainments.

Everyone can see that the present grade of broadcasted entertainment is not at the high standard where it really belongs, and with individual ownership it is practically impossible, or at least improbable, that there will ever be anything much better.

With the definite purpose of betterment in mind, the plan for this national society was made. The idea is this: Everyone who owns or contemplates owning a receiving set should join; he should believe it his conscientious duty to belong and to pay his yearly dues, from the total of which radio broadcasting stations will be purchased or leased by the society and with which artists (artists, you understand) will be paid for the programs which they will give in New York, we'll say, and which will then be directly relayed, from receiving set to transmitter, by all of the broadcasting stations owned by the society. By this plan there is but one program, and everyone can hear it.

The society states that its dues are not to exceed \$12 a year, which is really only \$1 every month, and the artists of the world can be brought to your home every day in the year, for three and a third cents a day! A 12-hour daily program is planned, too.

In this booklet the society says many things of interest, and extracts are here given which will not only give the reader a better idea of what the society stands for, but will show him the need for action on his part, for the benefit in such a society is not to be denied:

\* \* \* \* \*

Regulations by the government of broadcasting activities in the air are being formulated. The "White Bill," drawn to regulate radio, is intended to give Secretary Hoover authority to promulgate such rules and regulations as are found necessary. In the meantime, the erection of new broadcasting stations, or the completion of those in process of construction, is prohibited until permission is granted by the Secretary of Commerce.

This indicates that radio telephony, particularly as related to broadcasting, has reached a crisis. Hence, it behooves all friends of radio telephony to give a thought to the future, and as a result of such thought formulate a definite, specific and practicable plan, and having adopted such a plan, put united effort behind it, so that this latest and greatest development of science and art may become of permanent and lasting service to the greatest number.

Inasmuch as there are now no less than 600,000 owners of radio receiving sets in the United States, with a possibility of several million, under favorable conditions, unquestionably the owners of receiving sets, and those who contemplate owning receiving sets, are more vitally interested than any other factor, or more than all other factors combined.

It is unthinkable that so large a factor should fail to receive proper recognition from our Government. \* \* \* Our claims for recognition must be presented to the commission at Washington without delay, for, unless some concerted action is taken very quickly, the available space will be exhausted and the owners of receiving sets must then be satisfied with the character and quality of such free broadcasting as may be promulgated by those who have realized the opportunity and have participated in the allotment of the limited space available.

\* \* \* \* \*

Upon the basis that the majority, if not all of the present owners of receiving sets, and those who contemplate owning receiving sets, with the co-operation of manufacturers, jobbers, dealers and distributors in radio equipment, will become members of the society, we submit the following plan:

That an organization be perfected as

quickly as possible, the name of which shall be "The National Co-operative Radio Society," it being understood that this National Society is created for the purpose of financial gain.

**Membership:** Membership, or memberships, are available:

1. To any individual or firm interested in the welfare of radio telephony.

2. To any individual or firm owning a receiving set, or who may contemplate owning a receiving set.

3. To any corporation, manufacturer, distributor, jobber or dealer in radio apparatus or complete receiving sets, or kindred lines. (These are urged to take as many memberships as may be warranted by the pecuniary benefits to accrue from increased sales, due to de luxe program properly broadcasted by the National Society.)

4. To any radio engineer, or other individual holding certificate or permission to broadcast or receive.

5. Honorary memberships may be extended when considered advisable by the National Committee on Memberships.

**Objects:** The objects of the National Society are to effect a national community of interest among parties who are now interested or may hereafter become interested in radio telephony.

**Broadcasting:** The National Society will build, own or lease and operate a chain of broadcasting stations. Where broadcasting stations are already in existence suitable for the purposes of the National Society, they may acquire same by lease, purchase, or otherwise. Additional equipment for broadcasting is to be added from time to time, as the progress of the art of broadcasting may demand, to the end that a permanent, satisfactory and up-to-date broadcasting service may be maintained.

**Zones:** The United States will be divided into zones. \* \* \* Thus the program broadcasted, when relayed from station to station, will be available to all members located in each respective zone. The broadcasting stations will have sufficient power to cover a radius of 1,000 miles or more under favorable conditions. However, the broadcasting stations will be located approximately 500 miles from each other, so that satisfactory service may be rendered, even under unfavorable conditions. Amplification and auxiliary equipment will be used, if necessary.

**Program:** Program promulgated will begin at ten o'clock in the morning and be continuous until ten o'clock P. M.

The services of paid artists, entertainers and other talent (all to be of importance in their various walks of life) are to be paid for out of the funds of the National Society.

**Local Chapters:** A district chapter will be located in each zone and in all cities and towns contiguous thereto, the chapters to be operated under the supervision and instruction of the National Society.

**Finances:** It will be seen from the above that the primary objects of the National Society are to establish its own broadcasting stations, and to promulgate a daily de luxe paid program, and for this purpose and such other purposes as may be decided upon, the National Society will assess its members not more than twelve dollars (\$12) per year for each membership, payable annually, quarterly or monthly, as may be most convenient to the member. The moneys so received are to be disbursed as follows:

Building or leasing, or otherwise acquiring broadcasting stations.

Overhead entailed in operating and upkeep of broadcasting stations.

Remuneration to paid artists, professionals and other talent, employed by the National Society to take part in their daily program.

Such other expenses as may be necessary for the maintenance of the National Society.

**Organization Expenses:** For the purpose of defraying the expense of organization, it is required that each application for mem-



# FINCH RADIO PRODUCTS GIVE MAXIMUM SERVICE



Not like the rest  
They are the best  
---the very best.

Get More Fun Out of Your Radio—Read the Fastest Code Messages at Your Leisure

EVERY hour of the day the air is full of telegraphic signals telling of the important news events. Countless government and commercial messages are being exchanged between our country and foreign capitals. Are you listening in on these world events or are you a "radio wall-flower" because you cannot read the code fast enough? The things broadcasted by code are oftentimes more interesting than those transmitted from the broadcasting stations. By equipping your station with an amazing yet simple device,

- Finch Radio Relay...\$75.00
  - Std. Tape Register... 55.00
  - Telegraph Relay... 7.00
  - Paper Tape, per roll... .10
  - Register Ink, 2-oz. bot. .... .50
  - Register Ink, pt. bot. 2.00
- Prices of Other auxiliaries on request

## THE FINCH RADIO RELAY

(Patented and Patents Pending)

you can automatically receive and at the same time have a permanent record of any desired message whether or not you know the code. And you do not have to be present at the instruments to get any message you want. The Finch Radio Relay traps the message on a paper tape—makes a permanent record of it; in short, if you know what an ordinary ticker does, you know how the Finch Radio Relay works. Tremendously sensitive, rugged fool-proof, this remarkable instrument is easily adjusted to any vacuum tube receiver.

### OTHER THINGS YOU CAN DO BY RADIO WITH THE FINCH RELAY

- 1.—Automatically Receive and Record.
- 2.—Operate a Telegraph Sounder.
- 3.—Ring a Bell.
- 4.—Ignite Explosives by Radio.
- 5.—Control a Moving Vehicle.
- 6.—Visible Indication.
- 7.—Radio Burglar Alarm.
- 8.—Simultaneously Record and Re-Transmit Messages.

Tested by the New York "Evening Mail" Radio Institute, approved and awarded Certificate of Excellence.

## THE CLARION

"Like the Human Voice"

THE Clarion is one of the most faithful reproducers of the human voice and music that has ever been perfected. It has a soft, mellow tone that is absolutely free from those metallic sounds that are so objectionable to those who enjoy good music. And there is no distortion with the Clarion. Its many patented features fix that. Note the volume regulator which will allow you to regulate the sound like you do with your phonograph. The tone modulator also allows you to adjust the tone of the instrument. The Clarion comes finished in polished nickel or statuary bronze. A truly beautiful instrument that will harmonize with the very best receivers. Price. **\$15.00**



Patented

## GREATEST EVENT IN RADIO

FOR ONE MONTH ONLY

- V.T.2—Excellent Amplifier and Power Tube ..... \$8.50
  - V.T.1 or J Tube—Excellent Detector and Amplifier..... 7.50
- These tubes are not rejects and are guaranteed by us.

Tested by the New York "Evening Mail" Radio Institute, approved and awarded Certificate of Excellence.

## THE FINCH VACUUM TUBE RECEIVER

Designed and Built by Men Who Know Radio

THE Finch single tube vacuum receiver is a model instrument in every respect. It has three tuning controls, which insure great selectivity and freedom from interference. All of the parts are mounted on a pure bakelite panel. The cabinet, which is beautifully finished, is of hard wood, and measures 6½ inches high, 7½ inches deep and 18½ inches long. The hinged top allows the user to make interior adjustments with ease. Rubber covered binding posts used throughout. This is a receiver that you will be proud to own and operate. Detector and tuning unit, complete except vacuum tube, phones and batteries. **\$44.50**



Dealers and Jobbers—Write for our interesting sales plan. Other Literature sent on receipt of stamp.

**FINCH RADIO MFG. CO., 303 Fifth Ave., New York, N. Y.**

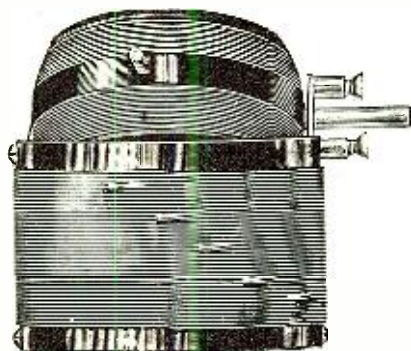

MOULDED COUPLER \$4.50  
¼" SHAFT

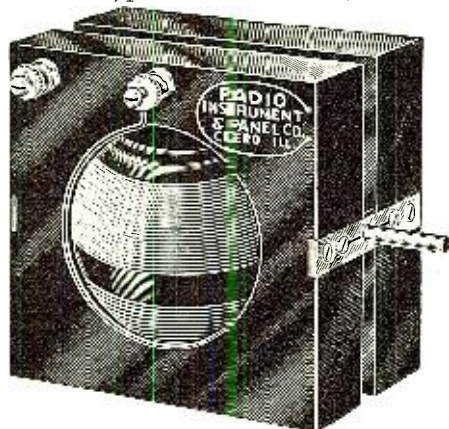

MAHOGANY VARIOMETER \$5.00  
¼" SHAFT

SPECIAL OFFER  
2 COUPLERS \$13.75  
1 VARIOMETER

**Buy Now** AND GET BEST PRICES AND SERVICE FROM AN ESTABLISHED HOUSE

### GET THESE POINTS:

Bearings will not bind. All metal parts white nickeled. Rotor balls hard rubber and solid mahogany. Windings of green double cotton covered wire.

#### VARIOMETER

Binding posts have large knurled thumbnut. Minimum clearance between rotor and stator. Mounts easily and is designed for low dielectric losses and maximum range of induction. All mahogany finish, wonderful appearance. Effective tuning range of 150 to 650 meters.

#### COUPLER

Moulded hard rubber rotor ball. Primary windings on black polished fiber tube. Has nine taps for varied inductance. Easily installed. Will operate perfectly and give highest efficiency. Save money by using this cheaper and better equipment.

#### LOOK AT THESE BARGAINS

HARD RUBBER VARIOMETERS. Green cotton covered wire, all parts white nickeled, rotor ball and stator forms all hard rubber. A beautiful product that will give results. **EACH \$5.00**

- |   |        |  |        |
|---|--------|--|--------|
| 3-plate Vernier Condenser.....                              | \$2.80 | Rheostats, Moulded Base.....                             | \$1.00 |
| 11-plate Variable Condenser, assembled without dial.....    | 3.20   | Vernier Rheostats .....                                  | 1.50   |
| 23-plate Variable Condenser, assembled without dial.....    | 3.60   | Potentiometers .....                                     | 1.50   |
| 43-plate Variable Condenser, assembled without dial.....    | 4.00   | 1-piece Moulded Dials, 3/16 or ¼ inch hole, each .....   | .75    |
| All-American Radio Frequency Transformer .....              | 4.50   | Grid Condensers .....                                    | .60    |
| 4-inch Moulded Dial, ¼-inch hole... ..                      | .95    | 1-piece Moulded VT Socket, each....                      | .75    |
| Audio Frequency Amplifying Transformers, ratio 3½ to 1..... | 4.00   | Bridging Condensers .....                                | .60    |
| Audio Frequency Amplifying Transformers, ratio 9 to 1.....  | 4.50   | Galena Detector Crystals moulded in lead cups, each..... | .20    |
|   |        | Small Knob Indicating Switch, each..                     | .50    |
|   |        | Large Knob Indicating Switch, each..                     | .50    |
|   |        | Contact points with nuts, each.....                      | .01½   |
|   |        | Contact stops with nuts.....                             | .01½   |
|   |        | Binding Posts, Moulded Knob, each...                     | .10    |

Detector Unit in a very neat appearing black case, compact and easy to carry..... \$65.00  
Amplifying Unit, two step, in a case that can be attached to detector unit..... 65.00  
Detector and One Stage of Amplification, all in one case..... 105.00  
Detector and Two Stages of Amplification, all in one case..... 140.00  
Radio Frequency, sensitive to finest tuning and capable of long range..... 190.00

All above sets, except amplifying unit, include B battery, phones and tubes.

Shipped immediately from stock—order now.

We pay transportation charges. If you are not satisfied in every respect with our equipment return at once and we will refund your purchase price.

DEALERS: write for our proposition.

**RADIO INSTRUMENT AND PANEL CO.**  
26 N. DESPLAINES ST., CHICAGO, ILL.



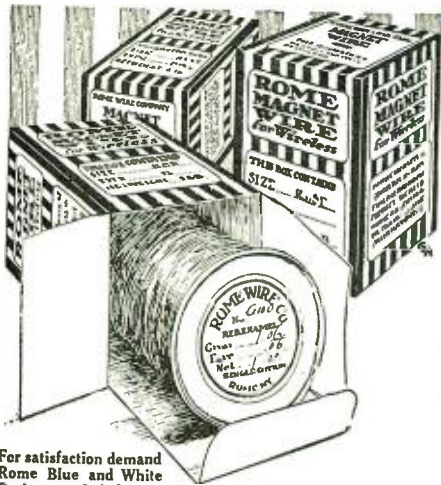

For satisfaction demand Rome Blue and White Package or Label.

# ROME RADIO WIRE

## Magnet Wire

Best Quality Plain Enamel Covered; Enamel and Single or Double Cotton Covered; Single or Double Cotton Covered.

All sizes: 1/4-lb. to 40-lb. packages.

## Antenna Wire

Best Quality Solid or Stranded Copper Antenna Wire, plain or tinned; put up in lengths of 100-ft. and 150 ft., or on 24" reels of 200 lbs.

At Your Dealer's

# ROME WIRE COMPANY

ROME, N.Y. . . . . BUFFALO, N.Y.  
 DISTRICT SALES OFFICES  
 NEW YORK . . . 50 Church Street CHICAGO . . . 14 E. Jackson Blvd.  
 DETROIT . . . . 75 Parsons Street  
 LOS ANGELES . . . J. G. Pomroy, 136 Arista Street

## CLINTON VACUUM TUBE RECEIVER



Everything complete in one unit.

No unsightly exterior batteries, etc.

THE ONLY ONE OF ITS KIND ON THE MARKET. MUST BE SEEN TO BE APPRECIATED

THE ONLY COMPLETE VACUUM TUBE SET ON THE MARKET

The "CLINTON" Vacuum Receiver complete with Vacuum Tube, Batteries, 2000 ohm headset, aerial wire, insulator and ground wire, only \$50.00. Everything complete; all you have to do is install it, following the simple directions, and you are ready to receive messages from the air.

CLINTON RADIOPHONE CO.

29 S. Clinton St., Dept. X. Chicago, Ill.

bership, or memberships, be accompanied by a fee of one dollar (\$1) (for each membership); this to be applied to the expense of organizing the National Society.

**Officers, Etc.:** A President, Vice-President, Secretary and Treasurer will be elected as soon as charter for the National Society is granted (charter has been applied for). Committees and subcommittees will be appointed by the President, so that the business of the National Society may be properly administered.

**Bonds:** The Treasurer of the National Society, Trustees or other parties who may handle the property or funds of the society will be bonded in sufficient amount to protect the financial interests of the National Society.

Now you ought to know what and why the National Society is. Further particulars and application blanks may be secured by addressing the National Co-operative Radio Society, 214 Saratoga St., New Orleans, La.

## PROMINENT RADIO MANUFACTURERS FORM NATIONAL ORGANIZATION

As the public interest which supports the radio industry is dependent upon broadcasting, it behooves the manufacturers and dealers to unite in some definite action regarding this situation. Moreover there are certain questionable practices that can best be corrected by forming an association of radio manufacturers. Therefore the Radio Apparatus Section of the Associated Manufacturers of Electrical Supplies was organized in New York City to place the radio industry upon a sound basis, to study the public taste in the matter of broadcasting programs, and to support and promote broadcasting stations, to promote the standardization of radio apparatus, to advance and protect the interests of the manufacturers of radio apparatus, to collect and disseminate information, and to promote cooperation among the members.

Committees have been formed to fulfill the purposes indicated by their names: Committee on Publicity, Committee on Receiving Sets and Equipment, Committee on Aural Devices and Accessories, Committee on Standards, Committee on Support of Broadcasting, and the Executive Committee, which is composed of the chairman and treasurer of the Radio Section, and of the chairmen of the standing committees.

In order to provide financial support for broadcasting, the expense of which has hitherto been borne by the manufacturers who send out the programs, the members of the Radio Apparatus Section of the Associated Manufacturers of Electrical Supplies will be taxed for an amount depending upon the annual gross sales of each member. In return for this, members of the R. A. S. A. M. E. S. will be entitled to affix their apparatus and include in their advertisements the insignia of the association, by means of which the public will be made cognizant of, and be led to show their preference for, the manufacturers who are supporting the entertainments which they enjoy. This insignia is but part of a broad plan of general publicity which is designed by the Committee on Publicity to acquaint the public at large with broadcasting programs and broadcasting policies.

Moreover, Governmental legislation may more readily be watched and opposed by this organization, and results should be better than those attained by manufacturers who fought restrictive legislation single-handed.

Profiting by the experience of electrical and automobile manufacturers, as well as manufacturers of engineering products in general, the Radio Apparatus Section of the Associated Manufacturers of Electrical Supplies has undertaken, through the Committee on Standards, the consideration of recommendations that ought to be followed



## American Electric

HIGH GRADE

## HEAD SETS

Army and Navy Type:

2500 OHM, PER PAIR, \$10.00  
 3200 OHM, PER PAIR, 12.00

Swedish-American Type:

2200 OHM, PER PAIR, . 8.00

American Electric

COMPANY

CHICAGO

## For Charging Radiophone and Automobile Batteries at home, use



## The Sterling Portable Rectifier

It is not necessary to lug your battery to a service station. Rectifier charges your battery without its being disconnected from Radio outfit.

Mechanism simple, effective and durable.

One thumbscrew does all adjusting. Either clip can be attached to positive terminal. No danger of injuring battery.

Price complete, \$16.00. (West of Rocky Mountains) \$17.00.

We Also Manufacture

Radio Frequency Transformers - \$4.00

Audio Frequency Transformers - \$6.00

Filament Rheostats - \$1.25

Filament D. C. Ammeters and Voltmeters - \$4.00

Sterling Pocket Voltmeters for testing Type "B" Batteries

34-B (0-30 Volts) - \$2.25

34-C (0-50 Volts) - \$2.75

Write for Booklet Giving Full Information

THE STERLING MANUFACTURING COMPANY  
 2831 Prospect Avenue Cleveland, O.  
 Over two and one-half million Sterling Electrical Devices in use today

## THE AMATEUR RADIO "MICROCOUPLER" IS MOST EFFICIENT BECAUSE IT: (Patent Applied For)

Has combined coarse and vernier adjustments.  
 Has no metal parts throughout.  
 Has no compounds between turns.  
 Permits closer maximum coupling.  
 Permits shortest possible grid connection.  
 Is excellent for DX, CW and PHONE work.  
 The coupler that brings in WSB and other long-distance phones and amateurs every night (since June) through all sorts of weather, on a small antenna. Special introductory price: For panel mounting, 8 taps, 150-450 meter range, \$3.60. Unit Panel Complete, \$7.75, postpaid.  
 AMATEUR RADIO EQUIPMENT SUPPLY, 1504 FEDERAL ST., PHILADELPHIA, PENNA. Limited First Stock.

## VACUUM TUBES REPAIRED

ALL MAKES DETECTORS AND AMPLIFIERS REPAIRED EQUAL TO NEW

Detectors, \$3.00 — Amplifiers, \$3.50

Work is guaranteed satisfactory. We have a competent organization.

Interesting Proposition to Agents

CURTISS RADIO COMPANY  
 126 South 8th Street Newark, N. J.



# Federal

RADIO PRODUCTS  
ARE UNIVERSALLY KNOWN AND ACCEPTED AS  
**THE STANDARD**  
FOR EFFICIENCY, DURABILITY AND DESIGN

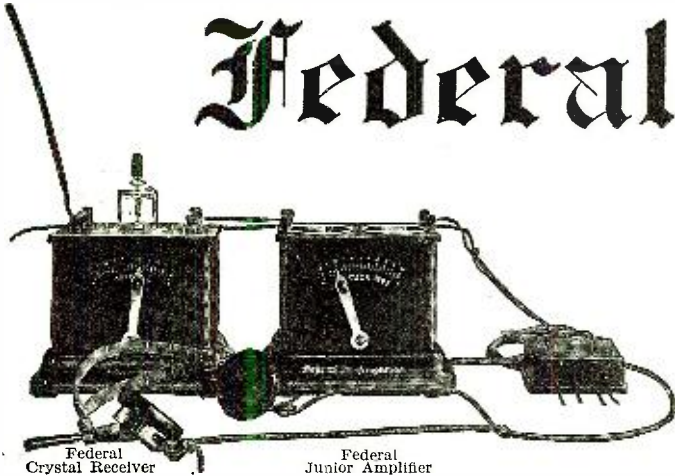

Federal Crystal Receiver

Federal Junior Amplifier

WE MANUFACTURE A  
**COMPLETE**  
LINE  
INCLUDING



Federal Head Telephones

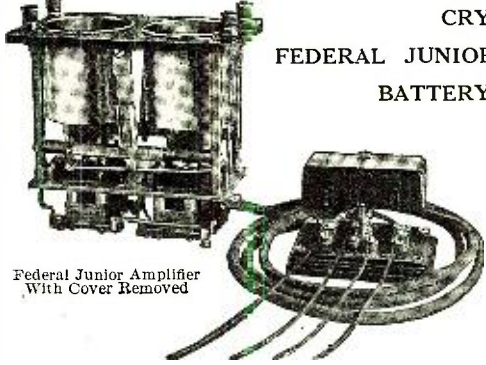

Federal Junior Amplifier With Cover Removed

CRYSTAL RECEIVING SETS,  
FEDERAL JUNIOR and SENIOR AMPLIFYING UNITS,  
BATTERY UNITS, TERMINAL BLOCKS,

## HEAD TELEPHONES

Microphones, Transformers, Jacks, Plugs, Condensers, V. T. Sockets, Rheostats, Anti-Capacity Switches, Etc.

*Demand Genuine FEDERAL Radio Products FROM YOUR DEALER and secure the best results*

**Federal Telephone & Telegraph Co.**  
BUFFALO, NEW YORK

## PERFECTO-VOX

(PERFECT VOICE)

### Announcing The Radio Frequency Receiver

This receiver has three stages of radio frequency amplification—detector, the new Western Electric power amplifier and loud speaker, with tubes mounted in one cabinet.

Receiver is so constructed that loop or outside antenna may be used. Loop is connected to cabinet by means of telephone jack.

When used with a loop, all the large broadcasting stations can be heard, and interference is reduced to a minimum by the use of the new movable iron cores in the radio frequency transformers.

Ready for delivery Oct. 20.

*Dealers and jobbers write now for prices and territory.*

**THE SCRIPPS MOTOR CO.**  
RADIO DIVISION  
DETROIT, MICHIGAN

All the name implies. The lowest priced high-grade receiver now on the market.

This receiver is complete with detector—two step amplifier—vernier control dials—filament control jacks. Sold on a money back guarantee.

*Order thru your dealer or write direct.*

Price, \$90.

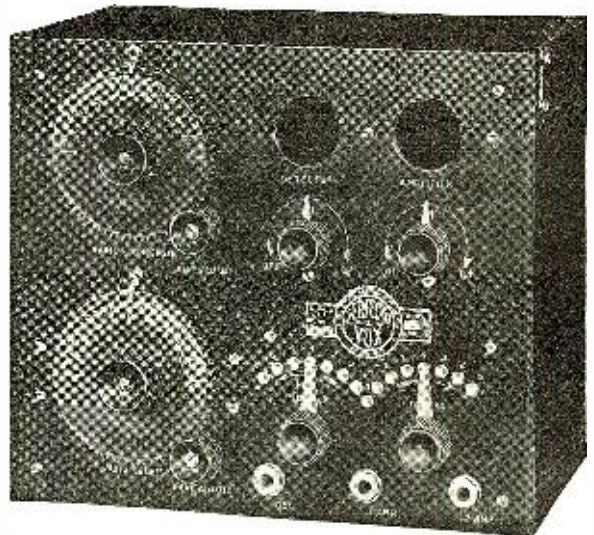





**Headphones**

A two pole, 3000 ohm phone that combines clearness with comfort—strength without being cumbersome — and is equally well adapted for use with either crystal or audion bulb sets.

List price.....\$7.50



**Variable Condensers**

The finest design, materials and workmanship mark the LISEN-IN Variable Condensers as "Instruments of Precision." Made in two sizes, listing at:

- 23 plate.....\$2.50
- 43 plate..... 3.50

All LISEN-IN products are guaranteed as represented and will give entire satisfaction or your money back without question.

At your dealer or jobber or direct from the manufacturer.

**NATIONAL RADIO COMPANY**

**50 Union Square  
NEW YORK, N. Y.**

*Live Wire Distributors  
Write for Our Interesting  
Proposition*

**FROM CAT WHISKERS UP—**

We can supply everything that's best in Radio, 1 or 101 of any article to user or dealer. Same day shipments.

*Inquiries are welcome*



**DISTRIBUTORS**  
Wholesale & Retail  
Westinghouse  
Brandes Federal  
Murdock, DeForest  
Radio Corporation  
and many others

At East Pittsburgh, Pa.—Next Door To KDKA

**"E. S. X." WIRELESS TALKING  
MACHINE ATTACHMENT**  
SILVER \$8.00      GOLD \$4.00  
ESSEX WIRELESS SPECIALTY COMPANY  
31 NEW STREET      NEWARK, N. J.

by manufacturers. These recommendations will be announced when the time is ripe.

Manufacturers desiring further information regarding the Radio Apparatus Section of the Associated Manufacturers of Electrical Supplies may address their communications to the Secretary, Mr. Elmer Bucher, at the association headquarters, 30 West 42d Street, New York City.

**SAFEGUARDING THE FUTURE OF  
RADIO—RADIO CHAMBER OF  
COMMERCE FORMED—GOV-  
ERNMENT DEPARTMENTS  
TO CO-OPERATE**

Government officials having to do with radio communication, including Secretary of Commerce Hoover, who is charged with its regulation, and the representatives of several other departments believe that if the newly organized Chamber of Commerce lives up to its plans and aims, the future of radio in this country is assured.

Based on sound principles of guaranteeing to the users of radio, and the public in general, standard and efficient radio sets, better broadcasting and aiming to make radio a public utility, the pioneer manufacturers formed the first Radio Chamber of Commerce last week. It was a representative meeting, there being over thirty radio manufacturing firms from all parts of the country present, said to represent over 80 per cent of the manufacturers. The possibility of "clique or sectional" control was eliminated by the constitution and by-laws adopted. The election of a board of governors, including eleven district vice-presidents, each of whom has a vote, guaranteed that each of the nine radio districts would have at least one representative on the governing board.

At the opening of the three-day session at the Wardman Park Hotel, Judge W. H. Davis of New York was made temporary chairman. In the absence of Secretary of Commerce Hoover, detained by coal conferences, the chairman presented a message approving of the formation of the national chamber from the Secretary, and carrying a promise of co-operation if the plans of the chamber to "maintain a high standard of quality and dependability in the manufacturing of radio apparatus" and to protect the public from inferior sets made by manufacturers who do not have the welfare of the industry under consideration, were carried out.

A committee of fifteen manufacturers was nominated representing the radio industry for officers and directors of the chamber.

During the first day's sessions Commander S. C. Hooper, of the Naval Radio Engineering Section, pointed out the value of an organization of reputable manufacturers to the country as an asset to national defense and urged the co-operation of manufacturers with governmental radio apparatus specifications. "The Navy Department," he said, "has practically made the present state of radio communication possible by its specifications of a standard vacuum tube and other devices." Standardization was one of the most important needs of the present industry, he stated, explaining that we could not afford to have lamps made by one firm which did not fit into sockets made by another. "Due to the inability of the radio manufacturers to cope with the tremendous demand for apparatus which swept the country recently," Commander Hooper pointed out, "practically a million men and boys have been forced to build their own sets, with the result that they know a lot about radio, as much perhaps as if they had taken an ordinary B. S. college course. "When those young men get to college they will demand advanced radio work, thus increasing our knowledge in radio development, besides being a potential asset in the number of operators in the event of war-time needs." Capt. Guy Hill, of the Army

**Belden  
Radio Coils**



**Variometers  
Vario-Couplers  
Receiver-Coils  
Amplifying-  
Transformers**

*We have exceptional facilities for the prompt and economical production of large or small coils in quantities. Let us figure on winding in accordance with your designs.*

**Belden Manufacturing Company**

*Electrical Wires, Cables and Cordage*

**2300 South Western Ave., Chicago  
Eastern Office and Warehouse, Metuchen, N. J.**

DOUBLE HEAD PHONES



**BOYS! A REAL  
RADIO SET  
ABSOLUTELY FREE**

RUSH your name and address and we will tell you HOW you can get this RADIO SET ABSOLUTELY FREE. RADIO SET comes to you complete, with single slide tuning coil, crystal detector and phone condenser. AND DOUBLE HEAD PHONES. No batteries required; no experience. Write Today for Free Radio Plan. HOME SUPPLY CO., 110 Nassau Street, Dept. 555, New York City.



**TRESCO  
RADIO**

Licensed Armstrong U. S. Pat. 1,118,149

The never-ending pleasure derived from radio is assured in TRESKO UNIVERSAL. The most discriminating amateurs in all parts of the world have been using Tresco receiving sets for the past seven years.

Today you benefit from these seven years' experience, and, in Tresco, purchase a receiving set that gives you even more than you expect. Ask your dealer; if he cannot supply, write us.



**RADIO INVENTIONS WANTED**

Useful radio inventions will be purchased by large manufacturer, either before or after filing patent. And their own patent attorney and expert will aid wireless experimenters and inventors to patent and commercialize their ideas. Write fully what you have, sending sketches and description. All correspondence held strictly confidential.

Address: P. O. BOX 291, GRAND CENTRAL, NEW YORK CITY





Radio Apparatus with that "BUILT-IN QUALITY"

*"Designed Then Built"*

Every part made in our own factory, backed by years of experience in the Radio and Electrical Industry, carefully tested and packed in individual cartons

MECHANICALLY PERFECT  
ELECTRICALLY RIGHT  
RADIO EFFICIENCY

VARIOMETERS VARIOCOUPERS  
VARIABLE CONDENSERS  
TWO-STEP AMPLIFIERS

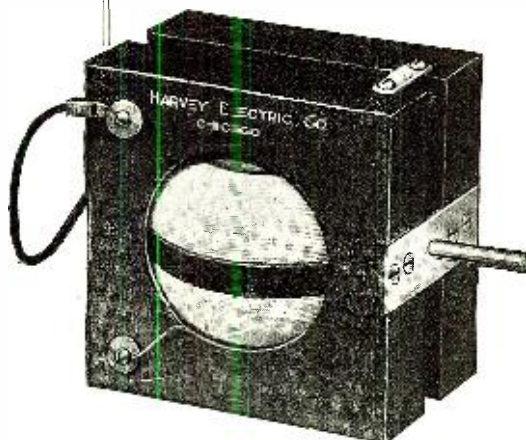

EMPIRE TRANSFORMER DIVISION  
**HARVEY ELECTRIC COMPANY**  
2000 Southport Avenue CHICAGO, ILL.

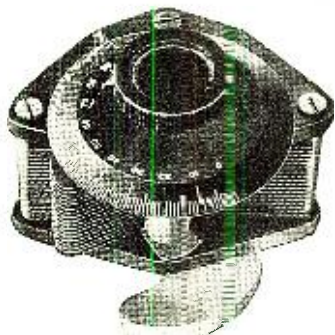

No. 3, Price \$4.75

**Chelsea Variable Condensers** (Die-Cast Type)

- No. 1—.0011 m.f. mounted .....\$5.00
- No. 2—.0006 m.f. mounted ..... 4.50
- No. 3—.0011 m.f. unmounted ..... 4.75
- No. 3—.0011 m.f. unmounted, without dial.... 4.35
- No. 4—.0006 m.f. unmounted ..... 4.25
- No. 4—.0006 m.f. unmounted, without dial.... 3.85

Top, bottom and knob are genuine bakelite, shaft of steel running in bronze bearings, adjustable tension on movable plates, large bakelite dial reading in hundredths, high capacity, amply separated and accurately spaced plates. Unmounted types will fit any panel and are equipped with counterweight.

Guaranteed for circuits up to 1,000 volts.

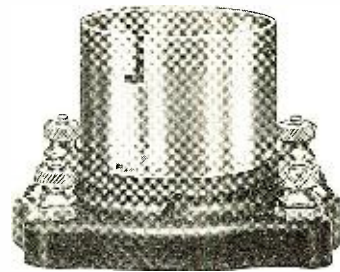

Price \$1.00

**Amplifying Transformer No. 50**

The Chelsea Amplifying Transformer gives the highest amplification possible and at the same time will not squeal, howl, or in any way cause noisy circuits. It is beautiful in design and embodies electrical characteristics unequalled by any. Guaranteed for all circuits up to 500 volts with a high safety factor. It will not fail in service.



Price \$4.50

**Bakelite Socket No. 60**

This socket includes a bakelite base supporting four external readily accessible binding posts. The tube receptacle is highly polished nickel and will take any standard detector or amplifying tube as well as the smaller size power tubes. Although primarily intended for receiving circuits, it will operate satisfactory on any circuit up to 1,000 volts. It may be mounted either on table or panel. Positive contact springs. An added beauty to any radio station.

Purchase Chelsea Radio Equipment from your dealer. If he does not carry it send to us. Write for our new No. 6 catalog.

**Chelsea Radio Co., 150 Fifth Street, Chelsea, Mass.**  
Manufacturers of Radio Apparatus and Moulders of Bakelite and Condensite.



# Variable Condensers

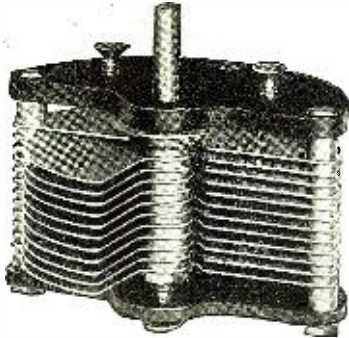

Variable Condensers to be efficient must be well made. Loose joints or faulty construction soon allows the plates to get out of alignment and decrease their efficiency.

A seasoned organization backed by a half million dollar equipment has placed the United Condensers in the front rank with radio engineers the country over.

Prices - 43 plate, \$4.50  
 23 " 4.30  
 11 " 4.00

without dial or knob

Liberal discounts to jobbers and dealers.

We invite correspondence with Radio Manufacturers who are interested in using our facilities and services for manufacturing Radio Equipment.

## UNITED MFG. AND DISTRIBUTING CO.

536 Lake Shore Drive  
 Chicago, Ill.

### THE GOODMAN



PATENT PENDING

The niftiest short-wave tuner on the market

\$6.00 and P. P. on one pound

Send for pamphlet. Order through your dealer.

L. W. GOODMAN  
 Manufacturer  
 Drexel Hill, Pa.

Signal Corps, and Dr. L. duP. Clement also spoke on the future of radio development, regulation and standardization.

A trip to the Washington Navy Yard was made by the delegates of the first day. On the second day the constitution and by-laws were adopted and Commander Hooper took a number of the visitors through the big Arlington Station. In the evening all the delegates and a number of Government officials attended a banquet, where Dr. S. W. Stratton, director of the Bureau of Standards, made an address, as did Dr. Louis Cohen, engineer of the Signal Corps, representatives of the Department of Commerce and Shipping Board Radio Section, and others. On Friday the manufacturers were the guests of Dr. Stratton and Dr. Dellinger at the Bureau of Standards Radio Laboratories.

Much remains to be accomplished before the Radio Chamber of Commerce completes its national scope and begins to function in its control of standard apparatus, but the new officials expressed themselves as well satisfied with the progress made and the co-operation promised by the Government officials.

## Ain't It So?

By HARRY E. MALI

There's a certain fascination  
 When you have the inclination  
 Just to hear some stuff that's broadcast  
 somewhere near.

But the height of satisfaction  
 If you really look for action  
 Is to hear a distant signal coming clear.

First the early days with crystal,  
 When you'd gladly use a pistol  
 On the bird who said you didn't get the  
 coast.

Then the day when with elation  
 You first got regeneration  
 And you heard a call from Cuba, was your  
 boast.

There's a certain fascination  
 When you have that inclination  
 Just to buy a set and listen with the rest.  
 But to scheme and save and barter  
 With some broom-wire for a starter  
 That's the way to get a knowledge of the  
 best.

First the shaky old cat-whisker  
 Which would well nigh wear a blister  
 On your fingers while you're looking for a  
 spot,

Then the regular progression  
 Till you reach the proud possession  
 Of a better set than ever could be bought.

When you make your last connection  
 You decide with deep reflection  
 That you've gone about as far as you can go,  
 Then some other bird devises  
 A new hook-up that surprises  
 And you're off as hard as ever. "Ain't it  
 so?"

### WESTINGHOUSE ENGINEER A PIONEER IN RADIO BROADCASTING

ALMOST any radio amateur who owned a set capable of good range reception prior to 1921 is familiar with the history of station 8XK of Wilkensburg, Pa., operated by Frank Conrad. These amateurs know of the phonograph concerts broadcasted by Mr. Conrad during a period of a year and which were heard as far west as the Catalina Islands. They may recall hearing his request for records one night and may have sent him one, for there were 500 records received in answer to his plea. This was early in 1920 before the radio broadcasting craze had swept the country and was, possibly, the first indication that radio broadcasting had some wonderful possibilities as a medium of entertainment.

## K R L High Grade V. T. Control Units

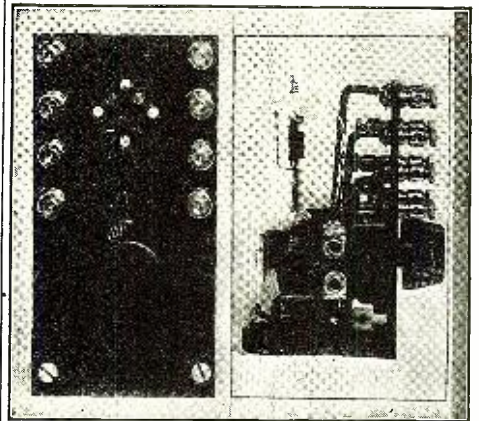

### SPECIFICATIONS

**PANEL:** Bakelite Grade XX 4 1/2 x 2 1/2 x 1 1/2 inches. Most compact on the market.

**BINDING POSTS:** Polished nickel plated with holes for cord tips.

**BASE:** Bakelite 3/8 inch into which is moulded tube receptacle. Contact springs of nickel plated phosphor bronze.

**RHEOSTAT:** High grade No. 120A Fada type.

**GRID CONDENSER:** Standard Dubilier Type 601 mica (not paper) .0005 M.F. with adjustable grid leak.

**PHONE CONDENSER:** Standard Dubilier Type 601 mica (not paper) .001 M.F. wired across phones and B batteries, a distinctive feature.

**WIRING:** Heavy buss bar of No. 12 tinned copper protected by spaghetti tubing. Compact design insures lowest possible resistance in connections.

**OPERATION:** Signal strength guaranteed not to be exceeded by any similar instrument.

Price each, \$5.75. Postpaid and insured. Radio frequency units of similar design with Murad transformer mounted on bakelite base in rear, \$12.00. Audio frequency unit with Federal transformer, \$13.00. With Thordarson transformer, \$10.00. Units may be harmoniously connected.

Subject to return in five days after receipt if not satisfied. At your dealers or direct from

The Kehler Radio Laboratories  
 Dept. R ABILENE, KANSAS

## RAC-AUDION

AUDION  
 \$5.00  
 5  
 TIMES  
 THE  
 AMPLIFI-  
 CATION  
 OF THE  
 ORDINARY  
 TUBE

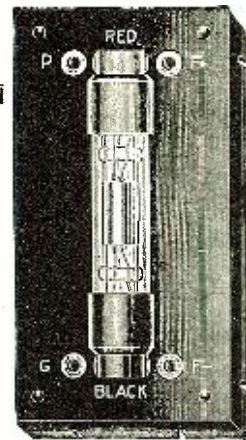

RECEP-  
 TACLE  
 \$1.00  
 WRITE  
 FOR  
 INFOR-  
 MATION  
 AND  
 DIAGRAM  
 USING  
 RAC  
 CHOKE  
 COILS

4 V-Fil 0.8 Ampere 60-Plate  
 New Jersey Radio Equip. & Install. Co.  
 120 BIDWELL AVE. JERSEY CITY, N.J.



Wireless Supplies and  
 Equipment at  
 Wholesale

MORSCAN RADIO CO.  
 196 Market Street, Newark, N. J.



# Keystone Radio Lightning Arresters

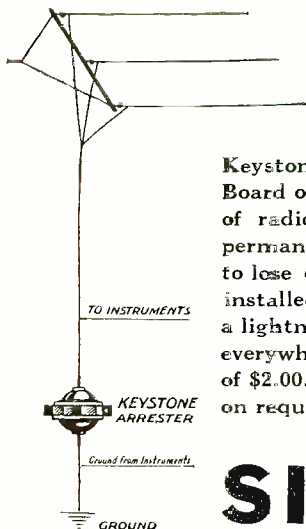

Keystone Arresters are approved by the Board of Underwriters for the protection of radio receiving sets. They provide permanent protection, have no vacuum to lose or fuses to blow. They can be installed outdoors and take the place of a lightning switch. For sale by Dealers everywhere or sent post paid on receipt of \$2.00. Circular and Instructions free on request

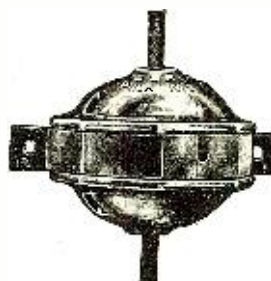

Type A, Keystone Radio Arrester. Retail Price \$2.00

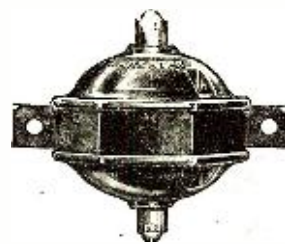

Type B, Keystone Radio Arrester. Retail Price, \$2.00

## SIMPLEX PANEL UNITS



Typical Front View of Panels

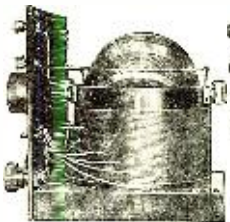

Simplex Vario-Coupler Panel



Simplex Variometer Panel

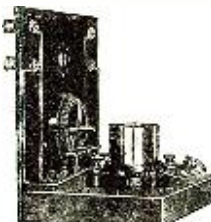

Simplex Detector Panel

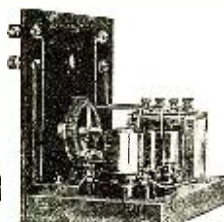

Simplex Amplifier Panel

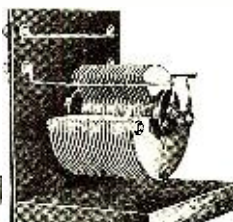

Simplex Condenser Panel

SIMPLEX PANEL UNITS make it possible to try out the many different hook-ups without disassembling panels. The beginner can first buy one vario-coupler panel and detector panel and get good results. Then he can add other units for greater sensitiveness and selectivity. Simplex instruments are always good and efficient. Circular on request. Sold by Dealers everywhere.

### ELECTRIC SERVICE SUPPLIES CO.

Manufacturers of Lightning Arresters for 30 Years  
Distributors for Simplex Radio Co.

17th and Cambria Sts. Phila., Pa.      50 Church Street New York, N. Y.      Monadnock Bldg. Chicago, Ill.

# "Your Wants in Radio Will Be Filled at Once if You Tell Them to Missouri"

#### VACUUM TUBES

No. UV-200 Detector	\$5.00
No. UV-201 Amplifier	6.50
No. UV-202 5 Watt Transmitter	8.00
No. UV-203 50 Watt Transmitter	30.00
No. UV-204 250 Watt Transmitter	110.00

#### CUNNINGHAM TUBES

No. C-300 Detector	\$5.00
No. C-301 Amplifier	6.50

#### SOCKETS

No. 30 Paragon	\$1.00
No. 550 Murdock	1.00
No. UR 542	1.00
No. UR 552	1.50
No. UR 541	2.50

#### AMPLIFYING TRANSFORMERS

No. 231-A General Radio	\$5.00
No. A-2 Acme Semi-mounted	5.00
No. UV-712 Radio Corp.	7.00

#### "B" BATTERIES

No. 763 Eveready, 22½ volts	\$1.75
No. 5156 Burgess, 22½ volts	2.00
No. 766 Eveready, 22½ volts, extra large	3.00
No. 2156 BP Burgess, 22½ volts	3.00
No. 774 Eveready, 43 volts	5.00
No. 6880 Eveready, 110 amp. hrs. - 52 lbs.	20.00

"If you do not see what you want listed here, send your order anyway. We'll fill it."



#### REGENERATIVE RECEIVERS

No. CR-3 Grebe, 150 to 1000 meters	\$65.00
No. CR-4 Grebe, 175 to 680 meters	65.00
No. CR-5 Grebe, 175 to 3000 meters	80.00
No. CR-8 Grebe, 150 to 1000 meters	80.00
No. CR-9 Grebe, 175 to 3000 meters with detector and two-stage amplifier, complete	130.00
No. RA Westinghouse, 150 to 700 meters	68.00
No. RC Westinghouse, 150 to 700 meters	132.50

#### LOUD SPEAKERS

No. R-3 Magnavox, 11-inch horn	\$45.00
No. R-2 Magnavox, 18-inch horn	85.00
No. AC-2-C 2-stage amplifier	80.00
No. AC-3-C 3-stage amplifier	110.00

#### TELEPHONES

No. 56 Murdock, 2000 ohms	\$5.00
No. 56 Murdock, 3000 ohms	6.00
No. 2500 Manhattan, 2000 ohms	6.00
No. 2501 Manhattan, 3000 ohms	7.00

#### BALDWIN PHONES

Types C, E, F, G, per set	\$16.00
Single Headsets, all types	9.00
Single Units (with cord)	8.00
Single Units (without cord)	7.75

#### ANTENNA WIRE

No. 65 Braided Wire, per 100 feet	\$0.50
No. 14 Bare Copper Wire, per 100 feet	.50

#### RHEOSTATS

No. 810 Remler, 4 ohms	\$1.00
No. 560 Murdock	1.00
No. 120-A Fada	1.00
No. 25 Paragon	1.50

#### ATWATER KENT UNITS

Variometer	\$8.00
Variocoupler	8.00

Please include sufficient postage with all C. O. D. orders

# MISSOURI RADIO SUPPLY COMPANY

4623 Maryland Ave.

SAINT

LOUIS

MISSOURI



# TUSKA

Market Reports



# RADIO



Tuska Variometer Type 200

The Tuska Variometer was the first moulded Variometer on the market; not only first to arrive, but first in quality.

All TUSKA RADIO follows this example. The name Tuska is a standard. Insist on Tuska Sets and Tuska Parts.

Send 5c for Tuska Catalog No. 3

## The C. D. Tuska Company

12 Bartholomew Ave., Hartford, Conn.

### DEALERS! DEALERS!

We are Distributors of  
**DeFOREST RADIO EQUIPMENT**

Western Electric and Stromberg-Carlson Phones

Western Electric Two-Step Amplifier and Loud Speaker

Klosner Rheostats, Thordarson Transformers, Variable Condensers

### MUSIO RADIO SET

Send for New Catalog

Wholesale Only

Prompt Delivery

North American

Radio & Supply Corporation

Formerly Aldan Accessory Co.

5 Columbus Circle, New York

8XK has not been very active during the past two years for KDKA, of the Westinghouse Electric & Manufacturing Co., at East Pittsburgh, Pa., has taken its place as the broadcaster of Pittsburgh and environs. But even so, little 8XK was the forerunner of powerful KDKA and actually was the indirect means of bringing the attention of Mr. H. P. Davis, vice-president of the Westinghouse Company, to the radiophone as a means of popular entertainment and instruction.

Many radio amateurs who know Frank Conrad as a broadcaster of ability may not know that he is assistant chief engineer of the Westinghouse Company and, besides being inventor of a great deal of radio apparatus, including a combined receiving and transmitting set for the U. S. Signal Corps which was used in France during the World War and a short wave meter, is one of the most prolific electrical inventors of the present day.

The radio amateurs know Frank Conrad as a radio amateur of ability, but few of them know that he stands near the top of his profession as an electrical designing engineer. Yet it is a fact that during the time he has been engaged in electrical designing, approximately 120 patents have been accorded him.

The field covered by the Conrad inventions is broad, including as it does alternating-current and direct-current electrical measuring instruments of the indicating integrating (including prepayment) and recording types; relays and relay systems; voltage and current regulators; switches; electrically heated boilers; arc lamps; dynamo-electric machines; transformers; motor-control systems; systems of electrical distribution; mercury-vapor rectifiers; automatic synchronizers, phase relation indicators; ground detectors; bakelite micarta gears; starting, lighting and gear shifting and ignition systems for automobiles; carburetors, hand grenades and radio telegraphy and telephony.

Despite his 30 years of service with the Westinghouse Company, Mr. Conrad is a comparatively young man as executives go. He was still in his teens when he secured a job with the Westinghouse Company then located in Garrison Alley in a very small building, and as his friends have stated, has been growing with the company and the electrical industry ever since.

Mr. Conrad is a flawless reasoner and attacks any subject with the same avidity with which he goes into engineering problems. He is able to concentrate so thoroughly upon what he reads that it is said he never forgets what he once has grasped. As those who know him state, he can remember the gist of the contents of every book he has ever read. For this one reason, perhaps more than others, he is remarkably well informed upon practically every scientific subject of modern times.

He is responsible in no small measure for the success of KDKA, as his experience gleaned in amateur broadcasting was available in perfecting this station. In fact, Mr. Conrad was the first person called in, when Mr. H. P. Davis, who first saw the radio broadcasting vision, determined to establish the first radio broadcasting station in the world to broadcast nightly concerts.

### Romantic Rancher Proposes to Unseen Radio Artist

Bachelor girls, sing for the radio! Accept this tip if you are looking for a husband!

Miss Ivy Buchtman, who sings every once in a while at the broadcasting station of the Crosley Manufacturing Company, Cincinnati, Ohio, the call letters of which are WLW, will tell you that radio and romance go hand in hand, her assertion being based on the following letter which she recently received:

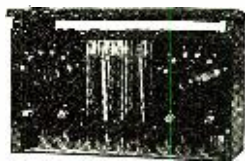

### KICO Radio "B" Storage Batteries for EFFICIENT Receiving

THINK over the following FACTS before making your next "B" battery purchase:

1. KICO "B" batteries allow single cell adjustments by means of switches mounted on panels. (The first storage "B" battery on the market with this feature.)
2. Rechargeable from your 110-volt A. C. line in series with the rectifier supplied with each battery.
3. One charge lasts from three to six months in the detector plate circuit.
4. Highly finished, durable and compact.
5. Life unlimited, as overcharging, short-circuiting or standing idle does them no injury.
6. Not an ACID battery.
7. One quart of distilled water puts the battery into service.
8. Your money back if unsatisfied within a 90-day trial.

	(Plain)	(Panels)
16 cell 22 volts.....	\$6.50	.....
24 cell 32 volts.....	8.00	\$12.00
36 cell 48 volts.....	10.00	14.00
50 cell 68 volts.....	12.00	17.00
78 cell 100 volts.....	16.00	21.00

Drop us a line for literature.

**KIMLEY ELECTRIC COMPANY**  
290 WINSLOW AVENUE, BUFFALO, N. Y.

### KLEIN'S RADIO and ELECTRIC SUPPLY CO.

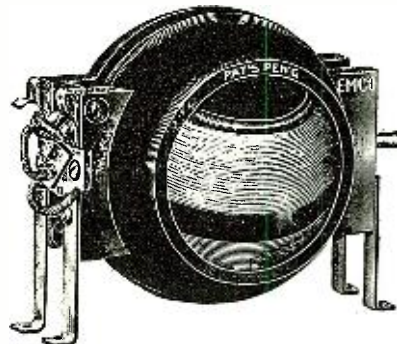

### EMCO MOULDED VARIOMETER

Moulded out of pure bakelite; removable legs for panel mounting. Pig-tail connection, eliminating bearing connection. Price, **\$7.50**

Send for our complete catalog of most modern Radio Equipment (including diagram of New Armstrong Regenerative Circuit,) mailed Free everywhere. MAIL ORDERS receive immediate attention.

48 FULTON ST. (near 3d Ave. N.Y.)  
34 PARK PLACE (near Woolworth Bldg., N.Y.) **NEW YORK**

### RADIO DEALERS AND MANUFACTURERS

We have them—all parts needed for the radio trade promptly delivered.

Send us your requirements for prices

**SMITH ENGINEERING CO.**  
One Union Square New York City

### International Radio Corporation

**DEALERS—Write for Prices**

We manufacture receiving sets, variable condensers, variocouplers, variometers, sockets, rheostats and parts for assemble of radio receiving apparatus.

**Dept. A, 42 Branford Pl., Newark, N. J.**



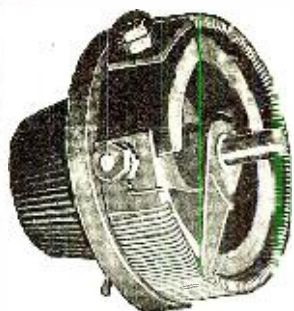

## SEE THAT SWITCH

### No. 200-The New Improved Hipco Wireless B Battery

The Rotary Switch Lever makes it easy to instantly get any desired

The Hipco Rheostat is especially designed for filament control of vacuum tubes. It operates on 4 to 6 volts. The resistance is made of a non-corrosive alloy and can be very readily renewed.

Made with several styles of knobs to match various dials.

List Price, **\$1.00** each.



- Phone Condensers .001 MFD. at ..... **35c**
- Phone Condensers .002 MFD. at ..... **35c**
- Grid Condensers .0005 MFD. at ..... **35c**
- Grid Condensers .00025 MFD. at ..... **35c**
- Grid Leak Condensers .0005 MFD. at ..... **50c**
- Grid Leak Condensers .00025 MFD. at ..... **50c**

voltage. No resistance to overcome, therefore, no loss of energy. It is also Refillable and Variable same as other styles of Hipco B Batteries and is especially designed for Vacuum tube work on plate circuits and is guaranteed to be perfectly noiseless.

- No. 200-22½ Volts, Price **\$3.50**
- No. 100-22½ Volts, " **3.00**
- No. 140-22½ Volts, " **2.00**
- No. 245-45 Volts, " **4.00**

For Sale at all Radio Supply Dealers

**HIPWELL MFG. CO. N. S. Pittsburgh, Pa.**



### BUY A HIPCO MULTIPHONE

Price **\$5.00** Complete With Four Sets of Head Phones

Let your friends and family listen in—reproduction 100% perfect. No trouble—nothing to get out of order.

### ROTARY SWITCH LEVERS

With same knob as illustrated



- No. 1-1¼ Radius List Price **50c** ea.
- No. 2-1½ Radius List Price **55c** ea.
- No. 3-1 Radius List Price **50c** ea.

We also manufacture same with knob to match Rheostat illustrated.

## WHY WASTE YOUR TIME WIRING?

Hook up with the "Socostat"!

HERE is a combination of socket and rheostat that eliminates the wiring of two separate parts. Saves time, material and money.

No exposed wires. The internal rheostat permits very sensitive filament adjustment. Tube noises reduced to a minimum. Bakelite base and cover. Nickel-plated receptacle takes any standard detector and amplifier tube. Rings and screws all nickel-plated.

Simplify your construction, and improve appearance and operation of your set.

Jobbers and Dealers write Automotive Electric Service Corp., 206 Amsterdam Ave., New York City.

Manufactured by

**FEDDERS MFG. CO., Inc.**

57 Tonawanda Street

Buffalo, N. Y.

### "SOCOSTAT"



Single-Unit Socket and Rheostat for table or panel mounting.

Guarantees a smooth and positive contact.

Price **\$2.50** each

Buy from your dealer, or if he cannot supply this new, improved device, send the money to us with your dealer's name and we will send direct, parcel post, prepaid,

Descriptive literature on request.





## The fastest way to learn the RADIO CODE

LISTENING to radio concerts is only half the game. The first step to a real knowledge of wireless signalling is the knowledge of the code. Then, once mastered, the real delights of radio will be yours. Think of listening to a steamer 200 miles out at sea; think of picking up messages vital and amusing; think of the fun of getting in touch with your pals; of "getting" Arlington, St. John, Cape Race or Chicago.

### A simple, logical method

All this is possible—nay, easy, if only you know the code. Now, a new way has been developed for learning it, something so simple and logical that you will wonder that no one has ever done it before.

Jack Binns has made two phonograph records that are marvels of simplicity and clearness and with their help you can learn the code in one evening—think of that.

And with them you get a book explaining the complete short-cut system on which the records are based.

**2 Records and Text-Book**  
— all for **\$2.00**  
or **Book alone — 50c.**

The price of two dollars is ridiculously small as compared with the great, permanent benefit that can be yours if you avail yourself of this big offer.

Just drop in to your dealer, either radio or phonograph, and ask for Jack Binns's Okeh Radio Records. Or send \$2.00 to the

**American Code Co., Inc.**  
206 Broadway  
NEW YORK CITY

"Chikasha, Okla.  
"June 10.  
"My dear young lady:  
"You will please pardon the liberty I take in writing to you. I have never met you personally, but, after hearing your lovely voice over the radio, I am so charmed that I am compelled to tell you how happy you have made me and how anxious I am to meet the charming possessor of such a marvelously beautiful voice.

"I am the owner of a large ranch many miles from any town of importance, and, until the advent of radio, I had very few opportunities of hearing good music. But thanks to the radio, which has conveyed the beautiful tones of your voice to me here, and I am now looking forward to the time of the year when I again will be able to hear WLW, where, I understand, you sing quite regularly.



Miss Ivy Buchtmann, whose voice so charmed a Radio listener that he wrote the accompanying letter, which shows what Radio can do in the matrimonial way.

"Now the prime object of this letter is to endeavor to arrange to meet you; that is, if you are young and not married. I am 30 years old, wealthy, and considered good looking. I never experienced an extra pulse-throb until I heard your sweet voice on the WLW radio. Please tell me if there would be any objection to my coming to Cincinnati to meet you and your parents. May I send you one of my photos and in exchange will you send me one of yours?"

"Hoping I may have the pleasure of hearing from you, please allow me to remain,

"Yours respectfully,

"J. M."

### NAVY BROADCAST FOR AMATEURS DURING THE MONTH OF JULY, 1922

July 1—English—Wayne Franklin Rositer your application for amateur registration was received without address Please forward same to complete form

July 2—Code two—Pearl Harbor call letters NPM transmits with arc set on eleven thousand five hundred meters at one thirty a m three thirty a m one thirty p m and six fifty five p m seventy fifth meridian time

July 3—English—following additional list of call letters assigned by Department of Commerce during week of June nineteenth nineteen twenty two WGAD Spanish American School of Radiotelegraphy Escondido P R WGAF Goller Radio Service Tulsa Okla WGAG Wisconsin Radio Show Milwaukee Wisc WGAH New Haven Electric Co New Haven Conn KFAE McArthur Bros Mercantile Co Phoenix Ariz KFAE State College of Washington Pullman Wash KFAF Western Radio Corp Denver Colo changed from KDZU

## Shipped from Stock

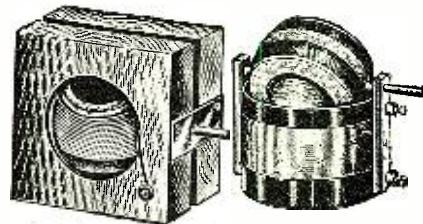

- Variometer, complete, high grade..... **\$3.25**
- Variocoupler, high grade, complete..... **2.75**
- Variometer Parts, all necessary parts except wire..... **1.50**
- Variocoupler Parts, complete set except wire..... **1.00**
- Standard Head Sets, 2,000 Ohms..... **4.90**
- Thordarson Amplifying Transformer..... **3.50**
- "B" Battery, Ra-o-vac, 22½ Volts..... **1.10**

Mail Orders Promptly Filled

**Scientific Dealers Supply Company**

2727 Fullerton Ave. Chicago, Ill.

### Quality Radio Supplies at Right Prices

"Long Distance Variometers—Plate or Grid." Polished blocks, natural or brown color.

Mahogany, cotton winding \$4.25 Green Silk \$4.75  
Poplar, cotton winding 3.75 Green Silk 4.25  
Unassembled, deduct 75c. Parts without winding, deduct 2.00  
Stator windings, cotton, set 50c Green Silk 1.00

#### VARIO COUPLERS

Bakelite Tube, cotton winding \$3.00 Green Silk \$3.35  
Varnished Tube, cotton winding 2.50 Green Silk 2.85  
Unassembled, deduct 50c. Parts without wire, deduct 1.50  
Mahogany rotors 35c Poplar 25c

#### VARIABLE CONDENSERS AND DIALS

3 Plate .00005 \$1.90 23 Plate .0005 \$3.00  
7 Plate .0001 2.40 43 Plate .001 3.50  
11 Plate .0003 2.60 3" Dials . . . . .60

Money back guarantee. Send stamps for mfrs. bulletin. Quantity discounts. Dealers and agents wanted. Special purchasing service for the trade.

McCONNELL CABLE AND SPECIALTY CO.  
426 South Clinton Street, Chicago, Ill.

## Radio Supplies

All Standard Goods—Immediate Deliveries

Kellogg, Manhattan, Teleradio Head Sets, Dials, Rheostats, Audio & Radio Frequency Transformers, Variable Condensers, Variocouplers, Bakelite Rotors and Stators, Jacks, Plugs.

A Complete Line. Largest Stock in the Middle West. Write for Catalogue.

DEALERS—ATTRACTIVE DISCOUNTS

AMERICAN RADIO MFG. CO. Dept. A.  
107 E. 13th St., KANSAS CITY, MO.

### RADIO FREQUENCY AMPLIFIERS

That Give Clear Long-Distance Reception With Loop Aerial

Write now for data and prices

**MASSEY RADIO COMPANY**  
Winchester - - - Virginia

### STEINER ELECTRIC CO.

115 N. Wells St., Chicago

### RADIO SUPPLIES

Branch Store—5239 N. Clark St.

Wholesale and Retail

## Best by Test!



Hundreds of manufacturers, dealers and owners of receiving sets everywhere have tested and found our crystals the most sensitive and efficient obtainable.

Double your pleasure and increase the efficiency of your set by using our ALL-SENSITIVE GALENA CRYSTALS. Galena Crystal, Mounted . . . . . 35c Galena Crystal, Unmounted . . . . . 25c

IMMEDIATE DELIVERY

Every Crystal

GUARANTEED PERFECT

Manufacturers, Jobbers, Dealers, write for quantity prices

**GALENA CRYSTAL MFG. CO.**

464 Bushwick Ave.

Brooklyn, N.Y.



**\$1.00**

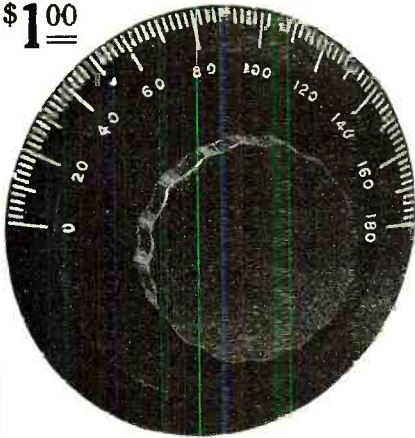

**CERTIFIED  
UNION RADIO**

**Apparatus and Accessories**

As a result of our endeavor to bring forth a high quality line of Radio Apparatus and Accessories, we are proud to announce that the four Union Radio parts shown in this advertisement have had the "Certified" stamp of approval placed on them by the New York "Evening Mail," and other recognized Testing Laboratories.

As all Union Radio Apparatus and Accessories are guaranteed by us without any reservation whatsoever as to workmanship and material, we stand ready at all times to replace or repair any Union Radio Set or part, which may not come up to the high standard of quality that we have established.

Knowing that the real earnest amateur can get satisfactory results only from the very best equipment, we urge your consideration, inspection and comparison of Union Radio apparatus and accessories.

Our catalogue "RADIO APPARATUS 'C'" illustrates and describes our complete line of Radio Apparatus and Accessories—Write for your catalogue today.

**RETAILERS AND DISTRIBUTORS**

Write for samples of Union Radio guaranteed and reasonably priced "Quality Products." Liberal terms and trade discounts.

UNION RADIO CORPORATION  
200 M. PLEASANT AVENUE, NEWARK, N. J.  
NEW YORK OFFICE 116 WEST 32<sup>ND</sup> STREET.

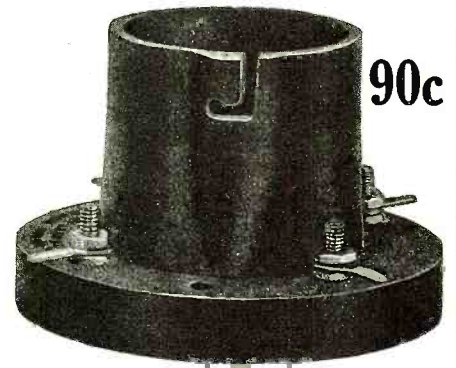

**90c**

**\$1.20**

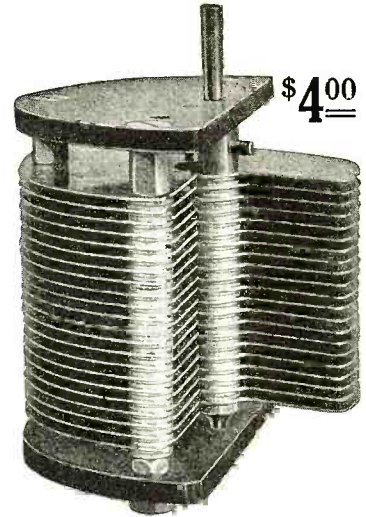
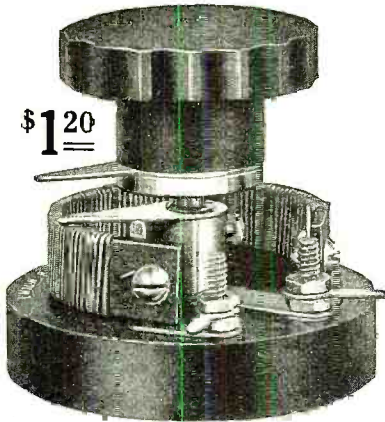

**\$4.00**

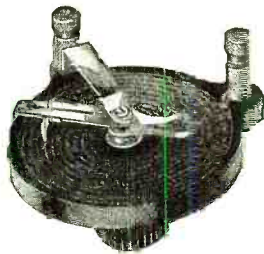

Patent Pending

*The picture tells the story*

**T**HIS VERNIER RHEOSTAT differs from others the same as a violin differs from a mandolin. Any vibration can be tuned exactly without gaps or breaks.

The finest and most perfect adjustment can be made by the turn of a single knob. It is really a new and radical departure from all standard types.

Price  
**\$1.50**

**The New Marco Vernier Rheostat**

**Type 100-A—Resistance Capacity 6 Ohms**

The resistance unit is made of the finest resistance material known—Ni-Chrome Wire

No drilling of screw holes in panel.

Smooth and noiseless in operation.

Moulded parts made of Bakelite.

No screws necessary. Nothing to wear.



**MARTIN COPELAND CO., Providence, R. I.**







**\$110**

Without  
Tubes,  
Batteries  
or Phones

**Type  
VC-1**

Everybody likes **VOLUTONE VC-1**—its appearance as well as the tone and volume of the broadcast on local and long distance work. VC-1 is the result of original thought on the part of radio engineers who have experimented for months to develop an ideal long distance home receiver, simple to operate, a loud speaker on long distance stations, a greater degree of selectivity in tuning, and reproduction with tonal qualities equal to finest phonograph.

Four vacuum tubes are used, with one stage radio frequency and two stages audio frequency amplification. Entire receiving unit mounted to bakelite panel. Mounts with controls on top in genuine quartered oak, walnut or mahogany cabinet. Separate compartment for "B" batteries and loud speaker built into cabinet. Filament control on four tubes, with potentiometer adjustment.

You will like it, too, when you see our Bulletin RN-2. Write for it today and ask your dealer to demonstrate the **VOLUTONE VC-1**. There is nothing else like it and we believe it will produce better results than sets selling at twice the price, \$110, without tubes, batteries or phones.

**DEALERS and JOBBERS**  
write for introductory offer

**THE VOLUTONE COMPANY**  
141 WEST OHIO ST., CHICAGO, ILL.

**GITHENS TRUTONE RADIO  
HORN—LOUD SPEAKER**



First one to sell  
on ten day trial  
Money back  
Guarantee

Retail Price  
**\$21.00**  
Includes  
Loud Speaker

Trutone has been pronounced the best on the market by experts. It has a clear true tone. Every radio fan should try Trutone and compare it with others. If YOU don't find Trutone the best, your money will be refunded. It is sold on a ten-day trial money-back guarantee. If not carried by your dealer write us.

Distributors and Dealers, write!

**AUTO PARTS MFG. CO.**  
1017 Trombly Ave., Detroit, Mich.

July 5—English—The Weather Bureau Department of Agriculture recently published pamphlets explaining the method of transmitting weather reports forecasts and warnings by Naval radio stations for the benefits of marine interests these publications may be obtained from the above named Bureau upon application

July 6—Code Six—US radio station Annapolis Md broadcasts time at eleven fifty five a m time and press at nine fifty five p m seventy fifth meridian time on wave length of seventeen thousand one hundred forty-five meters

July 7—Code eight—US Navy radio station Washington D C call letters NAA transmits time at eleven fifty five a m time weather and press at nine fifty five p m seventy fifth meridian time on wave length of twenty six hundred fifty meters

July 8—English—The following radio call letters were assigned during the week beginning June twenty fifth nineteen twenty two  
WGAY North Western Radio Co Madison Wis  
WGAZ South Bend Tribune South Bend Ind  
KFAJ University of Colorado Boulder Colo  
WHAB Clark W Thompson Fellmans Dry Goods Co Fayetteville Ark  
WHAC Cole Bros Electric Co Waterloo Ia  
WHAD Marquette University Milwaukee Wis  
WHAE Automotive Electric Service Co Sioux City Ia  
WFAF Radio Electric Co Pittsburgh Pa

July 8—English—The following radio call letters were assigned during the week beginning June twenty sixth nineteen twenty two  
WGAR Southwest American comma Fort Smith Ark  
WGAS Roy Di Co organization Chicago Ill  
WGAT American Legion Dept of Nebraska Lincoln  
WGAU Marcus G Limb Wooster Ohio  
WGAU B H Radio Co Savannah Ga  
WGAW Ernest C Albright Altoona Pa  
WGAX Radio Electric Co Washington Ohio Temporary

July 4—English—Following additional list of radio call letters assigned to stations during the week of June nineteenth by Department of Commerce  
WGAJ W H Gass Shenandoah Iowa  
WGAK Macon Electric Co Macon Ga  
WGAL Lancaster Electric Supply and Construction Co Lancaster Pa  
WGAM Orangeburg Radio Equipment Co Orangeburg S C  
WGAN Cecil E Lloyd Pensacola Fla  
WHAA State University of Iowa Iowa City Iowa  
WGAQ W G Patterson dash Glenwood Radio Corpn Shreveport La

July 11—English—the USS ILLINOIS will sail Saturday July fifteenth for a two weeks training cruise for naval reservists period it is planned to visit Bermuda period applications for enrollment are being received on board the ILLINOIS at ninety seventh street and North River New York City

July 12—English—Endeavors to establish a Navy American Radio Relay League station at the US Navy Radio Station Navy Yard New York have been abandoned owing to present economic conditions

July 14—English—The following broadcasting stations have been assigned radio call letters during the week beginning July third  
WHAM University of Rochester Rochester N Y  
KFAN Electric Shop Moscow Idaho  
KFAP Standard Publishing Co Butte Mont  
KFBA Ramey & Bryant Radio Co Lewiston Idaho  
KFAQ City of San Jose San Jose Cal  
KFAR Studio Lighting Service Co O K Oleson Hollywood Calif  
WHAN Southwestern Radio Co Wichita Kans  
WHAO Frederick A Hill Savannah Ga

July 17 1922—English—Beginning Wednesday July nineteenth and each Wednesday and Friday thereafter the United States Navy Yard New York will retransmit the Marine Band and Washington Navy Yard Band concerts beginning at nine thirty p m daylight saving time on wavelength four

**Standard Radio  
Horn**



Patent applied for  
**Special Design**

Will fit any receiver. Heavy material, no blast. Rubberoid Enamel finish.



No. 15 (as illustrated)  
5" Bell, 14" High.  
Price.....\$5.00.

No. 17, 7" Bell,  
19" High.  
Price.....\$7.50

Your dealer can supply you

We figure on **SPECIAL HORNS**  
FOR MANUFACTURERS

**Standard Metal Mfg. Co.**  
Oldest and Largest Manufacturers of Horns in U. S.  
237 Chestnut St., Newark, N. J., U.S.A.



**EVERETT  
DOUBLE RADIO  
PHONES**

"Not the loudest  
but the clearest"

It took thousands of dollars to make them what they are — Millions would not have made them better, yet a pair today costs only

**\$8.50 At All Dealers**

**EVERETT ELECTRIC CORP.**  
320 BROADWAY NEW YORK

**SAY, FELLOWS**

Save those radio profits by using our blue prints. Make VT equipment; don't be satisfied with an obsolete crystal set. Learn the radio game thoroughly by making your parts. Stamp brings full particulars.

**The Plan Bureau**  
1929 McCausland Ave. St. Louis, Mo.

**Newark Wireless Exchange**

We carry all makes of Wireless Apparatus

Send 10 cents for catalogue  
87 Halsey St. Newark, N. J.



# Now Ready! The DICTOGRAPH Radio Loud Speaker for the Home

THE Radio public has been waiting for the Dictograph Radio Loud Speaker. Perfected by Dictograph Products Corporation, the pioneer manufacturer of loud-speaking telephones, and world-famous for its sound-transmission instruments; the same supreme quality as other Dictograph products.

Years of experience have made possible this new Loud Speaker—the best in the world—and sold at a price that gives you DICTOGRAPH quality at no extra cost. The great, assured demand has made possible a reduction from the price originally announced. Instead of \$25, it is only \$20—complete with 5 ft. flexible cord.

See the Dictograph Loud Speaker at your dealer. Dealers can be supplied by local jobber—or inquire direct.



Price  
**\$20**

Complete with  
5 ft. flexible cord

*The Standard of the World*

The Dictograph Loud Speaker is beautifully constructed; the cabinet is of hardwood, ebony finished, with die cast black enameled aluminum tone arm. The horn is spun copper, highly polished, French lacquered, non-tarnishable. Completely equipped with 5 ft. flexible silk cord. For any vacuum tube receiving unit. No extra batteries required.



**DICTOGRAPH  
Radio HEAD SET**

3000  
Ohms  
Price  
**\$12**

Ask for the Dictograph Head Set—the best Head Set in the world, regardless of price. The name Dictograph is your guarantee of supreme quality. It insures the most sensitive and accurate transmission of sound known to Radio.

**DICTOGRAPH PRODUCTS CORPORATION**  
220 WEST 42d STREET (Branches in All Principal Cities) NEW YORK CITY

*Let Your Apparatus Speak for Itself*

## AMERICAN RADIO EXPOSITION

- A national exposition for radio manufacturers, dealers, inventors and amateurs, covering the entire field of radio.
- A complete exhibition of apparatus, accessories and materials.
- Daily demonstrations, broadcasting, lectures, orchestral concerts, Grand Opera artists in person—motion pictures illustrating practical uses of radio and the principles of its operation.

To be held at

**Grand Central Palace**  
46th to 47th Sts. & Lexington Avenue

—The heart of the great terminal zone, close to the busiest shopping districts.

NEW YORK CITY  
DECEMBER 21st to 31st, 1922

—Schools and colleges will be closed, making it convenient for young folk to attend. To these young people the magic of radio makes a specially strong appeal.

Manufacturers and dealers should contract for space now  
Address inquiries as to rates, etc., to

**AMERICAN RADIO EXPOSITION COMPANY**  
120 Broadway, New York City Telephone, John 0009

*Educational and Interesting*





## Ra-Fone

**Variometer**  
**\$3.80**

**Vario-Coupler**  
**\$3.80**

Stators  $4\frac{1}{2}$  inches square, rotors  $3\frac{1}{4}$  inches. Double cotton covered windings, No. 22 wire set in insulating varnish. Flexible leads to  $3\frac{1}{2}$ -inch secondary. Clear insulating varnish finish. Mounts flat to panel with 2 counter-sunk screws.

**Both guaranteed to be of very best material and workmanship and to receive perfectly up to 500 meters when properly installed. Immediate shipment by parcel post on receipt of price. Satisfaction guaranteed or money back.**

**Ra-Tone Electric Co.** 919 Park Place West  
DETROIT, MICHIGAN

one two meters (412 meters)

July 18—English—Radio amateur broadcast the amended weather broadcast schedule for the Arlington Radio Station NAA is as follows ten a m state weather forecast on five nine five zero meters X arc ten thirty a m Marine and aviation bulletin on five nine five XXX zero meters arc five p m special forecast and warnings on five nine five zero meters arc ten p m state weather forecast on two six five zero meters spark ten thirty p m Marine and aviation bulletin on two six five zero meters spark the marine and aviation bulletin will be immediately followed by hydrographic information

July 20—English—US Naval radio station Arlington Virginia call letters NAA broadcasts separate weather forecasts for each of the States east of the Mississippi except Indiana Wisconsin and Illinois and a general forecast for the section comprised therein at ten a m on a wavelength of five nine five zero meters arc and ten p m on a wavelength of two six five zero meters spark on Wednesdays from April first to October fifteenth inclusive period A summary of weather conditions as they affected crops during the previous week will also be included period times are seventy fifth meridian

July 21—English—Norfolk Va call letters NAM transmitting on one eighty five one meters spark broadcasts at ten forty five a m wind and weather forecasts and storm warnings for Virginia and North Carolina coasts advisory messages regarding storm warnings issued for Chesapeake Bay and middle and south Atlantic coasts and at four and eight p m storm warnings and advices issued in afternoon

July 22—English—Charleston SC call letters NAO transmitting on two two five zero meters spark broadcasts at ten thirty a m wind and weather forecasts and storm warnings for South Carolina coast advisory messages relating to storm warnings issued for middle south Atlantic and east Gulf Coasts and eight a m barometric pressure wind direction and velocity and state of weather at Charleston and at six p m storm warnings and advices issued in afternoon

July 23—English—Savannah Georgia call letters NEV transmitting on one eight one three meters spark broadcasts at eleven a m wind and weather forecasts and storm warnings for Georgia coast advisory messages relating to storm warnings issued for middle and south Atlantic and east Gulf coasts and eight a m barometric pressure wind direction and velocity and state of weather at Savannah and at six p m storm warnings and advices issued in afternoon

July 24—English—Jacksonville Florida call letters NFI transmitting on four five zero meters broadcasts at eleven a m wind and weather forecasts and storm and hurricane warnings for East Florida coast Jacksonville to Miami advisory messages relating to storm warnings issued for middle and south Atlantic and east Gulf coasts and eight a m barometric pressure wind direction and velocity and state of weather at Jacksonville and Titusville and at six p m storm warnings and advices issued in afternoon

July 25—English—Baltimore Maryland call letters NBZ transmitting on seven hundred meters spark broadcasts at ten thirty a m wind and weather forecasts and storm warnings for Chesapeake Bay advisory messages regarding storm warnings issued for middle and south Atlantic coasts and eight a m barometric pressure wind direction and velocity and state of weather at Baltimore and Norfolk and at four p m storm warnings and advices issued in afternoon

July 26—English—Philadelphia Pa call letters NAI transmitting on one nine four eight meters spark broadcasts at ten forty five a m wind and weather forecasts and storm warnings for New Jersey Delaware and Maryland coasts advisory messages re-

# RTS Switch Lever

The attention of jobbers and dealers is especially called to the RTS Bushing Lever. It has many improved features. The knob is of the well-known Marconi type,  $1\frac{3}{4}$  inches in diameter. The spring lever of nickel bronze has ground ends, insuring smooth and positive adjustment. It has a  $\frac{3}{4}$ -inch bushing and locknut for panel assembly. A guide bushing under the knob is an important feature, as it raises the lever to the proper height for all switch points. Retails at.....60c



**AMATEURS**  
Amateurs will find RTS Specialties on sale at their regular dealers. But if he hasn't them in stock, we will supply you direct.

**Discount to Dealers and Jobbers**  
Dealers and Jobbers: Write us today for special quotations and discounts on all RTS equipment.

**RADIO TESTING STATION**  
DEPT. R-9 25 STURGIS ST.  
BINGHAMTON, NEW YORK

## HYGRADE SPECIALS

Radiotron U.V., 200 Tubes	\$4.75
Radiotron U.V., 201 Tubes	5.75
Nc. 766 Eveready Variable B. Battery	2.25
45-Volt Cyclene Variable B. Battery	2.75
Electro Insulators, per dozen	2.00
7-Stranded Copper Aerial Wire, 200 Ft.	1.25
Arky Loud Speakers	4.00
.001 M.F. Signal Variable Condensers (with dial and knob)	4.00
Thordarson Amplifying Transformers	3.80
Acme Amplifying Transformers (Semi-mounted)	4.25
Federal Amplifying Transformers	6.25
Skindervikin Transmitter Buttons	.75
Murdock No. 56 Head Set, 3000 Ohm	5.75
Murdock No. 56 Head Set, 2000 Ohm	4.75
Federal 2200 Ohm Head Set	7.25
Diagraph 3000 Ohm Head Set	9.00
Western Electric Head Set	12.50
Rheostats, Fada 90—De Forest	1.00

**MARKO STORAGE BATTERIES**

6 volt 30 amp., guaranteed 2 years	10.00
6 volt 60 amp., guaranteed 2 years	13.50
6 volt 80 amp., guaranteed 2 years	17.00
6 volt 100 amp., guaranteed 2 years	21.00
Homecharger, charge your own battery	16.50

Above prices are F. O. B. New York

**HYGRADE ELECTRICAL NOVELTY CO.**  
41 WEST 125th STREET, NEW YORK, N. Y.

## "MICROSTAT"

A Vernier Throughout Its Range  
Indispensable for New Armstrong Circuit

7 Ohms  
2 Amperes



Price **\$1.50**  
Add 10c for postage Pat. Pend.

**Stepless Filament Control**  
Dealers and Jobbers write for discounts and complete list of products of merit

**WALD ELECTRIC CO.**  
Manufacturers  
101-103 Varick Street New York

## Armco Ingot Iron

for Electrical Uses

in Cold Rolled Strips and Bright Drawn Shapes and Bars

## Silicon Electrical Sheets for Radio

Transformers, Condensers, etc.

## Ward's Permanent Magnet Steel

for Highest Quality Magnets

**EDGAR T. WARD'S SONS CO.**  
Boston, Brooklyn, Newark, Philadelphia, Cleveland, Detroit, Chicago

## EXPERIMENTERS INFORMATION SERVICE

Designing Radio Engineers  
23rd Floor  
220 West 42nd St. New York City

## BALDWIN PHONES

made into LOUD speakers. I will supply Horn and Box, price reasonable. BALDWIN PHONES repaired, adjusted, tuned and new diaphragms put on. Wireless receiving sets built to order, repaired, etc.

Established 1910  
J. F. ARNOLD, 109 E. 125th St., N. Y.

We Manufacture  
**PHONE & GRID CONDENSERS**  
23 and 43 variable Condensers, Insulators, Contact Switches, Mounted Crystals, 2 Slide Tuning Coils. We carry in stock platinum wire for Detectors. Bases for audion lamps.

**MALTZ ELECTRIC COMPANY**  
Newark, N. J.  
Factory, PASSAIC, N. J.



# The RADIOGEM

(Patents Pending)

**\$1** Receiving Set—The Simplest Radio Outfit **\$1**  
 Made—Yet as Practical as the Most Expensive!

You need know absolutely nothing about wireless to operate and enjoy the RADIOGEM. It is so sturdy, so simply constructed that it is small wonder radio engineers who have tested it have pronounced the RADIOGEM a brilliant achievement. The RADIOGEM is a crystal radio receiving set for everyone at a price anyone can afford.

**Why The RADIOGEM Can Be Sold For Only \$1**

Here's the secret: The RADIOGEM Construction eliminates all unnecessary trimmings, cabinets and the like, which do not play any part in the operation of a set. You receive the RADIOGEM unassembled, together with a clearly written instruction book, which shows you how to quickly and easily construct the set, using only your hands and a scissor. The outfit comprises all the necessary wire, contact points, detector mineral, tube on which to wind the coil, etc., etc. The instruction book explains simply and completely the principles of radio and its graphic illustrations make the assembling of the RADIOGEM real fun. Remember the RADIOGEM is a proven, practical radio receiving set and will do anything the most expensive crystal set will do.

**The RADIOGEM is the Prize Winner of the Age**

Out of hundreds of radio models submitted recently in a great nation-wide contest, radio engineers, the judges, unananimously chose the RADIOGEM as the winner—the simplest radio-receiving set made! And the RADIOGEM costs you nothing to operate; no form of local electricity is required.

**DEALERS** The RADIOGEM is the wonder item of the radio age. It will storm the country, for the RADIOGEM'S price is so low everyone is able to buy one. Write immediately for full particulars before that shop across the street beats you to it.

Hear the programs of the Broadcasting Stations on the RADIOGEM



Receives up to 20 Miles



Take One to Camp or on That Motor Trip

**\$1**  
 Without Phone or Aerial

## The Only Authentic Book on the Construction and Operation of "The Armstrong Super-Regenerative Circuit"

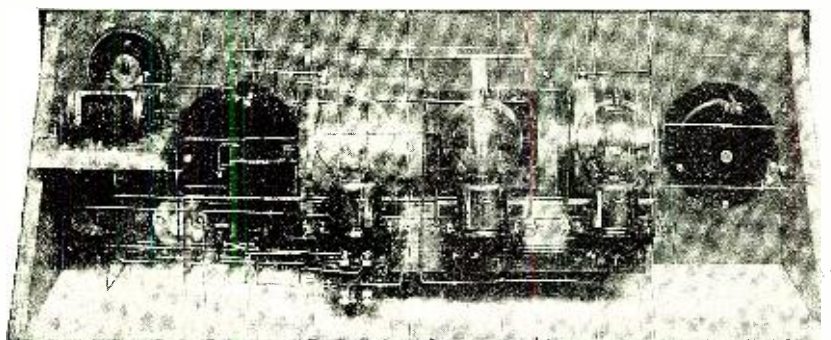

Described fully in 52 pages Including 21 Photographs and Hook-Ups, in simple non-technical radio language.

This set built by the author

**George J. Eltz, Jr., E.E.**  
 A. I. E. E.

Complete Description of Each of the Three Circuits Invented by **MAJOR E. H. ARMSTRONG, E.E.**

How to change a Regenerative Circuit to a Super-Regenerative Circuit  
**Price \$1.00 Per Copy** Mailed or at Your Dealer (DO NOT SEND STAMPS)

**RADIO DIRECTORY and PUBLISHING CO.**

45 VESEY STREET (Room 103) NEW YORK CITY

**NOTICE** The second edition of the **AMATEUR RADIO CALL BOOK** is now ready Mailed to you on receipt of \$1.00 (Do not send stamps)



**RECEL TOLEDO**

## Audion Control Unit

*The Hit of the Year*

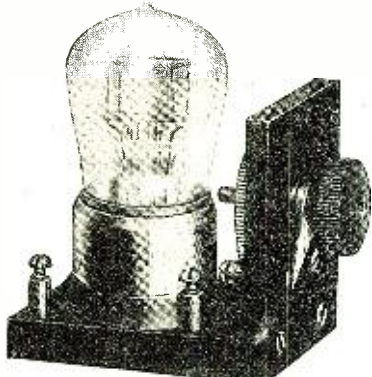

Compact, practical and efficient. For table or panel mounting. Moulded hard rubber. Rheostat 6 ohms resistance—2 amps. carrying capacity. Selling on sight.



This illustration shows a detector and two step amplifier using three Precel audion control units and two Precel transformers. Built by an amateur at a cost of \$17.00.

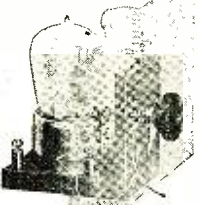

Phantom view showing Precel audion control unit mounted back of panel using but two screws.

*Write for literature and prices*

### Precel Radio Mfg. Co.

*Mfrs. of Precel Sets and Parts*  
30 Spitzer Bldg. Toledo, Ohio

garding storm warnings issued for north and middle Atlantic coasts and eight a m wind direction and velocity and state of weather at Delaware Breakwater and at five p m storm warnings and advices issued in afternoon

July 27—English—New York NY call letters NAD transmitting on one eight three two meters spark broadcasts at ten thirty a m wind and weather forecasts and storm warnings for New York and Connecticut coasts forecasts Sandy Hook to Grand Banks for European steamers advisory messages regarding storm warnings issued for north and middle Atlantic coasts and eight a m barometric pressure wind direction and velocity and state of weather at Sandy Hook and at five p m storm warnings and advices issued in afternoon

July 28—English—Boston Mass call letters NAD transmitting on two two five zero meters spark broadcasts at eleven a m wind and weather forecasts and storm warnings for New Hampshire Massachusetts and Rhode Island coasts advisory messages regarding storm warnings issued for North Atlantic coast and eight a m barometric pressure and direction and velocity and state of weather at Highland Light Nantucket and Block Island and at five p m storm warnings and advices issued in afternoon

July 29—English—Portland Maine call letters NAB on sixteen hundred twenty meters spark broadcasts at noon wind and weather forecasts and storm warnings for Maine coast Eastport to Portsmouth advisory messages regarding storm warnings issued for North Atlantic coast and eight a m barometric pressure wind direction and velocity and state of weather at Portland and at eight p m storm warnings and advices issued in afternoon

July 30—English—radio amateur broadcast the following eight stations send out daily bulletins of Government news mostly agricultural market data Arlington Va Navy five nine five zero meters Great Lakes Ill Navy four nine zero zero meters Washington DC Post Office one nine eight zero meters Omaha Nebr Post Office two five zero zero meters North Platte Nebr Post Office four thousand meters Rock Springs Wyo Post Office three thousand meters Elko Nev Post Office three thousand meters Reno Nev Post Office thirty two hundred meters

July 31—English—Radio amateur broadcast recently in Cleveland O a father forty eight years of age and his son fifteen years of age were killed in a tragedy brought on when an aerial touched a twenty two hundred volt wire period In a hurry to set up a receiving set to hear a concert the son with the aid of another boy who was seriously burned had attached the aerial to the chimney of his house and in doing so threw it over a high tension wire period Not heeding the caution of other persons to tie a rope to the aerial the young man clutched it period In the meantime friction of the aerial had rubbed off the insulation of the electric wire a flash the youth was killed instantly and his father who rushed to save him died within a few minutes period This fatality should serve as a warning to others to be extremely careful in avoiding high tension wires and for that purpose this narrative is published

## AMSCO Improved RHEOSTAT



Made of the best material obtainable. Tested in our laboratory for the maximum degree of efficiency necessary in RADIO reception.

Resistance 6 Ohms, carries 1 1/2 Amperes current. Designed for use as either a table or panel instrument.

Indestructible Condensate base, all metal parts, phosphor bronze, polished nickel.

Price \$1.10—Shipping weight, 1 lb.

DEALERS—Attention—Do business direct with the manufacturer.

ADVANCE METAL STAMPING CO.  
17 Thompson St., Dept. WA-101, New York, N. Y.



REC

We also manufacture Variable Condensers, Detectors, etc.

## NOVO "B" BATTERIES FOR RADIO

22.5-45 & 105 VOLTS

### NOISELESS DEPENDABLE GUARANTEED

**ASK YOUR DEALER**

NOVO MANUFACTURING CO.  
424-438 W 33rd ST.  
NEW YORK

531 SO. DEARBORN ST., CHICAGO.

## RADIO & AUTO STORAGE BATTERIES CHARGED FROM A LAMP SOCKET, at a Cost of a Few Cents, With an F-F BOOSTER



**F-F BATTERY BOOSTERS** Charge Automatically Operating Unattended. Leave Your Battery just where it is, without even disconnecting it, Screw Plug in Lamp Socket; Snap Clips on Battery Terminals; Turn Switch and Battery is Charged in Morning. Is it not gratifying to feel that Your Radio Batteries will never fail and You will be always Ready to Receive All Radiophone Broadcast Music, Sermons & News, never having to be careful of, or tell Friends

Charges Auto & Radio Batteries Your Batteries are dead? Both Waves of Current are Rectified thru Adjustable & Easily Renewable Infusible Carbon Electrodes, which Maintain a Constant Efficiency & Last thousands of hours. Also Charges Batteries right in Auto. No Skill Required. A METER Shows Current Flowing. Eliminating Guess Work. COMPLETE, COMPACT, SELF-CONTAINED PORTABLE AUTOMATIC CHARGING UNITS. F-F Battery Boosters are Full Wave Magnetic Rectifiers for 105-125 Volt 60 Cycle A. C. POPULAR PRICES. Type 6 Charges Radio "A" 6 Volt Battery at 6 Amperes \$15 Type B Charges Radio "B" Batteries Up to 120 Volts \$15 Type A-B Charges Both Your "A & B" Radio Batteries \$20 Type 12 Charges 12 Volt Batteries at 5 Amperes \$15 Type 166 Charges 6 Volt Batteries at 12 Amperes \$24 Type 1612 Charges 12 Volt Batteries at 7 Amperes \$24 Type 1626 is a Combination of Types 166 & 1612 \$36 The Larger Types are for heavy Batteries, or where time is limited. Shipping Weights 11 to 15 Pounds. Purchase from your Dealer, or Send Check for Prompt Express Shipment. If via PARCEL POST have remittance include Postage & Insurance Charges. Or have us ship Type desired C. O. D. Other F-F Battery Boosters Charge Batteries from Farm Lighting Plants & D. C. Circuits. FOR GROUP CHARGING use our 100 Volt Automatic ROTARY Rectifier, 12 Battery, 8 Ampere Capacity \$135. Order Now, or WRITE Immediately for FREE RADIO-AUTO & ROTARY Bulletins 32 & 32A.

**THE FRANCE MFG. CO.** OFFICES & WORKS  
Cleveland, Ohio, U. S. A.  
Can. Rep.: Battery Service & Sales Co., Hamilton, Ont., Can.

## I-Want-To-Know

(Continued from page 666)

used a Beverage antenna in the transatlantic amateur tests. However, for all round amateur and broadcast work, the Beverage antenna will not be suitable due to its directional effects.

Q. 2. What type of loop will give good results?  
A. 2. A loop wound on a frame 4' square with 10 turns of No. 18 wire spaced 1/2" apart will be satisfactory. A clip should be used to vary the number of turns.

## Wholesale RADIO Retail

COMPLETE STOCK. PROMPT SERVICE.  
SPECIAL DISCOUNT TO DEALERS.  
SEND FOR OUR CATALOG AND SAVE  
TIME AND MONEY.

### CHICAGO ELECTRICAL SUPPLY COMPANY

360 West Madison St. Chicago, Illinois

## MANUFACTURERS AND JOBBERS

We are in the market for your  
surplus stocks on all kinds of Radio  
and Wireless Apparatus.

**CHICAGO SALVAGE STOCK STORE**  
509 So. State St Chicago, Ill.



*Announcing*

**Dayton Radio Products**  
*developed in our own*

**Radio Research Laboratories**  
and backed by 33 years' experience  
in the manufacture of

*High Grade Electrical Products*

Variocouplers, Variometers, Rheostats, Variable Con-  
densers and Audiofrequency Amplifying Transformers

*Other products will be released as rapidly as they are perfected*

**The Dayton Fan & Motor Company**  
*Factory and General Offices*  
Dayton, Ohio

# PARAGON

TRADE MARK REGISTERED

*the*

## PIONEER

- 1915 First regenerative receiver ever manufactured bore the name PARAGON.
- 1916 First Trans-continental Amateur Reception (California from New York; not pre-arranged) effected with a PARAGON Type RA-6 Receiver.
- 1916 First Trans-continental Amateur Transmission (New York to California; not pre-arranged) effected by PARAGON designed transmitter.
- 1917-1918 PARAGON acknowledged supreme on Western Front.
- 1921 First Trans-Atlantic Amateur reception effected with PARAGON receiving equipment, at which time 27 different amateurs scattered thruout the Eastern section of the United States registered signals at Ardrossen, Scotland—3500 miles.

*THERE'S A REASON!*

*The* **ADAMS-MORGAN CO.**

Manufacturers

UPPER MONTCLAIR, N. J., U. S. A.



# DEALERS

WE HAVE SOLD RADIO APPARATUS  
SINCE 1916

Our enlarged facilities enable us to satisfactorily care for your needs as well in boom times as in the dull season.

We are manufacturers of the world-famous and original

## "SUPERADIO"



# PRODUCTS

- VARIOMETERS      VARIOCOUPERS
- RHEOSTATS        CONDENSERS
- SOCKETS            SWITCHES
- PLUGS

We also distribute a complete line of radio apparatus, from a binding post to the entire receiving outfit. We are distributors for Radio Corporation of America and other leading manufacturers.

*Established and prospective dealers send for special price lists. Delivery in 24 hours.*

## THE SUPERIOR RADIO & TELEPHONE EQUIPMENT CO.

81 East Long Street      Columbus, Ohio

### A HIGH GRADE VARIABLE CONDENSER AT A MODERATE PRICE

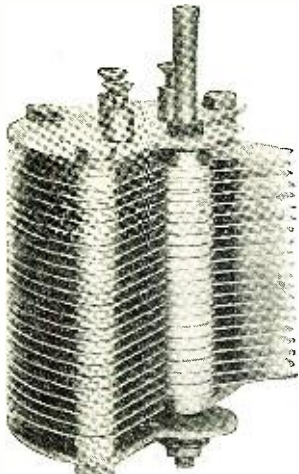

THREE SIZES

43 Plate.....	\$4.00
23 ".....	3.00
11 ".....	2.00

Designed by a reputable radio engineer, and built by a concern with 40 years' experience in the manufacture of electrical instruments.

MR. DEALER—Here is something that will interest you

**Zimmerman Radio Co.**  
206 E. 12th Street      NEW YORK

#### WAVELENGTH CONTROL

(493) Mr. John Teete of Petersburg, Virginia, asks: Q. 1. What effect on the wavelength has an increase of capacity of the tuning condenser?

A. 1. If the condenser is in shunt to an inductance an increase of its capacity will increase the wavelength. In the standard radio circuits an increase of capacity in any of the tuning condensers will increase the wavelength.

Q. 2. When is the capacity of a variable condenser greatest?

A. 2. In the typical semi-circular plate condensers, the capacity is greatest when the movable plates are completely covered by the stationary plates. With a Connecticut or Crosley condenser, the greatest capacity is had when the two plates are as close to each other as possible. With the roller type of condenser, in which the movable element is wound on a spool or series of spools, the maximum capacity is obtained when all the movable element is rolled on to the spool containing the other metallic sheet.

Q. 3. I have difficulty in tuning low enough to receive the broadcasting. Will a series condenser help?

A. 3. A variable condenser in series with the antenna will enable you to reduce the wavelength of your set considerably.

#### DOUBLE AMPLIFICATION CIRCUIT

(494) Mr. F. Parsons, of Milwaukee, Wisconsin, asks:

Q. 1. Is the hookup in Fig. 374 of the "I-Want-To-Know" column of June suitable for efficient reception?

A. 1. The circuit you mention has never given satisfactory results for any length of time and we would not advise its use.

Q. 2. Would loud enough signals be brought in on such a set to operate a loud talker?

A. 2. We do not believe that you could efficiently operate a loud talker with this circuit, unless the transmitting station is in the immediate vicinity.

#### AMPLIFICATION WITH CRYSTAL DETECTOR

(495) Mr. O. Tracht of Columbus, Ohio, wants to know:

Q. 1. Please show a hookup with jacks for a one stage audio amplifier with either crystal or vacuum tube as detector.

A. 1. The circuit you desire is printed on these pages. We show a variometer set, though any type of tuner may be used.

Q. 2. Will the crystal and one step audio amplifier work satisfactorily?

A. 2. A crystal detector with a one stage audio amplifier will operate well, but will not be as efficient as the vacuum tube detector alone. If you wish to increase the receiving range of a crystal set, it would be well to employ the circuit illustrated in the "I-Want-To-Know" department for August.

#### COMMERCIAL VALUE OF STATIC ELIMINATOR

(496) Mr. V. House of Mishawaka, Indiana, asks:

Q. 1. Would an instrument to eliminate static be of any value, commercially?

A. 1. An instrument which would entirely eliminate static and not interfere with reception would have a very great commercial value.

Q. 2. What type of current is the static?

A. 2. Static and atmospheric disturbances are of both interrupted D.C. and D.C. character. The clicks heard in the phones are caused by D.C. impulses while the rumbling roar is caused by interrupted D.C. of varying frequency. Static is much more severe on long waves than on short waves.

#### EXPANSION OF RECEIVING SET

(497) Mr. P. Pittman of Rockford, Illinois, requests:

Q. 1. Please publish a hookup of a efficient receiving set for all around work, one which can be added to from time to time.

A. 1. A circuit such as you mention is published on this page. By making the tuner and detector in separate cabinets, it is possible to add either radio or audio amplification at will.

Q. 2. Please show how I may add a radio and audio amplifier to the set.

A. 2. The addition of the radio and audio amplifier is shown. You may arrange the binding posts on a rear sub-panel to eliminate unsightly wiring, if desired. A height of 9" for each panel will be found suitable.

#### LOOP MODULATION FOR PHCNE

(498) Mr. C. H. Johnson of Galena Avenue, Freeport, L. I., writes:

Q. 1. May I use the enclosed diagram for C.W., I.C.W. and phone transmission?

A. 1. The hookup you enclosed is correct except for the position of the transmitting key. The key should be placed in the lead to the center tap of the filament or in series with the grid leak. The position in which you have it, the primary of the transformer, places too much strain upon the apparatus.

Q. 2. Will the loop modulation give good results?

A. 2. While the loop system of modulation will work, it is not as satisfactory as employing a separate modulation bulb or a modulation transformer in the grid circuit.

#### BEST HOOKUP FOR A LOOSE COUPLER

(499) Mr. Edwin Cummins of De Soto, Mo., wishes to know:

Q. 1. How may I hook up a loose coupler, two variable condensers, audio phones, etc., for best results?

A. 1. A circuit for such apparatus is connected in a manner which will allow efficient reception and is shown on this page.

Q. 2. Is there any method of eliminating the capacity effect of a tin roof adjacent to my aerial?

A. 2. The only effect the tin roof will have upon

## USE OUR FACTORY

Manufacturers and dealers who require wireless apparatus or parts can obtain quantity output and guaranteed delivery. We have over half a million dollars invested in special and automatic machinery. Wire and metal products our specialty. Send sample your product and receive our quotation on making.



### HEADBANDS

You know this headband. We can make prompt shipment on your order. Get our prices.

### THE AUTOYRE COMPANY

Oakville, Conn.

### Miniature Plugs and Pin Jacks



MINIATURE PLUGS ARE used for battery control or any switching purpose. More efficient, quicker in action and neater in appearance than binding posts. Supplied with side binding screw. Used with pin jacks, in nickel or brass finish.

Plugs—Cat. No. C-1 Price .....25c  
Jacks—Cat. No. C-100-200 Price .....11c



A. V. T. SOCKET with many distinct advantages. Greater contact surface, giving better connections that will not work loose. Pins mounted on genuine polished bakelite base, fused to prevent burning out tube.

Write for Descriptive Literature and Price Lists

**Ozburn Abston Radio Company, Inc.**  
Formerly V. H. LAUGHTER  
600-612 Monroe Ave.      MEMPHIS, TENN.

### Hard to Get Wireless Supplies

### E-Z to Get by Mail

## Phones - Parts - Panels

We will ship by return mail and pay postage ourselves. Send money order or certified check. No stamps.

Reference: Merchants and Manufacturers Bank, Newark

Murdock No. 56 2000 ohm phones	\$5.00
Murdock No. 56 3000 " "	6.00
Federal No. 53W 2200 " "	8.00
Holtzer Cabot 2200 " "	8.00
7-strand cable construction copper aerial wire, per 100-ft. coil	.65

See last month's Radio News for our Panel advertisement. What radio parts do you need for your set? Send enquiry for price and delivery. We have a large stock of the parts you know.

**L. FUNKE & CO.**  
223 Washington St., NEWARK, N. J.



# SUNRAID

Patent Pending

# PRODUCTS



**List Price**  
**3 in. \$1.00**  
**4 in. \$1.50**

## Dials

The new improved SUNRAID DIALS are of one solid piece of moulded condensite. The Dials are so constructed that when mounted on a panel they set off  $\frac{1}{2}$  of an inch from the surface of the panel, which gives a maximum of efficiency in smooth operation — no gripping.

SUNRAID PRODUCTS are guaranteed. Distributors wanted for all parts of the world. Write for proposition. AMATEURS—If dealer cannot supply you, write direct and send dealer's name and address. DISTRIBUTORS—Samples will be sent to you C. O. D. upon request.

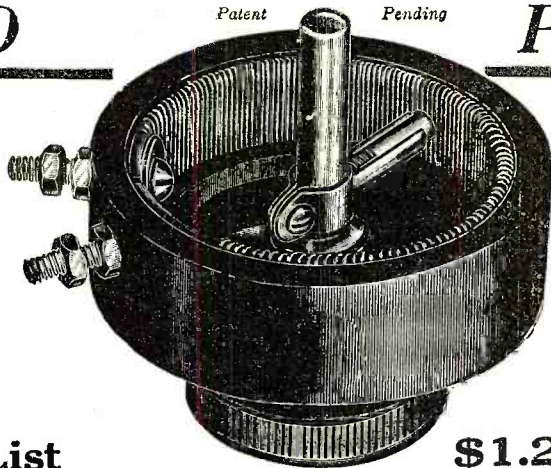

**List Price \$1.25**

## Rheostats

Radio men who want a Rheostat of high class workmanship that gives a maximum amount of service will find it worth their while to buy the SUNRAID RHEOSTAT. It gives perfect contact against winding at all times. (See spring attachment in above photograph.)

Windings guaranteed not to jump out.



**List Price \$1.25**

## Plugs

SUNRAID PLUGS are made of the best of material—casement of pure bakelite with a high polish. These plugs will take cords with spade or wire tips.

# SUNRAID



# RADIO CO.

534 EIGHTH AVENUE

NEW YORK CITY, U.S.A.

Trade Mark

# DUCK'S RADIO CATALOG No. 16 <sup>256</sup> PAGES

Continuously since 1909 Duck's Radio Catalogs have never been equaled for completeness and great wealth of radio data

Send 25c in coin carefully wrapped for your copy of this wonderful book, the most unusual and complete catalog ever put between two covers. Not sent otherwise. Enormous cost and tremendous demand prevent distribution at a less retainer.

Over 50 pages of latest hook-ups (wiring diagrams) and invaluable and up-to-date data and information on radio. Not only a catalogue, but a wonderful text-book on radio.

Never in the history of radio has there been such a catalog. The radio data and diagrams embracing upwards of 50 pages give the experimenter more valuable and up-to-date information than will be found in many text-books selling for \$2; and \$1 could be spent for a dozen different radio catalogs before you could gather together the comprehensive listing of worth-while radio goods found in this great catalog.

## DEALERS

We want live, responsible dealers in every city and town in the United States, both for the sale of our extensive line of radio apparatus and all other worth-while lines of radio goods, on all of which we can quote attractive dealers' discounts. We can offer you facilities and advantages that no other radio house can offer.

No. A666 Duck's Positive Contact Bakelite Tube Socket is beyond doubt the most advanced tube socket on the market today. To our knowledge there is no other type of tube socket that cannot be forcibly criticized from some angle. Either the receptacle does not easily accommodate the varying diameter of the bases of bulbs, or the notch on receptacle is not just right, or the receptacle is easily subjected to breakage, or connections are in an inconvenient place, or, and most important of all, the type and style of the contacts do not insure positive, certain contact without considerable manipulation.

In our new socket all these defects in other bulbs are overcome. The contact springs are so constructed that contact is made, not only on the bottom of the tube terminal, but also on the side of the terminals. When the tube is put into the socket and turned in the notch, the terminal pins on the tube immediately exert a pressure on the side of the phosphor bronze contacts, making a contact

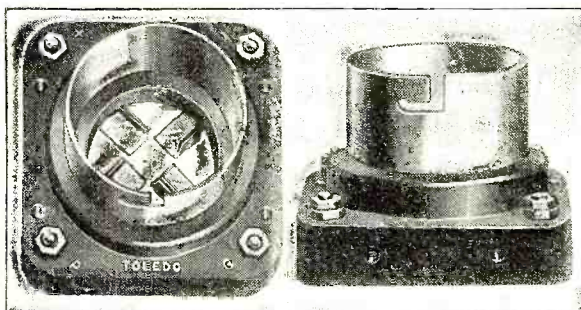

**Duck Products have stood the test of time.**  
**The largest line in America—58 complete instruments—62 parts.**

**There are many Duck products that completely dominate all competitive types.**

Our new No. A650 Duck Rheostat (at right) has just the necessary amount of resistance to take care of the drop in voltage from the battery when fully charged to the battery at its minimum working voltage. The base is of moulded composition. The resistance element is wound on a black fibre strip, the element being securely fastened in a slot in the base. Contact arm is of phosphor bronze of the proper tension to insure perfect contact and smooth operation. Adjustable to any thickness panel up to  $\frac{3}{8}$  inch, 2 $\frac{1}{4}$  inches in diameter. An exceptional Rheostat at a most popular price. No. A650 Duck Rheostat, \$1. Shipping weight 8 oz.

that is firm and sure. The receptacle of our socket is of brass, beautifully nickel plated, and moulded into a bakelite base, with all connections on top. No. A663 Duck's Bakelite Tube Socket, \$1. Shipping weight,  $\frac{1}{2}$  pound.

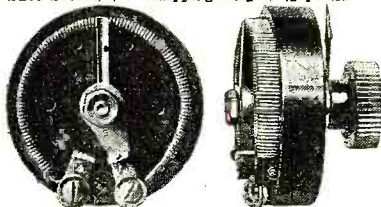

Our Nos. 700 and 701 dials and knobs (right) are of genuine black bakelite. Because of the ribbed construction of the dial it will not warp and being of bakelite it will not discolor. The threaded bushing in the dial which holds the knob is perfectly centered, as is the bushing in the knob itself which takes the shaft. This insures a perfect running dial. The bakelite knob is fastened to the dial by means of a threaded bushing. The set screw which secures the knob and dial passes through the composition and also the bushing, thus preventing loosening. Either  $\frac{3}{16}$ " or  $\frac{1}{4}$ " knob and dial, \$1. Shipping weight, 4 ounces.

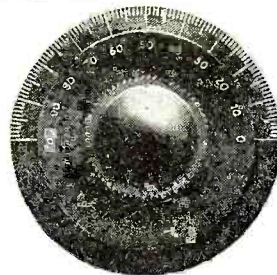

**The WILLIAM B. DUCK CO., 231-233 Superior St., Toledo, Ohio**



# RHAMSTINE\*

Announces a  
Radio Frequency  
Transformer



\$4.50  
Postage  
10c

PATENT APPLIED FOR

Once more Rhamstine\* has satisfied a definite radio requirement. The Rhamstine\* Radio Frequency Transformer is now available to the many thousands of radio enthusiasts who have been waiting for a guaranteed product, made to a fixed standard in quality and sold at a reasonable price. The Type 1 R.F. Transformer complete with special base mounting sells at \$4.50. While it has a range of 200 to 500 meters, it is especially well-suited for the wave-lengths of the present broadcasting services.

Consistently good engineering has been followed in its design and by comparison it is far the most attractive transformer in appearance that has ever been offered. Complete circuit diagram sent with each unit.

Manufactured by  
**J. THOS. RHAMSTINE\***  
2152 E. Larned St., DETROIT, MICH.

\*Maker of Radio Products.

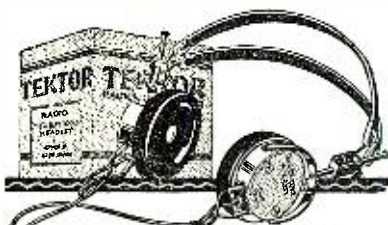

**TEKTOR**  
HEADPHONES  
Special introductory offer..

**\$9.00**

TEKTOR headphones are the loudest and clearest magnetic-diaphragm phones on the market. They are the same quality as sold everywhere at \$12 to \$15. High grade rubber composition caps, aluminum backs, black woven band covering, navy standard adjustment. Resistance 2200 ohms. Single phone, \$4.50.

If your TEKTOR headphone should prove to be not entirely satisfactory, return it—and your money will be refunded. Insist on TEKTOR at your dealer's—or order direct from us. Send money order or pay postman \$9.00.

DEALERS: Investigate unusual profits in TEKTOR.  
**TEKTOR CORPORATION**  
250 West 57th St., New York

the operation is to absorb a slight amount of energy either in reception or transmission and we know of no way to avoid this loss.

### AERIOTRON AMPLIFIER

(500) Mr. H. Brubaker, Ephrata, Pa., writes:  
Q. 1. What size potentiometer should be employed across the A battery in a receiving set?  
A. 1. The general value of the shunt resistance is around 200 ohms.  
Q. 2. I have an Aeriotron bulb and would like to employ a few more in an audio amplifier, will you please publish such a circuit?  
A. 2. You may use Aeriotron tubes in an audio amplifier with good results. Follow out any of the diagrams already printed in this magazine for a two stage amplifier.

### COATING FOR COILS

(501) Mr. Troy of Elmira, New York, asks:  
Q. 1. If spiderweb or honeycomb coils are boiled in paraffin will their distributed capacities be materially increased?  
A. 1. A large increase in distributed capacity will be noted if the coils are boiled in paraffin. It will be well to avoid such a procedure.  
Q. 2. Which material would you advise me to use in coating coils?  
A. 2. A thin coat of shellac will not greatly affect the distributed capacity and will prevent shortage and leakage from moist insulation. Some manufacturers of honeycomb or duolateral coils dip the completed coils in a thin solution of some insulating material and then rapidly spin the coils. In this manner all the excess material is cast off and the distributed capacity is kept low.

## Practical Home-Made Condensers

(Continued from page 655)

The next step is that of making the fixed plates for the rotating vernier condenser unit. These are cut from the fibre sheet to dimensions shown in Fig. 5.

After cutting, cover the ends of each with tinfoil, leaving an open space of 1 1/2" in the center. The tinfoil can be held in position by immersing the fibre plate in hot wax and laying on the foil before it cools, smoothing down as the wax sets.

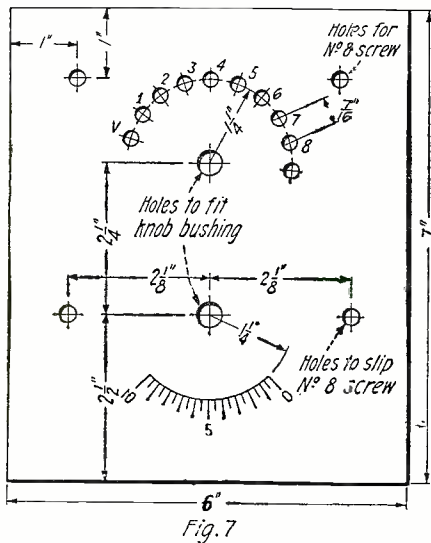

Layout of the Front Panel Supporting the Whole Unit.

Then cover the entire plate, excepting two 1/2" lengths at the ends, with a single layer of good grade writing paper. Here again the gummied flap of an envelope will be found convenient. Care must be used to get a perfectly smooth paper facing on one side, this being the working side of the plate. When all plates are mounted they should be immersed in the hot wax and the surface smoothed down tight with the fingers as the wax cools and sets. In order to avoid having to clean the foil of wax where the connecting washers bear, it is well to fasten a washer on each side, using machine screws and nuts. The screw can afterward be removed and the face of washer scraped free of wax.

This completes the parts on which hot wax is required and the next step is to make the rotating plate.

## "SUPERLATIVE" AMPLIFICATION



No. 41

You Can  
Increase Your Range  
Eliminate Howling and  
Distortion  
Bring Out the Full  
Clear Tone in Volume  
WITH

# JEFFERSON

## Amplifying Transformers

Furnished in two types either mounted or unmounted. Coils specially wound with No. 40 and No. 44 wire on a core of the finest rolled Silicon steel.

SEND FOR RADIO BULLETIN

Prompt Deliveries

**JEFFERSON ELECTRIC MFG. COMPANY**  
424 S. Green St., CHICAGO

## 3000 OHM SETS, \$4.50

2000 OHM SETS, \$4.00 1000 OHM SETS, \$3.50  
Plus 20c for Postage and Insurance.  
Satisfaction Guaranteed or Money Back.



We mail phones the day your order arrives. Every pair tested, matched, and guaranteed as sensitive as \$8 to \$10 phones. We have no agents or dealers. By ordering direct you save dealer's profits—circular free.

**TOWER MFG. CO., Brookline, Mass.**  
38 Station St.

## Radio Supplies

Clapp-Eastham, Paragon, Westinghouse RECEIVING SETS

Western Electric, Baldwin, Murdock and Brandes PHONES

Cunningham Tubes

Magnavox Loud Speakers

Remler Products

Radio Corporation Apparatus

22 1/2 Volt Tapped B. Battery, \$2.75

**ELECTRIC SUPPLY CO.**

Everything in Radio  
PORT ARTHUR, TEXAS



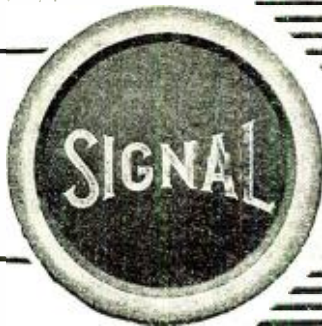

# Means RADIO Satisfaction

Radio equipment—whether you construct your own apparatus or buy the “custom-made” outfit—must be *made right*, or you cannot expect lasting satisfaction.

SIGNAL parts and sets are the product of a plant and an organization whose experience in making Radio equipment dates back to the earliest days of “wireless.”

There is seasoned knowledge and experienced handicraft built into every item of the SIGNAL line. Each piece will give you the service you have a right to expect.

Ask for SIGNAL when you want Radio parts or Radio sets and insure yourself against that “most embarrassing moment” when something goes wrong, just as you expect to entertain your friends.

For sale by dealers everywhere. Accept no substitutes.

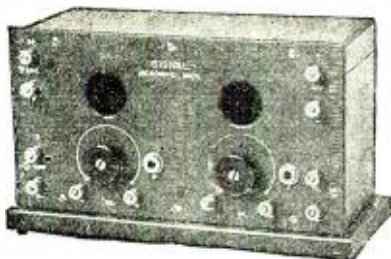

**Combination Detector and One Stage Amplifier**

Made to allow for the greatest flexibility of operation with the maximum of efficiency. A genuine vacuum-tube detector, with great latitude of adjustment, and an amplifier that functions without annoying discord.

**SIGNAL**  
Electric Mfg. Co.

1912 Broadway

Menominee, Mich.

33 S. Clinton St., Chicago

(1856)

**ON TOP**

PRINTERS' INK July 13, 1922

MONTHLY MAGAZINES CARRYING GENERAL AND CLASS ADVERTISING		
	Columns	Lines
Radio News	381	56,145
Motor	287	48,226
Town & Country (2 issues)	251	42,204
House & Garden	246	38,979
Vanity Fair	202	32,010
Field & Stream	194	27,811
Country Life	165	27,720
Popular Mechanics (pg.)	123	27,608
Arts & Decoration	128	21,661
System	148	21,303
Outers'-Recreation	141	20,312
Science & Invention	121	17,794
Popular Science Monthly	110	16,729
House Beautiful	101	15,576
National Sportsman	107	15,429
Outdoor Life	101	14,437
Life	77	11,139
Stream	70	10,058
American	9	1,111

Read by More Readers—  
Used by More Advertisers

**OVER 200,000**  
CIRCULATION

Published more  
paid advertising  
than any month-  
ly class magazine  
in America!



**RADIO'S GREATEST**  
MAGAZINE  
ESTABLISHED 1919



# ARMSTRONG

## SUPER REGENERATIVE CIRCUIT PARTS SPECIALS

1500 Turn Honeycomb Coils, Unmounted.....	\$1.50
1200 Turn Honeycomb Coils, Unmounted.....	1.50
40 Turn Honeycomb Coils, Unmounted.....	.50
75 Turn Honeycomb Coils, Unmounted.....	.65
12,000 Ohm Non-Inductive Resistance Coil.....	2.00
100 Millihenrie Iron Core Choke Coil.....	1.60
10 Millihenrie Air Core Choke Coil.....	1.25
5 Millihenrie Air Core Choke Coil.....	1.25
43 Plate Variable Condenser.....	2.95
23 Plate Variable Condenser.....	2.65
11 Plate Variable Condenser.....	2.45
Variometers at.....	2.45
Variocouplers at.....	1.95

Formica Panels Cut to Any Size

**Izenstark Radio Co.**  
509 South State St., Chicago, Ill.

# RADIO SUPPLIES

## REAL SERVICE GUARANTEED

201 Radiotron Tubes.....	\$6.50
6-amp. Tungar Charging Rectifier.....	28.00
6-volt, 110-amp. Storage Battery.....	20.00
Simplex Variometers.....	6.00
Simplex Variocouplers.....	6.00
Klosner Filament Rheostats.....	1.50
Fada Filament Rheostats.....	1.00
Jenkins Filament Rheostats.....	1.75
Bakelite Base V. T. Sockets.....	1.50
Fibre Base V. T. Sockets.....	1.00
4-inch Bakelite Dials and Knobs.....	1.35
3-inch Bakelite Dials and Knobs.....	1.00
Cotoco Condensers, .001 MF.....	6.00
Cotoco Condensers, .0005 MF.....	4.50
Audiotron 2-Filament Tubes.....	5.00
Western Electric Head Sets.....	12.00
Connecticut Head Sets.....	7.00
Federal Telephone Jacks..... 70c, 85c,	1.00
Ever Ready B. Batteries, 22½-volt.....	3.00
Ever Ready B. Batteries, 45 volt.....	5.00
Brach Arrestors.....	2.50
Audio Amplifying Transformers.....	7.00
Nickel-Plated Switch Points, ¼x¼ head, per dozen.....	.30
Nickel-Plated Binding Post.....	.10
R. C. Westinghouse Receiving Sets.....	132.50
Sr. Westinghouse Receiving Sets.....	65.00

Above Material in Stock.

Prompt Shipment or Money Refunded.

Send us your order with certified check; we pay the parcel post.

**JERE WOODRING & COMPANY**  
Hazleton, Penna.

This plate is to be carefully cut from a piece of 1/64" hard sheet brass, and it must not be allowed to buckle or bend. The shape and dimensions are shown in Fig. 6a. After cutting, all the edges should be carefully rounded with a fine file and emery paper. While working this sheet brass the other members should also be cut and finished. Fig. 6b shows the contact plate for the dial. The slots are to be laid out on the same centers as the contact buttons and then cut with a fine-tooth hack saw. It will be found convenient to clamp this piece to a thin piece of wood and clamp both together in the vice when sawing, making the cuts by forward movements only. All edges of this plate should be neatly smoothed up and the ends of each saw cut chamfered with a fine file in order that they will ride easily over the corners of the buttons when the dial is turned. The face of the dial should be carefully polished and it can be nickel plated for a few cents.

The third piece of sheet brass, as shown in Fig. 6c, is the strap that connects the dial bushing with the condenser shaft bushing, being placed back of the panel and under the nuts that hold the bushings in place.

The details of assembling this rotating vernier condenser are shown in plan and section by Fig. 8.

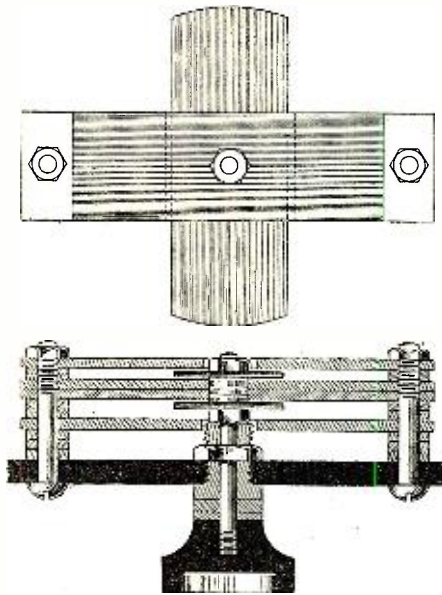

Fig. 8

Constructional Details of the Variable Condenser.

This type of condenser will be found very practicable for tuning certain makes of radio frequency transformers and as a vernier for close tuning in parallel with variometers. For the latter purpose a three-plate condenser will be large enough, or the five-plate design can be used, and its dimensions reduced. A very neat way of mounting these while building a variometer, is to use ¼" tubing in place of rod for the variometer shaft. Mount the condenser in back of the variometer and carry its small shaft through the hollow shaft of the variometer. Bore a hole through the center of the dial and place a small knob on the end of the condenser shaft. This takes no extra room on the panel and places the condenser knob in a handy location in relation to its accompanying variometer dial.

The last piece to make is the panel for assembling the entire unit. This is 5" by 7" or a convenient size for the units of a set built on this principle. The drilling is laid out in detail in Fig. 7. This panel is, of course, not required when the unit is mounted on the same panel as other apparatus.

## "ATTENTION AMATEURS"

- Stromberg-Carlson Phones. \$7.50
- Thordarson Amp. Transformer ..... 4.50
- Paragon Sockets..... 1.00
- Radiotron No. 201..... 6.50

**QUAKER LIGHT SUPPLY CO.**  
728 Arch Street  
Philadelphia, Pa.

## LIGHTNING PROTECTION

is not protection when the element of chance exists. It pays to be absolutely safe and sure. The **S&C Radio Lightning Protector**

is the only protector that eliminates all chances and protects house, instrument and operator, and permits use of instrument during storms. Installed directly into lead (not below), and requires no attention. Write for illustrated circular.

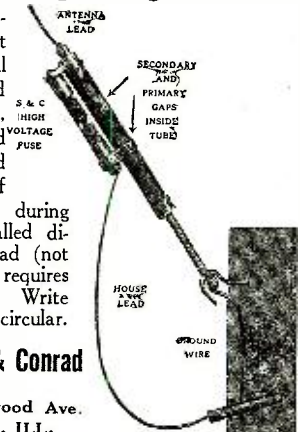

**Schweitzer & Conrad INC.**  
4437 Ravenswood Ave.  
CHICAGO, ILL.

**JENKIN'S VERNIER RHEOSTAT**  
Indispensable for adjustment on Radio Frequency and Detector Tubes. Patent instant cut-off switch. Write for folder. Liberal discounts to dealers and jobbers.  
Manufactured and Guaranteed by  
**Unity Manufacturing Company**  
224 N. Halsted St., Chicago, Ill.  
Phone Haymarket 1819  
\$1.75

THE CONDENSER you have been wanting is one with which you could get close and accurate adjustment and at the same time have sufficient maximum capacity. The **BAK-LAN** Condenser accomplishes this by having a total range of 1260 degrees or 3½ revolutions of the dial in changing capacity from zero to .004 MF. We guarantee satisfaction. Price, \$5.00 C. O. D. We have an attractive Dealers' Proposition.

**BAK-LAN APPLIANCE CO.,**  
556 Kenwood Avenue, Dayton, Ohio.

Complete Stock of  
**RADIO APPARATUS and SETS**  
Dealers: Write for our prices; they will interest you.  
**NORTHERN RADIO SUPPLY CORPORATION**  
542 W. Washington St. Chicago, Ill.

**IOWA AMATEURS**  
Westinghouse Grebe  
Clapp-Eastham De Forest  
Radiotron and Cunningham Tubes  
Burgess "B" Batteries  
Aerial Counterpoise and Ground Supplies  
Western Electric Magnavox Brandes Signal  
Universal "A" Batteries  
**RADIO SUPPLIES IN STOCK**  
**APPEL-HIGLEY ELECTRIC CO., Dept. A, Dubuque, Ia.**



The scale for the condenser pointer is scribed on the panel with a pair of dividers and a scratch awl guided by a straightedge. This should be done before boring the shaft hole in the panel, using the punch mark as a center for scribing. If it is possible to borrow a set of steel figures and letters these can be punched in the dial to make it look like a real factory job. If not they can be put on with "white ink," as used by draughtsmen.

The complete assembly is shown in detail in Fig. 9 and is largely self explanatory. The eight fixed condenser units are held in position by the connecting wires, which are stiff enough for this purpose. The wire from one binding post connects one end of each fixed condenser and both ends of the fixed plates of the variable condenser. The other end of each fixed unit connects to its corresponding dial button. Note that the first button is not used, being a support for the first blade of the dial when it is in position for using the vernier only.

In mounting the plates for the vernier they should be so spaced that the movable vanes will just touch the paper covering the foil. If too tight, the friction will wear the paper and short the unit. If spaced too far the capacity will be less than each of the fixed units. The movable vanes should be fixed to the shaft with a drop of solder as well as being held by the nuts on the shaft. This soldering should be done as each plate is assembled using a well tinned soldering iron at proper heat.

Using this idea for condensers the size and capacity of the unit can be varied to almost any extent and thereby fill all condenser requirements at very moderate cost.

In using the condenser for smooth continuous tuning the vernier dial must be turned back to zero each time the contact dial is moved one point. With a little practice this will be found just as handy and almost as smooth as that of a continuous condenser.

In case it is desired to mount on a panel with other apparatus, where space is limited, one can modify this design by making the condenser shaft of  $\frac{1}{4}$ " tubing, using a dial for turning it. The dial switch and fixed units can then be mounted back of the rotating unit, with the dial shaft passing through the hollow shaft of this, similar to the method described for mounting with variometers.

## The Use of Power Tubes in Radio Reception

(Continued from page 631)

ting, and he did not want to transmit. He could not be blamed for this opinion, because the average radio dealer sells vacuum tubes according to the above classification, and when asked for a detector tube, he almost invariably supplies the gaseous content detector tube.

The use of the gaseous content detector tube began with the early models of vacuum tubes when it was hardly possible to pump a tube sufficiently to get what is nowadays called a hard tube. As a matter of fact, the classification of vacuum tubes today, instead of being called detector, amplifier, and power tubes, should be rated as soft, medium, and hard tubes. With the customary use of the grid condenser and grid leak, practically all the modern receiving sets can use the hard tubes as detectors or amplifiers, or both. Though the gaseous content tube cannot be used for high amplification, or transmitting, the opposite is possible, that is, the hard or so-called transmitting power tube is an excellent detector and amplifier, and has a very real use in the saving of equipment in the modern radio station. Primarily, the soft detector tube was developed to its present point of efficiency by the demands of amateurs for a super-sensitive tube which under critical adjustment would

# The Conquering Power of Superiority

Formerly custom built for particular Radio Fans. Now available for distribution through jobbers and distributors who want the best for customers who DEMAND the best.



Radio buyers quickly grow to be discerning and critical buyers. Thousands of them are seekers of the best.

Insure for yourself the selling advantages and sales profits of The Conqueror's Superiority.

## THE CONQUEROR

*The Conqueror is adjusted and controlled by ONE KNOB. RESULT: Quick, easy, simple and super-sharp tuning.*

### FOURTEEN EQUALLY BIG FEATURES

- 1—Size of instrument  $7\frac{1}{2}$  x 15 inches. Entire equipment, tuner, detector and two stages of amplification in one handsomely finished solid mahogany hand-rubbed cabinet.
- 2—Wave Length: From 150 to 15,000 meters.
- 3—Panel and Shelf: XX BAKELITE, shielded. Bakelite binding post strip.
- 4—Rheostats: Special design, Ideal metal; air cooled. No dissimilar metals in contact to cause corrosion.
- 5—Potentiometer: fine control of detector plate voltage.
- 6—Sockets: made with locked contact. Positive contact, permanently efficient.
- 7—Transformers: designed for maximum amplification
- 8—Wire: square tinned copper, bus-bar type.
- 9—Condenser: no dielectric or bearing losses; balanced commercial type, single bearing, vernier attachment.
- 10—Only one duty performed by each battery—no greater drain on one than another. Even life—longer life.
- 11—No dead ends to reduce signal strength by absorption.
- 12—Absolute positive control of various tube circuits.
- 13—All Nickeled Parts highly buffed.
- 14—Certification; all parts and the complete instrument certified by laboratory test.

Write for Particulars

## Lewis & DeRoy Radio Corporation

Manufacturers of  
CONQUEROR  
PRODUCTS



560 Seventh Avenue  
NEW YORK CITY  
PHONE BRYANT 7759

WANTED—Back numbers of Radio News, Sept., Oct., Nov. and Dec., 1921, Jan. and Feb., 1922. Experimenter Publishing Co., 53 Park Place, New York City



23 Plate  
.0005 mfd.  
Max. to  
min. ca-  
pacity, ra-  
tio, 12 to 1. 4.25



**RADIO STORES CORP.**  
RS

43 Plate  
.001 mfd. Max.  
to min. capaci-  
ty, ratio, 22  
to 1. 4.75  
Pat. Pend.

**Your Dealer Will Tell You**

"A receiving set is no better than its variable condenser, and you should operate the best." Buy a—

**Radio Stores VARIABLE CONDENSER**  
Counterweight under dial. Brass studs through aluminum plates and die cast. Shaft held in true center through brass bushings. Metal inserts throughout.

**Radio Stores TORPEDO PLUG, 1.25**  
Conductive parts of heavy machined brass, insulated throughout. Screw binding post terminals. Separate anchor for tail of cord. Rigid. Durable, Strong, Light, UN-BREAK-ABLE.

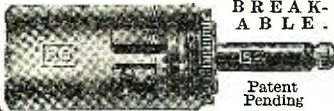

Patent Pending

222 West 34th St. New York City

If your dealer does not sell RADIO STORES products, send us his name with your order, and we will ship direct to you.

ADDRESS DEPT. 9N

**TUBES**

WE have recently received a consignment of Signal Corps VT 1 "J" Detector and VT 2 "E" tubes for amplifying C.W. and Phone Transmission. The "E" tube is ideal for the new Armstrong circuit. Write us for prices on one or quantities.

We also carry a complete line of all standard advertised parts and sets. We ship to any point in the United States and Canada.

"You don't pay us—you pay the postman."

**LEXINGTON**

**RADIO & ELECTRIC CO., Inc.**  
439 Lexington Avenue.  
New York City

**WE HAVE EVERYTHING**

A Complete Stock of

**RADIO SUPPLIES**

Panels cut and drilled to your order.

Free Technical Advice

RADIO DEPT.

**ELLIOTT ELECTRICAL SUPPLY CO.**  
68 East 116th St. NEW YORK CITY  
HARLEM S600

give an extended range to their receiving sets. By this, it is meant that extremely faint signals, or even those which could not be heard at all, could, by means of the "use of a soft tube very carefully adjusted, be heard with sufficient audibility to be read in a pair of ear phones. This increased sensibility was added to enormously by the use of regeneration by means of the Armstrong circuit. This development, however, occurred before the advent of the modern broadcasting station. Regeneration to the maximum, while increasing the sensitiveness of the tube, destroyed the tone of the signal received. However, as this was usually a spark signal, sent out in the telegraphic code, the destruction of the normal tone of the signal was not harmful to reception. In the reception of radiophone broadcasting, regeneration to the maximum is not possible; in fact, regeneration cannot be carried anywhere near the maximum point without extreme distortion and jumpiness of the speech or music. By jumpiness, it is meant that a loud signal will cause a greater response than a weak impulse, so that when a person is singing, the heavier notes come out twice or three times as loud as they should, while the weaker notes retain their normal volume. This, of course, spoils the music and the effect may be, most of the time, laid to

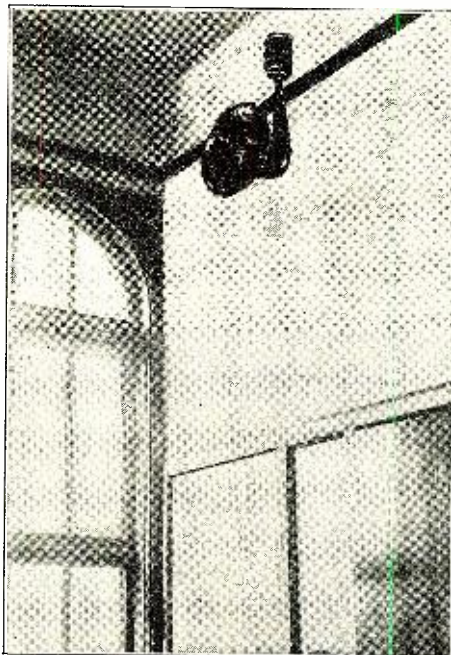

By Means of Loud Speakers Installed in Each Class Room, the Director of a School Can Communicate with the Students From His Office.

a critically adjusted soft tube used as a detector, with maximum, or nearly maximum regeneration.

This distortion of music and speech can be almost entirely eliminated by the use of a hard or transmitting tube as a detector. The five-watt power tubes now on the market, such as the Radiotron, type 302; Cunningham, type 202; Moorhead, or AP, type TT transmitter; the Western Electric VT2, available through sales by the U. S. Army, and the GE Gold Tip, Navy type, released by the U. S. Navy—all of them are excellent detectors, oscillators, regenerators, and amplifiers, when used in almost any standard radio receiving set or circuit. Perhaps they are not quite as sensitive for 2,000 mile spark reception as the gaseous type. They have sufficient sensitiveness to do as good work as the gaseous content type in the hands of the uninitiated as far as range is concerned, but they are far better in their rectifying properties in that they do not distort the received music and speech nearly as much.

For a man who lives within 25 or 30 miles of a broadcasting station and who has a vacuum tube detector set, a power tube

**Here It Is!**



Send for it NOW

**LUDWIG HOMMEL & CO.**  
530-534 FERNANDO ST. PITTSBURGH, PENNA.

**Panel Service**

We offer to the amateur and dealer **Real Panel Service.** Our panels are cut to your order. Only genuine Bakelite or Formica used.

1/8"	per square inch	.02
3/16"	" " "	.02 1/2
1/4"	" " "	.03

We also carry a full line of radio essentials. Dealers will find it profitable to have our latest price list and discount sheet.

**PITTSBURGH RADIO AND APPLIANCE CO., INC.**  
"Pittsburgh's Radio Shop"  
DESK A  
112 Diamond St., Pittsburgh, Pa.

**CANADIAN RADIO MANUFACTURERS AND JOBBERS**

We can supply your requirements in Variable Condensers, Rheostats, V. T. Sockets, Telephone Jacks, Plugs, Binding Posts and other Radio Accessories. We are equipped to manufacture Radio Parts to your design. Send us your enquiries and let us quote prices.

**RUSSELL GEAR & MACHINE CO., LIMITED**  
Toronto Canada

Manufacturers of Automobile Transmissions and Gears, Phonograph Motors, Stampings and Screw Machine Parts of all descriptions.

**WATCH FOR THE VARIABLE SUPERAMPLIFIER**

**25 Radio Frequency Circuits Postpaid 75c**  
Simultaneous R. F. & Audio Ampl., TUNERS, etc.  
**SUPERAMPLIFIER CO.**  
514 Fullerton Ave., Chicago

**BAKELITE-DILECTO PANELS**

Genuine Bakelite-Dilecto panels are specified by our Navy. They are the best obtainable and Max sells them at the lowest prices. Standard panels 3/16 in. thick, very accurately cut, with smooth, square edges. will cost you:  
6x7 ea. \$1.05-6x18 ea. \$2.25-7x10 ea. \$1.50-12x14 ea. \$3.50  
6x12 " 1.50-6x21 " 2.60-7x12 " 1.75-12x18 " 4.50  
6x14 " 1.75-9x12 " 2.25-7x18 " 2.65-12x21 " 5.20  
Other sizes: 1/8 in. thick, 2c per sq. in.; 3/16 in. thick, 3c per sq. in.; 1/4 in. thick, 4c per sq. in. Shipped C. O. D. or postpaid upon receipt of check or money order. Satisfaction Guaranteed.

**TUEX SUPPLY CO.,** 1429 STATE STREET, BRIDGEPORT, CONN.



substituted for his present detector tube will greatly add to his volume. In fact, a single tube set, using a power tube connected to a Magnavox, has received wireless speech and music audible 25' from the Magnavox horn, over 800 miles from the broadcasting station. While this is exceptional, a great increase in volume is always obtainable by the use of a power tube as a detector. With a single tube, for instance, a Cunningham or Radiotron five-watt transmitter, it is possible within 10 or 15 miles of a broadcasting station to use a Magnavox or other loud speaker, although the resultant volume will not be as great as might be desired. To do this, it is necessary to use 300 to 500 volts on the plates, cut out the plate battery potentiometer, and use as much regeneration as possible without distorting the received signals. The use of 300 volts on receiving set of this sort does not harm the receiving set because it does not pass through any transformer or other coils, but care must be taken that the loud speaker used will be able to stand the voltage. The Magnavox, of course, will not be harmed. Several other loud speakers can be used, but loud speakers made from phones attached to a horn are not safe with this arrangement because the windings are liable to be burned out. It is, however, practical to use with this method, a loud speaker made from a 70-ohm phone used in conjunction with a stepdown coil; the primary winding of this coil then takes the steady plate current of the tube and protects the receiver. A power tube may still be used without the use of such high voltages. One of the beautiful features about the use of the power tube as a detector is that it is on the job without critical adjustment, either for "A" battery or "B" battery. In other words, a power tube will work very nicely with 75 volts or 100 volts, it will work much better with 200 volts, and it will work at its maximum efficiency with 350 volts, if that is its rated capacity. A loud speaker made from phones and a horn may be used with 100 volts on the plates, providing care is taken that the polarity of the receiver is correct so that the steady plate current through the telephone receiver does not de-polarize the permanent magnets obtained therein.

The use of the power tube in this matter as a detector is a revelation. It will oscillate fully as freely as a soft tube; it will regenerate fully as well and yet is not fussy in regard to its plate potential or in general its filament adjustment. It gives far better rectification, does not distort as much, and all round is more satisfactory for use by the person who is none too familiar with radio adjustments, than is the soft tube.

However, there are many people who have more than just a vacuum tube detector; in addition, they usually have a two-stage amplifier. In this case three power tubes may be used to the best advantage, one as a detector and two as amplifiers. There are several things, however, to be taken into consideration when using equipment of this sort. In the first place the output of the detector tube must go through an amplifying transformer to get to the grid of the second tube. Again, the output of the first amplifying tube must go through another amplifying transformer before it gets to the output of the final tube. There are a number of combinations of "B" battery potentials which may be used for the purpose of supplying these power tubes, but always it must be borne in mind that the primary of the amplifying transformer must not be overloaded so that they will burn out. Even though the tubes themselves may be able to carry the high plate voltage, the average amplifying transformer that is on the market today will not stand much over 150 volts in continuous operation; therefore, we must limit the amount of plate voltage which we use on the detector and which we use on the first amplifying tube. We may use 100 volts on the detector tube and 150 volts

# Get This—

"GERACO" means a lot to Radio! The word identifies Radio accessories made to justify our policy that "only the best is good enough!"

Geraco products are the final result of months of careful experiments. They are the best that competent experts can do. They meet every test that anyone can devise—and make good.

Thus "Geraco" is our guarantee to YOU—and your guarantee to the Radio devotee.

"Geraco" identifies the Music Master Radio Amplifier, the Geraco Variometer and Dial (illustrated) along with the Variocoupler. Each item is absolutely good in every sense of that word. Depend on that!

All Geraco products are made from only the best dielectric material, either hard rubber or special Geraco compound.

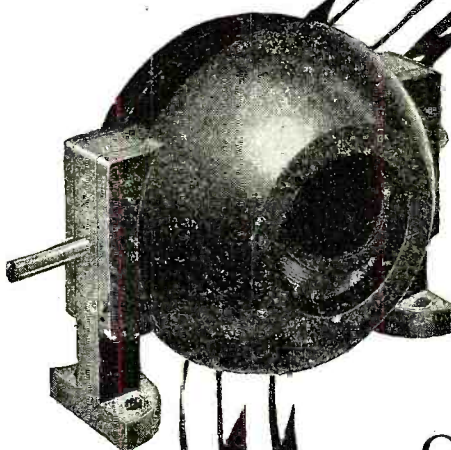
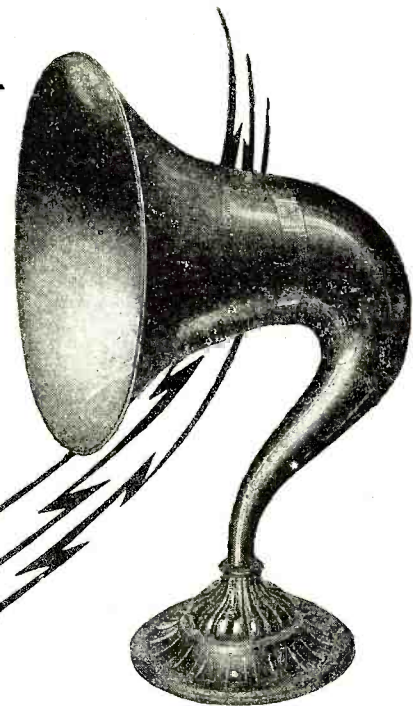

THE Music Master Radio Amplifier greatly magnifies volume and reproduces sound entirely free from that harsh metallic screeching. It is unequalled in resonance, the beautifully grained mahogany horn insures that.

21 inch for concert and out-of-doors \$45.00  
14 inch for general use in home . . . 35.00

GERACO Variometer and Vario Coupler assemblies are a long step ahead in the development of accurate tuning instruments.

Variometers . . . . . \$6.00  
Vario Couplers . . . . . 5.00

GERACO Moulded Dials, smooth black surface accurately calibrated—Size 3 1/4 inches 75c. Equipped with Special Geraco Chuck.

- |   |                                   |
|---|-----------------------------------|
| Write for complete information on Geraco: | Variocouplers, complete           |
| Variometer, complete                      | Variocoupler Tubes                |
| Variometer Rotors                         | Variocoupler Balls                |
| Variometer Post Assemblies                | Vacuum Tube Sockets               |
| Variometer Stators                        | Crystal Detector Bases            |
| Dials                                     | Aerial Insulators                 |
| Knobs                                     | The Music Master Radio Amplifiers |

Manufacturers, Jobbers, and Dealers—write at once for complete schedule of discounts

**GENERAL RADIO CORPORATION**  
Manufacturers and Distributors of  
**HIGH GRADE RADIO APPARATUS**  
624-628 Market St., Phila., Pa.



CUT PRICES	
Sterling 43 Plate Variable Condensers . . .	\$4.00
Queens Variometers . . . . .	4.75
Electrose 4-inch Dials . . . . .	1.00
Klosner Rheostats . . . . .	1.25
Federal Single Circuit Jacks . . . . .	.60
Federal Single Circuit Filament Control Jacks . . . . .	.85
Copperclad Antenna Wire . . . . .	.45
Paragon and Westinghouse Receiving Sets in stock. Big reductions on all radio apparatus too numerous to list. It will pay you to write us for your radio wants.	
<b>SOLAR RADIO CORPORATION</b>	
2 Stores (532 Nostrand Ave.) Brooklyn, N. Y.	
(879 Flatbush Ave.)	

Cardboard TUBES FOR WIRELESS Paper	
1/8 inch Wall	
2 1/2, 3, 3 1/2, 3 3/4 in. O. D. Per foot	30c
4, 4 1/4, 4 1/2, 4 3/4 in. O. D. "	35c
5 and 5 1/2 in. Outside Diameter "	40c
6 in. Outside Diameter "	50c
Postage Extra, Shipping Wt. 1 lb. per foot	
Dealers, write for special price list	
<b>BAEHM PAPER CO., INC.</b>	
219 FULTON STREET, NEW YORK	





**Recharge Your Battery at Home**  
Charges Both A and B Radio Batteries

Don't be without the use of your Radio Receiving Set while your battery is being charged. Get a Valley Charger and charge your battery right at home. Attach the Charger to your home lamp socket—attach the clips to the battery terminals and you will get a quick, tapering charge which just exactly charges your battery, but cannot over-charge or harm it in any way.

Will charge the A 6 volt battery at a 5 ampere rate, and the B 22½ volt battery at the required ½ ampere rate. 45 volt B batteries may be connected in parallel so that they can also be charged. **SATISFACTION GUARANTEED.** If your local distributor cannot supply you, write direct to

**VALLEY ELECTRIC COMPANY,**  
Department R, ST. LOUIS, MO.

----- Mail the Coupon -----  
Valley Electric Co., Dept. R, St. Louis, Mo.  
(Gentlemen: I am enclosing money order (or check) for \$18.00, for which send me a Valley Battery Charger with five-panel glass display case and indicator. If not satisfactory, I will return it and get my money.)

Name \_\_\_\_\_  
Address \_\_\_\_\_

**\$18.00**  
F.O.B. St. Louis

on the two amplifier tubes; however, the last tube of the amplifier is connected directly to the loud speaker and does not have to go through the amplifying transformer. If a Magnavox is used, as high as 500 volts may be used on the last stage, providing the tube will stand it. The first stage and the detector may use 100 volts each, and in this way, by carefully selecting the "B" battery voltage and putting in power tubes, the output of a detector and two-stage amplifier receiving set may be enormously increased, and this increase in output may be just enough to bring up the music and speech where it is a pleasure rather than a strain to listen to it. This use of power tubes in the reception of radio telephone broadcasting should be earnestly looked into, particularly when the receiving set is at such a distance from the broadcasting station that the received music is hardly loud enough to be eminently satisfactory. When greater amplification is desired, it is necessary to use a power amplifier and a loud speaking reproducer that will stand a heavy current. The main difference between a power amplifier and any other amplifier is that it contains amplifying transformers which are sufficiently insulated to carry the voltage necessary for maximum operation of a 5- to 30-watt transmitting tube. Power amplifiers of this sort may be attached directly to the output of a detector set or may be attached to the output of an ordinary two-stage amplifier, making four stages in all. This type of installation is more suited for outdoor use where great volume is necessary.

In all of the above discussions where high voltage is mentioned, the average radio enthusiast thinks that this should be obtained by the use of the common and popular 45-volt "B" battery in series. These 45-volt batteries, however, are made up of very small cells and are not designed particularly to stand the drag of a heavy plate current. A large number of battery manufacturers are now making a 100-volt block "B" battery, which not only contains sufficient cells to give the 100 volts but also these cells have sufficient capacity and size to stand the heavy plate currents demanded by such voltages and tubes. From a money standpoint, it is cheaper to buy for use with power tubes these block batteries, because they will outlast several sets of the smaller types.

It is also possible under certain conditions to use a motor generator set to supply the plate voltage for power tubes used in reception. Just as in a transmitting set, the hum of the commutator may be eliminated by the use of a filter system comprising a combination of chokes and condensers. There is one main objection, however, to the use of a motor generator for an amplifier in radio and that is the taking place, as the armature rotates, of a very minute sparking as each commutator segment leaves the brush. The commutator sparking gives off a more or less periodic radio wave which is picked up by the detector tube and amplified through the amplifier into a disagreeable buzz. This cannot be eliminated by the use of choke coils or condensers, but may be eliminated by a careful screening of the generator. This screen is then grounded. In some cases a screening of the generator leads is also necessary, but if the generator is carefully screened and grounded, the buzzing is eliminated. As a matter of fact, for outdoor use a slight hum is not objectionable and cannot be heard at more than a few feet away from the horn. The amplification, of course, can only be carried to the limit of the tube in the last stage of amplification. In other words, if music and speech are being reproduced with as much volume as the last tube can stand it will do no good to add another stage, using the same type of tube. It is, however, possible to still further increase the volume by adding another tube of a different type; for instance, a set may consist of a detector and two amplifier tubes



**PRESTO!**  
**As by magic—music shall be yours**  
YOU CAN BE A MODERN MAGICIAN

NO HOKUS-POKUS ABOUT THIS

2 Variometers **\$12.50** with 3 3-inch Moulded Dials  
1 Variocoupler

Durable wood construction, shouldered brass shafts, wiping contacts, beautiful white engraved dials.

¼" Black Fibre Panels, 1½¢ per sq. in., cut to size.  
Switch Levers, 1¼" Elade, 50¢. Switch Points, per doz., 35¢. Tube Sockets, 75¢ and \$1.10. Rheostats, Transformers, Armstrong Super-Reg. I. Vite Resistances, 12,000 ohm, \$2.50. Duo-Lateral Coils, 50¢ to \$3.00. Everything in Radio.

**EHLER-RADIO**  
30 N. DEARBORN ST. - CHICAGO  
Members American Radio Association

**The "Q. S. A." Line of Radio Equipment**

Are you being handed the inferior radio equipment now flooding the market? Long before the present boom "Q. S. A." equipment was well known to the amateur trade. Ask anyone of the old time amateurs and he'll tell you. Your only guarantee against inferior goods is to order from the "Q. S. A." catalog which will be sent for 10 cents in stamps or free with order from this ad. Below are some items not shown in our catalog but on which we can give you the same prompt service.

Fixed Receiving Condenser .001 mfd.....	\$.70
Vacuum Tube Socket, composition.....	.75
3-inch Bakelite Dial and Knob.....	.85
Sw. Lever Set, consisting of 1 Sw. Lever, 11 contact points, 2 Sw. Stops, and 3 Binding Posts—a very good buy at only.....	1.00
Stay-Hot Soldering Iron, burns alcohol.....	2.00
Grewal "always adjusted" crystal detector.....	2.00
Howard Filament Rheostats.....	1.10
Brush Lightning Arrester.....	2.50
11 Plate Variable Condenser.....	3.30
23 Plate Variable Condenser.....	4.25
Federal Jr. Crystal Set, Complete with Phones	25.00

**INDEPENDENT RADIO SUPPLY CO.**  
3239 Ogden Avenue CHICAGO, ILL.  
"A Radio Store with a Conscience"

**SALES**  
are increased and customers satisfied when your Radio Panels are made of

**BAKELITE DILECTO**

Cut, drilled and machined by our special methods, the result of years of experience. Our product is our best salesman. *Let us send you samples.*

**Standard Wireless Panel Company**  
49 MECHANIC STREET, NEWARK, N. J.

**Radio Salesmen**  
Make Money in Your Spare Time

Successful Radio Salesmen in all parts of the country are making money in their spare time by securing subscriptions to SCIENCE AND INVENTION and RADIO NEWS.

These magazines have an enormous circulation, are growing in popularity daily, and the demand for them is becoming universal. **Make them a part of your regular line.**

Attractive commissions paid.

For details and subscription blanks write C. J. Wolfe, Experimenter Publishing Company, 53 Park Place, New York.

**Hot Wire or Thermo-Couple?**

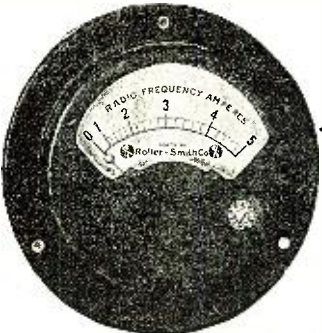

For small size, small capacity radiation ammeters the hot wire mechanism is far superior to the thermo-couple type. That's why our small 3½" radiation ammeters are of the hot wire type.

The Roller-Smith Company being the only maker of both hot wire and thermo-couple types is in a position to know which is best—and it does.

Send for Bulletins No. V-10 and No. V-810  
THEY ARE FREE

**ROLLER-SMITH COMPANY**  
15 Barclay Street New York  
Offices in principal cities of U.S. and Canada

**RADIO CLUB PINS**

An emblem made to order for your Club will work wonders—write today for free 52-page catalog, showing Radio emblems, class rings and pins. Samples loaned to officers.

No. 987

**METAL ARTS CO., INC., 7755 South Ave., Rochester, N. Y.**



of the five-watt type. A third stage may be added then, consisting of a 50-watt tube, and in these cases, it is almost always necessary to use a motor generator, at least for the last stage.

A set of the above type, using enormous amplification, if carefully constructed, will not distort any more than an ordinary two-stage amplifier set. A set of this kind will also have other uses than simply creating a greater volume of sound through one or two reproducers. Such a set will solve the problem of the apartment house where it is desired to use a radio set in each apartment.

To install a separate radio receiving set in each apartment would necessitate an enormous duplication of equipment. How much easier it would be to install a good receiving set on the roof, use power amplification, and have a reproducer only in each apartment. These reproducers, each of them, could be supplied with a switch to cut in the reproducer, and in this way each apartment could listen to the concerts; this is by no means a dream.

Several times during the last few years, the editor of this magazine, Mr. Gernsback, has prophesied and illustrated with drawings, installations of this type. It is with the greatest pleasure that the writer presents herewith photographs of an installation more or less approaching this in its results. This installation, designed and installed by a large western manufacturer of electrodynamic reproducers and power amplifiers, is not only unique but amply illustrates what can be done at present with modern radio equipment. While the installation is not in an apartment house, it is in a school containing 27 rooms. In each room there is an electrodynamic reproducer set in the corner where the voice or music can reach all the pupils distinctly. (This is shown clearly in Fig. 1.) In the principal's office, built into the wall beside his desk, is a power amplifier cabinet and a selector panel. (This cabinet and panel are shown in Fig. 2.) All 27 reproducers are controlled from the panel as is also the motor generator, which supplies all the current for this panel. Each one, or any number of the reproducers may be separately energized or, by means of a master switch, all of the reproducers may be put in circuit. A transmitter is then used so that the principal may talk to each, any or all rooms. This, however, is not the only feature of this installation, but there is, in another part of the school, the highest type of radio receiving set obtainable, installed by another concern. The output of this radio receiving set is wired directly into the power amplifier cabinet and by means of a switch, the radio music and speech may be turned loose in any one of the 27 rooms, just exactly the same way as the principal's voice itself. The complete outfit, consisting of the radio receiving set, power amplifier cabinet, selector panel, and motor generator set, as well as the 27 reproducers, taken all together, are not so expensive but what a modern high-class apartment house could afford to install the same type of outfit. The selector panel, instead of being at one point could easily be split up so that each reproducer at its particular location could be energized by the occupant of the apartment. In this way, radio would be available for everybody in the building and there are several high-class apartment houses now building which will contain radio installations.

To sum up, it may be said that a transmitting tube, while more or less misnamed, is very important in radio reception and by its use and the addition of a little "B" battery, increases in volume without increases of distortion may be obtained from receiving sets which are now thought to be working at their maximum volume. It is to be hoped that the use of power tubes in this connection will become more general because the use of them consistently in radio receiving sets will save one complete stage of amplification in a large number of cases

# Give Your Radio Set the Advantage of WESTINGHOUSE RADIO BATTERIES



Westinghouse "A" Batteries are especially built for the peculiar requirements of radio work. They deliver a constant, dependable flow of low voltage current. They are built to give long, low-cost service. They demand a minimum of attention.

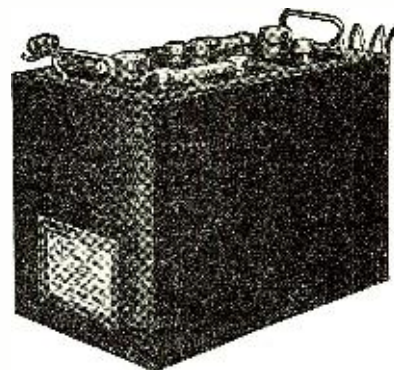

In the Westinghouse "B" battery you have a storage battery for "B" work—the latest development in radio practice. It has all the reliability and dependable performance of a storage battery and none of the disadvantages of a dry cell. The Westinghouse "B" gives a steady, continuous, noiseless service. It lasts indefinitely.

When exhausted it is easily recharged. The first cost is the last cost.

*Don't lose the enjoyment of your Radio by operating under unsatisfactory conditions. Get Westinghouse "A" and "B" batteries from your radio dealer or the nearest Westinghouse Service Station.*

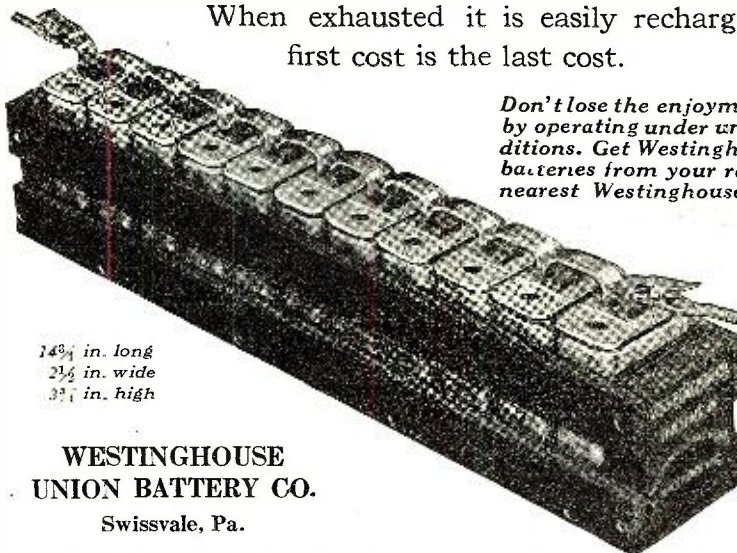

14 3/4 in. long  
2 1/2 in. wide  
3 1/2 in. high

**WESTINGHOUSE  
UNION BATTERY CO.**

Swissvale, Pa.

*"The best  
Westinghouse  
can build"*

## DEALERS ONLY—

Write for Harry Alter's RADIO "POCKETBOOK."

A net price catalog of radio supplies published each month. Our wholesale prices hit bottom.

The RADIO "POCKETBOOK" sent free to dealers only. Use your letterhead.

**HARRY ALTER & CO.**  
126 N. May St. Chicago

## MOON RECEIVING SETS

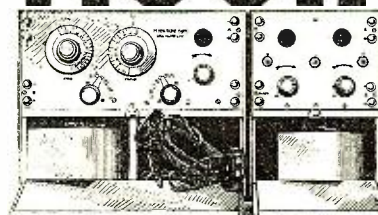

Vacuum tube sets with compartments for "B" Batteries and Phones. Write for Catalogue and Prices.  
Moon Radio Corp. 12 B Diagonal Street Long Island City, N.Y.







this looks very well if finished as recommended here.

A horn of this kind, provided with a Baldwin Type C receiver, makes a very good loud speaker, and will give just as good satisfaction as expensive ones. The cost of the material used in making this horn is practically negligible. The only cost is the time required. The satisfaction of possessing a loud speaker made by oneself will more than repay for the time consumed.

## How to Wire a Radio Set Correctly

(Continued from page 654)

ing makes soldering simpler. Excessive heat will burn it off, so that once it has been applied, care should be taken to regulate the heat.

After both surfaces have been cleaned, flux sparingly applied, and the iron heated, the work may begin. Holding the iron in one hand, melt about an eighth of an inch of wire solder on the tip of the iron and apply the iron to the two parts to be joined. The solder should flow freely to the two surfaces and connect the two parts. If it does not, either the iron is too cold, not enough melted solder is available to flow downward, or the iron is not being held right. If the solder flows, but does not join the parts or adhere to them, the surfaces may be dirty, or not enough flux applied to them.

In inaccessible places, or delicate work, it is sometimes impossible to solder a joint directly. If this is the case, apply solder to each part in turn, and then, pressing them together with pliers, hold the iron against the metal so that the solder applied will again be melted, and the joint sweated together.

This method will be found especially useful at first, when learning the art, and it produces better results than the usual method, although it takes more time.

When first planning the wiring of a set it is sometimes best to make a drawing of it, showing the wiring. With this can be seen the wires which cross each other, and plans may be laid for connections, which have the least possible number of crossings. In wiring two-step amplifiers and such apparatus where induced currents are a factor of inefficiency, especially tube apparatus, care should be taken not to have wires running parallel to each other for any appreciable distance. Well planned wiring pays in the long run.

In wiring transmitters, try always to keep power and radio-frequency circuits separate, as far as possible. In amplifying circuits, keep the wiring of the primary of the amplifying transformer separate and at right angles to the wiring of the secondary. Keep grid circuit wires short.

In the small sets where good wiring shows up best, try to make all bends at right angles, and have all lengths of wire on either a horizontal or vertical plane. This gives an orderly appearance to the apparatus.

Contributed by **SHELDON TRENT.**

## Radio Notes Gathered at London, England

By C. L. WHITNEY

THE Postmaster-General's scheme for wireless broadcasting by private enterprise has been considered by the Federation of British Industries, who suggest that only British-made apparatus should be used for receiving sets.

"Punch" recently published a very amusing "wireless" cartoon. An aeroplane, tearing along in a cloud of smoke and flame

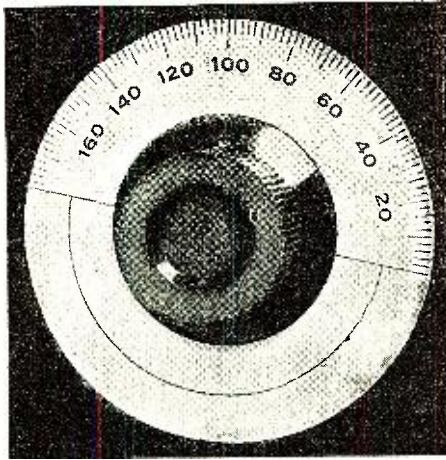

# SOMERVILLE DOLLAR DIAL

A Quality Product At a Production Price.

AT ALL RADIO DEALERS OR POST PAID FROM US **\$1.00**

**SPECIFICATIONS**—Bakelite knob, with concealed set screw and heavy brass bearing for 1/4-in. or 3/16-in. shafts. Dial of brass, heavily silver plated and lacquered, diameter, 3 1/4-in.

### ADDITIONAL EQUIPMENT

UV200 Radiotron Detector Tube.....	\$5.00
Stromberg-Carlson Head Set.....	7.50
Burgess Large 22 1/2 V. "B" Battery.....	3.00
	<b>\$15.50</b>

### SOMERVILLE ANTENNA OUTFIT

125 Ft. 7 Strand Copper Wire.....	.75
2 Brown Porcelain Insulators.....	.20
1 "Anchor" Lightning Arrester.....	1.50
25 Ft. Waterproof Ground Wire.....	.50
1 Lead-In Insulator Tube.....	.20
1 Ground Clamp.....	.10
	<b>\$3.25</b>

### SPECIALS

Westinghouse 1 1/2 v. Peanut Tube.....	\$8.00
General Radio Socket, to fit.....	1.25
General Radio Potentiometer.....	3.00
Coto-Coil R.F. Autotransformer.....	5.50

### Parts of a Single Circuit Regenerative Receiver Which Can Be Assembled and Wired at Home by Anyone

Chirad Variometer, Assembled.....	\$5.00
175-3000 Meter Bank Wound Load Coil.....	3.75
2 Somerville 4" Dials, with Pointers.....	3.50
1 Dead Ending Switch, for Load Coil.....	.75
12 Contact Points and Stops.....	.45
8 Somerville Metal Terminals.....	1.20
8 Somerville Terminal Indicators.....	.50
1 Paragon Tube Socket.....	1.00
1 Grid-Leak Condenser, .0005 Mfd.....	.70
1 By-Pass Condenser, for Phones.....	3.00
1 Condensite Celeron Panel.....	7.50
1 Quartered Oak Hinged Cabinet.....	3.75
General Radio Condenser, .0005 Mfd.....	1.10
Federal Panel Rheostat, 6 Ohms.....	1.10
<b>TYPE KD-CR-5 RECEIVER</b>	<b>\$32.60</b>

### We Promise Prompt Shipment on FEDERAL

Junior Crystal Receivers.....	\$25.00	No. 1425 } Fil. Control Jacks.....	{ \$1.00
Double Headsets, 2200 Ohm.....	8.00	No. 1428 }.....	{ 1.20
Double Headsets, 3200 Ohm.....	10.50	No. 226, Amplifying Transformer.....	7.00
No. 15, Universal Plug.....	1.75	No. 300, Filter Coil.....	7.50
No. 1421 } Plain Jacks.....	{ .70	No. 8, Detector-Amplifier Box.....	52.00
No. 1422 }.....	{ .85	No. 9, 2 Stage Amplifier Box.....	58.00
No. 1423 }.....	{ 1.00	Antenna Outfit (new code).....	7.00
		No. 400, Pleiophone Loud Speaker.....	14.00

# DEALERS

a cash basis only, allowing the usual discounts. Try Us!

We are jobbers of most of the high grade lines of standard equipment, and will fill your orders promptly on a cash basis only, allowing the usual discounts. Try Us!

### A M R A D

Short Wave Tuner, 2596.....	\$55.00	Crystal Receiver, New Type.....	\$23.00
Detector Two Stage Amplifier.....	65.00	Detector Control Box, 2771.....	16.50
Two Stage Radio Freq. Amplifier.....	40.00	VT One Stage Amplifier, 2776.....	22.00
Amplifier, Mounted, 2620.....	6.00	VT Two Stage Amplifier, 2776.....	42.50
Filament Rheostat, 2.3 amp.....	1.00	Variometer, Unmounted, No Dial.....	6.50
Potentiometer, 300 ohm, No Dial.....	1.50	Variometer, Unmounted, No Dial.....	7.75
Tube Base, 2164.....	1.00	Lightning Switch, New Type.....	5.00
Vernier Variometer, Unmounted.....	2.50	20 Watt "S" Tube, CW Rectifier.....	8.00

# CONSUMERS!

If your dealer does not carry above items, we will ship direct, postpaid.

## SOMERVILLE RADIO LABORATORY

REMOVED TO LARGER QUARTERS AT  
43 CORNHILL ST., BOSTON, MASS.

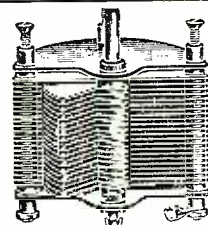

### "STANDARD" VARIABLE CONDENSERS

Excel Through Substantial Mechanical Construction  
Show Even Calibration Curve

<i>Low Resistance and Low Dielectric Loss</i>	
11 Plates, Capacity .00025 + M. F.....	\$2.35
23 " " .0005 + M. F.....	2.85
43 " " .001 + M. F.....	3.60
<b>Graduated Dials and Knobs, 4-in. \$1.00; 3 1/2 in. .90</b>	
<b>"Standard" Improved Rheostat</b>	
A departure from the customary design. Will not cause noise in the receiver. Resistor cannot come loose. Price with knob and pointer, \$1.00.	
All "Standard" Products Are Fully Guaranteed	
We ship postage prepaid upon receipt of price.	
Standard Appliance Mfg. Corp., formerly	
<b>STANDARD RADIO PRODUCTS CO.</b>	
432 E. 71st Street, N. Y.	

### KNOCKED-DOWN VARIABLE CONDENSER MONEY SAVING PRICES

An accurately made, fully efficient instrument that cannot get out of order or adjustment. Fully guaranteed. Extra heavy aluminum plates. All other parts heavily nickelplated. Knob and pointer included. Furnished assembled or knocked down at the following low prices. Easily assembled by anyone following instructions furnished. Save money—Order from us. Folder upon request.

No. of Plates	M.F.D. Capacity	Assembled	Knocked down
3	.00007	\$1.75	\$1.50
11	.00025	2.50	2.00
21	.0005	3.25	2.50
43	.001	3.90	2.90

**Lott's Better Radio Condenser Co.**  
473 Orange Street, Newark, N. J.



# Dr. T. O'Connor Sloane Will Teach You CHEMISTRY Right In Your Own Home



Good chemists command high salaries. Industrial firms of all kinds pay tempting salaries to get the right men. Salaries of \$10,000 a year are not unusual for chemists of exceptional abilities. The work of the chemist is extremely interesting. If you are fond of experimenting, take up chemistry. If you want to earn more money, the way is open through our Course in Chemistry.

**You Can Learn at Home**  
Dr. Sloane will teach you Chemistry at home in a practical, intensely interesting way. Our Course is remarkably simple. No special education required—if you can read and write plain English you can thoroughly understand and master every lesson.

### Easy Monthly Payments

The price of our course is very low and the tuition includes everything, even the chemistry outfit—there are no extras to buy with our course. You can pay in small monthly amounts as you go along. Our plan places a chemical education within the reach of everyone.

### Experimental Equipment Given to Every Student

One special feature of our course is that we give to every student, without additional charge, the chemical equipment he will need for his studies, including forty-two pieces of laboratory apparatus and eighteen different chemicals and reagents. The fitted, heavy wooden box serves as a carrying case for the equipment and as a laboratory accessory for performing experiments.

### SPECIAL 30-DAY OFFER

In addition we are making a special offer for a short time only. You owe it to yourself to find out about it. Mail the Coupon to-day for free book, "Opportunities for Chemists," and full details of our special offer. Act immediately before this offer is withdrawn.

—CUT HERE—

Chemical Institute of New York, Inc.  
(Home Ext. Division 10), 140-R, Liberty St., N. Y. City

Without obligation or cost, send me your free book, "Opportunities for Chemists," and full particulars about the Experimental Equipment given to every student, your plan of payment and special 30-day offer.

Name.....  
Address.....  
City..... State.....



## This Book On Home Beautifying Sent Free

Contains practical suggestions on how to make your home

artistic, cheery and inviting—explains how you can easily and economically refinish and keep woodwork, furniture and floors in perfect condition.

## --BUILDING??

If so, you will find this book particularly interesting and useful, for it tells how to finish inexpensive soft woods so they are as beautiful and artistic as hard wood. Tells just what materials to use—how to apply them—includes color card—gives covering capacities, etc.

Our Individual Advice Department will give a prompt and expert answer to all questions on interior wood finishing—without cost or obligation.

We will gladly send this book free and postpaid for the name and address of one of the best painters in your locality. Send for 10c we will also send you postpaid a 2 oz. bottle of Johnson's Liquid Prepared Wax.

S. C. JOHNSON & SON, Dept. RN10, Racine, Wis.  
"The Wood Finishing Authorities"

### CUSTOM TAILOR MADE TO FIT YOUR INDIVIDUAL CAR

Made in our custom shops after your order is received. We ship ordinarily guaranteed when correct name, year and model of car is given. You can easily apply it yourself.

**\$4.40 and up**  
Parcels Post Paid

We furnish instructions and all necessary tacks, welts and fasteners. Our Catalog No. 11 with samples is free for the asking.

**LIBERTY TOP & TIRE CO., Dept. R-1, Cincinnati, O.**

## TELEGRAPHY

(Office and Wireless) and RAILWAY ACCOUNTING taught thoroughly. Big salaries, great opportunities. Largest, largest school. Endorsed by Telephone Railway, Postal and Government officials. Expense low—opportunities to earn large portion. Catalog free.

**BODGE'S INSTITUTE, D Street, Valparaiso, Ind.**

and heading for certain destruction, brought forth the remark from a Yokel that "There's another of them wireless messages caught fire."

Radio amateurs in the district of Broadstairs should note that Mr. H. Pound, an amateur, transmits phonograph music and speech practically every evening at 9:30 on a wave-length of 440 meters. Mr. Pound's radio set has a transmitting radius of about 19 miles.

Mr. T. F. Rendall, a young electrical engineer of Sunderland, has constructed a crystal receiving set in a pill box. He believes it to be the smallest set in the world. It is complete in every detail and, according to the inventor, picks up clear messages from vessels passing along the northeast coast daily.

Before the war Belgium's merchant fleet had about 10 ships equipped with radio. She now has approximately 120, which are under the control of the Administration des Télégraphes.

A station with a range of a thousand kilometers is being erected near Prague, to deal with aeroplane service between Prague and Warsaw. Two stations are to be built in Bohemia for aerial navigation purposes also.

The Central Telegraph Office (London) has established radio communication with Berlin, Cologne, Posen, Rome, and Egypt, through the Post Office Radio Station at Leafield (GBL) near Oxford. Signals from this station have been heard in India and Australia. This station also maintains a regular service for press reports with Halifax (HX) on a wave-length of 8750 meters.

In the 1921 report of Mr. H. Kershaw, H. M. Commercial Secretary at Stockholm, on the economic commercial and industrial situation in Sweden, he states that serious consideration is being given to the possibility of practical use of the wireless phone, and that during the summer exhibition in Lulea, communication by radiophone was carried on between that city and Boden. Experiments were also carried out earlier in the year with the object of examining the possibilities of utilizing high-frequency power cables for communication via the wired-wireless which was invented by General Squier of the American Army.

The business men of Tokio and Osaka, Japan, finding that the telephone lines between the two cities are very congested at certain hours during the day, have decided to use radiophones, with Nagoya as a relay station. Their application has been placed with the Department of Communications for permission to establish this service, by the representative of the Daido Electric Motor Power Co., one of the chief promoters of the scheme.

Wireless Operators "stood bi" at noon on June 29 to hear the Last Post and Reveille sounded via radiophone by six bugler-boys at the Marconi House, London on the occasion of the unveiling of a roll of honor containing 348 names, 316 being those of wireless operators lost at sea on British vessels.

Rumor has it that the National Meteorological Office, Paris, will send twice daily a weather forecast by radiophone to the French rural districts. Probably Eiffel Tower will be used as the transmitting station. Receiving sets will be installed in parish schools or at the gendarmerie stations, and they will warn the peasants of impending storms by ringing a bell. The receiving sets will cost not over 200 francs or about \$18.

All have heard of the work that the famous St. Bernard dogs of the Alpine monasteries have done in rescuing mountaineers. At the Volot Observatory, on the peak of Mount Blanc, a wireless station has been erected specially equipped to resist the sudden atmospheric changes that

## Ford Runs 57 Miles on Gallon of Gasoline

A new automatic Vaporizer and De-carbonizer, which in actual test has increased the power and mileage of Fords from 25 to 50 per cent and at the same time removed every particle of carbon from the cylinders, is the proud achievement of John A. Stransky, 521 South Main Street, Pukwana, South Dakota. A remarkable feature of this simple and inexpensive device is that its action is governed entirely by the motor. It is slipped between the carburetor and intake manifold and can be installed by anyone in five minutes without drilling or tapping. With it attached, Ford cars have made from 40 to 57 miles on one gallon of gasoline. Mr. Stransky wants to place a few of these devices on cars in this territory and has a very liberal offer to make to anyone who is able to handle the business which is sure to be created wherever this marvelous little device is demonstrated. If you want to try one entirely at his risk send him your name and address today.—Adv.



### Are YOU Old at 40?

A very common cause of early old age is the disturbed condition of an important gland. Even big strong men are not exempt from this common and serious irregularity. Our plainly written, interesting and educational

## FREE BOOK

"Why Many Men are Old at Forty" may bring a priceless message to you. It tells of a simple, sensible way by which thousands have corrected this prostate gland condition. It tells how sciatica, back-aches, foot pains, interrupted sleep, mental depression, etc., are so often due to this gland. Sold for over five years upon a money-back-if-not-satisfied plan. Do not confuse it with massage, medication, violet rays, etc. No obligation.

Write for your copy of the FREE BOOK today.

**The Electro Thermal Co.**  
6013 Main St., Steubenville, Ohio

### LEARN ELECTRICITY IN 3 MONTHS

IN THE GREAT SHOPS OF

Make this the most profitable and enjoyable summer of your life. Come to Chicago, the electrical center and the country's greatest summer resort city. Learn Electricity in America's oldest, largest and best equipped school. Earn your way, free employment dept.

**FREE R. R. FARE** If you come now we will pay your railroad fare and give you free a course in auto truck and tractor electricity, a course in radio, and a life scholarship in the great Coyne School. This is the greatest offer ever made by a school. Write at once for particulars as we cannot keep this offer open long.

Write Today **Coyne**

Trade and Engineering Schools  
1300-1310 W. Harrison St., Chicago, Ill.  
Dept. 110

### INCREASED PRODUCTION AT LESS COST

—and better results assured. Such advantages are easily possible with this compact, practical precision machine for working in bakelite, formica, brass, copper, carbon, wood, etc.

**The Bolco Pony Bench Machine** combines bench saw, disc sander, drill, buffer, grinder and polisher. Especially adapted to rapid and accurate production of small duplicate parts. All metal. Saws up to 1-2 in. stock. Easily driven from line shaft or with 1-4 hp. or 1-3 hp. motor. Special Offer

Machine with wood saw, grinding and buffing wheels and sand 1-8 hp. ball bearing motor \$73.00. Write for circular.

**SOLD ON MONEY-BACK GUARANTEE**

**W. B. & J. E. BOICE • Dept. 710 • 114 23rd St., Toledo, Ohio**



usually put ordinary apparatus out of commission. Climbing parties are now warned to equip themselves with radio apparatus before setting out on a climb, so that help can be called for from the Observatory in case of emergency; SOS in another role.

One of the most famous wireless stations in Europe, at Poldhu, Wales has closed down for traffic. MPD will no longer be heard by ships at sea. Clifden, Marconi's Irish station, takes Poldhu's place and handles the news broadcasted each night at 1 A. M. on a wave of 5750 meters spark. Poldhu is perched on a rocky coast of Cornwall and was the first high-power station ever built, and it was from there that the first wireless message was flashed across the Atlantic. A 2,000-meter wave-length was used at that time, and the message was received at St. Johns, Newfoundland, on November 12, 1901. Poldhu will henceforth be used as a research station by the Marconi company. Poldhu's regular traffic to Paris, Madrid, and Berne, is now being handled by a new station using C.W. which is located at Ongar, 20 miles from the Radio House, Finsbury Square, London, where the traffic is sent from by remote control.

Every afternoon excepting Saturday and Sunday, the radiophone station at Eiffel Tower, Paris, transmits speech (in French) and music on a 2,600-meter wave-length which is not very sharply tuned. The transmissions commence at approximately 5 P. M., summer time, and are followed at 6 P. M., by weather forecasts in French. Special transmissions are fairly frequent from FL and as a rule, notice is given of these special concerts during the regular daily program.

The Marconi company's concerts from Writtle may be heard every Tuesday evening beginning at 8 P. M., summer time, on a wave-length of 400 meters. The call is "2MT", and the power is only one-half kilowatt.

The Hague concerts are sent out from PCGG on a wave-length of 1,070 meters, every Sunday from 2:30 to 5 P. M. The second part of the program is sent in English for the benefit of the amateurs in Great Britain.

The air station radiophone at Croydon (near London), call GED, uses a wave of 900 meters and may be heard at various times during the day, communicating with the aeroplanes running from London to European cities. Below is a list of other Government radiophone and C.W. stations used for communication with aeroplanes.

Evere, Brussels, Belgium, BAV, C. W. 900.

Bordeaux, France, AB, C. W. 1400.  
Le Bourget, Paris, France, ZM, C. W. and Telephone 1400 and 900.

Lyons, France, AL, C. W. 1400.  
Maubeuge, France, AV, C. W. 1200.

Nimes, France, AN, C. W. 1400.  
St. Inglevert, France, AM, C. W. and Telephone 1400 and 900.

Soesterburg, Holland, STB, C. W. and Telephone 1400 and 900.

Amsterdam, Holland, KLM, C. W. and Telephone 1400 and 900.

Castle Bromwich, Great Britain, GEC, C. W. and Telephone 900.

Didsbury, Great Britain, GEM, C. W. and Telephone 900.

India House, Great Britain, GFA, C. W. 1400.

Lympne, Great Britain, GEG, C. W. and Telephone 900.

Renfrew, Great Britain, GER, C. W. and Telephone 900.

Department stores in London are now selling radiophone receiving apparatus from regular stock.

A barber in Leeds has attached a wireless aerial to the striped pole over his door, and inside the shop he has a loud-speaking receiver to entertain his customers. It is said that broadcasting radiophone

# Super-Antenna

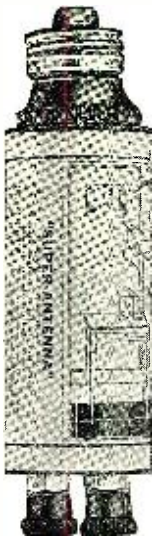

## Saves Cost of Aerial Attach to Any Light Socket

The "Super-Antenna" unit has been designed by one of the country's foremost engineers for Radic Vacuum Tube Reception over electric lighting circuits.

You can now pick up broadcasted concerts in any room or at the home of a friend by simply attaching the "Super-Antenna" plug to any electric light socket.

The "Super-Antenna" does away with the overhead aerial and the dangers of stringing wires. Eliminates expense of switches and lightning arresters. **Safeguards your Set—Will not blow fuses and is absolutely shock proof.** Operates on any electrical circuit from 32 to 120 volts, D.C. or A.C. and does away with alternating current hum. Does not use current. Switch can be turned "ON" or "OFF".

## Endorsed by Leading Electrical Institutions

The "Super-Antenna" unit in voltage, weight and design is made to conform with the requirements of the National Board of Underwriters and has been tested and approved by leading electrical experimental stations.

## Order at Once—Today!

On account of the heavy demand, we suggest you order at once. If your dealer cannot supply you, send check or money order direct giving us your dealer's name.

West of Rockies **\$3.00**      Canada **\$3.70**      PRICE **\$2.80**

## F. R. L. Super-Receiver—Radio Frequency

A high-grade perfect functioning three-stage Radio Frequency Receiver months ahead of any other set on the market. Easily tuned to hear distant points. Perfect modulation of music, speech or signals without distortion.

### 30 Mile Range Without Antenna or Ground

This unit has 1,000-mile receiving radius and a range of 150 to 600 meters. In addition to this, provision is made for an External Detector and Tuner for other wave lengths. Has no equal for sensitiveness and efficiency. All parts are made and tested according to the most exacting Standards, making certain accurate operation.



Price, including tubes. **\$240.00**

**DEALERS AND JOBBERS—Be the first in your territory to stock these units. Write at once for particulars.**

**SUPER-ANTENNA COMPANY**  
DEPT. 510      QUINCY, ILL.

# MANUFACTURERS ATTENTION!

## REAL RADIO SHOWS FOR REAL EXHIBITORS

The Great Southwest has Thousands of Fans and Is a Virgin Field.

Houston, Texas, Sept. 18 to 23 - - San Antonio, Texas, Oct. 9 to 15

New Orleans, La., Nov. 13 to 19

Other Big Dates Following

**NATIONAL RADIO SHOW AND EXPOSITION CO., Inc.** GALVESTON, TEXAS



# Efficiency is a Question of Method



A GANG PLOW in the hands of an unlettered peasant is more efficient than a crooked stick in the hands of the most learned man on earth.

The phenomenal growth and onward sweep of **CHIROPRACTIC** cannot be ascribed to the personnel of the profession. It is due entirely to the correctness of the fundamental idea, to the simplicity of the method, and to the results obtained.

The practice of **CHIROPRACTIC** consists of the adjustment, with the hands, of the movable segments of the spinal column to normal position for the purpose of releasing the prisoned impulse.

Employ none but a **competent** chiropractor.

**DEFINITION**  
The practice of Chiropractic consists of the adjustment, with the hands, of the movable segments of the spinal column to normal position for the purpose of releasing the prisoned impulse

Ask Your Chiropractor for "The Last Word"

Write for information regarding Chiropractors or Schools to the

**UNIVERSAL CHIROPRACTORS' ASSOCIATION, DAVENPORT, IOWA, U.S.A.**

All Rights Reserved

stations will soon be erected in areas centering on London, Cardiff, Plymouth, Newcastle, Birmingham, Manchester, Edinburgh, Glasgow, and Aberdeen. The wavelength will probably be 400 meters.

## Variable Condenser from Photo Plate Holder

(Continued from page 661)

construction of an efficient variable condenser involving a very small amount of work as detailed below.

Remove the thin hard rubber slides, as they will not be required. With a broken hack-saw blade cut a slot in the end of the holder midway between the two slots from which the slides were removed and of about the same thickness and width as these two slots. Through the new slot remove the black paper diaphragm which separated the photographic plates and on the other end of the holder cut an opening in the center about  $\frac{1}{2} \times \frac{1}{8}$ " to receive the connectors from the two inside fixed plates.

Procure a sheet of good straight zinc about 8"x36" and cut into seven pieces, three of them being of the same dimensions as the hard rubber slides. These plates form the sliding element and are joined together at one end by the screw R and the five clamp nuts N.

The two inside fixed plates are the same size as the photographic plates and the two outside ones have the overall dimensions of the plate holder.

Cut six pieces of rather heavy straight cardboard the size of the inside fixed plates (5"x7") and immerse them in melted paraffin. While still warm, put them quickly upon the fixed plates in proper position, scraping off surplus paraffin. They will adhere firmly, holding the plates straight and rigid. The outside fixed plates have cardboard on one side only and are fastened to the plate holder by small wood screws.

On one end of each of the inside fixed plates solder a piece of thin sheet brass about  $\frac{3}{8} \times 1\frac{1}{2}$ ", which, extending through the hole in the end of the holder, are bent and soldered to the outside fixed plates and to one another. The inside fixed plates are held in the holder by the small flanged locking bars which hold the glass plate in position. It is well to immerse the plate holder in hot paraffin before the slides are inserted, removing surplus material by holding near a gas jet.

This condenser will have considerable more capacity than the ordinary 43-plate rotary type, but this capacity may be easily reduced, if desired, by removing one or two of the plates, preferably the central sliding one.

The plate holder may be set edgewise in the cabinet on insulating supports, requiring very little room, and the sliding element may be adjusted by a rubber or bakelite rod extending through the end of the cabinet, or, if finer adjustment is desired, a rack and pinion may be operated by a knob in front of the cabinet.

If greater capacity is required two or more such plate holders may be placed side by side, with great economy in space, and fine adjustments may be obtained by operating each holder, or even each plate, independently of the others.

For the cardboard insulating sheets, one or more thicknesses of micanite or other insulating papers may be mounted on the fixed plates, using shellac instead of paraffin, but the construction above outlined is easier and will give excellent results.

4 MN

Radio 4MN has been assigned to J. V. Settle, Winder, Ga., who has two 5-watters Acme 200 rectified A.C., radiation 1.6 amperes.

Broadcasting Over W W J

DETROIT NEWS

Oct. 14, 1922

8.30 to 10.00 P. M.



"Listen In"

Hear the Gibson Melody Maids Concert

WWJ Detroit News Concerts are heard at great distances. Tune in on above date and hear the wonderful music possible on Gibson Instruments. You, too, will want to own a Gibson. New friends, new pleasures, new and interesting experiences, invitations galore—dinners, dances, week-end parties, outings—are some of the good things playing a Gibson brings into your life.

**Gibson** Instruments

Are easily learned in spare time without previous knowledge of music. A few weeks of pleasant, interesting study and you'll be able to play. And there's no other joy in life quite equal to hearing music you make on your own instruments.

**\$5.00 Monthly**

Buy a Gibson. The ultimate in construction, finish, tone quality and volume. Built like a violin. Adjustable bridge, non-warpable truss rod neck. 30 other exclusive Gibson features. Guaranteed for life. Non-Gibson instruments exchanged.

**Make \$25.00 to \$200.00**

Weekly selling, playing, teaching. Own a high-class, exclusive business. We furnish stock, advertise, help sell, carry accounts. Gibsons easily sold on confidential credit plan.

Send for FREE catalogue, FREE music and information about Mandolin, Mandola, Mando-cello, Mando-bass, Guitar, Harp-guitar, Mandolin-banjo, Tenor-banjo, Cello-banjo, Guitar-banjo. If interested in Agency, check here. Teacher. Clip, check and mail this ad today.

**GIBSON MANDOLIN-GUITAR COMPANY**

1730 Parsons St., Kalamazoo, Michigan

Foreign Dept., 25 Broad St., New York City

**High School Course in 2 Years** You can complete this simplified High School Course at home in

side of two years. Meets all requirements for entrance to college and the leading professions. This and thirty-six other practical courses are described in our Free Bulletin. Send for it TODAY.

**AMERICAN SCHOOL**

Dept. H 785 Draxel Ave. & 58th St.

CHICAGO

### RADIO MAILING LISTS

6900 Retail Radio Dealers covering the United States, by states, price per thousand \$7.50.

838	Radio Manufacturers	per list	\$10.00
1022	Radio Supply Jobbers	"	10.00
260	Owners of Radio Stations	"	4.00
14000	Radio Amateurs and Managers of Radio Stations	per M.	7.50

These are neatly typewritten and ready to send you on receipt of remittance covering the amount; guaranteed 97% correct.

**TRADE CIRCULAR ADDRESSING CO.**

166 W. Adam St., Chicago, Illinois



## Who Will Save the Radio Amateur?

(Continued from page 625)

give the radio amateurs the standing they should have.

We wish to state right here that we have no axe to grind with any organization, club or league, and if the thing is to be accomplished only through an organization we would be just as much in sympathy with such an idea as with any other.

What we wish, therefore, fellow-amateurs, is a manuscript of not more than 1,000 words, setting forth your idea as to the best plan to put the radio amateurs on a solid footing, where they can perform the greatest good for the community and for the radio art. The following, all of them past or present amateurs, will act as judges:

- H. GERNSBACK,**  
*Editor RADIO NEWS.*  
**LOUIS GERARD PACENT,**  
*President, Pacent Electric Co.*  
**ROBERT E. LACAULT,**  
*Associate Editor, RADIO NEWS.*  
**ARMSTRONG PERRY,**  
*Author.*  
**LEWIS MASON CLEMENT,**  
*of Western Electric Co.*

All the prize-winning letters will be published in rotation, and the editors reserve to themselves the right to publish all manuscripts, even though such should not win a prize. In publishing such manuscripts, full space rates will be paid.

Should two or more contestants submit the manuscripts judged to be the best, second best, etc., each will be awarded the full amount of the prize offered.

This contest will close in New York, November 15, 1922, and the prize winners will be announced in the January, 1923, issue of RADIO NEWS.

Address all manuscripts to *Editor, "\$500.00 Amateur Prize Contest,"* care of this publication.

## Pocket Radio Again

(Continued from page 629)

The set weighs only three ounces, but will respond to signals from distances equal to those covered by regular instruments of large dimensions and with equal intensity. It covers all wave-lengths between 150 and 700 meters when used in connection with an antenna whose natural period is about 200 meters.

The case was turned from a solid block of hard rubber and is 2" in diameter with a 3/16" wall. It was grooved in front to receive a standard watch crystal, and in back for a 1/16" hard rubber disc attached with screws, which protects the wiring and excludes dust.

Tuning is accomplished by means of knurled discs of rubber which project slightly through slots in the case, similarly to the celluloid score-keepers used in baseball games. These discs are fastened rigidly to the switch arm shafts so that by pushing on the rim, the shafts and switch arms are revolved. Stops are provided which engage with projections on these discs, causing the switch arms to stop on the end contact points. Connection to these movable arms is through hair springs fastened to the shafting. The contact points are made of brass rod 1/16" in diameter and are fastened to a circular panel in the tuner with screws about 1/16" long, eighty threads to the inch.

The tuning inductances are bank wound, without cores, with No. 32 S. C. and a 1/16" air gap between primary and secondary. They were wound on wooden forms covered with paper and removed after shelacking to bind and stiffen the turns. Taps

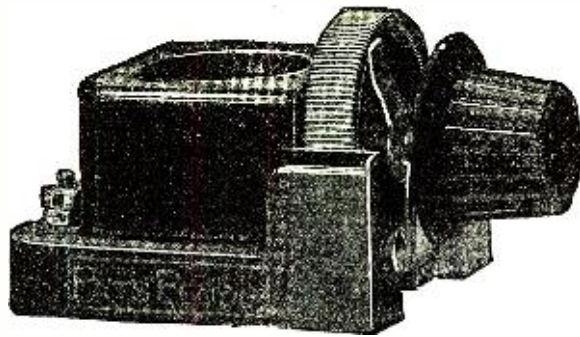

# KING Rheo-socket another

## Radio Surprise

Price \$3.00, f. o. b. N. Y. C.

Compact, increased efficiency, shorter connections, less wiring. Brings in stations you never heard before. Make this a part of your up-to-date set.

A high grade article in Red Bakelite with Phosphor-Bronze Contacts and Alloy Resistance Wire.

For Base or Table Mounting

# KING AM-PLI-TONE

82 Church St., New York

Manufacturers of the Famous King Am-plitone

Jobbers—wire or write for proposition

# RADIO WIRE

SHIPPED PROMPTLY

OVER FIFTY TONS IN STOCK

## MAGNET WIRE — AERIAL WIRE — LITZ WIRE

Size	ENAMEL			SINGLE COTTON			SINGLE SILK		
	1 lb.	½ lb.	¼ lb.	1 lb.	½ lb.	¼ lb.	1 lb.	½ lb.	¼ lb.
22	\$0.48	\$0.28	\$0.16	\$0.95	\$0.52	\$0.30	\$0.95	\$0.51	\$0.38
24	.55	.31	.18	1.05	.57	.32	1.07	.57	.21
26	.60	.34	.19	1.21	.65	.36	1.19	.63	.34
28	.64	.36	.20	1.36	.73	.40	1.44	.76	.40
30	.68	.38	.20	1.70	.89	.48	1.89	.98	.51

POSTAGE EXTRA

BANK WOUND VARIOCOUPERS, 150 TO 3000 METER RANGE, \$6.00

Send 5 cents to cover postage on our new perpetual catalog

No stamps accepted

**I. R. NELSON CO.** Broadcasting Station **Bond St., Newark, N. J.**  
W-A-A-M

Get a Handy Binder for your RADIO NEWS. Holds and preserves twelve issues, each of which can be inserted or removed at will. Price 65c. Experimenter Pub. Co., Inc., Book Dept., 53 Park Place, New York.



**TRADE MARK**  
**Red Devil Tools**

**You'll have need for a real pair of pliers!**



**YOU** can do better radio repair work with a good pair of slip joint pliers. Especially if they're forged of steel, and designed to stand a lot of hard work.

**"Red Devil" Pliers**

insure quality in pliers. They give good service, and cost no more than inferior tools.

"Red Devil" Slip Joint Pliers 9 1/4 inch, combines a shear cutter, burner grip, and screw driver.

Price 50c from dealers or us.

**Mechanics' Tool Booklet Free**

**SMITH & HEMENWAY CO., INC.**  
273 Broadway, New York, N. Y.

**Be a Certificated Electrical Expert**

**Earn \$3,500 to \$10,000 a Year**

You can do it. Even the ordinary Electricians—the screw driver kind—earn top wages, but I can quickly fit you for one of the big "boosing" jobs paying from \$70 to \$200 a week. Lack of experience or education no drawback. Learn at home in your spare time. Radio Course, Employment Service, Consulting Service and Big Outfit of tools, material and instruments given absolutely free. Investigate! Write today for Electrical Book, Sample Lessons, Proof and Guarantee Cash Bond—all FREE.

**L. L. COOKE, Chief Engineer**  
Chicago Engineering Works  
Dept. 667 2150 Lawrence Avenue Chicago



**Electrical** men with training are in demand. For more than a quarter of a century, this school has been training men of ambition and limited time, for the electrical industries. Condensed course in Electrical

**Engineering** enables graduates to secure good positions and promotions. Theoretical and Practical Electricity, Mathematics, Steam and Gas Engines and Mechanical Drawing. Students construct dynamos, install wiring and test electrical machinery. Course with diploma complete

**In One Year**  
Over 3000 men trained. Thoroughly equipped fireproof dormitories, dining hall, laboratories, shops. Free catalog. 30th year begins Sept. 27, 1922.

**BLISS ELECTRICAL SCHOOL**  
407 Takoma Ave., Washington, D. C.

**AMERICAN TIME CLOCK REPAIR & SUPPLY CO.**

**SECOND HAND TIME CLOCKS**  
Bought, Sold, Repaired and Exchanged  
**ALL WORK GUARANTEED**  
We Carry a Full Line of Supplies

489 Broadway, near Grand St., Phone, Canal 7951

**ELECTRICAL Training Book FREE**

Send me your name and address and I will send you my big new Electrical Training Book Free. It will show you how to qualify for high paying jobs in Electricity. Thousands now open. Prepare at home—quickly—during spare time under an Electrical Engineer. Take advantage of this unusual offer—only temporary.

**A. W. WICKS, President WICKS ELECTRICAL INSTITUTE**  
Dept. 1077 3601 Michigan Ave. CHICAGO

were taken by soldering leads of No. 36 wire, a delicate operation which was accomplished without charring the insulation of adjacent turns. The leads were carried through separate holes in the panel and soldered to their respective contact screws. This had to be done quickly to prevent heat from softening the thin panel and loosening the contact.

The detector is adjusted by means of a small knob attached to a shaft which carries the elbow of bronze wire projecting through a slot in the panel, as may be seen in the photograph. A hair spring bears on the galena crystal and is soldered to the end of the bronze elbow directly over the center of the crystal. It will be seen that through the combination rotary and sliding motion that may be given the detector adjusting knob, the hair spring contact may be raised from the crystal and moved to a new position, where it is brought down again by a spring strip on the back of the panel which bears on a projection of the shaft carrying the knob. The galena crystal is mounted with Wood's metal in a rectangular copper box 1/8" x 1/4". The surface was ground flat so that the hair spring contact would always bear on the crystal with uniform pressure at all points. The detector parts are of sufficiently rigid construction to hold a sensitive adjustment even when the set is given quite a jolt.

Binding posts for phone, aerial and ground connections are provided, being turned from phosphor-bronze rod and threaded 2-56. A brass post surmounted by a ring provides a convenient way to attach the set to one end of a watch chain.

Carrying out the idea of a complete vest-pocket outfit, a special receiver and head-band were provided. A single 1,000-ohm phone was turned down to the smallest practical dimensions and a groove made for winding on a Litzendraht cord attached to the terminals which can be unwound and connected to the set. An old pair of ear muffs with a light steel head-band was used in making a head-band for the receiver. By cutting off one muff and bending the wire frame of the other into a yoke, which can be snapped into holes in the receiver case, a very light and efficient head-band was made which folds up into a small unit around a spool containing wire for connecting the aerial and ground to the set. The entire outfit is carried comfortably in three vest pockets and when used with the time-honored bed spring antenna, will bring in a surprising number of stations.

**THIRTEEN BROADCASTERS LICENSED**

List of limited commercial or broadcasting stations licensed between August 12 and 19, 1922.

WKAN—Alabama Radio Mfg. Co., Montgomery, Ala.

**YOU HAVE A BEAUTIFUL FACE BUT YOUR NOSE?**



**BEFORE** **AFTER**

**IN THIS DAY AND AGE** attention to your appearance is an absolute necessity if you expect to make the most out of life. Not only should you wish to appear as attractive as possible, for your own self-satisfaction, which is alone well worth your efforts, but you will find the world in general judging you greatly, if not wholly, by your "looks," therefore it pays to "look your best" at all times. Permit no one to see you looking otherwise;

it will injure your welfare! Upon the impression you constantly make rests the failure or success of your life. Which is to be your ultimate destiny? My latest *Nose-Shaper*, "TRADOS Model 25," U. S. Patent, with six adjustable pressure regulators and made of light polished metal, corrects now ill-shaped noses without operation, quickly, safely and permanently. Diseased cases excepted. Does not interfere with one's work, being worn at night.

Write today for free booklet, which tells you how to correct ill-shaped noses without cost if not satisfactory

**M. TRILEY, Face Specialist - 1774 Ackerman Bldg., Binghamton, N. Y.**  
Also for Sale at Riker-Hegeman, Lisgett's, and other First Class Drug Stores.

**Dreyfuss Phones for Long Range Receiving**

The extreme sensitivity of Dreyfuss Phones makes them widely popular for long range receiving and listening in on low power stations. Can be used as loud speakers.

Excellent workmanship. Designed by engineers with over 18 years' experience in the radio field. Aluminum backs, rubber caps, finest materials.

**2000 Ohm Concert Type \$800 List**

**3000 Ohms, per pair - \$1200**

**1000 Ohms, single head band set, per pair - \$475**

**Immediate Deliveries!**

**P. M. DREYFUSS CO., Inc.**

150-152 Chambers Street, New York City  
29 Cedar Street 179 Greenwich Street  
Newark, N. J. New York City

UNCONDITIONALLY Guaranteed for 3 Years (A Written Guarantee)

**U.S. Storage Batteries**

Supreme for Radio Telephone

6 Volts	20 amp.	\$7.50
6 Volts	40 amp.	10.00
6 Volts	60 amp.	13.75
6 Volts	80 amp.	17.50
6 Volts	100 amp.	22.50
8 Volts	60 amp.	17.50

9 Cell B Storage Batteries	2 1/2 V.	\$7.50
20 Cell B Storage Batteries	50 V.	13.75
40 Cell B Storage Batteries	100 V.	20.00

If your dealer hasn't it, send money order or check direct

Mail Orders Filled Upon Receipt of Price  
**PRICE LIST MAILED FREE**

Dealers Write for Discounts

**U. S. STORAGE BATTERY CO.**

FAR ROCKAWAY, N. Y.

You can be quickly cured, if you

**STAMMER**

Send 10 cents for 288-page book on Stammering and Suttering, "Its Cause and Cure." It tells how I cured myself after stammering 20 yrs. B. N. Bogue, 879 Bogue Bldg., 1147 N. H. St., Indianapolis.



- KFBJ—Boise Radio Supply Co., Boise, Idaho.
- WKAP—Flint, Dutce Wilcox, Craunston, R. I.
- KFBK—Kimball-Upson Co. Sacramento, Cal.
- WKAQ—Radio Corp. of Porto Rico, San Juan, P. R.
- WFAY—W. J. Virgin Milling Co., Central Point, Oregon.
- WKAG—Edwin T. Bruce, M. D., Louisville, Ky.
- WJAZ—Chicago Radio Lab., Chicago, Ill.
- KFBM—Cook & Foster, Astoria, Oregon.
- WKAJ—Fargo Plumbing & Heating Co., Fargo, N. D.
- KFBL—Leese Bros., Everett, Wash.
- WKAH—Planet Radio Co., West Palm Beach, Fla.
- WJAX—Union Trust Co., Cleveland, Ohio.

### Typing by Radio Perfected

The Bureau of Standards recently explained some experiments by F. W. Dunmore which indicated that a recently perfected radio relay recorder might do away with code operators by printing the code message on a tape so that it could be read visibly by inexperienced men, but now the Naval aerial and radio experts have gone the bureau one better—they print radio messages automatically on a typewriter.

Co-operating with the Radio Laboratory of the bureau, experts of the Navy successfully tested the operation of the line-wire teletype by radio a few months ago, and succeeded in printing messages from a distance of nine miles. The radio circuit was established between the Bureau of Standards near Chevy Chase and the Naval Air Station at Anacostia.

More recent experiments have established the fact that teletype messages printed on a machine installed in an airplane and transmitted by radio can be recorded on a typewriter in a ground station. Future experiments will undertake the reversal of this operation; the sending machine being on the ground and the receiving apparatus installed in a plane in flight. Great interest is manifested by Naval experts as the new method will permit the sending and receipt of duplicate orders of record, eliminating errors and a knowledge of code, besides saving time of rewriting.

The practical tests made assure future commercial uses in aerial news reporting, when a correspondent covering an aquatic event, marine engagement, or sea maneuvers can send his copy straight to the desk. Another value, if aerial passenger lines are extended, would be the receipt and dispatch of typewritten telegrams, stock reports, news dispatches, etc., ready for delivery.

The sending instrument of the teletype resembles in general the commercial typewriter in that a keyboard having the letters of the alphabet and other conventional symbols on it is arranged so that it may be operated by hand. Each key is connected to the radio installation in the plane, and when a letter is struck on the keyboard a radio impulse is sent out from the antennae of the plane and is received at a ground station. The similarity to the typewriter is completed in the receiving device. When the letter A is struck on the keyboard in the air, the radioactive energy released travels to the recording instrument and selectively energizes the type-letter A, causing it to be reproduced on paper carried in the receiver.

The teletype has been in use for eight years in connection with land-wire operations, but its application to radio use is a recent development. The tests at the Naval Air Station are the first that have ever been conducted in aircraft.

# Take Advantage of the Quality and Prestige of

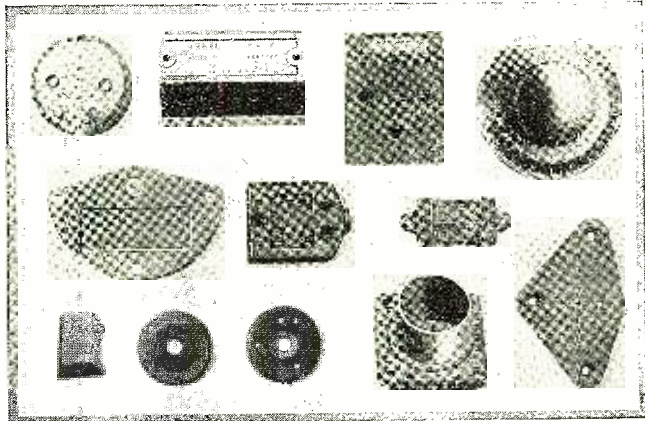

If it isn't Cutler-Hammer it isn't Thermoplox



## THERMOPLAX

COLD MOULDED

The high dielectric strength, the ability to withstand hard usage and be unaffected by varying temperatures—have placed C-H Thermoplox in a class by itself in the radio field.

Parts required by the radio equipment manufacturers may be moulded in any shape, with ratings, trademarks, directions, inserts formed during the moulding process.

Cost of dies is low because of their long life, and—delivery is assured through the operation of plants in Milwaukee and New York with an associated plant (Electroplox Co.) in Toronto, Canada.

### New Booklet Sent on Request

The new C-H Moulded Products booklet contains descriptions and illustrations of various parts as well as a standard line of Thermoplox Knobs.

### THE CUTLER-HAMMER MFG. CO.

Works: Milwaukee and New York

Offices and Agents in Principal Cities

Associated Canadian Plant: Electroplox Co., Toronto

SEND FOR THIS BOOKLET

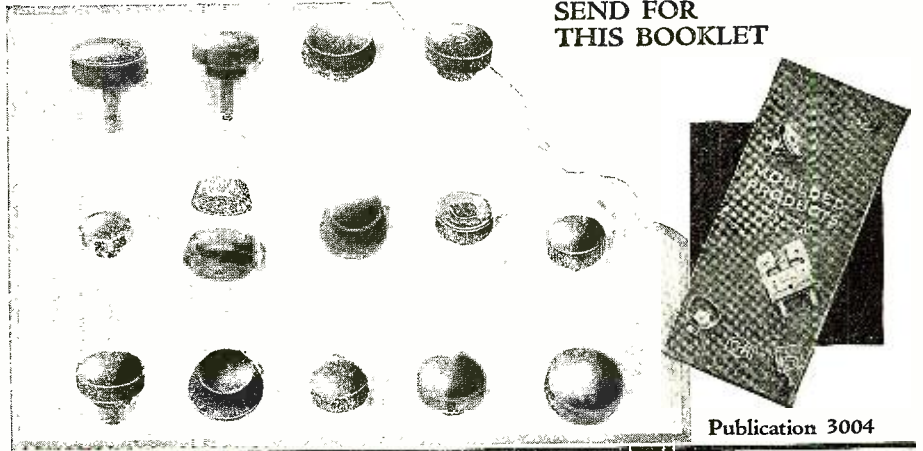

Publication 3004

## RADIO ANTENNA TOWERS

Simple. Sturdy. Easy to erect. Built of galvanized steel. Will last for years. 100 ft. high or less. Fitted to take pipe mast at top. Immediate shipment. Write TODAY for prices.

Radio Department  
**STOVER MFG. & ENGINE CO.**  
FREEPORT, ILLINOIS

### World Batteries

for  
**RADIO or AUTOMOBILE**  
**SAVE YOU 50%**

Buy direct from factory. Pay only one profit. Highest quality made—lowest prices.

#### WRITTEN TWO-YEAR GUARANTEE

We defy price competition; a glance at the prices below will convince you that the World Battery is the best buy on the market. Batteries shipped immediately. Express C. O. D. Begin now to get 100 per cent battery service at one-half cost. Mail your order today.

AUTOMOBILE PRICES	
6 Volt, 11 Plate	\$12.50
Ford, Dort, Chev.	
6 Volt, 13 Plate	14.50
Overland, Buick	
12 Volt, 7 Plate	18.00
Maxwell, Dodge	
Same 50% saving on all cars	

RADIO PRICES	
6 Volt, 40 Amps.	\$ 8.50
6 " " 80 " "	10.00
6 " " 100 " "	12.50
6 " " 100 " "	14.50

**SPECIAL RUBTEX BATTERY CASE**  
The Rubtex Battery Case is guaranteed indestructible and acid proof. Price for this case \$2.50 additional.

**World Battery Company** 1219 S. Wabash Ave., Dept. R  
CHICAGO, ILL.





**104  
PAGES**  
**65  
ARTICLES**  
**175  
ILLUSTRATIONS**  
**16  
PAGES  
ROTOGRAVURE**

**ON ALL  
NEWS STANDS**  
*25c The Copy*  
**SUBSCRIPTION  
PER YEAR**  
(12 Numbers)  
**\$2.50**  
*(Add 50c outside  
U. S.)*

**EXCLUSIVE RADIO ARTICLES A SPECIAL FEATURE**

**THE SLOT MACHINE RADIO**  
A startling device that will bring you any program you want to hear whenever you want to hear it by simply dropping a coin in a slot.  
**DON'T MISS THIS!**

*Some of the Radio Articles in the September Issue*

The Slot-Machine Radio. Who Discovered Radio? Radio Outfit in Pickle Bottle. Tikker Reception of T. W. Chopping Bowl Loud-Talker. Radio Concerts from a Lamp Socket. Five-Stage Amplifier on 110 Volts A. C. Radio for the Beginner. Simplest Radiophone Receiver. Radio Broadcast, Up-to-date. Photos of Broadcasting Stations. Radio Oracle.

SCIENCE AND INVENTION is just chock full of interesting articles and illustrations that appeal to everyone. It will hold your interest from cover to cover because it contains everything new in the field of science, invention and mechanics. Quoted by hundreds of newspapers and magazines all over the world every month.  
*Its editorial contributions constitute the brains of the scientific world. Its four-color cover designs are both artistic and attractive*

**Partial Contents for September, 1922**

**POPULAR SCIENTIFIC ARTICLES**  
Editorial  
Analysis of the Kiss  
Flowers Everlasting  
How Experts Identify Discharged Bullets  
Giant Triplane Carries Thirty Passengers  
Find Lost Radium in an Ash Pile  
Dr. Hackensaw's Secrets, No. 8.  
Secret of Electrical Transmission  
The End of the World—How Soon?  
Perspective Motion Pictures  
Instructive "Movies" Show Universe  
Automatic Book Venders  
Motion Pictures in Natural Colors  
Balsa Wood Iceless Containers

Flying Around World in Twenty-Four Hours  
Of What Are We Made?  
Metallic Model of the Spine  
Gas Producer for Autos  
Why the Smooth Golf Ball Won't Fly Straight  
Miscellaneous New Devices  
How Bones Grow  
A Substitute for Wood  
A Bicycle Canoe  
Scientific Problems and Puzzles  
**PRIZE CONTESTS**  
Motor Hints—\$50.00 in Prizes  
"Combination" Prize Contest—\$50.00 in Prizes  
How-To-Make-It Department—\$30.00 in Prizes  
"Clothes-Pin" Contest Awards  
Description of a Set

**AUTOMOBILES**  
Automatic Brake Control for Motor Cars  
Gas Producer for Autos  
Machine Mills, Drills and Grinders  
"Combination" Prize Contest  
**ELECTRICITY**  
Sound Wave Measures Ocean Depths  
Restoring the Moon  
Direct Current Bell Transformer  
Motor Hints—\$50.00 in Prizes  
How-To-Make-It Department—\$30.00 in Prizes  
Radio Concerts from a Lamp Socket  
Five Stage Amplifier Operates on 110 Volts A. C.  
Latest Patents

The Oracle—Question and Answer Box  
Patent Advice  
**CHEMISTRY**  
Denatured Alcohol Blamed for Deaths  
Practical Chemical Experiments—Paper No. 5—Qualitative Analysis  
Simple Chemical Laboratory Apparatus  
Firework Making for Amateurs  
**CONSTRUCTOR ARTICLES**  
Magic With a Conical Mirror  
Merry-Go-Round  
How I Built a Small Speed Camera  
Simple Chemical Laboratory Apparatus

**Experimenter Publishing Company**  
**53 Park Place**  
**New York**

Gentlemen:  
Please enter my subscription for Science and Invention for the term of one year for which I enclose herewith \$2.50 (add 50c for postage outside of United States).  
Name.....Town.....  
Address.....State.....





**“Whenever you want a hole drilled, use me,”**  
**urges Mr. Punch**

“As an Automatic Drill I’m hard to beat. I go easily through any kind of wood there is,” continues Mr. Punch, “and make the cleanest hole you ever saw. You need me in fixing up your radio set.”

Wherever you must have a hole drilled for a screw or for running wires, this Goodell-Pratt Automatic Drill and others in different sizes make it quickly. They bore through hardwood and soft with ease, and through plaster without a crack or a chip.

The Automatic Drill isn’t the only Goodell-Pratt Tool you need for radio work. There are bench drills, hand drills, plain and ratchet screw-drivers, tap holders and bench lathes. You’ll find that men who like to use good tools give these Good Tools a home.



Your hardware dealer has Mr. Punch and other Goodell-Pratt Tools or can get them for you. Talk to him about them today.

GOODELL-PRATT COMPANY

*Toolsmiths*

Greenfield, Mass., U. S. A.

**GOODELL-PRATT**  
**1500 GOOD TOOLS**



Mr. Punch Automatic Drill, No. 185  
 Price, \$7.60

This drill contains within the magazine handle eight drill points, 1-15 to 11-64 inch in diameter. They are in separate numbered compartments from which they are released one at a time through a hole in the rotating cap.

**A REAL TEST FOR TRANS-ATLANTIC RADIO CIRCUITS—CABLE SERVICE IS INTERRUPTED**

“An ill wind” may blow radio communication “some good.” In fact, it is very likely that the seizure of 10 trans-Atlantic cables by the Irish irregulars, reported by the Associated Press, leaving but seven to carry all the Old World news and dispatches, may give radio communication the opportunity it needs to show what it can do, especially in an emergency. To date it is reported that the Radio Corporation of America is clearing all its trans-Atlantic messages filed between Great Britain and North America without delay.

Officials of the Radio Corporation of America in Washington say they welcome the opportunity to handle the increased traffic and feel that after two and a half years’ operation they can handle their share at least. Ordinarily, the R. C. of A. carries between 20 and 25 per cent. of the trans-Atlantic traffic, but now it may get about 70 per cent.

The five commercial cables seized in Ireland terminate in Waterville, the four Western Union at Valentia, and the British cable at Ballingskelligs. The trouble seems to be that if the Government forces attempt to regain the stations the rebels will destroy them, as was the case with the Marconi station at Clifden, which operated to Canada. The three remaining cables direct to Penzance, England, became overloaded at once, and the only radio circuit in operation, that of Carnarvon, is busy night and day.

Radio Corporation officials admit, however, that the Carnarvon station will have to handle both Canadian and United States dispatches, although stations on this continent can relay messages between United States and Canadian points. The radio system is more flexible than cable communication, they point out, and when one station is loaded, part of its work can be transferred to another. High-speed transmission will enable the radio stations to carry great numbers of messages in periods free from interference, and practically no delay is anticipated.

The only other means of communication between the old and new worlds are the three French cables which land at Brest, and one commercial cable to the Azores and Lisbon, which usually serves the Mediterranean, and some of them are said to be in poor shape.

Radio stations in Europe and England are used for sending and receiving from specific sections; for example, the new station at Ongar, England, serves the Continent and Europe; while that at Carnarvon, in Wales, operates to Canada and the United States, and the British Postal radio circuit near Oxford handles Egyptian traffic.

It would seem that the Radio Corporation of America can handle the American end of the trans-Atlantic traffic with little trouble, and the stations at Marion, Mass.; Tuckerton and New Brunswick, N. J.; and Port Jefferson, L. I., will send; while the receiving station at Riverhead, L. I., will do the receiving from Carnarvon, Bordeaux, Stavanger (Norway), and Nauen and Eilvesse (Germany).

Just at this time of the summer, and in fact until late in September, is the worst season of the year for radio transmission, due to static, which will make more difficult the task of radio’s rescue of the disrupted cable service, but as the four sending stations can operate in duplex, many messages can be taken care of.

Recently the French-American circuit was shifted from Bordeaux to St. Assise, and after a test conducted with this country the station was opened for operation with co-operation of R. C. A. stations. It is reported that the new radio station just about completed at Bruges may go into circuit

**McTIGHE ALKALINE STORAGE B BATTERY**  
*For RADIO OUTFITS*



The McTighe Storage “B” Battery is the most satisfactory for radio use. It gives 22 volts, is inexpensive—no cells cannot be damaged by short circuit, overcharging, standing idle or uncharged. Can be fully charged from any light socket for less than one cent. Is furnished in an oblong glass which nests neatly.

The McTighe Rectifier is cheap, simple, durable and effective, and should be used when charging the McTighe “B” Battery. Rectifier, \$1.50. Rubber Fil er, 25c. Battery, \$5.00. F. O. B. Irwin, Pa. Prompt shipments. Discount to Dealers.

**ECONOMIC APPLIANCE CO.**  
 IRWIN, PENNA.

**MONEY for You**

Add to your Salary—Make Extra Pin Money. Start a lucrative business of your own. Spend an hour each day taking subscriptions for the “Radio News.” We’ll pay you well and you’ll enjoy the work. Write for full particulars. Circulation Dept., RADIO NEWS, 53 Park Place, N. Y. C.



# Every Radio Enthusiast Should Have These Books

## The fundamental principles of Radio are simple and easily understood And to know them adds wonderfully to the pleasure of Radio

### Wireless Course in 20 Lessons

By S. Gernsback, A. Lescarbourea and H. W. Secor, E. E. (11th Edition)

A Course that tells you everything you wish to know about "wireless," starting lesson No. 1 by explaining the Principles of Electricity. By simple, easy stages, this wonderful Course takes you into "Wireless" by the use of simple language so skillfully used that you understand every word. There is a lesson devoted to Theory and Mathematics. The last lesson is devoted to a history of Wireless.



This Course has been considerably revised in order that it meet many important changes which have occurred in Radio Telegraphy and Telephony within recent years. Much valuable data and many illustrations concerning the Vacuum Tube have been added. This comprises the theory of the Tube as a detector, and as an amplifier, and in addition has been included modern amplification circuits of practical worth. Incidentally, space has also been devoted to the development of the Radio Compass as operated and controlled by the United States Navy with its consequent great aid to present-day navigation.

Size of book is 7 x 10 1/4 inches, 160 pages, 350 illustrations, 30 tables.

Cloth bound in Vellum de Luxe, stiff covers, hand-sewed, gold stamped, each \$1.75

Same book, limp binding, colored cover.....\$0.75

### Experimental Electricity Course in 20 Lessons

By S. Gernsback and H. W. Secor, E. E.

A Course on the theory and practice of Electricity for Experimenters. One of the most complete and comprehensive treatises of this special subject ever published. Written by the same authors as the famous "Wireless Course."



Every phase of experimental electricity is treated comprehensively in Plain English. New Experiments are described and explained and nearly every application of Electricity in modern life is given in simple language.

A masterpiece. Just the book you need to tell you all about electricity and electrical facts in plain everyday language that you can understand. Explains every electrical device from a push button and bell to the biggest generator made. Worth its weight in gold for the man who wishes to know about electricity, and to the experimenter it is still more valuable because of its many facts, tables, etc.

The Best Electrical Text Book on the Market. Size of Book is 6 x 9 inches.

The book contains 128 pages, and more than 400 illustrations.

Cloth bound, stiff covers, hand-sewed, green and black stamped, each \$1.25

### The How and Why of Radio Apparatus

By H. W. Secor, E. E.

This newest book on radio matters fills a distinct gap in wireless literature. While the treatment is made as understandable and as free from mathematics as possible, it at the same time incorporates a wealth of technique and instruction for the Radio Amateur—the Radio Operator—the Installation and Designing Expert—as well as teachers and students of the subject in general.

A very broad field has been covered by the author, giving a great amount of information not found in other text-books. If you are engaged in any branch of the Radio or allied arts you will surely need this latest contribution to radio literature.



A glance at the following list of chapters gives but a very scant idea of the extensive and useful radio knowledge provided in its text:

The Induction Coil; The Alternating Current Transformer; Radio Transmitting Condensers; The Spark-Gaps; Radio-Transmitting Inductances; Radio Receiving Tuners; Radio Receiving Condensers; Detectors; Telephone Receivers; Radio Amplifiers; Construction of a Direct Reading Wavemeter and Decremeter; Antenna Construction; The Calculation and Measurement of Inductances; Appendix containing very useful tables, covering all subjects treated in this very unusual book.

This newest of Radio Work has 160 pages, 6 x 9 inches. Hundreds of illustrations and tables.

Cloth bound in Vellum de Luxe, stiff covers, hand-sewed, gold stamped, each \$1.75

Same book, limp binding, colored cover.....\$0.75

### A Thousand and One Formulas

By S. Gernsback

A Laboratory Hand Book for the Experimenter and for Everyone who wishes to "do things."

A Book brimful with very important and priceless information. The recipes and formulas are classified in such a manner as to be available quickly, without long research.



Invaluable for Students, Engineers, Physicians, Experimenters, etc.

Here are some of the chapter headings:

Cements and Glues; Compositions of All Kinds; Glass and Glassworking; Inks; Leather Polishes; Metal-craft; Perfumery, Soaps and Extracts; Photography; Blue Print and other Paper; Plating; Pyrotechny; Polishes and Stains; Varnishes and Paints; Various Cleaning Formulas; Wood-craft; Chemical Laboratory Hints and Experiments; Mechanical Laboratory Hints and Experiments; Electrical Laboratory Hints and Experiments.

There are a score of tables and hundreds of illustrations and Diagrams.

It contains 160 pages. The paper has been especially selected to stand rough handling in laboratories.

Size, 6 x 9 inches.

Cloth bound in Vellum de Luxe, stiff covers, hand-sewed, gold stamped, each \$1.75

### How to Make Wireless Receiving Apparatus



The 20 radio constructors who wrote the book know how articles should be made from simple materials.

Only modern apparatus is described, such as Receiving set without aerial or ground, magnetic detector, wireless relay, wireless lecture set, etc., etc. Book has 100 pages, each 5 x 7 inches, 90 illustrations, many full pages, paper bound, in two colors.

Price 35 Cents

### How to Make Wireless Sending Apparatus



Contains information on how to make 30 different pieces of wireless sending apparatus from materials easily obtained.

Tells How to Make an Experimental Arc Set, Speaking Arc, Quenched Gap, 1/4 K. W. Transformer, Oscillation Transformer, Photo Phone, etc., etc.

Book has 100 pages (size, 7 x 5 inches), 88 illustrations, paper cover printed in two colors.

Price 35 Cents

### Design and Construction of Audion Amplifying Transformers



Radio and Audio Frequency Type

This book will be of great interest to all radio amateurs. The transformers have never before been described in print. The possessor of vacuum tubes cannot afford to do without this book. It will enable him to build the necessary amplifying transformers very readily. The book is printed on good paper and has an attractive cover in two colors. Paper bound. Size, 5 inches by 7 inches. Contains many illustrations, diagrams and working data.

Price 25 Cents

DEALERS—Ask for wholesale discount

# EXPERIMENTER PUBLISHING CO., Inc., 53 Park Place, New York



with the R. C. A. stations; it is the first high-powered transmitting station in Belgium, and may prove a valuable adjunct in the present emergency. Radio will receive a severe test under summer handicaps, but is expected to save the situation.

**NEW RADIO SETS FOR ARMY TANKS**

Radio experts of the Signal Corps have just perfected a new tube transmitting and receiving set for the "Baby" or "Whippet" tanks which will handle both telegraph and telephone messages. So successful was the recent demonstration at Camp Meade with the radio-directed tank which took part in the fight of "Hill 285", leading and directing its brother tanks, that from 30 to 40 new sets have been ordered for the master tank of the Army.

The specifications of the new tank equipment, known as S.C.R. 143, dual telephone and telegraph set, call for a strong and compact set of about 50 watts, which will withstand the jolting of a tank in action over rough terrain and preserve a good tone. It will have a range of from five to ten miles.

Plans of the Infantry arm of the Service, which includes the old Tank Corps, provide for one radio or "signal" tank for each group of Whippet tanks, which will serve as a message and control center for the group. The signal tank will be equipped with a 6' aerial, the ground being the tank itself. Power for driving a small generator will be derived from storage batteries. A sound-proof helmet with phones, such as air-pilots use, will be supplied for the radio man, so that he can hear despite the rattle of the mechanism and roar of the engine.

The first practical demonstration showed the value of radio equipped tanks. They are not radio controlled, but radio directed. Captain C. H. St. Germain, Signal Officer of the Tank School at Camp Meade, took his station on one side of the maneuvering ground, after the sham battle last week, and, with his headset on and a transmitter in his hand, made the mechanical scout several hundred yards away go through its paces to perfection. At his radio orders it "charged" the hill, executed "by the left flank," "to the rear" and "halt," performing most creditably, directed solely by radio, which might have been several miles away. In actual battle, however, the tank commander would attend to all details as to moving about, relying on battalion or regimental headquarters for such information as when to advance or retreat and where machine-gun nests were located. Such information would be conveyed to the other tanks in the group by visual signals or the movements of the master tank itself, just as in airplane formations.

Future development is seen in the equipment of all tanks with receiving sets, so that inter-tank communication may be had in action, and some prophetic spirits of the Corps foretell of radio control enabling an "Amatol"—or "T.N.T."-filled tank to be sent into enemy lines and exploded—a "creeping torpedo" in fact which would undoubtedly carry fear and destruction into the enemy camp; but that is a subject for future development, although quite possible electrically and mechanically.

**NAVY RADIOS 7000 MILES DIRECT**

The Naval Radio Station at Cavite, P. I., now transmits directly to our Pacific Coast by means of a newly installed "barrage" receiver at San Francisco, thus covering a distance of about 7000 miles without relaying. Previously trans-Pacific messages eastward were relayed from Cavite via Pearl Harbor, Hawaii. The new receiver, designed by the radio research section of the Navy, is expected to save approximately \$20,000 a year



**"As good as Brandes"**

**BRANDES** is the standard headset. A counterfeit can never be its equal.

The fourteen years' experience required to make Brandes *Matched Tone* headsets as super-sensitive and as rugged as they are, is not acquired in fourteen weeks.

Only if a headset bears the name Brandes, can it be "as good as Brandes." And genuine Brandes *Matched Tone* headsets cost no more than imitations.

Send ten cents in stamps for the "Beginner's Book of Radio." It explains radio in terms that anyone can understand.

*Distributors and District Offices:*

Munsey Bldg., Washington, D.C. 76 Pearl St., Boston, Mass.  
33 S. Clinton St., Chicago, Ill. 709 Mission St., San Francisco, Cal.  
International Electric Company, Wellington, N.Z.

**C. Brandes, Inc.**

*Matched Tone Headsets*

237 Lafayette St., New York

In Canada—Canadian Brandes, Ltd., Toronto  
Distributors—Perkins Electric, Ltd., Montreal

RESULT OF 14 YEARS EXPERIENCE

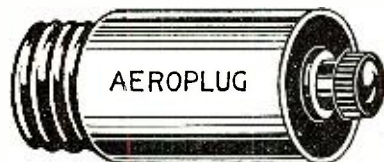

**AEROPLUG AERIAL**

Aeroplug is simple, reliable, and the best you can get for an inside aerial.

Just screw in any lamp socket, and turn key on; it does not use any current.

Perfectly safe; you can't get a short circuit; nothing to get out of order; no danger from lightning, and very little static. Place your vacuum tube receiving set in any room you wish and use radiator, water pipe or gas pipe for ground. Satisfactory results obtained when used with crystal set within close proximity of large broadcast stations.

**Price \$1.50**

*If your dealer can't supply, we will mail direct*

**STAR MANUFACTURING CO. 868 BERGEN STREET NEWARK, N. J.**

**WANTED:** Back numbers of RADIO NEWS, Sept., Oct., Nov. and Dec., 1921, Jan. and Feb., 1922. Experimenter Pub. Co., Inc., 53 Park Place, New York City.





**100 Articles  
Over 100 Illustrations**

FOR SALE  
AT ALL NEWS  
STANDS

20c  
The Copy  
\$2.00  
A Year

Canada and Foreign  
\$2.50 A Year

SEND  
20c. FOR  
SAMPLE  
COPY  
TODAY

SEE COUPON BELOW FOR  
SPECIAL OFFER

## “The Electrical Magazine for Everybody”

**P**RACTICAL ELECTRICS is probably the most novel magazine of its kind ever conceived. It is personally edited by H. Gernsback, editor of SCIENCE & INVENTION and RADIO NEWS. Mr. Gernsback, who founded the old MODERN ELECTRICS as well as the ELECTRICAL EXPERIMENTER, knows thoroughly what the public wants and has wanted for many years. In presenting this new magazine he but heeds the thousands of letters received by him to establish a new 100% electrical magazine that will beat the best that was in MODERN ELECTRICS and ELECTRICAL EXPERIMENTER.

Electricity covers such a tremendous field that the man who does not keep abreast with it does himself a great injustice. PRACTICAL ELECTRICS covers that field from every angle. It is written in plain every-day language that all can understand. It portrays the

entire electrical development of the month faithfully in non-technical language. It caters to everyone interested in electricity, be he a layman, an experimenter, an electrician or an engineer—each will find in this magazine a department for himself and plenty more.

The September issue contains 48 pages and over 100 different articles and over 100 illustrations, with an artistic cover in two colors. Professor T. O’Conor Sloane, Ph.D., is associate editor of the magazine.

### Leading Articles in the September Number

Old Time Trolley Experiences. Great Electric Advertising Signs. Electric Fountains. Musical Typewriters. High Frequency Current Experiments. Spectacular Illumination for the Brazilian Exposition. Home Medical Coil and Violet Ray Set. Home Made X-Ray Screens.

### PRIZES

This magazine offers a number of prizes, as follows:  
\$3.00 for the best picture of your electrical workshop.

\$3.00 for the best article on Elec-Tricks, the new department.

\$3.00 for the best “short-circuit,” the semi-humorous department.

In addition to this, the magazine pays high prices for all electrical experiments, electrical articles, etc.

See Current Issue for Full Details.

This issue also contains articles by some of the greatest living electrical writers, workers and students and the magazine will prove a revelation to any one interested in electricity.

Inasmuch as the new magazine has a circulation of only 33,000 copies, we urge you to place your monthly standing order with your newsdealer at once. Or if you wish, fill out the coupon below for your subscription and take advantage of our special offer.

Every issue besides its many other features contains the following departments:

- “New Things Electric”
- “Experimental Electrics”
- “Electrical Digest”
- “Junior Electrician”
- “My Laboratory”
- “Elec-Tricks”
- “Motor Electrics”
- “Short Circuits”
- “How and Why” (Questions and Answers).

Make all checks payable to: “Practical Electrics Co.”

### SPECIAL OFFER

Gentlemen:

Although your regular price is \$2.00 per year, you will accept my subscription at \$1.75 per year (Canada and foreign \$2.25). I enclose the money herewith and I have written my name and address in margin below.

**PRACTICAL ELECTRICS CO., 53 Park Place, New York**

R. N. 10-22



in coal and power bills at Pearl Harbor as well as considerable time, and will also aid in clearing Pacific traffic. The perfection of the "barrage" receiver thus makes for far greater efficiency in Pacific radio circuits.

**NEW BROADCASTERS**

Six Limited Commercial Broadcasting Stations were licensed by the Department of Commerce on August 11th:

- WJAQ—Capper Publications, Topeka, Kan.
- WAJT—Kelley-Vawter Jewelry Co., Marshall, Mo.
- KFBH—Thomas Musical Co., Marshfield, Ore.
- WLAJ—Waco Electrical Supply Co., Waco, Texas.
- WAJU—Yankton College, Yankton, S. D.
- WJAS—Pittsburgh Radio Supply House, Pittsburgh, Pa.

**RADIO EXPORTS TOTAL \$1,164,514 FOR SIX MONTHS**

American radio apparatus is beginning to be exported in considerable bulk, and in June shipments amounted to over half a million dollars, which is the greatest value of radio exports for several months. Experts of the Electrical Division of the Department of Commerce say that radio is only a part of recent gains in electrical exportations, which for June were \$2,000,000, greater than in May, being indicative of our recovery of export trade in electrical supplies and equipment.

Our total export values for radio equipment during the past six months amounted to \$1,164,514, June being the best month, with exports valued at \$547,364 and totaling nearly a million pounds of goods. The value for June was almost three times the exports of radio equipment for May. A sort of boom in the shipment of American radio goods to foreign countries started in February, which month saw the exportation of \$283,950 worth. There was a slump in March, during which only \$21,180 worth was shipped out, but in April the figures rose to \$116,221, while for May they increased to \$186,364.

The fluctuation is said by experts to result from occasional big orders which are completed during certain months and shipped out, the orders keeping to a more regular curve. In February, for example, the bulk of the shipments went to Poland and Danzig, where big radio stations were being built, boosting the export figures by \$258,094. The only other shipments of any size were to the British West Indies and the Philippines, which totaled only about \$20,000 together. Britain, Panama and Japan took most of the radio apparatus in March, and in April Poland and Danzig got \$12,790 worth, while Quebec and Ontario, Mexico and Cuba imported about seven times that value. During May, Ontario received \$118,836 worth of radio goods, Mexico \$14,044 and England \$13,444.

**AMERICAN EXPERT INVESTIGATES ABROAD**

Denmark has evidently caught the prevailing "Radio" epidemic, as reflected in requests for American wireless telephone apparatus listed in trade opportunities filed with the Department of Commerce. Australia and Italy also have buyers seeking American electrical equipment.

To make a study of foreign electrical development, including wireless operation and equipment, R. A. Lindquist, Chief of the Electrical Equipment Division of the Department of Commerce, sailed for Europe recently. During a three months' survey, Mr. Lindquist will investigate the electrical appliance possibilities for American equipment in England, Sweden and Germany.

*A New Member in the PACENT Plug and Jack Family*  
**THE PACENT DUO JACK**

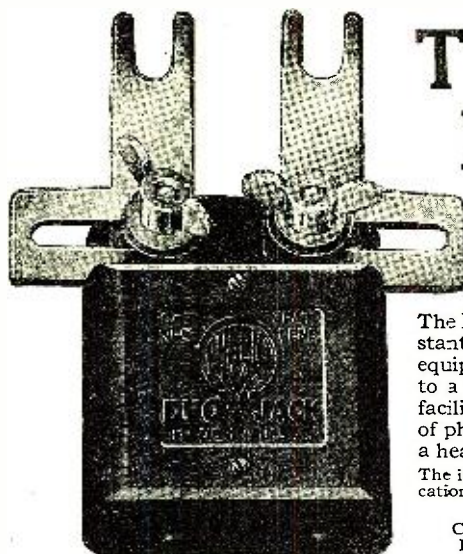

This new Pacent Radio Essential, like all previous members of the Pacent Plug and Jack Combination, fills a definite existing Radio need.

The Duo Jack enables you to instantly convert an ordinary set equipped only with binding posts to a plug and jack set. It also facilitates connecting two pairs of phones or a loud speaker and a headset to your receiver.

The illustrations suggest many applications for this very ingenious device.

Cat. No. 53  
List Price **\$1.50**

*The Pacent Duo Jack will be in production by October 1, but dealers and jobbers are advised to place advance orders at the earliest possible date.*

**PACENT ELECTRIC COMPANY INCORPORATED**

*Executive Offices:*  
**22 Park Place,  
NEW YORK**  
Telephone Barclay 9670



*Branches:*  
PHILADELPHIA, PA. Bourse Bldg.  
CHICAGO, ILL. 33 So. Clinton St.  
WASHINGTON, D. C. Munsey Bldg.

*Members Radio Section, Associated Mfrs. Electrical Supplies*

K. Q. V.—Pittsburgh, Pa.—BROADCASTING STATIONS—Washington, D. C.—W. M. U.

**Dependable Radio Equipment**

All orders with remittance promptly delivered, Post or Express paid. Always a large and varied stock of most modern and reliable Radio Equipment and Parts.



Stromberg-Carlson  
No. 2-A Headset

**\$750**

*Immediate Deliveries on All Items Listed*

- Aeriola Senior Westinghouse Receiver..... \$65.00
- Aeriola Grand Westinghouse Receiver..... \$25.00
- DeForest Radiohome Set, DT 700, less Batteries, Bulbs and Headset..... \$36.00
- DeForest 2-Stage Amplifier DT 800, less Bulbs and Batteries..... \$35.00
- Simplex Variometers..... 6.00
- King Amplitone Horns..... 12.00
- Holtzer-Cabot Headset..... 8.00
- UV 200 Radiotron Detector Bulbs, each..... 5.00
- UV 201 Radiotron Amplifier Bulbs, each..... 6.50
- No. 766 Eveready VT Batteries, each..... 3.00
- Gould 6 volt, 60-80 ampere Storage Batteries. 19.00

Enclose Certified Check or P. O.  
Money Order with Orders



R-3 Magna-vox Loud  
Speaker **\$45.00**

**DOUBLEDAY-HILL ELECTRIC CO.**

WASHINGTON, D. C. Dealers—Write for Discount PITTSBURGH, PA.

Net Wt.  
only 1 pound



PRICE  
**\$12.00**  
Postpaid

Size 5-5/16" x 3-11/16" x 3 3/4"

**A WONDERFUL ACHIEVEMENT!  
RADIO BLINKER RECEIVING SET  
THE THREE IN ONE SET**

Pat. Sept. 4, 1917—Oct. 12, 1920—Pat. Pending

- (1) A practical, efficient, self-contained Wireless Receiving Set for Radio Phone Broadcasting and Commercial Stations approximately 150 to 800 meters wave length. A newly designed, dust proof, crystal detector, extremely sensitive. Can be quickly adjusted by means of buzzer test and locked in position.
  - (2) A miniature Sending Set within limits of buzzer radiation.
  - (3) A Practice Set for code work.
- Ready for phones, aerial and ground connections. Sold on merit with our usual guarantee. Buy from your dealer or direct from us.

**FRANK B. PERRY & SONS**  
Providence, R. I.  
Newton Center, Mass.



# RADIO EXPERIMENTERS!!

## SKINDERVIKEN TRANSMITTER BUTTON

### MOST SENSITIVE MICROPHONE

**Y**OU can easily make a highly sensitive detectophone by using a Skinderviken Transmitter Button to collect the sound waves. You can build your own outfit without buying expensive equipment. Think of the fun you would have with such an instrument! It's very simple, too, and inexpensive.

You can install an outfit in your home and hear the conversation being held all over the house. You can connect up different rooms of a hotel. *This outfit was used by secret service operatives during the War. It is being used on the stage.*

So much for its commercial adaptations! You can procure apparatus of the same type.

One of the main advantages of the Skinderviken Transmitter Button lies in its ultra-sensitiveness. You can place it in any position you like. It is the greatest invention in microphones and has won recommendations from men of high standing in the scientific world. It is being used all over the world. You can mount it most anywhere. Card board boxes, stove pipes, stiff calendars and hundreds of other places will suggest themselves to you. The buttons cannot be seen by any one in the room as they are so small and light. Only a small brass nut is exposed to the view.

The only instruments needed to complete a detectophone outfit, in

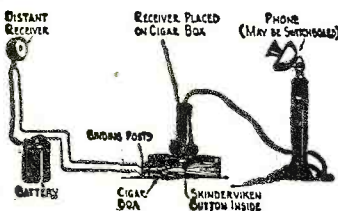

addition to a Skinderviken Transmitter Button are a receiver, battery, and, if desired, an induction coil.

**AS A PREMIUM**



**M**R. H. Gernsback, editor of this magazine, who is the dean of electrical experimenters, said: "In the writer's opinion, obtained by actual elaborate tests, the Skinderviken Transmitter Button is probably the most efficient device of its kind on the market today, due to its simplicity and other outstanding features. Should have a great future."

The same circuit connections apply to all experiments, regardless of how the transmitter button is mounted.

The button may be used to amplify RADIO SIGNALS by using it in a local circuit. It should be mounted on the diaphragm of a telephone receiver connected to the radio set and in circuit with a battery and a telephone induction coil. A wire should be soldered to the diaphragm

to make good contact or to the case of the receiver if it is a metallic one. A low resistance phone is used in the primary circuit of the coil.

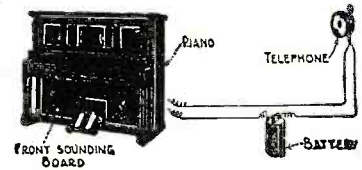

The Skinderviken Transmitter Button operates on one or two dry cells. It often happens that two cells produce too much current and the sounds are deafening. We recommend either one fresh cell or two worn out cells.

We have acquired a limited amount of these Transmitter Buttons and offer same free to our subscribers as a Premium, with a one year subscription to RADIO NEWS. These Buttons sell everywhere for \$1.00 and are worth it. We send you one prepaid upon receipt of the coupon below and the subscription price of our magazine. Do it today.

### USE THIS COUPON

EXPERIMENTER PUBLISHING CO., INC.  
53 Park Place, New York, N. Y.

Gentlemen:

Enter my order for one year's subscription to RADIO NEWS and send me as special premium, free of charge, one Skinderviken Button.

Enclosed find \$2.50 (Canadian and Foreign, \$3.00).

Name.....

Address.....

Town.....

State.....



**THE NAVY LEADS IN ELECTRICAL DEVELOPMENT**

Considerable credit is always given the Navy for its pioneer work, in many lines, among them electrical development, but a recent conversation with an officer of the Radio Section revealed the following items which are not generally known:

In the electrical field the Navy was the pioneer in many lines. Starting with the incandescent lamp, every new electrical discovery was fathomed and adopted by the Navy before its commercial use had been found practicable or profitable.

The Navy Department enabled the General Electric Company to produce the first electrically propelled ship in the collier Jupiter, now the airplane carrier Langley.

The radiophone, which through broadcasting has become the talk of the country, is simply the coming into commercial use of a development that has been in general use in the Navy for the last five years. It was installed experimentally in 1907 for communicating between the ships of a fleet.

Many of the great radio telegraph plants that now encircle the globe are owned and operated by the Navy. Without the Navy's interest, experiments and research, as well as their substantial contracts for apparatus, the radio industry in this country, it is said, would be in foreign hands.

The radio compasses that flank our great seaports are owned and operated by the Navy, but through their use any vessel can be told to a degree what her direction is from any station within call, and thus fix her position whether in fog or storm. This makes for better navigation and saves many a big liner from disaster as well as delay in making port.

Static interference is an element to be reckoned with in all phases of radio work, and has never been entirely eliminated. The Navy Department, however, has been engaged in research work looking to the elimination of static longer than any other Government department. While results have been attained which have reduced interference from this source to about half, it has not yet been completely removed.

**WORLD TRADE NEWS BY RADIO**

Since the recent decision of the Department of Commerce to have foreign commercial data broadcasted from radio stations in the neighborhood of its 34 district offices, schemes for the improvement of this service, particularly in the saving of time, have been received from several sources. One of the recent suggestions is that radio receiving sets be installed at all the branch offices of the department so that commercial data broadcasted from Government stations in Washington and other important centers may be received without delay and re-broadcasted locally. The plan is now being considered by the Bureau of Foreign and Domestic Commerce, and if a favorable report is made the department may be in the market for 34 A-L receiving sets. It is readily admitted by officials that much time would be saved in relaying the information from the Washington headquarters and getting a wide broadcast for the whole country, but fears are entertained that an appropriation for purchasing the receiving sets might not meet with the approval of an economically inclined Congress.

A great mass of foreign trade information is received by the department daily and released to the press, but much of it fails to reach all interested parties. For this reason a scheme of forwarding it by wire to the 34 central and co-operative offices in different sections of the country for broadcasting has been undertaken, and it is to improve this service that the use of radio for transmitting the data and news is suggested.

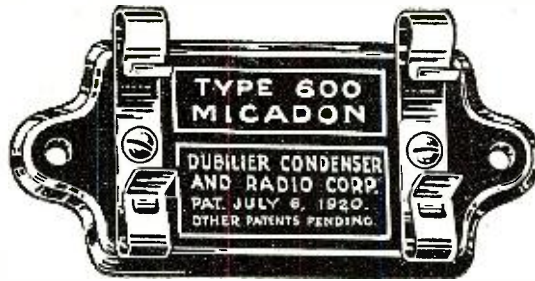

**75¢ each**

**Perfect Broadcasting Reception with this Mica Condenser**

Here we show the new Dubilier Micadon Type 600. It is a perfect Dubilier mica condenser. Use it and all the tube noises, due to fluctuations in the capacity of ordinary condensers disappear.

Dubilier Micadon Type 600 lasts indefinitely. Its capacity is *permanent* because the condenser elements are pressed together, so that they cannot dilate and contract with the oscillations in the antenna and thus cause the capacity to vary.

Dubilier Micadon Type 600 is provided with Fahnestock connectors and grid-leak clamps, but not with grid-leak. The grid-leak can easily be removed and replaced with the fingers.

Everything is soldered. The container is of molded composition. Provision is made for holding screws.

Price in capacities .001 and .002 mfd, 75c each, *without* grid-leak mounting.

Price in capacities from .0001 to .0005 mfd, 75c each, *with* grid-leak mounting.

Price in capacities from .0025 to .005 mfd, \$1.00 each.

*Order from your dealer*

**DUBILIER CONDENSER AND RADIO CORP.**

Department RN

48-50 West 4th St., New York

Branch Office, Munsey Bldg., Washington, D. C.

LICENSEES:

England—Dubilier Condenser Co., Ltd., London  
Canada—Canadian General Electric Co., Toronto

Germany—Telefunken Co., Berlin  
France—C. Carpart, Paris



**Vitalitone LOUD SPEAKERS**

ON THE MARKET THREE YEARS

**NEW MODEL, \$40**

MOST BEAUTIFUL APPEARANCE, HIGHEST EFFICIENCY, SENSITIVE, NO DISTORTION

**FULLY GUARANTEED, WITHOUT RESERVE**

*Immediate Delivery*

MANUFACTURED BY

**VITALIS HIMMER**

205 SIXTH AVE. NEW YORK

**MONEY for You**—Add to your Salary—Make extra Pin Money. Start a lucrative business of your own. Spend an hour each day taking subscriptions for the "Radio News." We'll pay you well and you'll enjoy the work. Write for full particulars. Circulation Dept., **RADIO NEWS** 53 Park Place, N. Y. C.



# OPPORTUNITY AD-LETS

Follow these advertisements every month. Reliable advertisers from all over the country offer their most attractive specials in these columns.

Classified advertising rate fifteen cents a word for each insertion. Ten per cent discount for 6 issues, 20 per cent discount for 12 issues. Name and address must be included at the above rate. Cash should accompany all classified advertisements unless placed by an accredited advertising agency. No advertisement for less than 10 words accepted.

Objectionable or misleading advertisements not accepted. Advertisements for the December issue must reach us not later than October 1st.

## THE CIRCULATION OF RADIO NEWS IS OVER 235,000

EXPERIMENTER PUBLISHING CO., INC., 53 Park Place, New York, N. Y.

### Agents Wanted

**Tailoring Agents**—We've got a wonderful line of all wool tailored to order suits and overcoats to retail at \$29.50. They're all one price. \$20 cheaper than store prices. You keep deposits, we deliver and collect. Protected territory for hustlers. Write J. B. Simpson, Dept. 173, 831-843 W. Adams, Chicago.

**Your chance to make Big Money** silvering mirrors, auto reflectors, metalplating. Outfit furnished. Write for particulars, International Laboratories, Dept. 48, 309 5th Ave., New York.

**Great Profits Assured** capable men joining immediately national selling organization for Evinflo Self-filling Ink-pencil pen. Writes with ink instead of lead. Send for Profit Proposition. Evinflo Pen Company, Dept. 64, Grand Rapids, Mich.

**We Wish Representatives** in every community to secure subscriptions for Radio News, Science and Invention, and Practical Electrics. This is a wonderful opportunity for Amateur Radio Enthusiasts to make big money quickly. Write Experimenter Publishing Co., Inc., 53 Park Place, New York City.

**Amateur Agents Wanted** in every city and town to sell radio apparatus. A few stocking agencies still open. Delfelco, 12 Meeting Street, Pawtucket, R. I.

**Ambitious men**, write today for attractive proposition, selling subscriptions to America's most popular automobile and sportsman's magazines. Quick Sales. Big profits. Pleasant work. Digest Pub. Co., Butler Bldg., Cincinnati.

**\$75.00 to \$150.00 Weekly**. Free samples. Lowest priced gold window letters for stores, offices and autos. Anybody can do it. Large demand. Exclusive territory. Acme Letter Co., 2800M Congress, Chicago.

**Big Money and fast sales**. Every owner buys gold initials for his auto. You charge \$1.50; make \$1.35. Ten orders daily easy. Write for particulars and free samples. American Monogram Co., Dept. 133, East Orange, N. J.

**Agents Wanted** in every city and town to sell standard radio apparatus. Attractive discounts given. If interested, write us at once stating age and radio experience. Wilmington Electrical Specialty Co., Inc., 912 Orange St., Wilmington, Delaware.

**Agents wanted**. We pay \$25.00 to \$200.00 weekly. Write Fragrant Bead Company, 2432 Bolton Street, Philadelphia, Pa.

**No dull times selling food**—people must eat. Federal distributors make big money; \$3,000.00 yearly and up; no capital or experience needed; guaranteed sales; unsold goods may be returned. Your name on packages builds your own business. Free Samples to customers—Repeat orders sure. Exclusive territory. Ask Now! Federal Pure Food Co., Dept. 68, Chicago.

**Make \$5,000.00 every year**—\$2,000.00 spare time. You share profits besides. Show "Weather Monarch" Raincoats and Waterproofed Overcoats. Ask about "Duo Coat" (No. 999). Free raincoat for your own use. Associated Raincoat Agents, Inc., B-448 North Wells, Chicago.

### Help Wanted

**Electrical Sales Engineer**, familiar with Radio, with equipped office, Phila., Pa., open for connection with manufacturer or distributor. H. W. Marks, 1420 Fairmount Avenue, Phila., Pa.

**Earn \$25 Weekly**, spare time, writing for newspapers, magazines. Experience unnecessary; details free. Press Syndicate, 5665 St. Louis, Mo.

**Be a Mirror Expert**, \$3-\$10 a day; spare time home at first; no capital; we train, start you making and silvering mirrors, French methods. Free prospectus. W. R. Herr Pres. 26 McKinley St., Baldwin, N. Y.

**Detectives Earn Big Money**. Excellent opportunity. Travel. Experience unnecessary. Particulars free. Write, American Detective System, 1968 Broadway, N. Y.

### Business Opportunities

**Make money at home** making toys and novelties. Send 5c for catalogue and particulars. New Specialty Co., 417 E. 71st Street, New York.

**Become a Landscape Architect**. Dignified, Exclusive Profession. Little competition. \$5,000.00 to \$10,000.00 income for experts. Easy by our method. Begin earning 3 weeks after you enroll. Write today. American Landscape School, 11R, Newark, N. Y.

### Chemistry

**Learn Chemistry at Home**—Dr. T. O'Connor Sloane, noted educator and scientific authority, will teach you. Our home study correspondence course fits you to take a position as chemist. See our full page ad on page 671 of this issue. Chemical Institute of New York, 140 Liberty Street, New York City.

### Correspondence Courses

**Correspondence Courses** at less than half original prices. Any school; any subject for men or women. Bulletin 1074 free. Courses bought. Instruction Correspondence Exchange, 1966 Broadway, New York.

**Dollars Saved**—Used correspondence courses of all kinds sold, returned and exchanged. List free. (Courses bought.) Lee Mountain, Pisgah, Alabama.

### Automobiles

**Automobile Mechanics**, Owners, Garagemen Repairmen, send for free copy America's Popular Motor Magazine. Contains helpful instructive information on overhauling, ignition wiring, carburetors, batteries, etc. Automobile Digest, 9528 Butler Bldg., Cincinnati.

### Books

**6 Different Business Publications** covering Accounting, Advertising Administration, Merchandising, Salesmanship and Taxation, all prepaid, only 25c. Value, \$1.50. Instructive, educational, practical. Waltham Co., Lafayette Bldg., Philadelphia, Pa.

**Electricians' Examinations**: Book of questions and answers with diagrams, symbols, tables, notes and formulas for preparation for license. \$1.25 by mail. Aaron Shapiro, 132 West 24th St., New York.

**Radio Manual**, everything the beginner should know. How to build and operate an inexpensive receiving set. Sixty-four pages, thirty illustrations. Twenty cents. Postpaid. Raydio Publishing Company, Caxton Bldg., Cleveland, Ohio.

**Study Human Nature**, know people, make more money. Send 10c for "Personal Power," a little book that points the way. Address Progress League, 31-A. G. Union Square, New York, N. Y.

**Books for Sale on Occultism—Mysticism—Theosophy—Mental Science—Advanced Thought—Sex Secrets—Seership—Clairvoyance—Crystal Gazing—Numerology—Astrology—Yogi—Hermetic and Rosicrucian Philosophy**. List Free. The Grail Press, Desk B, 712 G Street, N. E. Washington, D. C.

**Vibrations—Light—Color—Sound Literature**. Free. Stevens Publishers, 242 Powell, San Francisco.

**500 Mechanical Movements**, also illustrations explaining 50 Perpetual Motions. New book, Inventors' Universal Educator, fifth edition, tells how to procure and sell patents. Government and other costs. Covers matter from A to Z. 160 pages elegantly bound. Mechanical Movements greatly assist inventor—suggest new ideas that may prove of great aid in perfecting inventions. Tells how to select an attorney. Has valuable information regarding Patent Sharks and Brokers. Price, \$2.00. Postage, free everywhere. Money back if not satisfactory. Explanatory circular free. Fred G. Dieterich, 631 Ouray Bldg., Washington, D. C.

**We Buy and Sell back issues of Radio Amateur News and Electrical Experimenter**. Boston Magazine Exchange, 109 Mountfort St., Boston, Mass.

**Radio Building Books**, 25c. Amateur Electrician, 10c. ToyMaker Books, 10c—64 pages each, 150 kinds mechanical puzzles, leader and catalog, 10c. Western Puzzle Works, 15, St. Paul, Minn.

**Sexology Books** only for professional and advanced student readers. Forel, Kraft-Ebbing, Kisch, Robie, Ellis, Freud, Kay and other authorities. The Modern Book Association, 4150 Santa Monica Blvd., Los Angeles, Calif.

**Truth received through Vibratory Force of Mind—Christ's message**, 30c. Prof. James, 102. Barbara Rigler, 3122 Fifth Avenue, Chicago, Ill.

### Educational

**Bookkeeping in a week**. Dukes, 1857B Watson Avenue, New York, N. Y.

**Correspondence school courses** only one quarter original price, send for free price list 1,000 courses. Used courses bought. Students' Exchange, 47 West 42d St., N. Y.

**Used Correspondence courses** bought and sold. My prices are the lowest. A. J. Brooks, Hookset, N. H.

**Used Correspondence courses** rented. Courses bought. J. J. Henderson 154 Ridge Av. Yonkers, New York.

### Ford Owners

**Life Size "Red-i-Kut"** surefit patterns with simple illustrated instructions make Ford sport car building easy. The fast saucy "Pal" patterns with pressed metal streamline rear, only \$6.40 complete and delivered. Send for prospectus on making sport bodies—"Jifty Tops," "Gosum" Windshields. Kuempel Co., 94 Kuempel Bldg., Guttenberg, Iowa.

### For Inventors

**Inventors and Manufacturers**. For developing your invention, designing and constructing Automatic Machinery, Labor-saving Devices for all purposes. Coin-controlled Beverage and Food-dispensing Machines, consult John Frick, Mechanical Engineer, 1105 Arch Street, Philadelphia, Pa.

### For Men

**Blades Sharpened**. One Edge, 2c; double, 3c. New York Edge Co., Glen Cove, N. Y.

### Electrical Supplies and Appliances

**Electric Tattooing Outfits**, Illustrated Catalogue, 10c. Waters Rtg., 1050 Randolph, Detroit.

### Exchange

**Amateur Agents** wanted in every city and town to sell radio apparatus. A few stocking agencies still open. Delfelco, 12 Meeting Street, Pawtucket, R. I.

**Attention: Dealers, Manufacturers!** Hundred cavity mold for making 3/8-inch diameter hard rubber radio knobs. Also 10,000 brass inserts for knobs. Write immediately. Garfinkel, 221 Bryson Bldg., Los Angeles, Calif.

**Trade—1 K.W. D.X. Transmitter**. 2 S.W. Receivers. Like new, for cash. Make offer. Walleze, Danville, Penna.

**Amrad Tuner and detector** two step, \$90.00. Clapp-Eastham H.R. receiver with H.Z. amplifier, mahogany, \$65.00. Magnavox R3, \$40.00. All new, perfect condition. Send money-order. Ridgewood Orchard, Winchester, Va.

**200—20,000 Meter Receiver**, including Radiotron, \$35.00. Box 205, Williamsport, Pa.

**Bargain—Regenerative Receiver**, two-step Amplifier. New Oak Cabinets. Each, \$35.00. Together, \$60.00. Cost, \$90.00. Write for description. George Fisher, Main Street, Ramsey, N. J.

**Sell, \$35.00**. DeForest panel honeycomb set. Paul Gleason, Chillicothe, Ill.

**Sell or Trade** for radio parts, 15 dial omnigraph A1 condition. Write Wesley Kinman, 32 North Avenue, Canandaigua, N. Y.

**For Sale—Broadcasting Station** in A1 condition at attractive price. Formerly known as WHQ. The Times Union-Hickson Radiophone Station. For particulars, write Hickson Electric Company, Inc., 36 South Ave., Rochester, N. Y.

**Want Radio Set?** Write for reduced prices all radio supplies, batteries, tools, sporting goods. Price list free. Anderson, 340 Park Ave., N. Y.

**Sale—Complete 1/2 K.W. spark set**; Tuska short wave receiver; Arlington coupler; very cheap; all guaranteed. J. Sweeney, Pearsall, Texas.

### Engraving

**Engraving on Radio Panels**, etc., is our specialty, so is the making of patterns and copies for engraving work to be reproduced on Engraving machines. We are sole agents and instruct in the operation of Engraving Machines. The H. P. Preis Co., Columbus, Ohio.

### Health

**Pyorrhea (Riggs's disease—bleeding or swollen gums)**—hundreds have been helped by "Pyorident" the successful home pyorrhea treatment. Purifying, healing, preventative. Full month's treatment, consisting of a very beneficial massage paste and an antiseptic tooth-cleansing paste to be used in place of your ordinary dentifrice, together with full directions for treatment. \$1. postpaid. Or write for free booklet "R." Pyorident Mfg. Co., 439 Seventh St., Brooklyn, N. Y.

**Tobacco or Snuff Habit Cured** or no pay; \$1 if cured. Remedy sent on trial. Superba Co., S.E., Baltimore, Md.

### Instruction

**Learn Radio**. Books, omnigraph and simplified lessons furnished reasonable. Write for sample lesson. We solve electrical problems, low rate. Radio questions answered 2 for 25c. Ernest's Radio School, 4849 Easton Avenue, St. Louis, Mo.

**Learn Chemistry at Home**—Dr. T. O'Connor Sloane, noted educator and scientific authority, will teach you. Our home study correspondence course fits you to take a position as chemist. See our full page ad on page 671 of this issue. Chemical Institute of New York, 140 Liberty Street, New York City.

**Mouth-organ instructor**, 25c. Play in one hour. Elean Company, Bowling Green, Ohio.

### Languages

**Esperanto**. The International Radio Language is absolutely essential in international broadcasting. Textbook and 1800-word dictionary, all for 10c. Address W. Buchheim, 2110 Grove Street, Boulder, Colo. Do not procrastinate.

### Mail Order Business

**500 Things to Sell by Mail**. Remarkable new publication. Workable plans and methods. Loose-leaf, cloth binder. Prepaid, \$1.00. Waltham Company, Lafayette Bldg., Philadelphia, Pa.

### Miscellaneous

**Send us your Metal Work**. We are equipped to do metal stamping, power press work, soldering and plating, etc. Estimates furnished. T. E. Bennett Co., 7 Beverly Street, Providence, R. I.

**Sell your Snap Shots at \$5.00 Each**. Kodak prints needed by 25,000 publishers. Make vacations pay. We teach you how and where to sell. Write Waltham Institute, Lafayette Bldg., Philadelphia, Pa.

**We specialize in Advertising-Pencils**. Sample, with your ad, imprinted in Gold, 10c. Musial & Co., 423 Walnut Street, Yonkers, N. Y.



**Manufacturing**

Let us do your manufacturing and die work. Victor Eng. & Mfg. Co., 2524 W. Chicago Avenue, Chicago.

**Motorcycles—Bicycles**

Don't buy a Bicycle Motor Attachment until you get our catalog and prices. Shaw Mfg. Co., Dept. 6, Galesburg, Kansas.

Used parts for all motorcycles cheap. State wants. Schuck Cycle Company, 1922 Westlake, Seattle, Wash.

**Musical Instruments**

Cornetists, Trombonists, Saxophonists, Clarinetists, send for "Free Pointers," mention instrument. Virtuoso School, Buffalo, N. Y.

**News Correspondents**

Earn \$25 Weekly, spare time writing for newspapers, magazines. Experience unnecessary, details free. Press Syndicate, 566 St. Louis, Mo.

**Office Devices**

Addressing Machines, Multigraphs, Duplicators, Letter Folders, Multicolor Presses, Check Writers, Dictating Machines, Envelope Sealers, Supplies, about half new cost. Write for illustrated catalogue. Pruitt Company, 172 North Wells, Chicago.

**Patent Attorneys**

**Inventors:** Protect your invention through A. M. Wilson, Inc., Washington, D. C. Over 20 years of efficient, expert, confidential service. Skilled in Radio-Electrical, Chemical and Mechanical fields. Our 1922 illustrated Booklet, giving much necessary and very useful information which every inventor should know, will be sent free upon request. Prompt and careful attention. Highest references. Moderate fees. Send sketch or model for our careful opinion and preliminary advice. Write today to A. M. Wilson, Inc., 306-12 Victor Bldg., Washington, D. C. (Successor to business established in 1891 by A. M. Wilson.)

**Patents.** Send drawing or model for examination and report as to patentability. Advice and booklet free. Highest references. Best results. Promptness assured. Watson E. Coleman, Patent Lawyer, 624 F Street, Washington, D. C.

Millions spent annually for ideas! Hundred now wanted! Patent yours and profit! Write today for free books—tell how to protect yourself, how to invent, ideas wanted, how we help you sell, etc. Patent Dept 301, American Industries, Inc., Washington, D. C.

**Patents. Protect your rights.** Before disclosing invention write for booklet and blank form Evidence of Conception to be signed, witnessed and returned with rough sketch or model of your idea, upon receipt of which I will promptly give opinion of patentable nature and instructions. No charge for preliminary advice. Highest references. Prompt, personal attention. Clarence O'Brien, Registered Patent Lawyer, 751 Southern Bldg., Washington, D. C.

**Patent. Electrical cases a specialty.** Pre-war charges. E. P. Fishburne, 340 McGill Bldg., Washington, D. C.

**Patents—Send for form "Evidence of Conception"** to be signed and witnessed. Form fee schedule, information free. Lancaster and Alwine, 269 Ouray Bldg., Washington, D. C.

**Inventors aided.** Ideas developed and patented. Experimental machinery built. Practice in all courts. Richardson & Rogers, 20 Albee Bldg., Washington, D. C.

**Patent application filed on partial payment plan.** Trademarks, copyrights, etc. Milo B. Stevens and Company, 694 F Street, Washington, D. C. Established 1864.

**Patents**

**Inventor of better vernier rheostat than any now on market** will lease patent on royalty. Gordon Keam, 1174 Seward, Detroit, Mich.

**Inventors.** Before disclosing your idea to others write for our "Evidence of Disclosure" form. Send sketch or model of your invention for examination and advice. Ask for free book, "How to obtain a Patent." Avoid dangerous delays. Write today. Merton-Roberts & Co., 188 Mather Bldg., Washington, D. C.

**Patents Secured.** Prompt service. Avoid dangerous delays. Send for our "Record of Invention" form and Free Book telling "How to obtain a Patent." Send sketch or model for examination. Preliminary advice without charge. Highest references. Write today. J. L. Jackson & Co., 356 Ouray Bldg., Washington, D. C.

**Personal**

Exchange cheery letters with new friends! Send stamp. Betty Lee, Inc., 4252 Broadway, New York City, N. Y.

**Lonesome Club—Hundreds congenial people, everywhere,** want to exchange letters, post cards, photos, etc. Particulars Free. (Stamp please.) Exchange, Box 305-K, San Francisco, Calif.

**Printing**

Everything Printed.—Long run specialists. Samples. Quality Printery, Marietta, Ohio.

**Radio Outfits and Supplies**

Diagram, New Super-Regenerative Circuit as presented by Armstrong, only two tubes used to amplify 100,000 times, price, 50c. Crystal receiver, only \$7.50. Vacuum Tube Receiver, \$15.00, operates without ground. 3000-ohm Head Set, \$4.95. Free Catalogue. Ernest Electric Co., 4849 Easton Avenue, St. Louis, Mo.

Westinghouse and Other Standard Radio Sets and Parts. Liberal commissions paid for interesting others which enable you easily to Earn your Set and Make Money. Write for price list and proposition. Wheeler-Thomas Radio Co., Dept. 31, Holland, N. Y.

**Song Poems Wanted**

**Stories, Poems, Essays, Plays Wanted.** We teach you how to write; where and when to sell. Publication of your work guaranteed by new method. Walkmore Institute, Dept. J, Lafayette Bldg., Philadelphia, Pa.

**Song Writers!**—Learn of the public's demand for songs suitable for dancing and the opportunities greatly changed conditions offer new writers, obtainable only in our "Song Writers' Manual and Guide," sent free. Submit your ideas for songs at once for free criticism and advice. We revise poems, compose music, secure copyright and facilitate free publication or outright sale of songs. Knickerbocker Studios, 319 Galety Bldg., New York.

**Stamps and Coins**

105 China, etc., 2c. Stamp album (500 illustrations), 3c. Bullard, Station A-18, Boston.

**Scenery to Rent**

Settings for Opera, Plays, Minstrels, Plush Drops. Catalogue. Amelia Grain, Philadelphia.

**Telegraphy**

Telegraphy—(Morse and Wireless) and Railway Accounting taught thoroughly. Big salaries. Great opportunities. Oldest, largest school. All expenses low—can earn large part. Catalog free. Dodge's Institute, M St., Valparaiso, Indiana.

**Ventriloquism**

Ventriloquism taught almost anyone at home. Small cost. Send 2c stamp today for particulars and proof. Geo. W. Smith, Room 542, 125 N. Jefferson, Peoria, Ill.

**Wireless**

**Edison B. Battery Units**—One positive and one negative plate for 10c. 18 sets will make a 24-volt battery. Wilkinsburg Wireless Shop, 711 Penn Ave., Wilkinsburg, Pa.

**Reducing large stock**, new Clapp-Eastham HR Receivers, \$36.00; 11Z two stage amplifiers, \$36.00; Westinghouse RC stage amplifiers, \$36.00; Westinghouse RC Receivers, \$120.00. Cash with order. R. A. Saeger, Ankon, Pa.

**4GL Radio frequency transformers:** made right; priced right; factory to you, \$3.15 each with circuit; 200-600 meters. Savannah Radio Shop, 1223 East Duffy Street, Savannah, Ga.

**For Immediate Delivery**—Tubes, Magnavox, Westinghouse Receiving Sets, Phones, Condensers, Rheostats, Variometers, Couplers, Panels, Transformers, V. T. Sockets, Dials, Switch Points, and full line of parts. R. B. Electric Co., Galva, Ill.

**Attention!**—50 Vacuum tube hook-ups. The greatest collection of vacuum tube circuits ever brought under two covers at such insignificant cost. These diagrams will be found in the great "Rasco" catalog, which contains raw materials and parts in a greater profusion than any other catalog. 15c in stamps, or coin, will bring the catalog to you. Radio Specialty Co., 96-98 Park Place, N. Y.

**Boys! Don't Overlook This.** The "Rasco" Baby Detector. Greatest detector ever brought out with molded base. Fully adjustable. See former advertisements in this publication, or our catalog. Detector with Galena Crystal, complete 50c, the same detector with Radiocite Crystal, 75c prepaid. Send for yours today. Radio Specialty Company, 96-98 Park Place, New York City.

5 per cent. Discount on all makes of radio apparatus. Fifteen Panel set complete, \$75.00. Patterson Radio Shop, Hugo, Okla.

**A-1 Galena.**—Perfect, tested and guaranteed; imbedded in special metal, price 35c; AA-1 Galena (genuine), 50c. postpaid. National Specialties, 32R Union Sq., N. Y. C.

**\$10.00 Variometers**—\$3.00 while they last, manufacturers' samples. Horton, Christie Street, Ridgefield Park, N. J.

**Stromberg-Carlson Phones.** The professional headset at the amateur's price. Super-sensitive, comfortable, durable. Impedance correct for phone work with modern vacuum tubes. Equipped with five-foot polarity indicating, moisture-proof silk cords. A real radio headset for \$7.50. Carrollton Radio Shop, Carrollton, Missouri.

**Special! Radio frequency transformers,** \$5.95. Variometers (most efficient made), \$4.90; others at \$4.65. Variometers, \$4.70 and \$5.20. Rheostats, \$1.20. Vernier, \$1.45. Bakelite sockets, 72c. Dials, 72c. Headphones, \$1.90. Best composition insulators, 25c. Condensers, 11 plate, \$2.85; 23 plate, \$3.35 and \$3.85; 43 plate, \$4.25. Switch levers, 40c and 60c. Switch points, 3c. Binding posts, rubber, 9c; nickel, 6c. Bakelite panels, 6x7 inches, 80c; 6x10 1/2 inches, \$1.20; 6x14 inches, \$1.60; 9x14 inches, \$2.45. Other sizes to order. Lightning arresters, \$2.95. These parts are all standard. Do not confuse with cheap and inferior apparatus. N. B. Ristey, Spring Grove, Minn.

**Edison Elements for Test tube storage B batteries,** 6c per pair. A. J. Hanks, 608 Montgomery Street, Jersey City, N. J.

**Build your own electrolytic storage battery charger,** plates and complete instructions, \$1.00. Descriptive Circular Free. Peerless Electrical Parts Co., 105 Harris Street, Rochester, N. Y.

**Special! Switch sets lever, 10 points, 2 stops and 2 binding posts;** complete, 75c. Address Paul Steinhilf, Palestine, Texas.

**Join Radio Experimenters' League** conducted by amateurs for amateurs who are interested in radio and know enough to be able to construct a set. Send 50c for gold-plated Radio Research label button, membership card, identification number and pamphlet giving wiring diagrams of new Armstrong Super-regenerative circuit, also photographs of working set actually constructed, complete list of parts required and panel layout. Membership entitles you to 10 per cent. discount on all approved standard advertised receiving or transmitting parts; and your 50c will be credited to your first order for \$5.00 or more. Write today. Radio Experimenters' League, 9-15 Clinton Street, Newark, N. J.

**Let the World Know Who You Are.** Get your Radio Club insignia from manufacturer direct. Radio Club Label Buttons, solid gold, \$5.00; gold plated, \$1.00. Club name or initials engraved free when bought in dozen lots. Gold-plated sample button, postpaid, 50c to any radio club member or anyone about to organize radio club. Newark Jewelers' Guild, Rose and Kipp Streets, Newark, N. J.

**Wireless—Continued**

**Stop Paying for Battery Charging!** Sulphate causes most defects, and your troubles by using De-Sulphate, harmless, guaranteed, \$1.00 brings you enough for four batteries. Instructions for using. W. L. Green, Battery Station, Monroe City, Mo.

**For immediate delivery, Westinghouse Aerola Sr., \$65.00.** Premium one Phonoscope, Westinghouse type R.C. receiver, \$132.50. Premium choice of Federal or Eisemann phones. Hudson Radio Company, 326 Brown Street, Union Hill, N. J.

**Everything you need to know about building an Armstrong Super-Regenerative one, two and three-bulb circuit.** Pamphlet contains complete diagrams and photographs of set actually constructed and successfully operated. Also shows a comprehensive list of parts required and correct electrical values of the parts and panel layout with clear work. This treatise was produced in response to many demands for a reliable guide for amateur or professional. First portion contains Major Armstrong's own accurate description reprinted by permission from the "Proceedings of the Institute of Radio Engineers" and illustrated with their own absolutely accurate and dependable diagrams. Second portion is for those desirous of first building a practical set which will work and later mastering the theoretical details of its operation as their experiments lead them on step by step. Easily understood by anyone. We have prepared a limited edition at considerable expense and take pride in contributing this authoritative presentation of this latest and most wonderful development in the radio field. While supply lasts, \$1.00 prepaid. Radio Research Guild, 9-15 Clinton Street, Newark, N. J.

**Immediate delivery or money back.** Eisemann phones, \$200 ohms, \$38.00. Choice of Phone Plug or Jack as preferred. Hudson Radio Company, 326 Brown Street, Union Hill, N. J.

**Build Your Own Super-regenerative Circuit.** Photograph, diagrams and complete instructions for constructing a circuit as good as any like the Armstrong Circuit as is possible to publish. The only item omitted is the aerial. A great money-saver. 25c copy. W. G., 68 Glenridge Avenue, Glenridge, N. J.

**Radiotrons U.V. 200, \$5.00. U.V. 201, \$6.50.** As premium with each tube choice of Dubilier Grid Condenser, V.T. Socket or Moulded Rheostat. Immediate delivery or money back. Hudson Radio Company, 326 Brown Street, Union Hill, N. J.

**Special fixed condensers for the Armstrong super-regenerative circuit .01, .02, .0015, .0025 or other intermediate capacities fifty cents postpaid.** Radio Experimenters' League, 9-15 Clinton St., Newark, N. J.

**Radio Spot Puzzle,** latest thing out, 25c prepaid. We also sell the best made tuning coil for least money. Send 2c stamp for circular. Nifty Novelty Co., Newark, N. J.

**Armstrong Super Regenerative Circuit—Guaranteed choke coils for immediate delivery:** 5 and 10 Millihenrie \$120, 100 Millihenrie \$1.55, 1 Henrie iron core \$1.55, 15,000 ohm non-inductive resistance \$1.50. Henry I. Leviton, 138 N. LaSalle St., Chicago, Ill.

**Radiotron, Westinghouse, Myers, & W.E.—V.T.s.** We specialize in the distribution of vacuum tubes which are opened and tested before shipping, thus assuring satisfactory operation. Radiotron U.V. 200 detector \$5.00, Radiotron U.V. 201 amplifier \$6.50 Radiotron U. V. 202 power tube amplifier and transmitter \$8.00. Westinghouse WD11 Aeriotron detector tubes for Aerola Sr. sets, filament operating on 1.5 volt dry cell and .25 on plate, \$8.00 Western Electric amplifiers for W.E. Loud speaker \$11.00 Myers III-MU Audion amplifiers and detectors \$5.00. We insure all tubes and prepay postage. Try us! Immediate delivery or remittance returned. The Kelner Radio Laboratories, Dept. R, Abilene, Kansas.

**Radio Fans:** Don't buy a make-shift Radio Frequency Transformer. We manufacture the Universal Wave Length Radio Frequency Transformer invented by Dr. Miller as described in August Radio News. Use these in your new set for the coming cool nights and experience the surprise and thrill of your radio. Send name for complete data. Coast Radio Company, Inc., El Monte, Los Angeles, Calif.

**Variometers,** large size, with 3-inch dials and knob, fully assembled \$2.85; Variocouplers with 14 tabs, dial and knob \$2.50, variable condensers, very best construction; 23 plate, \$2.35; 43 plate, \$2.85. Large size variable condensers .002 mfg. \$4.25. All for panel mounting. 3-inch dial and knob 50c extra. Clinax air core radio frequency transformers, unassembled, range 150 to 500 meters, with wiring and instructions \$1.50; Simplex detector unit for panel mounting attaches to panel with two screws, wired complete, \$3.75. Add postage. Send for circulars. H. Butterworth, 331 Quincy St., Brooklyn, N. Y.

**How to Make Wireless Sending Apparatus.** 100 pages—88 illustrations. Written and published entirely for the wireless enthusiast who wants to make his own radio apparatus. Contains more information on "how to make it" than any other book we know of. Paper bound 35c. postpaid. Experimenter Publishing Co., Book Dept., 53 Park Place, New York City.

**Wireless Course in 20 Lessons.** By S. Gernsback, A. Lescaurba and H. W. Secor, E. E. Tells you everything you want to know about "Wireless"—theory, practice and history. A clear, concise course on every phase of this subject. 160 pages—350 illustrations, 30 tables. Stiff cloth cover, \$1.75. postpaid. Experimenter Publishing Co., Book Dept., 53 Park Place, New York.

**The How and Why of Radio Apparatus** by H. W. Secor, E. E. This newest book on matters fills a distinct gap in wireless literature in that, while the treatment is made as understandable and as free from mathematics as possible, it at the same time incorporates a wealth of technique and instruction for the Radio Amateur—the Radio Operator—the Installation and Designing Expert—as well as teachers and students of the subject in general. A very broad field has been covered by the author, at the same time giving a great deal of information not found in other text books. If you are engaged in any branch of the Radio or allied arts at all you will surely need this latest contribution to radio literature, which is destined to be found on every radio man's bookshelf here long. A glance at the following list of chapters gives but a very scant idea of the extensive and useful radio knowledge provided in its text: The Induction Coil; The Alternating Current Transformer; Radio Transmitting Condensers; The Spark Gaps; Radio-Transmitting Inductances; Radio Receiving Tuners; Radio Receiving Condensers; Detectors; Telephone Receivers; Radio Amplifiers; Construction of a Direct Reading Wavemeter and Decimeter; Antenna Construction; The Calculation and Measurement of Inductances; Appendix containing very useful tables, covering all subjects treated in this very unusual book. This newest of Radio Works, cloth bound in Vellum de Luxe, Gold Stamped and Hand Sewed, has 160 pages. Size of book, 6x9 inches. The How and Why of Radio Apparatus. Postpaid, \$1.75. Experimenter Publishing Co. Book Dept., 53 Park Place, New York City.



# your hands can make a RADIO PHONE CRYSTAL SET

—at a fraction of what one would cost  
made up!

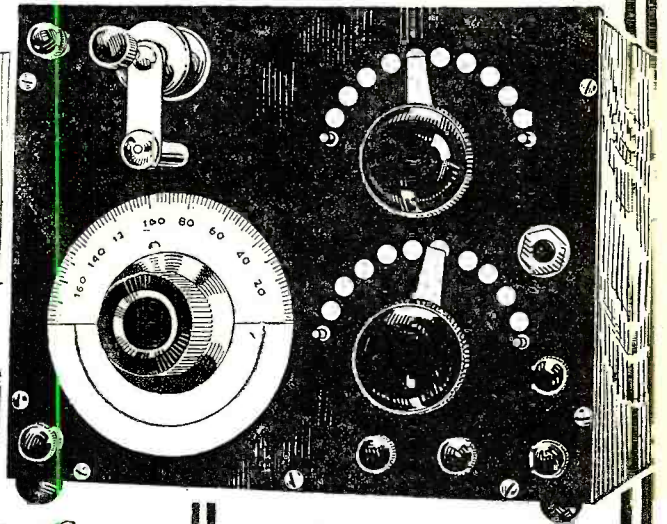

Pattern No. 3  
of "The Radio Con-  
structor" Series—  
Making Your Own

## Our Complete Instructions and Blue Prints Are Designed For Those Without Technical Knowledge

### No Machine Shop or Heavy Tools

You can build this splendid, reliable radio phone crystal set quite easily without a machine shop, or the use of any heavy tools. These patterns will make a handsome looking instrument with all the improvements to be found in the expensive, ready-made apparatus.

### Only Standard Parts Used

One of the foremost radio engineers has constructed this set for us, especially for the amateur, and he has used only standard parts that may be procured from any supply house, and that are lowest in price.

### As Simple to Make as to Read

All the fun of building your own without any of the hardship. In this set of patterns we do not merely give you pictures of how the apparatus looks, and mere diagrams, but each and every pattern supplied is full size.

This does away with all fussing and calculating, as we have done all the laying out in our own shop, and you need not worry that the final instrument does not come out right.

### Every Pattern is Full- Size

Take for instance the pattern for the panel. It is printed on heavy blue-print paper exactly the size of the panel to be used. The position of the holes and other markings are exact, so that all you have to do is to paste the pattern on top of your bakelite panel by means of ordinary library paste, and when dry drill right through the pattern wherever the marks are located.

50<sup>c</sup>

### Pattern No. 3

Complete radio phone crystal set, which when completed and hooked to aerial, phone and ground, is ready for action! You receive a Four-Page Illustrated Direction-Pamphlet. Size 8½x11½ inches. One Blue-Print Pattern, Size 16x22 inches. All Contained in a Heavy Two-Color Printed Envelope, 8x12 inches.

PATTERN NO. 3: HOW TO MAKE A RADIO PHONE

ORDER FROM YOUR DEALER—or direct from us

**CONSOLIDATED RADIO CALL BOOK CO., Inc.**  
PUBLISHERS

98 Park Place

NEW YORK CITY



Let These Guides

Solve Your Problems



# Electricity at your finger ends

## HAWKINS ELECTRICAL GUIDES IN TEN VOLUMES

3500 PAGES  
4700 PICTURES

\$1 A VOLUME  
\$1 A MONTH

SEND NO MONEY—SEND ONLY THIS COUPON

Know the facts in Electricity. They mean more money and better position for you. Hawkins Guides tell you all you need to know about Electricity. Every important electrical subject covered so you can understand it. Easy to study and apply. A complete, practical working course, in 10 volumes. Books are pocket size; flexible covers. Order a set today to look over.

**LEARN ALL ABOUT**

Magnetism — Induction — Experiments — Dynamos—Electric Machinery—Motors—Armatures—Armature Windings—Installing of Dynamos—Electrical Instrument Testing—Practical Management of Dynamos and Motors—Distribution Systems—Wiring—Wiring Diagrams—Sign Flashers—Storage Batteries—Principles of Alternating Currents and Alternators—Alternating Current Motors—Transformers—Converters—Rectifiers—Alternating Current Systems—Circuit Breakers—Measuring Instruments—Switchboards—Wiring—Power Stations—Installing—Telephone—Telegraph—Wireless—Bells—Lighting—Railways. Also many Modern Practical Applications of Electricity and Ready Reference Index of the ten numbers.

**SHIPPED FREE**

Not a cent to pay until you see the books. No obligation to buy unless you are satisfied. Send Coupon now—today—and get this great help library and see if it is not worth \$100 to you—you pay \$1.00 a month for ten months or return it.

**THEO. AUDEL & CO.,**  
72 Fifth Ave., New York City

Please submit me for free examination, HAWKINS ELECTRICAL GUIDE (Price \$1 a number). Ship at once prepaid, the 10 numbers. If satisfactory, I agree to send you \$1 within seven days and to further mail you \$1 each month until paid.

Name.....

Occupation .....

Employed by.....

Home Address.....

Reference .....

R. N., OCT.



# A Wonderful Chance to Go Into Business for Yourself!

## Men Needed to Start Radio Service Stations! Earn \$100 a Week and More

**H**ANG out your shingle as a Certified Radio-trician—a recognized Radio expert! Go into business for yourself. Don't be a wage slave any longer. Be your own boss. Work when and how you please. You can make big money—\$100 a week and more—doing easy, interesting work.

\$5,000,000 is being spent every week for Radio supplies, Radio installations and repairs, Radio information. Men who know nothing about Radio are making big money supplying the demand. Why don't you get into this great field of easy work and fine pay? Your present knowledge of Radio can help you win quickly a great success in this great field.

### Hundreds Getting Wealthy

Take advantage of the nation-wide enthusiasm for Radio. Open up a service station; sell equipment, make installations, repair sets, supply information. Millions of sets are being sold. Thousands of installations must be made. Sets must be repaired. New equipment must be supplied. Everywhere you can see the great opportunities awaiting you in this amazing new field.

Hundreds of men are already growing wealthy through this new wonder-science. The letter to the right shows how easy it is to make big money in Radio. You, too, can make \$100 a week, and more as an installation expert. This is the greatest opportunity of your lifetime. Get your share of the tremendous fortunes now being spent in Radio. Put your Radioknowledge, experience and

○ Tested and Approved by ○  
**S. H. JONES**  
○ Certified Radio-trician ○

You can earn a splendid salary testing equipment for Radio enthusiasts.



\$5,000,000 is being spent every week for Radio supplies, installations, repairs and information. Get your share of this business.

interest to work—and win financial independence in a short time.

### The Biggest Radio School Will Help You

Thousands of men with no knowledge or experience now are preparing for wonderful careers in this great profession. Will you allow these beginners to get ahead of you? Will you let them get all the big jobs while you sit idly by? Will you always be satisfied to be just an extra-good amateur when it is so easy to earn big money as a professional Certified Radio-trician?

The National Radio Institute, America's first and largest Radio School, will prepare you quickly, in your spare time at home, to enter into the great profession of Radio as a Certified Radio-



Hundreds of men are making splendid incomes as Radio installation and repair experts.

### Free Book Tells You How

The National Radio Institute is ready to give you the same practical instruction and help that has put hundreds of its graduates on the highway of Radio success—that has helped hundreds of them to go into business for themselves, and make more money than they ever made before. You have the basic knowledge of Radio now. Just a little training in the professional side of Radio will soon qualify you for your career in this field of unlimited opportunities.

Radio is paying enormous earnings to men all over the country today. It is making hundreds of men wealthy. It can make you wealthy, too. Find out at once your opportunity in Radio. Send for the interesting Big Book which tells all about the future waiting for you in this great field, and gives complete details of the wonderful new plan by which the National Radio Institute prepares you quickly in your spare time to become a Certified Radio-trician. The book is Free. Mail the coupon, or write a letter for it NOW!

## National Radio Institute

Dept. 1207

1345 Pennsylvania Ave., N. W., Washington, D. C.

NATIONAL RADIO INSTITUTE.  
1345 Pennsylvania Ave., N. W., Dept. 1207  
WASHINGTON, D. C.

Please send me your Free Book "How to learn Radio at Home," which explains the opportunities in Radio, and how you will quickly qualify me to become a Certified Radio-trician in my spare time at home, so I can take advantage of these opportunities.

Name.....Age.....  
Address.....  
City..... State.....

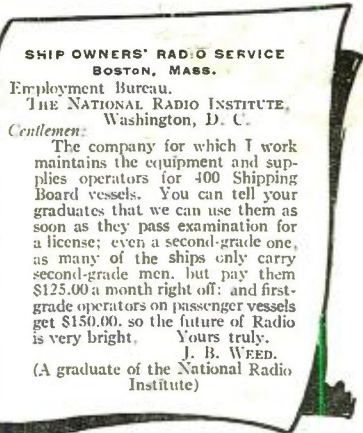

The National Radio Institute will help you earn \$100 a week as it helped these men.

trician. Prominent Radio experts (practical operators, mechanics and inventors) will give you the benefit of their knowledge and experi-

ence, give you the advice you want, help you in every way to achieve a splendid success in this great field.

The knowledge you have now of Radio operation and maintenance makes it easy for you to train yourself for a wonderful career. A few months of fascinating, easy training in the professional side of Radio will quickly fit you to earn big money as a recognized expert. Don't let your Radio knowledge go to waste. Use it to bring you the wealth, the success, the independence that you want. Cash in on it—big!

(Copyright, 1922, by National Radio Institutz)