

CIRCULATION OF THIS ISSUE OVER 225,000 COPIES

RADIO NEWS

REG. U. S. PAT. OFF.

25 Cents

June

1922

Over 125 Illustrations

Edited by H. GERNSBACK

A RADIO FIEND'S DREAM



CUNNINGHAM TUBES

for

HOME RECEIVING EQUIPMENTS



CUNNINGHAM
C-300
GAS CONTENT
DETECTOR

\$5⁰⁰

**Amplifies
as it
Detects**



The trade mark GE is the guarantee of these quality tubes. Each tube is built to most rigid specifications.

CUNNINGHAM Type C-300 Gas Content Detector Tube is the ideal tube to use in Home Receiving sets for clear reception of Radio Telephone Concerts, Market Reports and other news features which are sent out daily all over the country.

Nationally recognized as the one tube which gives the most satisfactory results for any type Receiving Set applicable to wave lengths between 100 and 3000 meters for both spark and C. W. Telegraph and Telephone, this Cunningham Detector Tube is recognized as the standard tube throughout the radio field.

In addition to its remarkable detector properties, low B. battery, quietness in operation, it is a free and persistent oscillator for regenerative amplification and C. W. reception and functions without distortion of the received signals.

The unusually fine results which have come through the operation of this tube in connection with home receiving sets have brought us many enthusiastic indorsements from users.

Write for further particulars to your nearest dealer, or write to us direct.

REMLER APPARATUS RADIATES QUALITY
CUNNINGHAM TUBES MEET EVERY AMATEUR REQUIREMENT

E. J. Cunningham

Trading as

AUDIOTRON MFG. COMPANY

248 First Street
San Francisco, Calif.

154 West Lake Street
Chicago, Illinois

It's a Shame for You Not to Make Big Money

-When Others Do It So Easily



He Does It

"Last week my earnings amounted to 554.37; this week will go over \$400."—F. WYNN, Portland, Oregon.



So Does He

"I had never earned more than \$60 a month. Last week I cleared \$306 and this week \$218."—GEORGE W. KEARNS, Oklahoma City, Okla.

And He--

"The very first month I earned \$1,000. I was formerly a farmhand."—CHARLES BERRY, Winterset, Iowa.



And He---

"After spending ten years in the railway mail service at salaries ranging from \$900 to \$1,600 a year I decided it was necessary for me to make a change . . . My earnings during the past thirty days were more than \$1,000."—W. HARTLE, Chicago, Ill.



WHEN a farmhand steps from \$50 to \$1,000 a month—when a fireman jumps from \$60 a month to a job paying him \$500 for two weeks' work—when a former railway mail clerk at a yearly salary of \$1,600 changes his job and earns \$1,000 in thirty days—and when hundreds of others quickly jumps from small pay to magnificent earnings in the same way—then it's a shame for you not to do equally as well.

There is nothing exceptional about these men. They'd tell you that themselves. Many had been clerks, bookkeepers, mechanics. Some had been policemen, farm hands, firemen. And then in one swift stroke, they found themselves making more money than they had ever dreamed possible.

The grind of routine work—the constant struggle to obtain even a small increase—all this was left behind. Today they know the thrill of making big money; they are no longer ruled by an office clock. There is genuine enjoyment in every hour of the day, for their work is filled with real fascination. They have found not only the most interesting, but the best paying branch of all business.

A field that they had never dreamed of as theirs they found to be easy and uncrowded. Earnings that they had always *hoped* to reach, and that their old jobs could *never* have paid, were right there in this new field waiting for them. Hundreds of others have found success the same way. You can too—let us tell you how.

How You Can Do It Too

What these men have done, hundreds of others have done, hundreds are doing today, hundreds will do to-morrow. And *you* can be one of them! For now the same opportunity that put these men into the big money class is open to you!

In the first place they discovered a vital fact about business. They discovered that the big money is in the Selling end of business. In the second place they discovered a new and amazingly easy way that will make *any* man of average intelligence a salesman, no matter what job he held before.

Salesmen are the very lifeblood of any concern—upon them depends the amount of profits made. The men who can put a product on the market and boost its sales are absolutely indispensable. No wonder that man for man Salesmen receive the highest pay. For the men who are Masters of Salesmanship—there is practically no limit to their earnings—except the limit they set themselves. And that is how these men and hundreds of others like them found the way to

their present handsome incomes. They are all Master Salesmen now!

Yet previously they had no idea of becoming Salesmen. If you had told them success awaited them in the field of Selling, they would have laughed at you. They would have told you that it was absurd to think of it—for they had never sold a dime's worth of goods in their lives! Then they learned of a great organization of top-notch Salesmen and Sales Managers formed for the great opportunities in the field of Salesmanship and to help them to positions in the lines that most appeal to them. Step by step—in their spare time at home—this great organization, the National Salesmen's Training Association, took them through every phase of selling. Every underlying principle of salesmanship was made as simple as A-B-C. Then as soon as they were qualified and ready, the Free Employment Service of this Association helped them secure good Selling positions. Almost before they realized it they were in the big money class.

SEND FOR REMARKABLE FREE BOOK AT ONCE

The same opportunity that has brought hundreds of others their good fortune is open to you. Whether or not you have ever thought of becoming a Salesman, you should examine the facts about the tremendous possibilities for big earnings in this fascinating field. Mail the coupon below. This will place you under no obligation. It simply means that you will receive, *entirely free*, a remarkable illustrated book on Modern Salesmanship and the personal stories of men in every part of the country who to-day are enjoying splendid success and earning five, ten and fifteen times as much money as ever before. It's a shame for you not to make big money when others do it so easily! Make a start now. Mail coupon at once to the National Salesmen's Training Association, Dept. 78-G, Chicago, Ill.

National Salesmen's Training Association
Dept. 78-G, Chicago, Ill.

I simply want to see the facts. Send me FREE your Book on Salesmanship and Proof that I can become a Master Salesman. Also list showing lines of business with openings for Salesmen.

Name

Address

City..... State.....

Age..... Occupation.....

RADIO NEWS

CONTENTS

VOL. 3

FOR JUNE

No. 12

| | PAGE | | PAGE |
|---|------|---|------|
| Editorial. By H. Gernsback..... | 1069 | Radiophone in New York Hotels..... | 1091 |
| World's First Wireless Telephone News Service By Maurice E. Pelgrims | 1070 | The Lackawanna Railroad Radio Experiments. By David W. Richardson | 1092 |
| Radio in Chicago Schools. By Roscoe Smith | 1071 | The Brooklyn Radio Show..... | 1093 |
| German Tests on Radio Signalling to Railroad Trains.....By Dr. Alfred Gredenwitz | 1072 | Teaching by Radio..... | 1094 |
| A Portable Radio Receiving Set in a Suitcase | 1073 | Broadcasting Over Electric Light Circuit. By Carl H. Butman | 1094 |
| President Harding a Radio Enthusiast. By S. R. Winters | 1074 | Delivering Bread in Radio Equipped Auto.... | 1095 |
| Avoiding the Beaten Path. By A. Hazelton Rice, Jr. | 1075 | College Students Make Their Own Tubes..... | 1095 |
| Why Panels? | 1075 | The Radio Age is Youth....By Everett Ewing | 1096 |
| Radio Talking Moving Pictures..... | 1076 | Radio For the Farmer..... | 1096 |
| Advertising Pays.....By "The Wanderer" | 1077 | Church Services by Radio..... | 1097 |
| 10 $\frac{3}{4}$ Carloads of Radio News..... | 1078 | Bureau of Standards Swamped With Inquiries | 1097 |
| New Radio Apparatus..... | 1079 | With The Amateurs..... | 1098 |
| Recruiting by Radio | 1080 | Europe's Storm Predictor..... | 1101 |
| Unsteady Arcs.....By F. M. Daggett | 1080 | Duplex Radio Telephony a Reality..... | 1102 |
| Is Radio Threatening the Phonograph and Theatre?.....By H. Gernsback | 1081 | Sermons and Jazz.....By J. Farrell | 1102 |
| A Practical Two Way Key. By Lewis Davenport | 1082 | Too Much Efficiency.....By Erald A. Schivo | 1103 |
| Amplifying Transformer. By C. Chandlee Pidgeon | 1082 | My C.W. Experiments.....By G. Ridleak, V.T. | 1104 |
| An Ultra-Compact Radio Receiver. By Paul G. Watson, I. R. E. | 1083 | How to Use the Vacuum Tube Detector. By Arthur H. Lynch | 1105 |
| A Coupled Tuner for Long Waves. By Raymond Evans | 1084 | An Efficient Junior Receiver..... | 1107 |
| Designing and Building C.W. Power Trans- formers. By Edward Thomas Jones, I. R. E. | 1085 | Three Money-Saving Kinks. By Ralph H. Card | 1107 |
| Telephone-Telegraph.....By W. K. Thomas | 1086 | A Simple Variocoupler.....By N. J. Nuity | 1108 |
| Design of an Audion Control Cabinet. By Glenn E. Flint | 1087 | A Simple Receiving Set. By Joseph Schuck | 1108 |
| Shall We Put the Brakes on Radio? By Armstrong Perry | 1088 | How to Grain a Bakelite Panel. By Irving Simpson | 1108 |
| The Eiffel Tower Radiophone Broadcasting Sta- tion | 1089 | Hard Rubber Dials at 0 Cents Apiece. By Fred A. Burgess | 1108 |
| Official Uses for Radio..... | 1090 | A Variometer That Can Be Built With a Jack- knife.....By Albert D. Hines | 1109 |
| The Very Latest in Radio Sensations..... | 1090 | Practical Hints for Amateur Constructors..... | 1110 |
| Real Radio Experimenters..... | 1091 | The Simplest "Valve" Cabinet. By Raymond Evans | 1114 |
| | | Radio Digest | 1115 |
| | | Who's Who in Radio. Commander S. C. Hooper | 1116 |
| | | Correspondence From Readers..... | 1117 |
| | | Club Gossip | 1118 |
| | | I-Want-to-Know | 1119 |

RADIO NEWS is published on the 25th of each month at 233 Fulton Street, New York. There are 12 numbers per year. Subscription price is \$2.50 a year in U. S. and possessions. Canada and foreign countries, \$3.00 a year. U. S. coin as well as U. S. Stamps accepted (no foreign coins or stamps). Single copies, 25 cents each. A sample copy will be sent gratis on request. Checks and money orders should be drawn to order of EXPERIMENTER PUBLISHING CO., INC. If you should change your address notify us promptly, in order that copies be not mis-carried or lost. No copies sent after expiration.

All communications and contributions to this journal should be ad-dressed to Editor, RADIO NEWS, 233 Fulton Street, New York. Unaccepted contributions cannot be returned unless full postage has been

Published by EXPERIMENTER PUBLISHING CO., INC.,
Publishers of Radio News and Science and Invention

H. GERNSBACK, President

S. GERNSBACK, Treasurer

E. W. DEMOTT, Secretary

included. All accepted contributions are paid for on publication. A special rate is paid for novel experiments; good photographs accompanying them are highly desirable.

RADIO NEWS Monthly. Entered as second-class matter June 8th, 1919, at the Post Office at New York, N. Y., under the Act of March 3, 1897, Title registered U. S. Patent Office. Copyright, 1921, by E. P. Co., Inc., New York. The Experimenter Publishing Co., 233 Fulton Street, N. Y., N. Y. The Contents of this magazine are copyrighted and must not be reproduced without giving full credit to the publication.

RADIO NEWS is for sale at all newsstands in the United States and Canada; also at Brentano's, 37 Avenue de l'Opera, Paris.

233 Fulton Street, New York City

“
 The right path is near,
 “ says Mencius,
 yet men seek it afar off,
 The right Receiver is here—
 the Grebe CR-5—
 The wise Radioist
 need seek no further!

Doctor Wu

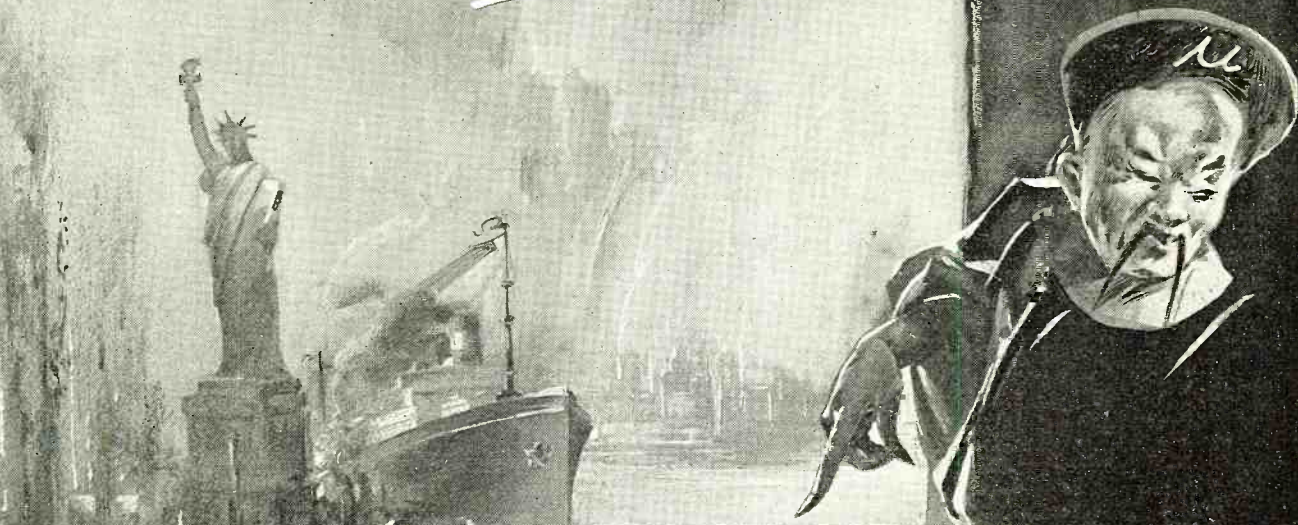

H.A. GREGG

GREBE RADIO

Licensed under
 Armstrong U. S. Patent,
 No. 1113149.

Frost-Radio

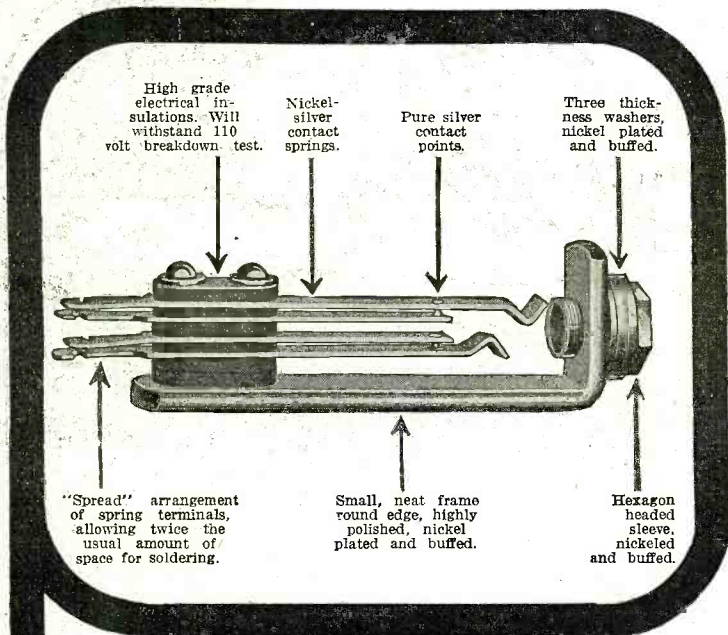

Improved JACKS and PLUG

Specially Designed for
Radio Panel Work

INTERCHANGEABLE WITH
OTHER STANDARD MAKES

Cuts are actual size



No. 132. Plug only, \$1.00

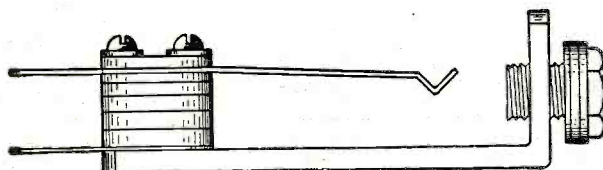

No. 133. Jack only, \$.65

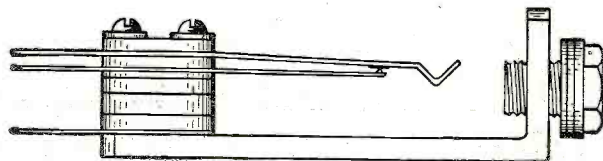

No. 134. Jack only, \$.75

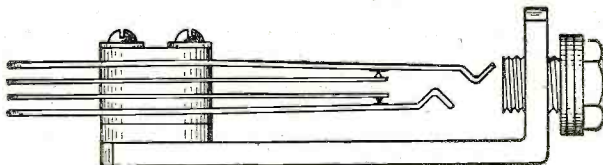

No. 131. Jack only, \$.90

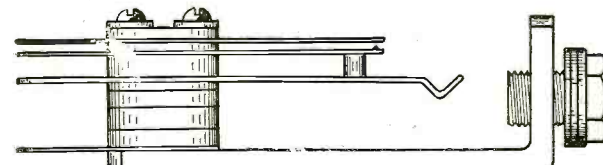

No. 135. Jack only, \$1.00

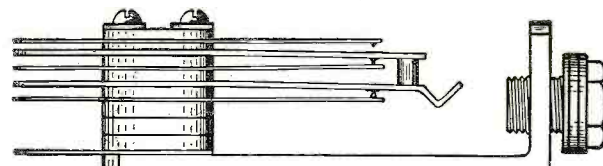

No. 136. Jack only, \$1.25

The smallest, neatest, most perfectly finished jacks and plugs that have ever been offered to the Radio trade. They have been specially designed for panel work and are of standardized construction so as to be interchangeable with other standard makes.

A particularly desirable and exclusive feature of the FROST-RADIO Jack is the "spread" arrangement of the spring terminals which allows twice the usual amount of space for soldering to the wiring. These terminals are heavily tinned.

Another striking feature is the nickel plated and highly buffed finish used throughout.

Sturdy construction, perfect spring adjustment, gripping contact of springs on tip and sleeve of plug.

Packed in individual containers.

Two-color wall posters now ready for Dealer distribution.

WE ARE NOW IN QUANTITY PRODUCTION AND ARE MAKING IMMEDIATE DELIVERIES.

Attractive Discounts to Distributors and Dealers. Write or wire for proposition and samples.

HERBERT H. FROST

154 W. Lake Street
Chicago, Ill.

THE CORRECT ANSWER TO THE "B" BATTERY PROBLEM

\$14.00

50 VOLTS
2 VOLT
STEPS

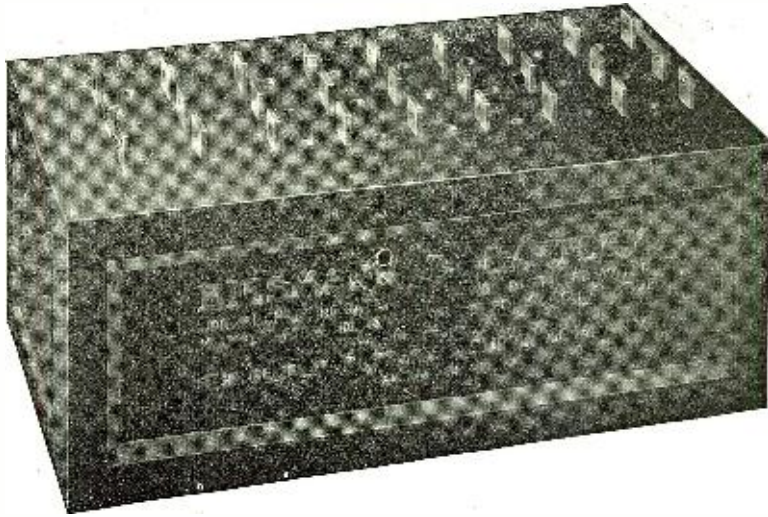

\$14.00

EASILY
CHARGED
LONG LIFE



THE BIEMANN "B"

FULLY GUARANTEED



COMBINATION DETECTOR *and* AMPLIFIER BATTERY

24 cells, individually tapped, permitting use of any voltage from 2 to 50 volts in steps of two volts each. Provides a noiseless circuit for the receivers. The electrolyte is a semi-solid; cannot spill or leak. One piece cast "Rub-Tex" Indestructo case, of which the individual cells are a part. Highly polished and neat in appearance. Pasted type plates especially developed for Radio service. Can be re-charged at any Battery Service Station, or on any type of vibrating rectifier by using the circuit provided with the battery. Complete instructions with each battery. Contacts between cells easily accessible. Over-all dimensions; 9 inches long, 4½ inches wide, 4½ inches high.

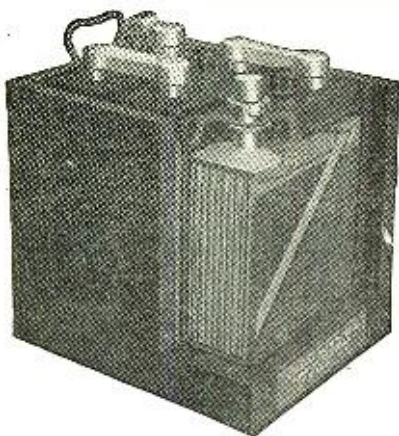

The "BIG SIX" A-BATTERY

A FEW FACTS BRIEFLY STATED

Semi-solid electrolyte which cannot spill—No injurious sulphation—Plates will not buckle—Highest electrical efficiency and voltage maintenance—Quickly and easily recharged—Can stand idle indefinitely without injury—Superior physical properties—Hard wood case

THE "BIG SIX" IS FULLY GUARANTEED AS TO LIFE, CAPACITY, ELECTRICAL EFFICIENCY, DESIGN AND WORKMANSHIP

| | |
|--------------------------------|---------|
| 6 volts— 40 Ampere Hours | \$20.00 |
| 6 volts— 60 Ampere Hours | 22.00 |
| 6 volts— 80 Ampere Hours | 25.00 |
| 6 volts—100 Ampere Hours | 28.00 |

Furnished in one piece cast "Rub-Tex" Indestructo case at an additional charge of \$2.00 on each battery.

MANUFACTURED BY
General Battery and Supply Co.,
CHICAGO, ILLINOIS

JOBBERS
Write For Our Interesting Sales Proposition

SOLE DISTRIBUTOR

HERBERT H. FROST, 154 West Lake St., CHICAGO, ILLINOIS



"A Quality Achievement"

Herbert H. Frost 154 West Lake St.
CHICAGO



FROST-FONES FROST-FONES FROST-FONES FROST-FONES FROST-FONES FROST-FONES FROST-FONES FROST-FONES FROST-FONES FROST-FONES

FROST-FONES FROST-FONES FROST-FONES FROST-FONES FROST-FONES FROST-FONES FROST-FONES FROST-FONES FROST-FONES FROST-FONES

FROST FONES

"A Quality Achievement"

The **IDEAL RECEIVERS** for use with Home Radio Set *Combining Maximum Efficiency with Permanent Sensitiveness*
GUARANTEED BY THE NAME

❖ PRICES ARE THE RESULT ❖
❖ OF QUANTITY PRODUCTION ❖

NO. 162 — FROST FONES 2000 OHM SET \$5.00

NO. 163 — FROST FONES 3000 OHM SET \$6.00

*Deliveries Will Continue to Our Jobbers
Attractive Literature Mailed on Request*

Herbert H. Frost 154 West Lake St.
CHICAGO



FROST-FONES

FROST-FONES

DUBILIER MICADONS for Two Remarkable Mica Condensers

Use Micadons Type 601 Like
Building Blocks

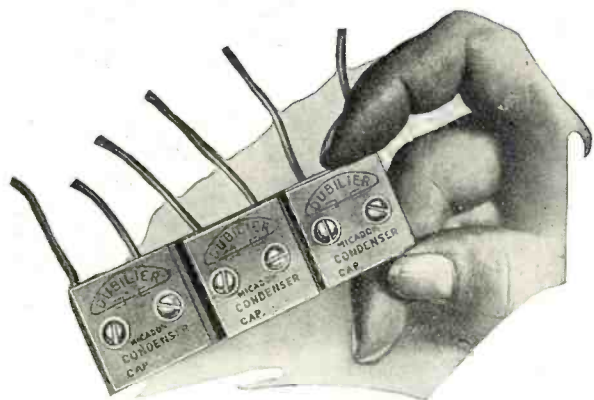

Dubilier Micadon Type 601 is here shown one half full size. It has the same perfect mica insulation, the same *permanent capacity* that has always characterized the famous, larger standard Dubilier mica condenser.

Dubilier Micadon Type 601 is only a little larger than a postage stamp. Micadons Type 601 can be used to build up capacity as if they were building blocks. Simply add one to the other with a few machine-screws, and you pile up any desired capacity. Connect them in series or multiple.

Buy Micadons Type 601 by the dozen, and keep them on hand.

The capacity ranges from .005 to .0001 mfd.

Price 35 cents each. By the dozen, \$4.00.

Make Your Own Grid-Leak With a Lead Pencil



Sandpaper the surface of Dubilier Micadon Type 601 between the terminals. Next rub point of an ordinary black lead pencil over the roughened surface as here shown. To adjust the grid-leak thus made rub away as much of the graphite

that has been deposited as may be necessary.

Every tube should have an *adjusted* grid-leak, and this is the way to make one simply and cheaply.

Why Tubes Howl

Faulty condenser construction interfere with the reception of tainment. The alternate layers material dilate and contract in the antenna—sometimes as The capacity varies correspond howling, whistling and sput

Micadons Have

Dubilier patented Micadons and costly experimenting to are *mica* condensers made like condensers adopted as standard cent of the governments and

This means that in the Dubiling and conducting layers have constitute a single mass. The Hence there can be no dilation The capacity is *absolutely per* poor condenser construction, are

Dubilier Micadons last indef as paper condensers do.

Amazingly

Dubilier Micadons are amaz the smallest receiving condens the popular demand for inexpen be used either with the cheapest

Two types of Dubilier Micadons They are pictured and described

Specify Dubilier condensers ample. Micadon is a trademark, applied only to these remarkable

Examine your set and see if it has not you are not receiving perfectly.

Order Dubilier from your turers, The Dubilier Condenser

LICENSEES FOR CANADA
Canadian General Electric Co.
Toronto

LICENSEES FOR ENGLAND
Dubilier Condenser Co., Ltd.
London

DUBILIER CONDENSER

Perfect Broadcasting Reception for 35 cents to \$1.00 each

and Whistle

causes many of the noises that broadcasted music and enter- of insulating and conducting with the oscillations of current often as a million times a second. ingly. The tube responds with tering.

Permanent Capacity

have been developed after long overcome this difficulty. They the famous, larger Dubilier mica equipment by ninety-five per radio companies of the world.

lier Micadons both the insulat- been pressed together so as to air has all been squeezed out. and contraction of the layers. *manent*. Tube noises, due to impossible.

initely. They will not burn out,

Low In Price

ingly low in price. Also they are ers ever produced. They meet sive mica condensers which can or the most costly receiving set. are made—Type 600 and Type 601. on these pages.

and follow the government's ex- adopted for your protection and little mica condensers.

has Dubilier Micadons. If it broadcasted news and music

dealer or from the manufac- Co., 217 Center Street, New York.

LICENSEES FOR GERMANY
AND SOUTH AMERICA
Telefunken Company
Berlin

For the Price of a Single Grid-Leak Holder

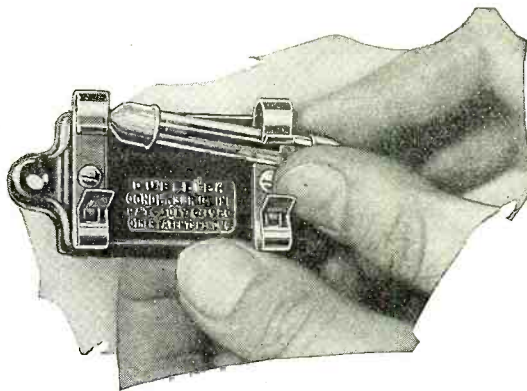

Here we show Dubilier Micadon Type 600 half size. It is a perfect Dubilier mica condenser, especially made to improve broadcasting reception. It costs no more than an ordinary grid-leak holder.

Dubilier Micadon Type 600 lasts indefinitely. Its capac- ity is *permanent*. There can be no variations and no leakage.

Dubilier Micadon Type 600 is provided with Fahnestock connectors and grid-leak clamps. The grid-leak can be easily removed and replaced with the fingers.

Everything is soldered. The container is of molded com- position. Provision is made for holding screws.

Use a Crystal Detector Instead of the Grid-Leak

It is easy to substitute a crystal detector for the grid- leak if desired. Thus it becomes possible to use Dubilier Micadon Type 600 with crystal detector sets and obtain all the benefits that follow when a perfectly constructed mica condenser is used.

Price of Dubilier Micadon Type 600 in capacities ranging from .001 to .005 mfd..... 75 cents each

Price of Dubilier Micadon Type 600 in capacities ranging from .005 to .01 mfd..... \$1.00 each

COMPANY 217 CENTER STREET, NEW YORK

WITHERBEE

RADIO **A** BATTERY

"Built Right Since 1903"

Pioneer in Radio Telephone Service

Recognized The Leader

Because:—

- ☐ It has served successfully ever since Radio began.
- ☐ The first by many years to appear in the one piece hard rubber case, the only kind that may safely be used in the home. It will not become dirty and acid soaked. Soft rubber feet insure perfect insulation.
- ☐ Made with extra heavy plates and separators to compensate for the repeated cycles of complete discharge and possessing every requisite for radio service.
- ☐ Nineteen years of conscientious effort combined with successful manufacturing experience are behind the product, the best of its kind.

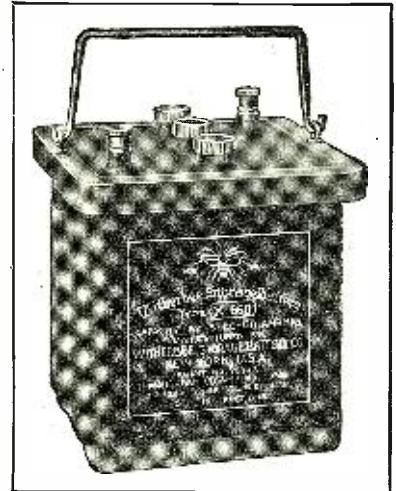

The Trade are cordially invited to write

Witherbee Storage Battery Co., Inc.

643-655 West 43rd Street

New York, U. S. A.

Works, Belleville, Newark, N. J.

Builders since 1903 of quality storage batteries for motor cars, starting, lighting, ignition and for portable and stationary uses.

TRADE



MARK

TRADE



MARK

BARKELEW

Radio Ground Switches For Lightning Protection

Disconnect
the
Radio Set

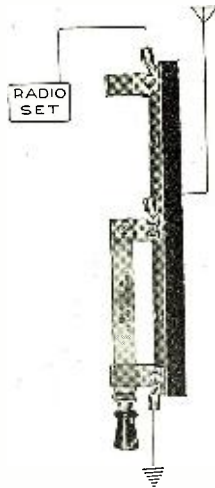

Ground
the
Antenna

Use a Knife Switch—You Can See It Work



Cat. No. 600—Price \$2.50

Low in price, compact, well built. A switch that will stand all ordinary usage. Copper Parts, 60 Ampere Stock. Ebony Wood Base. Break 5 inches.



Cat. No. 601—Price \$3.15

A heavy, rugged switch for use in schools, public buildings.

Copper Parts, 100 Ampere Stock. Ebony Wood Base. Break 5 inches.

Both Switches fully meet the latest requirements of the National Electric Code and are approved and listed by the Underwriters' Laboratories.

Send For Bulletin No. 27 on Radio Ground Switches.
Discounts To Electrical and Radio Distributors.

The Barkelew Electric Mfg. Co.

Middletown, Ohio, U. S. A.

15 So. Clinton St., Chicago, Ill.

75 Fremont St., San Francisco, Cal.

7-9 W. Canal St., Pittsburg, Pa.

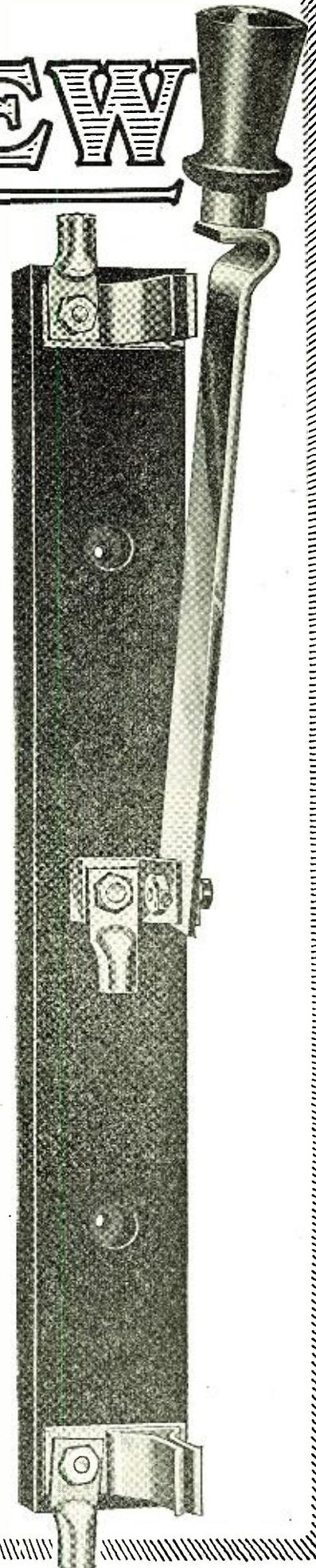

A New Radiophone Easily Operated By A Child

Will receive broadcast radio entertainments within a radius of fifty miles—*clear as a bell*

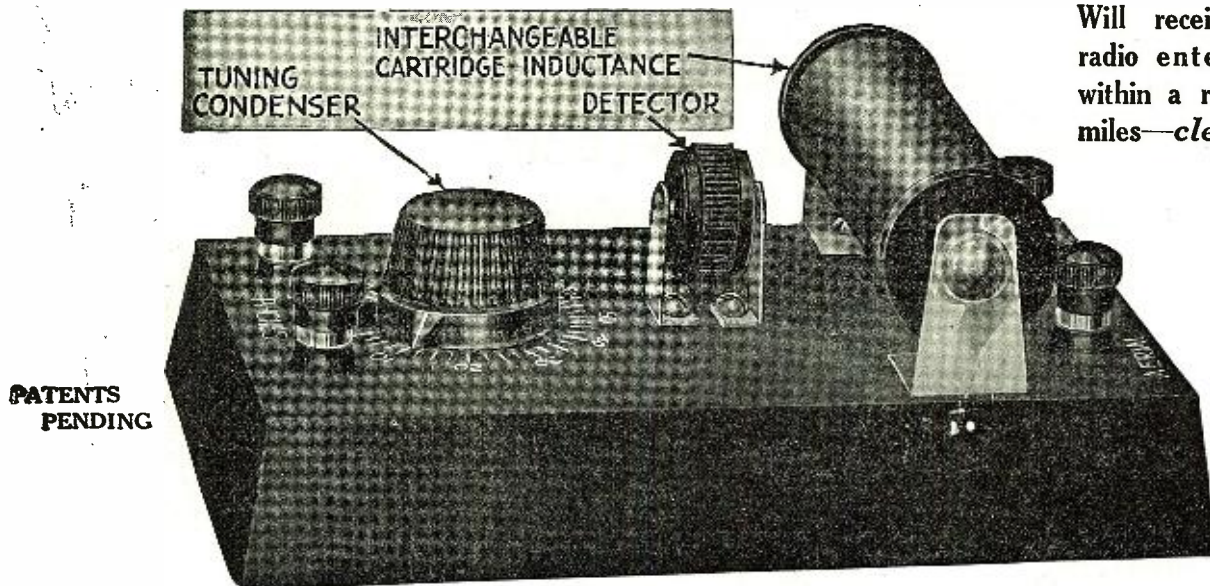

Price \$12.50

(Without Phones)

NATIONAL AIRPHONE

(MODEL G)

This set has been perfected by experts in the design of Radio Receiving Apparatus—to meet the very exacting requirements that the most recent developments in the Radio Art have made necessary.

Outstanding Points of Superiority:

1. Ultra-sensitive Foolproof Detector; entirely enclosed in composition case. Air and dust proof, no fussy minerals, no Catwhisker, no balls nor spring. To adjust for maximum sensitivity simply rotate the black disk slowly.
2. Most Compact Radiophone Receiving Set Made: 6½" long, 4¼" wide, 2¾" high,—small enough to put in coat pocket or desk drawer.
3. Entire casing constructed of hard rubber composition. No wood, no warping, no losses through leakage.
4. Rugged construction throughout, nothing to get out of order, insuring long life in service.
5. Elimination of all switches, current taps and switchpoints prevent loss of electrical energy.
6. Use of interchangeable cartridge coils gives wide range over which radiophone broadcast or radio telegraph signals can be heard. 25 miles or over for radiophone concerts; up to 1000 miles for telegraph signals depending upon coils used.
7. Two Cartridge tuners, wave length 150 to 400 meters supplied with each outfit, one takes in general broadcasting stations (360 meters), the other from 500 to 1000 meters.
8. Anyone without previous experience can operate a NATIONAL AIRPHONE, no delicate adjustments necessary, no fussing.
9. Variable Mica Condenser used is acme of simplicity—high capacity, impossible to short-circuit.

We are now ready to assign territory to Jobbers and Dealers who will appreciate the advantages of a well designed serviceable and efficient outfit.

TRADE MARK **NATIONAL AIRPHONE CORPORATION** REG. U.S. PAT. OFF. New York City

20-22 Hudson St.



RADIO NEWS

H. GERNSBACK—Editor
ROBERT E. LACAULT—Associate Editor

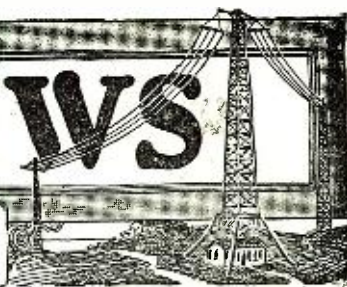

Vol. 3

JUNE, 1922

No. 12

Radio and the Beginner

AN editorial for the special benefit of the Radio novice is most important today. Thousands and thousands of people are becoming interested in this new art every day, nay, every hour, and nearly all of these people are, as a rule, lost in a wilderness of technicalities. Most of the "wise ones," the experts, the radio engineers *et al* are so busy these days, making money in radio that they have only contempt for the novice and his "foolish questions." It is like asking a professor of mathematics for the best method of adding 2 and 2!

To start at the beginning. The art of radio was invented by the German, Professor Heinrich Hertz in 1887. His were laboratory experiments. The Italian, Guglielmo Marconi then stepped in and took the laboratory experiments out into the open. To him belongs the credit of making radio *practical*. Hertz transmitted no messages, *only impulses* over a few yards. Marconi was the first to send wireless messages over miles.

The radio telephone, contrary to general belief is not a new invention. It was invented by the "Danish Edison," Valdemar Poulsen in 1902. Sending the human voice through space has been in practice for over two decades now, but as with other inventions, the public refused to be interested.

As for the recent new word, coined by the public: the Radiograph—don't show your ignorance by repeating it. A radiograph is a picture taken by X-rays, surely no radio here.

As to outfits. Unless you have money to burn, start with a crystal outfit. Learn to creep before you walk. A beginner can, of course, start with a vacuum tube outfit if he has friends who can guide him, and answer his questions, but as a general rule *if you really wish to learn* all about radio, start with a good crystal set. Select one that is easy to operate and that will stay put. The chances are that a carefully built apparatus will work better than one that looks like the home-made variety, now flooding the market.

Ninety-nine out of one hundred people when they start in radio wish to hear the broadcasting stations that send out hourly entertainments. If you live within 25 miles, *as the crow flies*, from such a station, you may be reasonably sure of hearing it clearly with your crystal set. Fifty miles have been covered with such a set, but that is an exception, only realized under certain ideal conditions.

Phones. Use a good set of 2,000 or 3,000 ohm phones with a crystal set. With such a set the music or other signals are never *very* loud; for that reason it is best to use two receivers—a regular head set. A single 1,000 or 1,500 ohm receiver can be used if desired, in a room where there is absolutely no noise, but two phones are always better.

A 75-ohm receiver—the kind used on the house or public phone is of no use in radio. Don't waste time with it.

Loud talkers. At the present time there exists no device on the market that will make the music, received from a crystal outfit, loudly audible in a room. Loud talkers, or amplifiers, at present, can only be used with vacuum tubes.

Aerials. Use a single wire stretched taut, about 100 feet

long. Such a wire may be of copper, or copper clad (iron core with copper surrounding it), not a *copper plaid* iron wire. The wire may be bare or covered with insulation. It makes no difference. The wire (diameter) should not be less than No. 14 B & W, wire gauge. If anywhere possible make the wire point in the direction of the broadcasting station. In other words, if, let us say, you live in New York and wish to hear WJZ at Newark, (which is west from New York), run your aerial wire from west, due east. The lead-in from the aerial (the wire connecting the aerial to the outfit), should be connected to that end of the aerial *nearest* to Newark. The free or open end of the aerial, therefore, *points away* from Newark. This is correct. The lead-in wire should be soldered to the aerial or better, *much better*, have aerial and lead-in a single un-interrupted piece of wire. Use good aerial insulators for the suspension of the aerial. Any radio store supplies them. Remember, the electrical energy collected on even a good aerial is less than one-hundredth of a fly power. Therefore, the *very best* insulation is none too good. Keep the aerial as far away from buildings, walls, trees as possible, never less than one foot. If you live in a steel building, keep aerial and lead-in even further away. It is immaterial if the aerial runs parallel to the ground. Thus the writer used an aerial with ideal results as follows. A single rubber-covered, stranded automobile cable 100 feet long was attached to the highest point of the water-tank on the roof of a 10-story apartment house. The wire ran down at an angle of over 45° where it was hooked with insulators near the cornice of the building. Thence it ran down to a window into the apartment. Total of aerial, plus lead in, 100 feet.

Grounds. The best ground connection is made on any cold water pipe, nearest to the receiving set. Insulation of the ground wire is not necessary. A bare wire will do, of the same size as that of the aerial. Be sure to use a ground-clamp or else solder the wire to the pipe. Wrapping the wire over a clean-scraped water pipe is all right for temporary use, but it will give trouble without fail in due time. Therefore, avoid it. If a water pipe cannot be had the next choice is a gas pipe. It is, however, not satisfactory and is condemned by fire underwriters. Connection on the radiator is the third choice. It is, however, not at all efficient. If you live in the country, the best ground, if no water pipe is available, is a metal rod or pipe driven to a depth of 6 feet or more into *moist* ground (near a well or creek). Ground connection to be made with ground clamp, or soldered.

Lightning danger. Fire rules provide that an extra wire must be connected to the aerial by means of lightning switch, or lightning arrester. This extra wire *must* be grounded outside of the building. Thus connected an aerial becomes the *very best* protection against lightning a building could have, because it acts as a lightning rod. Landlords should welcome such aerials, unless they are stupid and refuse free insurance to their building.

Finally. If you wish to be successful in radio, be patient. Don't blame the apparatus. Hunt for the trouble. Use your head. Think. Think again. Usually he who seeks finds.

H. GERNSBACK.

World's First Wireless Telephone News Service

By MAURICE E. PELGRIMS

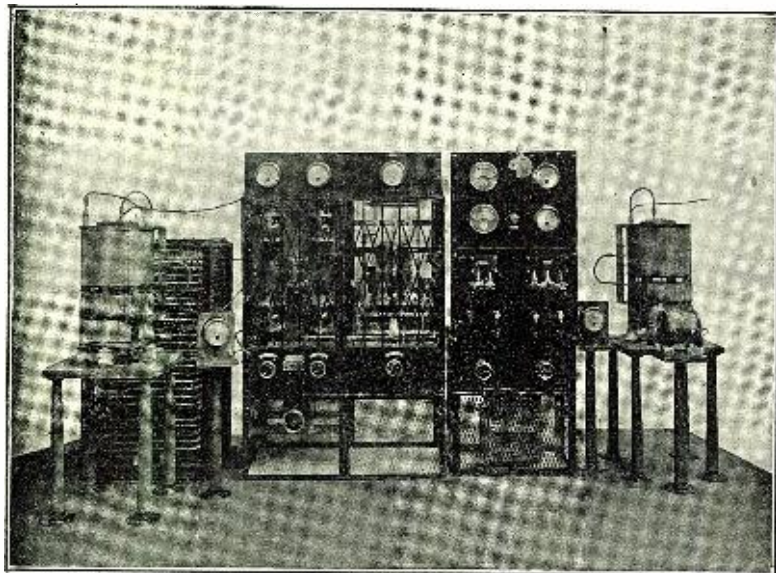

Fig. 2. An earlier type of radiophone transmitter used by the British Marconi Co. in their tests.

As far back as 1913, the British Marconi Company commenced experimenting, with a view to designing a low powered valve wireless telephone set, the intended range of which was 50 kilometers, and early in 1914 the first sets were actually being manufactured. During the tests then carried out, the above distance was exceeded, but the longest range attained was never determined. In these sets continuous oscillations were produced in a closed circuit by means of a three-electrode valve and a 500-volt anode battery, and this circuit was coupled to the aerial in the ordinary way, the microphone being inserted directly in the aerial as indicated in Fig. 1.

During the war, the development in wireless telephony was limited chiefly to low power sets, and those manufactured were, for the most part, used in connection with aircraft. Since the Armistice, however, rapid progress has been made in the development of high power valve telegraph and telephone sets.

A great step forward was realized when this company developed its 6-K.W. telegraph and telephone transmitter. Wireless telephone tests with this set were carried out between Chelmsford, England, and Madrid, Spain and the results, both with regard to telegraph signals and speech, were most satisfactory—the speech in particular being reported to be of exceptional strength and quality. As a result of the success obtained, work was then begun on the design of a similar but larger set than the above, and after its manufacture, this was erected and tested in the experimental building of the Marconi Company's works at Chelmsford, England, and thus the first 15-K.W. valve set came into being. Fig. 2 illustrates a predecessor of the 6-K.W., a 3-K.W. telegraph transmitter, from which the 6-K.W. telegraph and telephone transmitter was evolved. Fig. 3 shows the latest 15-K.W. set, which is described further on.

The diagram, Fig. 4, shows the connections of the 15-K.W. set and the circuits employed. The source of power is a 200-cycle, 500-volt, 15-K.W. alternator, which feeds the primary of a 20,000-volt transformer, the secondary or high tension winding of which has a tapping at its middle point. By the use of two rectifying valves connected to its secondary, it becomes possible to charge the condenser "K₁" unidirectionally every half cycle, but

of course only to half the total voltage. By this means "K₁" is kept charged at about 10,000 volts, and acts as the source of high

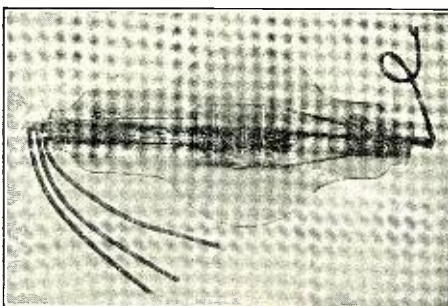
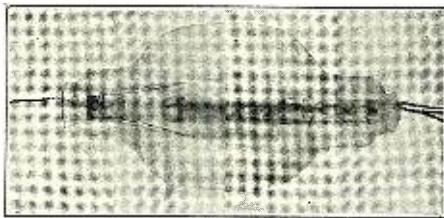

Fig. 3. The "MT" and "MT4" Valves Used as Transmitting Tubes in This High Power Radiophone.

tension direct current supply feeding the transmitting and low frequency magnifier valves. The voltage across the condenser

"K₁" does not remain absolutely constant, but varies slightly for each half of the 200-cycle supply. The aerial current follows this slight variation of the supply volts, and this produces the hum which is heard at the receiving end when speech is not being transmitted. The two high frequency circuits are the aerial "AL₁E" and the closed circuit "L₂CK₂". A continuously oscillating current is maintained in "L₂CK₂" by the transmitting valves and the reaction coil "R." The energy in this circuit is transferred to the aerial by the coupling coil "C."

For the wave-length used, the frequency of the continuous oscillations in the aerial becomes approximately 100,000 per second. In order that speech may be heard at the receiving end, the high frequency transmitting aerial current must be modulated in accordance with the wave forms produced frequency of the speech wave may be taken as 800 cycles per second, but instead of being a sine curve, it is one which is rich in harmonics. It is the distortion of these harmonics which produces bad quality speech. There are several methods by means of which the aerial current may be modulated in accordance with the speech frequencies; the one used, however, and that which is found to give the best quality speech, is to absorb the energy in the aerial in accordance with the speech wave form. Reference to Fig. 4 shows clearly how this is effected. The variations in the microphone current are transformed up to produce a curve of varying voltage, which is similar in shape to that of the varying current. By means of a two-stage low frequency amplifier, the amplitude of these voltage variations is magnified up, and then impressed on the grids of the absorption valves. As the resistance of a three-electrode valve varies with the voltage impressed on the grid, the conducting power of the absorption valves will follow the varying voltage curve produced by the speech. The absorption valves being connected across the aerial tuning inductance, they will absorb energy from the aerial in the varying degree to which they are made conductive by the impressed speech volts. As this energy is dissipated as heat in the valves themselves, they must be large enough to stand this energy loss without becoming overheated. The "MT" and "MT₄" valves are illustrated in Fig. 3. Although much larger, these valves are similar in construction to the ordinary three-electrode receiving valve; the filaments are

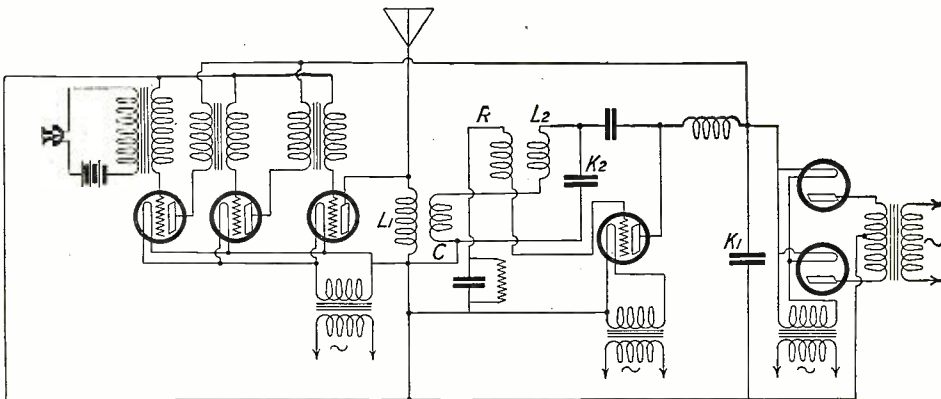
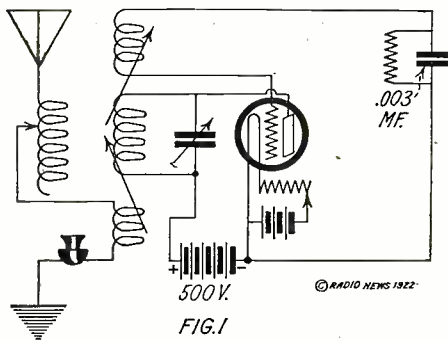

FIG. 4

© RADIO NEWS 1922

Diagram of Connections of the 15 K.W. Radiophone. The Action of This Circuit is Fully Described in the Article.



On the left is the circuit used in an earlier type of transmitter, while on the right is a view of the 15 K.W. radiophone, one of the latest products of the British Marconi Company.

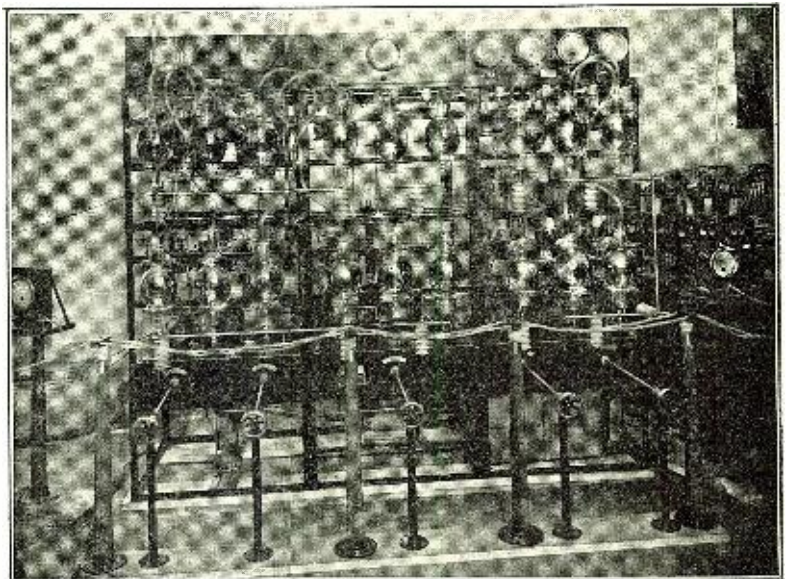

made of tungsten, and the anode and grid are of nickel.

In the 6-K.W. set, the six transmitting valves (Type MT₄) are mounted on the left hand side of the panel. The rectifying valves (Type MR₄) are in the middle of the panel, while of the four valves (MT₄) on the right hand end of the panel, three are absorption valves, and one is a low frequency magnifying valve. In this case the low frequency amplifier consists of one stage only, whereas in the 15-K.W. set there are two stages as shown in Fig. 4. In the middle of the panel, at the bottom edge, there is the electromagnetically operating signalling switch, which is used for keying when the set is being used for C.W. telegraphy. During telephony, of course, it is not in operation. On the extreme left are mounted the inductance and condenser (corresponding to L₂K₂) which form the closed circuit. The aerial tuning inductance L₁ is to the right of the panel.

After completing the 15-K.W. set and in order that independent reports regarding the performance of same might be obtained from many places by experimenters using various types of receivers, the Marconi

Company, decided to give a series of public programs on a well known wave-length. Thus a commercial radio company actually provided the opportunity to numberless amateurs to cooperate in the trials of a



A V. 24 Receiving Valve. Amplifier and Oscillator.

new radio telephone station before the latter would be placed into actual service. For a period of 10 days, February 23 to March 6, the Chelmsford station daily transmitted between 11:00 and 11:30 A.M. and between 8:00 and 8:30 P.M. a complete telephone program, which included in addition to the daily news, vocal and instrumental selections. The experiments were followed with close interest by the British, as well as the Continental amateur operators, who provided interesting data by reporting to the company the strength of the signals received. Ships at sea, both naval and commercial, contributed also, to a great extent, the telephone messages being copied as far as 1,500 (Continued on page 1124.)

Radio in Chicago Schools

By ROSCOE SMITH

THAT the three "R's," reading, 'ritin' and 'rithmetic are to be taught by radio and that educational facilities have been suddenly advanced to an incalculable degree by

the distribution of lessons and lectures simultaneously to Chicago High School students are facts accomplished, is readily acknowledged by Western educators as a result of the development in Chicago's

educational progress vouchsafed by no less a person than William Bogan, principal of the Lane Technical High School and one of the most widely known educators of the Middle West.

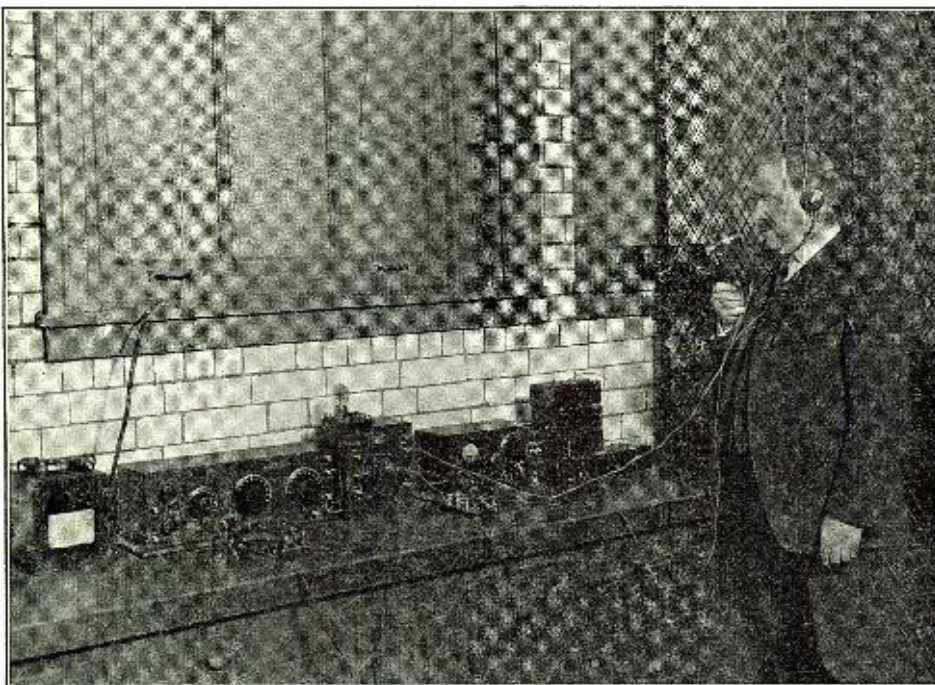

Mr. William Bogan, of the Lane Technical High School Giving Instruction by Radio to High School Students.

Night classes in many schools in widely scattered areas will be taught languages, history and other branches of learning, there being one professor for each subject, and broadcasting of the lessons in this manner will make possible a single lecturer preaching to thousands of students. Pupils having receiving sets in their homes will be able to take class-room instruction without going to the school.

"If enough schools are equipped with receiving sets" said Mr. Bogan, who is enthusiastic over the possibilities of the innovation, "the Board of Education can afford to employ dramatic stars to give performances. The instruments will amplify distinctly and noted lecturers can now be employed with greater facility than was possible before under the old system."

Already, Lane, Tilden, Austin, Englewood, Parker, Lindbloom, Senn Schurz, Crane and Bowen High Schools are equipped with amplifying and receiving sets and are taking messages daily. The Lane outfit is made up of four storage batteries, 60 ampere capacity, Paragon regular receiver 10, Clapp-Eastman two-step detector, to be replaced by Paragon; Paragon 10-watt telephone C.W. and I.C.W., Boston key, "B" batteries, one-kilowatt spark set, Kellogg phones, two aeriels fan and inverted L. Then also the boys have started to manufacture radio sets. Fifty

(Continued on page 1126)

German Tests on Radio Signalling to Railroad Trains

By DR. ALFRED GRADENWITZ
Berlin Correspondent of "Radio News"

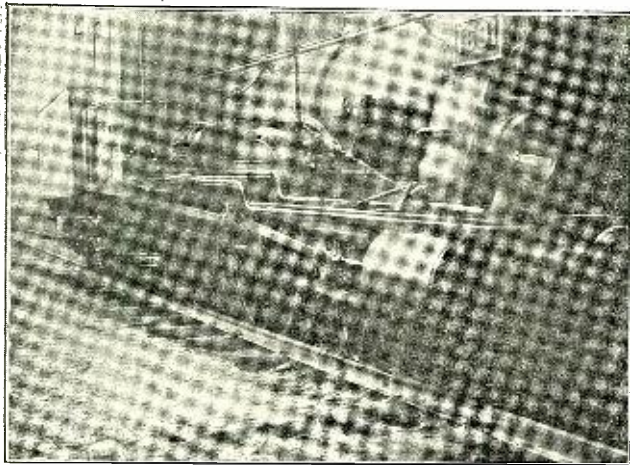

Figs. 4 and 5. These views illustrate the type of antenna used on the engine to receive from the station, which transmits warnings to the engine driver.

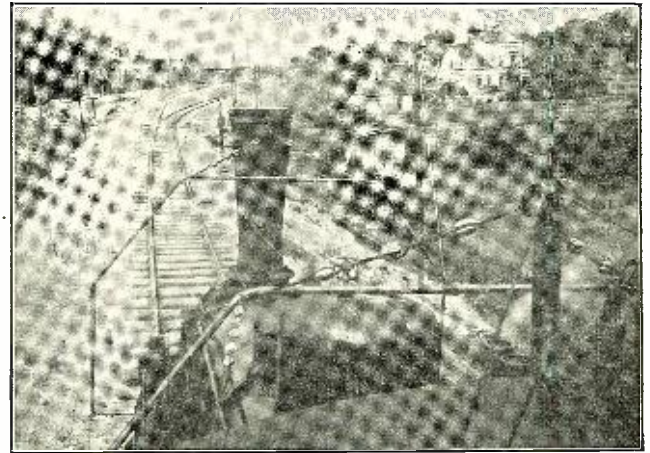

I NTERESTING tests on the transmission of signs by radio to the engine of a travelling railroad train have been made by Messrs. C. Lorenz A.G., of Berlin. These signs are intended to draw the engine-driver's attention to the approach (not to the actual position) of a signal, thus reducing even more the risk of that signal being passed by.

Inasmuch as the station sending out the sign would never be able to ascertain when the train to be warned is approaching some signal, while the arrangement of a special outfit for each train happening to pass over the line obviously is quite out of the question, a process had to be used by which all trains passing the signal to be announced, rather than any particular train, are warned. A method analogous to the closed-circuit current principle was, therefore, adopted, all trains on the line permanently receiving by radio a sign which, at the place of warning, is made to disappear. However, this disappearance of the sign is effected by some attachment installed near each warning post, rather than by the sending station, which, on account of the remaining trains, has to continue working permanently. Inasmuch as the transmission of the sign to the engine is effected by means of electric waves, provision has to be made at all warning posts for preventing the electric waves from striking the engine.

A system of "wired wireless" was adopted, the antenna being given a form especially suitable for transmitting (inductively) the waves sent out by the transmitter to the telegraph wires running along the railroad line. The sending station is located in the immediate neighborhood of the telegraph line. The antenna comprises 10 bronze strand wires running parallel to the telegraph wires, to a length of about 120 meters. Semi-circular iron bows encircling the telegraph wires were, to this effect, fitted to three telegraph poles, the 10 antenna wires being stretched out between these bows.

The general arrangement of the sending station (situated close to the Angermünde

railroad station) is inferred from Fig. 1. A booth installed at the foot of the embankment comprises the sending apparatus proper, a wire connected with the antenna starting from its roof. The antenna was, in the course of these experiments, occasionally lengthened by twice its original length, with a view thus to increase the amount of energy absorbed by the antenna and transmitted to the telegraph wires. The arrangement shown in Fig. 2, having

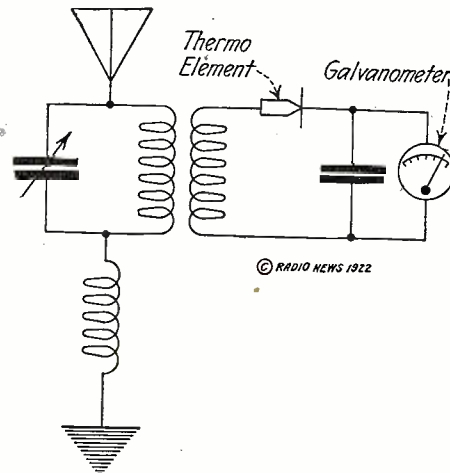

Fig. 6. The Connections of the Receiver. A Continuous Current is Generated in the secondary Circuit by the Rise in Temperature of the Thermo Element caused by the Received High Frequency Energy.

proved to be most advantageous, was ultimately adopted.

The earth connection necessary for the transmitting station is made up of two iron sheets one square meter in area, dug vertically into a ditch running along the station booth, at about three meters apart, and entirely immersed in water. The fundamental wave, according to the arrangement in Fig. 2 (120 meters length) was found to be 1,150 meters.

The wave-generating outfit consists of

a Poulsen continuous current-high frequency alternating current transformer, the continuous current being derived at 220 volts from the Angermünde electricity works and converted to 450 volts by means of a convenient converter set, in order at that voltage to be used for the operation of a Poulsen arc light generator. Fig. 3 is a diagram of connections of the whole arrangement.

The high frequency alternating current side is an oscillation circuit, comprising a variable oil condenser and a coil of wire (self-induction) joined to the earth conductor and antenna respectively.

The receiving outfit installed on the engine again comprises an antenna destined to absorb the incoming waves, transferring them to the receiver proper, in order there to be made perceptible to the human senses. Figs. 4 and 5 show details of the antenna: Two Ω -shaped steel tubes are by means of porcelain insulators hung up above the engine boiler, the antenna proper (15 parallel bronze strand wires) being arranged between them. A conductor from these wires leads across the engine roof to the driver's stand, where the various organs making up the receiver are installed. The receiver comprises a variable air condenser conveniently connected to a coil of wire. Another coil, inductively coupled with the latter, derives the high frequency energy from the main circuit, supplying it to a thermo-electric cell. The latter consists of two suitable contact pieces, touching each other under a given pressure. On passing through that contact, the high frequency energy will raise its temperature, thus generating a continuous current in a properly

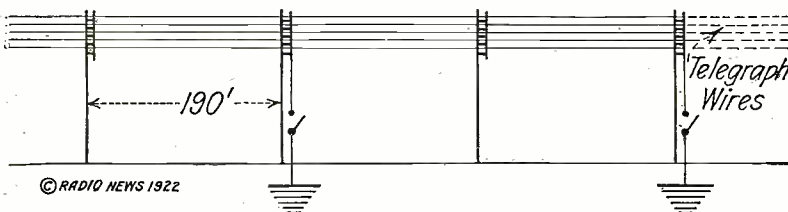

© RADIO NEWS 1922

Fig. 7 left; Figs. 8 and 9 right. The screening net which interferes with reception and acts as a warning.

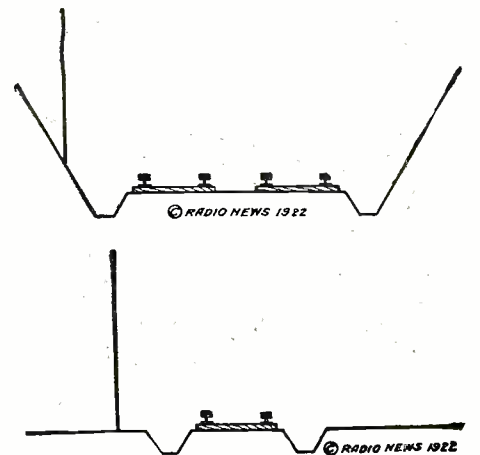

© RADIO NEWS 1922

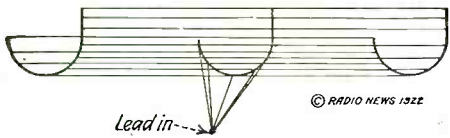

Fig. 2. The Arrangement of the Antenna Used. With Semi-Circular Hoops the Antenna Encircles the Telegraph Wires.

arranged circuit. The heated circuit comprises a sensitive galvanometer deflected more or less by the continuous current. This deflection is made use of for detecting the presence of electric waves striking the engine. The indispensable earth connection is provided by connecting with the body of the engine. Fig. 6 is a diagram of connections of the receiver.

The phenomena occurring in the receiver can be described as follows: The waves permanently radiated from the sender, provided that the receiver is tuned to the same wave-length, are permanently received on the engine, the galvanometer needle being permanently deflected. The

The transmitting station from which, by a system of wired wireless, warnings are sent out to engine drivers that they are approaching signals on the track.

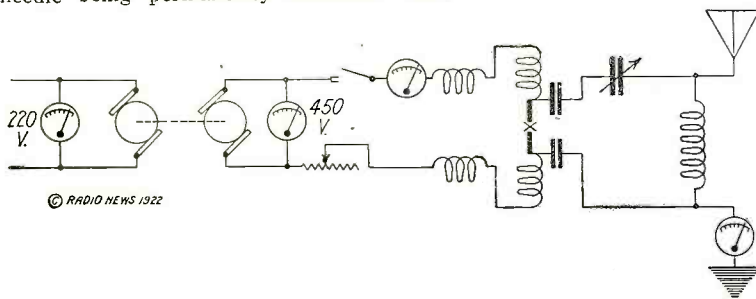
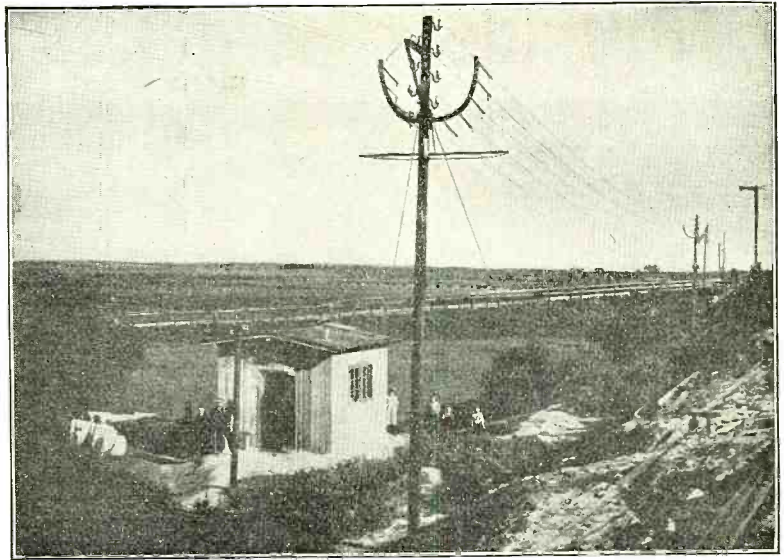

Diagram of the complete circuit used at the transmitting station. With a converter to step up voltage, a Poulson arc is used.

galvanometer is so arranged that its needle, in this case, is permanently invisible. As soon, however, as the electric waves cease striking the engine, the needle reverting to its zero position, will cause a red disc to appear, thus warning the driver of the approaching signal.

The screening net is an arrangement provided at all intended warning posts and is intended to prevent the electric waves from striking the engine. Two such nets were installed on the experimental line, viz., at Neukunkendorf and Lüdersdorf re-
(Continued on page 1140.)

A Portable Radio Receiving Set in a Suitcase

A PORTABLE radio receiving set, completely installed in an ordinary suitcase, capable of "picking-up" a wireless broadcasting service 250 miles away, represents perhaps the most compact outfit for its capacity yet built. The device was perfected by Brent Daniel of Washington, D. C., and was demonstrated at the Thirty-fourth Radio District Annual American Convention held at the National Capital on February 17 and 18.

The first station heard after the compactly-built wireless receiving unit was put into operation was one in New York City. A station in Newark, New Jersey, was also heard. An amateur station in Ohio—approximately 400 miles away—was noted with faint audibility. The signal strength at these distances, to be sure, is not great. When the transmitting station is located only 10 or 15 miles away, this diminutive wireless receiver imparts sufficient strength to be distinctly heard over a large room.

This portable amplifying receiver operates in the absence of an antenna. A loop is used, this unit

as well as all other parts of the outfit being enclosed in a common suitcase. The use of a loud speaker or amplifier is the secret of the large capacity of this radio outfit when compared to its size. The inventor describes his progeny as super-sensitive.

The containing suitcase weighs barely 40 pounds. The electron tubes, loop, amplifier, and other intricacies essential to a complete radio receiving set are bound between a case of leather not exceeding 14" by 22" in dimensions. The success of this portable amplifying receiver is due in no small measure to the use of a special design of electron tube, which makes it possible to use two
(Continued on page 1124.)

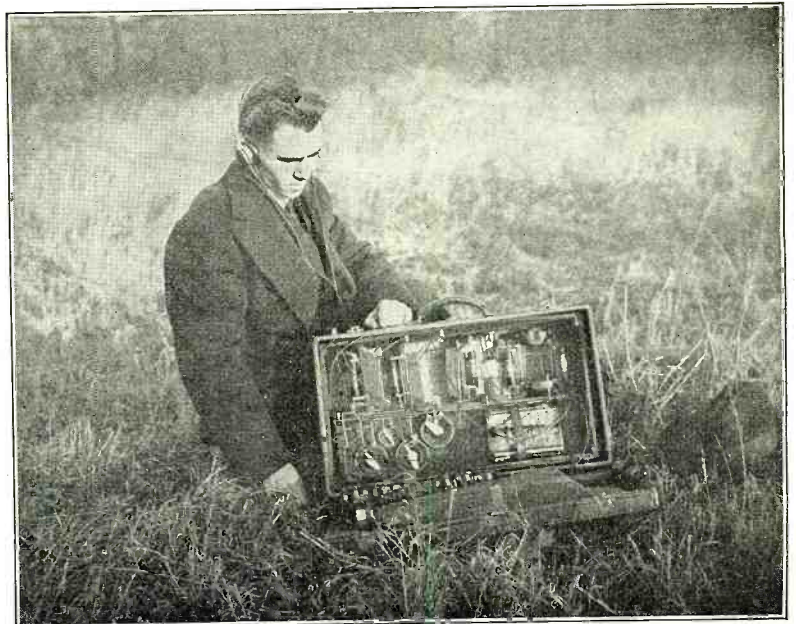

This Complete Receiver in a Suitcase Will Bring in Loud Stations Ten Miles Away, While Distant Stations Can be Heard With the Phones.

President Harding a Radio Enthusiast

By S. R. WINTERS

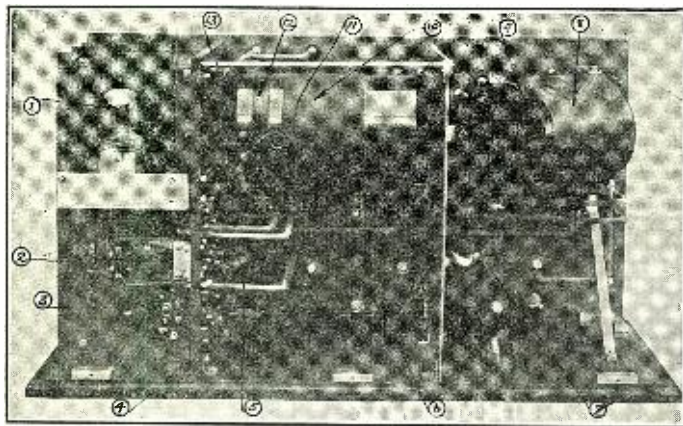

Back View of the President's Receiver, Showing the Three Main Divisions Shielded From One Another.

- 1, Detector Tube. 2, Amplifying Transformer. 3, Telephone Switch. 4, Shield. 5, Filament Rheostat. 6, Secondary Condenser. 7 Antenna Condenser. 8, Antenna Coil. 9, Receiver Compass Switch. 10, Secondary Coil. 11, Receiver Compass Switch. 12, Stationary Tickler. 13, Movable Tickler.

The antenna, as now constituted, is situated along the roof of the White House, extending to a towering tree on the south side of the Executive Mansion, Shades of George Washington! — could his imagination in its keenest moments visualized such a scene of marvelous progress?

Secretary of the Navy Denby sponsored the suggestion of installing a radio telephone for the exclusive use of President Harding, the idea being broached at a session of the Cabinet when other subjects of import were being discussed. Secretary Denby received instantaneous approval, action being

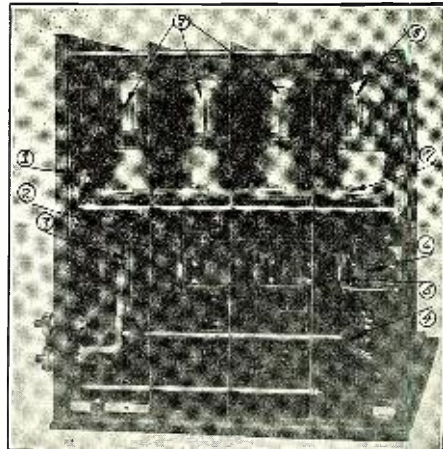

Side View of the Receiver, Showing the Three Stages of Amplification With Detector, Each Shielded from the Other.

- 1, Panel Shield. 2, Amplifier Shield. 3, Telephone Condenser. 4, Telephone Switch. 5, Transformer Condenser. 6, Amplifying Transformer. 7, Tube Mounting. 8, Detector Tube. 9, Amplifying Tubes.

PRESIDENT WARREN G. HARDING joined the ever-increasing army of amateur radio enthusiasts. The

The suggestion of received instantaneous

Secretary Denby received instantaneous approval, action being

A. H. Taylor, in charge of the Navy radio

White House, heretofore surrounded by an atmosphere of documents of State and politicians who come and go on their errands of basking in the sunlight of political favors, will in the future share interest with an environment smacking of aerials, dielectrics, transformers, wavelengths, microfarads and a multitude of technical details incident to radio telephony. For, be it known to the world that the President of the United States has had installed in his study a high-power radio telephone for the reception of music, lectures, and conversations that circulate through ether like bees swarm around the bung-hole of a molasses barrel.

While President Harding may be rightfully classified as a novice in the radio game, his receiving instruments are of ultra-modern design. The uttermost ends of the earth, under favorable atmospheric conditions, constitute the unlimited field for his "listening-in." The radio telephone may be tuned to a wave-length of 25,000 meters, whereas the average receiving outfit of the amateur functions in the neighborhood of 375 meters. Suggesting the high regard in which the President holds his newly-introduced "entertainer," the instruments occupy a book-case which is located alongside the desk of the Chief Executive. The loop aerial, which at first was placed around the moldings in the Presidential study, was later displaced by a conventional antenna because of the former's inability to operate at the frequencies specified.

forthwith. Commander S. C. Hooper, the "Father" of Navy Wireless; Commander

o'clock on the day of the Cabinet meeting, when the suggestion was approved, and at 4:35 o'clock on the same day—or two hours and thirty-five minutes later—the radio receiving equipment had been installed in the White House.

The receiving set, elevated to the unprecedented distinction of occupying quarters in the mansion of the Chief Executive, consists of a receiver and amplifier consolidated into a single operating unit. Another power amplifier resolves itself into a supplementary appliance. The receiving outfit, composed of a series of circuits, and controlled from the front by as many knobs, differs from the conventional amateur receiver inasmuch as the latter is controlled by a single knob. The series of knobs on the Presidential radio telephone receiver, controlling the volume and reproduction of sound, lend themselves to easy manipulation once President Harding has familiarized himself with the "new-comer" to the White House. The unit for the reception of communications includes an amplifier of four vacuum tubes and three transformers, the purposes of these being to amplify the strength of incoming

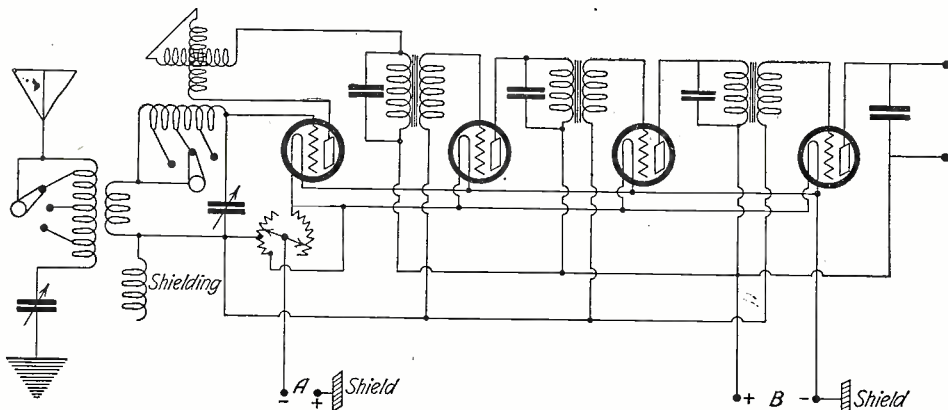

The Circuit Used in the Receiver Installed in the President's Study Permits Reception on All Wave-lengths From 200 to 20,000 Meters and Provides Three Stages of Audio Frequency Amplification.

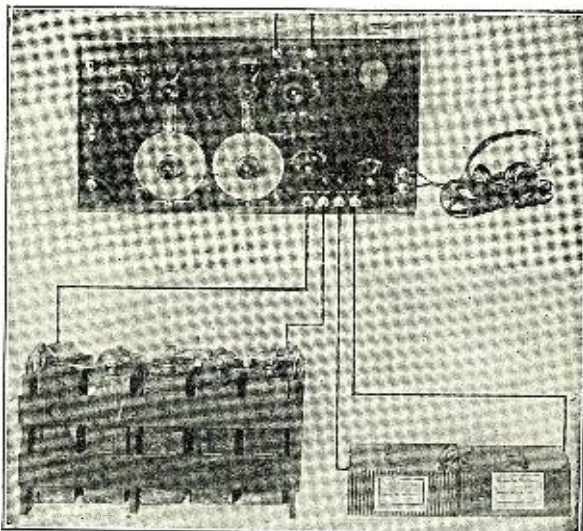

Outside View of the Receiver With Filament and Plate Batteries and Telephones Connected. Lead in From the Antenna Atop the White House is Brought to This Receiver. The President is Enthusiastic over the Results Obtained.

(Continued on page 1216)

Avoiding The Beaten Path

By A. HAZELTON RICE, Jr.

THE Editor of this magazine, as you well know, has been bringing to your attention, constantly, the advisability of getting out of the beaten path in the field of radio experimentation. How many, I wonder, have followed his advice? I know it is discouraging, expensive, and sometimes thoroughly disgusting to spend many anxious hours in earnest effort only to have our pet brain-child turn out a complete failure, when the money so expended would have fed the amplifier for many a day, but it is the purpose of this article to stimulate experiments along a new line, which should prove interesting and ultimately successful.

At present, thanks to the splendid coöperation of the American Radio Relay League, it is possible to transmit messages to practically any part of the country in an incredibly short time. This, in itself, is a wonderful achievement. Yet, how much better, if we could speak directly to whomsoever we might desire. This is, of course, possible at present, but only within the limited range of our radiophone transmitters. Why, then, would it not be possible to relay speech through as many stations as might be necessary to reach the party desired? There are many stations today well equipped to act as "radio exchanges" and when such a system is prevalent throughout the country we may expect a new organization, collaborating with those existent, known, perhaps, as "The American Radio Exchange."

At the present time a conversation between Boston and San Francisco can be carried on only by means of amplification at various points along the route. Is it not reasonable to assume, then, that in the near future we shall be talking to friends

and relatives by radiophone over vast distances in the same manner? This is not so far-fetched as it may seem at first glance.

Let us suppose, for instance, that our good friend IZE at Marion, Mass., wishes to speak to that king of all amateur sta-

and tremendously amplified at each. It sounds so easy that it is surprising that the system is not already in operation, and yet it is more than probable that there is much experimenting to be done before satisfactory operation can be hoped for and it is right there that the value of the editor's advice to "avoid the beaten path" is apparent.

Many of you have heard Arlington time signals repeated on 200 meters by broadcasting stations. Why not the voice?

The development of such a system will undoubtedly create an enormous demand for apparatus of new design which means a healthy growth of the radio manufacturing industry and security for the radio amateur. It's coming, men, just so sure as the Soldier's Bonus. Yes, I'm an ex-service man, so you can see how positive I am. Now let's all get busy and see what happens by "Avoiding the Beaten Path."

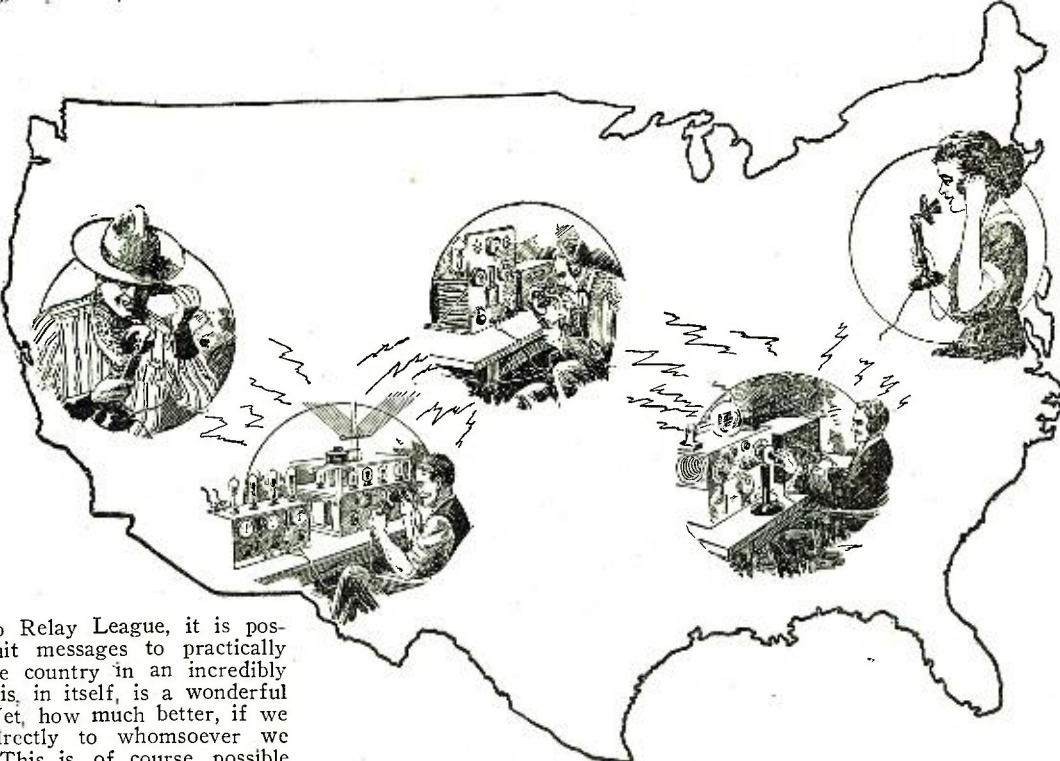

Something Interesting to Try. Relaying the Voice Instead of Messages, Through Amateur Stations.

tions, 5ZA at Roswell, New Mexico. The distance, let us assume, is beyond the range of his several five-watt tubes. He, therefore, calls a "radio exchange" station in the second district asking him to clear a "line" to 5ZA. The second district man can, perchance, reach another "exchange" in the fourth district, and so on until the destination is reached. Whereupon IZE, tuned to the exact wave of the second district exchange, suddenly hears something like this: "Hello, hello,—this is 5ZA, Roswell, New Mexico. What's on your mind, old man? Shoot!"—the voice being repeated at three or four "radio exchanges"

happens by "Avoiding the Beaten Path."

Editor's Note:

The suggestion given in this article is worth trying by the owners of good phone sets. In this and other magazines several circuits for duplex operation have been published, but as far as we know very few amateurs use them. Relaying phone messages may be accomplished in the following ways, either by using different wave-lengths or by receiving on a loop aerial and sending with an outdoor antenna.

We would be glad to hear about it if anyone tries it.

Why Panels?

IT seems strange to me that amateurs as a whole should be so strong for the panel type of receiving set, when just as good results and ever so much more experience and fun can be had with the individual instrument type of set.

It might be well to explain here just what I mean by the individual instrument type of set. By this I mean the set that consists of the various instruments scattered around on a table or board and connected up with the ever handy No. 18 wire.

In using panels it may be that the boys are looking to neatness or a saving of space, if so, that is all right, but I prefer to believe that, in most cases at least, it simply is another demonstration of how folks will "follow the leader." As Mr. H. Gernsback remarked in one of his "peppy" editorials "Most of you," referring to amateurs, "are like sheep following blindly

some well meaning but misguided leader. Someone gets up a certain type of outfit and immediately the majority of amateurs follow suit and copy it, down to the last screw."

With the separate instrument kind of set, it is possible to change the "hook-up" as often as you like without much trouble. As you know, some circuits work better for C.W. than they do for spark, and vice versa; also some are specially adapted to certain wave-lengths, so you can let your mode of "hook-up" be governed by what you want to receive. When RADIO NEWS reaches you, instead of just reading about the various new stunts, you can try them out for yourself and if some "fan" in the neighborhood is particularly enthusiastic about the circuit he is using, you can try that out also.

You will have to admit that the average

possessor of a panel set will not change his "hook-up" from one end of the year to the other, simply because it is very inconvenient and means a lot of work to do so and at the same time he is not sure that the results will justify it. He thereby loses a lot of good practical experience.

Perhaps some are under the impression that they get a higher degree of efficiency with a panel, but experience has taught me that this is not so. With my two-V.T. outfit scattered around on a board, I hear NSF (Radiophone) regularly (800 miles), and occasionally I get KYW, Chicago, quite distinctly (1,125 miles). Can't be much loss in efficiency there. E. E. Bucher in his "Wireless Experimenters Manual," page 281, says: "A panel or cabinet receiver adds nothing to the electrical efficiency of a set, except that it is manipulated with less dif-

(Continued on page 1146)

Radio Talking Moving Pictures

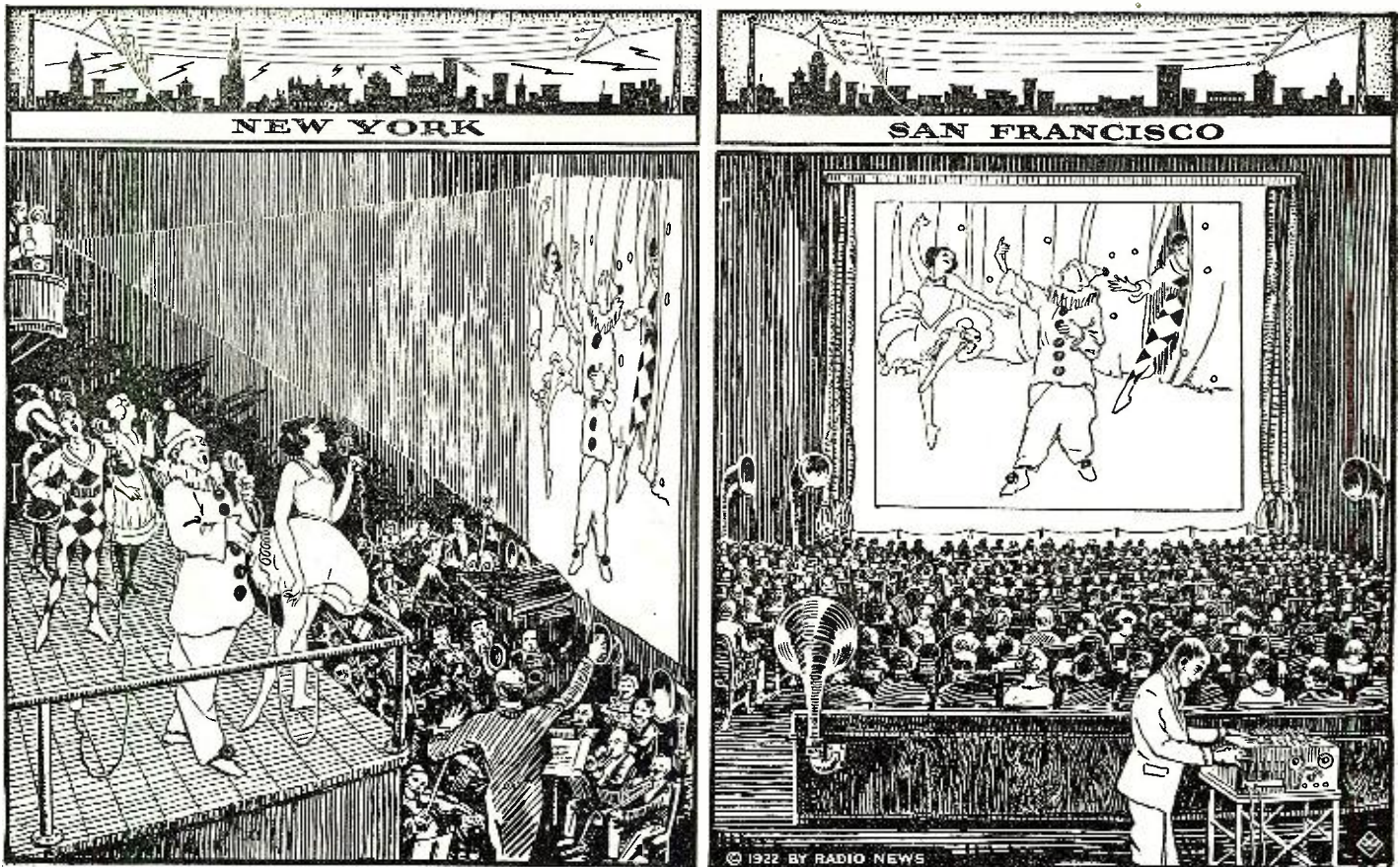

The Opera by Radio, in Synchronism With the Movies. In San Francisco and All Over the United States Audiences Are Listening to the Voices of the Opera Singers Broadcasted by Radio While Moving Pictures Show the Movements of the Players.

We received a short time ago an interesting manuscript from the Rothacker Film Company whereby mention was made that Harry J. Powers, Jr., was the inventor of a certain radio talking moving picture. That is very interesting to us for the main reason that the idea is an invention of Mr. H. Gernsback and was described in RADIO NEWS in September, 1919.

Inasmuch as there is so much interest in these matters, we are reproducing Mr. Gernsback's article at the end of this story for the benefit of all concerned.

—Editor.

THE "movies" and the "speakies" have at last been wedded. The radiophone was the minister.

Through experiments conducted in Chicago it has been proven that talking motion pictures are a practical possibility—not the "canned" talking pictures on the phonograph principle that have been tried, but talking pictures by means of the human voice transmitted by radiophone from a broadcasting station to as many theatres as are on the movie-speakie circuit.

A device has been perfected whereby any number of motion picture theatre projection machines can be operated in perfect synchronization with a master projection machine at the radiophone broadcasting station. This master machine itself projects a picture which furnishes cues to the actors who supply the sounds heard by the theatre audiences.

This is the principle of the radio talking movie; A motion picture is produced in the studio as usual, the scenario writer having supplied speaking lines and sound effects as

though the production were to be given behind the footlights. A number of theatres are equipped with radiophone receiving instruments and projection machine synchronizing apparatus. The movie company, possibly composed of the same persons who made the original film in the studio, is assembled at the radiophone broadcasting station.

Out at the theatres the overture has overtured and the audiences settle back for the evening's feature movie-speakie. Buz-z-z goes the signal at the broadcasting station and in all the theatre projection booths. The master projection machine begins throwing the photoplay upon the screen at the broadcasting station and simultaneously, to a fraction of a second, the silversheets at the various theatres are illuminated with the shadow-drama.

At the broadcasting station the movie actors re-enacting the drama, speaking out their lines, word for word, just as though the many different audiences were seated in front of them instead of in many different theatres many miles apart. The actors watch the film being screened by the master projector very closely lest they supply the speakies too swiftly or too slowly for the movies.

Thus when the heroine screams for help the audience will hear her cries. They will hear the hero's shout of encouragement as he speeds to the rescue, and when he fires the shot that puts an end to the villain's villainy, the movie-speakie fans will hear the deafening roar.

The radio talking picture is the invention of Harry J. Powers, Jr., connected with the Erlanger theatrical interests with headquarters at the Colonial Theatre, Chicago.

The wedding of the movies and the speakies took place at the Chicago practical picture studio of the Rothacker Film Co.: Frank Bacon, famous as the star of "Lightnin'," was the best man. Bacon is a radiophone enthusiast and he found time between matinee and evening performance to enact the first scene of the historical experiment that proved the radio talking picture possible.

The Rothacker studio lights flashed on. Bacon took his position behind a table set in front of a black velvet curtain. Watterson R. Rothacker, president of the film company, shouted "Camera!" the cameraman began to crank and the world's first radio talking picture was in the making.

"Ladies and gentlemen," began Bacon, accompanying his words with those inimitable gestures of his, "it gives me great pleasure to be the first to try to demonstrate something which will prove the most wonderful, the greatest amusement the world has ever known—the human voice synchronized with motion pictures through the radio telephone. We are living in a very rapid age in which nothing seems impossible."

To one side of the studio set a stenographer was taking down Bacon's words in shorthand so that he could later give a precise repetition of them over the radiophone broadcasting apparatus.

"Suppose that in a motion picture," continued Bacon, "the heroine is in great temper; she sees a water glass and, seizing it, she smashes it down upon the table thusly." Bacon smashed the glass.

And on through 200 feet of film Bacon proceeded, ringing a dinner bell, blowing a whistle and finally firing a revolver at an

imaginary abductor of the banker's daughter.

"And this," he concluded, lifting a radio receiver to the table, "is the receiving end of the wonderful radiophone which makes it possible for you to hear my voice—or any actor's voice. Upon this occasion I predict that the time is at hand when the radiophone will supply natural sounds in connection with motion pictures in theatres all over the world."

Scene II of the experiment followed next day after the negative had been developed and two prints made. One print was placed in a projection machine at the Rothacker laboratory and the other in a projector at the broadcasting station. The signal to start was received from the broadcasting station by the receiving instrument beside the projector at the Rothacker plant. Both projectors started simultaneously.

For a number of feet of film the two screens remained blank save for numbers flashing up, which were to enable the two projector operators to get their widely separated machines into synchronization. How this was possible is perhaps the crux of the radio talking picture invention.

The two projectors were running "neck and neck" when upon the two screens Bacon, the photographic image, made his bow. At the broadcasting station Bacon, the actor, stood ready to repeat his words of the day before to fit the position of Bacon, the image, on the screen before him. At the receiving end the lips of Bacon, the image, began moving and, right upon the dot, through the receiving instrument came the words of Bacon, the actor. When the water glass was broken in the picture the sound of breaking glass was heard, and when the screen dinner bell rang the real bell rang.

By the time the experiment progressed to the revolver shot one machine had gained in speed. This was because the human element entered into it; one operator ran his machine too fast.

Harry J. Powers, Jr., the inventor of the synchronizing device which the speedy operator failed to follow, saw that if the radio talking pictures were to be a success the human element would have to be absolutely eliminated—save for the movie actors re-enacting the drama at the broadcasting station. These, by rehearsals and careful observance of the cues screened by the master projector, can do their part, he feels sure.

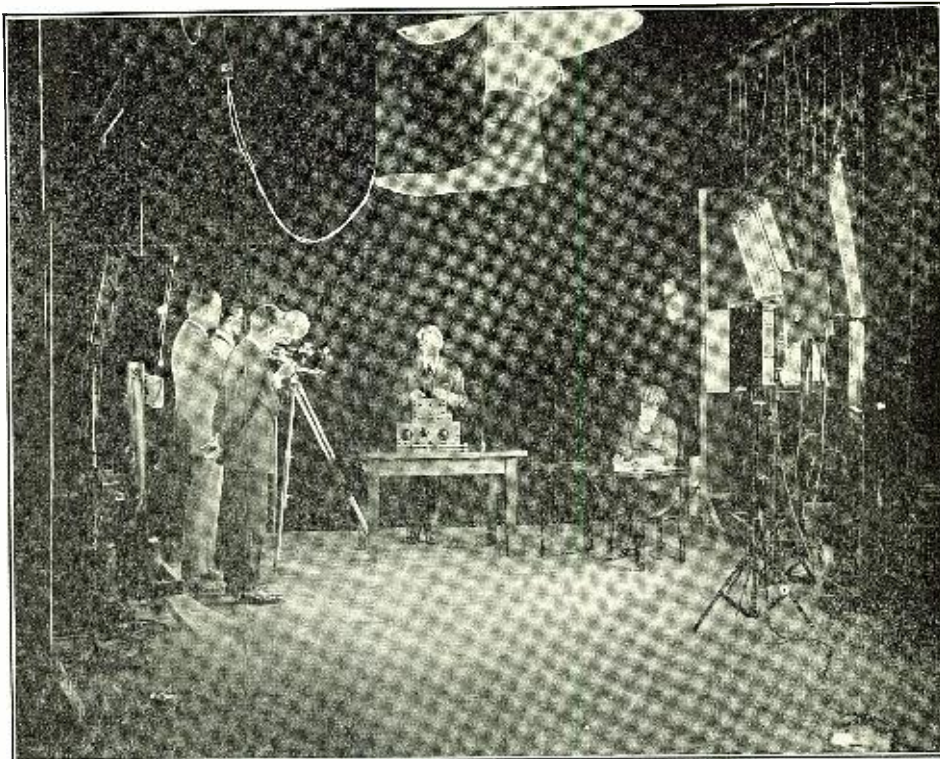

Frank Bacon in the Studio Where Experiments Were Conducted on the Radio Speaking Movie. Mr. Bacon's Words From the Radiophone and His Actions on the Screen Synchronized.

The problem of eliminating the human element at the theatre projection machines was mechanical. The Rothacker technical staff and engineers employed by Powers have solved it. However, the projection machine operator in the theatre booth will never be eliminated except with respect to the regulation of the projection machine's speed; it will always be necessary to have a skilled projectionist beside every machine.

Harry J. Powers, Jr., has kept the radio talking picture experiments rather a secret pending patent matters. However, he is now ready to give a public demonstration in Chicago. He plans to equip a number of Chicago theatres with radiophone receiving instruments and Frank Bacon will broadcast the speakies from a broadcasting station being installed in the Wrigley building.

Powers does not claim that all problems

have been solved—merely that the practicability of the radio talking movie has been demonstrated. For example, there is the problem of applause. With the voice of the actors coming through the radio receiver the audience will be more liberal with applause. During the applause will the movie-speakie be temporarily shut off, or what? And different audiences will not applaud the same periods of time.

The possibilities of the radio movie-speakie stimulate the imagination. It has been said that a large part of an actor such as Otis Skinner—namely the voice—is lost upon the picture screen. Will the time come when an actor like Skinner can stand at the radiophone broadcasting station and give a true performance before hundreds of audiences in all parts of the country? Is the radiophone to add the final touch of realism to the shadow stage?

(Continued on page 1202)

Advertising Pays By "THE WANDERER"

TURN back to your January issue, and find the article, "Who Can Use This Man," by "The Wanderer." Did you read it with perhaps a thought that something must be radically wrong with the author, if he couldn't secure a satisfactory position with the ability and experience he claimed for himself? As the author, it had not occurred to me in that way, until when talking with a brother operator on a recent West Indies cruise, he told me what impression the article had made on him, at the time of reading. It was just this: that a man of the experience and ability claimed, must be lacking in some respect; personality perhaps, not to be able to find a niche for himself. Had you thought of it in that way? Whether you had or not you'll doubtless be interested in the results obtained, and then may judge for yourself where the original trouble lay.

Before the January issue had reached the writer, replies began to reach him from various parts of the country. After a reasonable length of time, in which all interested parties had communicated with the

writer, it was found to be a singular fact that every reply but one, came from east of the Mississippi. As there were 21 answers, this is indicative of one very large factor, which explained to me why radio opportunities did not come to hand as readily as I had been led to believe by various propaganda. It is distinctly apparent that the present day radio opportunity is in the east. As the writer was on the west coast, naturally opportunities were few. This is readily explained after a little logical thinking. The greatest field for radio sales lies in the circles surrounding the large broadcasting stations. The most prominent broadcasting stations are those of the Westinghouse company, but of which the west coast has none. True, there are numerous broadcasting stations on the west coast, but for the majority they are of low power and short schedules, none of them having the facilities for entertainment that the Westinghouse stations have. Therefore, they do not command nearly the interest of the public that the eastern stations with their excellent programs can claim. So

much for that. Now is it not logical to assume that if the greatest sale for experimental equipment is in the east, and the largest part of the raw materials for manufacturing purposes is from eastern sources, that it would be poor business to pay transportation on raw material to the west coast, make the marketable product there and ship it back to eastern markets for sale purposes? The common sense answer is, manufacture in the east, where the raw materials are, and ship only enough finished product west to meet demand. Double transportation costs are then avoided. The proof of this can be found in the fact that all manufacturers of radio equipment, with one or two exceptions, are found east of the Mississippi.

To return to direct results from my original challenge. Both telegraphic and postal replies were received; many good propositions among them. Each was answered promptly, but nothing "jumped at." I being resolved not to rush blindly into anything. Negotiations were opened with

(Continued on page 1201)

10 2-3 Carloads of Radio News

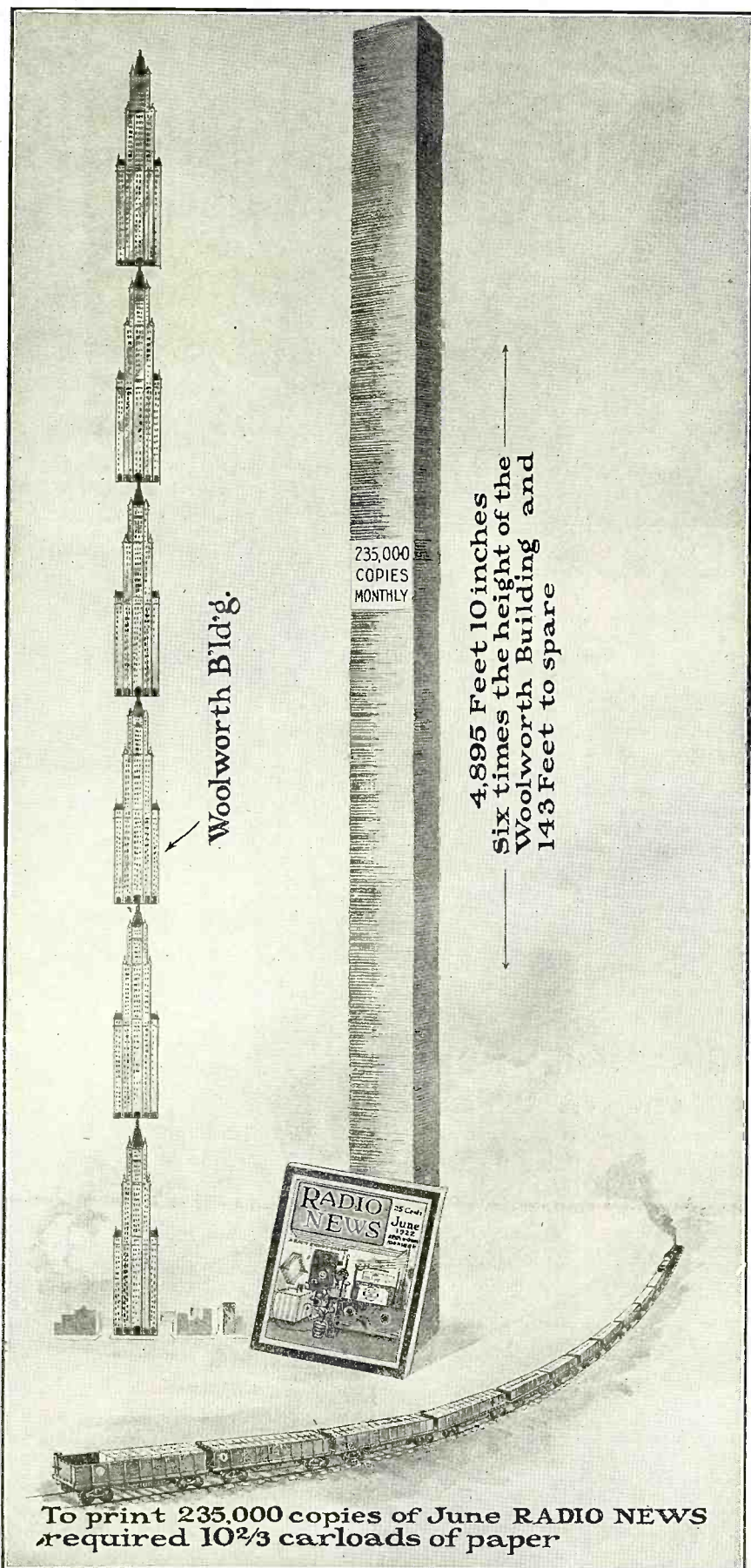

RADIO NEWS with this issue completes its third year. When we look back upon the first issue which had 48 pages, and of which 20,000 copies were printed, we admit that it makes us feel somewhat foolish. That is, of course, when we contemplate the present issue which has 168 pages and 235,000 copies. But as you probably know, anything is possible in Radio to-day.

In the Editor's editorial of August, 1919, he states as follows: "The Radio field is big enough for a monthly journal of 120 pages." Frankly speaking, when the Editor wrote this, he thought that this was a nice pipe dream and that this figure would probably never be reached! But how tame our wildest expectations sometimes are, is best proved with the present issue.

Think of a pile of RADIO NEWS stacked on top of each other that would reach the astounding height of 4,895 feet, or over 6 times as high as the Woolworth building! It took 10 $\frac{2}{3}$ carloads of paper to print this issue. All of these are simple facts, and you can figure them out for yourself just as well. But the end is not yet. What the ultimate circulation of RADIO NEWS will be no one can foretell. It may be half a million. It may be more. We refuse to make any prophecy because wild as we might make it, we would probably be far below the mark.

We do not say all this in a boasting or vainglorious spirit, because we realize that it is not ourselves that made this magazine possible, but our readers. We believe we cannot do better than publish the Editor's first editorial in the initial issue of RADIO NEWS in July, 1919. The platform upon which RADIO NEWS was built, and which spells its success, is exactly the same to-day as it was then, in volume No. 1, issue No. 1. We reprint part of that editorial, herewith:

1st. Only Radio—100% of it—nothing else.

2nd. An Organ for and by the amateur. The amateur's likes and dislikes and wants will always come first in this magazine.

3rd. Absolute Independence. RADIO NEWS has only one Boss—its readers. This magazine is not, nor will it ever be, affiliated with any stifling, commercial radio interests whatsoever.

4th. Truth—first, last and always. When you see it in RADIO NEWS you may be sure that it is so. Not being affiliated with commercial radio interests, this magazine will have no reason to suppress important articles, discoveries, etc.

5th. RADIO NEWS is and will be the sworn enemy of all adverse and unfair radio legislation. Our Washington representative will inform us immediately of any new radio legislative measures. No unfair bill will become a law before all amateurs have had their say.

6th. The uplift of American Radio Amateurs out of the "kid" class, into the serious status to which the art is entitled. Amateur Radio is not a plaything or a sport—it is a useful mind-ennobling art—it vanquishes distances, it saves lives and IT WILL BE AS NECESSARY AS THE TELEPHONE TEN YEARS HENCE. (Our prophecy came true in 3 years.)

7th. Instructive first and last. Up-to-date scientific articles for your instruction will always have first place in RADIO NEWS. We shall publish purely scientific articles every month, articles that on account of their length are often crowded out of other publications.

(Continued on page 1216)

If All the Copies of Radio News Printed This Month Were Piled Up, They Would Reach a Height Equal to That of Almost Six and One-quarter Woolworth Buildings On Top of Each Other!

Some New Radio Apparatus

AN ORIGINAL "B" BATTERY.

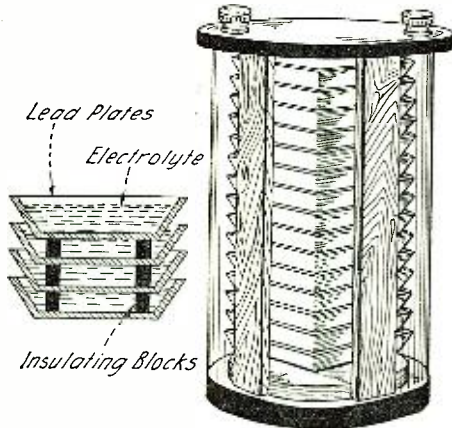

This is a Real Departure in "B" Battery Construction. Note the Sectional View on the Left.

The "B" battery problem is a universal one, as amateurs of other countries experience the same difficulties in finding the proper type of "B" battery, as we do. The accompanying sketch shows a clever design for a storage "B" battery in which some square plates, made of lead, act at the same time as positive and negative plates, as well as containers for the electrolyte.

To constitute a battery of any voltage, it is merely necessary to pile up the proper number of plates, separating them by small insulating pieces, as shown in the sectional view. Each plate being positive on one side and negative on the other, each unit furnishes two volts and the connections to the first and last plates may be made by means of a connector, or other clamping arrangement.

The drawing shows a complete 40-volt battery enclosed in a glass jar with the proper mounting to keep the plates from moving.

NEW LOUD-SPEAKER.

A new loud speaker, appropriately called the "Adapt-O-Phone," has just been placed on the market by a Detroit maker of radio products.

The Adapt-O-Phone uses the regular head set. The receivers are held in position against the manifold by set screws and are protected from injury by soft rubber sleeves.

By using both receivers the fullest audibility is obtained, and the sounds are rounded out and amplified by the horn, giving clear, undistorted tones.

This new loud talker is very attractive in appearance. The base is of mahogany; the manifold is heavily plated and polished, and the horn is japanned.

With the increasing custom of sending out concerts, bulletins, sermons and other messages of general interest, the need of a satisfactory, low-priced loud speaker is widespread; and this one should meet with great popularity.



A Well Designed Loud Talker to Which May be Adapted a Head Set.

LISTENING THROUGH FLEXIBLE TUBES.

The old principle of the speaking tube, or the doctor's stethoscope is receiving considerable attention in connection with receivers for radio entertainments.

For those who do not care to invest in an amplifying receiving set with a loud speaking horn, or purchase several head sets, this seems the best method of entertaining a group of persons from one receiving set.

A series of tests, made by the writer, has revealed several interesting features in connection with the use of these flexible tubes.

The most startling is, that a group of persons listening through flexible tubes from a receiving set without amplification can hear speeches or music clearer and more distinctly than with amplifiers and loud speakers, without tubes. More of the words spoken at the broadcasting station are readily understood without mental exertion. This is undoubtedly due to the absence of distortion of the sound caused by present day amplifiers and loud speakers.

Another interesting observance was that a deaf person who can barely hear from a pair of receivers, can hear very clearly through the tube device. This is due to the concentration of the sound waves by a special mouthpiece before entering the tube then the conduction of the sound clear into

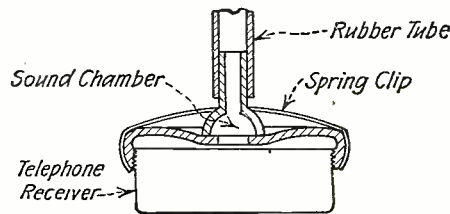

© RADIO NEWS 1922

With This System it is Possible for Several Persons to Listen From Only One Telephone Receiver.

the inner ear by the tubes and small ear pieces. This carries the sound to the ear drum itself causing a clear sensation of the sound, that was only indistinct when using the receivers alone.

The problem seems to be one of concentration of sound waves instead of amplification as in a horn. In one device, the Tube-O-Phone, this is accomplished by attaching a mouthpiece, shaped similar to that of a bugle or cornet mouthpiece, over the receiver opening, by means of a spring clip. The sound waves caused by the vibrating diaphragm are reflected to the small opening where the tube is attached. This concentrates the sound at the opening of the tube, causing an intensified vibration in the air column inside.

The size of the tube bears considerable importance to the volume of sound received at the ear. A very small tube causes too much friction and deadens the sound while a large tube gives too large an air column for weaker crystal sets to set in vibration. A 3/8" tube seems to be the best for both crystal and vacuum tube receivers.

Another interesting feature is that the addition of branches to the tube for more persons to use, does not diminish the volume of sound any appreciable amount up to three or four persons per receiver for crystal sets and six or eight for vacuum tube apparatus.

An added feature of flexible tube devices is that the ear pieces are so much lighter in weight than the receivers, the ears do not become tired from the pressure as is often the case when listening in with receivers for any length of time.

RADIO AND THE VICTROLA.

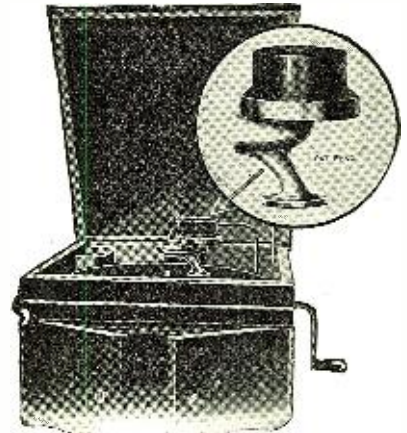

By Means of This Adapter it Becomes Possible to Use the Sound Box of a Victrola as a Loud Speaker.

A Jersey manufacturer has devoted considerable time and expense in conducting tests into ways of amplifying Wireless Music, Concerts, Speech, etc., with the least possible distortion, and finds the careful and expensive constructed Tone Chamber of the Talking Machine to be superior to any Horn or Loud Speaker. If you will look back to the early days of the Phonograph, you will no doubt remember that the use of Horns was discontinued years ago. The most expensive Talking Machines manufactured to-day have part wood and part metal Tone Chambers.

The Tone Chamber of your Talking Machine enables you to reproduce Wireless Music, Concerts, etc., with that tone and clearness characteristic of the Victrola. Simply connect the phones from your Head Set to the Tone Arm of your Talking Machine with this new adapter.

This attachment permits the phone from any Standard Head Set to fit 90% of the Standard makes of Talking Machines. It is handsomely finished and is an attractive addition to any machine.

A NEW REFILLABLE "B" BATTERY.

In a new type of "B" battery recently placed on the market separate cells connected by means of springs fixed on the cover and bottom of the wooden container, are used. This makes possible the elimination of exhausted cells and their replacement by new ones without the throwing away of the whole battery. A system of taps is provided, for the use of only a part of the battery as necessary with soft V.T.'s.

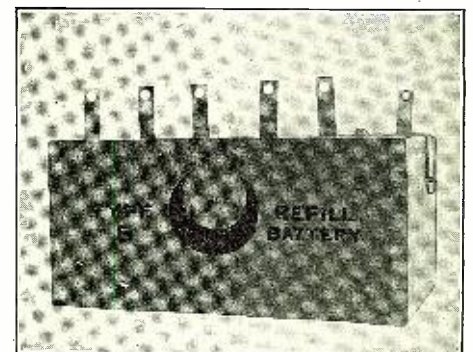

This "B" Battery is Composed of Separate Elements Which May be Changed When Exhausted.

Recruiting by Radio



These Aviators Wear Special Helmets With the Telephones Mounted Inside. Each of Them is Equipped With a Microphone.

creasing popularity, no one can forecast the vastness of its future, but it is safe to say that in the next few years there will be an opportunity for the trained man in this field of endeavor that will be comparable to the early days of the motor car," was an assuring statement of this recruiting invitation borne on the electric waves. By reason of the novelty of the experiment and because of the desirability of putting the communication on record through the enduring medium of a magazine this radio telephone message will bear repeating here in its entirety:

"This is BM5, the United States Army Air Service Radiophone station, at Mitchel Field, Garden City, Long Island, New York. Opportunity in the form of an enlistment in the United States Army is knocking at the door of many men tonight through the instance of the radiophone. The Air Service at Mitchel Field is sending out its call broadcast for men of good character between the ages of eighteen and thirty-five, to men who make the most of an opportunity to learn a trade, to develop their character and to improve their physique. Two hundred such men are needed at once at Mitchel Field to

learn the specialized work of the Air Service; to become expert in one or more of the twenty odd trades that comprise aviation,—trades which in turn are more or less allied with the motor car, thereby offering an opportunity for employment in two or more important industries in civil life upon the completion of a three-year enlistment. Interest in a man's work is the greatest single factor in his happiness and efficiency, and with this fact in mind each man in the Air Service is given work for which he is best fitted. Congenial work is that which is commenced with interest and completed with success. Travel in itself is an education, and at the present time two aviation squadrons are forming at Mitchel Field for duty in Panama. There the work of the Air Service will be carried on identically as it is here, and those men who enlist for these squadrons will truly have the opportunity to earn, learn and travel. The Air Service of the United States Army today is looking for men who will meet it half way, men who will make the most of opportunities offered and become of value to the service, thereby fitting themselves for promotion in the Air Service, and remunerative employment in civil life in the event that they do not enlist. Men who are listening—by that fact—demonstrate their interest in radio work. The United States Army today is probably the biggest single exponent of the radiophone, and the Air Service offers practically unlimited opportunities to learn this interesting work from every angle. With its

(Continued on page 1180)

"THIS is BM5, the United States Army Air Service radio telephone station at Mitchel Field, Garden City, Long Island, New York," was the introductory sentence flung into space, to be radiated throughout the United States recently. It marked a departure, the radio telephone being employed as an agency in boosting the enlistment figures of the Air Service of the United States. Instead of inanimate posters extending the opportunity for accessions to this branch of the Government service, recruiting was vitalized and made inviting by a fascinating appeal circulating through the ether and "picked-up" by expectant ears attuned to a nation-wide broadcasting service.

The message, other than advertising the needs of the Air Service for 200 recruits, was prophetic of the amazing possibilities of radio telephony. "With its present in-

The combination transmitter receiver used aboard the airplanes. Note the method of suspension of the set

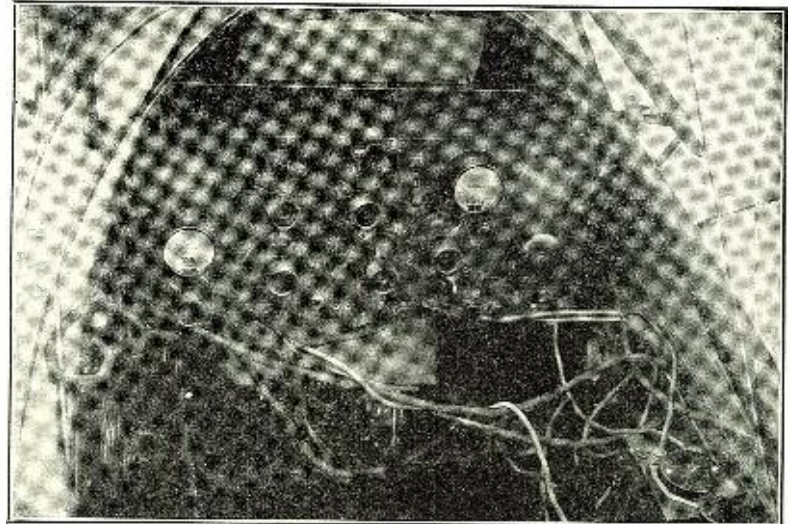

Unsteady Arcs By F. M. DAGGETT

ARC installation, with power ranging from two to five k.w., of either the ignition, compensating-wave, or the back-shunt method of signalling (of which the majority in use are of the back-shunt type), are rapidly gaining popularity as radio-transmitters aboard ship.

Naturally, a great number of the men chosen to operate these sets, and to care for them, although being old, experienced spark operators, are not altogether familiar with the peculiar characteristics of the arc transmitter. On being sent aboard ship these men are instructed in the starting and stopping of the apparatus and given a hazy idea of its operation, the method of adjustment, and balancing. They are thus

introduced to the arc, which, to many, seems a deadly infernal machine, ready to electrocute them should they make the slightest slip.

For the past few years I have watched inexperienced operators on their initial trip adjusting and balancing arcs of the back-shunt type, and four out of every five will make the same mistakes, which I wish to point out.

BACK-SHUNT ARCS

In the back-shunt arcs there are two radio-frequency circuits, the antenna circuit and the back-shunt, or absorbing circuit. Upon the depression of the key, the energy is transferred from the absorbing circuit to the antenna in such a manner that the an-

tenna is connected to the arc before the absorbing circuit is disconnected, and vice-versa. The absorbing circuit consists of a condenser, inductor and a resistor. The resistor is variable in steps while the inductor is varied gradually by an iron plate which is brought nearer or set farther away from the coil so as to cause the inductor-coil to possess greater or lesser reactance. By adjusting either or both of the variable factors, the absorbing circuit is balanced with the antenna circuit to draw the same load from the arc. The finer the balance, the steadier will be the tone emitted, and therefore the easier will be the interpretation of the signals.

(Continued on page 1181)

Is Radio Threatening the Phonograph and Theatre?

By H. GERNSBACK

WE take the following editorial from a musical trade journal, *The Music Trades*, on the date of March 4th.

"The radio concerts that have suddenly become popular have set many people to thinking, prophets to predicting, and, as usual, pessimists to foreboding disaster.

"One night last week one of these pessimists was holding forth to a group of acquaintances in which he prognosticated the early eclipse of the phonograph because of the advent of the radio.

"Who," he demanded, "will care to turn on a phonograph, which is limited to the records in the cabinet, when a whole world is beckoning? Why should anyone listen to a record of the "Sextette" from "Lucia," for example, even though Galli-Curci be included, when they can be rigged up with the Metropolitan Opera House and hear the entire opera? No, this is the end of the phonograph—the beginning of the end. With the receiving horn of the radio in his library a man is *en rapport* with the cosmos. When he can hear the living voice, why should he turn to a dead record?"

"Thus the prophet of pessimism.

"We believe most earnestly that the musical industries must take into account this astonishing new device. The fact that Mr. Kreisler, for example, is no longer limited to the sitting capacity of an auditorium, but is enabled by this new miracle of science to transmit the thrilling tones of his instrument to a vast unnumbered audience, not alone in this country but even across the heaving seas, must be reckoned with as a new thing in music which will inevitably play its part in the future.

"That it will never displace, or even interfere with the phonograph, we do not consider even remotely probable, although one hears the expression frequently nowadays, and presently, in the radio magazines which are springing up, we may find it reiterated by its enthusiasts.

"The peculiar virtue of the sound reproducing instrument is that it fixes permanently, ready for instant use, so: nothing that we love. On the radio, though we may hear Kreisler playing the "Devil's Trill" Sonata of Tartini or the Wieniawski Concerto, we are subject to the caprice of the artist's choice of program. But on the phonograph we have the selection of the pieces we desire. If we wish Kreisler to play his "Caprice Viennois" we need but place the record on the turntable and his bow is at our bidding. If we want an encore he has no power to refuse. If we want his "Old Refrain," or the "Grieg Nocturne," or whatever he plays that we want, we need only to take the record from our cabinet and our wish is gratified.

"No radio can supplant such a satisfactory, obliging and complaisant companion.

Whatever the development of the radio may be in the home life of the nation—and certainly its possibilities seem to be Aladdin-like—we may be sure that the place of the phonograph is secure.—C. F. O."

This quasi apology, indeed, makes interesting reading and simply goes to show what Radio is doing to the phonograph. It is known notoriously throughout the phonograph trade that Radio has been making great inroads upon the phonograph business, and while we do not mean to maintain that Radio will drive the phonograph out of the field, still when you ask people why they are not using phonographs or buying phonographs, the reply invariably is that they are using the Radio at the present time.

Of course, radio is a new thing, and just now on the ascending scale. Its novelty has as yet not worn off, but even the phonograph people, if they are honest with them-

This is precisely what we are coming to. The machines of the future will serve the double purpose of record-music and radio. This will give the public a new incentive to buy phonographs, which incentive seems to be lacking at the present time. The more the two can be cemented together, the better it will be not only for radio,—which does not need any assistance today—but certainly for the phonograph.

RADIO AND THE THEATRE

It is not only the phonograph business that is having nerves every time the word radio is mentioned, but the theatrical business is running the phonograph a close second, foolish as it seems.

From a recent issue of the *Billboard*, we have plucked the following choice morsels which we give to our readers for what they are worth.

WANT PAY FOR RADIO CONCERTS

Actors' Equity Association Adopts Resolution Advising Members to Seek Compensation

Following the publication in *The Billboard* two weeks ago of a warning to the effect that the free concerts sent broadcast by the radiophone companies were injuring show business, the Actors' Equity Association last week went on record as opposed to its members giving ethereal performances without proper compensation. A resolution to this effect, adopted by the council of the Actors' Equity, read:

RESOLVED: That the attention of our members be drawn to the fact that the radiophone is a profitable commercial enterprise, which also in a way enters into competition with the theatre, and that, therefore our members be advised to seek proper compensation for any services they may be invited to give to the radiophone companies.

In explaining the Equity stand in regard to what they term the "radiograf", Mr. Paul Dullzell, assistant executive secretary, says:

"The General Electric Company and the Westinghouse people have been getting in on a lot of good stuff for nothing. Also the general electrical appliance houses. The radio concerts are a money making scheme and the artists who make them possible should be compensated.

"Heretofore the understanding has been that the advertising afforded the actor and the singer is of great advantage to them. For instance, they are told impressively that an audience of 400,000 has its ears clamped to the receiving apparatus all over the land and sea.

"I can see where the vaudeville managers already have just complaint. If this thing grows—and it bids fair to assume enormous proportions—there will soon be no incentive to go to the theatres. When audiences can hear everything in their own homes they won't have to go out to be entertained. What they will miss in stage settings and the personality of the actor will be made up by the novelty of the radiophone itself.

"We considered this a matter of such importance that at the meeting of the council last week it was resolved to suggest to our members that they seek compensation for ethereal performances."

E. F. Albee, head of the Keith Circuit, in an interview with a daily paper this week was quoted as saying that appearances for the radiophone by Keith artists was a violation of contract.

THE RADIOGRAFT

The Radiograf is a wonderful invention and is enjoyed by hundreds of thousands of people. A good many prominent actors and actresses have

(Continued on page 1146)

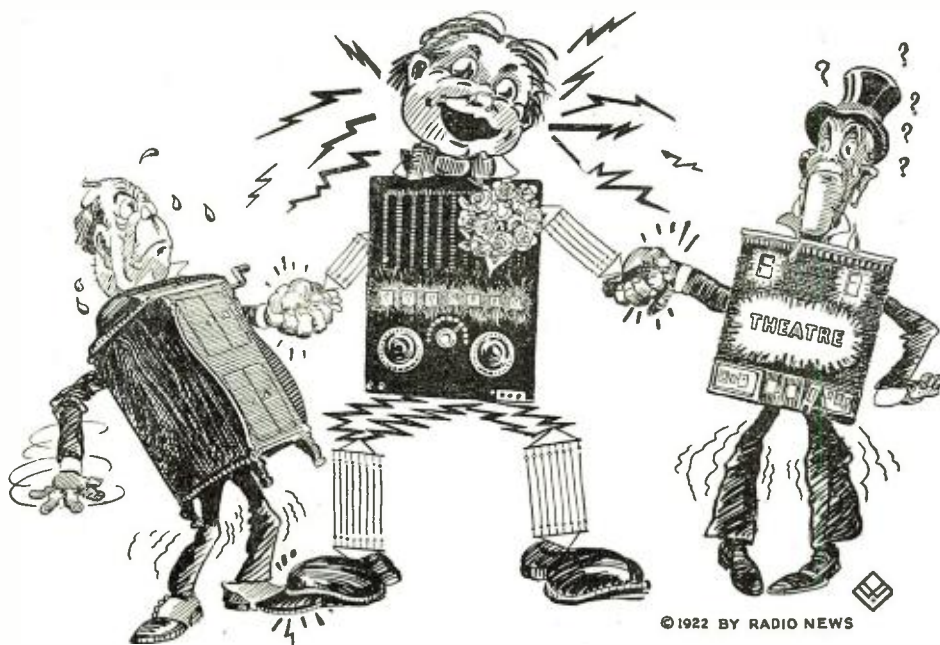

Kid Radio is Not Old, But is Now Very Strong and it Seems That the Phonograph and the Theatre Are Somewhat Afraid of Him. Are Their Fears Justified?

©1922 BY RADIO NEWS

selves, will not deny that radio is their great competitor. It costs money to buy phonograph records once you have the machine. It costs nothing to have all the music in the world which you desire, once you have a radio outfit. But there is no reason in the world why the two should not get along harmoniously even as conditions are now.

You will no doubt find, during the next two years, that every phonograph store will be selling radio appliances. In many cities throughout the east they are already doing this, having been driven to it by lack of business. The leading phonograph trade journal now has a radio section. The logical upshot of it all will be met when the phonograph interests instead of opposing radio open their arms and welcome it. One of the largest phonograph manufacturers already has seen the light after having seen the "handwriting upon the wall." *Beginning this fall, he will equip all his phonographs with radio.*

A representative from another large phonograph company came in to see the writer the latter part of March and wanted to know where he could buy 10,000 small crystal sets that were, as he put it, "absolutely fool-proof" and which outfits were to be placed in the company's phonographs. He wanted delivery in two weeks!!



A Practical Two Way Key

By LEWIS DAVENPORT

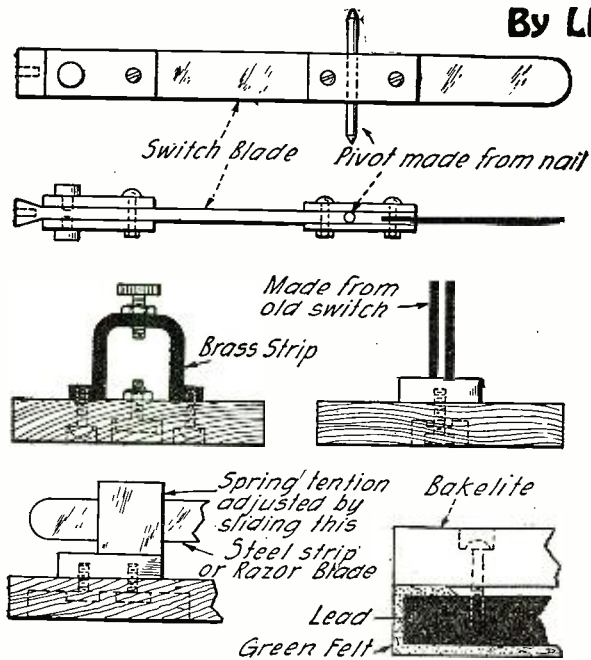

Details of the Parts Composing the Key.

THE two way key has not been given a fair chance in the radio game. It being discarded or never given a serious thought by most of us because we hear some would-be speed king trying to imitate

an automatic sender with one of them sending out an awful mixture of dots and dashes which we could not decipher. We naturally thought that they were designed for that purpose only and good communication could not be carried on with them. But when the key is properly made and used correctly, it is capable of turning out good readable signals which not only have a musical swing and are pleasing to the ear, but are easy to copy. Like anything else it takes a little practice to operate it. Trouble, however, comes from trying to send too fast.

While stationed at the air base at Pensacola, Fla., I designed an adjustable two way key capable of handling one-half KW. with a naval seaplane set. The standard aircraft key is flame-proof and the sending arm looks and acts very much like a pump handle. The said handle soon becomes corroded or stuck and is very hard to operate. Twelve words per is considered good speed with one of them. Ten words, however, is the standard speed owing to the adverse conditions. I could easily get twenty or more out of my key.

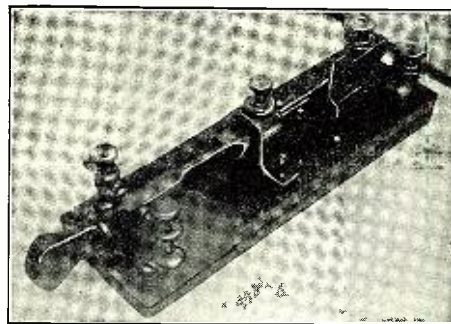

This Photograph is a View of the Completed Key.

And the land stations seem to copy it all right.

Am enclosing a photo and sketch of my key which has adjustable spring tension and distance between contacts. It is constructed from a base, old switch, contacts and a few odd screws. The base is bakelite and has a lead bottom covered with felt. It will stay still while sending and does not have to be screwed to the desk. An old Gillette razor blade will do for the steel spring. The knob was made from an old switch handle and all the other parts found in the junk box. The main advantage of this key is that it may be constructed for practically nothing if one has a little hand practice with tools.

Amplifying Transformer

By C. CHANDLEE PIDGEON

THE Ford coil, which has found many uses in the wireless game, now furnishes part of the material for a very cheap and satisfactory audio frequency amplifying transformer.

I have made a very satisfactory amplifying transformer by taking one of the secondaries of a Ford spark coil. The following details will enable anyone to make a similar device.

First cut about forty pieces of silicon steel, about No. 26 gauge, in the shape shown in Fig. 1. A sheet of this steel may be obtained from any radio supply house for about 20 cents.

If you have access to a lathe, turn a piece of hardwood, about 2 inches long, down to 45" in diameter. If no callipers and scale, or micrometer, are handy, just turn the piece to 1/2". Next wrap one layer of heavy sewing cotton on the cylinder, thus made, securing both ends to the cylinder; next cut a few strips of writing paper or wrapping paper the width of the Ford secondary, 1 1/2", and wrap about a half dozen layers of this paper around the cotton-covered cylinder, securing the layers to each other, but not to the cylinder. Shellac or insulating varnish is best

to use, but liquid glue may be used for this. When the core thus formed is dry, it is ready for the winding.

A small nail or brad driven in the core about 1/8" from one end will prevent rotation of it on the cylinder, or mandrel, and will furnish anchorage for the inner end of the winding. The primary of the amplifying transformer is now wound on the core prepared as above stated, by unwinding from the Ford secondary, which will later become the secondary of the amplifying transformer.

Solder a piece of larger wire, about No. 32, silk covered, to the end of the fine wire of the Ford coil. Attach this wire to the nail on the core, leaving a couple of inches

for making connections when the coil is finished. Start the winding about 1/8" from the end of the core and wind evenly to 3/8" from the other end. This wire, if wound evenly, should wind about 300 turns per layer; insulate each layer with a layer of paper. The paper taken from the coil from which the wire is unwound is very satisfactory, and one layer is enough. A little glue or shellac will hold it in place.

In unwinding, be careful when near the end of the layer, and start unwinding the paper at the proper time, or you will break the wire.

After winding about a dozen layers, see if the coil will go inside of the secondary. If so, continue until it will just fit. If the work has been carefully done, about fifteen layers will be wound. After having completed the winding, sever the wire and solder a piece of larger wire to the end, for connection purposes. Now wrap two or three layers of writing paper or tracing cloth, cementing with glue or shellac.

Next, carefully remove the cardboard tube from the interior of the Ford secondary and find the inner end of the winding. To this, solder a piece of wire for a term-

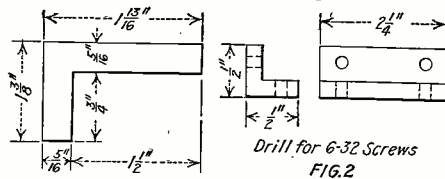

Sizes of the Laminations and Mounting for the Transformer Are Given Here.

(Continued on page 1144)

An Ultra-Compact Radio Receiver

By PAUL G. WATSON, I. R. E.

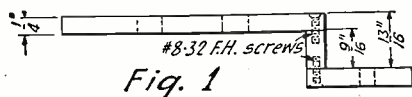
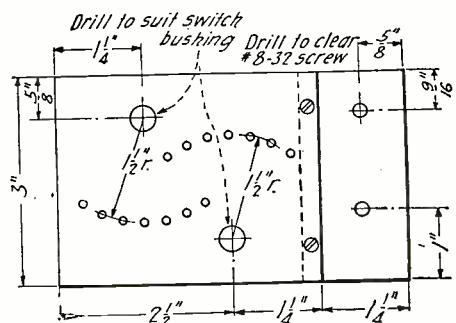
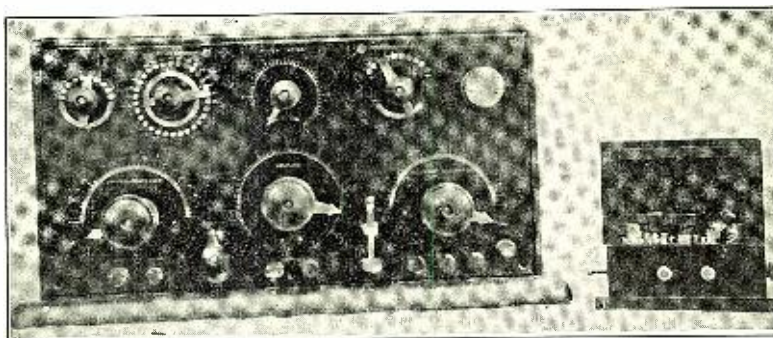

Fig. 1



This Photograph Shows the Size of the Small Receiver Compared to a Big Marconi Tuner, as Used Aboard Ships. Note the Extreme Compactness of the Outfit Described in This Article.

THE accompanying drawings and cuts show the details of an ultra-compact radio receiver made several years ago when the crystal detector was still in more or less general use. While the idea of making the radio receiver in a compact form is not new, it is rare to find one that works efficiently. It is because of the unusual results secured recently with this little tuner that this description is given. The sudden popularity of radio music makes a small receiver popular with the layman in radio. It can safely be said that, within a radius of fifty miles of the radiophone broadcasting stations, good clear music can be picked up on this receiver, not of sufficient volume to work a loudspeaker without amplification, but will be fine and clear in a head-set.

I have found, by recent experiment, that the proportions of the tiny loose coupler have to be kept in a definite ratio to get best results.

The primary coil of the coupler is triple bankwound with No. 24 single silk covered wire and has six taps taken off at regular intervals. The outside diameter of the tube is one and five-sixteenths inches, and one and three-quarter inches in length. This tube, if the size is not available, can easily be made by winding paper strips on a form and keeping them together with shellac. The secondary tube can be made likewise according to sizes given later. Both should be baked in an oven at a moderate heat to dry them thoroughly.

The order in which the turns fall in bank winding is shown in Fig. 3. The taps should be taken off when the turn is on the outside layer, so as not to upset the winding order. In winding the primary tube begin at the end "A" (Fig. 3), the end fastened to the mounting block, and wind until the tube is full, leaving a quarter-inch space at "A" for mounting. The wooden mounting block can be fastened to the case by a wood screw. The inside of the primary tube should be smoothed off and several coats of light shellac applied, to make a bearing surface for the secondary, as the coupling is varied.

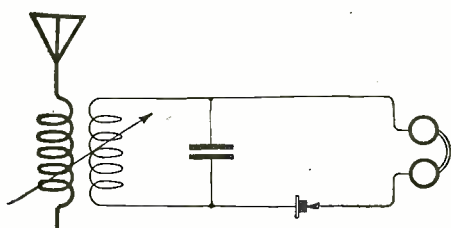

Fig. 5

Wiring Diagram of the Receiver.

When applying the shellac, care should be taken to have one coat dry before applying another.

In order to make the winding in layers, as explained, successfully, the wire should be bent at right angle when taken from the top layers to the bottom ones. See Fig. 3. This makes the winding easy as it is kept in place tightly by the layers wound over the bent portion.

The secondary is constructed along the same general lines as the primary coil. The outside diameter of the secondary tube should be five-sixteenths of an inch less than the inside diameter of the primary tube. The secondary winding is triple bank wound, with No. 26 single silk covered

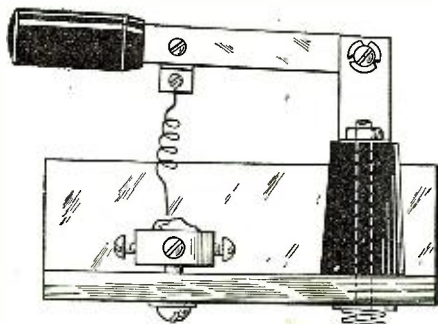

Fig. 2

The Crystal Detector of the Receiver. This Detector is Very Simply Constructed

wire. The leads for taps should be taken off the inner turns and passed through small holes in the tube. The taps should be six in number. The leads for taking these taps to the panel should be made of tinsel or 'phone cord, which will not interfere with the moving of the secondary. After the winding and taps are complete, a coat of insulating varnish should be applied to the winding to make it firm. On top of this winding, which starts a quarter-inch from "B" (Fig. 3), paper is wound, and held in place with shellac. This paper is added until the secondary will just fit loosely in the primary tube, then the outside should be given a couple of coats of shellac and smoothed off. These two surfaces, the outside of the secondary and the inside of the primary are the coupling bearings.

The two wooden ends should be placed before winding, and in the case of the secondary end, all holes should be drilled before placing. They may be held in place with shellac and small brass nails. The coupling guide rod, which fastens to the secondary end, is a one-eighth-inch round brass rod, threaded on both ends, one end

for a knob and the other for two clamping nuts to hold the secondary end. This rod guides the secondary into the primary and prevents its falling about inside the box. A stop should be arranged, if necessary, on the bottom of the case to prevent the secondary from pulling out of the primary. In the original, the detector recess acted as this stop.

The crystal detector is shown in Fig. 2, and needs very little explanation. The arm and hinge clip are from a battery switch, the catwhisker clip is from the contact clip of the same switch, and is fastened to the arm with a machine screw or solder. The column itself should not be over one inch high, as a higher column would make the switch clip touch the top of the case. The tie rod is self explanatory; it may be a long 8/32 machine screw, or a piece of threaded rod. It serves as both a binder and a contact. The crystal cup can be purchased for a small sum in any radio supply store, or can be made from the end of an old gun shell. In either case it is recommended that the crystal, preferably galine, should be mounted in fuscable metal.

The 'phone condenser is made of mica interleaved with nine sheets of copperfoil, one inch by two and one-half inches, and the unit boiled in paraffine as a binder.

The panel of this set is quite different from some of the other midget panels, in that it includes the detector recess. The size and methods of assembly are shown in Fig. 1. It can be made of dry hardwood, substituting wood screws for the 8/32 machine screws, but for the maximum efficiency, quarter-inch bakelite should be used. No method of mounting the panel in the box is shown, since it is unimportant. However, three brass brackets in positions "A" Fig. 1, will prove very satisfactory.

The switch levers can be secured on the radio market, preference being given to a switch which includes a panel bushing. The switch points should be of proper size to match the switch levers. Four binding

(Continued on page 1179)

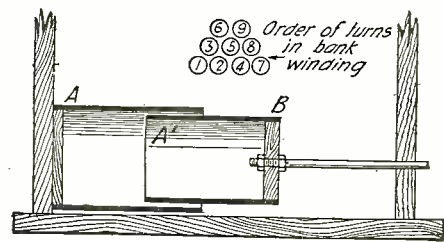

Fig. 3

This Diagram Demonstrates the Method of Winding the Primary Coil.

A Coupled Tuner for Long Waves

By RAYMOND EVANS

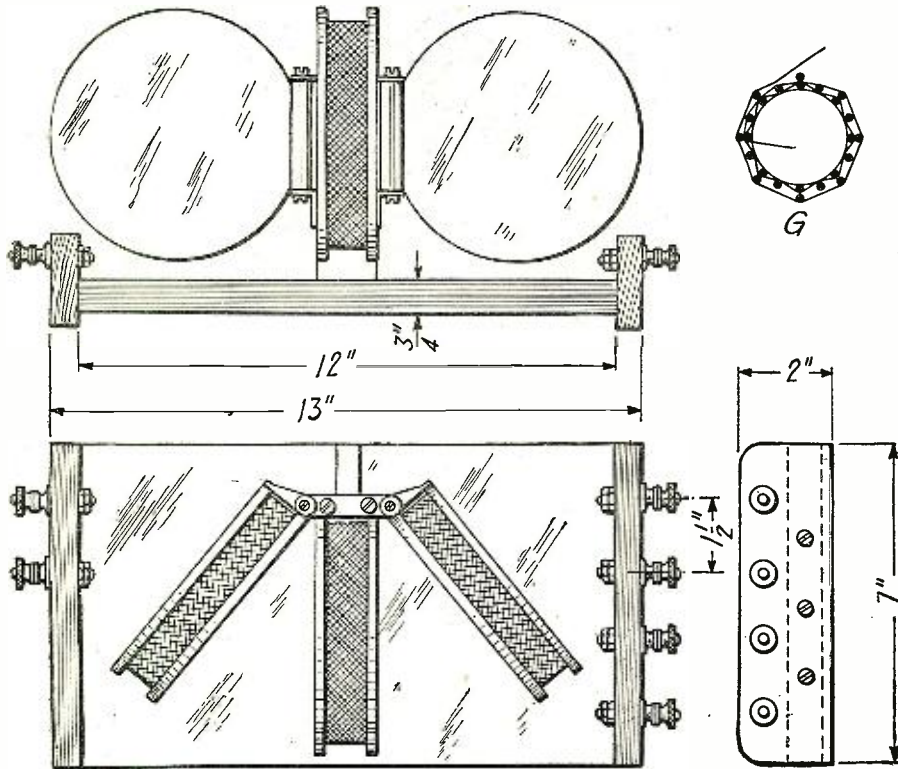
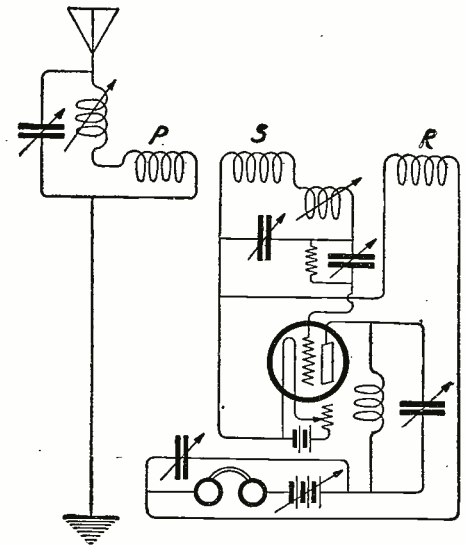

Fig. 1. Plan and Elevation of the Long Wave Tuner Described in this article. Details of the Bakelite Strips With Binding Posts Are Here Shown and the Method of Winding the Inductance Coils.



Wiring Diagrams of the Circuit to be Used With the Tuner Described in Conjunction With a V.T. Detector.

its relatively low resistance at radio frequencies, but should this be beyond the experimenter, good results can be obtained with ordinary cotton covered or enamel wire.

For the base, select a piece of well-seasoned oak or mahogany, 12" long by 7" wide and $\frac{3}{4}$ " thick.

This must be planed perfectly smooth and given a thorough polish with shellac varnish, which, besides adding to the appearance, increases its insulating properties.

The formers or bobbins, of which three are required, can either be turned in the lathe, or built up of three pieces screwed or glued together.

When this operation is complete, they must be given the shellac varnish treatment similar to that of the base.

Two pieces of $\frac{1}{2}$ " sheet bakelite are next to be cut and filed to shape as in Fig. 1, and although primarily intended as terminal blocks, they also act as feet for the instrument, thus raising the base $\frac{1}{4}$ " and leaving a space underneath for wiring.

The bakelite hinge pieces C (Fig. 2), which are required for the primary and regenerative coils can readily be cut and filed from sheet material.

They must finally be drilled and tapped carefully to take the two pivot screws and the two anchoring screws as shown. The anchoring screws are used to secure the ends

(Continued on page 1122)

THE reception of undamped signals at long wave-lengths, is a problem which calls for maximum efficiency of design in the instruments used, chiefly because of certain losses, which, though negligible on the shorter waves, are a matter of extreme importance when working on long wave-lengths.

Of these losses, the ones which require the most careful consideration are: Firstly, losses from distributed capacity effects; and secondly, losses due to the high frequency resistance of the windings. The former can be minimized by spacing all inductance windings and by eliminating dead ends, etc., and the latter, by using heavy gauge or special wire.

In the accomplishment of this, ordinarily, the receiver becomes a most cumbersome piece of apparatus and, with the object of providing a tuner which, though neat and compact, nevertheless does not sacrifice its efficiency, the writer is placing before the readers of this magazine instructions for the building of a coupled tuner which certainly will "deliver the goods."

The capacity of the tuner about to be described, depends largely upon the values of the aerial, and the instruments used in conjunction with it.

However, using average values of loading inductance, capacities, etc., it should readily respond to wave-lengths lying between 5,000 and 16,000 meters.

The writer advocates the use of a separate tuner for shorter waves, with the necessary change-over devices on grounds of greater efficiency.

By examination of the drawings, it will be seen that our tuner consists of three separate coils or inductances, namely, the primary "P," secondary "S" and the regenerative or tickler coil "R."

All three are mounted on a small pillar of wood or ebonite D, the secondary being

fixed, and the primary and regenerative coil capable of movement.

No variations of the windings are made

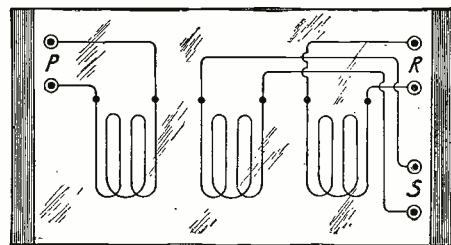

Method of Connecting Binding Post Terminals to the Ends of the Coils. The Directions Should be Carefully Followed.

as is usual by the use of switches, as it has been found that more accurate tuning can be readily accomplished by means of condensers loading coils, variometers and by coupling adjustment.

The inductances are wound with "Lit-zendraht" wire preferably, on account of

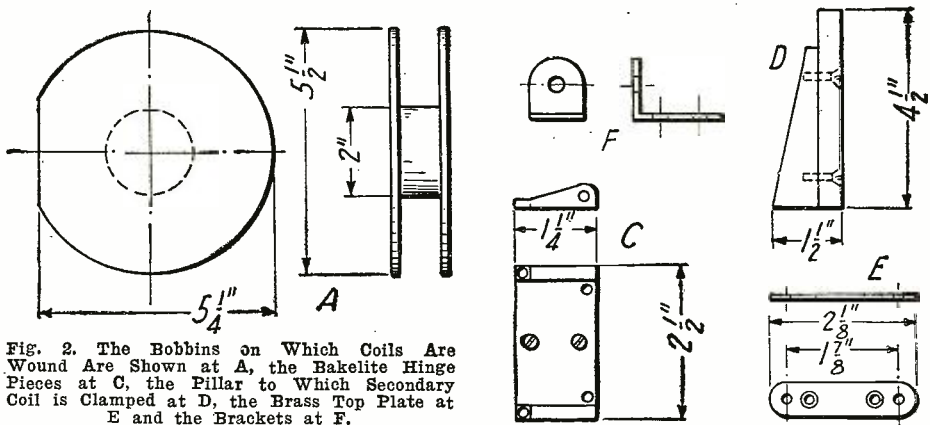
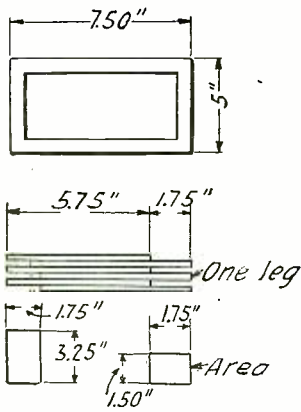

Fig. 2. The Bobbins on Which Coils Are Wound Are Shown at A, the Bakelite Hinge Pieces at C, the Pillar to Which Secondary Coil is Clamped at D, the Brass Top Plate at E and the Brackets at F.

Designing and Building C. W. Power Transformers

By EDWARD THOMAS JONES, I. R. E.



$A = 1.75 \times 1.50 = 2.625 \text{ sq. in.}$

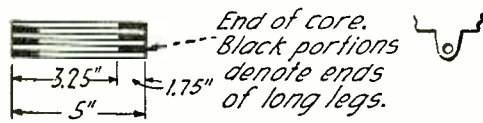

Fig. 1

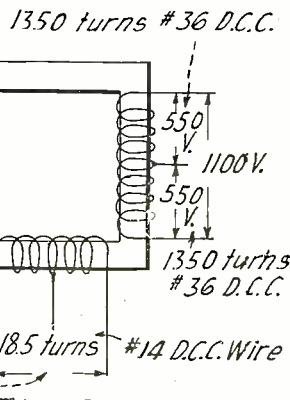

Fig. 2

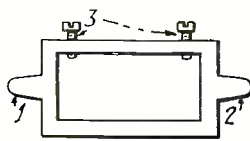
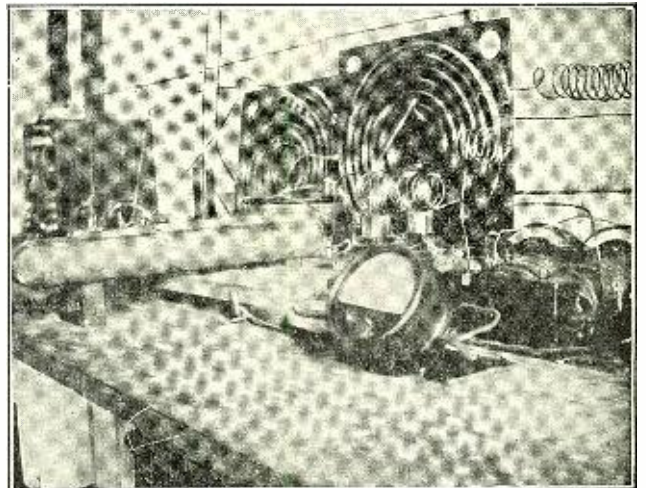

Fig. 3



The photograph shows the author's experimental station. On the left are drawings of the iron core.

where P.v. = Primary voltage
 $I_0_s = 100,000,000$
 a = cross sectional area of the core in square inches
 B = flux density per square inch of core cross section
 f = primary source frequency

Then:

$$\text{Primary turns} = \frac{110 \text{ volts} \times 100,000,000}{4.44 \times 2.625 \times 60,000 \times 60} = \frac{11,000,000,000}{41,958,000} = 262 \text{ turns No. 14 double cotton covered wire.}$$

NOTE.—As a matter of correction—270 turns were allowed and it worked out as contemplated. Number fourteen wire was selected because No. 13 figured and that is the nearest standard kept in stock by most electrical concerns. For merely a matter of record it might be stated that No. 16 double cotton covered wire will do, and very little heat will be developed in the windings at full load.

From the above the secondary turns were easily computed. We already know that the secondary voltage is related to the primary voltage as the ratio of turns between the two varies. Therefore

$$\frac{\text{Secondary Voltage}}{\text{Primary Voltage}} = \frac{\text{Secondary turns}}{\text{Primary turns}}$$

Where = $\frac{1100}{110} = 10$
 Then—10 times 270 (primary turns) = 2700 turns in the secondary.

WINDING THE PRIMARY

Number 14 double cotton covered wire allows 13 turns per inch. Since there are 270 turns to be placed on the primary it will require 20.77" of winding. This is equivalent to five layers and a few turns over—when 4" is considered the length of the winding. To be exact it will take 5.19 layers.

Insulate the primary winding from the iron core with three layers of empire cloth. By laying a piece of electrician's tape under the first few turns of the winding the free end of the wire can be held permanently in that position without the possibilities of its coming loose and causing much trouble after the winding has been completed.

FILAMENT LIGHTING WINDING

The author has had considerable success (Continued on page 1182)

IT is practically useless to repeat to you, readers, that saying which is just rounding into shape, "The old spark set is doomed," for any of you who have kept astride with the great progress made is listening to C.W. and I.C.W. transmitters the country over.

When it was first thought that a 500-volt generator unit was necessary to successfully operate the tube set, many amateurs retreated in great disappointment. Their fears were soon eliminated by the appearance of the self rectification A.C. system, wherein a transformer of special design is employed to furnish both the filament lighting current and the plate high tension voltage. These transformers are for sale on the market and are of great value to the amateur whose house-lighting source is alternating current.

BUILDING THE TRANSFORMER A "CINCH"

If it is possible, try to obtain an old phase-splitting transformer. The dimensions of the core are exactly the same as those given in the drawings. The author bought one of these old transformers from an electrical repair company's junk pile for \$5.00. Only the core can be used to complete the C.W. transformer; however, the phase-splitting transformer windings comprise a primary of three pounds of No. 20 double cotton covered wire. Another primary winding has sixty feet of No. 8

double silk covered wire, and the secondary winding comprises two pounds of No. 25 double cotton covered wire. This wire can be used for other purposes and can be well considered in the bargain. The core consists of pure silicon steel laminations measuring seven and one-half inches in length by five inches in width (See figure 1). The area of each leg is 2.625 square inches, or 1.75 inches by 1.50 inches wide.

Having the core and its dimensions it was an easy matter to compute the primary turns required.

If you are not successful in obtaining one of these transformers already put up as described above—get in touch with some transformer company and purchase the lamination pieces 14 mils thick, in such sizes that it can be easily cut to make the legs described in the drawings.

While there are two legs measuring seven and one-half inches in length it is plain that in each case none of the core strips are over 5.75" in length.

The pieces to fill in the gaps at each end are cut as shown—measuring 1.75" wide and 3.25" in length. They are alternately put in from each leg and lap over each other in the center about 1.50".

COMPUTING THE PRIMARY TURNS

$$\text{Primary turns} = \frac{P.v. \times I_0_s}{4.44 \times a \times B \times f}$$

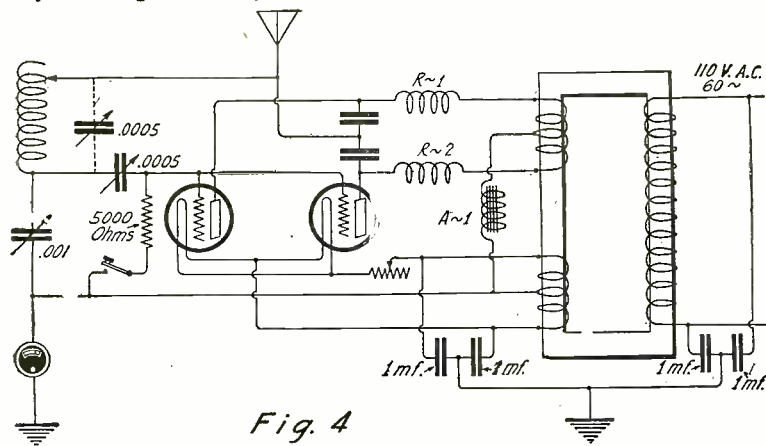
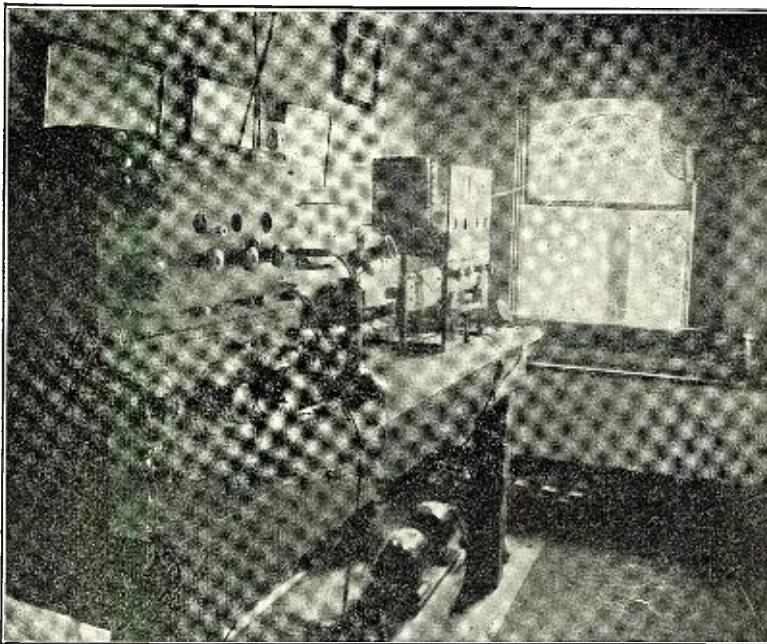

Fig. 4

Hook-up of a self rectifying C.W. set entirely supplied by A.C.

Telephone-Telegraph

By W. K. THOMAS



Mr. Thomas' station. The radiophone and C.W. set may be seen near the window. Note the motor-generator under the table.

THE writer has obtained most excellent results with the use of the four U.V.202 Radiotron tube set which is to be described and pictured here. Dimensions in details are not essential factors, but the general arrangement of various parts should be given careful attention. Keep the audio-frequency and radio-frequency circuits separated. The front panel and in fact all parts are made of $\frac{1}{4}$ " micarta. The front panel is 14×18 ", main shelf 10×14 " and the sub-shelf 4×14 ".

Mounted on the main panel is an antenna current meter in the center at the top. Holes $1\frac{1}{2}$ " are drilled as peep holes for each tube and as the shelf is mounted on micarta uprights 10 " from the top of the main panel the alignment of the holes should be such as to permit a proper vision of the active elements, plate, grid and filament. No rheostats should be used in the filament circuit of these or any other transmitting tubes; vary the voltage by means of tapped primary winding of the filament heating transformer. The general position of all knife switches and their purpose is plainly seen by sketch A. Two milliammeters should be incorporated in the set. One to register the grid current, full scale deflection need not be more than 50 M.A., and another to register total plate current which should be maximum scale deflection of 250 M.A. Three jacks are used and two plugs. With this arrangement the use of but one key is necessary. One of the plugs is shunted across the key, which when plugged in the upper jack on the left-hand side of the panel will make and break the six-volt circuit to the buzzer and when plugged in the right-hand jack on the front panel will make and break the grid leak for continuous wave transmission. The other plug is across the microphone and when plugged in the lower left-hand jack closes the six-volt circuit through the microphone and modulation transformer.

On the main shelf are mounted four suitable sockets, and an inductance coil and buzzer. Some of the sockets on the market today are not suitable for tube transmission with a tube whose filament rating is even as low as 7 volts, 2.35 amperes. The inductance has an overall size of 7 " diameter and $9\frac{1}{2}$ " high, being wound with

No. 10 bare copper wire, 35 turns $\frac{1}{4}$ " apart. Micarta uprights are bolted at each end to the outside of a micarta tube, which has previously been blocked in the center and at both ends with a wooden disc to prevent sagging. The wire is then wound in grooves and fastened at both ends securely. The builder can readily devise some sort of suitable clip for No. 10 wire.

On the small sub-panel, parallel with the main panel mounted on another set of uprights, are the modulation transformer, grid condenser, grid leak, plate condenser, audio-frequency choke coil, and two radio-frequency choke coils. The grid condenser is made up of seven pieces of copper foil $.002 \times 1\frac{1}{2} \times 2\frac{1}{2}$ " as conductors with very thin strips of India mica as dielectric, pressed and immersed in boiling paraffine. For the grid leak a Ward Leonard tube of from 3,000 to 5,000 ohms should be used. a resistance of 3,000 ohms was found to be the best value. The plate condenser used is a .25 mfd. condenser, but any that will stand the operating plate voltage is suitable, in fact a duplicate of the grid condenser is satisfactory. This condenser prevents a short on the plate supply. The audio-frequency choke coil is made up of approximately 3,000 turns of No. 30 D.S.C.

wire wound on micarta square tube that fits snugly over the center leg of a stack of "E" punchings, the dimensions of which are shown in sketch "B." Both radio-frequency choke coils are wound on micarta spools, the dimensions of which are shown in sketch "C" and should be wound full with No. 30 D.S.C. wire. These spools do not necessarily have to be made of micarta, but can be constructed by using cigar box wood.

Across the back micarta uprights that hold the rear of the main shelf is bolted a micarta strip 1×14 " on which is arranged the necessary connecting posts, for filament, plate, grid, buzzer, microphone supply and are arranged as shown in sketch "D."

Various sources of plate supply have been experimented with, the most satisfactory being the motor-generator, which is a direct coupled affair, delivering 150 watts at 440 volts. The filament supply is obtained by stepping down the 110 volts (60 cycles in this case) to 7-8 volts. Across the secondary of this transformer is shunted a 100-ohm resistance, the center of which is tapped to obtain the same effect as actually tapping the center of the winding. A suitable transformer for this purpose can be made by using No. 10 D.C.C. wire as the secondary with 35 turns and No. 22 D.C.C. wire for the primary with from 350 to 400 turns, tapped for variation of output. These windings can be wound on a micarta tube $2\frac{1}{2}$ " long, primary winding directly over the secondary and assembled in either an "E" shape or square "O" shape. There are so many designs of transformers that may be used for this purpose that one can usually obtain a suitable transformer, such as a discarded sign lighting transformer; however, sketch "E" shows a transformer that has little or no drop, regardless of whether one or five U.V. 202 tubes are being operated. A good 5 mfd. condenser should find a home across the generator or plate supply, and if necessary more than one audio-frequency choke coil.

Using this set, operating continuous wave with 2.4 amps in the antenna at a wave where the resistance was 8 ohms, the signals were copied by Mr. Jack Stevens, at Catalina Islands, California, approximately 3,000 miles, on the night of April 19, 1921, and also by Mr. Farmer, operator on board S.S. West Prospect when 2,750 miles west of San Francisco, making a total distance of almost 6,000 miles. Nightly communication has been carried on at distances of

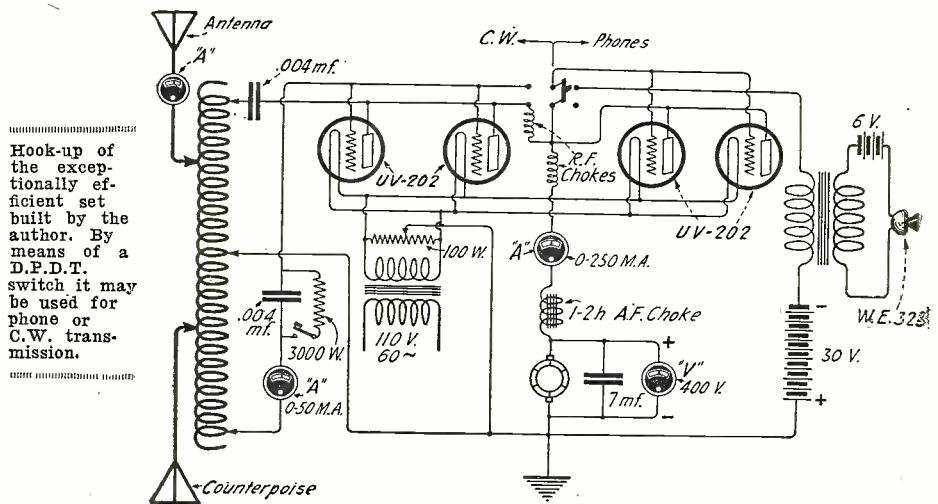

Hook-up of the exceptionally efficient set built by the author. By means of a D.P.D.T. switch it may be used for phone or C.W. transmission.

from 300 to 1,200 miles. The voice, 1 amp. and current (two modulators and two oscillators) has been heard as far south as Florida, east to Philadelphia, and north to Michigan. About a year and a half ago, 8LF was never heard farther than Ellendale, North Dakota, and was using 1,000 watts spark input with 5.1 amps. in the same antenna. Total watts input to antenna using spark was 246 watts and on C.W. 46.8 watts. Six times the distance has been covered with 200 watts less input. Efficiency on the spark transmitter was about 12 per cent and on C.W. 61 per cent.

The antenna system is composed of six parallel wires 3' apart and 65' long, suspended at the far end on a ship-mast affair on top of a telegraph pole planted in the rear of the residence, and the house end is a mast on the house, both 45' above the ground. The counterpoise is exactly the same size, suspended on the same supports, 10' above the ground. This antenna has a low natural and also low resistance, and operates most efficiently at approximately 200 meters.

The receiving equipment shown in the photograph was discarded some time ago, being substituted by a Mentho Radio receiving set, being a single circuit receiver, detector, and two-stage amplifier. Continuous wave signals are received exceptionally well on this receiver and with perfect ease, free from all body effects.

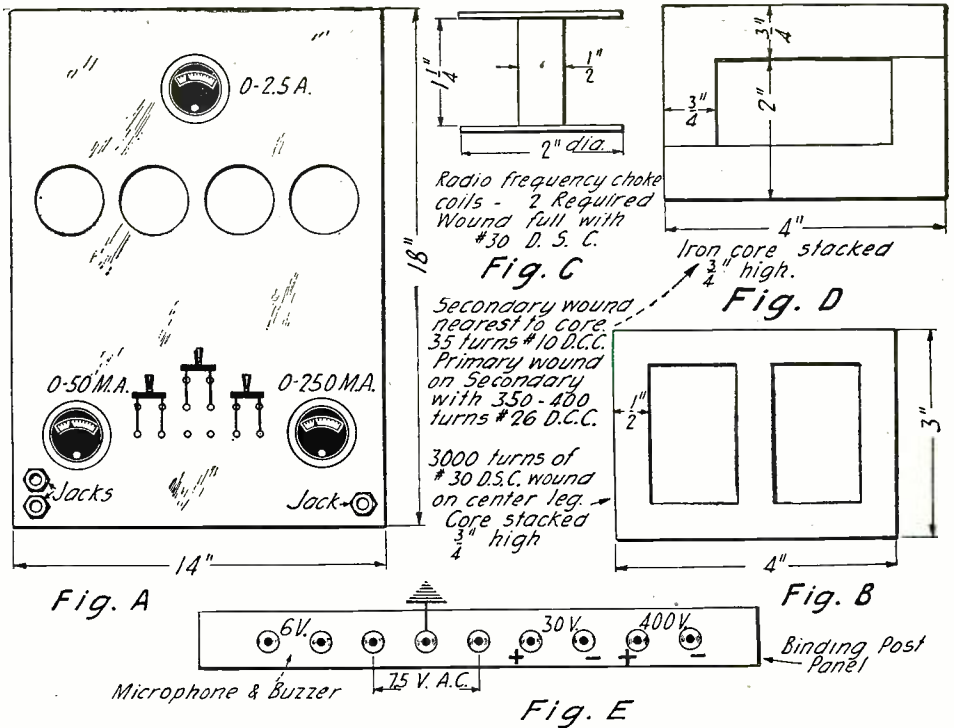

Data for the Construction of the Transformer and Choke Coil is Given Here With the Layout of the Panel.

Design of An Audion Control Cabinet

By GLENN E. FLINT

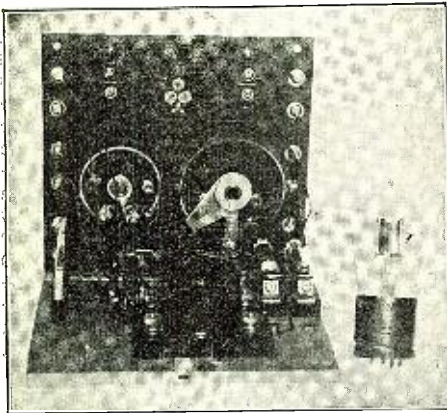

Thanks to the Multiple Controls, a fine Adjustment of the V.T. is Possible, Insuring Maximum Efficiency.

WHEN I became a "Wireless Bug" I wanted something a little different than I could find on the market in the line of a tube control cabinet. With a little common sense and labor I designed one which is very compact and thoroughly convenient in using the various hook-ups. I believe it will meet with the approval of other amateurs, therefore I will attempt to place the "dope" at your disposal.

Below is a list of material and equipment needed. The amateur will find everything "standard" and easily procured.

LIST

- Bakelite for panel, 1/8" x 6" x 6".
- Twelve "Rasco" Binding Posts, No. 201.
- Two Connecticut Switches, No. 15-Y.
- One Federal Tel. Jack., open circuit.
- One Federal Tel. Jack., two circuit.
- One Remler tube socket.
- One Radio Corp. Grid leak and mounting.
- One Radio Corp. Grid Cond. and mounting.
- One Radio Corp. Potentiometer (wire wound).

One Paragon Rheostat.
 One Cond. for shunting across Tel.
 Two 2" Dials to be mentioned later.
 First lay out the panel and drill as in Fig. 1, which shows all measurements. In all cases a 1/16" hole should be drilled first as a larger drill if not sharpened accurately will "travel off." The measurements for the binding posts on the right-hand side of the panel are identical to those on the left, therefore have been omitted in the drawing. Holes for the binding posts are 3/32". Holes for potentiometer shaft and rheostat shaft are 17/64". Holes for mounting above two instruments on panel should be laid out by marking through the screw holes onto panel with sharp scriber. The holes at "F" are for observing the tube in operation and the design will be left to the builder. For the two Conn. switches "C" lay out a 7/8" circle centered as shown. Just inside this circle drill 1/8" holes until center piece falls out. Smooth up with a round file leaving 7/8" holes for

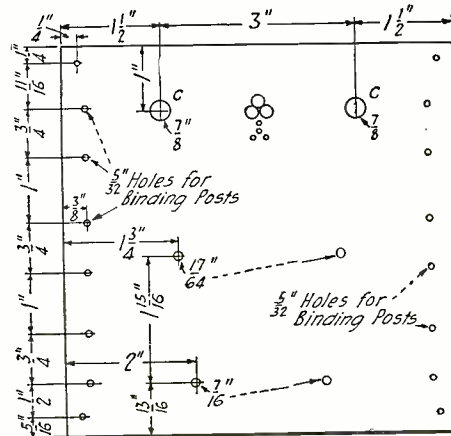
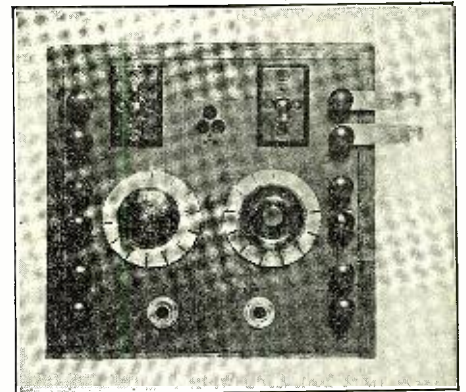

Fig. 1

This is the Layout of the Front Panel, With Dimensions of Holes to be Drilled.



External Appearance of the Completed Unit.

barrels of the switches. Holes for the switch plates should be laid out in the same manner as for the potentiometer and rheostat. They should be drilled and tapped for 6/32" bolts. Flat-head machine screws are used. Bakelite takes a thread nicely if care is used. The holes for the telephone jacks are 1/16". The open circuit jack is mounted to the left and the two circuit jack to the right (facing front of panel). Explanation of the jacks will be taken up later.

After the panel is drilled it should be mounted permanently on a sub-base as in Fig. 2. By using this idea everything may be withdrawn from the cabinet for inspection without breaking any connections or using flexible leads as is the case where instruments are mounted in the cabinet proper. The cabinet does not need much explanation beyond that given in Fig. 2, except that the panel should fit inside the front. The cabinet base as shown has a groove cut 1/8" from the top and front edges. Mounting the sub-base on the panel 1/8" up from the bottom leaves a portion of the panel to fit in the groove of the cabinet-base, thus keeping the panel-front flush.

(Continued on page 1185)

Shall We Put the Brakes On Radio?

By ARMSTRONG PERRY

ABOUT once in so often someone gets the idea that the operation of natural laws is all wrong, and starts out to put the universe on a practical working basis.

Old King Canute was a conspicuous example. The tide did not suit him and, although he was too lazy to walk to the beach he expected to have energy and authority after his carriers had toted him there to stop the waves when they had washed as far up the sand as he wanted them to go. He was in a position to exercise a more powerful influence over the writing of history than over the effect of the moon, but it has leaked out to posterity that one or the other of two things happened: either Nutie moved or he got wet.

A less influential and more timid man is commemorated in a once popular song:

"Oh, Mr. Captain, stop the ship.

I want to get off and walk."

Official records in this case show that the r.p.m.'s of the propeller did not diminish, and if the would-be pedestrian alighted from the vessel before she reached her destination he had the choice of two things, neither of which was walking.

Radio sales gradually picked up speed with the public from the time when the first keen youth discovered that he could play with the science, to the time when it was found that a whole show, lecture or church service could be thrown to the winds and then caught and utilized by isolated individuals shut off from the amusements, instruction and religious solace of the city. Then suddenly these sales shot ahead at a rate that made the manufacturers and dealers dizzy. Now some of them are crying: "Hold up! Wait a minute! Give us a chance to catch up!"

According to their imperialistic ideas, or their timidity, some of them are imitating King Canute and others are repeating the prayer of the sea-sick voyager. Will the tide and the ship stop?

One dealer said to me:

"I have visited every manufacturer of any account within a thousand miles. I have placed good sized orders in a score of places. The apparatus comes through only in dribbles—one receiver on an order of five hundred; one amplifier where I ordered two hundred. I wish that for three months manufacturers would stop their advertising and stop talking for publication. When I cannot make deliveries to my customers they get sore. There is going to be a reaction that will hurt the business all along the line."

And a manufacturer said: "I do not know whether it is safe to increase my plant and output to meet the demand or not. Such a strong wave of interest is sure to collapse sooner or later and be followed by an ebb tide that will leave some of us high and dry if we are not careful."

These gentlemen were both looking at the matter in the light of long business experience. A layman like myself is not in a position to dispute their arguments except on the basis of the experience and observation of the average man who is only a radio

customer and user. It is my opinion, formed from this point of view, that the conservatives will have only the choice between getting onto the band wagon or taking their positions beside the clown with the donkey cart.

That radio is a fad, in some of its phases, is proved by the fat push-cart ladies in the metropolis who now display tuners where once they sold tunics and who have added a line of transformers to their stocks of "transformations." That it is a speculative business in some of its phases is proven by the traders who picket the radio stores and rush in to bid on every consignment received, even before the box is opened. Customers just now are paying bonuses to get apparatus. That there will be ebb tides as well as flood tides is as inevitable in radio as it is in the ocean. But, considering the fact that chewing gum is still sold from push carts, that cigarette smoking, the fad without an excuse, is nicotineing the lungs of increasing thousands of women as well as of men, the only conclusion that I can

MR. PERRY, in this article, has touched a vital chord in the Radio situation. Almost everyone wishes that things in Radio were not moving quite so fast. Everyone for his own selfish reasons naturally wishes that a guaranteed boom should only have started six months from the time it actually did. This is mainly the case with all manufacturers who are losing sales to-day, simply because they were not ready.

But we might just as well attempt to stop the earth in its orbit, for all the good our complaints will do. We were all caught unawares and we now have to pay the penalty. Nature itself, however, will put a temporary stop to Radio activities. We are certain to see during the next three months, a slackening up of the public's interest in Radio, due mainly to seasonal changes such as vacations, static, and also for the reason that during the summer time more people are wont to be out doors than during the fall, winter, and spring.

Everyone interested commercially in radio has the greatest possible chance he ever had to catch up during the summer months, and prepare for a boom that will be at least twice as great during the coming fall and winter, as the one we have just witnessed. If our manufacturers and dealers are wise, they will look into the situation during the next few months and get ready for the radio avalanche which is sure to bear down upon us, beginning with October next. This is not an idle prophecy but it is made with full knowledge of all facts at hand.

—Editor.

reach is that the demand for radio apparatus, which has everything to recommend it to the popular mind, will develop according to the natural laws of such things and that someone will supply the demand. The fellow who tries to stop the ship now may be only expressing a conservatism which, closely coupled with sound judgment, will bring in a lot of power later on. And the optimist may op himself into a tight place. But neither is going to do much to the tide of interest that would not happen anyhow, for it is too high, too broad and too deep to be much influenced by the views of any one man or any one group of men.

The gum habit is based on the desire to eat after the stomach will hold no more. The cigarette habit, the psychologists say, has its roots in the sucking instinct, which is among the earliest to appear in the human animal but is normally laid aside at weaning time. The radio habit grows from the same instinct that has supported all the slower means for the communication of ideas.

Radio is fundamentally a means of communication, not merely a form of amusement. Has history ever furnished an instance in which a means of communication has been discarded, except for a better means of communication? Some very old methods are still in use where the newer ones are not yet available. Runners run with messages in Africa. Letters are carried on horseback in some parts of the United States. But the moment the railroad train, the steamship, the automobile and the airplane; the telegraph, the cable, the telephone, and radio became available, communication increases so rapidly that congestion occurs as often as dullness in the business that it creates.

Air jazz may pass out, but the history of the phonograph robs us of the hope that it will go until some more fiendish formula for mixing unrelated sounds is discovered. Sermons from the sky may come to have as slim an audience as many of those preached to empty benches in churches and synagogues that ought to be filled, but at birth,

marriage and death if at no other times humans have always felt the desire for an authorized representative of organized religion. This sustains the church when all else fails. Spiritual advice and instruction will always find a place in the air. Lectures may lose some of the thrill newly added to them by the mystery of listening to a speaker in a distant city, but there have always been seekers after knowledge and wisdom and the enormous increase in the numbers of students in colleges and universities is a guarantee that for many years to come there will be alumni who will keep up an active demand for the serious radio address. Presidents, Cabinet members, bureau chiefs, Congressmen, Governors, thousands of men in public life, have many more invitations to speak than they can possibly accept. Hero worship is as old as the world and if there ever comes a time when there will not be enough interested common

citizens to make an audience for a prominent man with a message it will be a reversal of all the history of all the ages.

The Apostle Paul, in his speech to the Athenians, told them that he had discovered in them a thirst for news. Today we can compare it with the rush to buy a special edition of the daily paper. News by radio has become so popular already that the Associated Press has been obliged to protect its members who are not provided with broadcasting stations by forbidding the use of its service in radio broadcasts. What could happen to destroy an instinct that has persisted for twenty centuries and probably many more?

Music, good music, has been a priceless possession of humanity for more centuries than the historian knows. It has developed to a point where the mastery of a voice or an instrument can be achieved only by one who devotes a lifetime to the art. No auditorium is large enough to hold the music lovers who want to hear Galli-Curci, McCormack, Mary Garden, Elman, Hoff-

(Continued on page 1172)

The Eiffel Tower Radiophone Broadcasting Station

HAVING heard of the tremendous success of the radiophone broadcasting in this country, General Ferris, head of the French Army Signal Corps, recently decided to organize such a service for the benefit of the public within a radius of 1,500 miles from Paris. The same kind of information and entertainment as broadcasted here, is transmitted by the Eiffel Tower station every evening for a few hours, and at present the interests of the population for radio is growing as it did here a few months ago.

The transmitting set, which is shown in the photograph, makes use of several oscillator tubes in parallel, upon the grid of which the voice and music, previously amplified, is applied. The amplifier consists of six power tubes, which may be seen on the top of the cabinet, and the oscillator of

of the tubes when compared with it.

At the present time, the radiophone transmitter used for broadcasting purposes is only an experimental one, but it is the intention of the Signal Corps to erect a more

direct communication between Paris and London. Arrangements have been made with the Post Office department to permit direct communication between a subscriber in Paris to a subscriber of the telephone service in London. At the present time experiments are being carried on to determine the practicability of this Duplex system, and it is expected to have a regular service installed very soon. Another transmitter will also be installed for the communication between a telephone subscriber in Paris and a ship at sea, or an airplane travelling between the two cities. This has already been accomplished by means of special stations installed at the aerodrome in both Paris and London, but the power used in the transmitting sets does not always permit a constant communication during the whole trip. As soon as an airplane is over the

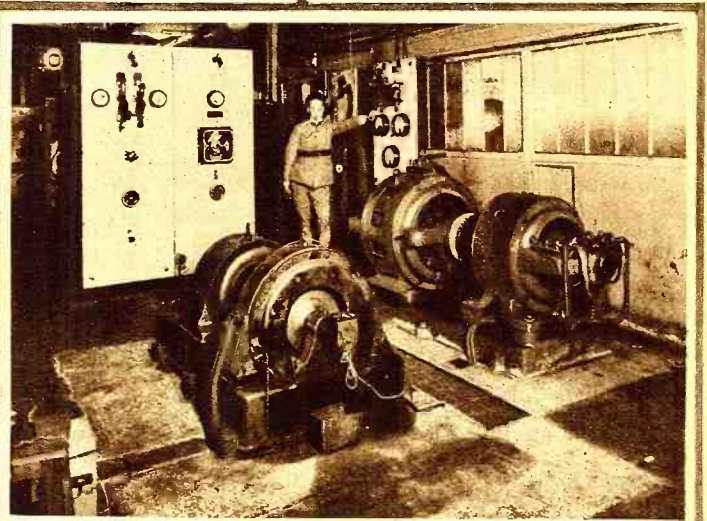
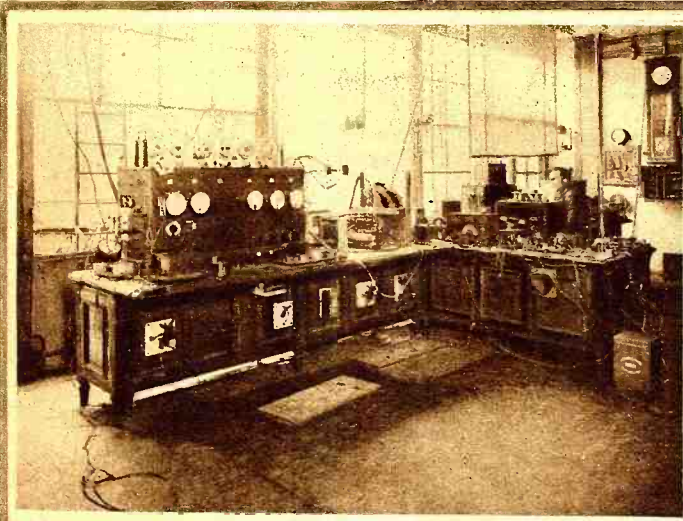
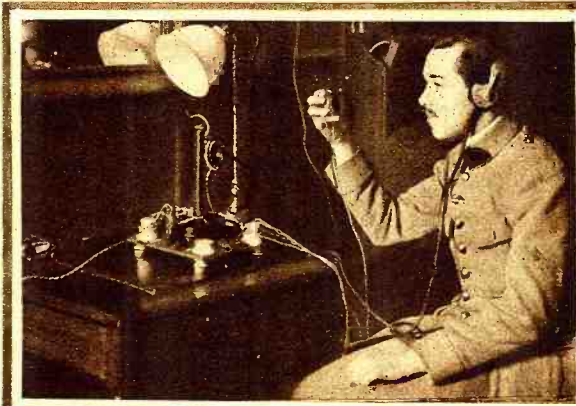

Three high power tubes supplied with 2500 volts D.C. on the plates. The transmitting room, which is situated at a distance of about 60 ft. from the set, is equipped with the proper microphonic devices for the reproduction of voice and music. The efficiency of this radiophone transmitter was recently demonstrated when a North African station, receiving on a loop aerial, was able to entertain 35 people with a Parisian concert, thanks to a loud speaker. This station is exactly 1,450 miles from Paris.

Previous to this transmission by means of vacuum tubes, experiments were carried out with a high frequency alternator shown in one of the photographs. These were successful, but since the advent of the vacuum tube, the high frequency alternator was no longer used on account of the greater flexibility

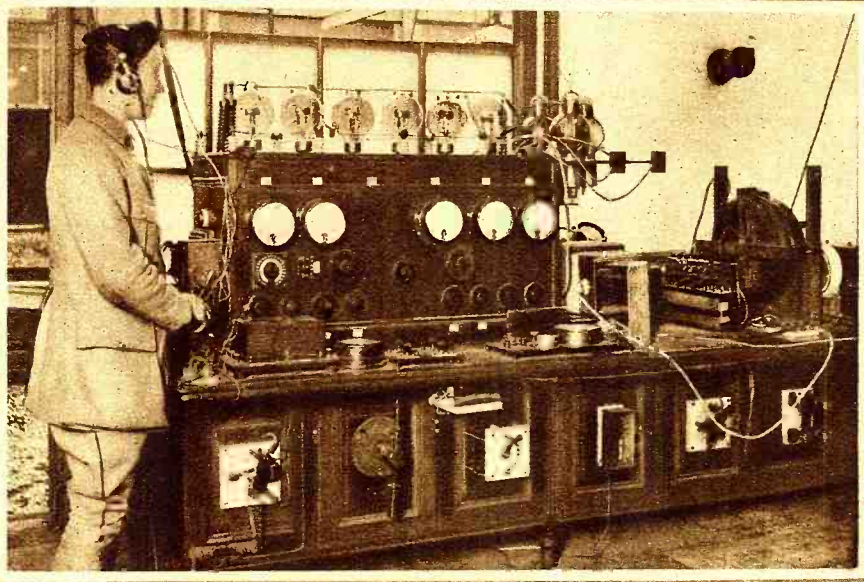

The Top Photograph Shows the Operator Announcing the Program in the Special Transmitting Room. Below Are, on the Left, a General View of the Complete Transmitting Room and on the Right the High Frequency Alternator Used in Early Tests. The Lower Picture is a Close-up of the Radiophone Set Which Radiates Over 800 Watts in the Aerial. On Top of the Cabinet Are the Amplifier Tubes and on the Right the Oscillators.

channel communication becomes difficult and it has to reach one of the coasts to obtain good communication with the nearest station.

With a powerful set, which is to be installed in the Eiffel Tower, according to present plans, it will be possible to keep in touch with any of the persons travelling between Paris and other European cities.

At the present time the airplanes and ships, travelling between England and France, enjoy the concerts sent every evening, while in the air or at sea. In every case the speech has been reported perfect from very distant points and this proves that the radiophone has reached a certain degree of perfection.

powerful set for permanent service in order to be sure to reach all parts of France.

Another purpose for which the radiophone transmitting set may be used is for the

When one remembers the old arc radio telephone, which produced beside the voice a series of noises, one appreciates the improvements made recently.

Official Uses for Radio



©Underwood & Underwood.

Mr. T. C. Gale, at the Government Station at Washington, is Broadcasting the Weather Reports, Crop Reports and Other Government Messages to the Public.

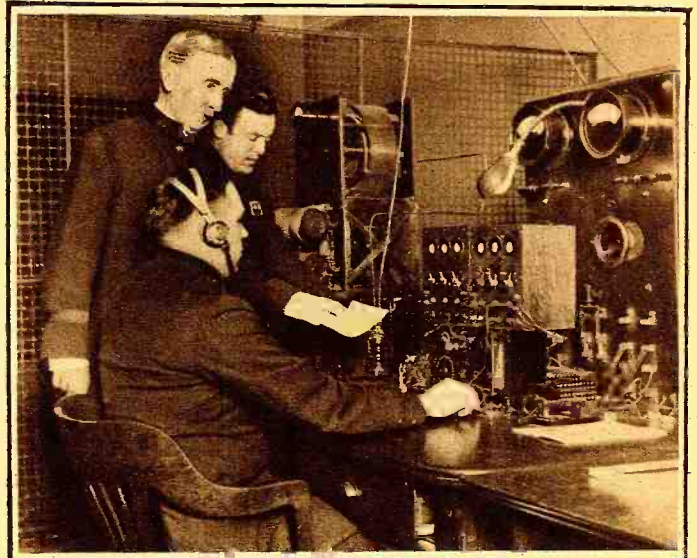

©Kadel & Herbert News Service. New York

The New York Police Department Radio Station. This Station is in Constant Communication With the Police Boats in the Harbor.

THE government is utilizing radio in a multitude of ways. Never before has radio been adapted for so many purposes as it is now. Each day some new field is found for it. By means of radio the government is now able to keep in closer and more personal touch with the people. When there is some important communication to make known, it is addressed directly to the homes of thousands by radio-

phone, sometimes before the newspapers have even had a chance to print it.

Each day the government station at Washington broadcasts on schedule, information of all kinds. We learn the weather reports; to some of us this is merely interesting, but to others, of vital importance. The farmers are given the crop reports and market quotations on their products. In many other ways official informa-

tion is given to the public.

The Police Department of New York has just installed radio transmitting and receiving apparatus at Headquarters, and is finding it extremely useful for communication with the police boats in the harbor, and in these days of bootlegging and smuggling, the air is sometimes kept busy with hurried calls for reserves from the

(Continued on page 1162)

The Very Latest in Radio Sensations

ED. WYNN is very much worked up about radio, ever since his show was broadcasted some weeks ago. The "Perfect Fool" threatens to become a choice specimen of "radio nut." Having carefully addressed what appeared to be a

soup-plate in place of an audience for about two hours, and having been assured that his voice was being carried to millions all over the United States, Ed. simply had to find out what it was all about. He temporarily abandoned his statistical con-

sideration of the number of people in the United States who prefer to eat with their knives and drink coffee out of their saucers, to study a small primer on the art of radio. Of course, in a few days

(Continued on page 1162)

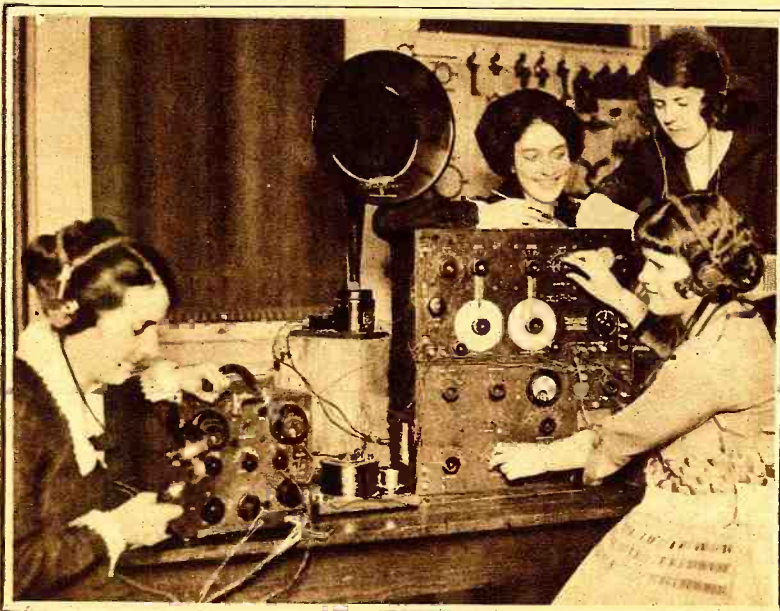

©Underwood & Underwood.

The Girls at Radcliffe College Have Found Quite a New Thrill in Transmitting and Receiving Radiophone.

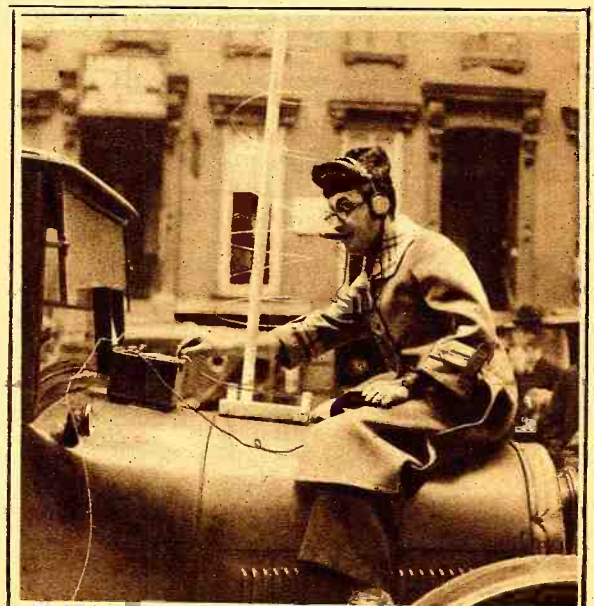

Ed. Wynn Was Found in This Strange Attitude by the Camera Man. He is Trying to Pick up the Show he Broadcasted a Few Weeks Ago.

Real Radio Experimenters



©Keystone View Co.

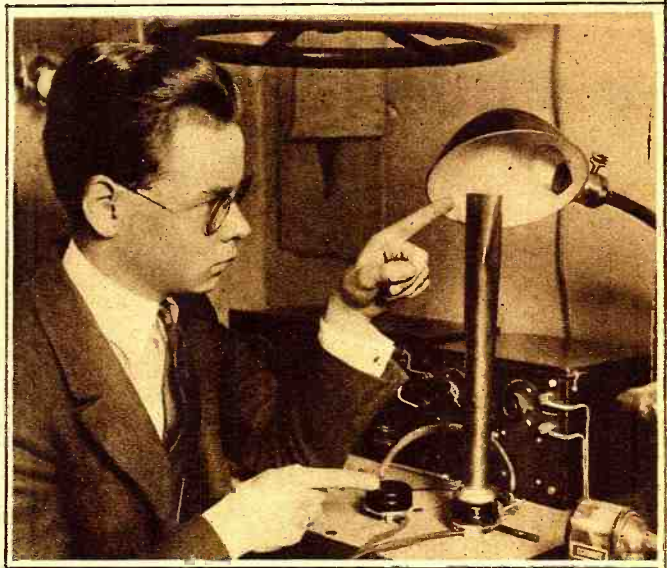

©Kadel & Herbert News Service.

This Young Man Has Cleverly Adapted a Tin Horn and an Electric Light Reflector Into a Radio Loud Speaker. The Two Amateurs on the Left Are Conducting Experiments on Transmission and Reception of Radiophone Using a Tree as an Antenna.

EACH day and each evening there are thousands of people in the United

sity for ability of any kind in tuning to a minimum. The apparatus has been disguised

States who listen and enjoy the information and concerts broadcast by radio. They have purchased receivers but know little or nothing of their operation. The manufacturers of the receivers have reduced the neces-

and camouflaged until it looks like a phonograph, or a washing machine, or anything, in fact, but a piece of radio apparatus. This is as it should be. The great majority of the public have not the time or inclination to study the theory of radio or the operation of the receivers. They want their receivers operated by pushing a switch, and the manufacturers are catering to their wishes.

But there is another class among those who listen in—the great body of amateurs who have for years, been experimenting with radio and partly through whose ei-

(Continued on page 1157)

Radiophone in New York Hotels

"CALLING Mr. James Smith!" shouts the hotel bellhop. "Here you are, boy, I'm Mr. James Smith. Who wants me?"

"Mr. Jones on the 'America' wants to speak to you on the radiophone, sir. He's 300 miles out to sea. Just take the nearest telephone booth. Thank you, sir."

Mr. Smith went to the telephone booth and spoke to Mr. Jones on the America. From the booth he held a long conversation with his friend who was comfortably reclining on a settee in his stateroom on board the S.S. America, miles out to sea.

A little later on, Mr. Smith went to his bedroom on the twelfth floor of the hotel and, being rather bored and in need of entertainment, he glanced through the program in the newspaper of the local broadcasting station. He found a selection that he fancied would please him and lifting the telephone receiver, he spoke to the telephone operator:

"Will you give me a call at 8:30 and let me hear Miss Aether when she sings the Rosary?"

No, this is not a fanciful dream. We are

not conjuring up possibilities for the year 1923. It is actually happening or about to happen here and now in several New York hotels. And it is only beginning.



©Kadel & Herbert News Service.

The Receiving Set in the Telephone Exchange of the Hotel McAlpin With Mr. H. R. Martin, Telephone Manager, Tuning In.

Mr. Augustus Nulle, of the Waldorf Astoria, and the McAlpin, in co-operation with Mr. H. R. Martin, telephone manager, was the first to inaugurate this service. It has been taken up by Sherry's and the Claridge and others are following in line. There will soon be no hotel complete without it. The people demand it and, in conformity with the slogan of the New York hotel service, what the people want they must get if it is possible to give it to them. Mr. Nulle and Mr. Martin have demonstrated it to be not only possible but easily accomplished.

The Peacock Alley of the Waldorf has long had its attractions, but they must look to their laurels since the "loud speaker" has appeared in all its familiar and

(Continued on page 1158)

The Lackawanna Railroad Radio Experiments

By DAVID W. RICHARDSON



©Underwood & Underwood

Edgar Sisson, Jr., Who Accompanied Mr. Richardson on the Experimental Railroad Trip.

ALL those who are interested in radio, remember back before the War in 1914, when the Lackawanna Railroad instituted the world's first wireless communication from a moving train to stations located in the principal cities along the route. Considerable success was achieved with the apparatus then available, but the War came along and further development ceased for the time being.

It was not until March 22, 1922, that tests were again started with better equipment and the advantage of recent developments in receiving apparatus. The first test made was with a temporary one-wire antenna on a single car, on a short run out to Morristown, N. J. On this run, using regenerative circuit, a detector and two-step amplifier, amateurs along the way were copied, and WJZ at Newark, N. J. was received with considerable strength at a distance of about 25 miles.

Two days later, another temporary antenna was installed on two 70-foot cars lying in the yards at Hoboken. A 15-watt radiophone transmitter was tested, and with better receiving apparatus, we were heard

nine miles out from the Hoboken yard. The receiving results were remarkable. Many stations were copied.

Among those which came in best were 3AHN, readable some 50 feet from the loud speaker, 1ARY, readable all over the car, 9ZL on C.W., readable 70 feet from the loud speaker, 9XI on C.W., readable at 40 feet, and 5EA. In fact every district except the 6th and 7th was heard some time during the evening. This proved conclusively that reception was possible even with a low antenna, only six inches above the

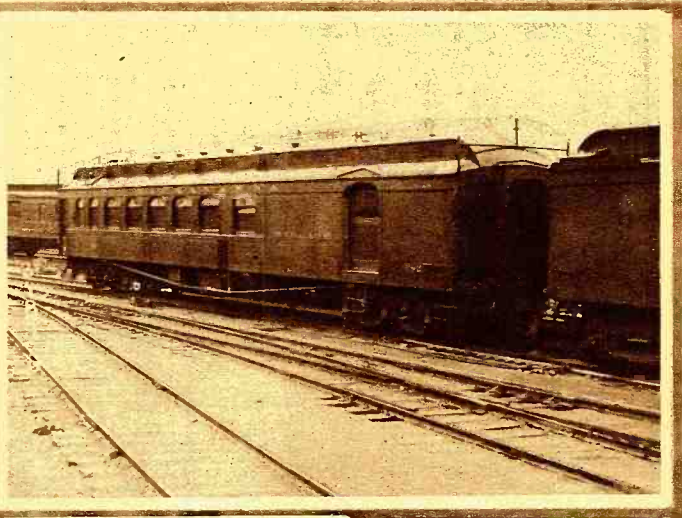

©Underwood & Underwood

View of the Train on Which Experiments in Transmitting and Receiving Were Conducted. Note Antenna.

top of the cars.

A test on Sunday, March 26, gave, however, still more gratifying results. A buffet car was equipped with three 4½-inch, six-wire cages, one on each side, and one in the center. The same 15-watt phone set was installed and a detector two-step amplifier, in conjunction with a regenerative set, was used. This car was placed in the Lackawanna Limited, leaving Hoboken at 10:20 A. M.

Underneath the iron superstructure of the terminal, a few local amateurs were picked up, and one or two radiophones, readable on the loud speaker. After leaving the terminal, there was a great increase in signals, and as the Bergen tunnel in Jersey City was approached, many local amateurs were picked up. Inside the Bergen tunnel, which is 4,283 feet long and 90 feet underground, one or two C.W. stations and several ships were heard distinctly. Upon emerging from the tunnel, signal strength increased with a "bang." Going through Newark and the Oranges, various tests on the transmitting set were conducted, and no effort was made to receive. Upon reaching Stroudsburg, Pa., a telegram awaited our arrival
(Continued on page 1199)

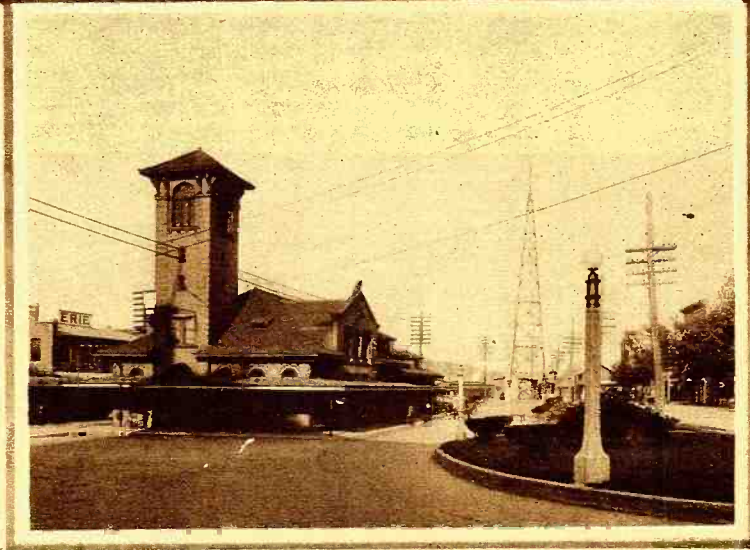

One of the Stations Along the Line With Antenna Tower Erected to Communicate With the Train.

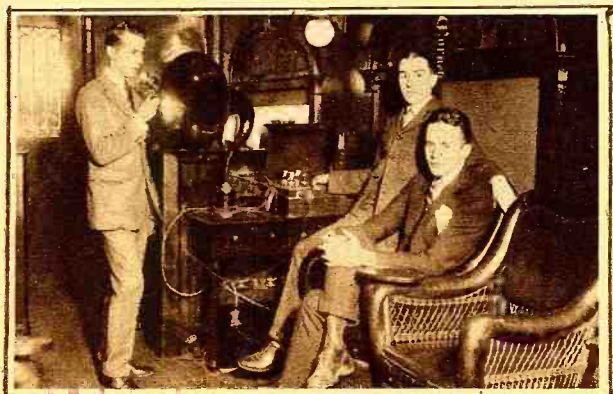

©Keystone View Co

Interior of the train showing transmitting and receiving station. Right: Close-up of the antenna system.

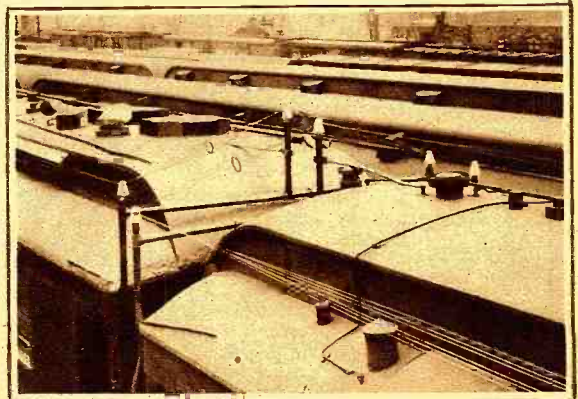

©Keystone View Co

The Brooklyn Radio Show

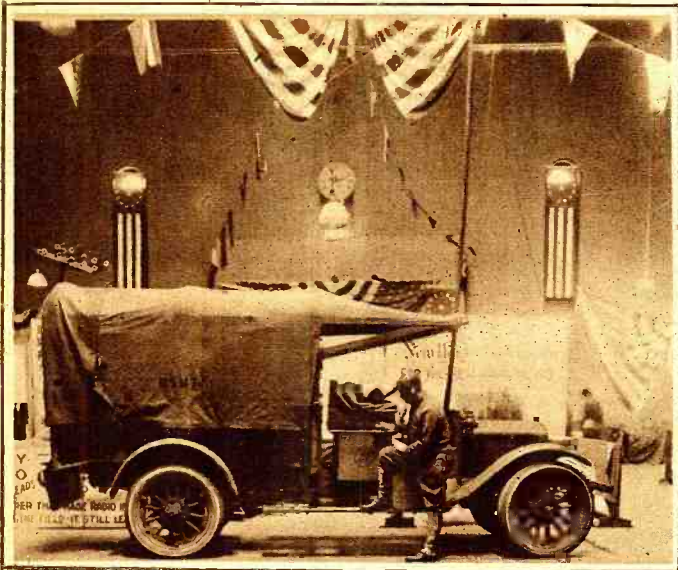

The Signal Corps Exhibited a Field Radio Station Completely Equipped in a Truck. Note the Antenna Mounted on top of the Truck.



The U. S. Navy Had a Very Interesting Exhibit of the Types of Radio-Phone Transmitters and Receivers Used on the Battleships and on Seaplanes.

AFTER many strange wanderings in what we were previously satisfied were uninhabited portions of Long Island, we discover that Brooklyn is really quite a large place. We were attempting to go to the Brooklyn Radio Show, but no one seemed to know exactly where it was and, in any case, we never have been able to arrive anywhere in Brooklyn without losing the way at least twice. We rode on the old subway and on the new subway and on various other subways that seem to have sprung into existence since we last visited Brooklyn. We passed through innumerable underground passages and eventually found ourselves hurrying gaily on an express to Coney Island under the serene and misguided impression that we were heading in the general direction of Dean Street.

After a careful tour of inspection of several armories, we at last found the one we were looking for.

It was afternoon and we inspected the Brooklyn Radio Show almost in solitary state. We regretted we had not brought our rubber heels with us as the hollow sound of the old and trusty dogs tramping on the wooden floor gave us the distinctly uncomfortable sensation of being the center of observation of a great many beaming salesmen who awaited our arrival at their respective booths. We do not usually buy anything at shows, but we felt so alarmingly conspicuous and sensed the contempt of the salesmen to such an extent that we fell for some sort of two-dollar contraption which is supposed to be a blow-torch or something, and which we shall probably never use; it hasn't worked yet but we have hopes.

The show was, however, a welcome relief after our experiences at the New York show and it was rather a delightful sensation to be able to examine all the apparatus at close quarters without being jostled by

a mob of the curious. We were assured that the place was crowded in the evenings and we took their word for it.

The same tendency which was noted at the New York show was again in evidence to an even greater extent. The old familiar forms of radio apparatus are gradually giving place to the new, and the main idea seems to be able to make them look as little like pieces of radio apparatus and as much like phonographs as possible.

The latest product of a well-known manufacturer was exhibited for the first time and seemed to be the superlative in simplicity of tuner design. There are only two operations: one pushes a switch and turns a dial. A new method of controlling filament current by means of balance tubes was employed. Mounted alongside the detector tube and each amplifying tube was a balance tube containing the resistance element. This tube occupied the same posi-

(Continued on page 1160)



©Underwood & Underwood

The new style of radio receivers won't spoil the drawing room scenery. Look at the one on the right. When the front panel is closed it might be mistaken for a book case. The one on the left is a receiver disguised as a small phonograph.

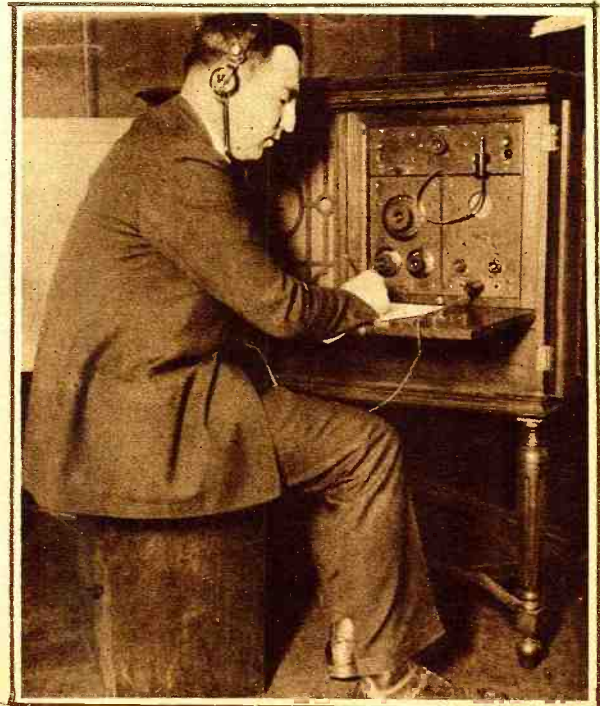

©International, Chicago

Teaching By Radio

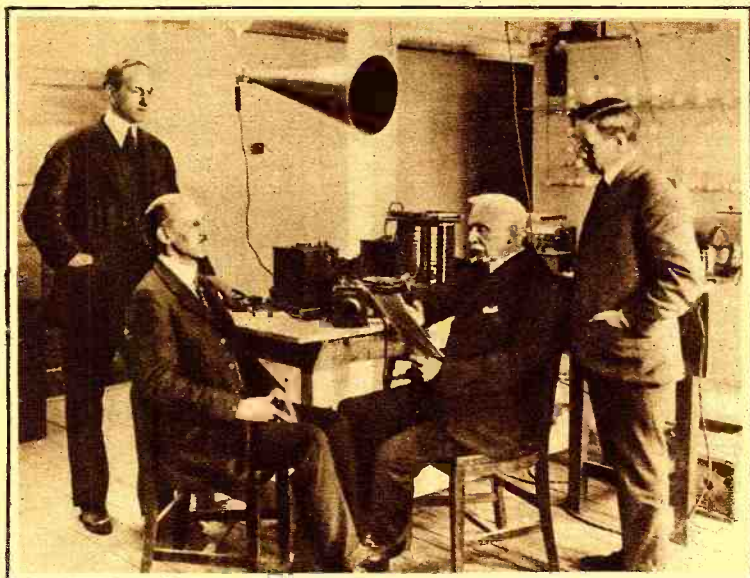

Giving instruction by radio. The broadcasting station from which lectures on various topics will be delivered by prominent men.

ENTERING a field of almost limitless possibilities in the realm of education, Tufts College recently announced the completion of plans for what is probably destined to be the world's first wireless college. A series of lectures will be given free twice a week, broadcasted by radio telephone to more than 35,000 persons scattered in a great circle, the circumference of which stretches from Wisconsin to Northern Florida.

Nothing comparable to this plan for spreading instruction has ever been devised even by extension or correspondence schools. Some of these institutions number their pupils by the thousands, but the limits of the new "Tufts Wireless College" are marked only by the number of people who cannot afford to purchase the simple and inexpensive apparatus for receiving wireless telephone messages. There will, of course, be no charge for instruction. In

having no tuition fees, no buildings, no campus, no enrollment, the Tufts Wireless College will be unique among colleges of the world.

The broadcasting will be sent out from the Amrad Transmitting Station at Medford Hillside, Mass.

In the announcement given out recently the instructors and the subjects of their lectures are listed as follows:

Dean Charles Earnest Fay, A.H., Litt. D. Wade, Professor of Modern Languages and Dean of the Graduate School, will give the opening and introductory address on a date next week to be announced. He will describe the lectures to be given and in general tell of the aims of the course. As a lecturer on literary and geographic subjects, Dean Fay has few equals. He has been a pioneer in the development of mountaineering in the Canadian Rockies and the Selkirks since 1900. Mount Fay in the Sel-

kirks is named after him.

Dr. Harvey A. Wooster, Jackson Professor of Political Science and head of the Department of Economics at Tufts, will deliver the second lecture of the course on "The Story of Money."

Dean Gardner C. Anthony, A.M., Sc.D. of the Engineering School, will talk on "The Story of Engineering."

The remaining speakers and the subjects, which cover a wide field of human knowledge, are: "Changes in Europe," by Arthur I. Andrews; "Preparedness Among Animals," by Dr. Alfred Church Lane; "The Story of Architecture," by Dr. William F. Wyatt; "Athletics," by Clarence P. Houston, Assistant Professor of Physical Education and a former Tufts football star; "The Story of the Bridge Builder," by Professor Edward H. Rockwell; "The Conservation of Bird Life," by Dr. Herbert V. Neal; "College Music," by Professor Leo R. Lewis. This lecture will be illustrated with selections by the Tufts College Glee Club. Professor Albert H. Gilmer will speak on "The Modern Drama" and Dean Lee Sullivan McColester, of the Crane Theological School, will speak on "The Place of the Minister in Modern Society." A speaker to be selected by the Dean of the Dental School will treat the subject, "The Relation of Dentistry to Medicine."

Although it is impossible to give the exact dates of the lectures, the entire course of thirteen will be complete before May 1.

In the initial statement it was made clear that the lectures would be of a popular nature and not beyond the understanding of the thousands of young men and boys between the ages of 15 and 25, who are especially interested in wireless. Also the lectures will not exceed 30 minutes in length and will be delivered in such a way that "students" can take notes if desired. Some of the lectures will be given in the afternoon in order that women, many of whom are taking an interest in the radio telephone, may listen.

Broadcasting over Electric Light Circuit

By CARL H. BUTMAN

LOCAL radio telephone broadcasting by means of "wired-wireless" on an ordinary electric light circuit was demonstrated in the office of the Chief Signal Officer of the Army on Friday, March 24, for the first time before officers of the Corps, scientists and members of the press.

The air is left clear for long-distance communications. This new development in radio is believed by experts to promise a great utility by relieving the congestion in the ether due to the great number of broadcasting stations, particularly for local consumption. By purchasing an ordinary short-wave radio receiving set anyone who is fortunate enough to have an electrical lighting system in his house, is within reach of entertainment, locally at least.



©Kadet & Herbert News Service.

General Squier Listening to the Radio Concert With Apparatus Invented by Him in Which the Electric Light Line is Used to Carry the Waves.

The demonstration included the receiving of news, music, and vocal talks from a distant room in the Munitions Building where a radio telephone transmitter (SCR 67), was connected through an ordinary light socket to the lighting circuit of the building. Music from a phonograph was transmitted to the 110-volt electric line through a standard microphone, such as was developed during the war for aviators.

In General Squier's office a standard Westinghouse short-wave radio receiver was connected with the lamp socket on his desk, and by pulling the cord, he started and stopped the music. No head pieces, no extra wiring or antenna were used, the sound coming from a loud-speaker near the set (Continued on page 1158)

Delivering Bread in Radio Equipped Auto

PRESIDENT HARDING, who is said to listen in by wireless at the White House to the gossip of the continent has nothing on the man who drives one of the Kolb Bakery Autocars, in Philadelphia. William E. Gamble, manager of the Kolb Bakery for the General Baking Company has recently made this possible by completely equipping one of his Autocar motor trucks with a complete wireless outfit, and has painted on the outside of the truck that this is "The first wireless equipped commercial vehicle in the world," a statement which is undoubtedly true. While this first equipment is somewhat in the nature of an experiment, it is an indication of the progressive character of the Kolb Bakery and their desire to take advantage of the most modern equipment in order to facilitate and constantly improve the remarkable delivery service by which their Bond Bread is supplied to millions of consumers every day.

The wireless outfit in the Kolb Autocar is complete in every detail, and is a highly interesting indication of the successful operation of wireless telephoning under conditions which only a few months ago would have seemed impossible. The picture herewith indicates how limited the aerials are on top of the truck. The ground is accomplished by connecting a wire to the frame of the Autocar. The apparatus inside the truck is a complete radio receiving outfit, having a detector with three stages of amplification and a magnavox horn attachment, by means of which radio concerts can be heard by a large number of people. The entire apparatus is mounted on a separate set of cushioning springs, which protect it from sudden jars when the truck is in motion.

It is possible to receive radio messages just as clearly when the Kolb Autocar is in motion as when it is standing still. It is now literally possible for the Kolb Bakery to telephone to anyone of the several broadcasting stations in Philadelphia and ask that station to notify the driver of their wireless Autocar that they wish to get in touch with him and the Autocar driver, no matter where he might be, if he had the head-piece over his ears and was tuned in,

The first commercial vehicle to be equipped with a radio receiving outfit is seen at its rounds delivering the bread.

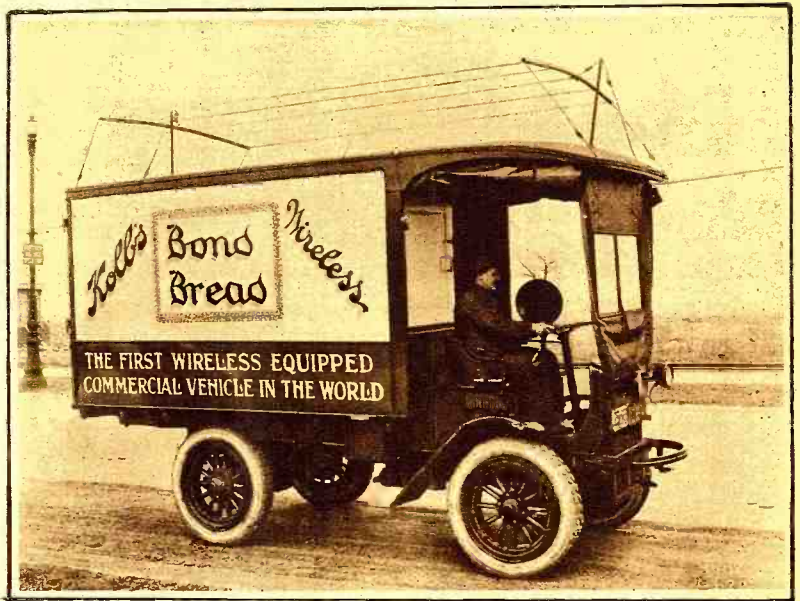

would get the message and, while he could not reply by radio, it would be possible for him to get in touch with his home office by an ordinary telephone immediately. This gives Kolb's Bakery a degree of control over their delivery service which has hitherto been impossible for any firm to achieve.

The picture shown on this page was taken within a quarter of a mile of the big Naval radio station at League Island. While this picture was being photographed League Island was booming out its world-wide messages, but it was possible for the small apparatus in the Kolb Autocar, standing almost in the shadow of that great sending station, either to listen to the code messages which the government was sending to ships at sea or to tune them out entirely and relay to an interested audience the concert which was then being broadcasted from Gimbel Brothers' department store, in Philadelphia.

We may predict that in the future customers will order their goods by Radio as they do today by phone.

WE MAY HAVE NICKEL-IN-THE-SLOT RADIO STATIONS.

With radio telephony in the stage it is today, it only remains for some enterprising person or concern to come along and open public radio phone booths, wherein any citizen may drop a coin and "listen in." First, one would consult the daily schedule and program to learn what was in the air, before making an investment, but once assured of entertainment, he could sit down and listen. This service need by no means be limited to music, but might include press dispatches, baseball bulletins, prize fight returns and election reports. Even those who have no home aerial receivers, will undoubtedly soon have the privilege of renting one temporarily when desirous of "hearing" the air, so to speak. It is an opportunity for some genius to combine a nickel-in-the-slot machine with a receiving set, and some scientists are wondering why it hasn't been done already.

College Students Make Their Own Tubes

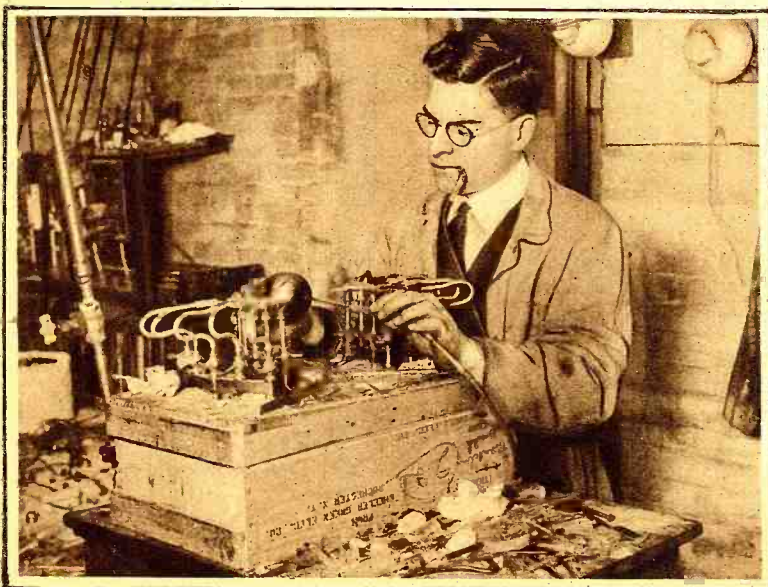

©Kadel & Herbert

Prof. B. R. Northrop, of Cornell University, is blowing the glass in the construction of vacuum tubes for college use.

FOR experimental purposes and also, we believe, to beat the high price of vacuum tubes, the students of Cornell University make their own vacuum tubes. The accompanying photograph shows one of the professors giving a finishing touch to a transmitting tube. The construction of the electrodes, as well as the work of the glass, is not the most difficult part of it as they can be made easily after a little experimenting and after burning one's finger a few times. The difficult point is the evacuation of the tube to obtain a high degree of vacuum. Unless a suitable pump is available, the job cannot be accomplished by an amateur. We know of some experimenters who made tubes of the audiotron style with a simple mercury pump. The first tubes were, of course, of the soft variety, but worked very well as detectors. The others, more carefully made, worked well as amplifiers with a rather high voltage on the plates.

In making tubes the gas contained in the electrodes is evacuated by heating the grid, plate and filament during the exhaustion.

The Radio Age Is Youth

By EVERETT EWING*



The greatest number and sometimes the best customers at the radio dealers are youngsters like this. They are eager to learn all they can and often know a great deal more about radio than the majority of their elders.

sets have been made by boys who have studied the big machine and who have become well grounded in the mechanics and technique of the receiving set through observation and study.

The set cost the boys of Troop 7 almost nothing, friends of the scouts giving the panel, considerable wire for aerials and coils, tubes and batteries. Some parts were purchased by the boys of the troop who, with a set of blueprints and under the supervision of R. N. Koolage, acting scoutmaster, erected the aerial and built and installed the set.

The Troop 7 receiver is connected with a three-strand No. 12 copper wire aerial, 100 feet long, and about 50 feet above the ground extending from the assembly house of the Wesleymen's Bible Class to the Community house of Epworth Methodist Church, where troop headquarters are maintained. The set has an audion and three steps of amplification, and both headpieces and loud speakers are used in receiving. An ingenious arrangement of phonograph sounding boxes and horns has made the incoming tones so loud that they have been heard on

WHILE hundreds of persons, lately interested in radio because of the success with which voice and music sounds are transmitted and received, are besieging electrical dealers, the boys of the community are building their own. This building activity has among its leaders the Boy Scouts, many of whom are among the most advanced of radio experimenters.

Their work in setting up practical outfits and demonstrating them as perfect receivers of long distance entertainment has had as much to do, as has any other element, with taking the radio out of the "toy" class. Play things, radio outfits may be, but they are of that type of "plaything" that engrosses the adult.

Boy Scouts in Norfolk, Va., are typical of Boy Scouts anywhere in America. What they are doing in Norfolk is being done elsewhere in radio, and in all the other crafts which engage their attention.

Two of Norfolk's dozen troops, No. 4 and No. 7, have completely equipped receiving stations, which for weeks past have been receiving KDKA at Pittsburgh, WJZ at Newark, and other stations.

The station of Troop 7 is a model after which scores of boys in this section are building their equipment. It is somewhat oversized, having a bakelite panel 15 by 30 inches—enough of the composition to make

At the right is the receiving station of the Boy Scouts at Norfolk, Va. This apparatus was designed and built by the boys themselves.

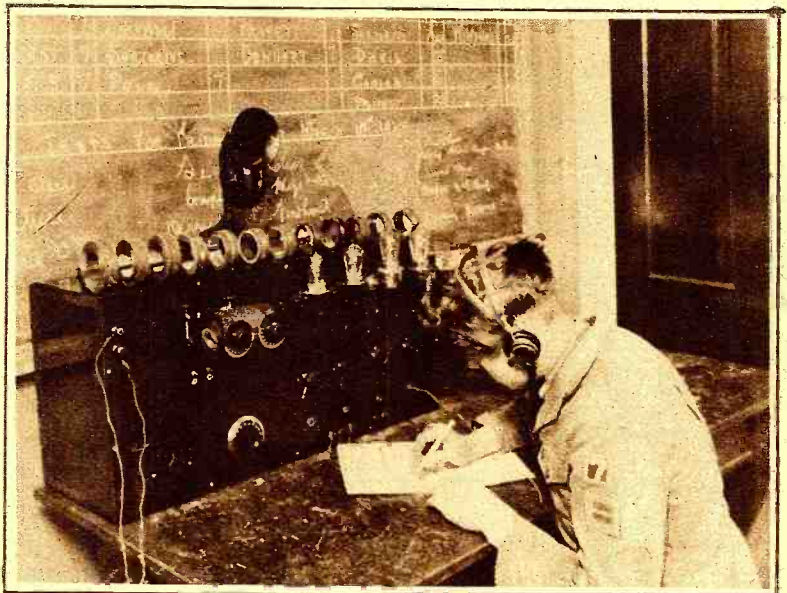

three or four set fronts. But it was made large purposely, that every detail of the outfit might be distinctive—might be easily seen, readily understood and copied in the making of other outfits. Many smaller

all three floors of the community house. A horn amplifier or a sounding box is attached each Friday night at troop meetings and whenever the troop has company, and large
(Continued on page 1209)

Radio For the Farmer

A FEW years ago when one mentioned the subject of radio, it was linked with maritime interests and to most persons this Marconi science was considered the essence of mystery, but since the close of the great war the shroud of mystery has been swept aside and today nearly everyone can talk intelligently on the subject. Many of the thousands of service men were trained in the art of operating a radio set and became so enthused with the work that after being discharged they still continued to study and construct sets of their own design. In this manner radio spread throughout the country and ceased to be purely of maritime interest. It is now a common sight to see an antenna or several of them in an inland town and they are of more value than mere

playthings, for they lead to rooms containing radio instruments. Uncle Sam is giving the "Radio Farmer" particular attention, special weather reports, market prices, etc., are broadcasted for the use of the farmer. The long winter days of isolation from the world are past in a modern farmhouse; the saying is something like this, "Boys, to your radio set and copy press," rather than the famous words in Snowbound "Boys a path." The government has arranged a varied press schedule, Arlington, Va., and Key West, Fla., broadcast press at 10:00 P. M., seventy-fifth meridian time form the east coast, while San Diego and San Francisco take care of the west coast, the former at 5:00 A. M., seventy-fifth, and the late midnight, local time, when it is usually possible to tune in several wireless phones conducted by amateurs, or experimental stations, who

set their own schedule. Now comes the entertaining part of radio; picture a jolly crowd gathered around the fireside munching apples and nuts while they hum to the sweet strains of music from some distant radiophone station. Speaking of radio concerts, they can be put to advantage at a barn dance by using a loud speaker; it is fast becoming a popular way and also an economical way of furnishing music; in fact, so economical that union orchestra leaders are protesting at its use as they are losing their jobs. Some argue that radio apparatus is so expensive they can't afford to install a receiving set, but this is a false impression, for a fairly efficient set can be bought for \$20 or \$25, capable of producing the above named results. It will be one of the best investments a farmer could make, for there is something in the air all the time.

*Radio Editor, Norfolk (Va.) *Edge-Dispatch*.

Church Services by Radio

THE broadcasting of church services by Radio is not a novelty. This was done a year ago by the Westinghouse Company from its Pittsburgh station KDKA. However, the recent progress made in radio broadcasting permitted the public in a larger radius to listen to these services even in smaller towns, using some amateur stations. The ministers and priests began to broadcast their sermons through the radiophone on Sundays so that a greater number of people may be reached right in their homes, which is a great advantage for those living at isolated points, and who cannot personally attend the services. At present this is done on a rather small scale from broadcasting stations having a limited range. In the very near future the radiophone will be able to reach any ships travelling in mid-ocean and also any explorer at very remote points of the almost uninhabited countries.

Reading a sermon over the radiophone to an invisible audience of thousands. The illustration below shows the choir singing during the service.

©Kadel & Herbert

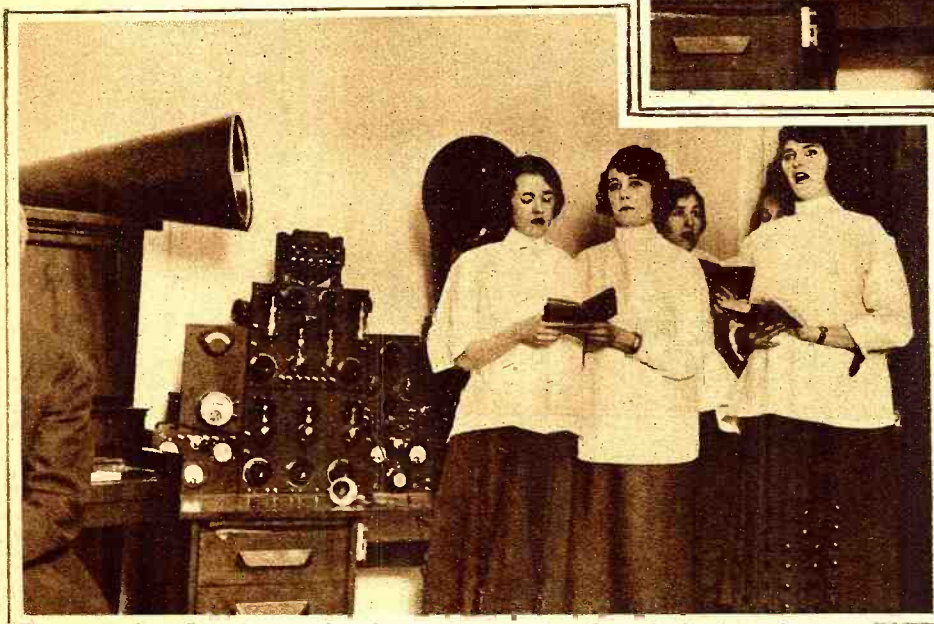
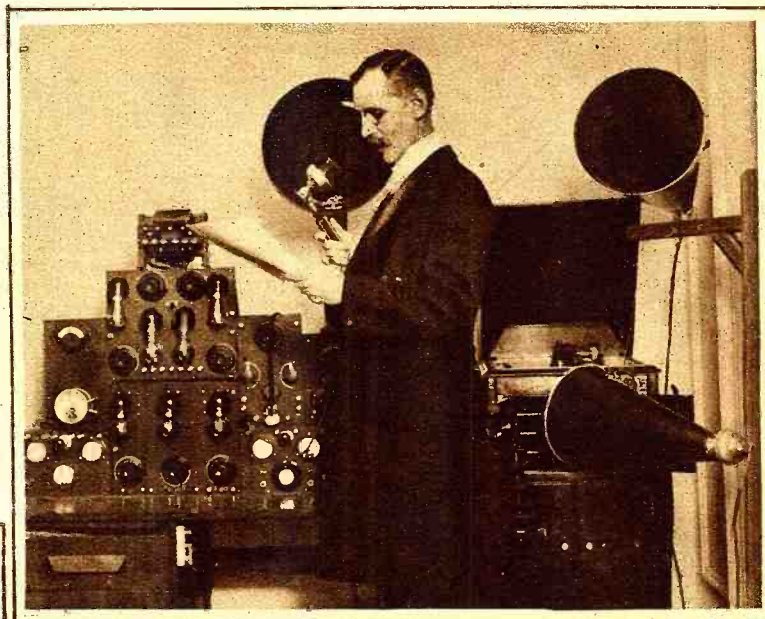

Aboard ships, for instance, the passengers and crew may listen to religious services on Sunday if a loud speaker is used. This is actually done on several ships of smaller size where it is possible to assemble everybody in a single room.

While in camps this summer, many will be able to enjoy sermons while sitting in front of a loud speaker.

During Easter, preachers of every religion were particularly active in broadcasting sermons and services. One of them, more daring and up-to-date, broadcasted his sermon from an airplane flying over New York City and New Jersey. Aboard the plane were also some artists who sang, giving a very good concert from the clouds. When one thinks of this, one may wonder what the very near future will bring us. The flying singers in 1922; what in 1925? Maybe the transmission of silver by radio so that we can drop our coins on the collection plates without leaving home.

Bureau of Standards Swamped With Inquiries

THAT the boys and girls are interested in Radio is proved by the accompanying photograph showing a fraction of the mail received by the Bureau of Standards, since the publication of the little manual which contains instructions for making a simple radio receiving set. In this small pamphlet, which was published recently, is given full data for the construction of apparatus which may be easily made at a very low price. This pamphlet was written by one of the engineers, to be distributed among boys and girls on the farms to enable



©Underwood & Underwood

Here is Mrs. W. F. Harlow, of the Bureau of Standards Answering Some of the Inquiries Sent in by Radio Fans About the Small Crystal Set Shown in the Picture.

them to construct a set for the reception of weather and market reports which are of great interest to the farmers. One of these devices is shown in the picture with the young lady "listening-in" to the music broadcasted by a nearby station, while answering the mail.

The Bureau of Standards recently issued the second pamphlet of the series in which is given full instructions for the construction of a more selective apparatus. Some other pamphlets to be published at a later date will give data for the assembling of vacuum tube sets.

WITH THE AMATEURS

THIS Department is open to all readers. It matters not whether subscribers or not. All photos are judged for best arrangement and efficiency of the apparatus, neatness of connections and general appearance. In order to increase the interest in this department, we make it a rule not to publish photographs of stations unaccompanied by a picture of the owner. We prefer dark photos to light ones. The prize winning pictures must be on prints not smaller than 5 x 7". We cannot reproduce pictures smaller than 3 1/2 x 3 1/4". All pictures must bear name and address written in ink on the back. A letter of not less than 100 words giving full description of the station, aerial equipment, etc., must accompany the pictures.

PRIZES: One first monthly prize of \$5.00. All other pictures published will be paid for at the rate of \$2.00.

Radio Station 5HK at Oklahoma City, Okla. This Month's Prize Winner

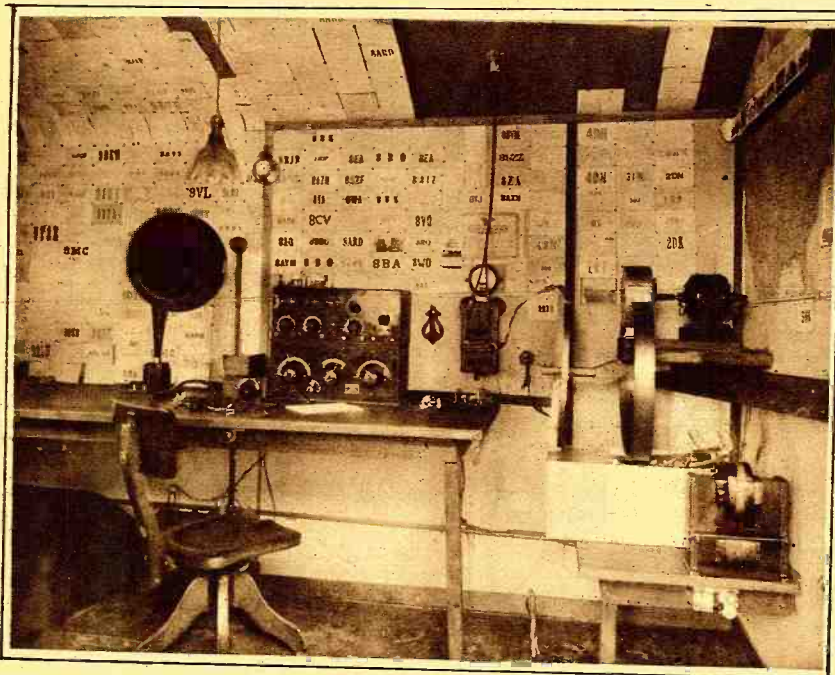

This Spark Station Designed by its Owner, LeRoy Moffet, Jr., Has Had Exceptionally Good Results in DX Work. Note All the Cards From Various Districts Lining the Walls and Ceiling. His Success May be Partly Due to His Excellent Antenna System.

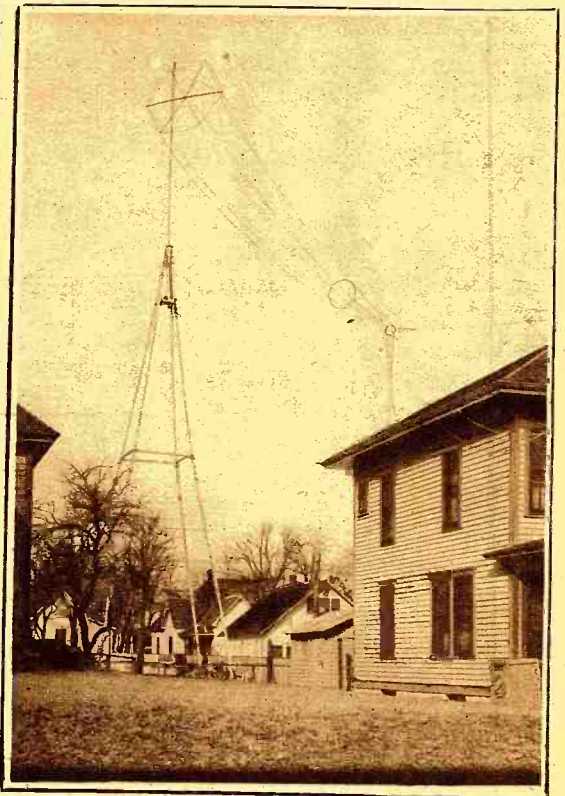

I SEND herewith a description of radio station 5HK.

The antenna used is a cage of six No. 12 copper wires of which the total length is 105'. It is supported at the high end by a tower 93' high made of 5" by 5" fir timbers 34' long. The base is 20' square and rests on four concrete pillars each 9' in the ground and 4' square at the bottom. It stands everything and is well worth the time and money it took to put it up. The large hoop at the top is 12' in diameter. A 1/2" piece of copper tubing is used to keep the spreaders an equal distance apart. The next hoop is 3' in diameter and a 9" cage lead-in is used. The lower end is supported by the house and is 35" high.

The ground used is a counterpoise insulated 8' above the ground and suspended in a fan shape covering an angle of 80 degrees. It covers all of the yard back of the "shack" and the yard to the left of the picture. It is made of 11 wires of No. 12 copper, or about 1,100' of wire.

The transmitter has proven to be efficient. The transformer is a 1-K.W. Acme. The condenser is an "HE," and stands the strain well. It is an oil-immersed affair composed of 58 copper plates each separated by four 8" by 10" photo plates. The

condenser is made up in sections of 8 plates to the section, and the whole immersed in transformer oil. A split primary 22" in diameter and made of 2 1/2" copper is used with a secondary made of 24' 3/4" brass. The gap is an eight-tooth Benwood driven by a 1/8 H.P. series motor with variable brushes so that any tone may be had. A low tone has been found to be more QSA.

The radiation is rather high, being seven thermo amperes.

The receiver is a Z-Nith regenerative and two-step audio frequency amplification, Baldwin phones type E, and Magnavox. Western Electric and A.P. tubes are used for amplifying and detecting. We can hear amateurs and commercials 100' from the Magnavox and can hear KDKA and WJZ music all over the shack, as well as many other phones.

We have received some 600 cards since September reporting 5HK in 40 States, a few of which follow: Boston, Mass., Seattle, Wash., Eugene, Oregon, San Francisco, Cal., Isle of Pines, and Canada. Have worked 6XAD in California, 7ZU in Montana, 4CO in Georgia, and 8RQ in Pennsylvania.

We are very glad to relay traffic.

Amateur Workmanship Contest

After conducting several courses of instructions, through their columns, on the principles of Radio Telegraphy and the methods for constructing a home-made Radio receiving set that may be applied to receive the frequent radio concerts conducted in this city, the *Cleveland Press* with the cooperation of the leading radio equipment store in this section launched a radio contest to stimulate the construction of home-made receiving sets, particularly among juveniles of Cleveland.

Prizes were awarded each for the best constructed set with a crystal detector and the vacuum tube detector, at a total cost of less than \$4. A prize was also awarded to the most ingenious set.

Over 200 sets were entered in the exhibition which was held in the lobby of one of the big local movie palaces. All the parts of the sets submitted, where possible, were made by hand and the remarkable display offered a fine example of the ingenuity of the American youngster. This contest also served to enliven everywhere a great deal of enthusiasm in radio activities for home use.

John Mracek Jr's Station

At Chicago, Ill.

THE photo shows three cabinets, the lower two forming one unit. The left one is a regenerative short wave receiver, tuning up to 1,200 meters. The cabinet on the right contains a detector and two step radio frequency amplifier and may be connected to any other set, being a complete unit. The upper cabinet is a 2,000 meter crystal-audion detector, change being effected by a cam switch. By plugging the phones in the other jack, code may be practiced with the buzzer. The key is for that purpose. At the extreme right are the jacks, where as many phones as desired may be plugged in. At present three Western Electric headsets are used as are Western Electric V.T.'s.

The aerial is a three wire 40' high, 65' long with a 15' lead in. The writer's intention is to install a radiophone transmitter very shortly. The number of stations

This receiving outfit was designed and constructed by the owner. The workmanship seems very good.

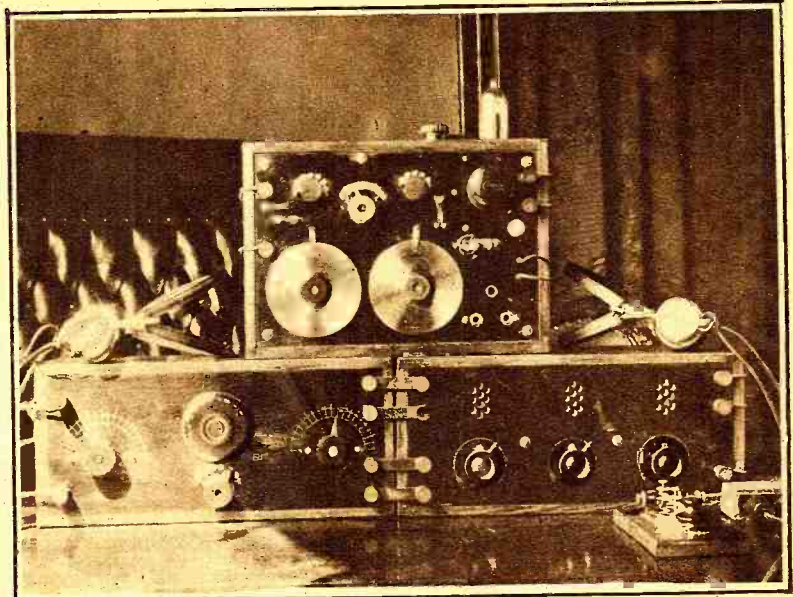

received on this set are too numerous to mention. About six radiophone stations are heard very clearly, 9LY and 9AG being rather prominent by the amount of "juice"

they knock through the phones. This outfit was designed and constructed by the writer, the only parts being bought were the binding posts, knobs, rheostats, etc.

Chauncy Hoover's Station

At Marshalltown, Iowa

YOU recently published a picture of my old spark station, but having disposed of my spark set I am sending you herewith a picture of my new C.W. station. Equipment consists of 20 watt C.W. and I.C.W., using four 5 watt Radiotron tubes and Acme 200 watt transformer, inductance, etc., with eighteen jar electrolytic rectifier. IDH sure fire circuit giving 3.2 amps. radiation with 375 volts on plates. Receiving equipment, Paragon R.A. Ten with one stage. Antenna, 62 ft. long, 45 ft. high, five wires two ft. apart with counterpoise of the same dimen-

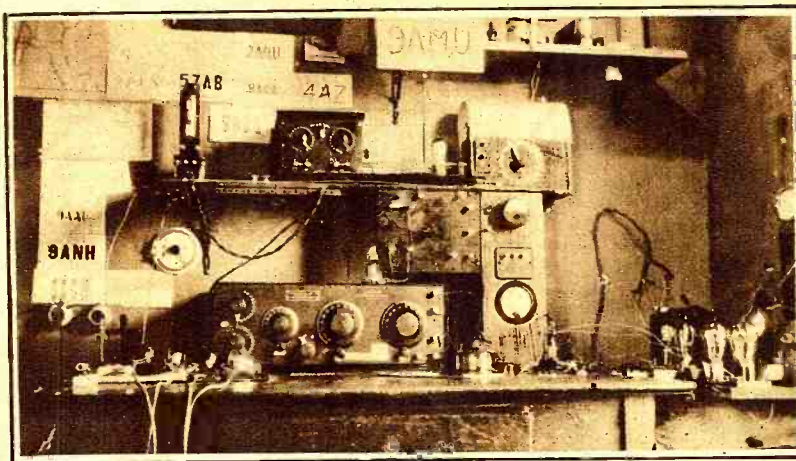

This Station Uses Four 5-Watt Tubes, C.W. and I.C.W., and Has Been Copied Almost All Over the United States

sions twenty feet under aerial.

This station has been heard in all districts except sixth and seventh with a range to date of about 1,200 miles.

WUBC

U. S. Army
Field Artillery School,
Camp Knox, Ky.

Works on all waves. Will QSR for all amateurs when possible.

We use: 1 SCR. M. 1915 Pack set; 1/4 K.W. 500 cycle, 2 amps. in antenna.

C.W.—set using 2 V.T. —2's—Western Elec. in parallel.

Emil Spon's Station

At Sharon, Pa.

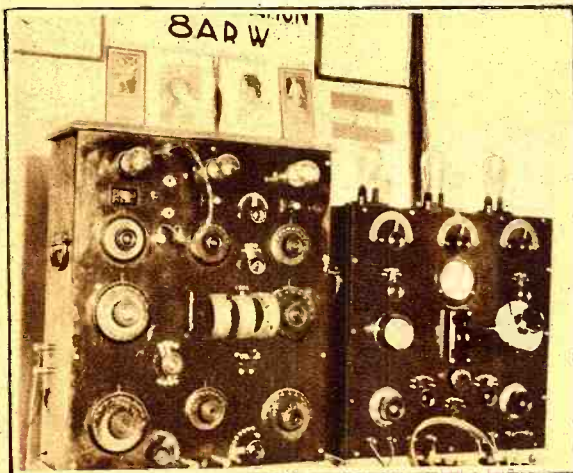

SO many Radio friends have asked me for photos and description of my station that I have decided to send some photos of same, hoping they

will be published in RADIO NEWS.

The receiver on the left, in the photographs, is the combined short and long wave receiver, which was published in the (Continued on page 1201)

The receiver on the left, was described in detail in a previous issue. The transmitter, which consists of three 5-watt tubes may be used for C.W., I.C.W. or phone.

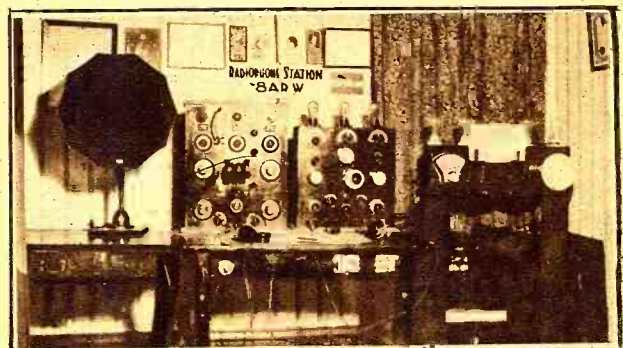

Cecil Barrett's Station 9AYI, at Watertown, S. D.

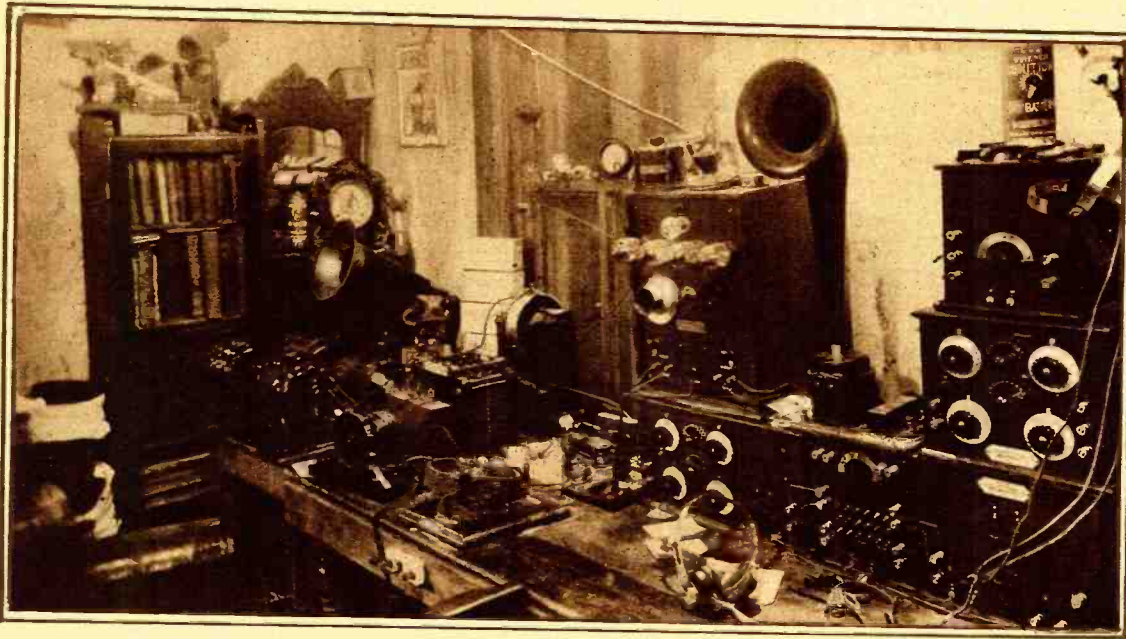

A Well Equipped Station Which Has Some Good Records on C.W.

THIS is a picture of my station 9AYI located at Watertown, So. Dak. For receiving, I use an "Ace" regenerative re-

ceiver and two-step amplifier. The switch panel shown between the regenerative and two-step is used to control the amplifier,

is employed to equalize with the radiating aerial, which is 30' high and 40' long.

(Continued on page 1209)

phones and Magnavox. The rheostat on the panel controls the current on the loud speaker. I copy all the Government stations, NAA all over the room through the loud speaker, and many amateurs and phones very readily from my receiving aerial 125' long and 55' high. I use Murdock and Brandes head phones.

Above the regenerative is shown my phone which is a "Knight." It uses 500 volts on the plate and six-volt filament on four 5-watt power tubes. In the aerial circuit is an ammeter and a variable condenser. As this phone is built to oscillate on a fixed wavelength, the condenser

Harold Hufnagle's Station --- George Kingsley's Station

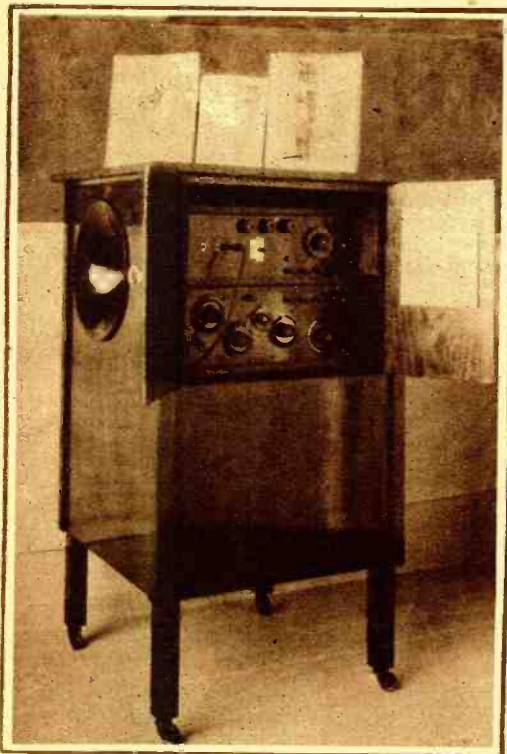

Adopting the New Idea Harold Installed His Receiver and Loud Talker in a Cabinet Which May be Moved in the Parlor for Radio Dances.

THINKING that my Radio Station may be of interest to others I am sending a print to you for publication. My sending set is a 500-watt spark transmitter similar to all others. My receiving set, called "The Radiotrol," is mounted in a cabinet, consists of a regenerative receiver with a Radiotron detector and two stages of amplification with V.T.'s as amplifiers. I use

150 volts on the plates. By the plug and jack method I can use either Baldwin receivers or the Magnavox. I use two aerials, both single wire, one for sending and the other for receiving.

I get the music from all the big stations; it can be heard in a large room and is loud enough to dance by.

GEORGE KINGSLEY'S STATION.

THIS is a picture of my home-made set which I am sure will look good in RADIO NEWS. It is of the honey-comb coil tuner type, with vernier DeForest condensers, radiotron

detector tube, a three-stage amplifier (A.F.), Western Electric V.T.'s, and the loud speaker is a horn and Baldwin phones.

With this set I get all the Radiophone stations, concerts, lectures, market and weather reports, etc., as well as spark and arc stations. With the honeycomb coils I can tune in any wave-length and I find this very convenient, having the possibility of getting any station with my set.

A partial list of the Radiophone stations that I hear are: Westinghouse Electric Co. at Pittsburgh, Newark and Chicago; Reynolds Radio Co. at Denver, Colo.; 5ZA at New Mexico; Oklahoma Radio Shop at Oklahoma City, Okla., and the Western Electric Co., New York. All these stations come in well on only one step of amplification.

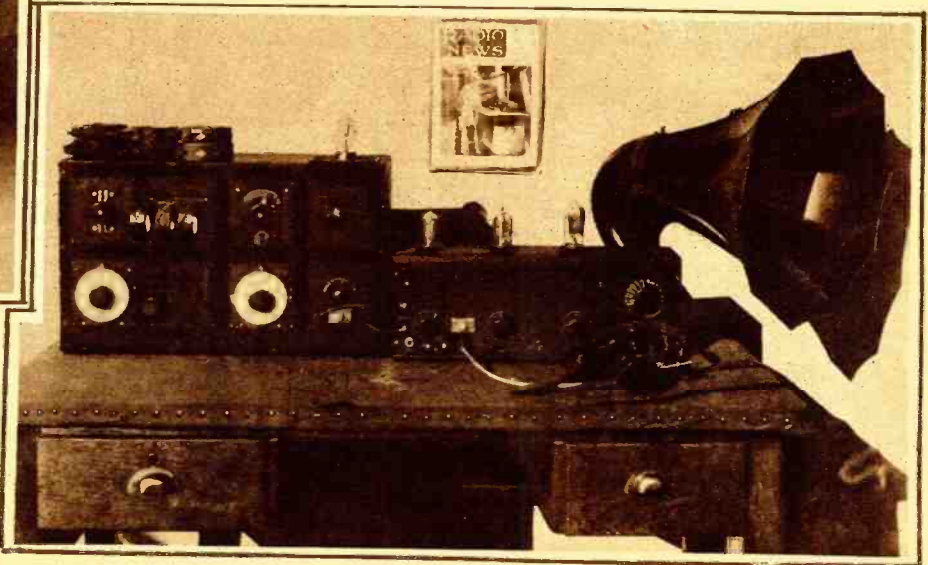

A Very Neat Looking Set, Entirely Made by the Owner. It Makes Use of Honeycomb Coils for Tuning.

Europe's Storm Predictor

FAR up inside the Arctic circle lies the desolate island of Jan Mayen. It is called the St. Helena of the North Atlantic Ocean, why, no man knoweth.

However, it is really a section of great interest to the meteorologist, as it lies directly in the north winds' path.

The climate of Europe is perfectly modified by the drift from the north, which is caught to some extent by Iceland, against which the tail of the Gulf Stream works so as to passify its chilling effects. But poor Iceland suffers, and the descriptions of the climate of that land, one of the most sombre places in the world, depict pretty closely the climate of the far off Jan Mayen Island.

The idea has been formulated by the Norwegian Government to establish on this outpost of the habitable world, a meteorological station which will notify the regions to the south of the approach of good or bad weather. Presumably, it will usually be bad weather, for what good can be supposed to come out of the Arctic night? Jan Mayen has a night lasting nine months, and a day

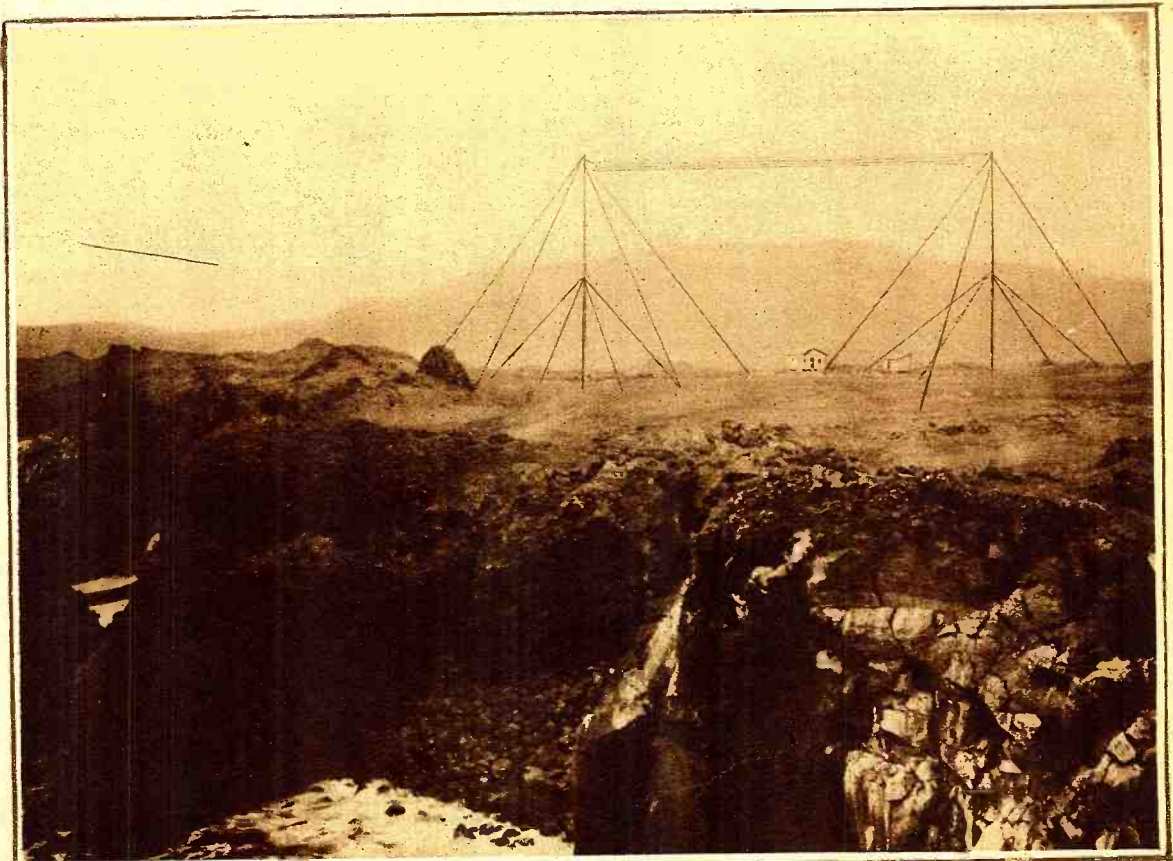

Above is a General View of the Radio Station Installed on Jan Mayen Island to Transmit to the World the Weather Observations Taken on This Remote Spot of the Far North of Europe. Below is a View of the Telefunken Transmitter.

of three months. The island is located 500 miles away from any land. The British Government is certainly most interested in the success of this isolated weather station, and has offered to contribute to the cost and upkeep of the establishment.

The illustration shows the interior of the station, which looks very comfortable, but when we think of the frightful desolation outside, of the high winds and intense cold; it would seem to be anything but a desirable berth for the enterprising meteorologist.

In old times, it is told of navigators, that their way of reaching their destination instead of going on the great circle, was to take two sides of the triangle for their course. They would start say due east or due west from their home port, sail until they estimated themselves as due north or due south of their destination, and then would change their course to one at right angles, so as to do a second leg of the triangle. To go to Jan Mayen island, a somewhat similar plan might be followed; if the navigator would get his ship on a

(Continued on page 1216)

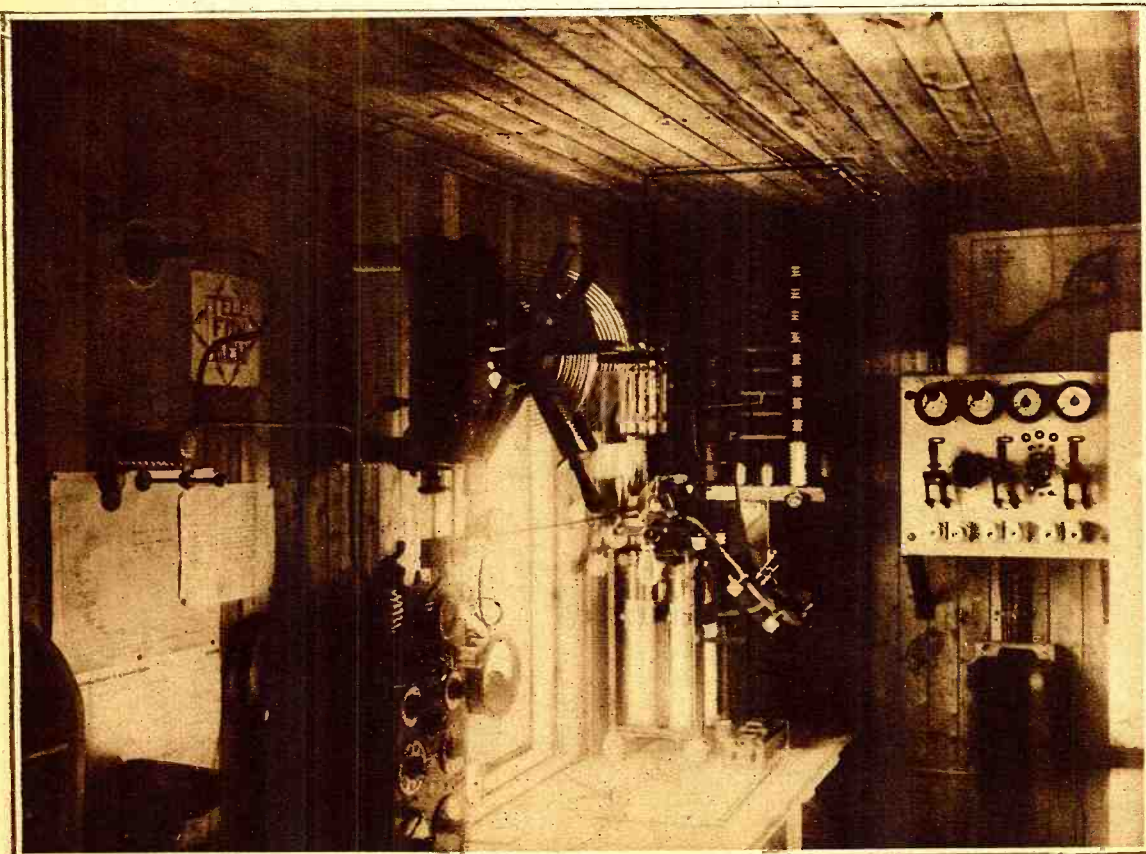

Duplex Radio Telephony a Reality

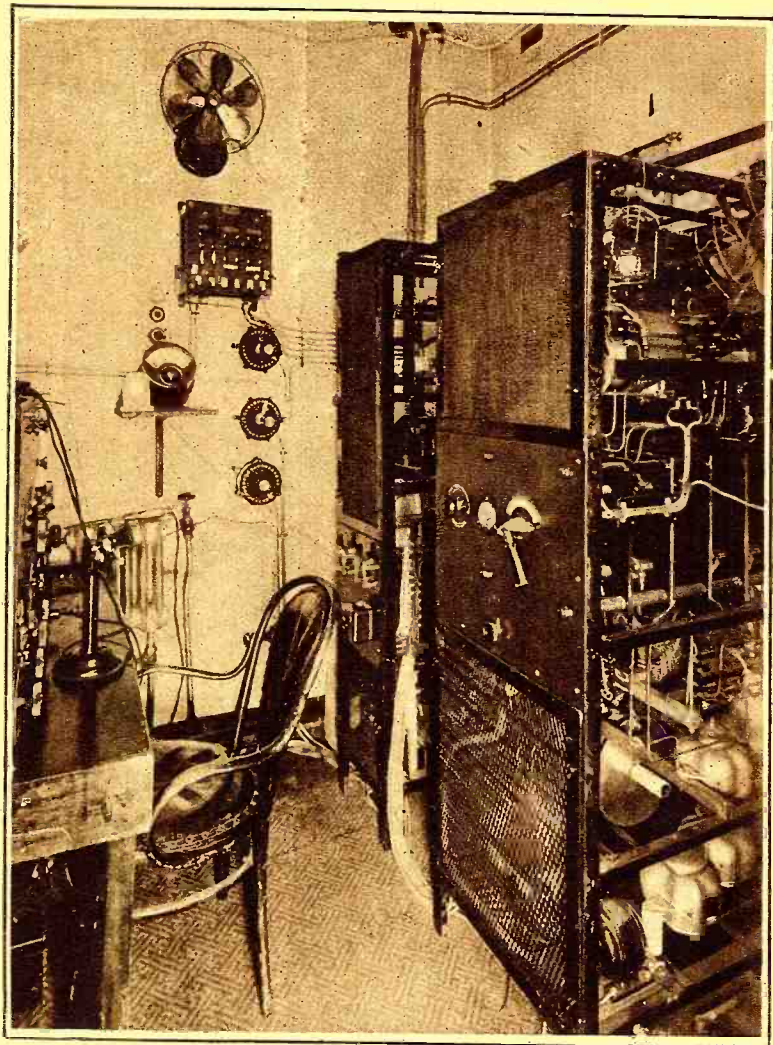

The radio room on board the S. S. "America", from where, in communication with Deal Beach, N. J., successful tests in simultaneous transmission and reception of radio telephony were accomplished.

RADIO telephony, heretofore limited to a single operation, either reception or transmission, has been revolutionized as a result of tests of the duplex radio telephone transmitter, which were completed recently with the arrival of the steamship *America* in New York.

Up to this time the radio telephone has been handicapped by conditions similar to those of the ordinary apartment house speaking tube. In radio telephony it has been necessary for the operator to throw a switch when he desired to talk after listening, or vice versa. This prevents a landline telephone from being linked up with the radio telephone system, as it is not practical to provide a control or "send-receive switch" at each land phone.

Now, with the advent of the duplex wireless equipment, an achievement of the enterprising radio engineers, a conversation may be carried on through the ether as simply and as naturally as between land telephones.

SHIP-TO-SHORE TEST

Tests made on the *America* during her trip to Bremen and return demonstrated the possibilities of the duplex system for use in connection with the regular telephone conversation between the vessel and shore which was carried on while the ship was 1,700 miles at sea. When 360 miles outside Ambrose light, the captain of the *America* was able to talk to a friend in New York, the words being picked up from the air at Deal Beach, N. J., and transferred to an ordinary telephone wire connected with New York.

The duplex type of radio telephone equipment has been designed to enable land lines to be linked in with the radio system, and the tests made from the *America* showed the system to be practical.

The equipment installed on the *America* consists of three main units—the kenetron
(Continued on page 1208)

Sermons and Jazz

By J. FARRELL

SERMONS and jazz may not necessarily mix, but there is certainly no reason why the same man who controls and operates a broadcasting station for the transmission of religious matter cannot also operate a station for broadcasting popular musical and vocal hits. At least that is the belief voiced by Thomas J. Williams, dealer in electrical appliances and accessories, Washington, D. C., who controls both the broadcasting station of the Church of the Covenant in Washington and a station in his shop for sending out entertainment.

Mr. Williams had sold so many radio receiving outfits recently that he began to give thought to the kind of local broadcast services available for his customers. Many of his customers were "novices" interested only in receiving "voice." He found that beyond some phonograph concerts and a few lectures sent out by local agencies the bulk of the matter broadcasted was in telegraph code.

Thereupon Williams decided that his customers needed more and better entertainment (present company excepted), and for that purpose he has installed in his shop a "two 50-watt tube" radiophone transmission set. The call letters are "WPM" and the wave-length is 360 meters. A one 5-watt tube amplifier is used, and the station has been heard at 400 miles.

(Continued on page 1208)

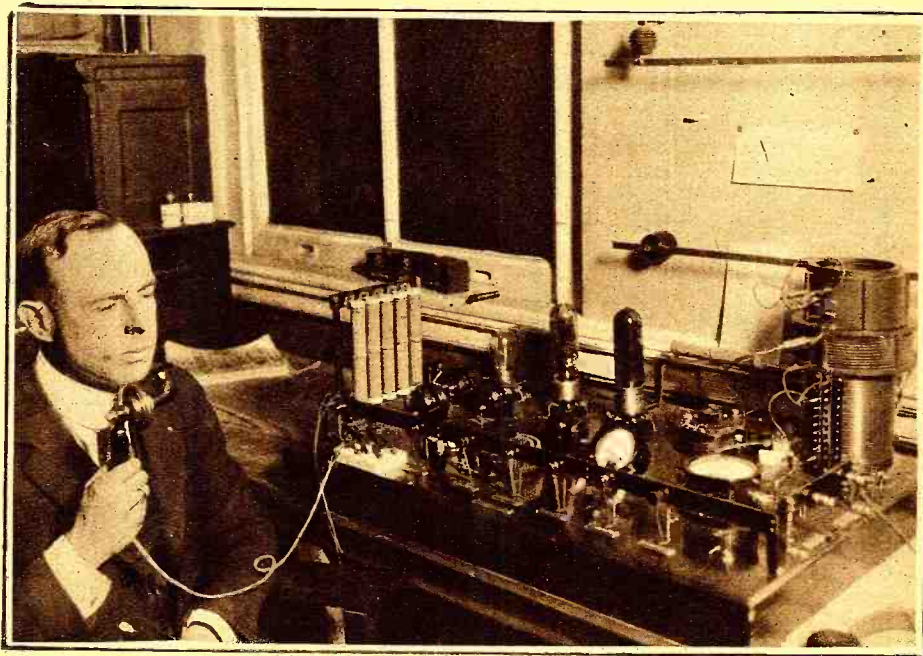

Mr. Thos. J. Williams, of Washington, D. C., Who Broadcasts Entertainments for the Local Amateurs.

Too Much Efficiency

A Play In One Act

By ERALD A. SCHIVO

SCENE: A modern wireless receiving station. There is a transmitting key to the right of the apparatus. Paul Bickel, a very capable radio operator, is busy copying a radiogram, when a door slams and he looks around curiously. There enters Mr. Harold Benton. He is a typical representative of the higher middle classes, about thirty-two years of age.

BENTON (angrily)—So you are the young man who is forever interrupting our dances!

OPERATOR (using the transmitting key) — One moment please.

BENTON (still angrily) — That's what you're always doing, drumming constantly on that key. Yes, I know all about you now, young fellow. Some one told me it was this station that was causing all the interference.

OPERATOR (swinging his chair so as to face the visitor) — Just what do you mean?

BENTON (seeming thoroughly aroused) — Are you trying to insinuate that you don't know? Are you trying to deny things that I am now positive of?

OPERATOR (very much puzzled) — Come, be seated and explain yourself in a more rational manner. I understood you to say that I am interfering with your dances, but what has that got to do with me? There are others higher up, you know.

BENTON (sneeringly) — Oh, very innocent, aren't you? (He walks threateningly towards the operator.) I'll tell you what you are, a mean, low-down pest, a man who likes to break up the pleasures of other persons by sending an endless string of trash.

OPERATOR — But—

BENTON (interrupting) — No "buts" about it. (He stops within a few feet of the operator and glares at him.) For instance, one of the hotels in this city transmits music by wireless telephone every night, say a fox-trot is being played, and my friends and I are dancing. Suddenly a loud roar drowns out the fox-trot entirely, and all must wait until you, one of the most troublesome amateurs, decides to stop the infernal racket.

OPERATOR (amused) — Well, hasn't an amateur a right to send whenever he pleases?

BENTON — No, you have no such right. I heard that all amateurs were to stop sending when certain music was being transmitted.

OPERATOR (laughing) — I guess those rules don't apply to me. You see, I'm

BENTON (interrupting) — They apply to you! (He advances a few steps nearer the operator.)

OPERATOR (somewhat troubled because of Benton's threatening advance) — If you'll give me time to explain—

BENTON (truculently) — There are no explanations to be made. Other amateurs do not interfere with us as you do. You're much louder than any one else, and it is very seldom that you are not sending while the music is going. Listen, if I hear you again while we are dancing to the music

OPERATOR (pressing the key a number of times) — Stop! You poor fool, this is a commercial wireless station, and we don't stop transmitting important messages just to let folks finish a dance!

BENTON (looking at his watch and laughing) — Say, young fellow you certainly got fooled this time. (He puts down the chair and sits on it.) I'm a personal friend of this company's manager. He was telling me about the wonderful operators he had. Ha, ha, ha, ha.

OPERATOR (puzzled) — What's the joke?

BENTON (laughing) — The joke, well, I guess that's on you, but I bet the manager of this company that I could distract any one of his operator's attention so that a certain message would be missed at a particular time.

OPERATOR (sarcastically) — Well?

BENTON (still laughing) — Ha, ha, the manager chose your watch because you were supposed to be one of his best operators. All my talk about interfering with me and my dances was just to keep your attention from your work. The message was to be sent at eight-thirty. It is past that now and you have not copied it. Oh, wait until I collect that bet.

OPERATOR (typewriting rapidly) — And I suppose you won the bet?

BENTON — I'll say so. The manager is with a friend of mine and has been ever since the bet was made some hours ago. He had no chance to warn you and you couldn't help but listen to me when I came in.

OPERATOR (handing a sheet of paper to Benton) — Suppose you read this

message I received while you were raving away a while ago. I don't use a pencil or typewriter for every one I receive, you know.

BENTON — By Gosh! You got it!

THE TRANSMISSION OF HY FREQUENCY'S POLAR AFFINITY.

Prof. X. RAY, of WHEATSTONE BRIDGE, INDUCED his niece, AUDION BULB, to leave her home with the GALVANIC PILE, her LOOSE COUPLED guardian, and SWITCH to him.

She was CONDUCTED to the TERMINAL by her POLAR AFFINITY, HY. FREQUENCY. She STEPPED UP into the Pullman, where the CONDUCTOR took her as a CHARGE.

She came in CONTACT with the Misses STATIC and WHIMHURST, who tried to INFLUENCE her to BREAKER self away

(Continued on page 1207)

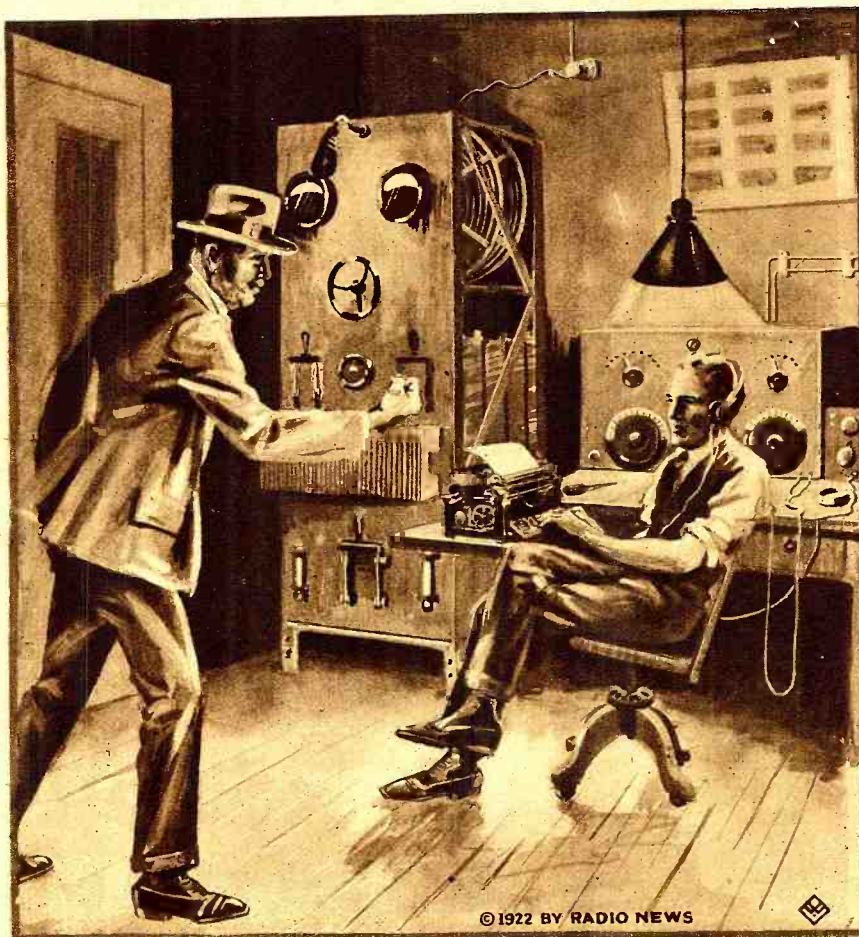

© 1922 BY RADIO NEWS

"I'll tell you what you are; a mean, low-down-pest; a man who likes to break up the pleasures of other persons by sending an endless string of trash."

of a wireless telephone, I will come over here and smash this set to smithereens! Do you understand?

OPERATOR (noticing that Benton is not advancing towards him) — Oh.

BENTON — Do you understand, I asked?

OPERATOR (quite amused) — I guess I know how you feel, well enough. (Pauses.) The only trouble—(He uses the transmitting key.) The only trouble—

BENTON (interrupting rudely) — Get me! The very next time I hear you, there will be all the trouble you may wish for. I intend to conduct my dances without your everlasting loud buzzing, and that's final.

OPERATOR (very much amused) — Oh, continue with you're raving all you want to.

BENTON (looking at his watch) — Raving! Laughing at me, are you? I'll finish this wireless station this moment! (He picks up a chair.)

My C. W. Experiments*

By G. RIDLEAK, U. T.

Chief Radio Engineer, Toronto Lunatic Asylum

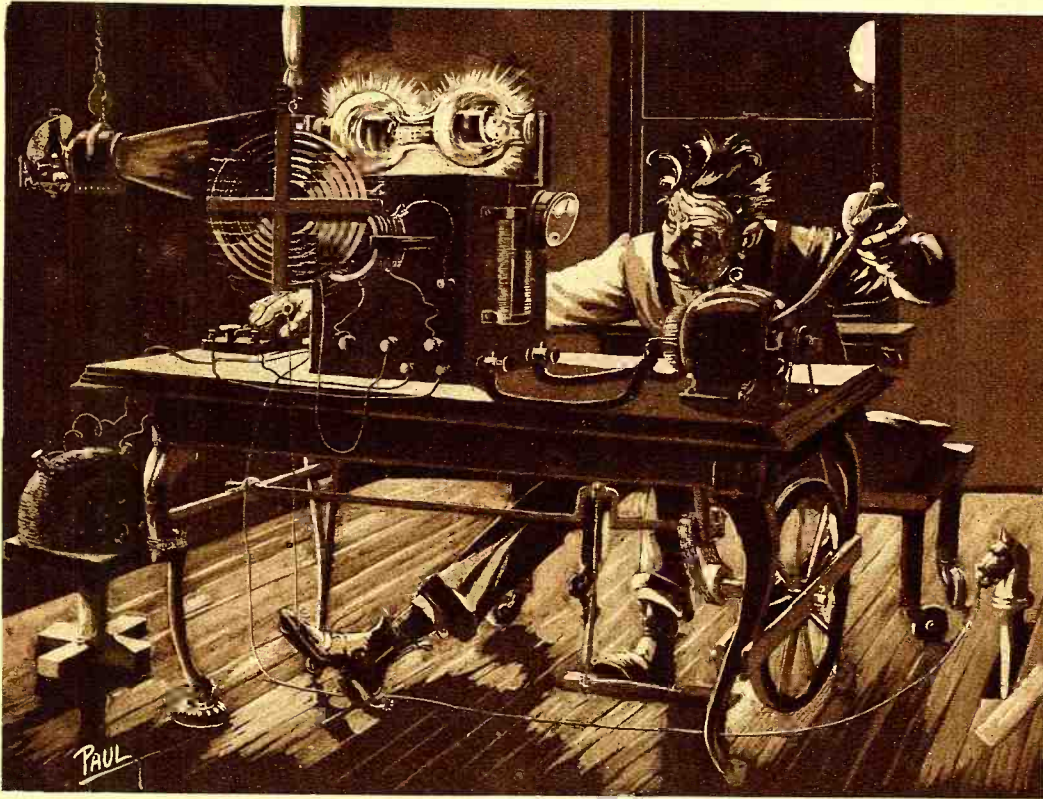

To Overcome the Difficulty I had in Making My Oscillation Transformer Oscillate, I Attached it to the Ceiling by Means of a Long Rubber Band and Fixed at the Bottom a String Attached to My Toe; I Could Then Make it Oscillate Strongly.

WELL, fellows, I guess by now you must have thought that I had died, or got married, or met some similar fate. The truth of the matter is that during the past few months I have been too busy to write. You see, the doctor who is in charge of the Institution where I am employed wanted me to carry out a few experiments for him. He maintained that most great discoveries had been the result of an accident, and quoted as an example the case where Newton invented the telephone because an apple fell on his head. So he gave me a big padded celenium cell to work in, and told me to conduct a series of tests with the object of finding the boiling point of nitro-glycerine. He said he hoped the ensuing accidents might bring to light some timely information concerning the value of nitro-glycerine as a substitute for the liquids at present used in fire extinguishers. The only piece of information brought to light was that it requires a six weeks' sojourn in the hospital to recover from the effects of being blown through a plaster ceiling. Since this had practically no bearing on fire extinguishers, I abandoned the investigation and returned to my former experiments in continuous-wave transmission.

Last month, when I re-commenced my wireless work, I was troubled by a rather peculiar phenomenon. Near my station there dwells a large flock of Ohming pigeons. They had a habit of perching on my aerial and picking wire-worms and small bits of static from it. Of course,

since they kept hopping around, the capacity of the aerial was always changing, which made it difficult to copy my signals. This was most annoying, to say the least. But I soon fooled the pigeons by putting up a phantom aerial. Three of them broke their necks, because when they tried to land on it, it wasn't there. This so discouraged the rest that they never troubled me any more, but spent the remainder of their spare time in a nearby magnetic field, picking currents off the electric plants.

For my ground system I originally used a radiator. I connected the set to the radiator, since I found that this gave better results than connecting the radiator to the set. A little while later I decided that I wasn't getting as much radiation as I should, probably due to the fact that I hadn't connected to a very good radiator. Therefore, I tried out an insulated counterpoise, and my hot wire ammeter immediately jumped as if it had been shot. In fact, it actually started to do handsprings and flapjacks all over the table. (Now you tell one.)

A rather interesting piece of apparatus is my oscillating transformer. At first I experienced considerable difficulty in making it oscillate. To overcome this I suspended it from the ceiling by means of a long section of rubber band. I then tied a piece of string to the bottom of the transformer and wound the other end of the string around the toe of my boot. Thus, by merely tapping the floor with my foot, I was able to keep the transformer oscillating beautifully.

For power tubes I use four of the well-known (advertising space for sale) valves. I have found these valves unequalled for

either rectifying, amplifying, oscillating, or percolating.

The high voltage direct current is supplied by a 300-volt home-brew storage battery. I built this battery myself, using test tubes and lead plates. Each plate is filled with holes and the holes are filled with red lead and litharge. Either that or they are filled with litharge and red lead; I've just forgotten which. These holes are the most expensive part of the battery. The best variety are found only in the Holy Land, and before being shipped to this country they must be carefully packed to prevent them from becoming bent; they vary in price from 80c. a pound for the smooth kind to \$1.50 a pound for the wooly variety. This is the retail price, of course; doubtless they could be obtained a good deal cheaper if they were bought at wholesale. However, the cost is more than compensated for by the results produced, since careful tests revealed the fact that this battery has a capacity of almost 100 cubic feet per Scandinavian kilowatt hour.

As one might naturally expect, the battery becomes discharged from time to time. To charge it, I built an electrolytic rectifier operating directly from a 110-volt A.C. gas mantle. The anodes of this rectifier consist of small sheets of aluminum, and the cathodes of the same sized sheets of lead. I chose lead for the non-rectifying elements because I recognized the truth of the old saying that, "You can drive a horse to water but a cathode must be lead." The electrolyte consists of a dilute solution of Mulsified Cocoa Nut Oil. Before using the outfit I had to form the aluminum plates. This I did by connecting up the rectifier, turning on the current, and letting it run for about three hours. During this time it ran at least 10 miles and got itself so overheated that I was able to boil an egg in it.

When I first built the rectifier I had a lot of trouble because of the electrolyte's tendency to creep up the sides of the jars. Three or four times an hour I had to catch it and put it back where it belonged. One afternoon I actually discovered it trying to creep across the Wheatstone Bridge, so I tied a brick around its neck and fastened it to an anchor gap. I haven't had the slightest trouble with it since.

Until a few weeks ago I used a variable condenser shunted across the primary of the oscillating transformer, for the purpose of tuning. However, this particular vari-

(Continued on page 1160)

*By permission of the Warden, Fred A. Burgess, Esq.

THE BEGINNER

How to Use the Vacuum Tube Detector

A Simple Discussion of the Most Suitable Arrangements for Receivers Used for Broadcasting Reception Employing Vacuum Tube Detectors

By ARTHUR H. LYNCH

IN the two preceding articles of this series we considered first the simplest form of receiving outfit, which would admit of some slight degree of regulation, gradually proceeding through the design of a receiver employing a loose coupler. We have tried to design this simple equipment in such a manner as to permit the novice not only to enjoy that feeling which attends "making one's own," but to permit him to find some use for each instrument as his knowledge of radio and the instruments he has made expands.

VARIABLE CONDENSERS

For some reason or another the term "wave-length" has been given a great deal of attention—very much more attention than it deserves. It is a common occurrence to overhear a conversation in a restaurant, a haberdashery or even the sleeper of a transcontinental flier having this much used and greatly abused term as the topic under consideration. Most conversations of this nature degenerate into arguments and little is decided for the very good reason that those persons doing the arguing have a general but indefinite idea of what the subject really is.

Instead of attempting to explain what wave length is, and drawing a lot of circles extending from a stone thrown into a pond, let us consider this wave length bugaboo merely as a name and forget all about it. We can do so quite easily and still hear just as much or more of the radio concerts as the fellow who delves into books on the subject and acquires a very clear picture of just what he wishes to know, but finds it very difficult to assemble a receiver properly.

All radio transmitting receiving depends upon the passing of electricity from a sending station to a receiving station, or a number of receiving stations, through the medium we call the "ether"—for want of a better name.

Regardless of the amount of power used at a transmitting station or the number of

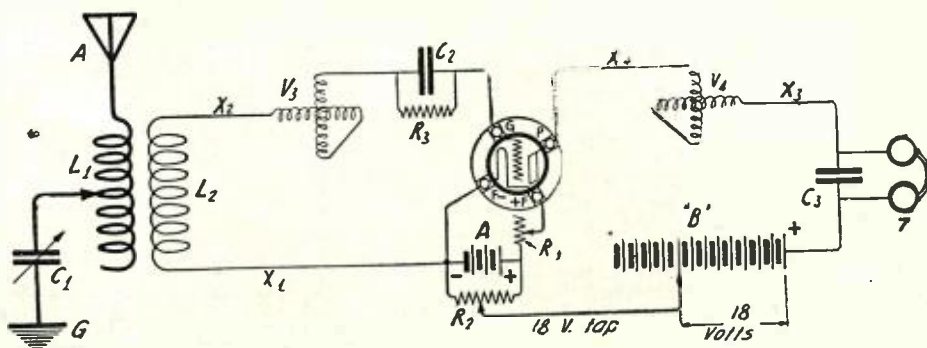

Fig. 4. This is the Standard Regenerative Circuit Using Two Variometers.

miles over which it will carry, for a given adjustment of the transmitter used with a given antenna and ground system the wave length remains approximately the same. This statement is subject to question and is not 100 per cent correct technically, but

entirely safe in considering that a sending station having an aerial of a definite size and a ground system of a certain size to which is connected a certain amount of wire, wound in the form of a spiral, is going to send out waves in the ether of a definite length or measurement, regardless of the amount of power used to force those waves.

We are not so much concerned with the sending out of the waves, for that is being well taken care of by folks skilled in the radio art who are perfectly qualified to look after that part of the business for us. What we do want to bring about, though, is the best method for catching those waves. In order to accomplish our desire it is but necessary to arrange some sort of electrical apparatus which may be counted upon to absorb part of the energy forced into the ether from the sending station.

An absorber suitable for the accomplishment of this purpose must comprise elements of such dimensions that their individual values added together equal the value of the radiating and sending equipment. Remember, however, that this value has nothing to do with power. A simple method of considering this problem is to look at it in this way: a table three feet long and a chair two feet long, when placed side by side, measure five feet in length and two other tables, each two and a half feet long, placed side by side, also measure five feet in length. No matter how wide the pieces of furniture happen to be makes absolutely no difference. The same thing applies with regard to the consideration of wave length and power.

Broadcasting transmission is being taken care of by stations beyond our immediate control, so we may consider them as the table and chair. Instead of measuring five feet, most of them happen to measure three hundred and sixty meters. Our most important problem, therefore, is to find some combination of units to take the place of the two tables which also measured five

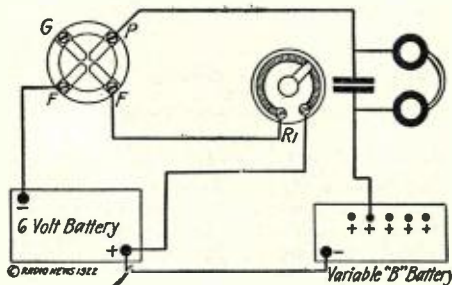
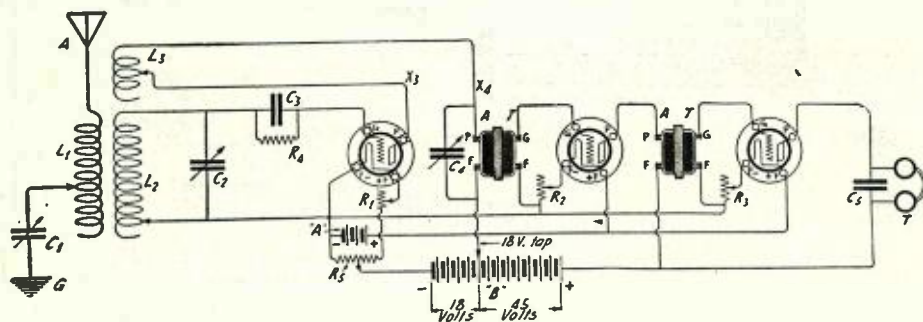

FIG. 5

Connections to a Variable "B" Battery.

for all radio telephone reception it will be found to be near enough to the truth for all practical purposes; if good for nothing else, the statement should serve very nicely as a topic of discussion for the aforementioned sleepers, etc.

So, for our own particular needs we are



To a Regenerative Circuit a Two-Step Amplifier May be Added to Boost the Signal Intensity.

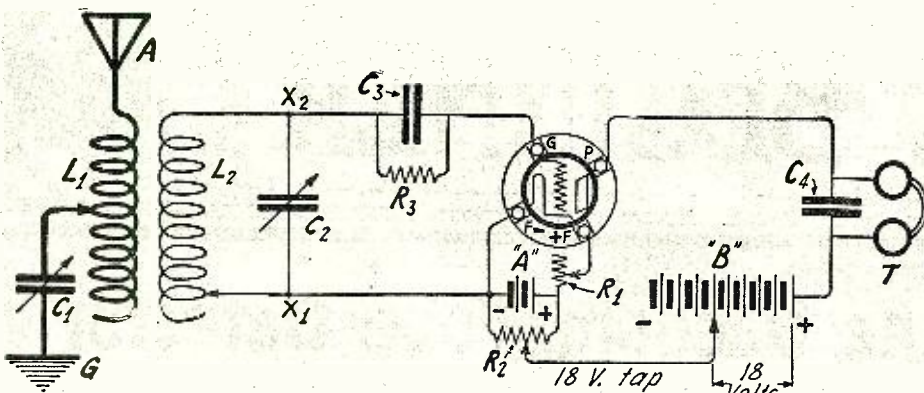
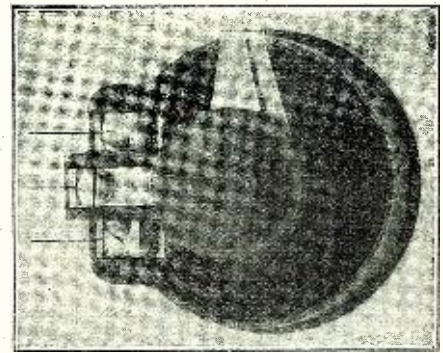

Fig. 3. Hook-up of a Plain Vacuum Tube Detector Circuit.



This is a Potentiometer Sometimes Used to Obtain a Fine Adjustment of the Plate Voltage.

feet, in order that we may absorb the greatest amount of energy from the current passing through the ether in all directions. In order to do this it is necessary that the units at the receiving station match those of the transmitting station. We mentioned that before, but repeating it may make it clearer and it is quite important.

At the broadcasting station an aerial of a certain size has been put up and connected to a suitable amount of wire wound in the form of a spiral as well as to the ground. To try to put up the same size aerial, wind the same kind of a spiral and the same sort of ground connection found at the broadcasting station would be a job, indeed. We are very fortunate in not being called upon to do any such thing as this, for it is possible to use units in our receiving station with variable values, which we may control to suit our needs.

If Bill Jones found that he could hear music from one of the broadcasting stations by using an aerial one hundred feet long and Doc Smith would like to do the same thing, the latter would be "up against it," as they say in Paris, if he could not find more than fifty feet of open space in which to string his wire and there was no other way for him to compensate for the difference. Fortunately, there are two methods at his disposal. We have considered the first method rather thoroughly previously, in the form of a single slide tuner and a loose coupler, but the second now calls for our attention.

VARIABLE CONDENSERS

Variable condensers may be used in a number of various ways in receiving circuits, but we need only consider them, for the time being, in connection with bringing the receiving station to the same measurement or tune as that of the transmitter. First, let us consider a variable condenser in series with the antenna circuit, as shown in Fig. 1. In this position a condenser, either fixed or variable has the effect of reducing the electrical value or wave length of the circuit. At times the reduction of this value is desirable. For instance, where the electrical value of the waves coming from the broadcasting station is, let us say, 360 meters and we had an antenna several hundred feet long, we would find, if we had the necessary measuring instruments, that the long wire would have an electrical value greater than that of the station we desired to hear. Placing the condenser in the circuit as shown in Fig. 1, would reduce this value, permitting us to bring the circuit to any value within range of the condenser and the variable inductance, without having to actually change the length of the aerial wire itself.

Then again, where we use an inductance coil fitted with a switch having points connected to various sections of the coil, several turns apart, as indicated in Fig. 1, the variable condenser may be used to furnish accurate regulation between one point and

the next, making individual turn adjustment unnecessary. The use of a variable condenser for this purpose is most common in connection with the regulation of the value of the secondary circuit of the loose coupler described last month. The arrangement for this circuit is shown in Fig. 1.

We have, therefore, two distinct methods of bringing a receiving station into a posi-

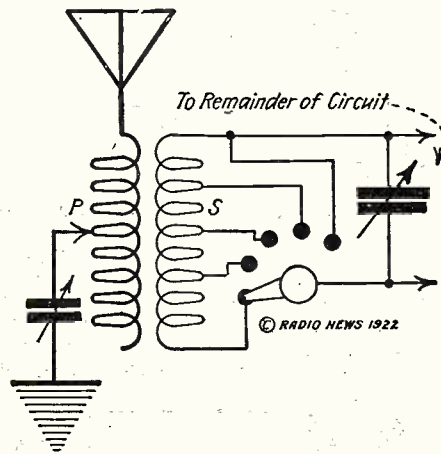

Fig. 1. Showing the Connections of Variable Condensers in the Primary and Secondary Circuits of a Loose Coupler.

tion of electrical equality with a given transmitting station without changing the exterior connections at the receiving station. We may, therefore, use aërials of almost any size, within reason, for broadcasting reception, compensating for their difference by means of employing more or less turns of the tuning coil or loose coupler, or altering the value of the condenser. The former is known in radio parlance as

"inductance" and the latter is called "capacity."

THE VACUUM TUBE

It is hard to pass an opportunity, even in such a circumstance as this, when we are supposed to attend strictly to the business of "doping" out some home-made equipment for broadcasting reception, to linger for a moment or two in considering some of the outstanding facts concerning the development of the vacuum and what it has done for the radio art beyond the particular angle which now holds our interest.

Edison is credited with having discovered the fact that the filament of an incandescent lamp, when energized by an electrical current to a certain temperature, having a metal plate inserted in the evacuated glass globe and connected to the source of power used for lighting, has the effect of passing a current between the plate and the filament. The accepted explanation of this phenomena is that the passage of the current through the filament of the vacuum tube, which in this case may be an ordinary incandescent lamp to which a plate has been added, causes a disintegration of the filament in the form of small particles, called "electrons." These electrons are attracted by the plate and flow toward it continuously as the current is applied to the filament. They form the path over which current between the plate and the filament is permitted to pass.

Fleming was the first to apply this phenomena for any practical purpose, connecting it up as a valve for the reception of radio waves. DeForest then discovered that the addition of a small metallic element in the form of a grid, when properly connected in a receiving circuit, had the effect of greatly increasing the effectiveness of the former device without necessitating any other changes. Armstrong made further

(Continued on page 1164)

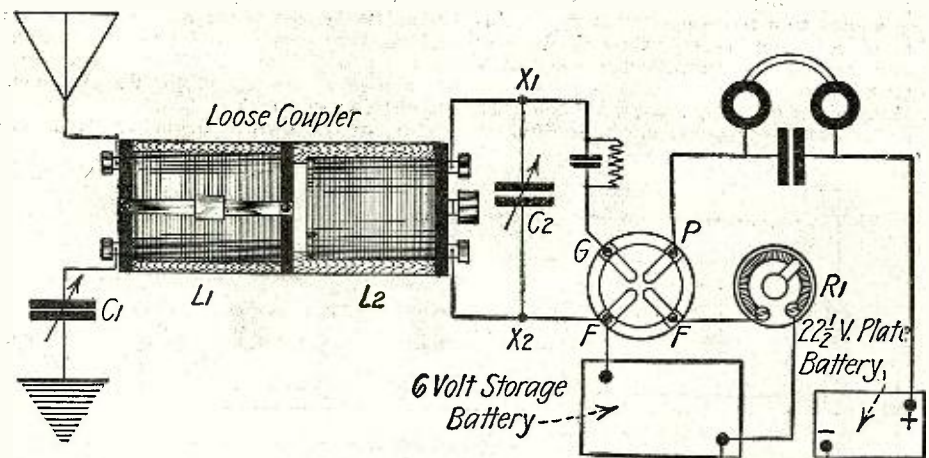

Fig. 2. Diagram of Connections for a Loose Coupler With a Vacuum Tube Detector. Note the Grid Leak and Condenser Between the Point X1 and the Grid Contact on the Tube Socket.

An Efficient Junior Receiver

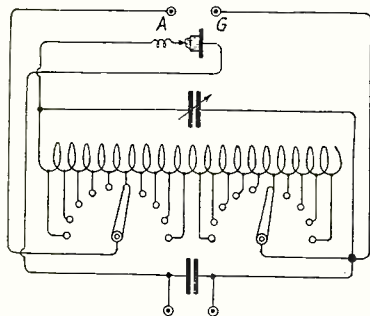

Fig. 2

Complete Wiring Diagram of the Set. The Two Binding Posts at the Bottom Are for the Telephones.

TO-DAY in almost any magazine you chance to pick up it is possible to find the advertisements of junior receivers of some kind. Most of these are nothing more than a tuning coil and detector mounted in some kind of box or cabinet. These are easily made and are quite efficient on short waves for some distances. That is the reason I am describing the junior receiving set I constructed of material taken from old apparatus. Yours may be of old material or of material bought for the purpose.

To begin with, a cabinet is constructed to the inside dimensions of six by nine inches by six inches in depth. The material used was birch one-quarter inch thick. It is put together with small screws and glue. When the glue has set it is stained a mahogany color and varnished. This coat is allowed to set for three days and is then rubbed down with pumice and water and varnished again. If this is done carefully you will have a cabinet closely resembling a factory product.

The front panel is of bakelite or formica one-quarter inch thick and cut six inches wide and nine inches long. Before drilling, a template of the front panel is made of heavy paper and the location of the instruments are figured out and marked on this, so as to reduce the chances of mistakes. The template is then laid over the panel and the transferring is done with some sharp pointed tool. The drilling of the

holes for the panel mounting screws, the switches and switch points, variable condenser and detector is accomplished with some small sharp drill.

The tuning coil is number twenty-four enamel insulated magnet wire, wound on a tube six inches long and three and one-half inches in diameter, the winding is tapped at twenty equal spaces. The switch levers, switch stops and switch points are put on the front panel and the taps are connected to the switch points and the coil is mounted behind the panel with wooden brackets as shown in Fig. 4. This completes the tuning coil and controlling switches.

The variable condenser is, or can be, any standard condenser having a capacity of about .0005 m.f.; mine was a Murdock panel type having that capacity. The

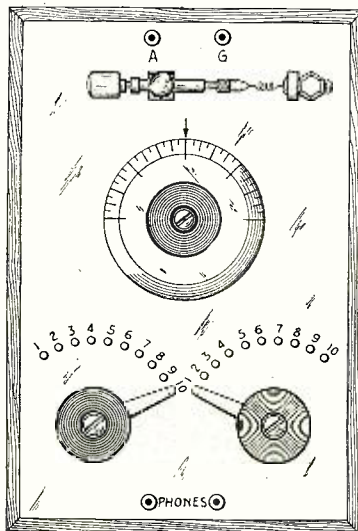

Fig. 1

This Crystal Receiver Provides Sharp Tuning, Thanks to the Variable Condenser.

condenser is mounted back of the panel and the indicating dial is screwed onto the shaft.

The detector can be of any good reliable type of crystal (preferably galena) detec-

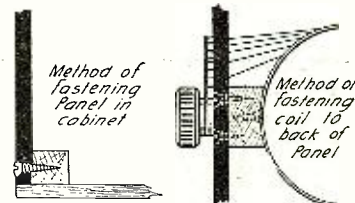

Fig. 3

Fig. 4

Construction Details of the Receiver. The Coil is Maintained Against the Panel by Means of a Block of Wood and Screws.

tor. It may be either an old one or it may be purchased for this purpose. It is taken from its base and mounted at the top of the front panel.

A small fixed condenser having a capacity of about .0015 m.f. is used for the phone or stopping condenser. This is screwed to the bottom of the cabinet and is used to shunt across the phones. This, completed, makes the set ready for work on wiring after the binding posts are put in place as shown on the drawing of the front panel.

Run a wire from the switch level on your left to the binding post at the upper left and mark this A. The other switch is connected to the other binding post and marked G. A wire is run from the left side of the tuning coil winding to one of the variable condenser terminals, then to one binding post on the detector. From the other detector binding post a wire is run to the phone condenser and then to the phone binding post on the left. Another wire is run from the other variable condenser binding post to the right hand end of the tuning coil winding, to the phone condenser and then the other phone binding post. The set is now completely wired and the cabinet can be closed and sealed as shown in Fig. 3.

For use the aerial is connected to the binding post marked A and the ground to G. The phones are connected to the binding posts on the bottom of the panel. Most of the tuning is accomplished through the switches while the variable condenser is used mainly to tune out interference.

Three Money-Saving Kinks

By RALPH H. CARD

HERE are three ideas which are very practical as well as novel:

First.—Have you ever wanted some stranded wire when you were in a hurry or when your pocketbook was empty? If you have not, you are a lucky "bug," but the time may come when you will be in just such a predicament and here is a way to pull yourself out.

Put a number of wires together, all of the same length, and fasten one end to a nail or hook on the wall, then place the other end in the chuck of your hand drill, making sure that they are all even. Stand back far enough to pull the wires taut, not too tight, then turn the crank of the drill slowly until the wires are twisted into one. This makes a neat, smooth, stranded wire which is excellent for your antenna or for any other purpose where stranded wire is superior. By using cotton covered wire you can make a neat power cable. Several strands of wire from the secondary of a spark coil makes a neat wire for winding variometers and other regenerative coils.

Second.—Some time when you want a few volts for experimental work, you can get them out of those old dead dry cells which are under the cellar stairs. Remove the cardboard wrappers and punch the zinc full of holes. Then get as many large-mouthed mason jars as you have batteries. Do not do this unless you are on good terms with the cook, as the cells will expand and can not be removed from the jars. Place the batteries in the jars and fill with a solution of water containing one-fourth vinegar and adding a teaspoonful of salt to each jar. Connect the cells in series and let them set for a day. When the cells are saturated, you will have a battery which will serve quite well in an emergency.

Third.—Do you know that if you have a smooth, straight-grained board you can make a neat panel for your C.W. set? We all know that Bakelite and Formica are the best materials for panels, but they are both expensive and when it comes to cutting the holes for the meters you certainly have a job before you. The main objection to

wood is the grain marks which spoil the appearance of the panel, and as it is not a perfect insulator, it is best to mount the binding posts on fibre strips in the rear of the panel. The large meter holes may be drilled with a regular expansion bit. The panel is prepared in the following manner: Smooth the wood off with sandpaper first, then purchase a pint of dark metal primer such as is used by auto body painters. After you have strained the primer through cheese-cloth, give the panel a good heavy coat and leave it for a day to dry. The next step is to rub it with a very fine sandpaper, always rubbing in the same direction with the grain. Now you are ready for the last step, which is to give the panel another coat of primer. This coat should be applied in a room where no dust can fall on the panel. The second coat should be applied very thinly and evenly. When you have completed the work I am sure you will be more than satisfied with the result. I would not advise using a wooden panel for an amplifier.

A Simple Variocoupler

By N. J. NUITY*

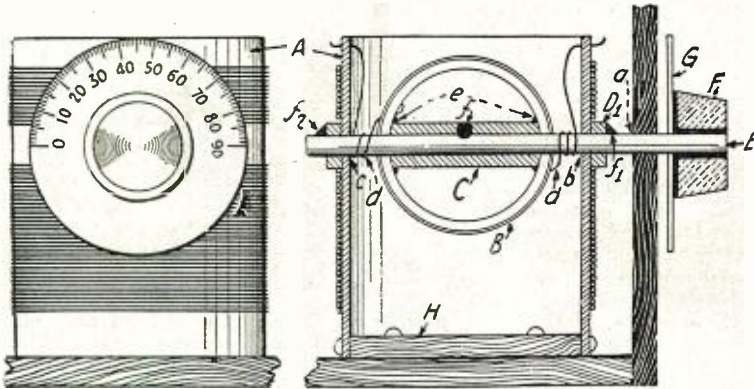

This variocoupler can be made from odds and ends in a few moments with very few tools.

THE high cost of variocoupling should cause no terrors to the financially embarrassed "ham" whose ingenuity and imagination knows no elastic limit, particularly at a time when his pecuniary assets fail to register a positive reading on his pocket "dollarometer."

The variocoupler illustrated herewith was designed and constructed one Sunday morning in time to tune in and listen to the radio sermon. (Pretty good "stall" for not going to Sunday School, eh what?)

The tools needed to construct this coupler are found in every home; these are a screw-driver, pair of scissors, some glue, a bit of sealing wax, and the family ice pick. The drawing is almost self-explanatory.

The stator and rotor forms are made by wrapping ordinary cardboard around bottles or other suitable cylindrical forms of the proper size. Glue well and allow same to

dry, then shellac. The stator (A) should be about $3\frac{1}{2}$ " in diameter. The rotor (B) should be of convenient size, care being taken to see that it will spin freely within the stator when placed in position.

The rod (E) is nothing more nor less than a smooth, round lead pencil. Such pencils usually measure $\frac{5}{8}$ " diameter by 6" long. The knob (F) is simply a medium sized cork. The dial (G) is made of paper, shellacked and glued to the knob (F). Heat the ice pick to the blushing point and "drill" a hole through the cork and dial. Mount the "knob and dial" securely to one end of the pencil shaft, using plenty of glue to make it stick. This leaves knob, dial and shaft as a single unit, see E-F-G in illustration.

Make a thin cardboard cylinder by wrapping a strip of cardboard about 4" wide several times around the pencil. Remove pencil

and allow this cylinder to dry. Then cut off a length equal to the inside diameter of the rotor tube. This will be the piece C. Two small washers (D₁ and D₂) are cut from what is left.

With the red-hot ice pick, carefully "drill" the holes b and c in stator form and d, d' in rotor. The holes b and c should be large enough to form a friction bearing for the rod E.

Next place the tube C within the rotor form, and glue in place. Take care to line the tube C with the holes d, d', and use a good amount of glue here, as indicated by the marks e, e'.

When the stator form assembly is set, put windings in place and shellac. When dry, assemble as shown in the drawing. Adjust position of rotor to position of zero coupling and twist knob until zero point on scale points to set mark. When this is done, secure rotor to shaft by burning a notch through C into shaft with the red-hot ice pick applied in broadside position. Fill said notch with sealing wax (f) and the job is done. Also fasten the collars D₁, D₂ with small dabs of sealing wax f₁ and f₂. Should it become necessary to remove the shaft assembly, remove the sealing wax at points f, f₁ and f₂ and the shaft will pull out.

The writer has made several variometers and variocouplers by this method. They cost practically nothing, yet give splendid results.

For best results a quick drying glue, such as book binders use, is the best. This comes in granulated form and can be made up as needed by heating with a little water in a double boiler.

A Simple Receiving Set

By JOSEPH SCHUCK

FOR the benefit of the newly struck wireless bugs I wish to describe a simple receiving set that has given good results; it is simple in construction and cheap in price. This entire set cost \$2 complete. It has a 150 ft. aerial and receives music clearly and distinctly from three New Jersey radiophone stations, WOY, WJZ, WNO. The loose coupler: The secondary is a quaker oats tube wound with 10 turns of copper wire, and the primary tube is $\frac{1}{2}$ inch larger than the secondary tube wound with 10 turns. Both are mounted on cardboard and hinged so the secondary can be moved freely in and out of the primary.

The wire with which both tubes are wound was taken off the magnets of an ordinary door bell; these may be bought at any junk shop or electrician's for 10 cents.

The detector consists of a test clip which cost 10 cents and a binding post which cost 15 cents. The cat whisker of the detector is an ordinary sewing needle with 6 inches

(Continued on page 1148)

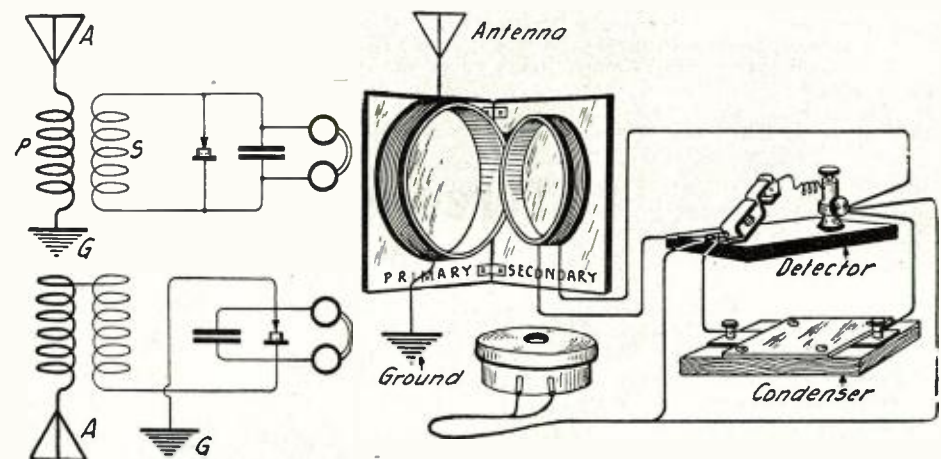

This Set Will Give Good Results Over Short Distances and is Easily Made. Its Cost is Not More Than \$2.00.

How to Grain a Bakelite Panel

By IRVING SIMPSON

MANY amateurs who construct their own apparatus have wanted to "grain" their panels so that the finished instrument might compare favorably with a manufacturer's product. Many dislike the idea of experimenting on a new panel, fearing that it will not turn out as it should. However,

if the directions below are followed out, success is assured.

Lay the panel on a flat table or workbench; take two pieces of wood of the same thickness as the panel and lay one at each end, in the direction that the "grain" is to be run. Fasten the wood with a few countersunk flat-head wood screws. The end pieces serve in two capacities, first, as a clamp to hold the panel in position, and

second, to keep the edges from becoming rounded.

It is advisable to drill the panel previously, as rough edges around holes are taken off during the process of graining.

Spread a film of oil over the panel; olive or any other good grade of oil of medium consistency will serve. With a medium grade of sandpaper on a block of wood rub

(Continued on page 1207)

*Chief Radio Engineer the Kitchen Radio Laboratories.

Hard Rubber Dials at 0 Cents Apiece

By FRED A. BURGESS

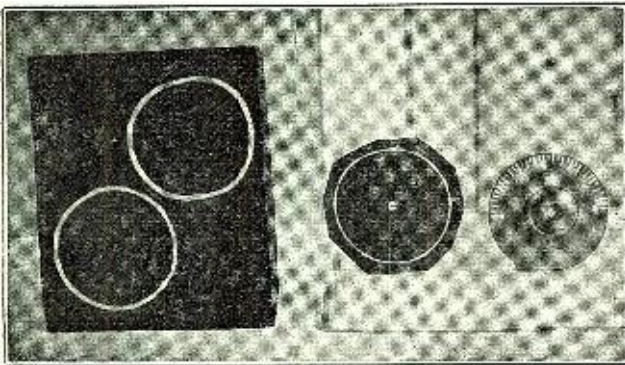

A good looking dial may be made from the hard rubber of an old battery jar.

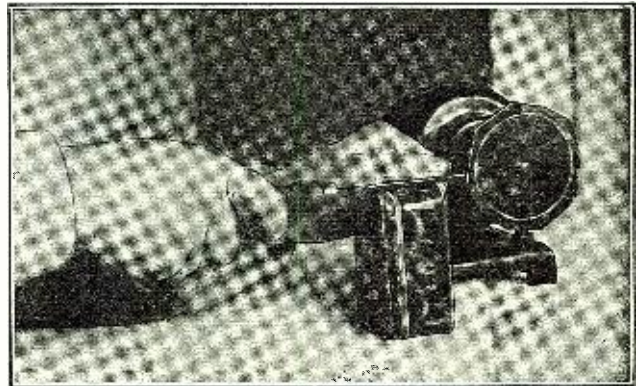

THE latest fashion in wireless apparatus has decreed that all sets must be equipped with indicating dials. These may be made of lacquered brass, white celluloid, hard rubber, or any similar substance, but they must be dials. The best looking ones are undoubtedly those that are made of some shiny black material, with the scale engraved in white.

Now these dials have no practical value as far as the efficiency of the set is concerned. They are merely ornamental. Yet no modern set can be considered complete without them. However, the prices asked for them by manufacturing concerns make many an amateur hesitate about putting them on that new set he is building. To overcome this, several substitutes have been suggested, such as: small phonograph records, etc. Cheap as these may be, they cannot begin to compare in looks with the real dials. Therefore, we shall describe a simple method whereby we recently made half a dozen hard rubber dials, comparing favorably with any of the manufactured products now on the market, at a total cost of 0c. each.

The raw material consisted of the sides of hard rubber storage battery jars. When a jar becomes cracked or broken, due to its strenuous life in an automobile, it is discarded and replaced by a new one. Dozens of these broken jars are thrown away every week at all storage battery service stations. They can usually be had for the asking, and the hard rubber obtained by cutting them up often comes in very handy around the station, as this article will prove.

Fig. 1 shows the three stages in the evolution of the indicating dial. The left-hand object in the photo is a discarded battery jar, with two 3-inch circles marked in white on its side. Each of these circles will eventually become a finished dial, similar to the one in the right of the photo. When we salvaged a couple of jars from the nearest service station they were a dull, dirty black color, with tar or pitch smeared all over them. This pitch we chipped off with a knife, taking care not to scratch the hard rubber for fear of impairing the appearance of the finished dial. After the pitch had been scraped off the two large sides were cut from the jar. At ordinary tem-

peratures the hard rubber is rather brittle and breaks quite easily if you attempt to cut it. However, if it is heated thoroughly it becomes as pliable as soft leather and may then be cut almost as easily as cheese. We heated our jars by holding them about six inches above the flames of a gas stove until the rubber had smoke for half a minute or so. It was then quite soft and we had no difficulty in cutting out the sides by running a sharp knife around the edges. However, care must be taken not to heat the jars too long, as they will become scorched.

From each jar we had obtained two sheets of hard rubber 7" long and 6" wide. We cleaned these sheets by scrubbing them with soap and water, and then marked circles on them 3" in diameter. Next we drilled a $\frac{3}{8}$ " hole through the rubber at the center of each circle. Then we heated the sheets and cut roughly around the lines. This resulted in small, irregular pieces of hard rubber, each one with a circle marked on it. One of these pieces is shown in the center of Fig. 1.

(Continued on page 1128)

A Variometer That Can Be Built With a Jack-knife

By ALBERT D. HINES

EVERY amateur, sooner or later, wants a variometer set but many are prohibited from owning them because of the price and many cannot make them because a lathe is required.

The one that I am going to describe can be built with a jack-knife and if made carefully is as good as can be made by a lathe.

The material required for a variometer set is as follows:

Six pieces of $\frac{1}{4}$ " brass rod 3" long, six pieces of wood, 5" square and 1" thick, seven pieces of wood, 5" square and $\frac{1}{8}$ " thick, three pieces of wood, 5" square and $\frac{1}{4}$ " thick, four pieces of wood, $5\frac{3}{4}$ " square and $\frac{1}{4}$ " thick, one piece of wood, 5" square and $1\frac{1}{2}$ " thick.

That used by me was well seasoned white wood, but a harder wood can be used if one has patience and a good sharp knife. All of the pieces should be planed and sand papered to the above sizes.

After securing the wood two templates should be made, one for the winding form and one for the rotor. These are made, as shown in Fig. 1, of heavy cardboard.

When the templates are finished we are ready to start on the rotor.

Take two of the 5" x 1" pieces and on one side of each draw, in the exact center, a circle with a radius of $2\frac{1}{4}$ ", and on the other side of each draw, in the exact center, a circle with a radius of $1\frac{1}{8}$ ". With a knife and using the template for the rotor, cut down to these circles. The smaller circle corresponds to A on the template and the larger one to B. When finished, smooth the pieces with sandpaper. A line is then drawn through the center of each of the larger circles, and $\frac{1}{8}$ " on each side of this line another line is drawn. This is to help in putting the pieces together later.

Take two of the 5" x $\frac{1}{8}$ " pieces and on

one side of each draw two concentric circles, in the exact center, with radii of 2" and $1\frac{1}{8}$ " respectively, and on the other side, in the exact center, a circle with a radius of $1\frac{1}{8}$ ". Cut from the 2" circle down to the $1\frac{1}{8}$ " circle and smooth up.

In the exact center on each side of one of the 5" x $\frac{1}{4}$ " pieces, draw concentric cir-

(Continued on page 1142)

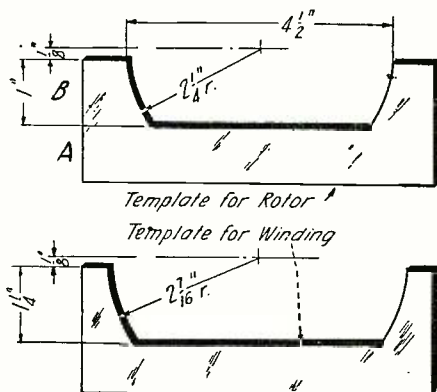
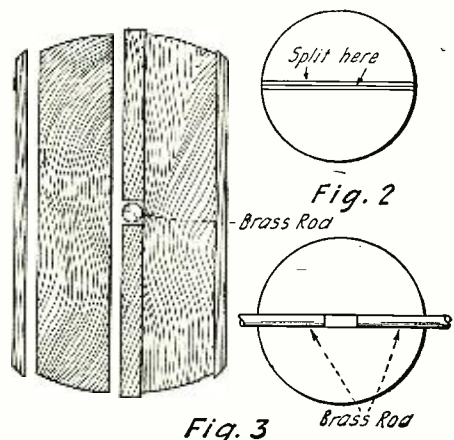

Fig. 1

Dimensions of the Templates Used in the Construction of This Variometer.



The Semi-Circular Pieces Are Cut as Shown and the Six Wood Pieces Glued Together With the Brass Rods in the Center.

Practical Hints for Amateur Constructors

D.L. COIL MOUNT FROM CARTRIDGE FUSE.

A practical mounting for D.L. coils may be made from a burned-out cartridge fuse. When mounted it will work just as satisfactorily as any similar type of mounting, and its cost is practically nothing.

With a sharp knife an arc is cut in the fuse to permit the outer edge of the coil to be taped to the fuse in the manner shown in the diagram. The mount on the panel is made from an old fuse holder. By means of two pieces of bent tin and a length of

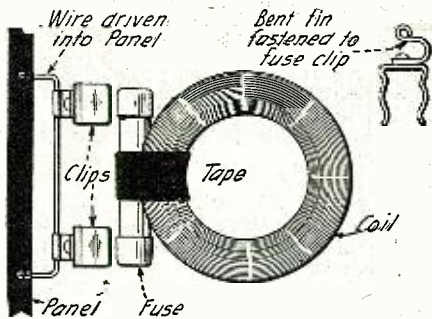

A Burned Out Fuse Can be Used as a Mount for D.L. Coils Very Successfully.

wire, this mount is driven into the panel, and connections taken from the rear.

Contributed by WALLACE HOWARD.
Boulder, Colo.

A DUST-PROOF CRYSTAL DETECTOR.

Obtain a bottle with a hole in the bottom such as sold in novelty stores as trick perfume bottles. Then buy a mounted crystal and heat a piece of wire and force into the lead mounting. The catwhisker is a piece of brass wire about 24 or 26 gauge, twisted around a pencil to make a spring. File the end of the catwhisker to a sharp point. This is put through the cork in top of the bottle and one wire of your set connected to it.

WINDING COILS WITH A HAND-DRILL.

I have noticed that a great many amateurs have trouble in winding the wire on their tubes by hand. Nearly all amateurs possess a hand-drill, and with a little adaptation, they may easily construct a coil-winder as shown in the diagram. It will only cost about fifteen cents and will save considerable time and trouble and add to the appearance of the finished coil.

The two end pieces are adjustable in order that different lengths of coils may be wound. The taps are taken off from the inside of the tube while winding.

Contributed by N. J. HUGHES.
Detroit, Mich.

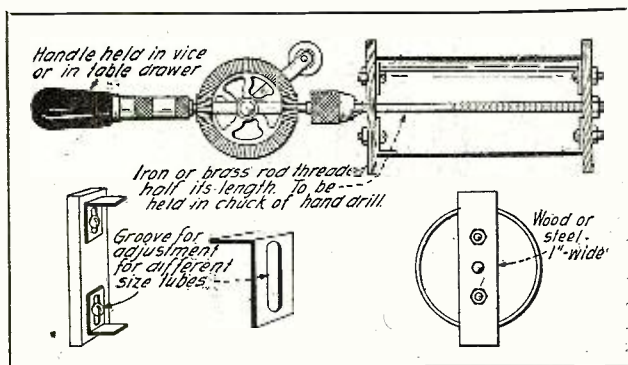

AN UNUSUAL DOUBLE CRYSTAL DETECTOR.

I have been experimenting with crystal detectors and found the one illustrated to be very simple and convenient. To make

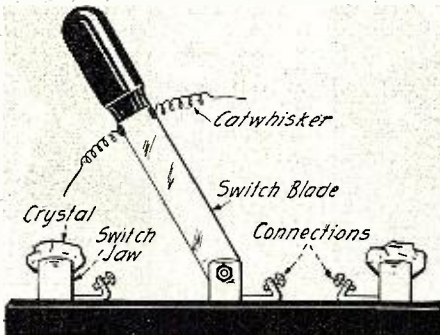

This is a Clever Idea. A Single Pole Double Throw Switch is Converted Into a Double Crystal Detector in the Simple Manner Shown.

this detector I used a single pole double-throw switch. The two contacts were spread slightly; in one I inserted a piece of radiocite and in the other a piece of silicon. On each edge of the knife-blade I soldered a catwhisker. Connections were taken from either contact on the center of the switch. In this way I could change from one crystal to the other.

Contributed by
SIDNEY BARENBLATT.
New York

VERNIER ADJUSTMENT FROM AN OLD BINDING POST.

Here is a simple vernier arrangement for variometers and condensers which will be found very convenient in tuning for C.W.

Fig. 1 shows the rubber knob and the binding post from which the vernier is made. Almost any type or size of rubber knob may be used. The dimensions shown, of course, will require to be changed accordingly. The knob I used measured one-half inch in diameter and one-half inch deep with a knurled rim three quarters of an inch in diameter. To adapt this binding post face off the one-half inch length to one-quarter inch, and bevel the length to an angle of 45 degrees. This can be conveniently done by screwing the knob on a threaded rod which is put into a collet and turned in a lathe. The threaded rod is an 8-32 machine screw with the head cut off. An 8-32 round-head machine screw, a one-half inch spring to pass over the machine screw and a small brass washer complete the vernier. A hole is drilled through the panel slightly below the dial of the variometer to pass the 8-32 machine screw. The screw is inserted through this hole and the spring washer slipped over it, and, lastly, the tapered rubber knob is screwed on.

It is preferable to use a machine screw which is threaded only at the end on which the knob is screwed as a machine screw, entirely threaded, tends to catch in the hole when the vernier is manipulated. To operate the vernier a slight pressure is applied while turning which permits the tapered periphery of the vernier to engage with the rim of the dial, enabling a micrometer adjustment.

Contributed by SAMUEL W. ELLNER.
New York.

HANDLE FOR VARIABLE CONDENSER.

When tuning for C.W. it is necessary to obtain very fine adjustment of the variable condenser. It is sometimes difficult to accomplish this with the knob provided.

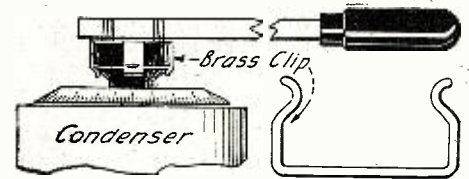

Fine Adjustment and Absence of Body Capacity Effect Are Obtained With This Condenser Handle.

The capacity of the hand also tends to prevent fine tuning of the circuit. This may be remedied and easy adjustment obtained by using a long handle attached to the condenser knob. An easily made removable handle is shown in the diagram. It is made from a few scraps of brass and a brass rod. The strips of brass are cut long enough to fit the knob when bent in the manner shown. Two strips are used at right angles to one another and clamped together. The brass rod is strapped with wire or tape to one of the brass clips.

Contributed by CHAUNCY HOOVER.
Marshalltown, Ia.

CHEAP CARDBOARD TUBES.

The following may be of use to some of the amateurs who wish to make a tuning transformer and do not know where to get a suitable pair of paper tubes.

Most all grocers sell yellow corn meal put up by the Quaker Oats Co.; also rolled white oats out up by the same company.

A 10c. package of yellow corn meal comes
(Continued on page 1207)

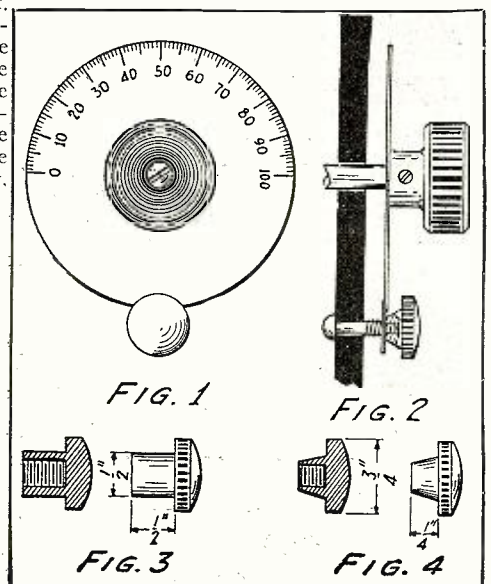

On the Left is Shown a Simple Method of Winding Coils With a Hand Drill. On the Right an Old Binding Post is Used to Make a Vernier Adjustment for the Dials of Condensers or Variometers.

A QUENCHED GAP FOR SPARK COIL SETS.

Small spark coil transmitters are generally equipped with open spark gaps which are noisy and rather inefficient as compared with a quenched gap, such as are used by commercial and naval stations. Here is a description of how to make a quenched gap for your spark coil transmitter which will be quiet and, if properly tuned, efficient. The sparking surfaces are made from sheet copper, fairly heavy, two inches square, with one inch square lugs for connecting

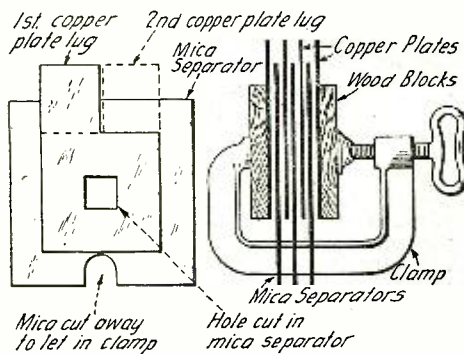

This Spark Gap Will Give Your Spark Coil a Better Tone and You Will Cause Less Interference.

and cooling. These plates must be perfectly flat and smooth. The separators are cut from sheet mica and should be three inches square, with hole one inch square cut in center. Use from two to three gaps per $\frac{1}{4}$ " spark. Make two blocks $\frac{1}{4}$ " thick by 2" square of hard wood. These are for the ends. A small clamp which can be bought at the 5 and 10 cent store is used to hold the gap together. To assemble gap, place one of the wooden blocks on a table, then a sheet of the copper, then a sheet of mica and another sheet of copper, etc. Care should be taken to alternate the lugs first on one side and then on the other. When all the copper sheets are in place, put on the other wooden block and clamp tightly in the clamp. Connect in the same manner as a plain gap, varying the number of gaps in the circuit until the maximum spark is delivered. This can be found by listening in on a receiver or with a wave meter. Another way is to use a flashlight lamp with one turn of wire parallel to the oscillation transformer turns. When the lamp lights brightest, the most current is being obtained.

Contributed by I. D. BALL, Battle Creek, Mich.

MAKE YOUR OWN LOUD SPEAKER.

A few pieces of gas fixtures, a receiver, and a large funnel are all that is needed to make the loud speaker shown in the illustration.

At the ten-cent stores you will find U-shaped pieces of gas fittings which sell for ten cents each. Purchase three of these. Also one small piece (straight) four inches in length and one straight piece six inches in length. Each of these cost ten cents also. This makes a total of fifty cents for gas fittings. Next purchase a large tin funnel in the same store for ten cents.

A small round (flat) piece of brass (9) is sweated onto the end of piece (4) shown in the drawings at (B). Two holes are drilled through this brass piece and through the cap of the telephone receiver (5), and the brass piece is made fast to the receiver cap by two screws and nuts (8) (8) see Fig. C.

All joints are sweated together and wiped to make the piping air-tight.

This little instrument works very well and after being polished looks like a fac-

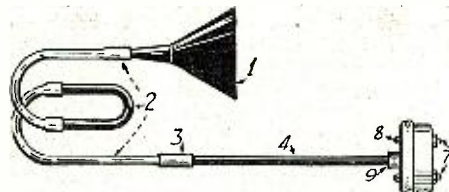

Fig. a

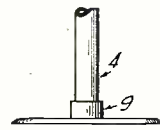

Fig. b

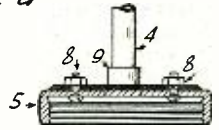

Fig. c

With a Few Gas Fixtures and a Funnel a Loud Speaker Can be Made.

tory job. It throws weak signals out into the room at greater volumes than most instruments of this type do. It also helps the builder to save some of his hard-earned cash. Make your own.

Contributed by RAY-DIO.

EASY METHODS OF MEASURING COUPLING.

Many an amateur has wished for some good method of measuring his coupling, whether close or loose and how much or what degree, in order to jot down notes on the position of his instruments while copying a certain station. The loose coupler presents little difficulty in this regard, and a simple and very effective way of measur-

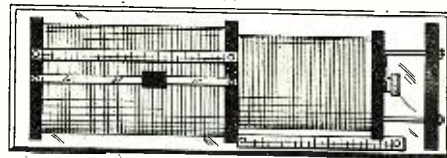

Fig. 1

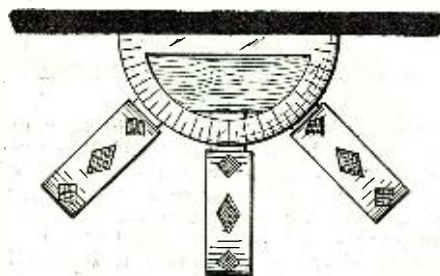

Fig. 2

This is a Good Method of Measuring the Coupling of Honeycomb Coils or a Loose Coupler.

ing may be provided by screwing a rule, preferably marked in centimeters, on the ends of the primary parallel to the slider as shown in the sketch. A rule screwed to the base of the coupler under the rods which support the sliding secondary, in such a position as to be easily seen, will measure the coupling.

Honeycomb coils present a more difficult

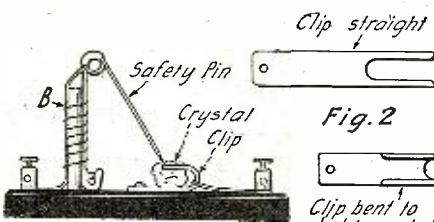

Fig. 1

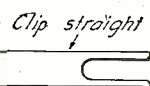

Fig. 2

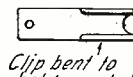

Fig. 3

A Crystal Detector Can be Made With a Safety Pin and a Few Odds and Ends.

problem. The old method of measuring with a ruler the distance between their extreme ends is slow and inaccurate. A much easier and quicker method is to place a protractor where the coils separate, at the mounting or panel, and then the coupling can be taken down on paper in degrees. Figure 2 shows how this may be accomplished. With these simple additions any amateur can keep for reference the position of his coils or coupler when hearing some elusive station.

Contributed by TALCOTT MINER BANKS, JR., Williamstown, Mass.

A SAFETY-PIN CRYSTAL DETECTOR.

The clip is made of brass 16 to 18 gauge, about one-half inch wide by two inches long, cut as per Fig. 2. Instead of using the brass clip a test clip will do to hold the crystal. The rod (b) is a wooden rod such as is used by the butchers to hold meat together. The safety-pin is bound to the rod with wire, a hole being drilled for the rod. No dimensions are given as this is left to the experimenter and whatever materials he has on hand.

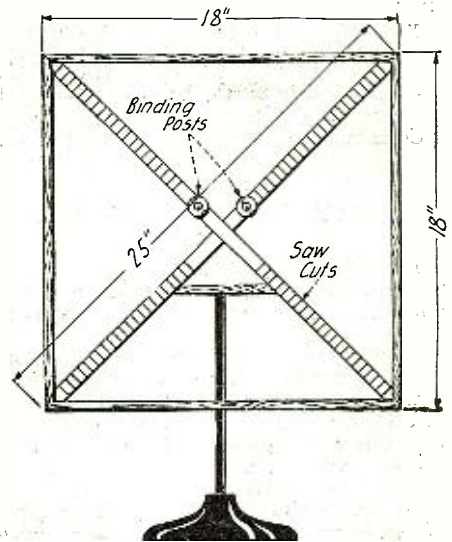

Good Results Will be Obtained at Short Distances With This Loop, Using One or More Tubes.

HOW TO MAKE A LOOP ANTENNA.

Many amateurs living in apartment houses are handicapped in their erection of an antenna by lack of space. I have constructed a loop aerial as shown in the diagram and obtain very good results with one vacuum tube detector.

To construct this loop, two laths of wood $25\frac{1}{2}$ inches long should be obtained. A notch is cut in the center of each and they are joined together to form an "X." Four laths of wood each one-eighth inch long are nailed across the extremities of the cross supports to form a square. Commencing $3\frac{1}{2}$ inches from the center, saw-cuts $\frac{1}{2}$ inch apart are made on both edges of the cross support beginning at the first or inner saw-cut. No. 22 D.C.C. wire is wound tightly in a clock-wise direction to the outer edge. The loop is then turned over and the wiring continued in an anti-clock-wise direction back to the first saw-cut on the opposite side. Two binding posts are fastened to the cross supports to which the ends of the wire are connected. A strip of wood is fastened across the two opposite legs of the cross supports. A hole is bored of corresponding size in the center of the bottom protecting piece and a dowel is inserted to permit the loop to revolve.

Contributed by CECIL GUYATT, Brooklyn, N. Y.

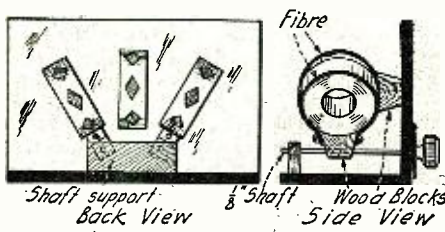

You Can Mount the Honeycomb Coils at the Back of the Panel in This Simple Manner.

BACK MOUNTING FOR HONEY-COMB COILS.

A very simple and efficient method of mounting honeycomb coils on the back of the panel is illustrated in the diagram.

To construct this mounting, 3 pieces of hard wood are shaped in the manner shown to permit the honeycomb coils to be held to them by means of the fiber strip. Holes are drilled at the base of two of the pieces of wood to permit 1/8 inch brass rods to be wedged in. The ends of each of these brass rods are threaded and pass through the bakelite panel. Knobs are attached. The other ends of the brass rods are passed through the holes in the back rest, which may be a piece of wood. These two mountings constitute the primary and the tickler coils. The base of the secondary coil is fastened directly to the back of the panel and remains stationary.

Contributed by LOUIS CHOMINARD, Fall River, Mass.

EASILY CONSTRUCTED V.T. SOCKET.

The cost of the V.T. socket illustrated in the accompanying diagram was only ten cents and the socket is very easily constructed.

Four springs are mounted on a piece of hard rubber taken from a battery jar. Four 8-32 brass screws and eight nuts are used as binding posts. The springs may be made from pieces of phosphor bronze and sufficient quantity may be purchased for a nickel to make a dozen sockets.

For an amplifier cabinet, a longer piece of rubber may be used and several mounted on the same strip. The paper washer insulator is necessary to prevent the edge of the socket-shell short circuiting the springs.

Contributed by FRANK E. BENNETT.

MAKING A SPIDER-WEB INDUCTANCE.

I read recently an article on "How to Make a Spider-Web Inductance from a

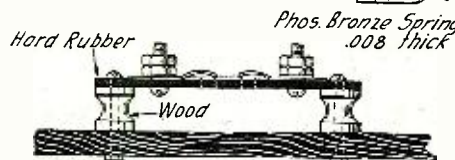
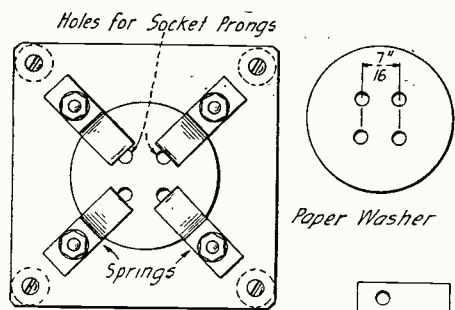

Make Your Own V.T. Sockets. It Isn't Difficult.

Phonograph Record" and as the constructor was warned to be careful not to break the record, I thought I would make one that would not break very easily.

On a piece of cardboard draw a circle with a diameter 1 7/8 inches, and with the same center draw a larger circle 4 inches in diameter as shown in the diagram. On the circumference of the small circle mark off sections 1/8 inch and 1/8 inch, so that between each 1/8 inch space there is a 1/8 inch space. Draw the short lines between the circumference of the circles by placing a ruler in line with the center and the marks as shown by the dotted lines. The 1/8 inch spaces are cut out and the form is ready for winding. After being wound the coils are dipped in shellac or hot paraffin. The size of coil illustrated will hold about 25 turns of No. 30 D.C.C. wire. Larger or

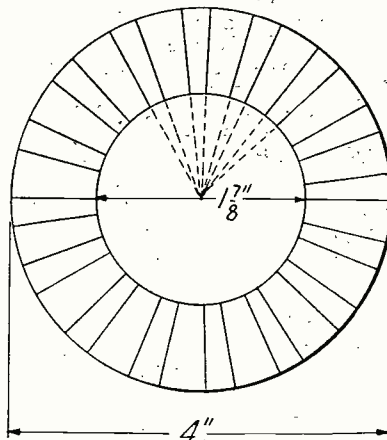

This Shows How to Wind Spider Web Inductances.

smaller coils may be made in the same manner, but an odd number of slots must be made or it will be impossible to wind correctly.

Contributed by EVLYN O. LUND, Vining, Minnesota

A WELL DESIGNED CRYSTAL DETECTOR.

Most crystal detectors made by amateurs seem to be hard to adjust and lose their adjustment very easily, but the design of the crystal detector shown in the diagram permits easy adjustment and once it is found the sensitive spot can be retained. The manner in which the catwhisker is formed is responsible for this. The detector is easily made. The elbow "G" and the angular piece "D" are made from 1/8 brass sheeting. The elbow is fastened to the angle piece with a small brass rivet "C." The angle piece is fastened to the bakelite base by a brass bolt "H" which leaves the angle piece free to rotate easily. Fastened to the upper part of the elbow "G" is a piece of 1/8 brass rod which is filed flat on one side and fastened to the elbow with another brass rivet "B." One end is threaded to take a composition binding post knob "A" and the other end has a small hole drilled in it to receive the catwhisker. The catwhisker is soldered in. The rest of the detector needs no explanation. The cup is of the ordinary kind and everybody knows what a binding post is for.

Contributed by FLOYD RITTMAN, Pittsburgh, Pa.

COMPACT GRID LEAK AND CONDENSER.

Obtain a piece of thin wood, such as that used in cigar boxes, and cut it to size 2 3/4 x 4". Cut two holes for binding about 2 3/4" apart. Then put down a sheet of tin foil about 1/8" smaller all around than the

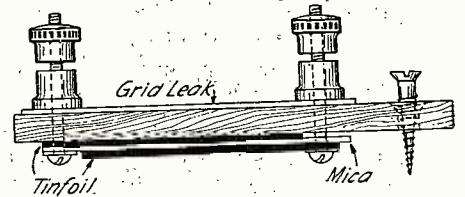

A Grid Condenser and Grid Leak Are Easily Made in One Unit.

wood form. Next put on a sheet of mica or waxed paper, leaving a space for the binding post to make contact with the upper foil. Now put on the next tin foil and insert the other binding post, being careful not to tear the foil. Of course washers should be used to insure good contact and to prevent tearing the foil. On the reverse side of the wood slip a strip of drawing paper on the posts and mark the grid leak with a soft pencil or India ink. Glue strips of heavy paper over the condenser to keep the upper plate in place. If these instructions are followed a neat job will be the result.

Contributed by W. D. McMILLAN, Savannah, Ga.

A DIAL WITH VERNIER FOR THE CONDENSER.

With a little care a good-looking and serviceable dial with vernier for the variable condenser can easily be made.

On a piece of bristol board (any fairly stiff pasteboard could be used, but I chose bristol board on account of its smooth white surface) describe two circles, one 1 3/4" in diameter, and the other 1 1/2". These are to be the vernier and dial, respectively. On the vernier describe two more circles, one 1 1/2" in diameter and the other 3/4". Similarly, describe on the dial a circle with a diameter of 1 1/4" and one 1/8".

Draw the horizontal and vertical diameters on each. Divide one quadrant of the vernier into ten equal parts and number the division lines as shown in the drawing. Divide the dial into thirty-six equal parts and number half of them as per diagram.

Carefully cut out both dial and vernier and cut out the space within the smallest circle of each.

Remove the scale and pointer from the condenser and fasten the vernier to the panel in place of the scale. The dial is put in place of the pointer. Care must be taken to center the vernier and dial exactly in order to secure accurate readings. The dial should be put on so that when it is in the position shown in the drawing the movable plates of the condenser are entirely within the fixed plates.

The method of operation is as follows: If the zero point on the vernier does not coincide with any division on the dial look

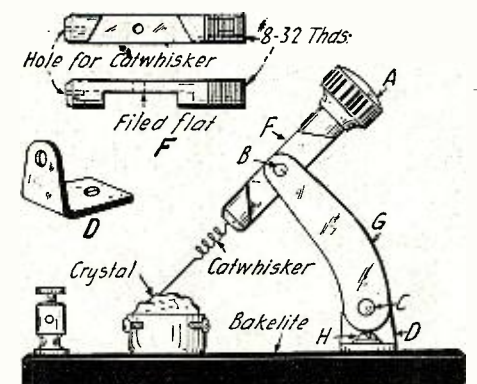

This Crystal Detector Will Not be Put Out of Adjustment Easily.

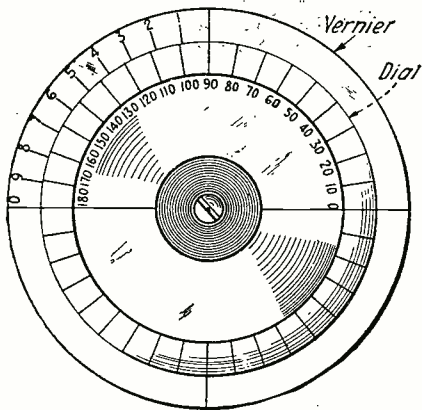

Close Readings of the Dial May be Obtained by the Addition of This Vernier.

along the vernier until a line is found which does coincide with one on the dial. Add the number of this line to the smaller of the two divisions on the dial which the zero point of the vernier is between. To illustrate, if the zero point lies between 90 and 100, and line 3 of the vernier coincides with a division of the dial, the correct reading is 93 degrees.

With this arrangement readings accurate to one degree can be taken. By increasing the number of divisions on the dial and vernier, readings to 1/2 or 1/4 degree, or even less could be made, provided the necessary degree of accuracy be observed in marking the divisions. If there were ninety divisions on the dial and ninety-one on the vernier readings accurate to 6' could be taken.

Contributed by L. DONALD KOONS, Waverly, N. Y.

A SPRING SOCKET.

In circuits employing several stages of amplification microphonic noises are sometimes very annoying. If something drops

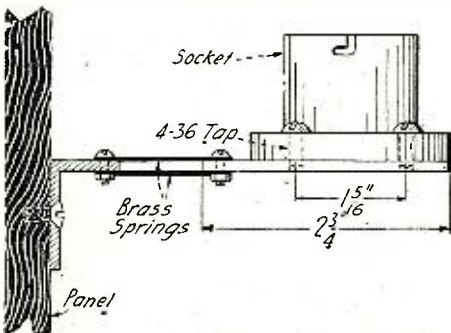

A Spring Socket Which Will Prevent Jarring Noises.

on the operating table an enormous boom is heard on the receivers. Any vibration nearby is repeated in the phones. This can be partially eliminated by mounting the socket on springs. In the diagram is shown a very simple method of accomplishing this.

Contributed by SHELDON TRENT, Bronx, N. Y.

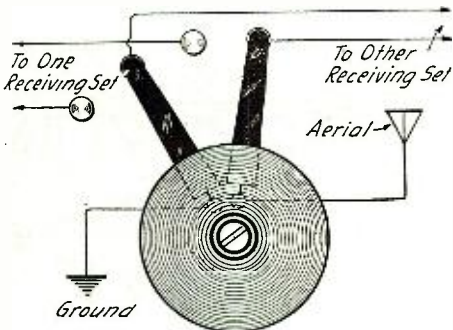

This D.P.D.T. Switch Can be Mounted Easily on a Panel.

MAKING HEADSETS MORE COMFORTABLE TO WEAR.

No doubt a number of fellow "radio bugs" are the possessors of Murdock "55" head sets and find them rather uncomfortable to wear for two or three hours at a time. No small amount of this discomfort is due to the rather sharp edges of the headband. The accompanying illustration shows how this may be eliminated for the small expenditure of "two bits" or less. Simply remove the two screws marked "A" and "B" and take the headband apart. Then purchase sixteen inches of rubber tubing of sufficient size to slip over the headband easily, yet snugly. This may be purchased at almost any drug store. Cut the tubing in two pieces, each eight inches long, and slip one piece over each half of the headband, as shown in the illustration. Reassemble the headband and you will find it much more comfortable to wear. The added comfort to the wearer is well worth the small amount expended, and it might be

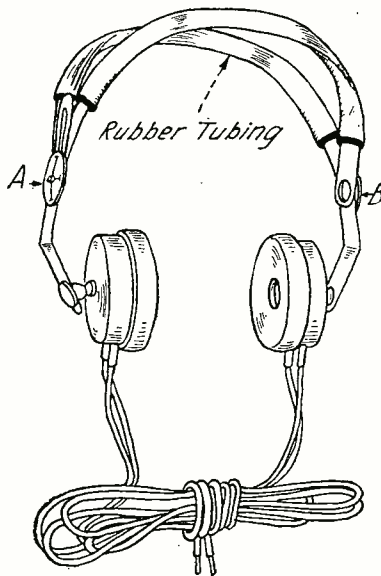

This Idea Makes the Phones More Comfortable

well to note that this same "stunt" may be applied to any headset having a similar headband.

Contributed by DE WITT H. THOMPSON, Pecatonica, Ill.

PANEL TYPE D. P., D. T. SWITCH.

Here is a switch which may be very easily made by any amateur and which is particularly adapted for panel mounting. It is so compact that it takes up very little space on the panel and has a much better appearance than the ordinary types of D. P. D. T. switch.

It consists of an ordinary two blade switch, but two blades are insulated from each other and connections are taken from each.

It may be used for any purpose in which a D. P. D. T. switch is required. In the illustration connections are shown for changing the antenna and ground leads from one receiving set to another.

Contributed by AUSTIN POTTER, Detroit, Mich.

LEARN THE CODE ON THE VICTROLA.

Sometimes it is difficult to arrange for code practice with another amateur. But that is no reason why one should not practice if there is a Victrola in the home. The diagram shows how this is accomplished. The wooden plate is studded with round head tacks spaced as desired. For the dashes three are placed close together and

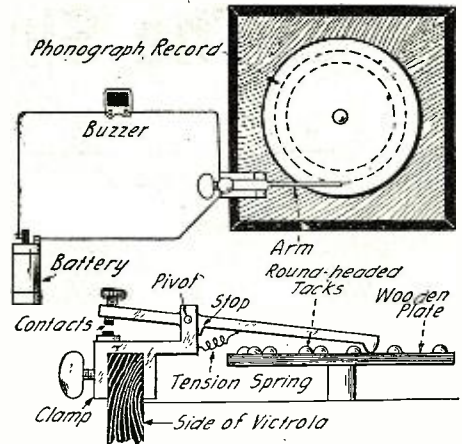

You Can Make Your Own Omnigraph on the Home Victrola in This Way.

a single tap represents a dot. The clamp is made from a piece of wood. The contacts may be copper pennies and the central arm a very thin piece of tin.

Contributed by FRANK O'NEIL, New York.

A LOW PRICED PANEL.

Probably many have regretted blowing in a dollar or two on a panel and would gladly welcome a neat, well insulating panel. For the one I devised two pieces of window glass, a piece of black paper the same size as the panel, and some shellac and enamel are all that are required.

The scales are marked on the paper with the enamel and when dry the opposite side is given a coat of shellac and placed over one pane of glass. The side on which the scales are made is then coated with shellac and the second pane of glass laid upon it. All three are clamped together. When dry the holes are drilled with a sharp iron drill, using a little oil or turpentine. The

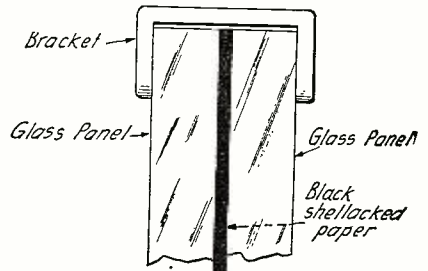

Glass Makes a Cheap and Efficient Panel.

best manner of holding the completed panel to the cabinet is by means of square brackets fitting over the edge.

Contributed by OWEN MOREHEAD, Minneapolis, Minn.

AIDING DETECTION WITH A HORSESHOE MAGNET.

By placing a magnet a certain place on the bulb and at a suitable weight the signals will be increased many times. My signals are increased about 5 times the original strength. I am using 1 radiotron (Continued on page 1209)

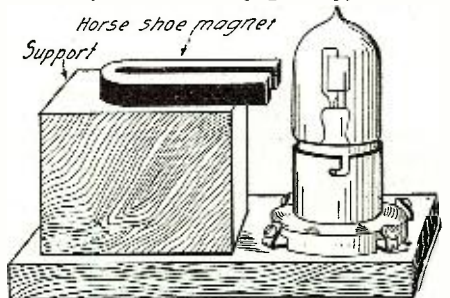

A Horseshoe Magnet Held in This Position Will Aid Detection.

The Simplest "Valve" Cabinet

By RAYMOND EVANS

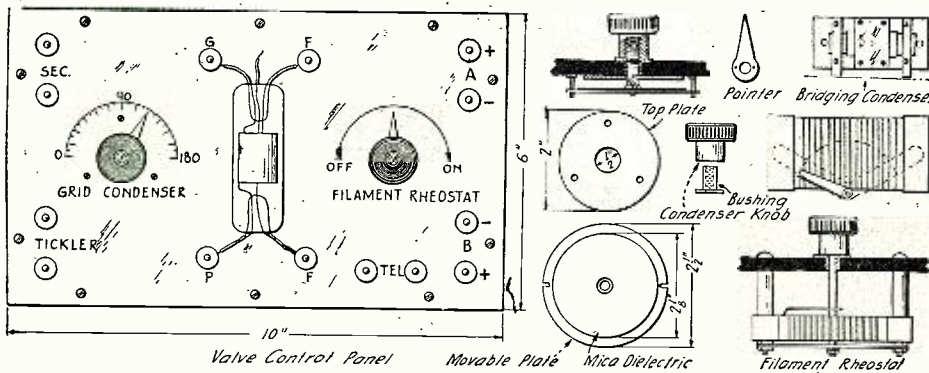

Layout of the Panel and Constructional Details of the Rheostat and Condensers Are Shown Here.

QUITE a large number of radio enthusiasts have grown to look upon the "valve" receiver as a piece of apparatus, the contents of which are more or less enshrouded in mystery, and certainly being beyond the constructional ability of the average wireless experimenter. Actually, this is not the case, and, although the valve cabinet about to be described, is designed upon professional lines, the construction generally is not above the experimenter, provided a reasonable amount of patience is shown and care taken.

The instrument in question was designed with an eye to the maximum of efficiency, and at the same time compactness and ease in operation have not been overlooked. Notwithstanding the fact that the cabinet only measures 10" x 6" x 3", one built similarly and utilizing the same circuit in conjunction with the usual tuning coils, condensers, etc., and a single valve and no additional amplifying devices, although used on an aerial only 20' high and 55' in length, both European and American undamped signals were heard in Sydney, Australia. From this it will be seen that a little perseverance on the part of the constructor will be amply repaid.

The drawings, although made to scale, only show a few of the most important measurements, which will act as a guide when scaling-off for the remainder, these having been omitted on the score of clearness, and to avoid confusion.

The panel itself is made from 1/4" sheet ebonite (or bakelite) and measures 12" x 6". Its sides must, of course, be square and parallel before beginning the marking out process, in order to avoid error. This can be done by means of a file.

As a foundation for the marking out, draw a pencil line centrally across the length and width of the panel, and it will be found that this will assist greatly in locating the positions for the various holes. The terminal posts, of which there are 14, are arranged a fixed distance from the edge of the panel, those for the valve being 1" from the edge and 2" apart, while the remainder arranged in pairs 3/4" from the edge and 1" apart. Center punch the positions for all holes before drilling, and scribe the scales with a pair of dividers, according to the method described in previous articles in this magazine.

The drilling must be done carefully and accurately and holes must not be put in on the slant, and must be of the correct sizes for the terminals or screws, as the case may be. Finish the panel by polishing or graining in the usual way and fill in the scales with a little zinc oxide. The letter-

ing can be done in white, with a fine pointed camel's hair brush.

The condensers can next be gone on with. These are the "grid" and "bridging" condensers, the former of which in this case is made variable, and the latter of a fixed value. Taking the grid condenser, this is made on the "Doule" principle, the details of which, as shown on the drawing, will give a better idea of its construction. It will be seen that there are two plates, both of sheet brass about 1/16" or 1/8" in thickness (the exact gauge does not matter) the top one being fixed by three small screws to the inner side of the ebonite panel, and the lower one arranged to move to and from the fixed plate when the adjustment knob is turned. The knob itself is turned from rod ebonite and a brass bush is securely fitted within it. The hole shown in the brass bush must be of suitable size and tapped 1/4" Whitworth thread. A small brass bush is also to be turned, and forced tightly into the panel in the hole provided for the grid condenser spindle. The central hole of this bush must be sufficiently large to accommodate the condenser spindle, which is threaded also 1/4" whitworth. The hole, therefore, should be 17/64" in diameter. An ordinary 1/4" brass bolt or screw can be used for the spindle, which must be cut to the correct length and rivetted firmly and squarely into the lower or moving plate of the condenser, as shown. It is advisable before finally fixing it, to see that the inside thread in the knob is an easy running fit on the spindle, otherwise the condenser might have a tendency to jam when completed. Two small guide pins are next fitted in position on the back of the panel; 1/8" brass wire straightened and driven tightly into suitable holes will serve the purpose admirably. These serve to prevent the plate moving axially when the knob is turned, which of course would defeat the object of the internal thread arrangement in the knob. To complete the mechanical portion of the condenser, a very small spring or spring washer is placed on the spindle behind the panel. The exact number of turns and strength of this spring must be found by experiment, as its function is to keep the moving plate out the full distance from the fixed plates as the particular adjustment of the knob allows. The mica dielectric for this condenser is made from the best clear sheet, free from cracks and mineral streaks, .002" in thickness, and is cemented firmly down to the inner surface of the brass moving plate in the position shown by the shaded portion in the drawing. Use shellac varnish for the purpose and place under a flat weight until set. To complete the condenser, fit a brass pointer to the knob in any position on the

scale and secure with two small pins, as shown. The adjustment of the pointer will be explained at a later stage. The bridging condenser next requires our attention. As its value has already been determined experimentally, one of a fixed value will serve our purpose, and at the same time take up less room and require less attention than a variable one. Cut from 1/8" sheet ebonite a piece 2 1/4" x 1", and another 1" x 3/4". This latter is the cover piece and is fixed with four small screws (8BA) so as to compress and hold the mica and tinfoil flat; it is shown shaded on the drawing. The mica dielectric measures 1" x 1/2" and is .002" in thickness. Six will be required. For the plates, cut five strips of tinfoil 1 3/8" long and 3/8" wide, of which three go to one side and two to the other, all being interleaved with the mica sheets. The actual area of the plates overlapping must measure 5/8" x 3/8", this being the active portion of them. These plates are carefully assembled and interleaved with the dielectrics in the usual manner and are secured by means of very thin shellac varnish, after which the ebonite cover piece is screwed down securing them. Connections are made by cutting 1/8" strips of say 20-gauge sheet brass and screwing them by means of small screws in the positions shown. Connections from outside can later be soldered to the overhanging ends of these brass strips.

A filament rheostat may take many forms, some of which require considerable skill and constructive ability, but the design used by the writer in this particular case is quite simple in construction and if correctly made is also foolproof. It consists of a piece of slate or ebonite measuring 3 1/4", long 1/2" wide, and 1/2" in thickness. If a lathe is available, it can be placed between centers, and a length of 2 1/4" evenly in the center can be rounded off, as shown in the drawing, in order to facilitate the smoothness of the winding. A thread with a pitch of about 20 to the inch could then be cut in the rounded-off part, to be used as a winding slot so that consecutive turns of the winding will be evenly spaced. If a lathe is not available, then the edges can be knicked with a three-square file instead. Starting 1/4" from the beginning of the rounded portion, wind in the thread some 22-gauge "Eureka" resistance wire until the space is full, and make both ends secure by soldering to its neighbor. The object of leaving the 1/4" space at the beginning, is to provide for an OFF position when the contact arm is at the adjustment shown on the drawing. The rheostat is securely fastened to the panel by means of two screws 2" in length, but is spaced 1" away from the panel by means of two pieces of fibre or brass tube, which

(Continued on page 1206)

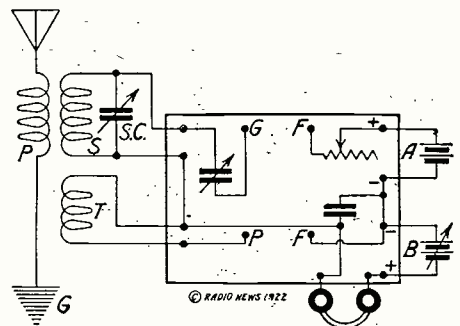

How to Connect a Receiving Set to the Control Panel.

Radio Digest

SOME EFFECTS OF THE DISTRIBUTED CAPACITY BETWEEN INDUCTANCE COILS AND THE GROUND.

TECHNICAL ABSTRACT.

A coil of wire wound in any of the familiar forms called "inductance coils" behaves in an electric circuit primarily as an inductance. The potentials of the different parts of the coil are, however, different from each other and from the potential of the ground. For this reason the coil also behaves to a certain extent as an electric condenser, or rather a system of condensers. These capacity effects of inductance coils are particularly important at the high frequencies employed in radio communication. The effective capacity of an inductance coil depends in general both on the capacities existing between parts of the coil itself, and on the capacities existing between parts of the coil and the ground.

On account of the importance in radio communication of capacity effects in inductance coils, careful studies of these effects, both theoretical and experimental, have been made at the Bureau. An interesting result which has been found is that one effect seems to depend primarily on the capacity of the coil to ground. This effect is observed when two condensers in series are connected across the terminals of the inductance coil, and the common terminal of the two condensers is grounded. If the inductance coil possesses capacity to ground, the familiar criterion for resonance in the system, computed from the known values of the capacities of the two condensers, will not obtain.

If both condensers are variable, and the system is adjusted for resonance by successively assigning arbitrary values for the setting of one condenser, and then tuning with the other condenser, it would be expected from elementary considerations, neglecting the effects of distributed capacity, that the successive resonance values of the capacity of the two condensers in series, determined as the product of their capacities divided by their sum, would be constant. On account of the distributed capacities, this simple relation does not hold. It is found, however, that under the conditions above mentioned, with the common terminal grounded, the capacity of the two condensers in series determined as the product of their capacities divided by their sum, is linearly related to the reciprocal of the sum of their capacities. This relation has been verified both mathematically and experimentally.

The condensers used in making accurate radio measurements are provided with metal shields and one terminal is connected to the shield. The shield is usually grounded. If two shielded condensers are connected in series so that a grounded common connection is made to the two terminals which are connected to the shield, and if the unshielded terminals are connected to an inductance coil, the relation above mentioned will obtain. This relation is therefore particularly useful in making accurate radio measurements.

The results of both the mathematical and experimental investigations of this particular phase of the problem of capacity effects in inductance coils are given in a publication of the Bureau which has just appeared, Scientific Paper No. 427, "Some Effects of the Distributed Capacity between Inductance Coils and the Ground," by Gregory Breit. Copies may be purchased for 5 cents from the Superintendent of Documents, Government Printing Office, Washington, D. C.

DAYTON STORE INSTALLS RADIOPHONE.

The Rike-Kumler Co., of Dayton, Ohio, operating one of the largest department stores in that city, is installing a radio telephone set which is expected to be in operation by the last of April. The station will be located on the seventh floor of the company's structure and will be used to a great extent for what is believed to be the first time in the history of radio, broadcasting of "store news" such as special bargains, etc. It is planned, however, to also give regular concerts, as well as to broadcast market reports, road conditions in the vicinity, and new stories to be supplied by local newspapers. It is also hoped to

Radio Articles Appearing in the May Issue of Science and Invention

Marvels of New Ocean Greyhound.
Radiophoning From Ship to Shore.
Thomas A. Edison Becomes a Radio "Fan."
Dancing to Radio Music on the Ocean.
Chicago Police Adopt Radiophone.
What Caused the Signals? By John G. Merne.
Radio on Aircraft.
New Radio Tone-arm.
Religion—via the Ether.
Radio Recorder Continuous in Operation. By Arthur H. Lynch.
Simplest Radiophone Receiver. By H. L. Jones—Second-prize winner.
Radio Constructor Hints. By H. Winfield Secor.
Radio Broadcast, With Map Supplement, Showing Location of all the Broadcasting Stations in the United States—Their ranges, call letters, etc.
Radio For the Beginner—No. 3—How to Operate a Vacuum Tube Receiver. By Armstrong Perry.
Radio Oracle—Question and Answer Box.
Latest Patents.
Patent Advice.

make arrangements whereby talent appearing at local theatres will give occasional programs.

In connection with the station, the store also plans to install a radio department expected to be one of the most complete in the state.

According to the announcement of the plan made by I. G. Kumler, one of the firm members, it is intended to make an especial bid for the rural trade with the radio set. It is declared that a large number of farmers in the vicinity of Dayton have already installed receiving sets, and, with this service daily, that more will be installed. The road reports will cover every road leading to Dayton for a distance of 25 miles, reports to be made to the store daily by correspondents and this information then compiled and broadcasted for the use of the farmers who may desire to visit the city in their machines. The company also believes that the advertising service will be appreciated by the farmers inasmuch as they can be informed of all special sales several hours in advance of the time they would receive the information in the newspapers.

COLUMBUS, OHIO, HOTEL TO BE EQUIPPED WITH RADIOPHONES.

Guests at the Chittenden Hotel in Columbus, Ohio, soon will be able to step into the main parlors and hear all the latest radio concerts, press reports, etc., being broadcasted throughout the day and evening. Announcement has been made by N. A. Court, manager of the hotel, that it is the intention of the management to install a radio receiving set, using the best equipment it is possible to obtain. Negotiations are now being conducted with manufacturers of radio apparatus.

If plans work out as it is hoped, the guests may be able to hear the concerts in their own rooms. Radio engineers are working on a plan whereby the concerts can be thrown out into the room, using a loudspeaker, and then picked up by microphone and transmitted on to the hotel telephone trunk line, making it available to the various rooms. If the proposed arrangement is carried out successfully, it is believed that the project will be unique in radio as well as hotel annals, and the matter is being watched with extensive interest.

With the proposed installation of a radiophone set at Ohio State University in Columbus for the purpose of broadcasting concerts, weather reports, press items, and addresses by prominent local and visiting men in the city, added interest is given to the hotel's program.

131 BROADCASTERS LICENSED.

Chief Radio Inspector W. D. Terrell, of the Department of Commerce, announced in Washington that 131 licenses for radio broadcasting have been issued and that 30 applications are pending.

NAVY'S BULB TRANSMITTER IN HAWAII HEARD IN EUREKA, CALIFORNIA.

Radio signals from the Naval Honolulu Station (NPM) were heard at the station at Eureka (Table Bluff, Calif., NPW, 2,081 miles distant), in a recent test conducted by Naval Communication service. Honolulu used a 5-KW. bulb transmitter with a wavelength of 1,510 meters. The signals received at Eureka, while audible, were not readable. Naval experts say that the bulb transmitter has been used successfully for distances up to 1,000 miles and although the signals were not readable at Eureka, over twice that distance away, the tests are considered of prime importance in developing this economical form of radio transmission.

VESSEL POSITIONS BY RADIO

The Radio Corporation of America has advised mariners that the daily positions of their ships at sea will be forwarded to their respective home offices by the company if addressed to one of the following stations: Chatham, Mass., WCC; Siasconset, Mass., WSC; New London, Conn., WLC; New York, N. Y., WNC; Cape May, N. J., WCY; and San Francisco, Calif., KPH.

NEW RADIO STATION IN ARCTIC

A radio station has just been established on Jan Mayen Island, in the Arctic Ocean. It is operated by Norwegians and communicates with English, Norwegian and Swedish meteorological stations. As the island is visited by sealing and whaling vessels, this communication should be of great value to them.

NEW BROADCASTING STATIONS

Among the recently licensed limited commercial radio broadcasting stations are the
(Continued on page 1130.)

Who's Who in Radio

No. 16

Commander S. C. HOOPER

ACTIVE interest in railroad telegraphy in his boyhood days doubtless influenced Stanford Caldwell Hooper to later in life follow the pursuit of radio telegraphy and radio telephony. He has earned for himself the appellation, "Father of Navy Wireless."

Commander Hooper was born on August 16, 1884, in Colton, California. He was educated in the public schools of San Bernardino, Calif., and was appointed to the United States Naval Academy from his native State on August 31, 1901. From 1912 to 1915 he was radio officer assigned with the Atlantic Fleet, the first person in this country to occupy the position of fleet radio officer. His initiative and efforts were responsible for transforming the personnel of radio operators of the Navy from an organization of uncertain accomplishment to one of efficiency, where drills, constant practice, and well-defined regulations make for progressive achievements.

He assumed his present position as Officer in Charge of the Radio Division, Bureau of Engineering, United States Navy Department, in 1915. His services in this capacity have been continuous with the exception of eight months' duty at sea during the World War, he being in command of the Destroyer *Fairfax*. When America entered the European conflict, the responsibility devolved upon Commander Hooper to execute Government instructions to take over privately-owned and commercial radio stations—approximately 600, all told—and formulate a just basis of compensation. Also, in the absence of radio facilities in the Shipping Board for its enlarged ship-building program the Radio Division of the Navy Department furnished and installed wireless equipment on approximately 2,500 new vessels of the Shipping Board and also took care of the radio installations on approximately 500 vessels of the American Merchant Marine, which were requisitioned by the Shipping Board.

Every vessel, including tugs, in the service of the United States Navy Department is equipped with instruments for transmitting and receiving radio messages. When Commander Hooper assumed direction of the Radio Division of the Navy Department the Washington office and seven Navy Yards located in different sections of the country had each only one Radio Aid in service, or a total of eight radio technical civilians. Today, there are 70 technical ci-



Commander S. C. Hooper

vilians in the employ of the Radio Division and the various Navy Yards. Some years ago, capital ships were supplied with only five radio operators; today, from 25 to 50 operators accompany seafaring vessels.

Three of Commander Hooper's accomplishments in Navy radio stand out prominently as having national and international importance.

(a) He established the chain of Navy

high power shore radio stations which connected our outlying possessions in the Pacific by radio with Washington through the mediums of the Cavite, Pearl Harbor and San Diego radio stations and also our possessions in the Canal Zone and the West Indies through the mediums of the Darien and Cayey stations, communication facilities with our Atlantic, Pacific and Asiatic Fleets being made secure through these stations.

(b) It was due to his suggestions that the Radio Corporation of America was formed, thereby insuring the establishment of a strictly American radio commercial concern to handle commercial radio traffic, particularly trans-ocean communications with foreign nations, and assuring to American industry and American trade satisfactory commercial service by radio.

(c) He caused the practical development of the radio compass to such an extent that, whereas three years ago this device was not put to any practical use, it is now in general use throughout the Naval and Merchant Marine services as an aid to navigation, particularly during thick weather, and is a valuable adjunct of the National defense. The importance of the radio compass service as an aid to navigation alone can be appreciated when it is understood that the 35 Naval shore radio compass stations furnished during the fiscal year 1921 more than 53,000 radio bearings to 21,622 vessels.

From the standpoint of the practical utilization of the radio compass, therefore, it can be said, without fear of contradiction that Commander Hooper is also entitled to the appellation "Father of the radio compass service."

Numerous articles have appeared in *RADIO NEWS* describing the use of the Radio compass on board ships and on land. Many lives have been saved at sea by the added safety which the radio compass provides by guiding ships lost in fog.

Beware of the Shark

By BERT A. TEETERS

A YOUNG man in a mid-western city recently purchased a radio receiving set for the purpose of "sitting in" on some of the concerts and entertainment programs which were being broadcast from a nearby Radiophone station. His knowledge of wireless and wireless regulations was extremely limited—so much so that his set had been assembled by a friend who had progressed further in the game. As this youth sat, one evening, in the little booth outside the house where his set was installed, there came a knock on the door. Answering it, he was surprised to see a stranger standing there, who, when the youth opened the door, threw back his coat and displayed a very official-looking badge.

"I'm an inspector," said the stranger. "I want to

look the station over," and he stepped inside the door and began looking around. "Where's your license?" was his next re-

mark.

"License?" replied the youth, "why, I didn't know one was required as I have only a receiving set."

"Where did you get that idea?" demanded the stranger. "Certainly you have to have a license. Too many of you fellows have been getting away with that stuff and defrauding us. If you haven't a license, you'll either have to make out an application or I'll have to report the case."

"Well, I am willing to do that," said the amateur. "Where do I get the blank?"

"I'll let you have one of my extras," he was told and the stranger proceeded to pull a "blank" from his pocket. He then informed the youth that a \$10 fee would have to accompany the application.

"Why, I haven't got that

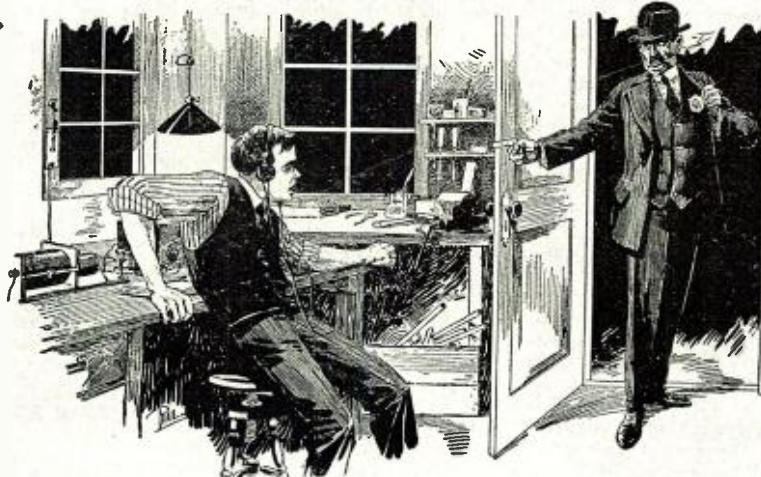

"I'm an inspector", said the stranger; "I want to look the station over."

(Continued on page 1210)

Correspondence from Readers

A GRIEVANCE.

Editor, RADIO NEWS:

Have read and studied RADIO NEWS with interest and profit during the past year.

Many articles do not give the addresses of writers. This is unsatisfactory because reference to transmissions and receptions give but partial understanding of distances covered. Instance: "Long Distance Hook-up," by William Bessey, 781, May, 1921. (*We are correcting this.—Editor.*)

The word "Amateur" may be well chosen; but it seems to me that "novice" or "tyro" would be more appropriate. A very large percentage of so-called amateurs have no more conception of correct and timely transmission than could be expected of ten-year olds. They seem to think that speed is all important. They sit and pound out gibberish from all quarters under the seeming impression that such is telegraphy. Many of them are not within wave-length regulations. The consequence must surely mean elimination of the "Amateur" transmitter unless something can be done. Our Government cannot round them up individually. Some of us would like to keep the privilege of operating a transmitter, if possible.

The recent and present efforts to popularize radio telephony presages a stampede in that direction which, indeed, seems already under way. All well and good. This will mean the greatest educational and pleasure-giving application that civilization has known. It cannot be stopped and no one wants to stop it, but some of us who have a little understanding of telegraphy would like to keep our transmitters for that purpose, as well as for telephony. Amateur telegraphy has its place. In some ways it cannot be supplanted by telephony.

The boys who care not for consequences, so long as their splutterings occasion interference in Brazil or equally distant places must be eliminated, lest all amateurs go with them in the otherwise inevitable restriction. How can it be done most certainly and most effectively? In the name of real, scientific endeavor, let's get busy before it is too late.

J. E. STUART.

A SECOND "WANDERER."

Editor, RADIO NEWS:

The article "Who Can Use This Man?" by "The Wanderer," has struck me so forcibly that I am writing this, partly because I have often thought of doing so, partly because I want to let you know the "Wanderer" is not alone in his predicament, and also because I want to get a load off my chest.

The reason the article hits me "dead center" is because it is nearly word for word my own experience. The only exception I see is that "Wanderer" served an extra year, while I was "out" of the Navy about five months before going back for an extra year. I got "out" again last April. Another period of fruitless travel between Boston, New York and Philadelphia, and search for profitable employment ashore (I have a wife and family that I naturally wish to live with).

Finally, I "shipped over" last June (30th) and am now "out" once more. Got "out" on Alnav 75, special order discharge, honorable conditions, total 4 years 5½ months service in the navy, 2 years as first class and 2½ years as chief radioman. Add to this three of Uncle Sam's first class commissioned officer's tickets covering a period of two years each and all service records good. More addition, is an amateur outfit since 1909 (coherer to regenerator set and amplifiers), and various other radio experience, such as building, selling, calibrating,

repairing, inspecting and operating radio apparatus and stations ashore and afloat. While in the navy I was on several of the trans-Atlantic stations, WGG, WSO, etc., and have handled 100 kw. arc, 200 kw. high frequency generator, 300 kw. timed sparks, photographic recorders, radio compass, Marconi and navy standard types, and medium and low power arc, spark and lamp sets, telegraph and telephone types galore, etc. What does it get you? Wanderer, O. M., the game is dead, as far as it goes as a livelihood, save for the anointed few, of which we two are not.

I have tried and failed to land a job, position, or plain work, anything for a start, to show that I can "deliver the goods" with plenty of amps., but it's no go so far. Like "Wanderer," I want to know: "Where do the high power stations get their experienced radio men for, ship engineers, operators, etc?"

Where do the manufacturers get their trained men?

I've never seen "ads" for anything like

Some of the Interesting Articles Appearing in the May Issue of Practical Electrics.

Open Circuits in Auto Systems.

Automatic Telegraph Recorder.

Secret Telephony.

World Without Electricity.

Summer Time Electrics. By H. Winfield Secor, Assoc. Member American Institute of Elec. Engineers.

radio engineers, designers, assemblers, draftsmen, and so on.

And the large concerns seem to think you are a very inquisitive person, one who deserves no interviews or information relative to obtaining a position. What you do get is, "There is really nothing at present; we will be glad to take your address," or perhaps you are referred to Mr. So-and So, and he takes your application which is the last thing you do for that concern.

Whew! Now I feel better. I guess "Wanderer" said all I've said, but we are as alike as two destroyers, and I guess we are both feeling about the same.

It would be interesting indeed, if you would publish the eager replies from the manufacturers, etc. "Wanderer" is going cheap at \$125 a month, but it's not much of a risk. I'd do the same any day for a start until, as he says, I could produce the goods to prove to the engaging parties that they were not stung.

I am married to Radio and always have and always will be, but I've about decided to quit as far as a career is concerned. You see "Wanderer" had only been out a week when he wrote that article. I have been out seven weeks this time, seven weeks the time before last and six months about two years ago. I am not becoming a "Doubting Thomas." I am one.

Should you get more eager replies than you can find use for, I would take it as one of the best acts of kindness I ever received, if you would "take my name and address for it."

Fraternally yours,
A RADIOMAN.

In this issue will be found a complete story of the "Wanderer." Frankly, we believe that the "Wanderer" had a good excuse for not finding a job for the reason that he was located out west and at the

time there was not the great radio activity in the west that there is now. But for a radio man in Philadelphia who cannot find a position these days—frankly, there must be something wrong in his make-up.

Practically every daily newspaper is now carrying a radio section. In many of these there are "help wanted" ads and hardly a day passes when there is not a call for a good radio man. Take for instance the New York Mail, New York Evening World and New York Evening Globe. All of these carry advertisements constantly which call for good radio men. We believe the writer of this article would do well to brush up a bit on the situation and get a good job at once.—EDITOR.

4DS.

There has been a recent change in the call 4DS which is listed under the name of Fred A. Chapman, Ward, S. C., to W. S. Malone, 246 Hillside Street, Ashville, N. C. It is requested that all amateurs please change their call books accordingly.

RE TRANSATLANTIC TESTS.

Editor, RADIO NEWS:

Since my article appeared in RADIO NEWS (page 700 of the February issue) I have received numerous inquiries for data, etc., with regard to H.F. transformers, as used in the recent Trans-Atlantic tests.

To these I have replied in full in most cases, but would like to thank, through the medium of your columns, all those who sent congratulations, etc.

I am the sole manufacturer of the particular type of H.F. transformer used in the tests and shall be pleased to forward full particulars of the same to any who care to write me at the address given below.

A. G. GREENSLADE,
9 Jelf Road, Brixton, S.W. 2,
England.

AN ANTI-PHONE ONE.

Editor, RADIO NEWS:

Get ready for some stiff words. I have to get it off my chest some time, so I might just as well do it now.

Why do you have to spoil a perfectly good magazine with this phone business? Use the space for something of more value. The radiophone is nothing but a nuisance anyway. How about using the space for "C.W." information?

If the Government would wipe out entirely these broadcasting stations, it would be a boon to the radio game. Anybody can get these concerts, but let some of the so-called "Amateurs" try to copy some "8" or "4" with their "Wonderful Westinghouse receivers." (If they can copy.)

I have been in the radio game for eight years, and have had a set working ever since the war, but I have never come across anything so funny as to sit and listen to some man with a radiophone receiver try to talk on wireless.

He talks all about the future of the phone, but he does not know that the code will never be surpassed. Every time a phone station adds a mile to its sending distance, the code station adds 15 or 20 miles.

I have nothing on the broadcasting stations personally, but when it comes down to trying to put the amateur off the air until eleven or twelve o'clock, that is going too far.

Where is the Government going to get its operators? Where would the big stations get their engineers and operators? Where would the broadcasting stations get their operators, if it wasn't for the amateur?

(Continued on page 1205)

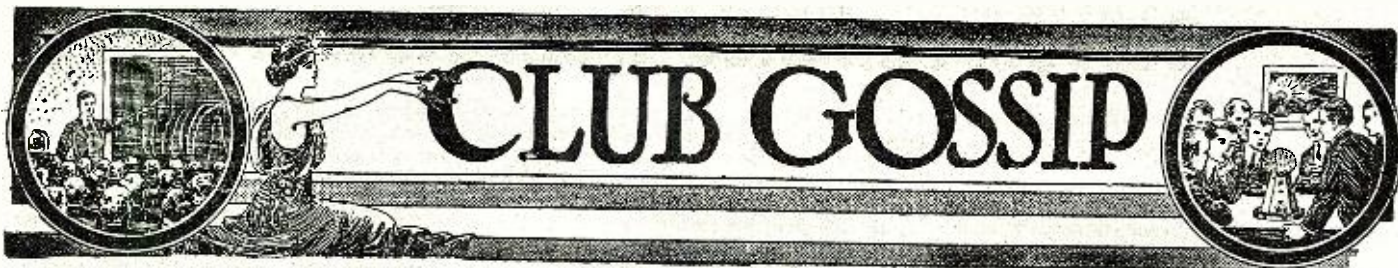

THE UNIVERSAL RADIO ASSOCIATION

The Universal Radio Association was organized on March 7, 1922, in the city of Everett, Mass. The following officers were elected: President, Mr. Ayers, vice-president, Mr. H. Mellen; secretary-treasurer, Mr. A. McClellan, chief operator, Mr. F. Dale, and publicity agent, E. Stewart. Meetings are held at the home of Mr. McClellan, 146 Central Avenue, Everett, Mass. A complete receiving set is in operation at the club-rooms and a transmitter is soon to be installed. All interested are invited to attend the meetings.

MORNINGSIDE RADIO CLUB

Owing to the inability of Mr. J. Jacob to attend the meetings of the club, it has elected as its president Mr. George McDonald.

The club is very desirous of communicating with other clubs and will greatly appreciate a line telling what other clubs throughout the country are doing. Address all communications to the secretary, Mr. Owen A. Marsh, 3915 Peters Avenue, Sioux City, Iowa.

THE SOUTHERN ONTARIO RADIO ASSOCIATION

Plans for what is hoped will be the most successful year yet experienced, were laid at the meeting of the Southern Ontario Radio Association held in the clubrooms, 20 Ferry St., Windsor, Ont., on Tuesday evening, March 14.

Robert Moore was elected president for the year 1922 and the following other officers were chosen at the meeting: Kenneth Atkinson, vice-president; Robert C. Hunt, treasurer; Charles R. Wadge, secretary. Members of the advisory committee are: D. Aitchison, chairman; W. Baker, R. Bridwell. The following welcoming committee, whose duty it will be to welcome new members and visitors, was appointed: C. D. Lane, chairman; G. Brett, J. Green.

One of the most important new plans laid was one to better regulate the amateur stations in the border cities, and to this end a traffic committee, consisting of R. Moore, traffic manager, R. Bertram and H. Wilson, was appointed.

After the election the new officers assumed their duties and conducted the regular business of the meeting.

THE RED BANK RADIO CLUB

The Red Bank Radio Club, of Red Bank High School, is now in full swing with about twenty-two members enrolled. A complete radio telephone and telegraph transmitter and receiver will be installed as soon as the club treasury gets on a somewhat firmer basis.

The meetings are scheduled for every Tuesday evening at 7.30 in the physics laboratory room, where a small temporary set is now installed. The faculty takes a great interest in the progress of the club's reception of the many radio telephone stations in this vicinity.

The officers elected for the ensuing three months are: President, Arthur E. Thiessen, 2BND; secretary John Osborn; treasurer, J. Elwood Harvey, and chief operator, Edwin Compton, 2CAY.

One of the expert instructors from Camp Vail, the nearby Signal Corps School, gives very interesting talks in radio theory and practice at every meeting. Code practice tables will also be installed and an expert will give instructions in code practice.

All radio fans wishing to join are urged and invited to come to these meetings.

ROSELLE PARK RADIO CLUB

The Roselle Park Radio Club is continually growing both in membership and activities. The club was organized in October, 1920, with fifteen members, and today it numbers seventy-two.

The club has grown through the leadership of Robert Horning (2KK).

The first affair that the club attempted was a dance with the music furnished entirely by radio from station WJZ. This was supplied through the courtesies of Messrs. J. Andrew White and W. A. Easton. This dance was held on February 24, 1922.

Interesting lectures have been given by individuals of the club. Mr. E. M. Tingley gave an interesting talk on March 23rd on "Amplifying Transformers and Condensers."

A very important event which the club is undertaking is a lecture on Tuesday, May 9, 1922, at 8 P. M. sharp, by Mr. Paul F. Godley, our hero of the trans-Atlantic tests, on "Regenerative Receiving", and his experiences abroad. This lecture will be very interesting, and the club extends an invitation to surrounding organizations

of the Second District to send their delegates to this meeting. The lecture will be given in the high school auditorium, Grant Avenue, Roselle Park, N. J.

The club will, in the future, have a regular program printed of lectures and other activities of the organization and will gladly furnish any clubs interested with same. This can be obtained through the secretary, Mr. C. A. Reberger, Roselle Park, N. J.

PHILADELPHIA AMATEUR RADIO ASSOCIATION

The Philadelphia Amateur Radio Association held its last regular meeting in the Widener Memorial Library, at 1200 North Broad Street, on Monday, April 3, 1922. Mr. W. C. McFadden, who is from the Laboratory of the Philadelphia Navy Yard, gave a talk on radio frequency and discussed the subject fully. This was very interesting to all the amateurs, as they have been experimenting on it.

Mr. Chas. Van Du Vera gave a short talk on "Practical Experiments With Audio Frequency", which was very interesting. Information and prices were given by the president on "Condensite Celoron". Mr. John Delf, Jr., talked on "Nw Circuits for Using Audio Frequency", and discussion followed.

The president decided on account of the hot weather the next meeting would be the last until the third Monday in September.

It was suggested at a meeting held in February that the stations allowed to broadcast music by the recent edict of the Department of Commerce be made to do so on wave-lengths of 1,200 to 1,600 meters and that the amateurs remain on the wave-length of 200 meters so as not to interfere with the commercial broadcasting stations. The public could, with very little trouble, hear the commercial stations by adding a small inductance to the sets which they have.

By this the amateurs would not cause any QRM with the commercial stations and at the same time the amateurs could broadcast music on 200 meters. As the Philadelphia Amateur Radio Association is one of the affiliated clubs of the A. R. R. L., it was decided to abide by the decision of the A. R. R. L. concerning the matter. J. W. Forsyth, 6543 N. Lambert St., Philadelphia, is the association's corresponding secretary.

BENSON RADIO CLUB, BROOKLYN, N. Y.

The first meeting of the Benson Radio Club was held on March 2, at the home of the president. There was an election of officers, as follows: President, John McMahan; secretary-treasurer, Frank Murray.

There were thirteen charter members present at the meeting, who conversed about many important matters of the club.

The aim of the club is to help the less experienced members of the club with their problems. A code class has been opened for the purpose of increasing the speed of some in order that they may obtain their licenses.

A fine set has been placed at the club's disposal by the president; on this some good results have been obtained. If things continue as they have lately, the club promises to be one of the most interesting in the district.

Correspondence from other clubs or amateurs is invited. Address all communications to Secretary, Frank J. Murray, 69 Bay 20th St., Brooklyn, N. Y.

THE RADIO CLUB OF DANBURY, CONN.

The Radio Club of Danbury has been formed with a membership of 25, with the prospects of an increase soon. Only about one-half the members have receivers. None have transmitters, although some will soon install them.

We have no permanent club rooms as yet and no club apparatus, but we expect to soon have both. The officers are: President, Guthrie Sands; vice-president, Lawrence Smith; secretary, G. D. Ryder, and treasurer, Arthur Leonard.

Anyone who wishes to correspond with us should address the secretary at 16 Division Street, Danbury, Conn.

THE EASTON RADIO ASSOCIATION, EASTON, PA.

The Easton branch of the Lehigh Valley Radio association reorganized on March 17th and elected the following officers: A. M. Umholtz, 140 Bushkill Street, president; H. Shook, 1133 Ferry Street, vice-president; Richard G. Bright, 610 Lincoln Street, secretary-treasurer.

We have meetings every two weeks on Friday night; these have been held in the local Y. M. C. A. building, in the past. Our membership is now 45 and we are trying for 100. Our new

name is the "Easton Radio Association."

Please make a note of this and consider us as one of the many other associations throughout the country. Correspondence from other associations is invited.

THE SPRINGDALE RADIO CLUB, SPRINGDALE, ARK.

With Fred E. Reed as president, the radio fans of Springdale have organized a club under the name of Springdale Radio Club, with the object of studying the radiophone and wireless telegraph. The club has at present about 35 enthusiastic members and a good prospect for as many more next meeting.

The boys will soon have installed a high powered receiving station and later will put in a sending apparatus. Until the sets are installed the club will study and discuss various important points relative to the wireless.

At the last meeting the following lectures were given: "The Comparison of the Words Wireless and Radio", by Manville Buford; "The Aerial and the Ground System", by Harold Clark; "The Crystal Detector and Minerals", by Donivan Youree; "The Tuning and the Tuning Instrument", by Anthony Urbahns; "The Condenser Used in Receiving Circuit", by Anthony Urbahns. "Hertzian Waves and Wave-Lengths", by Autry Joyce, operator.

THE RADIO CADET CORPS

The Radio Cadet Corps, an organization of New York boys extending all over the State, and headed by Col. E. E. Schemble, will have a big booth at the coming Radio Show in the 71st Regiment Armory, May 22 to 27th. They have secured space from the show managers in the Hotel McAlpin, and will erect a complete field camp and radio apparatus, giving demonstrations to the inquiring lads who attend the show. They will have on display at their tent the largest hand-made radio transmitting apparatus ever built by an amateur, they declare, it having been made by one of their members, Sergeant John Herrwagon. The Radio Corps has about 200 members at this time; they will have complete uniforms, and under Col. Schemble and Major Robert Abells, will aid in "policing" the armory during the big radio show.

THE SUNSET CLUB

The Sunset Club, being the order of "oldsters" gathered together by Mrs. C. A. H. Rugg during the war, with no applicant for membership under sixty-five years of age received, has gone in strong for radio. Next Wednesday afternoon, April 26th, they will hold a meeting in the roof garden of the McAlpin Hotel, when they will give a concert and series of talks to their branch clubs throughout the country via the radio broadcaster, their messages being sent from the hotel and amplified at the Wanamaker station. The Sunset Club members ranging in ages from 65 to 98, have settled all their worldly cares and have decided to enjoy the balance of their lives in useful work and play, and it is remarkable that this decision has seemingly deducted many years from their ages. Mrs. Rugg lives at 317 W. 96th St., New York. Headquarters of the club is at the Hotel McAlpin.

AMATEURS CO-OPERATE IN RADIO CONTROL

Following the tentative report of the Department of Commerce on Radio Telephony allocating waves according to class of service (this list is available if desired), the Amateur Committee accepted the recommendation that the band for amateurs be 150 to 275 meters, and that the limits be fixed by law under the Department of Commerce.

Their report also recommended that their status be established by law, and that the Secretary of Commerce subdivide amateur allocation into small or wave-length bands for various classes of amateur transmitting apparatus, starting at the shortest wave, spark and continuing in the following order: interrupted or modulated continuous telegraphy, telephony and continuous wave telegraphy.

For the purpose of self-policing among the amateurs, it was suggested that amateur Deputy Radio Inspectors be created, elected from their numbers by the amateurs of each locality and appointed by the Radio Inspector of each district, to serve without compensation or for one dollar a year if compensation be legally required. Such Amateur Inspectors should be given whatever authority is necessary in the opinion of the District Radio Inspector, and their duties should be to accomplish observance of the Radio Communication Laws and Regulation of the United States and of any local co-operative measures as are agreed to in each community.

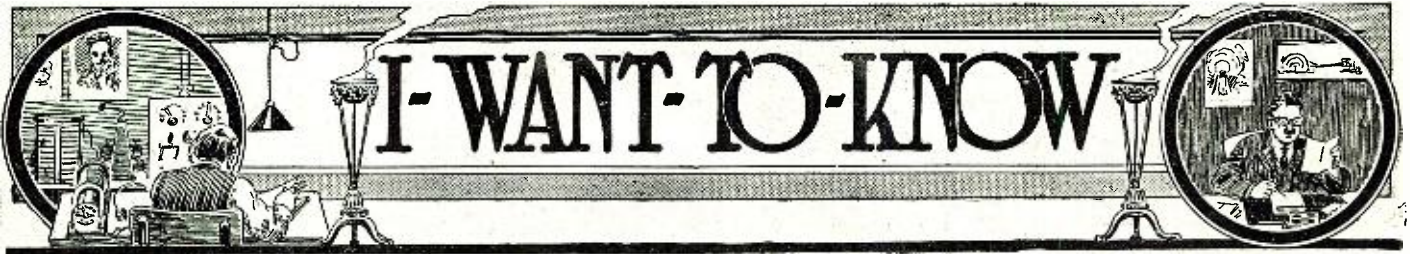

THIS Department is conducted for the benefit of our Radio Experimenter. We shall be glad to answer here questions for the benefit of all, but we can only publish such matter of sufficient interest to all.

1. This Department cannot answer more than three questions for each correspondent.
2. Only one side of the sheet should be written upon; all matter should be typewritten or else written in ink. No attention paid to penciled matter.
3. Sketches, diagrams, etc., must be on separate sheets. This Department does not answer questions by mail free of charge.
4. Our Editors will be glad to answer any letter at the rate of 25c for each question. If, however, questions entail considerable research work, intricate calculations, patent research, etc., a special charge will be made. Before we answer such questions, correspondents will be informed as to the price charge.

You will do the Editors a personal favor if you make your letter as brief as possible.

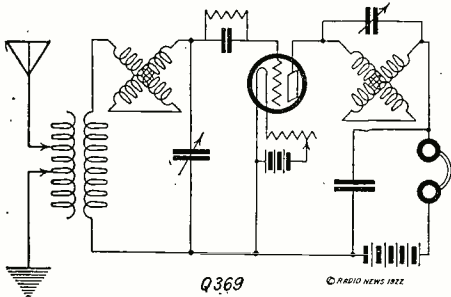

This is One Method of Increasing the Range of a Regenerative Receiver by Means of Condensers.

ONE TUBE PHONE TRANSMITTER AND RECEIVER

(367) Mr. Walter Thain, 1412 E. Eighth Avenue, Pine Bluff, Arkansas, wants to know:

Q. 1. Please publish the circuit of a simple short range radio telephone such as was pictured on the cover of the February RADIO NEWS, using one tube for both sending and receiving.

A. 1. Diagram you request is published on this page. A four-pole double throw switch is the only control necessary to change from a transmitting to a receiving position with this circuit. The high tension is supplied by plate batteries to the value of 200 volts. Dry cells are used for the filament battery, making the entire outfit easily portable.

CUTTING OUT RADIO FREQUENCY AMPLIFIER

(368) Mr. Clifford Glick, of New York, writes as follows.

Q. 1. What switching arrangement should I use to cut out a two-step radio frequency amplifier, and use the detector alone?

A. 1. Switching arrangement is shown in diagram on this page. Two D.P.D.T. switches are used. They should occupy the actual positions indicated and leads kept as short as possible.

INCREASING WAVE LENGTH RANGE OF REGENERATIVE RECEIVER

(369) Mr. C. McDermott, Bellevue, Iowa, asks:

Q. 1. How can a standard type short wave regenerative set be loaded to tune to 1,000 meters.

A. 1. Two circuits are published on this page showing how a standard short wave regenerative receiver may be adapted to increase the range of wave lengths and still retain regeneration. In one circuit a double-pole double-throw switch is used to transfer from short waves to longer waves. In the latter position the rotor of the plate variometer is put in series with the grid circuit and a small variable condenser shunted across it. Regeneration is obtained by direct feed-back action. This is a very efficient circuit,

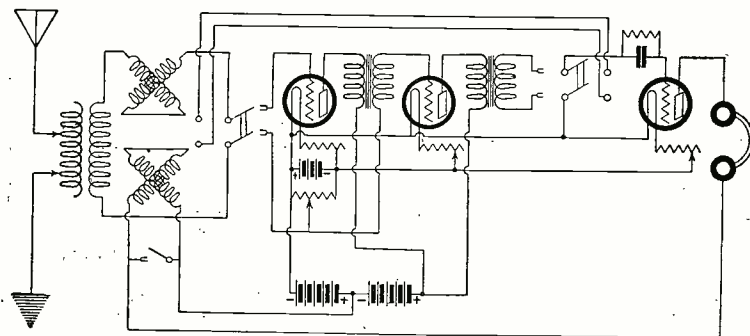

and there is no loss on the shorter wave lengths.

Q. 2. Has a variable grid condenser an advantage over a fixed one?

A. 2. There is some advantage in using a variable grid condenser especially with regenerative circuits.

Q. 3. How far can the Government market broadcasts in Washington be heard?

A. 3. It is impossible to answer this, as it naturally depends upon the amount of amplification used at the receiving station, how great a distance reception may be effected.

REGENERATIVE RECEIVER FROM LOOSE COUPLER

(370) Mr. A. H. Haun, Jr., Williamsport, Indiana, wants to know:

Q. 1. Could a 3,500 meter, receiving transformer, loose coupler, be used with the same results in place of the double slide tuner in W. F. Allston's article, "A Regenerative Receiver from a Double Slide Tuner" in the February issue of RADIO NEWS.

A. 1. Two circuits are shown on these pages which may be used to obtain regeneration with a loose coupler by means of condensers. One is practically the same circuit as that described in the February issue, adapted for use with a loose coupler. The second is another adaptation which will obtain the same results.

LIGHTING FILAMENTS FROM A. C.

(371) Mr. Arno A. Voight, Hawley, Pennsylvania asks:

Q. 1. Can an ordinary toy transformer attached to a 110 volt house current, tapped at 6 volts be used for the filament current in a Radiotron V.T.?

A. 1. Yes. A toy transformer may be used for this purpose.

Q. 2. Can it be used for plate current if tapped at 22½ volts?

A. 2. This would be possible if some means of rectifying the A.C. is also employed. The hum of the A.C. would, however, be noticeable in the phones.

Q. 3. Would you please publish this hook-up if it can be used?

A. 3. The circuit you request is published on this page. The potentiometer should be used in the position indicated as this assists in reducing the hum of the A.C.

ELIMINATING HUM FROM INDUCTION

(372) Mr. Howard G. Ehrenfried, Tiffin, Ohio, wants to know:

Q. 1. Is there a hook-up one can use that will eliminate the hum made by the motors in a motion picture theatre located about 50 feet from my aerial?

A. 1. Circuit is shown on this page which may be used to eliminate the hum caused by induction. Regeneration is obtained by means

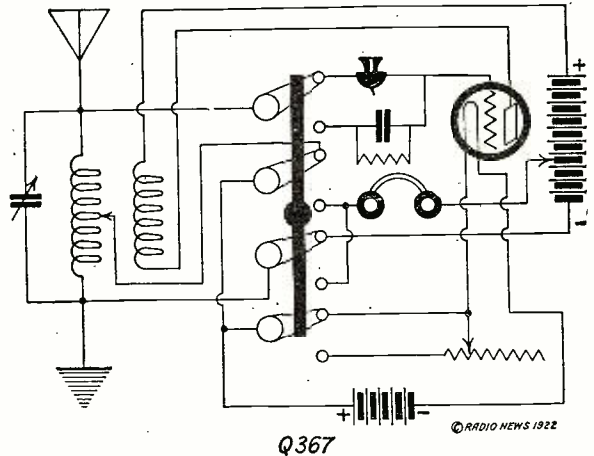

With This Circuit One Tube is Used for Radiophone Transmission and Reception. This is the Circuit Used in the "Cowboy" Outfit on the February Cover.

of the vacuum tube, while detection is made by the crystal. The hum of the induced current does not usually pass the crystal. You may also try shunting your antenna with a choke coil having an iron core.

A SIMPLE CRYSTAL RECEIVING CIRCUIT

(373) Mr. James Keelins Villanova, Pa., asks:

Q. 1. Could you please give me a hook-up to eliminate hum from arc lamps?

A. 1. See answer to question 372.

Q. 2. What is the natural wave length of a two-wire aerial, 80 feet long, 50 feet above the ground?

A. 2. In the "I-Want-To-Know" department of the April-May issue we published charts from which you may calculate the wave length of your antenna from its dimensions. We refer you to these charts.

Q. 3. Please publish hook-up for one variometer, crystal detector, fixed condensers and phones?

A. 3. Hook-up for this simple receiving circuit appears on this page.

REGENERATION AND AUDIO FREQUENCY AMPLIFICATION IN ONE TUBE

(374) Mr. K. McLean, Somerset, South Africa, asks:

Q. 1. Is it possible to obtain regeneration and audio frequency amplification with one tube?

A. 1. The circuit is shown on this page, whereby regeneration and audio frequency amplification are obtained in a single tube. The primary and secondary of the audio frequency transformer should be shunted by a condenser to pass radio frequency.

AMATEUR TRANSMITTING LICENSE

(375) Mr. Henry Huning, Ventura, California, wants to know:

Q. 1. What is the wave length of an aerial, one wire, 20 feet high at one end, 35 feet high at the other, and about 70 feet long?

A. 1. You may calculate the wave length of your antenna by its dimensions from chart published in the "I-Want-To-Know" department—April, May issue.

Q. 2. Please inform me as to where I can get data on transmitting license?

A. 2. Amateur transmitting license may be obtained by making application to the radio inspector at the Custom House, San Francisco. Upon request he will send you necessary blanks.

INDOOR LOOP AERIAL

(376) Mr. Frederick Elwood, Beecroftbottom, W. Va., wants to know:

Q. 1. Would an indoor loop aerial 25 feet by 25 feet be suitable for receiving KDKA and WJZ and amateurs; having only one wire?

Method of cutting radio frequency amplifier out of the circuit to use detector tube alone is shown. The switches should occupy the actual positions indicated.

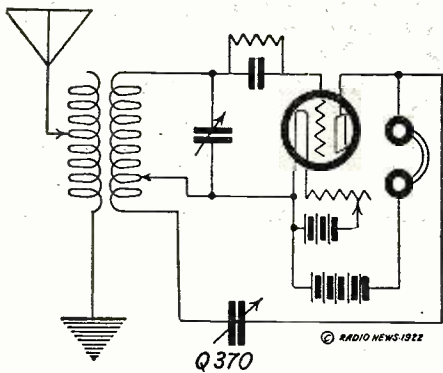

Q370
To Make a Regenerative Receiver From a Loose Coupler This Circuit May be Used. Only Two Condensers Are Required for the Purpose.

A. 1. This would be too large a loop. To receive on the short wave lengths a loop 6 foot square is the largest size for efficient reception. As the loop increases in size beyond these dimensions, the efficiency is reduced as it is necessary to use a smaller number of turns.

Q. 2. Would it be better to have two or more wires, and if so, how many?

A. 2. Two turns on a loop 6 feet square will give very good results on 200 and 300 meters. Shunt loop by .0005 M.F. condenser. With a loop 4 1/2 feet square, wave length range from 190 to 450 meters may be obtained with 4 turns shunted by a variable condenser of .0005 M.F. capacity.

Q. 3. Where can Myers tubes be procured?
A. 3. These tubes may be purchased from the Radio Audion Company, 90 Oakland Avenue, Jersey City, N. J.

RECEIVING TUBE PLATE VOLTAGE

(377) Mr. Thomas O. Nelson, Alexandria, Va., wants to know:

Q. 1. What is the wave length of an aerial: height 37 feet, length 27 feet, 4 wire. No. 18 bare copper, spaced 23 inches apart?

A. 1. See answer to previous question.

Q. 2. What is the proper plate voltage to use on a Moorehead A.P. tube (amplifier and oscillator)?

A. 2. With this type of tube, plate voltage may be from 45 volts to 100 volts.

Q. 3. Can this tube be used in a telephone set, using about 100 volts of flashlight batteries as the high voltage source?

A. 3. It would be possible to use this tube in the manner you mention for short distance transmission purposes.

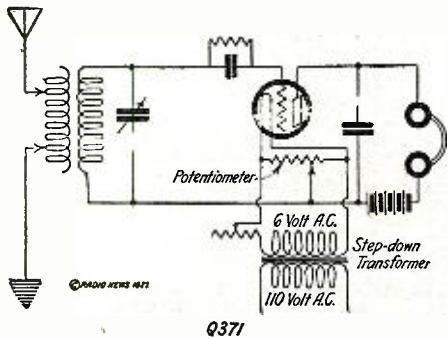

Q371
The Filament of a V.T. May be Lighted by A.C. if a Step-Down Transformer and Potentiometer Are Used.

SHORT WAVE RECEIVING ANTENNA

(378) Mr. Gerald K. Dabler, Wyanet, Ill., wants to know:

Q. 1. What are the wave lengths of the following aerials? Four wire aerial, the wires being 70 feet long, 40 feet high each spaced 2 feet apart. One wire aerial 200 feet long, 40 feet high, also a two-wire aerial, the wires being 100 feet long, 45 feet high, spaced 4 feet apart?

A. 1. The approximate wave length of the first antenna would be 180 meters, the second would have a natural wave length of about 290 meters and the third about 160 meters.

Q. 2. Which of the above aerials is the best for short wave receiving?

A. 2. The last-named aerial would be the best to use for short wave reception purposes.

RECEIVING RANGE OF CRYSTAL DETECTOR

(379) Mr. Ralph Cress, Ligonier, Indiana, wants to know:

Q. 1. Would I be able to hear the broadcasting station at Chicago, 110 miles away on an aerial 30 feet high and 100 feet long, using a loose coupler, mineral detector, .001 M.F. condenser and 2,000 ohm receiver?

A. 1. It is extremely unlikely that you will be able to hear radiophone transmission at this distance. The normal receiving range of a crystal set, under good conditions, is not more than 40 miles.

Q. 2. Is there any apparatus I could add which would enable me to hear it without installing an audion set?

A. 2. No. It will be necessary for you to use a vacuum tube to effect reception.

DRILLING HOLES IN GLASS

(380) Mr. Howard M. Benson, Royalton, Vt., writes as follows:

Q. 1. How can I make holes in a glass panel to mount my apparatus upon?

A. 1. Drilling holes in glass is a lengthy process. Turpentine or camphor solution must be applied to the hole while drilling. The best method is to submerge the panel in a solution of turpentine or camphor. Another method is described on page 1026 of April-May issue of RADIO NEWS.

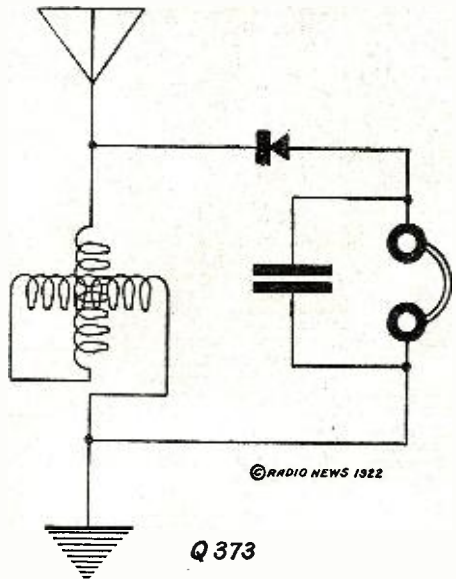

Q373
One of the Simplest Receiving Circuits. A Variometer is Used as the Tuning Inductance. It May Be Used Later in a V.T. Circuit.

Q. 2. Is it best to have a grid leak and condenser with each step of amplification?

A. 2. If transformers are used for amplification grid condensers are not required. In some special cases grid leaks may be used but these are usually not essential.

Q. 3. What is the Armstrong regenerative circuit, and could it be used with a spiderweb tuner having two variable condensers?

A. 3. The Armstrong regenerative circuit is one which produces regeneration or oscillation by tuning the plate circuit of a vacuum tube. It may be used with any type of tuning coils or condensers.

WAVE LENGTH OF CAGE AERIAL

(381) Mr. Sherman Holland, Crisfield, Md., wants to know:

Q. 1. What would be the natural wave length of a four-wire cage aerial, five inches in diameter, 90 feet long, 35 feet high at one end and 30 feet high at the other end?

A. 1. The approximate wave length of this antenna would be 180 meters.

Q. 2. Would this aerial be good for 200 meter reception?

A. 2. Yes. This antenna would be suitable for reception on 200 meters, but no particular advantage is obtained by using a cage aerial for reception.

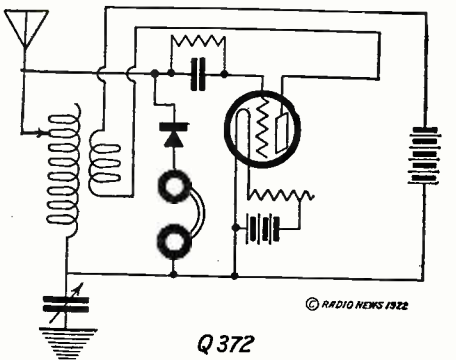

Q372
This Circuit Will Assist in Eliminating Induction Hum From Various Causes.

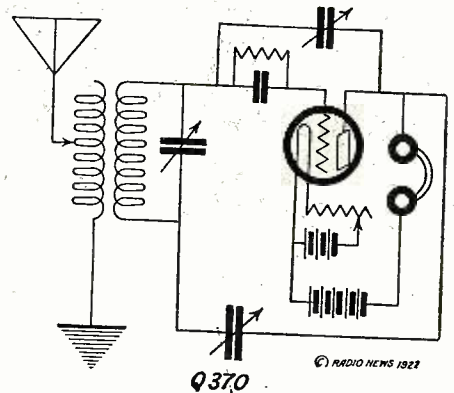

Q370
Here is Another Method of Producing Regeneration by Means of Condensers in Connection With a Loose Coupler.

Q. 3. Which are best for reception of radio phone, 2,000 or 3,000 ohm phones?

A. 3. 3,000 ohm phones are better for reception purposes.

RESISTANCE AND INDUCTIVE COUPLED RADIO FREQUENCY AMPLIFICATION

(382) Mr. B. H. Anderson, Detroit, Mich., wants to know:

Q. 1. Is inductive or resistance-coupled radio frequency amplification practicable for short wave reception? Which is better?

A. 1. Resistance-coupled radio frequency amplification cannot be efficiently used on short-wave reception below 800 meters unless in conjunction with the super-heterodyne system. Inductive coupling may be used satisfactorily on short wave lengths. When radio frequency transformers are used, they are effective for a limited band of wave lengths only. Different transformers may be used for the various bands of wave lengths.

METHODS OF AVOIDING INTERFERENCE

(383) Mr. E. P. Enrietta, Damar, Kansas, wants to know:

Q. 1. Can the arrangement described as a wave trap on page 598 of March, 1921, RADIO NEWS, be used to cut out interference of telegraph signals when listening in on radiophone music. If not, is there any way to do this?

A. 1. This arrangement may be employed to avoid interference. Other methods include the use of tuned radio frequency amplification and the use of a loop for reception. The latter method is very selective.

THE BEST ANTENNA FOR SHORT WAVE RECEPTION

(384) Mr. W. D. Myers, Greentown, O., wants to know:

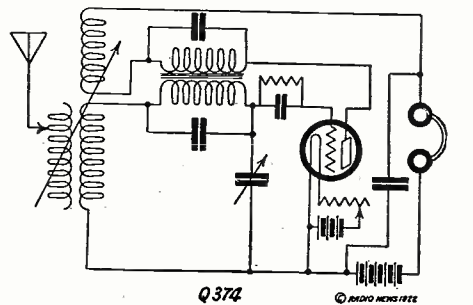

Q374
It is Possible to Use One Tube for Three Purposes, to Detect, Regenerate and Amplify at Audio Frequency.

Q. 1. Please tell me which of the following antennae is best for short wave C.W. and phone reception: A single wire 200 feet long, two wires the same length, or a four-wire antenna 40 feet in length, the height in each case being 50 feet.

A. 1. The best antenna you can use at the height of 50 feet would be one composed of two wires spaced six feet apart and 100 feet long in one direction.

RADIO FREQUENCY TRANSFORMERS

(385) Mr. Ralph Osborn, Darien, Conn., writes as follows:

Q. 1. Kindly let me know where I may obtain the amplifying transformers referred to in the January, 1922, RADIO NEWS, page 590?

A. 1. These transformers may be obtained from the Radio Instrument Co., Hutchins Building, 10th and D Streets, N. W., Washington, D. C.

Q. 2. How many would be needed to cover the entire range from 150 meters to 20,000 meters?

A. 2. We understand these transformers are (Continued on page 1150)

MURDOCK

radio necessities



MURDOCK REAL RADIO RECEIVERS have delivered complete satisfaction, on a "money-back" basis for 14 years. Those years of experience have so simplified and perfected our production that there are today no receivers quite so good at so low a price.

The latest Murdock achievement, the No. 56 Receiver, is a highly sensitive instrument which retains all the rugged strength of previous types. Important features are, the improved comfortable headband, the "Murdock-Moulded" ear pieces shaped to exclude outside noise, and the moulding of all parts into one durable unit.

All models of Murdock receivers are sold with free trial offer and money back guarantee. Use them in direct comparison to any other phones for 14 days. Make any test you wish. Then at the end of the two weeks, if the Murdock Phones are not entirely satisfactory, return them and your money will be refunded!

Many of the complete "ready-to-operate" wireless sets now on the market include Murdock Phones as standard equipment. If the set you buy does not, be sure you get a set of Murdock receivers to complete your station. We strongly urge you to go to your dealer and convince yourself of the quality of Murdock receivers, by actual examination, before you buy. Prices \$5.00 to \$6.00.

Murdock Phones are the standard bearer for a complete line of "Made-by-Murdock" radio parts and instruments. This includes the famous Murdock condensers, and the new Murdock Rheostat at \$1.00.

*Buy Murdock Radio Apparatus
From Your Dealer*

WM. J. MURDOCK CO.

What's Wrong With YOU!



Pep, Nerve, Vigor—Gone?

Do you dare ask yourself why your strength and vitality are failing—why your life-forces are ebbing away? Look at yourself in the glass and ask what's wrong? Ask yourself why you are unable to achieve success and get the joy out of life. Do you realize that your ailments and weaknesses are dragging you down? Is it Catarrh, Constipation, Rupture, Nervousness, Indigestion, Rheumatism, Impotency, Bad Blood and the numerous results of Youthful Folly and Excesses? Are you Flat Chested, Round Shouldered, too Thin or too Stout? I want to help you—I can help you.

STRONGFORT'S M.—The Modern Science of Health Promotion will Banish Your Ailments and Revive Your Fading Powers and Manhood—no matter what your condition is, or what caused it. I guarantee it.

Mention the subjects on the free consultation coupon on which you enclose confidential information and send with 10c to help pay postage, etc., on my book "Promotion and Conservation of Health, Strength and Mental Energy." It's a man-builder and a life-saver. Send for my free book Right Now. TODAY.

STRONGFORT
The Perfect Man
LIONEL STRONGFORT
Physical and Health Specialist
Dept. 853, Newark, New Jersey

Cut Out and Mail this Free Consultation Coupon

Mr. Lionel Strongfort, Dept. 853, Newark, N. J.—Please send me your book, "Promotion and Conservation of Health, Strength and Mental Energy," for postage on which I enclose a 10c piece (one dime). I have marked (X) before the subject in which I am interested.

- | | | |
|-------------------------|---------------------|---------------------|
| .. Colds | .. Flat Chest | .. Rheumatism |
| .. Catarrh | .. Increased Height | .. Youthful Errors |
| .. Asthma | .. Pimples | .. Vital Losses |
| .. Hay Fever | .. Blackheads | .. Impotency |
| .. Obesity | .. Insomnia | .. Falling Hair |
| .. Headache | .. Short Wind | .. Weak Eyes |
| .. Thinness | .. Flat Feet | .. Gastritis |
| .. Rupture | .. Stomach | .. Heart Weakness |
| .. Lumbago | .. Disorders | .. Poor Circulation |
| .. Neuritis | .. Constipation | .. Skin Disorders |
| .. Neuralgia | .. Biliousness | .. Dependancy |
| .. Deformity (Describe) | .. Torpid Liver | .. Round Shoulders |
| .. Female | .. Indigestion | .. Lung Troubles |
| .. Disorders | .. Nervousness | .. Sloop Shoulders |
| .. Successful Marriage | .. Poor Memory | .. Muscular |
| | .. Manhood Restored | .. Development |
| | | .. Great Strength |

Name
Age Occupation
Street
City State



Are YOU Old at 40?

Perhaps the most common cause is the disturbed condition of an important gland. Even men of iron constitution are not exempt from this amazingly common irregularity. We have for limited distribution, an ethically accurate, educational and interesting

FREE BOOK

Its message may prove of unsuspected value to you. It explains how a disturbed condition of this vital gland may cause sciatica, backache, painful and tender feet, interrupted sleep and other extremely uncomfortable and often serious conditions. It tells of Thermanalid, a simple means by which the essential of a new hygienic principle, done into convenient form corrects this prostate gland condition and its attendant health faults without medicine, massage, or knife. The record of its success for five years is incontrovertible. The book is free. Simply address

THE ELECTRO THERMAL CO.
6002 Main St., Steubenville, Ohio

WHO ARE YOU LISTENING TO?

Do you know there is a chart showing the location of every Broadcasting Station in the United States, together with the wave lengths they send at, that will tell you at a glance what stations you can "get" on your set?

There May Be Some You Are Missing

Full instructions furnished with each chart. Sent prepaid upon receipt of 35c in stamps or money order.

Address Dept. R. N. 4

RADIUS MAP CO.
827 St. Johns Place, Brooklyn, N. Y.

A Coupled Tuner for Long Waves

(Continued from page 1084)

of the windings before taking through base and to terminals.

The pillar "D" is preferably made from ebonite or bakelite and is secured to the base by means of screws from underneath.

The flattened portion of the secondary former is secured to the front of the pillar by means of screws from behind, thus holding it firmly in the center of the base.

The brass top plate "E" and the pair of brackets "F" are cut from 1/16" sheet brass and shaped as shown in the drawing. The top plate is provided with two countersunk holes for screwing down to the top of the pillar and two clearance holes through which the pivot screws work.

The two brackets "F" are screwed to the pillar, one on each side as shown. Next, six terminal posts are required; the plain brass ones will do, but of course, insulated tops would be preferable.

With regard to the windings, as this is the most important part of the construction, great care must be taken. The use of Litzendraht wire is to be recommended, say 49/38 for the primary and 27/38 for the secondary and regenerative coils.

In the event of this being too costly, wind the primary with No. 22 D.C.C. and the others with No. 24 D.C.C. wire. Do not use the usual method of winding, but space each layer by placing small strips of 1/8" fibre evenly around the winding as shown at G. The position of these strips must be "staggered" in order to give the winding the characteristic spacing which reduces the capacity effects of the coil. The primary must be wound with approximately 500 turns of No. 22 wire, the secondary 700 turns of No. 24 and the regenerative coil 1,000 turns, also of No. 24 wire.

The inductance should be approximately, primary 3,000, secondary 10,000 and regenerative coil 15,000 microhenries, respectively.

Shellac each layer as completed, and after the required amount of wire has been wound on, secure the ends to the two anchor screws which are provided at the back of each of the formers.

Before assembling, lacquer well all terminals, screws, the brass plate "E" and the brackets "F."

The assembling is an easy matter and should not take more than a half hour. Be sure to have the coils fitted into position in their correct order, namely, from left to right, primary, secondary and regenerative coil. Drill small holes in the wood base immediately beneath the nuts at the back of terminals and at the back of each of the formers, large enough to allow a rather heavy flex wire to pass through.

In wiring up the tuner use a heavy grade lighting flex, that with the vulcanized rubber insulator is to be preferred as the braid covering can be removed more readily.

Cleat the wire up underneath the wooden base and pass the ends through the holes to the coils and terminals, as shown in the wiring diagram.

In operation this tuner is simplicity itself, as all adjustments of wave-lengths are made on the loading coils, variometers and condensers, and apart from this, extremely interesting results can be obtained with this method of coupling variation.

The approximate maximum aerial inductance value (with an average sized aerial) to be used in conjunction with this tuner should be between six and seven millihenries, although this can be reduced considerably if the primary condenser be connected in parallel, as shown.

Of Substantial Construction.

Practical Radio Devices

Distributed By Jobbers Throughout The Country

VARIABLE CONDENSERS

Straight line capacity variation with eccentric plates. Well constructed condenser with large area plates.

Variometers & Vario Couplers

WITH DIRECT CONTACT BY FLEXIBLE "LEADS"

GROUND SWITCHES

COMBINED WITH A LIGHTNING ARRESTER

The only combination on the market. Extremely compact, meeting the Underwriters' latest Requirements.

"HYDROGROUNDS"

THE ONLY REAL GROUNDING DEVICES

COMPLETE RECEIVING SETS

DETECTORS, 2-STEP AMPLIFIERS

Rheostats, Lightning Arresters
V-T Sockets, Insulators, Dials, Knobs

Distributed by

| | |
|-----------------------------|-------------------------|
| Stanley & Patterson |New York |
| Wetmore Savage Co. |Boston |
| DeVeau-Bartling Co. |Detroit |
| United Radio & Electric Co. |Chicago |
| Hartzell Sales Co. |Huntington, W. Va. |
| O. B. Radio Co. |Omaha |

Send stamps 10c for complete catalog

BAKELITE PANELS CUT TO ORDER

3/16" thick.....02c square inch
1/4" thick.....02 1/2c square inch

We also carry a complete line of magnet wire, tubing, radio outfits and parts.

MAIL ORDERS PROMPTLY FILLED

DEALERS.—We distribute for all leading manufacturers. Write for price list and discount schedule.

PITTSBURGH RADIO AND APPLIANCE COMPANY, Inc.
112 Diamond St. Pittsburgh, Pa.

Electrical men with training are in demand. For more than a quarter of a century, this school has been training men of ambition and limited time, for the electrical industries. Condensed course in Electrical

Engineering enables graduates to secure good positions and promotions. Theoretical and Practical Electricity. Mathematics. Steam and Gas Engines and Mechanical Drawing. Students construct dynamo; install wiring and test electrical machinery. Course with diploma complete

In One Year
Over 3000 men trained. Thoroughly equipped fireproof dormitories, dining hall, laboratories, shops. Free catalog. 30th year begins Sept. 27, 1922.
BLISS ELECTRICAL SCHOOL
407 Takoma Ave., Washington, D. C.



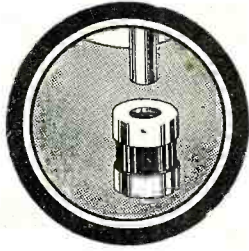

You are Burning Money when you do not protect your Vacuum Tube with Radio Safety Fuses

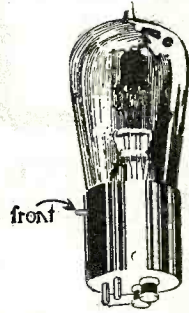

Draws the Line on "Burning Out"

No matter how, where or when you set up an excessive amperage in your set, your bulb filament is absolutely protected when you "shoe" your tube with the

RADECO SAFETY FUSE

for VACUUM TUBES, METERS and other delicate electrical instruments

Slipping directly on the filament terminals of any standard tube used in any standard socket, this tiny fuse affords absolute protection to the filament, without detracting a particle from the efficiency of your set.

Carrying Capacity
 $\frac{1}{2}$, $\frac{3}{4}$, 1, $1\frac{1}{4}$,
 $1\frac{1}{2}$, 2, $2\frac{1}{2}$, 3
 Amperes

Of reliable workmanship, the Radeco Fuse never fails on its job. It is easy to attach and may quickly be replaced. For the protection of meters and other delicate apparatus this fuse is actually worth more than its weight in gold.

Come only in packages of four

4 for \$1

Order by mail or from your dealer

DEALERS: The Radeco Fuse is selling "red hot". Order now for immediate delivery

STORAGE BATTERIES

6V 60-80 hour

U. S. L. standard Radio batteries. "De Luxe" stained wood box. Neatest on market and guaranteed new and good. Unusual value.

\$15

Delivery Prepaid

"B" BATTERIES

45 volt

Complete in handy wooden case and adjustable phosphor bronze "jiffy" connectors. Better than block batteries—if one 4.4 V. unit weakens prematurely, it can be removed and replaced—thereby not impairing total voltage, which makes this the best battery value to be had at any price. Set of 10 Renewal Units, 45 Volt, \$3.10 postpaid. Just the thing for C.W. work.

\$3.60

Include Postage on 4 Lbs.

HOLZER CABOT PHONES

2200 OHMS

Extremely sensitive and of far better workmanship than ordinarily found at this price.

\$8 pr.

Other Phones at \$5.00 to \$15.

We offer unsurpassed value in Special **CRYSTAL DETECTOR SETS** Complete except Aerial **\$25**
 Not a cheap set, but a real set at a low price

➔ We carry at all times a complete stock of Radio parts and sets. Order at standard prices from any standard catalog. ➔

Reliable Goods at Right Prices

RADIO EQUIPMENT CO.

630 Washington St. (4th Floor) Boston, Mass.

New England's Oldest Exclusive Radio Store

We carry only the Best Radio Goods

FADA

*talks about
FADA equipment*

An observable fact about the 2nd District Radio Convention and Show at the Hotel Pennsylvania, New York City, last month was the prominence of FADA rheostats.

Many progressive manufacturers have adopted them as standard. The Z-nith detector-amplifiers use FADA rheostats: And one of the most sensational receivers exhibited, "the special Myers receiver with radio and audio frequency amplification" was equipped with FADA inductance and series-parallel switches and FADA rheostats.

FADA rheostats cost only

\$1.00



DEALERS: Write for the FADA trade catalog. You will find it profitable to stock FADA equipment.

F. A. D. ANDREA

Manufacturer of FADA Radio Products

1882-A Jerome Ave. N. Y. C.

A similar value can be used for the secondary loading coil, which, of course, must be provided with the necessary tappings and dead end switches. Using a tuner designed and wound on the principle of that just described, the writer has been able to daily read in Sydney, Australia, signals from the American stations, Pearl Harbor, Cavite, Guam, Annapolis, Darien and San Francisco, besides Carnarvon in Wales, Great Britain and Lyons, France. This is a maximum distance of over 12,000 miles. Glance at the map and see what it really means.

One thing is certain, and that is that non-tapped coils are destined to "carry on the good work."

World's First Wireless Telephone News

(Continued from page 1071)

miles. This latter record was secured by the White Star liner S.S. Baltic, which employed a crystal detector.

These experiments were of great interest also from another point of view, constituting an actual historic event in the annals of wireless communication, in so far that for the first time, the day's news was distributed broadcast over a great distance in the form of articulate speech.

At present the station is doing its regular work on a special high-wave and is rendering great services. Probably some of our American amateurs will be able to hear it also, considering their unusual records in long-distance reception.

Photographs by courtesy of the British Marconi Co.

A Portable Radio Receiving Set in a Suitcase

(Continued from page 1073)

dry-cell batteries in supplying filament current.

Five stages of amplification are in force—three of radio, two of audio, and a detector. By the use of tuned radio-frequency transformers, extreme sensitivity is insured. The amplifier consists of the following elements: Six electron tubes of special design with sockets; two filament rheostats for controlling filament temperatures; a stabilizer for adjusting the outfit to maximum sensitivity; a tuning condenser for adjustment to the wave-length of radio telephone transmitter, and dry-cell batteries for supplying filament current; "B" batteries for affording plate voltage; three tuned radio frequency transformers, grid leak and condenser, and two audio-frequency transformers.

Heavy storage batteries are required to keep the tubes lighted for several hours, a disadvantage in the form of contributing to the weight of the equipment. A greater amplification constant signifies greater sensitivity, a principle recognized by the inventor in building such an extremely compact unit. Likewise the larger the loop or receiving coil the greater the volume of energy "picked up." The actual dimensions of the loop used in this particular suitcase of 12" by 21". A panel or door is provided on the outside of the containing suitcase for access to controls when adjustments are to be made. There is a conspicuous absence

THE McTIGHE STORAGE B BATTERY

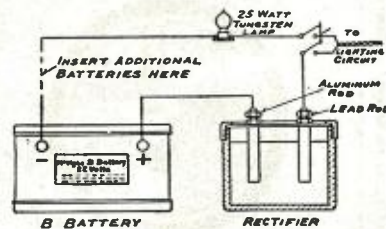

The McTighe Storage "B" Battery is of the alkaline type, is the most satisfactory source of plate potential, and can be charged from your lighting circuit for less than one cent. Can also be charged from farm lighting systems.

In ordinary service a one-hour charge will last for several weeks.

The Battery is furnished in a 24 volt unit in an attractive case.

It is noiseless and cannot be injured by accidental short circuit, over charging or by standing idle.

Descriptive leaflet on request.

PRICES

| | |
|---------------------|--------|
| Battery | \$4.00 |
| Rectifier | \$1.50 |
| Rubber Filler | .25 |

F.O.B. Irwin, Pa.

ECONOMIC APPLIANCE CO.

Successors to McTighe Battery Co., IRWIN, PA.

Whitall Electric Co.

Distributors & Dealers

All Radio Coporation Material—The New General Electric Tuner with Radio Frequency Amplifier and Detector—Radio Frequency Transformers. Complete Clapp Eastham Line—Remler — Signal — Paragon — DeForest—General Radio—Murdock —Baldwin—Westinghouse.

Prompt delivery of famous Clapp Eastham HR Receiver and HZ Amplifier—Dealers and Amateurs write.

SEND 6c FOR CATALOGUE

WESTERLY, RHODE ISLAND

NEW ORLEANS RADIO

APPARATUS and SUPPLIES

ROSE RADIO SUPPLY

604 Gravier St., New Orleans, La.

Send 10c for Latest Catalog

Radio Supplies in Stock—Shipments Made Promptly

REMLER RADIO

We carry complete stock

Remler Radio Standard Parts

RADIO PROTECTORS

- No. 200 Brach Vacuum Gap Arrester \$2.50
- Keystone Air Gap Arrester..... 2.00
- S. P. D. T. Line Switch, 60 amp... 2.65
- Westinghouse Pa. Protector..... 2.00

AMPLIFYING TRANSFORMERS

- UV-712 Audio Frequency\$7.00
- UV-714 Radio Frequency 6.50
- No. 41 Jefferson, Mounted 4.25
- No. 45 Jefferson, Mounted 7.00
- Rhamstine Amplifier ... 3.50
- Thordarson Amplifier .. 4.00

VARIABLE CONDENSERS

- No. 367 Murdock Condensers 4.50
- No. 3660 Murdock Panel Condensers 4.00
- No. 1 Chelsea Condensers, .0011 5.09
- No. 2 Chelsea Condensers, .0006 4.50
- No. 3 Chelsea Condensers, .0011 4.75
- No. 3 Chelsea Condensers, .0006 4.25
- No. 3005 U Cotocoil, .0005 4.50
- No. 3007 U Cotocoil, .0007..... \$5.00
- No. 3010 U Cotocoil, .0001..... \$6.00

SWITCH PARTS

- R-10 Short Lever Switch..... .75
- R-12 Long Lever Switch..... .75
- Switch Contacts with 2 nuts..... .04

BOOK DEPARTMENT

- Wireless Course in 20 Lessons, postpaid...\$1.75
- Design and Construction of Audion and Amplifying Transformers } These three \$1 postpaid for 3 books
- How to Make Sending Apparatus
- How to Make Receiving Apparatus
- Radio Hook-ups. By Sleeper, Postpaid... .85
- Wireless Telegraphy and Telephony. By Morgan. Postpaid 1.65
- How to Pass U. S. Wireless License Examinations. By E. E. Bucher, of Radio Corp. of America85
- Practical Wireless Telegraph. By E. E. Bucher 2.50
- Vacuum Tubes In Wireless Communication. By E. E. Bucher 2.50
- Practical Amateur Wireless Stations. By Editor, Wireless Age, J. Andrew White. .85
- Wireless Experimenters Manual. By E. E. Bucher 2.50

RADIO HEAD SETS—NO DELAY—SHIPMENTS FROM STOCK

- Andrae 2,000 Ohm Head Sets.....\$5.25
- Andrae 3,000 Ohm Head Set..... 6.25
- Brandes Superior Matched Tone Head Sets with Improved Adjustable Head Bands 8.00
- Federal 2,200 Ohm Head Sets, No. 53W 8.00
- Brandes Navy Type, Matched Tone Head Sets14.00

VACUUM TUBES

- Cunningham Radiotrons, and W. E. Detector Tubes 5.00
- Amplifier Tubes 6.50
- 5 Watt Power Tubes 8.00
- W.E. VT I Amplifying Tubes..... 7.50

TUSKA RADIO

- No. 200 Tuska Variometer with knob and dial..\$7.75
- No. 201 Tuska without knob and dial6.75
- No. 230 Tuska Variocoupler 7.50

COMPLETE RECEIVER UNITS

- CR 5 Grebe Receiver..\$80.00
- RORK Grebe 2 Step Amplifier 55.00
- CR 9 Grebe Receiver with Amplifier, 1 unit....130.00
- RC Westinghouse Receiver and Amplifier unit 132.50
- H.R. Clapp-Eastham Receiver Unit with Amplifier 80.00

LOUD SPEAKERS

- Type R-3 Magnavox...\$45.00
- Type L-V Westinghouse, Vocarola 30.00
- Amplitone 12.00

- Westinghouse Aeriolo, Sr..... 65.00
- Westinghouse Aeriolo, Jr. 25.00

CRYSTAL SET

- General Electric Crystal Set..... 18.00

RADIO HEADQUARTERS

You can not only get reliable and prompt service in Radio supplies from us, but you can have the benefit of our sixty years experience in electrical and telephone supplies, and in Radio since its beginning. Our experience is yours in selecting the right kind of equipment, and our large buying facilities assure you the right price.

Our big Milwaukee establishment is a veritable broadcasting station of Radio supplies. Let us serve you. We list on this page some of the items in stock that are in large demand.

JULIUS ANDRAE & SONS CO.

117 MICHIGAN ST. MILWAUKEE, WIS.

RADIO DIAGRAMS AND FORMULAE

- In Loose Leaf Form85
- Pattern No. 1—Make Your Own Short Wave Regenerative Set. } Both patterns \$1.00
- Pattern No. 2—Make Your Own Detector Amplifier. }
- Complete Library of 14 Books and Patterns. Postpaid15.00

Frost-Radio Improved Jacks and Plugs

Specially designed for Radio Panel work, interchangeable with other standard makes. These are the smallest, neatest and most perfectly finished jacks and plugs offered the Radio Trade.

Packed in individual containers. An exclusive feature of the Frost-Radio Jack is the spread arrangement of the spring terminals.

nals, which allows twice the usual amount of space for wiring. Terminals are heavily trimmed.

No. 133, Jack only, 65c

No. 134, Jack only, 75c

No. 132, Plug only, \$1.00

No. 131, Jack only, 90c

No. 135, Jack only, \$1.00

No. 136, Jack only, \$1.25

High grade electrical insulations. Will withstand 110 volt break down test.

Nickel-silver contact springs.

Pure Silver contact points.

Three thickness washers, nickel plated and buffed.

"Spread" arrangement of spring terminals, allowing twice the usual amount of space for soldering.

Small, neat frame round edge, highly polished, nickel plated and buffed.

Hexagon headed sleeve, nickered and buffed.

Over Sixty Years Experience at Your Service



IMMEDIATE DELIVERY

Price  \$5.00

PANEL MOUNTING Standard Variocoupler Parts

| | |
|--|---------------|
| Variocoupler Rotors with rods..... | \$.75 |
| Variocoupler Tubes..... | .45 |
| Standards for Variocoupler..... | .70 |
| 1/2 lb. of No. 22 Magnet Wire..... | 1.00 |
| Bushing, screws and nuts for assembling..... | .25 |
| Postage..... | .15 |
| Total | \$3.30 |

"READ 'EM"

Binding Posts—16 Styles



| | |
|-------------------------|-------------|
| Antenna..... | B Battery + |
| Ground..... | Plate |
| Condenser..... | Detector |
| Tickler..... | Secondary |
| Variable Condenser..... | Primary |
| A Battery..... | Grid |
| A Battery +..... | Phones |
| B Battery..... | filament |

Price 15c each

Switch Arms

Price 50c each
 Knob 1 1/4" Knurled or Fluted Bakelite Lever
 1 1/2" Phosphor Bronze Nickerled. Bushing to fit up to 3/8" Panel. Switch arms, same as above with 1" radius knobs, price 40c.

Order from this Advertisement

The KUEBLER RADIO COMPANY

26 Boody Bldg. Toledo, Ohio



of earmarks on the exterior of the suitcase to betray its real identity. There is a button-like fixture for adjusting the tuning condenser; a stabilizer for bringing the portable radio-receiver to maximum sensitivity and a single-action electrical switch for introducing and suspending filament current. Also there is a modest arrangement for connecting the outfit to an antenna if desired. These objects are visible, but not conspicuous enough to identify the real intent of the suitcase on casual observation.

Another feature of this portable amplifying receiver is its capacity to locate the radio-transmitting station, the coil in the leather container having directional powers. Similarly, indicative of its variable uses, a plug may be arranged on the suitcase that a telephone receiver may be connected in place of the amplification horn. Thereby, when held in front of a Bell telephone land-line transmitter, conversation may be relayed to a friend at some distant point. Practical experiments have included a realization of this innovation. When related to the amplifying equipment, the small amount of energy "picked-up" by the receiving loop is so enlarged in volume that conversation or music may be heard in any part of an ordinary room. Without attempting to appraise its ultimate value as a contribution to the multiple agencies of radio communication, this strangely-formed equipment is assuredly arresting in its appeal to the popular imagination. When demonstrated recently in Washington, its performance added another chapter to the marvels of wireless as viewed by the public.

Radio in Chicago Schools

(Continued from page 1071)

sets are now being built in the wood-working and machine shops of the various high schools. One of the completed sets, made by the Austin High School was installed in the Board of Education Building and the manufacture of apparatus is progressing steadily.

"The student of the future" said Albert Bauersfeld, Supervisor of Technical Education of the Board of Education, another radio fan, "will adjust his headset and be ready for the morning wireless lesson in arithmetic, the central wireless station broadcasting the lessons. Teachers in the schoolrooms throughout the city, instead of going to the blackboard will adjust the wireless outfit, manipulate a few knobs and buttons and then for the lesson!"

The extraordinary developments in radio as the ranks of amateurs and professionals are being rapidly augmented in Chicago and the Middle West has prompted a census of radio fans who actually have sets that function properly and operators who are licensed. Nearly 3,000 have received licenses and approximately 5,000 persons have receiving sets installed in business houses, homes and offices in the Chicago section.

Market reports are being broadcasted, quotations and agricultural information sent out by the Chicago Board of Trade, such reports going out every half hour and received by investors, publishers, and by the schools for educational purposes, by farmers who are far removed from the cities within a 500-mile radius and who await the reports with eagerness intent on keeping posted on fluctuating values in the different markets.

"Our reports have made a great hit," said John Mauff, secretary of the Chicago Board of Trade. "They are taking like wildfire and seem to fill a long felt want.

IT WILL

Last Longer
 Prevent Noise
 Maintain Voltage
 Avoid Leaks
 Prevent Shorts
 Save You Money



2 Year Written Guarantee

ROYAL RADIO BATTERIES

The Royal is built to give satisfaction. It is full size—a real battery and not a toy. Two sizes, 5 volt, 100 ampere hours and 6 volt 120 ampere hours. The cost is less than for other batteries of only 60 and 80 ampere hours. That is because you buy direct from the factory and do not pay in-between profits.

Royal construction insures absence of noise, highest capacity and constant voltage. You avoid frequent recharging—so annoying with small batteries. Jars tested to 60,000 volts. Extra heavy separators and correct assembly prevent rumbling. Royal Radio Batteries are covered by a 2 year written guarantee and with reasonable care will last five years. They are the product of years of experience in building high grade batteries and will give satisfaction to amateur and expert alike.

| | |
|------------------|---------|
| 6 V. 100 A. H. - | \$18.80 |
| 6 V. 120 A. H. - | \$21.85 |

Buy Direct From Factory

Cut out the big in-between profits. Save about half. Retail value of our \$18.80 battery is \$34.00. You save the \$15.20 dealer profit. We take all shipping risks and guarantee safe arrival of battery by express. You run no risk. Shipment anywhere in U. S. We require only a \$5.00 deposit with order, and balance C. O. D. Batteries shipped fully charged. Send today. Get this full size, guaranteed battery and avoid troubles. Also you save money. State whether you want straight post or screw type terminals. Order Now!

K. E. Battery Co., Dept. 125
 646 N. Michigan Blvd. - Chicago

References, National Bank of the Republic, Dun or Bradstreet, Chicago Association of Commerce.



WIRELESS TELEPHONE

BROADCASTING stations are now in operation at important centers all over the country. You can easily receive these interesting daily programs with an ABC wireless receiving UNIT. ABC UNITS come to you ready-to-operate and complete in every detail. They are built on the sectional system, so that you can increase the range of your station at any time.

Ask your radio or electrical dealer about this and other exclusive features of ABC UNITS. If he cannot supply you, send us his name and address and enclose ten cents, for your copy of our catalog. Request Catalog R-6.

JEWETT MFG. CORP.
 342 Madison Ave. Dept. R 5 New York City

ABC UNITS

NATIONAL "B" BATTERY

**LASTS LONGER
 SERVES BETTER
 COSTS LESS**

For amplifying tubes, detector and plate circuit. The National "B" Battery gives more hours of service, is moisture proof, silent and free from leaks.

DEALERS

Write for special offer and discount.

National Electric Novelty Co.
 53 Walker Street NEW YORK

BROOKLYNITES WE CARRY A FULL LINE OF RADIO SUPPLIES AT SPECIAL PRICES

| | |
|---|--------|
| Radio Service V.T. Sockets..... | \$.80 |
| 002 M.F. Phone Condensers..... | .25 |
| 0005 M.F. Grid Condensers..... | .25 |
| 22 1/2 Volt B. Battery, Small..... | .90 |
| 22 1/2 Volt B. Battery, Large..... | 1.60 |
| No. 763 Eveready 22 1/2 Volt B. Battery..... | 1.75 |
| No. 766 Eveready 22 1/2 Volt Large Variable B. Battery..... | 2.50 |
| Arkay Loud Speakers..... | 4.50 |
| No. 14 Solid Copper Aerial Wire, lb..... | .45 |
| 7-22 Stranded Copper Aerial Wire, 100 ft..... | 1.00 |
| 6 Volt 40-60 Amp. Titan Storage Battery..... | 14.00 |
| 6 Volt 60-80 Amp. Titan Storage Battery..... | 16.00 |

KENSINGTON RADIO SUPPLY CO.
 4416 Eighteenth Ave. Open Evenings Brooklyn, N.Y.

Genuine GANAERITE Crystals

Individually Tone Tested.
 Most Sensitive Mineral Rectifier Developed.
 Mounted Crystals, Postpaid, 50c.
 Trade Discounts to Dealers and Clubs.
 Now Delivering Promptly on Large Orders.

THE HARRIS LABORATORY
 26 Cortlandt Street New York City.



Eveready "A" Batteries
 —hardwood box, mahogany finish
 —convenient handle, nickel plated
 —rubber feet protect the table
 —insulated top prevents short circuits
 —packed vent caps prevent spilling
 No. 6860—90 Amp. Hrs.—45 Lbs.—\$18.00
 No. 6880—110 Amp. Hrs.—52 Lbs.—\$20.00



Eveready "B" Battery No. 766
 Equipped with 5 positive voltage taps ranging from 16½ to 22½ volts. Fahnestock Spring Clip Binding Posts—an exclusive Eveready feature. Price \$3.00

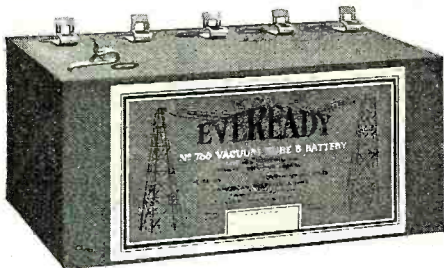

Eveready "B" Battery No. 774
 Equipped with 6 positive voltage taps at 4½ volt intervals ranging from 18 to 43 volts. Fahnestock Spring Clip Binding Posts—an exclusive Eveready feature. Price \$5.00



For Better
 Results

USE

EVEREADY

"A" and "B" BATTERIES

with your radio set

For sale by the better radio supply dealers everywhere

Send today for descriptive booklets

NATIONAL CARBON COMPANY, Inc., Long Island City, N. Y.

Atlanta

Chicago

Cleveland

Kansas City

San Francisco

DANGER!! LOOK OUT FOR FIRES!!

EVERY AERIAL ATTRACTS LIGHTNING—

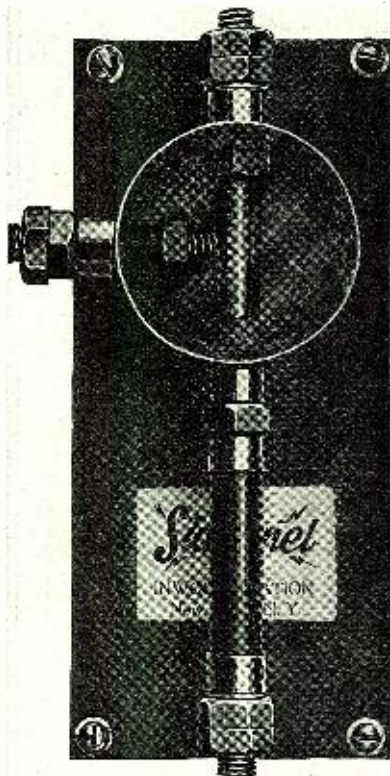

An Aerial — A Lightning Storm — And No protection Will Set Your Home Or Property On Fire

Thunderstorms are very prevalent at night. Are you safe while asleep? A lightning bolt might strike your aerial—*what then?* An EXPLOSION; maybe DEATH; possibly a fire; or else RUIN your entire radio outfit.

The ordinary lightning switch is not a positive protection—you might forget to use it.

HERE IS: the most practical, absolutely new, SIDBENEL AUTOMATIC LIGHTNING ABSORBER, the most valuable radio protective invention of this day (Patents applied for). If installed in your aerial circuit you will have no further fear of possible danger connected with every radio set. Receiving is possible during any electric storm. Requires not more than ten minutes for installation. Complete with directions, **\$3.00**

DO NOT HESITATE—SEND YOUR MONEY AT ONCE

SIDBENEL radio equipment is guaranteed to equal or surpass in performance any instruments selling at triple the price. Manufacturers of vacuum tube sets, SIDBENEL Radio Storage "B" battery (Patents applied for), taps, switches, dials and radio accessories.

If your dealer has not received his supply yet, send check or money order direct for immediate shipment.

SIDBENEL RADIO MFG. CO.

Box 10—Inwood Station

NEW YORK, N. Y.

Perkins CONSOLE Radio CABINETS



Perkins Consoles meet the great demand for Radio Cabinets of beauty and quality.

Send for description of the three latest models. Prompt delivery. Prices right. Attractive proposition to dealers and jobbers.

PERKINS PHONOGRAPH
831A N. Wood Street, CHICAGO, ILL.

COMPANY

A month ago they had to wait until the next day to get their market information but now they get it every half hour. We have been swamped with letters thanking us for establishing the service. One letter from Grand Island, Nebraska, says, 'Your reports are going to do wonders for the farmer.' Another from Monticello, Indiana, tells us that the writer, a business man there, is the only person with a radio telephone set but that he has plenty of company every half hour to hear the market reports. Others are planning to install sets in the near future. From Plano, Illinois, we received a letter from the high school telling us that they are using the reports we send out as a part of the course in agriculture. The Board of Trade feels that the radio telephone will be a great thing for business in this district and we will soon install our own sending station to handle our reports. We also will send out Bureau of Agriculture reports.'

Hitherto the radio was regarded as a toy. To-day it is recognized as a scientific marvel that has come like a thunder-clap out of a clear sky, made practicable by the amplifier and other additions, a force that is recognized everywhere as paramount in the affairs of men.

Within the radius of the Chicago Board of Trade broadcasting it is estimated that 20,000 persons are equipped to receive the messages.

Hard Rubber Dials at 0 Cents a Piece

(Continued from page 1113)

The next operation was to turn these down until they were perfectly round. Ordinarily this would require the use of a lathe, but for the experimenter who does not possess such a machine, it can be accomplished otherwise. We happened to have a small electric motor that had been used as a polisher in a jewelry shop. One end of the shaft was drilled and tapped to receive an 8/32" bolt. Accordingly we took advantage of this and fastened the pieces of hard rubber to the motor shaft by means of a bolt slipped through the holes in their centers. In this manner as many as four or five could be placed on the motor at once. We then started the motor, held a chisel against the edge of the rubber discs, and turned them down as on an ordinary lathe. This is shown in Fig. 2.

The next step was to engrave the dials. We removed them from the motor, placed them face upwards on the table, and by means of a protractor marked off every five degrees in an arc of one hundred and eighty degrees around the edges. We then made deep, straight scratches on the rubber at these marks. This was accomplished by laying a ruler on the discs and scoring deep lines at the marks with the sharp point of a compass.

To give the dials a shiny finish we rubbed them vigorously with powdered pumice stone on an oil-saturated rag. In doing this we found that the polish on the dials varied directly as the amount of elbow grease applied in rubbing them. Accordingly we rubbed, and rubbed, and rubbed and then rubbed some more, adding fresh oil and pumice stone as required, until our dials had as shiny a finish as any now on the market.

Lastly, we wiped off all the oil, filled the scratches with white ink, printed the fig-



A superior insulation having every desirable characteristic in radio-frequency service

“RADION” New Process **HARD RUBBER**
Warp-Resisting

WE developed “RADION” in our laboratories as an all-purpose insulation, whose properties make it supreme in the Radio field. Thousands of “RADION” panel sheets are being sold by Dealers daily because men who build Radio sets have learned that—

1. “RADION” resists warping.
2. “RADION” resists enormous voltage in high frequency currents.
3. “RADION” does not chip and is easy to cut, drill, tap, thread, stamp and engrave.
4. “RADION” comes in stock panel sizes 3/16 and 1/4 in. thick, 10 x 12 in., 8 x 15 in., and 20 x 24 in. Three colors—Black, Brown and the new Mahoganyite (beautiful mahogany grain).

“RADION” New Process **RADIO PARTS**
Hard Rubber

“RADION” Dials

Standard 3 in. and 4 in. diameter with set screws 3/16 or 1/4 in. shaft hole. Knob and Dial moulded in one piece.

“RADION” Socket Bases

A “RADION” Hard Rubber Socket Base of approved design for standard makes of Detector and Amplifier Tubes.

“RADION” Aerial Insulators

Strongly imbedded metal rings. Perfect out-door insulations for antennae wire work.

“RADION” Tubing

for Variometers, 2 and 4 in. outside diameter, 1/8 in. wall, unpolished, standard 2 foot lengths in stock.

“RADION” Hard Rubber Rods, Discs, Slider Blocks, Knobs, etc.

DEALERS We are advertising extensively in radio sections of leading newspapers. “RADION” Hard Rubber Panels and Parts are being called for now by thousands of Radio fans. Write for prices on stock “RADION” supplies. Don't delay—the rush is already on.

MANUFACTURERS Our three great factories are equipped for special moulding of radio parts in large quantities in “RADION” Hard Rubber, such as Radio Cabinets, Ear Caps, Receiver Cases, Y-pieces, Storage Battery Jars and Parts, Knobs, Buttons, Bushings, Ferrules. “RADION” Panels cut to any size on quantity orders. Let us estimate on your specifications.

RADIO SALES DIVISION

AMERICAN HARD RUBBER COMPANY

11 Mercer Street :: New York

Bradleystat

REGISTERED U. S. PAT. OFF
PERFECT FILAMENT CONTROL

The Perfect Filament Rheostat

Absolutely Stepless Current Control

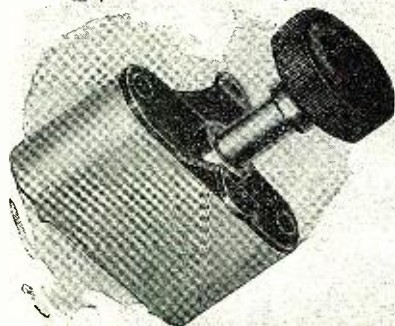

The BRADLEYSTAT consists of two small columns of graphite discs enclosed in a porcelain container. The resistance varies with the pressure applied to these discs by the adjusting knob and screw. There are no steps or jumps in the resistance. You can get just EXACTLY what you want!

No coils—No contact sliders—No delicate parts. An internal switch opens the battery circuit when the Bradleystat pressure screw is released.

PRICE \$1.85

For use with any 1/4 or 1 ampere receiving tubes or with 5-watt power tubes

If your dealer hasn't a Bradleystat and will not get it for you, send us \$1.85 PLUS 10 CENTS for postage and we will mail you one.

DEALERS, ACT QUICK

Allen-Bradley Co.

287 Greenfield Ave. Milwaukee, Wis.
 Manufacturers of Graphite Compression Rheostats for Twenty Years

ures 0, 90, and 180 at their respective positions, and put the dials away until the white ink hardened. We then added hard rubber knobs and our dials were complete. One of them is shown in the right of Fig. 1.

The only things we had to buy were the knobs. The dials themselves cost absolutely nothing. Yet in appearance they compared very favorably with many of the dials now selling for over a dollar each. Therefore, they represented a very considerable saving, and if you are as thrifty as you ought to be, you will never buy another dial again, but will make your own and laugh at the high cost of keeping up with the fashion.

Radio Digest

(Continued from page 1115)

Licensed March 22, 1922

- Call Station
- WCN Clark University, Worcester, Mass.**
- WJT Electric Equipment Co., Erie, Pa.
- WSX Erie Radio Co., Erie, Pa.
- WPR Federal Institute of Radio Teleg., Camden, N. J.
- WIP Gimbel Bros., Philadelphia, Pa.
- WGV Interstate Electric Co., New Orleans, La.
- KGW Oregonian Publishing Co., Portland, Ore.
- KOA Y. M. C. A., Denver, Colo.*

Licensed March 18, 1922.

- WPA Fort Worth Record, Fort Worth, Tex.
- KHJ Kierulff, C. R., & Co., Los Angeles, Calif.
- WHN Ridgewood Times Print. and Pub. Co., Ridgewood, N. Y.
- WBT Southern Radio Co., Charlotte, N. C.
- WFI Strawbridge & Clothier, Philadelphia, Pa.
- WOO Wanamaker, John, Philadelphia, Pa.

Licensed March 16, 1922.

- WSL J. & M. Electric Co., Utica, N. Y.
- KDPT Southern Electric Co., San Diego, Calif.
- WHD West Va. Univ., Morgantown, W. Va.
- WKY Oklahoma Radio Shop, Oklahoma City, Okla.**
- KGG Hallock and Watson, Portland, Ore.
- KGO Altadena Radio Lab., Altadena, Calif.
- WIL Continental Elect. Sup. Co., Washington, D. C.
- KGU Marion A. Mulrony, Honolulu, T. H.
- WGR Federal Tel. & Tel. Co., Buffalo, N. Y.**
- KSD Pulitzer Print. Co., St. Louis, Mo. (St. Louis Post-Despatch.)
- WRW Tarrytown Radio Research Lab., Tarrytown, N. Y.
- WPM Thos. J. Williams, Inc., Washington, D. C.
- WIK K. & L. Electric Co., McKeesport, Pa.

Licensed March 14, 1922.

- WRR City of Dallas, Dallas, Tex.
 - KSL The Emporium, San Francisco, Calif.
 - KRE Maxwell El. Co., Berkeley, Calif.
 - WBS D. W. May, Inc., Newark, N. J.
- CHANGES.
- KND Leo J. Meyberg Co., San Francisco, Cal.**
 - KYJ Leo J. Meyberg Co., Los Angeles, Cal.**
 - KYW Westinghouse Elect. & Mfg. Co., Chicago, Ill.**
 - WWJ Detroit News, Detroit, Mich.**

YOUR FRIENDS CAN LISTEN TOO

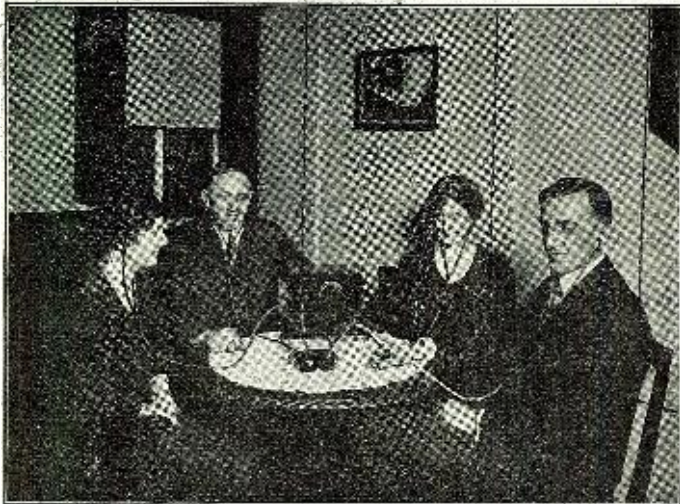

Attach a TUBE-O-PHONE to your receiver. Clearer and more distinct than receivers alone on both crystal and tube sets.

Fits any make of receiver.

Satisfaction guaranteed.

With a TUBE-O-PHONE, two persons can hear from one receiver. With a pair of TUBE-O-PHONES, four persons can hear from a pair of receivers. Additional branches can be attached.

Tube-O-Phone \$2.50 Per Pair \$4.50 Additional Branches ea. \$1.25

Postage paid

SCIENTIFIC DEVICES COMPANY,

WILKINSBURG, PA.

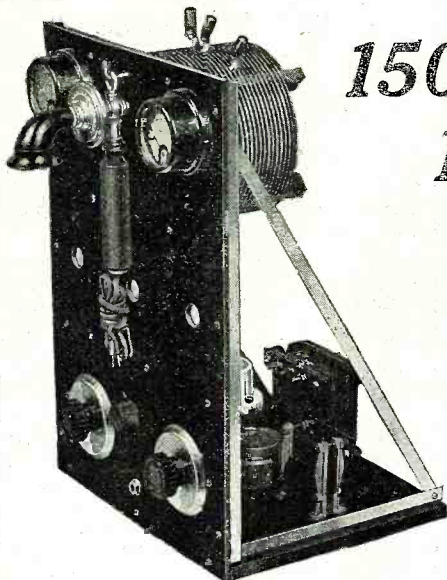

The new improved Benwood Wireless Telephone for C.W., I.C.W., Modulated Buzzer and Voice Transmission. See Specifications.

1500 MILES WITH CW! 1100 MILES VOICE!

MUSIC heard 40 ft. from phones by stations in 300 to 400 mile radius! These are actual results obtained by our testing station 9ZB, using this set. You can get just as good work out of it. This high-class set is just the thing for your broadcasting and DX work—either with C.W., I.C.W., Modulated Buzzer or Voice Transmission. An ideal set for the local radio club or the more progressive amateur. Think of the range this set will give you! If centrally located, you will be heard in almost every state in the Union.

Radiates 1½ to 3 Amps.

We guarantee that this outfit will radiate 1½ amperes on the average amateur antenna when assembled in accordance with our instructions. It will radiate 2 to 3 amperes when used with an antenna whose fundamental wave length is 225 to 275 meters. That is why you can get such good results as shown above.

Specifications

The set comes to you completely assembled with all parts mounted on panel, as shown, but not wired. Full instructions and wiring diagrams are furnished. You can wire in and start sending in less than an hour after you receive it.

The outfit is complete with motor generator, minus tubes, and consists of the following:—Panel 12x18x3/16, angle brass supports, hardwood base, 3 tube sockets, 1 power rheostat, 1 80-watt filament trans., 1 modulation trans., 1 C.W. inductance, 1 hand transmitter, 1 0-3 Radiation meter, 1 0-500 Milliammeter, 1 21-plate condenser, 1 43-plate condenser, 1 tapped condenser, 1 L-300 choke coil, 1 2000-volt filter condenser, 1 10,000-ohm grid leak, plug and jack connection for microphone buzzer and C.W., 1 600-volt 220-watt motor generator. Boxed for shipment, \$200.00, f.o.b. St. Louis, Mo.

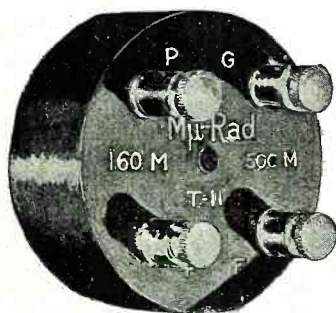

The Wonderful MU-RAD Radio Frequency Amplifier for 160 to 550 Meter Wave Lengths.

GET LOUDER SIGNALS

**Greater Amplification
Than Any Other on the Market**

No howling regardless of the great amplification given. No plate circuit tuning adjustments to make. Equally effective on Phone, C.W. or Spark. These are some of the big features in this new departure in Radio Transformers. The MU-RAD combines regeneration and straight R.F. Amplification in a single unit, giving maximum radio frequency amplification at short wave lengths (160 to 550 meters). Type T-11, as shown, can be used with any type of tube, and we guarantee it to give greater amplification than any other on the market when properly used or you receive your money back. With diagrams and full instruction, each\$9.00

**Full 4 to 1 Amplification
Without Howling or Squealing**

Take advantage of the latest improvements and discoveries in Audio Frequency Amplification. The new Benwood Transformer, shown at the right, is specially made to get maximum amplification when used with any bulb on the market. It is completely sheathed in metal, avoiding all inductive effects, so that it gives full 4 to 1 amplification without howling or squealing. The base is 2½ x 3½ in., height only 2 in.—ideal for either base or panel mounting. The core is best laminated steel, giving highest transference of energy—it will bring in your signals loud, strong and clear. The "Benwood" Amplifying Transformer, each\$5.00

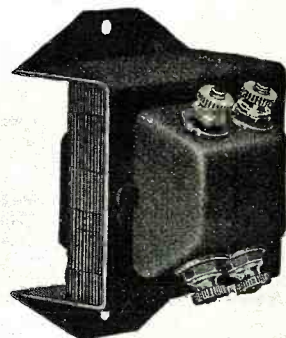

The new "Benwood" Audio Frequency Amplifying Transformer. See description.

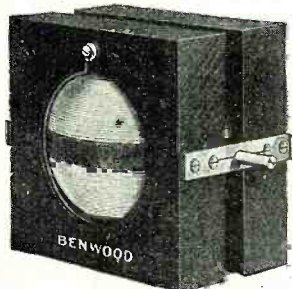

**Signals 2 to 10 Times
Louder and Clearer**

A properly designed variometer brings in signals 2 to 10 times louder than the various other types of inductances on the market. With this fact in mind we have designed what we believe to be the "last word" in variometers—the "Benwood" variometer shown above. Inductances are wound with double cotton covered wire and no shellac, paint or varnish is allowed to cover the wire and diminish the effectiveness of operation.

The "Benwood" features are—minimum distributed capacity, minimum distance between stator and rotor, large size wire or both coils, positive contact bearings and proper design (mechanical as well as electrical). This variometer will get splendid results in wave lengths from 150 to 650 meters when used with the average variocoupler. Price, each\$5.00

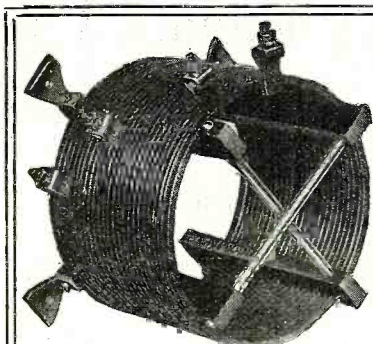

**The Only
Practical
"CW" Panel
Inductance
on the
Market**

**Note Its
Features!**

This is the only "C.W." Inductance made for panel mounting. The copper ribbon is wound on FORMICA supports, giving highest possible insulating qualities. Each Inductance furnished with four of the new type BENWOOD PATENTED HELIX CLIPS which will fit either a round or flat surface. Each clip furnished with molded insulated handle which enables tuning of the set with current on.

Standard size, as shown in cut, consists of 25 turns of edge-wise wound soft drawn copper strip ¾ in. in width and 1/16 inches in thickness. Turns are a full 6 in. in diameter. Type A-1 (as shown)—each \$8.50. Type A-2, 50 turns, ideal for stations requiring more than 250 meter wave, price each\$12.50

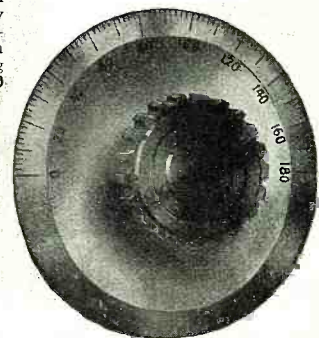

**An Improvement
On Any Set**

Every amateur takes pride in the appearance of his set, and in fact a great deal depends upon the neat, efficient construction for best results. This high-grade indicating dial is beautifully nickel-plated, 3½ in. in diameter, and has extra heavy 1½ in. knurled edge Bakelite knob. It is drilled for ¼ in. rod, and has setscrew to make positive grip. 180° graduations permit closer adjustments, and metal disc acts as an efficient shield for the operator. It will fit perfectly flat on your panel and add greatly to its appearance. The "Benwood" Superior Dial, a big value at\$1.50

Send 10c in Stamps for Catalog Comprising Latest Price Directory

Exclusive Agents for DeForest Apparatus—all territory West of Mississippi River

Dealers:—Write for Our Proposition

THE BENWOOD COMPANY, INC.,

**1111 OLIVE STREET
ST. LOUIS, MISSOURI**

"WORLD WIDE MAIL ORDER SERVICE"

Read Code With Your Eyes!

Not With Your Ears!

Finch Radio Relay Permits Messages to be Copied on Paper Tape With Unerring Accuracy, at Any Speed and Over Any Distance.

Why worry about reading code when you can read from a tape at your leisure. How nice it would be to have a graphic record of news dispatches, market reports, etc. The Finch Radio Relay, which is now licensed for non-commercial use, makes this possible. It is inexpensive, easy to operate and absolutely reliable. Tremendously sensitive, yet rugged and fool-proof. May be used in connection with any vacuum tube receiver.

DID HE GET IT, OR NOT?



THE OLD WORRISOME WAY

If you can't read code let the Finch Radio Relay read it for you. If you listen only to the broadcasting you are missing a lot of interesting things.

PRICE OF RELAY \$75.00

STANDARD TAPE REGISTER \$40.00

Literature describing other uses for the Finch Radio Relay gladly furnished upon receipt of stamp. Patented and Patents Pending.

FINCH RADIO MFG. CO.
303 Fifth Ave. New York City



THE NEW FINCH WAY
EVERY MESSAGE
PERMANENTLY RECORDED

* Only weather.
** Also weather.
*** Also market and weather.
NOTE.—List complete to date March 22

STANDARDIZED RADIO APPARATUS

A reduction in the prices of various items used in radio sets has been effected by the standardization of radio apparatus by the Bureau of Engineering, of the Navy, in cooperation with manufacturers, it was learned at the Department today.

Receiving sets of medium range and those used on aircraft as well as amplifiers, are reduced approximately 60 percent in price, which, it is pointed out, should be of interest to the general public, as this type of receiving set is used in receiving the free broadcasting of concerts and lectures from many parts of the country. Detectors used in such receiving sets are now reduced about 75 percent in price.

Medium size transmitting sets, both of the arc and spark type, are reduced practically 30 percent, and various types of insulators used in assembling a radio set are reduced about 20 percent. Vacuum tubes for transmitting and receiving, the latest thing in radio to come into common use, are averaging 40 percent less than they have been selling for.

All the above material is also greatly improved in efficiency, it was pointed out, the latest vacuum tubes, for example, having over 1,000 percent longer life than the early tubes had.

RADIO COMPASS BEARINGS SENT 2,239 SHIPS

During February Naval Radio Stations in the Fifth District, including the coast lines of Maryland, Virginia and North Carolina, supplied compass bearings to a total of 2,239 vessels, of which 1,878 were merchant ships, necessitating 5,190 bearings.

In reporting on the work, Rear Admiral Hugh Rodman, Commandant of the District, stated that the bearings were given on an average of 3.7 minutes each. "The figures show the amount and the importance of this work carried on by the radio stations and the dependence mariners are putting on them. Recently with exceptionally stormy weather, there have been few opportunities for astronomical observations at sea, and much low visibility, hence vessels have learned to depend upon the radio stations, using their services continually. On several occasions these stations have saved vessels from going ashore by warning them of their dangerous positions."

In appreciation of the service rendered them, the masters of a number of ships have commended the stations through letters to the Navy Department.

Master R. R. Wilmott, of the S.S. Agibay, who encountered bad weather on his maiden trip from Mexico to Boston, and had compass trouble, wrote the department that he called the stations at Hatteras and Lookout asking his position, which he received immediately to learn he was 23 miles in error. Picking up the bearings sent him, he made for the Diamond Shoals Light Ship, and after six hours running he had to bear off sharply or he would have run into the ship, so accurate was his radio compass data.

The commander of the British S.S. Barbadian also thanked the Department for assistance rendered in the neighborhood of Cape Henlopen, which enabled him to extricate his ship, although in a bad fog, and reach Five-Fathom Light Ship and safety. He conveyed his "heartfelt thanks" to the operators at the Cape May and Cape Henlopen stations for their prompt and excellent bearings. Accurate bearings were also

11th EDITION
REVISED AND
ENLARGED

WIRELESS COURSE

IN TWENTY LESSONS

S. Gernsback
H.W. Secor &
A. Lescarboua

A Course for the Beginner in Radio. From the Principles of Electricity to the Theory of Vacuum Tubes and Amplifying Circuits.

The Best Seller!

ALL ABOUT RADIO

160 Pages
360 Illustrations
30 Tables

Beautifully Stiff Bound
in Red Cloth
Gold Stamped
Price \$1.75 Prepaid

Exactly the Same
Books But Soft
Bound, and not Gold
Stamped
Price \$1.25, Prepaid

The Experimenter Publishing Co.,
Inc.,
236 Fulton Street, New York,
N. Y.

Enclosed find \$1.75 for
which send me one copy of
 Soft bound WIRELESS
 Stiff bound WIRELESS
COURSE. Postpaid.

Name
Town
Address
State

Size 7 x 10 Inches

Latest News on the Radio!



THE BOX TELLS HALF THE STORY, THE FACTS BELOW TELL THE REST

A Dry Rechargeable Storage Battery!!

In Both A and B Batteries

A development in keeping with the wonders of the radio. It is the product of exhaustive scientific research by competent engineers, and has successfully passed all tests and has been OK'd by professors of leading technical universities. While it is not of as recent arrival as the radio-
phone it is comparatively new; but its position, in the automotive world, aboard ship, in aviation and on the radiophone is positively secure. The thousands in daily use giving efficient service and backed by our guarantee will be its best testimonial.

Read These Important Facts

1. Spilling and overflow of acid, characteristic of the wet storage battery and which will ruin carpets, rugs, and curtains is eliminated by the CHICAGO RECHARGEABLE DRY STORAGE BATTERY.
2. The destructive and exceedingly disagreeable features of the unavoidable gassing of the wet storage battery are done away with by the CHICAGO RECHARGEABLE DRY STORAGE BATTERY.
3. The unhealthful and penetrating obnoxious odors thrown off by the wet storage battery are not present in the use of the CHICAGO RECHARGEABLE DRY STORAGE BATTERY.
4. The constant risk of EXPLOSION and danger of fire connected with the use of the wet storage battery are eliminated by the CHICAGO RECHARGEABLE DRY STORAGE BATTERY.
5. The lack of quick recuperation in the wet storage battery demands its being charged so often as to annoyingly interrupt the use of your set. The CHICAGO RECHARGEABLE DRY STORAGE BATTERY does away with this sacrifice of pleasure as it will hold its charge about twice as long as the old wet battery.

A Battery—60-80-100 Amperes

6. The use of the wet storage battery carries with it fluctuations in the filament circuit which necessitates bothersome adjustments while your set is in use. To get an EVEN flow of current use the CHICAGO RECHARGEABLE DRY STORAGE BATTERY.
7. The "B" battery now in use in the form of a dry cell comes in separate units and is difficult to keep in order. Use the CHICAGO DRY STORAGE RECHARGEABLE "B" BATTERY, which is in one compact container and can be RECHARGED, thus eliminating the expense of replacing short lived dry cells.
8. The use of the wet storage battery does not improve the efficiency of the less expensive sets. Use the CHICAGO RECHARGEABLE DRY STORAGE BATTERY and get more satisfactory results for less original outlay and cost.
9. The wet storage battery is unsightly. The CHICAGO RECHARGEABLE DRY STORAGE BATTERY not only does not detract from the beauty and appearance of a room, but ADDS TO IT.
10. The CHICAGO RECHARGEABLE DRY STORAGE BATTERY can be purchased direct from the manufacturer if your radio dealer does not have it in stock. Write for prices.

B Battery—45-52½ Volts

Dealers — Attention

There is no question of doubt but what the CHICAGO RECHARGEABLE DRY STORAGE BATTERY improves the efficiency, and the smoothness of any radio set, regardless of the price of the instrument. Wide-awake dealers should order "A" and "B" batteries for demonstrating sets today. Insures the best possible demonstration. Write and ask how to convert your wet storage battery into an efficient dry storage battery and in this way put yourself in a position to give this valuable service to your customers.

*Both A & B Batteries are built in indestructible rubber cases.
Wooden battery cases should never be used in a home.*

CHICAGO DRY STORAGE BATTERY CO.

Telephone Sunnyside 2820

Chicago, Illinois, U. S. A.

5235 East Ravenswood Ave.

JEFFERSON

Amplifying Transformers



No. 45



No. 41

Secure maximum amplification by using transformers designed especially for the new Audiotron and Radiotron Tubes.

Jefferson Transformers are the result of exhaustive tests of every kind, and are positively unequalled for audibility and amplifying power.

Our No. 45 Navy Type is the most widely used transformer in the country. If you are not getting maximum amplification try it and note the improvement, the absence of distortion and the clearness of tone.

The No. 41 Transformer is also a very popular type. It is wound with No. 40 wire while the No. 45 is wound with No. 44 wire. Otherwise the construction is identical. The highest grade 36 gauge Silicon steel is used for the core. The Primary Resistance of the No. 41 is approximately 900 ohms, of the No. 45 approximately 1800 ohms. Secondary Resistance: No. 41, approximately 5000 ohms, No. 45 approximately 8500 ohms.

Transformers are mounted in attractive brass frames, with genuine Bakelite panels which carry the primary and secondary terminals. These Transformers are also furnished unmounted.

Send for Radio Bulletin

Jefferson Electric Manufacturing Company

424 S. Green Street
Chicago, Ill.

| | |
|--|-------------------|
| Large Variometers, inside windings..... | \$5.00 |
| Variocouplers, multiple and single turns on bakelite tubes | 4.00 |
| Large Variometer Balls | .80 |
| 22 DCC Magnet Wire | quarter pound .30 |
| (All Sizes Carried) | |
| Hard Maple Stators for variometers, per pair.... | 1.20 |
| Windings in place | 1.60 |
| Large Variometer Balls, wound and axles in place | 1.60 |
| OAK CABINETS | |
| 6"x14"x7" deep with hinged tops, and reinforced. | \$.35 |
| 7"x7"x7" deep with hinged tops, and reinforced. | \$.25 |
| 7"x10"x7" deep with hinged tops, and reinforced. | \$.30 |
| 7"x12"x7" deep with hinged tops, and reinforced. | \$.35 |
| 7"x18"x7" deep with hinged tops, and reinforced. | \$.45 |
| 12"x14"x7" deep with hinged tops, and reinforced. | \$.50 |
| Dealers Write for Proposition. | |
| MEADE BAKELITE AND RADIO APPARATUS | |
| 944 Jefferson Ave. Brooklyn, N. Y. | |

CABINETS

We build cabinets for any size panel, in any finish. Will quote on one or a thousand. Please send us your specifications.

NATIONAL CABINET CO.
DAYTON, OHIO

responsible for the safety of the S.S. "Tamiahua," off Cape Hatteras in very thick weather, for which E. W. Sundstrom, Master, thanked the Navy Department.

NEW DIAMOND SHOAL LIGHT SHIP HAS RADIO FOG SIGNAL.

New Light Ship 105, destined for use at Diamond Shoal, off Cape Hatteras, which has just passed her trials on the Hudson River, will be the largest and best equipped light vessel in the world, according to a statement from the Light House Service of the Department of Commerce. She will be the first vessel of the service to carry a radio fog signalling apparatus, outside of two installed on light ships off New York, Fire Island and Ambrose Channel and one off Sea Girt, N. J.

The 105 will replace the old Light Vessel 72, sunk by the guns of a German submarine on August 6, 1918. Besides flashing a light, she has three separate fog signals; a steam chime whistle, a submarine bell and the automatic radio fog signal. She is a 147-foot ship and is a self-propelled oil burner.

The radio fog signal, or direction finding, consists of sending out a distinctive radio signal of simple form, such as a series of dots or a combination of two dots, on a 1,000 meter wave, which picked up by a vessel enable the master to point his radio compass in the exact direction of the signal, which he identifies, for example, as Ambrose Channel; then picking up Sea Girt he can find out his exact position by the intersection of the lines on his chart. No mathematics are necessary, and he can re-check his bearings by a third signal from another station.

By following the signal, that is by keeping the coil aerial parallel to the direction of the signal and at its maximum sound, a due course on the point may be run; as the coil is revolved, on a vertical spindle provided with a pointer, the sound diminishes, coming to a minimum when the coil is at right angles to the sound, when by the aid of a graduated circle below the coil, the position of the coil with respect to a known direction is found.

INSPECT FIFTH NAVAL DISTRICT RADIO COMPASS STATIONS BY SEAPLANE.

Radio Compass Stations at Cape Hatteras and Cape Lookout, were inspected by the Superintendent of the District on March 16 in one day by seaplane and reported to be in excellent or very good condition. There has been a flood covering the grounds at Hatteras with from eight to ten inches of water; repairs were found necessary at Morehead City; and the fire house at Hatteras was said to be a fire menace, but a new house is nearly finished. If the trip had been made by ordinary means the Superintendent says, he would have needed a week instead of a day in a seaplane.

CANAL ZONE RADIO ACTIVITIES.

Radio Operations in the Canal Zone for the week ending Feb. 18, averaged the following words daily from each Naval station: Balboa, 6,157; Colon, 1,904; Cape Mala, 371; La Palma, 69 and Puerto Obaldia, 249. The following week the traffic was a little less, the stations averaging as follows: Balboa, 4,912; Colon, 1,921; Cape Mala, 467; La Palma, 229, and Puerto Obaldia, 249.

SAN FRANCISCO NAVAL RADIO

The trans-continental and trans-pacific circuits of the Naval Communication Service were extended to the Army Headquarters at the Presidio of San Francisco early in March. In order to handle the traffic efficiently, the Naval Superintendent has asked the Commanding General to lease a



Positions Secured!

Radio is outgrowing itself again! During the last few months the surplus of experienced operators has been absorbed and there is a gaping demand for properly trained operators for both land and sea jobs.

We have a position for every graduate of this school and a good paying position is waiting immediately for every student on completing our course.

This school holds a record for qualification of First Class and First Grade Operators.

Send for 44 page Catalog Free

MASSACHUSETTS RADIO and TELEGRAPH SCHOOL, Inc.
18 Boylston St. Boston, Mass.
Formerly Boston School of Telegraphy. Established 1903

Radio Supplies

ALL KINDS

- Cunningham Tubes
- A. P. Tubes
- Paragon R. A. 10 Receivers
- Clapp-Eastham Receivers
- Baldwin Phones
- Brandes Phones

ELECTRIC SUPPLY CO.

Everything in Radio
Port Arthur - - Texas

BAKELITE RADIO PARTS

Moulded To Your Design

Northern Industrial Chemical Co.
11 Elkins St. Boston, Mass.

Moulders of Electrical Insulation

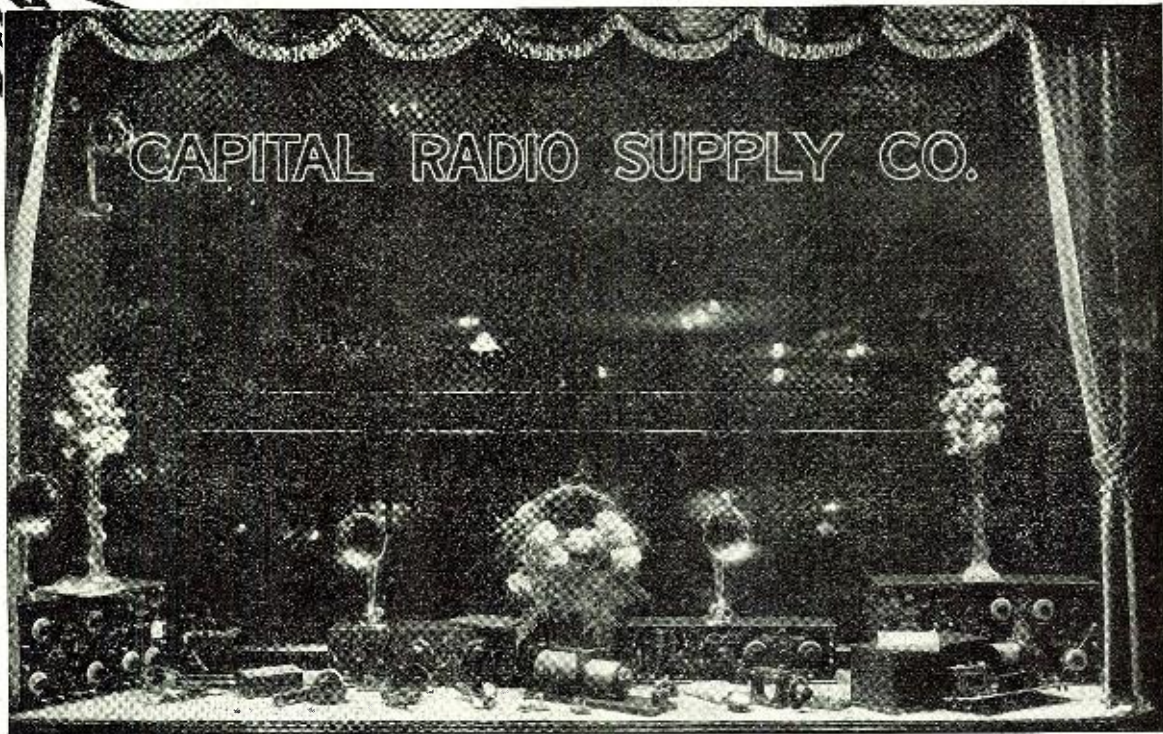

The CAPITAL Serves Indiana, Ohio and Kentucky

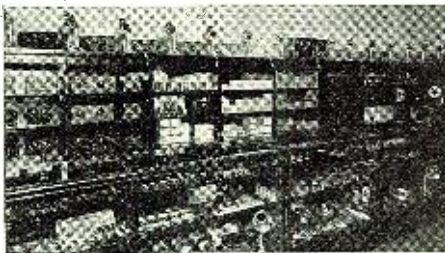

Interior of Salesroom

THE Capital Radio Supply Company, located at Indianapolis, was organized by prominent business men for the purpose of supplying this territory with the finest, most dependable and efficient radio equipment made.

Among the prominent manufacturers who are represented by this company are Grebe, Kennedy, Remler, King Am-pli-tone, Hipco Batteries, Western Electric, Signal and Tuska.

Because of the financial strength, the experience and efficiency of the organization and the geographical location, the Capital Radio Supply Company is logically the distributor to successfully handle this rich territory.

CAPITAL RADIO SUPPLY COMPANY, Inc.

Indianapolis, U. S. A.

MAKE NO MISTAKE!
The
**Klosner
 Vernier
 Rheostat**

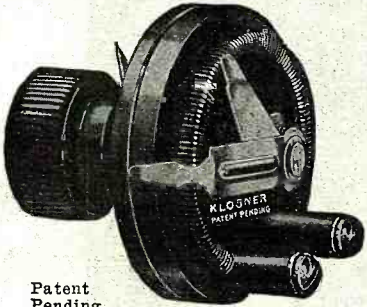

Patent Pending

is the only Vernier Rheostat made having the exclusive feature of using but

ONE SINGLE KNOB

for both rough and fine adjustments. This feature allows the symmetrical appearance of the single knob to be retained when mounted on a panel with other instruments, and, at the same time adds to the simplicity and ease of operation in obtaining the necessary fine adjustments for best results from the modern critical vacuum tubes, especially when receiving phone and C.W. signals.

We invite comparison with any other filament rheostat now made. Look for the name KLOSNER moulded on the base. Your Dealer has them or send direct to us.

Price \$1.50

Shipping Weight One Pound
 A Two Cent Stamp Brings Interesting Literature.
 Made Only by The Originators

The KLOSNER IMPROVED APPARATUS CO.

2404 Crotona Ave., New York, N.Y.

direct land wire from the Presidio to the Radio Station, Yerba Buena Island.

GOVERNMENT BOOK ON RADIO.

A new edition of the Principles Underlying Radio Communication, Signal Corps Communication Pamphlet No. 40, has just been published by the Government Printing Office. Copies may be secured by addressing the Superintendent of Documents.

The new revised edition covers elementary electric principles, dynamo-electric machinery, radio practice, construction and operation of important types of transmitting and receiving sets. It comprises 600 pages with 300 illustrations, and the international code.

SOURCES OF ENTERTAINMENT, NEWS AND WEATHER REPORTS.

Ninety-eight radio stations were broadcasting music, concerts, lectures, and market and weather reports, according to the Department of Commerce on March 23.

Among the sending stations are 10 newspapers, a church, a Y. M. C. A., several large department stores, and two municipalities. Many manufacturers, radio sales and equipment shops, and five universities are also sending out amusement features in several forms so that today "all who listen may hear," just as all who "ran" have been able to "read" for many years. Even Hollywood, Calif., has a broadcast.

On March 10 the list of broadcasting stations sending entertainment on 360-meter wave were as follows:

- Allen, Preston D., Oakland, Calif., KZM.
- American Radio & Research Corp., Medford Hillside, Mass., WGI.
- Atlantic-Pacific Radio Supplies Co., Oakland, Calif., KZY.
- Bamberger, L., & Co., Newark, N. J., WCR.
- Bible Institute of Los Angeles, KJS.
- Church of Covenant, Washington, D. C., WDM.
- City of Chicago, Ill., WBU.
- Cox, Warren R., Cleveland, Ohio, WHK.
- Crosely Mfg. Co., Cincinnati, O., WLW.
- DeForest Radio Tel. & Tel. Co., New York, N. Y., WJX.
- Detroit News, Detroit, Mich., WWJ*.
- Doubleday-Hill Electric Co., Pittsburgh, Pa., KQV.
- Doron Bros. Elec. Co., Hamilton, O., WRK.
- Duck Co., Wm. M., Toledo, O., WHU.
- Dunn & Co., J. J., Pasadena, Calif., KLB.
- Electric Lighting and Supply Co., Hollywood, Calif., KGC.
- Examiner Printing Co., San Francisco, Calif., KUO.
- General Electric Co., Schenectady, N. Y., WGY.
- Gilbert Co., A. C., New Haven, Conn., WCJ.
- Goul, C. D., Stockton, Calif., KJQ.
- Hamilton Mfg. Co., Indianapolis, Ind., WHK.
- Hatfield Elec. Co., Indianapolis, Ind., WOH.
- Herrold, Chas. D. San Jose, Calif., KQW.
- Holbrecht, J. C. (Sacramento Bee), Sacramento, Calif., KVO.
- Howlett, Thos. F. J., Phila., Pa., WGL.
- Karlowa Radio Co., Rock Island, Ill., WOC*.
- Kennedy, Colin B., Co., Los Altos, Calif., KLP.
- Kluge, Arno A., Los Angeles, Calif., KQL.
- Kraft, Vincent I., Seattle, Wash., KJR.
- Lorden, Edwin L., San Francisco, Calif., KGB.
- Marshall-Gerken Co., Toledo, O., WSZ*.
- Metropolitan Utilities District, Omaha, Neb., WOU*.

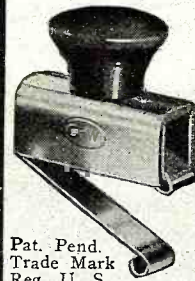

**G-W
 SLIDERS,
 RODS and
 DETECTORS**

Pat. Pend.
 Trade Mark
 Reg. U. S.
 Pat. Office

If your dealer can't supply you order direct. Dealers write for proposition.

DISTRIBUTORS WANTED

AMATEURS TAKE NOTICE!

A new quality product neatly made 50,000 marketed in ten days has proven the efficiency of our slider.

3/16" Slider 25c

1/4" Slider 30c

Finished Brass Slider Rods Drilled

| | |
|-----------------------|----------|
| 3/8" square, 8" long | 15c each |
| 3/8" square, 10" long | 18c each |
| 3/8" square, 12" long | 20c each |
| 1/2" square, 8" long | 22c each |
| 1/2" square, 10" long | 25c each |
| 1/2" square, 12" long | 28c each |

GEHMAN & WEINERT

Manufacturers of G-W Radio Products.

42 WALNUT ST. NEWARK, N. J.

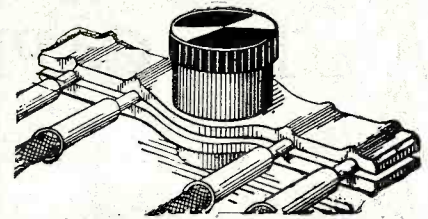

FOUR SETS OF PHONES!

25c will buy a set of Multiple Binding Post Connections (patent pending) which provide the only practical means of attaching as many as 4 pairs of telephone receivers to a pair of ordinary binding posts.

Dual connection set provides same connection in attaching Magnavox and outfit to storage battery.

Either set will be sent postpaid upon receipt of 25c in coin or stamps. Satisfaction guaranteed or money back.

PORTABLE WIRELESS TELEPHONE CO.

Dept. C Commercial Bank Bldg., Stockton, California
 Attractive Dealer's Proposition

STORAGE BATTERIES FOR WIRELESS USE

Special Prices

| Volts | Amps. | Price |
|-------|--------|--------|
| 6 | 20 | \$7.25 |
| 6 | 40 | 9.75 |
| 6 | 60 | 13.50 |
| 6 | 80-100 | 22.00 |

One year unconditional guarantee, free repair or a new battery at our option, shipped fully charged, ready for use.

Add \$50 for special crating.

Distributors—Jobbers—Dealers—write for discounts and exclusive territories. If your dealer hasn't it, send check or money order direct.

P. M. DREYFUSS

Fourth Floor

150 Chambers St. New York City

MAKE MONEY AT HOME

YOU can earn from \$1 to \$2 an hour in your spare time writing show cards. Quickly and easily learned by our new, simple "Instructograph" method. No canvassing or soliciting; we teach you how, guarantee you steady work at home no matter where you live, and pay you cash each week.

Full particulars and Booklet free

AMERICAN SHOW CARD SCHOOL
 55 Ryrie Building Toronto, Can.

Write For Our FREE BOOKS On

PATENTS MUNN & Co.

631 Woolworth Bldg. NEW YORK
 Scientific American Bldg. WASHINGTON, D. C.
 Tower Bldg. CHICAGO, ILL.
 611 Hanna Bldg. CLEVELAND, O.
 Hobart Bldg. SAN FRANCISCO, CAL.

Radio for Everybody



At last a simple, compact, inexpensive radio receiver is available for everyone located within reasonable distance of a broadcasting station. This is the new G. E. Radio Broadcasting Receiver Model E R-753.

Model E R-753 is no bigger than an average hand camera and is easily set up almost anywhere. Tuning is as simple as focusing a pair of field glasses. In fact any member of the family can learn how to use it in a few minutes.

The apparatus comprises a highly sensitive crystal detector, tuning inductance, condenser, and other accessories—all contained in a neat, metal E Z case. Telephone head pieces are supplied. By including G E antenna equipment A G-788 we have a complete set.

Price

| | |
|--|----------------|
| <i>Crystal Detector Radio Receiver Model E R-753</i> | \$18.00 |
| <i>G E Antenna Equipment A G-788</i> | 7.50 |

| | |
|-------------------------------------|----------------|
| <i>Total for complete equipment</i> | \$25.50 |
|-------------------------------------|----------------|

At Your Nearest Radio Dealer

Radio  **Corporation**
of America

Sales Department, Suite 1802
233 Broadway, New York City

Another **TELMACO** Achievement

The TELMACOPHONE

Here is the Height of Telmaco Perfection

Equipped with Baldwin Type C Unit, inverted horn, reflected tone. Equal to any other horn twice its length. Designed and perfected by expert acousticians. Complete in every detail.

Don't be misled into buying a loud speaker offered for less, and expect satisfaction; for a loud speaker of quality cannot be sold for less. Only after the most exhaustive tests and comparisons with the other loud speakers; and only after the most thorough research, laboratory tests, and field demonstrations has the Telmacophone been perfected, and offered now, for the first time, to the public.

Telmaco Amplifiers, Receivers, Detectors, Variometers and Variocouplers have earned a national reputation for quality, endurance and satisfaction not excelled by any other line. You can expect equal satisfaction from the Telmacophone.

We advise the purchase of the Telmacophone without unit for those who have Baldwin Unit of their own.

Dealers! We are distributors for nearly all standard lines. Full discounts on the Telmacophone. Write for proposition on our complete line.



No Extras to Buy.

Nothing to get out of order.

Price Complete
\$20.00

Fully Guaranteed

Price without Baldwin Unit, but with cap attached, \$14.50.

RADIO DIVISION

Telephone Maintenance Co.

Note New Address

20 So. Wells St. Dept. B. Chicago, Ill.

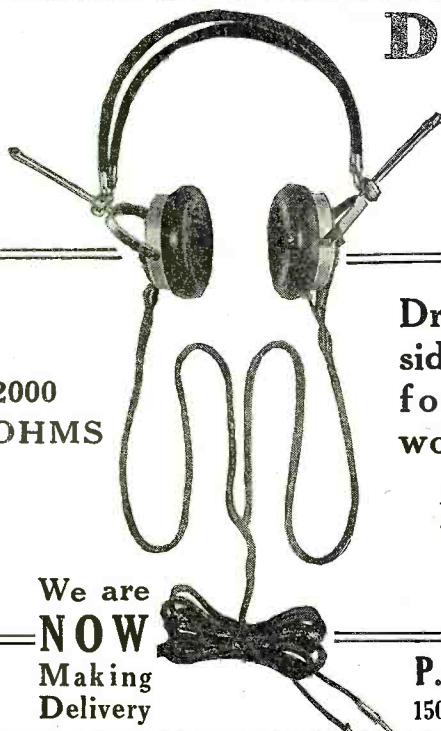

DREYFUSS PHONES

(concert type)

\$8.00 Per Pair
List Price

2000
OHMS

Dreyfuss Phones are considered the Best Phones for Radio Telephony work.

Designed by Telephony Engineers of over 18 years experience

Distributors:—Get in touch with us for open territories

We are **NOW** Making Delivery

P. M. DREYFUSS CO., Inc.
150-152 Chambers St. New York, N. Y.

Meyberg Co., Leo J., San Francisco, Calif., KDN.
Meyberg Co., Leo J., Los Angeles, Calif., KYJ.

Missouri State Marketing Bureau, Jefferson City, Mo., WOS (Markets).

Montgomery Light & Water Power Co., Montgomery, Ala., WGH*.

Newspaper Printing Co., Pittsburgh, Pa., WPB.

Northern Radio & Electric Co., Seattle, Wash., KFC.

Palladium Printing Co., Richmond, Ind., WOZ.

Pine Bluff Co., The, Pine Bluff, Ark., WOK.

Pomona Fixture & Wiring Co., Pomona, Calif., KGF.

Portable Wireless Tel. Co., Stockton, Calif., KWG.

Precision Equipment Co., Cincinnati, Ohio, WMH*.

Precision Shop, Gridley, Calif., KFU.

Radio Const. & Electric Co., Wash., D. C., WDW.

Radio Corporation of America, Roselle Park, N. J., WDY.

Radio Shop, Sunnyvale, Calif., KJJ.

Radio Telephone Shop, San Francisco, Calif., KYY.

Reynolds Radio Co., Denver, Colo., KIZ*.

Rike-Kumler Co., Dayton, Ohio, WFO*.

Rochester Times-Union, Rochester, N. Y., WHQ*.

Seeley, Stuart W., East Lansing, Mich., WHW (Market and Weather).

Service Radio Equipment Co., Toledo, Ohio, WJK.

Ship Owners Radio Service, New York, N. Y., WDT.

Union College, Schenectady, N. Y., WRL.

University of Minnesota, Minneapolis, Minn., WLB*.

Univ. of Wisconsin, Madison, Wis., WHA*.

Warner Bros., Oakland, Calif., KLS.

Wasmer, Louis, Seattle, Wash., KHQ.

Westinghouse Elect. & Mfg. Co., Springfield, Mass., WBZ.

Westinghouse Elect. & Mfg. Co., Chicago, Ill., KYW.

Westinghouse Elect. & Mfg. Co., Newark, N. J., WJZ.

Westinghouse Elect. & Mfg. Co., East Pittsburgh, Pa., KDKA.

Western Radio Electric Co., Los Angeles, Calif., KOG.

Western Radio Co., Kansas City, Mo., WOQ*.

White and Boyer, Wash., D. C., WJH.

Wireless Telephone Co., Hudson County, Jersey City, N. J., WNO.

(See additional stations licensed between March 11 and 22).

*Designates also sending markets and weather on 485-meter Wave-length.

TWENTY-SIX STATES BROADCASTING.

Today there are broadcasting radio telephone stations in 26 states of the Union, California leading with 26 stations, Pennsylvania, second, with 11; New York, 9; Ohio, 8; New Jersey, 6 and District of Columbia, 5. Twenty other states have one or more stations, but 23 have no stations broadcasting as yet.

NEW COMMERCIAL LAND STATIONS.

Twenty-seven new commercial land stations have been added to the list of Radio Stations in the United States, edition of June 30, 1921, according to an announcement by the Department of Commerce.

Camp 61-C, So. Calif. Edison Co., KFM, 540 meters.

Chicago, Ill., City of Chicago, WBU, 360 and 420 meters.

Insure your copy reaching you each month. Subscribe to Radio News—\$2.50 a year. Experimenter Publishing Co., 236-A Fulton St., N. Y. C.

Radio brings it MAGNAVOX tells it

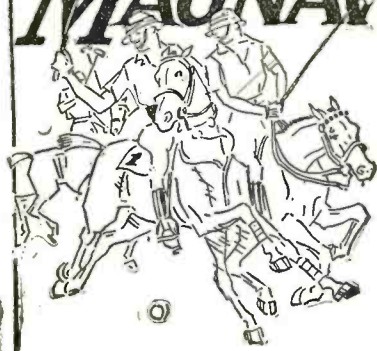

The Magnavox Radio, constructed on the *electro-dynamic* principle (with movable coil)—the most sensitive and also powerful converter of electrical energy into sound waves.

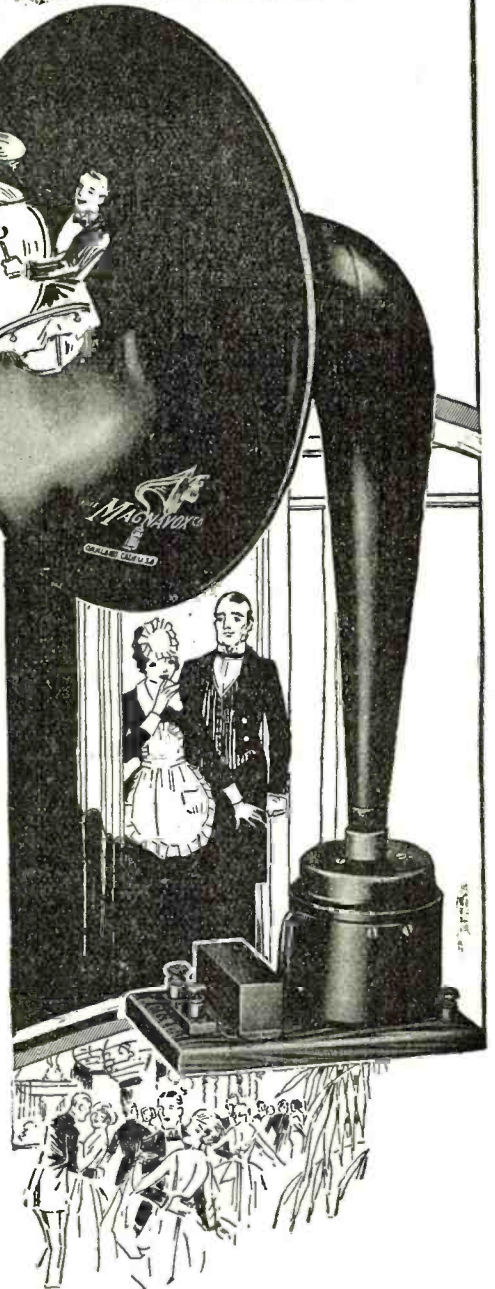

To enjoy the fullest possible service and value from your receiving set, equip it with a Magnavox Radio—the *scientifically correct* reproducer. Comparative tests by experts and amateurs alike have established Magnavox Radio as the world's standard loud-speaker.

Concert and dance music, speeches, songs—Magnavox Radio amplifies them all in volume and marvelous clarity, multiplying many times the use you now get from your wireless. The hookup is simple, and no extras or adjustments are required.

No wireless receiving set is complete without the Magnavox Radio. Any dealer will demonstrate for you, or write us for descriptive booklet and name of nearest dealer.

THE MAGNAVOX COMPANY

Oakland, California

New York Office: 370 Seventh Avenue, Penn Terminal Bldg.



The Magnavox Power Amplifiers insure getting the largest possible power input for your Magnavox Radio. Can be used with any "B" battery voltage up to 1,000.
2 and 3 stage

MAGNAVOX Radio

It is the development of the Magnavox Radio which has removed the last limitation and restriction from the use of home radio sets.

Tune Up With Us! Save Money!

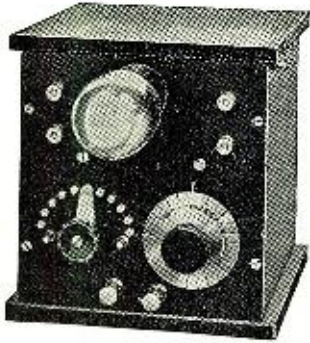

Price Prepaid
\$20.00

low price of only \$20.00 prepaid, which includes 22½ volt "B" Battery, 150 ft. aerial wire and insulators. The only additional equipment necessary for successful operation are phones, vacuum tube and a 6-volt storage battery or dry cells.

If your dealer hasn't the "Miraco" in stock order one direct today from this ad or write for literature describing this apparatus. Dealers write for Proposition.

MIDWEST RADIO COMPANY, Dept. A, 3423 DURY AVE. CINCINNATI, OHIO

"EVERYTHING FOR THE RADIO MAN"

"Miraco" Radio Receiver

You are missing two opportunities if you are contemplating installing a Radio Receiving Set and pass this extraordinary offer by. You are missing the opportunity to save money; you are missing the opportunity of enjoying beautiful Radiophone Concerts, speeches, etc., or the thrill of catching signals out of the air.

"Miraco" Vacuum Tube Radio Receivers are made to be sensitive to every detail flashed through the air, durable and handsome and yet at the

RADIO PANELS

and

Other Insulation for Wireless Work

BAKELITE - DILECTO

Grade XX Black was used by the Government during the war for this purpose. It is the

STANDARD OF THE WORLD

THE CONTINENTAL FIBRE COMPANY

NEWARK, DELAWARE

New York, 233 Broadway
Pittsburgh, 301 Fifth Ave.
Los Angeles, 411 S. Main St.

Chicago, 332 S. Michigan Ave.
San Francisco, 75 Fremont St.
Toronto, Ont., Canada,
89 Wellington St., West

A welcome addition to your library! Send \$2.50 today, plus postage for 7 lbs., and your copy of bound volume No. 2 of Radio News will come forward by return mail.
Experimenter Publishing Company, Inc. 336a Fulton Street, New York City

Cleveland, Ohio, Warren R. Cox, WHK, 360 meters.

Dayton, Ohio, Rike-Kumler Co., WFO, 360, 485 meters.

East Lansing, Mich. Stuart Seeley. U. S. Weather Bureau, WHW, 485 meters.

Gridley, Calif. The Precision Shop, KFU, 360 meters.

Hamilton, O. Doron Bros. Elec. Co., WRK, 360 meters.

Indianapolis, Ind. Hatfield Elec. Co., WOH, 360 meters.

Jefferson City, Mo. Missouri State Marketing Bureau, WOS, 485 meters.

Kansas City Mo. Western Radio Co., WOO, 360, 485 meters.

Medford Hillside, Mass. American Radio and Res. Corp., WGI, 360 meters.

Montgomery, Ala. Montgomery Light & Power Co., WGH, 360 meters.

Newark, N. J. L. Bamberger & Co., WOR, 360 meters.

New London, Conn. I. W. T. Co., WST, 300, 450, 600 meters.

New York, N. Y. I. W. T. Co., WCG, 300, 475, 600 meters.

Philadelphia, Pa. T. F. J. Howlett, WGL, 360, 250 meters.

Pine Bluff, Ark. Pine Bluff Co., WOK, 360, 510 meters.

Pomona, Calif. Pomona Fixture & Wiring Co., KGF, 360 meters.

Richmond, Ind. Palladium Print. Co., WOZ, 360, 485 meters.

Rochester, N. Y. Rochester Times-Union, WHQ, 360, 485 meters.

Rock Island, Ill. Karlowa Radio Co., WOC, 360, 485 meters.

San Francisco, Calif. Examiner Print Co., KUO, 360 meters.

Seattle, Wash. Louis Wasmer, KHQ, 360 meters.

Schenectady, N. Y., General Elec. Co., WGY, 360 meters.

Springfield, Ohio. Ford Motor Co., WNA, 465 meters.

Toledo, Ohio. Wm. B. Duck Co., WHU, 360 meters.

Toledo, Ohio. Service Radio Equip. Co., WJK, 360 meters.

Note.—Stations with 360 meter wave-length transmit news and concerts; stations with 485 meter wave-length transmit markets and weather.

German Tests on Radio Signalling to Railroad Trains

(Continued from page 1073)

spectively. The length of each screening net, in order to warrant the appearance of the red disc, should not be below a given minimum corresponding to a normal travelling speed of the train. In the present case, they were made each 180 meters long, consisting of five iron wires parallel to the telegraph lines, placed in the same vertical plane and stretched out between four poles (each 60 meters apart). They are between the telegraph wires and the embankment, being 25 cms. distant from one another and thus screening, as it were, the telegraph wires from the engine as it is passing by. The iron wires are short-circuited among one another at each of the four poles. Earth plates near the second and fourth poles respectively allow the net, whenever desired, to be grounded; they are connected together by an iron wire dug into the soil. Fig. 7 shows the arrangement of such a screening net and Fig. 9 shows the railroad profile at each of the two screening nets.

RESULTS OF TESTS

Some striking phenomena were, at the very outset, noted in connection with the tuning of the receiver. The engine being



You Get the Best Results
by Using a

Stromberg-Carlson Radio Head Set

HEAD SET RECEIVERS

Receivers are equipped with a one-piece bipolar permanent magnet, of high grade magnet steel; provided with phenol fiber spool heads, slotted soft iron pole pieces, corrosion proof diaphragm, enameled copper wire coils. All parts are encased in a receiver shell of cast non-magnetic insulating material, that is unaffected by either moisture or temperature changes. Each coil is wound to 500 ohms. The coils are connected in series. This gives a combined resistance of 2,000 ohms.

THE HEAD BAND

A head band is furnished of the spring wire type, covered with heavy brown webbing, correctly shaped, light in weight and comfortable to the operator. Knurled thumb screws are provided on both ends to permit locking the adjustment after it is once fitted to the head. There is also provision for separating the receivers which permits two observers listening in on a circuit simultaneously.

THE CORDS

Each No. 2-A Radio Head Set is equipped with a 5-ft. brown silk moisture proofed, receiver cord which is forked in two branches, one branch for each receiver.

These fine instruments, made by a Company engaged in the manufacture of telephone apparatus for 28 years, bring in the long distance tones with accuracy and distinctness.

They give the fullest measure of enjoyment because of the quality of the tones. Convenient and comfortable. The construction of the Stromberg-Carlson Head Set allows simultaneous use by two observers.

Price \$7.50 each f.o.b. Rochester, including two head set receivers, head band and forked 5-foot cord.

Mail the coupon for our Free Bulletin No. 1030-R, describing the No. 2-A Radio Head Set and other superior apparatus of our manufacture.

Stromberg-Carlson Telephone Mfg. Co.

Send me your free bulletin 1030-R describing your No. 2-A Radio Head Set.

Stromberg-Carlson Telephone Mfg. Co.

ROCHESTER, N. Y.

Branches; Chicago Kansas City Toronto

Address Nearest Office

Name.....

Address

FACTS WORTH READING!

EXTRACTS FROM A STRANGER'S LETTERS

Experimenters Information Service,
45 Pinehurst Ave., New York.

Craig, Alaska, 10/21/21.

Gentlemen:

Received parts of your 160 to 1000 meter receiver, just completed the set and given same a few days' tests.

Am very much pleased and wish to state that it is the best receiver I have ever worked. The latest commercial receivers (Navy Tuners) approach yours very closely in selectivity. Can copy stations 1000 miles distant thru interference by stations of equal power only 100 miles away, both tuned to 600 meters. Some of the Pacific Coast amateurs come in QSA without regeneration. Heartily recommend your BLUE PRINTS to anyone wanting a first class design.

(Signed) Winfield S. H. Wood.

Experimenters Information Service,
45 Pinehurst Ave., New York.

Craig, Alaska, 11/22/21.

Gentlemen:

On 600 meters I get everything on the Pacific Coast. Stations 1500 to 2000 miles come in very loud. I get ships and 1KW land stations in the Hawaiian Islands fine.

The best work of your receiver is in Phone work. After a few days' test I was able to get the Avalon Phone fine and since have heard them nightly and sometimes an hour before dark. After a few nights' adjustment was able to get the bulletins and music from the Fairmont Hotel in San Francisco. Next I picked up the music from the Post Intelligencer Office, Seattle. (Note: This phone is 10 watt Output). Have never heard this feat duplicated. Everything on one bulb.

(Signed) Winfield S. H. Wood.

The above receiver built from one of the 22 Blue Print Designs we produce. Inspect them at your dealer or write for new illustrated Bulletin "W"

EXPERIMENTERS INFORMATION SERVICE

45 PINEHURST AVENUE,

NEW YORK CITY

Western Distributor

COMMONWEALTH EDISON CO., 72 WEST ADAMS STREET, CHICAGO

placed in a shed about 600 meters distant from the sending station and comprising three parallel tracks, a deflection of the galvanometer needle was noted while the sender was operating, the magnitude of which depended on the actual position of the engine in the shed, reaching a maximum on the central track. Outside of the shed, the deflection would cease altogether. This phenomenon was found to be due to a power transmission line passing through the shed. Moreover, during tests on the experimental line, the receiving energy, as indicated by the galvanometer needle, would undergo frequent changes. In order more closely to investigate these phenomena, a detailed survey of the whole line was made, bringing out all its characteristics, after which the galvanometer deflection was measured from pole to pole, thus preparing an accurate curve of the receiving energy in connection with the configuration of the ground. The following factors were found to give rise to fluctuations in receiving energy: Slopes, cuts, approaching or withdrawing telegraph wires, signal posts, crossings, branchings, etc. Although these influences can be practically compensated by increasing the sending energy and properly coupling the receiving detector with the receiving circuit, it is preferable to provide some attachment (condenser) for controlling the receiving energy. Inasmuch as the screening nets above described would exert no absolutely reliable effects, they will have to be replaced by screening tunnels.

Taking the above into account, the tests in question have shown the practicability of the method for the wireless transmission of signs to a railroad engine.

A Variometer that Can be Built with a Jack-knife

(Continued from page 1113)

cles having radii of $2\frac{1}{8}$ " and $2\frac{3}{4}$ " respectively and cut down to the $2\frac{1}{8}$ " circle and smooth up. Through the center of this piece draw a line, and $\frac{1}{8}$ " on each side of this line draw another, and with a saw or the knife split the piece on these lines, leaving two semi-circles, as shown in Fig. 2.

You now have six pieces of wood which are ready to be glued together. These should be put together, as shown in Fig. 3, with two pieces of brass rod in the center. Take care that the ends of the brass rod do not touch each other.

The circles drawn on the pieces, when cut out, will help to center each piece.

The pieces should be held in carpenters' clamps or a vise until thoroughly dried. If preferred, these pieces can be put together with brass screws instead of glue.

Three balls should be made as described, for plate, grid, and vario coupler. The plate coil should be wound with No. 18 D.C.C. wire starting at the lower edge and winding toward the center, joining the wire in the center. Take care, and wind the two sides in opposite directions so that when joined in the center the wire will run all in the same direction.

The grid and vario-coupler balls should be wound with No. 24 D.C.C. wire.

One end of this winding should be soldered to one of the brass rods, and the other end to the other rod.

The stator is made of two of the $5\frac{3}{4}$ " x $\frac{1}{4}$ " pieces, and in the exact center is cut a circle having a radius of $2\frac{1}{2}$ ". This can best be done with a coping saw, but if none is handy a row of holes can be bored all around and then the remaining wood can be cut out with the knife. Finish these



7" Bell, 19" High
\$7.50

Standard Radio Horn



Pat. Applied For

Special Design

Will fit any receiver.
Heavy material, no blast.
Rubberoid Enamel finish.

Your Dealer can supply you

We figure on Special Horns
for Manufacturers.



5" Bell, 14" High
\$5.00

Standard Metal Mfg. Co.

237 Chestnut Street

Newark, N. J., U. S. A.

A welcome addition to your library! Send \$2.50 today, plus postage for 7 lbs., and your copy of bound volume No. 2 of Radio News will come forward by return mail.
Experimenter Publishing Company, Inc. 238a Fulton Street, New York City

A Real Radio "B"

24-Volt

Storage Battery

Rubber Screw Caps seal jars tightly. No seepage between jar and cover.

Glass Jars. Leak-proof. Allow clear view of solution-level.

Threaded Rubber Insulation protects the plates.

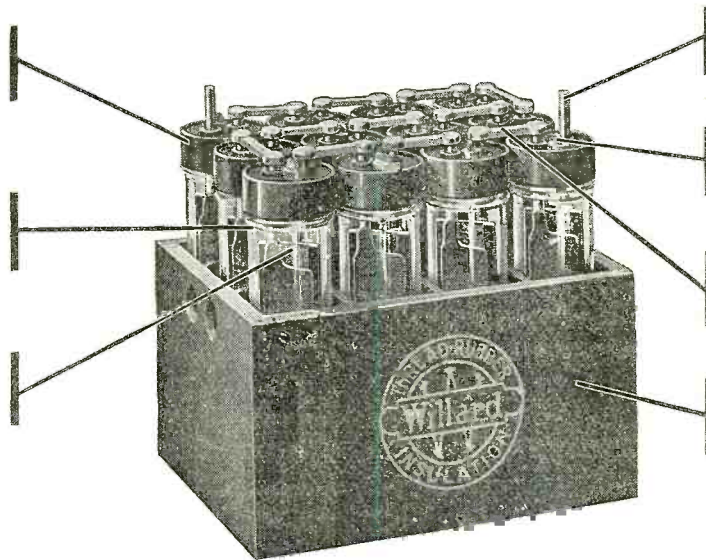

High terminal posts permit ample room for clamps.

Rubber vent plugs—easily removable.

Connectors heavy enough to provide firm grip for clamps.

Heavy Oak Case. Coated with Acid-proof paint.

Built especially for radio reception—to bring in voice, music and signals, louder, clearer and with greatest reliability. Rechargeable—will last for years. Made up of 12 individual 2-volt

cells in tubular glass jars. Separate cells are easily added to increase voltage. Threaded Rubber Insulation and leak-proof glass jars eliminate all frying and hissing noises.

Ask about the Radio "A" Battery of the special Willard All-Rubber Radio Type. Eliminates all ground noises. One piece rubber case. Threaded Rubber Insulation. Absolutely leak-proof.

WILLARD STORAGE BATTERY COMPANY, CLEVELAND, OHIO
Made in Canada by the Willard Storage Battery Company of Canada, Limited, Toronto, Ontario

Willard

THREADED RUBBER BATTERY

RADIO SUCCESS

IS ASSURED BY CAREFUL PLANNING

Plan Bureau Blue Prints

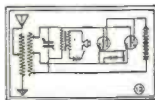
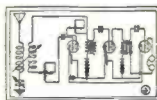
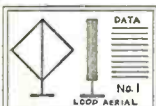
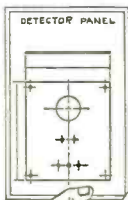

Are especially prepared to serve the amateur or commercial man, expert or novice. Genuine goodness and low prices have made them extremely popular. We receive letters of commendation almost every day. OUR METHOD IS TO GIVE YOU CLEAR AND CONCISE BLUE PRINTS FOR USING STANDARD PARTS AND MATERIALS THUS ENABLING YOU TO BUILD CHEAPLY AND QUICKLY. WE DO NOT SELL PARTS.

Complete set of receiver plans. Just out. Details and shows you exactly how to make the following:

Three different aeri-als. Short wave tuner. Long wave tuner. Detector unit. (VT)

One stage amplifier. Two stage amplifier. Three stage amplifier. Loud speaker.

Proven VT hook-ups for receiving. 12 separate blue prints for 50c.

Proven VT hook-ups for phone transmis-sion. 12 separate blue prints for 50c.

Several cabinets. Several hook-ups. 18 blue prints in all giving every detail needed. Right up to date. Price \$2.00 postpaid.

THE PLAN BUREAU 1929 McCausland Ave. ST. LOUIS, MO.

NEW PRICES AND OFFERS

Special Parado Offer No. 6

This complete outfit will give you a receiving set with 2-step amplifier with a range of 1,000 miles. It includes Parado Offer No. 1 advertised in the January Radio News, and Parado Offer No. 2 advertised in the March Radio News.

Complete Parado Receiving Set No. 1 \$36.60
Complete 2-step amplifier set..... 31.60

Entire Outfit, Parado Offer No. 5..\$68.20

NOTE—You can order both sets or either at the above prices.

Complete instructions for assembly and connections furnished FREE with order.

Write for other combination offers and FREE BULLETIN P-14

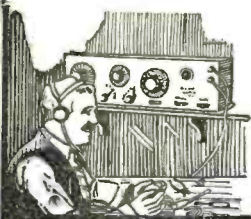

Peoria Radio Sales Co.
Dept. B
PEORIA,
Illinois

DEALERS and AGENTS

We are making special offers to our dealers and agents to represent us all over the country. We are distributors of the best equipment. Get our prices on these lines of apparatus:

- Acme Clapp-Eastham Grebe
- Adams-Morgan DeForest Moorhead
- Baldwin Jewell Murdock
- Brandes Federal Pacent
- Westinghouse Radio Corporation

Write to-day for New Dealers Discount Schedule No. 7

KLAUS RADIO CO.

Dept. 200
Eureka, Ill.



FIRST TESTED THEN SOLD

Opportunities in Radio

OUR GRADUATES BECOME:

- Radio Operators
- Radio Supervisors
- Radio Engineers
- Radio Repairmen
- Radio Inspectors
- Radio Teachers
- Traffic Managers
- Radio School Directors

No Preliminary Training Necessary

ARC SPARK VACUUM TUBES
ABSTRACTING REPAIRING
OPERATING

Send for Illustrated Booklet

Y. M. C. A. RADIO SCHOOL
158 East 86th St., New York, N. Y.

"Best Radio School in the East"

Why Good Dancers Are Popular



Everyone admires and wants to dance with the person who knows the latest steps. No need to envy good dancers who are popular and sought after in every social gathering. Arthur Murray, dancing teacher to the Vanderbilts, has invented a remarkable new method which enables ANYONE to learn all the newest dances at home—in private. IN ONLY A FEW HOURS. Even a child can learn by this fascinating, easy method. You need no music or partner. More than 60,000 people have learned dancing by mail. Mr. Murray's instructions are guaranteed to be EASIER than that of a personal teacher. You can learn the Fox Trot, Waltz, Conversation Walk, and other new dances at a fraction of the cost of personal lessons.

FREE DANCING LESSON

To prove that Arthur Murray's remarkably simple picture method will make you an accomplished, confident dancer EASILY and QUICKLY. We will send you, in plain cover, a sample dancing lesson without charge. No obligation. For mailing send 10c. Will you write today?
Arthur Murray School of Dancing, Studio 250 100 Fifth Ave., N. Y.

with sandpaper. Two pieces like this are required for each variometer.

The last thing to make is the winding form. First, from the 5" x 1 1/2" piece, whittle a 4 7/8" cylinder. Then on one end of this cylinder and in the center draw a circle with a 2" radius, and starting 1 1/4" from this end whittle the wood to this circle using the template for winding; be very careful not to get this too small.

From the remaining 5" x 1/8" piece, cut a 4 1/4" circle and screw it to the end of the winding form; this will prevent the wire from slipping. The winding form should now be wound for a distance of 1 1/4" with No. 18 D.C.C. wire and given several coats of thick shellac, on the outside only. Be careful not to get any shellac between the winding and the form, or you will be unable to get it off.

When the shellac has dried, remove the 1/8" piece and gently tap the winding all around the upper edge to remove; be very careful not to tap in one place all the time. When the coil comes off, give it a coat of shellac on the inside and let it dry.

Now wind the form again with No. 18 D.C.C. wire, in the opposite direction and proceed as above. These two windings complete the stator for the plate variometer. The grid stator should be wound in the same way, using No. 24 D.C.C.

Put one of the windings through the hole in the 5 3/4" piece so that the large end will come flush with the edge of the hole. Place the piece face down on a flat surface and tamp a piece of string soaked in shellac, gently around the coil; this will hold it in place. Do the same to the other winding, taking care that the free ends of the wire can be connected together easily. You now have two pieces like those shown in Fig. 4.



Fig. 4

String tamped in here



Fig. 5

The Winding Form for the Stator Coils

The grid stator windings are fixed in the same way.

You now have two complete variometers ready to assemble; this can be done in several ways, but the way used here was by taking two brass pieces 1/2" x 3/4" x 1/8" and boring a 1/4" hole in the center and two smaller holes for screws 1/8" in from each end. These bearings must be placed in the exact center of the stator or else the rotor will not turn freely. One end of the stator winding goes to one of the bearing, the other to a binding post and the two inside ends are joined together. The other bearing is connected to another binding post.

The primary for the variocoupler consists of 50 turns of No. 24 D.C.C. wire on a 5" tube tapped every five turns, and the coupler ball is supported so as to rotate over this.

Amplifying Transformers

(Continued from page 1082)

inal. Slip the primary into the secondary and fill the space between, if any, with

Radio panels

HAVE your panels made to your own specifications. Celoron Radio Panel Service assures you the highest type, best serving, best looking radio panels made, machined and engraved to your own individual specifications.

CONDENSITE CELORON

Grade 10—the highest type of radio insulation that we produce—has a wide variety of uses in the radio field. It is extremely high in surface and volume resistivity, high in dielectric strength and low in dielectric losses. This material is particularly suited for panels because it machines easily, engraves beautifully and is extremely handsome in appearance. It has been approved by the Navy Department, Bureau of Engineering, and is the grade we recommend.

Where economy is a factor we can supply panels made of Vulcanized Fibre Veneer. This material is made of a center section of hard, grey vulcanized fibre veneered on both sides with a waterproof, phenolic condensation product. It has a fine, smooth, jet black surface, machines readily, engraves nicely and is applicable for use in the construction of radio equipment where very high voltages at radio frequencies are not involved.

Celoron Shielded Plates (patent applied for) are made with a concealed wire mesh embedded directly under the back surface of the plate. This wire shield, when properly grounded, very effectively neutralizes all "howl" and detuning effects caused by body capacities. Shielded Plates are made in both Condensite Celoron Grade 10 and Vulcanized Fibre Veneer.

Send today for our Radio Panel Guide

Are you an enthusiast? Write today for our radio Panel Guide that describes these panels in detail—quotes prices—and tells you just what the panel you want will cost.

Are you a Radio Dealer? Get in touch with us. Learn how easily Celoron Radio Panel Service enables you to sell panels completely machined and finished to your customer's specifications. No waste, no bother. Write for our special Dealer Proposition today.

Diamond State Fibre Company

Bridgeport, (near Philadelphia). Penna.

Offices in principal cities

Branch Factory and Warehouse, Chicago

In Canada: Diamond State Fibre Co. of Canada, Ltd., Toronto

AMPLIFICATION WITHOUT DISTORTION

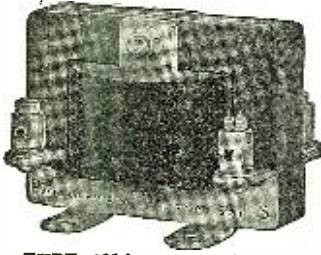

TYPE 231A TRANSFORMER

imum so that telephone signals will not be distorted and at the same time is rugged mechanically so that open circuits will not occur causing signal distortion and also is so designed that eddy currents will be reduced to a minimum.

Multi-stage, audio frequency amplification is neither necessary nor desirable for ordinary work. Two stages of amplification with properly designed transformers is all that should be required. Why not use a transformer which will give you all the amplification necessary in one or two stages?

PRICE, COMPLETELY MOUNTED, \$5.00

A vacuum tube socket plays an important part in amplification. The prongs of the tube must make perfect contact to prevent the introduction of noises. The springs in our Type 156 vacuum tube socket are so arranged that contact noises are entirely eliminated.

RUGGED ATTRACTIVE RELIABLE

PRICE \$1.50

Send for
Free Radio Bulletin 911N



TYPE 156 SOCKET

GENERAL RADIO COMPANY

Massachusetts Avenue and Windsor Street, CAMBRIDGE 39 MASSACHUSETTS

Standardize on General Radio Equipment Throughout.

melted paraffine.

Next, insert the core pieces, first from one end and then the other, to make a closed core for the transformer. Use enough pieces to firmly wedge them in the interior of the coil.

Now, bend two pieces of brass, like Fig. 2, and clamp to the core to hold it and to support the transformer. Drill for 6/32 screws. These pieces may be 1/8" or 3/8" thick, and the screws which clamp them on may also clamp on a piece of bakelite, on which binding posts are mounted for connection with the terminals of the coil.

I have completed one transformer, all but mounting, and have left a secondary which will make another transformer. As my Ford coil cost me \$1, the two transformers will cost \$1.50. This transformer is giving satisfactory service and compared favorably when used alongside a transformer made by a well-known manufacturer, which I borrowed from a friend.

Is Radio Threatening the Phonograph and Theatre?

(Continued from page 1081)

been invited to speak into it and have done so without charge. But now we learn that it is entering into competition with the theatre, since citizens prefer to sit at home and be entertained for nothing rather than go out into the night and spend their good money for theatre tickets. In order to draw the attention of our members to this matter the Council has passed the following:

"Resolved, that the attention of our members be drawn to the fact that the Radiograph is a profitable commercial enterprise which also in a way enters into competition with the theatre and that therefore our members be advised to seek proper compensation for any services they may be invited to give to the Radiograph Company."

The Radiograph Co.—FRANK GILLMORE, Executive Secy.

(By the way—what is a Radiograph?—Editor.)

Of course, anyone who thinks about the matter calmly must appreciate the fact that if anything, radio certainly gives the theatre, the actors, and the singers, the best possible advertising that they could ever think of having. Think of an audience of 300,000 people listening to a singer! What better advertising could there be. And some of these 300,000 people when they get to town, as they invariably do, will wish to see or hear that singer in person. The radio audience is not always a radio audience; it frequently becomes a theatre audience as well. To think that a radio man is shut in all year around is ludicrous.

Even the most ardent radio fan after listening in for five or six days in the week will wish to go to a show on the seventh day. One of these days the theatrical interests will wake up to the fact that in radio they have the greatest possible and the very cheapest advertising medium they ever dreamt of in their wildest dreams. We predict that within a year the waiting list of our broadcasting stations will be so great that it will take months for our great singers and actors to be accommodated.

Why Panels?

(Continued from page 1075)

ficulty than the isolated instrument type."

I have tried out at least 15 different circuits with my outfit, besides numerous short distance Radiophone and C.W. circuits. I have also tried boosting the voice with two V.T.'s in an ordinary telephone line. Not many owners of elaborately mounted sets can make a similar statement and consequently their knowledge of the

Everything—

The new branches—arcs and tubes—of the revised examination of the Department of Commerce are fully covered in the Home Study Course of the Radio Institute of America.

Enrollments are coming in by every mail. Why aren't you one of the wide-awake wireless men who have seen the new and greater opportunity opened to them by the Home Study Course, which is specially designed to land them one of the enviable jobs at the world's greatest radio station?

It will be equipped to work simultaneously with five other nations in widely separated and distant parts of the world.

A position at this station is the height of every operator's ambition, for it means unlimited opportunity to succeed and progress to higher, more responsible and better paying positions in the radio industry. So far as opportunity goes the successful future of these men is assured.

How about you?

The Radio Institute of America has been an established and successful institution for over fifteen years. It has trained over 6,000 men, 95% of whom have successfully engaged in this new branch of science and industry.

Write for our booklet and further details—Now.

HOME STUDY DIVISION

Radio Institute of America

(formerly Marconi Institute)

324 Broadway, New York

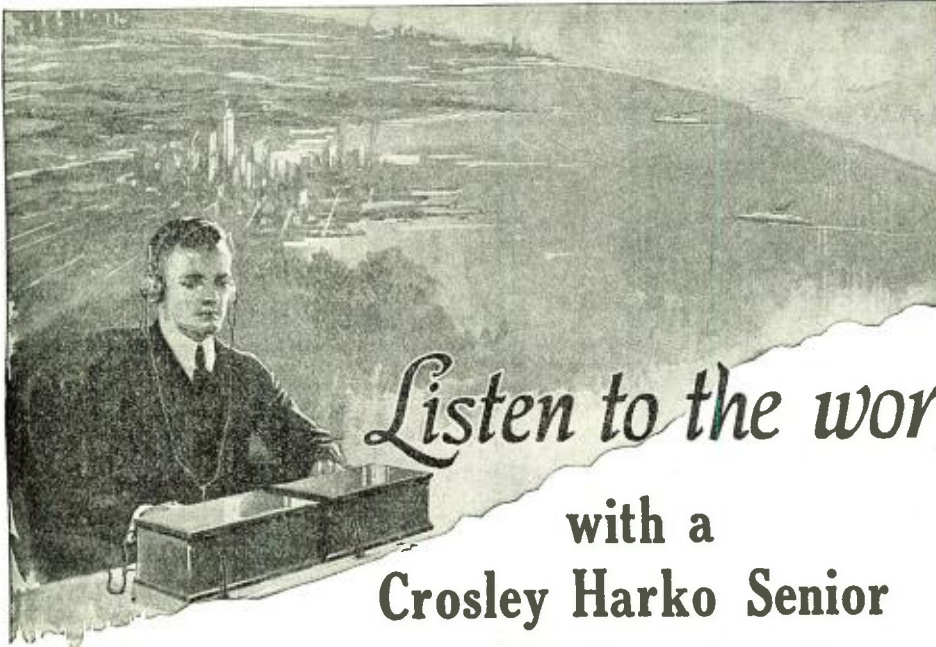

Listen to the world!

with a
Crosley Harko Senior

**Remarkable Achievements
of the Crosley Harko
Senior**

Dr. Chas. Steinmetz's lecture in Schenectady on the 24th of March was heard in Denver, Col., with a Harko Senior.

Reports throughout the U. S. confirm the fact that the Harko Senior is the equal of any apparatus at any price for the reception of broadcasting stations. This instrument in Cincinnati picks up regularly and efficiently broadcasting from Newark, N. J., Chicago, Pittsburgh, Schenectady, Detroit and many distant points.

Thousands enjoy, weekly, in the public square of Cincinnati, concerts tuned in and amplified with the Crosley Harko Senior and 2-Step Amplifier.

The simplicity of the Crosley non-regenerative circuit makes operation of the Harko Senior receiver easy and eliminates objectionable radio telephone carrier waves. Use of this apparatus permits swinging from one concert to another and affords a choice of broadcasted entertainment.

Quantity production accounts for the low prices. Efficiency is assured under the rigid inspection and tests of the engineering department.

Wide awake dealers handle Crosley Radio goods. The money back guarantee indicates the satisfaction they give. The large Crosley plants are of capacity to fill all orders promptly.

Crosley Harko Senior \$20 - Crosley 2-Step Amplifier \$25

Harko Senior tuner and detector pictured coupled with a Crosley 2 step amplifier. Tuner and detector alone brings in distant concerts loud and clear with head phones. 2 step amplifier and a loud speaker unit amplifies nearly 100 times. Fills room with all sounds from distant points. Sold without batteries, tubes or head phones. Any dealer will supply you.

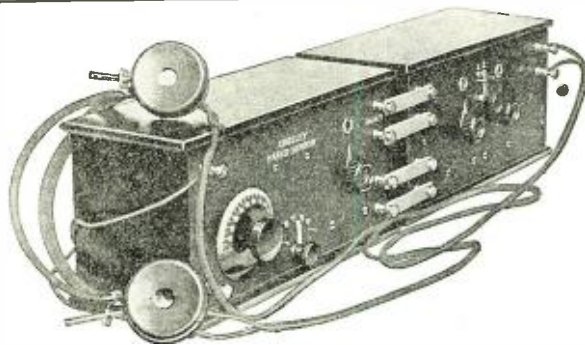

Any dealer should be able to supply you with these standard Crosley Radio Goods

Crosley porcelain vacuum tube socket, (base or panel mounting), biggest seller on market same as used in Crosley apparatus; price 60c.



Crosley Rheostat for vacuum and filament current control. Duplicate of those used in Crosley Harko Senior and Crosley 2-Step Amplifier; price 60c



Crosley Model B Variable Condenser (.0005 mf capacity). Pat. pending. A radically better condenser, louder signals, less internal resistance. Used in Crosley Harko Senior. Better—costs less. Price \$1.75; knob and dial 50c extra. Other models \$1.25 and \$2.25.

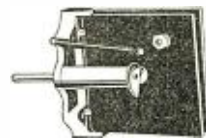

Crosley Sheltran completely shielded amplifying transformer, 9 to 1 ratio. Same as used in Crosley 2-step amplifiers. Price \$4.00.

- Harko Crystal Receiver \$9.00
- with antenna and phone15.00
- Crosley Detector Cabinet Unit 7.50
- Crosley Variometer parts 1.50
- Crosley Variocoupler parts 1.50
- Magfon Amplifying horn10.00
- Stock Cabinets, 2.50 to 10.00

Tap switches, taps, binding posts, storage batteries and all radio parts. Better—cost less. Write for catalog.

USE THIS COUPON FOR CATALOG AND INFORMATION

CROSLEY
MANUFACTURING CO.
RADIO DEPT
·CINCINNATI·O·

CROSLEY MANUFACTURING CO., Radio Dept.,
Send me your radio apparatus catalog and full details of outfit featured here.

Name

Address

My dealer who should handle your goods is.....

Please check here—Dealer
Individual

Reduce Those QRN Atmospheric NOW with Burgess "B" Batteries



Noiseless! That describes Burgess "B" Batteries. *Absolutely* noiseless! Weak and distant audio frequency signals can be received with multi-stage amplifiers and Burgess "B" Batteries because Burgess "B" Batteries *do not* draw out signals.

The batteries illustrated are supplied with both flexible wire terminals and binding post terminals. The binding post terminals are complete with hexagon nuts and brass nuts making it possible to attach wires directly to the cells, without the use of solder or bolts. If you can't get Burgess "B" from your dealer just drop a line to us care Dept. G.

BURGESS BATTERY COMPANY

General Sales Office
HARRIS TRUST BLDG., CHICAGO

Offices and Distributing Warehouses:
CHICAGO, ILL.
111 W. Monroe St.
MADISON, WIS.
Main & Brearly Sts.
KANSAS CITY, MO.
2109 Grand Ave.
ST. PAUL, MINN.
2362 University Ave.
BOSTON, MASS
136 Federal St.
NEW YORK
50 Church St.
WINNIPEG, MAN.
701 Wellington Ave.

"whys" and "wherefores" of wireless is that much less.

These are my reasons for thinking that the set, whose "hook-up" can be changed in a few minutes, ought to appeal to the amateurs—the wide-awake ones at least. Of course things are different for the fellow who has enough of the where-with-all to have a few V.T.'s, transformers, variables, etc., hanging around on the work bench, besides the regular set in his room. But since the vast majority of "hams" seem to be in the same box as I am, namely, nearly always broke, I have hopes that the suggestions contained herein will be of value to some of them.

STATEMENT.

Of the Ownership, Management, Circulation, Etc., Required by the Act of Congress of August 24, 1912, of Radio News, published monthly at New York, N. Y., for April 1, 1922.
State of New York } ss.
County of New York }

Before me, a notary public in and for the State and county of Queens, and authorized to act in and for the county aforesaid, personally appeared Hugo Gernsback, who, having been duly sworn according to law, deposes and says that he is the Editor of the RADIO NEWS, and that the following is, to the best of his knowledge and belief, a true statement of the ownership, management (and if a daily paper the circulation), etc. of the aforesaid publication for the date shown in the above caption, required by the Act of August 24, 1912, embodied in section 443, Postal Laws and Regulations, printed on the reverse of this form, to wit:

1. That the names and addresses of the publisher, editor, managing editor, and business managers are: Publisher, Experimenter Publishing Co., 233 Fulton St., New York City, N. Y.; Editor, Hugo Gernsback, 233 Fulton St., New York City, N. Y.; Managing Editor, Robert E. Lacault 233 Fulton St., New York City, N. Y.; Business Manager, R. W. DeMott, 233 Fulton St., New York City, N. Y.

2. That the owners are: (Give names and addresses of individual owners, or, if a corporation, gives its name and the names and addresses of stockholders owning or holding 1 per cent or more of the total amount of stock.) Experimenter Pub. Co., 233 Fulton St., New York City, N. Y.; Hugo Gernsback, 233 Fulton St., New York City, N. Y.; Sidney Gernsback, 233 Fulton St., New York City, N. Y.; R. W. DeMott, 233 Fulton St., New York City, N. Y.; H. W. Secor, 233 Fulton St., New York City, N. Y.; Dr. T. O'Connor Sloane 233 Fulton St., New York City, N. Y.; Mrs. Catherine Major, 233 Fulton St., New York City, N. Y.; M. M. Finucan, Hartford Bldg., Chicago, Ill.

3. That the known bondholders, mortgagees, and other security holders owning or holding 1 per cent or more of total amount of bonds, mortgages or other securities are: (If there are none, so state.) None.

4. That the two paragraphs next above, giving the names of the owners, stockholders, and security holders, if any, contain not only the list of stockholders and security holders as they appear upon the books of the company but also, in cases where the stockholder or security holder appears upon the books of the company as trustee or in any other fiduciary relation the name of the person or corporation for whom such trustee is acting, is given; also that the said two paragraphs contain statements embracing affiant's full knowledge and belief as to the circumstances and conditions under which stockholders and security holders who do not appear upon the books of the company as trustees, hold stock and securities in a capacity other than that of a bona fide owner; and this affiant has no reason to believe that any other person, association, or corporation has any interest direct or indirect in the said stock, bonds, or other securities than as so stated by him.

5. That the average number of copies of each issue of this publication sold or distributed through the mails or otherwise, to paid subscribers during the six months preceding the date shown above is (This information is required from daily publications only.)

H. GERNSBACK, Editor.

Sworn to and subscribed before me this 6th day of April, 1922.

(SEAL) JOSEPH H. KRAUS.

Notary Public Queens County Register No. 2951; New York County Register No. 3337; New York County Clerks No. 439. (My commission expires Mar. 30, 1923.)

A Simple Receiving Set

(Continued from page 1108)

of wire coiled into a spring to keep the needle from moving when placed on a certain point.

HOMCHARGE YOUR BATTERY for A Nickle

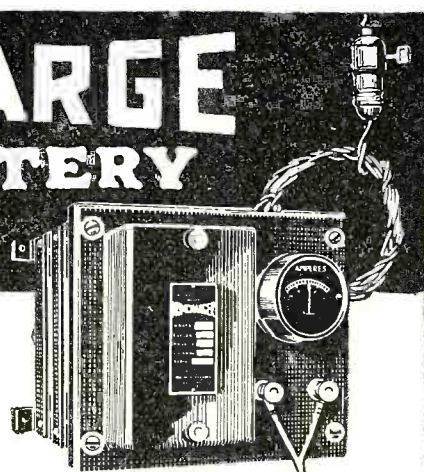

A perfect rectifier at last, fully automatic and foolproof in every respect. It can be operated by anyone.

The HOMCHARGER

Connects to any alternating current lamp socket, gives a taper charge—will fully charge any "A" battery over night. It is self-polarizing. Connect your battery either way and it will always charge. Automatically disconnects battery when power is interrupted. Restarts charging when connections are restored. Adjustable for wave form, frequency and voltage. Contains only one moving and two wearing parts, lasting thousands of hours, replaceable as a unit for \$1.00.

The highest charging rate, greatest efficiency, and simplest of any rectifier selling for less than \$100.00. Bulletin 628 proves it. Ask for your copy.

Manufactured in sizes for charging three or six cell batteries from both alternating and direct current circuits. Cannot injure battery—will last a lifetime—approved by underwriters—satisfaction guaranteed. For sale by all Radio, electrical and accessory dealers or shipped express prepaid for purchase price—\$18.50.

ATTENTION MOTORISTS:
Send for special bulletin 58 showing how easy it is to "HOMCHARGE" your battery.

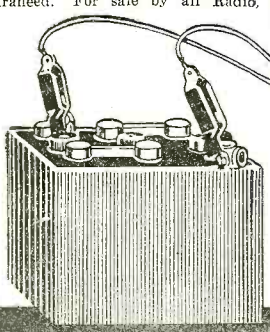

THE AUTOMATIC ELECTRICAL DEVICES CO.
118 West Third St. CINCINNATI, OHIO
Canadian Distributors—Rowley & Moody, Ltd., Toronto

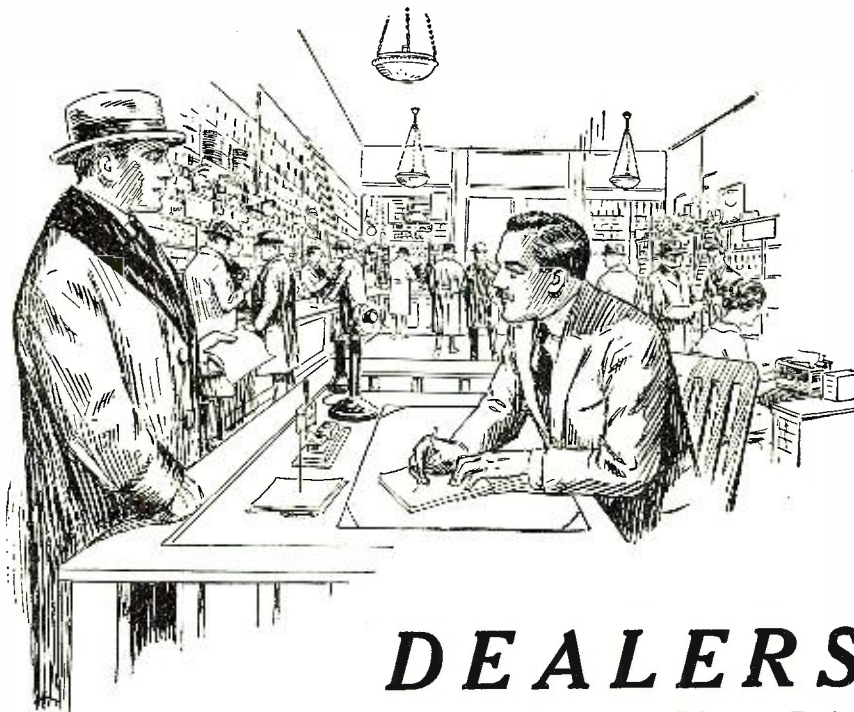

DEALERS—

(Wireless Enthusiasts Please Refrain from Listening)

WE don't claim to be accomplishing the impossible, but we do know that last month we delivered more reliable merchandise to our hundreds of dealers than was delivered by any other radio supply house in the United States.

A special bulletin has just been issued showing some fast selling items on which we can make *immediate delivery* and giving complete delivery information on our entire line, including Radio Corporation, Acme and others.

If you are not a dealer and have listened in on this talk, we would ask you to find if your dealer has been in touch with us and if not—why not!

RADISCO sells only to dealers who can prove conclusively that they have a legitimate jobbing or retail business.



This trade-mark means "quality apparatus" to the consumer and "concentrated buying" to the dealer.

RADISCO

RADIO DISTRIBUTING CO.

Newark, N. J.

Wholesale Only

BETTER RADIO EQUIPMENT for LESS MONEY

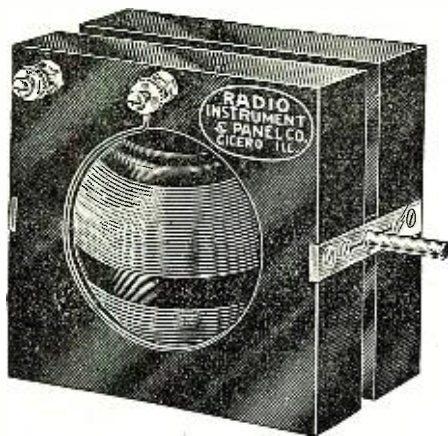

VARIOMETER \$4.50

IMPROVED VARIOMETER

Binding posts have large knurled thumb nuts. Wood forms accurate. Minimum clearance between rotor and stator. Mounts easily, and is designed for low Di-Electric losses and maximum range of induction. Black rubberized finish will not chip or peel off. Effective tuning range 150 to 650 meters.

IMPROVED COUPLER

Primary windings on black formica tube. Has 6 taps for varied induction. Rotor held by spring clip making it possible to hold range when once found. Easily installed. Will operate perfectly and give highest efficiency. Save money by using this cheaper and better equipment.

*Shipped Immediately From Stock.
Order Now.*

RADIO INSTRUMENT & PANEL CO., Mfrs., Box 75, CICERO, ILL.

GET THESE POINTS:

All wooden parts carefully impregnated with a black high dielectric strength, non-inflammable, water-proof compound. All positive "Pig-tail" contacts. Bearings will not bind. All metal parts white nicked. Rotor balls solid mahogany. Windings of green double cotton covered wire, guaranteed not to peel or come loose. White nicked shields furnished.

Make your own highly efficient regenerative set with 2 of our variometers, a loose coupler and necessary parts at a small expense. As a special inducement and to assist you keeping down your costs we offer the three at \$12.00.

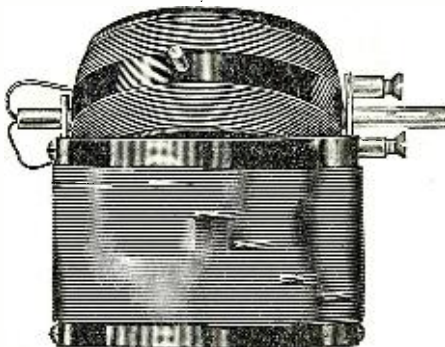

COUPLER \$3.75

TRADE ESCO MARK

MEANS THE LAST WORD IN

Motors—Dynamotors—Generators—Motor-Generators

Designed and Developed by PIONEERS

In Perfecting High Voltage Apparatus for Wireless Operation

ESCO PRODUCTS ARE STANDARD

*Sold by PRINCIPAL DEALERS Everywhere
Used by LEADING EDUCATIONAL Institutions*

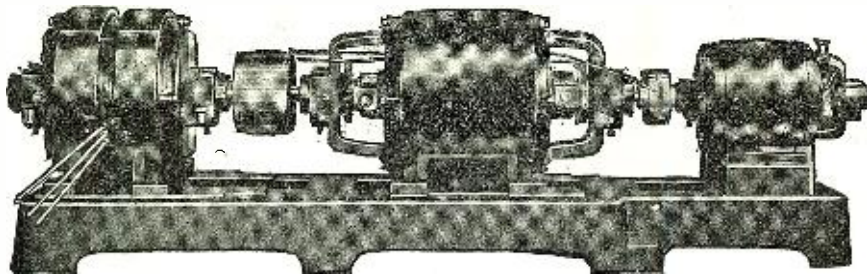

This outfit enabled 1BCG-GREENWICH, CONN., to be the first to get across the Atlantic in the recent Amateur Contest.

Ask for Bulletin 237
Listing over 200
Combinations

ELECTRIC SPECIALTY CO.

211 South St., STAMFORD, CONN., U. S. A.

The phone condenser consists of three sheets of waxed paper, such as chewing gum is wrapped in, 4 inches long and 2½ inches wide, and two sheets of tinfoil, 3 inches long and 1½ inches wide. This tinfoil can be procured from a cigarette box. A sheet of wax paper is used first, then a sheet of tinfoil with a short piece of wire on it for connection, another sheet of paper and the foil and wire with another sheet of paper, on top of all roll the condenser up and tape slightly.

The phone was purchased at a second-hand shop for 50 cents, while some N.A.A. tested galena cost 25 cents, the entire receiving set costing about \$1.10. Some aerial wire costing about 90 cents and insulators may be bought. Two hook-ups are shown, both of which should give good results.

I Want to Know

(Continued from page 1120)

made in three types to cover wave lengths from 150 meters to 12,000 meters.

Q. 3. Would three stages of radio, detector, and three stages of audio frequency amplification be practicable, using the radio frequency transformers mentioned?

A. 3. It is possible to use this amount of amplification if the proper circuit is employed.

DRY CELLS FOR FILAMENT LIGHTING

(386) Mr. Neville Whitney, San Ardo, California, asks:

Q. 1. What is the approximate wave length of a four-wire inverted L aerial 60 feet long, 40 feet high?

A. 1. See answer to question 375.

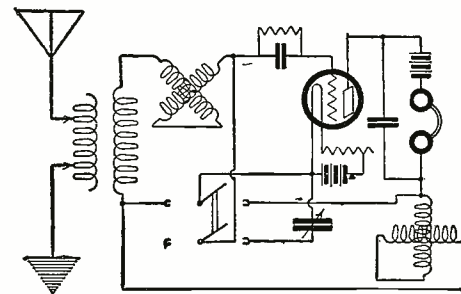

An Efficient as Well as Simple Circuit to Increase the Wave Length Range of a Regenerative Receiver.

Q. 2. Could 200 meter reception be accomplished on this aerial with a short wave regenerative receiver rated at 150 to 600 meters?

A. 2. Reception on 200 meters may be accomplished satisfactorily with this type of antenna.

Q. 3. Could I use 4 dry cells in place of the storage battery on my Radiotron U. V. 200?

A. 3. You may use three dry cells to light the filament of your tube but they will last only a short time and will not give constant service. It is cheaper and more satisfactory to use a storage battery to light the filament.

DOUBLE-GRID AUDION

(387) Mr. Lewis Ernst, St. Johns, Michigan, writes:

Q. 1. Where can I obtain a double-grid audion and what is its cost? An article about them appeared in the May, 1921, issue of RADIO NEWS.

A. 1. These are known as the Philips, Dubbel-Roosterlampen, and may be obtained from Radio, Engestraat 14, Deventer, Holland. The price of these tubes is 14 florins.

CONSTANTS OF SINGLE CIRCUIT REGENERATIVE SET

(388) Mr. W. T. Hatch, Brewerton, Washington, wants to know.

Q. 1. Please publish the constants for the various parts of the answer to question 328, consisting of one stage radio frequency amplifier, detector and two-step audio frequency amplifier.

A. 1. The tuning elements consist of a loose coupler or any form of variocoupler with condenser of .001 M.F. capacity in series with the primary, and .0005 M.F. condenser across the secondary. One side of the secondary connects to a 400 ohm potentiometer across the filament battery. Tuned radio frequency is obtained by

There is a Prest-O-Lite Battery for Radio Use

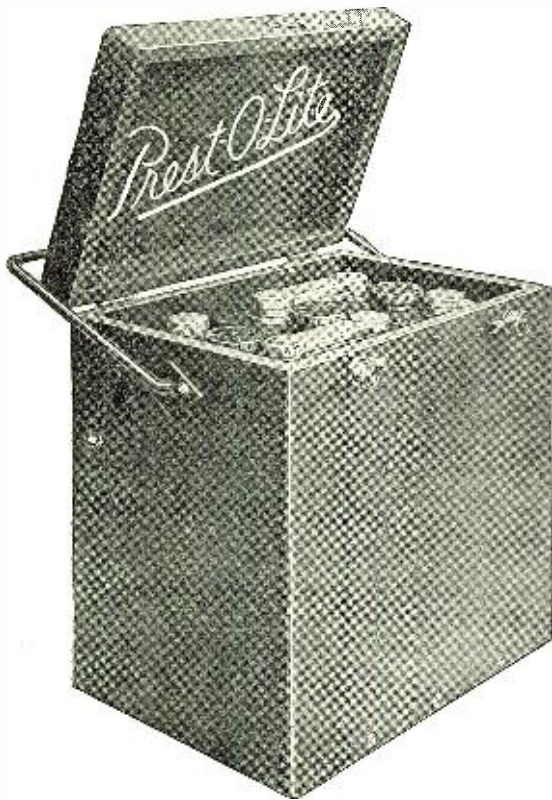

Especially designed for radio purposes, it comes in a handsome box, mahogany finish, with rubber feet to avoid scratching furniture. It harmonizes with the decorations of any home.

Because it is a Prest-O-Lite Battery, with the famous Prest-O-Plates, it is a long lived battery. Prices \$15.85 to \$37.50.

Choose a Prest-O-Lite for your radio equipment. Ask for it at any Prest-O-Lite Distributor or Dealer, or write us directly.

We advise the selection of a battery of ample capacity to avoid frequent recharging.

THE PREST-O-LITE COMPANY, Inc.

Carbide and Carbon Building
30 East 42nd Street, New York

Eighth and Brannan Streets, San Francisco, Calif.

In Canada: Prest-O-Lite Company of Canada, Ltd., Toronto

➤ **ATTENTION DEALERS!**

Prest-O-Lite Batteries for Radio Equipment make the quickest moving stock to-day. Write for our proposition.

Prest-O-Lite BATTERY FOR RADIO USE

Announcing T-B-H RADIO PRODUCTS

— Quality First —

These T-B-H Radio Telephone Head Sets reproduce broadcasted vocal or musical sounds with unexcelled clearness. They are sold at the popular price of \$8.00 per pair retail.

"Use 'em 10 days—If you don't like 'em send 'em back and get your money."



T-B-H
Radio
Head Set
List Price
\$8.00 Per Pair

SPECIFICATIONS

- RESISTANCE—2,000 Ohms
- CORD—6 Foot
- COILS—Wound with best grade copper wire—enamel insulation
- CAP—Genuine Hard Rubber
- CASE—Aluminum
- MAGNETS—Best grade magnet steel
- DIAPHRAGM—Rust Proof
- HEAD BAND—Sanitary Type—Triple Adjustment—Something New.

No Orders Accepted That Cannot Be Filled in 15 Days.

DISTRIBUTORS AND AGENTS WANTED

ADDRESS

THE TELEPHONE BOOK HOLDER CORPORATION

Manufacturers of

Radio Telegraph and Telephone Equipment

Dansville, New York

DX Radio Frequency Amplifying Transformers

| Wavelength Range | Price |
|------------------|--------|
| 170—450 .. | \$8.00 |
| 400—1200 .. | 8.00 |
| 900—3000 .. | 8.00 |

Standard Plug Mounting \$1.00

Higher Range Transformers listed in Bulletin

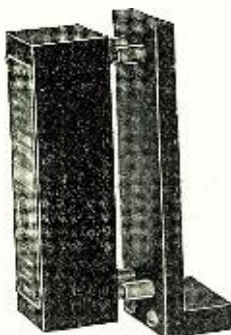

Will
Bring in that
Long Distance
RADIO
CONCERT

Summer Static
is practically eliminated by using
D x RF Transformers with

Coil Aerial

RF Amplifier
Circuit Diagrams, 25c.

Send for
Bulletin No. 12

Curves and Data
on Coil Aerials, 50c.

**RADIO
INSTRUMENT COMPANY**
WASHINGTON, D.C.

varying the inductance of the variometer in the plate circuit of the first tube. The remainder of the circuit is an ordinary detector and two steps of audio frequency amplification.

TUNING WITH VARIOMETERS

(389) Mr. E. A. Crabtree, Utica, New York, wants to know:

Q. 1. Can sharper tuning be obtained in receiving set with plate and grid variometer than with only a variocoupler? If so, why do some of the expensive sets use only the variocoupler?

A. 1. Sharper tuning and proper control of regeneration is obtained by means of variometers. Some of the sets on the market today use the single circuit because it is simpler to operate.

LIGHTING FILAMENT WITH 110 VOLTS D.C.

(390) Mr. Emil Herlin, Brooklyn, New York, wants to know:

Q. 1. Could a resistance inserted in the 110 volts D.C. supply reducing it to 10 volts, be used as power tube filament supply. If so, please give constructional details.

A. 1. This is practicable, although it is rather an expensive method. On page 112 of the August, 1921, issue of RADIO NEWS, you will find details of a circuit of this nature.

Q. 2. Would a Chelsea .001 variable condenser be all right for condenser C. 1. of the hook-up on page 689, June, 1920, RADIO NEWS.

A. 2. No. A larger capacity condenser of about .0015 M.F. should be used.

RESISTANCE AND INDUCTIVELY COUPLED REGENERATIVE CIRCUIT

(391) Mr. Lawrence Lyons, Jr., of Brook, Indiana, wants to know:

Q. 1. Which is the better, resistance-coupled or inductive coupled radio frequency amplification?

A. 1. With a given number of tubes, inductive coupling provides a higher ratio of amplification than resistance coupling. Resistance coupling is more flexible and can be used on wave lengths over 800 meters but not below. A radio frequency transformer is only effective over a limited band of wave lengths; above and below this particular range, different transformers must be used. Inductive coupling is, therefore, preferable on short wave lengths and resistance coupling on long wave lengths.

CAMP AERIAL FOR RECEPTION

(392) Mr. Nevin R. Yost, of York, Pa., wants to know:

Q. 1. What is the best type of aerial to use at camp? There are many trees and also a large stream of water nearby. It is intended for receiving only.

A. 1. You may use a single wire antenna, 125 feet long and erect it as high as possible. A buried wire in the wet earth beside the stream of water should make a good ground.

Q. 2. What is the receiving range of an Aeriola Senior

A. 2. It is impossible to answer questions of this nature. There are too many conditions to be taken into consideration for us to give the approximate range of any particular set.

AERIAL FOR RECEPTION OF RADIOPHONE

(393) Mr. H. B. Sterling, of Richmond Hill, Ontario, wants to know:

Q. 1. Please give the best possible construction of an aerial for reception of radio broadcasts at a distance of about 400 miles, using honeycomb coils and one stage of amplification.

A. 1. A very efficient antenna would be one composed of two wires 100 feet long, spaced 6 feet, at a height of 80 feet.

Q. 2. Can water-works system be used as the ground?

A. 2. Yes. This makes a satisfactory ground for reception purposes.

LOOSE-COUPLER WITH VARIOMETER

(394) Mr. Leonard C. Meyer, Ontario, wants to know:

Q. 1. Could an ordinary loose coupler (maximum wave length 1,500 meters), be used with an ordinary set of variometers? If so, would its effect be greater or less than the variocouplers that are sold to use with variometers?

A. 1. An ordinary loose coupler may be used in this manner. Better results will probably be obtained with a type of variocoupler especially designed for short waves and for loose coupling.

Q. 2. For short waves, should the primary condenser be shunted or in series with the honeycomb primary?

A. 2. This depends upon the natural wave length of your antenna and the size of honeycomb coil used. It is customary to have the condenser in series with the primary inductance.

HARD TUBES FOR AMPLIFYING

(395) Mr. O. A. Rasmussen, Texas, wants to know:

Q. 1. Please publish a hook-up showing all connections of a one stage radio frequency amplifier and detector connected to a regenerative receiver, using two variometers and loose coupler.

A. 1. The hook-up you request will be found in this department of the April-May issue of RADIO NEWS.

Q. 2. Can a soft tube be used as a detector
(Continued on page 1157)

RADI FREQUENCY AMP, F. CAT. N

IS THE NEXT GREAT STEP FORWARD IN RADIO RECEPTION THE BARAWIK RADIO FREQUENCY TRANSFORMER

Provides the Instrument that opens up this wonderful field
DESIGNED FOR AMATEUR AND BROADCASTING RECEIVING APPARATUS
The Product of Careful Engineering
Greatly Increases Receiving Ranges

Permits of tuning sharp enough to suit the most discriminating amateur.

Complicated tuning is done away with. So simple to handle that the beginner in radio gets excellent results.

With each transformer is supplied a short treatise on radio amplification and a number of wiring diagrams showing various radio frequency hook-ups. It is easy to get good results on radio frequency amplification when using Barawik transformers.

Using this transformer with only one step of radio frequency amplification and a detector, both phone and C.W. stations from the Atlantic Coast were distinctly received while making tests at Chicago. Signals that a detector alone cannot pick up are brought in strong. An additional step of radio frequency amplification greatly increases the audibility of the signals. Adding two steps of audio frequency amplification will produce the maximum in radio reception.

A loop aerial with a radio frequency amplifier set will bring in radiophone messages over surprisingly long ranges—hundred mile records are common. Also, in localities where a number of stations are operating, one station can be tuned in and interference from the others practically eliminated by use of the "directional" feature of the loop.

Responds to wave lengths of 150 to 550 meters which covers all amateur and broadcasting stations.

DETAILS

An inductive type transformer, coils in pancake style wound on moulded bakelite, proven to be the most practical and efficient style of construction for R.F.A.

Non-magnetic core is able to respond to high radio frequencies.

Enclosed in polished nickel finish brass case, which provides perfect shielding.

Suitable for panel, base or tube mounting. Binding post connections for easy wiring connections.

Windings impregnated and sealed in and therefore not subject to atmospheric conditions.

Pure amplification without tube noises or distortion. Static disturbances are eliminated to a great extent.

Can be used with Radiotron, Cunningham, Moorhead, A.P. or Meyer tubes.

SPECIAL FEATURE

Transformer is arranged so that it can be mounted in any standard vacuum tube socket same as a vacuum tube. This has two advantages: First, easy wiring; second, transformer can be mounted or dismounted instantly. At present we are only offering a range of 150 to 550 meters which is what is required for amateur and present broadcasting wave lengths. We will very soon have on the market other ranges so that any wave length can be tuned in by simply switching transformers.

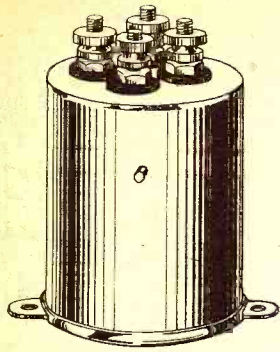

B995 Price \$4.50

IMMEDIATE SHIPMENTS

**Dealers and Jobbers
Write for our proposition**

Long distance records never before accomplished by other methods of reception are regular performances with radio frequency amplification.

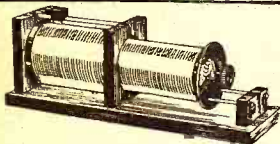

\$7.50

\$7.50

ARLINGTON RECEIVING TRANSFORMER

Will tune in all stations up to 4,000 meters. Very efficient on short waves and for radiophone reception. Used with our Detector Two Step Amplifier it produces very excellent results. Also does good work with crystal detector. Silk covered windings on formica tubes. Very fine mahogany finish woodwork. Base size 6x18 inches. Slider controls primary, 12 point switch on secondary. Can be tuned very close. A wonderful value at our price.
B720, price.....\$7.50

DIAL AND KNOB

A fine looking knob and dial moulded in one piece. Neat clean cut design. Polished black finish. Clear plain engraved scale with enameled letters and markings in contrasting white enamel. Ribbed knob that fits the hand. The two sizes used on the same panel can be arranged to produce a very attractive effect.

B905—Three inch diameter for 3/16 inch shaft. Each, 75c. Dozen \$7.20.

B906—Three inch diameter for 1/4 inch shaft. Each, 75c. Dozen \$7.20.

B907—Four inch diameter for 3/16 inch shaft. Each \$1.00. Dozen \$9.60.

B907—Four inch diameter for 1/4 inch shaft. Each \$1.00. Dozen \$9.60.



VARIABLE CONDENSERS

One of the best made condensers. One of the few that will stand up on C.W. work. Rigid, accurately spaced plates. Formica ends. Engraved scale. Clear glass case. Perfectly set aluminum plates.
B806 43 plate .001 Mfd.....\$4.75
B808 21 plate .0005 Mfd.....\$3.85



PANEL MOUNTING TYPE

With Knob and Scale
Same high grade as above for panel mounting.
B812 43 plate .001 Mfd.....\$4.45
B813 21 plate .0005 Mfd.....\$3.55
B814 11 plate .00025 Mfd.....\$3.15

BINDING POSTS

Brass polished nickel finish. Extra fine quality. Fitted with washer and 6/32 screw extending 5/8".
B370—Large size barrel and knob 3/4" long. Dozen 95c. Hundred \$6.50
B372—Smaller size barrel and knob 9/16" long. Dozen 84c. Hundred \$5.50
B374—Large size with composition knob. Dozen 95c. Hundred \$6.50
B376—Large size with hole for phone tip or wire. Dozen 95c. Hundred \$6.50
B378—Small size with hole for phone tip or wire. Dozen 84c. Hundred \$5.50



SWITCH CONTACT POINTS

Brass, polished nickel finish. All have 5/8" long size 6/32 screws.
B360—With head 1/4 x 1/4" and two nuts. Per dozen, 35c. Hundred, \$2.50
B362—With head 1/4 high 3/16 diameter and two nuts. Per dozen, 35c. Hundred, \$2.50
B364—With head 1/4 x 1/4 and soldering lug. Per dozen, 35c. Hundred, \$2.50
B366—With head 1/4 x 3/16 diameter and soldering lug. Per dozen, 35c. Hundred, \$2.50

BARAWIK RADIO SETS

These instruments all have the same general appearance and size. They match perfectly when placed beside each other. They are of extra fine quality—instruments anyone will be proud to own. We guarantee them to produce satisfactory results.

RADIO FREQUENCY TUNER

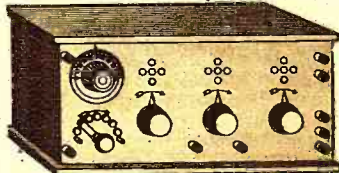

Including two stages radio frequency and detector, wired complete, price \$50.

Consists of a high grade tuner mounted with two stages of Radio Frequency Amplification and a Detector. Tunes stations from 150 to 550 meters. Uses our Barawik radio frequency transformers. Will bring in clearly radiophone and code messages regular detector sets cannot pick up, besides being very efficient for regular receiving. Fine mahogany cabinet. Satin finish condensate panel. No tubes included.

DETECTOR TWO-STEP AUDIO FREQUENCY AMPLIFIER

Wired complete price \$34.00
Knocked down, not assembled, price \$25.00

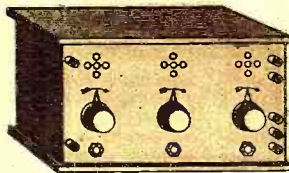

A very sensitive high grade instrument. Signals that cannot be heard with detector alone will be brought in strong. Has one detector and two amplifying circuits. Standard tube sockets, grid condenser in detector circuit, two amplifying transformers, 3 jacks and a plug. Satin finished Formica Panel. Fine Mahogany finish large size cabinet. Hinged top. Interior easily accessible. Binding posts for all necessary connections.

Two-Step Audio Frequency Amplifier

B223—Wired completely assembled. Price.....\$30.00
Knocked down, not assembled, Price.....20.00
Same general construction as our detector two-step amplifier but without the detector.

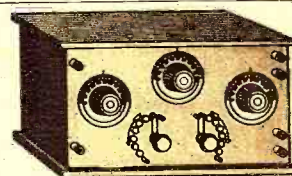

REGENERATIVE TUNER

B224
Wired complete Price \$35.00
knocked down, not assembled, price \$30.00

This is a standard make Armstrong licensed set. Range from 180 to 600 meters. Will tune sharply and bring in signals strong even under difficult conditions. Fine Mahogany finished large size cabinet. Satin finished Formica Panel. Two high grade variometers, with varicoupler for closest tuning. Engraved dials, knobs, switches, binding posts for all necessary connections, etc. A high-grade outfit worth much more than we ask.

BARAWIK "B" BATTERIES

PLATE CIRCUIT "B" BATTERIES

Look what you can save on these batteries. Don't pay more. We guarantee them to equal any on the market regardless of price. Absolutely uniform. Extra long life.



B180—Large Signal Corp type size 5x3x2 1/4, 15 cells, 22 1/2 volts. Each \$1.10 Dozen \$11.25.

B182—Navy size, 6 1/2 x 4 x 3, 15 cells, 22 1/2 volts. Each \$1.75. Dozen, \$19.00.

B184—Variable Navy size, 5 taps giving range from 16 1/2 to 22 1/2 volts in 1 1/2 volt steps. Each \$2.25. Dozen \$24.00.

B186—Double Navy size 6 1/2 x 4 x 6, 30 cells, 45 volts. Suitable for amplifier circuits and power tube use. Two or more of these units in series may be used in C.W. and radiophone circuits. Each \$3.40. Dozen, \$36.00.

B188—Combination tapped 45 volt, 30 cell, 6 1/2 x 4 x 6 battery. Tapped to give 2 1/2, 21, 19 1/2, 18 or 16 1/2 volts. Handles both detector and amplifier tubes. Each \$3.50. Dozen, \$40.00.

SOLID GENUINE CONDENSITE CELORON PANELS

Notice our very low prices on this fine quality grade 10 genuine solid sheet Condensite Celoron (a product with mechanical chemical and electrical properties like formica and bakelite). Machines well without chipping. Won't warp. Waterproof. Highest mechanical and dielectric strength. Attractive natural polished black finish which can be sanded and oiled for extra fine work.

| Panel Size Inches | 1/4" thick | | 3/16" thick | | 1/2" thick | |
|-------------------|------------|--------|-------------|--------|------------|--------|
| | Art. No. | Price | Art. No. | Price | Art. No. | Price |
| 6x7 | B450 | \$0.50 | B460 | \$0.75 | B470 | \$0.98 |
| 6x10 1/2 | B451 | .75 | B461 | 1.13 | B471 | 1.47 |
| 6x14 | B452 | .89 | B462 | 1.20 | B472 | 1.60 |
| 7x18 | B453 | 1.28 | B463 | 1.80 | B473 | 2.40 |
| 9x14 | B454 | 1.28 | B464 | 1.80 | B474 | 2.40 |
| 12x14 | B455 | 1.70 | B465 | 2.30 | B475 | 3.20 |
| 14x24 | B456 | 3.40 | B466 | 4.60 | B476 | 6.40 |

RADIO CABINETS

Fine Looking cabinets, solidly built. Made of seasoned wood in waxed antique mahogany finish. Hinged tops. Front rabbeted to take panels. Panels not included.



| Panel Size | Inside Dimensions | | | Art. No. | Price Each |
|------------|-------------------|---------|------|----------|------------|
| | High | Wide | Deep | | |
| 6x7 | 5 1/2" | 6 1/2" | 7" | B420 | \$2.45 |
| 6x10 1/2 | 5 1/2" | 10" | 7" | B422 | 2.65 |
| 6x14 | 5 1/2" | 13 1/2" | 7" | B424 | 3.15 |
| 7x18 | 8 1/2" | 17 1/2" | 10" | B426 | 3.35 |
| 9x14 | 8 1/2" | 13 1/2" | 10" | B428 | 4.2a |
| 12x14 | 11 1/2" | 13 1/2" | 10" | B430 | 4.30 |

WE PAY TRANSPORTATION CHARGES

EAST OF THE ROCKIES

THE PRICES QUOTED DELIVER THE GOODS TO YOUR DOOR

FAST SERVICE—TRY US AND BE CONVINCED

THIS GUARANTEE PROTECTS YOU—Examine the goods we ship you. They must suit you in every respect. If you are not satisfied with your purchase return the goods at once and we will refund the price you paid.

THE BARAWIK CO. 102 South Canal Street, CHICAGO, ILL.

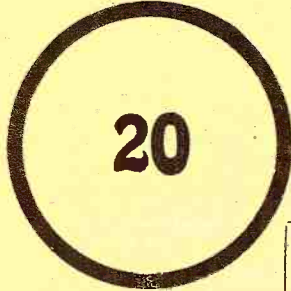

TWENTY RADIOPHONE DIAGRAMS

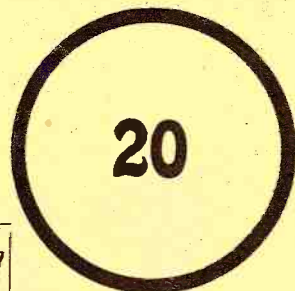

The most complete selection of diagrams and hook-ups for **RADIO AMATEURS** enabling anybody to rig-up a wireless

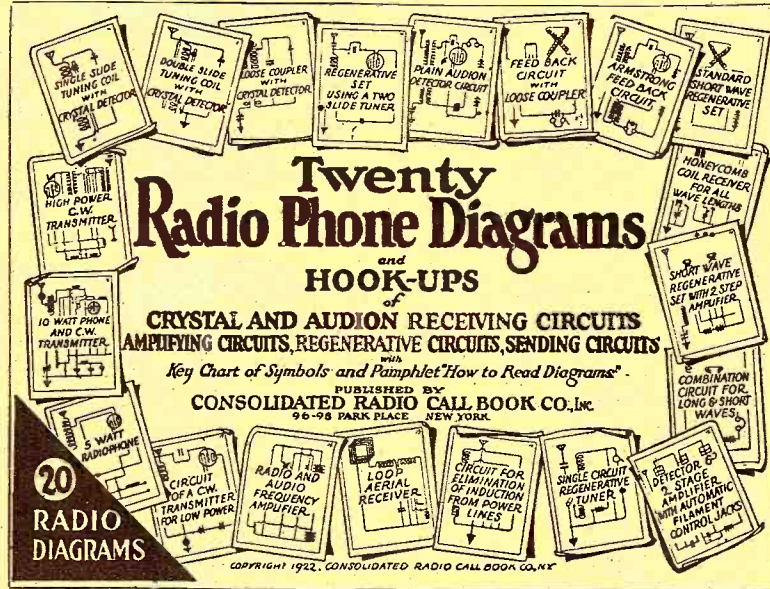

telephone outfit from the simplest crystal detector circuit, to the most ultra-modern regenerative and amplifying radio set.

TITLES of DIAGRAMS

1. Single Slide Tuning Coil with Crystal Detector.
2. Double Slide Tuning Coil with Crystal Detector.
3. Loose Coupler with Crystal Detector.
4. Regenerative set, using 2 slide tuner.
5. Plain Audion Detector Circuit.
6. Feed-back Circuit with a Loose Coupler.
7. Armstrong Feed-back Circuit.
8. Standard Short Wave Regenerative Set.
9. Honey-comb coil Receiver for all wave lengths.
10. Short wave regenerative set, with 2 step Amplifier.
11. Combination Circuit for Long and Short Waves.
12. Detector and Two stage Amplifier with automatic Filament control Jacks.
13. Single Circuit Regenerative Tuner.
14. Circuit for elimination of induction from power lines.
15. Loop Aerial Receiver.
16. Radio and Audion frequency amplifier.
17. Circuit of a C.W. Transmitter for low power.
18. 5 Watt Radio-Phone.
19. 10 Watt Phone and C.W. Transmitter.
20. High Power C.W. Transmitter.

SET OF 20 RADIOPHONE DIAGRAMS

consisting of twenty blueprint diagrams, size 8½ x 11½ inches and one four page direction—pamphlet 8½ x 11½ inches containing: Illustrated Symbol Key Chart, Direction How to Read Diagrams, How to Follow Circuit, etc. and explanation of each diagram. All contained in heavy, two color printed envelope size 9 x 12 inches.

PRICE 50c Prepaid

Either Direct from us or for sale by the following responsible Dealers:

| | | | |
|--|---|--|---|
| Alamo Sales Corp. Indianapolis, Ind. | Fergus Elec. Co. Zanesville, O. | New England Motor Sales Co., Green- wich, Conn. | Schmidt & Co., R. Rochester, N. Y. |
| Am. Electro Tech. App. Co., N. Y. City | Findley Electric Co. Minneapolis, Minn. | New Era Shop Milwaukee, Wis. | Sears, Roebuck & Co. Chicago, Ill. |
| American Hdw. Stores, Bridgeport, Conn. | Flecken & Son, M. M. Trenton, N. J. | Newman-Stern Co. Boston, Mass. | Service Radio School, Washington, D. C. |
| Andrae & Sons, Julius, Milwaukee, Wis. | Fuller Co., Seth W. Galveston, Tex. | Nichols Radio Sup. Co., Galveston, Tex. | Shotton Radio Mfg. Co. Scranton, Pa. |
| Anthracite Radio Shop Scranton, Pa. | Gurd & Co., Wm. London, Canada | Nola Radio Co. New Orleans, La. | Smith Radio Lab. Sarnia, Ont., Canada |
| Atlantic Radio Co. Boston, Mass. | Hall Electric Co., Wm. Dayton, O. | Noll & Co., E. P. Philadelphia, Pa. | Smith Novotoy Elec. Inc., Charlotte, N. C. |
| Bamberger & Co., L. Newark, N. J. | Hatfield Electric Co. Indianapolis, Ind. | Northern Radio & El. Co., Seattle, Wash. | So. California Elec. Co., Los Angeles, Cal. |
| Banister & Pollard Co., Newark, N. J. | Heustis, A. E. Fitchburg, Mass. | Northwest Radio Serv. Co., Seattle, Wash. | Southern Elec'l. Sup. Co. San Diego, Cal. |
| Benwood Specialty Co. St. Louis, Mo. | Hickson Electric Co. Rochester, N. Y. | N. S. W. Bookstall Co. Sydney, Australia | Southwest Radio Sup. Co. Dallas, Tex. |
| Bluebird Electric Shop Newark, N. J. | Hiro Wireless Sup. Co. Marion, Ill. | Paentz Electric Co. New York City | Sprutt-Shaw Schl. Vancouver, B. C. |
| Brode Electric Co. Los Angeles, Cal. | Holt Electric Util. Co., Jacksonville, Fla. | Paramount Radio Sup. Co., Atlantic City | Sterling Electric Co., Minneapolis, Minn. |
| Brown, J. Edw. Glenbrook, Conn. | Hughes Elec'l. Corp. Syracuse, N. Y. | Paul's Electric Stores Medford, Ore. | Stubs Electric Co. Portland, Ore. |
| Bullock's New York, Neb. | Jenkins, Lester I. New Bedford, Mass. | Pearlman's Book Shop Washington, D. C. | T. & H. Radio Co. Anthony, Kans. |
| Bunnell & Co., J. H. New York City | Karlawa Radio Corp. Rock Island, Ill. | Penn Radio Apparatus Co., Reading, Pa. | Tuska Co., C. S. Hartford, Conn. |
| Burham & Co., Deptford, S. E. S. England | Katzenbach & Co., F. S. Trenton, N. J. | Penn. Marconi Wireless Schl. Phila., Pa. | United Elec. Stores Co. Braddock, Pa. |
| California Elec. Co., San Francisco, Cal. | Kendall Co., W. D. Worcester, Mass. | Phila Schl of Wireless Tele. Phila., Pa. | United Electric Stores E. Pittsburg, Pa. |
| Carter Electric Co. Atlanta, Ga. | Keubler Radio Co. Toledo, O. | Piedmont Electric Co. Asheville, N. C. | U. S. Radio Co. Pittsburg, Pa. |
| Catton, Neill & Co. Honolulu, T. H. | Killoch Co., David New York City | Pioneer Electric Co. St. Paul, Minn. | Warner Bros. Oakland, Cal. |
| Central Radio Co. Independence, Mo. | King Radio Co. Pittsburgh, Pa. | Pitts Co., F. D. Boston, Mass. | Western Radio Co. Kansas City, Mo. |
| Central Radio Co., Kansas City, Mo. | Klaus Radio Co. Eureka, Ill. | Pitts. Radio Sup. Co. Pittsburgh, Pa. | West'n Radio Elec. Co., Los Angeles, Cal. |
| Chase, Geo. H. Newport, R. I. | Kluge, Arno A. Los Angeles, Cal. | Radio & App. Co. Pittsburg, Pa. | Wheeler Green Electric Co., Rochester, N. Y. |
| Chicago Radio Ap. Co. Chicago, Ill. | Krauss & Co., A. F. Detroit, Mich. | Port Arthur Rad. Lab., Port Arthur, Tex. | Whitall Electric Co. Westerly, R. I. |
| Cleveland Co., L. W. Portland, Me. | Kusel Co., D. & F. Watertown, Wis. | Post Office News Co. Chicago, Ill. | White Co., The Columbus, Ga. |
| Cloud & Son Macy, Ind. | Lehigh Radio Co. Bethlehem, Pa. | Precision Equipment Co. Cincinnati, O. | White & Boyer Co. Washington, D. C. |
| Con. Radio & Elec. Corp. N. Y. City | Liberty Incandescent Sup. Co., Pittsburgh, Pa. | Radio Development Co., Springfield, Mass. | White & Bro., Frank Canton, Ill. |
| Cutting & Washington New York City | Liberty Radio Sup. Co. Chicago, Ill. | Radio Distributing Co. Newark, N. J. | Williamson Elec. Co. Seattle, Wash. |
| Daily Battery & Equipment Co., Pitts- burg, Pa. | Linze Elec'l Sup. Co. St. Louis, Mo. | Radio Electric Co. Pittsburgh, Pa. | Wilson Co., Harold K., Grundy Center, Iowa. |
| Delaney-Felch & Co. Pawtucket, R. I. | Ludwig Hommel & Co. Pittsburg, Pa. | Radio Equipment Co. Boston, Mass. | Winner Radio Co. Aurora, Colo. |
| Detroit Electric Co. Detroit, Mich. | Luther, H. E. Centerville, Ia. | Radio Equip't. & Mfg. Co., Minneapolis | Wireless Mfg. Co. Canton, O. |
| Dewey Spitz, Goods Co. Milwaukee, Wis. | McCarthy Bros. & Ford, Buffalo, N. Y. | Radioelectric Shop Cleveland, O. | Wireless Press New York City |
| Doubleday-Hill Elec. Co. Pittsburgh, Pa. | McMillan Bros. Pittsburg, Pa. | Ray-Di-Co. Chicago, Ill. | Wolfe Electric Co. Omaha, Neb. |
| Dreyfuss Sales Co. New York City | Manhattan Elec. Sup. Co., N. Y. & Chic. | Reynolds Radio Denver, Colo. | Y. M. C. A. Los Angeles, Cal. |
| Duck & Co., Wm. B. Toledo, O. | Marshall-Gerken Co. Toledo, O. | Reuter Electric Co. Cincinnati, O. | Zamotski Co., Jas. M., Baltimore, Md. |
| Dunn, J. J. Pasadena, Cal. | Mater Elec'l Const. Co., Oshkosh, Wis. | R. I. Elec. Equip't. Co. Providence, R.I. | Zibart Bros. Nashville, Tenn. |
| Electric Motor & Eng. Co. Canton, O. | Meyberg Co., Leo J., San Francisco, Cal. | Riverside Laboratory Milwaukee, Wis. | |
| Electric Importing Co. N. Y. City | Mohawk Elec'l. Sup. Co., Syracuse, N. Y. | Rose Radio Supply New Orleans, La. | |
| Elite Electric Shop El Paso, Tex. | National Radio Corp. Atlanta, Ga. | Roy News Co., Pre'k J. Toronto, Can. | |
| Eric Book Store Erie, Pa. | Nat'l Radio Institute, Washington, D. C. | Sands Electric Co. Wheeling, W. Va. | |
| | | Sayre-Level Radio Co. Phila., Pa. | |

Consolidated Radio Call Book Co., Inc., 98 Park Place, New York City

RADIO APPARATUS

*Distributors of Reliable Radio Apparatus to Schools,
Colleges, Radio Clubs and Experimenters
All Over the World!*

“PITTSCO”

Specializing on “RADIO
CORPORATION’S Products



“PITTSCO”

Now has three Stores.
Send us your orders.

The present tremendous demand for Radio Apparatus has practically made it impossible for us to render our usual SERVICE. Reasonably prompt delivery however can be made on the items listed.

AMPLIFYING TRANSFORMERS

| | |
|--|--------|
| No. P-1 General Radio, semi-mounted..... | \$5.00 |
| No. 50 Chelsea, semi-mounted..... | 4.50 |
| No. A-2 Acme, semi-mounted..... | 5.00 |

ANTENNA WIRE

| | |
|---|------|
| “Pittsco” No. 14 Hard drawn copper, (80 ft. per lb.) per lb. | .40 |
| 500 ft. (Special value) | 2.25 |
| “Pittsco” 7 strand No. 22 tinned copper, per ft. | .01 |
| 500 ft. | 4.00 |
| 1000 ft. | 7.50 |
| “Pittsco” 7 strand No. 20 Phosphor bronze per ft. | .02 |
| 500 ft. | 7.50 |

ANTENNA INSULATORS

| | |
|---|-----|
| No. P-1 Electrose Ball insulator | .35 |
| No. P-2 Electrose 4 inch strain insulator..... | .45 |
| No. P-3 Electrose 10 inch strain insulator..... | .75 |

“A” BATTERIES (Storage Batteries)

| | |
|----------------------------------|-------|
| Yale 6 volt 60 Ampere-hour..... | 18.00 |
| Yale 6 volt 80 Ampere-hour..... | 21.00 |
| Yale 6 volt 100 Ampere-hour..... | 25.00 |

Note.—These batteries are shipped carefully crated and fully charged ready for use.

“A” BATTERY RECTIFIERS

| | |
|---|-------|
| No. P-1 Tungar, 5 ampere type, complete with bulb | 28.00 |
| No. P-2 Tungar, 2 ampere type, complete with bulb | 18.00 |
| No. P-3 F F Battery Booster, 5 ampere type..... | 15.00 |

“B” BATTERIES

| | |
|---|------|
| No. 763 Eveready, 22.5 volt, small size..... | 1.75 |
| No. 766 Eveready, 22.5 volt, large size, 16½ to 22½ volts | 3.00 |
| No. 774 Eveready, 43 volt, large size, variable..... | 5.00 |

CRYSTAL RECEIVING SETS

| | |
|--|-------|
| Aeriola, Jr., Westinghouse, complete with tele- phones | 25.00 |
| Every-man’s DeForest, complete with telephones | 25.00 |

CONDENSERS (Variable)

| | |
|--|------|
| No. 1 Chelsea, fully mounted, .001 Mf..... | 5.00 |
| No. 2 Chelsea, fully mounted, .0005 Mf..... | 4.50 |
| No. 3 Chelsea, unmounted with dial .001 Mf..... | 4.75 |
| No. 4 Chelsea, unmounted with dial .0005 Mf..... | 4.25 |
| No. 367 Murdock, fully mounted, .001 Mf..... | 4.50 |
| No. 368 Murdock, fully mounted, .0005 Mf..... | 4.00 |
| No. 3660 Murdock, unmounted without knob and dial, .001 Mf. | 4.00 |
| No. 3680 Murdock, unmounted without knob and dial, .0005 Mf..... | 3.25 |

JACKS (Radio Type)

| | |
|------------------------------|------|
| No. P-1 Open circuit | .70 |
| No. P-2 Closed circuit | .85 |
| No. P-3 Two circuit | 1.00 |

LOUD SPEAKERS

| | |
|--|-------|
| Arkay, horn only, satin finish..... | 5.00 |
| Federal Pleiophone, complete with phone..... | 14.00 |

PLUGS

| | |
|----------------------------------|------|
| No. 34-B Firco, round type | 2.50 |
| No. P-1 Western Electric | 1.10 |

SOCKETS

| | |
|--|------|
| No. 156 General Radio, improved model..... | 1.50 |
| No. P-1 Chelsea | 1.00 |
| No. P-2 Clapp-Eastham, bakelite type..... | 1.00 |
| No. UR-542 Radio Corporation..... | 1.00 |

TELEPHONES

| | |
|---|------|
| No. 56 Murdock 2000 ohms..... | 5.00 |
| No. 56 Murdock 3000 ohms..... | 6.00 |
| No. 2A Stromberg Carlson 2000 ohms..... | 7.50 |
| No. P-1 Holtzer-Cabot 2200 ohms..... | 8.00 |

Let “PITTSCO” fill your orders for any of the above items.
Our SERVICE on these at the present time will please you.

F. D. PITTS CO., Inc.

12 PARK SQUARE

BOSTON MASS., U. S. A.

WOOLWORTH BUILDING,
PROVIDENCE, R. I.

3 STORES

276 WORTHINGTON STREET
SPRINGFIELD, MASS.

THE "RICO" TRI-POLE DOUBLE HEAD 'PHONES

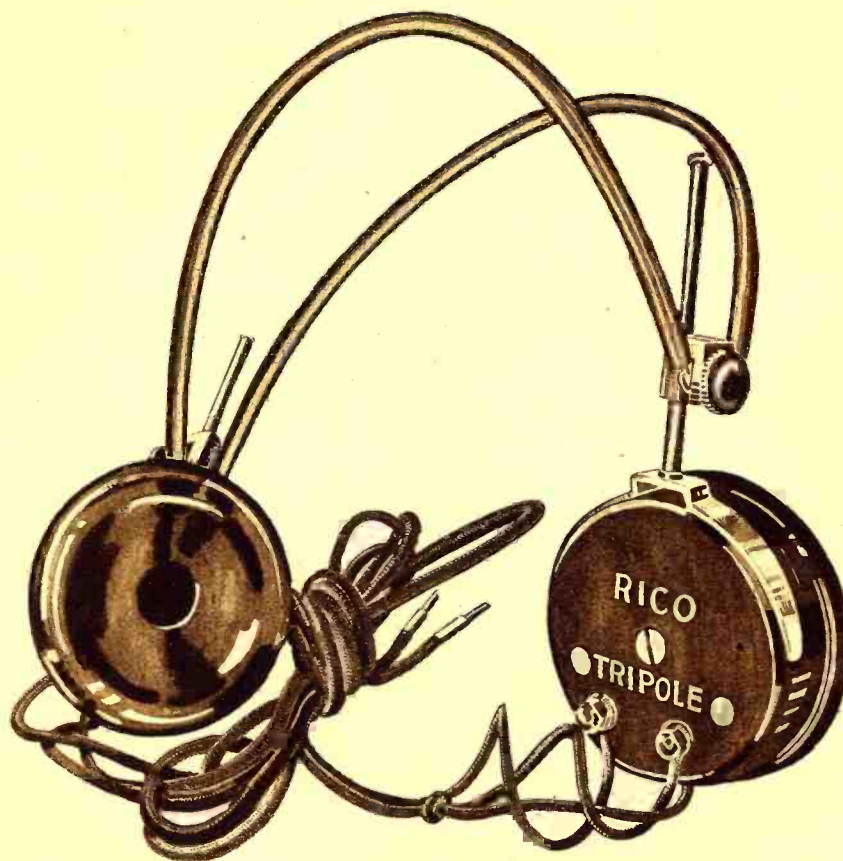

PATENTS PENDING

mark a new advance in telephone receivers. These receivers are built on a radically different plan than all other receivers. *The pull on the diaphragm is where it should be—in the mathematical center of the diaphragm.*

RICO receivers "talk for themselves." A trial will convince you. Super-sensitive, especially designed for broadcast work—sounds are brought in sharp and clear. Not a receiver of extraordinary sensitiveness, but an all round receiver whether used for broadcast radiotelephone work, or for long distance radio telegraphy.

OUTSTANDING MECHANICAL FEATURES

Lightness. Stability. Aluminum shells. Non-rusting diaphragms. Guaranteed tungsten magnets. Neat black mercerized cord. Head band adjustable not only to every size head but *the two bands are adjustable as well*; the only head band made in this manner. Sanitary soft rubber covering that can be washed, will not catch the hair,—especially appreciated by ladies.

RESISTANCES: 2,000 and 3,000 ohms. Can be made up to 6,000 ohms if desired.

PRICES

"Rico" TRI-POLE Head Sets, 2,000 ohms, \$6.50

"Rico" TRI-POLE Head Sets, 3,000 ohms, 7.50

DELIVERY beginning May twentieth. We have an especially attractive proposition to jobbers and dealers.

Wire or write to

RADIO
INDUSTRIES
CORPORATION

131 Duane Street

New York City

with an R. F. amplifier using a hard tube and give good results or would a soft tube as amplifier be better?

A. 2. The first tube for amplifying radio frequency should be a hard amplifying tube, preferably one with small elements widely spaced. The detector tube may be either a soft or a hard tube.

SINGLE CIRCUIT REGENERATIVE SET

(396) Mr. Joseph M. Morrison, Plainfield, N. J., wants to know:

Q. 1. Referring to the hook-up of the regenerative set on page 832 of the March issue of RADIO NEWS, what size wire should be used for the primary?

A. 1. No. 22 D. C. C. wire may be used.

Q. 2. What size form should the primary coil be wound on?

A. 2. A tube 3 1/2 inches in diameter, about 6 inches long may be used.

Q. 3. Would the set be improved by putting variometers in the plate and grid circuits?

A. 3. No. The variometers are not necessary in this circuit.

RADIO FREQUENCY AMPLIFICATION WITH REGENERATION

(397) Mr. Arthur P. McArthur, of Oakland, Cal., wants to know:

Q. 1. You have, for some time, given circuits of radio frequency amplification in RADIO NEWS, but I have noticed that in no case has there been any visible method of making the set oscillate or regenerate for C. W. work. Please explain the manner of producing regeneration.

A. 1. There will be no difficulty experienced in obtaining oscillation with radio frequency amplifying circuits. The chief difficulty will be in the opposite direction. Regeneration or oscillation may be obtained by tuning the plate circuit of any of the amplifying tubes, or by feed-back action between the circuits.

VARIOCOUPLER WITH CRYSTAL

(398) Mr. G. W. Matthews, Taunton, Massachusetts, wants to know:

Q. 1. Could a variocoupler be used in a hook-up with a crystal detector, a variable condenser and phone condenser? If so, please give hook-up.

A. 1. A variocoupler may be used in this manner. The primary of the variocoupler is connected in series with the antenna and ground. The crystal and the phones are connected in series with the secondary of the variocoupler, and the variable condenser shunted across this circuit.

Real Radio Experimenters

(Continued from page 1091)

forts radio has become the thing it is today or the thing it may become tomorrow. A glance at the workshops of any of these amateurs would reveal a haphazard conglomeration of radio instruments of all kinds with a maze of wires running in all directions over the table. They have never been satisfied. In their love for their hobby they have tried one thing after another and experimented with every known circuit to find improvements. The results of their experiments were recorded and, by such mutual assistance to one another, their combined efforts have been successful in improving the art of radio. The names of some of these men are written in the Radio Hall of Fame.

The illustration shows some of these experimenters at work. Two young men are seen erecting transmitting and receiving apparatus in the open with a tree for antenna. Experiments have already been conducted along this line. These young men will endeavor to prove that it can be done, or, by trying new stunts, will improve upon the experiments.

Another young man has just hit upon the happy idea of utilizing an old tin cylindrical horn and an electric light reflector to make a loud speaker. A simple thing, but history has demonstrated that some of the most revolutionary discoveries of science have been based upon just such simple ideas and impressions.

A little bird on a telegraph wire
Said to his friend, "I declare!
When wireless telegraphy comes into vogue
We'll all have to sit on the air."
E. M. F.

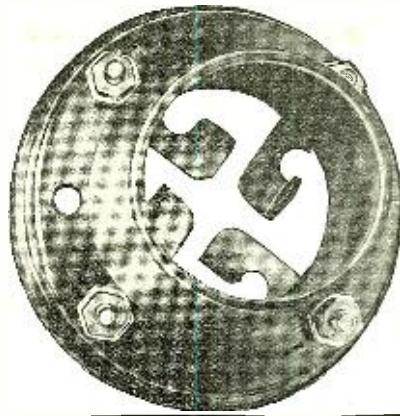

**NEW! SOMERVILLE
(RED BAKELITE)
TUBE SOCKET 75c**

1. Moulded in one piece, from real natural color bakelite, having very low leakage losses.
2. Absence of metal shell, eliminates ground hum.
3. The phosphor-bronze contact springs are laminated, and their shape permits a wiping contact on the sides of tube pins, as well as the usual contact with the extremities.
4. Contacts are arranged with maximum spacing to take care of high voltages used with power tubes.
5. Terminals are larger than usual, to permit the use of heavy conducting wires.

Don't Forget These Exclusive Features

SOMERVILLE 22 1/2v. "B" BATTERY, now ready, \$1.75

Has 5 positive knurled terminals, 16 1/2v., 18v., 19 1/2v., 21v. and 22 1/2 volts. Made to our specifications by one of the world's foremost battery manufacturers. Twice the capacity of the small signal corps size. Should last six to nine months.

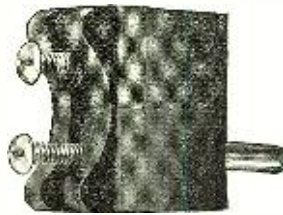

**SOMERVILLE
HONEYCOMB
COIL PLUG, 55c**
for
Panel Mounting

With Side Coil-Strap Plates, for mounting H-C Coils, 60c each.



**SOMERVILLE
MICA CONDENSER**
Mounted between bakelite
Power factor, 1 1/2, 500 volt
.00025 mfd. } **\$1.00**
.0005 mfd. }
.001 mfd. }
.002 mfd. } Postpaid

**SOMERVILLE CONDENSERS
THE LINE NOW COMPLETE**

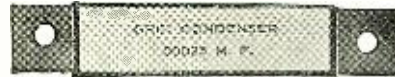

Grid Condenser, .00025 Mfd. \$.25
—Above, with 1/2 Meg. Grid Leak.40
Grid Condenser, .0005 Mfd.25
—Above, with 1 Meg. Grid Leak.40
Phone Condenser, .001 Mfd.25
Phone Condenser, .002 Mfd.40
Phone Condenser, .005 Mfd.70

Quadrupled production of our famous CW Condenser enables us to make a new price schedule.



1000V. C.W. Condenser, .0005 Mfd. \$.60
1000V. C.W. Condenser, .001 Mfd.60
1000V. C.W. Condenser, .002 Mfd.60
750V. C.W. Condenser, .005 Mfd.80
500V. C.W. Condenser, .01 Mfd. 1.00

Above ratings are for D.C. only. When used with A.C., a safety factor of 75% should be observed. Each condenser is tested at double above ratings, and any found defective should be returned for replacement.

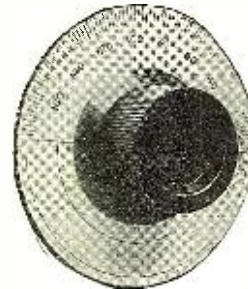

**SOMERVILLE
DIAL
INDICATORS**

For 1/8, 1/4 and 3/8 in shafts
4 in. dia. .. \$1.75
3 1/4 in. dia. .. 1.60
Knob only80
Postpaid from us by return mail, or from your local dealer.

This is the first metal dial with flanged knob and has the following exclusive advantages over imitations.

The knob is of real bakelite and will retain shape and finish.

The dial is of brass heavily plated with real silver and coated with a special non-peeling lacquer, which preserves the silver finish long after nickel dipped and "German" silver dials are mottled and tarnished.

The heavy brass bushings and special method of assembly, assures a dial which runs true on the shaft.

The surface finish permits writing call letters on the lower calibration space.

The dial is insulated from shaft bushing, and when grounded acts as a shield from capacity effect from body.

INSIST ON THE ORIGINAL AND BEST

EVERYMAN'S SECTION

The AERIOLA-SENIOR is admirably adapted for the hotel room or apartment as well as for an extended camping trip. It does away with the bulky storage battery, which must be charged constantly, as the vacuum tube requires but 1/25th the energy of the regular tube, and operates from a single dry cell, and small "B" battery.

Complete With Tube, Two Batteries, and \$8 pair Head Phones, **\$67.25** Postpaid, East of Mississippi, West of Mississippi, \$1.00 Extra.

Temporary antenna may be made from a pound roll of annunciator wire, price 70c. **STANDARD WESTINGHOUSE ANTENNA OUTFIT, \$7.50.**

SPECIALS!

Amrad "S" Tube (Rectifier) \$7.50
Porcelain Socket for above15

HOLTZER-CABOT PHONES, \$8.00
2200 Ohms

With Patent Universal Plug, \$1.00 Extra
CHIRAD K-D SHORT WAVE SET, \$10.00
2 Variometers, 1 Variocoupler

CONDENSITE CELORON PANELS
3/8 in.; cut to size, per sq. in., 3c.

IF YOUR DEALER DOES NOT YET CARRY SOMERVILLE PRODUCTS, send us your entire order and find out why our mail order service is so popular; We pay the postage!

Our "Add-a-Page" Catalog sent for 25c. or free with your initial order.

SOMERVILLE RADIO LABORATORY
RETAIL - SALES - DIVISION
176-178 WASHINGTON ST., BOSTON, MASS.

Do You Get the Same Sound In Both Ears?



"Superior", 2,000 ohms, weight 14 ozs. complete with head band and polarity indicating cord. \$8.00.

WHEN unmatched receivers are used the signals will sound differently in each ear. You naturally and unconsciously favor the receiver giving the loudest response. The value of the other receiver is entirely lost—it is worse than useless. To give maximum efficiency, receivers must be matched perfectly in tone. That is the reason you should insist on Brandes *Matched Tone** receivers. Have you ever stopped to figure out how much signal strength you lose in an ordinary pair of phones? Send 5c for Catalog G. Standard Since 1908.

C. BRANDES, Inc.

Room 723, 237 Lafayette Street, New York City
 CHICAGO OFFICE AUSTRALIAN AGENTS
 33 South Clinton St., Chicago, Ill. International Electric Co., 55 Courtney Pl., Wellington, N. Z.
 Member Radio Section Associated Manufacturers of Electrical Supplies.
 *Reg. U. S. Pat. Office.

BRANDES Matched-Tone HEADSETS

Radiophone in New York Hotels

(Continued from page 1091)

engaging ugliness to charm the listeners of the famous runway with its mysterious music.

Mr. Martin, in an interview, demonstrated his apparatus in the telephone exchange room of the McAlpin which was located after burrowing through many strange and hitherto unknown passages on the top floor of the building. An antenna on the roof connects to a honeycomb coil receiver with detector and two step amplifier. The output was connected through the Monitor and the main switchboard to any room or booth in the hotel, or, we suspect, panhandled to the outside.

Mr. Martin stated that he expects soon to have a transmitting set in operation, in order that two-way conversation with ships at sea may be maintained. The other hotels will undoubtedly follow the example of the McAlpin in this regard; for, incidentally, is it not the quickest, surest and most novel way of providing passengers on incoming steamships with a method of securing accommodations at the hotel. Hotels have long had an arrangement with the radio companies to allow passengers to send radiograms free of charge to the hotel, but imagine the stampede at the radio room of the Olympic when it is announced to incoming passengers that they can speak direct to their hotel in New York.

Broadcasting Over Electric Light Circuit

(Continued from page 1094)

on the wall.

With receiving sets of similar type the entertainment could have been heard in any room of the great building, but not outside, as the circuit was a private lighting circuit for the building. In a small town, or a large city with a single lighting system anyone with a receiver could plug in, get the news of the town, the entertainment, etc., sent out by a central station.

All the work necessary to install the apparatus, was to bring in the receiving apparatus, connect to ground, hang up the horn, and screw an ordinary plug into the light fixture, practically the same as an electrical flat iron or toaster is connected. "Every home, every room in a hotel where there is an electric lamp can now keep in touch with the world," General Squier said. "The main feature about it is the fact that it permits local broadcasting without paying the penalty of broadcasting in space from the usual antenna, which has resulted already in so much confusion," he continued. There is no interference, no fading, and weather does not affect the broadcasting by the new method.

The process is based upon General Squier's invention of "line radio" or "wired wireless," perfected some time ago which permits the use of a line as a guide, but the messages go on wireless waves which follow the line. The turning of the switch, however, cuts the circuit and the sound ceases.

A few days ago General Squier asked some of his assistants to try an experiment along the lines just developed, with the result cited above. He was assisted by

"ILLINOIS" THE RELIABLE MADE RIGHT - STAYS RIGHT



STYLE No. 1



STYLE No. 2

Three Styles: No. 1, Panel; No. 2, Open Type as shown; No. 3, Fully Encased. Anti Profiteer. Less than pre-war prices. Fully assembled and tested.

| | Style No. 1 | No. 2 | No. 3 |
|------------|-------------|--------|--------|
| 67 Plates, | \$7.00 | \$8.00 | \$8.50 |
| 43 " | 3.50 | 4.50 | 4.75 |
| 23 " | 2.75 | 3.75 | 4.00 |
| 13 " | 2.25 | 3.25 | 3.50 |

Money back if not satisfied. Just return condenser within 10 days by insured Parcel Post.

Options: — With Style No. 1—instead of Scale and Pointer, a 3-inch Metal Dial at 50 cents extra, or a 3-inch Bakelite Dial at \$1.00 extra. Large Knobs. Both excellent values. Or we will, if desired, supply the Condenser with smooth 3-16 inch center staff, without Scale, Knob and Pointer, at 15 cents off the list to those who prefer to supply their own dial.

Vernier with single movable plate applied to 13, 23 or 43 plate condenser, \$3.00 extra.

We allow no discounts except 5 percent on orders of 6 or more.

Sent Prepaid on Receipt of Price

Except: Pacific States, Alaska, Hawaii, Philippines and Canal Zone, add 10c. Canada add 25c.

Foreign Orders other than Canada not solicited.

G.F. JOHNSON, 625 Black Ave., Springfield, Illinois.



VERNIER

50 Church Street, New York, N. Y.
9 South Clinton Street, Chicago, Ill.
414 Finance Building, Cleveland, Ohio
1042 Granite Bldg., Rochester, N. Y.
422 First Avenue, Pittsburgh, Pa.

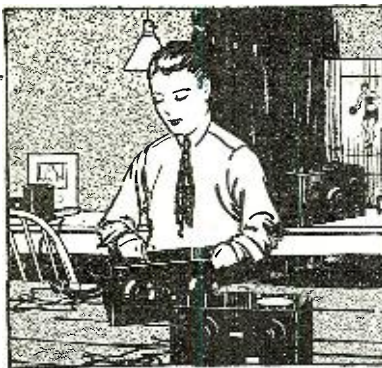

Sheldon Building, San Francisco, Cal.
932 Real Estate Trust Bldg., Philadelphia, Pa.
321 Title Building, Baltimore, Md.
415 Ohio Building, Toledo, Ohio.

Don't Waste Time Looking for Insulation Leaks—Use FORMICA

FORMICA insulation for Radio sets gives you the assurance of continued, trouble-free service. It is approved by the navy and the signal corps. It means clearer, surer, reception of messages from the air.

Formica is the dominant insulation for radio purposes—used in an overwhelming majority of sets made by manufacturers and by amateurs who build their own. Radio dealers all over the United States sell and recommend it. They know its high efficiency and great durability.

A drill is the only tool necessary to work up a Formica panel. It will not chip or crack. It does not absorb moisture, therefore will never warp. It retains its good looks and insulating power indefinitely in spite of weather conditions.

Formica is good all the way thru—an even high quality. There are no weak places in it to cause trouble.

Formica is for sale by most radio dealers. Ask for it.

The Formica Insulation Company

4618 Spring Grove Avenue
Cincinnati, Ohio

FORMICA
Made from Anhydrous Redmanol Resins
SHEETS TUBES RODS

By merit alone—



CHIROPRACTIC

has grown from an idea in the mind of *one* man in 1905 to the second largest health profession in the world.

DEFINITION
The practice of Chiropractic consists of the adjustment, with the hands, of the movable segments of the spinal column to normal position for the purpose of releasing the prisoned impulse.

There are now approximately 15,000 practitioners, more than a hundred schools and about 10,000 students.

Twenty-one state governments have recognized the science as distinct and different from anything else on earth.

This growth in less than seventeen years has been, not only without the aid of other professions engaged in getting the sick well, but in spite of their utmost efforts to prevent.

Chiropractic has never had a single dollar of endowment from state or national governments. It has overcome the prejudice of the public, the opposition of other professions intent on its extermination, and adverse laws in every state in the Union.

It has recruited its patients from among those upon whom other methods failed, and with these failures of other methods upon which to prove its efficiency it has grown like a green bay tree.

Ask Your
Chiropractor
for
"The Last Word"

Write for information regarding Chiropractors or Schools to the

UNIVERSAL CHIROPRACTORS ASSOCIATION, DAVENPORT, IOWA

R. D. Duncan and S. Isler of the Signal Corps Radio Laboratory at the Bureau of Standards.

Future uses for the new invention which the General has made public, suggest that a hotel can supply all its guests with music, from a sending station in the basement; a phonograph salesman can demonstrate his new records to everyone in town by putting them on the light circuit; one orchestra can furnish music for the local playhouses and movies; invalids at home or in hospitals can get the news and such entertainment as is furnished locally; even advertising could be sent out to every citizen in town by agents and stores.

The Brooklyn Radio Show

(Continued from page 1093)

tion in the circuit that is customarily occupied by the rheostat. The resistance element, of iron or alloy, is designed to pass a certain current. If the current increases, the temperature of the iron, and consequently its resistance, also increase, reducing the current to normal. In the opposite manner, if the current decreases, the temperature and resistance of the iron decrease, permitting more current to pass.

The four tubes of this receiver are resistance-coupled, providing high amplification at radio-frequency. Before the last tube a choke-coil is connected in parallel with the last coupling resistance to provide amplification of audio frequency. In appearance the receiver resembles the smaller type of phonograph. The loud speaker is inside the cabinet with the opening to the front. The tubes are mounted upright on the top panel with the tuning dial in front of them. By pressing a little switch on the side, the filaments of the four tubes are lighted and kept at a constant current by the balance tubes. Connections for the filament battery and the antenna and ground are at the back of the cabinet. There are two binding posts for the antenna for long and short waves. A loop may be used in place of the antenna and ground.

A receiver was exhibited by another manufacturer which had the same general appearance as the one we have just described. Filament control, however, was made by rheostats in the usual manner and the controls were located at the side of the cabinet. On the top of the panel a jack was provided for plugging in a loud speaker. This receiver was merely a short wave regenerative tuner with detector and two-step amplifier complete in cabinet form.

Another new and very handsome combination radio receiver and phonograph in a cabinet of Period design was shown. The circular opening of the horn of this cabinet was painted in a brilliant lemon color. In the left compartment was a single circuit regenerative tuner and two-step amplifier. The necessary "A" and "B" batteries were inside the cabinet. The same horn was used for the phonograph and radio receiver.

All the leading manufacturers had booths at the show and exhibited their latest types of apparatus which have already been described.

My C.W. Experiments

(Continued from page 1104)

able condenser wasn't exceptionally efficient. The rotary plates didn't make very good contact with the stationary plates all around the scale, causing considerable loss of energy. I took it into a blacksmith's



LEARN TELEGRAPHY

(Wireless or Morse)

AT HOME

In Half the Usual Time

Let the OMNIGRAPH Teach You Wireless

"Just Listen—The Omnigraph will do the teaching"

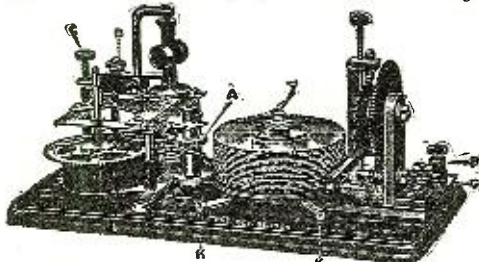

The Omnigraph is an *Automatic Transmitter* that teaches you both the Wireless and Morse Codes, at home, without any expense except the cost of the machine itself. Merely connect to battery and your Buzzer, or Buzzer and Head Phones, or to your Sounder and the Omnigraph will send unlimited messages by the hour, at any speed you desire.

USED BY THE U. S. GOVERNMENT

Write for Free Catalogue

For a few dollars you can have a complete outfit that will make you an experienced operator in the shortest possible time. No hard, laborious work—just learn by listening. The Omnigraph is adjustable so you can start receiving messages slowly, gradually increasing the speed as you become proficient.

You'll be surprised how quickly you will attain speed. Even if you are already an operator the Omnigraph will help you. It will make you more proficient, more accurate and more confident. Thousands of Omnigraphs are in use today and thousands of operators owe their success to them.

The Omnigraph Mfg. Co., 20 Hudson St., New York City

We also manufacture the OMNIGRAPH RADIO RECEIVING SET. A complete Vacuum Tube Set including Tube, a pair of 2,000 ohm Phones, A and B batteries, Aerial Wire, Safety Switch, Insulators and Ground Clamp. All enclosed in a carrying case, handsome enough to install in your parlor or sitting room. Price \$48.00. Nothing to approach it at anything near the price. No previous knowledge of wireless required. Set comes to you completely wired. Nothing additional to purchase. Just erect your Aerial, place the Phones to your ears and listen-in. Absolutely guaranteed.

Announcing **WESTRAD** "WESTRAD"

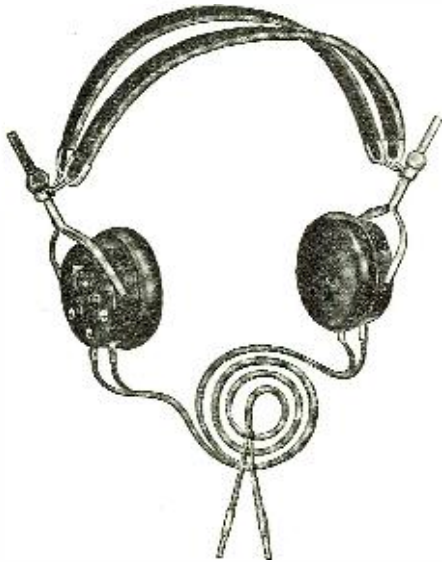

Frost Fones

No. 162—2000 ohm..\$5.00
 No. 163—3000 ohm.. 6.00
 Undoubtedly the best phone on the market for the amateur's use. Approved by our Engineers.

Manufacturers and Jobbers of Quality Radio Apparatus Exclusively.

Our specialty is supplying the Radio needs of Amateurs.

TO AMATEURS

If your dealer does not have equipment shown on this page write us. You will find that every item represents the best of its kind.

TO JOBBERS AND DEALERS

The Amateur will ask for the equipment approved by Radio Engineers. We carry, manufacture and show in our ads nothing but Radio Apparatus which has been thoroughly tested and approved.

WATCH FOR NEW ITEMS!



PHONE PLUG No. 137

Takes the cord tips. Sliding sleeve permits tightening the set screws to hold the cords permanently.
 Price\$1.25

FROST JACKS

Supplied with washers to fit any panel. Spring terminals spread to permit easy soldering. Pure silver contacts, nickel-silver springs. Interchangeable with other makes. Packed in individual containers. Prices listed under each style.

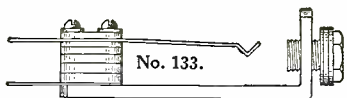

No. 133. Jack only.....\$0.65

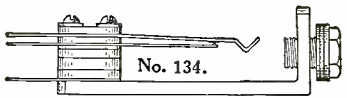

No. 134. Jack only.....\$0.75



No. 131. Jack only.....\$0.90



"WESTRAD" DIALS

Bakelite

3 inch.....\$1.00
 3/16" or 1/4" shaft.



Electro-se Insulators

Midget No. 1061.....\$0.30
 Ball Type..... .45
 Strain Type No. 10..... .45

Aerial Wire

7 Strand No. 22 100 ft.
 Copper\$0.98
 Phosphor Bronze..... 2.45

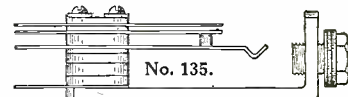

No. 135, Jack only.....\$1.00

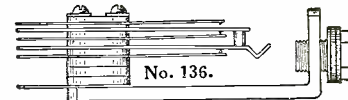

No. 136. Jack only.....\$1.25



\$5⁷⁵

"B" Storage Battery

This is a liquid storage battery made of only new materials; grids of the plates are moulded individually and are designed for radio work only (not old automobile battery plates cut up). The plates are pasted, given a forming charge; discharged and recharged in accordance with the best practice. They come to you charged. Rubber and wood separators used. Voltage variable on positive end; 18-20-22-24 volts. Price each.....\$5.75

Frost Radio Plug No. 132



Specially designed for panel work. Standardized construction makes plugs interchangeable with other standard makes. Packed in individual containers.
 Price, each.....\$1.00

Radio Hand Microphone No. 155

This hand microphone is designed especially for radio work. It is not suitable for wire telephone work.

Price, each **\$6⁰⁰**



WESTERN RADIO MFG. CO., INC.

154B Whiting St.

H. E. WILLMORE
 Vice-President and Gen. Mgr.

CHICAGO, ILL.

**"How Do I Come Through?
I Can't Depend on My Ammeter!"**

You don't hear such statements from users of the

**Weston
Thermo-Ammeter**

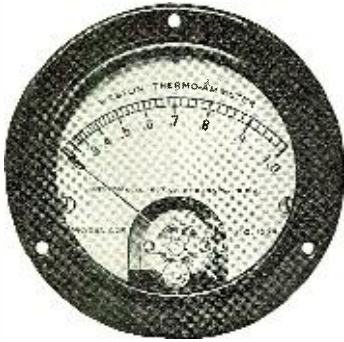

This Instrument has made the measurement of high frequency currents as simple and reliable as any ordinary electrical measurement.

It is free from all the objections and uncertainties of the "hot wire" types.

It is highly accurate; thoroughly compensated against temperature or working errors; it is instantly responsive; it has no zero error or lag, and is designed and built to give permanent satisfaction.

It is a truly scientific Instrument and is the most economical type that can be used in the antennae.

This Instrument is in service in many thousands of Transmitting Sets, including most governmental, commercial and marine outfits, and is now being bought in large quantities by amateurs and experimenters to replace unsatisfactory types.

Complete information concerning this particular Instrument and the complete group of Weston Radio Instruments is contained in "Circular J." Write for it. If your dealer cannot supply your needs from stock, we shall be glad to do so.

WESTON ELECTRICAL INSTRUMENT CO., 173 Weston Ave., Newark, N. J.



Insist on Getting

U. S. EAGLE GALENA, 25 Cents

U.S. EAGLE GOLDENA, 35 Cents

MOUNTED U.S. EAGLE GALENA or GOLDENA, 2-in-1, 50 Cents

Patent Applied

Marvelous Crystals of sensitivity; Improve your Radio Reception by the use of these Crystals. No better on the American Market. Each Crystal is packed in a container and labeled U. S. Eagle Galena or U. S. Eagle Goldena.

Attractive proposition for dealers and jobbers. Immediate shipment. Will use your own labels on request. Also in bulk.

EVERYTHING IN RADIO SUPPLIES SEND FOR CATALOGUE

U.S. RADIO CO. of PENNA., Inc.

Distributors and Manufacturers of Radio Apparatus

Corner Ferry and Diamond Streets
Pittsburgh, Pa., U. S. A.

shop and got it fixed. I am now using it in the grid circuit as a fixed condenser. As in most other sets, I have the grid leak connected across this grid condenser. And, by the way, I have found that a very simple method of making the grid leak is to stick a pin into it.

The test of my outfit is like most other radiophone stations. However, unlike most other radiophone stations I do not transmit a wireless concert every night, or for that matter, any night. I understand that there are five other amateur radiophone stations in North America that do not gum up the air with nightly concerts, but at least two of them are using the Colpitt's circuit, and consequently have been unable to make their sets oscillate.

It is most peculiar, but as soon as an ether hog gets a radiophone set he feels it his bounden duty, for the benefit of mankind in general and his own locality in particular, to put on a three-hour musical program every night. The mere fact that his phonograph is a \$15 atrocity, his modulation 90 per cent gargle, and his only record a badly worn and much scratched version of "Turkey in the Straw," is nothing in his young life. Fortunately, this type of pest is becoming extinct, and the sooner they all get discouraged and turn their attention to the collection of postage stamps, the better for the rest of us who enjoy listening to some of the really good concerts that are being broadcasted every night.

But I fear I am digressing. My own set, with the insulating counterpoise, has an antenna current of about eight-tenths of a megohm on a wave-length of 200 kilograms. My station is situated in Toronto, and its call is 1/2DF. Any letters from Buffalo or Honduras regarding my signals will be greatly appreciated.

Official Uses for Radio

(Continued from page 1090)

police boats. Communication is also maintained with other police stations. The Police Department also keeps a constant watch in order that they may be in a position to render any assistance possible in response to calls for help or medical aid. The numbers and descriptions of stolen automobiles are made public from this station almost immediately after their theft, and in this way, the apprehension of the thieves is often accomplished.

The Very Latest in Radio Sensation

(Continued from page 1090)

this was child's play to him, and he is now launching forth in experiments which will undoubtedly revolutionize radio.

He was recently found by a wandering camera-man in the strange attitude depicted in the illustration. In response to a request for information he carefully explained that radio signals travel around the world eight times a second and that there is no reason why the waves started off on their mad career a few weeks ago by his voice, should not still be dashing around the world. He was endeavoring to pick them up. He was not quite sure what he would do with them if he did

Federal RADIO APPARATUS

WILL SIMPLIFY YOUR OPERATION



Federal Anti-Capacity Switches

should be used in circuits where ordinary switches would have too high a capacity, with resulting loss in signal strength.

Phosphor bronze springs, silver-plated; roller type cams; Bakelite insulation; silver contacts.

Price (In U. S. A.) \$2.80



Federal Universal Plugs

For plugging in head telephone sets, power supply, microphone transmitters, transmitting keys, or as many other things that the ingenious radio operator may think of.

A decided improvement over the ordinary telephone switchboard plug.

Price (In U. S. A.) \$1.75

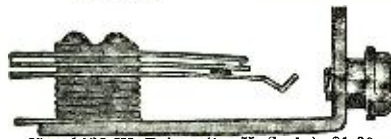

No. 1435-W Price (in U. S. A.) \$1.00

Federal Filament Control Jacks

Eliminate innumerable switches and complicated controls on your Detector and Amplifying units.

Simplify operation; save current; make your set up-to-date and efficient.

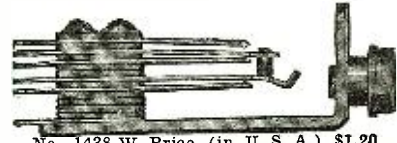

No. 1438-W Price (in U. S. A.) \$1.20

Federal Telephone and Telegraph Company
BUFFALO, N. Y.

To Receive Broadcasting Radiophones

THE RADIOHOME RECEIVER

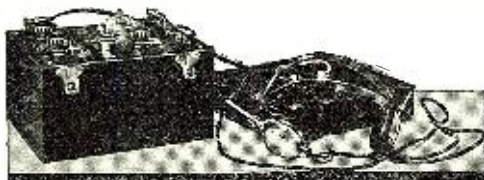

The Radiohome Receiver

field. Yet we have been manufacturing these sets for some time—for the general public. The Radiohome Receiver has a simple, two-slide tuning circuit with a range of 145-800 meters, a vacuum tube detector, and grid leak and rheostat. The price—less tube, batteries, receivers and antenna—is \$36. In a cabinet that is identical in size and finish with the cabinet of the Radiohome, is the DT-800, two-step amplifier. Three phone jacks are embodied in this instrument for detector, 1st step and 2nd step. Less tubes and batteries the price is \$35. We believe you will find no other set on the market to compare with this combination for the reception of radiophone programs by the newcomer in the field.

Catalog H, listing ALL DeForest Equipment has been out five weeks. It is yours for 12c in stamps.

DeForest Radio Telephone & Telegraph Co.
NEW YORK CITY

THE DT-800 AMPLIFIER

Every amateur is frequently being asked for advice as to what set should be purchased for the reception of radio telephone programs of music, news and stories. Many an amateur hesitates to recommend the standard amateur equipment as, to the average citizen, such terms as coupling, condenser, tube and "B" battery, mean nothing, and his friends would be confused and bewildered by the array of controls on the average set.

We illustrate two pieces of radio receiving apparatus which will, doubtless, appear unfamiliar to the amateur which will, doubtless, appear unfamiliar to the amateur which will, doubtless, appear unfamiliar to the amateur



The DT-800 Two-Step Amplifier

RADIO SERVICE PRODUCTS

The Amplitron

A Real Loud Speaker—Designed and constructed especially for radio work. Reproduces radio phone speech and music without distortion—equally good for code. For use with a Baldwin Type C or Stromberg-Carlson Phone. Price (as illustrated). \$10.00

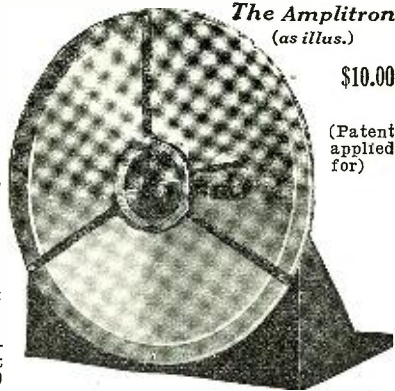

The Amplitron (as illus.) \$10.00

(Patent applied for)

The Little Wonder Portable Radio Set



Built right and compact—perfected by four years' development and manufacture. Simple to operate. Receiving Set Only, Type S8, \$7.50

Other Radio Service Products

- Single VT Sockets Type S2.....\$1.50
- Single VT Sockets Type S10..... 1.00
- Double VT Sockets Type S3..... 2.25
- Triple VT Sockets Type S4..... 3.25
- Grid Condensers .0005 mf. Type S15..... .35
- Phone Condensers .002 mf. Type S16..... .35
- Grid Leak Condensers Type S30..... .50
- Variable Grid Leak Type S40, 1/2 to 3 megohms75

We carry numerous other types of interest to Radio dealers and wireless men. Radio Service Products are for sale by all reliable dealers.



Type S3



Type S10

RADIO SERVICE & MFG. CO.

Factory: Lynbrook, Long Island Sales Office: 110 West 40th St. New York City

pick them up, but there was some vague suggestion about using them for running his automobile or something. Mr. Wynn assured the camera-man, however, that the real reason for sitting on the radiator was to keep warm.

The girls at Radcliffe College have developed a new thrill. The life of the college girl, in spite of all its little intricacies and complications, was threatening to become dull. How can a "flapper" properly and efficiently "flap" if things are so terribly apparent? Conversation over the telephone with a "stander" who probably had his coat-lapel adjusted to show the official badge of membership, used to provide a slight sensation, but the wire telephone is so obvious, don't you know! The radiophone has solved all this. The girls in the illustration have just connected by radio with somebody who has the "loveliest voice" and they are trying to decide what he looks like. He says he is an amateur, and that doesn't sound quite so interesting, although now and then it is rather amusing. One of the girls won't be satisfied until she hears an aviator talking. She had a flurry for aviators during the war and she wants to hear what they sound like over the radiophone. The girls have provided themselves with quite a wicked-looking apparatus, too, and they insist they know all about it.

How to Use the Vacuum Tube Detector

(Continued from page 1106)

discoveries concerning important improvements in the usages to which the tube might be put and one of the most important receiving circuits in use today is the discovery of Armstrong. However, there is another investigator who has done much for vacuum tube development who has never been given the consideration his work deserves, for up to the time of his discoveries vacuum tubes were admitted to be the most wonderful invention in radio, but they were anything but stable in their operation, requiring great skill and continuous diligence in order to make them perform. Langmuir found that a very high state of evacuation was necessary to maintain stability of operation and it is because his findings have been put into practice in the great factories where vacuum tubes for transmission and reception are made that present-day communication may be so effectively carried on. We must truly thank this investigator for the ease with which it now is possible to build and operate a broadcasting receiving station.

However, we are not so much concerned for the time being with the history or the theory of operation of the vacuum tube; what we require most is some simple description of the suitable method for using this marvelous little tube of which we have heard so much. We must take it for granted that those novices who are following this course of instruction, if you please, are keeping pace with the new developments and are managing to garner the necessary empty salt boxes, etc., to keep pace with the making of the apparatus we have been considering.

A FEW SIMPLE CIRCUITS EMPLOYING VACUUM TUBES

Let us, for the present, forget all about the single slide tuning coil we made according to the description given in this magazine two months ago and confine our efforts to arranging a vacuum tube receiving circuit employing the loose coupler we made according to the directions given last

ENAMEL }
SILK } Insulation
COTTON }

EASTERN &
WESTERN
STOCKS

All Sizes Immediate Delivery

MAGNET WIRE

Specializing in Sizes 38 to 44

Quality Guaranteed

Flexible Formed Cords for Headsets

R. W. LILLIE CORPORATION

50 Church St.
NEW YORK CITY

176 Federal St.
BOSTON, MASS.

BEACON

Can Supply You with all Radio Parts and Sets.

BEACON RADIO & ELECTRIC CO.
246 Greenwich St., near Park Place, New York City

VARIABLE CONDENSERS

IMMEDIATE DELIVERY

| For Panel Mounting | Unassembled | Assembled |
|--------------------|-------------|-----------|
| 43 Pl. | \$2.75 | \$3.50 |
| 23 Pl. | 2.25 | 2.75 |
| 11 Pl. | 1.90 | 2.25 |

PLATES: Rotary 2 1/2c Stationary 3c.
Dealers Write for Proposition.

BRANFORD RADIO & MFG. CO.
Branford, Conn.

Compare it with ANY
It SPEAKS for ITSELF

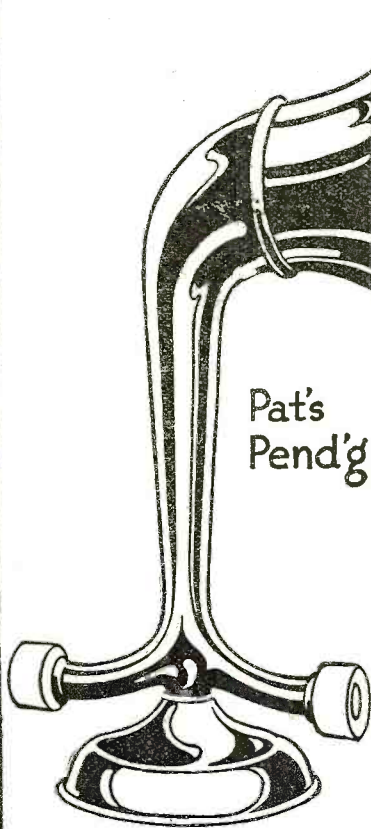

PRICE \$12.00
F. O. B.—NEW YORK CITY

THE BIGGEST VALUE LOUD TALKER

Listen to the Concerts, News, and Dance with a KING "AM-PLI-TONE". Just slip your head phones on the "AM-PLI-TONE" and you and your friends will be SURPRISED. Polished Cast Aluminum Body with Nickel Plated Base and Horn. No Sheet Metal is used, the "Tinny" Sound is Left Out. The VOLUME is DOUBLED because TWO head phones are blended into one POWERFUL tone. A BIG HIT—A BIG SELLER and IMMEDIATE DELIVERIES.

DEALERS and DISTRIBUTORS—what more can you ask?

WRITE TODAY FOR TERRITORY.

Notice.—All infringers of this device will be vigorously prosecuted.

KING "AM-PLI-TONE"
82 Church St., New York City

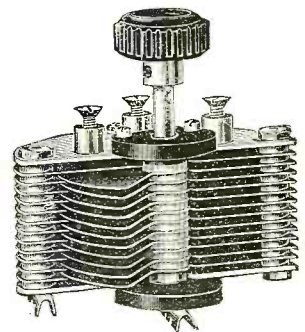
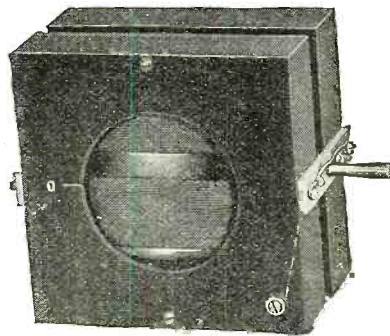
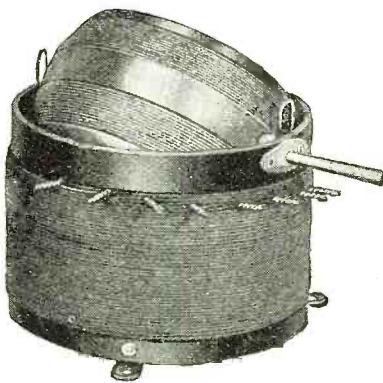

NEW YORK COIL COMPANY'S Variometers, Variocouplers, Variable Condensers and Amplifying Transformers possess a degree of workmanship and efficiency which have justly given them leadership.

JOBBERS—We make actual deliveries—not promises. Our trading is done on a commercial and business-like basis. It will pay you to investigate.

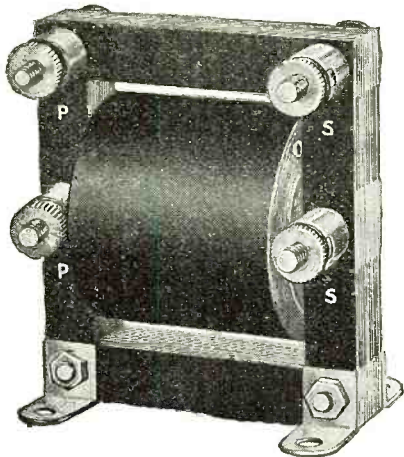

NEW YORK COIL COMPANY
338 PEARL STREET N. Y. CITY, N. Y.

BRACH VACUUM GAP LIGHTNING PROTECTION

America's Foremost Radio Protectors
Approved, Listed and Recommended
by the National Board of
Fire Underwriters
Electrical No. 3962

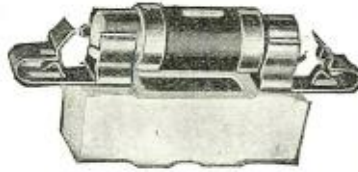

The development of Vacuum Arresters has resulted in the discarding of air-gap types by many railway signal, police and fire alarm systems, and other important circuits in favor of the Vacuum type.

Radio Engineers Insist on the *Brach Vacuum Arresters* to guard against voice current losses, to protect from lightning inductive damage and to help clear aerials of static.

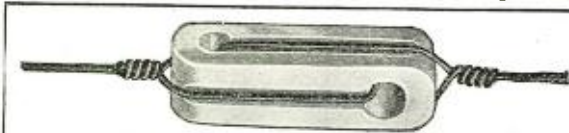

**Brach Porcelain
Strain Insulator**
8c each

Shipped 1,000 to Barrel. Send for Quantity Price List.

L. S. BRACH MFG. CO. Newark, N. J.
Specialists in Lightning Protective Devices for 16 Years

"The Magic Power House"

**Double the Power
At Half the Cost**



WIZARD BATTERIES
are guaranteed Radio batteries made in types suitable for every "B" battery need. Designed to give the maximum service at a minimum cost.

Get them from your dealer
Write for Catalog

WIZARD BATTERY CO.
173 LAFAYETTE ST. NEW YORK CITY

APRIL BARGAIN PRICES

The following prices are all made subject to prior sale. No C. O. D. orders accepted unless $\frac{1}{3}$ the amount accompanies orders. Add postage.

| | Reg. Price | Sale Price | | Reg. Price | Sale Price |
|--|------------|------------|--|------------|------------|
| Sp. Copper Tube Oscillation transformer—1 K.W. | \$12.00 | \$5.95 | 10 pt. wide tooth rotors | 4.50 | 2.25 |
| 1/4 K.W. Thordarson transformers | 14.00 | 10.00 | Radiogram pads (standard) | .30 | .20 |
| 1/2 K.W. Thordarson transformers | 22.00 | 15.95 | Formica panels (brown) 7 1/2 square 3/8 inch thick | 1.70 | .90 |
| 3/4 K.W. fully mounted Acme trans. | 16.00 | 12.00 | Boston Jr. transmitting keys | 3.50 | 2.15 |
| 1/2 K.W. fully mounted Acme trans. | 22.00 | 17.50 | Amrad crystal receiving set | 22.00 | 15.00 |
| 1/2 K.W. semi mounted Acme trans. | 18.00 | 14.00 | Amrad "B" battery control box | 9.50 | 5.00 |
| 500 Volt 175 watt motor generator | 137.00 | 80.00 | K5e amplifier cabinet | 32.00 | 20.00 |
| 500 Volt 200 watt generator only | 59.00 | 45.00 | Shottan point switches | .60 | .55 |
| DeForest MT100 regenerative tuners | 42.50 | 25.00 | DeForest G100 grid leaks | .75 | .35 |
| Midget audion cabinets | 10.50 | 4.50 | Western Electric phone cords | 1.00 | .75 |
| K20a Rotary enclosed gaps with motor | 25.00 | 12.50 | Large knob and pointers for variometers | 1.00 | .45 |
| K20b Rotary enclosed gaps with pulley | 20.00 | 10.00 | Victory Storage "B" Batteries | | |
| Murdock No. 483 condenser sections | 3.25 | 2.00 | 50 volt size | 15.00 | 8.50 |
| 1 K.W. quenched gaps | 30.00 | 17.50 | 25 volt size | 8.00 | 4.50 |

KARLOWA RADIO CO.

606 Best Building

Rock Island, Illinois

Get a Handy Binder for your RADIO NEWS. Holds and preserves twelve issues, each of which can be inserted or removed at will. Price 65c. Experimenter Pub. Co., Inc., Book Dept., 236-A Fulton St., New York.

month. We are going to find use for the single slide tuner later on.

Receiving circuits employing vacuum tubes do not differ very greatly from the circuits we have considered up to the present and it is a more or less simple matter to alter our present arrangement so as to take advantage of the greater sensitivity and selectivity of the tube method of reception. If we refer to the diagram shown in Fig. 6, last month, we shall find a method illustrated for the use of our loose coupler with a fixed condenser, a detector and a pair of telephone receivers. This circuit may be very well employed for use with a vacuum tube by making the changes indicated in Fig. 2 of the present description.

Here we illustrate a receiving circuit in which a loose coupler and two variable condensers are employed to affect the tuning. As may be seen, one variable condenser is connected between the ground and the slider binding post on the loose coupler primary, L1. The condenser is represented in the diagram by C1. L2 represents the secondary of the loose coupler and C2 is a variable condenser, connected directly across the terminals of the secondary, L2. Where only one variable condenser is available it should be employed in the position indicated by C2, and the connection from the slider terminal of the primary of the loose coupler should be made directly to the ground without employing the condenser, C1.

It is not advisable for the novice to attempt the making of variable condensers, for it is a very hard job to line up the plates properly where they are of the rotary type, but there is one simple method which may be employed with very satisfactory results and it is described on page 965, RADIO NEWS for April-May. X1 and X2 merely indicate the points in the circuit to which connection is made between the terminals of the loose coupler secondary and the other units employed.

THE GRID CONDENSER AND LEAK

A small condenser, known as a "grid condenser" because it is placed in the grid lead of the vacuum tube, is connected to a point between X1 and the terminal "G" of the vacuum tube socket. The accompanying diagrams do not represent vacuum tube connections according to the dictates of ordinary practise for the reason that the author has found that many persons find it rather difficult to determine just how to connect the wires in their circuits, where the tubes are shown in the conventional way. Rather than designate the vacuum tube itself by the ordinary symbol, a pen picture of the vacuum tube socket has been used and it is merely necessary to make the connections to the terminals indicated by the letters; these letters actually appearing on the base of most tube sockets now on the market. The elements of the vacuum tube to which these terminals connect are indicated for convenience, and reference is to be made to them in the discussion of the action of the various circuits to be covered in a suitable manner after the primary matter of getting a satisfactory operation has been disposed of.

The method of making the grid condenser is similar to that described in the second article of this series and illustrated by Figs. 1, 2 and 3, of that article, except that the size of the metal sheets should be $\frac{1}{2}$ " x 1" or $1\frac{1}{4}$ " and there should be only two sheets in all, separated by a piece of mica and held securely to a base as shown in Fig. 3.

Some vacuum tubes require a grid leak in order to stabilize their operation when they are used as a detector and a proper leak resistance, suitable for performing this function with most tubes may be made by

GET THE BEST RESULTS FROM *YOUR* WIRELESS USE BRIGHT STAR "B" BATTERIES

Don't be Satisfied with Inferior Results Caused by not Using the Best—



NO. 1590 WITH 15 TERMINALS

THE BRIGHT STAR "B" BATTERY

NOISELESS—Allowing Clear-toned Reception.

LONG SERVICE with Sustained Voltage.

STRONG RECUPERATION Between Periods of use.

BINDING POST TAPS—Making Connection Positive and Easy.

BRIGHT STAR BATTERY CO., DEPT. R
NEW YORK :: CHICAGO :: SAN FRANCISCO

PARAGON

TRADE MARK REGISTERED

the PIONEER

- 1915 First regenerative receiver ever manufactured bore the name PARAGON.
- 1916 First Trans-continental Amateur Reception (California from New York; not pre-arranged) effected with a PARAGON Type RA-6 Receiver.
- 1916 First Trans-continental Amateur Transmission (New York to California; not pre-arranged) effected by PARAGON designed transmitter.
- 1917-1918 PARAGON acknowledged supreme on Western Front.
- 1921 First Trans-Atlantic Amateur reception effected with PARAGON receiving equipment, at which time 27 different amateurs scattered thruout the Eastern section of the United States registered signals at Ardrossen, Scotland—3500 miles.

THERE'S A REASON!

The **ADAMS - MORGAN CO.**

Manufacturers

UPPER MONTCLAIR, N. J., U. S. A.

\$8.50
EFFECTIVE APRIL 15th

EVERETT

Double Head Phones

(3000 Ohms)

have proven that *quality tells* for we have been *swamped with orders*.

But—W have already made arrangements for increased production so that we can supply the demand.

Buy from your dealers

Everett Electric Corp'n.
 320 Broadway, N. Y. C.



Dependable Radio Equipment

Don't spend a nickel on Radio until you know **WHAT** you are buying, and **WHY!**

We are one of New York's oldest Electrical Supply Houses and are studying and testing *Radio Appliances* since their inception for commercial and private uses.

We will tell you how to install a *Complete Receiving Set* and sell you the correct, necessary appliances—or, we will supply you

Address all inquiries to Radio Dept.

We sell Anything and Everything Electrical

Phones Rhinelander 5825, 5660

with a complete Receiving Set approved by our trials—offering you a choice of several types at various prices.

Regular Shipments of all Parts Arriving Daily. Complete Line now in stock.

—Western Electric—

HEAD PHONES
PER PAIR \$15.00

DEALERS!

There are Special Inducements for you—Prices and Deliveries Right

H. Goldberg (Est'd 1894)
1373 Third Ave., Bet. 78th & 79th Sts.
NEW YORK, N. Y.

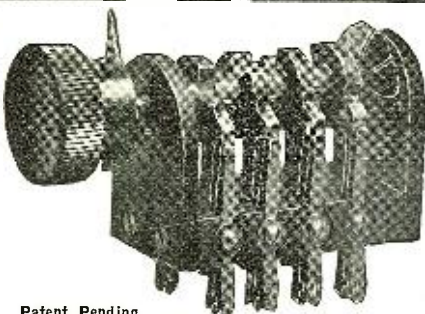

Patent Pending

JOBBER-DEALERS

This switch is revolutionizing amplifier construction, owing to convenience of operation. It will be to your advantage to write or wire for our attractive proposition.

MANUFACTURERS

Why not use this switch in your sets Write for descriptive folder.

STORM-LEE RADIO APPARATUS CO.

742 HIGHLAND AVE.

THE ROTARY AMPLIFIER SWITCH WITH AUTOMATIC FILAMENT CONTROL
GIVES COMPLETE CONTROL OF DETECTOR AND ONE-TWO OR THREE STAGES

The ROTARY AMPLIFIER SWITCH takes the place of filament control jacks in the vacuum tube control panel, giving much greater convenience at lower cost. With this switch you may change from detector to any desired stage of amplification by merely turning one knob. Filaments of unused stages being automatically extinguished.

UNIVERSAL IN USE

This switch is adjustable, by loosening one nut the cams may be adjusted to meet practically any switching requirements.

SPECIFICATIONS

INSULATION—BAKELITE
SPRINGS —NICKEL SILVER
CONTACTS —STERLING SILVER

Price - - - \$5.00

If your dealer cannot supply you write us

NEWARK, N. J.

drawing a line between the two terminals of the grid condenser with india ink. Various values of resistance may be obtained by making the line wider or narrower, as the occasion demands. The grid leak in the circuit, Fig. 3, is indicated in the drawing by the symbol R₃.

CONNECTING THE BATTERIES

Where vacuum tubes are used in receiving circuits, two distinct sources of power must be available; one for heating the filament of the tube and the other for supplying a comparatively high voltage, used to impress a positive potential upon the plate element of the tube, with relation to the filament. Let us consider them one at a time.

First and very important is the battery used to energize the filament. It should be a six-volt storage battery and its ampere-hour capacity, where one tube is employed should not be below sixty, and where more than one tube is employed its capacity should be eighty or more. Unless the proper battery is used the novice is likely to encounter some rather severe difficulties. It should be borne in mind that there are some vacuum tubes which do not require six volts for the operation of their filaments, such as the tubes used by the Army and Navy during the war and the tube employed in a receiving set now on the market which is used with a single dry cell. Six volts should never be applied to these two classes of tubes, nor should a six-volt storage be connected to the filament of a standard six-volt tube without having some regulating resistance in series with it, permitting regulation of the filament brilliancy.

Presupposing that a suitable six-volt storage is available and that standard receiving tubes are to be employed, a wire should be connected between the negative terminal of the battery and the terminal shown in the diagram by F. The negative terminal of a battery is generally indicated by a minus sign (—), the letter "N," or "NEG" may be painted black. The positive terminal of a battery is generally indicated by a plus sign (+), the letter "P," "POS" or is painted red. In most radio circuit diagrams the six-volt storage battery is indicated by "A." As may be seen from the diagram the positive terminal of the storage battery is connected to one terminal of the regulating resistance, commonly called a filament rheostat and indicated in the diagram by "R₁." The remaining terminal of the rheostat is connected to the terminal indicated by "Fr" of the vacuum tube socket.

We now come to the battery which is used to supply the plate with its comparatively high potential, and here we find that there are several variations which may be made, each one of which tends to give us more satisfactory results. Let us start from the very simplest method and then consider the changes which may be made. The battery as we are now considering it, by the way, is known as the "plate battery" or the "B battery." It is generally composed of a number of comparatively small dry cells connected together and bound together in the form of a miniature brick by some sort of wax or other composition. The general voltage of such a battery is in the neighborhood of 22½ volts, though some of these batteries are made with taps, in order to permit the user to secure a number of different voltages, generally ranging from about fifteen to the limit of the battery by connecting to the various taps. In the first place we will merely consider the battery as one which is not variable.

A wire should be connected from the positive terminal of the "A" (six-volt storage) battery to the negative terminal of

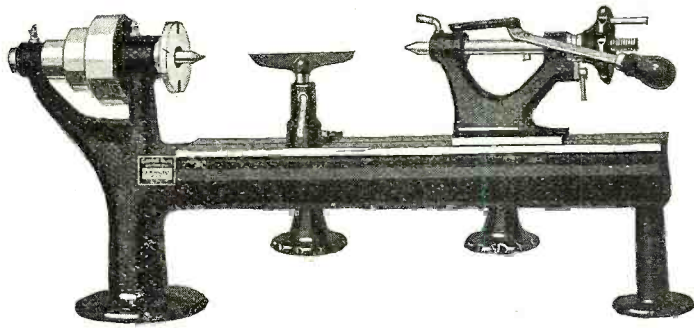

Bench Lathe
No. 494
Price, \$40.00

“Radio work means money for someone,” says Mr. Punch

Someone is going to size up the opportunity in the radio business. He is going to equip himself with a fine set of tools, and this Bench Lathe will be his first choice.

He will get in on the ground floor and help the radio amateurs to develop their sets. With this lathe, he can wind coils perfectly besides the thousand-and-one things for which lathes are made.

It isn't too costly for a small shop, and it's good enough for a big one. It's a great help, too, in garages, electrical service stations, and miscellaneous repair shops.

Choose from these 1500 good tools

Send for a catalog showing the Goodell-Pratt 1500 Good Tools. Each one is right for its particular job—made by men who know good tools and love them.

GOODELL-PRATT COMPANY, Greenfield, Mass., U. S. A.

Toolsmiths

GOODELL-PRATT

1500 GOOD TOOLS

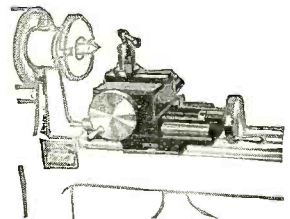

Slide Rest No. 132
Price, \$17.00

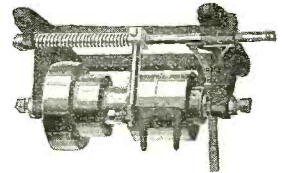

Countershaft No. 130
Price, \$12.00

Good tools for motor cars

Like all the Goodell-Pratt 1500 Good Tools, these are made for good workmen—the most exacting judges of good tools—by toolsmiths who have spent their lives in the business.

Write for complete details concerning the Goodell-Pratt Bench Lathe and other motor tools.

Condenser
No. 3

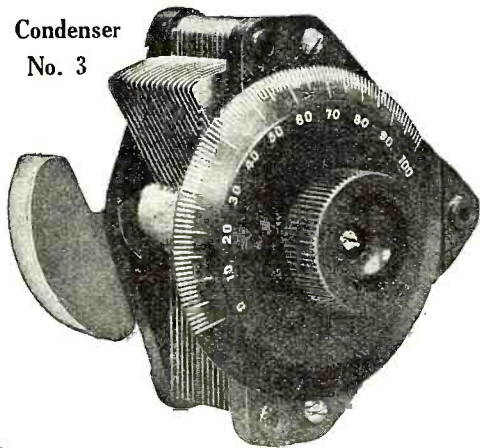

CHELSEA

Variable Condensers
(Die-Cast Type)

| | |
|---|--------|
| No. 1.—0011 m. f. mounted..... | \$5.00 |
| No. 2.—0006 m. f. mounted..... | 4.50 |
| No. 3.—0011 m. f. unmounted..... | 4.75 |
| No. 3.—0011 m. f. unmounted, without dial | 4.35 |
| No. 4.—0006 m. f. unmounted..... | 4.25 |
| No. 4.—0006 m. f. unmounted, without dial | 3.85 |

Top, bottom and knob are genuine bakelite. Shaft of steel running in bronze bearings, adjustable tension on movable plates, large bakelite dial reading in hundredths, high capacity, amply separated and accurately spaced plates.

Unmounted types will fit any panel and are equipped with counterweight. Purchase from your dealer; if he does not carry it, send to us.

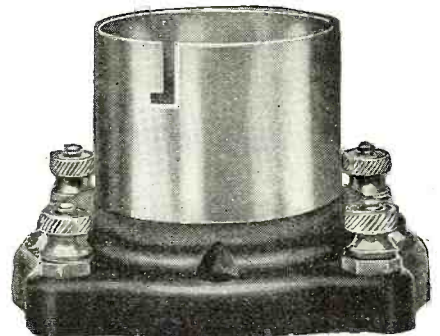

“Chelsea Bakelite Socket No. 60”

This socket has a bakelite base supporting four external, readily accessible binding posts. The tube receptacle is highly polished nickel and will take any standard detector and amplifier tube as well as the smaller size power tubes. It is primarily designed for receiving circuits, and may be mounted on either table or panel. Positive contact springs.

An added beauty to any radio station.

Price as shown, \$1.00

Purchase from your dealer.



NO. 50. PRICE AS SHOWN, \$4.50

The Chelsea Amplifying Transformer is a supreme attainment in design of Audio Frequency Transformers. It embodies the best of materials obtainable in design, which result in an efficiency attained namely high efficiency factor. It is unexcelled in electrical characteristics.

GOODELL-PRATT RADIO CO., 150 Fifth Street, Chelsea, Mass

Radio Apparatus and Moulders of Bakelite

R. T. M. TUNER & DETECTOR

Has a Tuning range of 150-650 meters. Tuning is very simple, brings in the music sharp and clear. Cabinet has mahogany finish, panel is made of hard rubber and has also the appearance of mahogany finish. All wiring is in the back of the panel, thus giving it a very neat front appearance. The B battery is contained within the set and outlets for A battery leads in the back. Price **\$38.00**

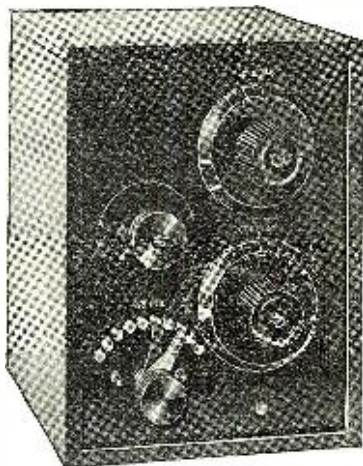

R.T.M. two steps complete finish connected to the R.T.M. tuner by means of bust bars... **\$38.00**

Send for Dealer's Proposition

RADIO TELEPHONE MFG. CO.
150-152 Chambers Street NEW YORK CITY

the "B" or plate battery. The positive terminal of the "B" or plate battery should then be connected to one terminal of a pair of telephone receivers. A wire is then run from the remaining terminal of the telephone receivers to the terminal "P" of the vacuum tube socket. Where a "B" battery provided with regulating taps is used it may be well for the operator to change the position of the wire connected from the plate terminal of the socket until the best position is found. This method is indicated in Fig. 5.

Where even finer adjustment of the plate voltage is desired and this is frequently found to be the case when certain classes of vacuum tubes are used for detection, the use of an "A" battery potentiometer is valuable. The name of this little device is enough to frighten most beginners, but it is a very simple unit to connect in circuit and equally as easy to use. Three terminals are provided; the two outside connections being made, one each to the positive and negative terminals of the "A" battery and the third connected to the 18-volt tap of the plate or "B" battery.

The potentiometer is made up of a high resistance connected directly across the "A" battery with a movable arm passing over and making contact with the resistance. Manipulation of the movable member permits the voltage regulation on the plate circuit from approximately eighteen to twenty-four volts. The potentiometer is shown in the diagram Fig. 3, by R2. The condenser, C4, is that which was used in the circuit employing a crystal detector, described last month. Its use increases the clarity of the signals.

MAKING A SIMPLE REGENERATIVE SET

Just as soon as the person uninitiated in radio runs upon a description of a regenerative circuit he quite frequently loses heart. There is little more complication in this form of circuit than those we have been considering and but a single change is necessary in the diagram shown in Fig. 4 to make a suitable regenerative circuit for broadcasting reception.

Again we come to one of those awe-inspiring terms, when reduced to practise and stripped of its vagueness is not very formidable and is the only detail necessary to transform the circuit we have been considering into a regenerative circuit and that unit is called a "Variometer." The circuit is the same as Fig. 2 the only difference being that a variometer is placed between the terminal "P," of the vacuum tube socket and one terminal of the telephone receivers. This variometer is used to tune the plate circuit and actually controls the regeneration permitting amplification of the received energy, by the method discovered by Armstrong to be described in detail later on.

TO OPERATE THE V.T. RECEIVER

Whether we use the regenerative or not will depend upon just how much time we are able to devote to the circuit as well as the amount of money at our disposal between the purchase and installment of this series of articles. To describe the detail of the construction of a variometer. See the article in this issue. We hope to see that those who are interested in the regenerative circuit of the regenerative variometers will find the information of interest.

Start at the beginning of Radio and go step by step, in clear diagrams and full explanations, from the first set-up to the final listening in, with a copy of

"RADIO for EVERYBODY"

By AUSTIN C. LESCARBOURA
MANAGING EDITOR, *Scientific American*

Here's the book you've been waiting for—the A B C of Radio with all explanations and instructions written so everyone can understand them.

This book is a complete guide on what to buy, how to set up, how to operate and listen in—authoritative, complete, easily understood.

Price \$1.50, by mail \$1.60

SCIENTIFIC AMERICAN
MUNN & CO.
237 BROADWAY NEW YORK CITY



352 pages.
180 diagrams
and illustrations

KNOCK DOWN CONDENSERS (STRAIGHT LINE TYPE)

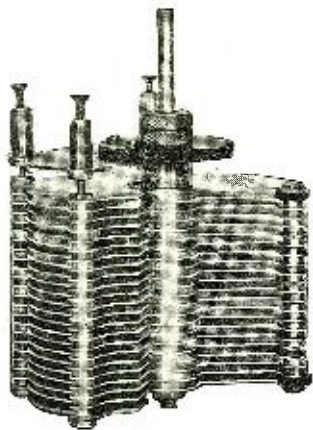

Plates 1/32" thick

| | | |
|------------------|-----------|--------|
| 31 plate .001 | Knockdown | \$4.75 |
| Assembled, | | 6.00 |
| 45 plate .0015 | " | 5.00 |
| Assembled, | | 7.50 |
| 23 plate .00075, | Assembled | 5.00 |
| 15 plate .0005 | " | 4.50 |

Dealers write for discounts

MONTROSE MFG. CO.

619 St. Johns Pl.
BROOKLYN, N. Y.



"Listen to others' advice—but act on ours"

THESE ARE GOOD IF YOU NEED THEM

THE KLEIN VARIABLE CONDENSER

Capacity, 23-plate 0005 m.f.d. Capacity, 43-plate .001 m.f.d. A very reliable condenser, beautifully made in aluminum with brass 1/4 in. shaft and fittings; bakelite bushings, set screw tension.

Price No. 106, (23 plate) \$3.25
Price No. 105, (43 plate) \$4.25

THE KLEIN 3-COIL MOUNTING

A decided improvement. The binding posts at base make connections easy and quick, besides acting as legs. Well made in polished bakelite with nickel-plated mountings.

Price, Each \$5.50.

THE KLEIN VARIOCOUP-PLER AND VARIOMETER

Range 150 to 600 metres; 3/16 in. shaft. A well made instrument that has earned popular favor with our customers.

No. K. 104 Price \$5.00 (dial extra).

THE KLEIN SUPERSENSITIVE GALENA CRYSTAL DETECTOR

A very desirable compact little instrument. No glass shade to obstruct vision while operating. Nickel-plated brass on bakelite base.

Price, with crystal \$1.50; without crystal \$1.25.

THE KLEIN VARIOMETER

We recommend this variometer for its special feature of a spring contact which assists in eliminating tube noises. Workmanship and efficiency up to our usual high standard.

Price \$5.00. (Dial extra).

Our early connections and favorable arrangements with all reliable sources of Radio Equipment ensure regular shipments from the factories. Write for price list of Complete Sets and Parts. Special terms to Dealers. EXPERT ADVICE FREE. Phone Beckman 1767-2999.

The Klein Radio & Electrical Supply Co.

48 FULTON ST.
(Near 3d Ave. L.)
NEW YORK, N. Y.

position in which it was found to bring in signals with the crystal detector. The coupling-distance between the active part of the primary and secondary windings—should be rather close and the condenser across the secondary should be left at zero. Now rotate the lever of the filament rheostat R1 until the filament of the vacuum tube is heated. Do not increase the filament current too rapidly and just as soon as signals are heard in the telephone receivers, adjust the variometer after the position of the primary slider and the switch used to control the number of turns in the secondary winding are found, keeping the primary as far from the secondary as possible without reducing the intensity of the signals. Follow these adjustments by manipulating the variable condenser, C2. Do not burn the filament of the vacuum tube any more brilliantly than absolutely necessary because that is bound to reduce its life. It is mighty good practise to thoroughly adjust every other part of the circuit before you increase the filament brilliancy to increase signal strength. There is a strong tendency among folks not thoroughly familiar with vacuum tube operation to overheat the filament. It is a costly practise and should not be indulged in.

So much for this circuit. We may now spend a moment or two in considering the manipulation of the variometer used to produce regeneration and amplification and illustrated in Fig. 4. It is usually safer to spend some time operating the non-regenerative circuit in order to become familiar with its adjustment before attempting the regenerative form, which only takes a minute or two for the insertion of the variometer in the "hook-up" as radio circuits are popularly called. We assume, therefore, that a knowledge of the manipulation of the first type of circuit has been obtained and the proper connection for the variometer between the telephone receivers and the plate of the tube socket has been made.

Proceed as in the former case and leave the variometer at its zero position. After all the other adjustments have been made it is but necessary to slowly rotate the movable coil of the variometer until the signals are heard at their maximum, which it is found to be several times as loud as those received before. If the variometer is rotated too far the signals are likely to become mushy and lose their natural tone and a "howl" is likely to be heard in the telephone receivers. It does not take long to become adept in the adjustment of the regenerative circuit of this character and very satisfactory results may be obtained where it is employed. In operating any of the circuits described so far, it should be borne in mind that there is really nothing difficult about them and it is sometimes found helpful to review the subject from time to time, picking out the slight changes made in the circuits as we progress.

Should We Put the Brakes On Radio
(Continued from page 1088)

man. Radio takes such artists to the cultured audiences that cannot come to them. Is the love of music likely to die, with this new means of communication in its infancy?

Loneliness is given more frequently than any other reason for the desertion of the farm and removal to the town. The attempt of the majority of farmers to get off the soil and at the same time buy the:

EFFECTIVE LIGHTNING PROTECTION

With the S & C Radio Protector



The S & C High Voltage Fuse in Combination with Two Enclosed Close Spark Gaps, Direct to Ground

Eliminates { **Danger To The Operator**
Danger To The Receiving Set
Danger To The Building

No more worry about that Ground Switch—You Need None

You May "Listen In" on a stormy night with a feeling of Security

No Danger from Lightning or Crosses with High Voltage Power Circuits.

Installed Outdoors. Never Fails to Intercept and keep Outdoors, High Potential Currents of any Nature

S & C Fuses are Depended upon for the Protection of High Voltage Power Equipment up to 150,000 Volts

WALL MOUNTING TYPE \$12.00
STRAIN TYPE 6.00

DESCRIPTIVE MATTER ON REQUEST

SCHWEITZER & CONRAD, INC.
4437 Ravenswood Ave. CHICAGO, ILL.

"A"

JAXON

"B"

STORAGE BATTERIES

Sold direct from the Factory to you at a Big Saving







| | |
|---|---|
| <p>"A" STANDARD. Wooden cases, cedar separators; TWO YEAR GUARANTEE.</p> <p>6 Volt 60 Amp. Hr. \$13.25</p> <p>6 Volt 80 Amp. Hr. 16.35</p> <p>6 Volt 100 Amp. Hr. 18.00</p> | <p>\$5.75</p> <p>Prepaid or from your dealer</p> |
| <p>"A" ARMORED. One piece rubber composition "Permenenta" case; rubber and cedar separators. The good qualities of both and none of their faults; THREE YEAR GUARANTEE.</p> <p>6 Volt 60 Amp. Hr. \$17.50</p> <p>6 Volt 100 Amp. Hr. 22.50</p> | |
| <p>"B" STORAGE. Rechargeable; large capacity, variable voltage; full charged; pasted plates; Rubber Separators. TWO YEAR GUARANTEE. Prepaid or from your dealer, \$5.75</p> | |

SENT EXPRESS COLLECT

Send for our Radio supply list with prices.

JACKSON BATTERY CO., 1124 R Jackson Blvd., Chicago, Ill.

More New Pacent Radio Essentials

Pacent Audioformer

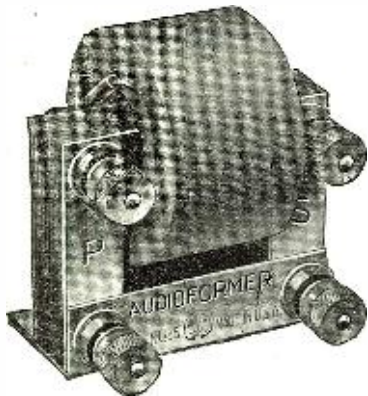

Here is the smallest and most efficient audio-frequency transformer on the market today. It is being manufactured especially for the reception of radio telephone music and speech and is so designed as to give maximum efficiency at all audio-frequencies. The Pacent-made Audioformer will make music worth listening to.

Catalog No. 25
Pacent Audioformer Price . . \$6.00

**Dubilier Type 600
Condenser**



This condenser manufactured by the Dubilier Condenser Company by the superior Dubilier process can be secured for your receiving equipment. The Dubilier Type 600 Condenser has accommodations for a grid leak, yet the condenser costs less than a grid leak or a condenser purchased separately, and is provided with Fahnestock connectors. Use Dubilier Condensers.

Capacities up to 0.005 mfd.
Price \$0.75
Capacities over 0.005 to .01 mfd.
Price \$1.00

Pacent Crystal Detector



The Pacent Crystal Detector is perfect in construction and reasonable in price. It is dust-proof, rust-proof and fool-proof. Has moulded top and base with glass cover. Crystal instantly accessible. All parts heavily nicked and highly polished. A truly beautiful instrument incorporating every feature a good detector should have. Pacent-made and Pacent-stamped.

Catalog No. 30A Crystal Detector.
Price without crystal \$1.50
Catalog No. 30 Crystal Detector.
Price with crystal \$1.75

Pacent Electric Company, Incorporated

LOUIS GERARD PACENT, PRESIDENT

150 Nassau Street

New York City



MEMBER OF RADIO SECTION, ASSOCIATED MANUFACTURERS OF ELECTRICAL SUPPLIES

THE "ALL-AMERICAN"

RADIO FREQUENCY AMPLIFYING TRANSFORMER

EFFICIENT ON 150--550 METERS



Designed for amateur and commercial broadcasting receiving instruments—sharp enough for the discriminating amateur and absolutely practical for the average layman who finds tuning complicated. Perfect shielding with low distributed capacity and properly impregnated to protect it from atmospheric conditions—giving pure amplification without annoying tube noises and distortion. Static disturbances are eliminated to a great extent. Can be used with Radio-tron—Cunningham—Moorehead A. P. or Meyer tubes. Guaranteed to give satisfaction.

TYPE R-10 (AT YOUR DEALER) \$4.50

AUDIO FREQUENCY TRANSFORMERS

TYPE R-3 Ratio 10 to 1 Mounted \$4.50

TYPE R-2 Ratio 3 to 1 Mounted \$4.25

THE "ALL-AMERICAN" IS THE ORIGINAL 10 TO 1 TRANSFORMER

They are manufactured strictly on a quality basis and are guaranteed to give satisfactory service. Comparison will show that they are without question the most efficient on the market. The fact that such a large number of manufacturers of AMPLIFYING units use our transformers is proof that they are superior.

We are placing on the market radio and audio frequency amplifiers to fit every receiver. Write for our bulletins describing the new "ALL-AMERICAN" radiophone receiving apparatus.

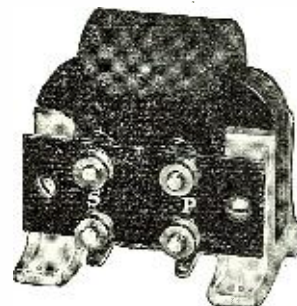

RAULAND MANUFACTURING CO.,
35 S. Dearborn Street CHICAGO, ILL.

Successors to All-American
Electrical Manufacturers

use A-P tubes for efficiency

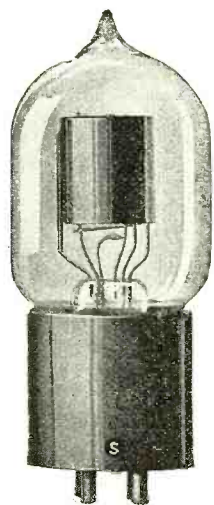

THE A-P ELECTRON RELAY

—the most sensitive detector of spark signals known to the radio art. Price \$5.00.

—“the tubes that are used by those who **KNOW**”

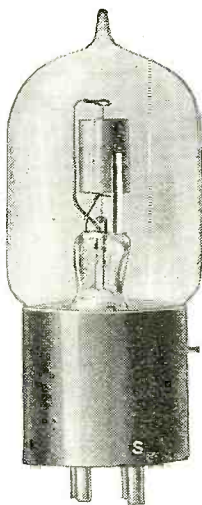

THE A-P VT AMPLIFIER OSCILLATOR

—the Amplifier used by the U. S. Navy. “Use the tube the Navy uses.” Price \$6.50.

A-P tubes are licensed by the Radio Corporation of America under DeForest Audion and Fleming patents for amateur and experimental use in radio communication. Equipped with the SHAW standard four-prong base.

Atlantic Pacific Radio Supplies Company

Henry M. Shaw, President

638 Mission Street, San Francisco, California
Eastern Office: 5 Kirk Place, Newark, N. J.

National distributors for the Moorhead Laboratories, Incorporated.

CALIFORNIA HEARS NEW YORK

3,000 miles

WITH

A=P Tubes

On March 25, 1922, Rock Ridge Radio Station, (KZY) Oakland, California, succeeded repeatedly in receiving both music and speech by radio telephone from the broadcasting station of the General Electric Co. (2X1), Schenectady, N. Y., an air distance of approximately 3,000 miles. A-P Tubes were used exclusively in the Rock Ridge receiving apparatus —“The tubes that are used by those who know.”

USE A-P TUBES FOR EFFICIENCY

Equipped with the SHAW standard four-prong base

Don't Let Dissatisfaction and Lost Radio Business Remind You Next Month to Place Your Orders with RAY-DI-CO



DO IT NOW!

USE THIS COUPON

RAY-DI-CO ORGANIZATION

1547A North Wells Street

Send me prices and information on the following Radio Apparatus:

Name _____

Address _____

RAY-DI-CO ORGANIZATION

1547A N. Wells Street

Chicago . . . Illinois

Here at Last — the radio head set you have been waiting for



Backed by years of experience in the making of voice reception apparatus this head set is the last word in unequalled distinctness, extreme sensitiveness and pure clear tonal qualities.

Your receiving outfit equipped with this radio head set will assure you of maximum service in faithfully reproducing all broadcasted vocal and musical sounds.

The sanitary headband is self-adjusting, with a spring tension that automatically takes up the wear. The wearer is assured of the greatest comfort with minimum surface pressure. The removable interiors are entirely insulated from the case and allow for temperature changes.

Give yourself a treat—try them—you will find they are all we claim—and more.

Superior Features

Lightweight, 12 oz. Extremely sensitive. No distortion. Anchored cords. Matched receivers. Centered pull on diaphragms. No hair catching projections. Small, compact; maximum efficiency.

Dictograph Products Corporation
220 West 42d Street New York, N. Y.



**EASTERN
RADIO**

INSTITUTE

TEL
BACK BAY
5 9 6 4

899 BOYLSTON ST.
BOSTON, MASS.



RADIO today is commanding the interest of more people than any other industry! Splendid opportunities are NOW available for those who are alive enough to see the possibilities. My fifteen years' experience in Radio tells you that FORTUNES will be made within the next five years for those who train themselves now and take advantage of the present opportunities.

The EASTERN RADIO INSTITUTE is the OLDEST, LARGEST and BEST EQUIPPED Radio school in New England. THOUSANDS of satisfied graduates tell our story best! Day and Evening classes. Start any Monday.

REMEMBER:—Our ORGANIZATION with YEARS of PHENOMENAL EXPERIENCE and SUCCESS is behind EVERY man who enrolls!

"Ask any man in Radio—he will tell you!"

Our illustrated prospectus for the asking.

F. L. PITTS, Director.

**TIMES
APPLIANCE CO.**



145 West 45th St.
NEW YORK, N. Y.

Distributors for

WHOLESALE ONLY
Write for Price Lists

We Handle

RADIO CORP. of AMERICA
WESTERN ELECTRIC CO.
CLAPP-EASTHAM CO.
The BRANDES CO.
DE FOREST RADIO TEL. & TEL. CO.
FEDERAL TEL. and TEL. CO.
And Other Reliable Radio Manufacturers

Transmitting and Receiving
Equipment of All Kinds

You want these

**TIMES
ESTED SPECIALS**
FIXED PHONE CONDENSERS
FIXED GRID CONDENSERS
FIXED GRID LEAKS

products of the soil at the same prices that they commanded when everyone had at least a vegetable garden, has led to some legislative efforts, to control natural laws, that would make King Canute realize that he was a "piker" if he could look back from across the Styx. Are folks who still live on the soil, either by reason of unusual success in agriculture or of failure to acquire the wherewithal to leave it, going to give up their air-neighbors? Will they stop buying radio just as it begins to put them one jump ahead of the buyer in the race for profits? Will they turn deaf ears to the friends who, after the day's work, give them a show better than the average fellow who has moved to town can have except by using the same means?

A few dozen centuries ago a scientist by name of Archimedes informed the world that he could pry the globe out of its orbit as easily as he could fork a potato out of its hill if he could only find a place to put the end of his lever. The fellow who undertakes to change the course of radio, except by making it easier for the public to use, is going to encounter a similar difficulty. If we put on the brakes, the only result will be a squeal and a trail of smoke from the brake band.

The shutting off of publicity may seem to some persons a means of retarding the speed of the advancing wave of interest in radio. A short and convincing study of this method can be made by interviewing anyone who has tried to suppress information that was of interest to the public. If money could hush up anything the daily papers would be smaller than they are and more profitable to the owners. Politicians have sometimes made use of propaganda about one issue to turn public attention from another, when the matters were not so near to the heart of the people that they would be conscious of loss or damage, whichever way the scales balanced; the use of publicity in restricting the sale of products long considered as necessities was well tested during the war: but an attempt to keep the public waiting for a thing that everybody wants, just to enable manufacturers and dealers to play safe, is less apt to succeed than an appeal to the "cop" at 42nd Street and Fifth Avenue to hold up the traffic while a kid hunts for the penny he has dropped.

There have been suggestions of a monopoly in radio, an organization that held the situation in the hollow of its hand. One of the means by which this alleged monopoly is said to be able to slow down the business if it wants to is by refusal to license competing manufacturers to use certain circuits that are supposed to be indispensable to highly efficient apparatus. But one manufacturer at least is putting out a receiver that is said to work as well as the patented circuits, and it does not and cannot employ those circuits. Another manufacturer markets a receiver that, according to report, any user can convert into a type supposed to be monopolized, simply by changing a connection or two. I asked a dealer if he thought this practice was honest. He replied that it was no more dishonest than taking your money out of one pocket and putting it into another to foil the designs of a pickpocket! Honest or dishonest, the public will find a way to get the use of the thing it wants. It willingly or grudgingly pays the man who has control so long as he is not hopelessly hoggish, but once it is convinced that a man or a corporation is getting more than its due, it must be mollified by concessions or at least made to think that it is getting them. Putting prohibition into radio only stimulates a genius similar to that of the home brewer.

There are a certain number of brakes that are being applied to the rapidly-mov-

GET OFF TO A FLYING START UNIFORM YOUR UNITS

BUY THE BEST — ADD THE BEST — AND YOUR RESULTS
WILL BE THE BEST

| VACUUM TUBES | |
|---------------------------------|---------|
| No. UV-200 Detector | \$ 5.00 |
| No. UV-201 Amplifier | 6.50 |
| No. UV-201 5 watt transmitter | 8.00 |
| No. UV-203 50 watt transmitter | 30.00 |
| No. UV-204 250 watt transmitter | 110.00 |

| ATLANTIC-PACIFIC | |
|------------------|------|
| A. P. Detector | 5.00 |
| A. P. Amplifier | 6.50 |

Send us your orders for Tubes,
Our stock is complete

| SOCKETS | |
|------------------------|------|
| No. 550 Murdock | 1.00 |
| No. UP-552 Radio Corp. | 1.50 |
| No. UR-542 Radio Corp. | 1.00 |
| No. UT-541 Radio Corp. | 2.50 |
| No. 30 Paragon | 1.00 |

| CONDENSERS | |
|-------------|------|
| No. UC-1014 | 2.50 |
| No. UC-1015 | 5.75 |
| No. UC-1803 | 5.00 |
| No. UC-1806 | 7.00 |
| No. UC-1831 | 9.00 |

| CHOPPERS | |
|--|------|
| No. PX-1638 motor driven | 7.25 |
| Shaft Bushings for 1/4 or 5/16 shaft, each | .20 |



| TELEPHONES | |
|-------------------------|---------|
| Type C Baldwins | \$12.00 |
| Type E Baldwins | 13.00 |
| Type F Baldwins | 14.00 |
| No. 56 Murdock 2000 ohm | 5.00 |
| No. 56 Murdock 3000 ohm | 6.00 |

| RHEOSTATS | |
|-------------------------|------|
| No. 25 Paragon | 1.50 |
| No. 214 General Radio | 2.50 |
| No. 560 Murdock | 1.00 |
| No. 120-A FADA new type | 1.00 |
| No. 810 Remler 4 ohm | 1.00 |

| AMPLIFYING TRANSFORMER | |
|---------------------------|------|
| No. A-2 Acme semi-mounted | 5.00 |
| No. UV-712 Radio Corp. | 7.00 |
| No. 231 Gen. Radio | 5.00 |
| No. 231 Gen. Radio | 5.00 |

| POWER TRANSFORMERS | |
|-------------------------|-------|
| No. UP-1368—325 watt | 25.00 |
| No. UP-1016—750 watt | 38.50 |
| No. UL-1008—Oscillation | 11.00 |

| "B" BATTERIES | |
|--------------------------------------|------|
| No. 763 Eveready 22 1/2 vol's | 2.00 |
| No. 766 Eveready 22 1/2 volts tapped | 3.00 |
| No. 5156 Burgess 22 1/2 volts tapped | 3.00 |
| No. 2156 Burgess 22 1/2 extra large | 3.50 |

| REGENERATIVE RECEIVERS | |
|------------------------------------|--------|
| No. RA Westinghouse 150-700 meters | 68.00 |
| No. DA Westinghouse two stage | 70.00 |
| No. RC Westinghouse short wave | 132.50 |
| No. C. B. load coil for same | 6.00 |
| "Aeriola Jr." | 25.00 |
| "Aeriola Sr." | 75.00 |

| LOUD SPEAKERS | |
|----------------------------|-------|
| No. A-3 Magnavox, new type | 45.00 |
| VOCALOU, station type | 30.00 |

SEND US YOUR ORDERS—NOW

Please include sufficient postage with all C. O. D. orders

MISSOURI RADIO SUPPLY COMPANY
4623 Maryland Ave. SAINT LOUIS MISSOURI

— MOULDED — RADIO — ACCESSORIES —

MANUFACTURED OF
APPROVED MATERIAL

Specifications Solicited

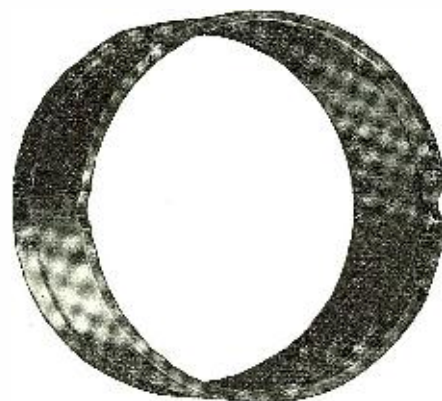
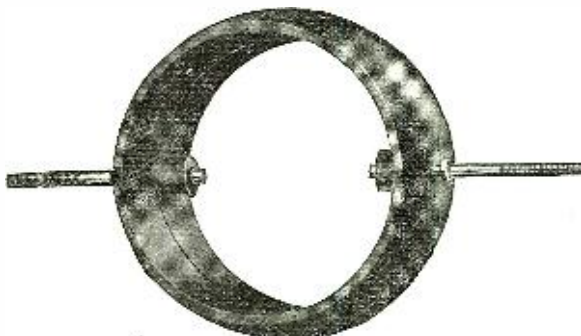

form
the de
Transfor
highest gra
able and prop
fects the resul
high amplification
equalled either in
acteristics or good appea

Dials Rotors Couplers Panels Stators

CHelsea RAdio INsulating Corp.
FACTORY
SPRINGFIELD, MASS.

Manufacturers of Radio

Try REYNOLDS RADIO Service

(Old)
"9ZAF"

from DENVER

(New)
"KLZ"

| <p>FEDERAL Jr. RECEIVING SET.....\$25.00</p> <p>No. 14 Stranded Aerial Wire, 100 ft.....\$1.00 No. 14 Stranded Aerial Wire, 150 ft..... 1.50 No. 14 Solid Aerial Wire, 100 ft..... .75 No. 14 Solid Aerial Wire, 150 ft..... 1.10 Hopewell Insulators, All Sizes</p> <p style="text-align: center;">BOOKS</p> <p>Experimental Wireless Stations. Edelman....\$3.00 Wireless Telegraphy & Telephony. A. P. Morgan 1.50 Radio Hook-ups. M. B. Sleeper..... .75 Design Data. M. B. Sleeper..... .75 Design of Modern Radio Sets. M. B. Sleeper.. .75</p> <p>Acme 200 Watt CW Transformers..... 20.00 Clapp Eastham Filament Transformers.....12.50</p> | <p style="text-align: center;">MAGNET WIRE</p> <table border="0" style="width: 100%; border-collapse: collapse;"> <thead> <tr> <th>Spool</th> <th>Size</th> <th>SCC</th> <th>SSC</th> </tr> </thead> <tbody> <tr><td>4 oz.</td><td>20</td><td>\$.45</td><td>\$.50</td></tr> <tr><td>4 oz.</td><td>22</td><td>.50</td><td>.55</td></tr> <tr><td>4 oz.</td><td>24</td><td>.50</td><td>.65</td></tr> <tr><td>4 oz.</td><td>26</td><td>.55</td><td>.70</td></tr> <tr><td>8 oz.</td><td>20</td><td>.65</td><td>.80</td></tr> <tr><td>8 oz.</td><td>22</td><td>.75</td><td>.90</td></tr> <tr><td>8 oz.</td><td>24</td><td>.80</td><td>1.00</td></tr> <tr><td>8 oz.</td><td>26</td><td>.85</td><td>1.15</td></tr> <tr><td>12 oz.</td><td>20</td><td>.90</td><td>1.10</td></tr> <tr><td>12 oz.</td><td>22</td><td>1.00</td><td>1.25</td></tr> <tr><td>12 oz.</td><td>24</td><td>1.10</td><td>1.40</td></tr> <tr><td>12 oz.</td><td>26</td><td>1.25</td><td>1.65</td></tr> </tbody> </table> <p style="text-align: center;">COMPLETE LINE JEWELL METERS</p> <p style="text-align: center; font-size: small;">Include Postage with all orders</p> | Spool | Size | SCC | SSC | 4 oz. | 20 | \$.45 | \$.50 | 4 oz. | 22 | .50 | .55 | 4 oz. | 24 | .50 | .65 | 4 oz. | 26 | .55 | .70 | 8 oz. | 20 | .65 | .80 | 8 oz. | 22 | .75 | .90 | 8 oz. | 24 | .80 | 1.00 | 8 oz. | 26 | .85 | 1.15 | 12 oz. | 20 | .90 | 1.10 | 12 oz. | 22 | 1.00 | 1.25 | 12 oz. | 24 | 1.10 | 1.40 | 12 oz. | 26 | 1.25 | 1.65 |
|--|---|-------|-------|-----|-----|-------|----|-------|-------|-------|----|-----|-----|-------|----|-----|-----|-------|----|-----|-----|-------|----|-----|-----|-------|----|-----|-----|-------|----|-----|------|-------|----|-----|------|--------|----|-----|------|--------|----|------|------|--------|----|------|------|--------|----|------|------|
| Spool | Size | SCC | SSC | | | | | | | | | | | | | | | | | | | | | | | | | | | | | | | | | | | | | | | | | | | | | | | | | | |
| 4 oz. | 20 | \$.45 | \$.50 | | | | | | | | | | | | | | | | | | | | | | | | | | | | | | | | | | | | | | | | | | | | | | | | | | |
| 4 oz. | 22 | .50 | .55 | | | | | | | | | | | | | | | | | | | | | | | | | | | | | | | | | | | | | | | | | | | | | | | | | | |
| 4 oz. | 24 | .50 | .65 | | | | | | | | | | | | | | | | | | | | | | | | | | | | | | | | | | | | | | | | | | | | | | | | | | |
| 4 oz. | 26 | .55 | .70 | | | | | | | | | | | | | | | | | | | | | | | | | | | | | | | | | | | | | | | | | | | | | | | | | | |
| 8 oz. | 20 | .65 | .80 | | | | | | | | | | | | | | | | | | | | | | | | | | | | | | | | | | | | | | | | | | | | | | | | | | |
| 8 oz. | 22 | .75 | .90 | | | | | | | | | | | | | | | | | | | | | | | | | | | | | | | | | | | | | | | | | | | | | | | | | | |
| 8 oz. | 24 | .80 | 1.00 | | | | | | | | | | | | | | | | | | | | | | | | | | | | | | | | | | | | | | | | | | | | | | | | | | |
| 8 oz. | 26 | .85 | 1.15 | | | | | | | | | | | | | | | | | | | | | | | | | | | | | | | | | | | | | | | | | | | | | | | | | | |
| 12 oz. | 20 | .90 | 1.10 | | | | | | | | | | | | | | | | | | | | | | | | | | | | | | | | | | | | | | | | | | | | | | | | | | |
| 12 oz. | 22 | 1.00 | 1.25 | | | | | | | | | | | | | | | | | | | | | | | | | | | | | | | | | | | | | | | | | | | | | | | | | | |
| 12 oz. | 24 | 1.10 | 1.40 | | | | | | | | | | | | | | | | | | | | | | | | | | | | | | | | | | | | | | | | | | | | | | | | | | |
| 12 oz. | 26 | 1.25 | 1.65 | | | | | | | | | | | | | | | | | | | | | | | | | | | | | | | | | | | | | | | | | | | | | | | | | | |

REYNOLDS RADIO CO., DISTRIBUTORS DENVER, COLO.

613 19th Street

WETMORE - SAVAGE COMPANY

BOSTON, MASS.

Jobbers of

ELECTRICAL SUPPLIES

AUTOMOTIVE EQUIPMENT SUPPLIES

Have recently entered the field of

RADIO APPARATUS and SUPPLIES

We will do a Wholesale Business only and solicit correspondence with reliable manufacturers who are desirous of receiving the best representation for the New England States.

Edelman's Raytainer

(Registered)

A complete wireless telephone loud speaking receiver. Handsomely mounted in phonograph style cabinet with scientific wood horn. Patented. Patents Pending. Licensed for Experimental and Amateur Use. May be used without outside aerial. Uses the famous Edelman Radio Concentrator. Guaranteed satisfactory. This is the real machine, and at a popular price.

Type R.S.4, Four vacuum tubes.....\$225
 Type R.S.3, Three vacuum tubes..... 185

Edelman's Famous Multitone Supplies

| | |
|---|---------|
| Two step amplifier, Audio Freq., \$30.00, Radio Freq. | \$36.00 |
| One step amplifier, Audio Freq., \$18.00, Radio Freq. | 21.00 |
| Same, fitted with loud speaking horn, extra | 13.50 |
| Rubber tired V.T. sockets (Best Yet) | 1.00 |
| Multi audio frequency transformers..... | 4.50 |
| Multi, radio frequency transformers..... | 6.00 |
| Rheostats, single—Vernier | 1.35 |
| Rheostats, double, for both detector and amplifier, 5 ohms, 4 amps..... | 2.35 |
| Variable condensers, .0005 M.F..... | 4.25 |
| Mica phone diaphragms, make your headset musical toned | .55 |
| Multitone phonograph connector, attaches to any machine, loud | 5.00 |
| Wizard, complete crystal set with phones and aerial | 14.00 |

Catalogue sent for 25c
Dealers and Agents Wanted. Prompt Deliveries.

PHILIP E. EDELMAN, E. E. Radio Div., 9 Church St., New York, N.Y.

Radio Galena Crystals

Perfect and Sensitive

Direct from Mine

Sizes—Twelve and Twenty-five Cents

Discounts in quantity orders

Empire Electric Machinery Co.

401 Penn Ave. Joplin, Mo.

NOTICE

TO ALL RADIO CLUBS

On and after May 1st we deal with radio clubs and amateurs direct on Wizard "B" and Witherbee A Batteries wholesale and retail. Club secretaries send for our Bulletin R. C. I. Amateurs send for Catalog 6. No A Batteries sold retail. Postage paid on "Wizards."

RADIO CLUB BATTERY HOUSE
Richmond Hill, L. I., N. Y.

Ref.—Lawson Silk Ptg. Co., 83 Grand St., New York.
J. K. Wheten, Vice-Pres.; Dictator Ftn. Pen Co.
342 Madison Ave.

SHELTER TENT \$1.45

Made of olive drab, 10 oz. waterproof canvas. Easily packed and carried, being in 2 sections which tightly fasten together with double buttons. Folds into compact bundle weighing approx. 7 lbs. Size 7 ft. x 4 ft. 6 in. Sold as high as \$10.00. Our 30 Day Anniversary Sale price \$1.45, plus 60c for packing and postage. Satisfaction guaranteed.

ATLANTIC STORES
446 Koplin Bldg. Atlanta, Ga.

ing radio business. One of these is dishonest advertising. Many a man is spending hard-earned money for a receiver that he is led to believe will enable him to hear grand opera and everything else that is in the air, and then finding that he can hear nothing at all with it unless he moves nearer to the transmitting station. Dissatisfied customers will spoil a lot of sales for honest apparatus, honestly advertised. Another thing that sooner or later will retard the game is the partial or complete failure of demonstrations of apparatus that is highly efficient, from the standpoint of the technical radio amateur, but that is judged on the one unsuccessful performance by persons who witness but the one trial. Recently I was present at such a demonstration before an audience in which the President of the United States was the guest of honor. KDKA and WJZ were within range but they could not be brought in with sufficient energy to be audible to any but those who used head phones. The timely assistance of local phone transmitters saved the situation, but the impression made was not as strong as the character of the audience demanded. The explanation that atmospheric conditions were bad raised questions in the minds of the listeners which would not have arisen if they had been led to expect only local stations.

Even at a great radio convention the demonstration of a receiver that was to provide the feature of the program was a failure. Yet, in the same city, a boy in his teens with a receiver that he made himself brought in KDKA strongly enough to fill a hall many times larger than either of those in which the failures took place. He, of course, had the advantage of better atmospheric conditions, but when the public goes to hear a radio telephone at work it does not expect it to be subject to the same limitations as a July picnic in a region famous for thunder showers. For a while it will not be necessary everywhere to promise music from a city hundreds of miles away. If a phonograph can be heard playing two miles away, most of the audience will marvel at it. If they come to hear that and happen to hear live artists singing a thousand miles away, the impression made is quite different from that created when they are promised the latter and only get the former.

Radio is still so new to the bulk of the population, even the well-informed part of it, that an amateur who knows the code can amuse groups by the hour just by copying code broadcasts and the twaddle of the hams.

The lack of service is dragging many a wheel that some day will have to be released from its brake and oiled. Radio clerks who are competent report that they are making good money these days by installing and repairing apparatus and giving instructions to beginners, but they are unable to keep up with the demand. Let any man who has had any experience with radio make it known and questions are showered upon him by those who want to know.

There is a persistent fear on the part of many amateurs, manufacturers and dealers that the government is going to jam on the brakes good and hard. If it does, it will be in response to a strong public demand. I doubt if anyone keeps in touch with the various government departments that are concerned with radio more persistently than I do, yet I have been unable to discover anyone in any department who has shown the slightest tendency to restrict anybody's use of radio any more than is necessary to give some other citizen his share of the ether. The report of the Technical Committee following the radio.

conference at the Department of Commerce indicated a desire to give everyone his share of the ether.

Of course, the technical amateur, and the business broadcaster, and everyone who wants to transmit or listen in, will say that all he wants is his share of the time and wave-lengths, but some men's idea of their share resembles the German conception of the Vaterland's share of the universe. There are approximately 110,000,000 citizens of the United States and twenty-four hours in the day. My share of the ether is twenty-four hours divided by 110,000,000, which is .00000021 of an hour, plus. This is .018144 of a second. Now as there are 20 available bands of wave lengths, I might feel entitled to twenty times that fraction of a section on one of them. That would make a little more than one-third of a second. But as the people of the United States, through their representatives in Congress have passed laws that lump their shares and put their transmitting into the hands of government and commercial stations except on one band of wave-length, I can claim only one-twentieth of my one-and-eight-tenths per cent of a second for the operation of my own transmitting set. That is .000907 of a second. If there are 1000 localities in which radio is used and I can operate in my locality without disturbing anyone in any of the others, then I figure that I ought to have 1000 times as many seconds, and that is about nine-tenths of a second.

A small difficulty creeps in here. In my locality there are ten million people within range of even a low power transmitter. So instead of dividing the time with 110,000, the average population of the thousand localities, I should divide with more than 91 times that number, which cuts me down to about .01 of a second. Also, I would like my share of time, about 8:30 P.M., after dinner is over and I know the amateur I want to radio to is home and ready for business. But that is just the time when all the other folks find it most convenient to open up or listen in. Somebody has to wait or else, in justice, we have to divide up the two or three most desirable hours among the ten million instead of figuring on a basis of twenty-four hours.

I heard a gathering of amateurs vote, after deliberate consideration, that they would not wait for anybody, unless compelled by law to do so. They knew that probably ten million people had, or soon would have, lumped their shares of the ether and, without asking for a chance to transmit, seek only to enjoy radio entertainment provided by stations that were able to give them what they wanted. The attitude of these amateurs appeared to be that it was up to the Government to give the minority the ether regardless of the majority. Their main argument was that they were engaged in technical research and experimentation which was so valuable to the country at large that it deserved to be protected. It made me wonder how many of them were prompted by their interest in science to listen for the United States Bureau of Standards, or the Army and Navy laboratories, or the transmitters of the companies that maintain trained scientific men, before opening up, and possibly causing interference. To be sure, the Government has reserved bands of wave-lengths for its own use, and yet it is possible for Government experimenters, while listening in, to be interfered with by nearby amateur transmitters.

The value of the work of some technical amateurs is undeniably great and is generally recognized. It is my impression, however, after much listening in, that the men

Give Your Radio Set the Advantage of WESTINGHOUSE RADIO BATTERIES



Westinghouse "A" Batteries are especially built for the peculiar requirements of radio work. They deliver a constant, dependable flow of low voltage current. They are built to give long, low-cost service. They demand a minimum of attention.

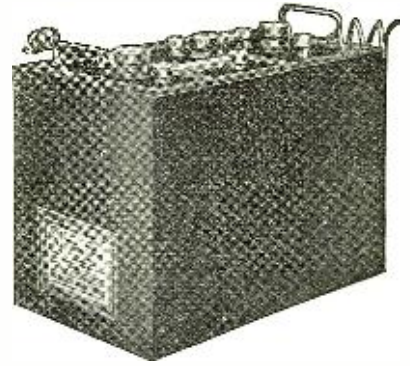

In the Westinghouse "B" battery you have a storage battery for "B" work—the latest development in radio practice. It has all the reliability and dependable performance of a storage battery and none of the disadvantages of a dry cell. The Westinghouse "B" gives a steady, continuous, noiseless service. It lasts indefinitely.

When exhausted it is easily recharged. The first cost is the last cost.

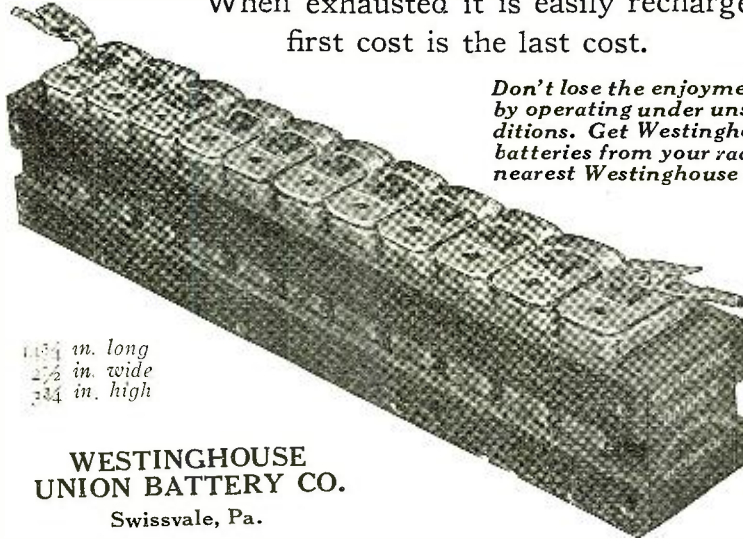

11 1/2 in. long
2 1/2 in. wide
3 1/4 in. high

Don't lose the enjoyment of your Radio by operating under unsatisfactory conditions. Get Westinghouse "A" and "B" batteries from your radio dealer or the nearest Westinghouse Service Station.

"The best Westinghouse can build"

**WESTINGHOUSE
UNION BATTERY CO.**
Swissvale, Pa.

(My) _____ (Name) _____ (is) _____

Boys and Grown Ups **MEMO - CODE** **Makes You a Real Radio Operator**

Copyrighted

KNOW MORE THAN THE OTHER FELLOW!

By my System and Chart, you will know the Code in 30 minutes. Get the real thrill of "Radio News"

COMPLETE SYSTEM \$1.00 Ask Dealers or Direct

H. C. FAIRCHILD 588 Broad St., NEWARK, N. J.

Immediate Shipment on Clapp-Eastham Sets

Type HR Regenerative Receiver, and type HZ two step amplifier. Regeneration is perfect on all wave lengths between 180 and 825 meters.

The range or distance from which signals are received and the clear sharp tones are a revelation to the experienced Radio man as well as to the person who "listens in" for the first time. The specifications tell the story to the expert and the Clapp-Eastham guarantee of satisfaction protects every purchaser of a Clapp-Eastham Radio set. Expert and Amateur alike.

SPECIFICATIONS

PANELS—Formica, handsomely finished.
 CABINET—Solid mahogany.
 CONDENSER—Balanced type with vernier.
 DIALS—Indestructible metal.
 ANTENNA-INDUCTANCE—Wound on formica tube.
 PLATE INDUCTANCE—Wound on molded ball.
 BINDING POST—Black rubber covered.
 SWITCH—Fan Blade.
 RHEOSTAT—Clapp-Eastham, type H400.
 CIRCUIT—Single circuit regenerative. Licensed under Armstrong U. S. Patent.

DEALERS — DEALERS

We can ship Clapp-Eastham sets within twenty-four hours.
 Write for our interesting sales proposition.

THE WHITALL ELECTRIC COMPANY
 SPRINGFIELD, MASS.

FOR SALE

Broadcasting Radiophones

- No. 660 500 Watt Type 300 to 500 miles Range
- No. 880 1000 Watt Type 500 to 1000 miles Range
- No. 990 2000 Watt Type 1000 to 3000 miles Range

Automatic Panel Type, using very latest domestic and foreign developments, insuring perfect modulation and maximum range. Early deliveries.

Newspapers, Department Stores, Universities and others may obtain full particulars from

MR. C. C. MUIR
 104 East 25th Street 8th Floor
 NEW YORK CITY

**211 RADIO MANUFACTURERS and DEALERS are now using our
 BINDING POSTS, SWITCH POINTS, ETC.**

The Reason QUALITY, SERVICE, PRICE

PREMIER DENTAL MFG. CO. 60 N. 2d St., PHILA, PA.
 SCREW MACHINE PRODUCTS *Get Our Literature*



SEXUAL KNOWLEDGE

320 Pages Illustrated Cloth
 By WINFIELD SCOTT HALL, M.D., Ph.D.
SEX FACTS MADE PLAIN
 What every young man and
 Every young woman should know
 What every young husband and
 every young wife should know
 What every parent should know
 Table contents & Commendations on request

\$1.00
 Postpaid
 Mailed in plain
 wrapper

AMERICAN PUB. CO., 624 Winston Bldg., Philadelphia

MAKE AND REPAIR YOUR OWN DEVICES ELECTRIC HEAT

JUST OUT—For the Journeyman and Experimenter
 How to Figure and Build Units. Where to Get Real Resistance Wire Without a License. What Materials to Use and How; What not to Use and Why. The Results of 5 Years and \$100,000.00 of Electrical Heating Development Exclusively. Learn the Branch of Electricity With the Biggest Future. Handy Pocket Size. Cloth Bound. for Only \$2.00. Postpaid. Money Returned if Not Satisfactory. Send Today.
ALEXANDER SWAN, 2d
 314 E. Third Street. Los Angeles, Calif.

who are doing the most valuable work do it after the most of us are in bed and asleep. They seem to select the hours when there is the least danger of their creating or encountering interference. Incidentally, they are not as a rule the hardest kickers. They accommodate themselves to the schedules of the majority.

For a number of years my work necessitated my estimating carefully the percentage of members of an efficient organization, who carried out its program consistently and achieved results. From this experience I feel safe, though I hope I am not, in offering to anyone who will prove to me that one out of every four of the organized radio amateurs of the United States is doing work that compares favorably in usefulness with that which is done under government auspices, a dinner at the Waldorf-Astoria and a pair of seats at any show he wants to see. If so many were, would not the published lists of calls heard be longer? These lists seem to show that comparatively few members are reporting to their own organizations. If the majority believed that their reports were of value, would they not send them? On the level, how many have any ideal before them except to enjoy the use of the latest scientific marvel and entertain a limited circle of friends? How many are doing work that would justify giving them the right of way at any time when a larger number of citizens wanted the ether? How many of the "calls heard" represent messages that could not have waited until after all danger of interference with an evening concert or a government broadcast had passed?

The promotion of radio as a means of exchanging individual communications has already resulted in making the air around our cities sound like a swimming pool when the boys' class is in. You may be able to distinguish a word now and then but you don't know who said it. This type of radio activity is putting the brakes on itself as effectually as a pair of skis that decide to go in different directions. Even when local amateurs attempt to regulate themselves, their success is possible only so long as their number is limited to a very small proportion of the population. If amateur transmitters continue to multiply, the complaints against them will eventually set a brake with a Government seal on it or their activities will automatically drive out all but those who are selfish enough to outdo their fellows in jamming.

The answer to the whole problem, from my point of view, is: put the brakes on transmission and boost the business of listening to broadcasts. It would be unjust to place insurmountable difficulties in the way of even the boy who has already purchased a spark set, but is it not a worse injustice to encourage beginners to install transmitters in view of the present situation, except in isolated districts? Temporarily, manufacturers, dealers and customers may be embarrassed by a shortage of receiving apparatus, but it will not take American manufacturers long to solve that difficulty.

Promote interest in the Government broadcasts. They will always be more important than any others and to many they will always be more interesting even than the excellent amusement programs provided by private concerns. There is something wrong with the citizen who does not want to hear what his Government is doing. A good many have acquired only enough interest so that they wire their representatives to find out what Congress is doing and stop it. Radio will enable us to get in a few minutes a day enough direct informa-

tion to decide whether what the Government is doing should be stopped or encouraged. Incidentally, it will be a help to manufacturers who are maintaining expensive broadcasting service to have Government broadcasts to fall back on if the increasing demands of entertainers, song writers and lecturers make the cost prohibitive. There must be something in the air all the time in order to keep the receiving sets selling.

The Government broadcasts, being usually on higher wave-lengths, create a demand for different types of receivers and a well-distributed demand is far better for the radio business than a demand concentrated on short-wave apparatus.

Boys should be interested in learning to receive code broadcasts. Picking up telephone stuff will not interest live youngsters long. It is too easy. They want to know something that everybody does not know. The Government offers them connections with the Army and Navy which do not obligate a boy to become a soldier or a sailor but to give him a sense of importance and a spirit of responsibility.

We should interest every community in completely organizing its radio service and getting everything that is in the air that would be of benefit to any of its citizens. The present radio craze can be turned into many useful channels. Successful American newspapers are never monopolized by one subject or a single group of subjects. Men seldom read the fashion pages, but these pages sell a lot of papers. Women pass over the sport news, but this appeals to thousands of men. Every department from the automobile column to the daily chess problem interests somebody. And so in radio we should encourage the market broadcast, the health lecture, the talks on radio and aeronautics, the business report, the weather forecast, the news digest, the toll broadcasting, the experimental work that is in competent hands. We should encourage all these in a definite way. We should encourage radio from the bottom up—from the home-made tuning coil and the crystal detector to the multi-stage amplifier. We should encourage it by making it possible for people to hear something worth while, and that means giving the "ham" his share of the air at a time of day when he will interfere least with the majority of radio users. It is unfair to concentrate on developing in the beginner the idea that transmitting is the all-important thing and then forcing prohibitions upon him. The painless and constructive method is to concentrate on teaching every beginner first to listen, and making him see that the big thing in radio is to pick up information of importance and give it to those who will be benefitted by it. By so doing he will be of immediate and definite value to his home town, to his Government and to Radio—a driving wheel and not a brake.

An Ultra Compact Radio Receiver

(Continued from page 1083)

posts are required, but these are mounted on the case, and not on the panel.

The size and construction of the case is shown in Fig. 4. The box is made, neatly, of three-eighth-inch hardwood, the entire box and lid being made in one piece and then sawed in two along the line marked "Saw Cut." This method overcomes many of the construction difficulties involved otherwise. As previously mentioned, the binding posts are mounted on the outside of the case, one for antenna, for ground

CONN RADIO CONCERTS

from
Ocean to Ocean



Brass Choir
San Francisco Symphony
Orchestra



Pictured here are some of the artists appearing in Conn Radio Concerts. Above—Frank Westphal's Rainbow Garden Orchestra, Chicago.



Ernest Pechin
Cornet Soloist



Mathew Amatore
Saxophone Soloist



John Dolan
Cornet Soloist



Simone Mantia
Euphonium Soloist



Eugene LaBarre
Cornet Soloist

THIRD OF NATIONAL SERIES Friday Evening, May 19

CONN radio concerts have taken the nation by storm! Our programs of March 17 and April 14 by America's leading dance orchestras and nationally famed soloists have occasioned universal admiration for Conn enterprise.

Isham Jones, Joseph Smith, Frank Westphal, Hal Nichols, D. C. Rosebrook and their orchestras have already played; Benne Henton, Charles Randall, John Leick, Mable Keith Leick and Fred Tait have given solos. More of their calibre are to appear.

Travelers on shipboard 1500 miles from the Atlantic and Pacific coasts, people in Northern Canada and in Central America will enjoy the same music which will be heard throughout the United States May 19.

Think of it—Conn Ltd. is entertaining people by wireless a quarter of the way around the globe

May 19 programs will be broadcasted from:

- New York, Station WJZ;
- San Francisco, Station KDN;
- Detroit, Station WWJ;
- Chicago, Station KYW;
- Pittsburgh, Station KDKA;
- New Orleans, Station WAAB;
- Denver, Station ZAF;
- Kansas City, Sweeney Station
- Seattle, Wash., Station KGB

Conn dealers are entertaining at radiophone concerts. Watch for local announcements.

Write to Conn Ltd. now for new saxophone book; FREE. Tells why the Conn is the world's finest, choice of the famous artists on the radio programs.

690 Conn Building C. G. CONN, LTD. Elkhart, Indiana
Agencies in All Large Cities

- Conn New York Co., 233-5-7 W. 47th St.
- Conn Chicago Co., 62 E. Van Buren St.
- Conn Detroit Co., 243 E. Grand River Ave.
- Conn Seattle Co., 1609 Third Ave.
- Conn New Orleans Co., 317 Baronne St.
- Conn Portland Co., 127 Tenth St.
- Conn Cleveland Co., 1220 Huron Road



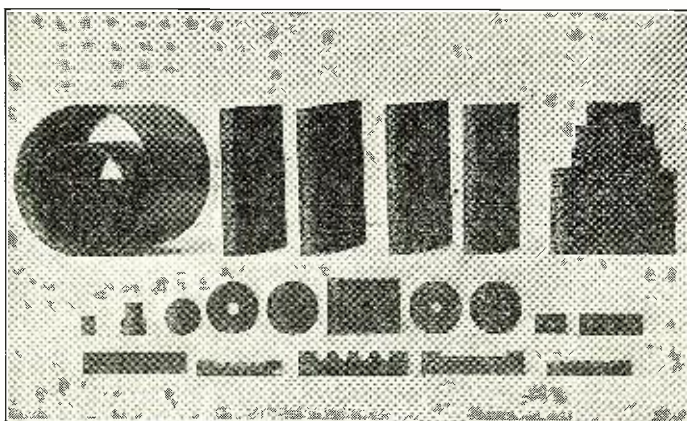

RADIO INSULATION

Vulcanized fibre is the best insulation that can be secured for your Radio Apparatus because of its high dielectric resistance, mechanical strength and adaptability of being machined accurately into almost any shape. It should be used for panels, coil cases and other insulating parts in your wireless outfit. Write today for samples and full information of

"THE INCOMPARABLE INSULATION"

which we manufacture in sheets, rods, tubes and all kinds of special shapes.

| | | | | | |
|--------------------------------|----------------------|----|----|-------------------------|----------------------------------|
| DELAWARE HARD FIBRE CO. | | :: | :: | Wilmington, Del. | |
| New York..... | 50 Church Street | | | New Haven..... | 209 Plymouth Bldg. |
| Pittsburgh..... | 1st Nat'l Bank Bldg. | | | Boston..... | 170 Summer Street |
| San Francisco..... | 235 Pine Street | | | Philadelphia..... | Fuller Bldg. |
| Toledo..... | 415 Ohio Bldg. | | | Rechester..... | 1040 Granite Bldg. |
| Chicago..... | 564 West Monroe St. | | | Dayton..... | 314 Dayton Savings & Trust Bldg. |

and two for 'phones. The positions of these may be varied to suit the taste of the constructor.

The circuit for wiring is shown in Fig. 5, and is a standard loosely-coupled crystal circuit. If the constructor finds it possible to add a variable condenser across the secondary, additional tuning accuracy will be found as well as an increase in wave length.

The original tuner is shown in Fig. 6, alongside of a Marconi Type 106 ship tuner. Some idea of the size can be formed

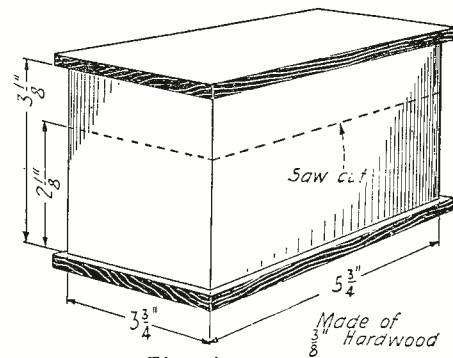

Fig. 4

Details of the Cabinet Construction.

CONDENSERS

- | | | | |
|---|----------------------------|--------|---|
| W | 43 Plate with 3" dial..... | \$5.00 | W |
| | 23 Plate with 3" dial..... | 4.00 | |
| | 3 Plate, with 3" dial..... | 3.00 | |

1 1/2" Rotary Switch Lever with 14 contacts, 2 Binding posts, 2 stops..... \$1.00

Crystal Detector Price \$1.00

Patent Pending



WESTFIELD MACHINE CO., Westfield, Mass.

New York Office 50 Church St.

from this comparison, and some of the details can be distinguished in the cut. This tuner, the small one, is being used in the vicinity of New York City, and at a distance of thirty miles from the radiophone broadcasting station, WJZ, at Newark, N. J. The music from this station was picked up on a small bell-wire antenna. The voice and music was very clear, the intensity good for the distance and antenna used. Ships on 600 meters came in fine; WHE could be heard on 1,800 meters, but required an additional loading inductance for that purpose. The general efficiency of this tiny set is very high in comparison to standard commercial and naval crystal receivers, and if each detail is carefully worked out, a fine little receiver will be the result, one well worth the time and money spent.

Recruiting by Radio

(Continued from page 1080)

KECO-RADIO STORAGE BATTERIES

The highest grade of battery built especially for the wireless instruments.

Solid oak box, natural finish, highly varnished, 6 Volt, 7 heavy "Cristol" Plates per cell, 60 Amp.

We are the largest builders of exclusive wireless batteries in the country. Thousands in use. Sold by all leading dealers or shipped direct, \$15.50 F.O.B.

KALB ELECTRIC CO. - - 7323 Manchester Avenue, St. Louis, Mo.

Dealers write for discounts for 1922



CONDENSERS

VARIABLE, 23 AND 43 PLATE
\$3.25 AND \$4.25; DIAL EXTRA

PHONOGRAPH ADAPTORS

FOR ANY COMBINATION OF RECEIVER AND PHONOGRAPH
IMMEDIATE SHIPMENT

MANUFACTURER

STUCKEMAN BROS., Inc.
18 RUTH ST. PITTSBURGH, PA.

Our new receiving sets are out this month. The ideal set for the beginner at an attractive price

The CONCERTINA \$45⁰⁰

We rewind your phones to any ohmage.
With No. 40 wire, per phone.....\$1.25
With No. 44 wire, per phone.....1.50

The Ridgewood Radio Shop

1603 Myrtle Ave., RIDGEWOOD, L. I.

present increasing popularity, no one can forecast the vastness of its future, but it is safe to say that in the next few years there will be an opportunity for the trained man in this field of endeavor that will be comparable to the early days of the motor car. The Air Service today presents its strongest appeal to the young man mechanically and electrically inclined, but, who through lack of experience, is unable to fill a position in a commercial shop. One enlistment in the Air Service well spent will fit that man to hold his own in any trade that he may have followed in the service. If you think that you have the qualifications and desire to join the Air Service you should apply to the Recruiting Officer, Army Building, 39 Whitehall Street, New York City, for further information, or better still, come out to Mitchel Field and see an aviation field in actual operation and have the Post Recruiting Officer go into the matter with you in detail. Who knows, but that this may be the very opportunity you are waiting for?"

Thus it was possible for everyone for miles around, and ships far out at sea, to

hear Mitchel Field's call for two hundred men. After sending out the above call, the field is now determined to back up every statement made, in order that men reporting to this station for enlistment will not be disappointed in their desire to learn a technical trade to which they may turn upon going back to civil life.

Unsteady Arcs

(Continued from page 1080)

After a number of days at sea, the operator gains confidence in his ability, and his timidity in handling the arc disappears. He feels that he is now prepared to break all long-distance records, and begins to overload his arc to its limit, and oft-times discovers that he is unable to balance the absorbing circuit with the antenna circuit, which are now indicating, say, for instance, 8 and 10 amperes, respectively; a fact which shows that the circuits are out of balance to the extent of 2 amperes. This does not phase him in the slightest, and the fact that the radiation meter is swinging from 8 amperes to 10 amperes each time the key is depressed seems natural. This is due to his spark habit of watching the meter go up and down the scale while transmitting. With the arc radiating 10 amperes into the antenna he feels that he should do great work, but to his surprise he is told by the receiving operator that his tone is unsteady and that he is much harder to read than when his signals were weak.

After many repetitions he finally gets his traffic off. His admiration for arcs falls rapidly; he begins to lose interest and to condemn the arc and its complications. He does not realize that oft-times the cause of the trouble lies in his formed habit of watching the radiation-meter swing each time the key is closed; and that, in arc operation, the only time the radiation meter makes any appreciable change in its readings while transmitting is when it is out of balance. This is an indication that the arc needs adjustment.

It is surprising how many operators will deliberately unbalance their arcs to see their antenna radiation increase. The fact that the antenna circuit is radiating 2 amperes more than the absorption circuit pleases them instead of giving them cause for worry. When one of the radio-frequency circuits indicates 8 amperes while the other reads 9 or 10 amperes radiation, a very unsteady and unsatisfactory note will be emitted by the arc due to the change in the generator's speed and e.m.f., which is caused by the swinging load. The greater the load, the greater will be the e.m.f. drop and the slower the speed of the generator, and vice-versa. This causes the motor-generator to race back and forth, producing a constantly varying voltage on the arc, and causing it to draw more or less current. The arc-length adjustments for 8 amperes and 10 amperes radiation are slightly different, hence another factor adding to the propagation of an uneven tone.

An experienced arc operator knows that a steady arc where the radiation meter barely moves when the key is depressed—and the load thereby shifted from the absorbing circuit to the antenna circuit—can be copied at a great distance on 7 amperes radiation than a baldly balanced arc on 9 amperes. It seems difficult to convince the "off the scale" spark operators of this fact. This is one of the most common causes of the unsteady arc tone when the apparatus is operated by inexperienced CW men, and the sooner they learn to balance their radio-frequency circuits properly so that the radiation meter varies only slightly, if at all, its position on the scale when the key is being manipulated the better will be the results obtained,

No. T-100

No. T-101

No. T-102

No. T-103

No. T-104

No. T-105

N-S NAA CRYSTALS

N-S RED-HEAD PHONES

Introducing Seven Better Radio Instruments

15 years of direct contact with the radio field has enabled us to develop these products. Each has new and unusual features that place it far ahead of common types—not one is a rushed-on-the-market experiment.

HERE THEY ARE

No. T-100 Reversible Rheostat
—Heavy metal plates of novel design form substantial case for condenser. Mica dielectric, capacity .00029 MF. Highly nicked and polished, mounted on insulating base. Can be removed for panel mounting.
—a BETTER rheostat
Price \$1.00

No. T-101 V. T. Socket—Mechanical features that make it the only socket on the market that is genuinely rigid and strong when used for panel mounting and perfectly adapted to table or brass mounting. All metal with Bakelite contact support.
—a BETTER socket
Price 75c

No. T-102 Stopping Condenser
—Heavy metal plates of novel design form substantial case for condenser. Mica dielectric, capacity .00029 MF. Highly nicked and polished, mounted on insulating base. Can be removed for panel mounting.
—a BETTER stopping condenser
Price 75c

No. T-103 Grid Condenser, of similar design as above. Proper capacity for grid circuit in V. T. Hookups.
—a BETTER grid condenser
Price 40c

No. T-104 Moisture-Proof Variable Grid Leak—arranged for front of panel mounting in connection with Grid Condenser. Nicked and Polished cover.
—a BETTER grid leak
Price 60c
—and better than ever the famous

N-S "Red-Head" Phones—3000 chms. A triumph in Radio Receiver design. Beauty of design and ruggedness of construction coupled with a supreme sensitiveness are features that make "Red-Heads" the ideal telephone receivers for radio work.
Price with Cords \$8.00
—and

N-S NAA [Arlington Tested] Supersensitive Crystals, individually tested and packed in convenient metal boxes Galena, Silicon or Goldite, price each 25c. Same mounted in cup, 40c each.

No. T-105 Crystal Detector—New and ingenious design provides every adjustment to facilitate proper contact with the crystal. Contact wire can be moved to any point on crystal. Pressure can be easily regulated. Contact wire instantly renewable
—a BETTER Crystal detector
Price \$1.00

No. T-106 Adaptaphone—Converts the sound chamber of phonograph into a loud speaker. Made of high-grade rubber. Will not scratch or mar parts or phonograph. Not necessary to remove cap from receiver. Will fit all phonographs except the Brunswick.
—a BETTER adapter
Price \$1.00

Number yourself among our thousands of friends and customers who know the reliability and accuracy of N-S Radio Products.

Send for new Bulletin which describes these products in detail.

Dealers: Write for our very attractive proposition
IMMEDIATE DELIVERY

RADIO BATTERY HANDLES

Send 50 cents
Canada 65c

Buffalo Sales Co.
322 Ellicott St.,
BUFFALO, N. Y.
Dealers wanted

| ENAMEL | | SCC. | | | | |
|--------|-------|---------|---------|-------|---------|---------|
| Size | 1 lb. | 1/2 lb. | 1/4 lb. | 1 lb. | 1/2 lb. | 1/4 lb. |
| 22 | .48 | .28 | .16 | .95 | .52 | .30 |
| 24 | .55 | .31 | .18 | 1.05 | .57 | .32 |
| 26 | .60 | .34 | .19 | 1.21 | .65 | .36 |
| 28 | .64 | .36 | .20 | 1.36 | .73 | .40 |
| 30 | .68 | .38 | .20 | 1.70 | .89 | .48 |

LITZ WIRE, AERIAL WIRE
from 20c to \$1.25 per 100 ft.

TUBES for TUNING COILS
Etc. Etc. Etc. Etc. Etc. Etc.

REEL EASY PRODUCTS

I. R. NELSON COMPANY
BOND STREET
NEWARK, N. J.

secondary winding. Number 36 D.C.C. permits 78 turns per inch. The secondary unit is to be wound in one pie in layers well insulated with thin empire cloth.* Allowing three and one-half inches for the winding space we will be able to place 270 turns on each layer. (It figures 273 but the average winder will not be successful in putting that many on each layer—considering this in the light it should, I have allowed but 270 turns per layer.)

We must also take a middle tap from the secondary winding at 1,350 turns which is half of the total secondary winding of 2,700 turns. By dividing 1,350 by 270 we ascertain that it will require exactly five (5) layers for one-half of the secondary, and ten layers for the complete winding. Care should be exercised in winding the second secondary section to see that it is wound in the same direction as the first winding.

After the windings are placed on the core pieces and the end pieces are alternately fitted in so as to form the closed core type of transformer, the two end pieces (shown in figure 3) are slipped on and the bolts 3 are screwed down upon the lamination joints until they are as tight as it is possible to get them. These end pieces come with the phase-splitting transformer and aid materially in having the transformer perform at its greatest degree of efficiency. There are four end pieces protruding one from each side of each clamping piece. These are shown by No. 1 in Fig. 3. A piece of bakelite was cut to fit on each side of the transformer and binding posts were mounted as can be seen in the photograph. The primary winding and filament lighting source coming to one side of the transformer and all the secondary leads to the piece secured on the other side of the transformer.

Figure No. 4 shows the circuit at its best. To begin with, the middle tap of the secondary winding must be connected to the middle tap of the primary winding through a choke having a value of approximately 1.5 Henry.

In the secondary legs are two radio frequency chokes comprising ten turns No. 8 bare wire three inches in diameter—spaced one-eighth inch between turns. Two .001 condensers are connected in series and the middle tap connected to the antenna and top of inductance unit. The two ends of the secondary winding go to both sides of the condenser unit and to the two plates as shown. Both grids are in parallel and connect to the bottom end of the inductance unit through a .0005 mfd. condenser.

The 7.5-volt source is brought to the two filaments which are connected in parallel and the middle tap continues on to the bottom side of the variable condenser of .001 mfd. capacity which has its other side connected to the bottom of the tuning inductance.

For signalling a 5,000-ohm resistance was connected in series with a telegraph key—this in turn shunted across the grid-filament circuit. The radiation ammeter is connected in the ground lead. In order to further effect 100 per cent rectification and reduce the A.C. hum—two 1 mfd. condensers are connected across both the A.C. primary source and the filament lighting leads. The middle taps of the condensers are brought to ground as shown in the drawing.

GENERAL CONSIDERATIONS

If a separate lighting transformer was

*The author had considerable trouble with various forms of windings. Pies are liable to break down every time and if the reader will take my advice obtained from hard work—performed in rewinding four or five secondaries in every shape and manner (and incidentally cutting several veins in my right arm on the fourth affair) he will follow the above directions out to the letter when building the secondary unit.

W. R. C. on Radio Goods Stands for the Same as Sterling on Silver.



Dealers!

Every article distributed by the Wintner Radio Corporation is subject to a rigid laboratory test.

We are manufacturers' distributors with sole rights in many states, and have available supplies for immediate delivery.

**Head Sets :-: Tubes
Variable Condensers**

- Fixed Condensers
- Variometers—Varicouplers
- Lightning Arresters
- Detectors—Sockets—Transformers
- Batteries and Battery Chargers.

Complete assortments to start your Radio department at \$250 - \$500 - \$1000.

WINTNER RADIO CORPORATION
115 WEST 30th STREET NEW YORK CITY

Telephone 0373-0374 Watkins

GALENA TESTED CRYSTALS — Wholesale Only

Condensers—11—21—41 Pl. K. D. use these in your manufacturing and put them in your new catalog.

Binding posts—switch points—switches. Wireless phone tuners— all prices and types. 24-page catalog—10c.

TRESCO - - Davenport, Pa.

Licensed Under Armstrong Patent No. 1113149

Newark Wireless Exchange

We carry all makes of wireless Apparatus

Send 10 cents for catalogue

87 Halsey St., Newark, N. J.

THE crystal receiving set

**PINK-A-TONE
DETECTOR of the air**

Manufactured by
PINKERTON ELECTRIC EQUIPMENT CO.
National Service Co., General Sales Agent
1831 Broadway, New York

EASTERN CLASSIC RECEIVING SETS

Model 101—102

MUSIC, News Reports, Opera Concerts, Talks brought right to your home. All the above is yours through the Eastern. The Eastern Classic is constructed with the finest instruments made. Each set is enclosed in a solid mahogany cabinet of the utmost ruggedness and beauty.

MODEL 101 is our improved detector unit tube type having a wave-length ranging from 200-1,500 meters. Its receiving capacity will bring the broadcasting from a distance approximately 125 miles. All sets equipped with the new type vernier rheostat, giving a much finer adjustment, which tends to eliminate distortion in the phones. Each set equipped with head phones and aerial equipment. List Price **\$75.00**

Model 102—two stage amplifier unit. List Price **\$125.00**

EASTERN RADIO MANUFACTURING CO.
122-124 Fifth Ave. (Near 17th St.) New York City

IMMEDIATE SHIPMENT



We can offer immediate shipment on orders for any of the items listed below. Postage must be included with all orders.

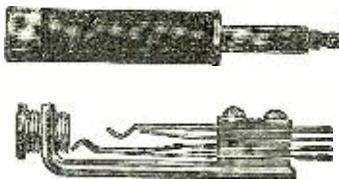

- Bakelite dials—drilled for 1/4 in. shafts \$1.00
- Plugs and jacks as illustrated—complete 1.50
- Plug only75
- Jack only85
- Socket as illustrated 1.00
- 10 to 1 Ratio amplifying transformer—guaranteed 4.50
- Binding Posts—black satin finish10
- Bakelite panel—3/8, 3-16 or 1/4—cut to size—runs 20 cubic inches to the lb—cutting charge, 35c per lb. 2.00
- De Forest condensers—panel mounting .0005 M.F. 4.50
- Mesco 1 KW. keys—1/4 inch Sterling silver contacts 2.75
- Trumbull-Vanderpoel antenna switches 3.25
- Acme 1/2 K.W. fully mounted transformers, regular price \$30.00—Our Price 17.50
- Beaugrand panel switch 1 1/2 in. radius60
- Skinderviken transmitter buttons70

Send 15c for complete literature.

ELECTRICAL SPECIALTY COMPANY

48-50 South Front Street

COLUMBUS, OHIO



SAVE MONEY ON STORAGE BATTERIES FOR WIRELESS USE

- 6 volts 40 amp... \$9.00
- 6 volts 60 amp... 13.00
- 6 volts 80-100 amp 19.50

Batteries shipped fully charged, ready for use. Guaranteed 18 Months on Adjustment

Distributors, Jobbers, Dealers—write for discounts. If your dealer can't supply you, send check or money order direct.

LIBERTY BATTERY CO.
4241 Armitage Avenue, Chicago, Illinois

AERIALS

A complete, two-wire Antenna Equipment, consisting of

- Two Adjustable Masts Insulators Guys
- Antenna Wire Spreaders Rope, etc.
- 20 ft., \$22.00 30 ft., \$26.00 40 ft., \$30.00

Shipped knocked down in sections—express Collect—with full directions for setting up.

Fits any slant roof—Easily set up. Write for descriptive circular to

HUDSON ENGINEERING COMPANY
Radio Division OSWEGO, N. Y.
SOLD EVERYWHERE

used the telegraph key could be connected directly in the primary side of the 500-volt power transformer.

BEST TO USE SEPARATE LIGHTING TRANSFORMER

There is no doubt in my mind that a separate lighting transformer would be the proper way to operate C.W. sets from A.C. sources. When the tubes begin to oscillate it is absolutely necessary to watch the filaments because there is some action in the transformer itself which causes an overload to the filament. Contrary to the general belief—it is a fact that even though the windings are properly selected—there is a favorable chance of burning out filaments when the tube is oscillating. For this very reason the author placed a variable resistance in the filament circuit of the tubes—even though the filament supply source registered seven and one-half volts on an A.C. voltmeter during a considerable number of tests. Another thing to consider is the fluctuation of line voltage common to house lighting sources.

For most efficient operation it is absolutely necessary to use two transformers. I myself offer no good excuse for using the transformer as it stands, with the exception that this is the first chance I have had at a close up of the operating characteristics of such types of transformers.

CONDENSERS

If you value the price of transmitting vacuum tubes be positive that all your condensers selected for operation in this particular circuit are of the best kind procurable. Faulty condensers may mean two tubes as fast as you put them in the socket. Two tubes went out of existence for me when the .001 mfd. condenser plates touched and the .0005 mfd. grid condenser punctured on the ends of a poorly constructed condenser of that type. This permitted the high voltage to jump between the grid and filament and it took but one jump in each tube to destroy the filaments. For the .0005 mfd. condenser it is recommended that one be built up from a sheet of 1/8th flint glass measuring 7" x 7" square—place the foil on each side with shellac, allowing one-half inch around the edges. The .001 mfd. condenser should be of the variable oil immersed type. Castor oil or or transil oil will do. It will be preferable to use the latter for the cost of castor oil has long been above our pocketbooks. *Take the former after burning out several good Radiotrons—especially the U.V. 203.*

The two .001 mfd. condensers connected in the plate circuit can be constructed as follows: For each condenser having a capacity of .001 plus, take two plates 1/8th inch in thickness by 7" x 7" square. Put foil on both sides as described above. Connect them in parallel. You will require four plates for the two condensers.

It is a very good idea to shunt a small .0005 variable condenser across the inductance unit so that the wave-length adjustments may be brought about more precisely. This is shown in the drawing by the dotted lines.

HIGH VOLTAGE CONSIDERATIONS

The Radiotron U.V. 202's have held up on a 600-volt plate potential. On this voltage the tubes require less filament voltage. It is not the best thing to do and for those who desire a lower voltage than that given in the beginning of this article the following modifications are given. Letting the primary stand "as is" i.e., 270 turns

| Plate Voltage each tube in circuit | Ratio | Secondary Turns, each leg of winding | Total Turns on secondary |
|------------------------------------|-------|--------------------------------------|--------------------------|
| 350 (normal) | 6.363 | 859 | 1718 |
| 400 | 7.272 | 981.5 | 1963 |
| 450 | 8.181 | 1104 | 2208 |

Design of an Audion Control Cabinet

(Continued from page 1087)

The sub-base is slotted at "A" and when panel is pushed in flush the slot will be astride the screw at "A" which is then tightened. The upper corners of the panel are held in place by mounting small brass angle pieces in the top of the cabinet and then putting 8/32" flat-head machine screws through countersunk holes in the panel corners and into threaded holes in angle pieces. A door is set in the back of the cabinet and hinged, thus allowing free access to the tube and leak.

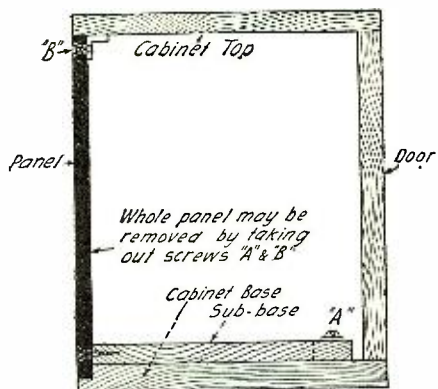
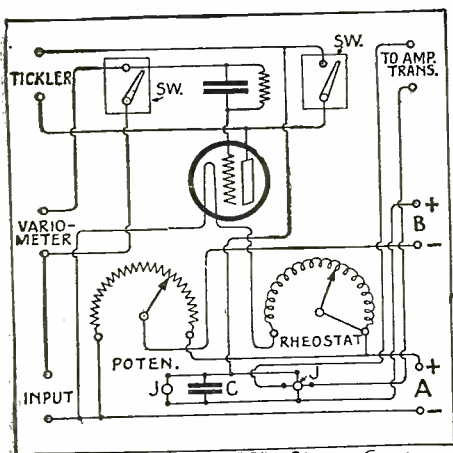

Fig. 2

Sectional View of Cabinet Showing Method of Mounting.

The dials were made of thin sheet aluminum in the following manner. Cut the dials 2" in diameter. Square up the end of a piece of 1 1/4" pipe and very slightly round its outside edge. Place pipe in a vise and then lay the dial on the end of the pipe, taking great pains to center it accurately. This will be held in place with the thumb while with a very light machine hammer you tap around the edge of the dial until you have a saucer about 1/8" deep when turned over. This task is not a bit diffi-



J" = Jacks "C" = Phone Cond.

Fig. 3

Complete Wiring Diagram of the Detector Control Cabinet.

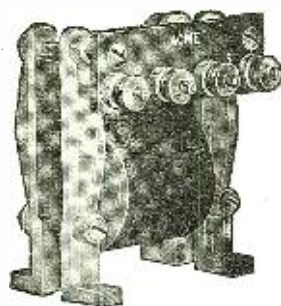

Amplifying Transformer

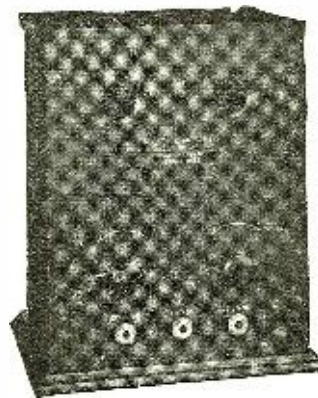

When You Amplify use Acme Apparatus

- ACME A-2 Amplifying Transformer
- ACME Y-1 Detector
- ACME Y-2 Amplifier
- ACME DY-10 Two Stage Amplifier
- ACME DY-12 Detector and Two Stage Amplifier

Radio Frequency Amplification Coming

ACME APPARATUS CO. CAMBRIDGE, MASS.

Transformers and Radio Engineers
and Manufacturers

NEW YORK OFFICE: 1270 BROADWAY



Wireless Supplies and
Equipment at
Wholesale

MORSCAN RADIO CO.
196 Market Street, Newark, N. J.

READ THIS DOPE

| | | | |
|--|---------|-----------------|----------|
| Wesco Antenna Wire | 250 ft. | 500 ft. | 1000 ft. |
| 7-22 Stranded Copper | \$2.20 | \$4.25 | \$8.00 |
| No. 14 Solid Copper | 1.60 | 3.00 | 5.75 |
| Wesco Magnet Wire—1/2 lb. Spools | | | |
| B and S, Ga. | Enam. | S.C.C. | S.S.C. |
| 20 to 24 | \$.55 | \$3.65 | \$3.90 |
| 26 to 30 | .65 | .95 | 1.30 |
| 32 to 36 | .80 | 1.40 | 2.15 |
| No. 23 Single Silk Covered, 90c per 1/2 lb. spool. | | | |
| Genuine Bakelite Panels—1/8 inch thick | | | |
| 6 in. x 10 1/2 in. | \$1.30 | 8 in. x 10 in. | \$1.50 |
| 6 in. x 14 in. | 1.50 | 12 in. x 14 in. | 3.25 |
| 6 in. x 21 in. | 2.25 | 12 in. x 21 in. | 4.75 |
| For 3/16 in. thickness add 50% to above prices. | | | |

Wilmington Electrical Specialty Co.
912 Orange St. Dept. G-7 Wilmington, Del.

Insure your copy reaching you each month. Subscribe to Radio News—\$2.00 a year. Experimenter Publishing Co., 236-A Fulton St., N. Y. C.

"ACE RADIO CONCERT RECEPTOR"

A
ACE
E

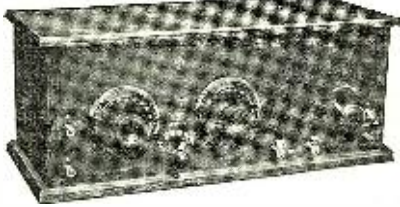

A
ACE
E

Licensed under Armstrong Patent 1,113,149

Type TRU Concert Receptor, \$50.00

This unit is especially designed for the efficient reception of Radio Telephone Concerts from even the most distant Broadcasting Stations. The ease with which this Receptor can be installed and the extreme simplicity of operation make it ideal for use by even the most inexperienced. No previous knowledge of radio necessary to secure results.

We stock a complete line of Radio Supplies and maintain a *prompt, reliable* Mail Order Service that reaches all over the world.

Send 5c in stamps for catalog to Dept. "A"

THE PRECISION EQUIPMENT CO., INC.

Manufacturers, Distributors and Retailers of Radio Apparatus

Cable Address
ACE
Cincinnati

Peebles Corner

Cincinnati, Ohio

Radio
WMH
8XB

cult and a very smooth job may be done with proper care. A hole is now drilled in the center of the dial and an 8/32" bolt is put through and tightened clear to the head with a nut. Place the bolt in the chuck of a lathe, electric drill or hand drill and while rotating it hold very fine emery cloth to the face of the dial until a very fine "spun" finish results. Do not use crocus cloth to finish as this puts an undesirable

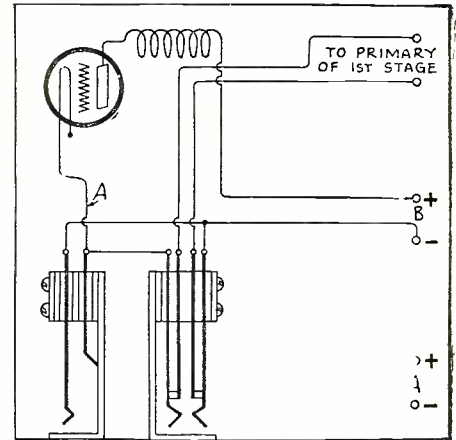

Fig. 4

Detailed Diagram for the Connections to the Jack Blades.

gloss on and destroys the satin or spun effect. The figuring on the dial will be left to the builder, it being done with black drawing ink. No description is necessary of the manner of putting dials on their knobs. It is a very simple and easy matter.

The tube socket, grid leak and grid condenser mountings are now mounted as are the instruments belonging on the panel and it is ready for wiring.

The wiring diagram is given in Fig. 3 (facing front of panel). No. 18 C.C. wire may be used for wiring. All connections should be soldered. After noting the diagram you will see that by closing the variometer switch a tickler circuit may be used, having tickler switch open. With grid and plate variometers both switches would be open, etc. It will readily be seen that there are ample posts to take care of all the various hook-ups in use today, without any bother.

The reason for the use of the two-circuit jack is to permit the addition of amplification. It is the writer's idea to build each stage in a separate unit carefully mounting binding posts on the different units so that they line up perfectly. When placed side by side they may be neatly connected

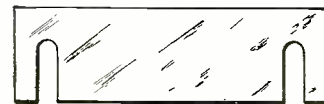

Brass Connecting Links - 12 Required
Fig. 5

To Obtain Good Contacts With a Large Surface These Links Should be Used Instead of Wires to Connect the Units.

by sheet brass connecting links, two of which are left in position in the photo for your observation. These links should be slotted as shown in Fig. 5.

It will now be understood that with the use of one two-circuit jack on each unit the primary of the amplifying transformer is automatically cut out when telephone set is plugged in. This of course makes it possible to plug into the detector tube

June EMPIRE RADIO Bulletin

FOR IMMEDIATE SHIPMENT

| | |
|--|--|
| <p>VACUUM TUBES</p> <p>Audiotrons (Double Filament Type) . . . \$6.00</p> <p>Radiotron UV 200 (Detector Tube) . . . 5.00</p> <p>Radiotron UV 201 (Amplifying Tube) 6.50</p> <p>Radiotron UV 202 (Power tube, 5-watt) 8.00</p> <p>VARIOMETERS AND VARIOCOUPLERS</p> <p>Fischer Variometer (Small Size) 4.50</p> <p>Fischer Variometer (Large Size) 7.00</p> <p>Fischer Variocoupler (Small Size) 5.00</p> <p>Fischer Variocoupler (Large Size) 7.50</p> <p>"B" BATTERIES</p> <p>2 1/2 V. (Small Size) "B" Battery . . . 1.00</p> <p>2 1/2 V. (Large Size) "B" Battery . . . 2.00</p> <p>2 1/2 V. (Large Size Tapped) "B" Battery 2.20</p> <p>4 1/2 V. (Large Size Tapped) "B" Battery 4.00</p> | <p>SETS</p> <p>Federal Jr., complete with aerial equipment \$25.00</p> <p>Aeriola Sr., Westinghouse Set 65.00</p> <p>Two Step Amplifier, for use with Aeriola Sr. 30.00</p> <p>Magnavox, Type R-3, for Radio Use . 45.00</p> <p>Vocarola, Westinghouse Loud Speaker . 30.00</p> <p>MISCELLANEOUS</p> <p>Moulded Vacuum Tube Socket75</p> <p>Fada Rheostat 1.00</p> <p>Thordarson Amplifying Transformer . . 4.50</p> <p>Acme Amplifying Transformer 5.00</p> <p>Chelsea Amplifying Transformer 4.50</p> <p>Federal Amplifying Transformer 7.00</p> <p>Radio Frequency Transformer 6.00</p> <p>Audiotron Adapter 1.50</p> <p>Western Electric Phones 15.00</p> <p>Chelsea Variable Condenser, .0005 . . . 4.25</p> <p>Chelsea Variable Condenser, .001 . . . 4.75</p> <p>Chelsea Bakelite Dial, 3 in. diameter . 1.00</p> |
|--|--|

Empire Radio Corporation

Manufacturers and Distributors of Radio Apparatus

271 West 125th Street

New York City

Radio Frequency Transformers

Type RT-1, for the amateur and broadcasting range, 175-500 meters. (Patent Pending.)

\$6.00

Will work on all tubes.
"The only completely shielded iron core R. F. transformer"



RADIO SERVICE LABORATORIES, Inc.

ASBURY PARK, NEW JERSEY

MONEY for You Add to your Salary—Make extra Pin Money. Start a lucrative business of your own. Spend an hour each day taking subscriptions for the "Radio News." We'll pay you well and you'll enjoy the work. Write for full particulars. Circulation Dept., RADIO NEWS, 236A Fulton St., New York City.

or any stage. With only one head-set in use it is plainly seen that the two-circuit jack must be used. In the average amateur station the second jack will seldom be out of use. Fig. 4 shows in detail the jack connections. Careful observation of the drawings and photos makes further explanation unnecessary.

The writer has the "dope" worked out for the amplifier units and will be pleased to submit same if this article gets by the editor's waste basket. He will also be very pleased to answer any question regarding this unit.

Wireless Masts

By Milford W. Howe.

I have read many articles in regard to length and height of aerials, but in very few cases are any descriptions given of methods of erecting the masts. For an inexpensive, neat appearing and durable mast, we found the ordinary iron water pipe the best.

Iron pipe can be procured, either new or second-hand. The latter is as good as new pipe if it is in fairly good condition. These pipes can be purchased at any hardware or plumbing shop.

A mast composed of pipe is not difficult to erect, if proper care is observed. Masts over 40' in length should be erected straight up. Masts under 40' can be raised at an angle or slant.

The following suggestions will aid in the erection of pipe masts:

The masts should be erected preferably on the end of a building. A socket is made on the peak of the roof at the end for the mast to slide through. About 6' of 8' below, a support is fastened having a slot through which the mast can slide. Part of the mast is placed in the socket on the peak and through the slot in the support. A pulley is placed on the support directly in line with the mast and so arranged that by pulling on the rope the mast is drawn straight up. A short piece of pipe (about 2') is attached to the lower end of the pipe and the rope is fastened to it by a hook. When the mast has been pulled up 15' or 20', a large pipe wrench is clamped around the pipe above the support to hold the mast while the rope is removed. Another section of pipe is connected to the mast and the short piece of pipe and rope attached to the bottom as before. The mast is again raised and the operation repeated until the mast is complete. It is again raised until the base, to which the 2' section was attached, is above the support. The mast is held by a pipe wrench and the short section removed. A board is placed under the end across the slot and the mast lowered on it. The base is made secure by nailing blocks around it.

For masts of any length the size of the pipe may vary from 1", 1 1/4" and 1 1/2". This is not necessary, but pipe of 1" should not be longer than 16'. For example, the mast might be of 1 1/4" pipe with a 16' section on the top of it of 1" pipe. The larger sections may be of full length, or 20'.

The pipes may be slid within each other and prevented from sliding down by a bolt, or the masts can be joined by the regular coupling.

One or two large pipe wrenches aid in the assembling of the pipe and of the erection of the same.

The mast should be guyed every 20' by No. 12 galvanized cap wire. It is best to insert strain insulators in the guys every 20', but they may be omitted in a receiving station.

IT SPEAKS FOR ITSELF

\$5.00

ARKAY

Loud Speaker

RADIO HORN

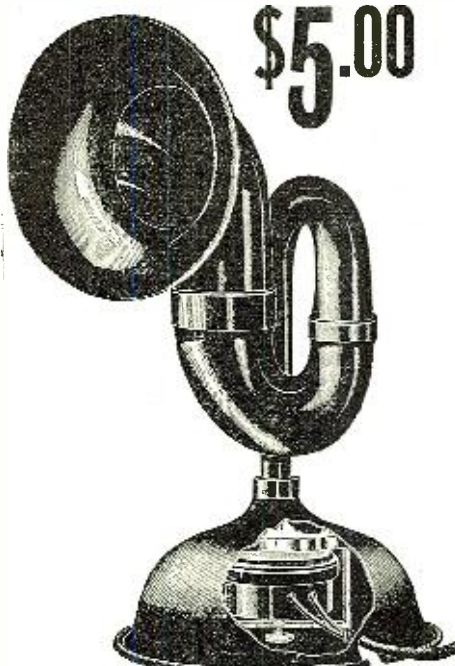

Will amplify your signals, speech or broad casted music without distortion.

This horn is constructed to fit any make of receiver through the use of an adapter under the base.

Works on one or two stages of amplification.

Price Black Enamel, without phone, \$5.00 each.

Price, Polished Nickel, without phone, \$6.00 each.

Order through your dealer or direct from us, remitting by money order the price of horns, plus parcel post to your address. Shipping weight 4 lbs.

DISTRIBUTED BY

| | | |
|--|--|---|
| CANTON, OHIO Wireless Mfg. Co. | NEWARK, N. J. Radio Distributing Co. Wholesale Radio Equipment Co. | PITTSBURGH, PA. Robbins Electric Co. Ludwig Hommel & Co. Radio Electric Co. |
| DETROIT, MICH. Grier Battery Supply Co. | NEW YORK, N. Y. Manhattan Electric Supply Co. Ship Owners Radio Serv. Co., Inc. | TOLEDO, OHIO Marshall-Gerken Co. |
| INDIANAPOLIS, IND. Hatfield Electric Co. | PHILADELPHIA, PA. Philadelphia W'less Sales Corp. Schimmel Electric Supply Co. | |

DEALERS—Write for Proposition.

RILEY-KLOTZ MFG. CO.

17-19 MULBERRY ST. NEWARK, N. J., U S. A.

MEMORIZE CONTINENTAL CODE BKUMA YRLSBUG

ALMOST INSTANTLY

Two Hundred and Fifty Beginners in Forty-Six States and Territories have reported Mastered Code in 30 Minutes. In 45 Minutes. In One Hour. In One Evening, Etc. Many have installed stations and with little practice obtained License as Radio Operators.

Do not be satisfied to limit the use of your Radio Receiving Set to Periodical Broadcasts of Music, Weather and Market Reports, Etc.

Master Continental Wireless Code Easily and Quickly

and Understand Everything you may hear at any time from anywhere. Eventually add a sending set to your outfit. Get in touch with the World. Talk Back, Ask and Answer.

Attentive Self Instructed Beginners Who Use Dodge One Dollar Radio Short Cut Do Arrive

| | |
|--|---|
| Sample, Code Memorizing Records made by Dodge Short Cut Students | Examples of Quick Success by Use of Dodge Short Cut |
| <p>W. A. Oettler Radio 2A01 Time required, thirty minutes</p> <p>E. Gundrum Radio 2BXY Time required, one hour</p> <p>Robert Gerbrick Radio 3BHP Time required, less than two hours</p> <p>Mrs. Julia Garrett Radio 5PJ Time required, odd moments ten days</p> <p>J. E. Farquhar Radio 3DW Canada Time required, one hour and half</p> <p>Jos. Dobry Radio 4BS Can. Time required, one evening</p> <p>Wah Soon Shin Radio 6 BDT Time required, odd moments four days</p> <p>Thos. F. Baird Radio 3KL Can. Time required, less than one hour</p> <p>J. Robert Ziegler Radio 3A10 Time required, thirty minutes</p> <p>W. M. Adler Radio 2BGG Time required, forty minutes</p> <p>David E. Day Radio 4BM Time required forty-five minutes</p> <p>Roland Richardson Radio 6AVH Time required, one hour</p> | <p>Woodhaven, N. Y. 340 Woodland Ave.</p> <p>Elizabeth, N. J. 303 Cherry St.</p> <p>Philadelphia, Pa. 2118 Hicks St.</p> <p>Fort Worth, Tex. 303 So. Jennings Ave.</p> <p>Hamilton, Ont. 18 Albert St.</p> <p>Edmonton, Alta. 10023 116th St.</p> <p>Honolulu, T. H. 1941 Faushal Lane</p> <p>Preston, Ont. P. O. Box 78</p> <p>Lancaster, Pa. 129 Dauphin St.</p> <p>New York, N. Y. 576 E. 143d St.</p> <p>Winston Salem, N. C. P. O. Box 48</p> <p>Oakland, Calif. 4258 Foothill Blvd</p> <p>Radio 2BGC 576 East 143rd St.</p> <p>Code Learned, Exam. Passed, License Obtained in Two Weeks</p> <p>To encourage other beginners I am glad to say that after studying your Code Memorizing Chart for about forty minutes, was surprised how well was able to understand messages which vibrate through the air. And what is more important about two weeks later passed examination and received my license. For thoroughly learning the Code and that quickly and easily, would recommend your Short Cut to any beginner.</p> <p>William M. Adler, New York City, Radio 2BGC 576 East 143rd St.</p> <p>Code Learned, Exam. Passed, License Obtained in One Week</p> <p>Before I knew of your Short Cut method had made many attempts to memorize the Code. I could not fix it in my mind, however, and having a Radio Set, realized just how much pleasure I was missing by being thus handicapped. So in seeing your ad in Radio News I immediately sent for your method, although was rather skeptical about it. But when it came to hand and I saw how perfectly simple the Code had been made I was certainly pleased. Took me just 30 minutes or one-half hour to fix the Code perfectly and permanently in my mind and in about a week or maybe a little longer, I could copy and send at the regulation speed to obtain my Govt. License 3A10. Shall certainly recommend your method at every opportunity and wish you success.</p> <p>Robert Ziegler, Lancaster, Pa. 129 Dauphin St.</p> |

INVESTIGATE—SAVE TIME AND EXPENSE—GET RESULTS

For Ten Red Stamps will mail Booklet containing information and Reports from 250 successfully self-instructed beginners—many of them now licensed operators.

No Instruments needed with this method. Entire necessary expense for Code instruction One Dollar, and limited study of Dodge Short Cut.

C. K. DODGE, Box 200 MAMARONECK, N. Y.

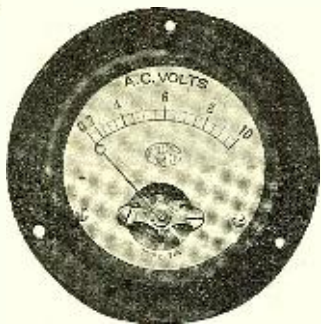

Type T1A, Flush Model

IF YOU NEED A VOLTMETER

You PAY for it
Whether you BUY it or not

For Instance: If you put too much voltage on the filament of your V.T. you burn it out. Result—a new tube, which costs about the same as a Roller-Smith voltmeter. So you see you do pay for the voltmeter whether you buy it or not.

Bulletin No. V-10 tells you all about Roller-Smith voltmeters for reading filament voltage. It also describes a complete line of 3½" A. C. and D. C. instruments for all radio work. Send for it. It's free.

Roller-Smith instruments are sold by all good dealers.

ROLLER-SMITH COMPANY

Electrical Instruments, Meters and Circuit Breakers



MAIN OFFICE:
15 Barclay Street, NEW YORK

WORKS:
Bethlehem, Pennsylvania

Offices in principal cities in United States and Canada

LOUDER SIGNALS WITH LESS INTERFERENCE

Can Be Secured With the
C&W TYPE 11 REGENERATIVE RECEIVER
and
TWO STAGE AMPLIFIER

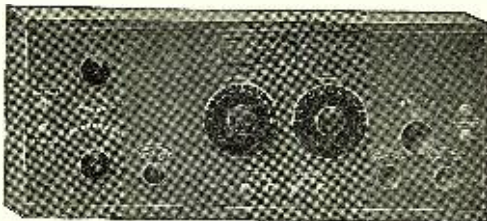

Two Instruments In One Cabinet Especially Designed for

RADIO TELEPHONE RECEPTION

This receiver is as SIMPLE TO OPERATE as the simplest regenerative receiver and, in addition, is more selective. It is DESIGNED and GUARANTEED by a COMMERCIAL RADIO COMPANY. Licensed under Armstrong Patents.

A descriptive circular will gladly be sent upon request.
Ask to see this receiver at your dealers.

CUTTING & WASHINGTON RADIO CORPORATION

Subsidiary

INDEPENDENT WIRELESS TELEGRAPH COMPANY, INC.

35 WATER STREET - - - - - NEW YORK, N. Y.
TELEPHONE BROAD 6500.

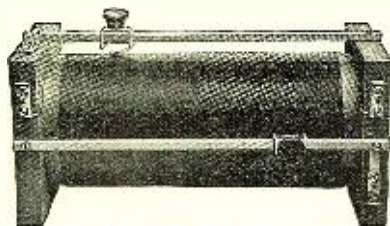

ESSEX TUNING COILS DOUBLE SLIDE Make Good Loading Coils LIST PRICE \$3.00

ATTRACTIVE DISCOUNTS TO DEALERS

3/16 in. Sliders, 25c; Mounted Crystals, 25c;
Aerial Wire Insulators, Radio Supplies

Mail orders shipped promptly

ESSEX MANUFACTURING CO.
117 MULBERRY ST., NEWARK, N. J.

We Manufacture

REX

RADIO APPARATUS & PARTS
& Can Make Deliveries
Write for Details

JENKINS MFG. CO.

4607 Ravenswood Ave. CHICAGO, ILLINOIS

WE HAVE EVERYTHING

A Complete Stock of
RADIO SUPPLIES

Panels, cut and drilled to your order.

Free Technical Advice

RADIO DEPT.

ELLIOTT ELECTRICAL SUPPLY CO.
68 East 116th St. NEW YORK CITY
HARLEM S600

A ¼" rope is used for the antenna rope and is run through a pulley attached to the top of the mast. The rope should be arranged before the mast is raised.

Pipe masts offer very little resistance to the wind, and tightly guyed, will withstand an 80- or 90-mile-an-hour gale.

An Efficient Amateur Receiving Circuit

By Paul G. Watson, I.R.E.

In the accompanying diagram is shown a circuit which is quite a departure from the ordinary amateur regenerative circuits. The writer had considerable trouble with howling and grinding when using the Armstrong and similar circuits on certain adjustments, so started to experiment to find a way to eliminate a portion, at least, of this noise. The work was done at the time the audion control panel, described in RADIO NEWS, for December, 1921, was made. The circuit is almost entirely free from howls of a number of circuits in connection with this and other audion circuits. This circuit is almost entirely free from howl and other local noises when the proper audion adjustments have been made. The customary regenerative distortion is present in this circuit as in all similar circuits, but it was found that in many cases it can be eliminated, partially at least, so that sparks and radiophone signals have their true tones. Music and voices are received regularly from WDY, WJZ and

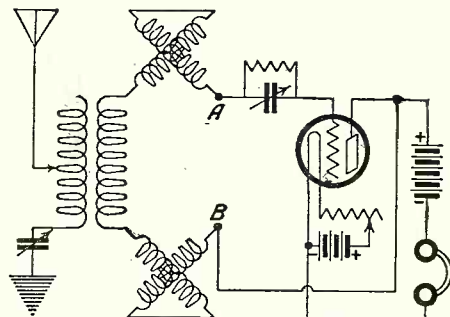

©RADIO NEWS 1922

This Circuit Has Been Found by the Author to be More Flexible Than the Conventional One.

KDKA, the last over a distance of 350 miles, and it is possible with each, to receive signals with no noticeable distortion.

One great advantage, in using this circuit is the flexibility of tuning. It has repeatedly proved itself to be equally efficient on 200 and on 600 meters. The writer is fully aware of the loss in efficiency of sets tuning over wide ranges, but it has been found by actual comparison with commercial and amateur apparatus, that there is no loss on either wave length; this is a very decided advantage.

The tuner itself is an ordinary regenerative set, consisting of two variometers and a variocoupler of standard design. In picking the variometers and coupler, attention should be paid to the size of the wire in the windings, as well as to the clearance. The wire should be of fairly large size, with a small amount of clearance between the rotary and stationary elements.

It will be found that shielding the panel with copper foil will remove the capacity effect of the hands, as the tuning is done. The shield should be connected to the ground terminal of the panel.

The short-wave condenser is .001 mfd. capacity, rotary variable. An arm was soldered to the shaft of the moving plates, so that it automatically short circuited at a point just beyond the 180 degree adjustment. A contact should be arranged on

CHEMISTS PREDICT STARTLING NEW ERA

Sun's Rays, Earth's Rotation and Atomic Energy in Matter to Be Used.

SEE REVISING OF BIBLE

Light Like Firefly's May Be Produced by Chemistry, American Society Hears.

DEMAND FOR INDUSTRIAL CHEMISTS INCREASING.

It is probably not far wide the mark to assert that there are more than 25,000 chemists employed in the United States today and the advance which has made up obvious that the demand is constantly increasing.

SAUSAGE GETS ATTENTION OF CHEMISTS

Is One of Many Topics in Pictures Drawn

URGES USE OF CHEMISTRY AS BUSINESS AID

Shows

Chemistry in the Home

One of our great-grandmothers' recipes were handed down to her daughter or passed back to an inquisitive No one thought of calling in aid in the work of the kitchen today chemists have entered the home and industry to make work easier and give the housewife a fairer deal.

AMERICA'S FUTURE BEFORE CHEMISTS

Dr. E. F. Smith Urges Upon Associates Recognition of Nation's Claims.

CHEMICAL SCIENCE MAY OUTSHOE PRICES

New Methods in Tanning to Be Discussed by Experts at Meeting of American Society.

4,000 EXPERTS TO ATTEND

Sessions Will Be Held at Columbia University-Next Month-Scientists to Speak.

Shoe prices may trend downward as a result of new processes of tanning based on studies of electrical discharges and used by the leather chemistry section of the American Chemical Society, which will meet at the University Sept. 10-12.

CHEMISTS CHANGE ALCOHOL INTO HIGH QUALITY SILK

Government Experiments Set Pace for New Industry Already Under Way and Patent Silk Worm May Lose Popularity

CHEMISTRY EXPERT HEADS 'CLEAN CLOTHES' COLLEGE

In Eleven Weeks He Teaches How to Remove All Traces of Hardship From Linen and Makes Student a Real Laundryman.

How to remove all traces of the dirtiest of life in a big city from the hands of a student without recourse to the use of soap, water, or even a scrubbing brush is the aim of the 'Clean Clothes' College, which is being conducted by Prof. F. M. B. in the laboratory of the University of Chicago.

CHEMISTS IN MONTREAL LEARN OF NEW GLASS

Said to Admit Unlimited Light and Bar All Heat.

Montreal, Aug. 22.—Noted chemist Dr. T. O'Connor Sloane, Educational Director of the Chemical Institute of New York, is one of this country's foremost authorities on chemistry. He was formerly Treasurer of the American Chemical Society and is a practical chemist with many well-known achievements to his credit. Not only has Dr. Sloane taught chemistry for years, but he was for a long while engaged in commercial chemistry work.

Chemists Are Employed To-day In Practically Every Branch of Industry

All industry to-day is three-fourths chemical. Every day brings new announcements of new ways in which chemistry is employed in business and industry. The sudden and almost unbelievable expansion of the chemical field in the United States has increased the need for trained men in our country. Industrial plants of all kinds pay tempting salaries to get good men—salaries of \$10,000 to \$12,000 a year are not unusual for chemists of exceptional abilities. If you want a profession that offers unlimited possibilities—if you are looking for more money—if you like fascinating work—take up chemistry. No other vocation offers such splendid opportunities for real money and rapid advancement. Chemistry is now recognized as the coming great science and the demand for trained men is increasing every month.

Learn Chemistry At Home

We will teach you Chemistry right in your own home, and in your spare time, in a practical and intensely interesting way. Our home study course written by Dr. T. O'Connor Sloane is practical, logical and remarkably simple. Endorsed by leading scientific and educational authorities. The entire course is illustrated by so many experiments that are performed right from the start that anyone, no matter how little education he may have, can learn and thoroughly master every lesson. Dr. Sloane teaches you in your own home with the same individual and painstaking care with which he has already taught thousands in the class room. And Dr. Sloane personally examines and corrects all examination papers, pointing out your mistakes and correcting them for you. His personal training will be of inestimable value to you in your future career. If you really want to learn Chemistry and will honestly apply yourself to our lessons, our course will give you just as thorough and just as complete an education in general chemistry as you would have received had you been able to attend College.

**Dr. T. O'Connor Sloane
Will Teach You.**



Easy Monthly Payments

You can pay in small monthly amounts as you go along. The price of our course is very low and includes everything, even the chemistry outfit—there are no extras to buy with our course. Our plan places a chemical education within the reach of everyone. No matter what your income is, you can meet our low terms, and you do not have to give up your present employment while learning.



Experimental Equipment Given To Every Student

We give to every student, without additional charge, this chemical equipment including everything you need for the entire course with the exception of a few pieces of apparatus which we teach you how to make. You couldn't buy so complete an outfit anywhere for one cent less than \$20.00. There are forty-two pieces of laboratory apparatus and supplies and eighteen different chemicals and reagents all enclosed in a fitted heavy wooden box with hinged front and cover. This hand-finished box serves not only as a case for the outfit but as a laboratory accessory for performing countless experiments.

Special 30 Day Offer

Besides furnishing the student with his Experimental Equipment as described above, we are making an additional special offer for a short while only. You owe it to yourself to find out about it. Write today for full information and free book "Opportunities for Chemists." Send the coupon right now while it is fresh in your mind. Or just write your name and address on a postal and mail it to us. But whatever you do, act today before this offer is withdrawn.

Chemical Institute of New York, Inc.

Home Extension Division 5 140-R LIBERTY STREET, NEW YORK CITY

Dr. Sloane, Educational Director of the Chemical Institute of New York, is one of this country's foremost authorities on chemistry. He was formerly Treasurer of the American Chemical Society and is a practical chemist with many well-known achievements to his credit. Not only has Dr. Sloane taught chemistry for years, but he was for a long while engaged in commercial chemistry work.

Many people would pay big money to have Dr. Sloane teach them chemistry. You can secure his services and personal training without one cent of extra expense by enrolling with the Chemical Institute of New York.

CHEMICAL INSTITUTE OF NEW YORK
Home Extension Division 5
140—R Liberty St., New York City.

Please send me at once without any obligation on my part, your free Book "Opportunities for Chemists," and full particulars about the Experimental Equipment given to every student. Also please tell me about your plan of payment and your special 30 day offer.

NAME
ADDRESS
CITY
STATE
R. N., June, '22.

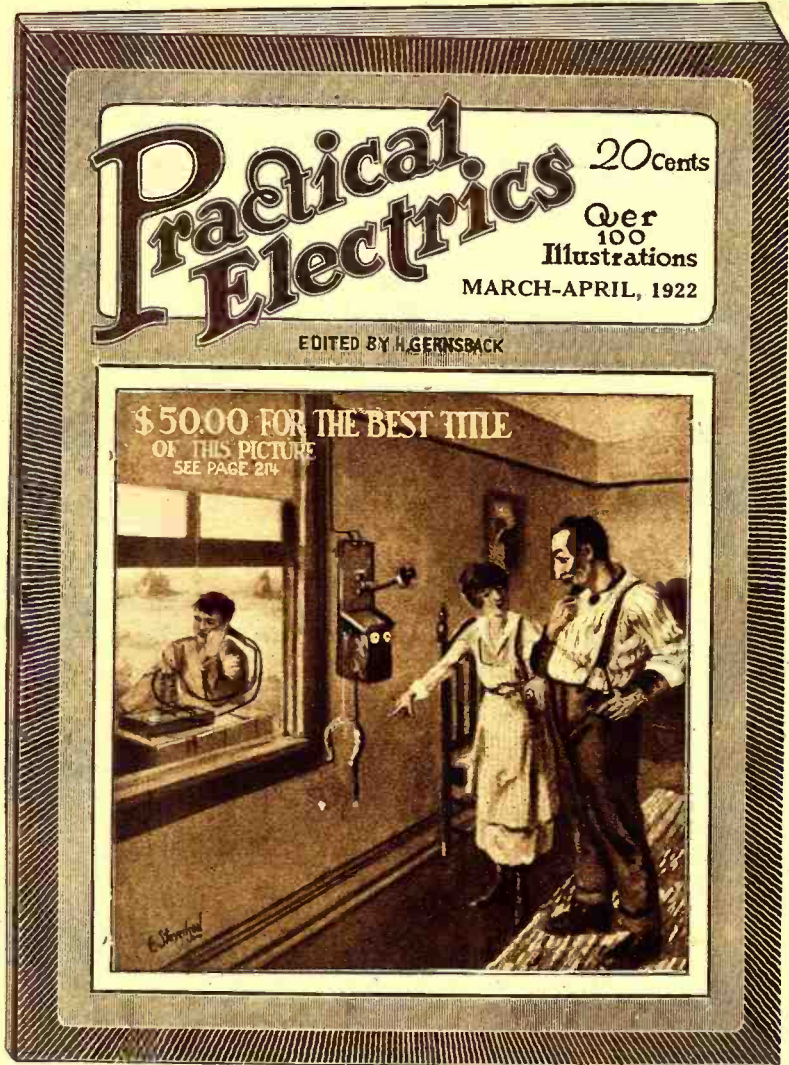

**100 Articles
Over 100 Illustrations**

**FOR SALE
AT ALL NEWS
STANDS**

**20c.
The Copy
\$2.00
A Year
Canada and Foreign
\$2.50 A Year**

**SEND
20c. FOR
SAMPLE
COPY
TODAY**

**SEE COUPON BELOW FOR
SPECIAL OFFER**

"The Electrical Magazine for Everybody"

PRACTICAL ELECTRICS is probably the most novel magazine of its kind ever conceived. It is personally edited by H. Gernsback, editor of SCIENCE & INVENTION and RADIO NEWS. Mr. Gernsback, who founded the old MODERN ELECTRICS as well as the ELECTRICAL EXPERIMENTER, knows thoroughly what the public wants and has wanted for many years. In presenting this new magazine he but heeds the thousands of letters received by him to establish a new 100% electrical magazine that will beat the best that was in MODERN ELECTRICS and ELECTRICAL EXPERIMENTER.

Electricity covers such a tremendous field that the man who does not keep abreast with it does himself a great injustice. PRACTICAL ELECTRICS covers that field from every angle. It is written in plain every-day language that all can understand. It portrays the

entire electrical development of the month faithfully in non-technical language. It caters to everyone interested in electricity, be he a layman, an experimenter, an electrician or an engineer—each will find in this magazine a department for himself and plenty more.

The March-April issue now on the news-stands contains 48 pages and over 100 different articles and over 100 illustrations, with an artistic cover in two colors. Professor T. O'Connor Sloane, Ph.D., is associate editor of the magazine.

Leading Articles in March-April Number

Telegraphic and Telephonic Transmission of Pictures. Antique Electric Motors. Electricity from Fruit and Vegetables. Old and New Measurement of Light. Induction Test for Locating Armature Troubles. Artificial Lighting.

PRIZES

This magazine offers a number of prizes, as follows:

\$50.00 Burnt-out Fuse Contest.
\$3.00 for the best picture of your electrical workshop.

\$3.00 for the best article on Elec-Tricks, the new department.

\$3.00 for the best "short-circuit," the semi-humorous department.

In addition to this, the magazine pays high prices for all electrical experiments, electrical articles, etc.

See Current Issue for Full Details.

This issue also contains articles by some of the greatest living electrical writers, workers and students and the magazine will prove a revelation to any one interested in electricity.

Inasmuch as the new magazine has a circulation of only 27,000 copies, we urge you to place your monthly standing order with your newsdealer at once. Or if you wish, fill out the coupon below for your subscription and take advantage of our special offer.

Every issue besides its many other features contains the following departments:

- "New Things Electric"
- "Experimental Electrics"
- "Electrical Digest"
- "Junior Electrician"
- "My Laboratory"
- "Elec-Tricks"
- "Motor Electrics"
- "Short Circuits"
- "How and Why" (Questions and Answers.)

Make all checks payable to: "Practical Electrics Co."

SPECIAL OFFER

Gentlemen:

Although your regular price is \$2.00 per year, you will accept my subscription at \$1.75 per year (Canada and foreign \$2.25) I enclose the money herewith and I have written my name and address in margin below.

PRACTICAL ELECTRICS CO., 236 Fulton Street, New York

R. N. 6-22

"RASCO HAS IT!"

THE Radio Specialty Co.—"Rasco" for short—is probably the most unique supply house in the United States, if not in the world to-day. This company makes a specialty of small orders, no order being too small to get immediate and prompt attention for the simple reason that most of our orders are small.

The reputation of this house was built upon service. Ask any of your acquaintances what they think of *Rasco* goods, *Rasco* service, *Rasco* promptness! Thousands of unsolicited testimonials on file to prove that we serve the public best! Be sure to get our great catalogue, containing several hundred different parts, which is illustrated below.

ORDER DIRECT FROM THIS PAGE. ALL GOODS SENT PREPAID IN 24 HOURS

1100 "RASCO" AUDIO FREQUENCY TRANSFORMER



We have compared many of the present transformers on the market but have finally decided upon a type that is the most efficient one we have seen so far. The best amplifying transformer is that in which the impedance of its primary is equal to or exceeds the impedance of the plate-to-filament circuit of the tube in which it is connected. We guarantee this transformer to equal any one on the market.

No. 1100 "Rasco" Audio Frequency Transformer (not assembled) each prepaid.....\$2.65

ANTENNA CONNECTOR

This antenna connector is made entirely of aluminum, is light and will not rust. The only connector of its kind. The 4 antenna wires go to the upper holes; the lower hole takes the lead-in. Don't solder your aerial, don't have loose connections. Dimensions 2" high, 1 1/4" wide, 3/8" thick.

No. 999, Connector, each.....\$0.35



PANEL KNOBS

No. 6241 is well made and has a good corrugation. Its dia. is 1", height is 3/4", hole 5/32". The shank is 1/4" high.

No. 6241, Knob, each.....\$0.06

MARCONI KNOB

Has a central hole of 5/32" and seat to hold the screw. dia. is 1 1/4", height 3/4".

No. 838, Marconi Knob, each.....\$0.15



RASCO POSTS

These are our very own patterns, from our own designs and look mighty handsome on any instrument. The top knobs are of composition, the bottom parts brass nickel plated polish.

No. 202 is nickel plated at bottom part.

"Rasco" Binding Post, 8/32 thread, each, \$0.10; doz., \$1.00.

No. 202, Post, each.....\$0.08

Nos. 650 and 651 made entirely in composition with a hexagonal brass nut in center.

No. 650 has 8/32 machine screw.

No. 651 has bottom wood screw.

No. 650, Post, each.....\$0.08

No. 651, Post, each.....\$0.08

Dozen, each style.....\$0.90

BRASS NICKEL POSTS

No. 029, Binding Post, each.....\$0.05

No. 030, Binding Post, each.....\$0.04

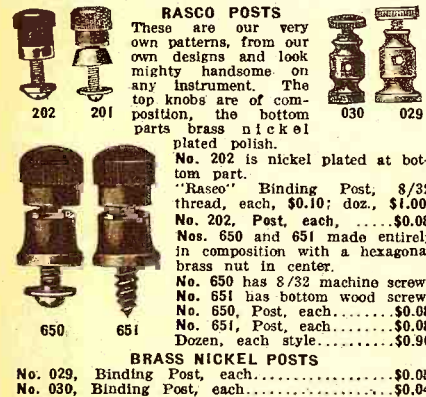

RASCO SWITCH POINTS

Nickel plated and polished. The following have been found the most popular.

No. 1 3/4" x 1/4", 5/32 thread, ea., \$0.03; doz., 35c

No. 2, 3/16" high, 1/4" dia., 6/32 thread, ea., \$0.03; doz., 35c

No. 3, 3/16" x 3/16", 4-36 thread, ea., \$0.03; doz., 35c

No. 4, 1/4" dia., 1/8" thick; stem 6/32, ea., \$0.03 1/2; doz., 40c

No. 5, 1/4" dia., 3/16" thick; stem 4-36, ea., \$0.03 1/2; doz., 40c

No. 6, 3/16" dia., 3/16" thick; stem 4-36, ea., \$0.03 1/2; doz., 40c

No. 7, 3/16" dia., 1/8" thick; stem 4-36, ea., \$0.03 1/2; doz., 40c

No. 7 1/2, Switch Stop, 3/8" long, 4-36 thread, complete with nut, ea., \$0.05; doz., 50c

No. 76, New style Switch Point, to be pressed into bakelite panels with forced fit. Wire is soldered to pin end. Head 1/4", dia., 1/16" thick, ea., \$0.03 1/2; doz., 40c

No. 77, same as above, but head is 1/4" dia. x 3/16" thick, ea., \$0.03 1/2; doz., 40c

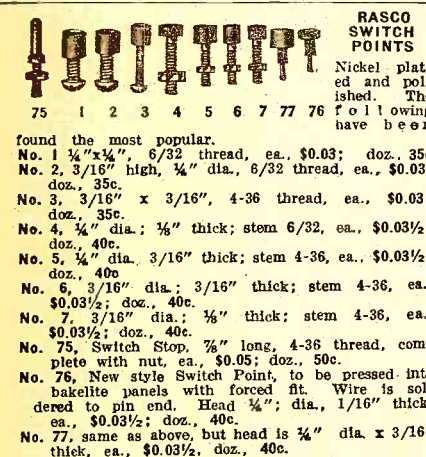

THE RASCO BABY DETECTOR



In presenting this little Detector, we feel sure that it fills a place never taken before by any small detector. It does a variety of things and does them all well and better than the outstanding part of the Detector, is the patented nickel detector cup and binding post. The knurled cap unscrews and you place the Galena Crystal in the cup, then replace the knurled cap and the galena crystal is held secure. The circular hole in the cap exposes enough of the crystal for ordinary purposes.

No. 1898, Rasco Baby Galena Detector. Price, prepaid.....\$0.50

No. 1899, Rasco Baby Detector with Galena and Radioactive Crystals. Price, prepaid.....\$0.75

1898

many \$5.00 detectors. The base is solid, black composition. Mounted on same is a nickel holder and binding post which holds a fluted hard rubber knob with its sliding rod member.

PANEL SWITCH LEVER

New style switch lever with lock fork. It is impossible for this lever, not to make positive contact at all times. The blade radius is 1 1/4". Blade is nickel plated and polished. Fork is phosphor bronze. The lock fork holds the screw (in which it rotates), securely. A loose contact is impossible.

No. 200, Switch Lever, complete as illustrated.....\$0.30



LITZ WIRE

This wire is recognized as the only thing for winding coils for Radio Instruments. Particularly recommended with our No. 343 Variocoupler Rotor, for vario-couplers, banked windings, etc.

No. 323, Litz Wire, 20 No. 38 strands, enameled double silk wire, per foot, \$0.02; per 100 feet, \$1.15

No. 890, Litz Wire, 10 strands No. 38 wire, per foot, \$0.01; per 100 feet, \$0.75

No. 891, Litz Wire, 16 cables of three strands No. 38 wire, per foot, \$0.03; per 100 feet, \$2.25



NOTE: This page contains only a few of our 300 specialties.

PANEL KNOB

This is a very distinctive knob and can be used on dials, panels, switches, condensers, etc. It is exceptional and well made. Dia. 1 1/16", height 1 1/16", comes with 8/32" bushing.

No. 815, Knob, each.....\$0.18



VARIOCOUPLER ROTOR

This rotor is used by all up-to-date amateurs. It is accurately turned of hard wood and is used as a secondary coil. It takes any finish, either shellac or stain and can be drilled readily for any size hole. Large hole 2" dia. Width of spool is 2". Total dia. 3 3/8".

No. 343 Variocoupler Rotor, each.....\$0.75

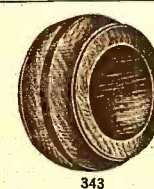

"RASCO" NAME PLATES

Our name plates are of brass with a black background. Letters are polished nickel. Order by name and number.

| | |
|---|--|
| 807 "Phones".....\$0.05 | 810 "Ground".....\$0.05 |
| 809 "Aerial".....\$0.05 | 812 "Primary".....\$0.05 |
| 811 "Secondary".....\$0.05 | 814 "Detector".....\$0.05 |
| 813 "Audion".....\$0.05 | 816 "On".....\$0.05 |
| 865 "Off".....\$0.05 | 840 "Increase Current" (Left).....\$0.10 |
| 839 "Increase Current" (Right).....\$0.10 | 834 "Series".....\$0.05 |
| 813 "Vacuum Tube".....\$0.05 | 830 "Receive".....\$0.05 |
| 831 "Transmit".....\$0.05 | 820 "2nd Step".....\$0.05 |
| 821 "3rd Step".....\$0.05 | 827 "Tickler".....\$0.05 |
| 819 "1st Step".....\$0.05 | 825 "Plate Variometer".....\$0.05 |
| 826 "Grid Variometer".....\$0.05 | 835 "B Battery".....\$0.05 |
| 823 "Secondary".....\$0.05 | 817 "Output".....\$0.05 |
| 836 "A Battery".....\$0.05 | 824 "Primary Condenser".....\$0.05 |
| 818 "Input".....\$0.05 | 828 "Parallel".....\$0.05 |
| 829 "Telephone".....\$0.05 | 837 "+ -".....\$0.05 |
| 833 "Detector Tube".....\$0.05 | 841 "(Blank)" (takes pen or pencil writing).....\$0.05 |
| 822 "Coupling".....\$0.05 | |
| 808 "Load Coil".....\$0.05 | |

Price of all of our name plates in dozen lots, 50c, with the exception of the two "Increase Current"

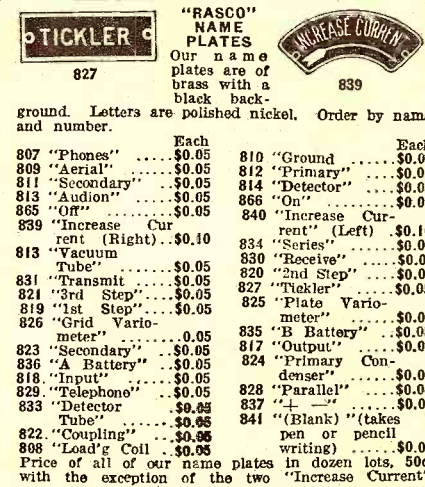

BAKELITE PANELS

We list below six panels, the sizes of which have been selected after carefully checking up many dimensions of the most popular radio apparatus on the market.

Note particularly that our prices are anywhere from 25 to 50% lower than those quoted by most other concerns. The reason is that we buy these panels in very large quantities, and we do not cut sheets to order. Remember always that when sheets are cut to order they cost you at least 50% more than our prices, because you must pay for the cutting and the necessary waste.

Note also that we ship these panels prepaid. This alone amounts to a considerable saving.

| |
|---|
| No. 350 6" x 12" x 3/16" thick, each.....\$1.90 |
| No. 351 6" x 18" x 3/16" " ".....2.85 |
| No. 352 9" x 12" x 3/16" " ".....3.00 |
| No. 353 12" x 18" x 3/16" " ".....5.65 |
| No. 354 6 1/2" x 19 1/2" x 3/16" " ".....3.50 |
| No. 355 6" x 7 1/2" x 3/16" " ".....1.20 |



"RASCO" LUBRICATED PANEL SWITCH

A radio switch that has two nuts at the end is a monstrosity, for the reason that it will never stay put. Our patent spring fork holds the switch handle always under uniform tension, at the same time it insures the best contact possible. New wiping contact, which covers every point of the switch point. Another new improvement is the lock fork, which can assume three different positions to accommodate the switch to various thicknesses of panels.

No. 1921 "Rasco" Switch, as illustrated, each \$0.50.



KNOBS

These knobs are favorite with all experimenters. The size of both is: dia. 1 1/8", height 1 1/8".

No. 4451 comes with 8/32 and 10/32 bushing.

No. 4451, Knob, each.....\$0.06

No. 199 (screw length 3/4") Knob, each.....\$0.10

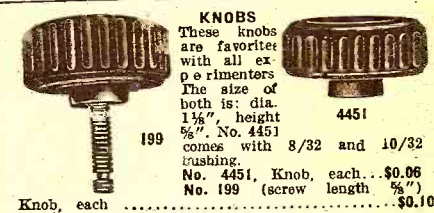

NAVY KEY KNOB

This navy key knob is now used on all standard wireless keys. It gives the right swinging motion and rests the fingers. It is a favorite with all advanced amateurs. Once used always used. The screw is 8/32 and will fit all keys.

No. 748, Key Knob, each.....\$0.28



THREADED BRASS ROD

We carry two styles, 6/32 and 8/32 thread. Only 6" lengths sold. No others.

No. 8032, Threaded Brass Rod 8/32 thread, per 6" length.....\$0.08

No. 6032, Threaded Brass Rod, 6/32 thread, per 6" length.....\$0.06

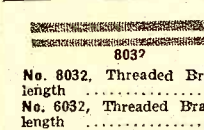

THE "RASCO" CATALOG

CONTAINS 50 VACUUM TUBE HOOK-UPS

Complete hook-ups of all important vacuum tube circuits are given in clear diagrams with complete explanation. Just to name a few:—The V.T. as detector and one-step amplifier; regenerative circuit; De Forest ultraudion; V.T. to receive undamped and spark signals; Armstrong circuits; one step radio frequency amplifier and detector; three stage audio-frequency amplifier; short wave regenerative circuits; V.T. radio telephone; 4-stage radio frequency amplifiers; radio and audio frequency amplifier, inductively coupled amplifier; Armstrong superaudion; radio frequency amplifier and crystal detector; etc., etc. The catalog contains 200 illustrations. On account of its great cost, it cannot be distributed free of charge. Mailed only upon receipt of The catalog contains 200 illustrations. On account of its great cost, it cannot be distributed free of charge. Mailed only upon receipt of





96-98 PARK PLAGE, NEW YORK CITY

This business was originated with the sole purpose to cater to the amateur who has small orders. ALL OF OUR ORDERS ARE SMALL and that is why your small order will never be side tracked by us. A trial order will make you a life customer. Order from the above illustrations. "We can only stick you once." Try us with a 50c order. ALL GOODS PREPAID.

DEALERS
Get Our Special Proposition

Factories
Brooklyn, N. Y.—Elkridge, Md.

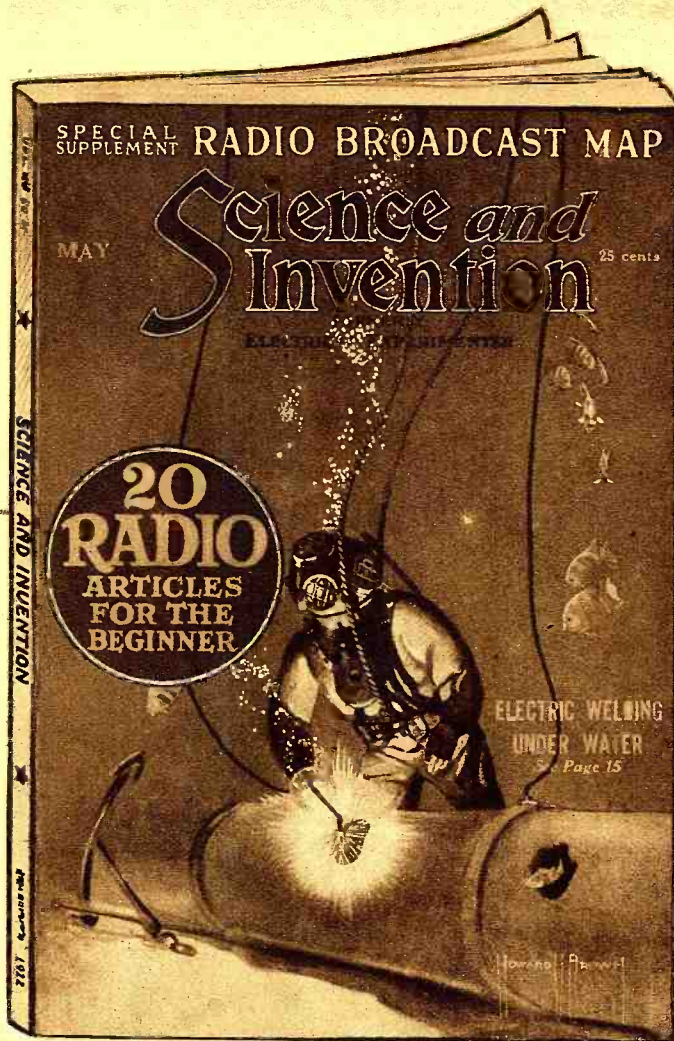
15c in stamps or coin.



**104
PAGES**
**66
ARTICLES**
**196
ILLUSTRATIONS**
**16
PAGES
ROTOGRAVURE**

**ON ALL
NEWSSTANDS**
25c The Copy
**SUBSCRIPTION
PER YEAR**
(12 Numbers)
\$2.50
*(Add 50c outside
U. S.)*

EXCLUSIVE RADIO ARTICLES A SPECIAL FEATURE

SPECIAL SUPPLEMENT!

RADIO BROADCAST MAP, printed on heavy bond paper, in two colors, showing location of all the Broadcasting Stations in the U. S.—Their ranges, call letters, etc.

Some of the Radio Articles in the May Issue

Chicago Police Adopt Radiophone. What Caused the Signals? Radio on Aircraft. New Radio Tone-arm. Religion Via the Ether. Radio Recorder Continues in Operation. Simplest Radiophone Receiver. Radio Constructor Hints. Radio for the Beginner—No. 3—How to Operate a Vacuum Tube Receiver. Radio Oracle—Question and Answer Box. Wonders of New Ocean Greyhound. Radiophoning from Ship to Shore. Thomas A. Edison Becomes a Radio "Fan." Dancing to Radio Music on the Ocean. Radio Set in a Fountain Pen. Radio Constructor Hints. Latest Patents. Patent Advice.

SCIENCE & INVENTION is just chock full of interesting articles and illustrations that appeal to everyone. It will hold your interest from cover to cover because it contains everything new in the field of science, invention and mechanics. Quoted by hundreds of newspapers and magazines all over the world every month.

Its editorial contributions constitute the brains of the scientific world. Its four color cover designs are both artistic and attractive

Partial Contents for May, 1922

POPULAR SCIENTIFIC ARTICLES
Electric Welding Under Water.
Editorial.
Marvels of New Ocean Greyhound.
Wonders of Modern Theatres—Describing the wonderful engineering and artistic features of New York's latest play-house.
Photography Without a Camera.
Perpetual Calendar on Fountain Pen.
Dr. Hackensaw's Secrets—No. 5—The Secrets of Invisibility.
Parlor Sorcery—Scientific tricks and paradoxes.
If New York City Were the Whole World.
The Radio Explorers—Scientific Fiction.
Anesthetics and Their Action.
The Color Organ—Human moods emotions expressed in colors.
How to Apply Imagination to Inventions.

One Broadside Lifts Five Leviathans From Sea.
A Tropical North Pole—A scheme for melting or reclaiming all the ice from the polar regions.
Gearless Friction Drive Car.
Popular Astronomy—Oxygen and Water Vapor Found to be Absent From the Atmosphere of Venus.
PRIZE CONTESTS
Electric Skates Contest Prize Awards.
Bent Wire Contest.
Motor Hints—\$50.00 in prizes for ideas.
Bottle Contest—Award of prizes.
How-to-Make-it Department—\$30.00 in prizes
Wrinkles, Recipes, and Formulas.
Description of Set of Second Prize Winner in \$300.00 Radio Receiving Set Contest.
Uses for Old Inner Tubes—\$10.00 in Prizes.

AUTOMOBILES
Gearless Friction Drive Car.
Motor Hints, \$50.00 Prize Contest.
ELECTRICITY
Building Your Own Electric Fixtures.
Latest Patents.
The Oracle—Question and Answer Box.
Patent Advice.
CHEMISTRY AND ELECTRO-CHEMISTRY
Practical Chemical Experiments—Qualitative Analysis.
Experimental Electro-Chemistry—First paper of a new series.
CONSTRUCTOR ARTICLES
Motorcycle Engine Monoplane.
A Modern Hero's Steam Engine.
How-to-Make-it Articles.

Experimenter Publishing Company

231 Fulton Street

New York

Gentlemen:
Please enter my subscription for *Science and Invention* for the term of one year for which I enclose herewith \$2.50 (add 50c for postage outside of United States.)
Name Town
Address State

the stationary element to receive this arm. A crude way to get this effect is to bend a corner of one of the rotary plates so it bears heavily on the stationary ones. As previously mentioned, this is a crude method, and apt to give trouble.

The circuit is shown complete in the diagram, including the audion. If it is desired to use this circuit with the audion shown in the December issue of RADIO NEWS, or a similar audion control, the secondary connections should be made at "A" and "B" to the "SEC" terminals of the audion, after the "TICKLER" connections of the audion have been short-circuited. It will be noticed that the variable grid condenser is of much importance in tuning, and eliminating the local noises common in regenerative tuners.

A "soft" tube was used, a pre-war "Audio Tron" and fine results, on all wavelengths up to 700 meters, were obtained. The circuit has been in use for about one year, in several local amateur stations, copying after the original, and is giving them complete satisfaction on both C.W. and spark. It oscillates readily, making it desirable for modern use, with the increase of C.W. sets. Fine regeneration is obtained as the point of oscillation is approached, amplifying signals several times.

Transmitting With A Regenerative Set

By Victor Andrew.

With the spark coil rapidly going out of use for short distance communication why not use low power CW? The average amateur thinks of a five watt CW set as the smallest. It is surprising to find how few amateurs know that their receiving set is transmitting CW with a range equal to the average spark coil. How often when listening to a concert have you heard a tweet-tweet of a CW, but you have not touched the tuning of your own set? Do you know that is another receiving set, probably within a mile or two, and other amateurs hear your receiving set in the same manner?

The average regenerative receiver radiates enough CW to be easily copied for a mile or two when QRM is not heavy. All that is necessary to make the receiver into a small CW transmitter is to put a key in the circuit. Communication can be carried on over as great a range as with the old Ford coil, and will not interfere with other stations in the same manner. The only difficulty is that sharper tuning is necessary at the receiving station. The receiving tuner enables the operator to easily and rapidly change the wave length. If it is intended to operate the set regularly as a transmitter a license should be obtained.

Two stations transmitting in this manner may use a break-in system that makes operating about the same as on a telegraph wire. When both stations have the receiving set operating, that is, the key held down, and are tuned correctly each will hear the other. One station may transmit, and both will hear the same tone in their receiving sets. In case the second station wants to break the first, all that is necessary is to open his key, as on a telegraph line. The transmitting station will cease to hear the note of the other stations, and will close his key immediately ready to listen to the other. Then the other station may transmit in the same manner. When calling a nearby station this is very convenient, as the operator calling can tell when the other operator is listening, and instead of letting the receiving station tune to the wave of the transmitting station, the transmitting station can tune to the wave of the receiving station.

When the stations are sufficiently loud telephone instead of telegraph signals may

The Sign of  Long Life

TRADE MARK

The Power Behind the Phone

DEPENDS UPON THE BATTERY

ACE RADIO BATTERIES

ARE PROVEN POWERFUL UNITS

Made in seven different plain and variable types. No matter what special purpose you may have for a "B" battery, you will find one ACE type that is especially adapted for your Radio use.

LONGER LIFE

BETTER SERVICE

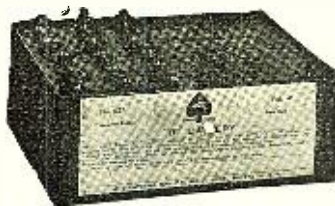

Made by the originators of the 16 tap, 45 volt variable Radio "B" battery. Your set cannot be truly efficient without an ACE battery.

"The Power Behind the Phone"

For sale at all Radio and Electrical Dealers

WRITE FOR CATALOG

ACE BATTERY M'F'G. CORP.

Gen. Offices 495 Broome St. NEW YORK CITY Factory 359 W. Broadway

EXPERIMENTERS:

The following are the per pound prices on enameled wire delivered to you, no charge for postage or spools. If you need any other insulation write for special price list.

| | | |
|----------------|----------------|-------------------|
| No. 14.....51c | No. 23.....71c | No. 32.....\$1.00 |
| No. 15.....52c | No. 24.....73c | No. 33.....1.02 |
| No. 16.....53c | No. 25.....76c | No. 34.....1.08 |
| No. 17.....55c | No. 26.....78c | No. 35.....1.14 |
| No. 18.....62c | No. 27.....81c | No. 36.....1.20 |
| No. 19.....64c | No. 28.....84c | No. 37.....1.35 |
| No. 20.....65c | No. 29.....88c | No. 38.....1.55 |
| No. 21.....67c | No. 30.....92c | No. 39.....2.00 |
| No. 22.....69c | No. 31.....96c | No. 40.....2.75 |

Immediate delivery. No order accepted for less than one pound, or less than \$1.00.

AMERICAN ENAMELED MAGNET WIRE CO.
MUSKOGON, MICHIGAN

A welcome addition to your library! Send \$2.00 today, plus postage for 7 lbs., and your copy of bound volume No. 1 of Radio Amateur News will come forward by return mail.
Experimenter Publishing Company, Inc. 236a Fulton Street, New York City

QUALITY R-A-D-I-O SERVICE

APPARATUS

Everything from a Plug to a Complete Set

| | |
|-------------------------------|------------------------------------|
| 7 Strand No. 22 Aerial Wire | 7" x 18" Formica Panel.....\$1.65 |
| 100 feet\$.75 | Switch Points, per dozen..... .40 |
| V. T. Socket75 | Test Clips75 |
| Lightning Arresters50 | "B" Batteries, 22½ Volts 1.95 |

Magnet Wire at Low Prices

Write for Our Attractive Price List

IZENSTRAK RADIO COMPANY

509 South State Street Chicago, Illinois

ACT Formerly, Chicago Salvage Stock Store NOW

POSITIVE, PRACTICAL LIGHTNING PROTECTION

"JACOBUS"

Type J. S. W.

The Vacuum Aerial Protector

Talk it over with your dealer and let him tell you how to keep your home and instruments free from lightning danger



Takes the place of the Costly ground or Lightning Switch in receiving Stations. Passes National Underwriters' Requirements Report No. 5763

\$200

Apex Electrical Specialty Co., Inc.

77 Orange Street Newark, N. J.

LOUD! NEW VOLATONE

GIVES TREMENDOUS VOLUME

VOLATONE—Cabinet and Loud Speaker Combined

The VOLATONE was designed for convenience in mounting radio receiving set in same cabinet as loud speaker. It eliminates cumbersome additional unit for increasing the normal volume of sound for an audience. The VOLATONE loud speaker unit has the tonal qualities of the finest phonograph. It is the last word in loud speaking equipment.

Use With Your Own Receiving Outfit

Space 10x10½x5½ back of VOLATONE unit for installing your own receiving equipment. Your telephone receiver rests on special mounting on front of VOLATONE unit.

A complete portable cabinet unit solidly constructed and beautifully finished. Nickeled trimmings, handle and lock. Choice of genuine mahogany, oak or walnut.

Outside dimensions 15x11½x7½. Price complete as illustrated, \$15.00. Immediate delivery.

Order direct from this ad or write for information. Dealers write for attractive proposition.

\$15

Sound passes through aluminum horn to curved wood sound chamber and is amplified and thrown outward. Patents pending.



THIS DOES IT

THE VOLATONE CO. 900 LAKESIDE PLACE. CHICAGO.

APEX SERVICE



All orders shipped same day as received. Give us a trial and we will give you Service. Price Bulletin sent on request. Local Amateurs invited to call and see our line. Open all day and every evening.

APEX RADIO CO., Inc., 1105 W. 69th St., Chicago, Ill.

be used. All that is necessary is to insert a microphone in the ground lead. If the sets are tuned to exactly the same wave either may speak, as in the ordinary wire telephone. Very sharp tuning is necessary to operate in this manner.

To transmit CW, of course, it is necessary to have the receiving set oscillating. To transmit the most power possible the set should oscillate as strongly as possible; with a tickler coil this is when the coil is coupled at maximum, with variometers it will be found that the set oscillates over a certain range of the plate variometer, and about the middle of this space is where the oscillations are strongest. Many sets will howl when oscillating as strongly as possible. In this case the resistance of the grid leak should be reduced. To increase the power of the set an amplifier tube may be used. With an amplifier the plate voltage may be increased considerably, often to as high as 200 volts. This will greatly increase the power of the set. If a simplified circuit tuner is used the power may be increased by connecting the aerial and ground across the plate coil, instead of the grid coil.

A New C. W. Wrinkle By Tom C. Hall

At my station, 7IL, I have recently installed a 5-watt C.W. set using A.C. on the plate, thereby making A.C.C.W. It has been working pretty well, radiating .8 of an ampere on 190 meters. I wanted to increase that still more, but I did not want to put more than about 360 volts on the plate. The next thing to do was to overhaul the circuit and try to make little improvements. The filament

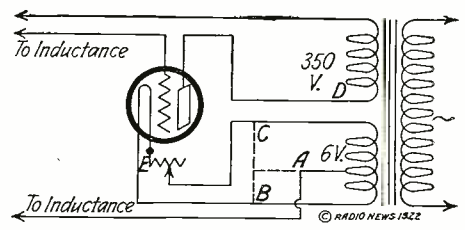

A Good Idea to Try Out if You Use A.C. on Your Tube for Transmitting.

was lighted by a separate winding on the transformer and of course this necessitated a center tap to hook the end of the grid circuit to, as is shown in the diagram. Now this is done of course to get a negative charge on the grid because no matter whether B is positive or C, A is always negative. But when using A.C. on the plate, the circuit oscillates only when D is positive. On the half of the cycle that D is positive either B or C will always be negative, therefore, take A and connect it to B and then C and observe the radiation meanwhile. The reason why it jumps on one or the other is because of the great impedance or choke coil effect that the transformer winding has for the radio frequency current. If you find that C is the right side, be sure that you connect on to point E because you know the rheostat has quite a resistance.

Before doing this, I was radiating .8 of an amp. on five watts and now I am radiating a whole one; one amp. on five watts, not bad, what?

If you are using A.C. on your plate, be sure to try this out. If you are not using A.C., you will want to try that too. It will help to retune a little after hooking up in this manner.

Variocoupler Construction

By R. U. Clark, 3rd.

Many experimenters regard the variocoupler as a comparatively new instrument, but some of the "old timers," who recall the famous "doughnut" receiving transformer, realize that the two instruments are almost identical.

As a matter of historical interest, as well as for the sake of illustrating certain points to be mentioned later, a picture of one of the forerunners of the variocoupler is shown here. This particular instrument was made by the author about nine years ago, and a similar type was described in print by him about 1912.

Here is an excellent example of what

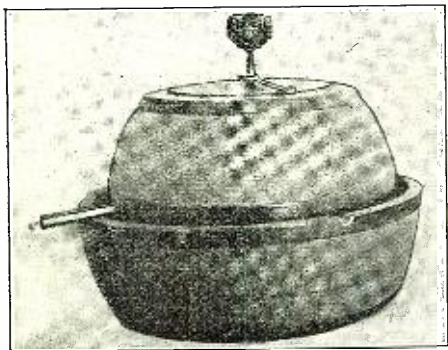

An Oldtime Variocoupler Made by the Author in 1912.

the average inventor has to contend with. Probably other experimenters described similar apparatus as far back as 1912, and yet the instrument is just now coming into widespread popularity after over nine years of use.

In the device pictured here, two spherical concentric coils are shown, the central one being wound on a solid core and tapped every few feet, with leads taken out to a multi-point switch mounted on the end of the wooden core. The two necessary connections for this coil are made to the brass rods which form the axis on which the coil rotates.

An outer coil is wound on a wooden shell, only one-half of the same being shown. Although these pieces were turned out on a lathe, there are several ready-made devices which can be substituted for these forms. For the inside core, one can use old croquet balls, rubber balls filled with wax, plaster, etc., heavy paper balls, rubber suction or force pump ends, round wooden and celluloid boxes, and many other common things. Wooden dishes, boxes, wax castings, paper bowls, and also many of the parts already mentioned can be used for the outside form, and the wide-awake builder will find many other objects adaptable to the same use.

Regeneration On 600 Meters

By George T. Conner.

Not many days ago a young citizen radio enthusiast in the fifth district was deploring the fact that his receiving set would not regenerate on commercial wave-lengths. This young man was using the conventional short-wave regenerative receiver which, without the addition of capacity or inductance from the outside, probably did not include longer waves than 375 meters or thereabouts. The primary circuit, however (as is frequently the case), would tune to about 600 meters.

"I can shunt my grid variometer with a variable condenser," said this young fellow, "and hear ship and shore traffic now and then—always very faintly. But no matter how I juggle my plate variometer it

DEPENDABILITY

Quality **KENNEDY** Service
EQUIPMENT

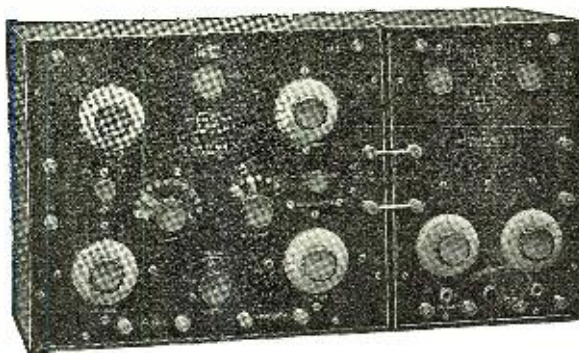

KENNEDY TYPE 220 INTERMEDIATE WAVE REGENERATIVE RECEIVER, WITH TYPE 525 TWO STAGE AMPLIFIER. EFFECTIVE RECEPTION ON WAVE LENGTHS FROM 175 TO 3100 METERS.

All Kennedy regenerative receivers are licensed under Armstrong U. S. Patent No. 1,118,149.

The Kennedy type 220 Intermediate-Wave regenerative receiver with type 525 Two stage Amplifier represents, we believe, the greatest quality value on the market today, considering the scientific design, excellent workmanship, superior finish and performance.

The Type 525 two stage amplifier matches perfectly the Type 220 Receiver in height, depth, and finish.

The Panels are polished formica, machine engraved and the Cabinet is genuine solid walnut, hand rubbed finish.

The Kennedy high standard quality is evident in this handsome and serviceable equipment.

Bulletins 201 and 501 describing these units, sent on request.

THE COLIN B. KENNEDY COMPANY
INCORPORATED
RIALTO BUILDING, SAN FRANCISCO

RADIUM JEWELL DETECTOR

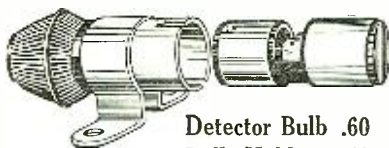

Detector Bulb .60
Bulb Holder .40

Requires no adjusting. Only occasional tuning, which can be done in one second.

No battery used. Can be applied to any receiving set. Takes the place of crystal detectors. No more fiddling around for sensitive spots; just pick up the phones and listen. Worth several times the price asked for this new invention. If your dealer can't supply, we will mail direct.

Dealers write for proposition.

Newark Electrical Supply Distributor for New Jersey
Peerless Wireless Co., Detroit—Distributors for Michigan

STAR MFG. CO., Newark, N. J.

A welcome addition to your library! Send \$2.00 today, plus postage for 7 lbs., and your copy of bound volume No. 1 of Radio Amateur News will come forward by return mail.
Experimenter Publishing Company, Inc. 238a Fulton Street, New York City



Recharge Your Battery at Home

Don't be without the use of your Radio Receiving Set while your battery is being charged by some Service Station. Get a *Valley Charger* and charge your battery right at home at one-tenth the usual cost.

Attach the Charger to your home lamp socket — attach the clips to the battery terminals and you will get a quick tapering charge which just exactly charges your battery, but cannot overcharge or harm it in any way. This *Valley Charger* has no troublesome bulb and will charge your automobile battery as well as radio battery. Satisfaction Guaranteed. If your local distributor cannot supply you, write direct to

VALLEY ELECTRIC COMPANY
Department R ST. LOUIS, MO.

----- Mail the Coupon -----
Valley Electric Co., Dept. R St. Louis, Mo.

Gentlemen: I am enclosing money order (or check) for \$12.00 for which send me a Valley Battery Charger with black metal case. \$15.00 for which send me a Valley Battery Charger with five-panel glass display case and indicator. If not satisfactory, will return it and get money.

Name _____
Address _____
Town _____

\$12 and \$15
F. O. B. St. Louis

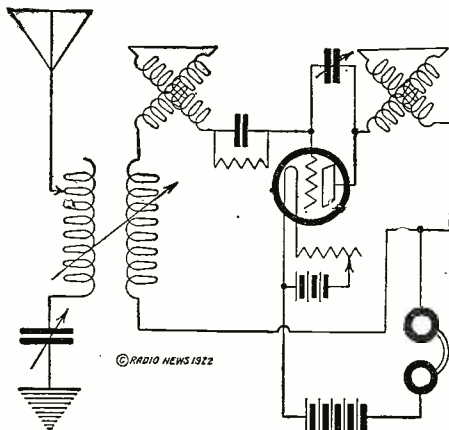



FIG. 1

A Variable Condenser Connected Between the Grid and the Plate of the V.T. in a Regenerative Circuit Helps to Make it Oscillate on Longer Wave-lengths.

simply doesn't amplify the signals." He then went on to say that if he could only corral the few dollars necessary to purchase another variable, to place across the plate variometer, he would keep the two circuits equalized and the set would regenerate on 600 meters just as easily as it was doing on amateur waves. However, being a lad in school and having no income of his own, the shrill whistles of the 500-cycle fellows would have to be passed up until another time.

It so happened that the author of this little article, though blessed with no more than a passing knowledge of radio theory and practice, had nevertheless solved this very same problem for himself some months before, and was therefore in a position to afford the young fellow in question instant relief—and that, too, without the outlay of another penny. Figure 1 of the accompanying diagrams will show how this was accomplished. With a short-wave regenerative set, located in a city in North Texas, ships, shore stations and even stations at the lower end of Mexico (Foreign stuff!) have been copied consistently on detector alone, regeneration of the signals being readily controlled by the plate variometer. The variable condenser "C" when used with the circuit shown does the trick, adding capacity to both variometers in like measure. With a .0005 mfd. variable condenser it will not be necessary to turn the pointer beyond about 30° on the scale to secure regeneration on 600 meters. Setting the condenser at 20° or 30° and completing the tuning with the variometer is not alone the easiest method, but it also allows of more flexibility with a consequent finer adjustment than could be secured by tuning altogether with the condenser.

Not long ago a navy type loose coupler, long since abandoned as unworthy a place in the modern receiving station, was res-

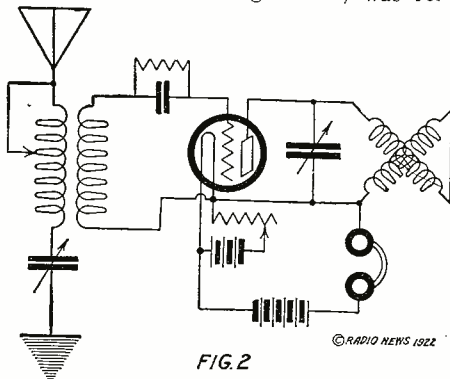

FIG. 2

Another Regenerative Circuit for Longer Waves. Note That There Should be No Connection Between the Filament and the Wire Crossing it. It is Shown by Mistake in This Drawing.

HYGRADE SPECIALS

Save You Money

- Radio Service V.T. Sockets..... .80
- 22½ Volt Cyclone Small B. Battery. .90
- 22½ Volt Cyclone Large B. Battery. 1.60
- 45 Volt Cyclone Large Variable B. Battery 2.75
- 22½ Volt Large Eveready Variable B. Battery 2.50
- Binding Posts (rubber cap), per doz. .75
- .0005 Mf. Grid Condensers..... .25
- .002 Mf. Phone Condensers..... .25
- Variable Grid Leak, ½ to 3 Megohms .65
- Electrose Ball Insulators, each..... .28
- per dozen 3.00
- 3 in. Bakelite Dials..... .75
- Arkay Loud Speaker 4.25
- Jacobus Lightning Arrester 1.75
- Western Electric Wireless Head Sets 14.00

MARKO STORAGE BATTERIES

- 6 volt 40 amp., guaranteed 2 yrs..\$10.00
- 6 volt 60 amp., guaranteed 2 yrs.. 13.50
- 6 volt 80 amp., guaranteed 2 yrs.. 17.00
- 6 volt 100 amp., guaranteed 2 yrs.. 21.00

We do not charge for crating. Above Batteries are fully charged when shipped.

Prices are F.O.B. New York

Hygrade Electrical Novelty Co.
41 West 125th Street New York

PSOULIESO

Does not mean anything, but if you want a word that means satisfaction in high grade radio apparatus remember

"RADIO RADIO VOX"

*Highest grade apparatus only.
Ask those who know.*

Scientific Engineering Association

817 Main Street Cincinnati, Ohio

FORMICA PANELS

3/16 Inch

| | |
|---------------|--------|
| 6 x 7 | \$0.75 |
| 6 x 10½ | 1.00 |
| 6 x 21 | 2.50 |
| 6 x 14 | 1.75 |
| 9 x 14 | 2.50 |
| 12 x 14 | 3.00 |
| 12 x 21 | 5.00 |

The Quaker Light Supply Co.

728 ARCH STREET
PHILADELPHIA



RADIO

Supplies in stock.
Finished sets.
Parts for Receiving and Sending.
Radiotron Tubes, UV-200, UV-201, UV-202, UV-203.

For Immediate Delivery

Electric Service Engineering Co.
105 West 47th Street New York
Bryant 2743

REDUCE DIELECTRIC LOSSES

NO CORE USED



- Rotor only, as illustrated, 3½" diam. 8" shaft.....\$1.75
- Wooden rotors, bare, 27/8" diam... .50
- Wooden rotors, wound, with shafts 1.50
- Variometers, completely wound.. 4.00
- Variocouplers 3.00

RADIO ROTOR SUPPLY CO.
65 BROAD ST. BOSTON, MASS.

cued from its dusty resting place in the "dead file" and given an opportunity to perform. The circuits were so arranged that by throwing a couple of D.P.D.T. switches either this coupler, tuning to about 3,500 meters, or the short wave set could be switched onto the detector. A circuit was utilized which left the plate variometer of the regenerative set in series with the plate of the detector tube *regardless of which tuner was being used.* The "utility" variable condenser was then removed from its place across the grid and plate connections (as shown in Figure 1) and placed across the plate variometer only. It is now possible to secure regeneration not only on the wave lengths embodied in the short-wave receiver, as originally intended, but regeneration of signals has also been easily secured on the highest tap of the loose coupler, or, roughly speaking, somewhere between 2,500 and 3,500 meters.

Some short-wave sets will require that the condenser herein referred to be eliminated entirely when tuning the grid variometer near zero—that is, at lowest wave lengths. In that case merely disconnect one of the condenser leads, or what is better, use a small S.P.S.T. switch for the purpose, opening the switch for lowest waves and closing it for regeneration of commercial signals. Figure 2 is the straight loose coupler hook-up, using a variometer in the plate circuit, loaded with a variable condenser.

It may be well to call attention to the fact that the secondary of either tuner is connected to grid and plate of the detector tube, with telephones and "B" battery in series between filament and plate line, with the plate variometer between the meeting point of 'phones and plate line and the plate. Or, to say it another way, as regards the plate variometer, let it come right next to the plate, so that the energy from the "B" battery must pass through it before reaching the plate. The diagrams give the proper method of connections.

These lines are written in the interest of those who, like the writer, were disappointed in the operation of their short-wave sets in that the receivers apparently would not give the results on commercial wave lengths which could be had at 200 meters or slightly over. And furthermore, in addition to the advantage of securing full regeneration with these hook-ups at 600 meters or slightly over. And furthermore, noted, in most cases at least, a decided gain in signal strength over the method of connecting the secondary to grid and filament. It is certainly well worth adopting.

The Radio Voice

By Hendricks Foote Sturges.

If Bobby Burns were alive today he would not be imploring some "Pow'r the giftie gie us, To see oursel's as ithers see us." It would rather be to hear ourselves as others hear us and see the image the sound of our voice calls forth in their minds.

So far, the voices over the wireless have all been pleasing to a greater and less degree. Some have excited, others inspired, and still others have soothed and calmed us. In spite of the fact that the artists enunciate more slowly than normal in order to avoid the vibrations that fast talking would produce, each separate voice has a character that is as distinct and plain "as the nose on your face" as the old saying goes. From the voices I hear by wireless I can picture youth, vivacity, and the more staid middle age. The frank and gracious person, the reserved and calm disposition, the brilliant quick mind and the slower and less orderly thinker. Their voices also give

LAWSAM

RADIO RECEIVING SETS

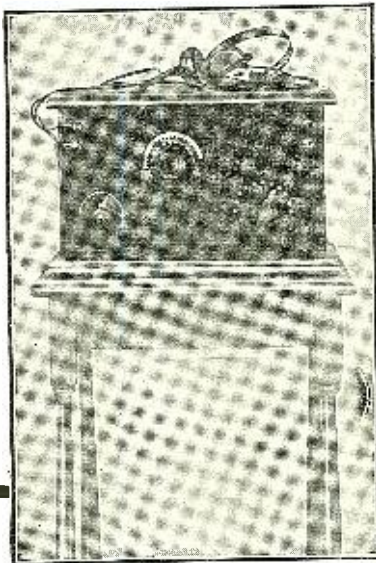

**Sturdy Stock—
Finest Instruments**
Scientifically Correct—A Price for All
\$20 to \$250
LIST PRICE
Including Aerial Equipment and
**Stromberg-Carlson
\$7.50 Head Set**

ALSO MANUFACTURERS OF
BINDING POSTS SWITCH POINTS
TUBE SOCKETS CRYSTAL DETECTOR PANEL
SWITCH LEVERS GUARANTEED GALENA, ETC.

ROSENTHAL LIGHTNING ARRESTER, distributed solely by ourselves is the *only* Lightning Arrester discharging at 220 volts. Protects against lightning and internal wiring short circuits—
List price \$2.00

DEALERS AND JOBBERS!

Due to Large Increase In Our Production We are Today Able To Make Immediate Deliveries. Orders are Rolling In. Don't Delay.
WRITE OR WIRE FOR PARTICULARS



FACTORY
ELIZABETH, N. J.

122 Fifth Avenue
New York City

PHONE
CHELSEA 7923

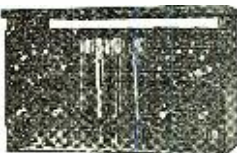

STORAGE BATTERIES

Designed Especially For
WIRELESS



KIMO "B" batteries give years of service. Are not harmed from short-circuiting, overcharging or standing idle. One charge lasts from three to six months while in the detector plate circuit. Can be recharged from your A.C. line in one hour. Money refunded if unsatisfied after ninety day trial. Prices as follows.

| | (With Panels) | (Plain With Clips) |
|---------------|---------------|--------------------|
| 32 volts..... | \$11.00 | \$8.00 |
| 48 volts..... | 13.00 | 10.00 |
| 68 volts..... | 16.00 | 12.00 |

KIMLEY ELECTRIC CO.,

KIMO "A" batteries. No more acid eaten rugs or furniture. Truly a parlor battery. Box and jars moulded in one piece from acid proof composition many times tougher than hard rubber. Guaranteed 18 months on Ford, Chevrolet or any car taking battery 9 1/2 x 7 1/2 inches, but will last several years as wireless "A" battery. Shipped ready for use with hydrometer for testing at \$24.00 or with wooden box and rubber jars. 6 volt, \$20.50; 8 volt, \$27.00; 10 volt, \$33.00. All 80 to 100 A.H.
Write for particulars

290 Winslow Avenue, BUFFALO, N. Y.

The material contained costs thousands of dollars to assemble. You can get a copy of bound volume No. 2 of Radio News for only \$2.50 plus postage.
Experimenter Publishing Company, Inc., 236A Fulton Street, New York City

**A NEW BOOK FOR EXPERIMENTERS!
ELEMENTARY TEXT-BOOK
ON WIRELESS VACUUM TUBES**

by
JOHN SCOTT-TAGGART
Member of the American Institute of Electrical Engineers
WRITTEN EXPRESSLY FOR THE AMERICAN AMATEUR

230 Pages. 130 real practical circuits.
The best book on C.W. and Telephony.
Handsomely bound in blue art vellum.

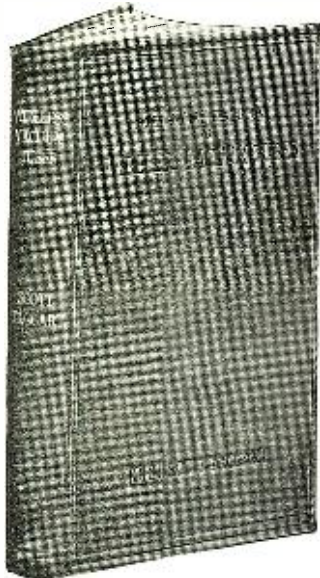

\$3.00 (post paid)

Retailers are invited to send orders for 12 or more copies on special terms. Amateurs should ask their dealers or order direct from

RADIO PRESS, Ltd.
34, Norfolk Street, London, W.C.2., England

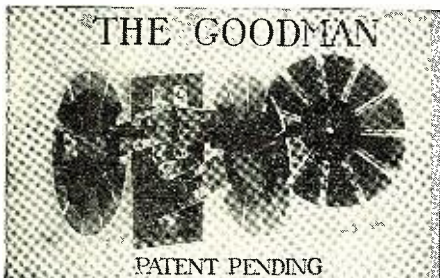

\$6.00 !!!

Nuff Sed
Send for Pamphlet

MADE AND SOLD BY
L. W. GOODMAN
Drexel Hill, Pa.

WHOLESALE DISTRIBUTORS
THE SAYRE-LEVEL RADIO CO.
905 Filbert Street, Phila. Pa.
Order direct or from your dealer

**Hard Fibre Parts
For Radio Work**

Also "VARNO" RADIO TUBING
In diameters from 2½" to 6"
Lengths up to 12"

J. SPAULDING & SONS CO., INC.

NEW YORK —484 Broome St.
BOSTON —15 Elkins Street
PHILADELPHIA—141 North 4th St.
CHICAGO —659 W. Lake St.
TONAWANDA —N. Y.

me their pictures as tall, stout, slight or just the average human being. You see by wireless the artist is free from the stage fright that hundreds of pairs of eyes inspire, consequently his voice is more normal for he can truly feel confident that his silent audience is eager, appreciative, expectant and grateful besides marveling at the wonder of being entertained by the cleverest talent, right at home in one's easy chair. Then, too, one is not or ought not to be afraid of what can not be seen, therefore, the performer may be free from any possible restraint or embarrassment and may recite, or sing or just speak, putting his natural self into his expressive voice.

The smile in the voice is the most difficult thing to put across and the listener can only be sure that it is a smile when there is that happy little catch in the voice that is natural in some people and delightful when it is natural.

In the voices that one hears often, those of the announcers, markedly those of Station WJZ, there is a comfortable sense of friendship and familiarity. So much so that when a strange voice announces, there is a distinct feeling of disappointment and you wonder where your old friend can be.

I remember what a revelation my own voice and laugh were to me when I heard them suddenly imitated by a parrot owned by a very dear friend of mine, and how if you will believe me, the sound of my laugh, as Polly heard it, sent those listening, and myself, into peals of merriment. One can little realize what pleasure the sound of his voice may give another.

**Measurements of Capacities
of Condensers**

By A. W. Parkes.

The method used in this experiment is called the bridge method because the hook-up is practically the same as for the Wheatstone bridge.

R₁ and R₂ are two preferably high resistances of the same value, if possible (say from 1,000 to 2,000 ohms). Large resistances are used so that a slight difference would not cause a great percentage of error in the work. C₁ is a known condenser of about .001 mfd. capacity, which is used as the standard of the work. If only approximate results are desired, consider the capacity of C₁, to be proportional to the number of degrees used. If more accurate results

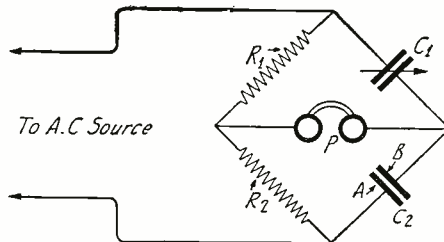

Determining the Capacity of Condensers by the Bridge Method.

are wanted, a calibration curve may be obtained from the makers. The exact capacities for certain readings can then be obtained. C₂ is the condenser to be measured—a telephone condenser or any unknown capacity that you wish to measure. In this way the capacity of the aerial and ground you are now using may be measured by connecting the aerial and ground to A and B, respectively. The A.C. source may be either from the secondary of a spark coil or from a buzzer. P is a pair of phones, no matter what resistance they may be, although the more sensitive ones give more accurate results.

When the connections are made as above, vary C₁ until the minimum noise results in

CONDENSER — DETECTOR

\$3.00

Internally Wired,
Ready for Use.

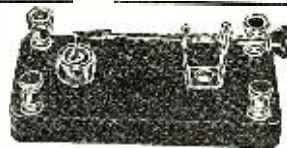

Fixed receiving condenser (001 MFD) neatly combined with a high-grade crystal detector. Phones hook on one end and tuning coil or loose coupler on the other end. Complete with Galena.



Aerial Insulators
B & P
25c Moulded Composition
Crystal Detector

Carefully made and tested in our own shop. Equipped with million point Galena. Equal to one audion tube

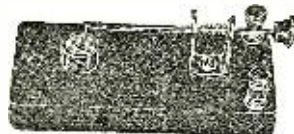

Complete with Galena Crystal
\$1.50

Radio Supplies by Mail
Products of Fada, de Forest, Grube, Arno and all leading manufacturers in stock. Immediate deliveries.
DEALERS.—WRITE FOR OUR PROPOSITION

The RADIO SHOP of NEWARK
41 South Orange Avenue, Newark, N. J.

NOTICE

I beg to announce that I am now located at

59-61 Park Place
New York City

In my new quarters I will be able to furnish my customers with all kinds of radio apparatus and parts.

FREDERICK WINKLER, Jr.

**BUILD YOUR OWN
WIRELESS RECEIVING SET**



You can SAVE at least \$25.00 By buying parts and assembling yourself

Think of the pleasure and practical experience you will gain in making your own set, with wave-length range from 170 to 2,500 meters. We furnish full-sized blueprint and complete detailed instructions for making this set and prices of parts for \$1.00.

Write today and get started
K. & G. WIRELESS SUPPLY CO.
Dept. 15A, 152 Chambers Street, New York City

the phones. If R_1 and R_2 are now equal, the capacity used on C_1 is equal to the unknown capacity. If, however, R_1 is not equal to R_2 , a simple proportion must be worked out as follows:

$$\frac{R_1}{R_2} = \frac{C_1}{C_2}$$

Consider that

$$\begin{aligned} R_1 &= 1000 \\ R_2 &= 3000 \\ C &= .0005 \end{aligned}$$

then

$$\frac{1000}{3000} = \frac{.0005}{C_2} \quad C_2 = .0015 \text{ mfd.}$$

The Lackawanna Railroad Radio Experiments

(Continued from page 1092)

informing us that the phone messages had been received several times along the route. From Stroudsburg, climbing up the Pocono Mountains, tests on the receiving set were made, with no special results. Local amateurs, ships, and 600 meter stations were copied. Various tests and changes were made in the transmitter, and, upon reaching Elmhurst Dam, all apparatus seemed to be in good working condition, namely, the receiving set had been protected from the jarring of the train, an amplifier tube, which had a loose element in it was replaced, and the transmitting set radiated 7/10 amperes into the antenna.

One or two long calls on C.W. were given, followed by calls by voice. When about 10 miles from Scranton, following a long call on voice, 8ARI, on 197 meters was clearly heard calling by voice, "Hello, 'D.L.' hello, 'D.L.'; hello, Lackawanna Limited. I am receiving your voice very clearly. Please come in and give your location." The Lackawanna Limited was then coming down the mountains at about 65 miles an hour, through ravines and cuts and through tunnels. There were hills on all sides, and one would suppose it to be a most inauspicious radio location. Communication was then established with 8ARI and conversation was kept up until the Limited had arrived in Scranton. The signal strength of 8ARI in Scranton was such that the many people who gathered in the special car could hear everything said. It is to be remembered that only a one car antenna was being used during this test.

While in Scranton SRH and 8BUW were both worked, and, upon leaving Scranton, bound for New York, a message was sent to the Scranton Times from Mr. Foley, Superintendent of Telegraph and Wireless, of the Lackawanna Railroad, via 8BUW. It was interesting to note that when 8BUW was repeating the message for verification, the Limited passed through a tunnel and the effect in this particular tunnel was hardly noticeable, although it must have been several hundred feet long. Steady two-way phone conversation was carried on until about 12 miles out, when, going around a mountain, 8BUW was completely lost and was not picked up again until the train had ascended to a large lake. Going along this lake, there was a marked increase in signals, and the following stations were listed: 8ADQ, 8BUW, and 8AOE. From them on the log of the trip was as follows:

| Time | Station | Remarks |
|------|-------------|--|
| 5:15 | 2BRB | Just readable. |
| 5:20 | 1RX | QRK. |
| 5:25 | 2BK | QSA, had been hearing him before but did not get call. |
| 5:35 | 1RX (again) | QSA. |

PERKINS RADIO CABINET

No. 220 K. D. (Knocked Down)

Thousands of Radio fans are building their own sets.

Mr. Dealer and Jobber. This business repeats again and again, when you have once started a fan out with reliable equipment, Perkins Radio Cabinets can be relied upon to give great service at very reasonable cost. Read the following points of merit.

SIZE—Depth 6"—Height 6", different lengths.

WOOD—Built of thoroughly dried genuine mahogany and quartered oak.

FINISH—Brown mahogany stained inside and out, varnished and rubbed, also dark oak stained inside and out, waxed and rubbed.

Panels 1/4" thick (usually of formica) slide into grooves of front standards, and are rigidly supported without use of screws. Formica panels not included in prices quoted, but should be ordered same length as cabinet.

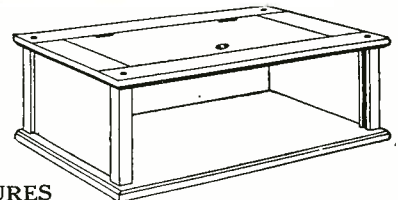
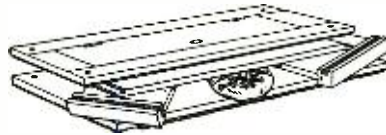
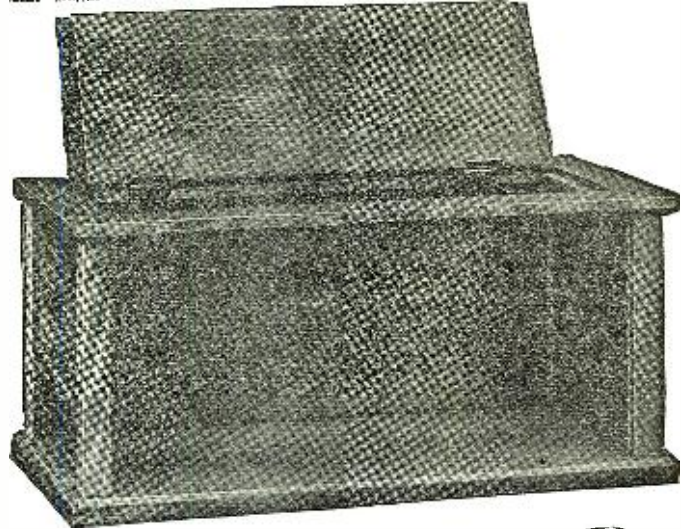

SPECIAL FEATURES

Free access for any desired assembly; also soldering, wiring, etc.

Binding posts may be assembled in vertical line near either end of the back panel of cabinet in line with corresponding posts or adjacent units. This permits shortest possible external connecting leads without crossing same.

Handy door in top is great convenience for slight adjustment, such as changing vacuum tubes, etc. Hinges are flush with top.

LIST PRICES AND USES

| Length | List |
|--|--------|
| 5 3/8" inches. This length is for vacuum tube detector. | \$2.75 |
| 7 3/8" inches. This length is for detector and single-stage amplifier. Can also be used for two-stage amplifier. | 3.19 |
| 10 1/2" inches. This length is for detector and two-step amplifier combined. | 3.25 |
| 16 1/2" inches. This length is for complete tuner—two variometers and one variocoupler. | 3.75 |
| 22 inches. This length is for complete receiver and vacuum tube detector combined. | 4.50 |
| 26 inches. This length is for complete receiver—vacuum tube detector and one or two-stage amplifier combined. | 5.50 |

Attractive Prices to Dealers and Jobbers. Write or wire for Discounts.

Mail orders filled promptly. Money-order or draft must accompany. Requests for credit must give satisfactory references and financial rating.

(No. 110 K. D. Oak Cabinets shipped knocked down ready for easy assembling and staining. Prices \$1.40 to \$2.60.)

PERKINS PHONOGRAPH COMPANY

ORIGINATORS AND EXCLUSIVE MANUFACTURERS

831A NORTH WOOD ST.

CHICAGO, ILLINOIS

CANADIAN AMATEURS!

HEADQUARTERS FOR THE BEST
RADIO EQUIPMENT

Write for Price List

SCIENTIFIC EXPERIMENTER, Limited

33 MCGILL COLLEGE AVENUE

MONTREAL

A welcome addition to your library! Send \$2.50 today, plus postage for 7 lbs., and your copy of bound volume No. 2 of Radio News will come forward by return mail.

Experimenter Publishing Company, Inc.

236a Fulton Street, New York City

10c. CHARGES 'A&B' STORAGE BATTERY AT HOME WITH AN F-F BOOSTER



So You will never have to give up in disgust when working a distant station. Is it not gratifying to feel that all the year round your Filament Battery will be ready when you want it? You know what it is like to have Friends call to "LISTEN IN" and then find Your Battery dead. F-F BATTERY BOOSTERS Charge Automatically and Operate Unattended. Screw Plug in Lamp Socket, Snap Clips on Battery Terminals and see the gravity come up. Both Waves of Current are Rectified thru Adjustable & Easily Renewable fusible Carbon Electrodes, which Maintain a Constant Efficiency & Last thousands of hours. Also Charges Batteries right in Autos. No Skill Required. AMMETER Shows Current Flowing, eliminating Guess Work. COMPLETE IN COMPACT SELF-CONTAINED PORTABLE AUTOMATIC CHARGING UNIT. F-F Battery Boosters are Full Wave Magnetic Rectifiers for 105-125 Volt 60 Cycle A.C. Current. PRE-WAR PRICES. Bantam Type 6 Charges A 6 Volt Battery at 6 amperes \$15 Type 'B' Charges 2 to 100 Volt Radio 'B' Batteries \$15 Radio Type A-B Charges Both Your 'A&B' Batteries \$20 Bantam Type 12 Charges 12 Volt Battery at 5 Amperes \$15 Type 166 Charges 6 Volt Battery at 12 Amperes. \$24 Type 1612 Charges 12 Volt Battery at 7 Amperes. \$24 Type 1626 Charges Both 6 and 12 Volt Batteries. \$36 The Larger Types are for heavy batteries, or where time is limited. Shipping Weights 12 to 15 Pounds. Order from your Dealer or Send Check for Prompt Express Shipment. If via Parcel Post have remittance include Postage & Insurance Charges. Or have us ship Type desired C.O.D. Other F-F Battery Boosters Charge Batteries from Farm Lighting Plants & D. C. Circuits. For GROUP CHARGING use our Full Wave, Automatic F-F ROTARY RECTIFIER of 100 Volt, 36 cell capacity. Order Now Or Write Immediately for FREE BOOSTER & ROTARY Bulletins 32 & 32A.

THE FRANCE MFG. CO., OFFICES & WORKS
Cleveland, Ohio, U.S.A.
Canadian Rep: Battery Service & Sales Co., Hamilton, Ontario

We were now going about 60 miles per hour and were in the Poconos, some 30 or 40 miles from Scranton.

- 5:37 WJZ Faint.
- 5:38 1YZ(?) Very faint.
- 5:45 1ARY Loudest station so far.
- 5:46 3MT(?) Very faint.
- 5:47 2BM QRK.
- 5:48 2BY(?) Not sure.
- 6:00 1RX Very QSA.

Now passing over plain, and signal strength much stronger.

- 6:15 1CNI QRK.
- 6:20 1BQL QRK.
- 6:40 1GM Very QSA.
- 7:05 2AHU QSA.
- 7:10 1ADL(CW) Very QSA.
- (6:50) 2ACY QSA, near Blairstown, N. J.)

Telegrams were received at Stroudsburg that our voice had been heard for 20 miles out from Scranton, and that our position report had been received by C.W. while passing Elmhurst Dam, 10 miles away.

We were now down near Mountain View, N. J. WJZ very QSA; can be heard all over the car, from the Phonotron. 21E(?) or 21A concert in Jersey City very QSA too. Long distance completely blotted out by interference from local amateurs and 2FP, who was so loud that he could be copied in the next car.

WJZ was then carried all the way into Hoboken, for the benefit of those who liked to listen to the music. One of the passengers wished to speak to his wife at Lyndhurst, N. J., whom, he said, was listening on his radio set to the WJZ concert, and so "DL" was tuned to 360 meters and the passengers broadcasted his message in the hopes that his wife, who was within a mile from the railroad, would pick it up. He has not informed us whether she did or not.

In the way of an experiment, perhaps the most interesting data gathered was that of the effect of location on signals. Nearly all previous theories seemed to be confirmed, except that of immediate proximity of rock, steel bridges, and bodies of earth. Very little difference could be noted whether the railroad ran through a steep cut, 30 or 40 feet deep, or was on the level. Whenever the train went through a thickly wooded piece of land, where the trees were high, all long distance signals faded out entirely. The nearness of a body of water or a stream, even though small, seemed to greatly increase signal strength. The position of the antenna in regard to the station from which we were receiving was another important factor, for often, going around a curve, on a perfectly level plain, would make one set of stations completely fade out and bring in another.

As mentioned before, small contours in the earth's surface, when they were not wooded, seemed to have little effect, but the location of a mountain immediately between the train and stations in a certain locality would cut out the signals entirely. This was evident very strongly when we lost 8BUW while rounding a mountain. But then, again, could hear him when higher upon a plain. The best signal strength of all was when passing on a high embankment across a bare plain. This seemed even better than the proximity of a lake. Of course, all these observations are those from only two trips, but yet they seemed to hold true in nearly every case.

These are only some of the experiments which the Lackawanna Railroad is conducting, and it is hoped that more data will be available soon. Mr. G. D. Murray, Jr., and the author, who are in charge of these experiments, will greatly appreciate any report of the signals of "DL," which is the temporary call used by the Limited. All

"E. S. X."



Wireless Talking Machine Attachment
PRICE \$3.00
Dealers write for Proposition
Manufactured by
ESSEX WIRELESS SPECIALTY CO.
31 New Street -- Newark, N. J.



"Ambu" 3 Ball Battery Tester 75c
Sent postpaid for

Tells at a glance the condition of your radio or automobile battery, and whether it needs recharging.

Consists of rubber bulb, and a glass barrel containing three balls—red, white and green. Fill with acid from the battery. If all three balls float, battery is fully charged.

This easily remembered jingle tells the rest—
"Sinks the WHITE, charge still RIGHT
Sinks the GREEN, charge is LEAN
Sinks the RED, charge is DEAD."

When the green ball sinks, it's time to recharge, if you don't want to get caught.

You don't have to know anything about chemistry, electricity or specific gravities, or puzzle over complicated scales; and you can "read" this Tester in semi-darkness. It is guaranteed to be accurate.

Mailed to any address in the U. S. for 75c. Canada and foreign countries, \$1.00. Some desirable territory still open for distributors. BATTERY APPLIANCE DIVISION, DEPT. RNH

American Bureau of Engineering Inc.
2632 Prairie Ave., Chicago



Head Receivers
Micro-Phones
Keys
Jacks
Plugs
Etc

HIGH GRADE WIRELESS APPARATUS MAKERS
American Electric Company
State and 64th Sts. CHICAGO, U. S. A.

Best Results Guaranteed

STORAGE BATTERIES
Storage B Battery cells, 2V., each.....\$0.35
Price per dozen, (24V.)..... 4.00
A battery, 6V, 85 amp. hour, guaranteed for 1 year against all defects18.00

FORMICA PANELS
3/16" cut to size, per sq. in.02

DRILLING
We lay out and drill holes any size up to 1/2" for 2c each, and from 1/2" to 1" at 4c each

AERIAL WIRE
7 No. 22 stranded copper, per 100 feet..... .70
1 1/2" Moulded knob12
Pencil mark grid leak50
Switch points, N. P. 1/4 by 1/4 head, doz..... .30

Send for free literature
HUGHES ENGINEERING CO.
P. O. Box 57 Terrace Park, Ohio

NEW MOTORS FOR ALL PURPOSES
STANDARD MANUFACTURERS
PROMPT DELIVERY

ALL SIZES UP TO 5 H.P.

We Specialize In Small Motors & Generators
ALL PHASES AND FREQUENCIES IN STOCK AT ALL TIMES.
Largest exclusive Mail Order Small Motor dealers in the world.
CHAS. H. JOHNSTON, Box EC3, West End, Pittsburgh, Pa.

WIRELESS, TELEPHONE GENERATORS
500 VOLT - 100 WATT - 3400 R.P.M.
FOR MOUNTING MOTOR GENERATOR SETS.

\$28.50 EACH

WRITE FOR CATALOG



METAL STAMPINGS and DIE WORK for RADIO PRODUCTS
We also carry detector minerals mounted and unmounted. Switch levers, etc.

RADIALL ELECTRIC CO.
187 PASSAIC ST., PASSAIC, N. J.

The Alamo Radio Electric Co.
RADIO APPARATUS ELECTRICAL SPECIALTIES
608 W. Evergreen Street
SAN ANTONIO, TEXAS

Read the Classified Ads on Pages 1220, 1221 and 1222

communications should be addressed to Department of Telephone and Telegraph, Lackawanna Railroad, Hoboken, N. J.

Emil Spon's Station

(Continued from page 1099)

March, 1921, issue. I have received many letters from all over the United States regarding this receiving set. I am now using electron relay for detector with Remler "B" battery, potentiometer and Cunningham or Radiotron amplifying tubes.

The transmitter consists of three 5-watt Cunningham tubes connected in parallel; antenna current 2.2 amperes on straight C.W. and 2.1 amperes on I.C.W. and phone. Voice and music has been reported QSA as far as 500 miles from different locations several times and straight C.W. was copied by 7LU, Grey Bull, Wyoming, on a detector only a distance of 1,600 miles, air line.

The M.A. set is composed of 3/4-H.P., 3,600 R.P.M., 110 volts A.C. General Electric motor, generator used to be 1/3 H.P., 110 volts, 1,800 R.P.M. Westinghouse motor, D.C., which I redesigned and rewound myself for 3,600 R.P.M., 3/4 K.W., 800 volts, D.C. generator.

The whole power unit is suspended by four coil springs to eliminate vibration, entirely. The motor is in the center, the generator on the left, direct coupled, and the transformer for the filament is on the right. The switchboard is fastened to the base of the machine.

The loud talker is a Baldwin phone, type C, placed inside of the fixture canopy, to which a large goose-neck phonograph horn is attached. Receptions from broadcasting stations can be heard all over a seven-room house through this loud talker, with a two-stage amplifier and some arc station. NAA can be heard one block from the house on the long-wave set. All the apparatus in my station is home-made, except standard parts.

Advertising Pays

(Continued from page 1077)

several concerns, but apparently the fact that I was located on the west coast caused several to back down, as nothing further was heard from some to whom replies were sent. Being convinced that the opportunity was there, but that I wasn't, it was decided to correct this technicality. This was done by going east, and getting right in among them. As I had other business east, it would offer me an opportunity to dig into each offer directly. One substantial eastern concern attracted me considerably; so much so that it was deemed advisable to permit several smaller offers to slip by with an eye to the more substantial proposition.

Accordingly, I came to Washington, clearing up my other affairs in a few days. As it was a little early to take up the better of the propositions, who were not quite prepared to make an immediate proposal, the writer decided that an investigation of another phase of the radio game in the east, as compared to the west, would not be amiss: that of the marine operating field. Accordingly, an attempt was made to be assigned to a short trip as an operator, and with the result that on the day application was made, three ships were offered immediately. This was in Norfolk, where at that date there was not an operator available, it being necessary to wire Baltimore for men for the other vessels. As my bluff had been called, I accepted a ship making a West Indies cruise for sugar, and return-



MU-RAD

R. F. TRANSFORMERS

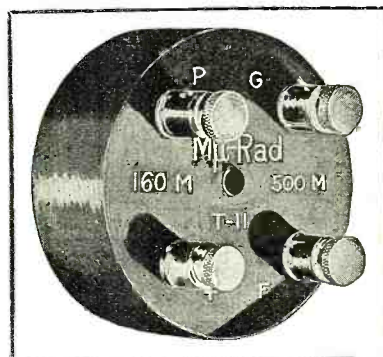

Manufacturers of Radio Victrola sets are standardizing on MU-RADS. Imitate those who know. Loud speakers being operated in N. Y. City from Chicago and Detroit broadcast using 3 ft. loop and two stages of MU-RAD T-11 R. F. amplification.

For the usual R. F. amplifier circuits we recommend Type T-11 transformers. Where user is more experienced and realizes the real advantages as well as the difficulties of extreme R. F. amplification, there are available also Types T-11A and T-11B for second and third stages respectively. These combinations give truly enormous sensitiveness.

For the longer wavelengths there is a new MU-RAD, Type T-12, having the same fine qualities as the T-11 series. T-12 will be available May 15th.

Type T-11.....\$6.00 Type T-11A.....\$6.50 Type T-11B.....\$7.50

At your dealers or direct from

MU-RAD LABORATORIES, Inc.

Branch Offices: ST. LOUIS, MO. ASBURY PARK, NEW JERSEY

WESTERN DISTRIBUTORS: THE BENWOOD CO., ST. LOUIS, MO.

Net Wt. only 1 pound



PRICE \$12.00 Postpaid

Size 5-5/16" x 3-11/16" x 3/8"

**A WONDERFUL ACHIEVEMENT!
RADIO BLINKER RECEIVING SET**

THE THREE IN ONE SET

Pat. Sept. 4, 1917—Oct. 12, 1920—Pat. Pending

(1) A practical, efficient, self-contained Wireless Receiving Set for Radio Phone Broadcasting and Commercial Stations approximately 150 to 800 meters wave length.

A newly designed, dust proof, crystal detector, extremely sensitive. Can be quickly adjusted by means of buzzer test and locked in position.

(2) A miniature Sending Set within limits of buzzer radiation.

(3) A Practice Set for code work. Ready for phones, aerial and ground connections. Sold on merit with our usual guarantee. Buy from your dealer or direct from us.

**FRANK B. PERRY & SONS
Providence, R. I.
Newton Center, Mass.**

Get a Handy Binder for your RADIO NEWS. Holds and preserves twelve issues, each of which can be inserted or removed at will. Price 65c. Experimenter Pub. Co., Inc., Book Dept., 236-A Fulton St., New York.

ATLANTIC
WAVES IN EVERY HOME
TRADE MARK REG. U.S. PAT. OFF.

ATLANTIC JR.

CRYSTAL RECEIVER

UNIQUE in DESIGN and CONSTRUCTION

Efficient, Attractive Telephones:
Double Headset (2000 Ohms)
Antenna Equipment, Complete
In Attractive Display Case

\$18

Dealers Communicate With

ATLANTIC INSTRUMENT CO., Inc.
13-21 Park Row New York
Tel. Barclay 6003

SUPER ENCO

REFILLABLE "B" BATTERIES

No Soldering Low Cost
Write for descriptive circular

ENCO ELECTRIC NOV. CO., Inc.
603-607 W. 130th St., New York

STOP GUESSING

Use the Pignolet Radio Double Scale Voltmeter and know at all times the voltage on your filament and plate and the condition of both your "A" and "B" batteries.

Send for our booklet on testing and adjusting your set.

Pignolet Instrument Company, Inc.
118 Liberty Street,
New York City

Wireless—A World Beater

NASSAU Storage Battery

4 Sizes **Guaranteed** Prices Months

| | |
|-----------------|--------|
| 6 Volt 40 Amp. | \$9.00 |
| 6 Volt 60 Amp. | 12.50 |
| 6 Volt 80 Amp. | 15.00 |
| 6 Volt 100 Amp. | 17.50 |

Shipped promptly anywhere, upon receipt of price.
Dealers, Jobbers, Distributors. Write for discounts.
NASSAU STORAGE BATTERY
P. O. Box 523, Far Rockaway, N. Y.

CONNECTICUT

RADIO EQUIPMENT

Variable Condensers, Transmitters, Head Bands, Panel Switches, Etc.

Connecticut Tel. & Elec. Co., Meriden, Conn.

ing would land me in New York, right in the heart of the radio opportunities. From what I could gather by inquiry, it would seem that conditions for marine operators are very much better on the Atlantic coast than the Pacific. At the time the writer left Seattle, there were three operators available for every opening, with no prospect of any immediate relief. Shipping seems to be on the up-grade in the east, which may lead to something of the same in the west in the near future.

At this writing I am in New York, having arrived but a few days ago from the West Indies. Already inquiry has been made among several who originally replied to my challenge, with the result that the writer is in rather a quandary as to just what to accept. Many good, bonafide offers are at hand, making it hard to choose the most promising. In addition to those originally interested in the "Wanderer," several other parties, whom the writer has approached, have made offers, with no idea that the writer was the author of the article in the January issue.

To sum things up, my conclusions are now, that there are numerous opportunities in the radio field for the trained man, but that at the present time, all these opportunities are in the eastern states. The tide of popularity which radio is creating is slowly sweeping westward, but the immediate, present-day opportunities are in the east.

A word or two in reference to salaries involved in the majority of offers may be of interest to those who are looking for opportunities in the radio field. It will be remembered that the writer offered to start at a wage as low as \$125 a month, until his value had been proven. Such experience, at so small a salary, appeared to attract a number of offers from smaller concerns, that were new in the game. This was to be expected, as a matter of course. However, the real offers, that came from firms of high standing, offered varying salaries, where such was specified, running from \$125 per month to start, up to \$250 monthly. All the substantial offers carried prospects of advancement as qualified, and correspondingly increasing salary. From this it may be seen that the salary to be expected from positions such as we are concerned with, are in proportion to those paid for capable, experienced men in most lines of endeavor.

As for the classes of work involved, this was also of a varying nature. From a \$125 a month opening as clerk in a department store radio department, various branches were covered, including radio draftsman, assembler, designer, supervisor of operators and director of instruction in a large radio school. This naturally allowed a pick of classes of work involved, and of salary offered. However, the two conflicted in some instances. The salary was low and the class of work attractive. The other extreme was high salary but unattractive work.

From the above, it will be seen that radio seems to hold first place for choice of work and salary, among present day professions.

In conclusion, I wish to extend my sincere thanks to all who saw fit to interest themselves in "The Wanderer," and particularly to the Editor of RADIO NEWS, for his valuable co-operation. I thank you.

Radio Talking Moving Pictures

(Continued from page 1077)

GRAND OPERA BY WIRELESS

By H. Gernsbach

A recent newspaper report from Chicago brought the not at all surprising news that

TWO STAGE AMPLIFIER in Oak Cabinet \$30.00

Cardboard Tubes, Seamless, Gray, 1/8-inch wall, 2 1/2x12, 25c; 3x12, 30c; 3 1/2x12, 35c; 4x12, 40c; 4 1/2x12, 45c; 5x12, 50c; 6x12, 60c.

Contact Points, Nickeled.....6 for 30c
Contact Points, Brass.....6 for 25c
Stops, Nickeled.....2 for 10c
Phone Binding Posts, Nickeled, each...15c
Binding Posts, H.R. Top, Nickeled, each.10c
Binding Posts, H.R. Top, Nickeled, each.15c

BRASS RODS, POLISHED AND DRILLED

| | | |
|---------------|---------------|---------------|
| 1/4x 7....15c | 1/4x 7....20c | BRASS SLIDERS |
| 1/4x 9....15c | 1/4x 9....20c | 1/4.....25c |
| 1/4x13....20c | 1/4x13....25c | 1/2.....30c |

MAGNET WIRE

Price per 1/2 lb. 1/4 lb. 1/2 lb. 3/4 lb. 1 lb. 1 1/4 lb.

| B.&S. Ga. | Enameled | Double Cotton | Double Silk |
|-----------|----------|---------------|--------------|
| No. 18 | — | \$.75 | — |
| No. 20 | \$.60 | \$.30 | \$.40 \$1.00 |
| No. 22 | .65 | .35 | .45 1.05 |
| No. 24 | .70 | .40 | .50 1.10 |
| No. 26 | .75 | .45 | .55 1.15 |
| No. 28 | .80 | .50 | 1.00 1.20 |
| No. 30 | .85 | .55 | 1.05 1.25 |
| No. 32 | .90 | .60 | 1.10 1.30 |

Prices net; parcel post prepaid anywhere in U. S. Send for our catalog FREE.

THE KING RADIO CO.
113 Sheridan Ave., PITTSBURGH, PA.

"COPPERWELD" ANTENNA WIRE

TRADE MARK REG. U.S. PAT. OFF.

50% Stronger Than Copper
Better than Solid Copper or Strands
Less Sagging and Stretching

Buy it in Cartons

At All Dealers and Jobbers
100-Ft. Cartons - 200-Ft. Cartons
COPPER CLAD STEEL CO.
Radio Dept. Braddock P. O. Rankin, Pa.

TUBING FOR WIRELESS

SET OF 6 CARDBOARD TUBES IN HEAVY MAILING BOX FOR \$1.00

Postage Prepaid

Each Tube is 12" Long with 1/4" Wall. Sizes are 3", 3 1/2", 4", 4 1/2", 5", 5 1/2". Make a Varlo-Coupler. Genuine Ganaerite Crystal. Postpaid 50 cents.

RUTHERFORD SUPPLY HOUSE
P. O. BOX 125 RUTHERFORD, N. J.

FREED-EISEMANN RADIO CORP.

Manufacturers of the "Marvel"

255 Fourth Ave., New York City

FREE TO BOYS! LARGE SIZE SCOUT KNIFE!

EXACTLY LIKE CUT!

Given for selling \$3.00 worth of Household Products. **W. R. T. N. C. W.** SEND NO MONEY.

Martin Chemical Co., Dept. F. B. 204 N. J. R. Ave., NEWARK, N. J.

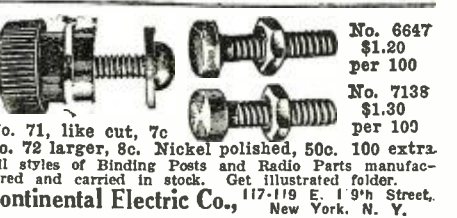

No. 6647 \$1.20 per 100
No. 7138 \$1.30 per 100
No. 71, like cut, 7c
No. 72 larger, 8c. Nickel polished, 50c. 100 extra.

All styles of Binding Posts and Radio Parts manufactured and carried in stock. Get illustrated folder.

Continental Electric Co., 117-119 E. 19th Street, New York, N. Y.

grand opera music had been transmitted by wireless telephone for over one hundred miles. Sensitive microphones placed on the stage of the opera house caught the sound waves; the impulses then being stepped up in the usual manner by means of a transformer were then led into an amplifying vacuum tube. Here the current was impressed upon the radio telephone transmitter in successive stages and then sent out over the aerial on top of the opera house. Wireless amateurs all about the surrounding country were thus able for the first time to hear grand opera. While this was only an experiment, grand opera by wireless will soon be an accomplished fact.

During the next few years it will be a common enough experience for an amateur to pick up his receivers between eight and eleven o'clock in the evening and listen not only to the voice of such stars as Scotti, Tetrizzini, McCormack and others, but also to the orchestra music as well, which is picked up by the sensitive transmitter along with the voice of the stars. The surprising thing is that it is not being done now.

The reason probably is due to the fact that as yet no means has been found to reimburse the opera companies for allowing everyone to listen in. While of course listening to the music is not as satisfying as witnessing the performance in person, still many music enthusiasts would rather stay home listening to the music alone than to witness the performance itself. To your true, dyed-in-the-wool opera fiend the performance is of secondary importance, the music always coming first.

But we must give a thought to the management, which cannot subsist on an empty opera house if everyone could listen in to the actual rendering of the opera without paying for the privilege. Needless to say that the producers would soon find themselves bankrupt. For this reason we cannot expect that grand opera by wireless will be an accomplished fact until some means has been found to reimburse the producers, and, as every wireless man knows, this is very difficult to do. Anyone with suitable radio apparatus can "listen in" to the music without much trouble. No matter on what wavelength the music would be rendered, every wireless man would find a way to listen to it without serious inconvenience.

Probably the only logical way out would be for the management of a grand opera company to advertise in the newspapers, stating that no grand opera via radio would be given unless a certain amount of revenue were guaranteed by radio subscribers before "radio performances" would be given. This would mean that probably ten out of one hundred radio stations, amateurs and otherwise would pay monthly or yearly dues to sustain the management, which then would not have to care how many were listening in.

This is the only practical solution. As for technical difficulties, there are of course none. All that is necessary for the producing company is to install a high-class wireless telephone outfit which can be bought on the market right now and which is immediately available. The rest is up to the wireless fraternity, which has nothing else to do but listen in.

At the receiving end, the future up-to-date radio opera enthusiast will, of course, have a first-class receiving outfit, using vacuum tube amplifiers, and a loud talker. Then it will be a simple matter to listen to Scotti himself, though he be a thousand miles distant. His voice will come out loud and distinct and the amateur's family will be enabled to "listen in" to their hearts' content.

There is still another novel scheme recently originated by the writer.



Above All

Quality is the wave length to which the wise consumer tunes today, in his purchase of radio equipment. He buys quality apparatus because he knows it produces quality results—constant, unvarying efficiency under ordinary conditions, anywhere.

It has been the privilege of the Marshall-Gerken Company not only to manufacture quality wireless apparatus, but to show users the value of quality in radio instruments. They have expressed their ideal of quality in the precision required of their engineers in the making of the smallest as well as the largest part; quality construction is the key to the facility of operation of Marshall-Gerken apparatus; the factor of quality again predominates in the simplicity of the instructions by which the amateur as well as the professional obtains the highest utility from Marshall-Gerken equipment.

In the establishment of their nation-wide reputation for making and selling thoroughbred apparatus, the Marshall-Gerken Company have set a high standard by which to test superior endurance and unusually satisfactory service of radio equipment.

Progressive Distributors and Dealers: Write for our illustrated Booklet, you will find it exceedingly interesting.

The Marshall-Gerken Co.
Quality **RADIO** Products
MANUFACTURERS—DISTRIBUTORS
Toledo, Ohio, U. S. A.

19 Different Sizes
Noiseless in
Operation



22½ to 100 Volts
Fully
Guaranteed

Novo "B" Batteries
FOR WIRELESS SETS

424 33d St., New York

NOVO MANUFACTURING COMPANY

531 So. Dearborn St., Chicago

Insure your copy reaching you each month. Subscribe to Radio News—\$2.50 a year. Experimenter Pub. Co., 236-A Fulton St., N. Y. C.

U.S. PATENTS



SEND FOR THIS FORM

Don't Lose Your Rights

Before disclosing your invention to anyone send for blank form "Evidence of Conception" to be signed and witnessed. A sample form together with printed instructions will show you just how to work up your evidence and establish your rights before filing application for patent. As registered patent attorneys we represent hundreds of inventors all over the U. S. and Canada in the advancement of inventions. Our schedule of fees will be found reasonable. The form "Evidence of Conception" sample, instructions relating to obtaining of patent and schedule of fees sent upon request. Ask for them,—a post card will do.

LANCASTER & ALLWINE

270 OURAY BLDG.,
WASHINGTON, D. C.

"Originators of form Evidence of Conception"

PAPER TUBES

FOR WIRELESS

ALL SIZES ON HAND
FOR IMMEDIATE DELIVERY
WHOLESALE & RETAIL

BAEHM PAPER CO., INC.
219 Fulton Street New York
Bet. Church and Greenwich Sts.

FROM CAT WHISKERS UP—
We can supply everything that's best in Radio, 1 or 101 of any article to user or dealer. Same day shipments.
Inquiries are welcome

UNITED ELECTRIC STORES CO.

DISTRIBUTORS
Wholesale & Retail

Westinghouse
Brands Federal
Murdock, DeForest
Radio Corporation
and many others

AT EAST PITTSBURGH, PA.—NEXT DOOR TO KDKA

Prompt Shipment

made to Bethlehem, Allentown, Easton, Nazareth, Lehighton, Bangor, Catasauqua, Slatington, Coplay, Lansford, Bangor, Emans, Hellertown and all other points in the Lehigh Valley and United States.

OUR MOTTO IS "All orders must leave the same day they are received. Satisfaction guaranteed."

FEDERAL, ACME, DEFOREST, MURDOCK, FADA, PARAGON, GREBE, BRANDES, BALDWIN, RADIO CORPORATION, WESTINGHOUSE, etc. Products carried in STOCK at all times.

Send us a Trial Order. Catalog mailed postpaid \$1.10
Bell phone 2548J

LEHIGH RADIO CO.

BETHLEHEM, PA.

Center & Fairview St. A. F. BREISCH, Gen. Man.

The underlying idea is not only to give grand opera by wireless, listen to the music and to the singers only, but to actually see the operatic stars on the screen as well. This is how it can be readily accomplished by means which are available today, and without the slightest technical difficulty.

Let us say, by way of example, that the opera "Aida" is filmed in its entirety. This may mean a four or five film feature. The opera will be filmed just like any other photo-play.

Our large illustration shows what happens next. The stars, singers, players, the chorus, orchestra, conductor, etc., are then assembled in a moving picture studio and in front of them is the usual screen. The opera "Aida," which had been filmed before, is now repeated on the screen while the entire cast follows the screen picture closely. Each performer, every star, every member of the chorus has his or her own microphone in which he or she sings the regular score, watching closely the film-play as the action is unreel on the screen. The moving picture opera through the film operator keeps time with the singers, and the singers themselves must keep exact time with the performance as it is unrolled on the screen before their eyes. Inasmuch as the identical cast has been filmed, it will not be difficult for them to keep time with their own performance, as may readily be imagined. In other words, when Scotti sees his own figure appearing on the screen he will know exactly how and when to sing into the microphone in front of him.

All of the microphones go to the wireless telephone station located in the radio room above, and there are, of course, sensitive microphones in the studio which pick up the sounds from the orchestra as well. All sounds are then stepped up through the usual amplifiers and are then fed into the high power vacuum pliatrons, which finally amplifies the original sound several million times. These impulses are then sent out over the usual aerial located on top of the house and are shot out all over the country instantaneously.

Five hundred to 1,000 miles away—and for that matter all over the country—every moving picture house will have been supplied with the identical film at the stated performance, it having been announced days ahead that the grand opera "Aida" will be given at such and such an hour.

Of course, where the distances are large, the hour of rendering the opera will vary. Thus, for instance, if Scotti were singing in New York and a performance would start at eight o'clock in the evening, New York time, it would start in San Francisco at four o'clock in the evening, as a matinee, due to the difference of time. Inasmuch as such performances would probably only be held once a month, people would not mind to inconvenience themselves due to slight difference of time.

Every moving picture house will have its receiving apparatus with its usual amplifiers and anywhere from six to one dozen loud talkers scattered through the house. Exactly at the stated time the moving picture operator will begin grinding away—the opera has begun. Simultaneously the distant orchestra will begin playing, filling the house with music.

When the actual performance begins, it will be an easy matter for the operator to keep time with the incoming music. All he needs to do is to grind faster or slower, and inasmuch as Scotti with his performers in New York is watching the identical film, the distant operator will have no trouble in having the music keep time with his film. If he finds that he runs ahead for one second, he can readily slow up the

"SHRAMCO PRODUCTS"

Amateurs: Send 5c in stamps, today for our new Catalogue L showing complete line of parts, raw materials and high grade apparatus.

Dealers: Write for our attractive proposition.

THE SHOTTON RADIO MFG. COMPANY, Inc.

8 Market St. Albany, N. Y.

"ELECTRICITY

Taught by a Master Teacher"

is the name of a valuable 56-page booklet which should be in the hands of every man and boy in the United States who is interested in electricity or electrical engineering. It is FREE. Send for your copy today. It tells the facts about the greatest industry on earth, and contains an astounding offer.

Engineering Division,
WORLD TECHNICAL INSTITUTE
Jersey City, N. J.

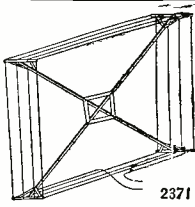

Receive on an
INDOOR COIL AERIAL

Drawing, circuit diagram, chart, and tables giving proper number of turns to put on coil for any wavelength. Data covering 0 to 3600 meters 50c; 3600 to 24000, 50c. Stamps not accepted.

C. A. DAVIS & CO.
2371 Champlain St. Wash. D. C.

C. W. APPARATUS OF ALL KINDS

Detector and One-step Amplifier in cabinets \$35.00

C.W. Chemical Rectifiers, complete, 500 mill-amp. Cap. 14 jars, will handle 1/2 amp. at 1,000 volts or less.
In cabinets 9.50

Prompt shipment

JONES ELEC. & RADIO MFG. CO.
120 E. Lexington St. Baltimore, Md.

WISCONSIN AMATEURS!

Westinghouse Remiter
Magnavox Brands
Murdock Rhamstine
A. P. and Cunningham Tubes
Willard Radio Batteries
Eveready Batteries, Panels, Wire, etc.
Order from any Standard Catalogue

CHAS. A. HONOLD CO., Sheboygan, Wis.

MANUFACTURERS ATTENTION

We are now ready to receive orders in our new Radio Transformer Department. Amplifying Transformers and all other types. Send specifications at once to receive prompt attention.

THORNTON TRANSFORMER CO., INC.
30 Church Street, N. Y. C.

next and vice versa. With a little practice it will be easy for the distant operator to time himself perfectly, thus giving the patrons of his house an ideal performance.

From a financial standpoint it would be good business for the opera company, as well as for the moving picture house, both of which would thus derive a new income running into the hundreds of thousands without hardly any expense whatsoever. The grand opera with an outlay of from one thousand to three thousand dollars could buy its high power radio telephone outfit, while every live picture house throughout the country would be able with an expenditure of less than five hundred dollars to buy its necessary radio telephone equipment and this cost would only be initial, because nothing except burnt-out vacuum tubes need be replaced and there is practically no cost of up-keep.

The writer confidently expects that this scheme will be in use throughout the country very shortly.

Correspondence from readers

(Continued from page 1117)

I wish you would put this in your magazine and let us have some discussion on the subject.

RALPH R. GARRICK.

(Words well spoken! Unfortunately for our old timers, the day has come when they will have to take a back seat, at least for a while. 999 people out of 1,000, interested in radio to-day want broadcast stuff, so it is the duty of the Editor to give the public just that. We have predicted for years that the time would come when code work would be replaced largely by radio telephony. In other words, as far as the amateur is concerned, radio telegraphy is surely on the wane. It is the story of the telegraph and telephone, repeated. The telephone has not displaced the telegraph, but the percentage of people using the telephone is thousands of times greater. There is no use trying to stem the tide, and much as we would like to see amateur radio telegraphy increasing, we do not hope for much just now when everyone has the radio telephone craze.—Editor.)

WESTINGHOUSE CO. EXPLAINS.

Editor RADIO NEWS:

I have just noted in the current issue of RADIO NEWS, on page 818, your letter of January 20 to the Honorable C. H. Houston, Assistant Secretary of Commerce. This letter contains a reference to the Westinghouse people of a character which may be taken in a number of ways, but the inference is that this company in some way has been a party to the restrictions recently placed by the Department of Commerce on the amateurs.

As a matter of fact, this company was the first to institute commercial broadcasting, and in so doing has really organized an entirely new branch of radio which has greatly stimulated interest and development in matters pertaining to it. The work of this company, as you can readily realize, has been undertaken at much expense and at considerable effort, for which there is hardly a compensating return, for you will appreciate that the business has been opened up to all manufacturers of radio supplies.

A short time ago a radio paper was almost a rarity on the newsstands, but they now occupy a position comparable with that of the *Saturday Evening Post*. You must admit that broadcasting is directly responsible for this.

From the very beginning the Westinghouse Company has recognized the position



Price \$5.00 Complete

HIPCO Multiphone

PATENT APPLIED FOR

PRICE \$5.00 COMPLETE WITH 4 SETS OF HEAD PHONES

The Wonder of the Radio Industry

Let your friends and family listen in—Reproduction perfect. No trouble—Nothing to get out of order

The Hipco Multiphone enables you to purchase four pair of receivers for less than the price of one. Reproduction 100% perfect—no trouble—absolutely nothing to get out of order. Your family or your friends may now enjoy radio concerts, lectures, etc., with perfect ease and comfort to all.

The Multiphone may be used in connection with any receiver. Simply place one of your receivers face down on Hipco Multiphone and draw the elastic bands over back of receiver to hold it firmly. The Multiphone will do the rest in a most pleasing manner. The extension tubes are all four feet (4ft.) long.



Wireless B Battery
Refillable Variable

Refillable and variable B Battery especially designed for Vacuum tube work on plate circuits, is guaranteed to be perfectly noiseless. It will give double the life of the ordinary battery.

The above cut shows part of the cover cut away which illustrates the convenience in inserting a new cell should one prove defective. These replacements are furnished complete with a positive and negative terminal soldered fast, and will be sent to any address upon receipt of 25c. They can be inserted without the use of soldering iron if desired.

| | |
|-------------------------|--------------|
| No. 100—22½ Volts | Price \$3.00 |
| No. 140—Volts 22½ | Price \$2.00 |
| Size 4½—x2½—x2½ | |

BOOSTER OR SECTIONAL B BATTERIES

| | |
|------------------------|------------------------|
| No. 110—Volts 4½ | No. 130—Volts 4½ |
| Size 4—x2½—x1½ | Size 2½—x2½—x1½ |
| Price \$.65 | Price \$.45 |

LIVE JOBBERS AND DEALERS WANTED

HIPWELL MANUFACTURING CO.

No. 825-835 NORTH AVE. N. S. PITTSBURGH, PA.

GOTHAM VARIOMETERS

Made of Mahogany and Genuine Bakelite tubing used for coupler, connections to rotors through rear hollow shaft. Wave length 150 to 500 meters.

Variometers complete, assembled...\$5.00
Variometers wound, unassembled... 4.00
Variocouplers complete, assembled. 4.00
Variocouplers complete, unassembled 3.00

All brass parts included in unassembled pieces

RADIO AND ELECTRICAL SUPPLIES

DAVID KILLOCH COMPANY

57 MURRAY STREET NEW YORK CITY

WRITE FOR CATALOGUE

TELEGRAPHY

(Morse and Wireless) and RAILWAY ACCOUNTING taught thoroughly. Big salaries; great opportunities. Oldest, largest school. Endorsed by Telegraph, Railway, Radio, and Government officials. Expenses low—opportunities to earn large portion. Catalog free.

HENRY J. RAPHEL Radio Accessories
Head Phones in Stock—Vario-couplers and Variometers
D. C. Battery Charger \$12.50 Mail Orders Filled Promptly
303 Pearl Street, New York City

Immediate Delivery

Precel Radio equipment is quality product. Everything which carries the Precel imprint is fully guaranteed. Precel means unexcelled. Five years of actual service is back of the Precel factory. We know from actual experience what the "Radio Fan" must have. We can give immediate shipment on the following three items. In a short time, we will deliver complete telephone receiving sets.

PRECEL TRANSFORMER

Coils specially wound and impregnated. Layers of wire separated by varnished paper of very high dielectric strength, minimizing the possibility of burning out. After long experimentation the ratio between the primary and secondary coils, which gives the maximum amplification with minimum distortion has been found. The high grade electrical sheet steel laminations in the core are separately varnished. Has two cast aluminum legs. Can be mounted on panel or used in standing position.

PRECEL RHEOSTAT

Designed for panel mounting. Can be used in standing position. Holes are provided for either panel or table mounting. Resistance 6 ohms. Carrying capacity 1 1/2 amps.

PRECEL V.T. SOCKET

Cast aluminum rim with composition base, spring contacts. Designed for use with the PRECEL rheostat. One set of holes in the panel supports both rheostat and socket. Holes are provided for bolting the two instruments together and having a detector unit.

Write for complete literature and price list

PRECEL RADIO & MFG. CO.

1052 Spitzer Bldg. Toledo, Ohio

ELDREDGE METERS

Check up on your B Batteries!



Weakened signals can often be traced to a drop below normal voltage of your batteries, yet thousands have overlooked this important feature. An **ELDREDGE POCKET VOLT-METER SHOULD BE A PART OF EVERY RADIOPHONE EQUIPMENT.** Reads either direction of current. Illustration shows scale 0-6 but they are also supplied in scales 0-30 and 0-50 volts. Price \$6.50.

Cheaper meters can be purchased but **ELDREDGE METERS** are **INDIVIDUALLY CALIBRATED** to a master instrument, an expensive process. Symmetrical design and high polished nickel finish.

Sole Distributors

John Firth & Co. Inc.

709 Sixth Ave. New York



RADIO SUPPLIES AND EQUIPMENT

Standard goods, under money-back guarantee. Sent prepaid on receipt of price.

RECEIVING SETS (Crystal)

- "Aeriola Jr." Westinghouse, complete with Brandes "Superior" phones.....\$25.00
 - "Radiola" De Forest, complete with Brandes "Superior" phones..... 25.00
 - No. 110 "Marvel" with double telephone head set 18.00
- ### CONDENSERS (For CW work)
- No. UC-1014 Radio Corp. .002 MF. 3000 volts.. 2.00
 - No. UC-1015 Radio Corp. .0003, .0004, .0005 MFD. 7500 volts..... 5.40
 - No. UC-1803 Radio Corp. .000025 MF. 10,000 volts..... 5.00
 - No. UC-1806 Radio Corp. .002 MF. 6,000 volts.. 7.00
- ### VACUUM TUBES
- No. UV-290 Radiotron detector..... 5.00
 - No. UV-201 Radiotron amplifier..... 6.50
 - No. UV-202 Radiotron 5 watt..... 8.00
 - No. UV 203 Radiotron 50 watt.....30.00
 - No. UV-204 Radiotron 250 watt.....110.00

Order from this ad today.
JACKSON SCHREIBER RADIO CO.
312 N. Euclid Ave., St. Louis, Mo.

RADIO

We carry a full line of Radio Sets and Supplies of the best makes. Hear our sets before buying.

CHICAGO ELECTRICAL SUPPLY CO.
360 W. Madison St. CHICAGO, ILL.

of the amateur and has been most friendly in its attitude toward him, and has never asked for nor attempted to put over any restriction of any kind relating to his activity. The action of the Government was just as much a surprise to us as it was to anyone else. In fact, in this same article you refer to the foolishness of a restriction which places all the broadcasting stations on a 360 meter wave-length. This restriction was imposed on us and has embarrassed us a very great deal, as it causes so much interference between the various stations.

I am writing you because I feel that the reference you have made in the letter referred to is not fair to us, in view of what we have done for this activity.

H. P. DAVIS, Vice President,
Westinghouse Electric & Manufacturing Co.

The Simplest Valve Cabinet

(Continued from page 1114)

slip over the screws, as shown. The adjustment gear consists of a brass spindle with a contact arm of spring brass or phosphor bronze soldered in a suitable position. The spindle first passes through the brass bush in the panel and is held in a central working position by means of an angle bracket or bearing piece. The spindle is finally kept at the correct tension by means of locknuts against their bearing piece. A brass pointer, similar to that of the grid condenser, must be secured to the knob in a position corresponding to that of the contact arm beneath it.

In assembling the working parts to the panel, make sure that these move with perfect freedom and all nuts, etc., are screwed tightly. The terminals must be fastened down very tightly, because unless they have been pinned, they sometimes have a tendency through constant handling to work loose.

The internal wiring can be done with 16-gauge bare copper wire, keeping strictly to the circuit shown, and all bends neat. The wire can readily be straightened in lengths by holding one end in the vise and stretching slightly by means of pliers at the other end. It will be advisable to solder all connections except those to the terminals, where the wire can be bent into a loop and secured tightly with a nut. Even connections to the back of terminals can be soldered if desired, but care must be taken for if too much heat is applied with the iron, the ebonite around the terminal will soften causing it to loosen. Use fluxite or resin, not acid upon any account, and even if fluxite is used, it must be carefully cleaned off when the soldering has been finished. The panel, when completed, can be mounted upon a suitable box or cabinet which one can build to his own taste, as in the writer's opinion, details are not here necessary.

OPERATION

The circuit used in the cabinet lends itself readily to either arc (undamped) or spark (damped) reception and on the latter adjustment, which we will treat first, local signals will come in with surprising clearness. For short waves a small coupled tuner should be used with arrangements in the primary circuit for increasing the wave-length by means of a small aerial tuning coil or variometer. The secondary inductance should be roughly variable, the major portion of the tuning being accomplished by means of the secondary condenser shown.

A tickler coil for waves below 1,000 meters, need have only about 10 turns on a 3" former, though with many valves regenerative coupling can be obtained with

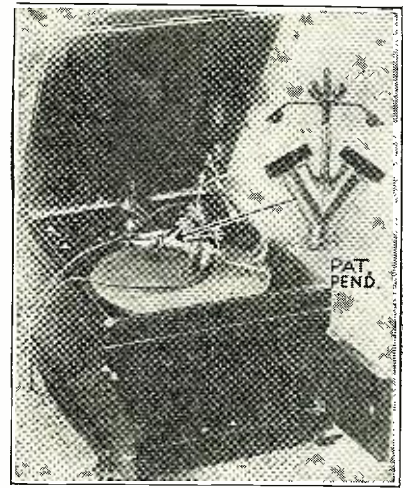

DUPLEX VICTROLA ATTACHMENT \$5.00

Make a first class loud speaker of your head phones and Victrola with a DUPLEX. Highly polished aluminum and nickel plate. If your dealer does not have the DUPLEX, state make of talking machine and we will send post paid on receipt of price.

Manufactured by
W. B. McMASTERS, Wheeling, W. Va.

STEINER ELECTRIC CO.

115 N. Wells St., Chicago

RADIO SUPPLIES

Branch Store—5239 N. Clark St.

Wholesale and Retail

WE MANUFACTURE RADIO

If you are in need of increased manufacturing facilities, or if you are about to bring out radio equipment and have no plant, get in touch with us at once.

BRIGGS AND STRATTON CO.
MILWAUKEE, WIS.

KRYSTAL-KLEER

For clear and distinct receiving use on your detector. Price one dollar at your dealer's or send half dollar P. M. O. for sample sufficient for fifty crystals.

The KRYSTAL-KLEER Company
5229 Broadway New York City
—Puts PEP in the Detector—

KUBEN CABINETS

The best on the market. We make them in any size and any quantity.

MANUFACTURERS: We solicit your requirements.

JOBBERS AND DEALERS: Write for price or stock sizes.

KUND & EIBEN MFG. CO.
204-224 Warrington Ave., Pittsburgh, Pa.

CLAPP-EASTHAM and GREBE SETS

Immediate Deliveries

MASSEY RADIO COMPANY

Wireless Equipment and Supplies

WINCHESTER VIRGINIA

\$3.50 R A C \$3.50 AMPLIFIER CHOKES

For Use With

RAC-3 AUDIONS

NEW JERSEY RADIO EQUIPMENT & INSTALLATION CO.

120 Bidwell Avenue Jersey City, N. J.

the tickler terminals of the cabinet "shorted," the valve itself supplying the necessary coupling (capacitive) between its elements. It would be advisable to try this first. Best results are obtained on spark signals with the valve either on the point of oscillation or oscillating very feebly. A test for oscillation is the double click obtained when the finger is tapped on the secondary terminal connected to the grid. The best adjustment for the grid condenser will be found by screwing the knob back and forth so that the pointer passes around the complete circle again and again. The best operating position after once having been found can then be varied minutely over 180 deg. of the circle, as shown.

When using the cabinet for the reception of long waves (undamped) the tickler coil may require as high a value as 5 or 6 millihenries, depending upon the valve, but this can better be obtained experimentally. Use must be made of a variable "B" battery outside the cabinet.

Should the valve refuse to oscillate, try different values of plate potential, filament temperature and regenerative coupling.

Bad insulation, faulty connections or short-circuited condensers will also prevent the valve generating oscillations.

The Transmission of HY Frequency's Polar Affinity

(Continued from page 1103)

from her guardians and CIRCULATE with them. They could not TRANSFORMER CURRENT of thought and met with such RESISTANCE that they were GROUNDED.

Would AMMETER at the STATION. she wondered, or would VOLT METER? Possibly DYNA MO, the negro cook, would METER. She was INTERRUPTED by SPARK PLUG at this PHASE. When he tried to CUT IN on her, she SHUNTED him across the LINE so quickly it made the SPARK GAP. The OVERLOAD on her nervous SYSTEM put her in HIGH TENSION so that when they hit a SWITCH she KICKED IT OUT, which SHOCKED some old ladies.

DISCHARGED at the STATION, DYNA MO was there to METER. They made CONNECTION with a TROLLY and were home in a FLASH. X. RAY was glad to RECEIVER after her TRANSMISSION and hoped that it did not EXCITER.

EDWIN G. GETTINS.

How to Grain a Bakelite Panel

(Continued from page 1108)

in one direction, commencing at the nearer end.

When the sandpaper begins to "bite in" it will be found that it is covered with particles of the bakelite which render the sandpaper useless. Because of this, quite a large quantity will be consumed. The depth of the "grain" will of course be proportional to the elbow grease used.

Practical Hints for Amateur Constructors

(Continued from page 1110)

in a container $3\frac{3}{4}$ " in diameter by $6\frac{1}{4}$ " long and is just right for a secondary coil to be wound on.

A 15c. package of rolled oats comes in a container $4\frac{1}{8}$ " in diameter by 7" long and



Trade Mark
Registered

ANNOUNCEMENT

THE SALES DIVISION OF THE
PHILADELPHIA SCHOOL OF WIRELESS TELEGRAPHY

will hereafter be conducted under the name of

PHILADELPHIA WIRELESS SALES CORPORATION

1533 Pine Street, Philadelphia

The new corporation is owned and controlled by the same parties as heretofore and the business will be carried on without change of personnel. This change of name was deemed advisable in that our trade name did not indicate the full scope of our business.

The name of the school will be used only for purely school matters.

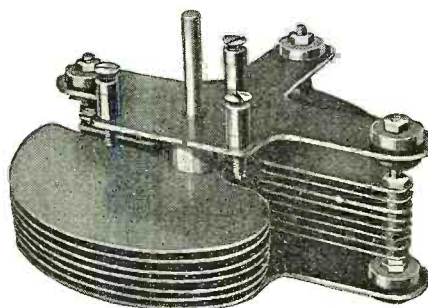

Variable Air Condensers

of Aluminum movable and fixed plates. Affords delicate adjustment on starting engagement of plates because of logarithmically curved shape of movable plates, as well as insuring positive operation throughout the range. Double end bearing of movable plates and lock nut on substantial spindle maintains constant and exact spacing between fixed and movable plates, preventing short circuiting. End support plates of heavy gage metal afford superiority over material that warps.

Manufactured by

Diamant Tool & Mfg. Co. Inc.
95 Runyon St., Newark, N. J.

MONEY FOR YOU—Add to your salary—Make extra pin money—Start a lucrative business of your own. Spend an hour each day taking subscriptions for the Radio News. We'll pay you well and you'll enjoy the work. Write for full particulars. Circulation Dept., Radio News, 236A Fulton Street, New York City.



GLOBE NOISELESS RADIO BATTERY

SAVE YOU 50% OF COST

And you get an unconditional written 2-year guarantee. Factory to user selling methods, and low operating costs make possible the remarkable low prices that we quote below, and the proven worth of the Globe Battery warrants the iron-clad guarantee that we give to every purchaser.

Designed Especially for Wireless

The Globe NOISELESS Radio Battery was designed with the special requirements of radio operation in mind. It is not an experiment! It is made by an old established company that for years have been making the very highest type of automobile batteries. Remember that the success or failure of your set depends on the quality of battery that you buy. The correct construction of the Globe makes them non-leak, non-conductive, non-deteriorating and prevents hissing and frying noises. We back these statements with a written guarantee.

Compare These Prices With All Others

A comparison of the prices that we quote will prove to you that you can save at least 50% by buying a Globe Battery. Send in your order now, it will be filled the day it is received. Batteries shipped by express $\frac{1}{2}$ O. D.

| Volts | Wts. | Price | Volts | Amps. | Price |
|-------|------|--------|-------|-------|---------|
| 6 | 40 | \$8.50 | 6 | 80 | \$13.00 |
| 6 | 60 | 10.00 | 6 | 100 | 15.00 |

Shipped Fully Charged Ready for Installation

Begin now to get 100% battery service at half cost by sending us your order today.

GLOBE BATTERY COMPANY

1219 S. Wabash Ave., Dept. R, Chicago, Ill.

will do well for a primary when properly wound.

The tubes are made very hard if well coated with shellac after winding.

I used two of these containers and obtained better results than from a receiving transformer that cost \$11.

Contributed by H. E. WADSWORTH.

Duplex Radio Telephony A Reality

(Continued from page 110e)

or power panel, the vacuum tube transmitter and the radio receiver. Power is supplied to the kenetron panel in the form of low voltage alternating current and after passing through the various pieces of apparatus, comes out in the form of direct current at a very high voltage.

This high voltage is fed into the radiotron power tubes, where it is transformed into radio frequency energy, the ether vibrations upon which the sound waves travel. Other radiotron tubes are used to control or modulate this high frequency in accordance with the voice variations, and this modulated or molded high frequency energy is radiated into the ether from the antenna on the ship.

TALKS OVER LAND PHONE

The radio receiver is connected to the antenna at the same time that the transmitter is in operation, and a special device is used to prevent the large power from the transmitter from entering the receiver, where it would prevent the incoming voice from being heard.

The interesting feature of a shipboard duplex installation is the fact that the antenna is being used to radiate several hundred watts of power, while at the same time the radio receiver detects and makes audible the extreme amount of energy that is being picked up from the distant transmitting station. Much research has been done to allow this simultaneous transmission and reception to be carried and a ship equipped with apparatus of this nature may communicate to any subscriber on land who has an ordinary telephone in his home.

Sermon and Jazz

(Continued from page 110z)

"Of course a great many sets in Washington can hear KDKA and WJZ," explained Mr. Williams in a personal interview, "but what is there for the rapidly increasing number of radio novices who have sets capable of hearing only medium-power stations? The man who buys a \$50 receiving set is entitled to as wide a variety of news and entertainment as is the man who buys a \$500 set. We propose to furnish such service. In our program instrumental and vocal artists will render concerts direct. We have employed considerable local talent for this purpose and arrangements have also been made with the Washington theaters to permit well-known singers and musicians to give concerts."

Mr. Williams is widely known throughout the city and has a great many friends. He is personally acquainted with a number of musical composers and vocalists who have volunteered their services, and also with several members of the United States Marine Band. Instrumental solos will occasionally be rendered by Marine Band musicians. The program will be broadcast every Monday evening from 8 p. m. to 9:45 p. m. Mr. Williams has been besieged by the local newspapers which have offered to furnish up-to-the-minute news dispatches

STAGG 0244

WOOD TURNING CO.
499 STAGG STREET
Corner Varick Av.
BROOKLYN, N. Y.

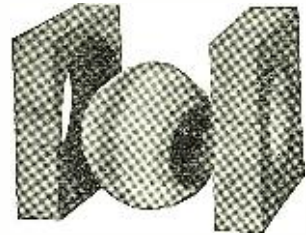

We are manufacturers of all sorts of wood work for Radio outfits: Rotors, Stators, Couplers, etc. All turning done by automatic machinery thereby securing perfect work.

GENERAL WOOD TURNING and FLOOR LAMPS

ASK **SORSINC**

When you contemplate the purchase of a new piece of radio apparatus—our experience will save you money and it costs you nothing.

SHIP OWNERS
RADIO SERVICE INC.

80 Washington St. New York

- Boston
- Philadelphia
- Baltimore
- Norfolk
- Savannah
- New Orleans
- San Francisco
- Seattle
- Portland

Have your Wavemeter calibrated—FREE

Send 6 cents in stamps for our latest booklet.

SCREW MACHINE PRODUCTS AND SHEET METAL PARTS

for **RADIO APPARATUS**

Let Us Work With You
DRAPERY HARDWARE MFG. CO.
200 13th Street Long Island City, N. Y.



We manufacture contact switches, screw machine and composition parts.

Write for dealers proposition

12 Months to Pay

You can easily earn money for the small payments. Parents often advance first payment to help buy a RANGER. 44 Bikes, colors and sizes. Factory to Rider prices. Delivered FREE, express prepaid, for 30 DAYS TRIAL. Terms to suit—cash or easy payments.

Tires, lamps, wheels, horns, repairs and equipment at half usual prices. SEND NO MONEY. Write today for our big, Free Ranger Catalog and marvelous prices.

Mead Cycle Company Write us today for free catalog
Dept. B-116 Chicago



NEW Kerosene Vapor GAS BURNER

Amazing new invention—makes gas out of coal oil. Costs less than coal or wood. No dirt—no work—greater heat—cooler kitchens. Fits any old stove. The remarkable SIMPLEX—years ahead of all competition.

\$75 WEEKLY for AGENTS

Write quick for terms
SIMPLEX UTILITIES MFG. CO., Dept. 650, 2533 S. State Street, CHICAGO

STORAGE BATTERIES and RECTIFIERS

AMERICAN BATTERY CO.

2056 N. Racine Avenue
Established 1889 CHICAGO

Wireless Operators Wanted

LEARN WIRELESS AT HOME IN SPARE TIME

The demand for experts exceeds supply. Pays big salaries, \$125 to \$250 a month to \$10,000 a year. Our home course will make you an expert operator in shortest possible time. Instruction by radio experts. We give you Best Theory, Text-Books, and Two Instruments Free, the wonderful Omnigraph and

FREE VACUUM TUBE Wireless Phone AND CODE SET

Given Free with Professional Course.

Special Low Cost, Quick, Simple

AMATEUR WIRELESS COURSE

Qualifies For Amateur License

FREE Learn-O-Graph given with Amateur Course.

Write for booklet "How to become a Wireless Operator."

NEW YORK WIRELESS INSTITUTE
154-V Nassau St. New York City



for broadcasting throughout the city. He may avail himself of this offer.

For several weeks past the sermons of the Reverend Dr. Charles Wood of the Church of the Covenant have been heard over a wide area in the East by radiophone. The service has become extremely popular and has received much publicity in the newspapers. The transmission set used by the Church of the Covenant is similar in construction to that used at Mr. Williams' electrical shop. The call letters are "WDM," wave-length 360 meters. The sermons are broadcast every Sunday at 11 a. m., 3:30 p. m. and 8 p. m., and have been heard as far as Marion, Ohio.

The Radio Age is Youth

(Continued from page 1096)

numbers enjoy distant entertainment.

The set has connection for a Tunit for wave lengths of 160 to 600 meters. This is the connection used for most work, although honeycomb coils are used in place of the Tunit from time to time to get wave-lengths up to 5,000 meters.

Many of the boys are studying the code and a number already have become proficient operators. Six telegraph circuits have been set up for practice and instructions are given at regular periods by Carlyle Stallings, assistant scoutmaster, who is the troop's chief operator. Avery Owen, who is shown in the picture, is the troop's second operator.

The "A" battery used to light the audion and amplifier tubes has approximately six volts and 80-hour amperage. The "B" battery is connected with three lugs, so that 22½ volts are carried across the audion and 45 volts across the amplifiers.

Over in the Brambleton section of the city, Robert Sanderlin, scout of Troop 4, has constructed a somewhat smaller set in his home. The set has detector and two steps of amplification. It is compact, standing about 7 inches by 14 inches and closely resembles the more "orthodox" type of receivers.

The spread, in this section, of radio enthusiasm among business and professional men is traceable directly to the success of Norfolk youth in "getting" the broadcasters of the north and east.

Aiding Detection with a Horseshoe Magnet

(Continued from page 1113)

U.V.200. The bulb is raised or else the magnet is placed as shown in the diagram.

The magnet must be level with the plate P'. It is better to have the poles of the magnet close together.

Contributed by **LESLIE LITTS,**
Paw-Paw, Illinois.

Cecil Barrett's Station, 9AY1

(Continued from page 1100)

My spark outfit consists of a 1-K.W transformer, six sections of Murdock moulded condenser, a 5,000-r.p.m. rotary spark gap and O.T. on 200 meters wave-length.

Two motor generators supply current to the phone, one a 500-volt 50-watt Radico and the other six volt for filament. Stor-

"SELECTOR"

Patent Pending

A RADIO SELECTIVE TUNER OR RADIO MULTIPLE CONTACT SWITCH

For Cutting in Vario Coupler, Loading Coil Taps, etc.

The "SELECTOR" reduces the leads to a minimum. Short Leads in Radio Instrument wiring are not alone necessary, but are imperative for proper functioning. The "Selector" combines all these very essentials, and in addition

NEAT COMPACT POSITIVE

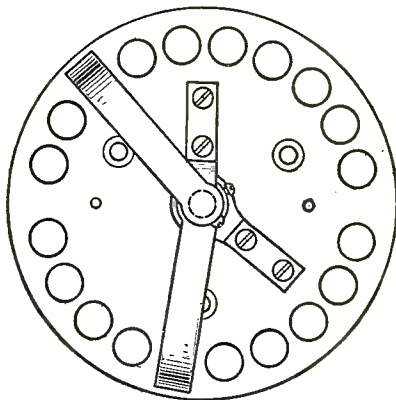

Rear View
"SELECTOR"
Wiping Contacts
Positive and Sure.

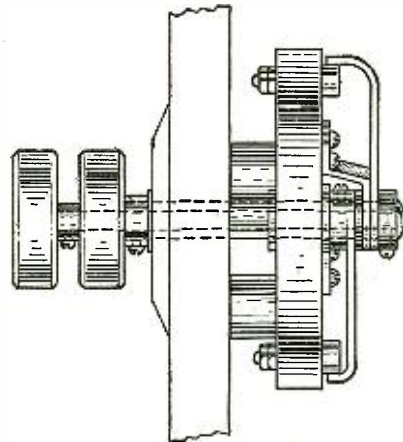

Side View

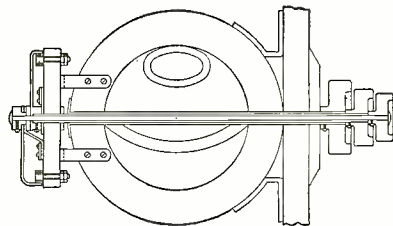

Can be mounted on Coupler or Coil Direct.

Mounted on Panel—two handles in one space—Compact also for table mounting. Replaces contacts on front of Panel. Saves space, labor and is compact.

Price, \$4.25

including Parcel Post anywhere in United States

Twenty-five Years Experience Staplizes Our Product. We Know.

NORRIS ELECTRIC SPECIALTIES CO., Inc.

*Radio Equipment
Electric Engineering Specialties*

126 Liberty Street

New York

ARNOLD LOOSE COUPLER

IMPROVED MODEL, PRICE \$18.00

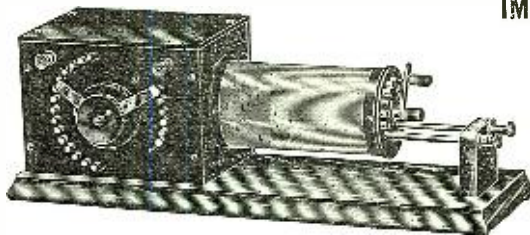

The most consistent piece of apparatus to hear the Radio Telephone (without distortion). Range of wave length from 200 to 2,500 meters.

Send 3c stamp for literature, which describes fully the loose Coupler, also the full line of Audion detectors, amplifiers; in fact the entire line of **ARNOLD AP-PARATUS.**

NOTE NEW ADDRESS

J. F. ARNOLD, Established 1910 **109 East 125th Street, New York City**

HAVE YOU SOMETHING TO SELL OR EXCHANGE?

A classified ad in Radio News will reach over 235,000 at a cost of only twelve cents a word.

WORK WANTED

Jacks and Plugs
Moulded Insulations
Punchings and Stampings
Screw Machine Parts

Send Prints and Specifications for Prices and Deliveries to

Hall Switch & Signal Co.
GARWOOD, N. J.

Mfrs. of Electrical Parts and Devices for over Fifty Years.



A REAL VARIABLE

The Haynes Variable Condenser was designed before it was built.

Mailing weight 2 lbs.

It Does Not Leak

THE HARD RUBBER insulating discs are exceptionally large. It has a straight line capacity curve. It is furnished in the following sizes: (Diameter 4 1/4 inches)

.0016 mfd. \$5.50
.001 mfd. 4.50
.0005 mfd. 3.50

We CAN make delivery

DEALERS—Here is a condenser that is worth twice its price and there is plenty in it for you.

THE HAYNES RADIO SHOP

629 Lexington Ave. (at 54th St.)
(Phone Plaza 6301) NEW YORK, N. Y.

HEAD SETS

"Old Glory"

\$8.00 List 2200 Ohms Guaranteed

Sensitive and Durable

We Can Make Delivery
Our Only Product

OLD GLORY HEAD SET CO.

1931 BROADWAY NEW YORK

Write us for Distribution

RADIO

Sets, Parts, Phones, Accessories

WANTED IMMEDIATELY!

Write or wire offers to:

N. FIELDS

5041 Haverford Ave., Philadelphia

age batteries are used in receiving. In the lower left hand corner is partly shown a Tesla high frequency coil used in experimenting.

Back of the generators is a small Victor phonograph which I use when sending music. On 200 meters I have received reports from as far as Galveston, Texas, and Memphis, Tenn., saying my C.W. had been received very QSA. Any reports on my signals would be gratefully received.

CECIL BARRETTE,
123 East Kemp,
Watertown, S. D.

Beware of the Shark

(Continued from page 1116)

much with me. I've only got three dollars in the house."

"Well, you can pay that much down, but see that you forward the remainder to headquarters within a week," came the ultimatum.

Alarmed at the man's manner, and fearing that he had violated some strict Federal regulation, the youth hurried into the house and soon returned with the three dollars and a promise to remit the balance to "headquarters" within the week. Needless to say, when he remitted the seven dollars with a letter a few days later, it was returned and at the same time, a real Federal man dropped in to get the details. Only then did the youth learn that he had been "stung" for the three dollars and that he was right when he had stated no license was required. The stranger had only insisted on his remitting the balance to "headquarters" to make his claim stronger, but that insistence led to the shark's downfall, for within a few weeks, through various other victims, he was traced and at last reports was facing a stiff term in the Federal prison for impersonating a Federal officer.

This, however, is only one of the many "skin games" which are being worked daily on unsuspecting amateurs in various parts of the country. The ever-increasing popularity of Radio activities has attracted the attention of the persons who live "by their wits," and the very newness of the game helps to serve their purpose.

However, it is not always the rank amateur who falls for the smooth talk and finds himself out of pocket as the result. A friend of the writer's, who has been indulging in radio work for four or five years, recently was victimized out of \$25 by a new variation of a very old game.

This friend read an advertisement in a local newspaper of a loud speaker, which he knew retailed at \$40, but which was offered at \$25. It was advertised as "brand-new, and without a flaw." Being interested, he investigated and found the advertiser located in a hotel room, with a radio set on a stand and the loud speaker attached. However, when he called, he found the advertiser apparently in a great hurry. He was asked to return at 4 p. m. as the man wanted to make an appointment and could not wait. That was all right with my friend, so he agreed. Promptly at 4 p. m., he called at the hotel, found the owner of the loud speaker and together they examined it. It was, as the advertisement said, absolutely new and in first class condition. Naturally, my friend paid over the \$25 for the instrument. He watched the man as the latter put the loud speaker into a case; "I had this built for it," the man explained, adding that the case was thrown in without charge. Of course, this pleased my friend more than ever and when the former

EVERYTHING IN RADIO HARDWARE

FRANK WHEELER and SON
MERIDEN, CONN.

"SUPERIOR" RECEIVING SET



\$4.75

In cabinet complete as shown

Guaranteed to bring in signals as loud or louder than any other crystal set made, regardless of price. We will prove this to your satisfaction or refund your money.

Parts for "SUPERIOR" set ready for assembling \$3.25

GENUINE "STEINMETZ" TESTED GALENA

Absolutely the most sensitive that can be had.

In sealed tin box 15c

At your dealers or

STEINMETZ WIRELESS MFG. CO. Pittsburgh, Pa.
5706 Penn. Ave.

ELECTRICAL TRAINING BOOK FREE

Send me your name and address and I will send you my big new Electrical Training Book Free. It will show you how to qualify for high paying jobs in Electricity. Thousands now open. Prepare at home—quickly—during spare time under an Electrical Engineer. Take advantage of this unusual offer—only temporary. A. W. WICKS, President WICKS ELECTRICAL INSTITUTE Dept. 229A 3601 Michigan Ave. CHICAGO

Salesmen

A large number of Salesmen have found a profitable field in soliciting yearly subscriptions for Science and Invention, Radio News and Practical Electrics. There is an opportunity for you in your own community. The commissions we pay are quite good. Write for particulars at once to C. J. Wolfe, Experimenter Publishing Co., 53 Park Place, New York.

owner of the speaker suggested that they step down for a cigar a moment while they discussed some radio novelties, my friend readily agreed. They returned to the room some fifteen minutes later, my friend picked up the case and departed.

Opening the case at his home an hour later, he found a block of plain wood inside! While he and the stranger had been down to get the cigars, an accomplice of the latter had switched on him. The victim of the game rushed back to the hotel only to find that the sharper had flown, but he did find two others who had been stung likewise, which was the reason for the 4 o'clock appointment. The sharper had so arranged his appointments close together that he was able to "Get" all three of them and still have time to make his getaway.

"The fixing game" is another one that many amateurs will fall victims to unless on their guard through pre-knowledge of how it is worked. The amateurs in many cities have more or less trouble with the power companies who often have almost prohibitive rules and charges. In such cases, the amateur is liable to have a call some evening from a fatherly-appearing old gentleman who, after many apologies, says he is an employe of the company.

"My son is in charge of power distribution in this district," he will assert, "and he would like to help you youngsters out in getting sufficient power with small cost. But, while he has the opportunity of doing this, he is risking a great deal, for he would lose his job if the company got next, and of course, then he would have a hard time getting a new one. However, he wants to help you out and if you can afford to pay him \$10 for the time he puts in, outside of working hours, connecting you up with another power line so you will have plenty of power, but without any further cost for current, he will do so. Now if you want him to, I'll have him call some evening this week, so you can pay him the \$10 and he can connect you up that night while it is dark."

A crooked game on the face of it even if the lineman would carry out his promise, because he would make the radio amateur an accomplice in the game of "skinning" the power company which would certainly be detected at some time.

Despite this angle, many amateurs accept the offer, and a few nights later, a man dressed as a lineman and with spurs on his feet, appears at the amateur's home. A little conversation and the \$10 is paid over and the lineman goes out, ostensibly to connect up with the outside power line. In reality, he beats it for the home of some other amateur with whom a similar appointment has been made and collects another \$10 and so on until he has collected from all with whom "appointments" have been made; then he and his accomplice leave for the scene of new operations. And the amateur? He can't even report his loss to the authorities for he then realizes he has in fact been cooking up a crooked game himself.

Many and many are the games being worked. Naturally, when an amateur gets "stung," unless he is personally "in bad" as in the last incident described, he will broadcast the information for the benefit of his fellow enthusiasts. But while he is telling of one, the sharpers are busy thinking up a dozen new ones. There is only one safe course. Unless you are absolutely certain, "watch your step." Consult with other amateurs. Talk to the dealers. Watch the Radio magazines carefully and keep up to date on developments, and if you do fall, don't hesitate to warn others to save them from being similarly victimized. Unless you do this, eventually you will join the club of "E. M."—Easy Marks, if you are not already a member.

"WORKRITE PRODUCTS WORKRITE"

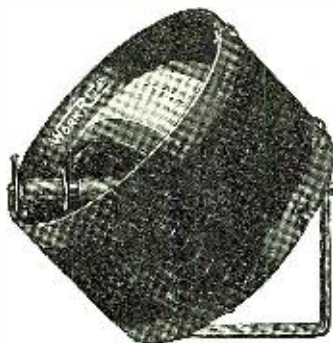

**WORKRITE
180° VARIOCOUPLER**

**Finest
Material**

**Finest
Work-
manship**

**Finest
Finish**

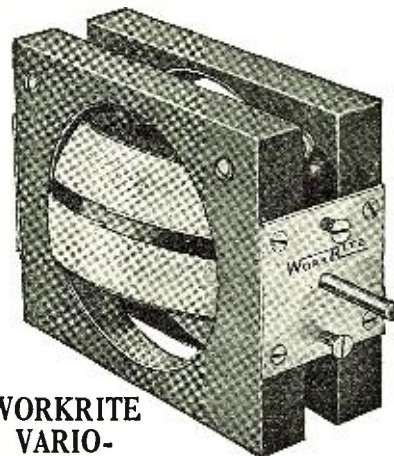

**WORKRITE
VARIO-
METER**

Here is the "Tuner Team" that radio fans have been going wild over wherever shown. Most dealers have their entire allotment sold before shipment is received. "They certainly do Work-Rite" is the verdict of all users.

One WorkRite Variocoupler and two Work-Rite Variometers are guaranteed to give you a tuner that cannot be excelled by anything on the market.

**WorkRite Variocoupler or Variometer
in Attractive Boxes - \$6.00 Each.**

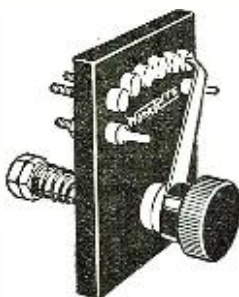

Just what you want. Remove the parts and use the block as a template for drilling your panel. Put up in neat individual boxes. Complete WorkRite Switch Sets, \$1.00.



WorkRite Binding Posts, 12c.

Work Rite Switch Points, 4c

Work Rite Switch Stops, 6c

Work Rite Switch Arm with Bushing, 50c.

TYPE "A" WORKRITE HYDROMETER

Double the life of your battery by giving it proper care. Fill and test it regularly with a WorkRite Hydrometer. Never let it become discharged below 1150, or it will soon be ruined. Full instructions for testing and care of battery with each "WORKRITE". Get one now! **PRICE \$1.00.**



Insist that your dealer furnish a "WORKRITE". Accept no substitute. If he cannot supply you, we will ship direct by mail prepaid.

JOBBER AND DEALERS—Write or Wire for Discounts

THE WORKRITE MFG. CO., 5605 Euclid Ave. Cleveland, Ohio.

For Best Results

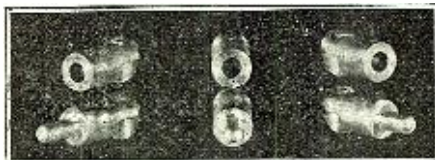

This new honeycomb 3-coil mounting complete with two handles, \$4.50 postpaid

T. S. F. Supply Company
Box 3C1 Cincinnati, O.

THE BEST LOUD SPEAKER IS YOUR Phonograph when used with the "Easy" RADIO - PHONOGRAPH CONNECTOR

Just slip the sound box (reproducer) off your talking machine, and replace it with the "Easy" Connector. Then your head phone will fit the connector perfectly. Phonograph horns are scientifically made to give the greatest possible amplification. Your complete receiving outfit can be placed in the record compartment of your phonograph. Then your RADIO apparatus becomes a beautiful piece of furniture instead of an unsightly conglomeration of parts—does not in any way harm the phonograph for playing records.

No. 2 Model, now ready, fits all Victor Phonographs and Victrolas, and all other machines with tone arm same size as Victor. Sent anywhere postpaid for **\$1.50** DEALERS: Radio and phonograph dealers are making big money on the rapid sale of this item. Every phonograph owner is a sure buyer. The discounts are attractive. Deliveries almost immediate. Orders filled in rotation. **BOYD FULLER & CO., 8446 Grand River Ave., Detroit, Mich.**

13

f you want the handiest audion controls made, get

G. A. LABORATORY TYPE DETECTORS and AMPLIFIERS

These units are made up in 2½ by 5 inch panels, designed to be set up side by side so that as many amplifiers can be added to the detector as are needed. Input and output posts are arranged to be clipped together, with the battery connections to be joined in parallel at the rear. G. A. Laboratory Type controls are guaranteed to give louder signals with less distortion or howling than any others at any price. If you find that they don't, send them back and your money will be refunded. Remember to put a 0.001 mfd. condenser across the first amplifier input when used with a regenerative receiver. Diagrams for connecting will be found on the under sides of the bases.

On the detector and amplifier units, respectively.

The Prices **\$5.95 & \$13.95** Postage 10c and 20c

The General Apparatus Co., Inc. 88-N Park Place New York City
Send 10c for the new G. A. Catalog

BANGERT ELECTRIC CO., Inc.

Headquarters for RELIABLE

RADIO RECEIVING SETS SUPPLIES and PARTS

THREE STORES

297 Fulton St., JAMAICA, N. Y.
27 Main St., HEMPSTEAD, L. I.
16 W. Merrick Rd., FREEPORT, L. I.

MANUFACTURERS OF TESTED, MOUNTED, GUARANTEED CRYSTALS

WRITE FOR DISCOUNTS

CARDBOARD TUBING

Seamless—Grey IN ANY LENGTH UP TO 28 INCHES

| | Per in. or Fraction | Per Ft. |
|-------------------------------|---------------------|---------|
| 2½, 3 and 3½ in. diameter.... | 3¾c | 30c |
| 4 and 4½ in. diameter..... | 4c | 35c |
| 5 in. diameter..... | 4½c | 42c |
| 5½ and 6 in. diameter..... | 5c | 50c |

Postage extra; shipping weight 1 lb. per ft. Binding Post, Switch Levers, Magnet Wire, Switch Points, Sliders and Slider Rods. Write for our prices.

Dealers Write for Discounts **MICHIGAN RADIO CO.** (Formerly Jeffery, Crawford Co.) 2173 Hillger Ave. Detroit, Mich.

Buzzer vs. Chopper

THE modulation of the continuous waves of a tube set can be accomplished in three ways: Modulation of the input, as in the case of a tube supplied with A.C. directly on the plate; modulation in the grid-filament circuit as in the case of a phone or buzzer modulated set; and modulation of the output of a tube as in the case of a chopper in the aerial circuit. Only the last two will be discussed here, and their advantages will be briefly outlined below:

BUZZER.

Advantages—1. Ease of obtaining any desired note.

2. Low power consumption buzzer.

Disadvantages — 1. Inefficiency (incomplete modulation).

CHOPPER.

Advantages — 1. Efficiency (complete modulation).

Disadvantages—1. Relatively high power consumption.

2. Complication of apparatus.

3. Difficulty of obtaining any desired note.

The following is a description of a method which has all the good points of the buzzer and chopper methods, and practically none of their disadvantages:

For low power sets, not over five watts, this method may be used, which consists of a circuit employing a buzzer connected to the ground lead.

But for sets over five watts, the following method should be used:

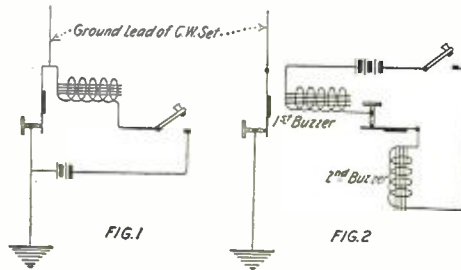

Fig. 2 Shows the Best Method of Producing I.C.W. With Buzzers.

Connection is made to the armature and contact of the first buzzer, also to field magnets on buzzer. The first buzzer should be of fairly heavy construction, the second one being used to vary the note of the first buzzer. The second is any H. F. buzzer.

It will be seen that the last method has the advantages of the chopper without its disadvantages.

Advantages—1. Ease of obtaining any note (by adjusting second buzzer).

2. Low-power consumption.

3. Complete modulation.

4. Insulation of key from aerial circuit.

By this method, the third point, and the most important one, has been secured with the advantages of the buzzer retained, and none of the disadvantages of the chopper.

Contributed by Wm. J. O'NEILL, JR.,

Transmitting Set Used by 6JD

Not much has been said of this hook-up, few amateurs know of it and few use it. Through experience I have found it deserves more attention, being at least 100 per cent better, and more efficient, than the regular transmitting hook-up. Using an Acme 1-kw. transformer, Benwood rotor and oil immersed condenser, I was radiating about 2½ amperes, and got practically no results at all. Upon changing to this hook-up, my radiation jumped to 6½ amperes on 5½" coupling and I have been reported "SA" all over the eastern half of the country.

Charge Your Radio Battery at Home with

Will charge Radiophone and Automobile Batteries from Lamp Socket



Initial Charging Rate, 6 Volt Battery, 10 Amperes

THE

Sterling PORTABLE RECTIFIER

It is not necessary to lug your battery to a service station. Rectifier charges battery right at home from alternating current.

Mechanism simple, durable; will last for years. One thumbscrew does all the adjusting. Higher charging rate, lower current cost. No danger of injuring battery by overcharging or getting clips on wrong battery terminals. Either clip can be attached to positive terminal.

Price complete\$16.00 West of Rocky Mountains 17.00

Insist upon the Sterling for absolutely reliable service. If your dealer cannot supply you, write us for bulletin giving full information.

THE STERLING MFG. CO. 2831 Prospect Ave. CLEVELAND, OHIO
Over two million Sterling Instruments in use today.

UNCONDITIONALLY Guaranteed for 1 Year

U. S. Storage Batteries

Supreme for Radio Telephone

| | | |
|---------|--------------|--------|
| 6 Volts | 20 amp..... | \$7.50 |
| 6 Volts | 40 amp..... | 10.00 |
| 6 Volts | 60 amp..... | 13.75 |
| 6 Volts | 80 amp..... | 17.50 |
| 6 Volts | 100 amp..... | 22.50 |

9 Cell B. Storage Batteries 22½ V. \$7.50
20 Cell B. Storage Batteries 50 V. 13.75
40 Cell B. Storage Batteries 100 V. 26.50

If your dealer hasn't it, send money order or check direct

Mail Orders filled upon receipt of price.

PRICE LIST MAILED FREE.

Dealers write for discounts

U. S. STORAGE BATTERY CO. FAR ROCKAWAY, N. Y.

The Largest Mfr. of Galena Crystals

(In The United States)



Mounted in Wood's Metal Guaranteed AA1 Perfect (Arlington Tested)

Galena Crystal Mounted.....35c
Wrapped carefully and packed in individual boxes with your name, or in bulk.

Manufacturers, Jobbers, Dealers, write for our special quantity prices.

GALENA CRYSTAL MFG. CO. 464 Bushwick Ave. Brooklyn, N. Y.

LEARN ELECTRICITY In 3½ months,

or 1½ months, DRAFTING, A U T O ELECTRICITY, 3 months, in America's Greatest Practical School. No need to take longer. Train quickly for big paying jobs. All practical work. No books, no classes. Open all year, enter any time, Day or evening. 23rd year. Earn your way. Special Offer now. Course in WIRELESS TELEPHONE FREE. Send for big new 80-page Catalog. State which course.

COYNE TRADE AND ENGINEERING SCHOOL Dept. 114, 49-51 E. Illinois St., Chicago, Ill.

There are several good reasons why this hook-up is better than the regular ones. It gives you shorter leads, therefore, more energy. All leads are active as the primary, as they are all included in the oscillating circuit. Most amateurs lose a large per cent of their energy through the condenser, brushing, bad insulation, etc. In this hook-up all the energy must pass through the primary of the oscillation transformer before reaching the condenser. As little or no current is lost through the gap, all current is utilized.

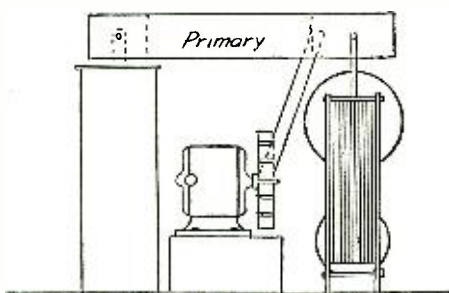
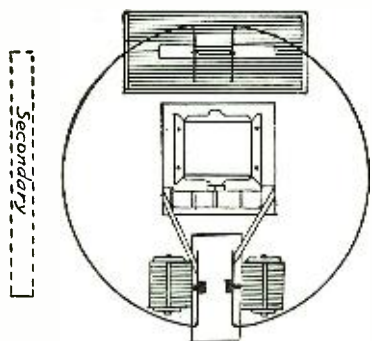
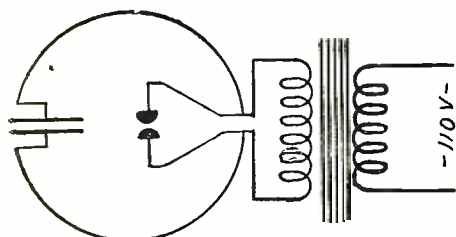

Only One Turn is Used in 6JD's Oscillation Transformer Primary.

The diagram shown here, I find to be the most compact arrangement of the transmitting apparatus giving the shortest connections. The primary is about 20" in diameter, with about 3½" of three-inch copper ribbon of each side. The primary is set directly on top of the transformer and condenser, with the gap in between. The gap connects to one end of the primary ribbons, the condenser to the other, while the transformer is connected about 6" from the gap. This puts all apparatus in parallel. It is advisable to set the gap up on a block of wood, so as to get it nearer the primary and give shorter leads. Care must be taken that the rotary motor is not brought too near the secondary of the transformer, thereby encouraging kick-backs. This type of primary is used with the regular secondary. Sometimes a little higher radiation can be had by reversing the aerial and ground.

I am sure this hook-up will solve a good many transmitting problems, and bring to light a good many more "DX" stations. It surely has done wonders for me.

Contributed by H. S. MORRIS.

Edison Radio Batteries

Operators and experimenters who demand the best radio equipment obtainable can now have EDISON BATTERIES built of the same materials as the thousands performing so satisfactorily in the service of the ARMY and NAVY.

Edison Radio Batteries are built of steel and have an alkaline electrolyte. They are strong, clean, long lived and have exclusive electrical features that are highly desirable in radio service.

The Edison Radio Cell Operates Silently

The voltage curve is flat, at the rate generally used. The terminals are convenient for "tapping in."

| | |
|---------------------------------|---------|
| For filament circuits: | |
| 6 volt 37.5 ampere hours | \$42.50 |
| 6 volt 75 ampere hours | 58.75 |
| 6 volt 112.5 ampere hours | 80.00 |
| For tube circuits: | |
| 2½ volt, 2½ ampere hours | \$2.50 |
| 22½ volt, 2½ ampere hours | 22.50 |
| Tray | 1.50 |
| 22½ volt, complete | \$24.00 |

All prices f. o. b. Orange, N. J.

Edison Radio Batteries can be furnished for any required voltage; prices on other assemblies quoted on request.

Edison Radio Batteries are an investment and not a continual source of expense.

Write for Bulletin 833.

Edison Storage Battery Company

Department C

ORANGE, N. J.

MINATURE PLUG

A new VICTOR product. A beautiful little plug highly polished bakelite shell nickel plated metal parts. For battery control or any switching purpose. Instant connection and disconnection. Mount pin jack shown in cut on your panel. More efficient and better looking than binding posts. With and without side screw. Without side screw for soldered lead 23 cents each P.P. With side screw 25 cents P.P. Nickel plated pin jack only with nut 11 cents P.P. CORD TIP JACK. Similar to pin jack in cut only smaller and drilled to take receiver cord tips. For connecting receivers in series. Set of four mounted on bakelite base 55 cents P.P. Set of six 75 cents P.P. Nickel plated pins only 11 cents each. Type 2 Pin Socket. Will take any standard four prong tube including power tubes. Fused. Mail P. P. \$1.00. Pins only nickel plated 11 cents. Brass 10 cents. Fuse only 10 cents. PINS FOR 50 WATT tubes. No "arcing or fusing" 20 cents each.

V. H. LAUGHTER DEALERS—Write for Prices P. O. BOX 78, MEMPHIS, TENN.



BE SURE AND SPECIFY

"WILMINGTON FIBRE" SHEETS, RODS, TUBES, WASHERS, Etc., SPECIALTIES

WILMINGTON FIBRE SPECIALTY CO., Wilmington, Del. BRANCH OFFICES "EVERYWHERE"

WIRELESS DISTRIBUTORS

Handle
B. & P. INSULATORS

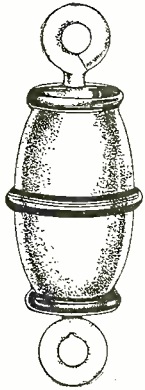

Aerial
Necessity
Insures
Safety
and
Perfect
Insulation

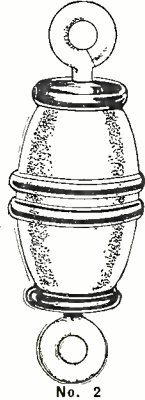

No. 1

No. 2

IMMEDIATE DELIVERY

Write for Exclusive Territory and Quotation

BANISTER & POLLARD CO.
206-208 Market St. Newark, N. J.

! HEADSETS !

Immediate Delivery!

| | | |
|-------------------------|----------------|--------|
| BRANDES "Superior"..... | 2000 ohms..... | \$8.00 |
| BRANDES "Navy"..... | 3200 ohms..... | 14.00 |
| MESCO..... | 2000 ohms..... | 6.00 |
| MESCO..... | 3000 ohms..... | 7.00 |
| STROMBERG CARLSON..... | 2000 ohms..... | 7.50 |
| EVERETT..... | 3000 ohms..... | 7.50 |
| WESTERN ELECTRIC..... | 2200 ohms..... | 15.00 |

Complete Receiving Sets

| | |
|--|--------|
| WESTINGHOUSE "Aeriola, Jr., with headphones..... | 25.00 |
| WESTINGHOUSE "Aeriola, Sr." with headphones and det. tube..... | 65.00 |
| WESTINGHOUSE R. C. (without tubes or phone)..... | 130.00 |
| WESTINGHOUSE Vocarola horn..... | 30.00 |
| MARVEL UC set, with "antenna"..... | 15.00 |
| MARVEL DeLux, with "Antenna"..... | 25.00 |

Batteries

| | |
|---|------|
| EVEREADY "B" Battery, 22½ volt, large size..... | 3.00 |
| CYCLONE "B" Battery, 22½ volt, small..... | 1.50 |
| CYCLONE "B" Battery, 22½ volt, medium..... | 2.00 |
| CYCLONE "B" Battery, 22½ volt, large..... | 2.75 |
| CYCLONE "B" Battery, 45 volt, medium..... | 4.00 |
| CYCLONE "B" Battery, 45 volt, large size..... | 5.00 |
| Copperweld No. 14 aerial wire, per 100 ft..... | .50 |
| Detector Tubes UV-200..... | 5.00 |
| Amplifier Tubes UV-201..... | 6.50 |

CASH IN ADVANCE and C. O. D. orders promptly shipped. WE PAY PARCEL POST.

N. Y. RADIOPHONE CO.

32 UNION SQUARE N. Y. CITY

Midwest Jr. Audion Receiving Set

This outfit mounted on solid mahogany, highly finished base and consisting of our junior 600 meter wave length Coupler wound with green silk covered wire and Formica Detector Tube panel enclosed in highly polished mahogany cabinet, equipped with Rheostat, grid leak, grid condenser, potentiometer and either binding posts or jack for phones. All nickel parts highly polished.

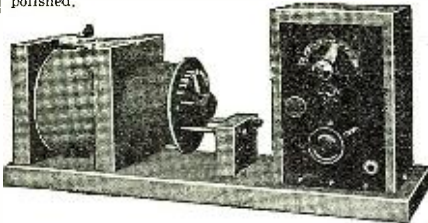

COMPLETE OUTFIT, \$22

| | | | |
|---|---------|--|--------|
| Same as above, with crystal detector..... | \$14.00 | Crystal Detector..... | \$1.75 |
| Audion detector tubes..... | 5.00 | Amplifier transformer..... | 4.00 |
| 2200-ohm head set..... | 8.00 | 60 amp. ground switches..... | 2.50 |
| 22½ volt B. batteries..... | 2.75 | Navy type, 2500 Meler loose coupler..... | 11.00 |
| 21 plate condenser..... | 4.25 | All sizes Formica panels..... | |
| 43 plate condenser..... | 4.50 | | |

SIEGAL ELECTRICAL SUPPLY CO.

Main 1364-1372, 154-156 W. Washington St., Chicago

HOME RADIOPHONE RECEIVER.

By Howard S. Pyle.

With radio telephone broadcasting stations now established as a permanent fixture, a great number of people, having no understanding of the essentials of radio communication, are greatly interested in the reception of the broadcasted news, concerts, and market reports now available. The majority of these have no particular interest in radio other than the reception of these schedules, and generally, upon inquiry of their local radio dealer, are swept off their feet with the array of apparatus, together with the technical terms, presented to them, as essential to the reception of these broadcasts.

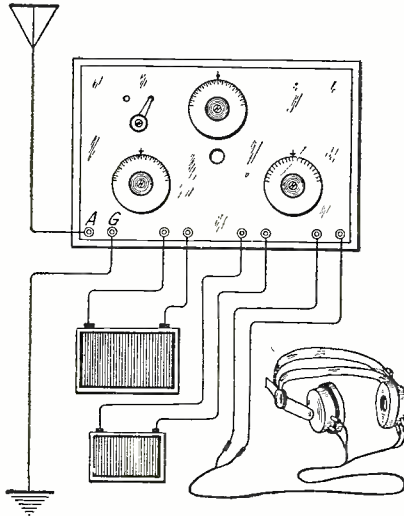

Showing the Connections of the Receiver.

They consider the multiplicity of knobs and dials, and various allied controls to be beyond their understanding, without considerable study of their manipulation and the majority will pass up the proposition with an idea that they will wait until radio becomes more simplified, before making it a part of their daily home life. Undoubtedly it will become more simplified, but it will take time, and with the present excellent programs now being offered through the air, one misses considerable entertainment by passing up an installation. One manufacturer has come to the front with a home installation that nearest approaches the ideal of the layman, and is as efficient as any outfit now available. However, their product can be yet more simplified, particularly by the man who wishes to build his own, and it is the purpose of this article to describe such a simplified outfit, designed by the writer, and which has been built by several interested parties, who knew little or nothing of radio. The beauty of this outfit lies in the use of all standard parts, without the necessity of winding mysterious coils, etc.; merely the assembly and wiring of the simplest type being necessary. This little outfit is a dandy regenerative tuner for relay work also, and in a number of practical tests, has proved as selective as the three circuit types, so popular nowadays. It has the additional advantage of just reaching the 600-meter wave, with a suitable antenna, which permits of commercial reception as well.

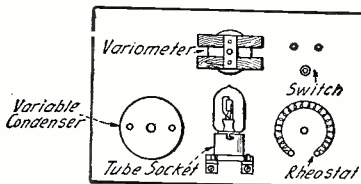

How the Parts Are Mounted Inside of the Cabinet.

Red Devil Tools

A Pair of Pliers for the Wireless Man



JUST the tool for making all kinds of adjustments and keeping your wireless set tuned up. A slip joint plier with thin nose for getting into inaccessible places. Forged of steel—built to last. Ask the man who knows tools.

From reliable hardware dealers everywhere, or from us, \$1.10. Mention style 1024—6½ inch.

Mechanic's tool booklet free.

SMITH & HEMENWAY CO., Inc.
Manufacturers of "Red Devil" Tools
273 Broadway New York, N. Y.

TUEX BAKELITE PANELS

Cut to exact sizes with smooth square edges. The standard insulation material of U. S. Army and U. S. Navy. Shipped postage paid.

SAVE MONEY BY BUYING TUEX READY CUT 3/16 INCH PANELS

| | | |
|-----------------|------------------|------------------|
| 6x7 each \$1.05 | 6x21 each \$2.60 | 7x18 each \$2.65 |
| 6x12 " 1.50 | 9x12 " 2.25 | 12x14 " 3.50 |
| 6x14 " 1.75 | 7x10 " 1.50 | 12x18 " 4.50 |
| 6x18 " 2.25 | 7x12 " 1.75 | 12x21 " 5.20 |

Your money back if not perfectly satisfied

TUEX SUPPLY CO.
1429 STATE STREET
BRIDGEPORT — CONNECTICUT

Panels for Your Set

We carry standard size panels of the following dimensions in stock

| | | |
|---------------|------------------------|--------|
| 7" x 20" x ¼" | Regenerative size..... | \$2.00 |
| 6" x 14" x ¼" | Consolidated size..... | 1.25 |
| 6" x 6" x ¼" | | .50 |
| 7" x 10" x ¼" | | 1.00 |

We pay postage

L. FUNKE & CO.

223 Washington St. NEWARK, N. J.

"GALENA"

| | |
|---|--------|
| Grade A.A. tested extra large piece..... | \$2.00 |
| Beautifully designed binding post N. P..... | .08 |
| Contact Points, N. P., per dozen..... | .30 |
| Ideal Broadcaster Receiver..... | 12.00 |
| Approved "Argus" Lightning Arresters.....each | 1.50 |

Immediate Delivery

IDEAL RADIO MFG. CO.

4880 Broadway, New York City

The entire equipment is housed in a nicely finished cabinet of oak or mahogany, only nine inches long, eight inches high and six inches deep. This makes it readily portable. The necessary equipment and its source is listed herewith:
 Wooden cabinet, homemade or cabinet shop.
 Formica panel, 8x9x1/8",

- Sears, Roebuck & Co.
- 3 dials and knobs.....Remler
- One small switch—1" radius.....Remler
- Two switch points.....Remler
- 8 hard rubber binding posts.....TRESKO
- One Junior Rheostat.....Remler
- One V.T. socket.....Remler
- One .001 mfd. variable condenser,

- Wireless Shop
- One standard variometer.....Chirad
- One grid condenser.....Remler

The variometer requires a slight changing in its wiring, and this will be considered first. It will be found that the rotor and stator windings of the variometer are connected in series, the other end of each being left free for the circuit connections. The connection joining the rotor to the stator, must be cut, leaving two distinct windings: one on the ball, and the other the stationary coil, both with two free ends. This makes practically an ordinary variocoupler of the variometer, with extremely close coupling possible.

There are no taps provided from either winding, so it will be necessary to take one tap from the primary, or stationary winding. This is easily done by soldering a short length of flexible wire to the connection between the two halves of the stationary winding. This connection will gen-

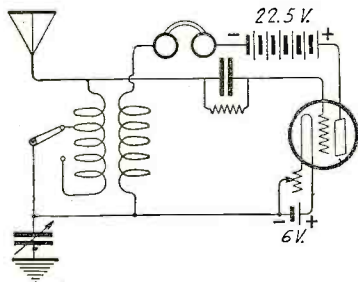

Hook-up of the Simple Radio Receiver Described in This Article.

erally be found between the two blocks of the stator, and is easily accessible. This completes our tuning element and regenerative feedback feature. No other alterations to any of the equipment is required other than that already described for the variometer.

The apparatus may now be assembled upon the panel, in the arrangement shown in the accompanying sketch. No dimensions are given in order that other equipment than that of the manufacturer listed may be used if on hand. A quarter-inch hole is drilled in concentric with the shaft of the variometer, but about an inch below the edge of the variometer control dial. This provides sufficient view of the tube filament, and also acts as an air vent.

After completion of the assembly, the last operation is the wiring, which is comparatively simple. The connections as shown in the diagram must be closely followed and particular attention paid to having the polarity of the B battery exactly as shown. Otherwise, the set will be inoperative.

A hard, or amplifier tube should be used, doing away with the bother of fine adjustment of plate and filament current, and a twenty-two and a half volt block of B battery used on the plate. The circuit is merely a single tuning circuit, with the variometer ball acting in the capacity of a tickler coil, feeding the plate current inductively through the grid coil.

TUSKA

Popular Radio Receiver

Type
224

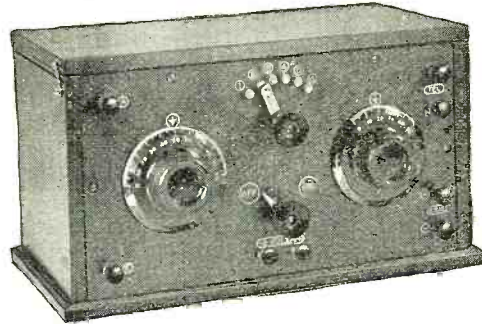

Price
\$35

Inspect this new Tuska Set at your dealers

The Type 224 Receiver is completely moulded. It is the ideal set for the beginner. Two knobs; one for wave length, the other for regeneration.

LICENSED UNDER ARMSTRONG PATENTS

Send 5 Cents for our New Catalog No. 3

The C. D. Tuska Company

24 Hoadley Place
Hartford, Conn.

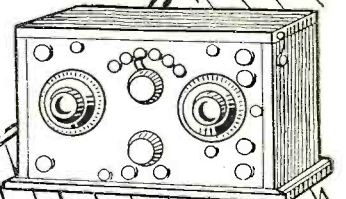

PATENTS TRADE-MARKS AND COPYRIGHTS

Before disclosing an invention, the inventor should write for our blank form "RECORD OF INVENTION". This should be signed and witnessed and if returned to us together with model or sketch and description of the invention we will give our opinion as to its patentable nature. Electrical cases a speciality.

Our illustrated Guide Book, "HOW TO OBTAIN A PATENT," sent Free on request. Highest References Prompt Attention Reasonable Terms

FREE COUPON

VICTOR J. EVANS & CO., Patent Attorneys

Chicago Offices: 1114 Tacoma Bldg. Pittsburgh Offices: 514 Empire Bldg. Philadelphia Offices: 714:715 Liberty Bldg. San Francisco Offices: Hobart Bldg. New York Offices: 1001 Woolworth Bldg.

MAIN OFFICES: 919 NINTH, WASHINGTON, D. C.

Name..... Address.....

Make Your Face Show Manhood



Every real man wants the clear, rugged, ruddy face of a real he-man; the healthy, clean skin and alert expression that comes from a vigorous life in the open air. All men want it—all women admire it. You can have it.

STAG

A Man's Cream For a Man's Face
—is a true facial invigorator and tonic prepared for men. Two minutes' use brings the red blood tingling to the surface, removes that oily, sallow appearance and leaves the skin clean, clear, firm and with healthy color. It invigorates and hardens the facial muscles and promotes an alert, forceful expression. A sixty-day treatment—with money-back guarantee—will be sent to you for a dollar bill.

Manhood Commands Admiration
Men and women all admire the man whose face shows the clean vigor of perfect health. Stag is made for you men who want to be one of those ruddy, forceful, hard-hitting fellows who are always so popular. Send your name, address and a dollar and it will come to you by return mail—fully guaranteed.

Stag Laboratories 1267 Park Place, West
Dept 616 Detroit, Mich.

"CHI-RAD"
RADIO SUPPLIES

COMPLETE SETS
MATERIAL AND PARTS
EXPERT ADVICE
EVERYTHING RADIO

Oldest Radio house in Chicago

Come and see us for your Radio Equipment—we'll give you service you will like.

Chicago Radio Apparatus Co., Inc.
415 So. Dearborn Street
CHICAGO, ILL.

MAKE YOUR OWN RADIO SET

It's simple, anyone can do it. Everybody is making them. Get music, speeches, etc., out of the air. We will mail you complete instructions, blue prints, etc. Send only \$2.00 today. American Utilities Co., Box D429, Excelsior Springs, Mo.

Europe's Storm Predictor
(Continued from page 1101)

meridian ten degrees west of Greenwich and then sail due north until he crossed the Arctic circle, he would pick up the desolate little spot. It is practically due north from the lands end, Cornwall, England, and just inside the Arctic circle, practically on the latitude of the north pole.

10% Carloads of Radio News
(Continued from page 1078)

8th. First in print with the News. You will find all important Radio News in this magazine from one to three months ahead of all other publications—always.

Now, my friends, it's up to you how great and how big RADIO NEWS shall be. Its future is in your hands. We're off. . . .

Three cheers for American Radio Amateu-rism—
Long live the Radio Amateur.

H. GERNSBACK,
Your Editor.

We said this three years ago. It holds good now, and with our readers' support, will hold good forever.

President Harding a Radio Enthusiast
(Continued from page 1074)

wireless signals. The amplifier may be manipulated by the President by turning one of the knobs, previously referred to, on the panel of the radio-receiver.

President Harding, in the rôle of an "exalted radio bug," to employ a phrase of H. Gernsback, editor of RADIO NEWS in the March issue of this publication, does not restrain his enthusiasm for the most recent diversion with which he has become identified. His first demonstration in manipulating the radio telephone was to receive a concert being given by the band of the

ELWOOD

RADIO HEADSETS

The seventeen years of practical experience in the making of telephones and receivers by this company, assures you of good design and workmanship.

Elwood headsets meet the exacting demands of all purchasers of radio units and parts. Both receivers operate in unison, insuring clear, harmonious and uninterrupted reproduction. Our absolute guarantee of the ohmage capacity of these headsets is your safeguard.

Receivers have metal case, highly finished. Headbands, have sanitary fabric covering, fully adjustable. Complete set packed in attractive carton.

We are also manufacturers of Binding Posts, Contact Points, Jacks and Plugs for Radio Work.

Elwood Electric Co., Inc.
Formerly Liddell Electric Mfg. Co.
2-4 Randall Avenue
BRIDGEPORT, CONN.



2000 ohm Head Sets \$7.00



3000 ohm Head Sets \$8.00

KEYSTONE RADIO ARRESTERS

Price \$2.00

Approved by Underwriters

To protect your radio apparatus and your property against lightning and to take off static accumulations. Can be installed out doors where a lightning arrester belongs, highly efficient, no vacuum to lose, no fuse to blow, offers permanent protection. Takes the place of a Lightning Switch.

For sale by Radio dealers, Department Stores and Electrical Dealers everywhere, or sent post paid on receipt of \$2.00.

Write for Circular.

ELECTRIC SERVICE SUPPLIES Co.

Manufacturers of Lightning Arresters for 30 Years

PHILADELPHIA NEW YORK CHICAGO
17th and Cambria Streets 50 Church Street Monadnock Bldg.

Branch Offices: Boston, Scranton, Pittsburgh



Type A, Keystone Arrester, with wire leads.



Type B, Keystone Arrester, with binding posts.

Navy Department, the entertainment being broadcasted from the Naval radio station at Anacostia, three miles from the White House. He is quoted as pronouncing the instrument and its effect as "wonderful." Mrs. Harding will likely vie with her husband in reveling in the benefits of a private radio telephone upon their return from a vacation in Florida, where they are sojourning at the time this article is being penned.

This high-power radio telephone will doubtless lend itself to a variety of uses in the future. When one's imagination is unbridled, it is easy to conceive that the President can "listen-in" when the fleets of the Navy Department as well as army headquarters in the field are exchanging conversations. And, the adage about the politician keeping his ears close to the ground may become obsolete; instead, his ears will be tuned to the reception of messages that fill the atmosphere with the voice of public opinion. The radio telephone receiving set of the President is elaborately supplied with accessories and is comparable to amateur equipment only in fundamental requisites. The tuning facilities afford a fine adjustment of wave-lengths, and other perfections of the outfit are responsible for the Navy Department labeling the apparatus as a magnificent mechanism."

A report, which has the earmarks of authenticity, but which the writer has been unable to verify, is to the effect that President Harding will soon deliver a message over a radio telephone to the thousands of amateurs and others interested in wireless communication. Such a Presidential deliverance would be broadcasted from the Naval radio-station at Anacostia, or by means of the radio telephone in operation in the United States Post Office Department. Be that as it may, the President frankly admits his enthusiasm about his radio telephone receiver and his expressed interest in radio telephony will further contribute to its phenomenal growth, whose swelling tide has gained such momentum in recent months.

HOW RADIO CALL SIGNALS ARE ASSIGNED.

America, or rather the United States, has only three international call letters out of the alphabet assigned for this purpose to the civilized nations. Actually they are initial letters, for they are used with the other letters of the alphabet in combinations of three or more letters, indicating a code name or station. All licensed commercial stations in this country are given calls by the Radio Section of the Bureau of Navigation of the Department of Commerce, in accordance with the allotment of letters permitted by the International Bureau of the Telegraphic Union at Berne, Switzerland.

To be exact, the United States may use all the three and four letter calls beginning with the letter N, all calls beginning with W and combinations beginning with K, except from KAA to KBZ, which belong to Germany. These are not all available for commercial use, however, as the Navy uses all calls starting with N, while the Army uses calls from WUA to WVZ, and WXA to WZZ. In issuing commercial calls, the Radio Service divides the country into an eastern and western section, giving the eastern section the initial letter W, and western stations K. Purdue University, for example, was recently assigned WBAA, being east of the north and south dividing line, and, incidentally, is one of the first of the four letter calls, the three letter calls for the Atlantic side being exhausted. New Mexico College, on the other side of the line, was recently assigned KOB—a Pacific call. A complete record of calls is kept in the Department of Commerce on what are termed K and W charts,

—you can't buy a better receiving set anywhere, at any price

\$40⁰⁰

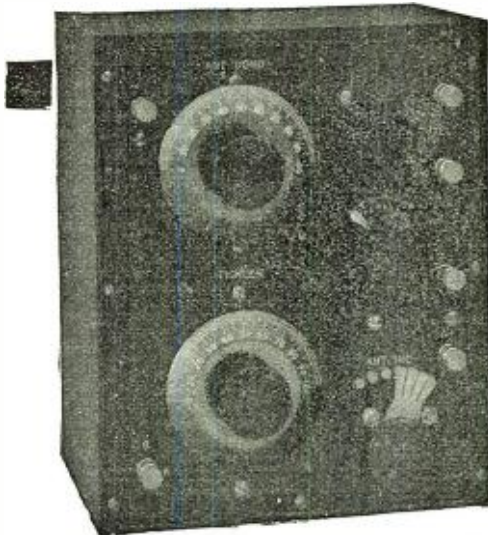

Licensed under Armstrong U. S. Patent, No. 1,113,149.

Specifications
CLAPP-EASTHAM TYPE H.R. REGENERATIVE RECEIVER
PANEL—Condensite handso rely finished.
CABINET—Solid mahogany.
CONDENSER—Balanced type, 2 Rotary 3 Stationary plates. Built as a Vernier.
DIALS—Indestructible metal. White figures on black ground.
ANTENNA INDUCTANCE—Wound on Formica Tube.
PLATE INDUCTANCE—Wound on molded ball.
BINDING POSTS—Black Rubber Covered.
SWITCH—Fan Blade.
RHEOSTAT—C. E. Type H 400.
CIRCUIT—Single circuit regenerative. Licensed under Armstrong U. S. Patent No. 1113149.
"B" BATTERY—Contained in compartment inside cabinet or external as desired.

QUANTITY—and at a reasonable price—is the appeal that the Clapp-Eastham Type H. R. Regenerative Receiver makes to men who know wireless equipment. The specifications and the Clapp-Eastham reputation tell them the story. To the novice, the appearance of the set, the clear, sharp tones, its wide range, and the perfect regeneration on all wave-lengths between 180 and 825 meters, is convincing evidence. The quality in the solid mahogany Cabinet is reflected all throughout the set. Ask your dealer to show it to you. If he's temporarily out—and he may be, because the demand has been phenomenal—write us. Send 6c in stamps for the C-E Radio Catalog. If you're at all interested in wireless you ought to have it.

CLAPP-EASTHAM COMPANY
RADIO ENGINEERS and MANUFACTURERS

120 Main Street

CAMBRIDGE, MASS.

127-21

VARNISHED TUBING

THE ORIGINAL "SPAGHETTI"

MAGNET WIRE

¼-½-1 lb. Spools

VARNISHES

For Coils, etc.

ANTENNA WIRE

100-150-200 ft. Coils

PAINTS

Waterproofing

MIRALITE
FOR RADIO PANELS

Insoluble in alcohol, Turpentine and Weak Acids; Infusible and does not burn readily; oil and waterproof; withstands action of ozone; easily cut and drilled.

Varnished Cambric, Varnished Paper, Fibre, Compounds, Waxes, Etc.

LARGEST STOCK OF INSULATING MATERIALS IN THE UNITED STATES.

MITCHELL-RAND MFG. CO.
 21 VESEY STREET, NEW YORK, N. Y.

A welcome addition to your library! Send \$2.50 today, plus postage for 7 lbs., and your copy of bound volume No. 2 of Radio News will come forward by return mail. Experimenters Publishing Company, Inc. 236a Fulton Street, New York City

INSTALL THIS RTS STANDARD DETECTOR PANEL



Front of Panel

ONLY \$5.95

Assembled (Without Tube) Prepaid by Insured Parcel Post

RTS

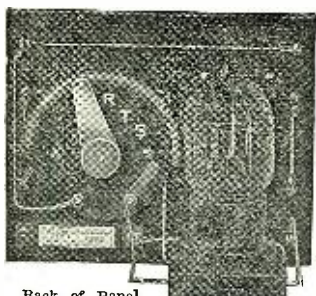

Back of Panel

Here is a correctly designed panel made of best grade Formica. Its signal strength is unequalled by any other tested in our laboratory. The exclusive use of silver plated wire greatly increases its efficiency.

We guarantee the RTS Detector panel to be exactly as represented and will refund your money if you are not satisfied.

Order TODAY before the price goes up

RTS RUBBER BINDING POSTS

These posts are as fine as any you can find. Bushing heavily nickel plated. Give the amateur's instruments the appearance of a first class outfit. Per Dozen, only - - - \$1.25

RTS BUSHING LEVER

This Bushing Lever is well designed and beautifully finished. The knob is the well known Marconi type. Spring lever is 1 1/4" long with ground ends insuring smooth adjustment. A guide bushing raises the lever to proper height for all switch points. Price, each 60c.

AERIAL WIRE

A new shipment of Lake Superior solid copper No. 14 aerial wire. An exceptionally good buy at 58c. per 100 ft.

NEW CATALOG AND SIGNAL LIST

Send for new illustrated catalogue containing list of signal abbreviations, 10c postpaid

RADIO TESTING STATION

Dept. R-6 25 Sturgis St. BINGHAMTON, NEW YORK

The "QSA" Line of Radio Equipment

Larger business has made necessary larger space and larger stock. So we have moved into new quarters where we will be better able than ever to supply your wants. Items below are offered for IMMEDIATE DELIVERY.

- Radiotron U.V. 200\$5.00
- Radiotron U.V. 201 6.50
- Radiotron U.V. 202-5 watt power tube..... 8.00
- Federal No. 226-W amplifying transformer..... 7.00
- Eveready No. 766 variable B battery..... 3.00
- FADA No. 120-A panel mounting rheostat..... 1.00
- Saco Clad amplifying transformers..... 5.00
- Paragon V.T. socket No. 30..... 1.00
- 45 Volt "B" battery, special at each..... 2.10
- Combat Radio Storage Battery 6 v. 80 A.....24.00

Catalog of "QSA" equipment will be sent for 10 cents which will be refunded on initial order or FREE with order from this advertisement.

Radiophone converts—Call, or write us for estimate on complete radio installation for receiving wireless music, etc. Come in and ask as many questions as you like.

Independent Radio Supply Co.

3239 Ogden Ave. CHICAGO, ILL.
"A Radio Store with a Conscience"

ruled into 27 squares each way, and used by horizontal and vertical alphabets to designate all calls. In the upper left hand corner in square 1, is inserted the name of the person or firm having the call AA, preceded, of course, by the chart or coast symbol W or K. If you had been first in line when the office opened you could have had WAA or KAA, the second applicant receiving WAB or KAB, but today you would get something like WWL or KQY, but more likely a four letter call. The three letters are very scarce today and doubling has begun. Westinghouse Electric, Pittsburgh, is an example, KDKA; several Post Office radio stations have four letter calls.

The above system applies only to Governmental and commercial sending stations, when an amateur, of which there are some 15,000 sending, applies for a call, international regulations do not apply, and the international letters are not used. For amateurs the country is divided into nine sections, each with a significant numeral. The district radio inspector handles the applications, and, directly upon inspection, issues a call. The first district is New England, and amateur chart No. 1, is arranged into alphabetical squares similar to the commercial K and W charts; where the letters intersect the senders name is inscribed. Call 1AA was assigned to Wm. E. Heckman, of Auburndale, Mass., as he was the first applicant in that section. The last New England applicant received call 1WZ. California is in the sixth district; District of Columbia, third; Portland, Ore., seven, and so on over the country. To designate special land stations, such as experimental, technical schools and special amateur senders, the letters X, Y and Z are inserted following the district symbol, and preceding the other letters, as, for example, 9ZF, Sioux City Radio Laboratory, Iowa, and 7XH, Oregon Agricultural College.

While we have but begun, apparently the system is capable of expansion, as mathematical calculations on "combinations" will prove.

MORE ENTERTAINMENT IN THE AIR.

During the past week 21 limited commercial broadcasting stations have been licensed by the Department of Commerce, among them five colleges, Purdue, New Mexico State, St. Joseph, St. Martins and Loyola. The Des Moines Register and Tribune has entered the aerial news field.

- Licensed March 31—Entertainment except as noted.
- WSY Alabama Power Co., Birmingham, Ala.
 - WTK Paris Radio Electric Co., Paris, Tex.
 - WGU The Fair, Chicago, Ill.
 - WEH Midland Refining Co., Tulsa, Okla.* April 3.
 - KFI Earl G. Anthony, Los Angeles, Cal.
 - KMC Lindsay-Wetherill & Co., Readley, Cal.
 - KMO Love Electric Co., Tacoma, Wash.
 - WWL Loyola Univ., New Orleans, La.
 - KLN Noggles Electric Works, Monterey, Calif.
 - KGN Northwestern Radio Mfg. Co., Portland, Ore.
 - WTT Geo. M. McBride, Bay City, Mich.
 - KGY St. Martins College, Lacey, Wash.
 - KQY Stubbs Electric Co., Portland, Ore. April 6.
 - WGF Register and Tribune, Des Moines, Ia.
 - KNJ Roswell Public Service Co., Roswell, New Mex.
 - WGL T & H Radio Co., St. Anthony, Kan.
 - WPJ St. Joseph College, Philadelphia, Pa.
 - WBAA Purdue Univ., W. Lafayette, Ind.
 - WCE Findley El. Co., Minneapolis, Minn.

WARREN RADIO LOOP

NO AERIAL

LESS STATIC

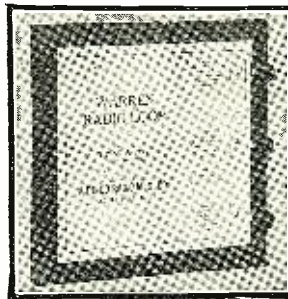

IF DAD SAYS—

"No AERIAL ON THIS HOUSE" don't allow his QRM to worry you, but purchase a WARREN RADIO LOOP

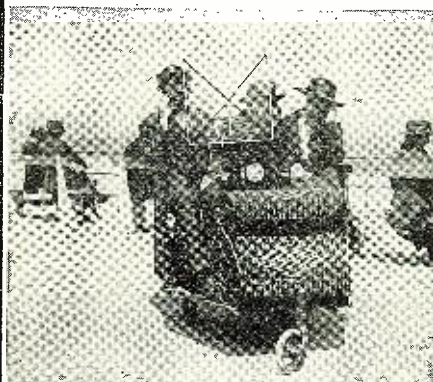

The LOOP that made the Radio Roller Chair famous on the Boardwalk at Asbury, Park, N. J.

Type A737 (300-700 meters).....\$10.00
Type A7236 (175-1000 meters)..... 12.00

Send your order through your dealer or direct to us with his name.

V-DE-CO RADIO MFG. CO.

Dep't. N ASBURY PARK, N. J.
Send for bulletin No. T101

Unequalled Low Prices On RADIO CABINETS

Assemble your set in one of these handsome cabinets, equal in appearance to the most expensive, yet priced unbelievably low. Everyone can afford them. A necessary protection against dirt, dust and atmosphere. Made of Oak; splined cover, will not warp; shipped knocked down, with full instructions for easy assembling and staining. Order today. cash or money order



| Panel Size | Inside Dimensions | | | Price |
|------------|-------------------|---------|------|--------|
| | High | Wide | Deep | |
| 6 x 7 | 5 1/2" | 6 1/2" | 7" | \$1.50 |
| 6 x 10 1/2 | 5 1/2" | 10" | 7" | 2.00 |
| 6 x 14 | 5 1/2" | 13 1/2" | 7" | 2.00 |
| 6 x 21 | 5 1/2" | 20 1/2" | 7" | 2.25 |
| 9 x 14 | 8 1/2" | 13 1/2" | 10" | 2.25 |
| 12 x 14 | 11 1/2" | 13 1/2" | 10" | 2.25 |
| 12 x 21 | 11 1/2" | 20 1/2" | 10" | 2.75 |

Radio Cabinet Co., 1460 Hubbard Ave. Detroit, Mich.

FREE

New Consolidated Radio Call Book with every order amounting to \$25.00 or more from our lists.

Send stamp for our latest catalogue. We pay transportation anywhere in the United States.

ASHTABULA RADIO SALES CO.
49 McGovern Ave., Ashtabula, Ohio

KHD Aldrich Marble & Granite Co., Col. Springs, Col.†
 KOB New Mexico Coll. of Ag. & Mech. Arts, State Coll., N. M.‡
 Note *—market reports only.
 †—weather only.
 ‡—also weather.

CANAL ZONE RADIO ACTIVITIES.

During the second week in March the radio stations in the Canal Zone, under the Navy, carried over 7,000 words daily, Balboa station carrying the bulk of the traffic, 4,065 words.

PAMPHLET ON RADIO APPARATUS.

The Bureau of Standards has just issued a pamphlet on "Construction and Operation of a very simple Radio Receiving Equipment"; this is the first of a series on radio construction, it is said.

BOYS AND GIRLS RADIO CLUB DEMONSTRATIONS.

The value of the Agricultural Radio Broadcasts sent out by the Post Office Department to the farmer is shown in detail in a pamphlet just issued through the cooperation of the Bureau of Standards, Bureau of Markets and Crop Estimates and States Relation Service. It suggests the organization of young folks radio clubs for the dissemination of this valuable information.

WWX RADIO ANNOUNCES CONTEST.

A new use for radio broadcasting was initiated by the Post Office Department on April 6, when the announcement of a national essay contest for high school pupils was sent out. The subject of the essay is highway economics, and the radio message gave the rules under which a four years' university scholarship, valued at \$4,000, may be won. The prize is offered by the Highway and Highway Transport Educational Committee, Willard Bldg. Wash., D. C.

NAVAL RADIO ESTABLISHES RECORD.

From Anacostia to Hawaii is a long jump, estimated at 5,000 miles, yet it was learned recently that the Anacostia Naval Station HOF had been heard by a resident of Wailuku, Maui, Hawaii. According to Commander Hooper, in charge of Radio, of the Naval Bureau of Engineering, Mr. Clifford J. Dow, of Wailuku, reported that he heard Anacostia transmitting on 360 meters. It seems probable, Commander Hooper says, that this is a world's record for transmission on uninterrupted continuous waves at short wave-lengths.

NAVY BROADCASTING STATIONS CLOSED EXCEPT FOR OFFICIAL BUSINESS.

Recently, Secretary Denby closed the Naval Broadcasting Station except for the transmission of official matter. There will be no more speeches sent for a while. The order closing the Anacostia Naval Radio Station to the public is believed to have been brought about by the protests which arose on the "Hill" after Senator Harry New sent what was termed a political speech to his constituents in Indiana. Democrats claimed that the Government station and radio were being used for political speeches. While he recently declared the Naval Radio to be at the service of the public regardless of political faith, Secretary Denby has restricted the operations of the stations to entertainment. Music, news and official dispatches temporarily until a study of the use of Government radio stations can be completed.

RADIO  BATTERIES

YOUR RADIO SET IS ONLY AS EFFICIENT AS YOUR BATTERY IS GOOD

When installing a Radio Set do not neglect the quality of the battery you use. Universal Radio Batteries are built in three types, as shown, all with heavy long life plates and special finish for this kind of work. Batteries assembled in glass jars. Write for prices.

Obtain from your dealer—if he can't supply you order direct from factory. Write for special catalog.

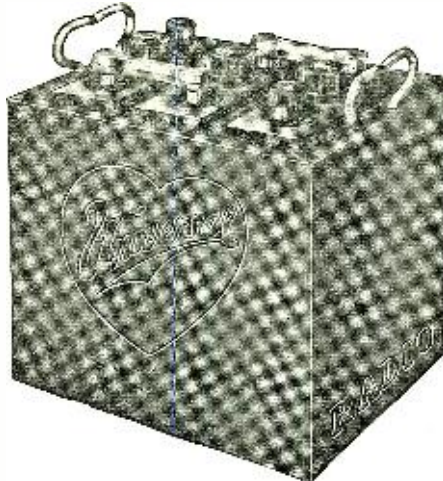

TYPE W R
 WR— 60 Amp....\$15.00
 WR— 85 Amp.... 17.50
 WR—105 Amp.... 21.00

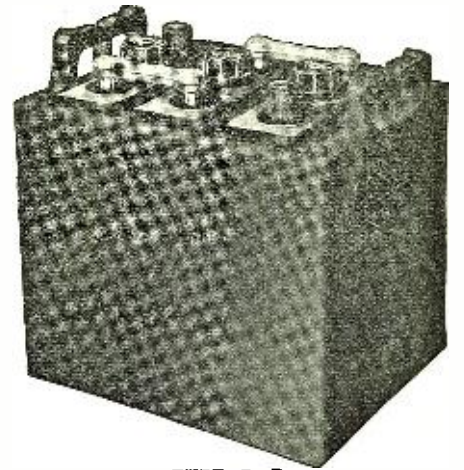

TYPE R R
 RR— 60 Amp....\$19.00
 RR— 85 Amp.... 21.00
 RR—105 Amp.... 25.50

UNIVERSAL BATTERY CO.

3441 SO. LASALLE STREET

CHICAGO, ILL.



D. H. E. Co. Pittsburgh Broadcasting Station Call, K.Q.V.

"Listen In" with the Stromberg-Carlson Radio Headset

The Stromberg-Carlson No. 2-A Headset reproduces broadcasted, long-distance vocal or musical sounds with unequalled distinctness. Fine tonal qualities, extreme sensitiveness and superior construction are its important features.

Order Above and Following Highest Grade Supplies by Mail

Enclose Certified Check or P. O. Money Order, Including Postage



Stromberg-Carlson
 No. 2A Headset
\$7.50

- R-C Westinghouse Receiver\$130.00
- Aerola Senior Westinghouse Receiver 65.00
- CR 9 Grebe Receiver 130.00
- CR 5 Grebe Receiver..... 80.00
- ROR-K Grebe 2-stage Amplifier..... 55.00
- R2 Magnavox Loud Speaker..... 110.00
- R3 Magnavox Loud Speaker..... 45.00
- UV 200 Radiotron Detector Tubes, each..... 5.00
- UV 201 Radiotron Detector Tubes, each..... 6.50
- No. 766 Eveready VT Batteries, each..... 3.00
- D.H.E. 6 volt, 80 ampere storage batteries, each..... 18.00

Full List of Parts and Supplies with Prices on Request

DOUBLEDAY-HILL ELECTRIC CO.

715 Twelfth St., N. W., Washington, D. C. Radio Dept.—Desk B 719-21 Liberty Ave., Pittsburgh, Pa.

Insure your copy reaching you each month. Subscribe to Radio News—\$2.50 a year. Experimenter Pub. Co., 236-A Fulton St., N. Y. C.

OPPORTUNITY AD-LETS

Follow these advertisements every month. Reliable advertisers from all over the country offer you their most attractive specials in these columns.

Classified advertising rate ten cents a word for each insertion. Ten per cent discount for 6 issues, 20 per cent discount for 12 issues. Name and address must be included at the above rate. Cash should accompany all classified advertisements unless placed by an accredited advertising agency. No advertisement for less than 10 words accepted.

Objectionable or misleading advertisements not accepted. Advertisements for the August issue must reach us not later than June 1st.

THE CIRCULATION OF RADIO NEWS IS OVER 235,000

EXPERIMENTER PUBLISHING CO. INC., 233 and 236 Fulton Street, New York, N. Y.

Aeronautics.

Model Aeroplanes that Fly.—Buy your complete outfit, scale drawings, fittings compressed air motors and all-best model aeroplane supplies from the Wadins River Manufacturing Co., Established 1900. Our new 52-page catalog illustrated, 24 latest models and designs. Send 5c for your copy. Wading River Manufacturing Co., 672 J Broadway, Brooklyn, New York.

Agents Wanted.

Big Money and fast sales. Every owner buys gold initials for his auto. You charge \$1.50; make \$1.35. Ten orders daily easy. Write for particulars and free samples. American Monogram Co., Dept. 133, East Orange, N. J.

Amateur Agents Wanted in every city and town to sell radio apparatus. A few stocking agencies still open. Deifelco, 12 Meeting Street, Pawtucket, R. I.

Your Chance to make big money silvering mirrors auto reflectors, metalplating. Outfit furnished. Write for particulars. International Laboratories, Dept. 48, 311 Fifth Ave., New York.

Agents.—Magnetized Extractor for Eyes. Invaluable pocket sample and particulars, 50c. Gem Cinder Extractor Co., 9924c Malta, Chicago.

Agents Wanted.—To sell postage stamps, large profits, sample sets 25c; make use of your spare time, and earn extra money. Chas. T. Egner, 1335 Pike St., Phila., Pa.

We Wish Representatives in every community to secure subscriptions for Radio News, Science & Invention, and Practical Electrics. This is a wonderful opportunity for Amateur Radio Enthusiasts to make big money quickly. Write Experimenter Publishing Co., Inc., 233 Fulton St., New York City.

Earn Price of Wireless Set selling "Magnetic Extractors" for eyes. Sample and plans 50c coin. Act quickly. Gem Cinder Extractor Co., 9924c Malta, Chicago.

Radio Equipment Free selling our goods. Write for free sample order and catalogue. Vanity Products, 309 Fifth Ave., New York.

Automobiles.

Automobile Owners, Garagemen, Mechanics, Repairmen, send for free copy of our current issue. It contains helpful, instructive information on overhauling, ignition troubles, wiring, carburetors, storage batteries, etc. Over 140 pages, illustrated. Send for free copy today. Automobile Digest, 528 Butler Bldg., Cincinnati.

Batteries

"B" Batteries, Rectifiers.—Prints and instruction for making rectifier, and recharging batteries sent for 75c money order. "B" Battery that lasts 10c. Arthur Raabe, 223 Eighth Ave., Long Island City, N. Y.

Storage BBB Batteries. Make yours, from guaranteed parts. Large capacity just it for that small CW set, as well as receiving. Plates negative, positive @ \$.08; Glass Jars for same @ \$.04. All makes of wireless goods on hand. Order direct what you need. Electric Service Shop, Bradford, Ill.

Used Storage Batteries, 6 volt, 15 amp., \$3; 40 amp., \$6; 120 amp., \$10. Also batteries for farm lighting. H. W. Barracough, 3649 N. Tenth St., Phila., Pa.

Books.

We Buy and Sell back issues of Radio Amateur News and Electrical Experimenter. Boston Magazine Exchange, 109 Mountfort St., Boston, Mass.

Electricians Examinations: Book of questions and answers with diagrams, symbols, tables, notes and formulas for preparation for license. \$1.25 by mail. Aaron Shapiro, 132 West 24th St., New York.

All sex Books Reduced.—Two red stamps bring catalog D. Smetana & Co., Owasso, Mich.

Business Opportunities.

Wanted.—Live Amateurs throughout the country to sell standard apparatus. Reasonable discounts. Hoboken Radio Shop, 404 Washington St., Hoboken, N. J.

Advertise.—30 words 100 magazines, \$1.50. Pennell Company, Covington, Kentucky.

Chemistry

Learn Chemistry at Home.—Dr. T. O'Connor Sloane, noted educator and scientific authority, will teach you. Our home study correspondence course fits you to take a position as chemist. See our full page ad on page 1189 of this issue. Chemical Institute of New York, 140 Liberty Street, New York City.

Correspondence Courses.

Correspondence Courses at less than half original prices. Any school; any subject for men or women. Bulletin 1074 free. Courses bought. Instruction Correspondence Exchange 1966 Broadway, New York.

Dollars Saved.—Used correspondence courses of all kinds sold, rented and exchanged. List free. (Courses bought.) Lee Mountain, Pisgah, Alabama.

For Advertisers.

Biggest Pullers on Earth.—Jacobus Letters, \$3.50. Jacobus Advertising Service, Irvington, N. J.

Games and Entertainment

Mystify, baffle and amaze your friends with a "Margo." Something new, novel and entertaining. Descriptive circular free. James T. Herr, Desk D, 2919 W. North Ave., Baltimore, Md.

Exchange.

Amateur Agents wanted in every city and town to sell radio apparatus. A few stocking agencies still open. Deifelco, 12 Meeting Street, Pawtucket, R. I.

Radiofone Receiver Complete; 1 K.W. spark transmitter. Cheap. New. H. Walleze, Danville, Penna.

Omnigraph No. 5, perfect condition, sell \$8 or trade for Electron Relay. J. G. Tizzard, Owen Sound, Ont.

Special Radio Storage Batteries, Edison, Lead all sizes, Radio Battery Service Station, 44 Bryant St., Malden, Mass. 1.K.M.

Apparatus for Sale.—Complete transmitters and receivers, and parts. Send for free list. Radio Assembly Co., 2521 Ridgeland Ave., Berwyn, Ill.

For Sale.—Four Tresco "Universal" variable condensers, \$2.00 each. One, "Chelsea" oscillator, \$2.50. One, 43 plate, E. I. Co. variable, \$3. One, Marconi, soft tube, \$4. One, "Arlington" tuner, \$7. One, set "Croft's Practical Electricity," \$15. Any of the above sent postpaid upon receipt of price. R.H. Pickens, Clemmons, N. C.

For Sale.—Loose coupler, 3000 meters, \$10; No. 2 Jr. 5-dial omnigraph, \$10; practice key, buzzer and inductance coil mounted, \$2.50. Dr. J. B. Ogden, 1 Madison Ave., New York City.

A Limited Number of Westinghouse sets at \$115 each. Antenna 7 strand No. 22 copper wire, 65c per 100 ft., complete detector units not assembled, \$3.85; 1 stage un-assembled, \$3 complete. Cash or C. O. D. Mack's Radio Shop, Ansonia, Conn.

Bargain.—New Vocaloid, \$21; detector one-step amplifier, \$16. Walter Lemke, Grand Rapids, Mich.

For Sale.—Complete receiving and transmitting set. Honeycombs, detector and two stage amplifier; transmitter, 10 watt radiophone, complete with tubes, batteries, microphones, CW, transformer and rectifier. All mounted and new. First \$235 cash takes it. W. J. Lindsay, Millbury, Mass. Box 446, Telephone Millbury 195.

Sale.—Honeycomb receiver detector 2 step in oak cabinet 11 x 18 mounting inside dial control coils 400-20000 included. Write offer. J. Kuh, 167 Sands St., Brooklyn, N. Y.

Sell.—15 dial omnigraph with case and buzzer, new. Christmas, 2343 Morris Ave., N. Y. C.

Variometers and Variocouplers, \$3 each, postpaid. Immediate delivery. Bengser-West Manufacturing Co., 133 Cooper St., Brooklyn, N. Y.

Have Quantity Salesman's Sample Regeneratives for sale, half price, just the set you want. Wonderfully efficient. Made of best materials by master craftsmen. Encased in beautiful grained leather covered cabinet. Easy to operate; no capacity effects. A wonder for CW and phone. Equals a Paragon. Will be placed on market soon, retailing at fifty-five dollars; will sacrifice samples at \$24 each. This is a bargain! Everyone in excellent condition; like new. Fully guaranteed. Grasp this opportunity—order one today—now! (Photo free.) Master Engineering Company, Omaha.

Sell. Trade.—Radio apparatus. Want wiring material, dynamo, gas engine. Ralph Leffer, Tiffin, Ohio.

For Sale.—Used wireless apparatus. Send stamps for list. Gilbert Meyers, Randolph, N. Y.

Ten Mile Radiophone complete, operates on B battery, \$35. Box 205, Williamsport, Pa.

A Bargain.—I. P. 500 Navy standard receiver, \$160. 7K-R 528 Market, Portland, Ore.

For Sale.—New omnigraph, 5 dials, \$14. Rex Russell, 57 Seventh, Muskegon, Mich.

For Sale.—Regenerative sets, amplifiers, inductances, other radio apparatus. S. Strobel, 3923 N. 6th St., Phila., Pa.

For Sale.—1/2 K.W. spark set nearly new, write for particulars. Herman Hirschberg, 111 E. Adams Ave., Vandergrift, Pa.

\$4 Ranger bicycle for Magnavox or Phonotone. New condition. Extras. Kenneth Tatum Alamogordo, New Mexico.

Sell.—Complete crystal set. \$20. DeWolf Thompson, Vineyard Haven, Mass.

Want phones, also magnavox with or without horn. Will sell or trade 15-dial omnigraph. What am I offered. Waterman, 192 Ainslie Street, Brooklyn, New York.

Hear Music! Receiving set mounted, one variable condenser. First money order of \$17 takes it. Box 134, Swedesboro, N. J.

200-20,000 Meter Receiver including Radiotron, \$35. Box 205, Williamsport, Pa.

Bargain.—Clapp-Eastham 1/2 K.W. spark set complete; transformer, condenser, rotary helix, key, \$35. DeForest 3/4 K.W. transformer, \$16; Duck ferron detector, with crystal, \$3. All good condition. R. C. Bryant, Clarksonton, Wash.

Special.—Complete \$45 receiving cabinet, \$5. \$25 Omnigraph, \$10. Marconi wireless records, \$4. J. A. Courtade, 215 Kent St., Greenpoint, Brooklyn.

(Exchange continued)

Brand New Paragon RA-10 and Fada detector cabinet to match. Never used, \$80. Edison "B" battery elements, six cents a pair postpaid. A. J. Moore, 668 Montgomery St., Jersey City, N. J.

Trade Pool Table, size (X) for Westinghouse set (No. 2). R. D. DeFord, Savannah, Tennessee.

Wanted.—Bound volume number 1, of Radio News. 5UE Convey, Ark.

New National Radio Omnigraph, \$25 cash. Fred Banister, Cuba, Ill.

Sell.—1 1/2 spark coil sending outfit cheap. Write Donald Beidler, Lancaster, N. Y.

For Sale.—Complete 1 K.W. wireless spark transmitter, \$60. Also two receiving sets. John Chidester, 661 W. Pike St., Clarksburg, W. Va.

Learn Code Quickly, must sell brand new \$25 Natrometer, \$20. Will ship express C.O.D. S. B. Ford, Jr., 1st Wing Hdgts., Det. Kelly Field, Texas.

Sell.—1/2 K.W. Thordarson transformer and unblowable aluminum oil immersed condenser, \$19.50. H. M. Hall, 1731 Winona St., Chicago, Ill.

Bargain.—Brandes Navy Headset, Eight Dollars. Brandes superior headset, four dollars, used very little. Guaranteed. Walter Hester, Eastly, S. C.

Sale.—NAA new coupler, \$5.50. William Menkiney, Rock Springs, Wyo.

Bargain.—Detector and 2 step amplifier automatic filament control. Lewis Neuman, Box 246, Braddock, Pa.

Will Sell.—1/2 K.W. cheap. Write C. R. Thorbahn, 1299 Woodlawn St., Scranton, Pa.

For Sale.—New Omnigraph number two; thirty Morse and Radio records. Bargain. Charles W. Beeson, Hidalgo, Texas.

Bargain.—Tuner, detector, phones, variable, \$20, cost \$45. Leland Lewis, Oneida, N. Y.

For Sale.—3/4 K.W. Thordarson trans. 15; aerial, switches, etc. Henry Nalbach, Monacaqua, Ill.

For Inventors.

Electrical Instruments & Mechanical Models made to your specifications. We specialize in semi electro-mechanical apparatus. Inventions developed and perfected. Light manufacturing, rates reasonable. Johnson & Wentink, 3225 Sheffield Ave., Chicago, Ill.

Health.

Pycorrhea (Rigg's disease—bleeding or swollen gums)—hundreds have been helped by "Pycorrdent" the successful home pycorrhea treatment. Purifying, healing, preventative. Full month's treatment, consisting of a very beneficial massage paste and an antiseptic tooth-cleansing paste to be used in place of your ordinary dentifrice, together with full directions for treatment. \$1 postpaid. Or write for free booklet "R." Pycorrdent Mfg. Co., 439 Seventh St., Brooklyn, N. Y.

Tobacco or Snuff Habit Cured or no pay; \$1 if cured. Remedy sent on trial. Superba Co., SB, Baltimore, Md.

Help Wanted.

Detectives Earn Big Money. Excellent opportunity. Travel. Experience unnecessary. Particulars free. Write, American Detective System, 1963 Broadway, N. Y.

U. S. Government Positions, \$92 to \$192 month. Steady work. No layoffs. No strikes. Pay sure. Short hours. Pleasant work. Paid vacation. Common education sufficient. Men, women, over 17. Schedule of examinations free. Write immediately. Franklin Institute, Dept. D111, Rochester, N. Y.

Earn \$25 Weekly, spare time, writing for newspapers, magazines. Experience unnecessary; details free. Press Syndicate, 5665, St. Louis, Mo.

Stop Daily Grind. Start silvering mirrors, auto headlights, tableware, etc. Plans free, Clarence Sprinkle, Dept. 64, Marion, Indiana.

Be a Mirror Expert, \$3-\$10 a day; spare time home at first; no capital; we train, start you making and silvering mirrors, French method. Free prospectus. W. R. Derr. Pres., 579 Decatur St., Brooklyn, N. Y.

Gov't. Railway Mail Clerks start \$133 month; expenses paid. Specimen examination questions free. Columbus Institute, R-3 Columbus, Ohio.

Detectives Make Big Money. Be one. Travel. Fascinating work. Excellent opportunities. We show you how by home study. Write American School of Criminology, Dept. R, Detroit, Mich.

Insects Wanted

Spend Spring, Summer, Fall, gathering butterflies, insects. I buy hundreds for collections. Send 25c (not stamps) for illustrated prospectus. Sinclair, Dept. 33, Ocean Park, California.

Games and Entertainments.

Stage, Circus, Acts, Contortion, Trapeze. Roman Rings. Illustrations, photos, \$5. Mdlie Scott, RT3, Box 145-A Memphis, Tenn.

Instruction.

Learn Chemistry at Home—Dr. T. O'Connor Sloane, noted educator and scientific authority, will teach you. Our home study correspondence course fits you to take position as chemist. See our full page ad on page 1189 of this issue. Chemical Institute of New York, 140 Liberty Street, New York City.

Learn by Listening: We teach Hawaiian Guitar using Our Phonograph Records. Send for particulars. Roach-Frankland, 307 East Fourth St., Cincinnati, Ohio.

Receive 100 Letters Daily, containing 25 cents. Instructions one dollar. J. Crawford, 726 Madison, Memphis, Tenn.

Play Mouth-Organ—Complete, easy instructor, 25c. Elsea Co., Bowling Green, Ohio.

Inventions Wanted.

Useful Radio Inventions will be purchased by large manufacturer, either before or after filing patent. And their own attorney and radio expert will aid wireless experimenters and inventors to patent and commercialize their ideas. Write fully what you have, sending sketches and description. All correspondence held strictly confidential. Address; Box No. 51, Radio News.

Languages.

World-Romc System, mastery to all languages. Six textbooks, \$1.75; French chart, 37c; Spanish, 37c; speech-organs, 37c. Pronunciation tables, 75 languages, 25c each. Languages Publishing Company, 8 West 40th Street, New York.

Mailing Lists.

2075 Farmers, every Nebraska county, \$3. Jeston's Service, Box 769, Omaha, Neb.

Manufacturing

Let Us Be Your Factory! Write today. Logan Machine Company, 222 South Clinton Street, Chicago, Ill.

Punch Press Work, enameling, printing on metal and celluloid. Samples free. Gilson Company, Niles, Mich.

Miscellaneous.

Luminous Paint, bottle 20. Laboratories E, Box 316, Portland, Oregon.

12-Tool Handy Set—Made of best steel. The most useful and practical tool on the market. Postpaid \$1.25. National Specialties, 321 Union Square, N. Y. City.

Motorcycles, Bicycles

Don't buy a Bicycle Motor Attachment until you get our catalog and prices. Shaw Mfg. Co., Dept. 6, Galesburg, Kansas.

Musical Instruments

Cornetists, Trombonists, Saxophonists, Clarinetists, send for "Free Pointers" mention instrument. Virtuoso School, Buffalo, N. Y.

News Correspondents

Earn \$25 Weekly, spare time, writing for newspapers, magazines. Experience unnecessary; details free. Press Syndicate, 566 St. Louis, Mo.

Office Devices

Addressing Machines, Multigraphs, Duplicators, Letter Folders, Multicolor Presses, Check Writers, Dictating Machines, Envelope Sealers, Supplies, about half new cost. Write for illustrated catalogue. Pruitt Company, 172 North Wells, Chicago.

Patent Attorneys.

Millions Spent Annually for Ideas! Hundreds now wanted! Patent yours and profit! Write today for free books—tell how to protect yourself, how to invent, ideas wanted, how we help you sell, etc.. 301 Patent Dept., American Industries, Inc., Washington, D. C.

Patents.—Electrical cases a specialty. Pre-war charges. B. P. Fishburne, 340 McGill Bldg., Washington, D. C.

Patents Secured. Prompt service. Avoid dangerous delays. Send for our "Record of Invention" form and Free Book telling How to Obtain a Patent. Send sketch or model for examination. Preliminary advise without charge. Highest references. Write Today. J. L. Jackson & Co., 356 Ouray Bldg., Washington, D. C.

Patents.—Send for form "Evidence of Conception" to be signed and witnessed. Form for schedule, information, fee. Lancaster and Allwine, 269 Ouray Bldg., Washington, D. C.

Patents On Radio.—My special experience and compilation of patents and literature enables me to advise inventors and manufacturers on radio inventions and patents. John B. Brady, Ouray Building, Washington, D. C. formerly with Radio Division, Navy Department, and Secretary, Government Radio Board, investigating radio patent situation.

Chief Patent Counsel and Consulting Radio Engineer for large corporation will aid a few more inventors in patenting their ideas. Strictly professional and confidential service at reasonable rates. Send full information first letter. Also have excellent connections for disposing of meritorious radio inventions. Correspondence invited. Address: Box No. 51, Radio News.

Patents.—H. T. Lowenstein, McLachlen Building, Washington, D. C. Send full description of invention for personal advice on how to proceed and estimate of costs.

Personal.

Exchange jolly, interesting letters through our Club! Send stamp. Betty Lee, 28 East Bay, Jacksonville, Fla.

Success or Failure—Which is your destiny? Scientific information "Success" pointers and personality sketch for 16c and birthdate. Thomson-Heywood, Dept. 580 Chronicle Bldg., San Francisco, California.

Printing.

Your name on fifty "Styloprint cards," 35c. Card case FREE. Imprimature Press, Waltham, Mass.

Everything Printed.—Long run specialists. Samples. Quality Printery, Marietta, Ohio.

Better Printing.—1,000 letterheads, envelopes, statements or cards, \$2.75. Gum labels, multigraph letters, \$4.50 M. Samples free. Howlett's, Dept. A. Paris, Illinois.

Post Cards and Pictures.

8 x 10 Kodak Enlargement, beautifully colored, \$1. Kodafin, 387 Bieleview Place, Milwaukee, Wis.

Photo Developing.

Project Movie Film With Kodak. Instructions and films, 25c. Exchange, J-837 Bowery, Akron, O.

Scenery for Hire.

Settings for all operas and plays. Catalog. Amelia Grain, Philadelphia.

Song Writers.

Song Writers!—Learn of the public's demand for songs suitable for dancing and the opportunities greatly changed conditions offer new writers, obtainable only in our "Song Writers' Manual and Guide," sent free. Submit your ideas for songs at once for free criticism and advice. We revise poems, compose music, secure copyright and facilitate free publication or outright sale of songs. Knickerbocker Studios, 319 Gaiety Bldg., New York.

Situation Wanted.

Situation Wanted as salesman for radio manufacturer's outfits and supplies. Victor Zoller, 6024 Fifteenth St., Detroit, Mich.

Telegraphy.

Telegraphy—(Morse and Wireless) and Railway Accounting taught thoroughly. Big salaries. Great opportunities. Oldest, largest school. All expenses low—can earn large part. Catalog free. Dodge's Institute, M. St., Valparaiso, Indiana.

Ventriloquism

Ventriloquism.—Taught almost anyone at home. Small cost. Send today 2 stamp for particulars and proof. Geo. W. Smith, Room M-541, 125 N. Jeff. Ave., Peoria, Ill.

Wanted to Buy

Mail Old Gold, unused postage, war and thrift stamps, Liberty Bonds, silver, platinum, diamonds, jewelry, watches, false teeth, magneto points, etc., new or broken. Cash immediately. Held ten days, returned if unsatisfactory. Ohio Smelting Co., 207 Lenox Bldg., Cleveland, Ohio.

Wireless.

Build Radio Sets.—We supply parts or complete units. Catalog 15 cents. Easily understood, assembly drawings, crystal detector set, non-regenerative receiver, regenerative receiver, 2 step amplifier. 25 cents each. All five \$1. No stamps accepted. Hatfield Airfone Company, Owego, N. Y.

C-300 Detector Tubes, \$4.67. Jupiter Radio Outfit, \$12.75. Send for list Radio Bargains. Maynard Ralston, North Baltimore, Ohio.

A-1 Galena.—Perfect, tested and guaranteed; imbedded in special metal, price 35c; A-1-1 Galena (genuine), 50c. postpaid. National Specialties, 32R Union Sq., N. Y. C.

Boys! Don't Overlook This. The "Rasco" Baby Detector. Greatest detector ever brought out with molded base. Fully adjustable. See former advertisements in this publication, or our catalogue. Detector with Galena crystal, complete 50c, the same detector with Radiotone Crystal 75c pre-paid. Send for yours to-day. Radio Specialty Company, 96-98 Park Place, New York City.

Bargains.—Detector units, \$5.50; amplifier units, \$8.50; tuners, \$12.50; etc. We build to order. Send for free circular. A-T Radio Supply Co., Gibson City, Illinois.

Dealers.—I will stock your radio department with all desirable merchandise at advantageous prices. Write for proposition. Box 21, Radio News.

Bargains.—Big sale on new stock radio apparatus, order today while they last. Honeycomb receiver including detector, 150 to 20,000 meters, condensers, coil-mountings, and detector controls assembled on engraved formica panel, enclosed in oak finish cabinet, with set of honeycombs, \$26.00. Short wave regenerative receiver and audion detector assembled on formica panel, 14 x 13 enclosed in oak finish cabinet, \$25. Cabinet receiver, 200 to 600 meters, 10. C. Clapp-Eastham Type B Q wave-meter, \$12.50. Thordarson amplifying transformers, \$3.50. A. P. Electron relay tubes, \$4.50. Amplifier, \$6. Orders filled same day received. Cambridge Radio Laboratory, Cambridge, Illinois.

Radio-Cabinets.—With all-wood tone chambers with or without phonograph combination any quantity in stock sizes or to order. Columbia Metal Co., 175 Powers St., Brooklyn, N. Y. Tel. ES-53 2726.

(Wireless continued)

Quality, Satisfaction, Service First. The Kehler Radio Laboratories.

Audion Controls, engraved bakelite panel, 7 inches x 4 1/2 inches. DeForest rheostat and non-leakable cap, nickel plated binding posts, grid condenser, brass wiring, etc. Can be used with any crystal or regenerative set. We also have full assortment of parts. Look for future ads. Guarantee Radio Equipment Co., 510 Claremont Parkway, Bronx, N. Y. C.

Kehler Magnavox Premiums.—The Radio Magnavox as is well known is the only loud speaker which will reproduce radio telephone speech and wireless music in any volume without distortion and without injury to the apparatus. Type R-3 Radio Magnavox, with 14 inch horn, \$45, input 5 watts, premium 1 Ace 45 volt large size B battery, \$5 each. Type R-3 Magnavox with 18 inch horn, \$85, input, 20 watts, premium 2 A.P. Moorhead and Radiotron amplifiers, \$6.50 each. For extreme and distortionless amplification of radio telephone speech and music the Magnavox power amplifier should be used. Magnavox 2-stage power amplifier Type AC-2 model C, \$50 premium 1 A.P. Type C power tube, \$7.50 each. Magnavox three stage power amplifier, Type AC-3, model C, \$110, premium 2 A.P. Moorhead Type C power tubes. Unsatisfactory goods subject to return within five days. 12 Hour Service or your remittance returned. Shipments F.O.B. either Oakland, California, New York City, or Abilene. The Kehler Radio Laboratories, Dept. R., Abilene, Kansas.

Single Tuned Regenerative outfit for sale with complete audion control all mounted on engraved bakelite panel, enclosed in hinged cabinet. Wave length 150 to 2000 meters. Lowest price, \$40. Hugo Sutor, 3825 Third Ave., N. Y. City.

Baldwin Phones. Why are Baldwin phones so sensitive? Briefly, because (1) the small armature is pivoted and designed to act as a fulcrum when connected to the diaphragm by a small link. There is no tension or springing of metal as in ordinary receivers. (2) 4 pole pieces of a single solenoid act upon both sides of a lightly balanced armature. (3) The force is concentrated at the exact centre of the mica diaphragm. (identically the same as used in all high grade phonograph reproducers). Original Type C, \$12; improved Type E, \$13; lighter Type F, \$14; antistatic Type G, \$15. Single loud speaker unit, Type C without core, \$6, this is the same unit as used in the Vocauloid and are excellent for making your own loud speaker; premium, 1 Stracey coupler which enables you to fasten your horn to your receiver. With each pair of phones purchased we shall give as premium 1 of the latest Federal universal plugs, \$1.75. These well known head sets are absolutely guaranteed and subject to return within five days if not satisfactory. 12 hour service or your remittance returned. Postpaid, insured. The Kehler Radio Laboratories, Dept. R, Abilene, Kansas.

For The Best, little wonder crystal set, \$15. For \$1, 12 switch points, 2 binding posts, 2 stops, 1 switch. Binding posts, 4c each, \$1 doz. Switch points, 30c doz. All nickeled. Add postage. Cecil Waldschmidt, Box 285, Metamora, Illinois.

Grebe! Grebe! Grebe! Notice the attractive premiums we offer on the latest Grebe regenerative sets and vacuum tube controls. These contain bakelite variometers, shielded units, and vernier controls. Type C.R. 3, \$65; Type C.R.-5, and C.R.-8, \$80 each; Premium 1 A.P. or Radiotron detector C.R.-9, \$130, premium 2 A.P. or Radiotron amplifiers. Type ROD detector and two stage amplifier, \$75, premium A.P. or audion amplifier, Type RORK two stage amplifier, \$55, premium large size Burgess B Battery, \$3 each. Absolutely new stock and guaranteed to be up to the usual well known Grebe standard, without question the finest regenerative sets on the market, representing the best work in radio engineering. Shipments F.O.B. Abilene. Unsatisfactory sets subject to return within five days. 12 hour service or your remittance returned. Kehler Radio Laboratories, Dept. R, Abilene, Kansas.

Grid Condensers.—Western Electric grid condensers Type 42D at \$0.35 each, enclosed in usual W. E. metal case. Kehler Radio Laboratories, Dept. R, Abilene, Kansas.

KRL at Radio Frequency.—Mu-rad radio frequency amplifying transformers types T-11, T-11A, and T-11B, \$9 each, premium Klossner vernier rheostat, or Federal 2-circuit automatic filament control jack, \$1.50 each. 12 hour service or your remittance returned. The Kehler Radio Laboratories, Dept. R, Abilene, Kansas.

KRL Arkay Radio Horns, will amplify your signals, speech or broad casted music without distortion. Black enamel finish, \$5 each; nickel finish, \$6 each, premium 5 foot Belden receiver cord, solid tips at both ends. Complete with Type C Baldwin unit, \$10.50. Nickel plated, \$11.50. Same as illustrated elsewhere in this magazine. 12 hour service or your remittance returned. The Kehler Radio Laboratories, Dept. R., Abilene, Kansas.

C.E. Regenerative Sets.—Best bargain in regenerative sets on the market, improved model in mahogany cabinet, \$40 each. Premium, 1 large size Ace variable B battery, 2 1/2 volts, \$3 each. Satisfaction or your money back. The Kehler Radio Laboratories, Abilene, Kansas, Dept. R.

RAC3 Audion, may be used as amplifier or detector. Try one of these excellent little vacuum tubes, 3.50 each. Receptable, \$1; premium L Type 42D H. E. grid condenser. Unsatisfactory goods subject to return within five days. The Kehler Radio Laboratories, Dept. R., Abilene, Kansas.

Antenna Wire.—Highest grade Beldic high frequency aerial wire. Consists of 7 strands of No. 22 tinned copper. No bothersome scraping. A pleasure to solder. Only 1c per foot. The Kehler Radio Laboratories, Dept. R, Abilene, Kansas.

Bargains in Edison Batteries.—6 volt 225 ampere hours, \$29. B Battery elements 6c a set, postpaid. I can also save you money on any brand new Edison Battery. A. J. Moore, 605 Montgomery St., Jersey City, N. J.

International Radio Co. variable condensers for panel mounting, with 2 1/2 inch metal dial and knob, .0095 Mfd., \$3.50; .001 Mfd., \$3.75; C.W. variable condensers .001 Mfd., \$4; set of three unmounted universal wound (honeycomb) coils for short wave set, \$1. These coils with .001 and .005 variable condensers make a fine regenerative set for radio phone reception. Large variometers, the \$6 kind, \$3.75. Variocouplers with 14 taps, \$3.75. Money refunded if not satisfactory. Add postage. H. Butterworth, 331 Quincy St., Brooklyn, N. Y.

RECLA



(Patent Pending)

Radio Sound Amplifier

Insert any standard telephone receiver and you will have a perfect clear tone loud speaker. Stands 14 inches high with a 10 1/2 inch bell.

Furnished in black enamel—\$12.50. Shipping weight 6 pounds.

Dealers—Write for proposition.

Manufactured by
RADIO ELECTRIC COMPANY
Fremont, Ohio

"CONTRACT WORK WANTED BY ONE OF NEW ENGLAND'S LARGEST MANUFACTURING COMPANIES. FULLY EQUIPPED TO MANUFACTURE THE FOLLOWING PRODUCTS:

- AUTOMATIC SCREW MACHINE PRODUCTS
- HAND SCREW MACHINE PRODUCTS
- MILLING MACHINE WORK
- POLISHING, PLATING, BUFFING
- GEAR CUTTING
- THREAD MILLING
- JAPANING
- PLASTIC MATERIAL PRESSING
- ELECTRIC MOTOR MANUFACTURE
- PUNCH PRESS WORK

OR

COMPLETE ASSEMBLED PRODUCTS OF ANY NATURE OF A MEDIUM LIGHT GRADE INTERCHANGEABLE TYPE.
WOOD WORK FROM BOX SHOOKS TO PLAIN TYPE OF CABINET WORK.

Please Refer to Box 234
This Magazine

LIST OF APPARATUS

The unprecedented influx of business with its resultant increase in detail has made it absolutely impossible for us to properly compile and print a new catalog.

We have just received from the printer, however, a complete list of apparatus, comprising several hundred items.

This, together with our Delivery Information Sheet will be sent to you on receipt of 2c postage.

A.H. CORWIN & CO.
Newark, New Jersey

(Wireless continued)

Quality, Satisfaction, Service First. The Kehler Radio Laboratories.

Variocoupler Parts.—Hardwood rotors, \$50. Send for list of other parts. Louis Griewisch, 301 South Oakland, Green Bay, Wis.

Lightning Switches, \$3.60; variometers, \$3.50; variocouplers, \$2.75. Haas, 2011 Atlantic Ave., Atlantic City, N. J.

We Will Reconstruct transformer of your old spark set so that it may be used for C.W. or phone work. Any voltage. Rates reasonable. Special 2 K.W. 2,500 volt transformer, \$50; 1/4 K.W. 500 volt, \$10. All standard apparatus and parts supplied. Radio Art Mfg. Co., 32 Bound Ave., Milton, Pa.

Come On Fellows.—Join the Radio Exchange and save money. This is the place you can get what you want, at prices you want to pay, and sell what you don't want at prices you do want. Our bi-monthly bulletins list all the used radio apparatus that our members have for sale. Have you anything you wish to sell or do you want any used apparatus? The prices in our catalog are incomparable. It is for the use of members only. The membership fee is 25c, and is all that you have to pay. Join now. The Radio Exchange, 804 Helen St., Sioux City, Ia.

Galena Crystals.—Higher test than the famous Kansas Galena, 25c. Postage 5c extra. Wade & Griswold, 1706 Indiana, Joplin, Mo.

Double Your C.W. and Radiophone Range! You can easily do it without adding another piece of apparatus or greatly changing your set. The new "Master Circuit" is the secret. Tested by many prominent ARRL Stations it more than doubled range of each station. One five watt set puts twenty watts into antenna; easily sends 2000 miles; fones 1000! Think of it! It's absolutely the best circuit out. Ideal for 200 meters. Guaranteed to double or increase your range regardless of what it is now. Send \$2 for complete confidential photoprints of this wonder circuit. Get it working for you—be the first in your town—surprise your friends by your phenomenal results. Order today—immediately. Master Engineering Co., Omaha, Nebr.

12 Hour Service or Remittance returned. The Kehler Radio Laboratories.

Black Fibre Panels for amateur sets 7" x 18" x 3/16", \$1.20, cut to order \$.01 sq. in. Immediate delivery. Geo. H. Mollahan, Lowell, Mass.

12 Hour Service or Remittance returned. The Kehler Radio Laboratories.

This is Real Service.—Panels cut to order, smooth sawed edges. We cut them exactly to size and ship the same day your order is received. 1/4" thick, \$0.01 1/2c per square inch; 5/16" thick, .02c; 3/8" thick, .03; 7/16" thick, .03 1/2c; 1/2" thick, .04c, why pay more? These radio panels are made of our highest grade black fibre. This material possesses high dielectric strength, is inexpensive, unbreakable and easy to work. Our special offer, radio panels 6 x 6 x 1/4", 50c; 6 x 12 x 1/4", \$1. We also carry a complete stock of fibre rod and tubes, the real thing for electrical insulation, special prices quoted upon application. We pay postage. Radio Instrument & Panel Co., Box 75, Cicero, Illinois.

Stop! Look! and Act! V.T.'s. Accessories With each of the listed tubes Radiotron U.V. 200, \$5, and A. P. Moorhead detectors, \$5.00; Radiotron U.V. 201 \$6.50, and A.P. Amplifiers, \$6.50; we will supply free of charge your choice of either of these 5 premiums—Latest Fada rheostat, Paragon V.T. socket, Murdoch socket, DeForest socket, and Remler rheostat, \$1 each. Either of the Federal single, closed or double circuit jacks listed respectively at \$1.70, \$0.85, and \$1. will be given as premiums with each Federal 226W or R.C. of A. U.V. 712 amplifying transformers, \$7 each. U.R. 1714 radio frequency amplifying transformer. Fada 5 ampere Nidrome Thermoplas power rheostat \$1.35 or R.C. of A. U. R. 542 porcelain V.T. socket will be given as premiums with each \$8 U.V. 202 power tube or A.P. Moorhead 5-watt Type C power tube, \$7.50 each, for C.W. or Radiophone transmission or power amplification. We absolutely guarantee the foregoing apparatus. Only new and high grade equipment carried in stock. Unsatisfactory goods subject to return within five days. 12 hour service or your remittance returned. Postage and insurance prepaid by us, thereby saving time and money. Remember us. The Kehler Radio Laboratories, Dept. R, Abilene, Kansas.

Rogers Receiving Radiometer. New patented variometer for panel mounting. Simple, compact, efficient \$4.00. Build your own receiver. Two radiometers, one variable condenser, directions and wiring diagram mailed upon receipt money order \$10.00. Rogers Radio Company, 5133 Woodworth St., Pittsburgh, Penn.

Wireless Telephone. We hear Chicago 900 miles fine on a good night. Do You? There is radio music in the air each evening, and the living voices of the artists can be reproduced in your own home and enjoyed by you and your friends. Are you satisfied with your receiving set or would you like to build one that will receive over 6,000 miles on a single bulb and quit experimenting? One that will be equal to any regardless of claims and price—with which you can read Honolulu, California, German, South America, French and English station and practically all of the high powered foreign and domestic stations, as well as amateur stations as far west as New Mexico. Anyone can assemble this outfit and wire it up and the remarkable ranges that may be obtained will surprise you. Why not make a set up to date and efficient? Don't experiment with unknown circuits. We will promptly mail you our simple diagram of a complete short and long wave receiver. 175 to 20,000 meters, together with complete instructions for wiring and assembling, price of each part and where they can be bought, leaving nothing to guess about, on receipt of fifty cents in coin or stamps. Here is a diagram no amateur can be without. Build your own Wireless Telephone receiver. Virginia Novelty Company, Martinsburg, West Va.

You Want a Synchronous Gap!—We have a few synchronous motors at prices you can afford. 1/8, 1/5, and 1/4 HP-220 and 110 volts. Price and full information on request. Stahl Rectifier Company, 1405 W. Jackson Blvd., Chicago, Ill.

Storage Batteries. Be a battery man. We have all material and can give instructions for making them. Sample Plate 40c. Foreign countries 50c. Windsor Specialty Co., 5419 Windsor Ave., Chicago, Ill.

(Wireless continued)

Attention!—50 Vacuum tube hook-ups. The greatest collection of vacuum tube circuits ever brought under two covers at such insignificant cost. These diagrams will be found in the great "Rasco" catalogue, which contains raw materials and parts in a greater profusion than any other catalogue. 15c in stamps, or coin, will bring the catalogue to you. Radio Specialty Co., 96-98 Park Place, N. Y.

Buy Direct From Manufacturers, mahogany cabinet containing short wave tuner with detector, \$30 with one stage amplification, \$45; two stage, \$60; three stages (Use loop), \$80. No jacks. Rear connections. Rogers Radio Company, 5133 Woodworth St., Pittsburgh, Pa.

Broadcasted Music and News received over ordinary telephone. Absolutely the cheapest hook-up possible and it works. Operation as a telephone not affected. Send 25c for complete instructions and blue prints. E. C. Barnes, Elec. Engr., 6207 Linden Ave., Seattle, Wash.

Dubilier Condenser for half K.W. Capacity .007. \$20. Acme Half K.W. transformer, \$10; O.T., \$3; Du-more 7,000 R.P.M. motor, \$5; magnetic rectifier, 10. James M. Hallowell, Jr., Chestnut Hill, Mass.

RS Radio Products.—Detector, \$6; one step, \$12; detector and one step, \$17; two step, \$22; detector and two step, \$27; 3/16 Bakelite panels special moulded sockets, transformers, ratio 3 to 1, transformers, ratio 10 to 1, \$1 extra. R. S. Radio Co., 9439 120th St., Rich. Hill, N. Y.



PATTERNS to make your own RADIO-CONCERT RECEIVER

PATTERN No. 1

Complete Shortwave Regenerative Set
50c

PATTERN No. 2

Detector and Amplifier Units
50c

With the help of our patterns you can build your apparatus as easily as mother or sister make a dress, using their patterns.

For Sale in all Radio Stores or direct from

Consolidated Radio Call Book Co., Inc.
98 Park Place
NEW YORK

IMMEDIATE DELIVERY

No Waiting, send your order today for any of the following items and we will ship promptly.

\$40⁰⁰



MOORE'S ALL IN ONE BATTERY & CHARGER SET

A combination of Charger, Battery, Hydrometer and Radio tool kit all in one container—Solid mahogany case, leather carrying strap, charge and discharged ampere meter. Pilot charge Lamp, attachment cord with plugs and voltage taps of 2-4 and 6 volts. 20 Amp. 2 year guarantee. List Price.....\$40.00

MOORE'S RADIO FREQUENCY TRANSFORMER

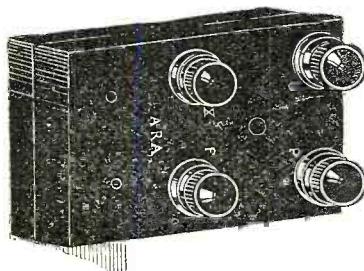

You receive louder and clearer voice and single reception less interference and absolutely no distortion. Reduce the cost of your receiving set 35%. This means 100% efficient radio reception. Guaranteed 150-450 meters. List Price.....**\$5.50**

A SOLID MAHOGANY CABINET

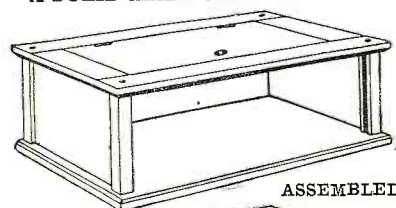

ASSEMBLED

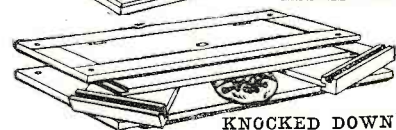

KNOCKED DOWN

Each Individual Cabinet Wrapper complete with light Assembling Screws. You can store 5 in space required by one old type Cabinet. Following sizes in stock for immediate delivery.

| Moore's Knocked Down Radio Cabinet | Formica | Complete | |
|------------------------------------|---------|----------|--------|
| 6 x 6 x 5 3/4 | \$3.10 | \$.75 | \$3.85 |
| 6 x 6 x 7 3/4 | 3.30 | 1.00 | 4.30 |
| 6 x 6 x 10 1/4 | 3.55 | 1.25 | 4.80 |
| 6 x 6 x 16 1/2 | 4.00 | 2.00 | 6.00 |
| 6 x 6 x 22 | 5.00 | 2.35 | 7.35 |

OTHER SIZES TO ORDER—10 DAY DELIVERY

WE CARRY A COMPLETE LINE OF RADIO PARTS

25 cents will bring you a catalog. Write to-day
Mahogany Wood Pulp Composition Greebe Type Variometers and Vari-Coupler Sets.
Variometers, \$5.00 90 degree—Vari-Couplers, \$4.50 180 degree—Vari-Couplers, \$5.00

WE ARE EXCLUSIVE DISTRIBUTORS FOR—

WRITE FOR **MOORE'S** DEALERS SET UP
WE CAN MAKE **PRODUCTS** IMMEDIATE DELIVERY
PAT. PEND.

If you are not listed, cash must accompany order

ELECTRIC SERVICE PRODUCTS COMPANY 10-12 S. WELLS STREET CHICAGO, ILL.

DUCK'S NEW CATALOG No. 16

275 Pages A Catalog Deluxe

"Over fifty pages of the latest hook-ups (wiring diagrams), and invaluable and up-to-date data and information on radio, including important instructions for building antenna."

"Send 25c in coin carefully wrapped for your copy of this wonderful book, the most unusual and complete catalog ever put between the pages of two covers. Not sent otherwise. It is not only a catalog, but a wonderful text book on radio. Enormous cost and tremendous demand prevents further distribution at a less retainer."

Never in the history of radio has there been such a catalog.

The radio data and diagrams embracing upwards of fifty pages gives the experimenter more valuable and up-to-date information than will be found in many textbooks selling for \$2.00, and \$1.00 could be spent for a dozen different radio catalogs before you could gather together the comprehensive listing of worth while radio goods found in this great catalog.

A brief summary of the radio goods listed in this catalog:

The entire radio catalog of the Radio Corporation, with a wealth of scientific and technical data on C.W. transmitting sets, and all the diagrams for the assembling of these sets; the complete Remler catalog, which embraces 25 pages, the Westinghouse, Eirth, Murdock, Federal, DeForest, Clapp-Eastham, Brandes, Connecticut Company, Thordarson, Turney, Magnavox Company catalogs, the best products of Adams-Morgan, Signal and countless other manufacturers, including our own complete line of radio apparatus, and many individual items and parts used in radio work today.

DIALS

On and after April 20th, we will be able to deliver sockets, dials and rheostats in very large quantities. Large capacity molds have already been made, and production of these items will mount to considerable figures daily.

SOCKETS

3" knob and dial with either 3/16" or 1/4" shaft is \$1.00; No. A666 Bakelite mold and socket with highly polished metal receptacle molded into base and connections on proper base, \$1.00; No. A650 Filament Rheostat \$1.00. This is one of the best rheostats in the market. Attractive discounts to dealers.

RHEOSTATS

DEALERS

We want live responsible dealers in every city and town in the United States, both for the sale of our extensive line of radio apparatus and all other worth while lines of radio goods on all of which we can quote attractive dealers discounts. We can offer you facilities and advantages that no other radio house can offer.

Send only 25c for copy of this wonderful catalog. You will need no other when you have Duck's, and you cannot find in all others combined what you will find in Duck's Wonder Catalog.

Type CV Crystal Receiving Set \$25.00

Beyond doubt the most advanced type of crystal set on the market for the clear and efficient reception of radio speech and music and telephone reception. Wave length range 700 meters.

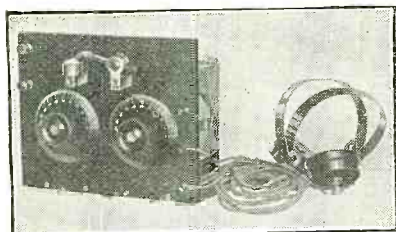

We caution the public unfamiliar with radio to be careful about the cheap, inefficient and poorly constructed crystal sets that are beginning to flood the market. We are the oldest dealers in America selling complete everything in radio. Established 1908.

In tests with this set the radio telephone station at Detroit (60 miles distant) was heard in Toledo with the greatest clearness and sweetness. Ideal set for persons residing within range of powerful radio stations in New York City, Springfield, Mass. Pittsburgh, Chicago and Detroit where wonderful concerts are broadcasted every evening.

THE WILLIAM B. DUCK CO., 231-233 Superior St., Toledo, Ohio

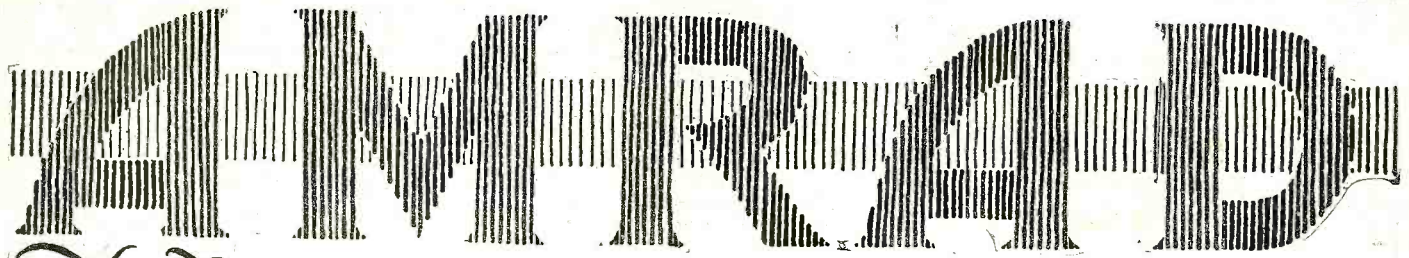

The Recognized Symbol of Superior Performance

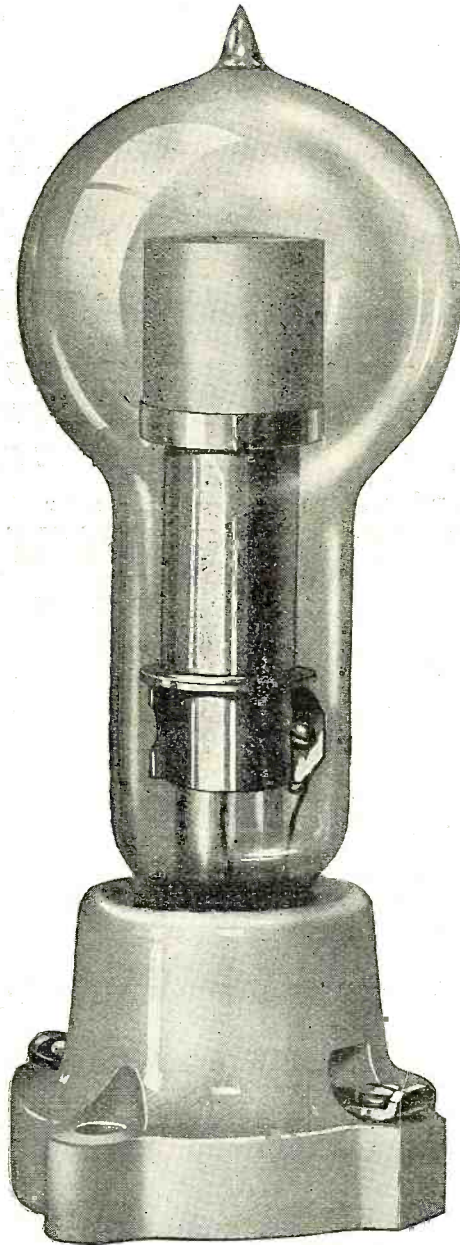

AMRAD S TUBE MOUNTED IN
STANDARD EDISON BASE

Rating, 20 watts. Voltage, 300-750
Capacity, 50 Mil. Amps. Life, 3000 Hours

Announcing the New "S" Tube— the rectifier Tube without a Filament

The new Amrad "S" Tube—The Tube Without A Filament—has already aroused widespread interest in the scientific world. It is now offered commercially as a rectifier of alternating current of any frequency, and finds instant application to small radio telephone and telegraph transmitting sets.

Amrad "S" Tube 3000 is used in the same manner as the familiar Kenotron, except that no filament heating current is required. Two "S" Tubes will pass sufficient plate current to operate two five-watt power tubes. "S" Tubes may be operated in series, parallel or series-parallel to accommodate higher currents and potentials.

The average life of the Amrad "S" Tube Rectifier is not known. As it has no filament to burn out, continued operation simply depends on the ability of its internal elements to stand up against the effects of heating and cooling. Its life is conservatively estimated at 3000 hours. The Tube in its present form is not applicable to receiving purposes.

ELECTROLYTIC CONDENSER NOW READY

Operation of radio telephone transmitters on AC current supply has been retarded by the lack of an effective filter—one that would eliminate AC "hum." The Amrad Mershon Electrolytic Condenser 38 mfd solves the filter problem. It does eliminate that AC "Growl". If punctured by excessive voltage, it heals automatically. Its first cost is the last cost. Included with each condenser is one charge of Chemically Pure Electrolyte.

PRICES

"S" Tube 3000...\$8.00

Condenser 2747 .. 8.00

Bulletin J describes both the Amrad "S" Tube Rectifier, and the Amrad Mershon Electrolytic Condenser—two vital accessories in CW Transmission. Write for your copy. Complete Amrad Catalog, 10c.

AMERICAN RADIO AND RESEARCH CORPORATION

New York District Office
21 Park Row

General Office, Factory and Laboratory
203 College Avenue, Medford Hillside, Mass.

Chicago District Office
600 So. Dearborn St.

Let These Guides

Solve Your Problems

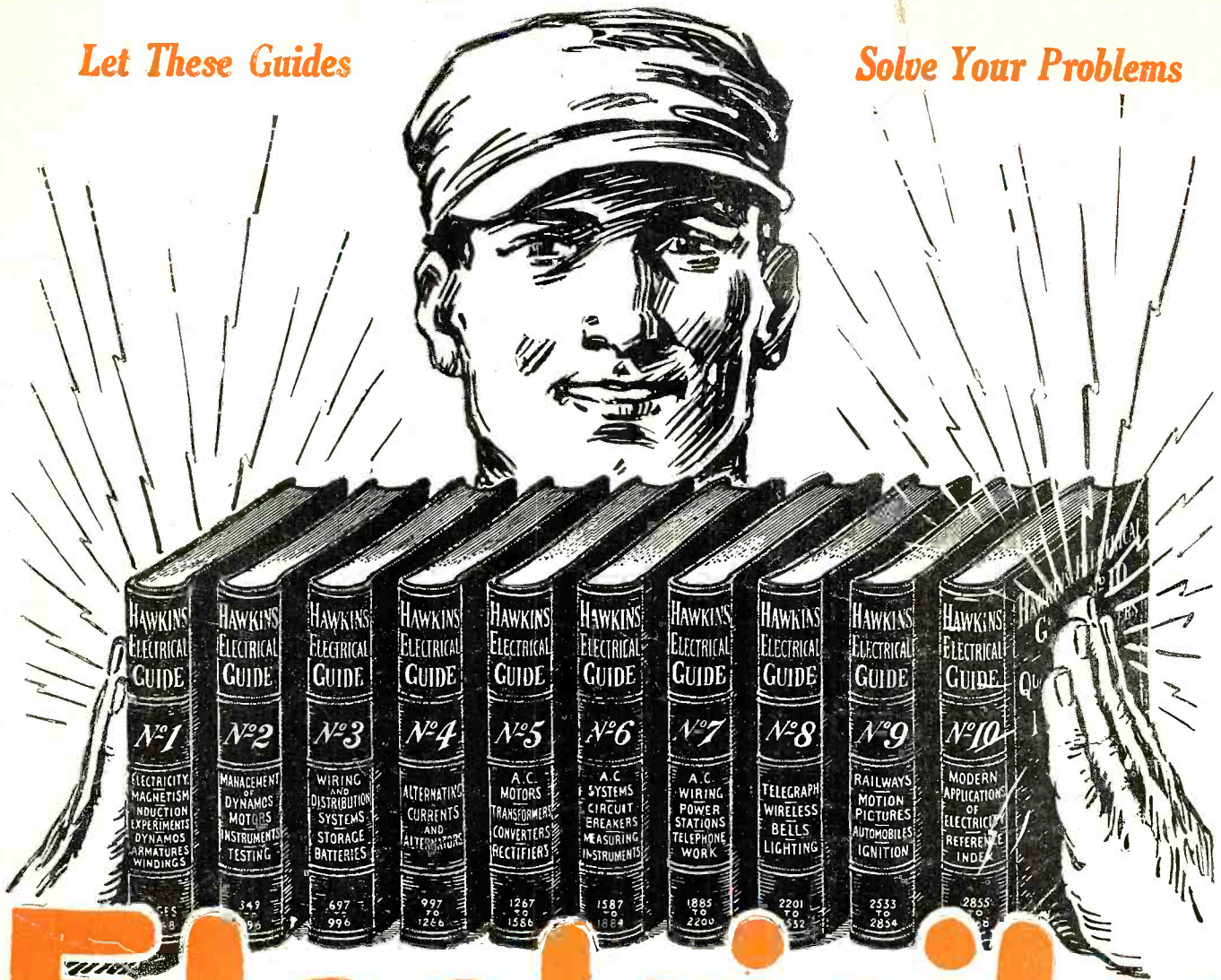

Electricity at your finger ends

HAWKINS ELECTRICAL GUIDES IN TEN VOLUMES

3500 PAGES
4700 PICTURES

\$1 A VOLUME
\$1 A MONTH

SEND NO MONEY—SEND ONLY THIS COUPON

Know the facts in Electricity. They mean more money and better position for you. Hawkins Guides tell you all you need to know about Electricity. Every important electrical subject covered so you can understand it. Easy to study and apply. A complete, practical working course, in 10 volumes. Books are pocket size; flexible covers. Order a set today to look over.

LEARN ALL ABOUT

Magnetism—Induction—Experiments—Dynamometers—Electric Machinery—Motors—Armatures—Armature Windings—Installing of Dynamometers—Electrical Instrument Testing—Practical Management of Dynamometers and Motors—Distribution Systems—Wiring—Wiring Diagrams—Sign Flashers—Storage Batteries—Principles of Alternating Currents and Alternators—Alternating Current Motors—Transformers—Converters—Rectifiers—Alternating Current Systems—Circuit Breakers—Measuring Instruments—Switchboards—Wiring—Power Stations—Installing—Telephone—Telegraph—Wireless—Bells—Lighting—Railways. Also many Modern Practical Applications of Electricity and Ready Reference Index of the ten numbers.

SHIPPED FREE

Not a cent to pay until you see the books. No obligation to buy unless you are satisfied. Send Coupon now—today—and get this great help library and see if it is not worth \$100 to you—you pay \$1.00 a month for ten months or return it.

THEO. AUDEL & CO.,
72 Fifth Ave., New York City

Please submit me for free examination, HAWKINS ELECTRICAL GUIDE. (Price \$1 a number). Ship at once prepaid, the 10 numbers. If satisfactory, I agree to send you \$1 within seven days and to further mail you \$1 each month until paid.

Name.....

Occupation.....

Employed by.....

Home Address.....

Reference.....

R. N., June

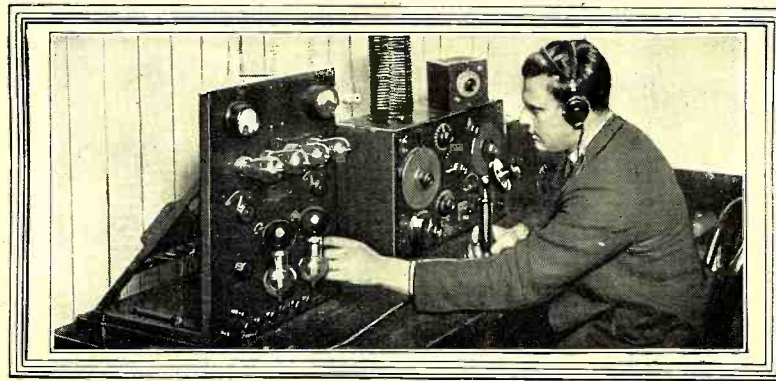

Become a Radio-trician

**Learn at home the greatest profession of today and the future.
Become a master of radio installation, operation, maintenance
repair, mechanics, design, inspection, salesmanship and invention.**

THE world is aflame with Radio. Never before in the history of the country has an industry leaped to the forefront as rapidly as this great, new science. Hundreds of thousands of radio receiving sets are in operation—tens of thousands of sending stations will be erected—and this enormous craze is permanent. Even today manufacturers are months behind their orders! Improvements are being made every day which must increase the demand for radio equipment to even *greater* proportions than now.

Men of foresight, men of vision know what this means. Never before has there been such an opportunity. Radio-tricians are needed today everywhere. More and more will be needed as the demand for radio installation, radio operation, radio maintenance, radio repair, radio salesmanship becomes greater and greater.

Wherever you go, there are hundreds of radio sets to be installed—wherever you go, thousands upon thousands of dollars worth of radio equipment is being sold—wherever you go, there are radio sets to repair; and if you seek adventure, there are radio sending stations calling to you from ships and land stations all over the world.

The Pioneer School

The National Radio Institute has a record of over

8,000 students. It is the pioneer school. It teaches every phase of radio from the ground up. It teaches by means of actual practice, actual assembling of a radio outfit, actual operation of radio equipment. It teaches by problem and principle so that National Radio-tricians are in demand everywhere.

Here is a profession which is paying enormous earnings to men all over the country today—a profession that will make hundreds of men wealthy—a profession far more lucrative than that of any other technical or mechanical employment you can secure.

What will you do?

The world is aflame with radio. What are you going to do to “cash in” on the demand for men, for equipment, for experience? Are you going to sit idly by wondering what it is all about, or are you going to make the most of this, the greatest opportunity presented to men of ambition in 50 years?

Write at once for the complete catalog to the National Radio Institute. This is the turning point in your life. Upon your decision *this instant* may depend your entire future. Mail the coupon, or write a letter **NOW**—*for your own sake!*

NATIONAL RADIO INSTITUTE

Radio Headquarters

Dept. 1077

N. W., Washington, D. C.

NATIONAL RADIO INSTITUTE, *Radio Headquarters*
Dept. 1077 N. W., Washington, D. C.

Please send me your book telling how I can become a Radio-trician through your Home Study Course, in my spare time. I am enclosing 10c (stamps or coin) to cover cost of packing and mailing.

Name

Address.....City.....State.....

Copyright, 1922, National Radio Institute