

CIRCULATION LARGER THAN ALL OTHER RADIO MAGAZINES COMBINED

RADIO NEWS

REG. U.S. PAT. OFF.

20 Cents
September
1921

Over 100 Illustrations
Edited by H. GERNSBACK



"THE 100% WIRELESS MAGAZINE"

Cunningham ANNOUNCEMENT



HERBERT H. FROST
Central Representative

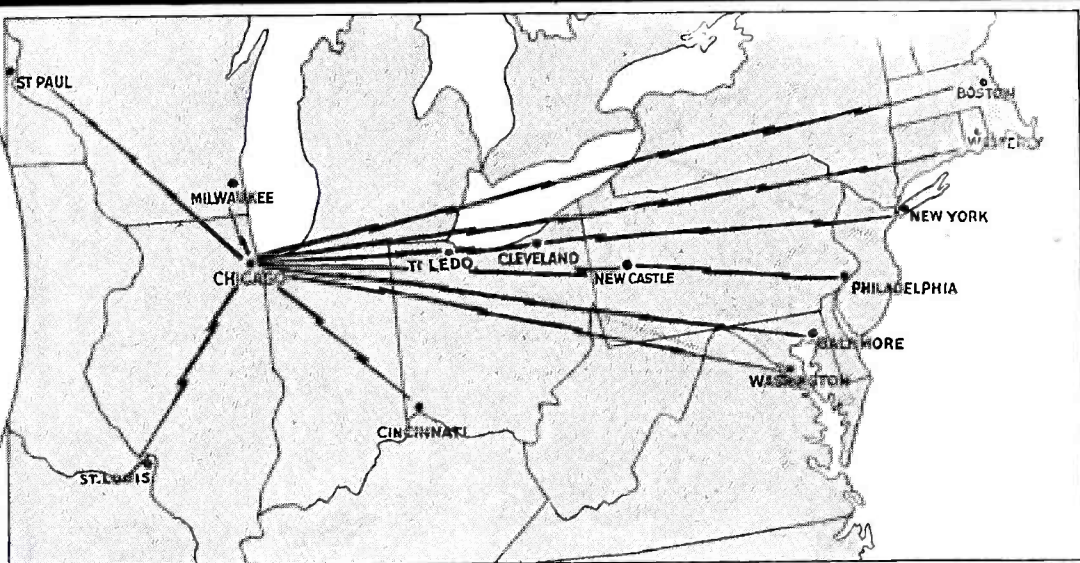

E. T. Cunningham

announces
the appointment of

MR. HERBERT H. FROST

as Central and Eastern Representative
of **REMLER RADIO APPARATUS** and
CUNNINGHAM TUBES, with offices
and stock rooms located at 154 West
Lake Street, Chicago.

Due to the increase of business and the recognized quality of Remler Apparatus and Cunningham Tubes, Chicago offices and stock rooms have been established. This will greatly expedite the filling of orders for eastern buyers.

We take this opportunity of thanking our dealers for their splendid co-operation and ask that they avail themselves of this new eastern radio service by placing their orders direct with Mr. Frost who will fill all orders promptly from our Chicago office.

E. T. CUNNINGHAM

Trading as
AUDIOTRON MFG. CO.

San Francisco, Calif.
35 Montgomery St.,

154 West Lake Street
Chicago, Illinois

REMLER APPARATUS RADIATES QUALITY

Attention Amateurs!

The Radio Dealers listed below carry Remler Radio Apparatus and Cunningham Tubes—they know quality merchandise. Write to or call on the nearest dealer—full satisfaction assured—ask him about the Cunningham Guarantee. Write for 32 page Remler Bulletin—just off the press.

- J. H. BUNNELL & CO., Inc.**
32 Park Place
New York, N. Y.
- CINO RADIO MFG. CO.**
218 W. 12th Street
Cincinnati, Ohio
- DEWEY SPORTING GOODS CO.**
268 W. Water Street
Milwaukee, Wis.
- WM. B. DUCK CO.**
224 Superior Street
Toledo, Ohio
- LINZE ELECTRICAL SUPPLY CO.**
1129 Olive Street
St. Louis, Mo.
- THE NEWMAN STERN CO.**
E. 12th St. and Walnut Ave.
Cleveland, Ohio
- PENNSYLVANIA WIRELESS MF. CO.**
507 Florence Avenue
New Castle, Pa.
- PIONEER ELECTRIC CO.**
137 East Fifth Street
St. Paul, Minn.
- RADIO EQUIPMENT CO.**
630 Washington Street
Boston, Mass.
- FRANK H. STEWART ELECTRIC CO.**
Old Mint Building
Philadelphia, Pa.
- TELEPHONE MAINTENANCE CO.**
19 No. LaSalle Street
Chicago, Ill.
- WHITALL ELECTRIC CO.**
42 Main Street, Westerly, R. I.
- WHITE & BOYER CO.**
812 13th St, N. W.
Washington, D. C.
- JOS. M. ZAMOISKI CO.**
19 No. Liberty Street
Baltimore, Md.

WIRELESS RECEIVERS

High Resistance

SUPER - SENSITIVE *Superphone* TELEPHONE DEVICES

MAGNIFYING APPARATUS

A Set of Receivers offering a Combination of a silent and loud reproduction of Wireless Signals
Efficiency of the Superphone Receivers

Sound is transmitted from one medium to another in vibrating waves. These waves travel in every direction unless they are forced into one particular direction. Attached to the second cap close to the diaphragm is a small round tube, this tube is made so that it fits snugly into the operator's ears. The sound waves are now forced into one direction—the operator's ears. This attachment makes the loss of sound impossible, giving the maximum reproduction. The feature that aids the clear reproduction is the resonant chamber directly below the diaphragm and above the magnet and coils.

THIS CUT ILLUSTRATES THE RECEIVERS WITH HORN ATTACHED

The high tension metal used as a spring forces the receivers close to the ears. The receivers are so attached to the head band that they rest against the ears in a vertical position. This makes it comfortable for the operator.



Patent Pending

Superiority of the Superphone Receivers

The features that are enjoyed by only the SUPERPHONE receivers, that of the LOUD TALKING HORN attachment and the attachment that fits into the operator's ears, make them superior to any set of receivers on the market at present. The construction and arrangement, not to say anything of the matched tones of the two receivers, place them far above the ordinary receivers.

Superphone Receiving Set with Cord and Headband

2000 Ohms	\$12.00
3000 Ohms	15.00
4000 Ohms	20.00
With Horn Attachments as above.....	\$ 5.00 Extra

High Resistance Loud Talking
Horn Apparatus for Use on
Wireless Instruments
Direct



Model No. 50,
12 In. Long
Price \$12.00



Our Super-Sensitive Detectagraph Transmitter No. 2
Price, \$8.00 Complete

Low Resistance

SUPER - SENSITIVE *Detectagraph* MICROPHONE DEVICES



Our New Special Loud Talking Receiver No. 25
Price \$7.50

Practical Instruments for Commercial and Scientific Purposes

AMPLIFY YOUR RADIO SIGNALS

With the new DETECTAGRAPH-TRANSMITTER, the amateur can amplify radio signals to such an intensity that he can hear the signals about his station without the need of the telephone head set.

The manner in which the amplifying process is attained is by attaching with tape the DETECTAGRAPH-TRANSMITTER to the regular wireless receiver.

By the addition of a loud talking telephone he is able to hear the messages many feet away from the instrument.

The super-sensitive DETECTAGRAPH-TRANSMITTER herewith shown is two and

three-eighths inches in diameter, five-eighths of an inch thick and weighs less than three ounces. It is the most sensitive sound-detecting device ever brought before the public.

Not only is this instrument applicable for amplifying radio signals, but it can be used with equal satisfaction for amplifying other sounds. Phonograph music, can be transmitted from one place to another by means of this instrument, and those who are afflicted with deafness will find enormous benefit by using this transmitter.

Can be used for any purpose where a sensitive detecting instrument is required.



Adjusted Model No. 60 Horn, High Grade Loud Talking Receiver, Cord Plugs and Desk Stand Base.
Price, \$15.00 Complete



Detectagraph Rheostat, especially made for amplifying circuits. Price, \$2.00 Complete



Detectagraph, \$18.00
This detecting instrument of marvelous sensitivity can be used for detecting secret conversations. Outfit consists of Sensitive Transmitter, 25-ft. Black Cord, Receiver, Headband, Case and Battery.



Our Special Loud Talking Telephone Transmitter No. 5, Price \$12.00

This model is especially made for Loud Talking Telephone reproduction. This transmitter can be used to advantage in connection with our Loud Talking Receivers or Horn Apparatus by wireless operators, window demonstrators, and in fact by every one desiring to build up their own loud talking telephone apparatus.



The Detectagraph Junior Deaf-Phone, \$18.00

Equal to any \$35 instrument made. Outfit consists of Super-Sensitive Transmitter with cord connector; Super-Sensitive Ear Piece with small black cord; Black Single Headband; Black Case and Two Batteries.

Order direct from ad. Or write for free descriptive new catalogue

G. BOISSONNAULT COMPANY
25 DEY STREET
(INCORPORATED)
NEW YORK CITY
Factory: Whitestone, L. I.
Makers of Super-Sensitive Hearing and Talking Devices

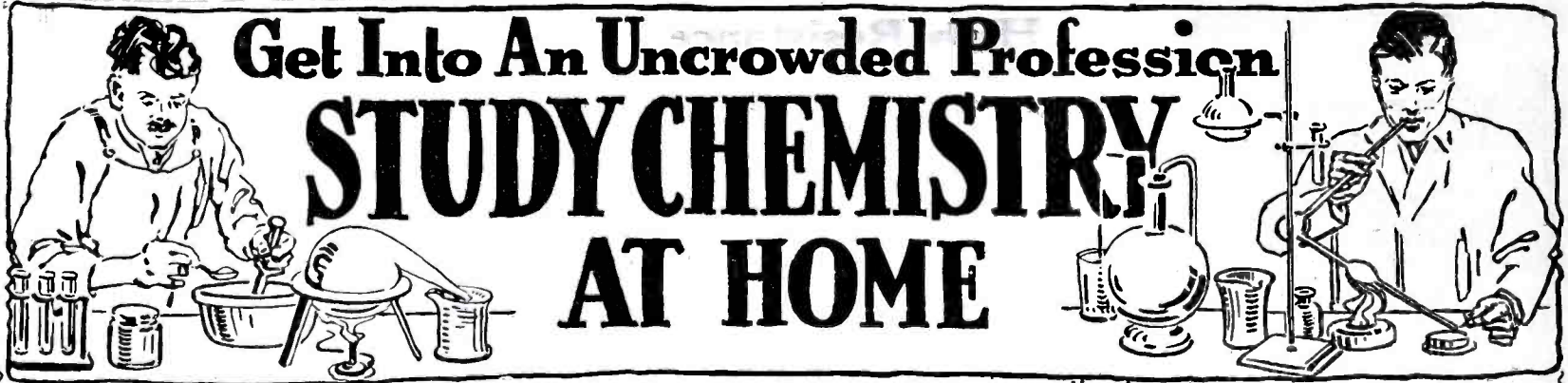

Get Into An Uncrowded Profession STUDY CHEMISTRY AT HOME



DR. T. O'CONNOR SLOANE,
A.B., A.M., LL.D., Ph.D.

Noted Instructor, Lecturer and Author. Formerly Treasurer American Chemical Society and a practical chemist with many well known achievements to his credit. Not only has Dr. Sloane taught chemistry for years but he was for many years engaged in commercial chemistry work.

Dr. T. O'Connor Sloane Will Teach You

Never before has the world seen such wonderful opportunities for chemists as exist today. The war has awakened the United States to the need of trained chemists and chemical engineers. Everywhere the demand has sprung up. In factories, mills, laboratories, electrical shops, industrial plants of all kinds, the lack

of trained chemists is acutely felt. In every branch of human endeavor the need for chemists has arisen. No profession offers such alluring opportunities—and the next ten years are going to show the greatest development in this science that this country has ever seen. You be one of the fortunate to get in now.

EARN BIG MONEY

Good Chemists Command High Salaries

Many industrial firms pay their chemists as high as \$15,000 a year. Salaries of \$10,000 to \$12,000 a year are very common. Why be satisfied with small pay and hard, thankless work—be your own boss and train yourself in a few short months to have a real profession. The work of the chemist is extremely interesting—if you are fond of experimenting,

if you like exciting and intensely interesting work, take up Chemistry. To the man who is dissatisfied with his present job, to the young man just deciding on his life work, Chemistry holds alluring charms, and countless opportunities. If you want to earn more money, the way is open through Chemistry.

You Can Study Chemistry At Home

Dr. T. O'Connor Sloane will teach you Chemistry by a practical, intensely interesting method. Our home study course written by Dr. Sloane himself is practical, logical and remarkably simple. It is illustrated by so many experiments that are performed right from the start of the course that no one, even with the most common education, will have any trouble in mastering this science. Dr. Sloane teaches you in your own home by the same successful system by which he has already taught thousands in the class room. This method is a short cut gained through years of experience which will save you weeks of time. And, Dr. Sloane personally examines and corrects all examination papers, pointing out your mistakes and correcting them for you. This personal training will be of inestimable value in your future career.

Pay As You Go Along

The price of our course is very low. The same education that we give would cost you close to a thousand dollars at a University. We ask only a small fraction of this sum. You can pay in small monthly amounts as you go along. Our plan of monthly payments places a chemical education within the reach of everyone. Write us and let us explain our plan in full—give us the opportunity of showing you how you can qualify for a highly trained technical position without even giving up your present job.

DIPLOMA GIVEN TO EVERY GRADUATE

To every student successfully completing our course we give a handsome diploma all ready for framing. Graduates of our school are qualified to take positions as chemists. With conscientious work ambitious graduates find promotion very rapid.

BIG CHEMISTRY OUTFIT Given Absolutely FREE To Every Student



We give to every student absolutely free this valuable chemical outfit. It includes everything you need for the entire course. You couldn't buy so complete an outfit anywhere for one cent less than \$25.00. There are forty-two pieces of laboratory apparatus and supplies and seventeen different chemicals and reagents all enclosed in a fitted heavy wooden box with hinged front and cover. Full particulars about this free outfit are given in our free book "Opportunities for Chemists." Remember we do not charge you one cent for the outfit.

SPECIAL 30 DAY OFFER

Besides giving absolutely free to every student a valuable chemistry outfit, we are making an additional special offer for a short while only. You owe it to yourself to find out about it. Write today for full information and free book "Opportunities for Chemists." Send the coupon right now while it is fresh in your mind. Or just write your name and address on a postal and mail it to us. But whatever you do, act today before this offer is withdrawn.

CHEMICAL INSTITUTE of NEW YORK

150—R NASSAU ST.

Home Extension Division

NEW YORK CITY

CHEMICAL
INSTITUTE
OF NEW YORK
Home Extension
Division
150—R Nassau St.,
New York City.

Please send me at once without any obligation on my part, your free Book "Opportunities for Chemists," and full particulars about the valuable chemistry outfit given free to every student. Also please tell me about your plan of payment and your special 30 day offer.

NAME

ADDRESS

CITY
R. N., Sept., '21.



FIRCO SACO-CLAD
amplifying transformer

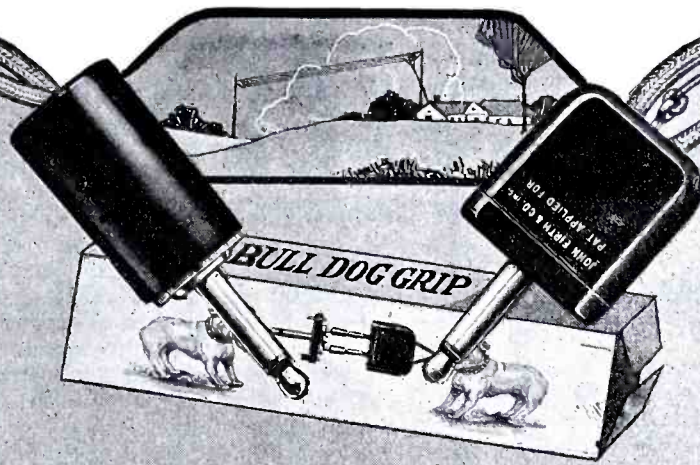

FIRCO RADIO EQUIPMENT

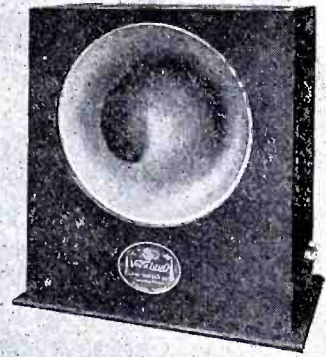

FIRCO VOCALOUD
Station Type

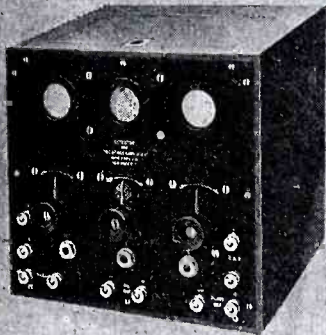

FIRCO STANDARD
Detector and 2-Step

 HERE might be a full page ad devoted to every instrument on this page. But the actual apparatus is far more convincing than anything we could say. So we simply refer you to your dealer. He has our elaborate loose-leaf catalogue, and will gladly obtain any instrument you ask for. In fairness to yourself, insist on examining Firco instruments before you buy.

Firco Saco Glads
(Patent applied for thruout the world.)
100% shielded. No magnetic leakage, and no howling even with six steps. Price, in individual cartons, \$5.00.

Firco Standard Apparatus
Equal to apparatus supplied to the Government. Solid mahogany cabinets. One to six-step amplifiers. Detector and two-step, shown, \$75.00.

Firco Audion Sockets
1/4" Bakelite base, nicked brass tube, wide phosphor bronze contacts, and other exclusive features. Unequaled value. Single, \$1.10; Double, \$2.30; Triple, \$3.50.

Brown Phones
Standard of Great Britain and Europe. Ultra-sensitive. 4000 ohms. Weight only 10 ounces. Reduced in price. Type A, adjustable, \$18.00, was \$22.00; Type D, for phone work, \$16.00 was \$20.00.

Imported Seibt Adjustable Phones, 2000 ohms, \$12.75

Vocaloud
This clear-toned loud speaker is proving the sensation of 1921 radio. No batteries, no adjustments, no extra equipment. Station type, in polished mahogany cabinet, as shown, \$30.00; Laboratory type, mounted on adjustable base, \$25.00.

Firco Midget Units
Quality equal to Standard Apparatus, but greatly simplified. Set of three units (Tuner, detector and 2-step), \$56.00; Tuner, \$15.00; Detector, \$11.00 and other units at equally reasonable prices.

Firco-Eldredge Meters
All nickel plated flush type. 600 volt meter, with multiplier, \$14.00. Other ranges, moderate prices.

Firco "Bull-Dog-Grip"
Interchangeable Telephone Plug. Insert or remove any standard cord tip in 10 seconds. Then, "The harder you pull, the tighter it grips." Type 34A, flat, \$2.00; Type 34B, round, \$2.50.

Leaflet describing any one instrument, sent for your dealer's name and 2 cents. Loose-leaf catalogue, 25 cents.

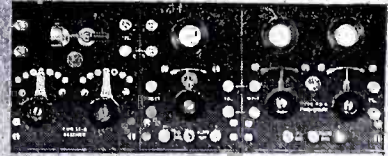

FIRCO MIDGET UNITS
(Tuner, detector and 2-step, \$56.00)



FIRCO VACUUM
TUBE SOCKETS

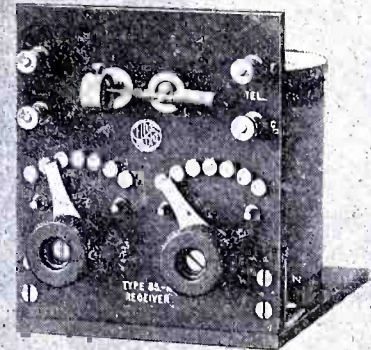

FIRCO MIDGET
receiving UNIT



IMPORTED BROWN
supersensitive PHONES

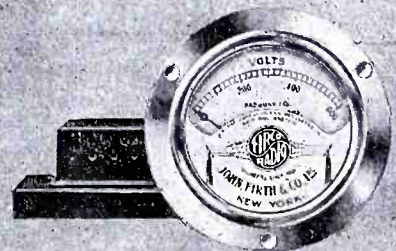

FIRCO 600
Volt METER

John Firth & Company, Inc.
18 Broadway New York
"Pioneers Since 1901"



THESE NEW FIRCO INSTRUMENTS are typical of the quality of apparatus which we have been supplying to the departments of the Government for many years — yet the prices are unusually low.

And remember, only a few of the instruments are illustrated here.

JOHN FIRTH

"RASCO HAS IT."

Radio Specialty Co.

96-98 Park Place
New York

"RASCO HAS IT"

FOR the past few months we have shown the amateur fraternity what prompt shipments mean. 99% of all orders are shipped within 24 hours and sometimes a good deal sooner. The radio fraternity today understands perfectly that the word "Rasco" is synonymous for service—marvelous service at that. We are showing a few *unsolicited* testimonials on this page, selected at random from hundreds that have reached us, and we only wish that we had sufficient space to print all of the enthusiastic letters. This company is unique in that it sells practically no complete apparatus or instruments—only parts, raw material, etc., are sold. If you are interested in any of the goods listed below, it is vitally necessary that you have our catalog in which you will find all these goods.

WHAT THEY SAY

Gentlemen:

I received my variocoupler rotor some time ago and it was *even better than I had expected*. The variocoupler I am using sure brings the stations in Q. S. A.
Wilson Kohli,
351 So. Monroe St.,
Tiffin, Ohio.

Gentlemen:

Enclosed you will find an order for some of your small parts, some of which I have found to be entirely satisfactory. If this order is given the same prompt attention as my first, it will afford me the utmost satisfaction.
W. E. Zingg,
112 Abbott Ave.,
Ocean Grove, N. J.

Gentlemen:

I received the order you sent me in good condition. I certainly do appreciate your promptness in sending out orders. I have dealt with other large

firms, but none of them give as much satisfaction as you do.
Leonard Mayers,
3809 Hollybeach Ave.,
Woldwood, N. J.

Gentlemen:

I like your service. Herewith find another order.
W. L. Fick,
3391 Hayward Place,
Denver, Colo.

Gentlemen:

The enclosed order is taken from the catalogue of a friend, who was very enthusiastic about your rapid service.

Milton Weidling,
870 Rockdale Ave.,
Cincinnati, O.

Gentlemen:

Have received two of your "Rasco" Dials promptly, and think there is nothing on the market equal to "Rasco" Dials, considering quality and price.

Stephen S. Peszel,
210 Fourth Ave.,
Schenectady, N. Y.

Gentlemen:

I received your catalog and I am very much pleased with it. I have two of the latest and supposed to be best books on radio and I find that there are only seven of the fifty hook-ups in those books shown in your catalog. Your catalog is small in size, but I have learned my lesson not to buy a book because it is big and nice-looking.

Richard W. Silbert,
3821 N. 13th St.,
Philadelphia, Pa.

Gentlemen:

I received the small shipment of parts from you some days ago and am much pleased with your promptness and care in executing the little order. I enclose another order for an assortment of small parts amounting to \$2.86.

W. S. McGann,
Berry, Demoville & Co.,
Nashville, Tenn.

WE GUARANTEE EVERY ORDER SHIPPED WITHIN 24 HOURS

DEALERS GET OUR SPECIAL PROPOSITION



THE "RASCO" CATALOG A COLOSSAL EVENT

There are many radio catalogs, but the "Rasco" catalog marks a radical change for the simple reason that it **CONTAINS 50 VACUUM TUBE HOOK-UPS**

This is the one and only radio catalog containing such wonderful free information. Complete hook-ups of all important vacuum tube circuits are given in clear diagrams with complete explanation. Just to name a few:—The V.T. as a detector; detector and one-step amplifier; regenerative circuit; De Forest ultraudion; V.T. to receive undamped and spark signals; Armstrong circuits; one step radio frequency amplifier and detector; three stage audio-frequency amplifier; short wave regenerative circuits; V. T. radio telephone; 4-stage radio frequency amplifiers; radio and audio frequency amplifier, inductively coupled amplifier; Armstrong superautodyne; radio frequency amplifier and crystal detector; C.W. transmitters; self-rectifying 2 tube C.W. transmitter; V.T. transmitter with 6 volt battery; radiophone using plate and grid modulation; one tube radio transmitter and receiver; experimental radiophone; radiophone using Colpitt oscillator circuit.

This list is only a partial one. You must positively see this wonderful book to appreciate it. It is made to fit the pocket—has heavy covers to withstand the wear and tear which it is sure to have at your hands because it will be your constant companion.

And Oh yes! Before we forget it. If you are in need of the following, remember "Rasco has it." These are only a few things contained in this catalog. Lugs, Nuts, Dials, Knobs, Washers, Crystals, Litz Wire, Selenium, Cord Tips, Cap Nuts, Tin Foils, Name Plates, Spring Posts, Switch Parts, Metal Ribbon, Carbon Balls, Binding Posts, Switch Points, Switch Levers, Carbon Grains, Metal Pointers, Contact Points, Low Melting Metal, Carbon Diaphragms, Screws, Copper Strip, "Spaghetti," Name Plates, Sliders, Mica, Switches, Resistance Wire, Variocoupler Rotors, Test Clips, Condenser Plates, Condensers, Antenna Connectors, Threaded Brass Rod, Ground Clamps, Etc., Etc.

The catalog contains 185 illustrations. On account of its great cost, this catalog cannot be distributed free of charge. It will only be mailed upon receipt of **15c in stamps or coin.**

Remember that this business was originated with the sole purpose to cater to the amateur who has small orders. **ALL OF OUR ORDERS ARE SMALL** and that is why your small order will never be side-tracked by us. **Try us with a 50c order.**

Radio Specialty Co.

96-98 PARK PLACE, NEW YORK CITY

Factories: Brooklyn, N. Y.—Elkridge, Md.

201 RASCO POSTS

These are our very own patterns, from our own designs and look mighty handsome on any instrument. The slant shaped bottom part gives these posts a very classy appearance, something you have never seen before. The top knobs are of composition, the bottom parts brass nickel plated polish. This is true of our posts Nos. 201-202 and 600.

No. 201, "Rasco" Binding Post, 1/4" thread, each, \$0.10, doz. \$1.00
No. 600, "Rasco" Binding Post, 1/4" thread, each, \$0.12, doz. \$1.25

RASCO POSTS

Nos. 650 and 651 made entirely in composition with a hexagonal brass nut in center.

No. 650 has 1/4" machine screw. No. 651 has bottom wood screw. No. 202 is nickel plated at bottom part.

No. 650, Post, each, \$0.08
No. 651, Post, each, \$0.08
No. 202, Post, each, \$0.08
Dozen, each style, \$0.90

RASCO SWITCH POINTS

Our switch points are made of brass, nickel plated and polished. The following seven sizes have been found the most popular.

No. 301, 1/4" x 1/4", 1/8" thread, each, \$0.03; dozen, \$0.35
No. 302, 1/4" high, 1/4" dia., 1/8" thread, each, \$0.03; dozen, \$0.35
No. 303, 1/4" x 1/4", 4-30 thread, each, \$0.03; dozen, \$0.35
No. 304, 1/4" dia., 1/4" thick; stem 1/2", each, \$0.03; dozen, \$0.40
No. 305, 1/4" dia., 1/4" thick; stem 4-30, each, \$0.03; dozen, \$0.40
No. 306, 1/4" dia., 1/4" thick; stem 4-30, each, \$0.03; dozen, \$0.40
No. 307, 1/4" dia., 1/4" thick; stem 4-30, each, \$0.03; dozen, \$0.40

Just a Sample Page from our Catalog. Order from this page if you wish. **All goods sent prepaid.**



RADIO NEWS

H. GERNSBACK—Editor
ROBERT E. LACAUULT—Associate Editor

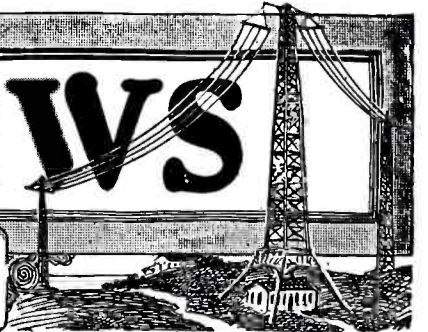

Vol. 3

SEPTEMBER, 1921

No. 3

NEW USES FOR RADIO

THE more we know about Radio in general the more applications we find for it. Radio is getting to be such a tremendous proposition that it fairly staggers the imagination when we try to think out what the future has in store for this youngest art of Electrical Science. That Radio should be used only for radio purposes seems a trite thought. Actually it is not. To how many persons would it occur to use a radio outfit for purposes other than Radio? But it seems that we are coming to just that, preposterous as the idea seems at first.

In the October issue of *Science and Invention* are described two applications for radio outfits that really have nothing to do with Radio primarily. The Westinghouse Electric Company now mounts a sensitive wireless receiving outfit on an auto truck using a loop aerial as antenna. And what do you suppose they do with it? They run the truck parallel to a high tension line to discover the leakage of the insulators! Wherever there is bad leakage, the crackling sound in the receivers of the radio outfit will reveal the energy going to waste. An insulator may look alright from the outside, but it might be porous and thus waste a lot of the company's power. The radio receiver will detect the bad insulator immediately. Then we have power companies in the West which are now opening and closing switches in distant sub-power plants by Radio. Instead of keeping an operator at each one of their substations to throw the switches in and out, this is now accomplished without the touch of human hands.

These ideas make one think of other purposes for which Radio might be used. At once the thought comes to mind of trailing an automobile by Radio. This is not as extravagant an idea as it seems at first. Every amateur knows that if his set is sensitive he will be able to hear in his phones the little Ford Car standing below his window,

provided it is running; in other words, the electrical waves given out by the ignition system are of sufficient strength to be recorded via radio.

It therefore should not be an impossibility to design a radio apparatus sensitive enough to hear an automobile as far as a mile away, once the set was attuned properly. Immediately, the police pursuing craft suggests itself. Often an automobile has gotten away far enough that it may use any one of two or three roads, thereby baffling the police, with the offending car making its getaway. If the pursuing car had a properly tuned radio outfit it should be simple to follow it, providing of course, the ignition system of the pursuing car is so screened that it does not affect its own radio set. This, however, could be accomplished and does not present an insurmountable technical difficulty.

Every amateur is familiar with the hum of the generators at the Power House. Perhaps this annoying feature can be used industrially to good advantage by constructing a special radio receiver to listen to the hum of various electrical machinery in order to find out if it is working correctly, as far as the electrical part is concerned. Sparking, uneven running, etc., would thus be readily detected.

Then we have the Fessenden Ore Detector, which uses radio to locate hidden and buried ores. The system was described some years ago in the *Electrical Experimenter*. It is a subject of a patent. It seems that the same system could be used for locating underground bodies of water, perhaps oil as well. It all depends upon the design of the outfit.

These are just a few ideas showing what has been accomplished and what has been proposed. There is no doubt in our minds that in years to come the non-radio uses for radio outfits will be tremendous. We should be glad to hear from our readers of some new suggestions for radio.

H. GERNSBACK.

IMPORTANT TO NEWSSTAND READERS:

In order to eliminate all waste and unsold copies, it has become necessary to supply newsdealers only with a sufficient amount of copies for which they have actual orders. Please note that your newsdealer will be glad to reserve a copy for you every month. This costs you nothing and you

will be assured of your copies. Hand your newsdealer a slip of paper on which write your name and address with a request to reserve a monthly copy of RADIO NEWS for you. This will be the only way to assure you of your copy hereafter.

THE PUBLISHERS.

Radio Guides Ships

By S. R. WINTERS

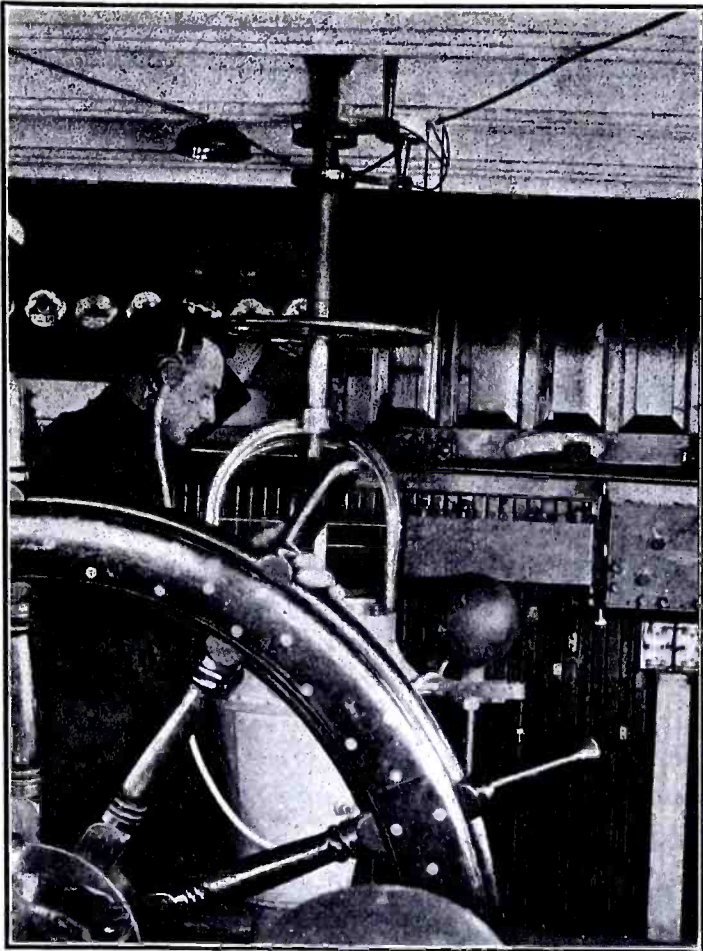

Piloting the Ship by Radio. Note the Receiver and Amplifier on the Right.

cons became permanent equipment on the Ambrose and Fire Island lightships marking the entrance into New York and at the Sea Girt lighthouse on the Jersey coast below Asbury Park. The apparatus is maintained and operated by the keeper of the lightstation, thus obviating the employment of additional forces. The signaling range of these stations is 30 miles, at a wavelength of 1,000 meters. In the absence of any sounding or sighting from the shore, a 45-mile voyage was completed on wireless bearings taken from the Fire Island light-vessel by the captain of the *Tulip*, who was a novice in the operation of the newly-devised apparatus. A 30-mile run, course 257°, from the Jones' Inlet buoys



The Pilot House of the "Tulip", on Which May Be Seen the Loop Aerial of the Compass Set.

THE lighthouse—a lofty structure reflecting a powerful light from its top as a guide to navigators, originating with the 550-foot tower erected by the Pharaohs 300 B. C.—may be displaced, or its service greatly augmented by the utilization of electric waves, common to radio communication, as fog signaling agencies. A device for determining the direction of the source from which the electric waves are transmitted has been perfected by F. A. Kolster of the Radio Communication Section of the United States Bureau of Standards, and the seemingly visionary and revolutionary theory of yesterday becomes the triumphant scientific achievement of today.

The preliminary experimentation with wireless as a vehicle in facilitating sea-going expeditions was begun in 1916 when the Navesink light station at Atlantic Highlands, New Jersey, was equipped with a one-half kilowatt transmitting equipment designed to automatically reflect a signal at frequent intervals. A radio compass was installed on board the lighthouse tender *Tulip*, with which a series of bearings were taken during the brief period of the experiments, which were halted summarily by the world conflict overseas. With the cessation of war, tests were renewed, and three lighthouses in the Chesapeake Bay equipped with wireless transmitting apparatus and a radio compass made a fixture on the lighthouse tender *Arbutus*.

The rigid requirements of the experimental stage were successfully met, and recently the so-called radio bea-

to Ambrose was negotiated by F. A. Kolster, the inventor of the radio fog signaling and radio compass system, without any information other than that furnished by the use of the radio compass.

Wireless as an agency in illuminating the voyage of the mariner is diametrical to the sound and visual signaling devices now in vogue. Instead of the captain of the vessel communicating with the lighthouse in determining the whereabouts of the ship, the navigator takes his own bearings. The inability of illumination from a lighthouse to penetrate fog, when guidance to a vessel is most imperative, is said to be overcome by the new method of directing the navigator to safety. With the possible exception of the most powerful light in the world, which emanates from a lighthouse on the Heligoland Island, Germany, with an electric installation of 40,000,000 candlepower, a common criticism of lighthouses is their failure

to function or clearly penetrate fog. The transmission of electric waves is not beset with this limitation and they are capable of spanning greater distances than either light or sound.

The device, as developed by the National Bureau of Standards, for determining the direction of the source from which the electric waves are transmitted, comprises a coil of wire wound on a frame about four feet square, preferably mounted over the vessel's pilot house and so installed as to be rotatable from within the latter quarters. As the coil is rotated about its vertical axis, the characteristic signals of the radio beacons are received in all positions with gradually varying degrees of intensity, until the coil becomes exactly normal or at right angles to the direction in which the radio beacon lies, at which time no signal is audible. The critical position of unyielding silence indicates the direction of the radio

beacon, and its bearings with respect to magnetic north is read directly from a magnetic compass which forms part of the equipment. The bearing of two or more radio beacons within range may be taken, thus determining at once the position of the ship. Not infrequently, however, it is only essential to set a direct course towards the radio beacon, as in approaching a lightship, for example, the ship's course is held on the radio bearing.

A lighthouse or lightship equipped with a simple, automatically operated radio transmitting apparatus simultaneously becomes a radio beacon which is identified.

(Continued on page 218)



The Navesink Light House at Atlantic Highlands, N. J., Equipped With a 500 Watt Set Operating Automatically at Frequent Intervals.

Flying Boat Radio Transmitter

By JESSE MARSTEN

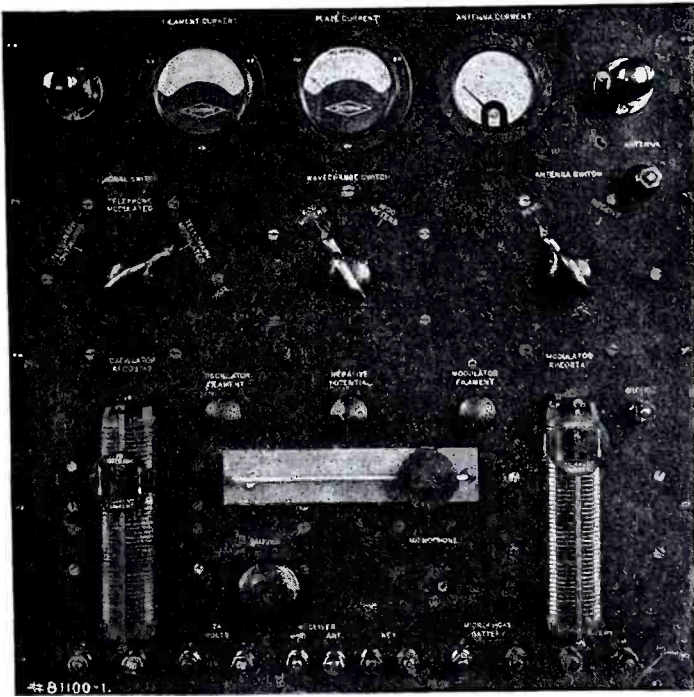

Front View of the 250 Watt Telephone and C.W. Set Used Aboard the Modern Flying Boat.

the fundamental wiring diagram, and Fig. 2 showing the actual circuits employed. Valve No. 1 is the oscillating tube, valve No. 2 the modulating tube, both being the high power General Electric Type P pliotrons. The D. C. voltage for the plates of these tubes is obtained from a 1,500 volt dynamotor, having two windings, one a 24 volt winding and the other a 1,500 volt winding. The 24 volt winding is supplied with current by a 24 volt Willard storage battery. The dynamotor is a two ball-bearing machine, having

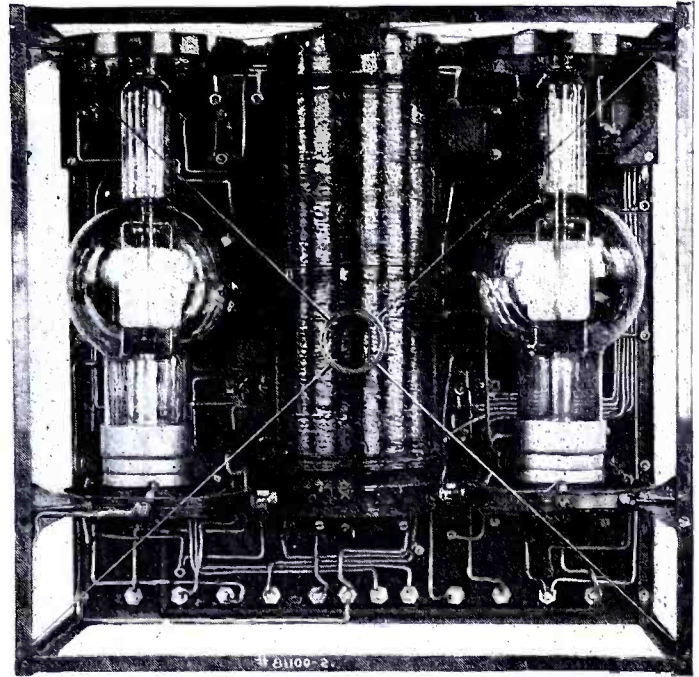

Inside View of the Set Showing the Two Tubes and the Inductance. Note the Simplicity of This Outfit.

THE particular design of any radio set—apart from output and efficiency, which should always be as large as conditions permit—depends largely upon where it is to be used. Thus the war gave rise to an immense variety of designs, for the conditions under which these sets were to operate were extremely diverse. For example, apparatus had to be built for battleships, submarines, dirigibles, sea-planes, trenches, etc. It is obvious that each of these stations was controlled by conditions peculiar to itself and therefore required a uniquely designed set.

In this article there will be described a telegraph and telephone transmitter, designed for use on the large Flying Boats of the type of the H-16 Naval Seaplane. This set was developed, designed and built by the Marconi Wireless Telegraph Co. of America co-operating with the Bureau of Steam Engineering of the Navy Department. It is obvious that aside from meeting the necessary electrical and range conditions, which applies to any type of transmitter, the chief considerations here were those of stability of operation, space and weight, the last two necessarily being a minimum.

The set was designed to meet the following conditions. The telegraphic range of the set was to be 100 miles over sea. There were to be two wave-lengths and two antennae, a main operating wave-length of 1,600 meters, and an emergency wave-length of 600 meters. The 1,600 meter antenna was to have a capacity of 0.0004 microfarads, and a resistance of eight ohms at that wave-length; the 600 meter antenna was to have a capacity of 0.00026 microfarads and a resistance of 20 ohms at that wave-length. Intelligence was to be transmitted in three ways: (1) Continuous Wave Telegraphy. (2) Tone Telegraphy. (3) Telephony.

Vacuum tubes are employed for the generation of radio frequency oscillations and for their modulation. Tone transmission is accomplished by means of a buzzer modulating the continuous wave.

The circuits employed in the set are shown in Figs. 1 and 2, Fig. 1 being

stream line dust caps over the ends, total weight of the machine being not more than 30 pounds. The filaments of the pliotrons, which take from 3.4 to 4.0 amperes, are supplied with current from the 24 volt Willard storage battery which has a capacity of 50 ampere-hours.

It will be seen from Fig. 1 that the oscillating circuit employed is the shunt feed or constant current system. The radio frequency oscillating circuit proper, L1 L2 RC1C2, is a balanced circuit consisting of two parts, (1) L1RC1 and (2) L2C2. Each of these circuits is tuned to the oscillating wave-length, that is, the circuits are balanced against each other. This is accomplished by winding the inductances L1 and L2 on the same form and making them of equal inductance values. Condenser C2 is made to equal the capacity of the antenna. An accurate balance is, of course, almost impossible to secure, due to variations of

the antenna capacity, but a close enough balance is obtained for practical purposes.

The coupling between the plate and grid coils is fixed mechanically. The necessary coupling variation required for the different wave-lengths is accomplished automatically when the wave-length is changed by altering the number of turns in the plate coil, and by changing to the new loading inductance required. As seen in Fig. 2, when the emergency 600 meter wave is employed the hanging-on ends of the two coils are short circuited by the wave-change switch.

It will be evident that the total oscillating current flows through the antenna coil and the grid balance coil, thus increasing the total losses. The advantage of this balanced circuit is that no critical adjustment of the plate grid coupling is required and a maximum of stability in operation is secured.

When C. W. telegraphy is employed, the modulator tube is not used. The telegraph key is connected across a high capacity condenser in the grid circuit, C. When the key is not depressed, this condenser prevents the grid charge from leaking, thus reducing the plate current and stopping oscillations. When the key is closed the grid filament circuit through the grid leak is also closed and the grid charge leaks off, thus permitting oscillations. For telephony, it is obvious that the key would have to be short-circuited, which is accomplished by the change-over signalling switch seen on the Front View of the transmitter.

The modulation system employed is the Heising or Constant Plate Current System, where the modulator tube is connected as an audio frequency shunt across the oscillator tube. The power of the modulator tube is exactly the same as that of the oscillator. The grid of the modulator is supplied with the necessary value of negative potential by means of a battery and potentiometer arrangement shown in Fig. 2. Inasmuch as the interference due to the aeroplane engine noises was very great, it was necessary to use a spe-

(Continued on page 234)

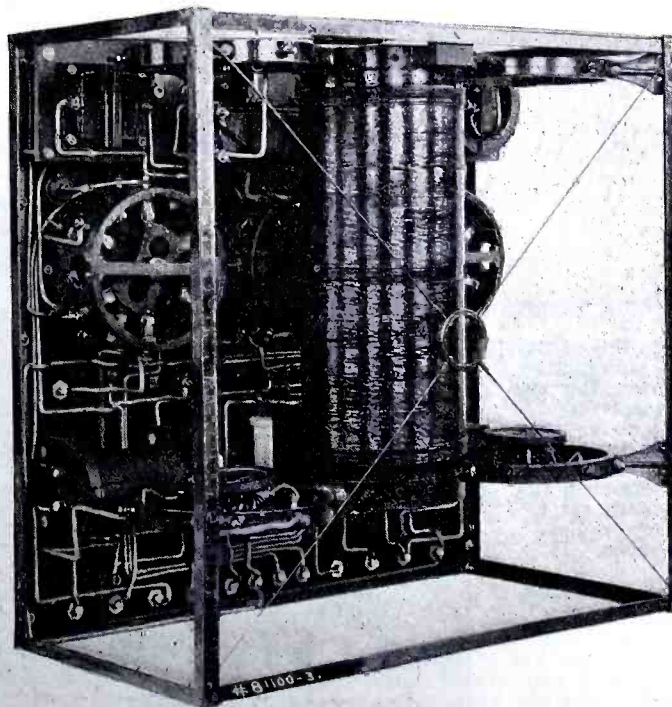

In This View the Tubes Are Removed to Show the Special Rotary Switches and the Modulation Transformer.

The Work of the 101st Signal Battalion

By GRANT LAYNG*

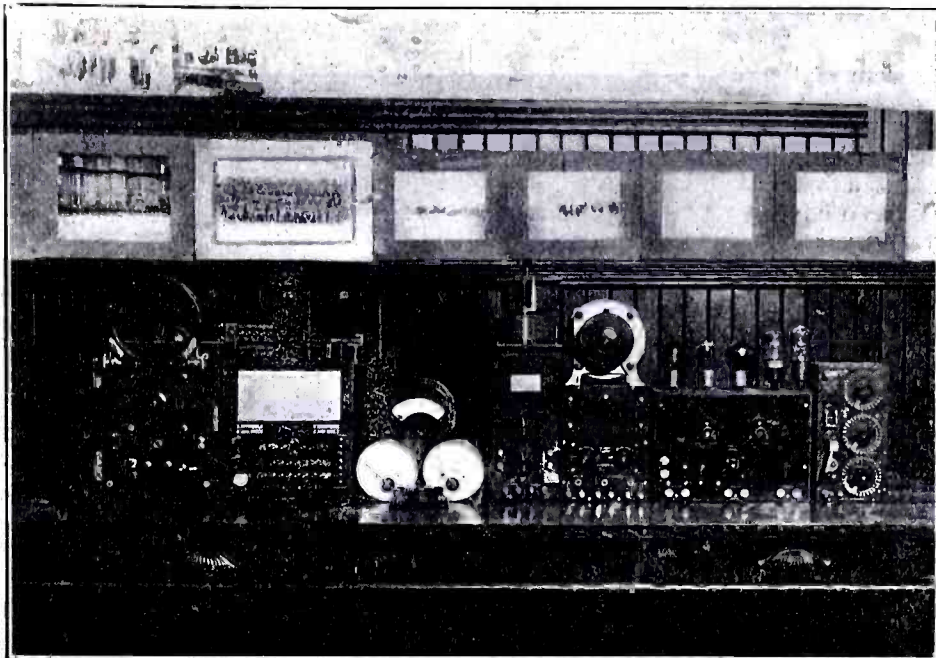

Here are various apparatus completing the equipment of the very efficient station installed in the Park Avenue armory.

three sets. The phones are connected by means of a plug and cord which is inserted in the set being used. All jacks on the block are short circuiting and the upper jack also controls the six volt battery on the load speaker. This gives great flexibility and is a very essential feature of a station in which it is necessary to constantly try out different types of receivers.

TRANSMISSION

The spark transmitter is a $\frac{1}{4}$ K.W., model 1915 Pack Set disassembled and installed in rear of the panel. It consists of an open core transformer, Dubilier condenser, quenched spark gap and pancake oscillation transformer, radiation of 3 amp. on 475 meters. The set as normally furnished used a hand generator turned by two cranks revolving at a speed of 50 R.P.M. Through suitable gearing this gives the generator a speed of 5,000 R.P.M.

In order to use this equipment as issued, the gear case was removed and gear disconnected from the generator. As the unit has an exciter mounted on the generator shaft the connections were changed so that the exciter operated as a D.C. motor and the fields of the alternator were excited direct from the D.C. supply mains. Although the generator would now run up to no load speed the flywheel was not sufficiently large to carry full load when the key was pressed. It was then necessary to obtain a $\frac{1}{6}$ H.P. 5,000 R.P.M. motor and with this connected to generator shaft the unit delivered full capacity. Both the exciter motor and the external motor are connected in parallel and start through the control resistance seen on the lower part of the panel.

The telephone set uses four V.T. 2 with a plate voltage of 350 volts obtained from a 110/350 volt Westinghouse Dynamotor. Simplicity is the keynote of this set which has no unnecessary controls on the face of the panel. The unit was first tuned with a variable inductance and variable condensers. When the correct condenser capacity was found, fixed condensers were substituted of the same capacity making a set practically impossible to get out of adjustment.

A radiation of .7 amp. is obtained using two tubes as oscillators or two as modulators. It has been reported QSA on phone as far as Asbury Park.

A recent drill was conducted by means of this phone set. The riding academy in

IN line with the reorganization and development of the National Guard; Company A, of the 101st Signal Battalion, N. Y. N. G., formerly the First Signal Battalion, has devoted considerable attention during the past season to the development of its radio organization and to the training of the radio personnel.

A full realization of the importance of Radio Service in the army of the future, has resulted in every effort being made to increase the efficiency of this branch of the service.

To carry out the work, Company A has established in the tower at the 71st Regiment Armory, 34th Street and Park Avenue, a radio station complete in every detail. Radio apparatus and equipment has been received from the Signal Corps, U. S. A., and in addition considerable special equipment has been furnished by the organization or built by its members.

The transmitting aerial is a flat top one, having 5-7 S. P. B. wires, $1\frac{1}{2}$ feet apart. It is 60 feet long, and L type with a 100 feet lead in from the high end.

The counterpoise consists of six wires 75' long spread out in the shape of a fan 90 feet beneath the flat top.

The receiving is all done on a single wire extending diagonally down from the top of the tower about 200' in length and at an angle of 30' from the transmitting aerial.

The short wave regenerative set at the left of Fig. 2 consists of a variable condenser with a three way switch in the primary circuit, a vario-coupler, two variometers, a detector and two stage amplifier.

The long wave honeycomb set was designed with a view to the greatest flexibility. The set is divided into three panels with individual boxes. The first consists of the honeycomb mounting and primary condenser with three way switch. The second panel is the secondary circuit complete with three variable condensers and the detector, the last consists of a two stage amplifier. All condensers are DeForest and the primary and secondary condensers have a vernier plate.

V. T. 1 Tubes and Baldwin phones are used.

Special attention is called to the distributing jack shown between the sets. This consists of two single throw triple throw anticapacity switches with a common han-

dle projecting through the top of the panel. This throws the antenna to either of the two sets and also lights the filament. Extra

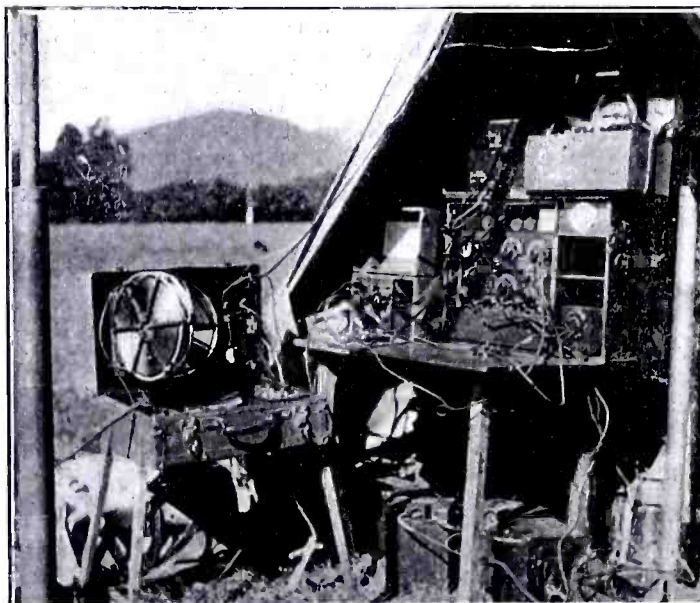

Inside View of the Field Station Installed at Peekskill, N. Y., by the 101st Signal Battalion.

contacts are provided for a third set so that it is possible with a short throw to connect the antenna and a battery on any one of

In this photograph may be seen the two receivers, each of them equipped with a two-stage amplifier, the spark set and the radio-phone.

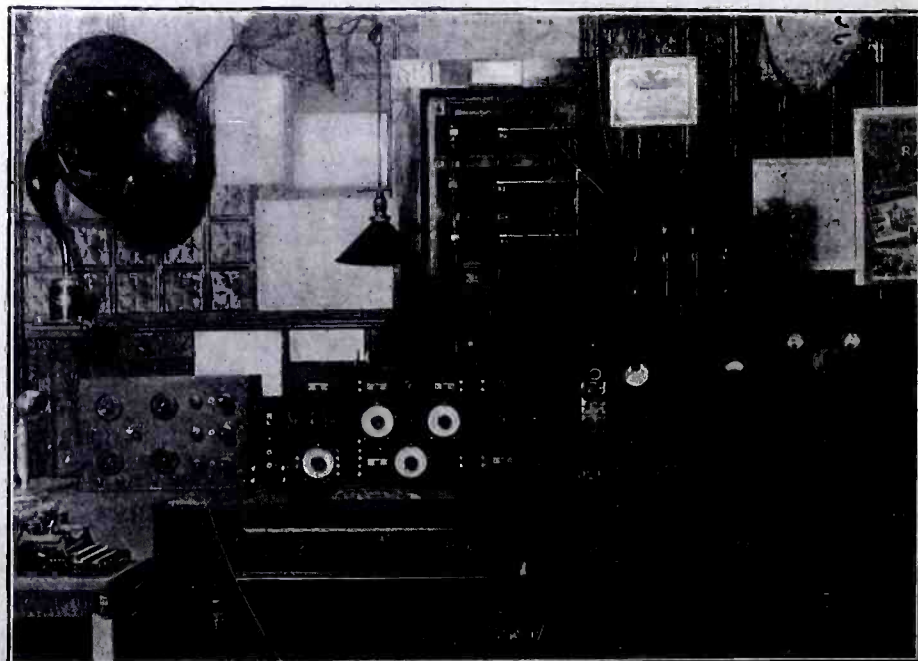

*Master Sergeant, 101st Signal Battalion.

which the mounted drills are held is about two miles from the armory and on this building a low portable antenna was erected—using the short wave set shown and three steps of audio amplification. Captain Gorman at the armory gave commands which were successfully executed by the entire company on horseback.

The experimental equipment used by the members of the radio detail consists of a wavemeter, a wheatstone bridge, a three stage shielded audio frequency amplifier, a two stage amp, and a six stage (4 radio and two audio) amplifier, besides various types of tubes, high voltage D.C. meters, milliammeters, etc.

The portable units are the newest army issue and consist of an SCR 54A crystal set, SCR 121A two stage amplifier, an SCR 79A complete transmitting and receiving unit and a station wavemeter. This main set used two W.E. 2 tubes for transmission and three V.T. 1 for reception. The power is obtained from storage batteries, one four volt 90 amp. hr. unit shown on top of case. Three batteries are used, giving 12 volts which light the tube filaments and run the dynamotor. Normal radiation is about .8 amp. on straight C.W., no method of interruption being provided. Besides this equipment there are four ¼ K.W. pack sets with hand generators for mule back transportation.

These portable units are used during the period of camp and a typical installation erected at Peekskill, N. Y., is shown using the above apparatus.

With reference to operation the station is open every night between 8 and 10 o'clock, two operators being on duty. Traffic is handled with amateurs and call letters used are SCR. In the coming fall, a shorter aerial will be erected for two hundred meter operation, at which time 2BGS will be used.

Amateur traffic will be very gladly accepted as the station is a member of the American Radio Relay League.

Radio stations are also established and are operated by members of the organization. 2BGT Radio Station number 1 is owned by Corp. Hunt, who is chief operator. There are two stations yet to be assigned as only members with the most modern equipment can be considered.

The radio room is open to visitors every Monday and Thursday night and all those interested are cordially invited to inspect the station.

In view of the present enlarging of the National Guard, there are a few openings for those men interested in radio work. Instruction is given in both the mounted and dismounted drill, together with work in visual signalling, and telegraph operating. All men receive Federal pay for the weekly drills and for two weeks of field service each summer.

Courses are provided in radio operation, by progressive classes, that is, a man enlisting in the organization first enters the class

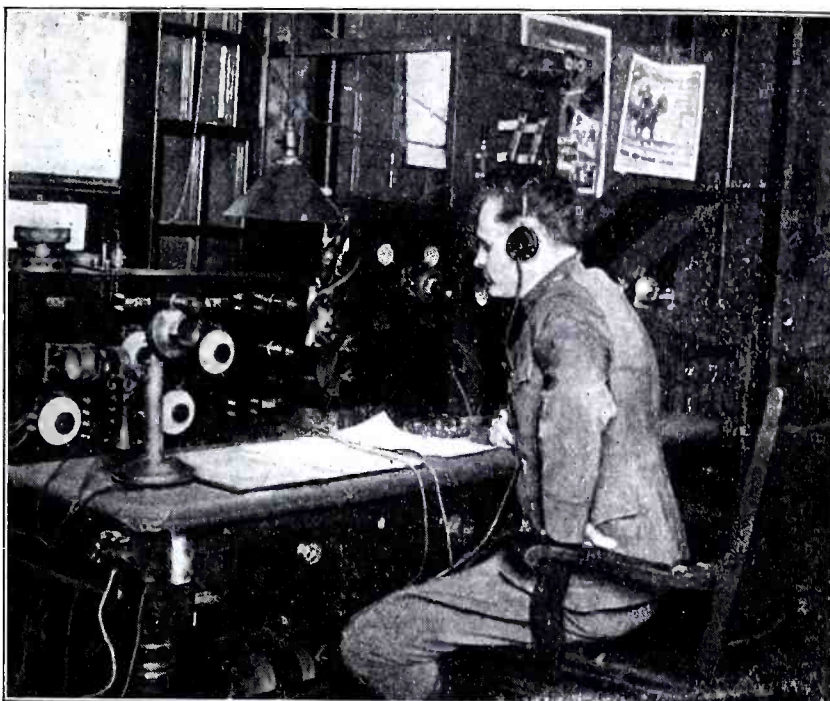

Here is Captain Gorman Conducting the Drill of the Company by Radio. A New Stunt Which Has Proved Very Successful.

in visual signalling and thoroughly learns the code. From this class graduates go to

Buzzer practice and after attaining a speed of twenty words per minute, advance to radio instruction. Lectures on the basic principles of wireless, consist of the first half of the instruction period, and actual operation, care and maintenance the second half. All men, before being allowed to operate the station are required to obtain operators' licenses from the Radio Inspectors' Office, and the organization at present has 15 licensed operators.

The equipment of the organization includes horses, motorcycles and trucks, as mobile operation is an essential feature of Signal Corps maneuvers.

The armory is equipped with a complete machine shop having a machine lathe, wood turning lathe, grinding stone, buffer, etc. A battery charging unit keeps the issue batteries in condition, and is also used by members with their own sets who wish to have their batteries

(Continued on page 218)

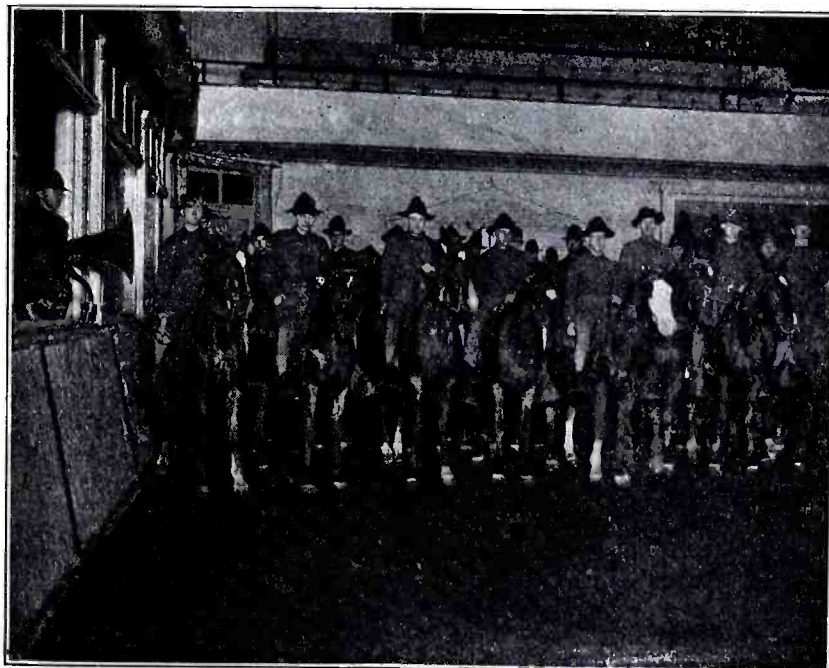

The Company Here Shown Drilled Without the Captain Being Present. Orders Were Received Through the Magnavox, Which May be Seen on the Left, Captain Gorman Sending Them via Radiophone From the Armory Two Miles From There.

Amateur Record an Historical Fact



Here is some good publicity for amateur radio. The record established by some radio amateurs is made known to the thousands of motorists passing there. Thanks to a tire company. Why not duplicate this in some other town?

A large tire manufacturing concern has recently placed in several towns some big posters on which is given touristic information about the town and a fact about its history.

The accompanying photograph shows one of these posters erected near Keyport, N. J., and relating as an historical fact the transmission of music by Radiophone to Scotland by two well-known amateurs, Messrs. H. and H. Robinson.

This fact is in itself good publicity for amateur Radio, for it shows to thousands of people the possibilities of Radiotelephony and the efficiency of amateurs' stations. Moreover, this may awake the interest of many who are not aware of the actual progress made and the practicability of Radio.

Another consequence and perhaps the most important is that, when passing this sign, many a bug will grasp the opportunity and use it as a convincing argument to show Dad what can be accomplished, with for instance two 50 watt tubes and a few other parts; and perhaps Dad, convinced at last, will let loose a check, thanks to which a new Radiophone will be born.

A Grip Radiotalker

By S. R. WINTERS

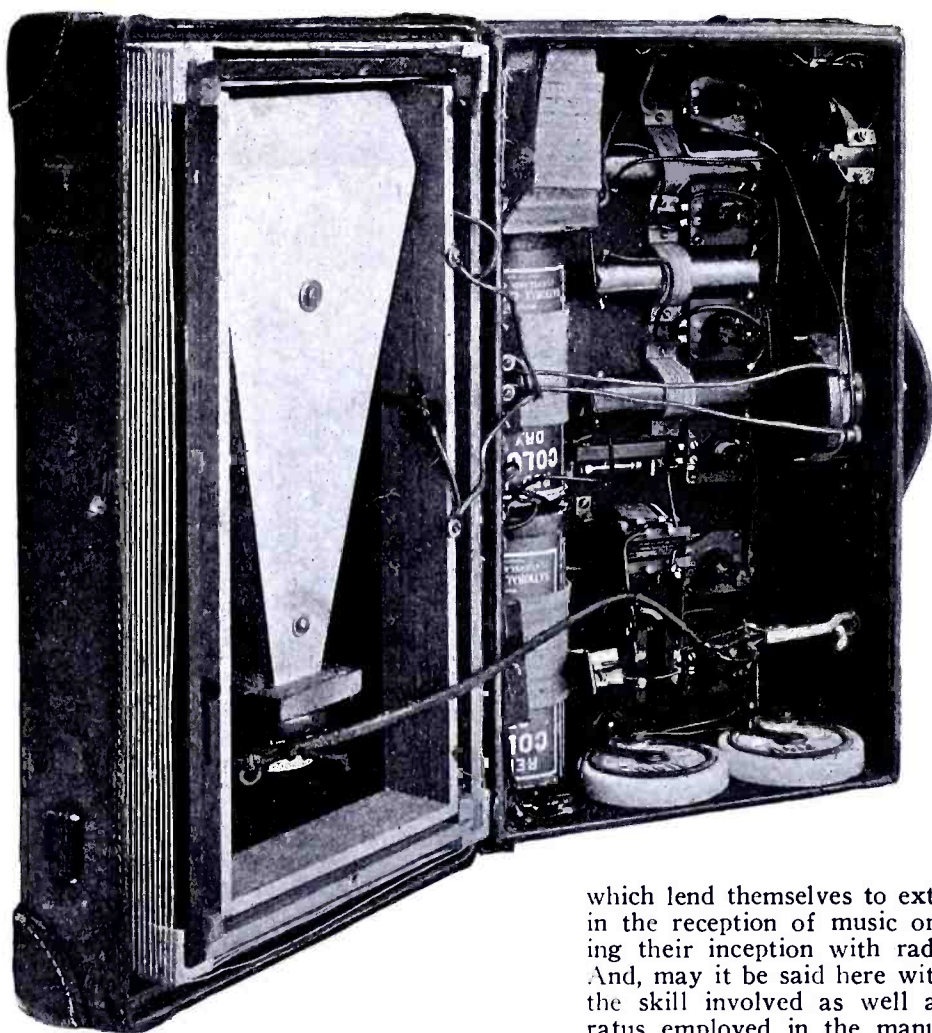

.....
 This photograph shows the inside of the entirely self-contained radio receiver equipped with a loud talker and five stages of amplification. Note the horn fixed in the center of the loop aerial.

SUPPOSE you are lounging in a hotel lobby when apparently a "knight of the grip" enters upon the scene, carrying a small-size suitcase. Abruptly, clearly-defined strains of music begin issuing from the leather-made container. Completely amazed, the group of aroused spectators are likely to ascribe the unexpected musical sounds to deceptive ears or to the mystifying powers of an unheralded stranger. The supposition is not far-fetched. Literally, a common suitcase has been transformed into a music-box through the ingenious efforts of P. D. Lowell of the Radio Communication Section, United States Bureau of Standards. Moreover, this self-containing musical unit is capable of harnessing a phonograph concert by the medium of wireless transmission from a point six or eight miles away.

"Portafone" is the descriptive term which implies its compactness and ability to corral sound vibrations from out of space. Barely weighing 30 pounds, the device from all exterior appearances is a suitcase. Scrutinizing observation alone reveals its modified aspects once the container is closed, an opening of 3 by 5 inches in size having been plugged in one side to facilitate the emission of sounds. Not markedly discernible to the casual observer is a button-like fixture under the leather handle of the suitcase for adjusting the tuning condenser, and to the left of the handle are a stabilizer for adjusting the veritable traveling music-box to maximum sensitivity and a single-action electrical switch for introducing and suspending the filament current. These are visible objects when the container is closed, but are not conspicuous enough to identify the cleverly concealed mission which they serve in the conversion of an ordinary suitcase into a complete musical unit.

Take a peep on the inside of the container. Here are to be found the intricacies

which lend themselves to extreme sensitivity in the reception of music or messages having their inception with radio transmission. And, may it be said here with emphasis that the skill involved as well as special apparatus employed in the manufacture of this musical suitcase are of such a nature as to preclude its duplication by amateur wireless operators at the present time. The success of the experimental unit is attributable to the use of a special design of small electron tube which renders it possible to employ two Columbia dry-cell batteries in supplying filament current. Six stages of amplification are in operation—three of radio, two of audio, and a detector. By the use of tuned radio frequency transformers extreme sensitivity is obtained—not an inconsiderable factor in the functioning of the apparatus.

The amplifier consists of the following elements: Six electron tubes of special design with sockets, two filament rheostats for controlling filament temperatures, a stabilizer for adjusting the device to maximum sensitivity, a tuning condenser for adjustment to the wave-length of radio telephone transmitter, two and one-half volt dry-cell batteries for supplying filament current—these being connected in parallel, two 20-volt "B" batteries for supplying plate voltage, three tuned radio frequency transformers, grid leak and condenser, and two audio frequency transformers. The apparatus is absolutely self-containing, functioning in the absence of an antenna. A receiving coil, 8 x 16 inches in dimension, is encased in the suitcase cover. This coil is of No. 26 copper wire, with 21 turns. The latter, as well as the horn and telephone receiver, are snugly arranged in the cover of the leather container. The complete "portafone" weighs approximately 30 pounds, and is 7 inches thick and 18 inches long. When receiving from a one and one-half K.W. radio telephone transmitter the device has a range of about eight miles.

The equipment was originally conceived as serviceable for field use in conducting experiments with respect to directional coil transmission, whereby exploration errands in the region of a transmitter coil could be

negotiated with beneficent results. The "grip radiotalker" was but a natural consequence. As such, it is adjusted to have maximum sensitivity at a wave-length of 350 meters, thus conforming to the present wave-length employed by the naval aircraft radio laboratory at Anacostia, on the outskirts of Washington. Concerts and technical news bulletins are distributed from this station every Friday night, beginning at 9 o'clock. The "portafone" is able to "pick up" the music emanating from Anacostia when located anywhere in the city limits of Washington. Merely by turning a button that connects with the electrical switch on the inside of the suitcase, and an adjustment of the stabilizer until the signal attains the greatest loudness, music issues from the 30-pound budget with unrestricted freedom. The cost of operation is represented by the amount of battery-power consumed, ordinarily two dry cells, costing thirty cents each, will last two or three evenings. A non-spilling type of small storage cell could replace the present dry cells, thereby greatly reducing the cost of operation.

The "grip radiotalker," a description applied by the writer, is a radical improvement over a previous design of "portafone," recently built by the Bureau of Standards. The forerunner of the instrument described in this article was contained in a box, with a horn projecting from the outfit. Its cumbersome nature compared with the more recent invention is obviously apparent. Messages as well as music are faithfully recorded and audibly reported by this virile suitcase. Its conversational powers—parrot-like, of course—are quite varied. The inventors have conducted a variety of "stunts." A groceryman was given an order by the instrument, the leather-bound container being placed on the counter while specific instructions were being issued. Even the pro-

(Continued on page 223)

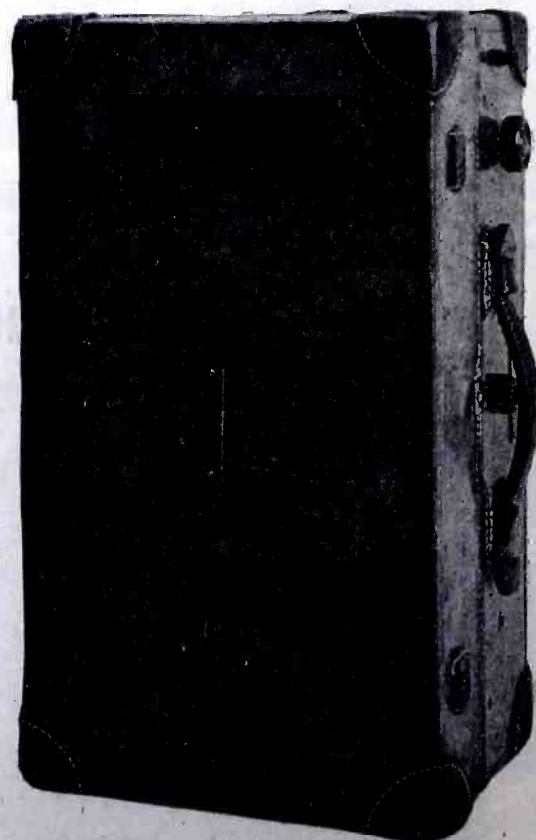

When Closed This Receiving Set Looks Like an Ordinary Suitcase. The Necessary Controls May Be Operated From the Outside and on This View May Be Seen the Condenser and Rheostat Knobs, and the Opening Cut Through Which the Music or Speech Comes Out.

A Novel Radio Controlled Automobile

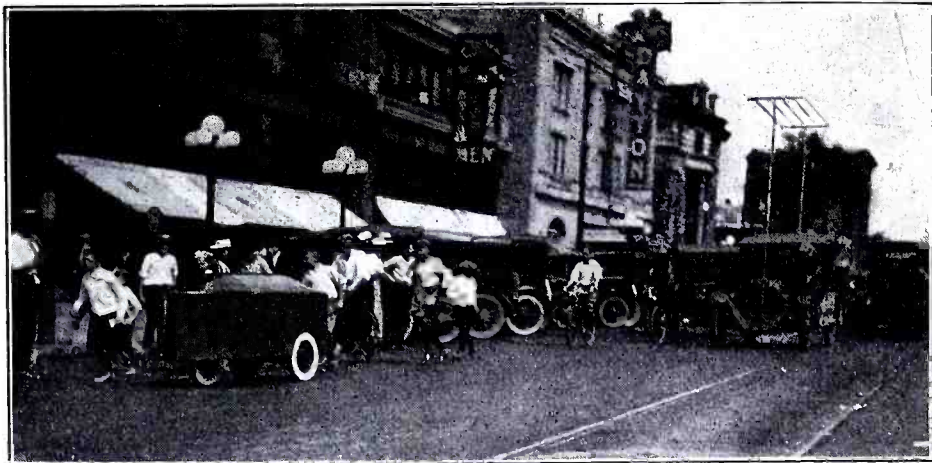
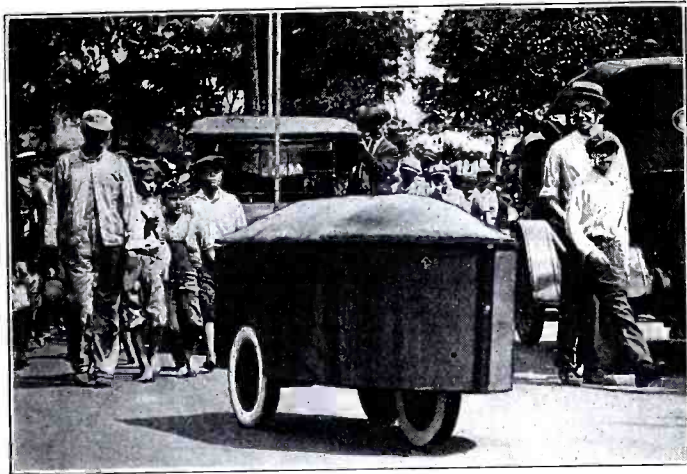

These Two Photographs Show the New Automobile Developed by Capt. R. E. Vaughan in the Streets of Dayton, Ohio. On the Left May be Seen the Radio Controlled Machine, Which Has No Outside Aerial, Curiously Watched by the Crowd. On the Right May be Seen the Automobile in Which is the Sending Set.

THIS new car, which is cigar-shaped, about 8' long by 3' high and 2½' wide, is mounted on three wheels equipped with pneumatic tires. It is propelled electrically by a motor supplied by storage batteries and may run at a speed varying from four to ten miles an hour.

This car, which was developed and perfected by Capt. R. E. Vaughan, Chief of the Radio Branch of the Engineering Division of the Air Service at McCook Field, Dayton, Ohio, was begun in January, 1921, and has been in practical operation for about three months. The first public demonstration was given on August 5, in the streets of Dayton, when the car was run through the entire length of the various streets in the business district during the hours when the traffic was heaviest.

The car, entirely controlled by Radio, can be made to start, stop, reverse, steer to right and left, blow a horn, ring a bell, fire a pistol and perform other functions; all the controls being obtained by pressing buttons on an automatic transmitter, which sends the proper combinations of dots and dashes operating each control. At the present time the range of operation depends entirely upon the range of visibility, for it is possible to control the car up to a distance of 50 miles.

During some experiments, the car was

controlled from an airplane and, thanks to the quick operation of the selector, the car may be driven along very narrow roadways at full speed, or through heavy traffic in



Captain R. E. Vaughan, Who Designed and Built the New Radio Controlled Car.

crowded business streets. The selector, which decides the various combinations of dots and dashes, is so quick in operation that several controls can be operated in a space of one-quarter of a second, and any one of the 12 controls can be made operative in less than one second. As may be seen in the photographs, there is no outside aerial; the aerial used consists of two pieces of wire cloth fixed in the cover and under the car and acts as a condenser antenna.

APPLICATIONS

The new system of control developed by Capt. Vaughan can be applied to anything mechanical that moves in the air, on the ground, on the water or under the water. As a war weapon, it could be used to direct tanks loaded with TNT, which could be driven to any desired point and exploded. This would be especially valuable in destroying enemy machine gun nests without losing hundreds of lives in making an assault, as the tank could be directed from an airplane, from which it is easy to locate the enemy's positions. Of course, torpedoes controlled by Radio could also be used to destroy the enemy ships in the same way.

At last, as suggested by a humorous paper, such Radio controlled automobiles could be used these days to carry some liquors along guarded roads without endangering the liberty of the owners!

Reporting Yacht Races by Radio



Reporting by radio becomes popular. This photograph shows the reporters of the Montreal Standard reporting the international yacht races on Lake St. Louis.

Photo Underwood & Underwood.

Another practical application of the Radiophone is shown in the accompanying photograph which represents the reporters of the sporting section of the Montreal Standard sending the results of the yacht races to the office of the paper, where they were immediately set in type and printed.

By this method considerable time was saved and several incidents of the race could be reported, as the boat carrying the reporter was close to the yachts. This enabled the Montreal Standard to beat the World and give its readers the detailed results of the international yacht races for the Royal St. Lawrence Club trophy well in advance of the other papers.

The American challengers which won the race had the characteristic names of "Bootlegger" and "Freebooter."

This demonstrates the practicability of the Radiophone for reporting, and several newspapers have already considered the matter seriously, but in the near future one will be able to see the reporters with the camera in one hand and the radio set in the other in direct communication with their office while on the sporting fields.

New Radio Apparatus

A NEW REGENERATIVE RECEIVER



This New Short-Wave Set Uses an Entirely New Process of Tuning, Which is Very Sharp.

The two accompanying photographs show an absolutely new type of short-wave re-

ceiver, which is now on the market, and which operates on a new principle. This receiver, equipped with spider web inductances, is tuned with variable condensers only, and has a new system of regeneration and oscillation control which is the new feature of this unique set. The range is 180-1,000 meters.

Thanks to this new device, the coupling is fixed, and yet a very sharp tuning is obtained by means of a special vernier system allowing an ultra fine adjustment; as in other receivers, three coils are used, but the hook-up is somewhat different. Owing to the patent situation more cannot be said of this instrument at the present time, but we hope to be able soon to give more details about it.

Besides the new reaction control, the receiver embodies some other new features such as inside dials and desk type front

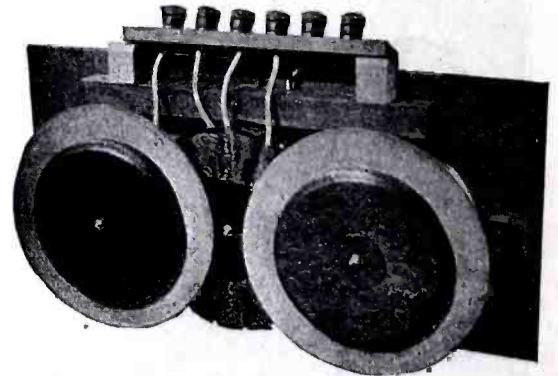

Inside View of the Regenerative Set.

panel, giving to this apparatus an unusual and neat, as well as attractive appearance. Further information regarding this set appears elsewhere in these columns.

Photos by courtesy of E. Turney Co.

A RADIO AND AUDIO FREQUENCY AMPLIFIER

This new three-valve amplifier receiver is the outcome of a lengthy series of experiments and the results obtained are claimed to be superior to any combination of three to five valves.

The apparatus consists of a polished cabinet 13" by 11" by 4". Three valves are used, each being controlled by a separate filament rheostat. The first tube amplifies at radio frequency, the second is the detector, and the third amplifies the rectified signals at audio frequency. This arrangement, therefore, allows the amplification of all signals before rectification, and is certainly the very best method of magnifying weak signals, as, when signals are very weak, there is practically no current to rectify so that they cannot build up by audio frequency amplifications only. The illustration shows that the panel contains an arrangement of multiple switches which control the operations of the three valves either individually or in cooperation. ALL THE VALVES DO NOT HAVE TO BE ALIGHT ALL THE TIME. By means of these switches the user can bring into operation just those valves necessary to give the correct amount of amplification for any signal, spark, CW or telephony. This also economizes plate and filament current. With all switches set at OFF, the center valve only is alight and operates on the best possible single-valve circuit as a detector amplifier. By moving the left hand switch to the left the respective valve is added to the circuit giving high frequency amplification, of course, in front of the detecting

valve. By moving the right hand switch to the right, the respective valve comes into operation and acts as an audio frequency amplifier of the rectified signal. When all

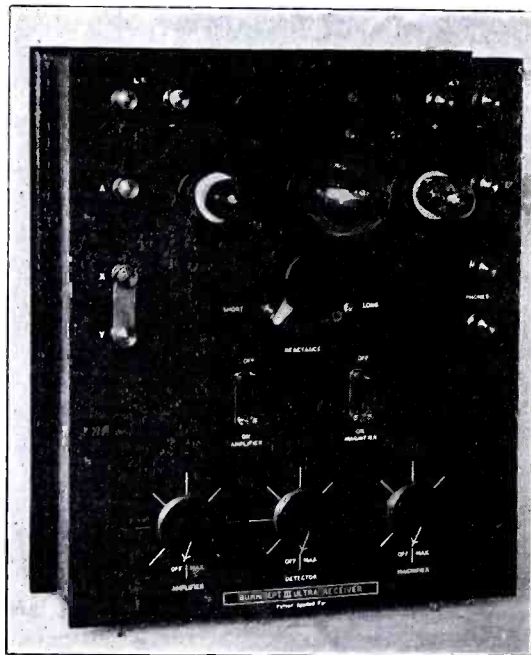

This Amplifier Embodies New Features. It Has One Stage of Tuned Radio Frequency Amplification, Detector, and One Stage of Audio Frequency. The First Stage and Detector or Detector and One Stage May Be Used at Will. Photo by courtesy of Burndept. Co.

switches are in the ON position, so that all three valves are in operation the amplifier is exceedingly powerful, having an amplification constant of between 200 and 300.

A well-known disadvantage of the usual radio frequency amplifier of the inter-valve transformer type is that, owing to the self-capacity of the transformers and their having a natural wave-length of their own, good amplification is obtained over a somewhat limited range so that special transformers have to be used to get best results over certain combinations of wave-lengths; e. g., a transformer giving best results at 1,000 meters would be poor over 5,000 meters or more, and a transformer amplifying at 17,000 meters would be very inefficient at 8,000 meters and no good at all at 1,000 meters and under. Also this type of transformer will not amplify at wave-lengths less than 500-600 meters. Resistance capacity amplification at HF is only suitable over 1,000 meters and has disadvantages in requiring high plate current, etc.

In this instrument all these difficulties have been completely overcome; no radio frequency transformers are used, but the design allows for steady and regular amplification (RF) on ALL wave-lengths from 150 meters to 24,000 meters. This feature, which is unique, is guaranteed, so that RF amplification on this apparatus becomes as easily handled as AF amplification which is in more general use amongst amateurs. The semi-circular series of studs in connection

(Continued on page 228)

AN IMPROVED CHANGE-OVER SWITCH

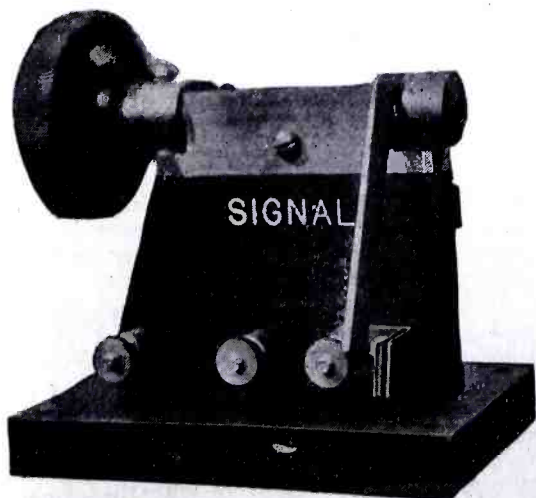

Right Side View of the New Change-Over Switch Showing the Blade Connecting the Aerial to the Receiver.

This switch comprises all good features incorporated in high priced amateur change-over switches, but in addition possesses all the qualifications of the modern commercial antenna switch.

It is operated by a large knob through a simple twist of the wrist. All contact members are mounted on opposite sides of a vertical formica support that allows no accumulation of dust or dirt to lower the resistance of insulating members.

The location of the contact members on both sides of the vertical support makes the switch very compact and neat in appearance and, in fact, it is much smaller than any other switch could be constructed, having anywhere near as high an insulation factor.

Another feature that is only found in commercial aerial switches of the most expensive construction, is an arrangement whereby the aerial is drained of any accumulated charge before the switch reaches the receiver position. Any operator who is

(Continued on page 228)

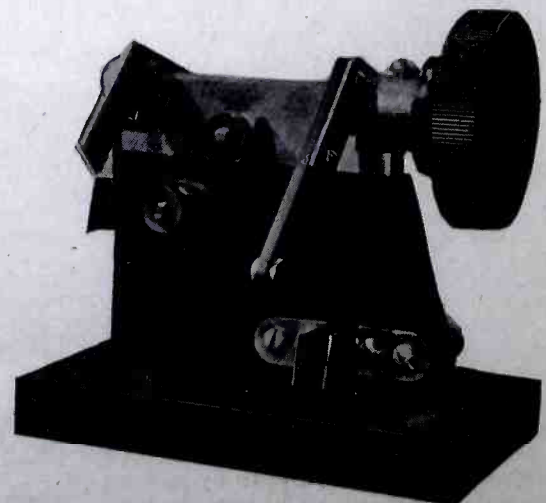

Left Side View of the Switch. Note the Well Designed Contact for the Motor Circuit. Photo by courtesy of "Signal" Co.

Radial Inductance Eliminating Q. R. M.

By EHLERT

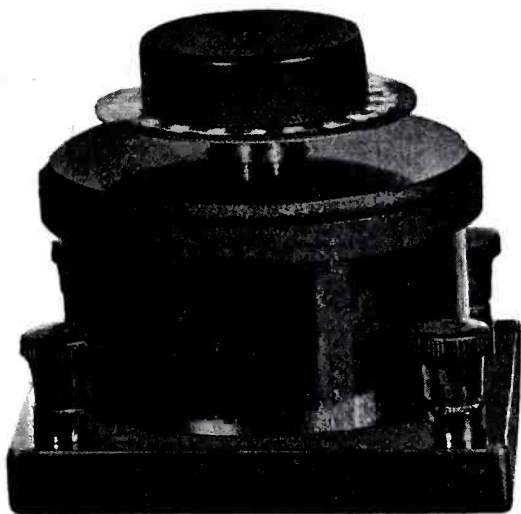

On the right may be seen the receiver built by the Navy, using radial inductances. The coupler is in the upper left hand corner. On the left is the coupler alone as it appears when mounted in its case.

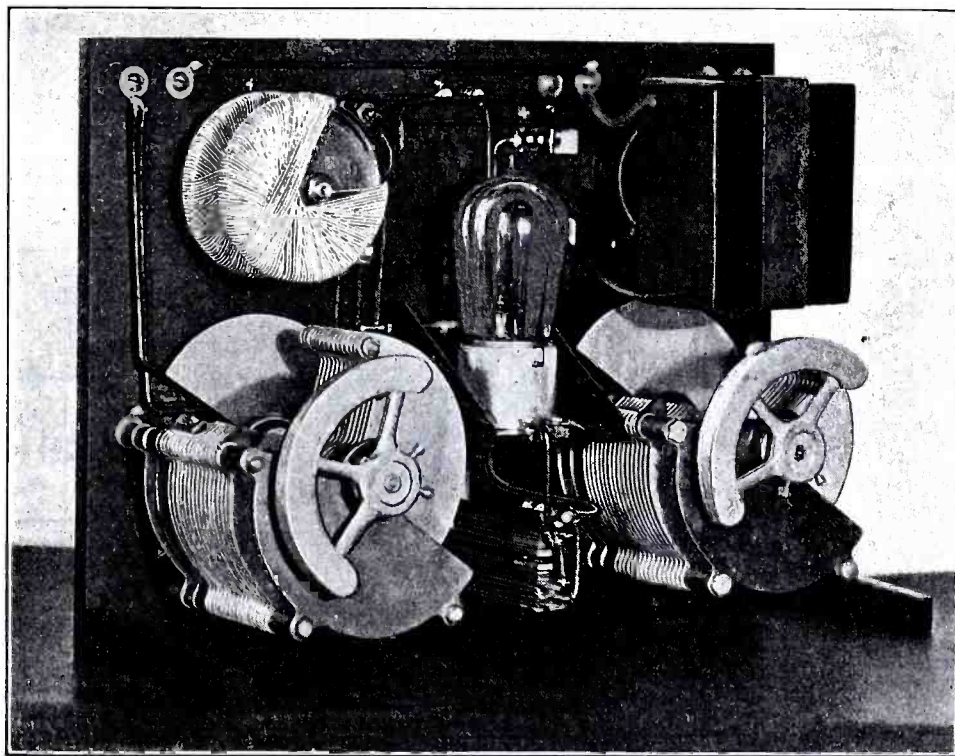

It has become a known fact that with the increasing number of amateur radio stations, from year to year, without mentioning the naval or commercial stations, QRM seems to be the most important factor that the amateur or commercial operator has to contend with. QRM or interference needs no introduction in radio, as this is our greatest enemy. Can it be stated now to all amateurs and commercial operators that this QRM has at last been conquered?

Yes, it has been conquered, thanks to the work of some long experienced men who have spent most of their time in the laboratories of the government. For the past two years this deadly QRM was fought and finally conquered. All the amateurs of the East know the terrific QRM that exists at all times around New York, where many stations are continuously working, mostly jamming, thereby squeezing in to get their traffic through.

Let us take into consideration New York, the most congested harbor in the world, that is, as far as radio is concerned. Eight commercial stations cover a vicinity within 100 miles and here QRM is drastic, no argument at all, as when one listens in, all he can hear is jamming, possibly QRM QTA. Above all, in Bedloes Island, sits a radio station known to the amateurs as WYCB, or WUM to the commercial operator; there, after two years, Mr. Bogdanoff, due to his experiments, possibly QRM QTA. Above all, in Bedloes Island, sits a radio station known to the amateurs as WYCB, or WUM to the commercial operator; there, after two years, Mr. Bogdanoff, due to his experiments, finally discovered these so-called coils, radial inductances, and with proper finishing touches, came to a practical QRM eliminator. This was accomplished by him in order to get away from induction from nearby high powered stations.

Mr. Ehlert, lately from the U. S. Naval station at New York, and Mr. Schaefer, of the Ship Owners' Radio Service Co., were consulted as to this new invention and after several weeks of experiments, he designed a receiver which can cut or tune out QRM more than any known receiver on the market at the present time. Most of the experiments were conducted at Fort Wood by Lieutenant Paddock, signal officer U. S. Army, in the following manner.

A quarter K.W. set was sending on three hundred meters wave-length using a large antenna, while below was another antenna connected to the receiver which was placed in another room. Thanks to the radial inductance, the receiving operator could cut out entirely the induction from the sending set and receive a transmission effectuated on four hundred meters wave-length by moving the two coils apart of only two degrees. This wonderful result may be obtained on

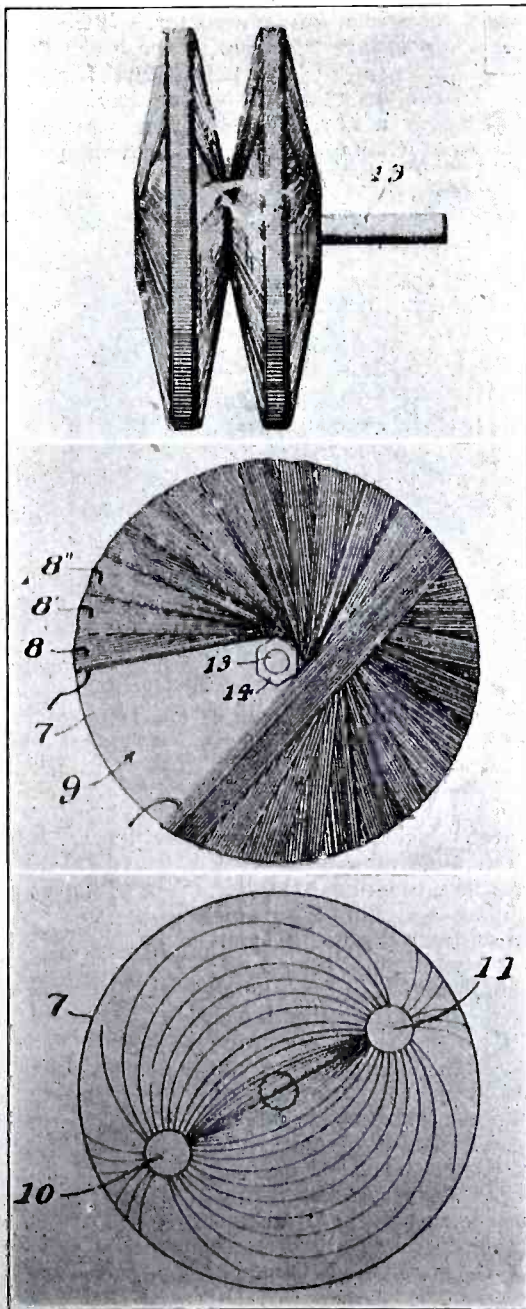

These Sketches Show the Method of Mounting of the Coils and the Special Process of Winding as Well as the Resulting Field Inside the Coil.

any wave-length and a station interfering with the reception of faint signals may be tuned entirely out by a very small variation of coupling.

As may be seen in Fig. 3, the coils are wound around a disc in sections overlapping each other, this produces a very concentrated field of the form shown in the diagram. As may be seen two coils are mounted on the same axle, one of them rotating in front of the other, so that the coupling may be varied.

These coils possess for a given wavelength the least distributed capacity of coil known, which in turn gives it the least high frequency resistance; a very important factor in short-wave reception.

The wire used is preferably some good or litz wire, insulated and of the gauge. The winding has no taps, being effectuated, as for the honeycomb of coils, entirely by variable condensers. One of the photographs shows a set built especially for experiment by the Navy, the radial inductance seen above the condenser on the photograph gives a good idea of the coils compared to the other receiver; with this receiver lengths up to 700 meters may be tuned in.

The new inductances will be built on the market will be built on a separate tuner shown in the photograph to use the apparatus or in conjunction with other instruments he already has. This is compact and fitted with a dial showing the value of coupling between the two coils.

In ending this description it may be said that undoubtedly the new form of induction is the solution of the QRM question, so important at the present time.

Correction

In one of the recent issues of RADIO NEWS, the Diamond State Fibre Company, in an advertisement, stated that the phase difference of the wave-length was found by the Bureau of Standards, to be 1.2. This figure should have been given as 1.8. The advertiser has written asking us to make this correction.

The 3-AWI Radiophone

at Philadelphia, Pa.

By L. PARKE*

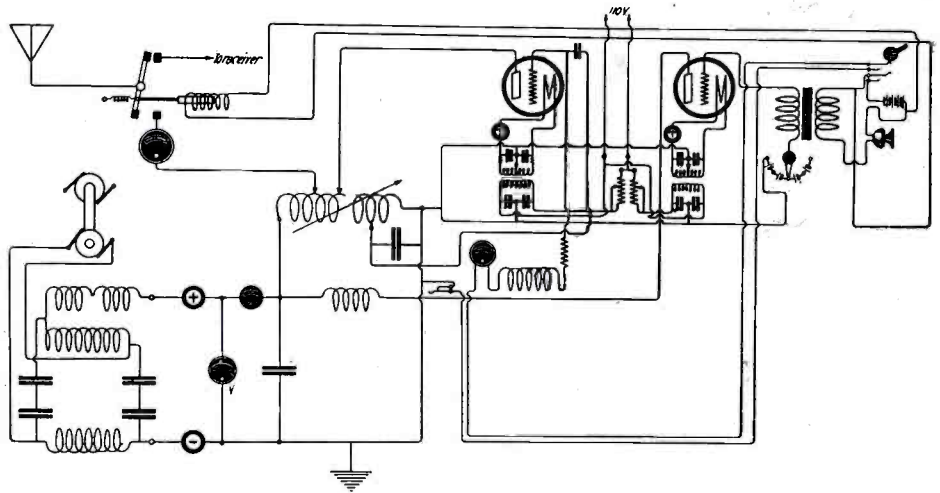
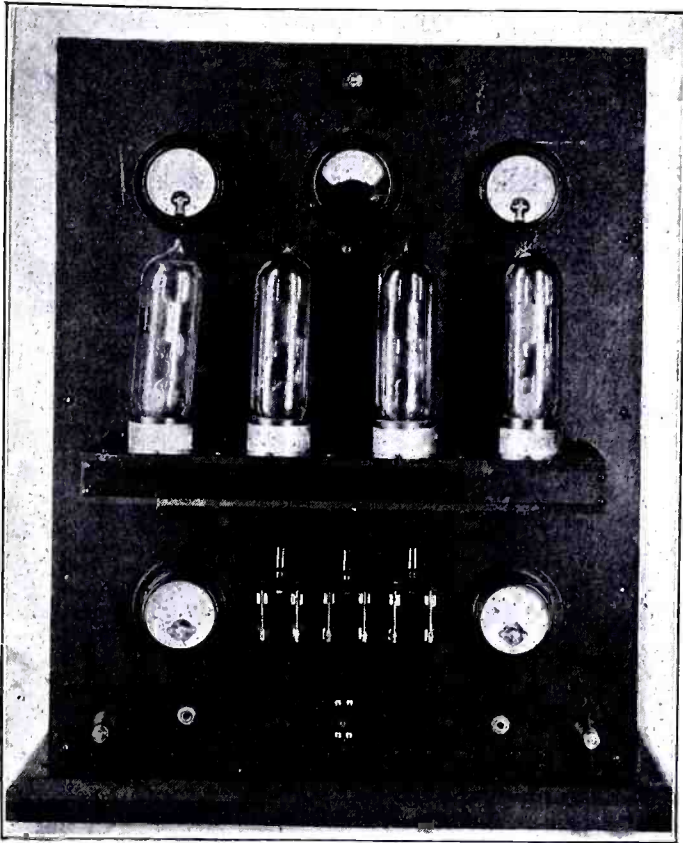

On the Left is a Photograph of the Well-Designed Radiophone Used at 3-AWI, While Above is the Complete Hook-up of the Set.

IN response to hundreds of letters coming from amateurs within a radius of 500 miles of Philadelphia, we will endeavor here to present some of the features of the radio telephone equipment at this station which has caused so much comment.

The owner, Thomas F. J. Howlett, is one of the pioneer amateurs in the third district and one of the first to successfully give concerts over the radiophone. Desiring to increase the range and flexibility of his equipment, the set illustrated and described below was designed for him by L. B. Traugott to meet his requirements and built in the shops of the Philadelphia School of Wireless Telegraphy.

In designing and building this phone, a specific effort was made to follow the latest engineering practice and to incorporate wherever possible the design, data and latest features which have been proven superior by several years of experimenting and observation of the leading authorities by the designer.

The main part of the equipment, namely, the power tubes, are of the new type UV-203. Four of these tubes are used, two in parallel as oscillators and two as modulators. The tubes are arranged on the front of the panel and the leads brought through the panel to the oscillating circuits in the rear. The transmitting unit is arranged on a hard rubber panel 20" x 25". All necessary controls being placed on the front of the panel within easy reach of the operator, and at the same time any circuits that could possibly carry high voltage current or any of the oscillatory current, are carefully arranged so that accidental contact by the operator is obviated. Three double-pole, single-throw switches are provided on the front of the panel, one controlling the main supply current to the filament transformers, one being provided for the oscillator tube filaments and one for the modulator tube filaments.

A meter is provided in the filament circuits of both the modulator tubes and oscil-

lator tubes to show normal operating filament currents. The upper portion of the panel holds three meters, grid current meter, radiation meter and a space current meter. Two jacks are provided at the lower portion of the panel, one for the insertion of a plug having

in circuit either a key for continuous-wave signaling or a chopper wheel for providing

control equipment on the transmitter panel.

A separate control panel is provided for the control of the oscillator filaments and modulator filaments. This unit is shown to the left of the transmitter panel in the accompanying photograph and consists essentially of variable resistances in series with the primary of the two filament heating transformers.

The filter system, together with the constant current choke coil, is also built as a separate unit in panel form. The front of the panel carries a double-pole, single-throw switch which, when open, completely isolates the entire equipment from the high voltage circuits. Above this switch is an especially designed circuit breaker in the negative lead of the high voltage circuit, which is adjusted to throw slightly above the normal space current of the tubes under normal operating conditions. Fuses are also provided in the filament circuits of the tubes to further safeguard them against accidental overloads.

The transmitting inductances, filament lighting transformers and their protective condensers, variable voltage supply for modulator grid potential, modulation transformer and the breaking relay are all mounted behind the transmitter panel in such a way that the transmitter panel is

(Continued on page 266)

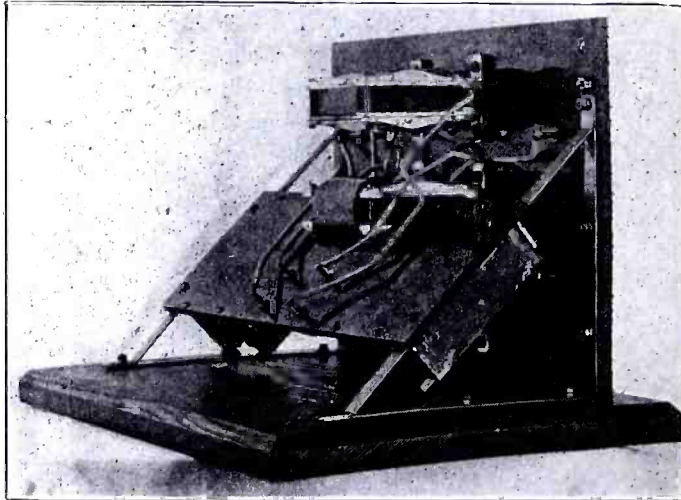

The Upper Photograph Shows the Back of the Filament Control Panel. The Lower One is an Inside View of the Set.

chopper modulated C.W. and the other for the insertion of either the microphone, a victrola tone arm, or a buzzer set, for buzzer modulated C.W., thus giving a flexibility of operation without the use of complicated switching.

A small anti-capacity switch is provided also at the lower portion of the panel operating a relay which throws the antenna from the transmitting inductance to the receiving inductance and at the same time, in the latter position, opening the grid leak circuit and throwing the lead off the transmitting tubes, thus allowing a "break in" operation while in use.

Three high tension terminal posts are provided on the panel front for antenna, ground and receiving inductance, respectively, which completes the

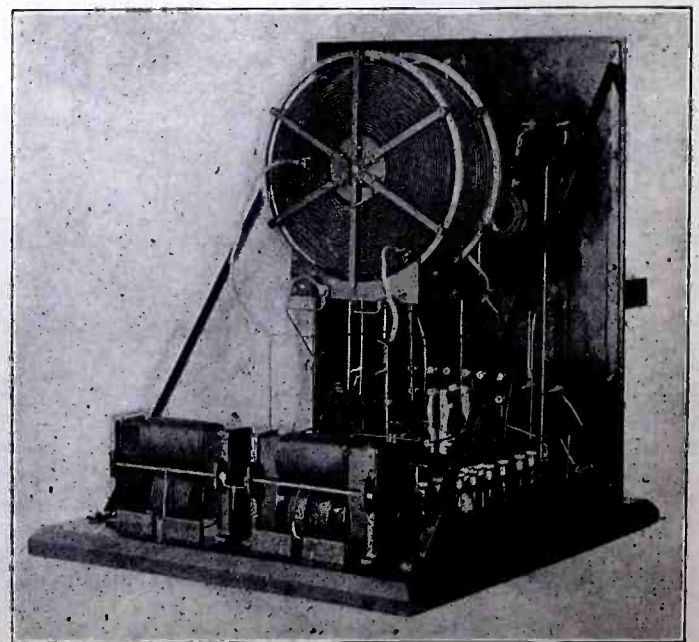

*In collaboration with L. P. Traugott.

Latticed Radio Towers for the Amateur's Station

By ALLAN K. THOMPSON

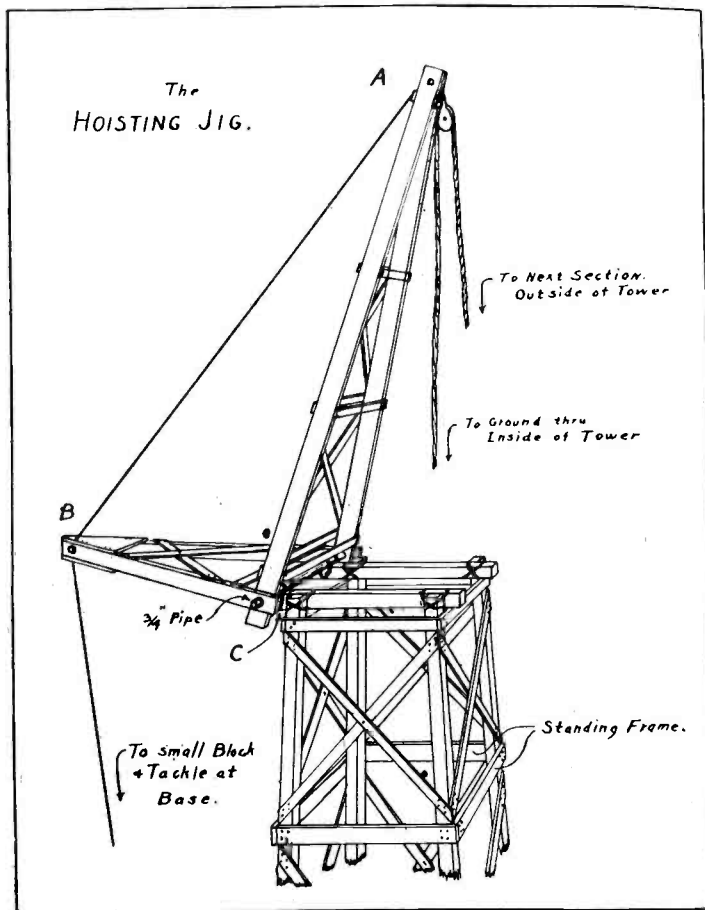

S_b in inches = Width at Base.
 S_t in inches = Width at Top.
 l in feet = Distance Down from Top.
 h in feet = Height of Tower.

Both ends of every section should be framed with 1 x 3 sticks, 5 inches back from the ends in order to give support while handling and, as will be seen later, to support the hoisting jig. A similar frame of 1 x 3 sticks should be placed on the upper ends of every section but the lowest one, at the point where the horizontal lath members would normally be placed (see sketch), to serve as "standing room."

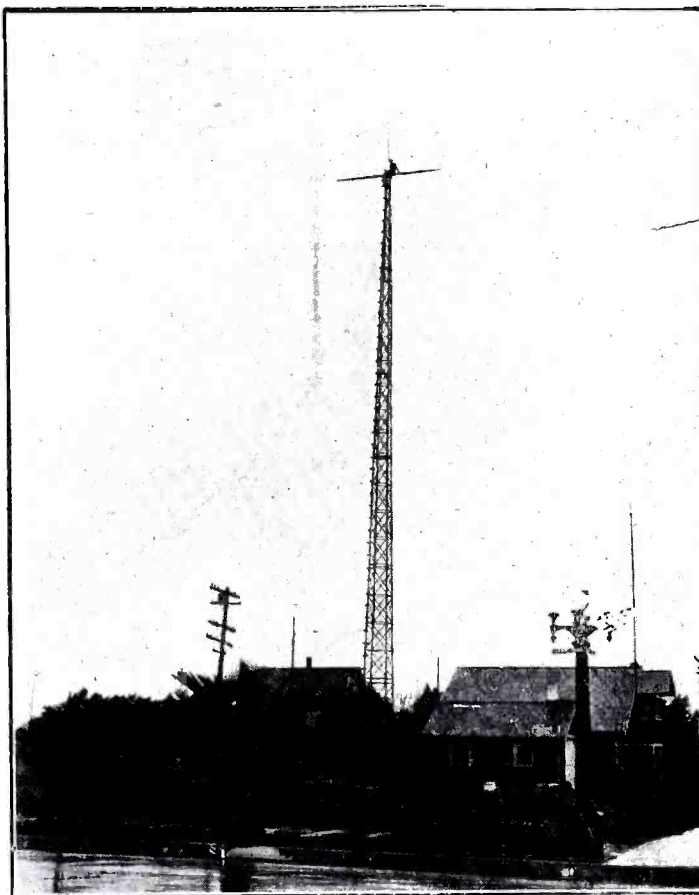

Here is the Tower Completed. Note the Builder at the Top Fixing the Spreader.

This Sketch Shows How the Sections are Hoisted Up to be Assembled.

A RELATIVELY high wireless pole must be of heavier construction and more rigid than one of average height. Built-up towers of latticed construction fulfill these requirements and are inherently more stable. They cost very little more than a correspondingly rugged pole of the straight type, while their greater serviceability and neater appearance make them more desirable.

The design discussed below was built and erected by the writer for 6ZN in San Fernando, California; owned by Mr. H. B. Denis and Mr. C. A. Taylor. It has been in service for several months and has withstood very severe wind strains.

The design chosen for this tower was 50" square at the base, 10" square at the top and 100' in height. Detailed dimension of this tower will not be given, but the method of construction and erection involved will be outlined, as this type presents some new features in both these operations.

Wireless poles should be guyed at shorter intervals, progressing toward the top, and the sections should be of corresponding lengths, i. e., joints should occur at the point where the guys are attached. The lowest or base section should, of course, be the longest and the others may be shorter by 2' successively, up the tower.

The exact size of the square section at each end of all sections should be next determined. This is readily given by the formula:

$$S_n = \frac{l(S_b - S_t)}{h} + S_t$$

Where S_n in inches = Width at any point.

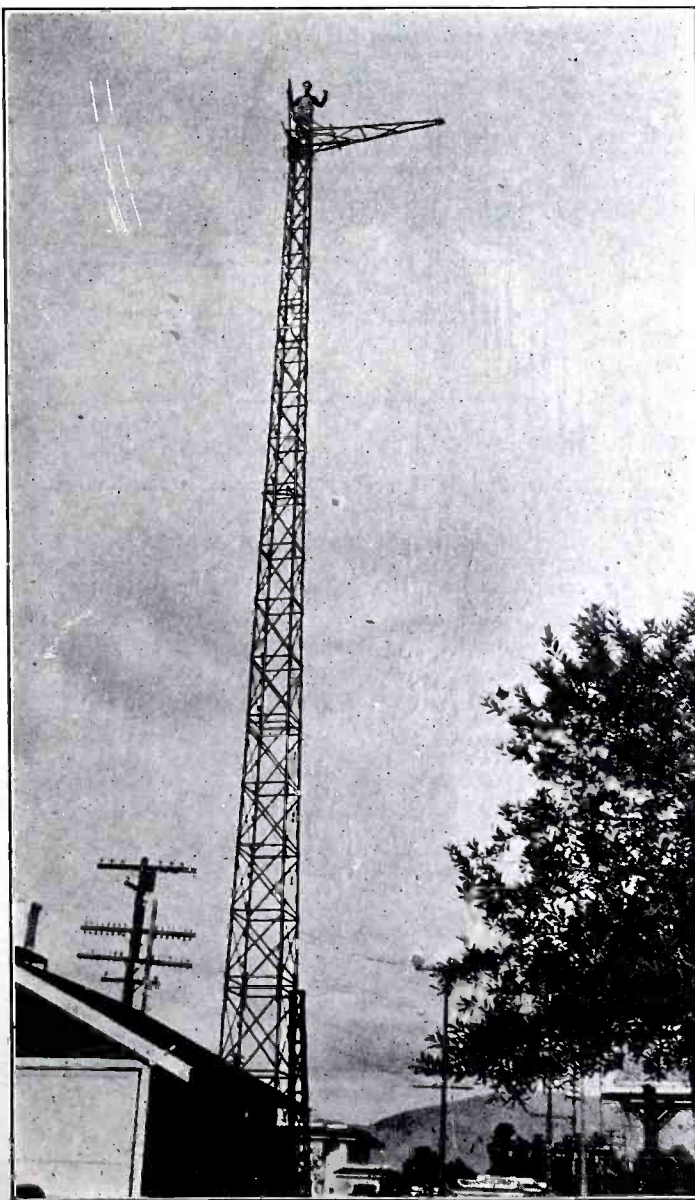

In This Photograph May Be Seen the Various Sections of the Tower, and the Hoisting Jig Being Fixed for the Erection of the Last Section.

The cross members should be placed so that the diagonals intersect at an angle of, or slightly less than 45°. The vertical side members are 2 x 2 in section and should be as straight and clear as possible. Two opposite sides of a given section may be made up alone and these two then combined with similar latticing to form the completed section. The latticing is made from 8' lath. These are slightly heavier than the ordinary lath, being 3/8 x 1 1/4 in section. A box nail 1 3/8" in length was used and not less than three were driven at each end. Two nails were driven through the intersection of the diagonal members and clenched. The four struts of any one section should be exactly the same length and their ends flat and square. Time will be saved by painting or staining the pieces before assembling, but they should be allowed to become thoroughly dry before assembling. The legs may be set in concrete and extend 2' into the ground or they may be allowed to rest on a smooth concrete base. If the former method is used, the concrete should not be placed until the section has been placed in a truly vertical position.

The joints are made by nailing and wiring 2' pieces of 1 x 2 along the inside of the struts. The two lowest sections may be joined in this manner and erected as one piece (about 30' or 40'). The guys should be attached and may be used to pull up from the opposite side. Heavy pike poles and several strong assistants can easily raise thirty or forty feet, high enough that the pull on the opposite guy will swing it into position. Steps should be firmly nailed to each section about 2' apart.

(Continued on page 236)

Break in Systems

By D. W. RICHARDSON of 3 DH and 3 XM

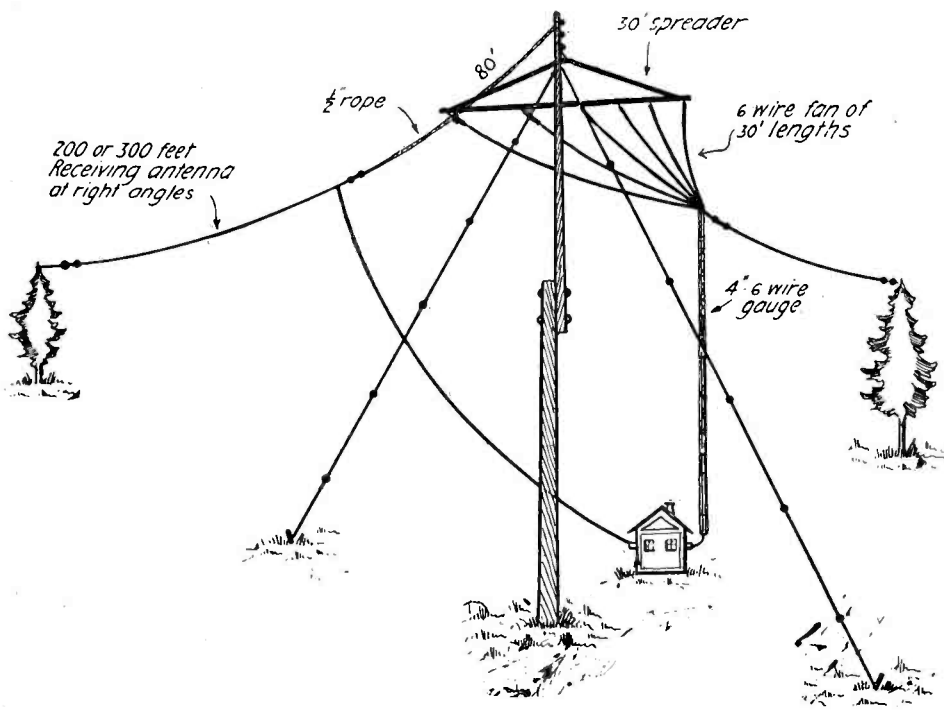

Using a sending aerial of the type shown and a single wire for receiving allows duplex work and higher efficiency of the sending set.

THE relatively few stations in actual duplex operation at present shows an ignorance of some very simple feats of engineering. The duplex system, besides being simpler than throwing a lot of switches while changing from sending to receiving, facilitates operation and saves endless interference by allowing the operator to be always alert to what is going on. When an operator is finishing a message which he is transmitting to a long distance station, he knows whether there is local interference or not, and does not give his "k" until the air is clear for the answer he is expecting, or if the receiving operator is troubled with interference, a simple "min" lets the sending operator know enough to wait. When the local interference is over, a simple "k" tells the sending operator to continue. In sending a message it saves endless repeating. If the receiving operator misses a word, he merely breaks-in, repeats the word before, and the sending operator takes it up and continues. If there is a string of messages to be sent, just an "r" from the receiving operator indicates that the message is O.K. and that he is ready for the next.

A break-in system is especially useful when the receiving station is having some trouble with a difficult message through static, for the sending station can keep repeating and repeating until the receiving operator has it all O.K. One never hears a

station with a break-in call while some station is calling him.

Two systems will be described, each with its advantages and both so simple that any one can install a system in a few hours of work.

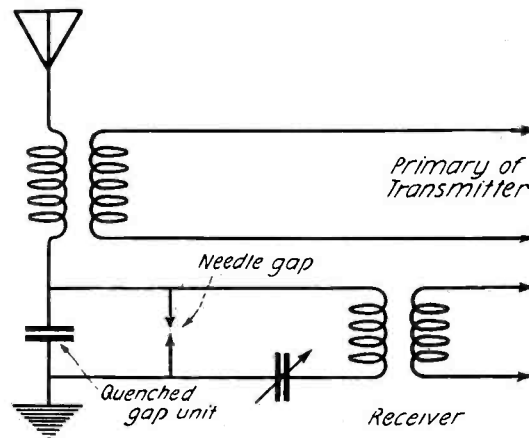

Another Simple System for Duplex Operation.

The first system involves a separate receiving antenna and should be used with bulb transmitters, especially when it is desired to be able to work two-way conversations, which can be done, provided there is a difference of approximately fifty meters between the outgoing wave and the received

wave. In this case, the sending set is always connected to the transmitting aerial and the receiving set is always connected to the receiving aerial, which should be at right angles and as far removed as possible from the transmitting antenna. (See diagram "A.") At least seventy feet of rope should be put in if the receiving antenna is hung on one of the transmitting poles, to let it hang as far away as possible. It should be several hundred feet long and of stranded wire or brass ribbon. A single wire is best, because it absorbs a minimum of static. It can be run to a tree or a pole several hundred feet away.

System "B," which does away with this extra antenna, is superior in that it is simpler. It is inferior in the fact that it can only be used with spark sets or bulb sets where a high voltage is used. (See diagram "B.") The leads to the receiving set can only be taken off near the ground (about 20 feet being the limit) where the potential to the ground is low, or in a counterpoise system, at the nodal point. A quenched gap unit does very well for the slight break in the circuit, or two brass or copper plates, 4 inches by 4 inches, separated by a thin piece of mica, with a hole 2 inches by 2 inches cut in it. These plates should be clamped together, in order that the resistance of this break in the circuit may be a minimum.

In both of these systems, a small needle gap is used across the aerial and ground leads on the receiving circuit, to keep what energy is absorbed from sparking in the cabinet. The grid leak on the detector should have a value between 10,000 and one-half megohm, in order that the bulb will not be polarized.

If a station is poorly wired, there may be various noises due to induction while the rotary motor is running. These can be avoided by grounding the frame of the motor and enclosing the leads in conduit or pipe and grounding the pipe, or else by controlling the set with relays and a six volt system. The latter, however, is unnecessarily expensive and should only be used when the sending set is a considerable distance away. As a rule, in the average station employing an induction or synchronous motor, there is no noise while the rotary is running.

There should be no trouble with these systems. The two antenna system has been in operation at 3DH for nearly a year, and the single antenna system is working perfectly at 2GR at present.

Description of 9 UQ Transmitter

By J. C. KOSITZKY

Due to numerous inquiries regarding my unusual transmitting tone, I give the following details for those interested.

The transformer, whose secondary is in series with the rotary gap motor (must be a series motor) is any small transformer, of variable voltage up to 60 volts, and may range from 50 to 100 watts output. Its secondary voltage may well be from 10 to 60 volts, and in six 10-volt steps.

The principle is simple. When the key is up, the secondary of the above transformer acts as impedance.

This makes the rotary move more slowly than it would if directly across the 110-volt line.

But on depressing the key, the secondary

becomes a source of potential in series with the line voltage, which gives the rotary motor line voltage plus transformer output voltage. The speed rapidly picks up on depressing the key. This "pick up" may be made to just equal the slowing down ordinarily caused by the transmitting transformer load; or the tone may be made to raise on the key depression. This tone is distinctive.

This works best on the light revolving arm type of rotary, as the change in voltage produces a more immediate change in speed than in other types of rotaries. Most rotary gap motors (series) will stand up to 140 or 150 volts, provided they are on the light revolving arm type of rotary.

If on depressing the key the speed falls off, then your transformer output is "bucking" or is 180 degrees out of phase with the line voltage. A reversal of primary connections of this transformer puts its output voltage in phase with the line voltage.

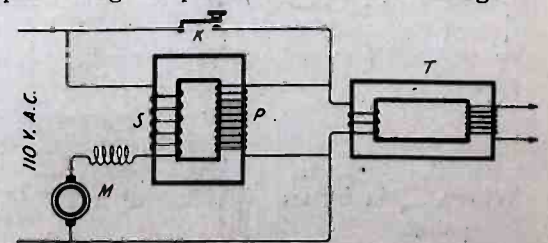

Connections of the Sending Set at G.V.A., Giving an Unusual Tone.

I. C. W. for the Amateur

By GARRETT W. LEWIS

FOR the past few months the amateur has found that each copy of Radio periodicals has contained one or more articles on the subject of bulb transmission; he has become convinced that C.W. has many of the advantages that he desires in spark, but the cost has prevented the average amateur from installing one. The object of this article is to describe the construction of C.W. and I.C.W. set that will work circles around the average spark set, and will cost much less. The actual cost of the set described was \$28, including the bulb. Using either a V.T. 2 or a U.V. 202, the radiation is about one ampere for straight C.W. and seven-tenths for I.C.W. Communication was established with 6AR from the author's station (7OZ) in Portland, Ore. Signals were reported QSA. The aerial at that time was 35' long and only 25' high.

The set proper is mounted on a piece of white pine with a fiber panel in front to hold the switches. The transformer and rectifier are under the table and are operated by the aerial switch. There are five parts to the set and they will be described in order.

THE HIGH VOLTAGE TRANSFORMER

The transformer is built on a core 1" square with inside dimensions $2\frac{1}{2}" \times 3\frac{1}{2}"$. Such a core will cost about \$1.50. The coils are wound on the long legs of the transformer, using linen tape for insulating. The primary consists of 440 turns of No. 18 D.C.C. Over this is wound the filament heating coil, consisting of 32 turns of No. 12 tapped in the center. On the other leg the high voltage secondary is wound, in two pies, each of 1,600 turns of No. 28 S.S.C. The pies are connected in series with a center tap brought out. One pound of No. 18, one-fourth pound of No. 12 and two pounds of No. 28 are needed.

THE RECTIFIER

This is the cause of much trouble to the amateur, because he does not allow enough

jars to cut the voltage across each cell to a value that will rectify. For this voltage, the author used six cells on each side of the cycle. The cells are in one-quart jars and consist of a pure lead and a pure aluminum electrode in a saturated solution of 20 Mule Team borax. The electrodes are 1" wide and 8" long, are immersed as much as possible in the solution and are separated 2". Six cells place a voltage of 65 volts across each cell, quite under the amount that such a cell will rectify. One set of electrodes will last about a year and give good service. At first the rectifier will not function and is liable to overheat the filter condensers, so it is best to break it in. This may be done by placing a load across the output; a set of four 25-watt lamps in series will do very nicely.

THE FILTER SYSTEM

The filter system consists of a choke coil and about eight microfarads of condenser. Four of the 2 MF. phone condensers will be the best that the average amateur can afford. They will stand up under the voltage required, as they are rated at 500 V. The choke coil is wound on a core about the same size as the transformer; it consists of one pound of No. 24 enamelled wire on each leg. The leads from the rectifier are run so that the coils are in series. The condensers are connected across each end of the choke. With this filter the author has had no trouble with A.C. hum at a distance of 10 miles.

THE INDUCTANCE

The inductance for this set is wound on a fiber tube $3\frac{1}{2}"$ in diameter. It consists

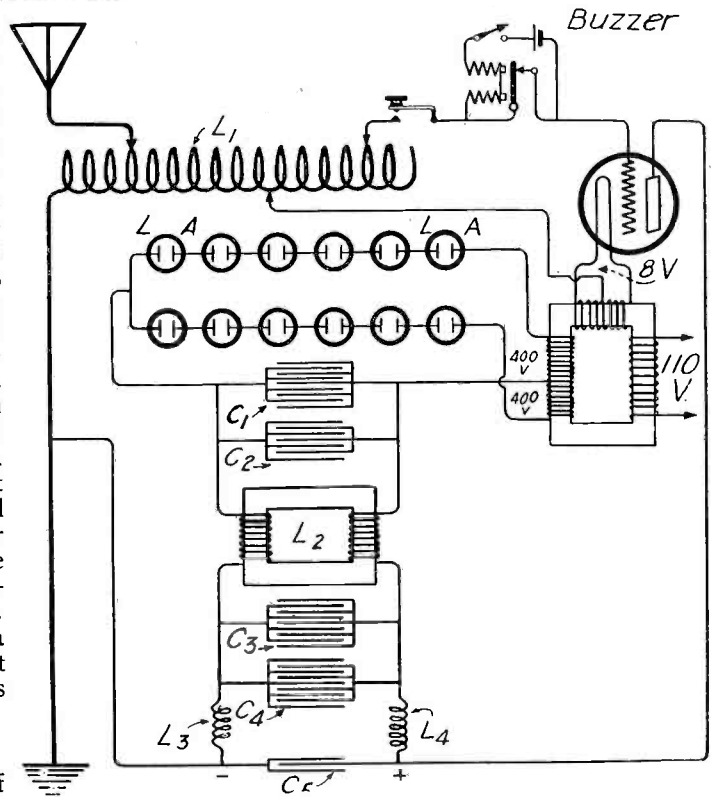

C.W. Transmitter Supplied with A.C. Electrolytically Rectified.

of 80 turns of No. 18 D.C.C. wire, not shellacked. Fifteen taps were taken off at each two turns, the rest tapped at every fifth turn. A little loop was made and taps taken off with flexible cord. The tube was fastened to the base directly in back of the switches that control the tuning.

THE INDICATORS

The amateur does not need a plate voltmeter, the rectifier will furnish the correct voltage. Neither is a plate milliammeter needed as the proper amount will be drawn. The experimenter will do well to watch

(Continued on page 254)

More Efficiency for the Rotary

By R. U. SEARES

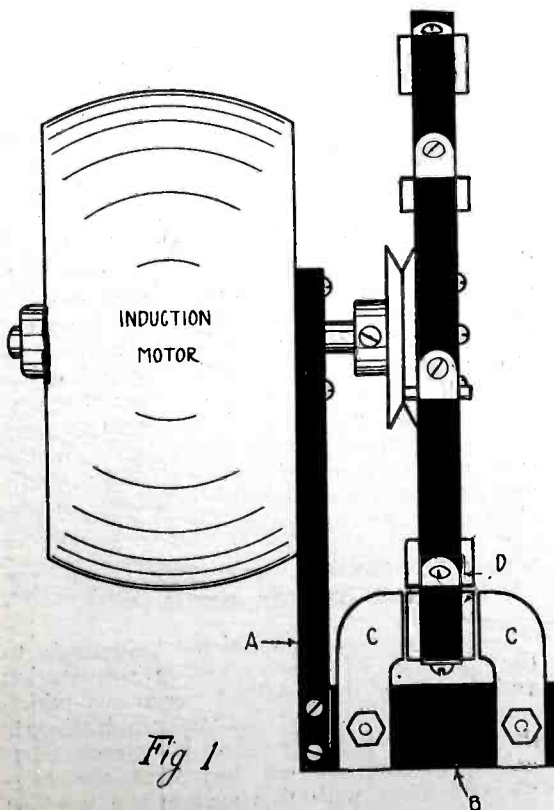

Fig 1

This Type of Electrode Shortens the Circuit and Has a Quenching Effect.

THE rotary spark gap herein described has the following advantages over the general type. The circuit through the wheel, from one stationary electrode to the other, is very short, permitting the use of more capacity. The flat electrodes used give a quicker break, thus improving the quenching qualities. Finally, to qualify with the essentials of good amateur apparatus, the construction is both simple and rugged.

A small induction motor which runs at 1,200 r.p.m., will give the best results if nine electrodes are used on the disk. On 60 cycles, the above combination produces a low musical note with good carrying properties.

The disk is 6" in diameter, $\frac{3}{8}"$ thick, and may be of bakelite or black fiber. At equal distances, nine holes should be drilled into the edge of the disk and tapped 8/32. Next, $\frac{1}{4}"$ from each hole, slots are cut radially into the disk to a depth of $\frac{1}{2}"$. These slots are made $\frac{1}{8}"$ wide by using several blades together in a hacksaw. It is of importance that the slots be not cut until the holes in the edge are tapped, otherwise the disk might crack, (particularly if bakelite is used) during the process of tapping. The disk is best connected to the motor by drill-

ing three holes and bolting it to a pulley which fits the shaft.

The disk electrodes, D, are cut from $\frac{1}{8}"$ sheet copper and dressed up carefully with a file. Fig. 2 shows the dimensions plainly. After these electrodes are formed, each is placed in a vise and the lug with a hole in

(Continued on page 252)

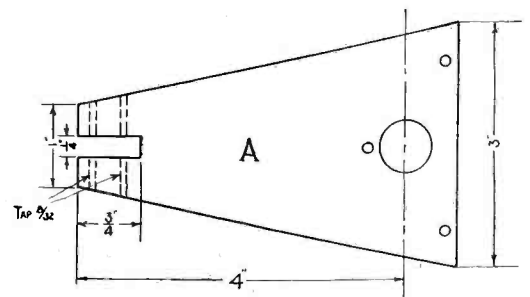
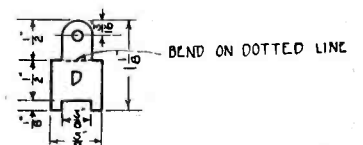

Fig 2



Detail of the Mounting of the Rotary Gap Electrodes.

Government to Broadcast News by Radiophone

A WIRELESS telephone, daily bulletin news service for the benefit of the country generally, and particularly the agricultural regions, is to be considered by the newly appointed National Radio Service Commission, which met and organized recently at Washington in the office of Postmaster General Hays. The commission was appointed by the Post Office Department, acting with the Department of Agriculture, and is composed of R. B. Howell (Chairman), of Nebraska; Courtland Smith (Secretary), of New York; William A. Wheeler, Bureau of Markets, Department of Agriculture, and James C. Edgerton, radio expert of the Post Office Department.

Market reports and other Government information have been sent daily by wireless telegraph from Washington to agriculture communities since April, but they are now considering the practicability of putting this service and bulletins of general news through by means of the wireless telephone, so that the farmer, or other business man, more or less isolated, who could not profit by the dot-and-dash message, may be able to listen to the spoken message.

More Good News for the Amateur

The Government has just announced that it will broadcast Radio Telephone News at stated hours during the day. This will supplement the Market News Service reported in these columns some time ago.

This new step by the Government will probably do more than anything else to popularize Radio and it will be the cause of loud-speaking Radio Telephone Receivers being installed in many places to entertain the public.

If our Radio Manufacturers can read between the lines, they will see that this will be a tremendous opportunity for them to put standard outfits on the market to enable laymen to receive Radio Telephone news to their heart's content.

—Editor.

The Commission's work of investigation will be divided with Mr. Howell in charge of ways and means; Mr. Wheeler in charge of news copy and service, and Mr. Edgerton in charge of apparatus, stations and operations.

The plan proposed is to utilize the major radio stations of the air mail service, each about 400 miles apart, and stretched across the United States, as stations from which to disseminate this news by wireless telephone. Each station will serve approximately 125,000 square miles of territory. Wireless telephone stations may be established and maintained in homes and places of business at approximately the small outlay of \$35 for the receiving set. There are no wires to bother with. A very simple antenna may be made from a single strand of wire stretched from the top of a house to another nearby building, says a bulletin issued by the Commission.

Amplifiers may be used so that large audiences, if desirable, can hear what is spoken. Several banks, farm houses, and county agents have signified a desire to install re-

(Continued on page 226)

The Termoionic Valve

We present to the radio fraternity herewith one of the great documents of the age. It is taken bodily from no less a paper than the Sunday "New York Herald" of June 12th. We have taken pains to copy the article verbatim, but the italics are ours. It seems that the correspondent of the "New York Herald" interviewed Senator Marconi at Fiume on May 28th, sending the dispatch to the "Herald." He was invited on Marconi's yacht "Elektra," and our readers will agree with us that he has seen many marvelous things. Just to mention a few: There were "termoionic valves," "sensitive revelations of the electric waves," "electric light bulbs which have been made a vacuum," "electrons attracted to a cold band," "size of the electro-magnetic waves varied by the human voice," "messages received on special 'semi' (?) vertical antennae," etc., etc.

We guarantee every reader an interesting ten minutes in the careful perusal of this article, which we might have dubbed "Unconscious Humor" or "The Vacuum Inside the Correspondent's Head." With all due respect to Senator Marconi, we must say that he has probably never in his wildest dreams uttered such an amount of crass nonsense as the special correspondent of the "New York Herald" attributes to him. It is a pity that our great dailies should assign non-technical men to important interviews.

THE "mystery cabin" on board the *Elektra* is quite small. Perhaps 12 feet by 12 feet by 8 feet. In spite of the weight of material there appears to be plenty of room. With the assistants we were at one time twelve people inside. But arrangement is the great thing. All the apparatus is fixed on screens and narrow shelves around the wall and made fast. For the unwary notices are appended: "The apparatus on this screen must not be touched unless current is off." In almost the center is a generator in a box 3 feet cube. The apparatus used for the experiments that morning was what is called "a piano cabinet telephone set," working from a one-half kilowatt generator. It works with the continuous wave system and is also fitted with a Morse code apparatus and a buzzer for wireless telegraph purposes. The telephone apparatus is the same as might be found in any office for speaking purposes. From this apparatus on board the yacht it is not pos-

sible to speak and hear at the same time except from two separate apparatus. But Senator Marconi said a new apparatus is now under construction which is easier to manipulate than this experimental one.

"PIANO" SET RECEIVES MESSAGES FROM UNITED STATES TO NAPLES

The "piano" set can receive wireless telegraph messages from the United States of America to Naples, and its telephone radius is always good for 200 miles, and on occasions has received and spoken up to 400, for instance, from Biscay to Poldhu. This set is the ideal set for all ordinary merchant vessels and costs from 500 to 600 pounds.

In the corner next to it are two ships' spark transmitters, working from the one-half kilowatt generator and capable of 200 miles radius. This system has been superseded by the valve (continuous wave) transmitter, but is carried on the *Elektra* in case of an SOS being received and for experimental purposes.

The beauty of the room, however, is the large valve transmitter working from the 3 kilowatt generator. Her distance is 1,500 miles. It is through her that the *Elektra* carries out the greater experiments, her talks with Poldhu, Chelmsford, Paris. Through her she needs no newspaper on board. By radiotelegraph or radiotelephone she receives when she wants all the news of the day. In a few short minutes, by merely altering the wave-length, we were picking up Paris with a lengthy 12 o'clock wire; a turn of the button to a longer wave and it was Nauen wirelessly a long message to New York. Two minutes later, Lyons. It was interesting to learn that Nauen transmits at a faster rate than any other station.

What, however, interested the uninitiated among us was the fact that the work appeared to be connected with a number of small glass tubes, which lit up as the current was turned on. These are the *termoionic valves*, the first of which was invented by Prof. Fleming of University College, London, consulting engineer of the Marconi Company, in 1904. The *termoionic valve* insured to radiotelegraphy and radiotelephony new and extremely sensitive revelations of the electric waves, new and efficient productions of oscillation. This valve has the ordinary appearance of an electric lamp. When it is used as a trans-

mitter it replaces the complicated sparking apparatus and the big high frequency alternators. Its efficiency, its invisible working and its silence, with the fact that it produces most marvelous results over thousands of miles, as, for instance, between England and Australia, proves that it is one of the most marvellous applications of physics yet known. Said Senator Marconi:

"To understand the working of the valve and the results it has given in radiotelegraphy and radiotelephony it is necessary to speak of the electronic theory. Electrons are contained in all conducting bodies at their ordinary temperature, but by rendering incandescent a thin metallic wire placed in space the electrons jump away from the metal in the same way as when water is heated—the molecules of the liquid break away and form vapor. If a metal filament is placed in a glass tube, such as an electric light bulb, which has been made a vacuum, and is surrounded by a metalband kept cold, it is noticed that when the filament is made incandescent a certain number of electrons break away from the incandescent filament and are attracted to the cold band.

"In such a case by switching into the space between the filament and the cold band an electric power this space becomes a conductor—that is, allows an electric current to pass, but only in one direction.

"If a metallic net is then placed between the filament and the cold band the electronic current is stopped, because a large number of electrons which are jumping off from the incandescent filament become absorbed by the metal, which becomes a potential negative. By neutralizing this potential negative with a small electric power the electrons are again free; therefore with the smallest variations of power on the metallic net there are very great variations on the electronic currents produced by the valves.

WEAKEST SOUNDS ARE AMPLIFIED BY MEANS OF THE METAL NET

"By attaching the metal net inductively to the antennae of the radiotelegraph station and receiving the smallest variations which are produced by the radiotelegraph signals they in their turn produce very strong variations of the current heard at the telephone. Thus with this system the weakest sounds are amplified, reinforced and rendered perceptible. Varying the potentiality

(Continued on page 223)

Effect of Counterpoise on Antenna Resistance

By Maurice Buchbinder

The resistance of an antenna is normally a function of three factors, only one of which is useful. These factors are dielectric losses, ohmic losses and radiation resistance. It is the object of antenna system design to make the first two factors as small as possible, in comparison with the other. In the course of this article, it will be shown how, by the use of a counterpoise, it is possible to greatly reduce the deleterious components of resistance, keeping the useful component substantially constant.

We first give a brief theoretical discussion of the above mentioned factors. By dielectric losses is meant the energy dissipation on account of the fact that the dielectric *e. g.*, the space between the antenna and the effective ground, is in part poorly conducting earth and poor dielectric. The losses from this source increase linearly with wave length. That is, if R_d be called the dielectric loss then $R_d = a\lambda$.

By ohmic losses is meant the energy dissipated in the conducting wires and earth by currents. Excluding the skin effect for short wave lengths $R_o = b$.

Finally the radiation resistance is $B_r = 1600 h^2$

$$\frac{1}{x^2}$$

in consistent units where h is the effective height of the system. It should be noted that the effective height is not constant

This chart shows the advantage of the counterpoise over the ordinary ground.

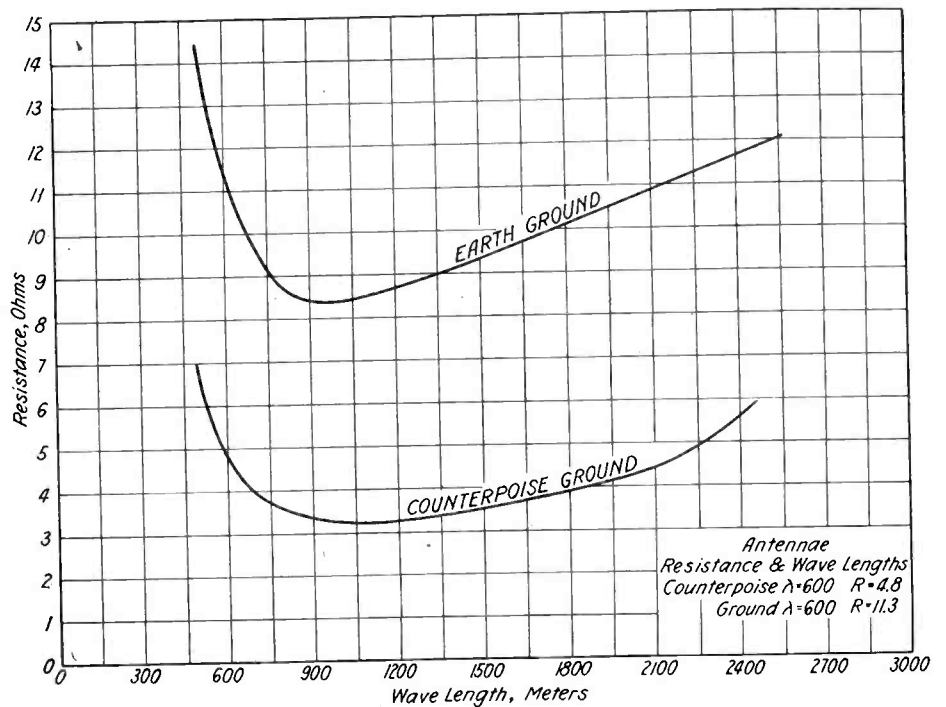

but varies markedly near the fundamental of the antenna due to change in the current distribution.

Now the effective height of a system will be substantially the same if it is a ground

system or a counterpoise system, provided the counterpoise is not lifted too high off the ground and is adequate in size. It follows that any advantage in a counterpoise (Continued on page 261)

Etherless Wireless

By O. H. KNAPP

Mr. Gernsback's editorial, "Fool Ideas," urging the amateur to pursue the untrodden path, is to blame for my reporting the following experiments:

Several months ago, while making a study of the usual method of reception, loop reception, directional reception, and underground antenna, I decided that long-distance reception depended upon energy received, not by high-frequency electromagnetic and electrostatic induction (the ether wave), but by earth conduction.

My home is in the country, nearly due west of Sayville and North Annapolis, so that I have unusual opportunities for experimenting with directional work in the open. To further investigate this idea of conduction, I devised and carried out several experiments which were interesting, as the results were exactly as predicted.

In this work a long-wave, single-tube receiving set of the usual type was used. One terminal of the open circuit was grounded through a small iron stake, and the other (antenna) terminal was connected to 250' insulated wire laid on the ground in an east-and-west direction (A). This, of course, constituted a very low antenna, and I could read Sayville, but he came in rather weak. The free end of the wire was now grounded through another iron stake, whereupon the signals from Sayville were increased many times, coming in stronger than on my 90' elevated antenna.

The 250' wire no longer acted as an elevated capacity, but as a mere conductor between two points of different potential on the earth's surface. Any potential wave advancing along the earth's surface will produce this difference at the two grounds, unless the crest of the advancing wave reaches both grounds at the same time, a condition possible only when the origin of

the wave lies in a line at right angles to a line joining the two grounds. The fact that Annapolis could not be heard when the grounds were in the east-and-west position seems to substantiate this view. The grounds were then changed to a north-and-south line and Annapolis came in so loud that I could read him 10' from the phones. With the grounds in this position Sayville came in very weak.

The distance between grounds was reduced with a corresponding reduction in signal strength, but I could hear Annapolis when the grounds were less than 2' apart. By describing a 10' circle with one of the grounds the other ground, acting as center, a station which could be heard strongest at 0°, could not be heard at 90°, came in as loud at 180° as at 0°, and again became silent at 270° (Fig. C). The above experiments were carried out on damp ground. A series condenser was used in the open circuit. When this condenser was cut in parallel it did not function, and very close compiling between open and closed circuits became therefore necessary.

It may seem that my hook-up is merely a loop with ground return, but this is not true, since a single loop of like dimensions can in no way equal the results of the double ground. I would rather believe that the loop, particularly at long distances, depends upon these ground waves which are equivalent to charges moving vertically and therefore capable of inducing potentials in the vertical elements of the loop.

With the grounds 250' apart in an east-and-west direction, I have read YN without the least trouble when I was unable to get him with my regular elevated antenna.

Earth conduction will, I believe, explain many things in radio, and I would certainly like to hear what some other experimenters have to say on this subject.

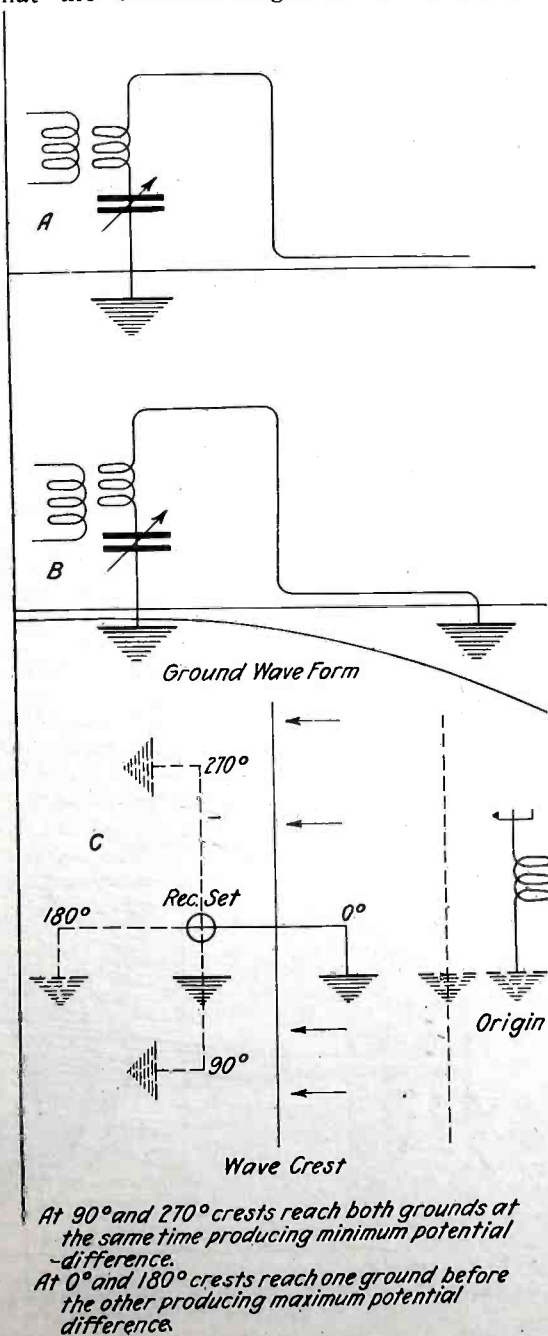

At 90° and 270° crests reach both grounds at the same time producing minimum potential difference. At 0° and 180° crests reach one ground before the other producing maximum potential difference.

Awards of \$100 Radio Accessory Prize Contest

- 1-Knob
- 2-Brass Rod
- 3-Switch Lever
- 4- " "
- 5- " Points
- 6-Insulation
- 7-Washer
- 8-Panel
- 9-Brass Tube
- 10-Soldering Lug
- 11-Spring
- 12-Nut
- 13-Soldering Lug
- 14-Spring
- 15 Nut

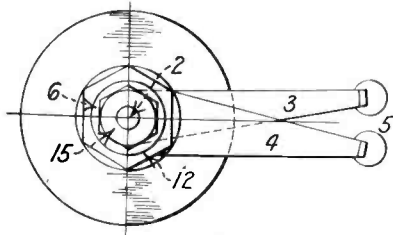
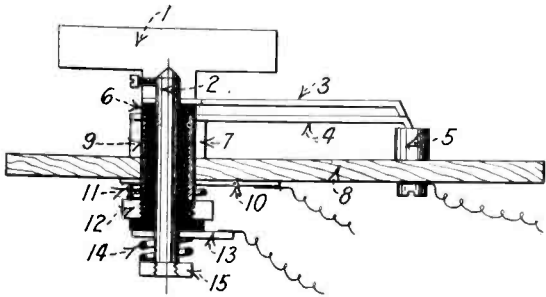

Fig. 1

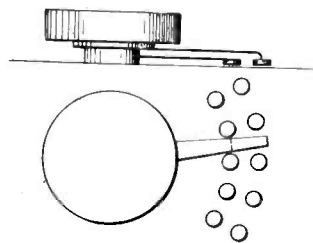

Fig. 2

With this type of switch two circuits may be tuned at the same time or it may be used as a D.P.D.T. of a new design.
Designed by Bernard Lintzman.

WE present on this page several of the accessories which were awarded prizes in our RADIO ACCESSORY CONTEST. Altogether 2,249 ideas were submitted and the ones shown on this page, and in subsequent issue of this magazine, are only a very small percentage of the ideas submitted. Frankly, we were somewhat disappointed in the quality of the suggestions received because very little that is really new and startling was submitted.

Many contestants did not understand the rules, some of them submitting, for instance, constructions of an amplifier, or complete radio sets, which was of course not what we wanted. Most of the other ideas were old, very old, re-invented while the rest were not suitable nor practicable. Entries were received from practically every country of the Globe and although quite a good deal of originality was displayed, there really was not a single idea that could be termed startling or brilliant. The contest itself may be termed a huge success if the quantity of replies is considered. It seems to show that there is a great and real need for improvements in the small, and oftentimes unseen, accessories of present Radio Outfits.

—Editor.

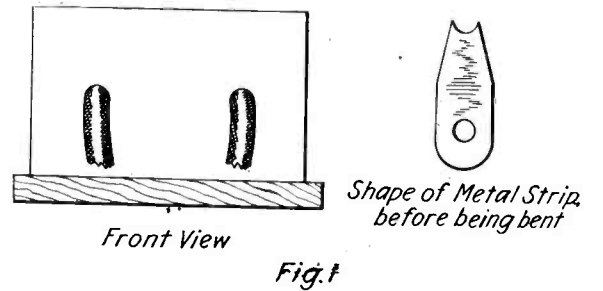

Front View

Shape of Metal Strip before being bent

Fig. 1

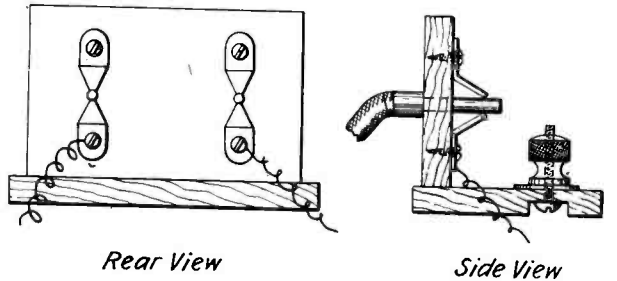

Rear View

Side View

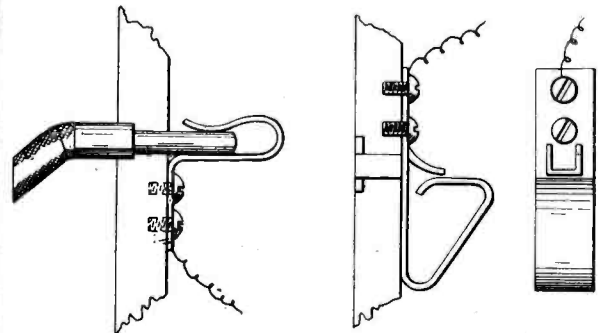

Fig. 2

Fig. 3

With These Devices the Telephone Cord Tips Are Used as Plugs.
Designed by Richard Carsten.

Prize Winners

- First prize, \$50.00.
Mr. Bernard Lintzman,
1823—19th St., Omaha, Neb.
- Second prize, \$20.00.
Mr. Keith la Bar,
3207 E. 27th St., Kansas City, Mo.
- Third prize, \$15.00.
Mr. Richard Carsten,
1400 E. 76th St., Chicago, Ill.
- Fourth prize, \$10.00.
Mr. Malcolm Gager,
1430 College St., Scranton, Pa.
- Fifth prize, \$5.00.
Mr. Philippé A. Judd,
1814 Gallia St., Portsmouth, O.

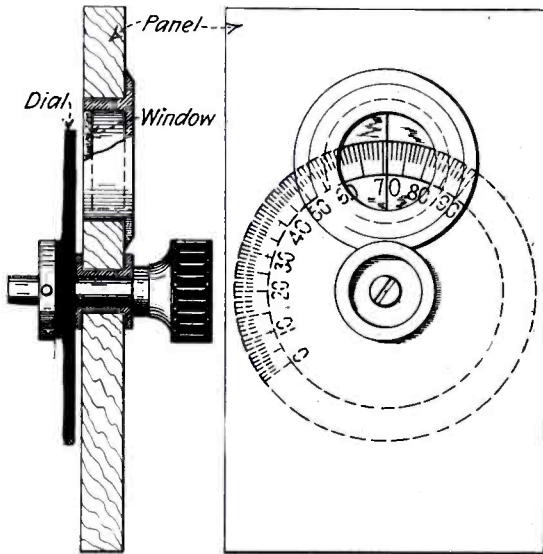

With This Little Window Only the Useful Portion of the Scale of the Dial is Shown as it is Mounted Behind the Panel.
Designed by Philippé A. Judd.

First Prize A D. P. D. T. SWITCH By Bernard Lintzman

In the new type of switch I designed, the knob is an ordinary composition knob with a set screw. The shaft is composed of two electrically independent parts, one a brass rod and the other a brass tube separated by an insulating flanged tube. These parts are fitted tightly together.

There are two blades, the upper one is freed onto the brass rod and is longer than the other. It is separated from the other blade by the insulating flange. The lower blade is fastened on the brass tube. There is a brass washer to keep the blades away from the panel. Contact is made by two coil springs, one on the brass tube and one on the rod; the one on the tube also serves to give the proper tension to the levers.

The switch can be made to any size and fit panels one inch thick. The diagram is self-explanatory.

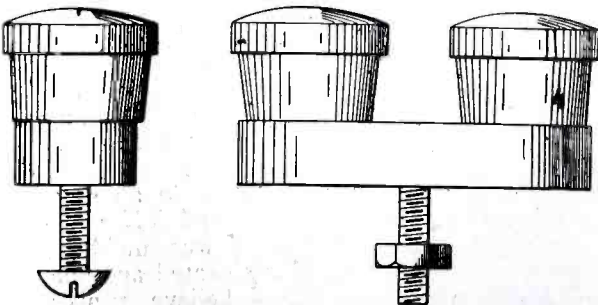
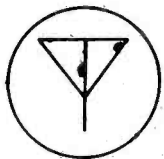

These Binding Posts Are Engraved With a Letter or Symbol Avoiding Any Wrong Connections or Engraving of the Panel.
Designed by Keith la Bar.

Honorable Mention

- Mr. Frank Dieringer,
441 W. McMicken Ave., Cincinnati, O.
- Mr. Philippé A. Judd,
1814 Gallia St., Portsmouth, O.
- Mr. Rudolph R. Young,
Gray, Pa.
- Mr. Richard Baker,
2716 Baldwin St., Los Angeles, Cal.

Editor's Suggestion:

By making one blade shorter and sliding on another set of points as in Fig. 2 the switch may be used as a D.P. multi-throw switch to tune 2 circuits at the same time.

SECOND PRIZE.

Engraved and Double Binding Posts.
By Keith La Bar.

Idea number one, an engraved binding post. These binding posts, which can be engraved with the symbol or letter designating the different parts of the apparatus, can
(Continued on page 267)

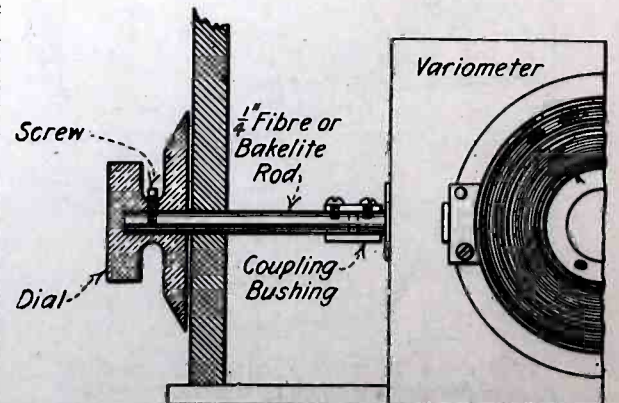

A Clever System of Coupling for Variometers Avoiding the Capacity Effect of the Operator's Hand.
Designed by Malcolm Gager.

Measuring the Characteristics of Vacuum Tubes

By LELAND J. LEASE

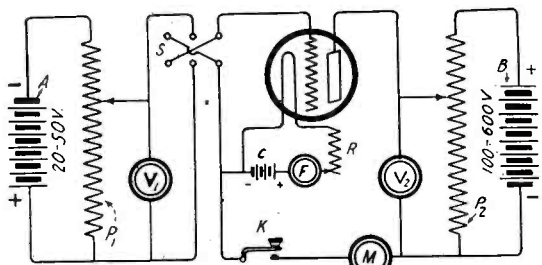

Fig. 1

Using This Circuit, the Various Characteristics of a V.T. May be Found.

IN the current literature on vacuum tubes we often find quite a discussion about their characteristics, but seldom do we find much about the actual measurement of these qualities, so that the average amateur may understand what they are and have a workable way of finding them. It is the purpose of this paper to explain to the amateur something of what these things mean and to give him a working method of measuring them with the apparatus he may have on hand.

Our work will concern: (1) the curves showing the effect of the grid and plate potentials and the filament current on the plate current (2) the amplification factor; (3) the internal plate impedance.

In the vacuum tube the heated filament throws off electrons. These have a negative charge. Now, if a positively charged body is placed in the field about the filament, these electrons will be attracted to it. Hence, we have the "plate" in the tube made positive by the "plate battery." When the negative side of this battery is connected to the filament, a current will flow from the filament to the plate, through the plate battery and phones to the filament again, but not in the reverse order. The greater the positive potential on the plate, the greater the number of electrons attracted, and hence the greater the plate current, up to saturation limit. This effect of plate potential is one factor that we propose to measure.

Suppose that now we put a grid in the field between the filament and the plate. If we put a slightly negative potential upon this grid, it will repel these electrons somewhat, causing fewer to go to the plate, hence there will be less plate current. If the grid is made sufficiently negative the plate current can be stopped entirely. Therefore it is easy to see that if we had a pulsating potential upon the grid, the plate current will pulsate in synchronism with it. This is another factor that we shall measure.

If we increase the temperature of the filament, more electrons will be emitted, hence the plate current will increase. This is the third factor that we propose to measure.

For the tube that you wish to test, find

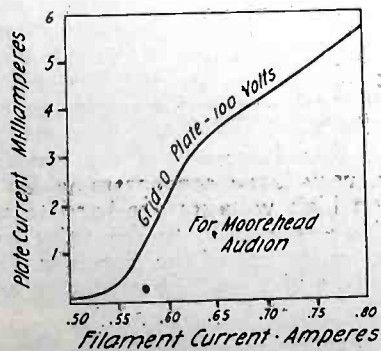

Fig. 3

Characteristic Curve of a Moorehead V.T.

out the maximum filament current and plate potential as given by the manufacturers as a guide and safety limit in your work, and do not exceed them much in your work. In the table below are given these limits for a number of the common tubes:

Tube	Fil-Amp.	Plate-Volts
Audiotron	.85	at 6 V 60
A-P Detector (Electron Relay)	.60	at 4 V 30
A-P Amplifier	.70	at 5 V 100
A-P Transmitter	.80	at 6 V 500
Radiotron UV 200	1.1	at 5 V 30
Radiotron UV 201	1.1	at 5 V 100
Western Electric VT1	1.1	at 4 V 40
Western Electric VT2	1.36	at 7 V 400
General Electric VT18	6.5	at 10 V 800
French Tube	.7	at 4 V 400
General Electric UV202	2.35	at 7.5 V 350

Let us study these changes separately. Set up your apparatus according to Fig. 1.

A is a battery or motor generator of from 20 to 50 volts as a source of grid potential. P₁ and P₂ are "slide wire" potentiometers of about 2,000 to 3,000 ohms for the regulation of the grid and plate potentials, respectively. B is a battery or motor generator of about 100 to 600 volts

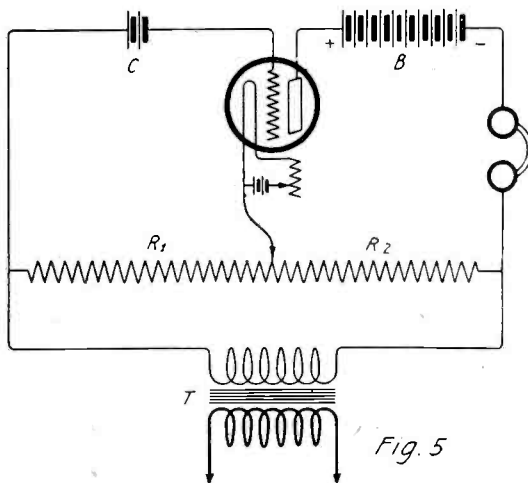

Fig. 5

This Hook-up of a V.T. is Used to Determine the Voltage Amplification Factor of the Tube.

for plate potential. V is d. c. voltmeter of a range of about 0 to 50 volts for measuring the grid potential. V₂ is d. c. voltmeter of about 0 to 600 volts for measuring the plate potential. M is a d. c. milliammeter of about 0 to 50 milliamperes. F is a d. c. ammeter of about 0 to 5 amperes to measure the filament current, and should preferably be read by steps of .05 amperes. K is any S.P.S.T. knife switch. R is the filament rheostat of about 0 to 10 ohms. C is the filament battery of six to eight volts. S is a reversing switch for the grid. It may be said here that reliable voltmeters and ammeters are necessary, if accurate work is to be expected.

The layout should be made neatly and systematically on the table with short, clean wiring and with the meters arranged for easy reading. This set-up will do for all the "curve measurements."

Suppose we wish to find the variation of the plate current with plate potential. The ammeter in the filament circuit is set by means of R to read the current recommended by the manufacturers for the particular tube you are using. The slider on P is set so as to make zero grid potential and S is closed and left alone. P₂ is now regulated so that the voltage on V₂ is changed by regular steps of from 5 to 50 volts, according to the tube used. The key K is closed after each change

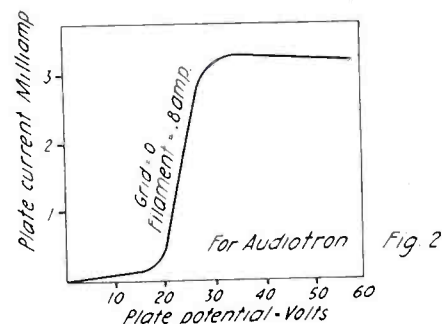

Fig. 2

Characteristic Curve of an Audiotron Tube.

for a long enough time to read the plate current in M. K is not kept closed, because of the danger of heating the plate too much and also to get rid of the effect of ionization in gas filled tubes. Plotting the plate potentials as abscissae and the plate current as ordinates will give us the curve of plate current vs. plate potential.

For an Audiotron this curve will be something like Fig. 2.

Next, we may leave the plate potential constant as recommended for the best operation of the tube and vary the filament current by steps of .05 amperes from maximum downward, reading the plate current as before. This gives us the curve of plate current vs. filament current, as in Fig. 3, which is for a Moorehead Audion A "hard" tube.

To get the effect of the grid potential, proceed as follows: Set the filament at the recommended operating value. Now set the grid at 0 and plot the plate current for the various plate potentials as in our first test. Next set the grid at -2 volts and repeat. Now reverse the grid to +2 volts by means of the switch S and repeat. This is continued for a range of 10 to 40 volts on the grid, depending somewhat upon the tube you are using. Plotting these results will give the set of curves similar to Fig. 4, which is for a Moorehead Audion A.

AMPLIFICATION FACTOR

The voltage amplification factor is the ratio of the plate and grid variation which will produce an identical variation of the plate current. If K be this factor V_p the plate potential, V_g the grid potential, then

$$V_p \text{ change} = K V_g \text{ change,}$$

$$V_p \text{ change}$$

and

$$K = \frac{V_p \text{ change}}{V_g \text{ change}}$$

This would mean that it would take a change in the plate potential K times as large to cause the same variation in the plate current as a given grid potential.

(Continued on page 265)

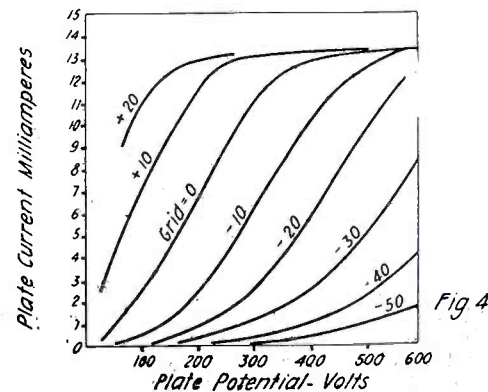

Fig. 4

This Curve Shows the Voltage Amplification Factor of a Moorehead Tube.

Rectifying A. C. for Vacuum Tubes

By L. R. FELDER

It is well known that for Radio telephone work the plate voltage applied to vacuum tubes must be constant voltage. It is desirable and preferable, if possible, that D. C. also be used for telegraphy, although it has been pointed out by several people that for telegraphy A. C. voltage may advantageously be employed. However, in telephony, straight D. C. is necessary for best results. With receiving tubes this D. C. is obtained by the use of batteries. In the case of transmitters this is not practicable as the voltage and power required are much higher than those for receiving tubes and the batteries which are used cannot supply these.

Direct current generators developing the required voltage and power are therefore used. Whether this is the most feasible and practicable solution from the amateur's point of view depends upon several considerations such as: (1) The apparatus the amateur has available; (2) the expense involved in rigging up a D. C. generator outfit as compared with other methods of obtaining D. C.; (3) the source and kind of power available in his house.

If the amateur has a D. C. generator of the necessary voltage and power, with a ready means of driving it, then he is very well off indeed and has nothing to worry about. But for the amateurs who have not

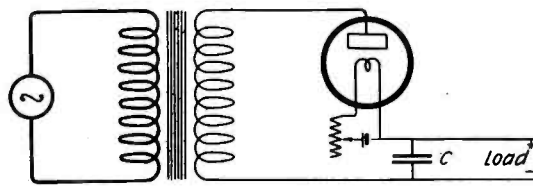

When Only One Rectifier Tube is Used, Only One Half of the Cycles is Rectified Producing a Pulsating D.C.

A. C. for amateurs presented some difficulties due to inexpensive rectifiers not being available for amateur purposes. However, this is no longer the case.

A complete understanding of the physical actions taking place in the rectifier tubes and their associated circuits, together with a knowledge of the principles involved in choosing rectifier circuit, will be of great assistance to the experimenter and will enable him with very little trouble to design his own circuits.

Fig. 1 shows the simplest form of tube rectifying circuit employing but one tube. Fig. 2 shows the two-tube rectifier. The one-tube rectifier of course rectifies but one-half of the wave, whereas the two-tube circuit rectifies both halves. Although the latter circuit requires a second tube, this increased expense is warranted by the increased efficiency and satisfaction thus obtained. The following discussion will, therefore, consider the two-tube rectifier.

Consider the circuit in Fig. 2, and assume that the alternating voltage between the terminals of the transformer secondary is represented by Fig. 2a. During the upper half of the wave, point A of the transformer is positive and current therefore flows through rectifier valve 1 into condenser C at terminal a. Thus terminal a of the condenser C is positive and a D. C. flows from C. During the lower half of the wave the positive potential is now at terminal B of the transformer and current therefore flows now through rectifier valve 2 into condenser C at terminal a. Thus terminal a of condenser C is again positive and the D. C. is supplied again by the condenser. In this way a continuous supply of D. C. is available at the condenser C.

No matter what the direction of the A. C. voltage, it is evident from the above that the valves permit current to flow into the capacity C in only one direction and thus enables a continuous current to be delivered. As long as the transformer voltage is higher than the condenser voltage, there will be an excess of voltage on the plates of the rectifiers and current will flow through the valves into the condenser. But even if the

condenser voltage should become higher than the transformer voltage (which it never does, by the way) there would not be a reversal of the flow of current, as the valves conduct in but one direction, thus assuring direct current.

The capacity C behaves in the fashion of a storage tank which stores electrical energy during the period in which the transformer supplies it, and then delivers this energy in the form of direct current throughout the whole period of operation. Thus the larger the condenser the less would be the drop in the terminal voltage of the condenser as it delivers this energy, and consequently the smaller would be the fluctuation in the rectified D. C. voltage which is what is desired. This will be more evident from the explanation of Fig. 3. The sinusoidal full-line curve represents the terminal voltage of the transformer secondary. The dashed curve represents the voltage across the condenser terminals, which, it is seen, is direct voltage. At point 1 the condenser is fully charged to the maximum voltage of the transformer. That is, current flows from transformer through recti-

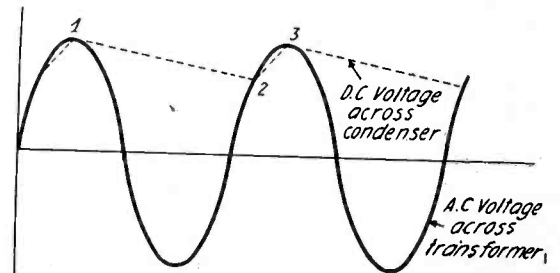

Fig. 3

The Sinusoidal Line Represents the Terminal Voltage of the Transformer Secondary. The Dashed Curve Represents the Voltage Across the Condenser.

fier valves into the condenser until the condenser is fully charged to maximum. This condenser voltage, therefore, bucks the transformer voltage and since they are equal, there is no longer any current flow. The condenser furthermore does not receive any more current for the maximum portion of the cycle up to point 2. However, it is delivering a direct current to its load and consequently its terminal voltage is steadily falling as seen from the slope of the dashed line. The larger this condenser C, the more electrical energy it can store and therefore the smaller will be the drop in condenser voltage. When the condenser voltage reaches the value at point 2, the transformer voltage has also reached that value and thereafter for the remainder of the cycle the transformer voltage is higher than the condenser voltage. Thus there will again be a flow of current into the condenser, charging it once more until its voltage reaches the maximum represented by point 3. Then the same actions take place for the rest of the cycle as before.

From the diagram and explanation it is evident that the condenser receives energy during a fraction of the alternating current cycle and delivers it the maximum portion of the cycle. The larger the condenser the more horizontal will be the condenser curve 123, that is, the less will be the fluctuation in the D. C. voltage across the condenser. However, very large condensers which will hold up on high voltages are hard to make and so there is a limit to the value of C. However, by the use of the circuit in Fig. 4, smaller values of C may be used with excellent results.

The effect of the inductances and con-
(Continued on page 240)

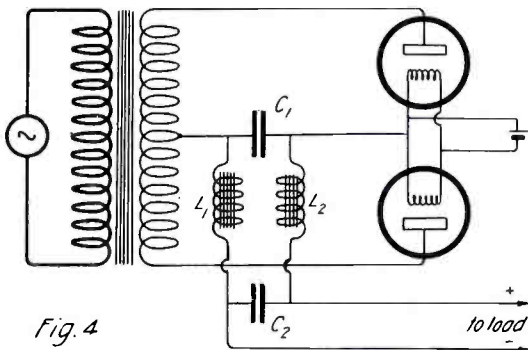

In This Diagram are Shown the Choke Coils and Condensers Used to Smooth Out the Slight Variations of Voltage of the Rectified Current.

this apparatus—and they are legion—the problem must be carefully considered. The cost of a D. C. generator outfit is very high, and it can safely be said that it is much higher than an outfit for rectifying A. C. The kind of power available in most districts is A. C. and where this is available and the amateur has no D. C. generator the best solution to the problem of obtaining D. C. is to rectify the A. C. which is at hand. This solution will be found satisfactory both from an electrical and economical point of view. If the power supply is D. C. this cannot be done, of course.

The use of rectified alternating currents offers some advantages which are not had when a D. C. generator is used. For example:

1. The plate voltage can be made as high as the tube will stand, and thus greater output is secured, or it can be made as low as you please and thus transmit at low powers. That is, the use of a transformer means flexibility and permits of plate voltage variation over a wide range. D. C. generators usually operate at fixed voltages or within a very narrow range.

2. The use of A. C. on the filament is available. This permits of an equalization of plate current in both legs of the filament, thus preventing excess current in one filament leg and decrease of the life of the tube. This is not secured with D. C. operation.

Up to the present time rectification of

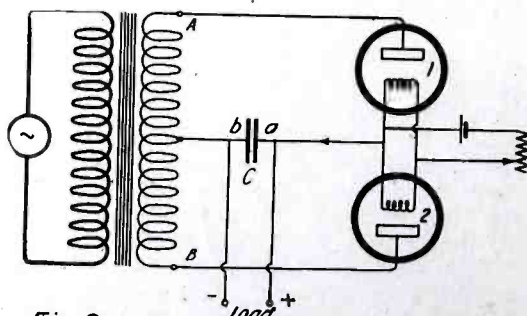

Fig. 2

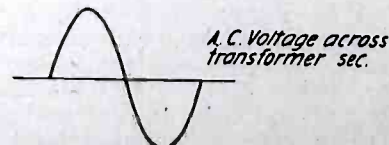

Fig. 2-A

This is the Standard Hook-up for Rectifying A.C., Through Kenotron Tubes, for C.W. or Radiophone Work.

"A" and "B" Batteries on 110 Volts A. C.

By JERROLD SWANK

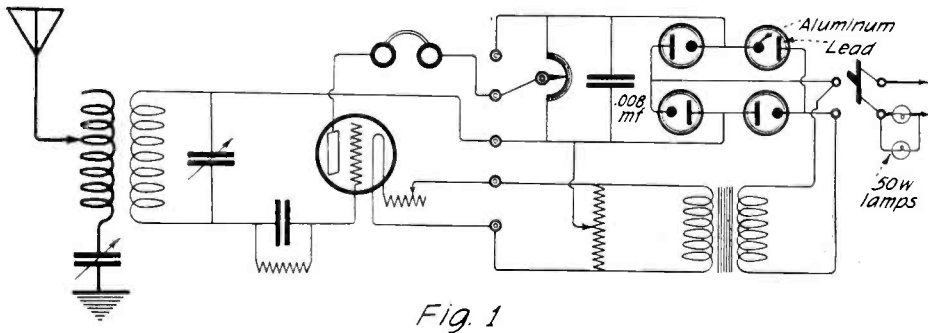

Fig. 1

On the left Fig. 1 shows the connection of the rectifier used in conjunction with a standard receiving circuit. While on the right the sketches are of the control panel and one rectifier unit.

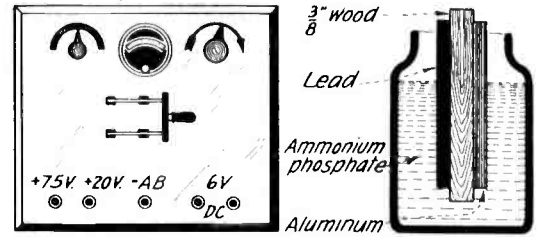

Fig. 3

Fig. 2

At last you can cut the high cost of operating V.T.'s. This combination H.V. and L.V. cabinet supplies both plate and filament current. It is very easy to make and should prove worth while. The six-volt filament current is supplied by a small step-down transformer, see page 447 of the January RADIO NEWS.

The "B" battery is supplied by an electrolytic rectifier from 110 volts A. C. Not much explanation is necessary here, as the drawings explain it very well. The rectifier consists of four pint Mason jars, each containing a sheet of lead and a sheet of aluminum separated by a 3/8" piece of hard wood. They are immersed in a saturated solution of ammonium phosphate. The con-

nection is shown in the wiring diagram. This arrangement rectifies both valves of the cycle and with the .008 M.F. condenser, gives a steady D. C. of about 75 or 80 volts, which is regulated by the potentiometer. This could be used for the plate of a short distance radiofone using the entire 75 or 80 volts. The voltmeter, while not absolutely necessary, is advisable to adjust the plate voltage for receiving, and should read up to at least 80 volts D. C. The stepdown transformer should, of course, have a secondary voltage of six volts. Fig. 3 shows how this may be used for a detector and two-step amplifier, using 22 1/2 volts on the plate of the detector and 75 to 80 volts on the plate of the amplifier tubes.

The operation is as follows: The cabinet is connected to the receiving set as shown and the 110 volt switch is thrown in. The regular rheostat is then used to adjust the filament temperature, after which the extra rheostat is adjusted until the A. C. hum is eliminated. The "B" battery potential is adjusted by the potentiometer on the rectifier cabinet. The extra rheostat must be of about 25 ohms. This device eliminates the necessity for both "A" and "B" batteries, is much cheaper both in first cost and operating expense, and furnishes a plate potential up to about 80 volts, which should be valuable in a combination radiofone and receiving set, or in either one singly. The writer will be glad to answer any inquiries in regard to the construction or operation of this outfit.

Throw That "B" Battery Away

By CHARLES L. WHITNEY

The following will describe a system I have worked out for doing away with a special "B" battery in operating an audion, or V.T.

No high voltages are used, and the danger of burning out the phones or the primary of the amplifying transformer is reduced to a minimum, besides providing a more compact arrangement for portable apparatus using an audion.

All that is necessary is a six-volt battery to run the filament.

The first hook-up is shown in Fig. 1. In this case a variation from zero to six volts is provided in the plate circuit by using the potentiometer connected across the "A" battery.

Fig. 2 shows another arrangement which provides a fixed voltage for the plate, this being whatever voltage the "A" battery happens to be. No variation is allowed in this circuit.

In Fig. 3 the voltage for the plate is taken from the drop across the filament terminals and is variable by means of a poten-

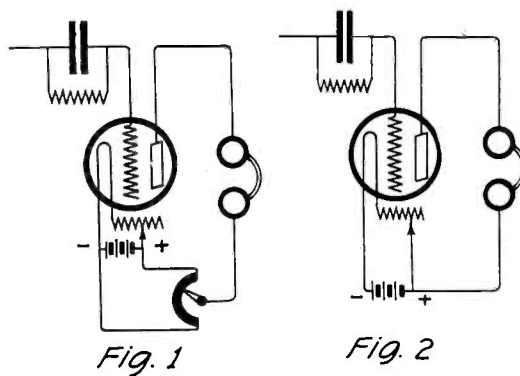

Fig. 1

Fig. 2

By Using the Drop of Voltage of the A Battery a V.T. May Function Without Other Source of Plate Voltage.

tiometer, while in Fig. 4, the voltage is taken in the same manner, except that there is no variation.

In experiments, which were carried out for a period of over a year, oscillations were maintained on 600 meters in a circuit shown in Fig. 5, with as low as three volts on the plate, while with another circuit, Fig. 6, on 12,600 meters oscillations were maintained with a voltage as low as 2 to 2.5.

The signal strength on both wave-lengths was slightly reduced when using this reduced voltage, but when using the full six volts, Fig. 2, no reduction in signal strength was experienced, comparing with the usual arrangement where 20 to 60 volts is provided for the plate. POZ, LY, YN, MUU, IDO and the rest of the high-wave fellows came in just the same strength, while spark and CW on short waves was the same. Even down as low as 200 meters amateurs were heard up to approximately 1,800 miles, but no regular tests were held on this wave.

The aerial used was 100' long, four wires 2 1/2' between wires, with an effective height of approximately 50'.

In using this arrangement some tubes were found to work better than others just the same as when using 20 to 60 volt plate arrangement, and even a transmitting tube which was built for 350 to 1,000 volts plate, was used with excellent results.

Now these circuits could be used with a 110-volt D.C. supply (or other high voltage) using an audion which was built for such voltage.

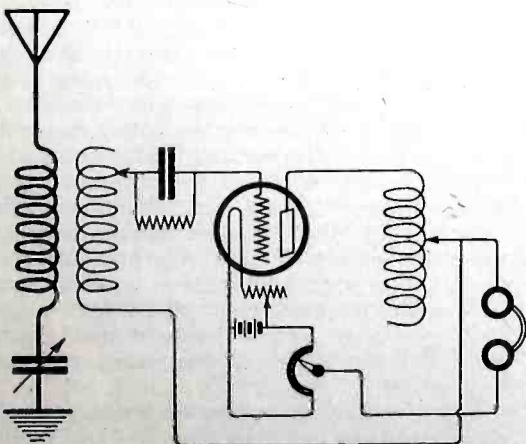

Fig. 5

A Regenerative Circuit in Which No B Battery Is Used.

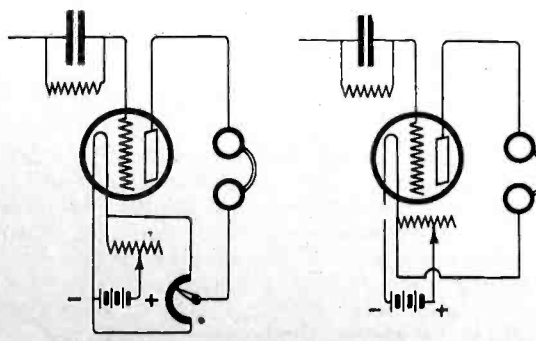

Fig. 3

Fig. 4

Two Other Methods of Using the Drops of Voltage of the A Battery.

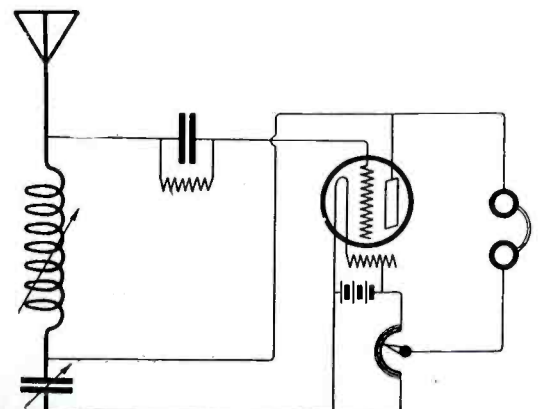

Fig. 6

This Ultra-audion Circuit May Oscillate Without High Plate Voltage.

Radio Digest

RADIO MEDICAL SERVICE.

Through a typographical error, the call letters of the Seamen's Church Institute of New York station were given as KDKE in the July issue of RADIO NEWS.

The correct call is KDKF and in case medical advice is needed by a ship it will be furnished free upon calling this station which is erected on the Institute building, 25 South Street, New York City.

FREE INSTRUCTION IN WIRELESS IS OFFERED.

Announcement is made by the officials of the National Radio Corporation, Inc., Atlanta, Ga., that they are offering a free course in Wireless Telegraphy and operating to those who desire to enter their service or that of the U. S. Merchant Marine. The course may be taken at one of their schools or by correspondence. The salaries range from \$85 per month upward.

The corporation is forming a chain of commercial stations and schools throughout the United States in addition to their manufacturing all kinds of commercial and amateur Radio equipment. This is the first company of its kind to spring up in any Southern State. Every effort is being made to unite amateur and commercial stations according a statement of Mr. A. E. Autrey, president of the company, who for several years trained Radio Operators in Atlanta for service in the Merchant Marine and was for some time connected with the Government there.

Although this offer is limited, considerable time and attention will be given to all applicants.

WIRELESS TELEPHONY EXPERIMENTS IN FRANCE.

Some experiments with wireless telephonic apparatus have recently been made between Sainte-Assise (near Melun) and Beauvais. Transmission and reception were effected by means of valve sets manufactured by the Société Française Radio-électrique using a transmitting energy of not more than five watts. The distance between the two stations is 74 miles.—(Abstracted from the Radio Review.)

STATIONS SENDING MARKET AND WEATHER REPORTS.

Name of Station	Call Letters	Wave-Lengths	Call-Work	Broadcasting Hours
Washington, D. C....	WWX	3800	3650	7:30 and 8:00 P. M.
Hazelhurst, N. Y.....	WWU	3800	3400	
Bellefonte, Pa.	WWQ	3800	3450	
Cincinnati, O.	KDQC	3800	3600	9:00 and 11:00 A. M., 12:00 noon, 7:30 and 8:00 P. M.
St. Louis, Mo.....	KDEL	3800	3750	9:15, 11:30 A. M., 12:30, 3:30, 8:15 and 8:45 P. M.
Omaha, Nebr.	KDEF	2900	4167	9:00, 11:00 A. M., 12:00 noon, 2:00, 3:00, 5:30, 8:00 and 8:30 P. M.
North Platte, Nebr...	KDHM	2900	3400	9:30 A. M., 12:00 noon, 6:00 and 9:00 P. M.
Rock Springs, Wyo..	KEHN	2900	3200	9:00 A. M., 12:00 noon, 6:30, 8:00 and 8:30 P. M.
Cheyenne, Wyo.	KDEG	2900	3800	
Salt Lake City, Utah..	KDEH	2200	3600	
Elko, Nevada	KDEJ	2200	3400	8:30 A. M., 12:00 noon, 4:00 P. M.
Reno, Nevada	KDEK	2200	2800	9:00 A. M. and 1:00 P. M.

Stations are also now being installed at Bryan, O., and Iowa City, Iowa.

The above stations are all 2-KW Federal arc transmitters and are not only used for furnishing communications to the Air Mail Service, but they are also utilized in broadcasting agricultural market reports, and weather reports. Broadcasts are now being transmitted from the stations as shown above at the hours listed.

It is proposed to install radio telephone

RADIO TELEPHONES TO BE PUT ON GERMAN EXPRESS TRAINS.

Wireless telephone instruments will be installed on a number of important German express trains, and receiving instruments will be placed in hotels and embassies, according to an announcement made recently.

Experiments conducted in a moving freight car have shown that the wireless system works well, the men engaged in the testing of the instruments being able to hold conversations with friends in Berlin. The tests were made under the observation of engineers, military attachés and the diplomatic representatives of the United States and Sweden.

It is said that in three weeks it will be possible for travelers on express trains to reserve hotel accommodations by Radio.

Radio Articles Appearing in the September Issue of Science and Invention

Radio Reports Dempsey-Carpentier Prize Fight With Special Feature Illustrations and Story. By Arthur H. Lynch.

British Use Radiophone in Airplane Service.

Resonance Wave Coil Antennae. By Major J. O. Mauborgne and Capt. Guy Hill, S. C., U. S. Army. Part two of specially written article, complete with diagrams and photos—the first authentic article on the use of a concentrated inductance as an antenna for both transmitting and receiving.

A Radiophone Set That Works. By Robert E. Lacault. A clever radiophone and C. W. Set which can be built easily by any radio amateur.

The Transformation of Professor Schmitz. By Geo. R. Wells. A gripping radio-electric tale.

Oracle—Question and Answer Column.

A NEW DIRECTION FINDER.

It is now well known that an ordinary direction finder of the single or crossed-coil type may give very erratic results at night and more especially at sunrise and sunset, the direction of the transmitting station appearing to wander about, the deviation in some cases reaching 90° from the true bearing. In the paper published in the February issue of the *Radio Review* Mr. T. L. Eckersley showed that one of the main causes of this aberration was the presence of a wave with a horizontal electric field coming down at an angle on to the receiver after reflection from the upper atmosphere. Such effects would, therefore, be expected when receiving from an inverted "L" aerial, broadside on to the receiving station, since the horizontal portion would radiate waves polarized in the direction to produce these disturbing effects. The system described by Messrs. Wright and Smith, of the Marconi Co., consists of the well-known combination of the Bellini-Tosi aerial and an open aerial, adjusted to give a heart-shaped diagram with a single zero. The plain aerial effect which was regarded as an evil by the users of the frame direction finder is here made to serve a useful purpose. The diagrams which accompany the paper show how the polar curve would be distorted by the night effect on certain assumptions. These diagrams indicate, however, that a receiver of this type may give very inaccurate results, since, although the position of the minimum remains unchanged, the shape of the curve on either side of it may be very different. If the signals are so strong that the minimum is sharply defined there should be no difficulty; this agrees with the results given in the paper, the signals from Lyons and Clifden being relatively strong. With weak signals, however, where one would find a wider silence range the correct zero could not be determined so accurately. The fact that experimental results agree with those predicted from these diagrams serves as a further confirmation of Eckersley's theory of the cause of the night effects.—(Abstracted from the *Radio Review*.)

LONG DISTANCE WIRELESS TRANSMISSION.

A discussion on this subject took place at a meeting of the Wireless Section of the Institute of Electrical Engineers on May 25. The discussion was opened by Mr. C. F. Elwell, who reviewed the theoretical and experimental work on the subject and maintained that there was no reliable data for the determination of the power required for distances and wave-lengths beyond those covered by the experiments of Austin. He thought that amateurs could assist in collecting data. Admiral Sir Henry Jackson regarded the measurements as too difficult for amateurs, but emphasized the necessity for such measurements being made. Messrs. Round, Eckersley and Lunnon described the work being done by the Marconi Company at Chelmsford, using a carefully calibrated aerial 16 meters high and determining by a substitution method the E.M.F. induced in it by some of the large American transmitting stations. Although varying considerably, the average E.M.F. was 1.8 times that given by the Austin-Cohen formula. The measured E.M.F. agreed fairly well with the field strength of 0.37 microvolts per cm. which we assumed as the basis for the tables of necessary transmitting power.

Captain Lee described somewhat similar measurements made by the Radio Communication Company using a four-foot frame with 120 turns: preliminary tests have given

(Continued on page 259)

Who's Who in Radio

DR. NIKOLA TESLA

No. 8

PERHAPS the ever-broadening field of invention has never known a genius more successful in developing far-reaching and original inventions than Dr. Nikola Tesla, whose name is known in every corner of the globe for his scientific achievements.

Dr. Tesla was born in Smiljan, Lika, border country of Austria-Hungary, in 1857. His early education was obtained in the elementary school of his native place. He continued his studies in the public schools in Gospic, Lika, and after spending a period of four years in the Lower Real School in Croatia, he graduated in 1873.

His parents had originally desired him to study for the clergy, which can be readily understood when one considers that Dr. Tesla's father was himself a very noted clergyman and orator. However, young Tesla had his mind set on mathematics and physics, and after prevailing upon his parents for permission to study engineering, he entered the Polytechnic School at Gratz, where for four years he studied mathematics, after which followed a two-year course in philosophic studies at the University of Prague, Bohemia. His practical career started in 1881 in Budapest, Hungary, where he made his first electrical invention, a telephone repeater, and conceived the idea of the rotating magnetic field, which later made him world famous. It may not be amiss to devote a few moments here to the manner in which this savant approached the idea of the rotating field and inductance motor.

One day, while attending the University, one of the Professors was demonstrating an experiment with the Gramme armature type of dynamo, when the idea occurred to the young physicist that the sparking of the commutator, which he alone had minutely observed, could be eliminated. The professor immediately denied that this was possible, but with a steady mind and self-conviction, young Tesla determined to work out his ideas, with the result that the modern induction motor was developed, which operates solely from alternating current and requires no commutator of any kind, thus overcoming the nuisance of sparking, inherent in former type direct current machines.

Realizing the value of his invention, he left for France in an effort to interest

someone in his device, but his efforts proved fruitless. At the time, he was employed by a prominent European engineering concern, but hearing of the rapid growth of the electrical industry in America, he promptly decided to come to this country, which he did in 1884, and since then has been a naturalized citizen of the United States. To this

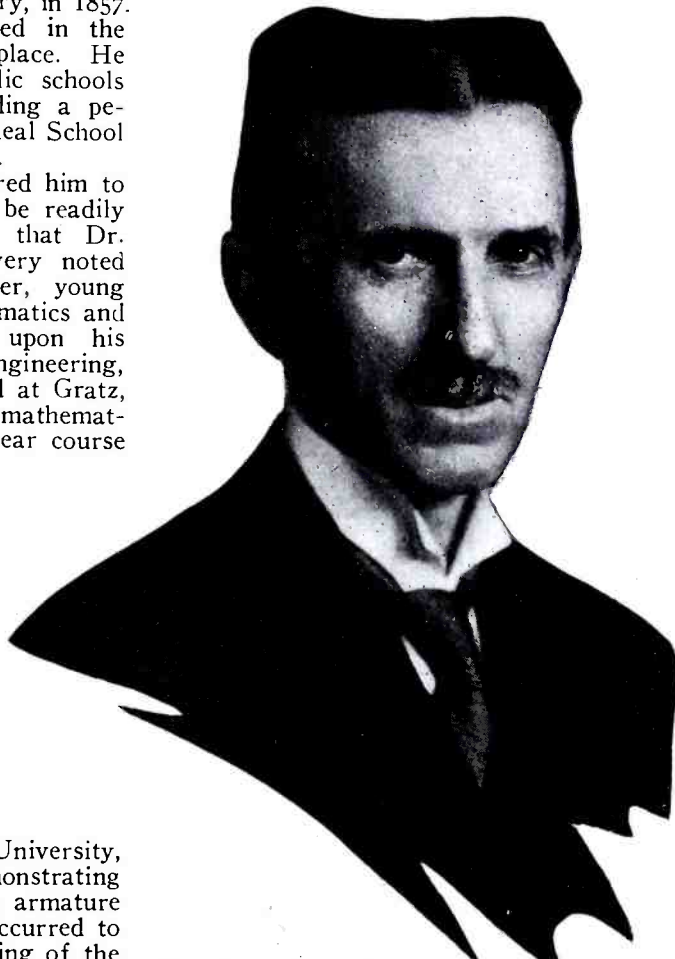

Dr. Nikola Tesla, Who Discovered the Principle of Rotating Fields and Has Invented Numerous Radio Instruments.

country he brought with him the various models of the first induction motors, which were eventually shown to George Westinghouse, the great American inventor, and it was in the Westinghouse shops that the induction motor was perfected by Nikola Tesla. Numerous patents were taken out on this phenomenal prime-mover, all of which are under Dr. Tesla's name, and he was, therefore, the first person, beyond the shadow of a doubt, to introduce the rotat-

ing field principle, in perfecting the induction motor, which is today universally used.

Large sums of money were expended by Dr. Tesla to protect his patents on this prime-mover, and he was at the time not permitted to express himself in print or give the history of his invention; thus, many erroneous impressions were entertained regarding his inventions. He was far ahead of Ferraris, Schallenger and many other early, able investigators.

Later, another type of machine was brought out by him in connection with his work in electric power transmission. This one had a field energized by currents of different phase relation (i. e., while one current was at zero amplitude, the other would be at maximum, etc.), producing a rotating field in which conductors were employed, and in this way the high frequency current was obtained. This type of machine was subsequently developed by Goldschmidt and is now known under that name, although Tesla described this principle in a patent dated 1889.

His next work, which attracted universal attention, was the production of high-frequency currents at high potentials. One of the first high tension apparatus built by Dr. Tesla consists of a step-up transformer, and a specially built kick-coil, which boosted the secondary transformer voltage to an enormous value. The terminals of this coil are connected to the large spark gap, which, when the apparatus was excited, was filled with a spark two feet long. With this device, Dr. Tesla was able to obtain a potential of one million volts, which is quite extraordinary with such a small apparatus.

In 1900 Dr. Tesla obtained his two fundamental patents on the transmission of true wireless energy covering both methods and apparatus and involving the use of four tuned circuits. He also obtained a number of other patents at the same time, describing many other improvements. Among these may be mentioned his application of refrigeration and the oscillatory systems with which he obtained remarkable results in his well-equipped laboratory in New York City.

In 1901 and 1902 several patents were granted to him describing a number of improvements, among which two have assumed great importance in the Radio art: one of these is known under the name of "tone wheel" and the other the "tikker." Others are making claim to these inventions, but Tesla was far ahead of any of

(Continued on page 258)

Should the Government Examinations Be More Severe?

By CHARLES A. REBERGER*

HAVE you been fortunate enough to sail the briny deep as a commercial radio operator and had the misfortune of being subjected to an attack of "mal de mer?" Let us presume you have. I am now assured and you will openly confess that, many a time as you sat in the cosy little radio shack, listening to the numerous ships working, you have more than once been compelled to slam the phones down on the table and murmur to yourself, disgustedly, "Gosh! What an awful 'ham' that is on," or perhaps, "How did that guy ever get away with a license?" or then again, some similar exclamation suitable for describing the "awful" operators on various vessels you happened to hear.

Shameful words to utter about our fellow "bugs," but true; this is the case with

a number of the sea-going operators of today and most of the boys will themselves admit, there would be no cause for such words being voiced had the Government exams. been more severe, thus insuring the type of radio men they would be. Had they been forced to pass a special test in the art of transmitting and the proper method of forwarding the various kinds of traffic to the coast stations, then, as they sallied forth to take up the duties of ship's wireless men, they could rest assured that the qualities of an efficient commercial operator were fulfilled to almost the highest degree. But this is not the only thing which makes a good operator, as will be revealed in paragraphs following.

Deep in our hearts we know that the questions which were asked in the exam-

inations of previous years, were only sufficient to allow us to just barely "get away with it" on board ship. Today the examinations are a little harder, but the questions asked by the inspector are questions which will be of very little benefit to us when a break-down occurs while at sea. When we first boarded our designated ships, little did we know about the forwarding of an "O. L." or the charging of such. Neither did we know (nor does the new operator of today) whether or not there is a charge for obtaining bearings from American or foreign radio compass stations and if so, the way of entering these charges on the abstract sheet. The making out of these abstract sheets was more than a puzzle and the charging of radiograms a mys-

(Continued on page 254)

*Chief operator S.S. Atlantic Sun.

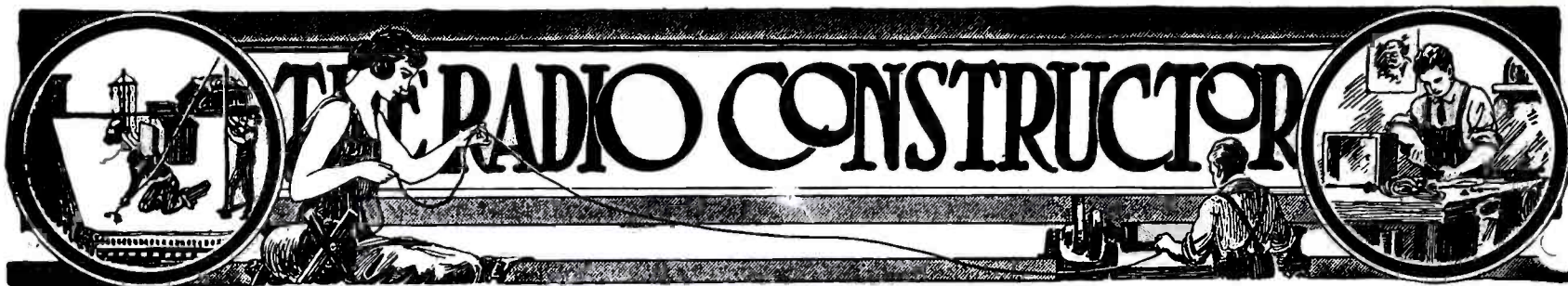

Practical V. T. Detector and Two-Stage Amplifier

By Frederick J. Rumford, A. M. I. E. E.

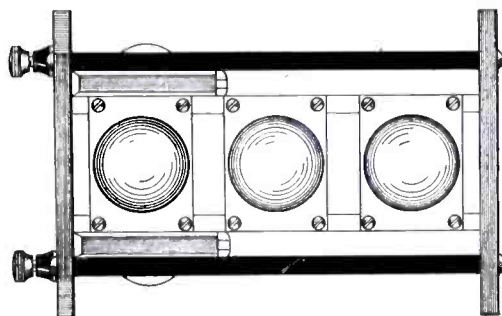

Fig. 3

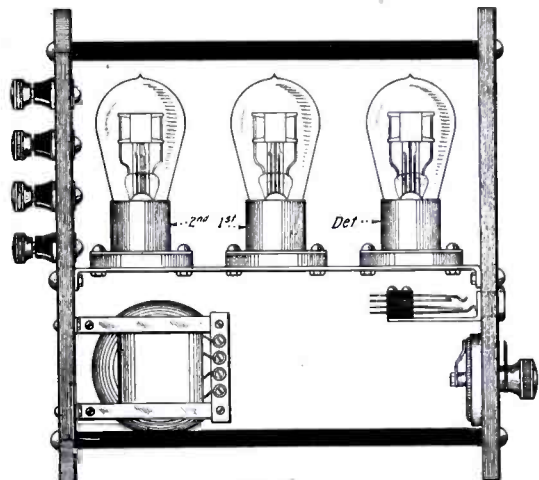

Fig. 2

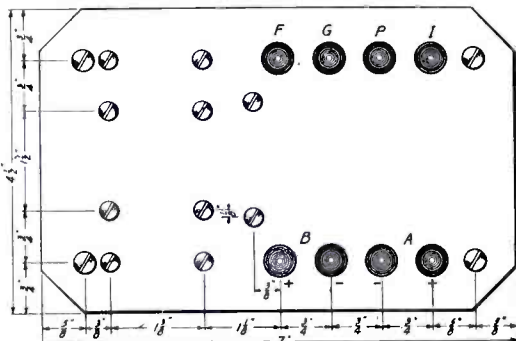

Fig. 4

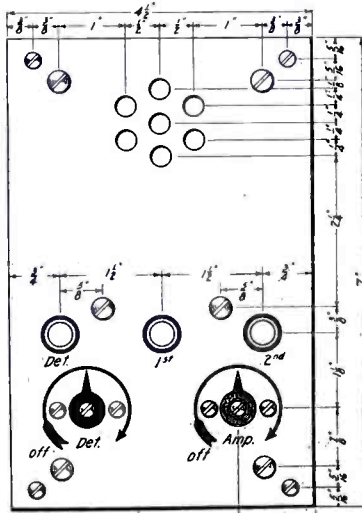

Fig. 1

In This Drawing Dimensions Are Given for the Construction of the Amplifier Which, as May be Seen, is of New Design

THE accompanying drawings show to good advantage my own private detector and two-stage amplifier, which have been in use for over a year; from this set I have obtained the very best results. I designed it for the purpose of combining efficiency, simplicity and compactness. It requires but very little work to build, and its actual cost is less than \$50. This price includes the tubes, and as every amateur knows, in the average detector two-stage amplifier sets, the tubes are an extra expense.

This outfit is so compact that I have often carried it from city to city in my travels. Those who build this set can mount it in a cabinet, if they so desire. It can be easily duplicated and requires but a few tools in the making, such as a screw driver, drill, etc. This outfit is similar to the one the Westinghouse Co. is at the present time offering to the public, but the outfit described below was designed by me personally a year or so ago, and this outfit has been made up also by several prominent radio men, and tried and tested for its true worth and proved to be successful in every way. It is composed of all standard parts which can be readily purchased in any radio supply store, but, no doubt, most amateurs have the necessary parts laying around their labs. It will take only very little time to assemble this outfit when ready. Below is the list of necessary items, with their re-

spective costs:

2 Formica panels, 7" x 4½" x ¼"	\$3.00
@ \$1.50	
2 Rheostats for back mounting @ \$2.00	4.00
2 Clapp-Eastham Amplifying Trans-	
formers @ \$4.00.....	8.00
1 V. T. Detector tube @ \$7.00.....	7.00
2 V. T. Amplifier tubes @ \$7.00.....	14.00
3 Murdock V. T. sockets @ \$1.00...	3.00
3 Telephone jacks @ \$.85.....	2.55
3 Grid leaks and condensers 0.0005	
mfd., 1 megohm @ \$.50.....	1.50
1 Telephone plug @ \$.75.....	.75
25" of round ¼" brass stock or rod..	.30
15" of flat brass stock ¼" wide ⅛"	
thick25
5' Bare copper wire B. & S. No. 8..	.30
Screws and bolts.....	.50
8 Large size binding posts @ \$.20...	1.60
Actual cost.....	\$46.75

With the accompanying data are four drawings as follows:

Fig. 1 shows the front panel with the different apparatus mounted along with the correct dimensions.

Fig. 2, side view and also the interior, showing the positions of the tube, transformers, rheostats and jacks.

Fig. 3 represents the interior looking down from the top.

Fig. 4 represents the rear

panel, showing the different dimensions for the placing of the binding posts and positions of the different attaching screws.

Fig. 5 shows the general hook-up with proper connections.

We will now pass on to the actual making of this set. The two 7" x 4½" x ¼" formica panels are given a dull grain finish with No. 0 sandpaper, and then rubbed with oil. After this is done, the usual marking off and drilling of holes is done as shown in Figs. 1 and 4. The rheostats and jacks are mounted on the front panel as shown, and the binding posts are next mounted on the rear panel, which panel will be cut out at the corners, see Fig. 4. This gives the panel a distinctive appearance and also provides for air in case the outfit is mounted within a cabinet.

The round ¼" brass rod is now cut into four 6" lengths, being drilled and tapped at each end to take ⅛" machine screws. If the outfit is not mounted in a cabinet, it would be advisable to have these rods nickel plated. For that matter, it would be a good idea to have all the metal parts that are exposed to view nickel plated, as this will set the outfit off to its best advantage.

The eight binding posts, of which four are on each side of the rear panel, are indicated by the engraving upon this panel as follows: On the right side: A is for the "A" battery, which in this particular instance is a 6 volt 60 amp. hour Eveready storage battery; B, for the "B" battery, which happens to consist of 20 No. 703 Eveready flashlight batteries wired in series multiple. The reason for this is that with three tubes functioning, the "B" battery will not stand up very long, and it also weakens the amplifying power of the outfit. There is a jumper wire which runs from the "B" battery negative to the "A" battery negative.

Now the posts on the left-hand side are as follows: No. 1 is for the tickler connection, P, plate, G, grid, and F, filament. As will be seen, there are but very few binding posts, not at all like the old amplifier sets, which had a large number of posts, and were very complicated and awkward to operate. All the tubes are of the same filament voltage and the plates are of the same "B" battery voltage.

We will pass to the making of the strips for the socket shelf. This is cut, drilled and tapped as per Figs. 2 and 3. The sockets are then placed upon the strips and held in place by means of screws and nuts; the

(Continued on page 232)

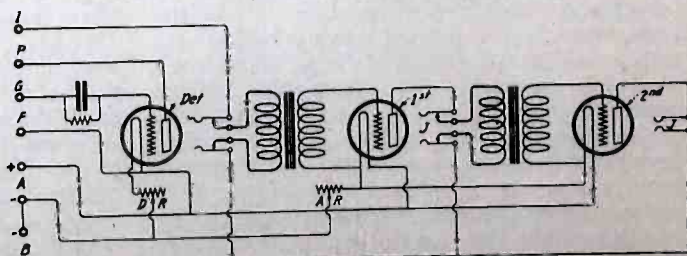
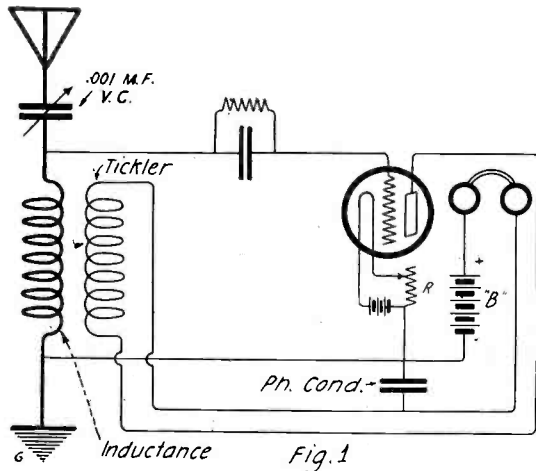

Fig. 5

Wiring Diagram of the Apparatus Described in this Article.

A Single Control Universal Range Receiver

By MORRIS LEVEY



General Hook-up of the Set.

THIS panel set consists of two separate sets, arranged so that either one can be used by throwing a four-pole double throw anti-capacity switch to right or left. The complete set is mounted on a panel measuring only 5" in width by 12" long, which makes it small and compact. The wave-length range of the short-wave part is from 170 to 800 meters with a .001 MFD variable in series with the antenna; and from 500 to 1,700 meters with the same condenser in shunt to the coil. The long-wave part has a range of from 1,800 to 14,000 meters with condenser in series, and from 4,000 to 25,000 with condenser in shunt. The position of the condenser is controlled by a series parallel switch. The two photographs show a back and front view of the set.

A single coil tuning circuit is used, making use of direct coupling for primary and secondary circuits, while a tickler coil is used to produce oscillations for beat reception of undamped waves or for regenerative amplification. The excellence of this type of circuit is attested to by the fact that the Westinghouse Electric Co. recently put out a short-wave regenerative set using a circuit of this type; this circuit is also used in the new Grebe CR-5 and Universal receiving sets. While a circuit of this type is not as selective as a loosely coupled one, the ease and rapidity with which signals can be tuned in more than compensate for this defect, although the signal strength is about the same. With the exception of the coil taps, the variable condenser is the only variable element for wave-length control, it being only necessary to swing condenser from zero to maximum to receive anything within wave-length of tap used. Fig. 1 shows diagram used.

The following parts will be necessary, the total cost of which does not exceed \$11:

One formica panel 5" x 12"; three indicating dials 3" in diameter; three large knobs; two switches with knobs about 1" in diameter, and two small switches with knobs about 1/2" in diameter; 24 switch-points; one 4-pole double throw anti-capacity switch; one .001 MFD variable condenser; one series-parallel switch for condenser; cardboard tubing 4" and 3 1/2" in diameter; six 6/32 thread brass machine screws, and six 10/24 thread

brass machine screws with nuts; one Radisco 1,200 and one Radisco 550 coil.

The panel should be drilled as shown in Fig. 2. After all holes are drilled, the panel should be rubbed with a fine emery cloth and oil to give it a grained finish.

The variable condenser should be mounted in the center of the panel. It is advisable to mount the condenser first, as this is always troublesome to line up correctly. No holes are shown in Fig. 2 for mounting the stationary plates of the condenser, as these holes will depend on the type of condenser used. I used a Murdock 43-plate condenser. Solder a flexible lead to rotating shaft to insure positive contact. Do not use a condenser having a greater diameter than 3 1/2", or there will not be sufficient clearance for the other parts.

To construct the long wave part of the set, tap the 1,200 Radisco coil at six equal points and bring the taps out to the six switch-points in the lower right-hand corner of the panel. The coil can be fastened to the panel by a brass bracket passed through the hollow part of the coil. Use 6/32 flat headed brass screws for fastening bracket, also countersink the holes for the screws. Mount the coil one inch from the right-hand center hole, which is for mounting the large tickler.

To mount the 550 Radisco coil tickler so that its rotation can be controlled by a knob and dial on the front of the panel, it will

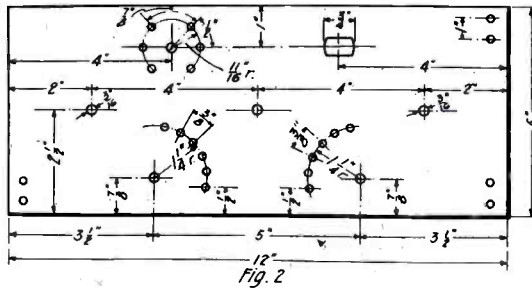

Layout of the Panel With Necessary Dimensions for Drilling the Holes.

be necessary to construct a brass bracket having an offset appearance. It can be made as follows: Get a piece of fairly stiff brass 3/8" wide by 6" long. One inch from one end bend the piece at right angles. Clamp the 1" end in a vise and twist the long end until it is at right angles edgewise to the piece in the vise. The piece of brass will now resemble a tri-square. Where the long end is bent over the 1" end, bend the long end again at right angles as though a right angled bracket was being made. Drill a 1/8" hole in the center of the 1" end. Cut a wooden plug to fit the hollow part of the 550 coil. Drill two holes in the long end, 1 1/2" and 2 3/4" from the bend. Fasten this bracket to the wooden plug. It will probably be necessary to move the tickler coil around the bracket until a position is found where the coil can be rotated without brushing the large 1,200 coil. Through the 1/8" hole pass a 1" length of 10/24 brass screw

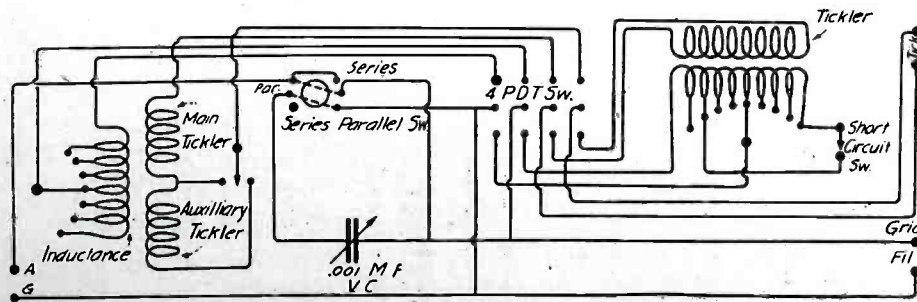

Complete Wiring Diagram of the Combination Short and Long Wave Set.

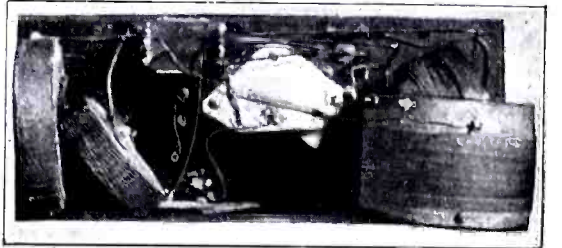
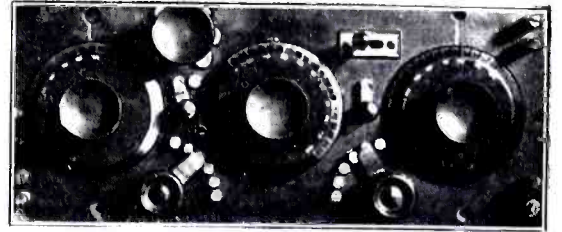

Front and Inside View of the Short and Long Wave Regenerative Set.

and tighten with a nut. Pass the rest of the screw through the hole in the panel and tighten with a nut. Then clamp dial to nut with a large knob having a brass bushing threaded for 10/24 thread.

In order to receive waves from 1,800 to 3,000 meters satisfactorily, it will be necessary to short circuit all unused turns of the 1,200 coil from the 2nd to the 6th tap. This is done by the small one-point switch (between condenser and long-wave tickler). This switch lifts short when it is open, or closes short when switch is closed. This short does away with dead end losses to extent that allows NAA and similar stations to come in with greater intensity than on a Navy standard medium range receiver.

The short-wave portion of the set, which is on the left side of the panel, consists of a short-wave vario-coupler, with the exception that the rotating coil is used as a tickler, while stationary coil is used for conductively coupled primary and secondary. These coils may have the following dimensions: Wind 54 turns of No. 24 S. C. C. wire on a tube 4" in diameter by 3" long. Start winding 1" from top and take taps at every nine turns. Bring taps to switch-points on lower left side of panel. Give the coil a coat of shellac.

The tickler consists of 36 turns of No. 26 S. C. C. wire on 3 1/2" tube about 1 1/4" wide. Leave a 1/4" space in center. Two brass screws 10/24 thread, 1 1/2" long are used for bearings. These shafts are passed through holes in the stationary tube about 1/2" from top. Solder the ends of coil to the heads of the screws. A flexible lead is soldered to each screw as it comes through the hole in the stationary coil. By using a 10/24 nut on the shaft on the back of the panel and soldering it, and by tightening the nut on the shaft on the face of the panel, the shaft will hold rigid with no end play.

In regards to the tickler, the constructor should consider this; if a larger winding than that given is constructed, it will be difficult to prevent the circuit from oscillating even with tickler at right angles on the smaller wave-lengths from 180 to 800 meters. But on the other hand, a larger tickler will produce oscillations on the longer waves from 600 to 1,700, whereas the small tickler will not do this even with a

(Continued on page 230)

An Example in Radio Economy

A Radio Receiver with Detector and Two-Stage Amplifier for \$75.00

By K. H. STARK

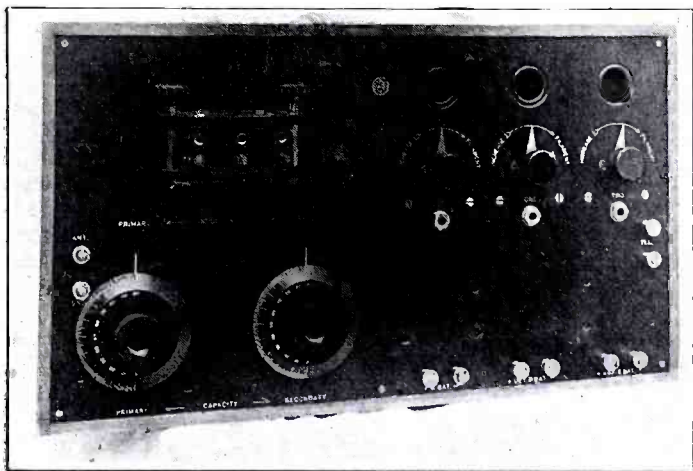

Front View of a Receiver and Two-Stage Amplifier, Which May Be Constructed by the Amateur at a Cheap Price.

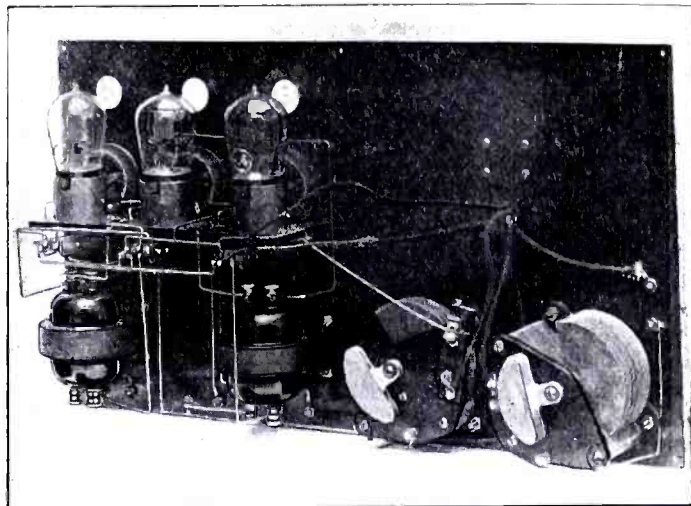

Inside View of the Receiver. Note the Simplicity of This Set.

not always produce finished instruments that look as well as you expected. The big fact though to bear in mind is that this home-made equipment usually operates as well or better than the most expensive that can be bought.

I want to describe an intermediate plan of obtaining instruments that function efficiently, that have the appearances of the best and that are economical in cost. The keynote

THE desires of the radio amateur of today as regards his receiving equipment are many and varied. The first problem is to have a receiver capable of receiving efficiently over a wave-length range from 180 to 25,000 meters. Aside from the actual tuning devices a vacuum tube detector and at least two stages of audio-frequency amplification will allow the use of a loud speaker that all may listen "via radio."

If the actual design and appearance of all this equipment is the only consideration and if the cost is secondary, then it becomes simply a matter of purchasing on the open market the necessary receivers, detectors, amplifiers and other equipment. The investment, however, of from \$150.00 to \$500.00 is entirely out of the question for the majority of us. There is a possibility of going to the other extreme, that is, to design and construct all of this equipment at home. This method, while being the most economical one, does

of this plan is to utilize in so far as possible the various radio parts which are now on the market by combining them into the sets of your desires. As an illustration, the accompanying photographs show a radio receiver with a detector and two stage amplifier built on a single panel for an amateur of limited means. He was willing to

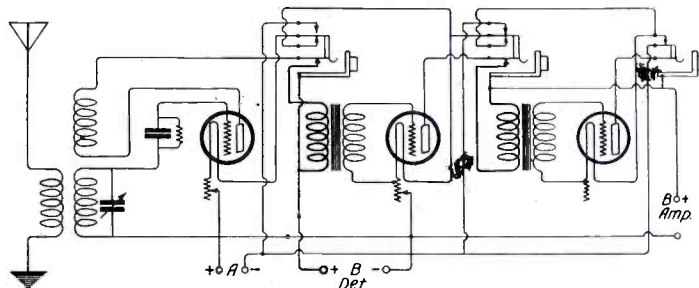

Complete Hook-up Showing the Connections to the Automatic Filament Control Jacks.

sacrifice the ultra-efficiency on the shorter wave-lengths that he might receive the long-wave stations without additional apparatus.

For the receiver proper the inductances were honeycomb coils. The lower signal strength on 200 meters to be compensated for by the amplification.

This amateur went to reliable manufacturers and told them of his problem. Their answer was the one he followed. They suggested that the receiving panel be laid out completely, all holes drilled and the lettering engraved. This combined with a salvaged cabinet which the amateur already had would provide the desired appearance of the finished set. Also by this method the parts on the panel could be added to as it was financially possible. A receiver and detector could be used from the very start at an initial cost of about \$40.00.

The completed instrument operates very satisfactorily. It is up to date in every respect. The new shielded intervalve transformers are used as is also the automatic filament control
(Continued on page 264)

Vernier Condensers

By F. S. WILLIAMS

IN C.W. and especially in telephone reception, the circuits must usually be very sharply tuned. A vernier adjustment is desirable and frequently indispensable. A

simple expedient for this purpose is shown in Fig. 1. A strip is cut from 1/8" bakelite, formica or other insulating material having the necessary strength and rigidity. The knob of the condenser is loosened and the end of the strip A slipped beneath. In most cases the strip must be filed thinner at this point in order to fit between the knob and the pointer of the condenser.

Another method is to drill a hole in the side of the knob and force a brass rod therein, as in Fig. 2. A small knob may be attached to the end of the rod, but this is not essential if the rod makes no electrical contact with the bushing in the knob of the condenser.

The above devices have the additional value of obviating capacity effects of the operator's hand.

Fig. 3 shows a small vernier condenser which may be attached to the binding posts of the variable condenser. The plates, two stationary and one rotary, may be cheaply obtained from a firm listing standard condenser plates. The base B is of bakelite or formica 2" by 1 1/2" by 1/8" thick. All the brass strips used are 1/16" thick and 1/2" wide. The piece C has each end turned up to a height of 3/4" and is made from a 3" strip. It is fastened to the base B by two

8/32 machine screws. The 8/32 screw D used as a shaft should be about 2" long. A larger shaft would be preferable; the plates are designed for a 1/4" shaft. The rotary plate is held between two nuts. The bearing holes in the piece C should not be large enough to allow any appreciable play. The bracket E supports the stationary plates and should be slotted at the bottom so that the stationary plates can be adjusted laterally
(Continued on page 264)

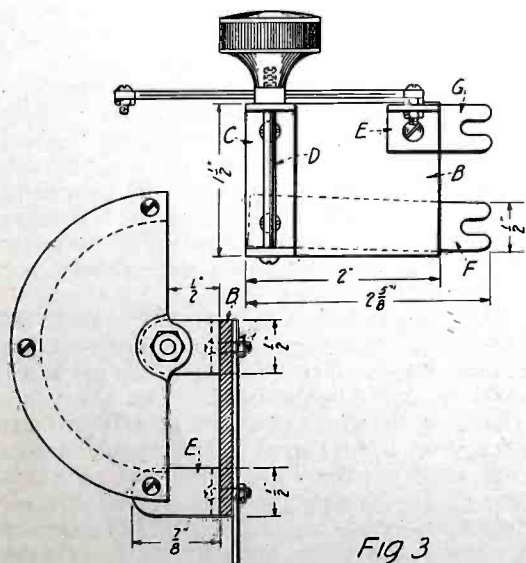

Fig. 3

This Type of Vernier May Be Used With Any Type of Variable Condenser.

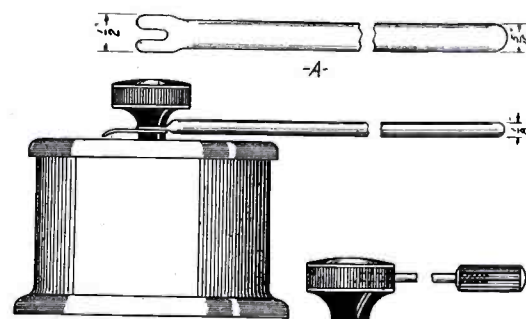

Fig. 1

Fig. 2

With These Handles, Fine Adjustment of Variable Condensers May Be Made Easily.

Radiomania

By CHARLES S. WOLFE

AFTER all, why not? De Quincy did his "Confessions of an Opium Eater" with just as little justification and got away with it, and it is possible that this revelation of my own dark past may strike a responsive chord in the breast of some other wight who, in his time, has suffered from Radiomania.

Why not? And yet, why? Unless I have some kind of a hazy idea that it may serve as a guide to the newly bitten ham. Not that it will prove to be such an admirable guide to the methods of procedure in such cases, but as a "How Not To Do It" article all I ask is a clear field and no favor.

The thing dates back to that momentous evening when my ears were for the first time irritated by the clasp of Holtz Cabots. The only thing about the outfit that was mine, barring the good intentions, were the ears. The set (I owe it to the chap to call it that) belonged to a new found friend of mine. If I am ever called on to testify before a jury of my peers as to the most envious moment of my life, I will be able to say without hesitation that it was that instant when I first heard the bell-like whistle of N.A.A.—on another man's set.

True, he was only heard after two hours of patient coercion of an innocent lump of galena with a piece of brass wire. But at the first shrill piping I knew that I was a gone gosling. My very pocket-book trembled, and you can take it from me, it had cause to.

For the next two weeks the only minutes that I can recall as being spent with my nose outside of a catalog were those intervals when I was dreamily reflecting. Reflection is the only cheap part of the radio game that I have ever been able to discover.

Having resolved to acquire a station, my first manoeuvres were purely diplomatic ones, calculated to feel out the family policy in the matter. I remarked in an offhand way to my father that the papers were full of wonderful yarns about this wireless telegraph business, and that I had heard that there were a couple of chaps in our town fooling with it. I made this little feeler with the air of utmost innocence, but long acquaintance with yours truly (Father was the first man I ever boarded with) had rendered father able to read between, around, above, and through the lines, and he failed to rise to the bait. He merely replied—and I must admit that his air of innocence made mine look like an open confession of guilt—that in his estimation the person who first jabbed holes in a perfectly good tin roof should pass the remainder of his life in the electric chair.

It is only fair to this stern and adamant parent that he should go down in history as the same man who, some two or three weeks later, cursed fluently and expressively as he aided me to point a pair of twenty foot spruces skyward.

To resume. My first experiment in the new art was classic. It deserves to trickle down to posterity along with Benny and his kite.

The very first piece of apparatus that I

purchased (I have the purchasee's word for it that it was apparatus) was a receiving condenser. It had been constructed by this eminent radio engineer himself, and, having been unable by any means to make it function, he passed it on to me—for a consideration. No doubt his justification was that I had more time to fool with it than he had.

It would certainly give me much pleasure to hold that poor old dust-covered relic up before my grandchildren and say, "Here, my dears, is the very first piece of wireless apparatus that your renowned grandpa ever owned." That simple pleasure is denied me. The condenser is no more. It has been no more since three days after I took it unto my bosom. I fear that at that period my bosom was no fit place for a struggling receiving condenser. My second purchase was a one-inch spark coil.

I bought that coil because the catalog said that it would give a good, hot spark, and I had a deep-rooted idea that a good, hot spark was more to be coveted than great riches. If that unfortunate condenser's ghost could be hailed back from the Great Beyond to bear witness, I am positive that it would cheerfully swear that all the claims

mystic maze of annunciator wire. For several days navigation within that room called for considerable skill. For even assuming that you escaped decapitation when you entered the door it availed you little—you were almost sure to be unchinned before you reached the gas fixture. And once in bed, it behooved the novice to do all his sleeping within six inches of the pillows. Any sudden changes in elevation were well nigh bound to prove fatal. It was by sleeping in this room for a whole week with that contraption that I won my family reputation for valor, a reputation which endures even unto the present day.

It must be recorded that I never heard anything on this forerunner of the loop. I have often thought since, though, that I would quite likely have gotten the arc light on the street corner had I had a detector of some sort to hook into circuit. It was later that I learned that the 'phones are not most efficiently placed when they are connected to the primary of a loose coupler.

Father had occasion to come into my room one night, and the next day we discussed the erection of my big outdoor aerial. Peace at any price was the keynote of his attitude throughout the council.

The very first evening that I completed the installation of my first real receiving station, I got signals. Old Sayville had not yet fallen from grace, and nightly his "press" was tearing great gaps in the atmosphere. I had listened to this larklet for about two minutes when I realized that I held the cup of Tantalus in my hand. I could hear that bird without the least bit of trouble, but he might well have been sending in the purest Martian. I couldn't understand a darned thing he said.

When this cataclysm was realized by the household, father assumed the air of a martyr. He was wont to roam out into the night and gaze wistfully up at those neat twenty-

footers. His yearning stare fairly shouted, "You'll keep the home fires burning for a couple of hours, but what in hell will I do with all that wire?"

Nettled, I went to the mat with the Continental code, and the day came when those flying combinations whispered perfectly understandable English in my ear.

On the evening that I first captured the scores as hurled forth by Arlington, father took back all the unkind thoughts he had ever thunk. He used to sit majestically enthroned on the front stoop in the early evening while all the neighborhood holders of those little red tickets flocked humbly around him and computed their losses for the day.

Pride goeth before a fall. The crash of Babylon produced no greater upheaval in the community than did the collapse of my aerial in our neighborhood. The sheer efficiency with which that thing fell has always been a source of wonderment to me. That such a little thing could do so much damage in so short a time surpasseth all understanding. Of course, the bill reached its really startling proportions by reason

(Continued on page 228)



Father Had Occasion to Come Into My Room One Night and the Next Day We Discussed the Erection of an Outside Aerial!

made by the manufacturer about that good, hot spark were Gospel truth. It ought to know.

Well, when the cunning little white flames had ceased playing through the in'ards of the receiving condenser I had about reached the conclusion that the guy who put out the bunk about connecting a condenser across the secondary terminals of a spark coil was a malicious liar.

Somewhat daunted by the suddenness of the fate that overtook my tinfoil beauty, I abandoned *pro tem* my attempts to shatter the ether, and turned from the emitting of etheric nuisances to the waylaying of a few. I stalked them with caution, being on totally unfamiliar ground. The catalogue on which I pinned my faith spoke glowingly of the possibilities of the indoor aerial—glowingly, but, I fear, somewhat hazily. The details were, for the most part, left to the imagination. My imagination is quite capable of some startling acrobatics if given anything like a loose rein, but in this case it was hampered somewhat by the dirth of materials at hand.

We began operations by stringing hence and thence across my bedroom a regular

Power by Radio

By KENNETH WARNER

THIS is a pirate story. I warn my readers in advance, so they may take full advantage of the thrills and mystery in the plot. It is not a tale of the Spanish Main days, where blood so often stained the ocean red, and the cries for mercy of those who "walked the plank" were unheard; but it is a tale where a corporation takes the place of the many-oared galley and brains and a check book take the place of the guns and a cutlass. And the cries for mercy of the victims still go unheard.

To be even a modern pirate story, the setting should be placed in a long, low room, dimly lighted, while outside of the tightly closed blinds, the storm raged and the waves on the lake pounded the shore with never ending ferocity. However, much as we might like to be so romantic, we must stick to the facts, which were somewhat different. The room (for there must be a room in which to conspire) was large and finely furnished, as befitted a modern pirate den. The lake was still there, but it was too peaceable to be even mentioned in such a story as this. In the center of the room stood a large, solid table, and around it sat twelve large solid chairs. For what could hold the modern pirate but an extremely large and heavy chair? Eleven of these chairs were occupied at the time, while "Captain Kidd" himself stood before the twelfth one. We must take a little better look at this important character before we note the eloquent harangue with which he is favoring the first, second, third, et cetera, mates of his crew.

Osborne Lewis was a leader. From his wide, straight forehead to his prominent chin he bore that look by which everyone recognizes a leader of men. And he was a leader, from the days when he pulled the cat's tail, through the days in school and college, where he led in both popularity and grades, until he graduated, the leader of his class in electrical engineering. And from the attitude of the listening men, he still led.

It would be an interesting character study to watch the faces of the men as they listened to Lewis speaking. Amusement, incredibility, doubt, acquiescence, and finally enthusiasm were the facial expressions of the listeners as the plan proposed by the speaker was brought out. Finally Lewis ceased speaking and awaited comment. For some time no one spoke. The audacity of the project staggered even the boldest.

"But the proof—," began one.

"Is easy," finished Lewis. "Are you in favor of adopting the proposition?"

"Aye." Eleven men spoke. The twelfth was Lewis.

* * *

If you will look through your electrical magazines for the latter part of the year 1920, you may see the following advertisement, which was printed in large type in several of the more important publications:

ATTENTION AMATEURS

We would like to communicate with several amateurs living at a distance greater than five hundred miles from the State of Minnesota. For some time we have been perfecting a device to send power by wireless, and at last we have succeeded far beyond our hopes. We now wish to place several receiving sets in the hands of reliable operators for a final test. We take this method of testing in order to bring our invention before the public. Amateurs living in manufacturing cities preferred. Those interested will please write to Box 84, News Bldg., Minneapolis, Minn.

At this time a chum of mine, Robert Greer, "Bob" for short, and myself, had what we thought was a rather complete station. A I K.W. Transmitter, a rotary with all the "fixin's" and a three step with Magnavox tacked on the end to drown out the neighbor's cat on lively nights,



The Voltmeter Wavered and Jumped to Twenty Volts! The Ammeter Followed Suit and Read About Five Amperes. Bob Jumped Up, Shouting, "It Works, it Works!"

constituted a fair set, in our estimation. Accordingly, when Bob hailed me one evening with a yelp of joy and fell on my neck like a long-lost brother, and informed me that at last we were going to receive our just reward, I sat up and took notice. Between shouts and noises that could not be classified, he said we now could divert our attention from the latest outrage in the form of a "squeak-box" and could be Somebody. Somebody, with a capital S. When I got him quieted down enough to get a word in edgewise, I said to him: "Either shut up or say something." This took the peak off of his enthusiasm and he shoved a magazine in front of me and pointed out the above advertisement. I took the paper and read the notice.

"I can't see that this is any reason for your gaiety," I said. "Where do we come in?"

"If we can be one of the stations used to test that contraption, and if it works we'll—," Bob started.

"Yes, if," I shot back.

But the long and short of it was that we answered the "ad" and told of the advantages of our set and somewhat more

than mentioned that we lived in a manufacturing center. We had talked it over and we didn't see how we could lose, and so we went in head first. Fortunately or unfortunately, as remains to be seen, we received due notice from the concern that our station would probably be one of those chosen. We filled out several yards of records and mailed them back. We had waited almost two weeks and had begun to think that the company had lost our address, when one day the express wagon stopped at our door and the driver inquired for me. I went out to see what he had for us and Bob came right along. It was a good thing he did, for I could never have carried the box the expressman gave me alone. And stamped in big letters on the box was, "Wireless Power Company, Inc." I "signed here," and we carried the thing into the shop. Although we had no instruction yet, we removed the outside box and then after taking several basketfuls of paper off we reached the treasure. It was a typical treasure box, all right; long, black and very heavy. On the top of the box were set in two meters; an ammeter and a voltmeter. Two

large binding posts and two knife switches were the only visible objects. We wanted to see "what made it go," but the company must have known the inquisitiveness of the average amateur, for there was no crack visible beneath the enamel, and we didn't know where to begin. And taking an ax to it was a rather risky business, for who knew what they might derive their power from, dynamite, cordite, or some other "ite" with considerable elevating power. Consequently we left the apparatus strictly alone until we should receive directions for its operation.

That afternoon we received a letter from the company stating that a series of tests was to be run for three days, commencing three days from that date. The first was to be run at 10:00 P. M., the second at 2:00 A. M. and the third at 10:00 A. M. The letter did not give the diagram of connections and so we were left in the dark as to the method of receiving. The voltmeter (so the letter told us) was connected across the incoming power line and the ammeter connected in series with a resistance coil used as a load. There were several of these resistances in the box and a selective device enabled anyone of them to be used. Thus both voltage used during the test and the actual power used could be readily seen or computed. A chart was given to us, showing just what the ammeter and the voltmeter should read at any given time, corresponding to the changes made in the sending apparatus. The aerial was to be connected to one post and the ground to another. A blank was given to us to note the readings at various times, and we were to specifically state any variation from the above "time table." We read this over several times, to be sure what was wanted, and then fixed up our shop ready for the test. We

(Continued on page 244)

WITH THE AMATEURS

THIS Department is open to all readers. It matters not whether subscribers or not. All photos are judged for best arrangement and efficiency of the apparatus, neatness of connections and general appearance. In order to increase the interest in this department, we make it a rule not to publish photographs of stations unaccompanied by a picture of the owner. We prefer dark photos to light ones. The prize winning pictures must be on prints not smaller than 5 x 7". We cannot reproduce pictures smaller than 3 1/2 x 3 1/2". All pictures must bear name and address written in ink on the back. A letter of not less than 100 words giving full description of the station, aerial equipment, etc., must accompany the pictures.

PRIZES: One first monthly prize of \$5.00. All other pictures published will be paid for at the rate of \$2.00.

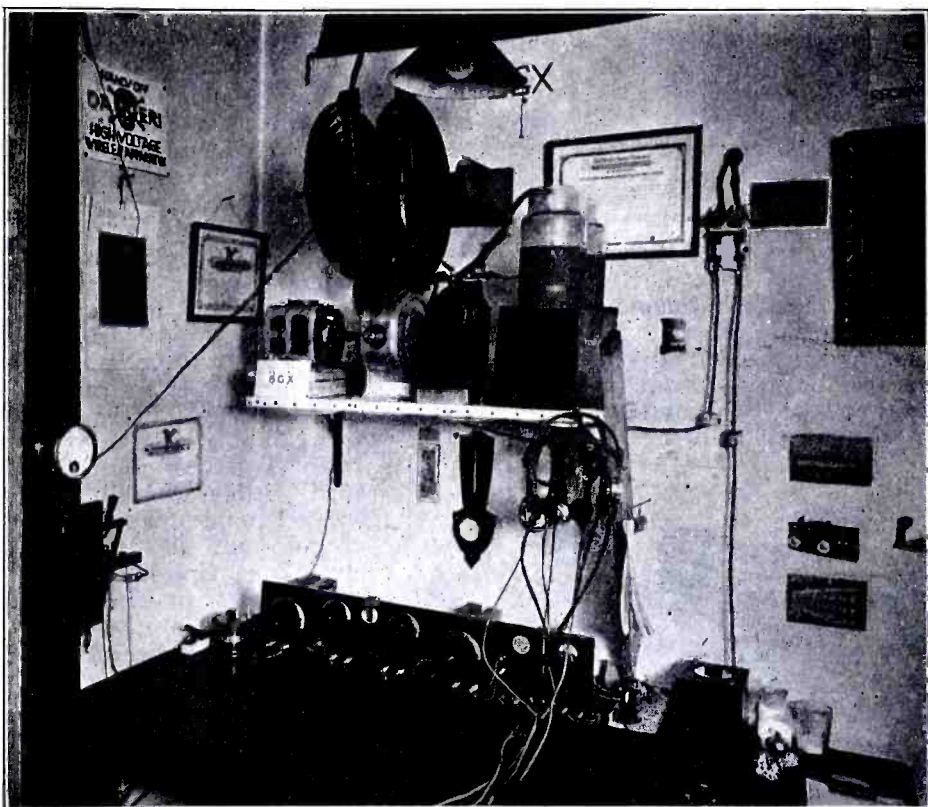

E. W. Thatcher's Station

8G X, Oberlin, Ohio

This Month's Prize Winner

Here is a good relay station neatly arranged and equipped with a wavemeter.

far end and are connected to the water system of the house.

The receiving equipment consists of a homemade Paragon-type short wave regenerative and two-step amplifier. There is also a long wave honeycomb coil set, which is not shown in the picture. The amplification is controlled by plug and jack system and a small contact is placed upon the antenna switch for the purpose of shutting off the "B" battery while transmitting. Western Electric phones are used.

The transmitting set is mounted on a shelf above the operating table, and consists of the following apparatus: A 1/2 K.W. half mounted Acme transformer with a Benwood enclosed gap, jars and O. T.

Signals from 8GX have been heard up to 2,000 miles, 6KA reporting them QSA during March. Communication was regularly carried on with stations up to 1,000 miles distant, and a great deal of relay work has been put through during the last season.

The antenna used is a four-wire inverted "L" type of stranded copper wire, spaced three feet apart and sloping from 60' high at one end to 50' high at the other.

For a ground connection, a radial system of buried wires spreads out under the antenna in the shape of a crowfoot. These wires are attached to six-foot rods at the

Robert A. Gerhard's Station, 8RL

Leighton, Pa.

The receiving set is mounted on a 12" x 1/4" x 18" formica panel, hand engraved. A set of honeycomb coils was made to cover all wave-lengths. The two variable condensers are 48 plate balanced type with vernier, the plates being made of 20 gauge aluminum, and the end pieces of bakelite.

A zinc plate, which is grounded, covers the inside of the panel. This overcomes the capacity effect when the hands are brought near for tuning. For this reason the coils were placed inside the cabinet, the top of which is hinged to permit the coils being readily changed, the knobs above the condensers controlling the tickler and secondary coupling.

The transmitter consists of a 1/2 K.W. transformer, rotary spark gap, oscillation transformer, and hot wire meter. The spark gap is mounted on the back of the panel and enclosed, a small window permitting observation of the spark.

The entire sending set, except motor and key, is home made.

The aerial consists of six wires 80' long.



This station is entirely home made and does, indeed, look fine. We extend our compliments to Mr. Gerhard for his workmanship.



F. H. Avers' Station 9 D B D

Portage, Wis.

The receiving outfit consists of an audion detector and three-step V. T. amplifier. In addition to these is a two-step microphone amplifier. Three tuners are used.

The regenerative receiver from 175 to 600 meters, Navy type coupler from 600 to 4,000 meters and honeycomb coils from 4,000 to 25,000 meters. The second step microphone consists of a Skinderviken transmitter button fastened to the diaphragm of the receiver of the first microphone circuit.

Leads from this button can be plugged into four different circuits, viz: a Magnavox loud speaker shown in the picture a Magnavox loud speaker in the theatre auditorium (this station is located in a motion picture theatre), a tape recorder and into the regular wire telephone. When plugged into the wire telephone this button is merely a transmitter in series with it and is a very satisfactory way of sending voice music and signals over the phone, such as music and speech from Madison, Wis., and Pittsburgh, Pa., and also time signals from Great Lakes and San Diego, Cal., to the jewelry stores for correcting their clocks, when the button is used with a tape recorder the vibrations of the incom-

ing signals on the receiver diaphragm causes the change of resistance in the button, causing it to operate the polarized relay, which in turn operates the recorder. Have several times reproduced music from Madison and Pittsburgh through the Magnavox in the theatre.

The transmitting set consists of a $\frac{3}{4}$ K.W. transformer, A m r a d quench gap, Murdock oscillation transformer and condenser. In addition to this there is a small transmitting radiophone using two bulbs, one oscillator and one modulator with a small motor-generator to supply the necessary plate current. A double throw switch changes it from the voice transmitter to a tone arm.

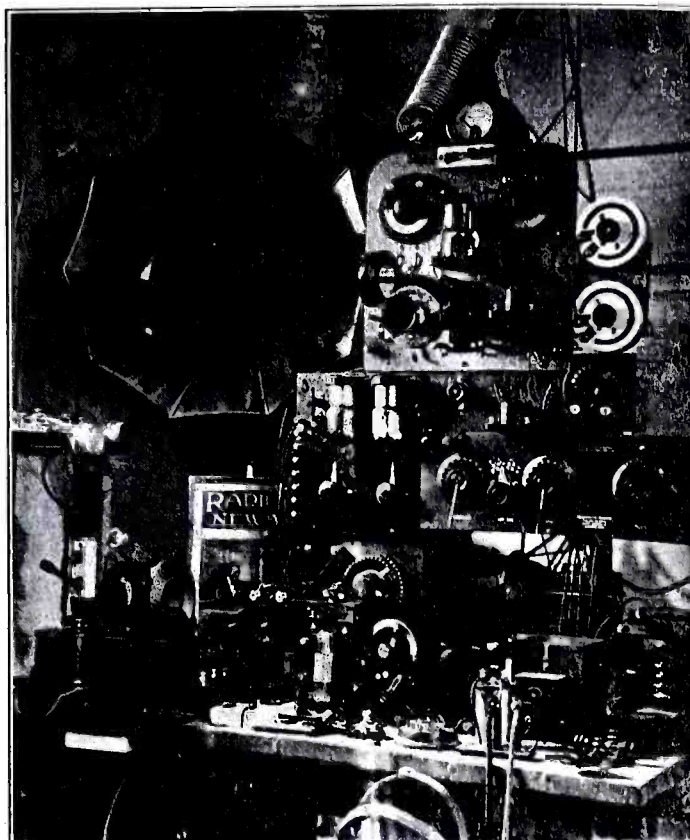

Owing to Lack of Space Frank Had to Pile Up His Instruments, Skyscraper Style. However He Has a Good Equipment and a Radiophone.

B. A. Noe's Station

The enclosed photograph is of my complete receiving set, which includes amateur spark, C. W., radiophone, and commercial spark stations, as well as arc stations. This set was designed and built by me and covers all wave lengths of any form. In the coil set use is made of the balanced primary circuit for spark stations, and the well known tickler circuit for arc stations. The regenerative cabinet can be placed in the circuit by simply replacing the coils in the coil set with plugs to which wires are attached and extended to the binding posts on the regenerative set. This is a desirable feature because it prevents having to take the coil set out and placing the re-

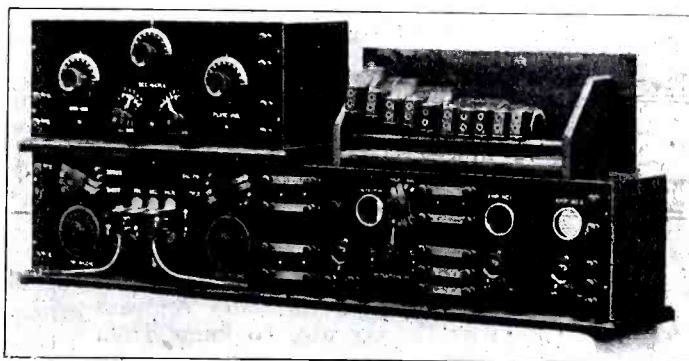

This Combined Long and Short Wave Receiver With Two-Stage Amplifier is Home Made, and May Be Called a "Peach", and its Owner Deserves a Compliment for This Nice Work.

generative set in its position, shown in the photographs, and also allows the use of

the primary condenser in the regenerative primary circuit. A resistance of about 8,000 ohms is used across the "B" battery in the detector circuit, which allows very fine adjustment of the plate voltage. All "B" battery is contained in the detector cabinet and is extended into the amplifier cabinet by means of bus bars, which connect up the detector and amplifier cabinets. The same arrangement applies to the "A" battery which enters the detector cabinet.

As proof of the efficiency of the set I will merely state that practically all the high-powered arc stations have been heard and also the radiophone of Catalina Island.

Ray L. Lenhart's Station

This is a photo of my receiving station. My aerial is of the inverted L type and is made up of three 7-strand copper wires 130 feet long and spaced two feet apart. It is 48 feet high at one end and 40 feet

high at the other. My ground is composed of water pipe and a sheet of zinc four feet square, buried five feet underground.

The tuner of my receiver is a "Radio

Apparatus Co." Navy type loose coupler with a wave-length range of 200-4,000 meters. All other instruments except the phones were built by myself.

The detector panel is of Bakelite, size $11\frac{1}{4} \times 16 \times \frac{3}{8}$ ", on which is mounted potentiometer, filament ammeter, rheostat, phone jack, "A" and "B" battery switches and an inverted tube receptacle. Two .001 mfd. variable condensers are also mounted on the panel. The one on the left is connected in shunt across the secondary binding posts, while the one on the right is a ground series condenser. The 40 volt "B" battery and grid condenser are mounted behind the panel, which is set in a quartered oak cabinet.

The two stage amplifier on the right is fitted with Paragon rheostats, Acme transformers and two home-made "B" batteries of 30 volts each. The panel is of grained Bakelite on the base behind which are mounted the two "B" batteries. This panel is also set into a quartered oak cabinet.

The loud speaker on the extreme right consists of an amplifying receiver connected to a horn.

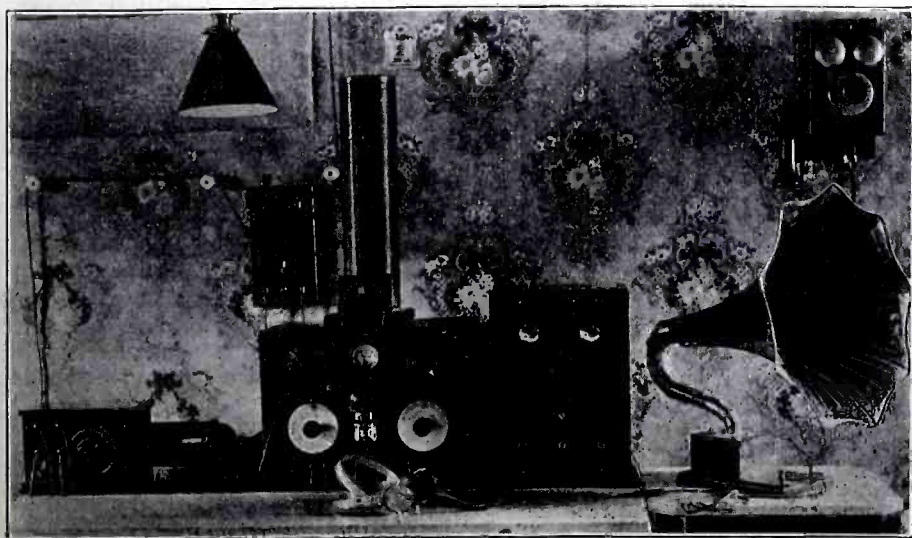

Another home-made set of good design. Let's see more like this.



Junior Radio Course

The Radio Compass

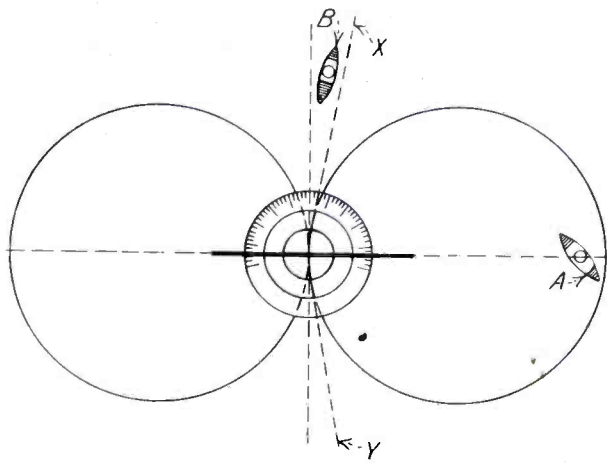

Fig. 2

The Two Circles on Each Side of the Loop Aerial Represent the Effective Area of the Radio Compass Station.

IN this lesson, we shall describe the radio compass and the loop aerial which is used in direction finding. The radio compass, which at the present time is extensively used along the coasts, has become an important factor in navigation, and a last improvement consists in the use aboard the ships themselves of the compass, which enables them when in a fog, or at night, to ascertain their true position.

The loop aerial, well known by all radio amateurs, is theoretically of the shape shown by Fig. 1. This aerial has the property of receiving stations which are in its plane. In practice, the loops are often given the shape of B, Fig. 1, and in case of very large loops they are made in triangular form for practicability of construction and operation, as C, Fig. 1.

These loops are generally wound with several turns and are, in fact, coils of big dimension; the number of turns used depends upon the range of wave-lengths to be received by the station. The loop is mounted on a shaft so that it may be revolved in any direction, and on the shaft is fixed a dial divided into 360 degrees, for the purpose of ascertaining which direction the signals received are coming from.

Fig. 3 illustrates the operation of the loop aerial. When the ship A sends, the loop L1 receives the signals with maximum audibility, for it is in the same plane with the ship, while the loop L2 does not respond at all to the signals, since it is at right angles to the sending station, thus having no induction from it through its turns. In Fig. 2 may be seen the effective field of action of the loop. On both sides signals may be heard when coming from one of these two circular areas.

If, for instance, the loop of the radio compass station is in the position shown in Fig. 2, a ship in the position A, will be received with maximum intensity, while the ship at B will not be received at all. It will be understood, therefore, that it

is possible to determine the exact position of a station by turning the loop so that the signals come in with maximum strength, but in practice another method is used to obtain accurate results which are not possible when the "maximum" method is used. If, for instance, the loop is turned slowly the signals are first heard very faintly, then increase in volume till the plane of the loop is in the direction of the sending station. They then decrease when the loop is turned further.

However, it is difficult to ascertain the exact direction of a station by trying to find the position for which the signals are maximum. The method used in practice is called the "minimum" method, and consists in finding the two directions on each side of the sending station where the signals become inaudible, then the number of degrees between these two directions is divided by two and the middle position is the true direction of the sending station. Fig. 2 illustrates this method. If the ship A is sending, the loop is turned in both directions X and Y, where the signals from station A cease to be audible in the receiver. Then, the middle position between X and Y is the true position of station A.

Of course, this type of radio compass does not allow the operator to know from which side of the loop the signals are coming. The effective field, from which signals may be received, is equal on both sides of the loop. This is of little importance when the compass station is erected on the shore and used in conjunction with other stations to determine the position of ships

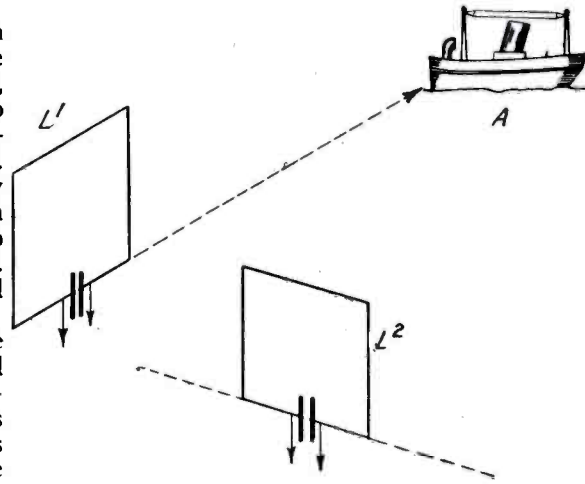

Fig. 3

The Station L1 Receives the Signals From the Ship A With Maximum Intensity, While Station L2 Does Not Hear Them at All.

at sea, for the signals are always coming from the same side as that of the sea; but if the station is intended for use on land to find the position of aeroplanes or movable field stations, it becomes more difficult to ascertain the exact direction from which the signals are coming.

The radio engineers tried to find a device giving a unilateral response, and several schemes have been designed which give the desired results, and of which we shall speak later.

The method of determining the exact position of a ship is clearly illustrated in Fig. 6. If the ship A asks by radio its position to the compass stations, it is told to send a long dash, while the compass stations turn their loops slowly and ascertain the direction from which the signals come, as already explained. Then, each of them, connected either by wire or radio to the land station B, sends to it the number of degrees they found the signals coming from, and by drawing on a map some lines from the stations in the direction given, shows the position of the ship at the intersection of these lines. This position is then sent by station B to the ship, which knows its exact location.

THE UNILATERAL COMPASS

The unilateral compass may be made in several different ways. One of the types that gives good results is shown in Fig. 4, and consists of a coil wound around one side of the loop and shielding it. The shape of the active field of the loop is of the form shown in Fig. 5; as may be seen, the effective area is greater on the free side of the loop, and is of the shape A, while it is very much smaller on the shielded side of the loop and is approximately as B.

It becomes possible by the use of such a shielded loop to ascertain the exact direction from which signals are sent, if the station sending them is out of the field B

(Continued on page 262)

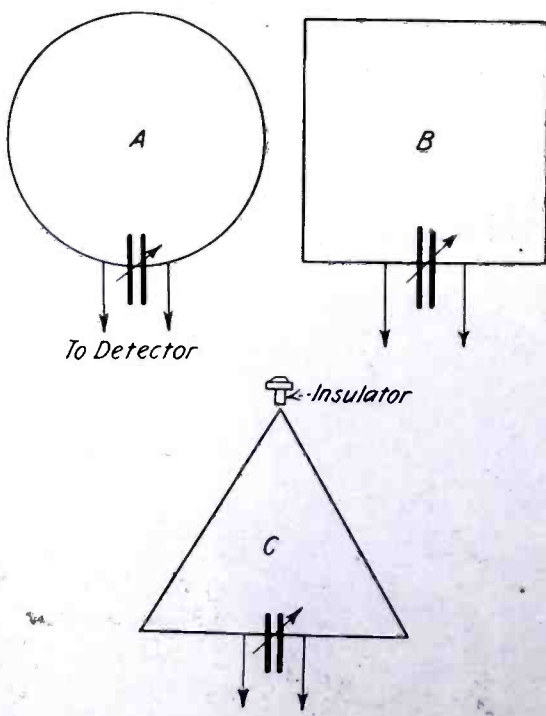
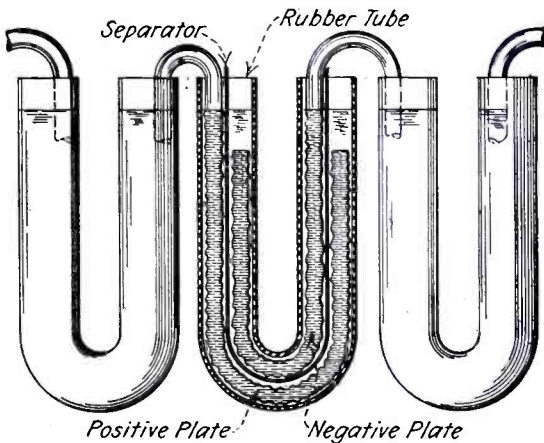
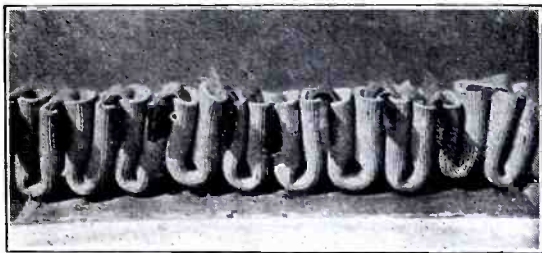

Fig. 1

Various Types of Loop Aerials Used in Direction Finding Work.

Junior Constructor



Here is a Clever Idea to Build a Storage "B" Battery Cheap.

A SIMPLE NON-ARCING KEY.

The idea is not original with me, but the application may be. Most every amateur has an old relay lying around the shop. The resistance, although 150-250 is preferred, is not essentially specific. In the event there isn't one around, any high resistance electro-magnet of sufficient ampere turns will easily lend itself to the office of a homemade relay. The construction of the relay is well known enough to enable its being left out here. At any rate, hook it up as in the accompanying diagram, and watch the sparks leave the key.

The explanation is simple: The current flows through the relay coils as long as the key is down. The key contacts as well as the relay contacts, carry the current to the transformer. Now, when the key breaks the circuit, the relay armature is still held down by reason of its own contacts, which will stay closed until the 110 volts, A. C. come to the zero-point of the phase, at which time they will open of their own accord, and since the phase is at zero, there will be no current, and consequently no arc at any of the points. Should the key open at zero itself, the relay will also open, then—sparkless again.

The amount of adjusting the relay spring and armature so as to release at the proper time, is almost negligible. The relay that the writer used with a one K.W. was a Mesco 150 ohm, and gave very good results, with a small tinfoil and paper condenser across the contacts.

Contributed by S. P. McCABE.

A SIMPLE HIGH POTENTIAL STORAGE BATTERY.

There are many uses to which a high potential battery can be put, especially in radio and allied electrical work, and al-

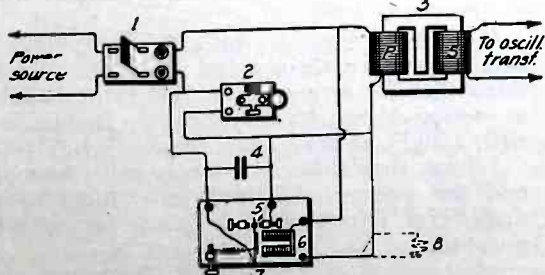

With an Old Relay Connected as Shown, No Spark Occurs at the Break of the Circuit.

though there are many types of high voltage cells on the market, there are few that can be made more easily than the one shown here.

In addition to being easy to construct, the battery to be described is not breakable, which is a very important item, and the cost of construction is very low.

The containers are made from short pieces of rubber tubing about 4" in length by 1/2" in diameter. This material can be bought for five cents a foot or less, and by bending each piece in the centre, a U-shaped container, open at each end, will be the result.

The plates for a battery such as we are considering can be made from small pieces of thin sheet lead about 8" long by 1/2" wide. The surface of each plate can be greatly increased by stamping it with a corrugated check protector.

Separators can be readily made from celluloid strips, which can be perforated on the check protector mentioned above.

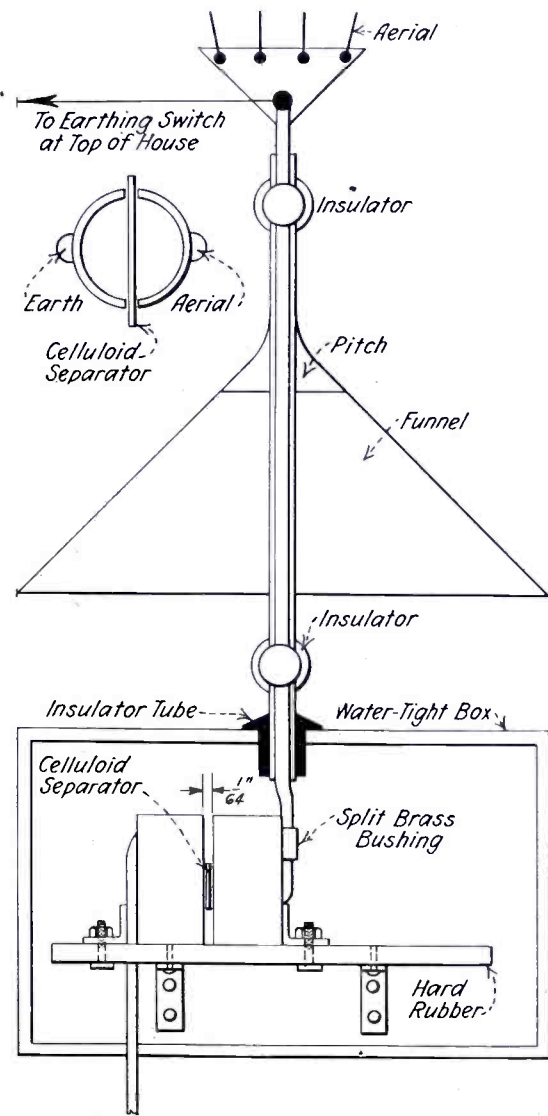

With This Device the Aerial May Discharge Itself During a Thunderstorm, if the Ground Switch is Not Closed.

Old pieces of film with emulsion washed off can be used, if desired.

In assembling, each lead plate overlaps another by 4", the rubber tubing being forced on over the lapping portions, and bent to the U-shape mentioned above. A separator is placed between the lead plates where they lap.

The usual acid solution is used to complete the battery, and the forming of the plates done by charging and recharging at about 2.6 to 2.9 volts per cell, too high a rate being avoided, as this causes boiling over and spoils the whole battery.

Contributed by R. V. CLARK.

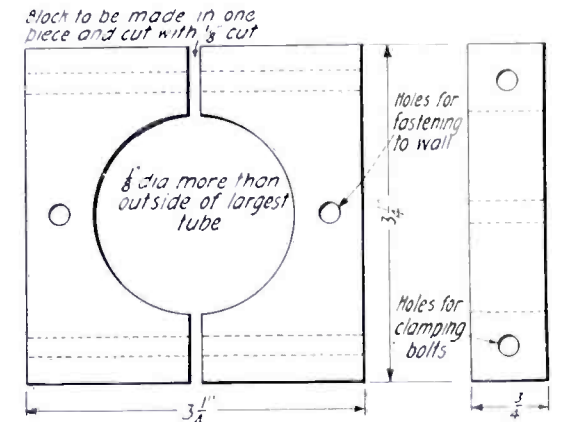
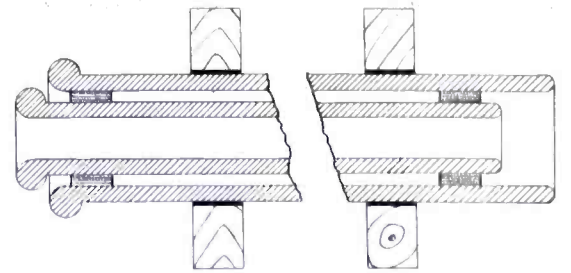

A Simple and Efficient Lead-In Insulator That May Be Made Cheap.

A RECEIVING AERIAL WITH A LIGHTNING GAP.

Now that the time for lightning and atmospheric is upon us, I should like to suggest a way for safeguarding an amateur station against this danger. As lightning makes me rather nervous, I wanted to devise a way which would prevent any electrical discharge from getting even as far as the lightning switch outside of the house, and recalling having seen a lightning gap on an old telephone system, I set about constructing one large enough for the purpose.

This gap, as can be readily seen from the sketch, is made by a piece of heavy split brass tubing, such as a bearing of an automobile engine, or like parts; some amateurs will probably find this bearing already in two sections. These sections are mounted on a piece of hard rubber and separated about a sixty-fourth of an inch. This is done by placing a very small strip of celluloid between the two halves. To the one on the right is fastened a length of No. 4 copper wire. The other one is fastened to the earth wire, which is made of a piece of No. 4 galvanized iron wire, which in turn is joined to a 10' length of iron pipe driven into the ground. The wires are joined to the pieces of brass by means of pretty strong rivets. The whole is placed in a water-tight box, and the lead-in and earth pass out through porcelain insulators. The copper wire, which by the way should be of the insulated kind, is held by two strong cleat insulators to the top of a pole about 7' long, driven in the ground.

To avoid any water running down the aerial, and then over the box, and thus

(Continued on page 259)

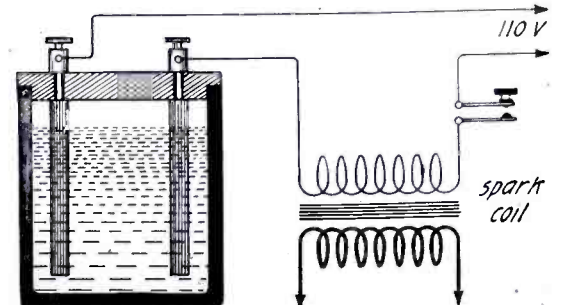

With Such a Resistance You Can Use the 110 Volts on Your Spark Coil.

Correspondence from Readers

ABOUT "OPS."

Editor RADIO NEWS:

In reading the May issue of RADIO NEWS I noted with much satisfaction that Mr. R. N. Oakley, 5YB, commended the work done by "Limie" operators on ships and on shore.

Although 5YB was with the Grand Fleet during the war, the same service was given by the English "Ops" after the war. I served 19 months in Scotch and English waters with the Mine Laying and Mine Sweeping Squadrons and at all times I have failed to see as many and as big "Hams" as we had with us aboard, myself included.

The English do not go to a Government school for 10 to 20 weeks to be then sent to the Fleet as full fledged "Ops." I have been told by different English "Ops" that their school period was at least 10 months even during the war, and when sent to the Fleet they were not permitted to handle the key for a good while. I will say here that the QRM in the English Channel is about as bad in peace times as it is around Long Island. How about it, 5YB, were those "B" stations busy?

And now for some enlightenment. Who can give me some information regarding an antenna that is wound in a loop form, but is used as an ordinary antenna with regular ground? Also, has anyone any new hook-up for a crystal detector?

I may add that while the knowledge of Radio is increasing very rapidly as to C.W. transmission and reception, amplification and so on, also is the cost, and if it goes much further where will the amateur come in, who has but a few odd dimes each week to spend for the construction of his "Set"? It would seem as if it were getting farther away from the fellow who would like to learn the Radio game. Every time I look at a regenerative set (without batteries \$75), I think of the time when the Radio "bug's" set was comprised of a one-wire antenna, a 75-ohm phone and a piece of carbon with a steel needle as a detector. "Ye Gods" how this Lil Ole World moves.

WALTER L. SMITH,
397½ So. High St., Columbus, O.

QUENCHED GAPS AND RADIO COMPASS.

Editor RADIO NEWS:

Here is another of the many, many unpleasant things that can be found in the otherwise O. K. Radio. Why is it that certain apparently ignorant Navy men will take it upon themselves to accuse other Radio men, Naval or amateur, of being liars, etc.

The first flagrant case of this came to my notice thru the columns of "Q. S. T.," just after the amateurs in the third district had started to complain about bad QRM from NAM and NAH. Someone, presumably a Navy expert (???) who did not have the courage to sign his name in full, just "D. B.," came out with the preposterous statement that it "is ridiculous for anyone to claim that a modern quenched gap transmitter can possibly emit a broad wave" and wanted to know "how many amateurs ever gave any thought to the fact that this apparent broadness of wave might be due to a broadly tuning receiver? Not many, I'll warrant," when the chief complainants were amateurs using the Paragon type of short-wave sets, the sharpest, or at any rate, nearly the sharpest tuned receiving circuit known, and they were over 200 miles away from NAM anyway. I, personally, have heard NAM on my short-wave Paragon, which will not tune any higher than 300 meters, yet my station (Canadian 3DS) is about 1,000 miles away (on one bulb). It certainly is most surprising to think that a Navy man, belonging to one of the best, if not the best, Navies, from a radio point of

view, anyway, would not know anything about the standard Navy quenched gap transmitter. Anyone who knows anything at all about the quenched gap knows that if the voltage per gap unit is not adjusted very accurately, the gap will not quench and will be as bad as a straight gap, which has not held international repute for producing a sharp wave. Also the quenched gap will permit a 20 per cent. coupling instead of 10 per cent., as with a rotary, and most people seem to think that this means that you can use about ½" coupling safely with a quenched gap without broadening your wave. However, when a quenched gap set is operated properly, as in WCG, a commercial station, it makes a very sharp wave. So much for Case No. 1.

Case No. 2 started with me when I read Paul Mansfield's letter in RADIO NEWS for May, 1921. Why is everyone taking a wallop at that fluke made in Phil Vernon's interesting disclosure of the U. S. direction finding system? Mansfield thinks Vernon needs a kick, but my private opinion, for all to read, is that Mansfield should be the kicked, not the kicker. How do we know that the linotype operator didn't make that fluke of "full power" for "low power"? Broad coupling need not necessarily mean

only amateurs that get their calls published in the "With the Amateurs" department are those who have a big call card showing in the photograph. I think you should make it a rule not to accept photographs of amateur stations for publication in this department unless accompanied by the station call letters. Through some oversight, none of the calls of the various stations were shown in the article "Government and Amateurs Join" on page 768 of the May, 1921, number. If some one wants to get the QST about market prices, who will he stand by for? The author only has the names of the cities down, and each city has probably half a dozen high power amateur stations that might or might not be the transmitters of the reports. I would like to see what other amateurs think about the calls.

H. S. GOWAN, 3DS,
120 King Street, West, Kitchener, Ont., Canada.

(Thanks for the hint, 3DS—constructive criticism is what we want. You'll see plenty of calls soon—didn't know you wanted 'em so badly. We're here to please, first, last and always.—Editor.)

HERE HE IS.

Editor RADIO NEWS:

Thanks very much for printing that knock of mine in the July RADIO NEWS. Might I say that I appreciate fun as well as the rest of you, but I wish you would use that space for more articles giving valuable information and hook-ups. As for "Calls Heard" one magazine is enough to print them. I wish all your numbers were as good as the August issue.

Sincerely yours,
ANDREW POTTER,
8BIP.

"MOUNTAINS OUT OF MOLE-HILLS."

Editor RADIO NEWS:

I have read with interest the letters in the past two issues of RADIO NEWS regarding the story written by Mr. Burgess in the May issue.

I wonder if Mr. Burgess realized what he was doing at the time he wrote that story? It seems that he has injured a number of super-sensitive dispositions when he mentioned the "Awful Racket Raisers' League." I do not think it takes a broad mind to see that the story was a humorous one and that there was no malicious allusion to the A. R. R. L. I am a member of that organization and I did not feel that the organization was injured in any way, neither did I feel compelled to sit down and write scathing remarks concerning the editors of RADIO NEWS, as did Mr. Mann, or accuse them of being unfair, as did Mr. Talianoff.

I am surprised that the A. R. R. L. has such hyper-sensitive men in its ranks. I do not think that such a spirit tends to promote the welfare of amateur radio and I am more than surprised that the matter was mentioned by the editors of "QST" in an editorial. It is making "mountains out of mole-hills" and a mighty feeble mole-hill at that.

It is cheap notoriety to write such "brick-bats" and dare them to be published and I think that the writers must feel rather small at seeing themselves before the public in such a light as they have shown themselves.

I hope that this controversy will die out and the energy expended in writing such distasteful letters will be used for better purposes.

JOHN B. DOWDEN,
Glen Cove, N. Y. Radio Station 2-BFF.
(Continued on page 226)

*I*N publishing the three letters in the adjoining column we bring to a happy close our recent controversy.

We much regret the fact that we find it impossible to publish all the hundreds of flattering letters as well as the brick-bats received during the last few weeks—and they are still coming in lively. We will say, however, that at least 75 per cent. of the letters so far received are on our side. We are publishing three letters, each one of which is written by a member of the A. R. R. L. We feel that these letters,—better than anything else—from the great League illustrates the true feelings of the majority of the American Radio Relay League. This closes the incident, as far as we are concerned and, we hope, to the satisfaction of all readers.
—Editor.

tight coupling. I do not think that such terms should be used in describing the coupling, as they are apt to be misleading. Vernon probably meant "coils wide apart" by "broad," because Mansfield is not the only person who knows that a broad wave cannot give as accurate a bearing as a sharp one, and surely one's own common sense would tell him that the rule of "minimum power necessary for sure communication" would apply even in this work. Now, to come to the point. Why don't they send Mansfield back to the radio school? Here he comes out with the following: "but if they are any kind of operators and have a sharp tune and high decrement we are able, etc." Well, I'll be dogwallowed if that sort of wave isn't a new one on me. First time I have ever heard of a sharp, broad wave. Perhaps Mansfield will kindly tell us what vessels use this type of wave. I would like very much to listen to one. This must be the kind of wave that one gets with rubber insulation between the plates of the 10-k.w. quenched gap, or else with a silver antenna.

By the way, I have noticed a little "nuisance" in RADIO NEWS. You editors seem to take exceeding care not to publish station calls along with descriptions of stations, especially commercials, etc. Also the

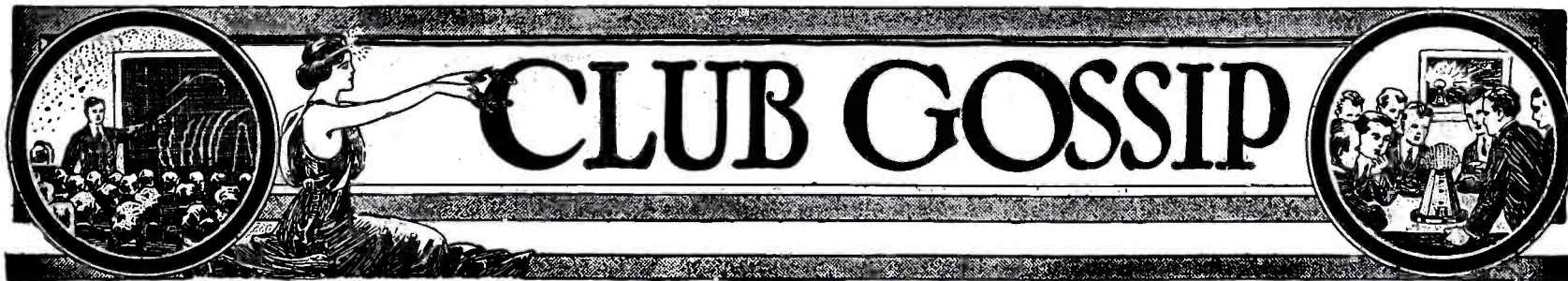

NEW NATIONAL ALPHA DELTA ALPHA RADIO FRATERNITY ORGANIZED

Alpha Chapter, Alpha Delta Alpha Radio Fraternity of Coe College, Cedar Rapids, Iowa, announces the affiliation with the installation of Beta Chapter at the State University of Iowa, Iowa City, Iowa.

Alpha Delta Alpha Radio Fraternity was founded at Coe College, Cedar Rapids, Iowa, in September, 1920, by 18 commercial radio engineering students. After being granted a charter by the College, Alpha Chapter was legally installed the following month. There is a present membership of 25 men. From the very first the organization has been marked by a spirit of enthusiasm and co-operation, which has had very marked results.

The nationalizing and establishment of chapters in the universities and colleges of the United States mark the forming of a new type of fraternity which should prove very popular. At the present time a number of petitions from some of the leading universities of the Middle West have been received by the fraternity, and very likely other chapters will be installed in the near future.

Alpha Chapter, Alpha Delta Alpha Radio Fraternity, recently sponsored an Iowa State Radio Convention which was held at Coe College, Cedar Rapids, Iowa, May 28, 1921. Reports from all concerned indicate that the convention was a great success. The main achievement was the establishment of the Iowa Radio Relay League, an organization solely for the amateurs of the State, which will be affiliated with the American Radio Relay League.

THE ROCHESTER (N. Y.) RADIO CLUB

The regular meeting of the Rochester Radio Club was held on May 27 at Mechanics' Institute. Reports of committees were received. The Banquet Committee reported that arrangements had been made to hold the event Thursday evening, June 16, at Powers Hotel. Professor Ballard, of Cornell University, spoke on "Some Phases of C.W. Transmission." He is considered one of the leading experts on radio in the country. A delegation was present from the Radio Association of Western New York, of Buffalo, two of whom spoke.

The Engineering Committee reported that cards were being mailed to those who were reported for violating Federal and club traffic laws and that conditions were being improved rapidly.

BATAVIA RADIO CLUB

The boys of Batavia, N. Y., have organized the Batavia Radio Club and have elected the following officers: President, John Valentine; vice-president, John Johnson; and secretary, Ackley Wicks. Richard Ogden and John Johnson have been appointed to make arrangements for weekly talks on radio subjects.

SYRACUSE AMATEUR RADIO ASSOCIATION

Fifty-one amateur wireless operators attended the first annual banquet of the Syracuse Amateur Radio Association recently. They were present from Utica, Skaneateles, Cazenovia and other Central New York places.

Among the speakers were E. L. Colby, head of the Colby Telegraph School at Auburn; W. G. Jackson, professor in North High School; Daniel Woodworth, of Syracuse, and Willard Taylor, of Syracuse. They outlined recent developments in telegraphic science.

SOUTHAMPTON RADIO CLUB

The Southampton, N. Y., Radio Club was reorganized recently and meetings are now held the first and third Wednesdays of each month. At the re-election of officers the following were elected: President, Leo Turner; secretary-treasurer, Clarence Deim; traffic manager, Robert Freeman, 2AO. The purpose of the club is to interest amateurs in the vicinity of Southampton in amateur relay work. The more advanced members are experimenting with C.W., while the others are getting good receiving sets installed. We invite correspondence with any other radio organization. Address all communications to Clarence Deim, Water Mill, New York.

THE COLLEGEVILLE RADIO CLUB

At a recent meeting of the Collegeville Radio Club, held in the station of G. G. Clamer, 8A1A, the election of officers was held. The results were as follows: President, A. C. Baden; secretary-treasurer, F. M. Mergenthaler. Amateur radio activity in this section has been on the increase all through the summer as is shown by the increasing membership in our club. Meetings are held every Tuesday at which business is first

transacted and then talks and discussions are held. Correspondence from other clubs would be appreciated and should be addressed to the secretary, Collegeville, Pa.

FORDHAM RADIO CLUB

The Fordham Radio Club has heretofore been functioning as an institution dealing with radio work in general, while those in the club, who specialized in continuous wave work organized a C.W. chapter, and were chartered by the club. The interest in C.W., however, has grown to such proportions and the membership has increased so rapidly that it became necessary to change our system. Now we are organized as a C.W. club with a "spark" chapter for these members who are not yet C.W. members.

As a C.W. club we have adopted a standard transmitter that all C.W. operators use. At a recent meeting a paper was read in which the details of construction and theory of operation were fully described. We have found the adoption of a standard set to be of material aid in getting the spark men into C.W. operation, and in solving the problems always encountered in C.W. work.

We are at present formulating plans for the erection of clubrooms, where a C.W. set will be installed. At that time we expect to take an active part in relay work.

At the present time local traffic is being handled smoothly by a number of the phone operators throughout the district, while the greater part of the D.X. traffic is handled on several nightly schedules by ZXX.

We expect very shortly to begin the publication of a club periodical, containing a permanent record of the proceedings of the club, and enough technical and humorous matter to make it interesting to the radio fraternity at large.

Pending the completion of permanent quarters, meetings are being held at the home of Mr. L. M. Cockaday, ZXX, 2674 Bailey Avenue, Bronx, every Monday evening at 8 P. M. Men desiring to join should attend a meeting at that address to make formal application. Communications should be addressed to the secretary, Mr. William Weller, 2156 Webster Avenue, Bronx, New York City.

IRVINGTON, N. J., RADIO CLUB

After a very busy season of lectures, radio talks, banquets and conventions, the radio club is having its clubhouse remodeled and redecorated, and while this work is progressing we have departed slightly from the regular routine of business and are laying plans for another busy season next fall, when we hope to have a 100 watt C.W. set, and telephone in operation. This set is being figured on at present but will be in the course of construction very soon. We will still retain our one-half K.W. set for emergency.

At the past Presidential election we had the official return station of Irvington, and had the set installed in a local news office. During the returns approximately two hundred phone calls were answered.

During the big fight between Dempsey and Carpenter we operated a battery of loud speakers placed in the Krueger Auditorium at Newark, N. J. This auditorium holds about two thousand five hundred people and was packed long before the fight started.

We also had a set at the Elks' Club in Irvington and received the returns there with loud speakers. The results were greatly appreciated by all present at both stations and after which the operators were deluged with questions pertaining to the mysteries of wireless.

The club holds its meetings every Thursday evening at 8.30 o'clock and visitors are heartily welcome at any of the meetings at the club house, 55 Linden Avenue.

RADIO SOCIETY OF CHRISTCHURCH, N. Z.

On Feb. 15th the radio society of Christchurch was formed, about twenty wireless enthusiasts meeting together at the home of Mr. R. I. Orbell. The following officers were elected: President, Mr. R. J. Orbell; vice-presidents: Messrs. L. Steel and H. Ragg; secretary and treasurer, Mr. L. F. Ball. The society now has over thirty members. Rooms have been secured in the center of this city and keys to buzzers, lectures, etc., are in full swing. We are not so fortunate as American amateurs, we have no permits yet, but we are informed that receiving permits will be granted shortly. The club is preparing for this by getting a receiving set together. This will be of the two-step amplifier type, using honeycomb coil tuning, etc. Several of our members possess fine receiving and transmitting sets. Transmitting, of course,

is not done at all, but a good many receiving stations are working. We are too keen to keep away from radio until permits are issued. European and American stations are easily received all the time, especially POZ, LCM, LY, YN, 1DO, NPM, NPN, NSS, KIE (spark and C.W.). All these can be heard on one bulb and can be heard with phones several yards away, using a four-stage amplifier (resistance coupled). This is rather good, considering that we are about twice as far from Europe as from the United States.

We would be very pleased to hear from anyone who cares to write. Correspondence from other clubs is especially invited. All communications should be addressed to the secretary, Mr. L. F. Ball, 114 Southampton Street, Christchurch, New Zealand.

RADIO IN ARGENTINE

I am an enthusiastic reader of your paper and would like to get into touch with some fellow "hams" out there.

I have a receiving set made up of a loose-coupler and a French army type tube. I get all the stations around here besides three or four radiophones.

I've also got a ¼ K.W. transformer and Murdock condensers and hope to soon have the set working.

It is very difficult to get anything out here unless one is a millionaire. Dealers charge exorbitant prices. One has to pay as much as three times the ordinary catalog prices. It would be fine if some firm started a shop here through an agent. I'm sure the amount of amateurs would increase surprisingly.

At present there are about 150 "hams" in the Argentine.

I would be very glad if you will publish this so as to get in touch with some of the boys out there. J. Horace Sotham, Guanacache 3965, Coghlan, F. C. C. A., Buenos Aires, Argentine Republic.

GREEN POINT RADIO CLUB

Several amateurs of the Green Point section of Brooklyn, N. Y., starting a radio club, notice is given here for those interested. All amateurs in this section are invited to correspond with Mr. George W. Pope, 1038 Lorimer St., Brooklyn, for detailed information.

THE SUNDAY LEADER RADIO CLUB

The Sunday Leader Radio Club was formed last January for the purpose of encouraging and helping the amateurs throughout the Maritime Provinces and Newfoundland.

For several months radio articles were published in the *Sunday Leader*, a Halifax, Nova Scotia, weekly paper, but on account of the difficulty of securing articles through the summer months it was decided to stop printing them.

It is hoped that the Maritime amateurs will send the secretary descriptions of their sets, constructional details of their homemade apparatus, hints and hook-ups, etc., as it will not be possible to have a radio column in the *Sunday Leader* unless they do so.

The S. L. R. C. will be glad to welcome as a member any Maritime amateur who sends in full particulars of his wireless set results obtained, call letters, etc.

Address all correspondence to the secretary, C. H. Starr, Windsor, Nova Scotia, Canada.

THE RADIO CLUB OF ELECTRIC LIGHTING INDUSTRIES

This club was formed to bring together the radio amateurs and those interested in wireless. The club has a membership of 140. The officers are the following: J. L. Prince, president; H. R. Searing, vice-president; H. F. Rotchford, secretary-treasurer.

The directors are the following: R. H. Nicholson, A. M. Mitchell, George Gropp, Gustave Shroff, George Ward and C. L. Law.

Also the following committees were appointed: Membership committee, code committee, operation and construction committee and library committee.

The code committee has secured an omnigraph and has started a practice class. The construction committee has started working on a 20-watt C.W. and phone set. Dues are \$1 per year. This club was formed by the radio amateurs of the New York Edison Co.

Any person interested in wireless, who is working for an electric lighting company, and who wishes to join this club, should write to the secretary-treasurer for an application blank. Address H. F. Rotchford, Radio Club, care New York Edison Co., 15th St. and Irving Place.



THIS Department is conducted for the benefit of our Radio Experimenter. We shall be glad to answer here questions for the benefit of all, but we can only publish such matter of sufficient interest to all.

1. This Department cannot answer more than three questions for each correspondent.
2. Only one side of the sheet should be written upon; all matter should be typewritten or else written in ink. No attention paid to penciled matter.
3. Sketches, diagrams, etc., must be on separate sheets. This Department does not answer questions by mail free of charge.
4. Our Editors will be glad to answer any letter, at the rate of 25c for each question. If, however, questions entail considerable research work, intricate calculations, patent research, etc., a special charge will be made. Before we answer such questions, correspondents will be informed as to the price charge. You will do the Editor a personal favor if you make your letter as brief as possible.

FRENCH TUBES.

(246) Roland F. Lough, of Plainfield, N. J., wants to know:

- Q. 1. Where can French tubes be purchased?
 - A. 1. These tubes may be obtained at the Electro Importing Co., 233 Fulton St., New York City; from W. R. H. Tingey, 92 Hatton Garden, London, E. C. 1, England, or from Burnham & Co., 19 Hand Court, High Holborn, London, England.
- Q. 2. Is the Universal audion suitable for a portable set?
 - A. 2. Yes, this type of tube may be used in a small set.
- Q. 3. Please give hook-up using one variocoupler, two variometers, one .001 mf. condenser and audion socket, a grid leak and condenser, a rheostat and batteries.
 - A. 3. This hook-up appeared as Fig. 2, page 443, of the January, 1921, issue of RADIO NEWS.

DATA FOR SHORT-WAVE SET.

(247) G. R. Rimla, of New Zealand, requests information:

- Q. 1. Please give me sizes, etc., of variometers for plate and grid circuits and for variocouplers, for short waves?
 - A. 1. This data appeared on page 526, February, 1921, RADIO NEWS.
- Q. 2. Would it be better to use a variometer for tuning the primary circuit than to use a loading coil with a unit and tens switch?
 - A. 2. The same results may be obtained with a variometer or tapped primary.
- Q. 3. For long waves, is it better to use a tickler circuit, or a Weagants circuit with tuned plate and grid circuits?
 - A. 3. A tickler circuit is somewhat simpler and is just as efficient.

WINDINGS FOR REGENERATIVE CIRCUIT.

(248) W. O. Kondolf, of Rochester, N. Y., would like to know:

- Q. 1. What windings should be used in the regenerative circuit, Fig. 2, page 704, April, 1921, RADIO NEWS, for the variometers and coupler for 150 to 600 meters?
 - A. 1. Reply to this may be found on page 526, of the February, 1921, issue.
- Q. 2. Is this the best regenerative circuit for short waves, or is the true Armstrong circuit better?
 - A. 2. This is the Armstrong circuit, but the coupling between the variometers should be adjusted for the best results.
- Q. 3. Is the circuit in Fig. 4, on that page, better than the ordinary tickler circuit for long waves?
 - A. 3. This is the tickler circuit, but with the plate inductance shunted by a variable condenser. Back copies of RADIO NEWS may be obtained from the Experimenter Publishing Co., at the regular price.

CAUSE OF HOWLING.

(249) Aymor Quinney, of Komoka, Ont., Canada, would like to have the following questions answered:

- Q. 1. What is the trouble with a vacuum tube when a hissing sound is audible?
 - A. 1. My detector hisses sometimes. I am using an electron relay tube. What causes this?
- Q. 2. The hissing sound in a vacuum tube is generally caused by the charge of the grid leaking inside of the tube. It may be caused by incorrect value of grid condenser or grid leak, or by wrong adjustment of the filament and plate voltage. The electron relay is rather difficult to adjust and 35 volts should be used on the plate for the best operation.
 - A. 2. This may be caused by incorrect value of plate and grid inductance, or incorrectly designed circuit, or else the last suggestion given to Q. 1 is the cause.

VARIOMETERS VS. HONEYCOMB COILS.

(250) Harold Lunk, of Pittsburgh, Pa., wants information:

- Q. 1. Which is the better for short-wave reception, a short-wave regenerative set or honeycomb coils?
 - A. 1. A short-wave regenerative set is better.
- Q. 2. Please give a hook-up for honeycomb coils, tickler circuit, the necessary condensers, audion detector and three-stage amplifier?
 - A. 2. The hook-up for the receiver was given on page 786, of the May, 1921, issue of RADIO NEWS, and the hook-up for the amplifier appeared on page 512 of the February, 1921, issue.

H. T. PLATE SUPPLY.

(251) Alva Flippin, of Ranier, Oregon, asks:

- Q. 1. Would it pay me to step up A.C. for the plate of a C.W. set, or get a motor generator? I use only a five-watt tube.
 - A. 1. To obtain H.T.D.C. with a transformer supplied with A.C., you should use two rectifier tubes with a filter circuit, while a motor generator will supply you directly with D.C. Considering the price, we believe you may obtain a small D.C. machine cheaper than a transformer and tubes. Consult the classified ads in the radio magazines.

C.W. POWER TRANSFORMERS.

(252) Emil Horlin, of Brooklyn, N. Y., asks some questions:

- Q. 1. Using stepped-up and rectified A.C. with the hook-up of Danna's radiophone set of page 689 of June, 1920, RADIO NEWS, would the choke coils be of the same size as described?
 - A. 1. The choke coil of the set you mention should be O. K. for the filter circuit.
- Q. 2. What range should the milliammeter of the same set read?
 - A. 2. About 200 milliamperes.
- Q. 3. What design of C.W. transformer should be used with this set?
 - A. 3. A suitable C.W. transformer may be built as follows: Iron core 6 x 4 1/4 inches outside dimension and 1 1/4 inches on a cross section. Primary should consist of 407 turns of No. 20 D.C.C. The secondary should be made in two sections of 1,230 turns of No. 30 S.C.C. each. The 24V. winding for filaments of rectifier tubes of 88 turns of No. 14 D.C.C. wire, and the six-volt winding for power tubes, 22 turns of No. 14 D.C.C. wire, with a center tap at the 11th turn.

CUNNINGHAM TUBE vs. RADIO-TRON.

(253) Edwin V. Worden, Jr., of White Plains, N. Y., sends the following:

- Q. 1. Would you please tell me whether there is any difference between the Cunningham V.T. and the Radiotron V.T.?
 - A. 1. No, they are of the same make.

ELECTROLYTIC RECTIFIER.

(254) Dale Stoddard, of Ames, Iowa, asks for the following information:

- Q. 1. How can I make an electrolytic rectifier and step-up transformer to change 110 volts A.C. to 250 volts D.C. for radiophone work?
 - A. 1. A transformer supplied with 110 volts, 60 cycles and delivering 250 volts, may be built as follows: Core 6 x 4 1/4 inches outside dimensions, 1 1/4 inches on a cross section. The primary consists of 407 turns of No. 20 D.C.C. The secondary wound in two sections of 924 turns of No. 30 S.C.C. wire each. The rectifier may be made of six, one-quart jars, with aluminum and lead plates 2 inches apart. Three cells should be connected on each side of the secondary.
- Q. 2. Please publish a hook-up for a radiophone using two bulbs, an audiotron and a Cunningham transmitter, with data for its construction.
 - A. 2. You will find on page 690 of the June, 1920, issue of RADIO NEWS, a hook-up and necessary data for the construction of a two-tube

radiophone, but you cannot use your audiotron for transmitting, as this tube is not made for that purpose and would probably glow blue. For the best results, use, if possible, two transmitting tubes of the same make.

AMPLIFYING TRANSFORMER.

(255) Lawrence Peterson, of Worcester, Mass., writes as follows:

- Q. 1. Regarding the construction of amplifying transformer in the February, 1921, issue of RADIO NEWS, page 533, where can I purchase, and what would the price be, of 20,000 feet of the wire used in constructing the amplifier?
 - A. 1. Some fine wire may be obtained from any well supplied radio shop. However, if wire of the size mentioned is not obtainable, enamelled wire No. 38 or No. 40 may be used instead.
- We suggest that you write to the Manhattan Electric Supply Co., 17 Park Place, New York City, or the Electro-Importing Co., 233 Fulton Street, New York City.

INSULATED WIRE FOR AERIAL.

(256) J. B. Urie, of St. Thomas, Ont., Canada, asks:

- Q. 1. Can insulated wire be used in an aerial?
 - A. 1. Yes, insulated wire may be used for an aerial, if no other wire is available.
- Q. 2. Is the circuit enclosed a suitable one?
 - A. 2. Yes, but we would advise a greater capacity for the stopping condenser, for instance 2 Mf.

REGENERATIVE SET.

(257) G. A. McBeth, of Bucyrus, Ohio, requests answers to the following questions:

- Q. 1. Can a regenerative hook-up be used in connection with one of the old type loose couplers?
 - A. 1. Yes, see page 443 of the January, 1921, issue of RADIO NEWS, Fig. 2.
- Q. 2. Please give data for making variometers for use on a regenerative set; the tubes I have are 4 1/4 inch and 3 1/2 inch outside measurement, and the wire is No. 28 D.S.C.
 - A. 2. Forty turns should be wound on the rotor and 40 on the stator.
- Q. 3. In the hook-up for a regenerative receiver, page 527, February, 1921, RADIO NEWS, there is no grid leak. Is this unnecessary, or is the tube not an audiotron?
 - A. 3. A grid leak should shunt the grid condenser.

THREE-STAGE AMPLIFIER.

(258) Irvin Stephens, of St. Charles, Mo., asks us to please answer the following questions:

- Q. 1. Please give a diagram of a detector and a three-step audio-frequency amplifier using same "A" and "B" batteries for all tubes.
 - A. 1. This circuit is given on page 512 of the February, 1921, issue of RADIO NEWS; if you wish to use a higher voltage on the amplifier tubes, the leads from the three last jacks should be connected together and to the positive of the extra "B" battery, the negative of which is connected to the positive of the first one.
- Q. 2. When using Acme transformers, is there danger of a howling noise at the third stage?
 - A. 2. To prevent howling, if there is any, the filament current should be adjusted carefully. A good precaution consists in connecting the iron core of the transformers to the positive of the "B" battery.
- Q. 3. Why is it that, with my new honeycomb coil set, I can cover all waves from 200 to 1,700, but never hear any radiophones, several of which are operating in St. Louis on from 200 to 500 meters?
 - A. 3. If you do not hear radiophone transmissions it is probably because you are out of their range, or because you do not properly tune your set. Tuning for C.W. or radiophone is very sharp and should be made slowly. Another probable reason is that your aerial has too long a wave-length and you cannot tune on short waves.

ANNOUNCING

MURDOCK

RECEIVERS

No. 56

(Patented.—Other Patents Pending)



**2000
OHM COMPLETE
DOUBLE SET
\$5.00**

**3000
OHM COMPLETE
DOUBLE SET
\$6.00**

The MURDOCK No. 56 Radio Receiver is a reproduction, with notable improvements, of the MURDOCK No. 55, which have deservedly earned a reputation of UNUSUAL SENSITIVENESS and LONG-LIVED DEPENDABILITY. Years of experience in production have so simplified our manufacturing processes that there is NOTHING QUITE SO GOOD AT SO LOW A COST. Every guarantee that has gone for the last 14 years with MURDOCK Radio Receivers is behind the MURDOCK No. 56.

Receivers encased in MURDOCK moulded insulation; magnet of best quality steel, embedded in case with pole pieces attached permanently and unchangeably; all receivers are by-polar; spools are wound with fine size pure copper wire with enamel coating, this method of winding ensuring a maximum number of effective layers; diaphragm is selected stock of thickness experimentally determined best; special attention is given to a most important feature of receiver efficiency, namely, the proper seating and clamping of the diaphragm; the cap or ear piece is MURDOCK moulded of size and shape best fitted for comfort and exclusion of outside noises; cords supplied with sets are five feet in length with durable mercerized finish. The headband wires are spring phosphor bronze and are covered with black-covered webbing. The design of the MURDOCK No. 56 Headband is unique because of the absence of screws on either Head Band or Receiver Adjusting Bale. The construction plan is the acme of firmness, strength, durability and service, all parts being riveted together.

A WONDERFUL VALUE

2000 ohms	\$5.00
3000 ohms	6.00
1000 ohms Receiver only.....	1.75
1500 ohms Receiver only.....	2.25
Double Head Band.....	1.50

GUARANTEE

Fourteen days' trial allowed in competition with any other receivers. If prior to, or at the expiration of the trial period, the receivers are not found to be completely satisfactory, the purchase price will be refunded upon return of the receivers.

“PERFECT SATISFACTION GUARANTEED OR YOUR MONEY BACK”

**BUY THEM FROM YOUR DEALER
SEND FOR BULLETIN No. 21**

**WM. J. MURDOCK CO. 50 CARTER STREET
509 MISSION STREET, SAN FRANCISCO, CALIF. CHELSEA, MASS.**

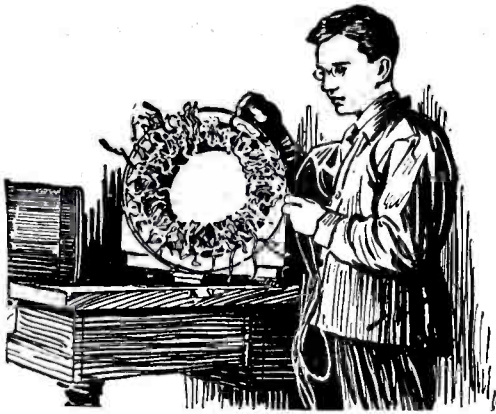

Become An Expert in Motor, Generator Repair and Armature Work

Trained men who are competent in Armature winding, Motor and Generator Repair and maintenance are in big demand right now. Take up this work and in a very short time you can step into this growing field and insure yourself a permanent, well paying position with big opportunities for advancement.

Learn in 3 Months

In 3 months you can qualify for positions paying good salaries. Come to this well founded and completely equipped school where you will learn to actually wind every type of D. C. and A. C. armatures. Experts teach and direct you.

Write for Free Book

Mail the coupon today for full particulars of our 3 months' course in Armature work beginning July 5th. Send the coupon and see how easy it is for you to become an expert in only 3 months.

School of Engineering of Milwaukee, Dept. G. 137 Broadway, Milwaukee, Wis.

Please send me full information about your three months' course in Armature work. No obligation on my part.

Name
 Address
 City..... State.....
 Age..... Education.....

\$1.75 LEARNERS SETS \$1.75
 With Code and Instructions



60c BUZZERS 60c
 Easily tuned; silver contacts; tone adjustments located on top.

\$1.50 SENDING KEYS \$1.50
 All brass, lever type, bakelite base and knob all postpaid.

AJAX ELECTRIC CO.
 Palmer St. Cambridge, 38, Mass.

NEW ORLEANS RADIO APPARATUS and SUPPLIES
ROSE RADIO SUPPLY
 604 Gravier St., New Orleans, La.
 Send 10c for Latest Catalog

PLATINUM WIRE
 IRIDIO-PLATINUM WALLOSTON
 for all radio work at prevailing market prices
WILDBERG BROS.—PLATINUM REFINERS
 Pacific Building, San Francisco

Radio Guides Ship

(Continued from page 184)

tified by its characteristic signal and the location of which is definitely indicated on the mariner's charts. It is essential that the ship be equipped with a radio compass, the coil being mounted over the pilot house. The receiving set and magnetic compass are located within the pilot house, thus facilitating the convenient manipulation of the device by the navigating officer. The shaft upon which the radio compass coil is supported extends into the pilot house, where it is directly connected through a bearing to the binnacle which carries the magnetic compass. Thus the wireless determination of the beacon station is read directly on the magnetic compass and the complete performance necessary in taking a bearing is merely that of rotating the wireless compass coil by means of a wheel to the critical angle of silence and then noting the position directly upon the magnetic compass cord.

The radio compass on shipboard entails calibration, as is true in the case of the magnetic compass. The metallic mass of the vessel is responsible for a deviation of the electric waves approaching the ship from its normal course of travel. The degree of deviation is dependent upon the relative position of the vessel. The result of calibration involves the application of a correction to the actual radio compass reading, either added or subtracted and varying in amount from zero to a maximum depending upon the fore and aft position of the ship with respect to the direction of approach of the electric wave. A horizontal axis represents the position of the radio compass coil with respect to the ship's center line, and a vertical axis shows the positive or negative amount of the correction to be applied for every position of the coil. A scale marked in accordance with this calibration curve is attached to the binnacle in such a fashion as to enable the observer to read the amount of correction to be added or subtracted directly and simultaneously with the radio compass bearing.

Other than obtaining bearings on known stations or near shore, an even superior virtue claimed for the new wireless signaling and compass system, is that of lessening the menace of fog—the bugaboo of sea-voyaging expeditions. Ships at sea, perhaps in distress or submerged in fog, can be located, and their course determined. In the interest of safety, every vessel at sea in fog could transmit radio fog signals effectively over a distance of 10 miles at frequent intervals. Such a practice would enable a companion ship, within range and when equipped with a radio compass, to ascertain the direction of the vessel thus signaling and thereby proceed with safety and without delay. Finally, in a large perspective, it is claimed that a universal adoption of the system as recently evolved would establish more effective safeguards around life and property on the commerce-traveled oceans.

The Work of the 101st Signal Battalion

(Continued from page 187)

charged.

A library with all the latest books on radio, active subscriptions to all radio magazines, keep the members in touch with the radio world. A gymnasium and a pool room are also part of the organization, and frequent dances and entertainments keep up the social end.

RADIO SUPPLIES

COMPLETE OUTFITS UNASSEMBLED PARTS

We carry a complete line.

Prepare now for winter season.

- CARDBOARD TUBING ALL SIZES
- WIRE—ENAMELED, COTTON AND SILK COVERED, ALL GAUGES
- AERIAL WIRE
- CONTACT POINTS
- SWITCH ARMS
- BINDING POSTS
- BRASS RODS BRASS SLIDERS
- KNOBS DIALS

Installations — Service Home Demonstrations Advice—Diagrams—Hook-ups

THE KING RADIO CO.
 113 SHERIDAN AVENUE
 PITTSBURGH, PA.

RADIO SUPPLIES 4th DISTRICT

We have a complete line of radio apparatus of standard makes, Acme, Amrad, Chelsea, Clapp-Eastham, Eveready, Federal, General Radio, Murdock, and Radio Corporation of America.

- FORMICA PANELS**
- 6 x 12 x 3/16 in. \$1.35
 - 6 x 18 x 3/16 in. 2.00
 - 9 x 12 x 3/16 in. 2.00
 - 12 x 18 x 3/16 in. 3.85

- RADIOTRON TUBES**
- UV-200 Detector \$5.00
 - UV-201 Amplifier 6.50
 - UV-202 5 Watt transmitting 8.00
 - UV-203 50 Watt transmitting 30.00
 - UV-712 Amplifying Transformer 7.00
 - PR-536 A. Bat Potentiometer. 2.00
 - 677B Battery 22½ V. 5 taps.. 3.00

Write for complete price list of Material Carried in Stock.

CARTER ELECTRIC CO. RADIO DEPT.
 63 Peachtree St. Atlanta, Ga.

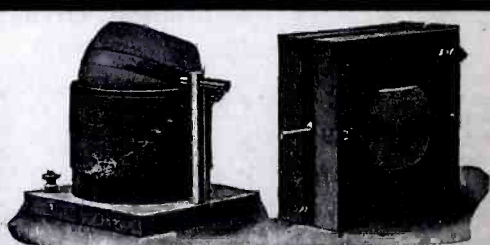

Variometers Couplers \$3.75 each

These instruments embody finest workmanship and best materials, all wooden parts genuine mahogany, coupler primary wound on formica tubing. Metal parts of brass. Wound for maximum results on short wave work. Money back if they fail. With Chelsea Dial \$1 extra.

Send for Bulletin Describing Unwired Regenerators

FREDERICK WINKLER, JR.
 304 Columbus Ave., New York City, N. Y.

REMLER

Radio Apparatus that Radiates Quality

Quality Built Into Every Item

The Remler Radio Mfg. Company is a highly perfected organization of expert Radio men, engineers and chemists who are pioneers in their field. These men have made a continuous study of the problem of perfecting radio apparatus, practically from the first days of the radio interests in America.

Quality in the manufacture of Remler Radio Apparatus, means the solution of hundreds of intricate problems in dozens of processes.

Remler Radio apparatus is designed and built to meet the requirements of the exacting amateur. Every Remler item is first studied and tested for its practical utility in the Radio field before it is put on the market. Great care and study is put into determining the size and design of every Remler item. This exclusive feature alone goes far in distinguishing Remler apparatus from all other radio lines. Far more important is the selection of choice materials, expert workmanship and built-in quality backing every Remler item. It is well to consider these factors when purchasing radio apparatus—ask for Remler—the Radio apparatus that radiates quality.

DEALERS:

There is an exclusive and very profitable proposition for you on Remler apparatus. Write for full particulars.

AMATEURS:

Write for 32 page Remler Bulletin just off the press.

REMLER RADIO MFG. COMPANY

E. T. Cunningham, Gen. Mgr.

163 Sutter Street
San Francisco, Cal.

154 West Lake Street
Chicago, Illinois

REEM

PRICE

\$6⁰⁰_—

TYPE 500
BAKELITE MOLDED

Variometer

TYPE 501
WITH BAKELITE
DIAL AND KNOB
\$7⁰⁰_—

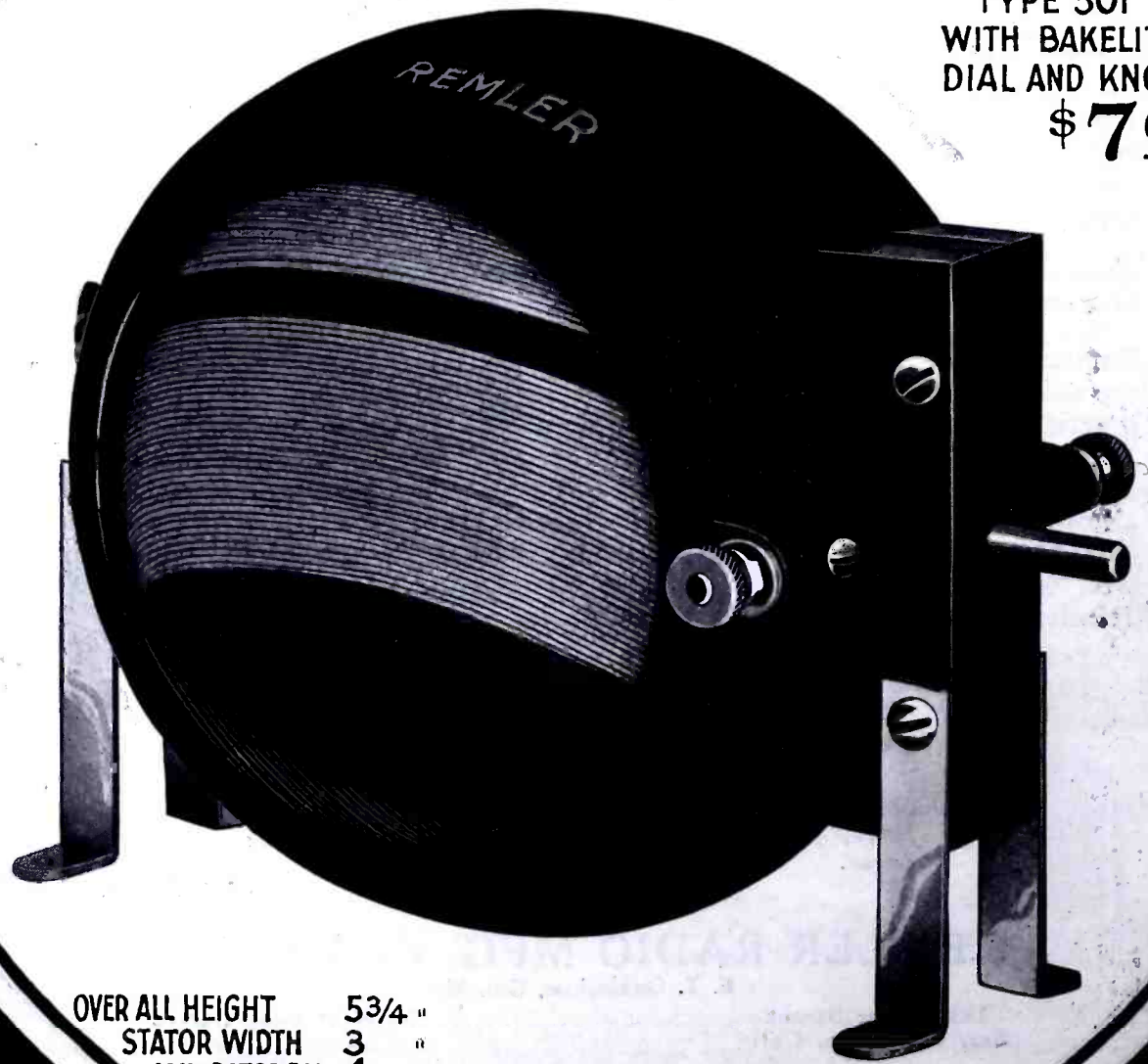

OVER ALL HEIGHT	5 ³ / ₄ "
STATOR WIDTH	3 "
MAX. ROTOR DIA.	4 "

FOR FURTHER INFORMATION SEE
THE REVERSE SIDE OF OPPOSITE PAGE

APPARATUS

THAT

REMLER

PRICE

\$6⁴⁰—

TYPE 504

180°

Vario Coupler

TYPE 503
WITHOUT BAKELITE
DIAL AND KNOB

\$5⁴⁰—



FOR FURTHER INFORMATION SEE
THE REVERSE SIDE OF THIS PAGE

RADIATES

QUALITY

REMLER

VARIOMETER-VARIO COUPLER

Specifications

Remler Type 500 Bakelite Molded Variometer.....\$6.00
 Remler Type 501 with No. 100 Bakelite Dial and Knob..... 7.00

ELECTRICALLY AND MECHANICALLY WITHOUT EQUAL

Stator molded in two halves from genuine Bakelite with primary winding molded on the inside, insuring an absolutely rigid winding. Rotor also molded from Bakelite. This all Bakelite molded construction insures accurate mechanical dimensions, strength and precludes the possibility of warping or shrinkage. Large dimensions permit the use of low resistance windings. Maximum stator diameter 5 $\frac{1}{4}$ " ; maximum rotor diameter 4" ; width across stator 3" ; shaft 3/16" diameter. Bearings backed up with spring tension. Wave length range 175-500 meters. Stator drilled and tapped for panel mounting. Brackets for table mounting. Polished nickel binding post terminals.

Remler Type 502 Panel Mounted Variometer.....\$9.75

Remler Type 500 Variometer mounted on polished Bakelite panel 5" x 5" x 3/16" with black hardwood base 5" x 3" x 3/8". Nickled input and output binding posts at opposite sides of panel. All lettering recessed and white filled. This panel matches Type 505 Vario-Coupler and Type 330 Detector panel permitting ready inter connection.

Remler Type 503 180° Vario-Coupler\$5.40
 Remler Type 504—with No. 100 Bakelite Dial and Knob..... 6.40

This vario-coupler has an exclusive feature—the coupling range is 180 degrees instead of 90 degrees (as is the case with all other vario-couplers). Primary winding green silk covered wire wound on fiber tube 4" diameter by 2 $\frac{3}{4}$ " deep. Ten taps are provided. Secondary rotor molded from bakelite. The bearing construction, of special design, is extremely rigid and is backed up with spring tension to insure perfect electrical contact at all times. Primary mounted at an angle of 45 degrees on wooden base 4" x 3" x 3/8". Can be readily mounted on either table or panel. Shaft 3/16" diameter. Rotor 3 $\frac{5}{8}$ " maximum diameter. Overall height, including base, 5 $\frac{1}{4}$ " ; total width, not including shaft extension, 4 $\frac{7}{8}$ ". This coupler will tune over a range of 150 to 600 meters with secondary variometer and with secondary condenser of .001 mfd. will tune to 700 meters.

Remler Type 505 Panel Mounted 180° Vario-Coupler.....\$12.75

Type 503 Vario-coupler mounted on a bakelite panel 5" x 7 $\frac{1}{4}$ " x 3/16" finished in glossy black with all lettering recessed and white filled. Input and output binding posts at opposite ends of panel. Special Remler switch with Bakelite knob to match dial knob varies the primary inductance. All panel wiring is the approved bus bar type and all connections to the primary taps are soldered. Hardwood base 7" x 4" x 3/8" is finished in black. Matches Type 502 Variometer Panel and Type 330 Detector Panel permitting ready inter-connection.

Remler Vario-Coupler Panel No. 505 with Type 502 Variometer for secondary tuning and the 330 Detector Panel provides an ideal short wave vacuum tube receiver of highest efficiency at an extremely reasonable price.

Write for 32 page Remler Bulletin—just off the press.

REMLER RADIO MFG. COMPANY

163 Sutter St.
 San Francisco, Calif.

154 West Lake Street
 Chicago, Illinois

APPARATUS THAT RADIATES QUALITY

A Grip Radiotalker

(Continued from page 188)

prietor of the "one-arm" lunch-room, it would seem, would respond to the novelty of this message-bearer and the patron of the café would not be compelled to serve himself. Imagine the consternation of being approached on the street and having a suitcase negotiate a conversation—not an impossible feat for this amplifying apparatus in its ability to repeat a wireless message being transmitted by a neighboring radio station.

Another redeeming feature of this equipment is its capacity to locate the wireless transmitting station, the coil in the cover of the leather container having directional powers. Similarly, indicative of its variable uses, a plug is so arranged on the suitcase that a telephone receiver may be connected in place of the amplification horn. Thereby, when held in front of a Bell telephone land-line transmitter, music or a conversation may be relayed to a friend at some distant point. Experiments have included a realization of this innovation. When related to the amplifying equipment, the infinitesimal amount of energy "picked up" by this small loop is so increased in volume that music or conversation may be heard distinctly in any portion of an ordinary room. Without attempting to appraise its ultimate value as a contribution to the multiple agencies of wireless communication, this strangely-formed equipment is assuredly arresting in its appeal to the popular imagination. Ultimately this device may supplement the talking machine, since one radio telephone transmitting station may supply music to a whole city.

The Termojonic Valve

(Continued from page 196)

of the metal net of the valve as a result of the reaction of the Marconi antennæ, oscillations are produced and the transmission of electro-magnetic waves. By means of a microphone the human voice further varies the size of the waves and the result is wireless telephony. It is evident that to vary the size of the waves by the modulation of the voice it is necessary to operate with waves of a constant size, such as the continuous wave produced by the termojonic valve.

"We have already spoken with and heard a few words from the United States, and I hope soon it will be quite complete. But," concluded the Senator, "it is reserved for wireless telephony to first speak across the Atlantic. Cables will never be able to do it, because of their electric capacity, which distorts the voice."

Later the Senator explained to me his wireless compass. By means of messages received on special semi-vertical antennæ then automatically marked on a compass, the position of the ship is fixed, also the shore station and that of any other neighboring ship. This is marked by diagonals on the chart, and course is steered accordingly. Last year, on three occasions, the *Elektra* was saved from disaster thanks to this compass. To show how good a ship she is, the log records that in 12,000 knots traversed last year only on three days was it necessary to have "fiddles" on the table.

This winter Senator Marconi hopes to take the *Elektra* to India, where he has been invited by Lord Reading, the new Vice-roy.

Arcs and Tubes

These new branches of the revised examination of the Department of Commerce are fully covered in the Home Study Course of the Radio Institute of America.

The Home Study Course will thoroughly equip you for the new examinations of the Department of Commerce, which went into effect July 1 of this year, and by enrolling for this course you will be taking a big step in the right direction and insuring your future. The ever-broadening field of radio communication offers every opportunity for future security and the job is usually looking for the capable ambitious man.

Enrollments are coming in by every mail. Why aren't you one of the wideawake wireless men who have seen the new and greater opportunity opened to them by the Home Study Course, which is specially designed to land them one of the enviable jobs at the world's greatest radio station? NOW—not some later day—is the time to act!

Consider, for instance, the opportunities of the "Promised Land."

"The Promised Land" is the name professional operators have given to the New York Radio Central Station, on Long Island. When completed, this station will be the largest and most powerful radio station in the world.

It will be equipped to work simultaneously with five other nations in widely separated and distant parts of the world, and will be epoch-making in the field of international communication.

A position at this station is the height of every operator's ambition, for it means unlimited opportunity to succeed and progress to higher, more responsible and better paying positions in the radio industry. So far as opportunity goes

The Radio Institute of America has been an established and successful institution for over fifteen years. The year round average attendance in its classrooms is now 298 students per month. It has trained over 6,000 men, 95% of whom have successfully engaged in this new branch of science and industry.

You, too, can be successful in this new field if you properly train yourself by means of the Home Study Course of the Institute. Radio offers an unlimited opportunity for future advancement—why not take advantage of it? Write for our booklet and further details—Now.

HOME STUDY DIVISION

Radio Institute of America

(formerly Marconi Institute)

324 Broadway, New York

the successful future of these men is assured.

How about you?

This new home course of radio training, which has been developed for the benefit of those who cannot attend the Institute personally, is the same course used at the Institute. It includes everything from basic principles of electricity and magnetism to actual operation of commercial radio equipment, including arc and tube transmitters. It also includes the same textbooks used in the Institute classes, as well as a buzzer set of greatly improved design with a variable automatic transmitter for code practice.

The graduates of the Radio Institute of America enjoy a great and exclusive advantage in the close connection existing between the Institute and the Radio Corporation of America, the world's largest radio manufacturing and commercial radio company.

Prominent executives in the radio field are former students of the Institute. The Radio Corporation employs thousands of men, in its executive departments, on ships and at shore stations and in factories and laboratories. A large percentage of these men are graduates of the Institute.

RADISCO BETTER "B" BATTERIES

No battery at the price
is as good:

No battery at any price
is better:

For radio phone work, Radisco Better "B" Batteries provide a reliable source of power without the disagreeable hum of a motor generator or the rectified 60 cycle tone.

Small Size, \$1.50

Large Size, 2.65

(With seven variable voltages)

Both sizes, 15 cells, 22½ volts,
operating life 600 to 1000 hours.

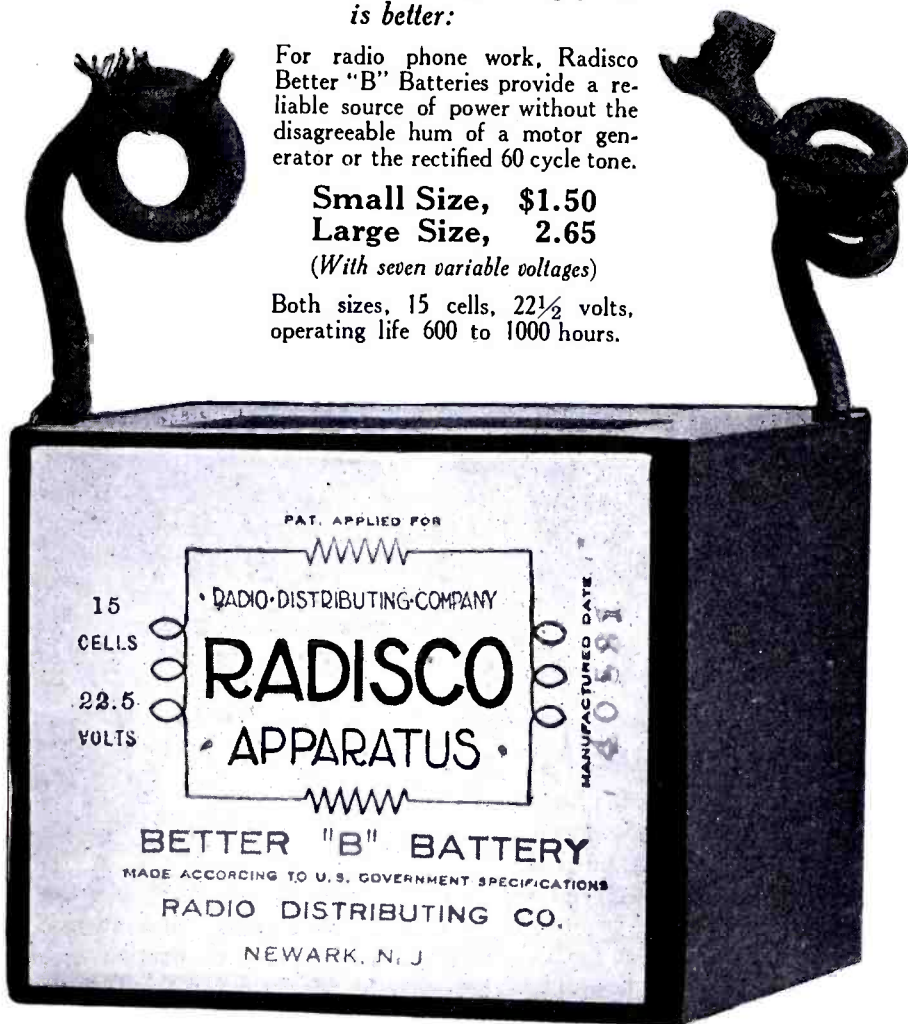

R A

"Your As"

BUY your radio apparatus
and can give you better
a month later.

There is little prospect for
ratus. Take, for instance,
here: The battery never was
buy, and today still continues
long life for your money.
the market a short time, and
war price levels.

This situation applies to all
that the Radisco trade mark is
possible price, consistent with

Buy your radio apparatus now
you who will gladly give you
the best results from your radio

RADIO DISTRIBUTING CO.

These Radisco Agents are Good Dealers

ALBANY, N. Y.
Shotton Radio Mfg. Co.
8 Market St.

ASHEVILLE, N. C.
Hi-Grade Wireless In-
strument Co.

ATLANTIC CITY, N. J.
Paramount Radio Supply
Arkansas & Pacific Aves.

BOSTON, MASS.
Atlantic Radio Co.
727 Boylston St.

BROOKLYN, N. Y.
Kelly & Phillips
312 Flatbush Ave.

CHICAGO, ILL.
Chicago Radio Labs.
1316 Carmen Ave.
Branch, Peoria, Ill.

EUREKA, ILL.
Klaus Radio Co.

KANSAS CITY, MO.
McCreary Radio Supply
4th and Delaware Sts.

McKEESPORT, PA.
K & L Electric Co.
427 Olive St.

NEWARK, N. J.
A. H. Corwin & Co.
4 West Park St.

NEW ORLEANS, LA.
Rose Radio Supply
604 Gravier St.

OMAHA, NEBRASKA.
O. B. Radio Supply Co.
406 Brown Building.

NEW BRUNSWICK, N. J.
Geo. N DeLaplaine
306 George St. and
8th and Magnolia Sts.

PHILADELPHIA, PENN.
Philadelphia School of
Wireless Telegraphy
1533 Pine St.

PITTSBURGH, PENN.
Radio Electric Co.
3807 Fifth Ave.

PLAINFIELD, N. J.
Paul R. Collier,
154 E. Front St.

PORTLAND, ME.
Atlantic Radio Co.
15 Temple St.

PROVIDENCE, R. I.
Rhode Island Electrical
Equipment Co.
45 Washington St.

SCRANTON, PENN.
Shotton Radio Mfg. Co.
P. O. Box 3
Branch 8, Kingsbury St.
Jamestown, N. Y.

SEATTLE, WASH.
Northwest Radio Service
609 Fourth Ave.

WASHINGTON, D. C.
Eastern Radio and Elec.
Co., 1405 Florida Ave.,
N. W.

Canadian
MONTREAL, QUEBEC.
J. B. Miller
136 Vendome Ave.,
N. D. G.

TORONTO, ONTARIO.
The Vimy Supply Co.
567 College Street.

RADISCO

Guarantee of Satisfactory Performance"

Now! Dealers have complete stocks
attention and a wider choice than

any further reductions on good appa-
ratus. The two Radisco Instruments shown
are high priced. It always was a good
policy to give you exceptional service and
the new coupler has only been on
the market based on rock-bottom, before-the-

Radisco apparatus. You can be sure
of the fully "Your Guarantee" of the lowest
"Satisfactory Performance".

There is a Radisco agent near
you for his advice and assistance to get
the best investment.

COMPANY, NEWARK, NEW JERSEY.



NEW RADISCO VARIO-COUPLER

"Accurate to the .002 part of an inch"

Entirely standardized and made with machine precision, so that
micrometer measurements show less than .002 in. (a fraction of a
hair's breadth) variation in all important dimensions. Moulded
base, Formica tube, all metal parts brass.

Hundreds in use, every one noted for "Satisfactory Performance".
Build your own regenerative set, but be sure to use Radisco
Couplers and Variometers.

Price of Coupler, \$7.50

This Mark  Your Guarantee

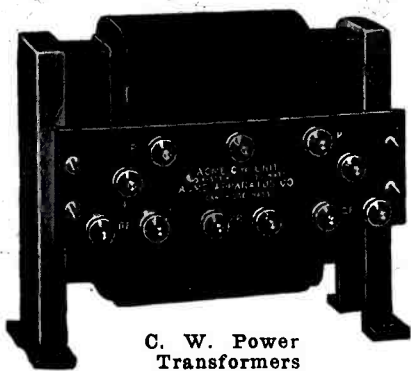

C. W. Power Transformers

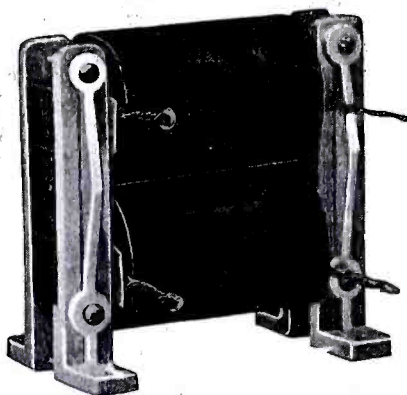

1 1/2 Henry Choke Coil

ACME C. W. APPARATUS

BEFORE buying any C. W. apparatus, get the Acme bulletins. They contain valuable information, and are free from your dealer, or direct from us.

Anyone having an A. C. supply can easily have an efficient C. W. radio telephone and telegraph transmitting station.

No storage batteries or motor generator required. Filaments lighted by an Acme filament heating transformer.

Plate and voltage current supplied by Acme transformers specially designed for that particular work.

High voltage direct current is obtained by rectifying the A. C. and smoothing out with Acme choke coils and condensers.

Such a station is highly satisfactory. No moving parts, no noise, plenty of power.

Use Acme apparatus thruout. Acme has the most complete line of C. W. apparatus—a special instrument for every need.

ACME guaranteed APPARATUS

- C. W. Power transformers
- C. W. Plate transformers
- Filament Heating transformers
- Modulation transformers
- Amplifying transformers
- Choke Coils
- Amplifiers
- Detectors

The apparatus with a guarantee

Acme Apparatus Co.
188 Massachusetts Avenue
Cambridge, 39, Mass.

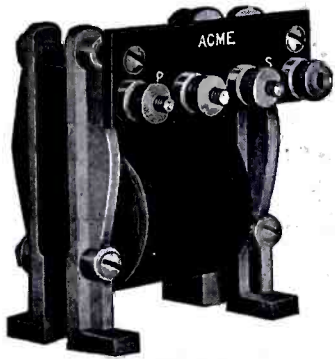

Amplifying Transformer.

*Transformer
and Radio
Engineers
and Manu-
facturers*

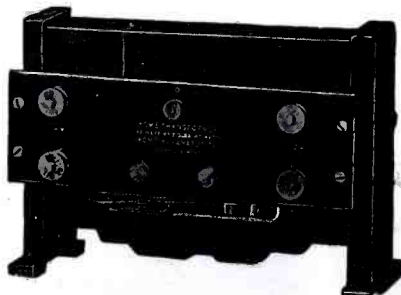

Filament Heating Transformer

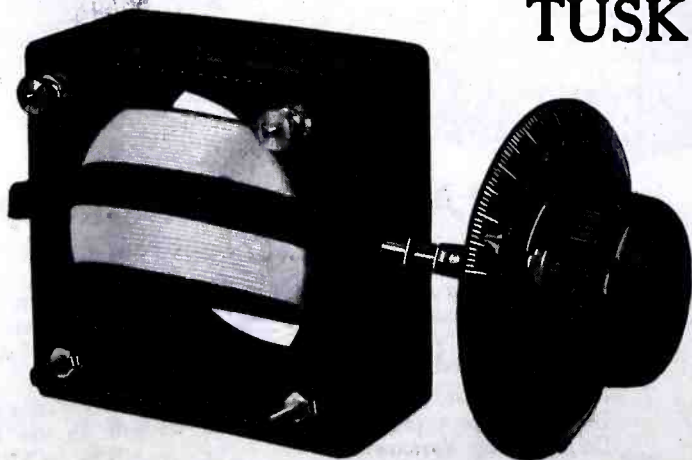

TYPE 200

PRICE \$7.25

TUSKA MOULDED VARIOMETER

*Mechanically and
Electrically Peerless*

See them at your dealer's
Send 5c for Catalog No. 2

Receiving Sets, Knobs,
Dials, Variometers, Va-
riocouplers, C.W. In-
ductances, C.W. Trans-
formers.

The C. D. Tuska Co.
HARTFORD CONN.

Government to Broadcast News by Radiophone

(Continued from page 196)

ceiving wireless telephones. From these stations, information may be relayed over cooperative farm land wire telephones.

The plan is to have a certain class of information sent out at a certain hour in order that those wishing it may be advised of the hour to expect it.

The British Government has just appointed a similar commission, composed of Winston Spencer Churchill, Secretary of the Colonies, as Chairman, with one representative each from Canada, Australia, New Zealand, South Africa, and India, which is to consider practical means available for the development of imperial communications by land, sea, air, radio telegraphy, and radio telephony.

Mr. Howell leaves in September to visit London, Paris, Budapest, and Berlin, at his own expense, to study the question, which has been of great interest to him as a civil engineer, in its possible use throughout the Western farming communities.

Correspondence from Readers

(Continued from page 214)

LET'S DROP IT.

Editor RADIO NEWS:

Having received so much criticism of G. Ridleak's article from prejudiced sources, I think you will welcome something written from a neutral standpoint.

First of all, in fairness to you, I must say that I have seen similar plays upon words in "QST," in articles contributed, to those which are causing the discussion. Since I believed the publishers of "QST" to be above any other motive, I took it as a little fun at your expense, and I do not see why that which you published cannot be interpreted in the same way.

The fact that you have published those insulting letters and the fact that you publish an "ad" for the A. R. R. L. Convention, proves to me your sincerity.

Some of the letters you have printed savor too much of the "grand-stand play" to be given any serious consideration.

This is a childish discussion at best, and bodes no good for amateur radio—let's drop it.

ALFRED J. POTÉ,
1BBF.

Boston 50, Mass.

HE UNDERSTOOD IT RIGHT.

Editor RADIO NEWS:

I have read with a great deal of amusement, the letters concerning the article by G. Ridleak in a recent issue of RADIO NEWS, and wish to state that in my opinion the whole thing was carried a trifle too far, meaning the comments by 8BIP, and 2PF, as well as Mr. Mann.

The American Radio Relay League is certainly not the organization that I think it to be, if a little thing like the fun which this article poked at it could hurt it. I consider this recognition of it in the same light that Henry Ford does his "Lizzie," namely, every knock is a boost, and anything that our contemporary publications of radio might say in derision about the League would be just one more sincere recognition of the great work it is doing and the big organization it is.

I might say here that the "Awful Racket Raisers' League" should be the official name of the ship operators who open up their 2 K.Ws. on high power and jam everything on 200 meters for 1,000 miles. They are

ANOTHER ACHIEVEMENT TYPE 580 DUBILIER CW CONDENSER

MADE IN
Single Capacities
0.001 mfd.
0.002
0.005
0.01
0.02
Price \$4.00

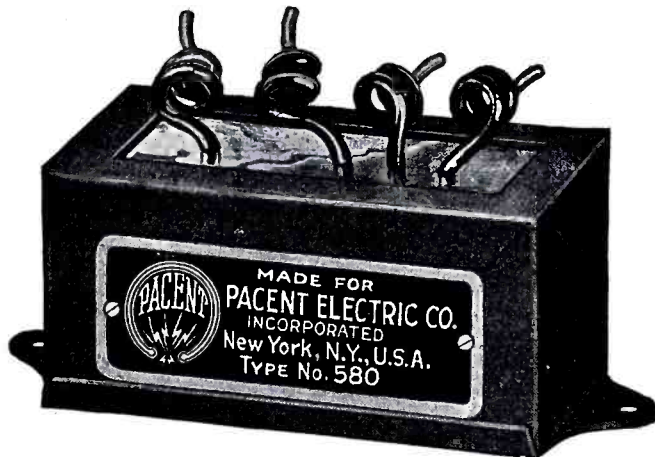

CAT. No. 310
Triple Capacity
0.0003 mfd.
0.0004
0.0005
5,000 volts
4 amperes
Price \$4.50

This latest addition to the already complete line of the Dubilier Condenser Co. will meet a long felt want of all amateurs interested in CW Transmission. This 580 Condenser is extremely compact, is of rugged construction and the losses are infinitesimal.

The Pacent Universal Plug



Price \$2.00

No connections to solder. Essential for modern radio, for transmission and reception. Approved by the Navy Department. Endorsed by foremost amateurs.

The Dubilier Universal Condenser

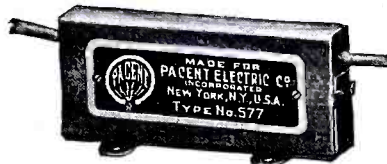

Price \$2.00

For transmission and reception. Supplied in most used capacities from .01 to .00025 mfd. Especially designed for C.W. Will carry 1 ampere at 1000 volts.

Pacent Standard VT Batteries



Supreme in the radio field. Guaranteed to give satisfaction. Silent in operation. The Standard "VT" Batteries are now supplied in the black and white boxes with diamond-shaped labels.

Pacent Duo-Lateral Coils

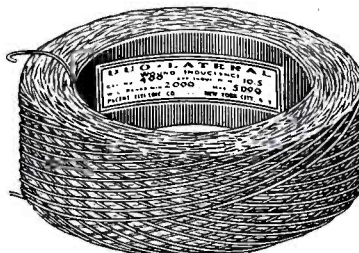

Lowest distributed capacity of any concentrated inductance. Endorsed by radio engineers. Used by most radio companies. Write for new low prices. Insist on "Duo-Lateral."

DEALERS AND JOBBERS—*You will be interested in our new proposition.*

AMATEURS—*Send five cents in stamps for Catalog No. R 1 describing "Pacent Radio Essentials"*

PACENT ELECTRIC COMPANY, Inc.
LOUIS GERARD PACENT, President

Sole Distributors for Wico's Complete Line of "Eventual" Apparatus.

Duo-Lateral Coils

Pacent Plugs

Rawson Instruments

Standard VT Batteries

Dubilier Condensers

Seibt Instruments

Special Distributors for Brandes Phones

Special Distributors of Westinghouse Equipment.

150 NASSAU STREET



NEW YORK CITY

Introducing New Model Klitzen Regenerative Tuner No. 225

\$35

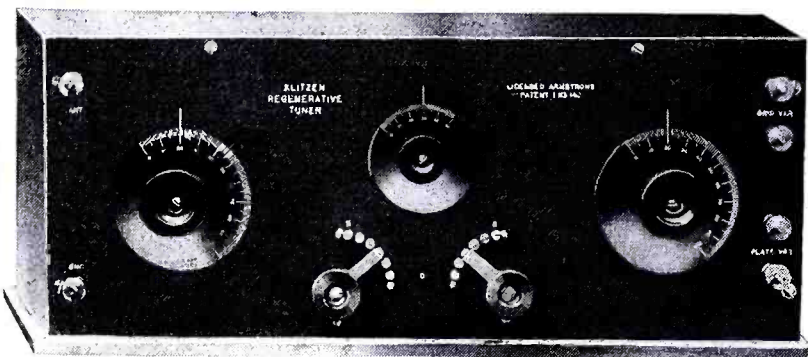

\$35

To introduce this tuner we will fill all orders received bearing postmark prior to September 30th at the low price of **\$35.00**.

Regular Price \$45.00

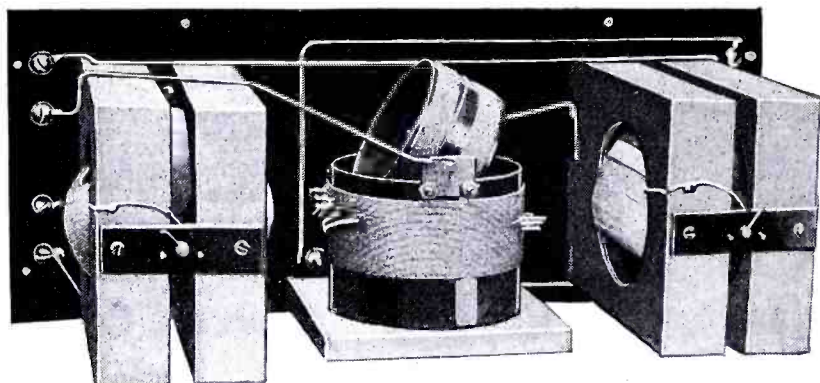

Genuine Mahogany cabinet hand rubbed. Offset variometers reducing capacity effect of hand while tuning.

Gorton pantagraph nomenclature throughout Wave range from 150 to 475 meters. Formica tubes on variocoupler. Hand rubbed Bakelite panel 16½" long by 6½" high by 6½" deep Overall Satisfaction guaranteed or your money back.

KLITZEN RADIO MANUFACTURING CO.

RACINE, WISC.

A REAL BARGAIN

Send your order in today. Cuts approximately full size.



No. 60 binding post, polished nickel with knurled hard rubber top
08c.
was 12c now

Send 2c stamp for descriptive catalogue R-21.



No. 110 switch lever, polished nickel with finely knurled knob. Bushing also furnished with this lever
45c.
was 60c now

DAVID KILLOCH COMPANY, 57 Murray St., NEW YORK

Get a Handy Binder for your RADIO NEWS. Holds and preserves twelve issues, each of which can be inserted or removed at will. Price 85c. Experimenter Pub. Co., Inc., Book Dept., 238-A Fulton St., New York.

the bunch of air hogs who deserve the shorted condenser, and I sincerely hope that the next one who tries it in our neck of the woods, blows his Dubilier.

FRANCIS L. PULLEN,
5ZAB.

Houma, La.

Radiomania

(Continued from page 208)

of the fact that the outfit arrived all at once, so to speak, in Jones' greenhouse. The roof of that institution did not deter it in the least.

We bartered more or less successfully with Jones. He was a coarse man, and seemed to value a few scrawny tomato plants above the onward march of science. Eventually we led the erring spruces once more roofward, where they remained until I hocked the whole outfit.

I developed a mania for freak apparatus, and some of the creations which have graced my table would make any radio engineer froth at the mouth. To the beginner I can only say, don't do it. I realize that you will just the same. We all do.

About this time some one called my attention to DeForest's notorious experiments *in vacuo*. He began, it seemed, with nothing, and evolved seven dollars and fifty cents worth of electric light and about eighteen dollars worth of contributory and accessory apparatus. I could ill afford it, Heaven knows, but needs must when the Bug drives, and eventually my 'phones were outraged nightly by the high plate voltage. The advent of this necessary evil, with its inevitable storage cell, marked the downfall of an heretofore irreproachable carpet. It was, in the eyes of my mother, a carpet of the first magnitude, but sulphuric acid is no respecter of carpets. Be it remarked, *en passant*, that I did not escape scathless.

So it went, one step followed by two

A Radio and Audio Frequency Amplifier

(Continued from page 190)

with a switch just under the valves sets the high frequency amplifier to the various wave-lengths required, the left hand stud controlling the shortest waves and the right hand switch the longest waves.

The panel is arranged so that magnetic reaction may be used if desired, in which case the brass link is removed from terminals X—Y and the tickler coil connected in its place. Contrary to the usual type of high frequency amplifiers, and due to the employment of a new circuit, reaction is absolutely steady and under perfect control; the size of reaction coil used with the usual type of single-wave circuit will be found quite suitable when high frequency amplification is switched on.

An Improved Change Over Switch

(Continued from page 190)

familiar with a disagreeable kick in the telephone receiver, when changing quickly from send to receive, will appreciate this feature of the new switch.

The closing of the switch in the sending position also closes the power circuit which starts the rotary gap motor and places power at the disposal of the key.

On throwing the switch to receiving position, the power is first cut off, then the aerial is drained and finally the receiving circuit is closed.

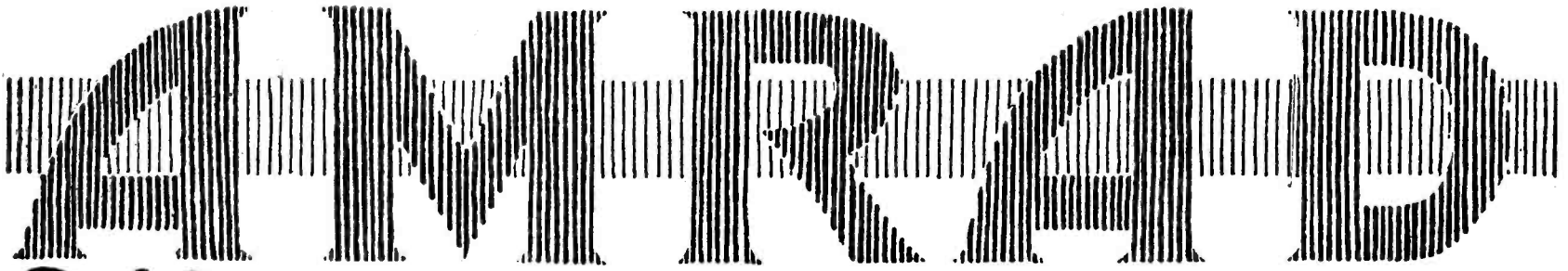

The Recognized Symbol of Superior Performance

A Real Variometer

This new Amrad development offers the exacting operator the very apex in efficiency and durability. No other variometer gives such strong signals. No other variometer provides any greater wavelength range than the Amrad. See it! Try it! Use it! The secret of its wonderful performance lies in the absolutely new method of winding, the close clearness made possible by accurate workmanship and the elimination of friction contacts which cause circuit noises. Couplers of the same design also available. Ask your dealer for descriptive Bulletin O.

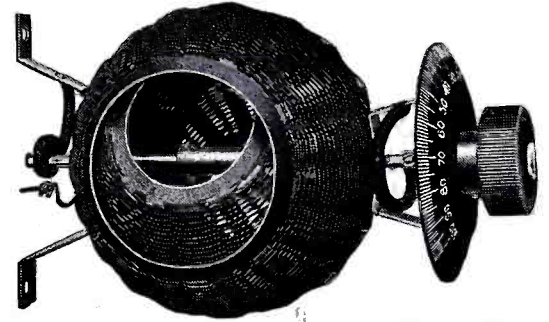

New Amrad Variometer No. 2606, as illustrated \$6.75
New Amrad Coupler, No. 2613..... 6.90
With Knob and Dial, 65c extra

A New-Fixed Condenser

A long-felt need is met at last. These new cartridge-type Fixed Condensers can be used in a standard grid leak mounting or between our special clips (10c pair extra), designed for fastening under a pair of binding posts. Four capacities; each the same price. Use .0001 mfd. for a Grid Condenser. Use .0005 mfd. or .001 mfd. across input binding posts of VT Detector to increase wavelength of regenerative sets. Use .002 mfd. for a telephone shunt or by-pass condenser. Different capacities can be clipped in or out in a second.

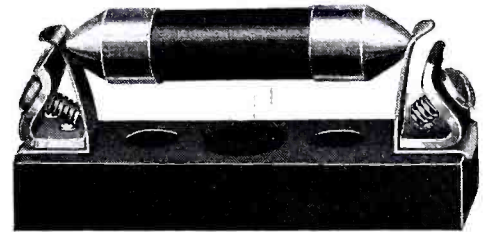

Fixed Condenser in Grid Leak Mounting.

A Novel Grid Leak

As simple as it is perfect. Rugged and permanent; not easily broken. Fits a standard grid leak mounting. Six resistance values; each the same price. For Radiotron U.V. 200, 1/2 megohm. For A-P Detector Tube, one and two megohms. For tubular Audiotron, three megohms. For old Electron Relay, four and five megohms. Grid Leaks and Fixed Condensers described in Bulletin N.



Amrad Grid Leak No. 2332, \$.35

Aerial Wire

The aerial problem solved. Pure copper wire, seven strands No. 24, in 125-ft. coils, per coil 60c. Our supply is limited; order at once from nearest dealer.

A New Synchronous Motor

Our Motor Division, which manufactures fractional horse-power motors for industrial purposes, under the trade name "TWIN-R", has made this valuable contribution to the Amrad line. This reliable and moderate-priced synchronous motor is being welcomed by those operators desiring a pure high spark frequency note. We can supply 1/12 H.P.—1800 R.P.M.—110 V.—60 cycle—synchronous motors (3/4 H.P. frame size). Its rugged construction, long bearings and tool steel shaft, 1/2" diameter, permit the use of the largest discs. Immediate deliveries. Send for Bulletin T.

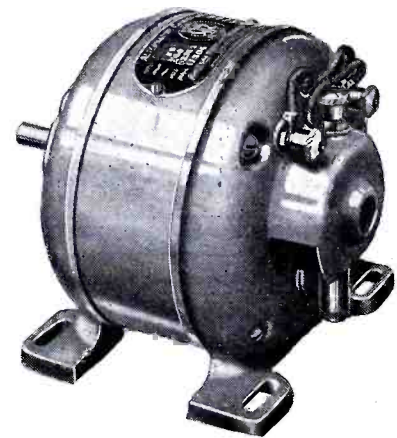

Synchronous Motor \$25.00
1/4 H.P. Frame

However, for greatest distance and lowest decrement the Amrad QUENCHED GAP is recommended.

All products trade-marked AMRAD and all products trade-marked TWIN-R—the big brother of AMRAD, are guaranteed to give satisfaction. Send 10c for complete catalogue.

AMERICAN RADIO AND RESEARCH CORPORATION

203 College Avenue, Medford Hillside, Mass.

15 Park Row, New York

608 So. Dearborn St., Chicago

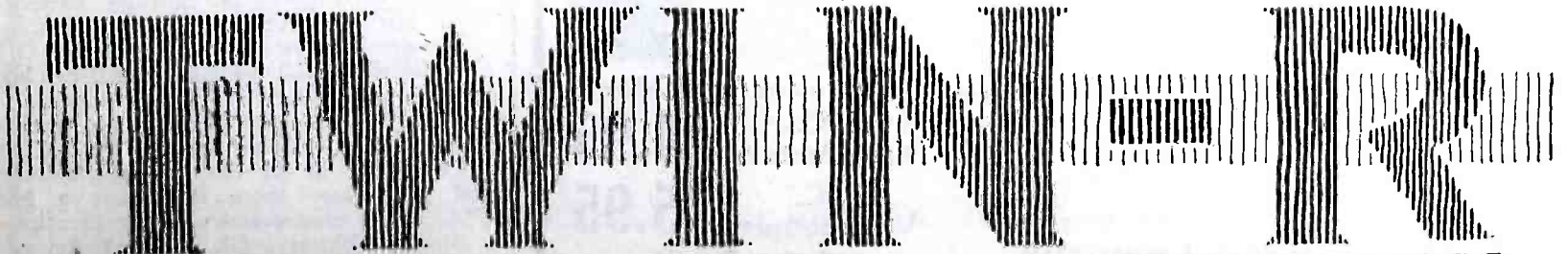

RELIABILITY

RUGGEDNESS



**EASTERN
RADIO**

INSTITUTE

TEL.
BACK BAY
5964

899 BOYLSTON ST.
BOSTON, MASS.

FALL CLASSES !!

Surely the spectacular Progress in the world of Radio has not escaped your attention! The marvelous achievement of listening to Radio Music must thrill even the most unimaginative!

The intelligent young men of today are taking advantage of this great Commercial expansion in Radio by preparing themselves NOW for the splendid opportunities presented by this fascinating science.

For years the EASTERN RADIO INSTITUTE has successfully trained Commercial Radio operators and its RESULTS, ADVANTAGES and SUCCESS must command your respectful attention!

The EASTERN RADIO INSTITUTE is the OLDEST, LARGEST and BEST EQUIPPED Radio school in New England! Founded in 1913 and SIX years older than any other Radio and Telegraph school in New England. The PIONEER school that has always led the way!

The EASTERN RADIO INSTITUTE has trained over 4,000 satisfied students and has actually enrolled, graduated and placed more Commercial operators in positions than ALL OTHER schools in New England combined! Ask any man in radio—he will tell you!

The EASTERN RADIO INSTITUTE has the latest Spark, Arc and Vacuum Tube sets and is the only school in New England giving "ARC" instruction upon actual apparatus. Ask any man in radio—he will tell you!

Graduates of the EASTERN RADIO INSTITUTE may be found all over the world as Chief Operators, Radio Inspectors, Engineers, Shipping Board Radio Supervisors, Directors of Radio Corporations, etc., etc. Ask any man in radio—he will tell you.

OUR FALL CLASSES, DAY OR EVENING, START MONDAY,
SEPTEMBER 12TH. ENROLL FOR THAT DATE IF POSSIBLE.
GRASP THIS OPPORTUNITY. YOU WILL NEVER REGRET IT.

REMEMBER—Our ORGANIZATION with YEARS of PHENOMENAL EXPERIENCE and SUCCESS is behind every man who enrolls. Ask any man in Radio—he will tell you. OVER 4000 SATISFIED GRADUATES TELL OUR STORY BEST! Why not be one!

Our illustrated prospectus is free. If you cannot visit the institute, send for one.

F. D. PITTS, Director

"The only school in New England devoted EXCLUSIVELY to the training of Wireless and Telegraph operators"

KANSAS CITY RADIO SUPPLY

Formerly McCreary Radio Supply Company

Authorized Central Distributors and Jobbers of Radio Corporation Products, Westinghouse Regenerative Sets, Magnavox and Radio Magnavox Apparatus, and Burgess Batteries. Reputable Dealers—We Can Supply You at Standard Discounts.

Quick Service on Radio Supplies

Write for Price Lists. We can fill all your Radio Needs Direct from Kansas City. Prices Right. Listen for our Radio Phone Bulletins and Concerts nightly from 8 to 11 o'clock.

SPECIAL BARGAINS IN VARIOMETERS AND VARIOCOUPERS

Same quality we manufacture for one of largest dealers in the country. Small size makes them extremely efficient on amateur waves. Fine for radio telephone work. Will tune below 200 meters. Make your own regenerative set complete for less than \$20. Why pay more? Order early for we anticipate a great demand at this special price.

Western Radio Company

Fourth and Delaware

KANSAS CITY, MISSOURI

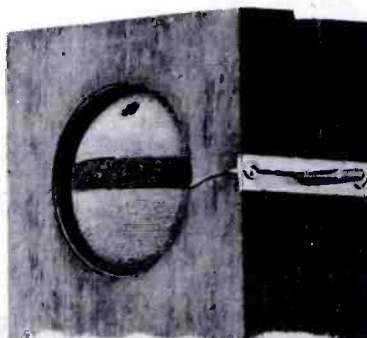

Introductory Offer

K. C. Variometers \$4.95
K. C. Variocoupler \$5.95

Postage Prepaid

Radio Station, 9XAB

steps, that by endless lamps, until in desperation I was about to turn once more to silicon and endeavor to start all over again, when, as suddenly as the disease had seized me, it quitted me. One night I was an ardent fan, the next morning I awoke with a positive distaste for all things radio. After vainly striving to arouse some enthusiasm, I swore off with a finality that left no doubt as to the sincerity of my intentions. I haggled for days with the Faithful, disposing of every last piece of my once cherished outfit and turned to pastimes new. I was done. D-O-N-E spells "through." I was out. It was over.

I have been back just four times since that irrevocable quit, and I haven't the slightest doubt that unless I am called into unexpected consultation with Peter I shall have that many more excursions. Don't try to throw the thing. It can't be done.

A Single Control Universal Range Receiver

(Continued from page 205)

high plate voltage (45 volts is best for all around work) over this range of wave-lengths. So a compromise was effected. A small 20-turn tickler was fastened permanently in the bottom of the stationary coil, and through a small two-point switch was either placed in series with rotary tickler or cut of circuit altogether. This auxiliary tickler is used only when the variable condenser is in shunt to tuning coil for waves from 600 to 1,700.

The series parallel switch for the condenser should not have blades longer than $1\frac{1}{4}$ ", to leave enough clearance for dials. Only three switch-points should be used for each side of the switch.

The four-pole double throw switch may be of the DeForest or any other make. It should be mounted in position shown by slot in Fig. 2.

A complete diagram is shown in Fig. 3.

In regards to results obtained, I have had this set with me aboard ship for a few trips during winter months and laying in Gulf ports I have heard amateurs from every district except the seventh. I have heard every medium and long undamped wave station worth while; such as NPL, NPO, NPM, KIE, KET, IDO, LCM, POZ, MUU, UA, FL, OUI, BYC, MFT, and numerous American and Canadian C. W. stations on one bulb only. In comparison with a Navy standard set on waves between 250 and 7,800 meters, this small set gave stronger signals, although it was not as selective.

Its compactness, ease of control and operation, universal wave-length range combined with its low cost make this set a desirable addition to any amateur's outfit.

Note:—The range of wave-lengths given above is for an antenna having a wave-length of 320 meters. If this set is to be used on an antenna of less than 200 meters, I would advise the constructor to increase the size of the winding of short-wave coil. Make it of 72 turns tapped every 12 turns, instead of 54 turns tapped every nine.

CURRENT GOSSIP.

Open Circuit—To a Storage Battery—What are you GASSING about?

Storage Battery—I'm going to be DISCHARGED, and I don't see how I can keep up with my CURRENT requirements.

Open Circuit—You ought to be working in my LINE; I've got some GOOD CONNECTIONS in the electric light industry, and you know there is always a good FIELD for commercial power generation.

Storage Battery—Oh, I don't know if you are so well off, you can't make both ends meet now without going SHORT.

By WM. H. PARMELEE.



No. 766 Eveready Wireless Station Battery
Standardized for use in U. S. Navy

What gives the Eveready Wireless B Battery its extra long life?

THE high quality of materials used —the refinement of process— thorough research and experiment—the suppression of corrosion—the perfect insulation of cell from cell.

Hitch an Eveready to your receiving set, and enjoy the marked increase in effectiveness. Go to your radio equipment dealer—or write us.



No. 763 Eveready Air-plane Wireless Battery. Standardized for use in U. S. Signal Corps Aviation Section

AMERICAN EVEREADY WORKS
of National Carbon Company, Inc.
226 Thompson Ave., Long Island City, New York
Chicago Atlanta San Francisco

EVEREADY

FLASHLIGHTS AND BATTERIES

Every wireless operator has use for an Eveready Flashlight

A-24-TE

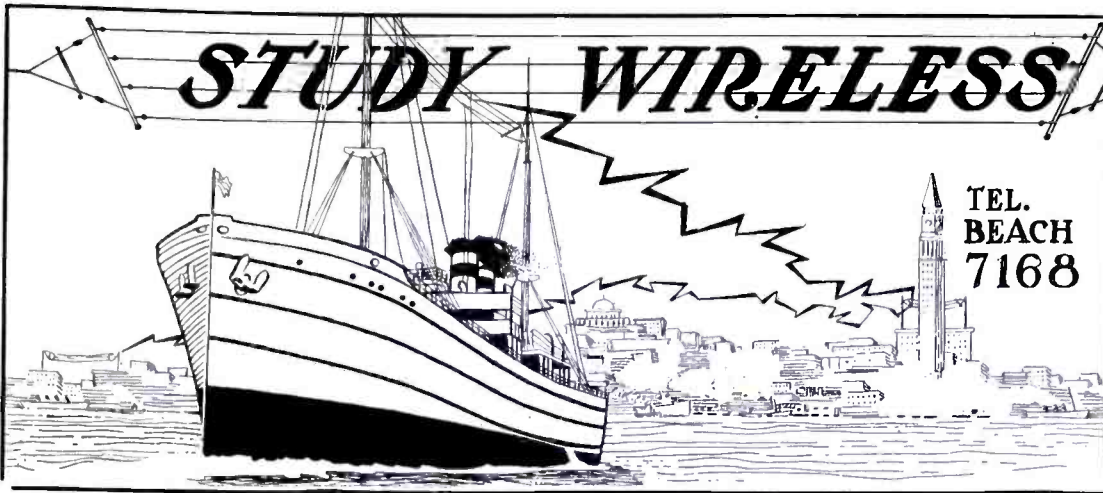

Results Count!

**The
Oldest
Wireless
School
in
New England**

Formerly the Boston School of Telegraphy, established in 1903. The home of Boston's first Wireless Station, when a De Forest Transmitter was installed at 18 Boylston St. in 1907.

Did you know that the Massachusetts Radio & Telegraph School produced more Licensed First Grade Commercial Operators during the first six months of 1921 than any other wireless school in New England?

Did you know that these men were trained in a shorter time and obtained higher marks on their government examinations than students from other schools?

Did you know that the Massachusetts Radio & Telegraph School established a record for the entire country by producing 22 graduates during a single month who obtained their first grade licenses?

Did you know that 50 graduates averaged 80% out of a possible 90% on their government examinations?

Send for our 44 page catalogue containing full information for prospective wireless students.

Fall Term, both day and evening classes begin Sept. 12.

GUY R. ENTWISTLE,
Director of Radio

MASS. RADIO and TELEGRAPH SCHOOL
18 BOYLSTON ST. COR. WASHINGTON ST., BOSTON
Dept. A *Send for FREE Catalogue* Dept. A

BANGERT ELECTRIC CO., Inc.

297 Fulton Street, Jamaica, N. Y.
27 Main Street, Hempstead, L. I.

Dealers in Radio Sets and Supplies—All Popular Makes
Radiotrons

THE BIGGEST RADIO OFFER YOU EVER HEARD OF!

By special mutual arrangement between the publishers, the three big radio magazines of the country are made available for a limited time at a special rate when ordered together:

"Radio News", the newsiest and best-illustrated radio periodical in the world

"Pacific Radio News", pioneer journal of western radio development

"Q S T", devoted wholly to amateur communication and the official organ of the A. R. R. L.

ALL FOR ONE YEAR

FOR

\$5

Don't miss this opportunity to secure the best contemporary radio literature of America coming to your door every month for a year—at a saving in real money, too. Send in your subscription today to

EXPERIMENTER PUBLISHING COMPANY, Inc.
238 Fulton St. New York City
Publishers of RADIO NEWS

RADIO AMATEURS of COLORADO, UTAH, NEBRASKA, and WYOMING ATTENTION! REYNOLDS RADIO CO., Inc. THE LARGEST EXCLUSIVE WIRELESS SUPPLY STORE IN THE MIDDLE WEST

Write for our Price List, we will be pleased to fill your orders, sending by Parcel Post or Express.

We carry a large stock of the following radio supplies and can make immediate delivery.

Audion Bulbs	Mounted and Unmounted Crystals
Sockets	Dials
Rheostats	Buzzers
Phones	Amplifying Transformers
Condensers	Plugs & Jacks
Tuning Coils	Switches, Points and Binding Posts
Couplers and Vario Couplers	De Forest Unit Panels
Lightning Ground Switches	Remler Detector and Amplifier Panels
De Forest and Remler Coils	Practice Sets
Coto Coils	Wireless Books and Magazines
Motor Generators	"B" Batteries
Keys	
Meters	
Crystal Detectors	

Exclusive Agents for De Forest, Remler, Radio Shop, Sabinaky and Fenstermaker in Colorado, Utah and Wyoming, also complete stock of Murdock, Firth and Clapp-Eastham supplies. Our "Reynrad" Short Wave Coils are the best thing on the market. \$2.00 each.

REYNOLDS RADIO CO., Inc.
613 - 19th St., DENVER, COLORADO

Practical U. T. Detector and Two-Stage Amplifier

(Continued from page 204)

size is left to the individual's own judgment.

The sockets are to be spaced equally apart, leaving a little margin of space at each end. The assembly in turn is mounted between the two panels as in Figs. 2 and 3 and held there by means of screws, which are passed through the panel and secured on the back by nuts. The brass rods may now be screwed between the panels. The two Clapp-Eastham amplifying transformers can now be fastened to the back of the rear panel by means of screws and nuts, which are properly spaced, as shown in Fig. 4. As mentioned above the holes above the jacks will give the necessary ventilation and also serve as windows so the brightness of the tubes filament may be observed.

Now that the outfit is assembled, the next step is the wiring, which is done with No. 8 B. & S. bare copper wire, and it is advisable to run the wire as straight and direct as possible, as No. 8 B. & S. wire is very stiff. It would be advisable to straighten the wire out, making it firm and rigid.

The ingenious arrangement of the different parts makes most of the leads comparatively short and direct. The wiring is extremely simple. The positive terminals of the filaments are connected together on the sockets by one wire running straight across: one wire runs from the negative terminal to the front panel and across the width, having the two rheostats connected from it onto one side of each. The other side goes to each individual tube socket, having one side of the amplifying transformer secondary connected to it. The three jacks are connected on one side to the plates of each individual tube, and on the other side, to one wire which runs direct to the positive binding post of the "B" battery; the two center strips of the jacks are connected to the two individual amplifying transformer primaries. The other side of the amplifying transformer secondaries are connected on one side of the grid leak and grid condenser which connect directly to the tube grids of each individual tube. The end jack connects on one side direct to the plate of the last amplifying tube, and the other side connects direct to the positive side of the "B" battery.

I have omitted showing the position of the grid leaks and grid condensers which are combined, but in the outfit described I have secured them to the inside of the rear panel; the builder may use his own judgment regarding this.

The grid leaks of this outfit are 1 megohm resistance and the grid condensers are of 0.0005 mfd. capacity. They were purchased from the General Apparatus Co.; the jacks and plug were purchased from the Federal Telephone & Telegraph Co., and the sockets from the Murdock Co. The rest of the necessary supplies were obtained from the nearest radio supply house. In this particular instance I used the Magnavox Radio Telemegaphone with one set of binding posts connected to the extra telephone plug, and the other set connected to a 6 volt 40 ampere hour storage battery, which had a rheostat connected in series, making various adjustments and continuous service possible. When the amateur wishes to use this loud speaker, he plugs into either jack he desires and, presto, the signals will be heard all over the room. With this arrangement the necessity of having the receivers clamped on the head all the time will be eliminated and will make it also possible to entertain any number of friends, when radio music is being transmitted. No doubt you have noticed by this time that very little adjustment is required in operating this outfit.

(Continued on page 236)

"ATLANTIC RADIO" SEPTEMBER BULLETIN

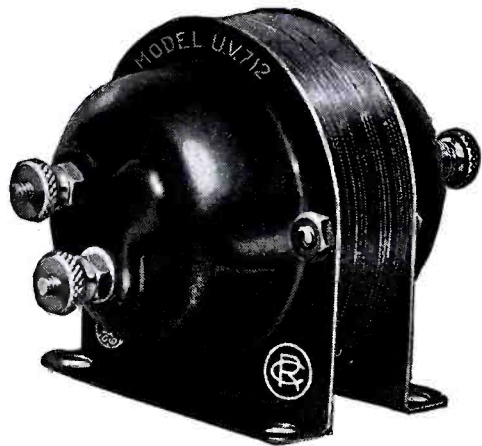

U. V. 712
Intervalve Transformer
"Radio Corporation"
\$7.00

ANNOUNCEMENT

WE TAKE pleasure in announcing a change of location,—Our Boston store is now located at 727 Boylston street, in the heart of the Back Bay business section. Quickly and directly reached by train or trolley. Additional floor space and an increased sales force enable us to give every customer immediate attention. This applies to mail orders as well as over-the-counter purchases. We cordially invite you to inspect our new store.



P. R. 536
"A" Battery Potentiometer (200 ohms)
"Radio Corporation"
\$2.00



WESTINGHOUSE RADIO EQUIPMENT

Westinghouse Radio Equipment embodies the latest ideas in receiving equipment, providing a most efficient set for telegraph and telephone reception over the amateur and normal ship-wave-length ranges.

Type R. A. Short Wave tuner, Style 307189, responds to a wave-length of 180 to 700 meters and is especially selective. Type D. A. detector-amplifier, Style 307190, combines a vacuum tube detector with a two-stage amplifier. Both units are mounted on Micarta panels attached to a polished mahogany cabinet. Simple in design—easy to operate—single-tuning circuit. Highly efficient.

Type R. A. Tuner.....\$65.00
Type D. A. Detector Amplifier.. 65.00
Type R. C. (Combination of above mounted in single cabinet)....125.00

TWO SPECIALS

ACME Type F-1 500 watt radio transformers. Exceptional efficiency, as high as 90%. Original price \$25.00. Special clearance price, \$19.50. Only two left, order at once.

Roller-Smith T-A-W Hot Wire Meters, Ranges, 0-1, 0-2.5, 0-5 amperes.

Special price, \$5.00. Just a few left.

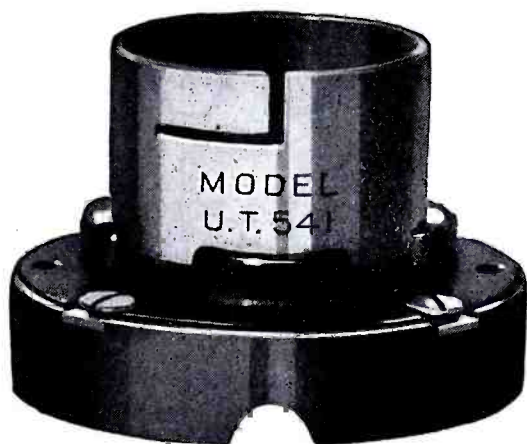

U. T. 541
Tube Socket for Radiotron
U. V. 203
\$2.50

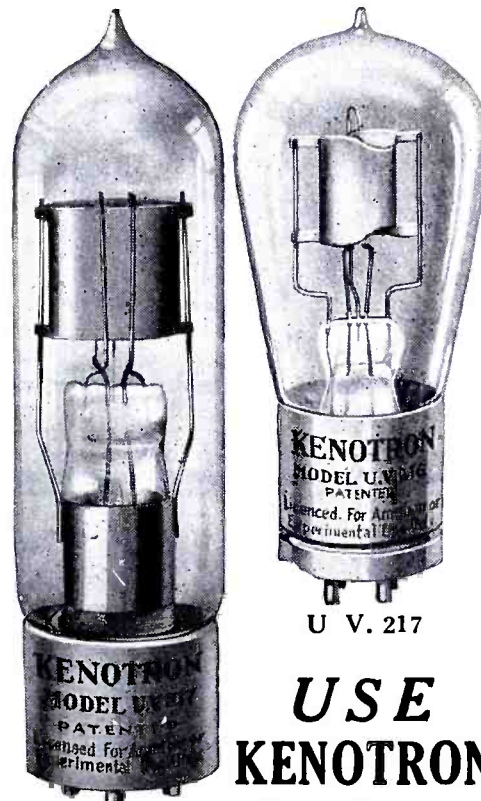

USE KENOTRON
Rectification
for C. W. Transmission

U. V. 216, 20 watt, for use with Radiotron U. V. 202, **\$7.50**

U. V. 217, 150 watt, for use with Radiotron U. V. 203, **\$26.50**

ATLANTIC RADIO COMPANY, Inc.

727 Boylston Street
Boston 9, Mass.

REQUEST "BULLETIN 14"

Branch: 15 Temple St.
Portland, Me.

Please include sufficient postage with all mail orders

Photograph shows an ABC SACO-CLAD amplifying transformer, slightly less than actual size.

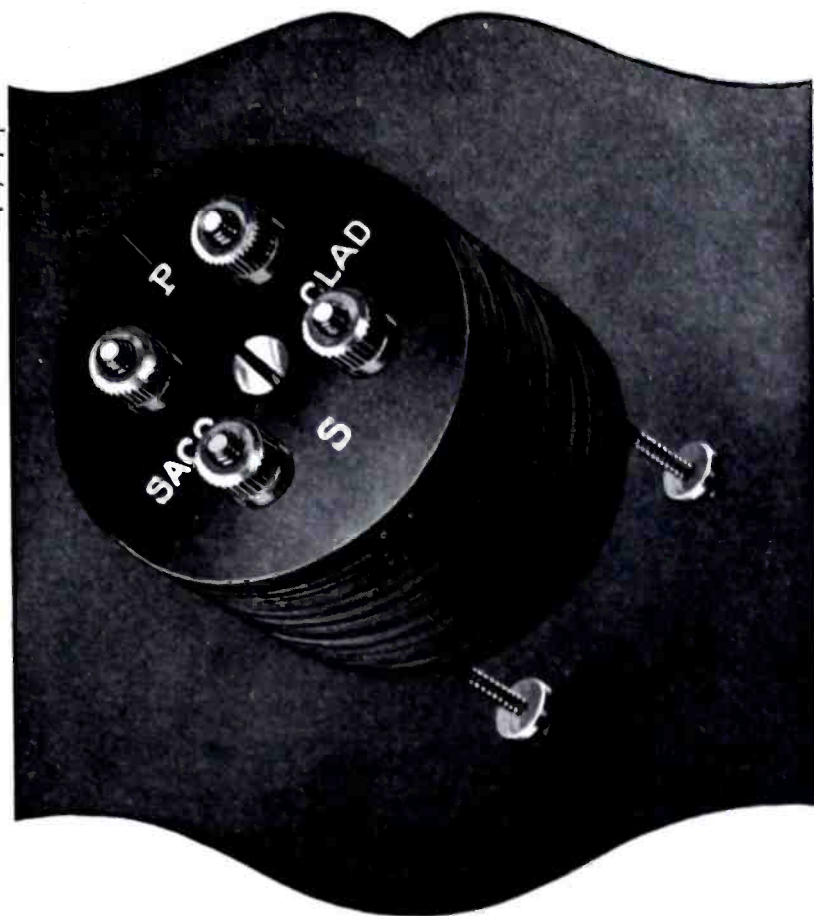

Use ABC SACO-CLAD TRANSFORMER No magnetic leakage-no howling

A SOLID WALL OF METAL, $\frac{7}{8}$ OF AN INCH thick, completely encloses the SACO-CLAD. Magnetic leakage is impossible.

The primary and secondary coils are wound around a laminated silicon steel core. Every part is securely fitted under pressure, and the whole held together in one solid unit. Ordinary rough usage that would ruin most transformers has no effect on the SACO-CLAD.

SACO-CLAD's step-up ratio is 4 to 1,—instead of the usual 3 to 1 or less. You can get a higher voltage in your grids, by using SACO-CLADS than with any other transformer.

SACO-CLAD transformers are designed to provide the correct ratio of impedance for present-day VTs. Six steps of SACO-CLAD

amplification have been used without any howling whatever! And with 800 SACO-CLADS already in use, there has never been a single burnout!

ABC SACO-CLAD transformers are built entirely in the ABC factory, including the windings. ABC engineers had to design a special winding machine to use No. 40 enamelled wire, in place of the usual No. 44. And, while there never has been a single burnout, the WIRELESS EQUIPMENT CO., INC., accepts full responsibility for all ABC SACO-CLAD transformers. Build your amplifiers with ABC SACO-CLADS,—and satisfaction is assured by the unequalled ABC guarantee, "Your Money's Worth or Your Money Back!"

\$5.00

ASK your radio dealer for ABC SACO-CLADS. If he should happen to be without them, send his name and address, and 10 cents for the new ABC 2-color catalogue, "Professional Radio Equipment at Amateur Prices." Request Catalog CR9. If there is no dealer in your vicinity, we will gladly fill your order by mail.

\$5.00

Wireless Equipment Co. Inc.
Newark, New Jersey

ABC SACO-CLAD
Standardized Radio
TRANSFORMER

Just mail this coupon and one dime today to the Wireless Equipment Co., Inc., Newark, New Jersey, for your copy of the new ABC catalog, CR9.

Name
Address
City..... State.....

UNWIRED INSTRUMENTS



Multiple Wave Tuner, Unwired \$45.00

The coil holder is the DeForest geared type and takes any size honey-comb coil, giving a wavelength range covering all intermediate waves from 150 to 25,000 meters. This permits of reception from spark or arc, and telephone stations doing amateur, commercial, navy, time and trans-Atlantic work.

The tuning condensers are of Chelsea make fitted with the neat engraved bakelite Chelsea dial. A DeForest condenser switch reduced the number of coils required to cover a given wavelength range in the primary tuning circuit. The cabinet is of seasoned polished oak with light walnut finish.

The cost of STANDARD wired and unwired instruments is but little above the cost of materials. Send stamp for circular describing regenerative receivers, tube controls, amplifiers or other radio equipment in which you are interested.

STANDARD ASSEMBLING COMPANY

19 BRIDGE STREET, NEW YORK

This unwired, fully assembled, tuner is but another of the many popular STANDARD products now being sold to experimenters.

These wired and unwired instruments are of the high grade formerly offered only for government work or commercial use but are now duplicated in high grade instruments for the experimenter.

The tuner illustrated is assembled from standard parts neatly mounted on an engraved grained formica panel, size $11\frac{1}{4}$ inches by 14 inches, $\frac{3}{16}$ inch thick.

Practical U.T. Detector and Two Stage Amplifier

(Continued from page 232)

fit. After you have adjusted the detector and the amplifier rheostats, it is then ready to use at any time. I have used Baldwin phones for a headset.

By shunting a variable condenser across the posts marked No. 1 and F, you will obtain a regenerative effect, or shunting at the tickler coil which may be a honeycomb coil across No. 1 and P and a honeycomb coil across G and F will act as a secondary having the usual primary will make it possible to tune any wave-length 100 to 20,000 meters with the usual variable condensers to make sharp tuning possible. It will be noted that all the apparatus is fastened to either the front or the rear panels and almost all the connections are made direct from the binding posts on the rear panel, making it possible to remove the different apparatus from time to time, whenever it is necessary to inspect them, or for the replacing of a new V. T. or for renewing old parts.

If traveling any distance, the outfit can be easily knocked down and the different parts stowed away in the corners of a bag or trunk. The complete diagram of the proper connections is shown in Fig. 5, with the proper symbols; or the letters and numbers are the same as on the panels themselves. To get the proper wiring for the backs of the panels it would be advisable to reflect the drawing in a mirror, or to place it on top of a plain piece of paper, right side up, and under this paper have a sheet of carbon paper, carbon side up. This last will give the best results as the tracing of the original drawing will make the proper impression upon the under side of the plain sheet of paper. This idea would apply to any or all diagrams.

I have covered all the necessary details pertaining to this particular outfit, but will say a few words more to the effect that its advantages are neatness, fine finish, compactness, workmanship-like construction, moderate price and efficiency. To really understand and appreciate its worth, it would be advisable to compare it with some of those sold in stores. The beginner can make this outfit without the least danger of making a "bull" of it, as all the parts are of well-known makes and widely advertised in all the radio publications, and it only requires patience and time to assemble.

I feel sure this outfit can be built without the least difficulty, as all the drawings are self-explanatory. In the event of difficulties arising, address a letter to me in care of the Editor of RADIO NEWS, enclosing a self-addressed envelope; this will be forwarded promptly and I will reply to same.

ESCO

GENERATORS—MOTOR-GENERATORS—DYNAMOTORS

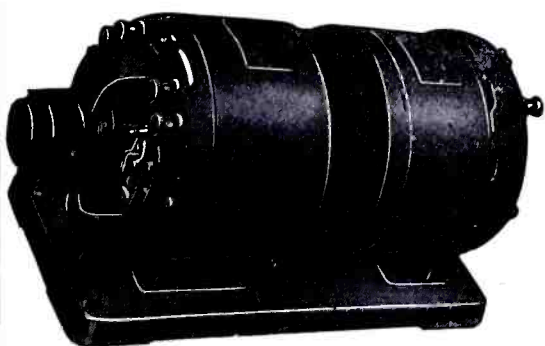

4 to 32 Volts for Filament
350 to 2000 Volts for Plate

Capacity

20 to 2000 Watts

Liberal Ratings

Write for Bulletin 231
which lists
200 Combinations

**Motors and Generators Developed and Built for
Special Purposes**

PIONEERS IN THE MANUFACTURE
of
HIGH VOLTAGE DIRECT CURRENT
RADIO GENERATORS

ELECTRIC SPECIALTY CO.

STAMFORD, CONN., U. S. A.

211 SOUTH STREET

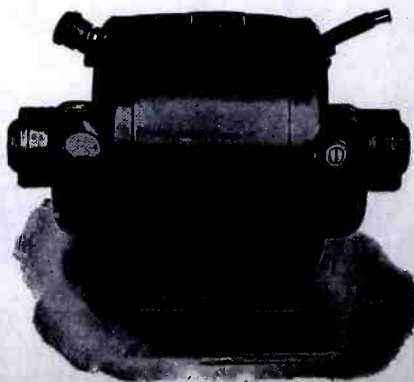

Latticed Radio Towers for the Amateur's Station

(Continued from page 193)

The succeeding sections were raised by means of the jig shown in the sketch. The jig should be as light as possible as it has to be managed by one or two persons in a rather small place. The side members may be 1 x 3 and are latticed much like the tower. The long leg must be two-thirds the length of the longest section to be raised. This is important as the section must be lifted from a point above its center of gravity, and must be raised to the level of the beneath section. The shorter leg may be

(Continued on page 240)

RADIO APPARATUS

**Distributors of Reliable Radio Apparatus to
Schools, Colleges, Radio Clubs and Experi-
menters All Over the World!**

"PITTSO"

**SERVICE FILLS ORDERS FOR
"GREBE RADIO" ANYWHERE!
THAT APPARATUS of PROVEN MERIT**



"PITTSO"

**SERVICE DISTRIBUTES "RADIO
CORPORATION'S" PRODUCTS ALL
OVER THE WORLD!
TRY US AND SEE!**

AMPLIFYING TRANSFORMERS

No. UV-712 Radio Corporation.....	\$7.00
No. P-1 Amrad, mounted.....	4.50
No. P-2 Amrad, unmounted.....	3.75
No. QO Clapp-Eastham, semi-mounted.....	4.00

AMPLIFIERS

No. DA Westinghouse, Detector and two stage, in beautiful cabinet.....	65.00
No. RORR Grebe two step with automatic filament control, a beauty.....	55.00
No. RORD Grebe Det. and two stage with automatic filament control.....	75.00
No. P-1 Amrad two stage in 10x5 cabinet, splendid value.....	\$2.50

AUDION CONTROL PANELS

No. RORR Grebe in cabinet, with tickler connections, hinged cover.....	17.00
No. RORA Grebe in cabinet with hinged cover, special value at.....	9.75
No. 330 Remler, with "A" Bat. potentiometer, just out.....	8.00
No. P-1 Paragon, moulded type.....	6.00

ANTENNA WIRE

"Pittsco" No. 14 hard drawn copper, 80 ft. per lb. Per lb.....	0.40
500 ft., special value at.....	2.25
"Pittsco" 7 strand No. 22 tinned copper, 65 ft. per lb., per ft.....	0.01
500 ft., special value at.....	4.50
"Pittsco" 7 strand No. 20 Phos. Bronze, per ft.....	0.02
500 ft. special value at.....	8.50

GROUND EQUIPMENT

No. P-1 100 Amp. 600 Volt ground switch, special value at.....	3.95
No. P-2 ground wire No. 4 weatherproof, per ft., special value at.....	0.06
No. P-3 Porcelain cleats with screws for No. 4 wire, per pair.....	0.10
No. P-4 "Pittsco" ground clamp.....	0.20

"B" BATTERIES

No. 7623 Standard, 22.5 V. Small.....	1.50
No. 7625 Standard, 22.5 V. large.....	2.65
No. 7650 Standard, 22.5 V. variable.....	3.50
No. 763 Everready, 22.5 V. small.....	2.25
No. 766 Everready, 22.5 V. variable, 16 1/2 to 22 1/2 Volts, large.....	3.00
No. 766 Everready, 22.5 V. large.....	3.50
No. P-1 Sorsinc, 22.5 V. large, and extra long life.....	4.00

CONDENSERS—(Fixed mica type)

No. 577 Dubilier, Universal type, for transmission and reception, suitable capacities, .0025, .005, .01, .025, .05 or .1 MF each.....	2.00
No. ROCC Grebe .0002 MF.....	1.00
No. ROCD Grebe .0005 MF.....	1.20

GRID LEAKS

No. MW-1 Radio Corporation, 1/2, 1, 1.5, 2, 3 or 5 megohms, each complete.....	1.25
Grid leaks only.....	0.75
Bases only.....	0.50

HOT WIRE METERS

No. P-1 Roller Smith, 0-2.5 flush mounting, A real value for.....	4.75
No. 127 General Radio, .5, 1, 2.5, 5 or 10 amps. flush or front mtg., each.....	7.75

LOUD SPEAKERS

No. R-3 Radio maxnavox, latest model.....	45.00
No. P-1 Phonotron, just out.....	45.00
No. P-2 Vocaloud, station type.....	30.00
No. P-3 Vocaloud, Laboratory type.....	25.00

PLUGS

No. 50 Pacent Universal type.....	2.00
No. 1428-W Federal, Brass.....	2.00
No. 1428-W Federal silver-plated.....	2.50

REGENERATIVE RECEIVERS

No. CR-2 Grebe, 175-680 meters, a special value at.....	39.95
No. CR-3 Grebe "Relay Special," 175-680 meters.....	65.00
No. CR-3A Grebe 175-375 meters, with tube control, complete set, a special value at.....	35.95
No. CR-5 Grebe 175-3000 meters, "Super-special," complete set, ideal for phone, spark and time signals.....	80.00
No. RA Westinghouse, 180-700 meters, very selective, beautiful cabinet.....	65.00
No. RC Westinghouse,—RA Receiver and DA Det.—Amplifier combined in one cabinet, splendid unit, compact.....	125.00

SOCKETS

No. MW-1 Radio Corporation, bakelite.....	1.50
No. UT-541 Radio Corporation for UV-203 tube.....	2.50
No. 156 General Radio, new price.....	1.50
No. 550 Murdock, moulded.....	1.00
No. P-1 Amrad, new price.....	0.75

RECTIFYING DEVICES

No. UV-216 Radio Corporation, 20 Watt "Kenotron" rectifier, for UV-202 tubes.....	7.50
No. UV-217 Radio Corporation, 150 Watt "Kenotron" rectifier, for UV-203 tubes.....	26.50
No. P-1 De Forest, 20 watt rectifying tube, for use with 5 watt tubes.....	7.00

TELEPHONES

No. 56 Murdock, double, 2000 ohms.....	5.00
No. 56 Murdock, double, 3000 ohms.....	6.00
Brandes, Superiors, double.....	8.00
Brandes, Transatlantic, double.....	12.00
Brandes, Navy Type, double.....	14.00

POTENTIOMETERS

No. PR-536 Radio Corp. "A" Bat. type.....	2.00
No. 93 Remler "A" Battery type.....	0.75

VACUUM TUBES

No. UV-200 Radiotron detector.....	5.00
No. UV-201 Radiotron Amplifier.....	6.50
No. UV-202 Radiotron 5 watt transmitter.....	8.00
No. UV-203 Radiotron 50 watt transmitter.....	30.00
No. UV-204 Radiotron 250 watt transmitter.....	110.00

Note:—All Radiotrons sent postage and insurance prepaid anywhere in U. S. A. Send us your orders for Radiotrons!

RADIOPHONE AND CW. APPARATUS. CW POWER TRANSFORMERS

Acme 50 watt 350 volts, mounted.....	15.00
Acme 50 watt 350 volts, unmounted.....	12.00
Acme 200 watt 350-550 volts, mounted.....	20.00
Acme 200 watt 350-550 volts, unmounted.....	15.00
Acme 500 watt 1000-1500 volts, mounted.....	25.00
Acme 500 watt 1000-1500 volts, unmounted.....	20.00

CHOKO COILS

Acme single coil, 1.5 Hen., 150 MA.....	4.00
Acme double coil, 1.5 Hen., 150 MA.....	6.00
Acme single coil, 1.5 Hen., 500 MA.....	6.00
Acme double coil, 1.5 Hen., 500 MA.....	8.00

CONDENSERS (Variable)

No. 182-G General Radio .001 Mf., unmounted with dial.....	9.70
No. 3 Chelsea, .0011 Mf., unmounted.....	4.75
No. 366-Int Murdock .001 Mf., unmounted.....	4.25

FILAMENT HEATING TRANSFORMERS

Acme 75 Watt, mounted.....	12.00
Acme 75 Watt, unmounted.....	9.00
Acme 150 Watt, mounted.....	16.00
Acme 150 Watt, unmounted.....	13.00

FILTERS

No. 170 Tuska, in cabinet.....	16.00
No. 21-AA Western Elec. 1000 Volt AC condenser.....	2.50

INDUCTANCES, CW.

No. 181 Tuska Cap. Feed-back circuit.....	7.50
No. 182 Tuska split filament.....	10.00
No. 183 Tuska grid tickler.....	12.50

METERS

Model 301 Weston, D.C. flush, 0-100, 0-150, 0-200, 0-300, 0-500 or 0-800 milli-amperes, each.....	8.50
Model 301 Weston D.C. flush, 0-1, 0-2, 0-3, 0-5 or 0-10 Amperes.....	8.50
Model 425 Weston, flush, Thermo-Ammeter, 0-1, 0-2.5 or 0-5 each.....	18.75
No. P-1 Jewel, A.C. flush 0-15 voltmeter, ideal for power tubes.....	8.00

MICROPHONE TRANSMITTERS

No. 5176-A Connecticut with adj. arm.....	4.00
No. HM-100 De Forest, hand type.....	6.00
No. 260-W Federal, hand type.....	7.00

MODULATION TRANSFORMERS

No. A-3 Acme Semi-mtd.....	5.00
No. A-3 Acme fully mounted.....	7.00
No. 231 General Radio, new type.....	5.00

RHEOSTATS

No. 560 Murdock, moulded, new type for back mounting.....	1.00
No. 214 General Radio, 2.5 Amp. type, just right for 1 UV-202 tube.....	2.50
No. 132 National Controller, 6.5 Amp. type, just right for 1 UV-203 tube.....	4.50

RESISTANCES

Type HS Ward Leonard 5000 ohms.....	2.75
Type HS Ward Leonard 10,000 ohms.....	3.50

"Let 'PITTSO' products, super-service and delivery solve your Radio problems"

SEND US YOUR ORDERS TODAY!

Send ten cents in stamps for Catalog No. 22. Over 100 pages, over 150 illustrations, over 600 items

F. D. PITTS CO., Inc.

12 Park Square

Dept. C

Boston, Mass., U. S. A.

RADIO APPARATUS
For
Amateur and Experimental Use
With
INSTRUCTIONS For CONTINUOUS WAVE OPERATIONS



Radio Corporation
 of America

Sales Division, Woolworth Building, New York City

C.W. INSTRUCTION

The most needed book of the hour

The Radio Corporation of America takes pleasure in announcing the publication of its new combination C. W. Instruction Book and General Catalogue of experimental radio accessories.

The first section covers:

- A. The Use of Radiotrons in C. W. Work.
- B. General Operating Instructions for Tube Sets.
- C. Nine Practical C. W. Radio Telegraph and Telephone Circuits and their Constants.
- D. Precautions in Using Transmitting Tubes.
- E. Radiotron Power Tubes.
- F. Kenotron Rectification.

The second section consists of a catalogue embracing a complete

line of radio telegraph and telephone apparatus for amateur and experimental use.

The first edition of this important book is limited. In order to insure *your* copy, sign the coupon on this page and return it to us promptly. Copies will be ready for distribution September 1, which will give you ample time to prepare for fall and winter C. W. experiments.

DEALERS:

You will need copies of this book and you will want to handle the new line of R. C. products. *Prepare for the fall trade.* Write direct to:

Radio Corporation
 of America

Sales Division, Commercial Department, Suite 1802
 233 Broadway, New York City

DO IT TODAY
 Sales Division, Commercial Department, Suite 1802
 Radio Corporation of America
 Woolworth Building, New York City

Gentlemen: Enclosed please find 25c in stamps, for which place me on the first mailing list to receive the new catalog on C. W. transmission and radio apparatus. Delivery on or about September 1, 1921.

Name.....
 Address.....
 City.....
 State.....

Flying Boat Radio Transmitter

(Continued from page 234)

nected so that it reads the total plate current supplied to both valves. In order to read the plate current of any one valve, it is necessary to extinguish the filament of the other valve. The filament ammeter is a 0 to 10 ampere meter and is also connected so that it reads the total filament current taken by both filaments. To read the filament current taken by one valve it is again necessary to extinguish the filament of the other valve. This is accomplished by means of the two filament pull switches seen on the front of the panel in Fig. 3. These pull switches are marked "Oscillator Filament" and "Modulator Filament," and when they are pulled out, the filaments are lit, when pushed in, the filaments are extinguished. On the side of these pull switches are seen two rheostats vertically mounted, one being for the oscillator and the other for the modulator valve. The slider knob on these rheostats are marked with directions for moving the slider for increased or decreased current. Between the two filament pull switches is seen another pull switch marked "Negative Poten-

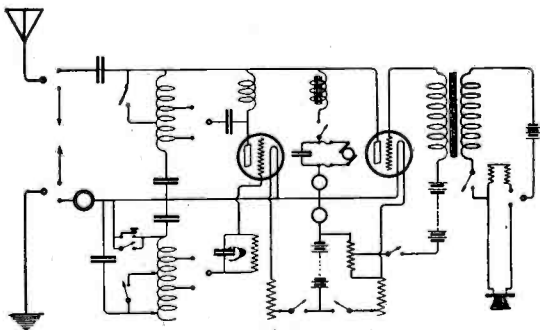

Actual Diagram of Connections of the Set.

tial," directly above a horizontally mounted rheostat. This rheostat is a potentiometer across the modulator grid battery and the pull switch throws this battery on or off. By adjusting the potentiometer, the proper value of grid potential is obtained. Beneath this grid battery potentiometer is seen the buzzer used for tone-transmission and the microphone jack into which the plug carrying the microphone is placed. At the extreme right side of the front panel directly under the pilot lamp is the antenna terminal set in a moulded insulator, and the ground terminal. At the bottom of the panel are the various binding posts each clearly marked to take its proper lead wire.

Just below the meters will be seen the three main switches. The right hand switch is the antenna send-receive switch, the center switch is the wave change switch designed for two wave-lengths, the left hand switch is the so-called signal switch which gives any desired kind of transmission, C. W. telegraph, tone telegraph or telephone. When the signal switch is connected to telegraph continuous, the plate circuit of the modulator valve is disconnected from the set; when it is connected to telegraph modulated, the buzzer and modulator are connected in circuit; and when connected to telephone modulated, the buzzer is disconnected and the microphone connected in its place.

Figs. 5 and 6 show clearly the construction of these three main switches, which are mechanically identical. The body is seen to be dilecto barrel perforated to provide for air insulation. The barrel is provided with the necessary number of switch jaws, the stationary part of the switching mechanism. The rotating or moving element of the

(Continued on page 242)

Increased Production Decreases Price!

Radeco SAFETY FUSES

FOR VACUUM TUBES Pat. Pending

New Price!

4 for \$1

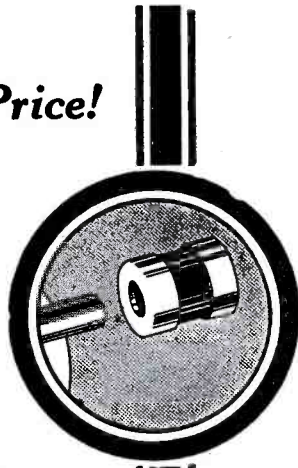

REDUCED in price because thousands of operators using RADECO Safety Fuses have reduced our manufacturing cost.

RADECO Safety Fuses belong on your Vacuum Tubes this minute.

SIMPLE! Just slip fuses on filament terminals of bulb. Can be used with any standard socket to prolong the life of your set.

Today, NOW, mail \$1 in cash, money order or certified check. You will receive *four* RADECO Safety Fuses by return mail. Your set is not up to standard if you are not protected by RADECO Safety Fuses.

Carrying Capacity $\frac{3}{4}$, 1, $1\frac{1}{4}$, $1\frac{1}{2}$, 2, $2\frac{1}{2}$ and 3 amp.

We carry a complete line of wireless equipment. Order from any standard catalog.

ORDER BY MAIL TODAY

Don't wait until your tube is burnt out!

Filament Rheostat



Most compact and universal Rheostat on the Market For back of front of Panel Mounting, 6 ohms, $\frac{1}{2}$ amps., $1\frac{1}{8}$ " dia.

\$1.75 Post-paid Immediate shipment

AERIAL WIRE 1c PER FOOT

7 strands No. 22 copper—tin plated to prevent oxidation. Maximum radiation and strength. Include postage at the rate of 15 lbs. per 1,000 ft. 500 feet for \$4.30.

44 V. VARIABLE "B" BATTERY \$3.60

Include postage on 4 lbs.

Complete in handy wooden case and adjustable phosphor bronze "jiffy" connectors. Better than block batteries—if one 4.4 V. unit weakens prematurely, it can be removed and replaced—thereby not impairing total voltage, a feature which makes this the best battery value to be had at any price. Set of 10 Renewal Units, 44 volt, \$3.10 post-paid. Just the thing for C.W. work.

Ground Wire 7c per foot

No. 4 solid copper—rubber covered—triple braid—include postage on 20 lbs. per 100 ft.

100 Ampere, 600 Volt, LIGHTING SWITCHES, \$3.75

SPECIAL—General Radio Modulating Transformers

List Price	\$4.50	Special (Unmounted)	\$3.00
List Price	\$5.00	Special (With Brackets)	\$3.50
List Price	\$7.00	Special (Fully Mounted)	\$5.00

RADIO EQUIPMENT CO.

630 Washington Street, (4th Floor) Boston

HOOK 'ER TO YER BULB-TUNERS

A full page ad could not do justice to our new line of C.W. and phone equipment shown in our new 24-page catalog. Our tuners need no advertising. 10 cents brings catalog full of phone and receiving hook-ups, code and other useful information.

TRESCO - DAVENPORT - IA.

Comfortable As An Old Hat

A Brandes Wireless Headset can be worn as comfortably as an old soft hat. Automatically adjustable; easy-fitting; light in weight. May be kept on through the longest sitting without a headache or other discomfort.

Why wear a heavy, cumbersome, binding or tiresome headset when you can have a comfortable—and 100% efficient—Brandes?

Three Types: "Navy" ... \$14
 "Trans-Atlantic" 12
 "Superior" 8

Sold on 10 days' trial. Money refunded if not satisfactory.

Send 5c for Catalog G

DEALERS: Write for Proposition

C. BRANDES, INC.

Room 823, 32 Union Square, New York City



BRANDES Matched-Tone HEADSETS

Latticed Radio Towers for the Amateur's Station

(Continued from page 236)

two-thirds the length of the long one. The inner ends of both are bored to fit a 3/4" pipe and are spread to a distance greater than the top of the section in place. A bolt through A supports a heavy pulley through which a 1/2" rope passes from inside the tower to the new section outside. A heavy wire (No. 10 or 2 of No. 12) is securely attached at A and is held at B in such a way as to prevent the members B-C from hinging. From B this wire extends down to a small block attached to the legs at the base.

A hinged support is constructed at C by wiring notched pieces of 2 x 2 to the pipe inside the side members. These in turn are firmly wired to the struts. The pipe itself, however, may be securely wired to the two struts on that side and rest on the 1 x 3 frame mentioned above. The jig may be laid in a folded position across the top of the tower, while the hinge is being attached.

The next section with guy wires attached is set up beside the base under A. The rope from A is attached with a yoke to two struts of this section at a point just above the center of gravity or middle. A light rope or wire should be attached at the same point on the opposite side to guide the section up and to prevent it from "going-on-over" when the jig is pulled back, as will be seen later.

The jig is then hinged back to the position shown in the sketch, the point A being just over the edge of the tower, and the small block tied securely.

One man should be at the jig where he can assist in lifting the section and be ready to fasten the joints quickly. Another will be needed to pull from the ground and manage the small block, and a third to steady on the guide rope. The section is pulled steadily up to its proper level and the supporting rope tied at the base. The small block is then slowly taken up until the section hangs directly over the tower, and re-tied. The guide rope is pulled up fairly tight at this time in order to prevent the weight of the jig from pulling the section clear over. A slight lowering of the hoisting rope will allow the new section to rest in position. The guys should be attached and the section plumbed, after which the joints should be made.

The jig may now be supported from the new section and the hinge unfastened, after which it is raised to the top of this section, set up as above and the next section placed in a similar manner.

If a cross arm is desired, it may be two latticed 1 x 3 fastened together at each end and bowed out in the center and having a guy from one end down 35' or 40' on the pole or it may be simply a 2 x 3 rigged with suitable bracing. The aerial rope should pass from the end of the cross arm through a pulley inside and down through the center of the tower.

Rectifying A. C. for Vacuum Tubes

(Continued from page 200)

denser C2 is to reduce still more the fluctuations in the D. C. voltage across C1. This is due to the fact that the combination of inductance and second condenser offer low impedances to the higher harmonics in the voltage wave 123, thus absorbing them and flattening out the D. C. wave so that it is nearly horizontal. Thus their effect is really equivalent to increasing the value of

"ILLINOIS" THE RELIABLE MADE RIGHT - STAYS RIGHT



STYLE No. 1

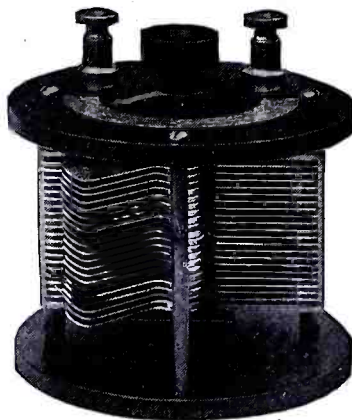

STYLE No. 2

Three Styles: No. 1, Panel; No. 2, Open Type as shown; No. 3, Fully Encased. Anti Profiteer. Less than pre-war prices. Fully assembled and tested.

	Style No. 1	No. 2	No. 3
67 Plates,	\$7.00	\$8.00	\$8.50
43 "	3.50	4.50	4.75
23 "	2.75	3.75	4.00
13 "	2.25	3.25	3.50

Money back if not satisfied. Just return condenser within 10 days by insured Parcel Post.

With Style No. 1, we will, if desired, furnish 3 inch Metal Dial with large Knob, instead of Scale and Pointer. Extra Price 75 cents. Or we will, if desired, supply the Condenser with smooth 3-16 inch center staff, without Scale, Knob and Pointer, at 15 cents off the list to those who prefer to supply their own dial.

Vernier with single movable plate applied to 13, 23 or 43 plate condenser, \$3.00 extra.

We allow no discounts except 5 percent on orders of 6 or more.

Sent Prepaid on Receipt of Price

Except: Pacific States, Alaska, Hawaii, Philippines and Canal Zone, add 10c. Canada add 25c.

Foreign Orders other than Canada not solicited.

G.F. JOHNSON, 625 Black Ave., Springfield, Illinois.

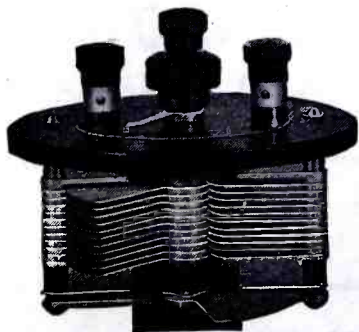

VERNIER

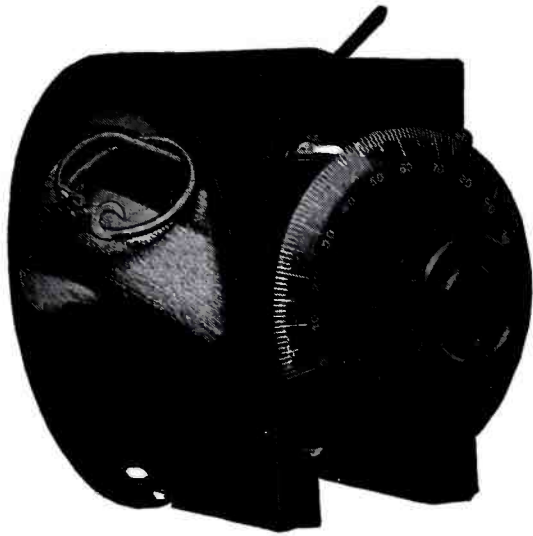

The Variometer

The now famous Z. R. V. Variometer has met with a tremendous sale to *thousands* of discriminating purchasers who know the quality of Clapp-Eastham products.

Complete with knob and dial...\$6.50
 Complete without knob & dial 5.75
 Variocoupler to match, with knob and dial..... 7.50

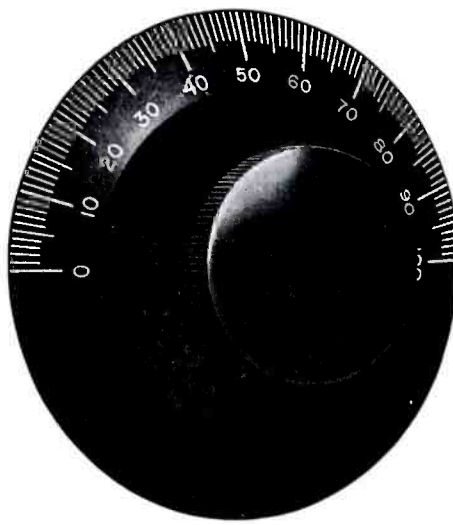

The Dial

This 3" knob and dial is our own product, heavy brass dial, black oxidized finish, composition knob 1 3/8" diameter. Supplied for 1/8" shaft only. This dial can not chip or warp and *will run true*. Its beauty is in keeping with the best products of the instrument maker.

Price, Dial & Knob F800H complete\$1.75
 No. 19 instrument switch to match above1.00



The Amplifying Coil

Our amplifying coils are distinctly different in design and their remarkable power of amplification with the tubes at present on the market can be testified to by several thousand satisfied users. You need not experiment with untried products unless you want to.

Type Q. O. Amplifying coil as illustrated\$4.00

Complete Catalogs Sent for 6c Stamps

Patronize your local dealer: If he won't supply our material your order will receive immediate factory attention.

CLAPP-EASTHAM COMPANY

120 Main Street

Cambridge, Massachusetts

HEADQUARTERS FOR RADIOTRON TUBES. ALL TYPES IN STOCK

THE RADIO MAGNAVOX

It is fast becoming known as THE WORLD'S STANDARD loud speaker and is noted for its faithful reproduction of Radio music and speech.

When you buy a RADIO MAGNAVOX you have a well constructed, rugged and efficient loud speaker for your Radio concerts and demonstrations.

Only one ampere required for field excitation and the signals will be as loud as your vacuum tube amplifier is capable of putting current into the RADIO MAGNAVOX.

The greater your amplifier output the more volume of sound from the Magnavox.

When other loud speakers chatter or stop working on account of too much current from your amplifier, THE RADIO MAGNAVOX is working at its best.

**VERY SENSITIVE ON WEAK SIGS AND ROARS LIKE A LION ON STRONG SIGS
 BE SURE TO GET THE BEST, THE RADIO MAGNAVOX, THE WORLD'S STANDARD**

PRICE, \$45.00

Manufactured by

THE MAGNAVOX COMPANY

Factory
 OAKLAND, CALIFORNIA

Sales Office: Penn. Terminal Bldg.,
 370 Seventh Avenue, NEW YORK, N. Y.

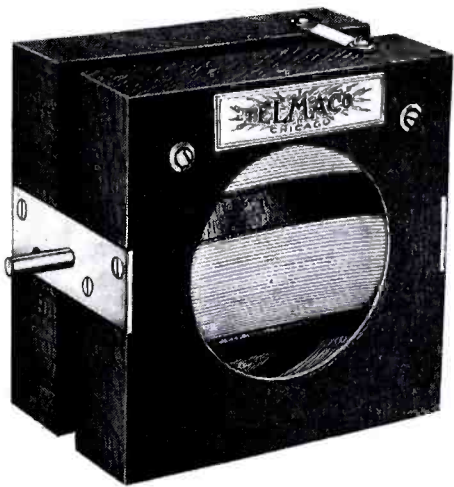

PRICE \$5.00



OUR NEW TELMACO CATALOG "N" IS READY. YOUR COPY SENT POSTPAID ON REQUEST.

This catalog describes the *Telmaco Variometers* and *Variocouplers* shown here. These two instruments embody radio and mechanical improvements, not found in others. *They are different. The Quality is convincing. The Value is Apparent.*

Our catalog also describes the *Telmaco* line of *Detectors* and *Amplifiers, Short Wave Receivers*, and the best makes of standard apparatus. *Prices are right.*

Distributors for *Cunningham Tubes.*

RADIO SUPPLIES DIVISION

Telephone Maintenance Co.

17 N. LaSalle St.

Chicago

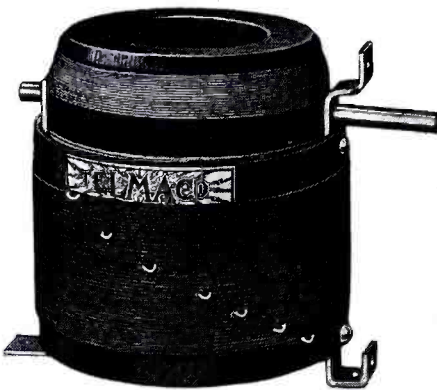

PRICE \$4.50

HOT WIRE AMMETERS OF QUALITY

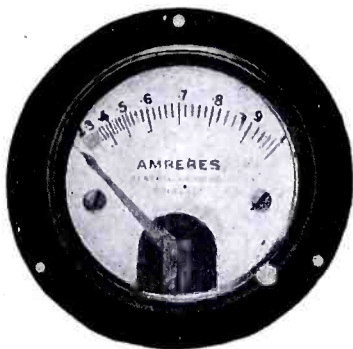

TYPE 127A

No engineer would think of designing an efficient steam plant without steam gauges. It is equally important that an efficient CW set be equipped with electrical gauges—hot wire ammeters. Our Type 127 Hot Wire Ammeters were designed particularly for radio work. In addition to their use in CW sets they are suitable for measuring the antenna current of spark transmitters, filament currents, and storage battery charging currents.

These meters are made, at the price named, in two types: Type 127A for flush mounting and Type 127B for front of board mounting. The diameter of these types is three inches. These meters are also made for portable use. The portable model is known as Type 127C and sells for \$9.00.

PRICE \$7.75

SEND FOR FREE RADIO BULLETIN 909N

GENERAL RADIO COMPANY

MASSACHUSETTS AVENUE AND WINDSOR STREET

CAMBRIDGE 39

MASSACHUSETTS

Standardize on General Radio Equipment Throughout.

FREE With Each U. V. 202 Power Tube FREE

With each Radiotron U.V.202 power tube, for radiophone and C. W. transmission, we will supply free of charge your choice of either the latest Murdock improved contact type V.T. socket for use with the above tube or the Radio Corporation of America's special 5000 ohm, size "M" Grid Leak with midtap at 3,500 ohms, designed by the General Electric Company for use with the U.V. 202. Price \$8.00. Our engineering department, upon learning the number and size of the power tubes you are contemplating to operate, will be pleased to recommend the correct covered capacity and voltage of the motor generator as well as the correct scale readings of the meters. We have excellent motor generators of various capacities and voltages, at reasonable prices, as well as jewel bearing meters, radio frequency, D.C. or A.C. Only new and high grades apparatus carried in stock and all goods guaranteed to arrive in perfect condition. All orders are filled within twelve hours and are shipped postpaid and insured.

THE KEHLER RADIO LABORATORIES, ABILENE, KANSAS

READ the CLASSIFIED ADVERTISEMENTS on PAGES 268-270. YOU'LL FIND MANY GOOD THINGS THERE

the first capacity. The use of the inductance and second condenser enables the use of low capacity condensers at C1 and C2. Across the terminals of C2 there will then be a D. C. voltage which is practically without a ripple.

There are certain values of C1 and C2 which are best for any given purposes and these values can be calculated by a method described by Hull in the *General Electric Review* of February, 1916. The derivation of the formulae used will not be given, but the formulae will be given and used in a practical example.

Let L be the total inductance which equals L1 and L2 together.

Let C be the value of C1 C2, the total capacity which is fixed.

Let w be equal to 2 f, where f is the frequency of the A. C. (60).

Let dV be the permissible fluctuation in condenser voltage which will not effect the operation of the set.

Let i equal load current.

Then these equations will give the relations between the various factors.

$$dV = \frac{8\pi i}{Lw^2 \left[C + \frac{i}{Lw^2} \right]^2} \dots\dots(1)$$

$$C_1 = \frac{i}{2} \left(C + \frac{i}{Lw^2} \right) \dots\dots\dots(2)$$

$$C_2 = \frac{i}{2} \left(C - \frac{i}{Lw^2} \right) \dots\dots\dots(3)$$

These equations give the minimum fluctuation in voltage for a given total value of C equal to C1 and C2 together.

Take the following practical example: Suppose it is desired to use 750 volts on the plate of a 50-watt tube and it is necessary to use rectified A. C. Let us say that the tube can be operated reasonably well even if the voltage fluctuates to the extent of 5 per cent., that is, the voltage may vary between 750 and 713.5 volts, then dV is equal to 37.5. The problem then is to obtain values for L, C1 and C2 which will give a fluctuation equal to this but not more. The plate current of the 50-watt tube at 750 volts will be about 100 milliamperes.

It is necessary to assume a value for the inductance, and from the experience of others if L1 and L2 are each chosen around 100 henrys, the value will be right. The secondary of old spark coils will do for each of these, thus getting a total inductance of 200 henrys. By substituting these values for L, current, and dV in equation (1) and solving for C we will see that C equals about 2 microfarads. Substituting now in equations (2) and (3) we find that C1 equals one microfarad and C2 likewise equals one microfarad, approximately. Small paraffined paper condensers, similar to the Western Electric telephone condensers, can be built to this capacity which will easily withstand this voltage.

By combining the inductances and capacities together on a small panel, a compact rectifying unit can be built. The cost of this entire rectifying unit with the valves will easily be less than a D. C. motor-generator outfit and will give just as good service.

Flying Boat Radio Transmitter

(Continued from page 239)

switch consists of two dilecto arms centrally located in the barrel, each arm carrying a copper blade at both ends, the arms being spaced on a shaft that terminates in the control handle seen on the front view. Each of these copper blades short-circuits two of the adjacent jaws, thus making the necessary electrical connections. The jaws

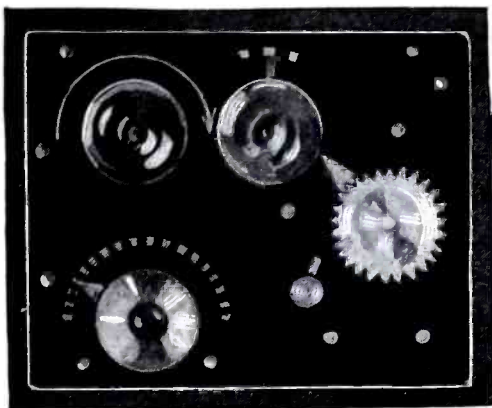

Condensite Celoron is Real Radio Insulation

Use the highest type insulation made. Produced expressly for radio and wireless work. Adaptable to every machining process and ready for every use—panels, plates, bases, rods, tubes, bushings, handles, cleats, etc.

To high resistivity and extreme water resistance. Condensite Celoron adds every other good quality demanded of an efficient insulator. It puts wireless insulation a step ahead. This Bureau of Standard test tells why:

Wave Length Meters	Approximate Frequency Cycles per second	Phase Difference Degrees	Dielectric Constant-K
373	804,000	2.0	4.7
1,295	231,500	1.8	4.8
3,067	97,800	1.8	4.9

Condensite Celoron is regularly supplied in standard size sheets, rods and tubes ready for all machining purposes—for experts and amateurs. Sold by radio equipment dealers everywhere. If your dealer cannot supply you, write us.

Diamond State Fibre Company

Bridgeport (near Philadelphia), Pa.

Branch Factory and Warehouse, Chicago
Offices in Principal Cities

In Canada, Diamond State Fibre Company
of Canada, Ltd., Toronto



If it's a Radiophone—It's a DEFOREST Invention

Get the "Interpanel" Idea—It's Cheaper in the End

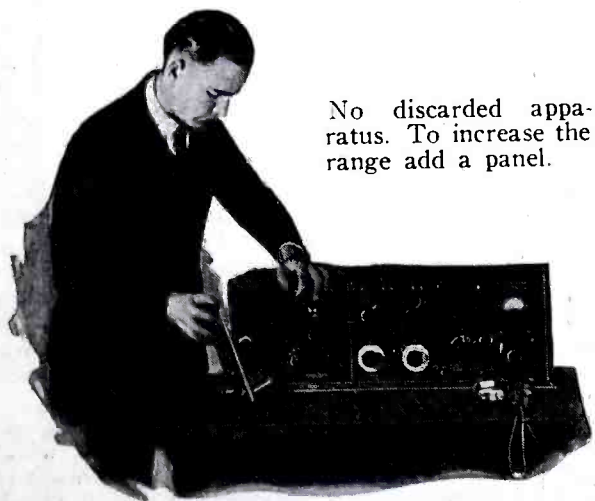

No discarded apparatus. To increase the range add a panel.

FOUR PANEL STATION

- Complete set of four units mounted horizontally.
- (1) Complete radio "Midget" transmitter. Phone sending range 30 miles (OT-3).
 - (2) Complete short wave tuner, 150 to 600 meters (MT-100).
 - (3) Complete audion control, especially for gaseous tubes (MP-100).
 - (4) Complete one-step amplifier (MP-200).
 - (5) Any additional step of amplification may be added.

Besides—it's more efficient—in fact, the most efficient system of wireless made.

The DeForest "Interpanel" Radiophone System is built on the unit idea, like a sectional bookcase. To lengthen your range, you merely add another unit.

Each panel is surprisingly small and compact, and a four panel station occupies but relatively little space (see illustration at left).

The "Interpanel" System is for both amateur and commercial CW telephone and telegraph radio stations. It is the only system that absolutely assures full efficiency in CW transmission.

Before deciding on your wireless outfit, carefully investigate the DeForest "Interpanel."

Address Dept. 97 for Catalogue

RADIOPHONE

REG. U.S. PAT. OFF.

DeForest Radio Tel. & Tel. Co., 1415 Sedgwick Ave., New York City

Manufacturers of Highest Grade Radio Apparatus

Pacific Coast Distributors, HENRY M. SHAW, PACIFIC RADIO SUPPLIES CO., 638 Mission St., San Francisco, Cal.

CO-OPERATIVE PURCHASING

Any amateur can secure membership in the Mutual Purchasers' Association without cost. Such membership entitles him to profit sharing dividends enabling him to buy at low cost. Send stamp for details or send us a trial order. Organized to render SERVICE and SAVING to the experimenter, we invite your investigation. Immediate shipments, large savings.

BALDWIN PHONES, Prices Reduced

Type C, small style.....	\$13.50
Type E, Ultra sensitive type.....	15.00
Type F, very small size.....	16.25

STORAGE BATTERIES, (Marko Make)

6 volt 20 to 40 ampere hour.....	14.60
6 volt 40 to 60 ampere hour.....	17.00
6 volt 60 to 80 ampere hour.....	21.50

(Shipped fully charged ready to use.)

B. BATTERIES

Acce 22½ v. fixed, year guarantee.....	2.50
Acce 22½ v. var. year guarantee.....	3.00
Acce 22½ v. small fixed.....	1.50
Acce 22½ v. small tapped.....	1.75
Acce 45 v. small tapped.....	3.50
Acce 45 v. large tapped.....	6.00

TUBE RECEPTACLES

General Radio.....	1.50
Paragon, Adams Morgan.....	1.00
Remler.....	0.70
Murdock.....	1.00

AMPLIFYING TRANSFORMERS

Clapp-Eastham, new mounting.....	\$4.00
Acme, new style mounting.....	5.00
Radiotron UV-712 specials.....	7.00
Sacoelad, small style.....	5.00
General Radio, new style.....	5.00
Federal, small compact type.....	7.00

VARIOMETERS—VARIOCOUPLERS

Special mahogany frames, with low resistance windings.....	7.50
Nightingale, short wave type.....	4.50
Nightingale, vario-coupler.....	5.00

DETECTORS—AMPLIFIERS

Acme Y-2 single stage amplifier, very small and compact.....	13.00
Acme Y-1 Radiotron control.....	10.00
Clapp-Eastham detector.....	12.00
Clapp-Eastham amplifier.....	18.00

C. W. INDUCTANCES (Tuska)

Single winding.....	7.50
Double winding.....	10.00
Three coil inductance.....	12.50

If you want something not listed write us. We carry a complete stock ready for shipment. If it's a standard item we have it.

MUTUAL PURCHASERS ASSOCIATION
2-4 STONE STREET Dept. R-45 NEW YORK CITY

BUY C. W. GENERATOR PARTS

and do your own winding

All parts complete ready for assembling with necessary winding data

\$18.00 each

These are ball bearing motors and cannot be duplicated. This is an overstock and we must move them. 500 Volt generators \$35.00. Rating 125 watts 1750 R. P. M. ¼ H. P. 40 degree Westinghouse motors 1750 R. P. M. 110 Volt 60 cycle—\$18.40.

The Electric Motor & Engineering Company

2nd Street, S. W. & B. & O. R. R.
CANTON, OHIO



SOMETHING NEW

THE PARKIN DIAL TYPE RHEOSTAT (Pat. pending), consists of a 3 inch molded Bakelite dial in the back of which is a circular groove containing the resistance element. This groove, being recessed, allows the dial to clear the panel by the usual distance of 1/16 inch. An off position is provided, and a stop on the dial engages the stationary contact at the extreme positions. The 360 degree rotation insures fine adjustment. A brass bearing insures a true running dial and smooth action.

All figures and graduations are filled with brilliant white enamel. All brass parts nickel plated. Bakelite knob.
Resistance is 5 ohms, carrying capacity 2 amps. No. 77 Parkin Dial Type Rheostat, postpaid.....\$1.75

FOR SALE BY ALL LEADING DEALERS

Send for free catalogue No. 5 describing our complete line. Dealers—Write for proposition.

PARKIN MFG. CO. SAN RAFAEL, CALIF.

are made of phosphor bronze, thus insuring good contact between jaw and blade. Although not all of these switches carry the high frequency current, they have all been designed to withstand the maximum high frequency potential to which any one will be subjected. Wherever possible air insulation has been provided by perforations.

At the top of any of the rear views of the set will be seen the sub-panel with its various parts. On the rear side of the sub-panel at the left is seen the antenna series condenser, capacity about 0.1 microfarads. At the center of the sub-panel is seen the long iron cored audio frequency choke coil and at the right top, Fig. 5, is seen the circular, square section radio frequency choke coil. In Fig. 4, at the left, near the bottom is seen the microphone transformer, and to the right of this, directly behind the loading coil, is seen a condenser, which is the balancing condenser in the grid circuit, capacity 0.0004 microfarads. Looking now at Fig. 5, we see at the right near the bottom a dilecto block on which is a small box. This box contains the grid leak and condenser, and behind this is the high tension 1,500-volt generator condenser, capacity 0.5 microfarads.

The wiring on the back of the set is clearly visible, the leads all being No. 12 B. & S., and covered with empire tubing. On any of the rear views there will be seen at the bottom, running horizontally, a lead encased in thick dilecto tubing. This lead is the plus 1,500 volt lead which must be heavily insulated, since it runs near some low tension leads. Wherever there is a lead which carries a very high potential, it is encased in this dilecto tubing to insure safe insulation.

It will thus be seen that all constants are fixed and that apart from the switches there are no movable elements. All necessary circuit changes are taken care of by the three main switches, and thus the operation of the set is a very simple matter.

*Photos by courtesy of General Electric Co.

Power by Radio

(Continued from Page 209)

decided to use our regular aerial for the test and rig up a temporary affair to use with our set for that night. We invited several amateur friends to come and view the proceedings. The day before we had everything set for the tests and were waiting rather impatiently.

A dozen times that day I went out to look at the weather. As yet we had had no snow, although we had had some cold weather. In the afternoon a storm blew up and about five o'clock it began to snow. We cursed the weather in general and the snow in particular, for the static was very bad and we were afraid it would spoil the tests.

Our shack was back of our house and so I invited Bob to stay for supper, which he gladly did, and which also shows how excited we were, considering that Bob only lives about two blocks away. About an hour after supper several "bugs" dropped in, most of whom were openly scornful. Of course, as we were one of the few stations chosen, we were very optimistic. Personally, I couldn't see the wisdom of any company in trusting a perfectly good Weston ammeter and voltmeter in the gentle(?) care of a full blooded ham, unless they had something to show for it. At any rate, we did not worry about it. As the time grew nearer, we grew more and more impatient. Finally, as Bob held up his hand for silence, we saw him turn around and heard him say, "NAA has just started her time signals." We scarcely breathed those five minutes. Finally Bob

Insure your copy reaching you each month. Subscribe to *Radio News*—\$2.00 a year. Experimenter Pub. Co., 236-A Fulton St., N. Y.

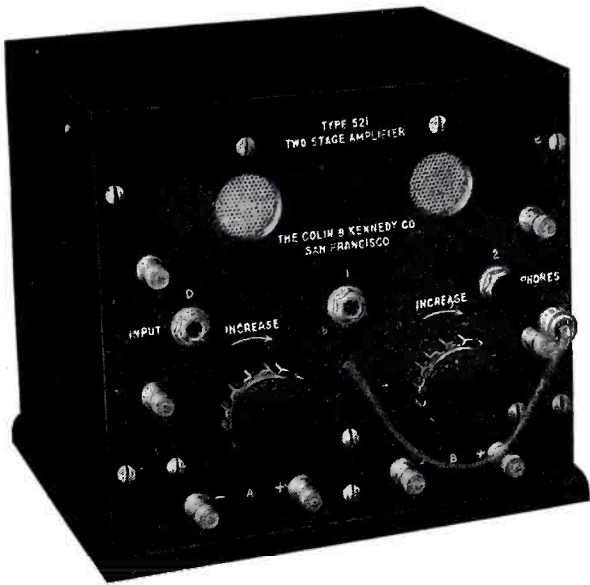

**KENNEDY
EQUIPMENT**

**Announcing
KENNEDY
TYPE 521
TWO-STAGE AMPLIFIER**

Designed for those who want maximum efficiency
in an amplifier occupying a small space.

Mahogany cabinet with hinged cover, affording accessibility to tubes and interior. Special Kennedy amplifying transformers, yielding maximum amplification with freedom from noise and distortion.

Plug and jack arrangement permits ready change from detector to first or second stage without disturbing connections to telephones. Also affords flexibility of connections to extra phones or additional units of amplification.

PRICE - - - - \$55.00

Ask your dealer

THE COLIN B. KENNEDY COMPANY
INCORPORATED

RIALTO BUILDING

SAN FRANCISCO

PARAGON

MEANS

"PERFECT MODEL OF EXCELLENCE"



AND IT IS FOUND ONLY ON
RECEIVERS
AMPLIFIERS
DETECTORS
V. T. CONTROLS
CONDENSERS
RHEOSTATS
RADIOFONES
SOCKETS
KNOBS
VARIOMETERS
SWITCHES
DIALS, ETC.

Manufactured by

ADAMS - MORGAN CO.

UPPER MONTCLAIR, NEW JERSEY

MOST DEALERS STOCK PARAGON PRODUCTS



No. 25 PARAGON RHEOSTAT \$1.50.
Six ohms 1 1/2 amps. max. Either panel or table mounting. Indestructible Condensite base. Highest grade on the market.

No. 30 PARAGON SOCKET \$1.00.
A real socket at a right price. Highly polished nickel shell and Condensite base. Indestructible. Laminated springs give smooth firm contact.

No. 70 VT CONTROL \$6.00.
Strictly high grade instrument. Does better work than many high priced cabinets. Finely finished indestructible Condensite panel embraces socket, rheostat, condenser, leak and nine terminals. Metal parts polished nickel.

WE'VE A DIAL FOR EVERY PURPOSE
and they all match. Cut shows 270 degree dial for our rheo. and potentiometer. Superb finish. Indestructible. Fits 1/4 inch shaft. Price 90c. Moulded of Condensite.

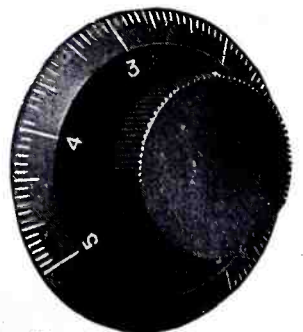

YOUNG TIMERS!

When you enter the game, **START Right**

Then, when you are an "Old Timer," you won't regret wasted dollars. The average set sold to a beginner is either soon junked and replaced by another, or causes its owner to give up the game entirely.

We have developed an ideal Beginners' Set, tuning from 180 to 1500 meters **MORE EFFICIENTLY** than either a slider tuned coil or loose coupler.

Every instrument can be used in gradually building up the most efficient receiver money can buy, the paragon circuit Short Wave and Honey-Comb long wave receiver.

Here's the set—

Tuska Variometer, . . . \$6.25	\$15 complete	Murdock Headset, . . . \$4.50
G. A. .0005 Condenser, . . .35		Amrad Detector, 2.50
Galena Mounted,50		Insulators,30

100 feet No. 14 Copper Aerial Wire, .60

As a quality guarantee—Tuska, G. A., Murdock, Amrad—Need we say more?
Our catalog contains expansion plan. 5 cents brings it.
Postage extra on all orders

Superlative Radio Company

A. K. Laing, Pres. S. G. Peticolas, V. Pres. W. J. Griffin, Sales Mgr.
Pelham Manor, N. Y.

Plugs 65c



DO YOU MAKE YOUR OWN APPARATUS? LOOK AT THESE PRICES



SP No. 2 80c ea.



B No. 1
10c ea.



B No. 3
12c ea.



B No. 2
15c ea.



S No. 3 75c ea.

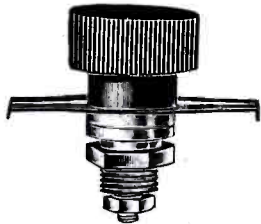

SP No. 1 80c ea.



S No. 1 50c ea.



S No. 2 75c ea.



C No. 1 30c ea.

SUMMER PRICES OUT.
WESTERN ELECTRIC
PHONES, \$12.
ALL PARTS AT A DIS-
COUNT.

DEALERS
WRITE FOR PROPOSI-
TION. STATE QUAN-
TITY.

American Electro Technical Appliance Co.

Dept. R

235 Fulton Street

New York City

NOTE OUR NEW ADDRESS

We have taken over a five story building
to accommodate our increasing business

Get your name on our mailing list.

PHILADELPHIA SCHOOL OF WIRELESS TELEGRAPHY

1533 Pine Street

Philadelphia, Pa.

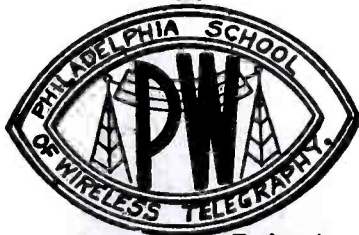

Reg. U. S.

Trademark

Have you something to sell or exchange? A classified ad in *Radio News* will reach 42,000 for only 6 cents a word.

snapped the stem of his watch and said, "TEN O'CLOCK."

All eyes were turned on the meters. Where, oh where, had the power gone? We continued to watch, but there was not a movement of the pointers. Bob looked at me and grinned rather sheepishly, and I returned the favor. One fellow started to laugh, but the look Bob gave him soon shut him up. No one spoke. Silently the fellows turned to go. I felt too disappointed to show my disapproval.

Suddenly Bob let out a yell, "Wait a minute. Are they going by our time or by Central time?"

"Righto," I shouted. "We're not licked yet. We've got another hour to wait."

The bunch came back and sat down, and this time when they started to laugh we laughed with them. We amused ourselves through the hour with a wireless concert, something a trifle unusual just then. However, the sender must have run out of records, for he stopped sending after about fifteen minutes.

It had stopped snowing about nine o'clock and had cleared off considerably. There was very little static just before eleven o'clock (our time) and so we expected good results. As eleven drew nearer even the most pessimistic of our audience grew more hopeful for the success of the tests.

Just before the time for the experiment I went over the connections to be sure that they were all in place, and closed the switches as we were directed, while Bob listened in on our auxiliary aerial for any disturbances of the ether. Bob hung his watch on the wall, where all could see it, and as the second hand traveled around the circle for the last time, every eye followed it. Thirty, forty, fifty, fifty-five, fifty-eight, fifty-nine, ELEVEN! As the little hand crossed the sixty mark we all stared at the meters. Suddenly a muffled whir was heard somewhere in the box and the voltmeter wavered and jumped to twenty volts! The ammeter followed suit and read about five amperes. Referring to our "time table" we saw that this was the correct reading. Bob jumped up and slapped the fellow nearest him on the back and nearly knocked him over, shouting "It works, it works," over and over. We saw with our own eyes over one hundred watts being transmitted by wireless! The dream of the inventors had come true! As this power was to continue for five minutes, I stepped over to the receiving set to listen for interference. At the lower wave lengths I could pick up a good many amateurs and some ships, both lake and ocean. As I went on through the scale I could hear NAR, then NAA, and then WSL transmitting at about 6,000 meters. I heard no more stations, although I turned up to 15,000 meters. And through this whole range I could detect no sound besides the signals and a little static. There was absolutely no interference! The five minutes quickly passed and the meters changed, again in accordance with the stated voltage and current. These tests ranged in time from one minute to ten minutes, and the power from five watts to a little over three hundred. Throughout the trial, which lasted twenty-five minutes, not one variation was noted. The apparatus was a perfect success!

We closed the shop for the night soon afterwards and went for a walk "to cool off," as Bob expressed it. I sent a telegram to the company telling of our success and congratulating them on their invention, and then piled in bed and dreamed of the test all over again.

The following day a certain Mr. Thomas, owner and general superintendent of one of the large manufacturing companies, called on me. I was at a loss to know the nature of his call, as I only knew him

A Moulded Variometer

For Table or Panel Mounting

Price \$6.50

Our Mageco Variometer Types M. V. G. and M. V. P. are moulded composition, highly polished and without a doubt the peer of all other types.

The fact that these variometers are moulded, makes each part accurate to the thousandth of an inch. The windings are moulded right into the forms, are wound with green silk wire No. 22 for Grid and No. 20 for Plate and are not shellacked, thereby reducing the distributing capacity to a minimum.

The clearance of 1/16 of an inch between the rotor and stator is just another proof of the accuracy of these variometers. The distributing capacity of this instrument is lower than any other type on the market.

Another added feature of this variometer is the simplicity with which it can be mounted on a panel and four screws on front of stators provide the necessary means for mounting. Size 4 1/2" x 4 1/2" x 3/4" wide.



Order from your dealer. If he does not carry them, write us, giving dealer's name.
Dealers: Order at once, as the demand is very great. Orders shipped in order received.

IMPORTANT ANNOUNCEMENT

The retail and mail order department of our business has been purchased by The Kuebler Radio Co., 321 1/2 Huron Street, Toledo, Ohio. This change was made in order to give our dealers greater co-operation and better service.

THE MARSHALL-GERKEN CO.

Manufacturers and Jobbers

29 Radio Building

Toledo, Ohio, U. S. A.

"INSULATE"

MOULDED COMPOSITION
 ON THE MARKET 20 YEARS:

ALSO
 "Hi Heet"
 SYNTHETIC-PHENOL
 Moulded - Compositions

100 } Different Knobs, Binding Posts, etc.
 In Stock in Quantities for
 Immediate Shipment.

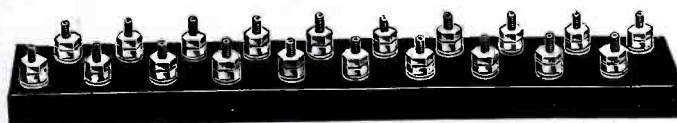
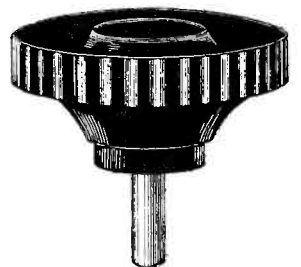
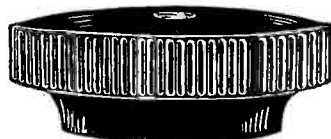

SPECIAL SHAPES—ANY SIZE—MOULDED TO ORDER.

WE SELL THE TRADE ONLY. NO RETAIL ORDERS TAKEN

GENERAL INSULATE COMPANY

999 Atlantic Avenue, Brooklyn, N. Y.

Trade Mark



**A
ACE
E**

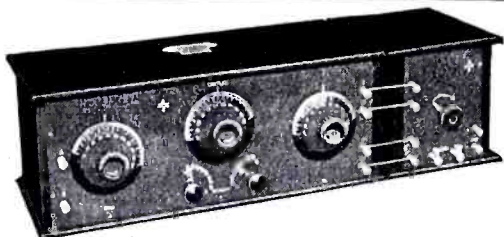

**A
ACE
E**

"SHORT WAVE VARIOMETER UNIT"

Introducing a popular priced model combining the essential features of efficient design with pleasing rugged construction throughout. The ideal receptor for the Radio Amateur.

ACE Type AVA Variometer Tuner.....\$45.00
Licensed under Armstrong Patent 1,113,149

ACE Type ATC Audion Control Cabinet.....\$12.00

Of course we manufacture a complete line of other Radio Equipment such as Amplifiers, Radio Telephone Units, etc. Send 3 cents in stamps for Catalog.

The Precision Equipment Co.

2437-2439 Gilbert Ave.

CINCINNATI, OHIO

YOU MAY PAY MORE BUT YOU CAN'T BUY BETTER

RADIO 8XB

MEMBER A. R. R. L.

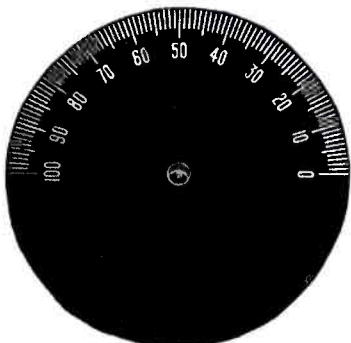

**ONE EMPIRE DIAL
FREE**

With Every Two Dollar Order

Don't miss this opportunity to get one of these serviceable dials for nothing;

**Look Over These September Specials
Carefully—Save Money**

VARIABLE CONDENSERS

Chelsea .0006 for panel mounting.....\$4.25
Chelsea .0011 for panel mounting..... 4.75

**PARTS FOR DETECTOR AND AMPLIFIER
PANELS**

Remler Rheostat 1.00
Fada Rheostat 1.25
Paragon Rheostat 1.75
Radio Service Socket95
Remler Moulded Socket 1.50
Grid Condensers35
Grid Leak Condensers50
Western Electric Plugs 1.00
Rhamstein Plugs75
Rhamstein Jaks75
Cabinet for 6x9x1/4" Panel 2.00

Acme Amplifying Transformers, mounted..... 5.00
Marko Storage Battery, 6 V., 40 Amp.....13.00

VACUUM TUBES

Audiotron, two filaments\$6.00
Radiotron, detector 5.00
Radiotron, amplifier 6.50
Radiotron 5 Watt Power Tube..... 8.00

DIALS, SWITCHES, BINDING POSTS

Chelsea 3-inch Dial 1.00
Adams Morgan 3-inch Dial 1.00
Adams Morgan 4-inch Dial 1.75
Empire 2 1/2-inch Dial25
No. 100 Switch, radius 1"60
No. 130 Switch, radius 1 1/2"75
No. 150 Series Parallel Switch85
Hard Rubber Binding Posts10
Nickel Plated Switch Points, per doz.50

Empire Radio Equipment Co.

Manufacturers and Distributors of Radio Apparatus

271 West 125th Street

New York City

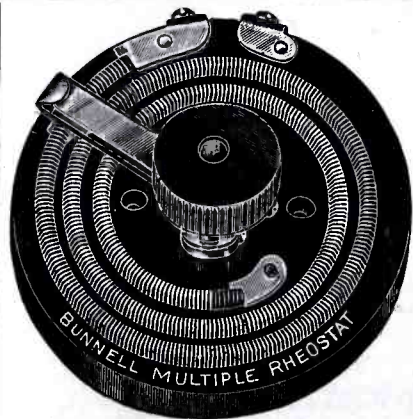

New! NEW! New!

**Bunnell MULTIPLE
RHEOSTAT
28 OHMS**

"Bunnell Quality"

Sample by Mail, \$3.00

Get descriptive circular
Send Stamp for Catalog 42 R.N.
We Carry High Grade Radio Goods

J. H. BUNNELL & CO.

32 Park Place

New York

READ the CLASSIFIED ADVERTISEMENTS on PAGES 268-270. YOU'LL FIND MANY GOOD THINGS THERE

as one of the "big men" of the town. He introduced himself and gave me a letter he had received that morning. I was astonished to see that it was from the wireless power company, and I hurriedly read it through. Briefly, it told of the tests they were making, and the part we were playing, and invited him to "go see" for himself. It also gave the location of one of their big power plants under construction in Minnesota, and the output in kilowatt hours ready for distribution at that time. They quoted him a price on power at about half of that of the local company. If he would be interested in their offer he should call on me and arrange to see the final tests. As befitted a modern business man, he decided to investigate any proposition that would save him something like \$10,000 a month in his power costs. Accordingly he asked if he might attend the second set of trials the following morning at 2:00 o'clock. Of course I told him I would be glad to see him there and to bring any friends he might wish. Later in the day Mr. Carroll, another owner of a large manufacturing plant, called me on the phone and read to me a letter received that morning from the same concern and similar to that received by Mr. Thomas. I told him he would be welcome at our station and I told him of the previous night's test. He promised he would be there "en masse."

These two men and a few friends arrived about midnight and during the remaining three hours we explained to them some of the mysteries of the wireless and entertained them with a little long distance work. The night was fine for transmitting and we worked about seven hundred miles. As the time approached we ceased sending and waited until Bob's watch (again set by NAA) read three o'clock. Less than thirty seconds after three we again heard the slight whir and the meters jumped as before. The operations were similar to those of the previous night, and so I will not repeat. The third day two more manufacturers joined the watchers. The morning was one of the worst for sending or receiving that I have ever tried to work in. A heavy, driving snow seemed to force the signals down to the ground and the static was terrible. But the power came through absolutely perfect, with no trace of waver in the pointers of the meters. The results were simply wonderful.

The next day we got ready to pack the outfit up and send it back, when we got a telegram thanking us for our assistance and telling us to keep the apparatus for the time being as more tests might be made in the future. We lovingly wrapped the outfit up and stuck it away in a big cupboard, and connected our set to our permanent aerial.

Things went on as usual for a month or so, until one day Bob came rushing home with the news that Mr. Thomas had accepted the contract offered by the wireless company and was now installing a receiving plant. We immediately hied ourselves to the scene of operations for a personal view. A large aerial had been erected between two smoke stacks and a switchboard installed. At this point the engineers of the wireless company made the installation of the receiving apparatus behind closed doors. From what we could pick up here and there, we made out that the concern was willing to take a chance on the discovery of the operating principle, rather than trust the patent office with their secret. Consequently we could only surmise what was in the crates and boxes that were carried inside of the fence. However, we stuck around, and finally the day came when the power was actually to be turned on. Mr. Thomas had extended

Announcing New Federal Apparatus



Federal Pleiophone
No. 400-W \$14.00

Federal Pleiophone

A loud speaking instrument of unusual merit for a reasonable price. For use with one or more stages of amplification.

Federal Micro-Telephone

An instrument designed for the convenience of the Radio-phone operator. Consists of a high resistance receiver and standard FEDERAL Microphone, with switch in handle for operating a remote controlled antenna switch.



Federal Micro-Telephone
No. 264-W - \$14.00

Write for Literature Describing C-W Accessories

Federal Telephone & Telegraph Co.

Buffalo, New York, U. S. A.

MANUFACTURERS OF STANDARD RADIO ACCESSORIES

Using An Inefficient Condenser is Like Carrying Water in a Sieve



The same judgement used in the purchase of radio equipment that you use unconsciously in everyday affairs will invariably lead you to select COTOCO condensers. Users are unanimous in proclaiming them "*the best.*"

This condenser used in conjunction with our inductance units will enable you to build a set that you will be proud to own.

If your dealer cannot supply you with our products, advise us, and send us his name.

COTO-COIL CO., 87 Willard Ave., Providence, R. I.

WHICH WILL IT BE OM?

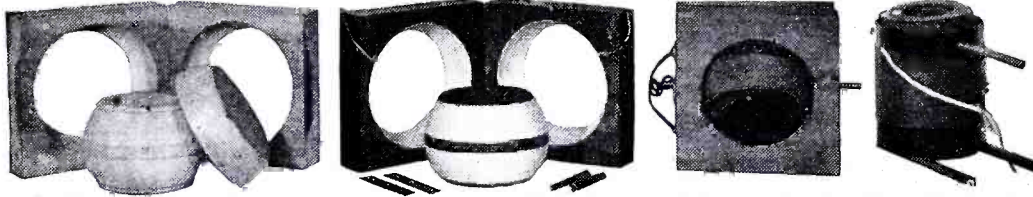
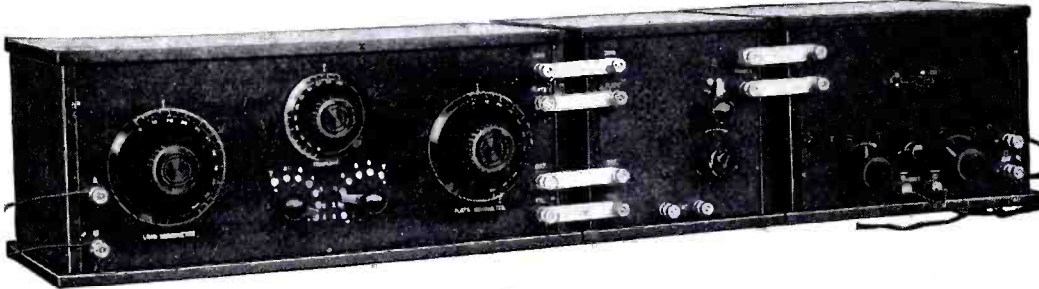

For it is certain the coming DX season will find your station equipped with a Variometer Short Wave Receiver, won't it? And you will want a RECORD BREAKER if it don't break a bank to get one. Not so?

Well here it is, either in solid mahogany cabinets or knocked down to various stages of completion!

TUNER.....\$50.00 DETECTOR.....\$18.50 AMPLIFIER.....\$40.00

Write for parts price lists. Complete wiring specifications furnished with parts. We carry a full line of Standard equipment and manufacture C-W apparatus and complete "CINOPHONES".



CINO RADIO MFG. CO.

218 West 12th Street

Cincinnati, Ohio

**RADIO
8-XY**

"CHI-RAD" VARIOMETERS AND COUPLERS

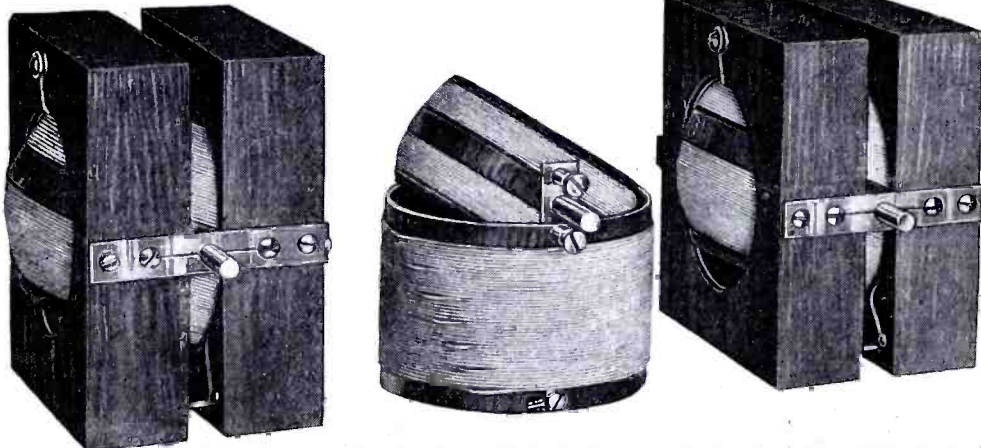

Variometer, P-1 \$5.00 (3 lbs.) Coupler, C-1 \$4.00 (2 lbs.) Variometer, G-1 \$5.00 (3 lbs.)
Prices, completely assembled as shown. Include PP on weight given. Chelsea Dials, \$1.00 each.

SPECIAL KNOCKED DOWN PARTS

The knocked down set includes all parts to make up two variometers and one coupler exactly as shown above. All windings in place, nothing to do but screw on bearings and connect up. Set can be completely assembled in 30 minutes. Price complete only \$10.00. Add PP on 6 lbs. Immediate delivery—the biggest value on the market—order your set today!

Read these specifications:

Variometer forms 4 1/4" sq., 3" wide when assembled. Coupler primary Bakelite, 3 1/2" Diam, 3 1/4" high. All shafts 1/4" diam. Designed specially for panel mounting—all screws covered by dials when assembled. Range 175-450 meters. Special condenser to shunt across secondary and increase range to 650 meters 35c extra.

CHICAGO RADIO APPARATUS CO., Inc.

508 SO. DEARBORN ST.

(Phone Harrison 1716)

CHICAGO, ILL.

INTRODUCING "PROFCO" The Compact Set



Efficient, Durable and Attractive a set that you will be proud to have in your station, assembled with all standard parts enclosed in a quartered oak cabinet, with all metal parts heavy nickel polished mounted on a Formica panel.

DETECTOR AND TWO STEP (Type A) \$55
(Size 9 in. Long, 5 1/2 in. wide and 3 in. high)

DETECTOR AND ONE STEP (Type A) \$40
(Size 8 in. long, 5 1/2 in. wide and 3 in. high)

Prompt Shipments Express Prepaid in U. S.

Write for descriptive bulletin.

"ALL STANDARD PARTS CARRIED IN STOCK"

Professional Radio Assembling Company
SAMUEL SCHNEIDER, Manager.

133 CROSBY STREET DEPT. N NEW YORK

A welcome addition to your library! Send \$2.00 today, plus postage for 7 lbs., and your copy of bound volume No. 2 of Radio News will come forward by return mail.
Experimenter Publishing Company, Inc. 236a Fulton Street, New York City

us a special invitation to be present, and while we were waiting for the time to turn on the "juice," he told us some of the details of the affair. The company saved so much money on the fact that they had no transmission lines to install, that they could sell power at about half of the ordinary price. The cost of installation was very high, about \$100,000, but as they saved so much one way, his plant could soon make up that amount and save money in the future. One-half was to be paid before the work was started and the other half on completion. We went out to see Mr. Thomas pull the big switch. The whole office force was lined up around the switchboard and in back of them stood the workers, waiting for the "power from above." The engineers said everything was O. K. and Mr. Thomas stepped over to the switch. There was absolute silence as he pulled down the switch. There was a flare of green, and then we could hear the whine of the motors as they increased speed. For an instant no one spoke. Then as by common accord a shout was raised loud enough to be heard a mile. And we didn't restrain ourselves, either. When it was all over we went out to see the final result. The aerial came down into a large brick building and the power wires came out of this, high up on the side. The only door looked like the door of a safe and I think it was stronger. We hung around a while and then went home to discuss it all over again.

Engineers came from all over the country to see the plant in operation, and many went home resolving to have such a plant. We learned in roundabout ways that a good many plants were being built all over the country similar to this one.

And then the crash came. We were at home when someone told us that the power at the plant had failed. We hurried down there and saw Mr. Thomas and the rest of the directors nearly frantic. On inquiry we found that the power went off at midnight and they had telegraphed the company for a man to fix it. The telegraph boy found the office vacant and no forwarding address. Inquiries were started at different plants where construction work was going on, but to their surprise, no one was working. And the last straw had just been reached when the engineers had forced their way into the receiving station. Instead of the intricate receiving apparatus they expected to find, they found only a transformer and a buried power line. And they had just traced the power line to a neighboring power house. We gathered in this information and looked at each other blankly. Urged by a common impulse, we turned and started for the house. We arrived out of breath and as we turned the corner I picked up the axe. Bob nodded his mute approval. We made short work of the black box, and in a moment the whole sham was laid bare. An old clock, long since run down, a series of contacts, a few flash light cells, several resistance coils and two meters, wound out of all accordance with the scales, completed the junk. The posts for the aerial and ground and the switches were dead. We turned and once more put the box back in the cupboard; not lovingly, however.

Eleven chairs around the big table were again occupied. As before, Lewis stood beside the twelfth one.

"The acting treasurer, Mr. Carson, will now make his report," he boomed. Mr. Carson rose slowly, as befitted a man of his weight and importance, and after carefully adjusting his glasses, read the following report:

One complete installation...	\$100,000.00
241 partial installations at	
\$50,000	\$12,050,000.00
Credit	\$12,150,000.00

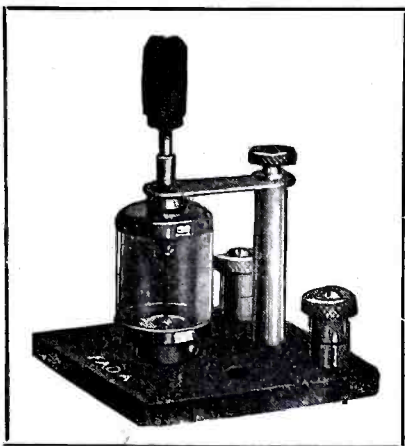

FADA PARTS

are the most satisfactory and economical ones to use in constructing your amplifiers, control panels, radio phone sets and receivers. The FADA crystal detector is used to-day in thousands of amateur stations to receive wireless concerts. And the FADA panel-mounting rheostat with its Thermoplax base (2 1/8" dia.) and smooth adjustment is, bar none, the best buy for your money. Everybody says so.

FADA CRYSTAL DETECTORS NOW \$2.50

FADA PANEL-MOUNTING RHEOSTATS ONLY \$1.25

MR. SUPPLY STORE MAN.—Here are plain facts. FADA instruments and parts are fast gaining a universal reputation for selling quickly with no come-backs. They are not a collection of bargain store cut-price radio supplies. If you desire to sell the highest quality instruments at a price the buyer gladly pays, write me your plans. My discounts are most liberal—you profit accordingly.

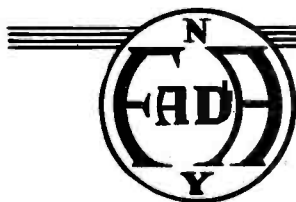

FRANK A. D. ANDREA

Manufacturer of
FADA RADIO PRODUCTS
1882-A Jerome Ave. New York City

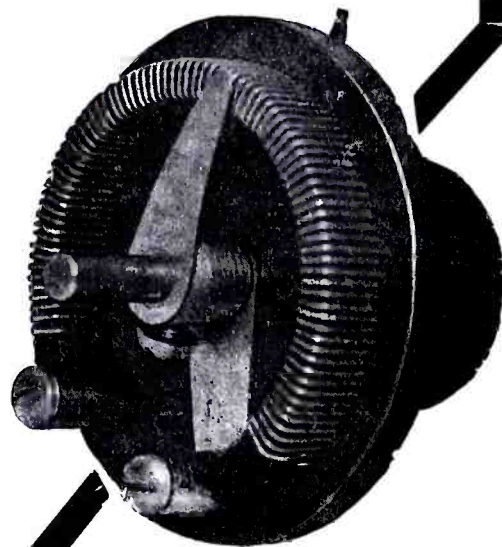

Condenser
No. 3

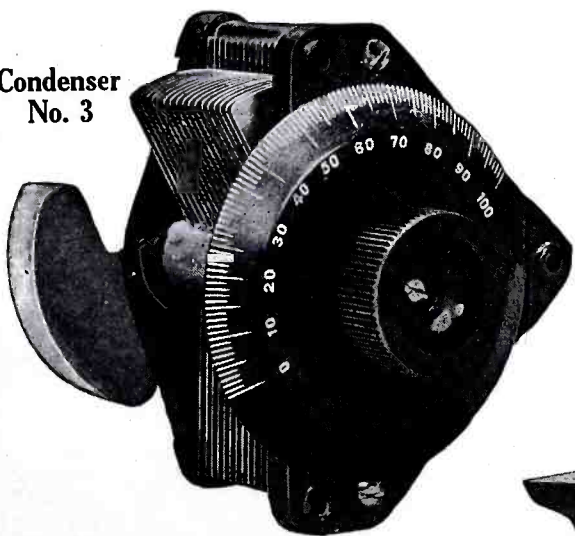

CHELSEA

Variable Condensers
(Die-Cast Type)

- No. 1.—.0011 m. f. mounted.....\$5.00
- No. 2.—.0006 m. f. mounted..... 4.50
- No. 3.—.0011 m. f. unmounted..... 4.75
- No. 3.—.0011 m. f. unmounted, without dial 4.35
- No. 4.—.0006 m. f. unmounted..... 4.25
- No. 4.—.0006 m. f. unmounted, without dial 3.85

Top, bottom and knob are genuine bakelite. shaft of steel running in bronze bearings, adjustable tension on movable plates, large bakelite dial reading in hundredths, high capacity, amply separated and accurately spaced plates.

Unmounted types will fit any panel and are equipped with counterweight.

Purchase from your dealer; if he does not carry it, send to us.

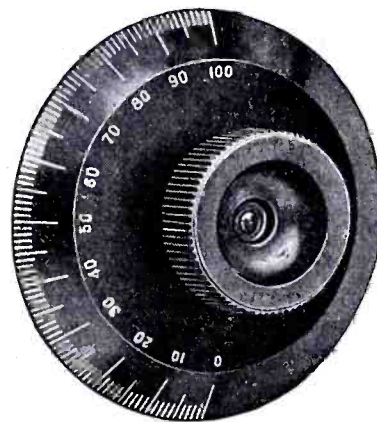

"CHELSEA" BAKELITE DIAL NO. 41.

The Chelsea dials are made of genuine bakelite, beautifully finished, and bear a 100 division semi-circular scale.

The dial is 3 1/4 inches in diameter, 1/4 inch thick, with a long, sloping, easily read marking. Chelsea bakelite dials run true and will not warp.

The complete dial and knob is made to fit either 3/16, 1/4 or 5/16 inch shaft. Specify size when ordering, otherwise the 1/4 inch hole will be furnished.

Chelsea dials are beautiful in appearance low in price accurate and durable in service, unexcelled by any, at any price.

Dial and knob complete.....\$1.00

Purchase from your dealer.



NO. 50 PRICE AS SHOWN, \$4.50

The Chelsea Amplifying Transformer is a supreme attainment in the design of Audio Frequency Transformers. It embodies the highest grade of materials obtainable and proper design, which reflects the result attained namely high amplification factor. It is unequalled either in electrical characteristics or good appearance.

CHELSEA RADIO CO., 150 Fifth Street, Chelsea, Mass.

Manufacturers of Radio Apparatus and Moulders of Bakelite



Longer Life— Better Service

from your "B" Batteries

Demand "ACE"—The Best

Here is our new Ace No. 627—45-Volt Variable B Battery. Made of special size cells and highest grade material.

Will give from 50 per cent. to 75 per cent. more service than any two small size B Batteries

ABSOLUTELY THE BEST B BATTERY OFFER EVER MADE

Cat. No.	30 Readings 1½ U. to 45 V.	Size 5⅞ x 4¾ x 2¾	Voltage	Weight 3½ lbs.	Life App. 800 Hrs.	List Price \$3.50	Price
623	Plain	2½x2x3⅞	22½	400	1	5	\$1.50
623	Variable	2½x2x3⅞	22½	400	1	5	1.75
625	Plain	3 x4x6⅞	22½	1,400	5	5	2.50
625	Variable	3 x4x6⅞	22½	1,400	5	5	3.00
626	Plain	3 x8x6⅞	45	3,000	10	6	5.00
626	Variable	3 x8x6⅞	45	3,000	10	6	6.00

Other Type Ace "B" Batteries

Send us your dealer's name if he does not carry Ace Batteries. Send for new Ace Catalog No. 20.

44 Court Street ACE BATTERY MFG. CORP. Brooklyn, N. Y.

Test Sets 1,000.00
Office, correspondence, rail-
road, etc..... 42,500.00
Installation of outfits..... 100,000.00

Debit \$143,500.00
Total gain\$12,006,500.00
Mr. Carson sat down in silence.
"Hmm, Twelve millions," mused Lewis.
"Not so bad. Next?"

More Efficiency for the Rotary

(Continued from page 195)

it is bent over until it makes a right angle. Each electrode is fastened in its slot by means of an 8/32 bolt ½" long.

The stationary electrodes, C, are shaped as shown in Fig. 1 from ⅛" sheet copper. They are both bolted to a piece of ¼" fiber, ¾" wide, which in turn is held in a slot in the supporting arm, A, attached to the frame of the motor. This supporting arm is of ¼" fiber and of the form shown in Fig. 2. Holes are drilled for bolts to hold the piece, B. The holes above the slot are large enough to pass the bolts freely, while those below are tapped to receive them. Further dimensions for this piece, A, will have to be adapted to the particular motor used. It is to be noted that the piece, A, besides acting as a supporting arm, also serves as an insulator to prevent the possibility of discharge between the stationary electrode, C, and the motor frame.

You can be quickly cured, if you

STAMMER

Send 10 cents for 288-page book on Stammering and Stuttering, "Its Cause and Cure." It tells how I cured myself after stammering 20 yrs. B. N. Bogue, 874 Bogue Bldg., 1147 N. Ill. St., Indianapolis.



THE "MIRACO" TYPE MW-8 VACUUM TUBE DETECTOR

Contains features not found in others at double the price. Complete with grid condenser, grid leak, tube socket (4-prong) and filament rheostat. There is ample space in the hinged covered cabinet for "B" batteries.

MIRACO CABINET DETECTOR less batteries and bulb, **\$9.85** Postpaid

Send 10 cents in stamps for catalogue which you may deduct on first order for \$2.00 or over

Attractive Proposition to Dealers

THE MIDWEST RADIO CO.

"Everything for the Radioman"

3423 Dury Ave., Dept. A
CINCINNATI, OHIO



INVENTORS

This company has specialized for years in the building of models, electromagnets, solenoids, etc., and in developing inventions. While we have never advertised except in some of our former catalogs that we do this class of work, we have had a persistent demand for such work, and we now have decided to let the public know that we now do such work as a regular thing. We have, right here in New York, a well equipped shop where every kind of research work can be done, and any model can be built probably at a lower cost than anywhere in the United States. This work is done under the personal supervision of

MR. H. GERNSBACK, Editor of SCIENCE AND INVENTION and RADIO NEWS

Mr. Gernsback has had past experience not only in developing inventions, but in patent matters as well, and has given advice to thousands of inventors during the past fifteen years, thru his Patent Advice Department in "Modern Electrics" as well as "Science and Invention" (formerly Electrical Experimenter.) Mr. Gernsback understands the needs and wants of the inventor, being an inventor of several hundred devices himself. If you decide to entrust this company with the building of your model or the developing of your invention, you may rest assured that such work will be done under expert guidance. Let us have your inquiries, blue prints or drawings.

This company builds models and shall be glad to assist you in obtaining a patent should you desire us to do so. This company specializes in all electrical work, glass blowing, screw machine work, etc.

E. I. CO., H. GERNSBACK, President 233 Fulton St., New York City
Established 1904

WHAT WE DO NOT DO:

This company does not buy inventions. It cannot finance patents, inventions or schemes. It does not give free advice promiscuously.



use A-P tubes for efficiency

NOTE NEW PRICES

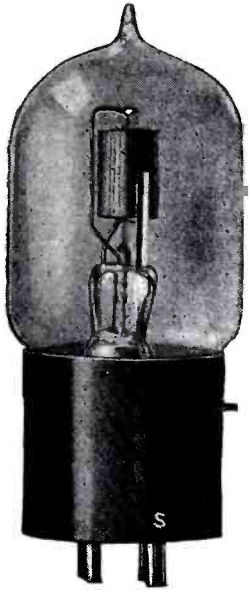

**THE A-P VT
AMPLIFIER-
OSCILLATOR**
—the amplifier used
by the U. S. Navy.
“Use the tube the
Navy uses.”
Price \$6.50

*A-P Tubes are licensed by
the Radio Corporation of
America under the DeForest
Audion and Fleming patents
for amateur and experimental
use in radio communication.*

*For the best book on Radio,
ask your dealer for “Ele-
ments of Radiotelegraphy,”
by Lieut. Ellery W. Stone,
U. S. N.*

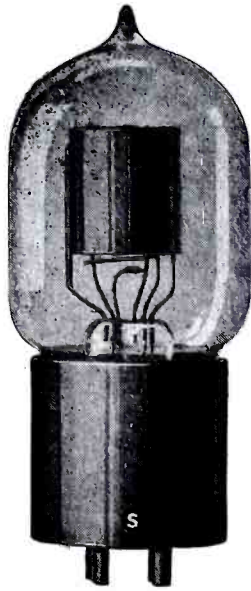

**THE A-P
ELECTRON
RELAY**
—the most sensitive
detector of spark sig-
nals known to the
radio art.
Price \$5.00

Do You Know WHY

the new Westinghouse Receiving Equip-
ment was designed solely for use with
A-P Tubes?

After the most exhausting tests in their laboratories at East Pittsburgh, the Westinghouse Research Department found that the A-P Tubes were the most efficient tubes on the market today—for regeneration—for amplification—for detection.

A-P Tubes proved to be the most quiet in operation and gave the loudest received signal strength. A-P Tubes also proved the most economical in filament consumption, requiring only half the A battery consumed by competitive tubes.

A-P Tubes are the pioneer tubes on the market today. They have passed the experimental stage and are a proved success. They have the highest base insulation of any tube on the market, and are the result of the design of the British, French and American Governments under the rigorous specifications of military requirements. It is not surprising that A-P Tubes are approved and adopted by the Westinghouse Electric & Mfg. Co.

Order from your dealer or write direct to

The Atlantic Radio Supplies Co., 8 Kirk Place, Newark, New Jersey
The Pacific Radio Supplies Co., 638 Mission St., San Francisco, California

Distributors for

Moorhead Laboratories, Inc.
Shaw Insulator Company

DeForest Radio Tel. & Tel. Co.
Diamond State Fibre Company

ESCO LONG-LIFE “B” BATTERIES



ESCO batteries teem with pep and energy, which together with their rugged and durable construction make their actual life extremely long. Every ESCO battery is thoroughly tested and inspected before it leaves the factory so that there shall be no defective batteries to cause our customers dissatisfaction. Prices are extremely moderate as witness below:

No.	Size	Taps	Voltage	Shipping Weight	Price
24	Variable	15	22½	5 lbs.	\$3.00
23	Plain		22½	4 lbs.	2.25
22	Variable	3	22½	2 lbs.	2.00
21	Plain		22½	2 lbs.	1.50

THE ESCO REGENERATIVE RECEIVER

has been reduced in price to

\$45.00

Shipping weight 11 pounds

ESCO VARIOMETERS & VARIO-COUPERS

also reduced as follows:

ESCO VARIOMETER without dial...\$7.50

ESCO VARIO-COUPLER without dial 8.00

For dials add \$1.00 additional

Shipping weight 2 lbs. with or without dials.

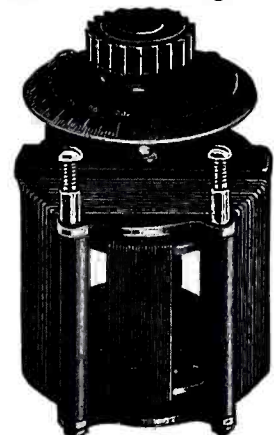

THE VARIOMETER

All Types of Baldwin Receivers Reduced

In line with our other reductions as announced above we wish to list our new prices on Baldwin receivers in effect on Sept. 1st.

- Baldwin Type C Mica diaphragm receivers, shipping weight 2 lbs.\$13.75
- Baldwin Type E Mica diaphragm receivers, shipping weight 2 lbs. 15.00
- Baldwin Type F Mica diaphragm receivers, shipping weight 2 lbs. 16.25

Prices on additional quantities are in proportion. Remember that the No. 14 size runs 80 feet to the pound, and the No. 12, 50 feet to the pound when computing shipping weights.

Our Famous ESCO Quality Aerial Wire

This pure, solid copper aerial wire with which we made our first big hit with the amateurs, still remains as one of our customers favorites. We have it in the No. 14 and No. 12 sizes. Prices are as follows:

- 100 feet No. 14 aerial wire, shipping weight 2 lbs.50c
- 100 feet No. 12 aerial wire, shipping weight 2 lbs.80c

SEND 15 CENTS FOR OUR COMPLETE LITERATURE

ELECTRICAL SPECIALTY COMPANY, 48-50 South Front Street, COLUMBUS, OHIO



Here It Is! A Complete Radio Receiving Outfit!

No additional parts required; complete in every detail. No batteries or other expensive renewal parts needed.

No license, or special knowledge necessary for operation; radio receiving outfit can be quickly set up for use.

Wave length range 180 to 2,500 meters.

It is not necessary to have a high, complicated antenna structure to receive radio signals with this set. Just connect a single aerial wire to the receiving set, ground one terminal, and connect phone to the other terminals and you are all set to receive all kinds of radio signals: messages from amateur stations, ships, wireless telephone speech and music, time signals, weather reports, press, etc.

"MARVEL" RADIO RECEIVING OUTFIT MODEL 105

Just the set for use on hikes, in camps, on motorboats, etc. No parts to break or to be renewed. COMPLETE "MARVEL" RADIO RECEIVING OUTFIT, Model 105, consisting of a Model 101 "MARVEL" Radio Receiver, 150 ft. antenna wire, telephone with leather covered headband and telephone cord, 5 porcelain insulators, ground switch, ground clamp, code chart, abbreviation chart and instruction book, all put up in attractive box (as illustrated).....\$15.00

"MARVEL" Radio Receiver, model 101, with code chart, abbreviation chart and instructions, \$8.00

Either of the above sets sent anywhere in the U. S. upon receipt of money order or check; sets will also be sent via Parcels Post C. O. D. Shipping weight Model 105 set is 10 lbs.; Model 101 Set, 4lbs.

LOOK FOR THE REGISTERED TRADE MARK ON EVERY GENUINE "MARVEL" RADIO RECEIVER; OTHERS ARE IMITATIONS.



DEALERS: We are looking for several well established dealers to sell these sets in the various sections of the country. "MARVEL" Radio Sets are now widely advertised, and should prove to be a "best seller" in the fall and around the Holidays. Write for proposition.

RADIO MANUFACTURING COMPANY

Executive Offices, 156 Fifth Avenue New York, N. Y.

Quality Radio Equipment

GREBE CR-5 REGENERATIVE RECEIVER

150 - 300 Meters

GIVES REAL RESULTS



A complete Receiver—only additional equipment needed are phones, batteries and detector tube. Includes in its range amateur, commercial and Navy wave lengths, special land stations, ship CW stations, Navy low wave arcs and "Time". Especially efficient for Radio phone and CW reception. Ease of operation unparalleled.....\$80.00

SPECIAL Thordarson 1-KW Type R Transformers reduced because of overstock—Formerly \$40.— While they last \$25.00

Full line of Radlotron Vacuum Tubes and Accessories and other Highest Grade Radio Supplies.

Mail orders promptly filled — Dealers—Write for Discount

DOUBLEDAY-HILL ELECTRIC CO.

715 Twelfth St., N. W., Washington, D. C. Radio Dept.—Desk B 719-21 Liberty Ave., Pittsburgh, Pa.

We retail for Klaus Radio Co.

PEORIA RADIO SALES

....CO....

PEORIA ILLINOIS

127 So. Jefferson Street

"FIRST TESTED—THEN SOLD"

Radio Men—Clubs—Schools—Colleges—get our Bulletins

CANADIAN AMATEURS' HEADQUARTERS FOR THE BEST RADIO EQUIPMENT

Write for Price List

SCIENTIFIC EXPERIMENTER, Limited, 33 MCGILL COLLEGE AVENUE MONTREAL

I. C. W. for the Amateur

(Continued from page 195)

the plates and not allow them to become red hot, as the life will be considerably shortened. An aerial ammeter is very useful, but the author used an ordinary flashlight globe shunted with a short piece of No. 22 copper wire as an indicator, until he was able to get an ammeter.

A Mesco No. 55 was used, and by removing the shunt across the sparking points and connecting them in series with the grid, a tone was produced similar to a chopper, with the modulation as good.

OPERATION

The grid should be broken with the key, as this gives the tubes less wear and provides more easily read signals than the compensated C.W. The change to straight C.W. is made simply by allowing the buzzer to stop, for when using the I.C.W. the buzzer is running at all times. When tuning the set, the receiving set may be used as a wavemeter using I.C.W. to tune with, the decrement of the I.C.W. will be very small and that of the C.W. will be nil so that all that is necessary is to tune to maximum radiation.

If an aerial of about 180 meters natural period is used, the best results will be obtained as the antenna current increases, as the radiated wave nears the fundamental. A switch must be provided to apply the plate current after the filament has been applied, so that destructive arcing will not start.

The tubes have only to supply enough energy to make up the radiation and the decrement loss, so it will benefit the experimenter to cut down the wire resistance in his aerial. The use of a counterpoise will eliminate the ground resistance. With a properly designed aerial, one ampere is about the best to be obtained from one five-watt tube.

Often some little misconnection will prevent the working of the set, but if the amateur will follow all the directions, he will have little or no trouble, and, providing he keeps the wave below 200 meters, he will never have anything to fear from the Radio Inspector.

Should the Government Examinations Be More Severe?

(Continued from page 203)

tery. The majority of the new operators, due to the lack of knowledge, leave abstract sheets, special traffic reports, etc., not filled out, and upon their arrival in port the man at the office gets the job. Little did we realize that the knowledge of just such things as mentioned above was what we would need most when acting as a ship's wireless man. The majority of us did not bother about studying such, for we knew that questions dealing with such subjects would not be asked in the examinations.

Many a time, while at sea, I have heard messages and "tr's" being transmitted to the land station in an entirely wrong manner and together with the operators falling all over the key, a most disgusting mess resulted. It is not surprising to hear ships working, using a very broad wave, which causes no little amount of QRM, and their sparks so rough and scratchy as to make it difficult to distinguish the characters in the sending. In such cases we can easily see that the man aboard knows little or nothing about the tuning of a wireless set or the procedure to be taken to insure having a fine, clear, commanding spark. Such a spark is more easily read through heavy in-

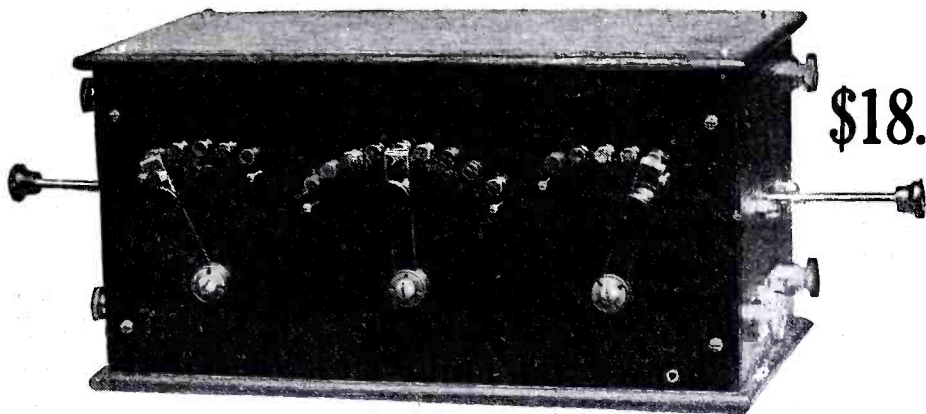

\$18.

Enjoy the Radio Phone Concerts Get the 200-600 meter Stations Clear as a Bell.

This Short Wave Regenerative Tuner is enclosed in a handsome quartered oak cabinet with a hard rubber panel. Because of its unique construction it is very selective and efficient—in a class by itself—the biggest value ever put out for only \$18. After you have used one in your own station, you will say it's the best investment you ever made in your life, because it delivers the goods.

Mr. Edgar C. Norton, Hinsdale, N. Y., says: "Three days from the day I sent my order I received your Short Wave Regenerative Tuner. I was surprised with the results. On a 2-wire aerial 100 feet long and 45 feet high I get everything on 600 meter spark and all short wave arcs come in clear as a bell. NSF and KDKA radiofone and music are heard loud and very distinct using one bulb. Your tuner does all you claim for it and more."

Are You Getting the European Stations? Tune in Stations You Never Heard Before

If you would like to increase your receiving radius, tune in stations you never heard before, tune out some of your present interference and get signals as clear as a whistle, send along the small sum we ask for the tuner you want, and it will be shipped same day your order arrives here.

- Price 600-2,500 meter tuner in quartered oak cabinet.....\$25.00
- Price with hard rubber panel..... 29.50
- Price 2,500 to 20,000 meter tuner in quartered oak cabinet..... 34.50
- Price with hard rubber panel..... 40.00

Mr. Walker S. Linthicum, Mt. Airy, Md., says: "Long Wave Tuner with one bulb you sent me. works O.K. With one Baldwin phone have heard signals 20 ft. from phone."

Send a 2-cent stamp for bulletins

COLBY'S TELEGRAPH SCHOOL, Auburn, N. Y.



THE THIRD EDITION OF THE CONSOLIDATED RADIO CALL BOOK

Very Greatly Enlarged — 192 Pages 32 pages more than 2nd edition, better paper, stiff covers, etc.

READ WHAT SOME OF THE PURCHASERS SAY

S.S. Newton April 26, 1921.
Claremont, Va.
Gentlemen:—Rec'd your new call book yesterday. It is fine. Many thanks.
Sincerely,
T. T. Scholey, Rdo. Elec.

Mattituck, N. Y.
Dear Sirs:—Received my call book to-day and it is well worth the waiting I did for it. Thanks.
Yours truly, Louis C. Gildersleeve.
April 28, 1921.

Buckhannon, W. Va., April 25, 1921.
Gentlemen:—I have received my copy of the Call Book Third Edition and I want to thank you for it. I must say that it is wonderful and I would not want to be without a copy.
Yours truly, W. M. Oliver.
P. O. Box 127.

Some of the special information contained in the new book: Radio rate sheet (charges to and from vessels, etc.); Cable rates; Table for finding cable charges to various points; Weather reports and hydrographic reports of the world; Time signal section of the world; American, French, British and Canadian radio compass stations; General information section; International abbreviations; High power radio stations of the world; Press schedules of spark stations.

The only book in print officially listing all the Radio calls as issued by the Bureau of Commerce. Every vessel and land station in the world is listed alphabetically, according to names of vessels or land stations, and according to call letters; Revision of American coastal stations under U. S. Naval control, and their new calls.

Every New Amateur Call Is Listed

SPECIAL—Wireless Map of the World in Colors Given FREE With Each Copy

Price \$1.50 Prepaid

Either Direct from us or for sale by the following responsible Dealers:

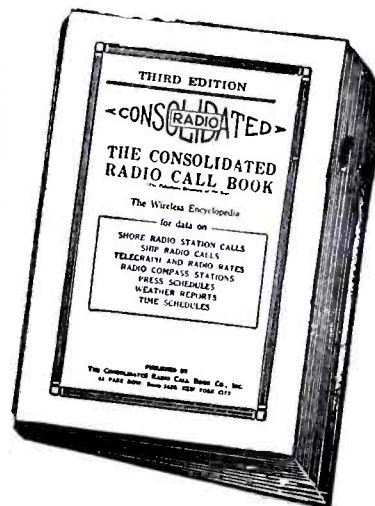

- Am. Electro Tech. App. Co., N. Y. City
- Alamo Sales Corp., Indianapolis, Ind.
- American Hdw. Stores, Bridgeport, Conn.
- Atlantic Radio Co., Boston, Mass.
- Bamberger & Co., Newark, N. J.
- Benwood Specialty Co., St. Louis, Mo.
- Brode Electric Co., Los Angeles, Cal.
- Brown, J. Edw., Glenbrook, Conn.
- Bullock's, York, Neb.
- Bunnell & Co., J. H., New York City
- Burham & Co., Deptford, S. E. 8, England
- California Elec. Co., San Francisco, Cal.
- Catton, Neill & Co., Honolulu, T. H.
- Central Radio Co., Independence, Mo.
- Central Radio Co., Kansas City, Mo.
- Chase, Geo. H., Newport, R. I.
- Chicago Radio Ap. Co., Chicago, Ill.
- Con. Radio & Elec. Corp., N. Y. City
- Cutting & Washington, New York City
- Delancey-Felch & Co., Pawtucket, R. I.
- Detroit Electric Co., Detroit, Mass.
- Dewey Sptg. Goods Co., Milwaukee, Wis.
- Doubleday-Hill Elec. Co., Pittsburgh, Pa.
- Dunn, J. J., Pasadena, Cal.
- Electric Motor & Eng. Co., Canton, O.
- Findley Electric Co., Minneapolis, Minn.
- Fuller Co., Seth W., Boston, Mass.
- Gurd & Co., Wm., London, Canada

- Hico Wireless Sup. Co., Marion, Ill.
- Hickson Electric Co., Rochester, N. Y.
- Holt Electric Util. Co., Jacksonville, Fla.
- Hughes Elec'l. Corp., Syracuse, N. Y.
- Jenkins, Lester I., New Bedford, Mass.
- Karlowa Radio Corp., Rock Island, Ill.
- Katzenbach & Co., F. S., Trenton, N. J.
- Kendall Co., W. D., Worcester, Mass.
- Killoch Co., David, New York City
- Klaus Radio Co., Eureka, Ill.
- Kluge, Arno A., Los Angeles, Cal.
- Krause & Co., A. F., Detroit, Mich.
- Kusel Co., D. & F., Watertown, Wis.
- Lehigh Radio Co., Bethlehem, Pa.
- Liberty Radio Sup. Co., Chicago, Ill.
- Linze Elec'l. Sup. Co., St. Louis, Mo.
- Luther, H. E., Centerville, Ia.
- McCarthy Bros. & Ford, Buffalo, N. Y.
- Manhattan Elec. Sup. Co., N. Y. & Chic.
- Marshall-Gerken Co., Toledo, O.
- Meter Elec'l. Const. Co., Oshkosh, Wis.
- Meyberg Co., Leo J., San Francisco, Cal.
- Mohawk Elec'l. Sup. Co., Syracuse, N. Y.
- Nat'l Radio Institute, Washington, D. C.
- New Era Shop, Milwaukee, Wis.
- Newman-Stern Co., Cleveland, O.
- Nichols Radio Sup. Co., Bwlg Green, Ky.
- Nola Radio Co., New Orleans, La.

- Noll & Co., E. P., Philadelphia, Pa.
- Northwest Radio Serv. Co., Seattle, Wash.
- N. S. W. Bookstall Co., Sydney, Australia
- Pacent Electric Co., New York City
- Parks, Henry Francis, Butte, Mont.
- Paramount Radio Sup. Co., Atlantic City
- Pearlman's Book Shop, Washington, D. C.
- Penn Radio Apparatus Co., Reading, Pa.
- Penn. Marconi Wireless Schl., Phila.
- Phila. Schl. of Wireless Tele., Phila., Pa.
- Piedmont Electric Co., Asheville, N. C.
- Pioneer Electric Co., St. Paul, Minn.
- Pitts Co., F. D., Boston, Mass.
- Pitts. Radio Sup. Co., Pittsburgh, Pa.
- Post Office News Co., Chicago, Ill.
- Precision Equipment Co., Cincinnati, O.
- Radio Distributing Co., Newark, N. J.
- Radio Electric Co., Pittsburgh, Pa.
- Radio Equipment Co., Boston, Mass.
- Radio Equip't. & Mfg. Co., Minneapolis
- Radioelectric Shop, Cleveland, O.
- Ray-Di-Co., Chicago, Ill.
- Reuter Electric Co., Cincinnati, O.
- R. I. Elec. Equip't. Co., Providence, R. I.
- Riverside Laboratory, Milwaukee, Wis.
- Rose Radio Supply, New Orleans, La.
- Roy News Co., Fre'k J., Toronto, Can.
- Sayre-Level Radio Co., Phila., Pa.

- Schmidt & Co., R., Rochester, N. Y.
- Sears, Roebuck & Co., Chicago, Ill.
- Service Radio School, Washington, D. C.
- Shotton Radio Mfg. Co., Seranton, Pa.
- Smith Bros., Sarnia, Ont., Canada
- Smith Novotoy Elec. Inc., Charlotte, N. C.
- So. California Elec. Co., Los Angeles, Cal.
- Southern Elec'l. Sup. Co., San Diego, Cal.
- Southwest Radio Sup. Co., Dallas, Tex.
- Sprott-Shaw Schl., Vancouver, B. C.
- Sterling Electric Co., Minneapolis, Minn.
- Stubbs Electric Co., Portland, Ore.
- T. & H. Radio Co., Anthony, Kans.
- Tuska Co., C. S., Hartford, Conn.
- United Elec. tores Co., Braddock, Pa.
- Warner Bros., Oakland, Cal.
- Whitall Electric Co., Westerly, R. I.
- White Co., The, Columbus, Ga.
- White & Boyer Co., Washington, D. C.
- Williamson Elec. Co., Seattle, Wash.
- Wilmington Elec. Spec. Co., Wilmington
- Winnor Radio Co., Aurora, Colo.
- Wireless Mfg. Co., Canton, O.
- Wireless Press, New York City
- Wolfe Electric Co., Omaha, Neb.
- Y. M. C. A., Los Angeles, Cal.
- Zamoiski Co., Jas. M., Baltimore, Md.
- Zibart Bros., Nashville, Tenn.

Consolidated Radio Call Book Co., Inc., 98 Park Place, New York City

ANNOUNCING The Crosley Variable Condenser

(Pat. Pend.)

"BETTER—COSTS LESS"

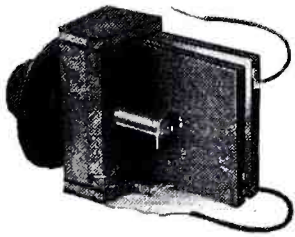

This Condenser works on an entirely new principle. The two plates are hinged and are opened and closed like a book by means of a specially designed cam. The plates are surfaced with copper. One copper sheet is covered with mica so

that when the two plates are clamped tightly together the maximum capacity is obtained. The maximum capacity of this Condenser will average about .0008. We rate it conservatively, however, at .0005.

This Condenser has several advantages over the ordinary type of air condenser. Will stand 1000 volts without breaking down. It can therefore be used for C.W. work. Has no body or hand capacity effect. Has much greater signal strength due to the fact that mica is a much more efficient dielectric than air. The calibration curve of this Condenser is almost a straight line. Has unusually low zero capacity—.00006.

Price without knob and dial.....\$1.25
With knob and dial..... 1.75
Mounted in cabinet with knob and dial..... 2.50

Sold on a GUARANTEED of absolute satisfaction or money refunded.

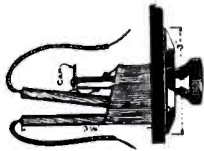

A SMASHING HIT

The CROSLY V-T SOCKET 60c

"BETTER—COSTS LESS"

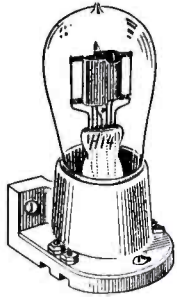

This Socket is made of porcelain—the ideal material for the purpose. Our own special design makes possible the use of this material. Has many advantages over other types of sockets in addition to moderate price. Suitable for either panel or base mounting. If your dealer does not handle them, order direct and send us his name.

Crosley Cabinets

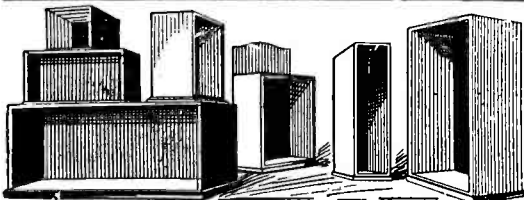

The tendency in the radio field today is to put apparatus in cabinets not only for appearance's sake, but as a protection from dust, dirt, atmospheric conditions, etc. Realizing the demand for attractive stock cabinets of various sizes, we are building them in quantities in our large wood working plant. These cabinets are all uniform in style. The panels are rabbated in to the front. As the outside dimensions and inside dimensions are either larger or smaller than the panel itself, we show panel size and also inside dimensions. Prices quoted do not include the panels.

All cabinets are waxed antique mahogany finish. Wood used is either gum, genuine solid mahogany or quartered oak. Lids or tops are hinged. Sizes and prices are shown below:

CABINETS

For Panel Size	Inside Dimensions			Mahogany or Quartered	
	High	Wide	Deep	Gum	Oak
6x7	5 1/2"	6 1/2"	7"	\$2.50	\$3.85
6x10 1/2	5 1/2"	10"	7"	2.75	4.40
6x14	5 1/2"	13 1/2"	7"	3.30	5.55
6x21	5 1/2"	20 1/2"	7"	3.90	7.30
9x14	8 1/2"	13 1/2"	10"	4.40	6.80
12x14	11 1/2"	13 1/2"	10"	5.25	10.60
12x21	11 1/2"	20 1/2"	10"		

Cash must accompany order. No C.O.D.'s. We pay transportation charges.

We can furnish genuine formica panels 3/16" thick, cut to the following dimensions: 6x7; 6x10 1/2; 7x9; 6x14; 7x12; 6x21; 7x18; 9x14; 12x14; 14x18; 18x21. Price of panels—2 1/2c. per square inch. For odd sizes order the next largest size; we will trim. We pay postage.

Every article bearing the name "CROSLY" is GUARANTEED to give absolute satisfaction or money will be refunded.

We shall be pleased to send literature describing the above mentioned and other radio apparatus to any one free of charge upon request. Get your name on our mailing list to receive latest Bulletin of other new Crosley products. If your dealer does not handle our goods, order direct and send us his name.

DEALERS—It will pay you to handle our line. Write for full particulars.

CROSLY MANUFACTURING CO.

Dept R.N. No. 3

CINCINNATI, OHIO

terference. It is these things which reveal to us the ship's operator's knowledge of commercial operating.

I firmly believe that the American operator, like our British friends, should be compelled to read blinker signals at a certain rate of speed before being given a license which entitles him to take charge of a ship's station. How often, while passing some unknown vessel in the dead of night, or while lying at anchor in some small harbor, are we asked by the captain to indulge in some sort of a conversation? From experience I am aware that very few fellows holding commercial grade licenses can read these signals. Why not have blinkering come under the duties of the sea-going operator? It would greatly help to make the radio man's presence aboard ship more valued and better friendship between master, mates and operator would surely result. Strange, that a few of our commercial men believe an operator is entitled to demand extra pay for blinkering. Should we be heartless enough to accept our monthly salaries for sending in two or three messages during the entire trip? We should do everything possible to make the radio operator's position aboard ship more respected. Remember, a radio man is considered an officer aboard all ships and it is up to him to uphold his rank.

We all know it is required of us to keep a "log" while at sea, but what sort of a log do half the operators keep, especially the fellows on the freighters? I believe masters should sign these logs daily so as to confirm its truthfulness. It is easy enough for us to put anything down in the log which would never cause any comment from the master, but he could easily tell if we really stood the watches which are entered in the log sheets. Some "ambitious" operators are not men enough to stand the watches they are supposed to. They copy press, weather and obstruction reports whenever they have ambition enough to put the phones on their heads. Operators themselves have informed me, shamelessly, of certain little incidents which occurred while at sea. While returning from "across," due to the clinging effect of liquor, they stood but one or two watches, sleeping half the rest of the time. Can we blame masters and mates for having a bad opinion of wireless operators? We can easily imagine what the relieving operator will have to contend with. These fellows who are disgracing the wireless game will soon be thrown out of the profession as they are not worthy of being in our ranks.

If we were forced to pass a severe examination, instead of a foolish one, we could be sure that masters would have no complaints regarding an operator's knowledge of wireless telegraphy. The operator would know how to do this and that without going down to the engineers for assistance. Engineers and captains do not want to listen to our troubles; if we hold a commercial grade license we are expected to know how to repair breakdowns.

Imagine an operator filling an air condenser with sea water to act as the dielectric, or imagine an operator putting a whole set of storage batteries on the "bum" by charging them in the wrong direction. I recall an incident which occurred during a recent voyage to Europe. Following the termination of Arlington weather broadcast, a fellow on one of the Hog Island boats immediately called NAA and asked him to repeat the last part of the forecast. He called on 600 meters and after receiving no acknowledgment called again. Can we blame a number of English operators for giving this fellow the grand ha! ha!? What a disgrace to the American operator! Never, during my wireless career, have I heard a British operator disgrace himself by asking the foolish questions which a good number of our "just out" American

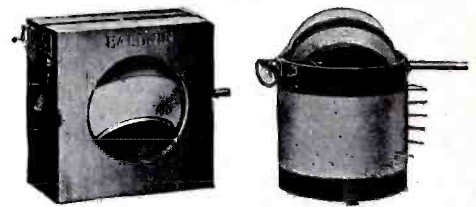

Baldwin Variometers & Vario-Couplers

The Baldwin Variometer and Vario-Coupler illustrated are particularly well adapted for C.W. and long distance, also for the construction of amateur Regenerative Receiving Sets. At the wave length of 150 to 580 meters the windings made on forms are spherical in shape and are carefully impregnated with moisture proof compound which does not affect the efficiency of the instrument.

The wood is well seasoned and will not warp or crack, connections are made to the rotors of flexible leads through the hollow shaft which is supported by adjustable bearings; this insures positive connections and eliminates the possibilities of noises due to poor contact. The primary of the Vario-Couplers are wound on Bakelite tubing 1/8 inch thick and four inches in diameter, fourteen taps are taken off and by means of two sets of switches a one turn variation of induction may be obtained. The instruments are particularly adopted for panel mounting:

Variometers, less dial; wave length 150 to 580 meters \$7.00
Vario-Couplers, less dial; wave length 150 to 580 meters 8.00

For circulars and quotations DEALERS kindly communicate with the

BALDWIN RADIO ELEC. MFG. CO.
1516 Emmons Ave., Sheepshead Bay,
BROOKLYN, N. Y.

CHALLENGE "A" BATTERY

(JOHNSON PROCESS)



Size of each cell 8 3/4 high x 6 1/2 wide x 2 1/4 long over all.

NONE BETTER

Price in sets of three cells (6 VOLTS) \$11.48

Challenge Battery Co., 16 W. Illinois St. CHICAGO, ILL.

1/4 H. P., 110 volts, A. C., 60 cycle, single phase, 1750 R. P. M.

MOTORS

LARGE QUANTITIES NEW WASHING MACHINE MOTORS

These are of standard manufacture and carry the full factory guarantee. Shipped in original boxes. Complete as cut. Suitable for operating Coffee Grinders, Cream Separators, Dottle Washers, Air Compressors, Small Lathes, Etc.

Mail \$3.00 each in Money order. We will send C.O.D. subject to full examination. Money Back Guarantee.

Regulate Speed Motors. Complete with Connections. Write for Catalogue. Special Quantity Prices—Value \$22.50

MANUFACTURER'S DISTRIBUTOR
GHAS. H. JOHNSTON - 501 S. W. E., Pittsburgh, Pa.

\$22.75 Each

PLATE BATTERIES

Always something doing with Ersoo Batteries on your plate.

Ersoo No. 503 22 1/2 volts.....\$3.90
Ersoo No. 803 36 volts..... 3.20
Black Fibre Panels, 1/4 x 20 x 7..... 3.00

Or cut to size .02 1/2 per square inch.

ECONOMY RADIO SUPPLIES CO.,
232 Sanford Street East Orange, N. J.

AMATEURS !!!

Are you getting ready for the opening of the Radio Season? You will find our bulletin interesting. We have a complete line of Parts. Among them: Knobs, Insulators, Binding Posts, Switch Points, Chelsea Dials, Condensers, Aerial Wire, Crosley VT Sockets, Battery Hydrometers, etc. Send 2c stamp for bulletin "A".

Sterling Radio Equipment Company
2723 Cooper Ave. Brooklyn, N. Y.

DO YOU KNOW THAT:

1. BI-LATTICE COILS (duo-lateral) are the best type of inductances for long wave reception?
 2. SINGLE LAYER COILS for short wave reception can be approached only by the best regenerative?
 3. UNIT RECEIVING INDUCTANCES is our specialty?
 4. OUR BULLETIN will be mailed to you for 3c?
- P. J. STOCKWELL, Box 157-C, READING, MASS.

GET A
WIXICO

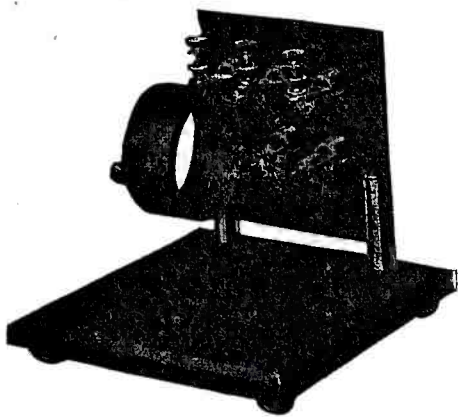

COIL MOUNTING

Pat. applied for
and bring your set up-to-date.

WRITE FOR PARTICULARS

Table Type Mounting.....	\$8.00
Panel Type Mounting.....	6.00
Plug Complete with Handle and strap..	.70

Above does not include coils. Plugs fit only WIXICO Mounting but are sold separately if desired.

See your dealer or write us.

We also handle a complete line of Radio apparatus. Send 4 cents for our catalog. Write us your wants.

THE AMOLECCO CO.
CINCINNATI, OHIO

A SUPER REGENERATIVE COIL SET

The New Spider-Web-Duplex
180-1000 Meters

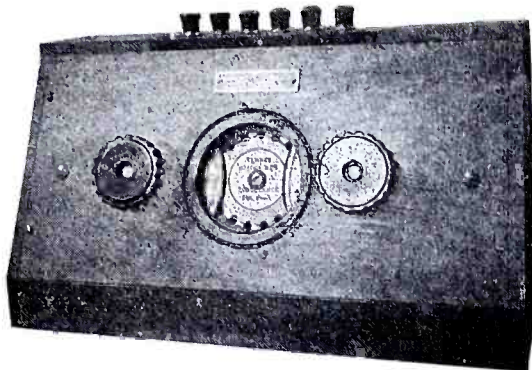

Size 10½ x 9 x 4

PRICE ONLY \$15.00

Owing to the very low price and ultra performance of this set it will surely be a tremendous seller.

ORDER ONE AT ONCE

You will be dumfounded with the marvelous results. There are no taps or switches to provide leaks. The Bureau of Standards are using Spider-Webs.

PACIFIC COAST AGENTS
HERROLD LABS.
SAN JOSE, CAL.

An entire new form of regenerative coil set tuning 180-1000 meters with great precision and an amplifying constant far greater than heretofore obtained.

FEATURES

Fixed coupling, new control, 180-1000 meters, 180 degree scales enclosed behind glass window with fine index line, direct vision.

IF YOU ALL OWNED ONE

Your transmitting and receiving range would be increased two-fold. Complete data sent free on request.

EUGENE T. TURNEY LABS.
RADIO HILL
HOLMES NEW YORK

Bound Volume of RADIO NEWS

THE second year Bound Volume of RADIO NEWS Magazine is ready for shipment. Volume No. 2 contains twelve numbers, starting with July 1920, and ending with June 1921. There are 936 pages, containing over two thousand articles and over three thousand illustrations, bound in red cloth, gold stamped. With its wide variety of original articles, editorials, suggestions and drawings, this bound volume forms a valuable reference book on all questions of radio. Send your orders at once, as we have only a very limited supply on hand.

Vol. No. 1 is sold out completely and cannot be procured any more; supply of Vol. No. 2 will not last very long; orders will be filled within 24 hours.

EXPERIMENTER PUBLISHING CO., INC., 235a FULTON ST., NEW YORK CITY

“The Greatest Radio Catalog In the World”—

The Universal Verdict of Tens of Thousands of Radio Amateurs

Mail 12 cents

in stamps or coin (not sent otherwise) for the greatest Radio Catalog published.

DUCK'S No. 15 BIG 225 PAGE WIRELESS CATALOG. JUST OUT

A Veritable Treasure House of Everything Worth While and Dependable in Radio. The largest, most comprehensive, artistic and educational wireless catalog published. The Beacon Light to guide you right in the selection of your radio purchases, and at prices that will command your attention. Every instrument guaranteed with privilege of return if not satisfied.

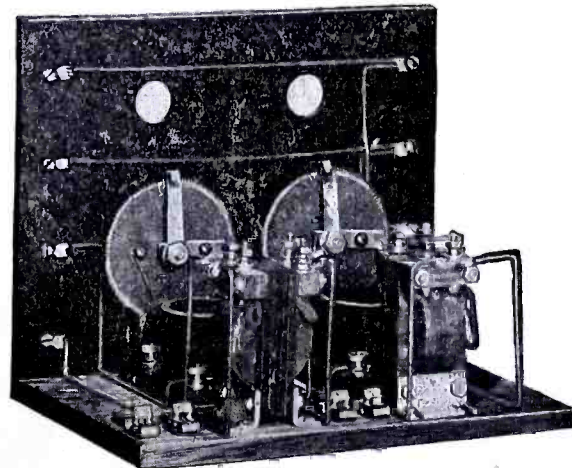
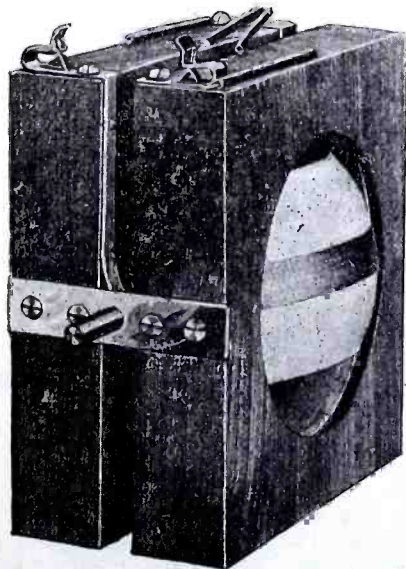
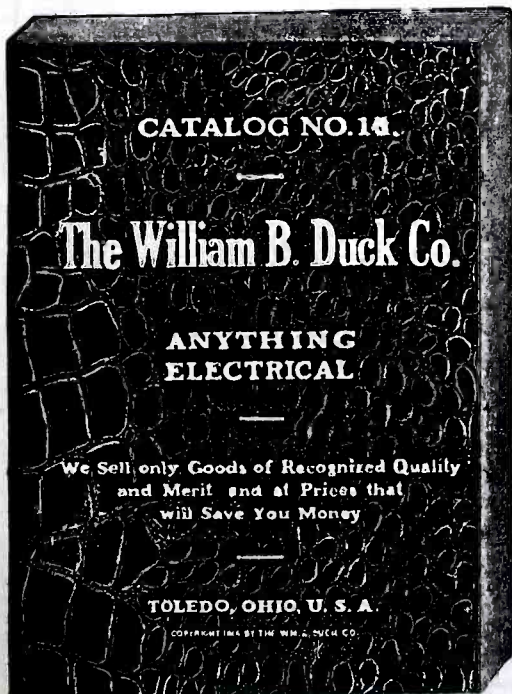

No. A214 Two-Step Amplifier, less batteries and bulb \$30.00

New Items in Stock not Appearing in Catalog No. 15

Murdock No. 56 2000-ohm Head Set.....	\$5.00
Murdock No. 56 3000-ohm Head Set.....	6.00
No. 92 Remler Socket.....	1.50
No. 810 Remler Rheostat.....	1.00
Remler Triple-Coil Mounting.....	6.50
Rhamstine Amplifying Transformer.....	3.50
Type 500 DeForest Rheostat.....	1.25
Saco Glad Amplifying Transformer.....	5.00

No. A600 Plate Variometer.....	\$6.50
No. A602 Grid Variometer.....	6.50
No. A604 Vario-coupler.....	6.00
Knob and Dial extra on any of above	1.25

New Reduced Prices on the Famous Baldwin Receivers

Type "C" Baldwin Receivers.....	\$13.75
Type "E" Baldwin Receivers.....	15.00
Type "F" Baldwin Receivers.....	16.25

THE WILLIAM B. DUCK CO.

231-233 SUPERIOR STREET

TOLEDO, OHIO

The SORSINC

"B" BATTERY
"THE LARGEST B-KNOWN"



22½ VOLTS QUIET

For Reception.
 For Transmission.
 Capacity 6400 M-A.
 Each cell 4" long by 1½" diameter.
 Will deliver 4 M-A for 1600 hours on intermittent service, and will safely deliver 40 to 50 M-A for C.W. work.

4 7/8" x 5 1/8" x 8"

Shelf Life: Guaranteed not to depreciate more than 10% in voltage in 6 months. WE USE THEM ON THE SHIPS WE CONTROL. WRITE FOR BULLETIN.

\$4.00 F. O. B. our U. S. Offices. Add Parcel Post Charges. Net Weight 12 lbs., Shipping Weight 14 lbs.

SHIP OWNERS RADIO SERVICE

Incorporated
 80 WASHINGTON ST., NEW YORK CITY
 BRANCH OFFICES:

- Boston, 175 Commercial St.
- *PHILADELPHIA, 2006 COLUMBIA AVE.
- *BALTIMORE, 407 LOBE BLDG.
- *NORFOLK, 26 HADDINGTON BLDG.
- *SAVANNAH, 409 MENDEL BLDG.
- *NEW ORLEANS, 710 MAISON BLANCHE ANNEX
- Galveston, 313 Amer. Natl. Ins. Bldg.
- San Pedro, 432 Palos Verdes St.
- San Francisco, 24 California St.
- *PORTLAND, ORE., 622 WORCESTER BLDG.
- Seattle, 3451 East Marginal Way
- *Honolulu, 408 Boston Bldg.
- London, 50a Cambridge St., Belgravia, S.W. 1

A COMPLETE LINE OF AMATEUR APPARATUS IS CARRIED IN STOCK AT THESE OFFICES

Our Branch Managers will be pleased to give you expert advice on your radio problems.

SORSINC MEANS SERVICE

PHILADELPHIA AMATEURS

VISIT THE



RETAIL STORE

2006 COLUMBIA AVE.
 PHILADELPHIA, PA.

(Opening Sept. 10th)

COMPARE OUR PRICES

Call or write for Price List
 Reliable Mail Service

CANADIAN AMATEURS

Build your own amplifier using our \$4.75 transformers fully guaranteed. We save you money on all Radio Supplies.

Send Stamp for list.

Western Canada Radio Supply
 Green Block, Broad St., VICTORIA, B. C.

VARIOMETERS, inside windings, \$3.75; VARIO-COUPLEDERS, BAKELITE TUBES, \$3.75; WOODEN BALLS, 55 cents each; 20/38 LITZ, 1 cent per foot; OAK CABINETS, 7 x 18 x 6" deep, \$3.50; other sizes in proportion; 22 DCC MAGNET WIRE, 30 cents quarter pound, all sizes carried.

Dealers Write for Proposition.

Meade Bakelite & Radio Apparatus
 522 Central Avenue Brooklyn, N. Y.

fellows do. The whole thing is, the British boys were compelled to pass a real examination.

What a difference between the American and English operators. Only the boys who sailed the seven seas can confirm the truthfulness of this statement. First, we can readily hear they all know how to use the key, being good senders. They can also correctly forward their traffic, regardless of the prefix. This operator is compelled to read the Morse lamp signals at a certain rate of speed and is very good when it comes to using other devices designed for daylight signalling. According to data obtained while in various cities of the British Empire, I really believe that only 50 per cent. of the American boys could pass an examination identical to the English, the other 50 per cent. getting a percentage of about 50. If we expect our fellows to be real good operators, they must be asked questions which will some day be of benefit. Never have I found a time, when any of the questions which were asked in the examination were of any use during the hundreds of little break-downs which occurred during the period I served as a commercial operator.

Why not give the applicant a practical test in the manipulation and the various circuits employed in the different makes of radio apparatus? If this were done, any operator, upon going aboard ship, would be sure to know the fundamental principles of the radio outfit aboard, whether it happened to be a "Navy Standard" or a "Marconi P8" set. Very severe questions should be asked regarding the various types of receiving sets. I know of operators who attempted to alter the circuits of receivers they knew nothing about, so as to employ a bulb instead of the plain crystal detector. After trying a number of ways to make the new hook-ups work, they failed and then decided to put the connections back in their old place. This they also failed to do correctly, and the result was a company repair man was necessary to overhaul the entire receiver, when the ship arrived in port. Some steamship companies have issued orders forbidding operators to alter any connections in either the transmitter or receiver; dismissal would result should these orders be ignored.

It seems as though a number of the operators know very little about the emergency power-storage batteries. I have visited ships in foreign ports and found these "bats" entirely run down. The operators aboard admitted they had no idea how the charging panel worked and so could not place them on charge. Suppose in the case of a collision, or running ashore we discovered that the batteries were too run down to operate the transmitter, what would be the result? What is the use of having emergency power if it is going to be useless in the time of need?

The sea-going operator who has himself found such conditions aboard many an American ship, is the only one who can realize the truthfulness of this article, which has been especially prepared for the amateur wireless "bug" who, in the future, contemplates going to sea and I hope it will prove a benefit. Why not make the American operator the best on the high seas? Stop to consider the proposition of making the Government exams. more severe. Wouldn't you rather have a hard time passing the test and be sure of being a good operator, than to get through easily only to discover when out at sea, that you were really only a "ham?" Think it over, boys.

*Chief operator, S. S. Atlantic Sun.

Who's Who in Radio

(Continued from page 203)

them.

A patent was granted to Dr. Tesla in 1914 on an improvement of far-reaching

UTTMARK'S NAUTICAL ACADEMY RADIO SCHOOL

NEW YORK BOSTON

Offers a thorough course in all branches of wireless telegraphy. Radio Operators earn at the start \$125.00 per month, and first class board, etc., free.

Our school prepares you for your license in three to four months. Positions guaranteed to first grade licensed operators. Also MORSE TELEGRAPHY.

Day and evening classes.

The leading Nautical School in U. S. A. Established 1804.

CAPTAIN F. E. UTTMARK, Principal

Write, call or phone for illustrated booklet.

8 STATE ST., NEW YORK, N. Y.

Facing Battery Park, N. Y.

Telephone, Bowling Green 8079

UTTMARK'S for Nautical Education

THE VICTOR TYPE 2 V. T. SOCKET

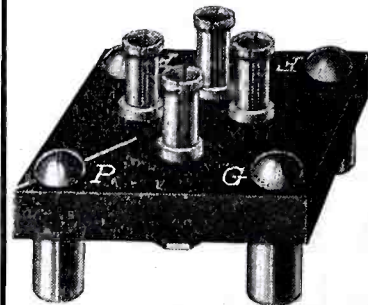

USE THIS SOCKET

(1) When the tube prongs are inserted in the slotted pins a contact surface of 3/8" by 1/4" is given.
 (2) No microphonic tone electrical or mechanical contact always sure and positive.

(3) Fused on plate and filament leads. You can't burn out that tube.
 (4) Nickel plated standards and screws. Pins natural finish. Mounted on 1/4" XX Bakelite base lettered P.F.G.P. in white.
 As shown in cut. By mail postpaid 75 cents. Cardboard template included. If you want to mount own V.T. pins only, 10 cents each. Template included with set of four. Investigate the miniature plug for use with pins. Ideal and positive switching arrangement for C.W. inductance, battery leads, etc.

V. H. LAUGHTER

P. O. BOX 78

MEMPHIS, TENN.

A BETTER "B" BATTERY for your Radio Set

CYCLONE BATTERIES

World's Best "B" Batteries

Variable and Plain

American products. Contains highest grade materials and best workmanship. Guaranteed to give the fullest and best satisfaction.

The best inducements for dealers.

Write for catalog.

Ask your dealer for Cyclone "B" Batteries or write direct to us.

Standard Electric Novelty Co.

182 Lafayette St.

New York City

FULL LINE OF RADIO EQUIPMENT
 Batteries, Tubes, Switches, etc.
 at lowest prices

Large Stock of Double Filament
AUDIOTRONS \$6.00 Prepaid

GALVESTON WIRELESS SUPPLY CO.
 GALVESTON, TEXAS

importance in wireless work. The application was filed in 1902. It described a new form of transmitter with which, according to Tesla's statement, an unlimited quantity of energy can be transmitted from a small and compact plant. This transmitter possesses the wonderful feature whereby static, the one nuisance of the Radio art, and any other interference, can be completely eliminated.

This master magician of modern electrical science has spent a fabulous amount of time and money in perfecting his inventions, and we await with great expectancy the next great stride in scientific development which will mark another epochal invention of Dr. Nikola Tesla.

Radio Digest

(Continued from page 202)

a field strength of 0.2 microvolts per cm. for the signals from Annapolis. Several speakers mentioned that the signals from the American stations are weaker during the night than during the day, although for stations in other directions the reverse is true. —(Abstracted from the Radio Review.)

Junior Constructor

(Continued from Page 213)

causing leakage, I placed a ten cent funnel over the wire, point upwards, and filled in the top of the funnel with pitch. At the extreme top of the copper wire there is fastened a C. E. 3339 "electro" connector, from which one wire goes up to the top of the house to the lightning switch and the other three to the aerial, which is 40' above the ground.

Contrary to the popular belief that the lead-in wire must not be brought to a lower level than the instruments, this system works O. K. in every way. Of course, it must be understood that this method cannot be used for a transmitting set.

Contributed by E. H. WALTHER.

SALT WATER RESISTANCE

Some of you "hams" who have small spark transmitters and employ batteries for power had better get on to this:

Secure a large "mayonnaise" jar, or a larger jar if you have more than a 1/2" coil to run.

Out of 1/4" bakelite cut a disc, leaving a 1/2" border around, so as to make it 1/2" in all around the jar (top). Cut out another piece large enough to fit snugly into the top of the jar. Then with some thick glue, glue the smaller disc in the center of the larger one and let them dry. It is best to clamp them until they dry.

Then one inch from the center, on opposite sides, cut slots one inch long and thick enough to allow a strip of tin to pass through freely. Secure two heavy brass binding posts. Next cut (with a hack saw) a slot 1/4" into the base of the binding posts, respectively.

Then cut out of galvanized tin two strips of same 1" wide and 3 1/4" long. Fit these into the slots in the binding posts and solder them on. Put the strips through the slots in the cover and put the cover on. Then prepare a solution consisting of one-half teaspoon of common salt (table) mixed in three-quarters of a jar of water. Put the cover with the strips fixed on and it will look as in preceding drawing. Then hook up as in diagram.

Contributed by BERNARD STAHL.

AMATEUR RADIO LEAD-IN INSULATOR.

The insulator described hereafter was made about one year ago, from two porce-

Station Type

In handsome mahogany cabinet, as shown.

\$30.00

Laboratory Type

Mounted on metal base, adjustable height

\$25.00

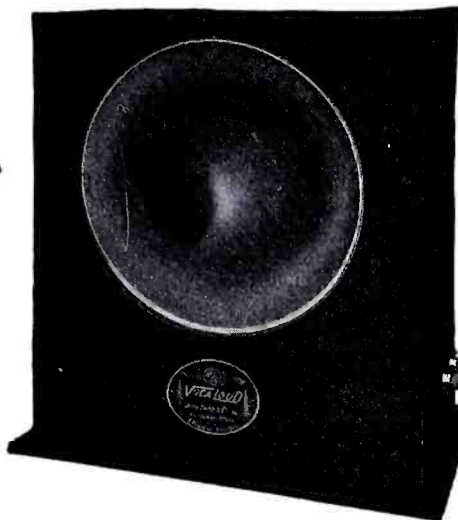

The

VOCALLOUD

THE IDEAL loudspeaker. Requires no batteries, no adjustments, no extra equipment whatever. Just hook VOCALLOUD right on to your receiving apparatus

and listen to your signals, —QSA all over your house! Uses genuine Baldwin reproducer,—equally good for telephone and telegraph. Your order shipped at once!

CORWIN'S improved SWITCH LEVER

Sure contacts, smooth operation, handsome appearance—all are characteristics of this improved switch. Many switches give their manufacturers more profit—none give their users more satisfaction. Try a Corwin Switch. As good as it looks!

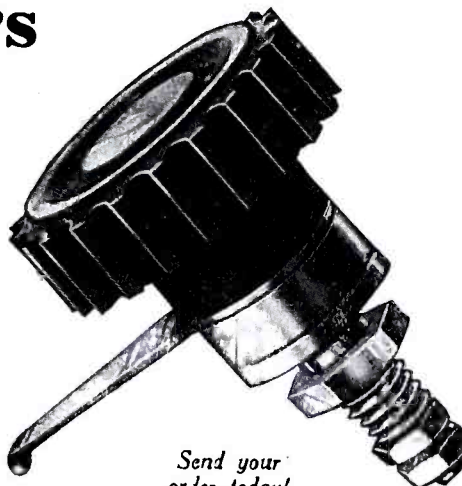

Send your order today!

PRICE: 90 cents, Postage, 5 cents.

Composition knob, identical with knobs used on standard No. 67 Corwin Dial. Brass shaft is moulded right into knob — it can never come loose. Blade, bushings, etc., nickel-plated brass. Contact radius, 1 1/4 inch.

Universal-Coil Mounting Plugs

For Radisco and all hand wound coils. No bending, no filing, they fit exactly in the first place.

80 cents postpaid

All orders for apparatus not listed as postpaid must be accompanied by postage charges.

CORWIN'S 1921 CATALOG 10c
Send for your copy today!

New Radisco Vario-Coupler

Accurate to the .002 part of an inch. Moulded base, Formica tube, all metal parts brass.

\$7.50 postpaid

Remember Corwin's reputation for shipping mail orders promptly and in perfect condition.

A. H. CORWIN & CO.
Dept. B2, 4 W. Park St., Newark, N. J.

NORTHERN ELECTRIC C-W APPARATUS

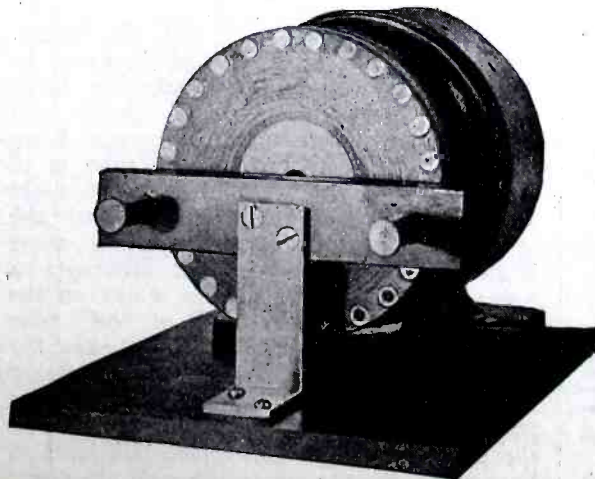

If you desire efficient and dependable apparatus in your C-W set you should send for our new catalogue. Everything from Acme power transformers to Ward Leonard grid leaks.

The **ROTARY MODULATOR** illustrated enables tone transmission to be carried on with power tubes. Why you should use the **ROTARY MODULATOR** in your C-W set is fully described in our catalogue.

Our Engineering Department is prepared to supply technical data and circuits for constructing the better class of experimental stations. There is no charge for this service and your inquiries will receive prompt attention.

Northern Electric Company
SCHENECTADY, NEW YORK
P. O. Box 371

MEMORIZE CONTINENTAL CODE ALMOST INSTANTLY BKUMA YRLSBUG

Beginners Have Reported Mastered Code in 30 Minutes. In 45 Minutes. In One Hour, One Evening, Etc., Etc.

Anybody who can read can learn code quickly and easily.

Dear Sir:—Was busy putting up set and did not really study your chart until one week before examination. With a few nights practice after having mastered Code was able to pass Government Examination with little effort. Your method is sure some easy way to learn that sticker—Continental Code.

Earl Cassell Grafton, West Va.
Call 8BCR 45 Lincoln St.

Dear Sir.—Think your short cut Continental Code Chart a wonder. Learned half the Code in fifteen minutes. Attention to wireless limited by High School studies. * * * My success due almost entirely to your method. Call 2A01. William A. Oettler, Woodhaven, N. Y., 840 Woodland Ave.

Worthless methods are advertised as best, easiest, quickest and other enticing titles. To avoid disappointment purchase no Code Memorizing Chart, Card or Device until satisfied by statement from actual user that same has proven efficient in use as well as in theory.

INVESTIGATE

If interested, not just curious, send ten cents for 28-page Booklet of information and Reports, giving local addresses, from 200 Short Cut beginners scattered over 44 States. Coupon for one dime good whenever you purchase will be enclosed. These reports from our quickly successful students are the concrete and tangible expression of desire to aid and encourage present and future beginners to equally quick progress over that rocky place in the road to amateur success—perfect Mastery of Code. The amateur of today will be the top notch operator of tomorrow.

NO BEGINNER CAN AFFORD TO IGNORE quick and easy success of those who have used DODGE ONE DOLLAR RADIO SHORT CUT WHICH TEACHES WITHOUT INSTRUMENTS. SAVES FIFTY DOLLARS TIME AND HOLDS THE RECORD FOR SIMPLICITY, EFFICIENCY, ECONOMY AND QUICK RESULTS.

C. K. DODGE

Box 200 MAMARONECK, N. Y.

The original tested crystals



Now 25c
GALENA or
SILICON

**Be Sure of Results!—Insist Upon Getting
N. A. A. TESTED CRYSTALS**

These exquisitely sensitive minerals are the best that money can buy for radio detector and wave meter work. Each crystal is individually tested, wrapped in foil and packed in a convenient lithographed tin container. N. A. A. (Arlington) Tested Minerals are the original tested crystals. To avoid their many imitations, look for the signature of J. S. NEWMAN on each box. Galena or Silicon, now.

At good Radio Dealers everywhere, or shipped direct postpaid on receipt of price. **25c**

THE NEWMAN-STERN CO.

Newman-Stern Bldg. Cleveland, Ohio

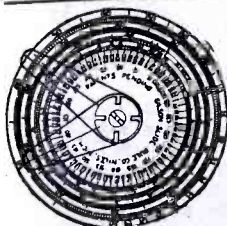

The Midget "FIVE-IN-ONE" Slide Rule is a combination Mannheim, Log-Log, Add and Subtract, Polyphase and Binary Slide Rule. It will instantly add, subtract, multiply and divide any combination involving whole numbers, fractions, decimals and mixed numbers. Gives every possible root and power of every quantity. The graduations are printed on metal coated with white celluloid and are grease and waterproof. While it is the most versatile calculator ever invented, its operation is simple and easily understood. Diameter 4".

Price with 16-page Instruction Book, \$1.50. Leatherette carrying case 50c extra. Catalog free. Your money back if you are not satisfied. Gilson Slide Rule Co., Niles, Mich

lain tubes discarded by a local electric company as useless, having their ends cut to a special length, for which there was no further use.

The assembly drawing shows how the tubes are arranged inside each other. On the outside of the inner tube, at points about 1/2" from each end, a layer of rubber tape is arranged, to a thickness which will just push tightly inside the larger tube. After the rubber tape is in place, the smaller tube should be pushed inside the larger one, and care taken that it is tight enough to avoid pulling out easily. In winding on the tape it is better to have a little too much than not enough, as the tighter the rubber is, the better, and if it is loose the inner tube will fall out. In placing the inner tube in its final position, the heads or capped ends of the two tubes should be kept at the same end, and after being assembled, a space of about 1/4" left between the heads of the tubes to give the regular "Petticoat" effect and to increase the surface over which leakage might take place in wet weather.

Another way to fasten the inner tube is to pack the plain ends and run hot wax or insulating compound in, making a solid insulator. If hot wax or insulating compound is run in the porcelain, it must be heated nearly to the boiling point, or it will crack when the wax is poured inside the larger tube. In packing the plain end to pour wax a layer of friction tape can be used, as this is a fair insulator, but rubber tape is much better.

In placing the tube, the way first described, the inner tube should have wax or some good insulating grease wiped over the part falling between the two pieces of tape, to prevent moisture accumulation on the unglazed porcelain surface. The inside of the large tube should be treated in the same manner.

There are various ways of fastening this insulator in the wall, some being plastered in place, making other support or fastening unnecessary, while others do not care to do this. In the assembly drawing a fastener used on the original is shown. A wooden block, of soft wood, and of the size shown in the drawing, was bored out to a diameter of 1/8" larger than the diameter of the outer tube. The block is then drilled for the two machine screw holes, using a 1/4" wood bit for boring. The exact size and spacing of these holes is not shown in the drawing, as this can be varied to suit the ideas of the constructor. After boring the holes to clamp the block together, it is split, running with the grain of the wood, with a 1/8" saw cut. After smoothing it off, the block is ready to use. The object of boring the large hole 1/8" larger than the tube is to allow a layer of rubber tape to be placed between the tube and the wood, making a watertight joint, and protecting the tube from breakage when fastening the clamp to the wall.

Two blocks, as described, are required to make the insulator fast.

After completing the blocks, the insulator is ready to install. A hole must be cut through the wall or partition large enough to allow the porcelain tube to pass easily and without undue pressure from any point. If one end of the tube is to be exposed to the weather, use the plain end, as the outer tube extends over the inner one, provided tubes of the same length are used. This will eliminate a great deal of leakage due to water on the porcelain. The inner end of the tube should be elevated an inch or so over the outer end to prevent water from following the wires inside. In placing the tube at an uneven level, to keep the water out, the blocks to clamp it in place will have to have the surface next to the wall cut down

RHAMSTINE ★



**Rhamstine*
Vacuum Tube Socket \$1.00**
ADD 4c FOR POSTAGE

Here it is! A plated, highly polished shell mounted on unbreakable condense-celoron base knurled binding posts on outside permit easy connections. Attractive, sturdy, durable. Just what you've been looking for. Ask to see it.

Rhamstine* Plug and Jack—Complete \$1.50
ADD 4c FOR POSTAGE

Rhamstine* Amplifying Transformer \$3.50
POSTAGE AND PACKING 10c

Circulars on request.

Dealers write for discounts.

Manufactured by

J. THOS. RHAMSTINE*

2152 E. Larned St., DETROIT, MICH.

*Radio Products.

GET THE NEWEST BOOK ON RADIO MATTERS ENTITLED

The How and Why of Radio Apparatus

By H. W. Secor, E.E.

This book fulfills a distinct gap in wireless literature. It incorporates a wealth of technique and instruction for the Radio Amateur—the Radio Operator—the Installation and Designing Expert—as well as teachers and students of the subject in general. If you are engaged in any branch of the Radio or allied arts at all you will surely need this latest contribution to radio literature, which is destined to be found on every radio man's book shelf before long. A glance at the following list of chapters gives but a very scant idea of the extensive and useful radio knowledge contained in its text:

The Induction Coil;	phone Receivers; Radio
The Alternating Current	Amplifiers; Construction
Transformer; R a d i o	of a Direct Reading
Transmitting Condensers;	Wavemeter and Decimeter;
The Spark-Gaps; Radio-	Antenna Construction;
Transmitting Inductances;	The Calculation
Radio Receiving Tuners;	and Measurement of In-
Radio Receiving Con-	ductances.
densers; Detectors; Tele-	

An appendix containing very useful tables, covering all subjects treated in its columns will be found in this very unusual book. Cloth bound in Vellum de Luxe, Gold Stamped and Hand Sewed. 160 pages. Size of book 6x9 inches. Postpaid \$1.75. Experimenter Publishing Co., Book Dept., 236a Fulton St., New York City.

AMATEURS!

Use the apparatus

8 Z R

uses. The apparatus that makes possible transcontinental transmission.

Write for a bulletin describing this apparatus

The American Radio Sales and Service Company

Great American Bldg. Mansfield, Ohio
Testing Station 8 Z R

ALKALINE STORAGE "B" BATTERIES

In oak cabinets, gives years of service without expert attention. Are not harmed from overcharging, short circuiting, or standing idle. Plain with clips, for single cell control, including rectifier, chemicals and directions. Thirty-two volts \$8.00; fifty volts \$10.00; sixty-eight volts \$12.00. Add 25% for batteries with control switches mounted in neatly engraved hard rubber panels. Pictures upon request.

KIMLEY ELECTRIC COMPANY
No. 290 Winslow Ave., Buffalo, N. Y.

at one end, so it can draw tight against the wall without cracking the tube.

After the hole is cut, the tube can be placed in the wall, giving about the same end space on each side, and then wrap the layer of rubber tape around the outside of the tube, from the surface of the wall to a point about $\frac{3}{4}$ " out, so that when the block is put around the tube, and drawn against the wall, the tape will fall under the block, and from packing as already described. After placing the block around the tube, the clamping bolts should be put through the two holes and, after washers are placed under both the head and the nut, should be drawn up to a light tension. The block should then be fastened to the wall, and the screws or other fastenings left loose. The other end of the tube should then be fastened in the same manner, and after getting the block attached to the wall, with the screws loose, the first set of clamping bolts should be drawn up to the desired tension, and the block fastened down tightly. The same is then done with the opposite end. This completes the installation except for painting the wooden blocks, to keep them from swelling with moisture.

In selecting tubes for this insulator it is desirable to have the tubes about 6" or 7" longer than the thickness of the wall, and to have as much space as possible between the walls of the two tubes, or in other words, use as small inside tube as the conductor will permit, and as large an outside tube as is available. Judgment must be used in connection with this statement, since the sizes of tubes ordinarily run from about $\frac{1}{2}$ " to about 2" inside diameter. Tubes in which the head of the smaller will slide into the larger should not be used. If it would be possible, due to having an extremely large tube, a third tube could be placed over the outside of the first, and fastened in the same manner, giving a still higher dielectric strength.

The insulator described above was used on a 1-k.w. amateur set for nearly a year, and several times as emergency insulator on board a ship, and has never broken down or shown brush discharge of any amount. The total cost of the original, including a roll of rubber tape, was 94c. which is as cheap as it is possible to make a good insulator. Purchasing the same tubes in a store brings the cost to \$1.25.

In case a brush discharge shows on the outer end during damp weather, it can be remedied by wiping off with a rag and some petroleum jelly, and then wiped clean.

Contributed by PAUL G. WATSON.

Effect of Counterpoise on Antenna Resistance
(Continued from Page 197)

must result from its reduction of the dielectric and ohmic losses. The reason for this reduction is quite clear as the counterpoise acts as an electrostatic shield for the earth beneath it, preventing the formation of high electric intensities or of conduction currents.

Little information is on hand regarding the resistance of typical amateur antennae. This is due to many reasons, particularly because accurate resistance measurements are so difficult to make. Of all the standard methods given the only one capable of good results is the one involving a C.W. oscillator as driver, and a standard resistance and condenser as phantom circuit. Even this method is full of sources of large errors to the inexperienced, errors of unwitting capacity, coupling and stray currents principally. In a subsequent article

SHRAMCO REO

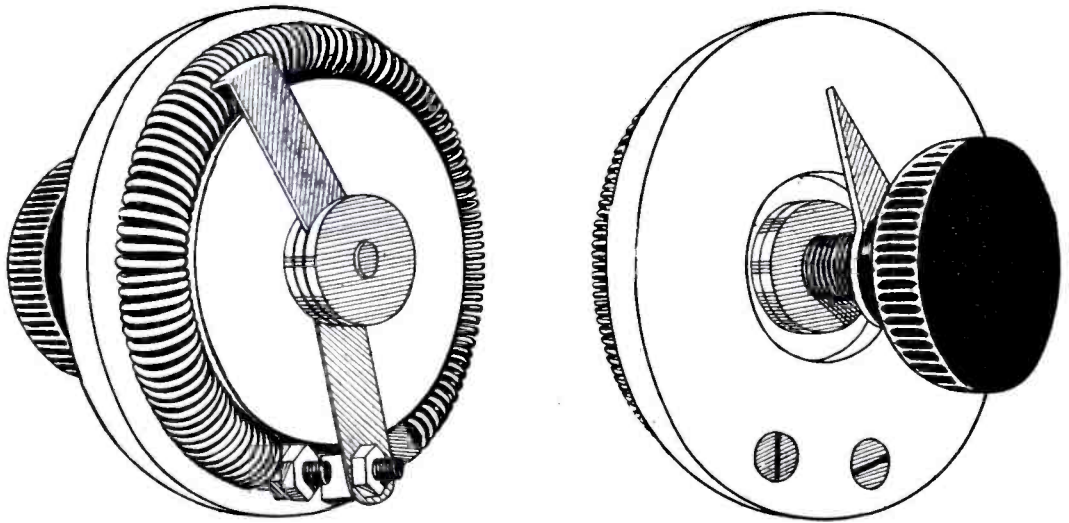

for your power tube—

New type Shramco Reo, No. 90P. 1.5 ohm Nichrome resistance. Current capacity 6 amperes. Price \$2.00, 1 lb. postage.

A BACK MOUNTED panel rheostat, specially designed for the Radiotron U.V. 202 and other transmitting tubes. Resistance element (1.5 ohm) is "Nichrome" wire, mounted on a solid block of asbestos. Allows unusually accurate and delicate variation of the filament current. All metal parts

brass. Spring phosphor bronze blade. Base 3". Overall height 2½". Handsomely finished and accompanied by an unconditional guarantee of complete satisfaction. Get the most out of your expensive power tube by using a good rheostat. Order a Shramco Reo today! Now ready for immediate shipment.

for your VT detector—

and amplifier, use the original Shramco Reo type 90. Similar to the power tube type, but with a "Nichrome" resistance of 6 ohms. Price \$2.00, plus postage for two lbs. Also available—"Midget" type 90A, same construction, but a 5 ohm resistance and 2½" base.

SHOTTON RADIO MFG. CO., INC.

P. O. Box 3,

Scranton, Pennsylvania

Catalogue "K", listing a complete line of high grade parts at reasonable prices, sent to any reader of Radio News for five cents in stamps.

The New KLAUS ROTARY SWITCH

ANOTHER ORIGINAL AND UNIQUE PRODUCT

There is NOT a MOVING PART on the entire assembly except the knob and blade. The shaft and collar remain stationary, thus insuring a positive and permanent contact. No loosened connections with a Klaus Switch.

Order one today for that new set and send for list of new instruments.



R
KLAUS
D
I
O

KLAUS RADIO CO.
EUREKA, ILLINOIS

Price 60¢

READ the CLASSIFIED ADVERTISEMENTS on PAGES 268-270. YOU'LL FIND MANY GOOD THINGS THERE.

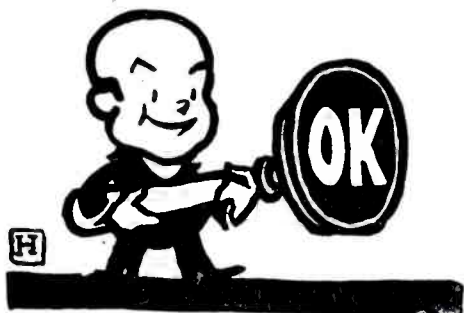

KELLY & PHILLIPS' service meets with universal approval because it embraces everything that is demanded by the discriminating amateur.

All orders are shipped on the day received unless it is absolutely impossible to do so.

A close connection with all of the leading manufacturers assures you of the high standard of quality which has made them leaders in their line.

Send us your next order and be convinced that KELLY & PHILLIPS' Service is better service.

Anything and everything in radio advertised in this magazine.

Radio Department

KELLY & PHILLIPS
312 Flatbush Ave.
BROOKLYN, NEW YORK

PRICES SMASHED

Magnet wire per 1/2 lb. spool			
B&S Ga.	S.C.	S.S.	Enam.
20 to 24	.70	.95	.60
26 to 30	1.00	1.40	.70
32 to 36	1.50	2.20	.85

B Batteries—Guaranteed

22 1/2 volt, small size	\$1.00
22 1/2 volt, large size	2.00
22 1/2 volt, large size, tapped	2.25
DeForest short wave couplers	3.75
Formica panels, 1/8", cut to any size, per sq. in.	1 1/2c.
Tresco 20,000 meter tuners	8.00
Two filament audiotrons	5.50
Aerial wire, stranded copper 7-22, per 100 ft.	.90
6 volt, 11 plate, 100 amp. hr. Storage Batteries, 18 months guarantee	22.00

Add postage on all apparatus.
Murdock, Clapp-Eastham, Acme, Westinghouse, Radisco, Federal, Simplex, Benwood, DeForest apparatus. Send 5c for our catalog.

30B 3BE
Wilmington Electrical Specialty Company
705 Adams Street Wilmington, Del.

AMATEURS

Our stock of OW and Spark Radio apparatus is complete. Send us your order and it will be filled same day it is received.

T & H RADIO CO.
ANTHONY, KANSAS

An Example in Radio Economy

(Continued from page 207)

system for the vacuum tubes. The photographs show clearly the constructional details. The actual dimensions will of course vary if other parts are used than those shown. The size of the panel in this case was 18" x 10" x 1/8". Thicker material would have been preferable for the panel, but at the same time considerably more expensive.

The wiring diagram in Fig. 1 shows the typical three coil tickler regenerative receiver circuit as well as the automatic filament control jack system. The filament control in particular is a very good feature and a most economical one for the tubes as well as the storage battery.

Here is a list of the materials used and their cost. The engraving as well as the assembly, machine work and wiring was done by the manufacturer. The assembly and wiring cost may be saved by those who prefer to do this work themselves.

Bakelite Panel 18" x 10" x 1/8"	\$3.60
One Honeycomb Coil Mounting (Three coil)	9.00
One 0.0006 Chelsea Condenser with Dial	4.25
One 0.001 Chelsea Condenser with Dial	4.75
Three FADA Panel Mounting Sockets	5.25
Three Automatic Telephone Jacks	4.20
Three FADA Panel Mounting Rheostats	3.75
Two UV-712 Intervalve Transformers	14.00
Ten FADA Binding Posts	1.60
One Grid Condenser and Leak	.85
One Phone Condenser	1.50
Engraving Complete	7.25
Assembly and Wiring	5.00

\$65.00

If we may add to the cost of \$65.00 an assortment of coils it is seen that for approximately \$75.00 we have a finished receiving equipment that is mighty fine in appearance, that is desirable to use and what is most important has been obtained for a very economical cost. In fact, to purchase a good detector and two stage amplifier alone would cost this much money and the receiver would be an additional expense of considerably more.

This is only one instance of the way satisfactory equipment can be had at a reasonable figure. Spark transmitting equipment, radio telephone sets, amplifiers, in fact, any instrument can be designed and built economically with the aid of a reliable manufacturer whose interest reaches beyond the cash drawer. This co-operation of the manufacturer means a great deal to all of us. It will help to reduce the high cost of radio, it will give you better equipment which means better results and it's going to mean the success of citizen radio the quicker.

To those whose work is serious, to he who has the success of amateur and citizen radio at heart, this problem of obtaining satisfactory equipment at an economical cost and everybody pleased is a mighty big problem. The receiver illustrated above is only a suggestion of what may be done to help along the good work.

Vernier Condensers

(Continued from page 207)

in relation to the rotary plate. The stationary plates are held together by 6/32 screws and nuts. The spacers generally used are .08" thick. It would be easier and perhaps better to use spacers as thick as 1/8", for the capacity would still be suf-

10c CHARGES YOUR BATTERY AT HOME WITH AN F-F BATTERY BOOSTER

and your station will never be closed because of a discharged battery. Is it not gratifying to feel that your filament battery will always be ready when you want it and that you will never have to give up in disgust when working a distant station?

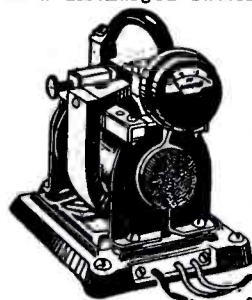

F-F Battery Boosters are automatic and operate unattended. Screw plug in lamp socket, snap clips on battery terminals and see the gravity come up.

Ammeter shows you the amount of current flowing. The full wave of current is rectified thru adjustable carbon electrodes which maintain a constant efficiency and last for thousands of hours. Everything complete in one compact, self-contained portable unit. The F-F Battery Booster is a Magneto Rectifier for 105-125 Volt 60 Cycle Alternating Current. Pre-War Prices Bantam Type 6 Charges 6 Volt Battery at 6 amperes. \$15 Type 16 charges 6 Volt Battery at 8 amperes. \$24 Type 166 charges 6 Volt Battery at 12 amperes. \$32

Shipping Weights 10, 12 and 15 lbs. Also Boosters for 12 Volt Batteries at same prices. Order from your dealer or Send Check for prompt Express Shipment. If via Parcel Post have remittance include Postage and Insurance Charges. Will also ship C. O. D. Also F-F Battery Boosters for charging batteries from Farm Lighting Plants. Direct Current Circuits and Direct Current Generators.

For GROUP CHARGING use the Full Wave, Automatic F-F ROTARY RECTIFIER of 100 Volt, 36 cell capacity.

Order now or Write for Free Descriptive Bulletin No. 32 or ROTARY Bulletin No. 32A. THE FRANCE MFG. CO. Cleveland, Ohio, U.S.A. Canadian Rep: Battery Service & Sales Co., Hamilton, Ontario

Canadian Amateurs ATTENTION

It will save you \$\$\$\$ to keep in touch with us.

We give you QUALITY, SERVICE, and a SQUARE DEAL.

Brown's Famous Receivers

used by, The Admiralty, Air Force, Foreign and Colonial Armies and Navies. Tests lately made show an efficiency of three times that of any other telephonic head gear.

4000 Ohm	\$19.25
8000 Ohm	20.50

Shipping weight 2 lbs.

Send .05c for our list

THE VIMY SUPPLY CO.
567 College Street TORONTO, ONT.

AUDIOTRONS

Genuine two filament bulbs

\$6.00

We have been able to obtain a last and final supply of genuine Two Filament Audiotrons which we are offering for \$6.00. As the last demand was so great we would advise those desiring them to order at once.

We ship Parcel Post, prepaid.

THE WHITALL ELECTRIC CO.

Bridge Street at Stearns Square
SPRINGFIELD, MASS.

STAMMER

If you stammer attend no stammering school till you get my large FREE book entitled "STAMMERING, Its Origin and The Advanced Natural Method of Cure," bound in cloth and stamped in pure gold. Ask for special tuition rate and a FREE copy of "The Natural Speech Magazine." Largest, best equipped and most successful school in the world for the cure of stammering, gutturing, etc. No sing-song or time beat. Write today. The North-Western School, 2366 Grand Ave., Milwaukee, Wis

ficient. The lug F is held by one of the screws by which C is fastened to the base. It can be turned radially so as to fit the binding posts of the large condenser. Lug G is similarly held by the screw holding bracket E.

Careful adjustment will be necessary to prevent the plates from striking together, especially if the narrower spacers are used. In any case, however, the vernier condenser will be found well worth the trouble of construction.

Measuring the Characteristics of Vacuum Tubes

(Continued from page 199)

A large value of K makes the tube desirable as an amplifier.

To measure it directly, set up the apparatus as in Fig. 5. R_1, R_2 is a non-inductive resistance so that the center contact may be varied to get the ratios of R_2 to R_1 . The slide wire in a Leeds and Northrup student's potentiometer works very well. This must have something on the order of 100 ohms, or it will be difficult to get a point of minimum sound in the telephones. The transformer T may be a bell transformer, a "current" buzzer, or a small alternator. The filament and plate batteries are set at their regular operating points of the tube. The grid

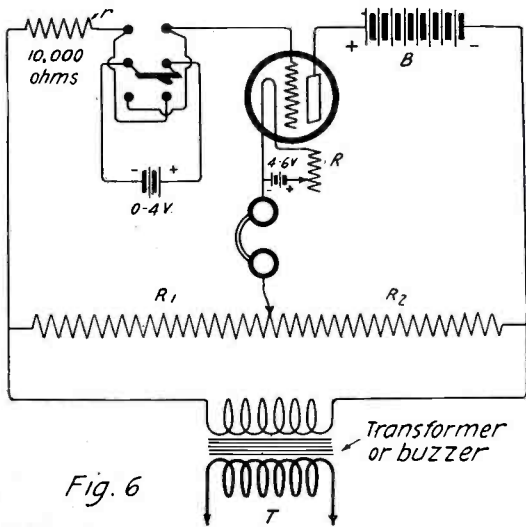

This Circuit is Used to Determine the Plate Impedance of a V.T.

battery C may be set at about -2 volts for one trial and at "zero" for another.

When the slider is adjusted to a minimum sound in the telephones,

$$K = \frac{R_2}{R_1}$$

The transformer may be replaced by a battery and key and the telephones by a d. c. galvanometer. When no current flows through the galvanometer, on closing the key, we have the same relation as given above.

THE INTERNAL PLATE IMPEDANCE

The internal plate impedance is the A.C. resistance between the plate and filament inside the tube. Set up the apparatus as in Fig. 6. R_1 and R_2 are the same resistances used in the test just given. R is a non-inductive known resistance of about 10,000 ohms. The filament and grid batteries are set at their best operating values as before, and the grid potential set at -2 and "zero" and trials taken. When the slider is adjusted to minimum sound in the phones the internal plate impedance R is

$$R = \frac{R_1}{R_2} r$$

RADIO SERVICE Apparatus of Merit

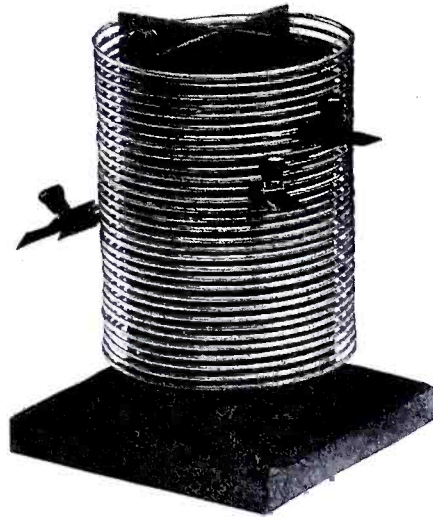

C. W. — C. W.

A real efficient inductance, wound on a slotted Formica form, 4½" diameter of 31 turns of Number 10 hard drawn copper wire. Supplied with 3 special clips making adjustments variable to any fraction of a turn. Suitable for panel or bench mountings. Materials and workmanship the finest obtainable.

Type S50 Inductance, price.....\$8.50

C.W. Mica Grid Condenser, mounted (stands 1,800 volts)\$1.00

C.W. Navy Type Filament Control Rheostat\$2.00

LOWER PRICES ON V. T. SOCKETS

Radio Service Sockets are still acknowledged the best obtainable.

Ask your dealer for Radio Service Sockets and obtain the

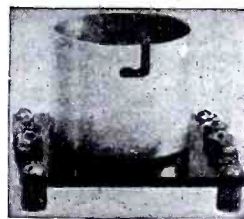

same high quality as the Navy specifies; at a price you will be glad to pay.

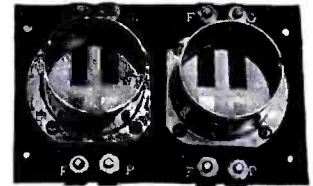

Type S24 Aluminum Socket only50c
Type S10 Single Socket.....\$1.00
Type S3 Double Socket... 2.25
Type S4 Triple Socket... 3.25

THE SENSATION OF RADIO

THE LITTLE WONDER PORTABLE RADIO SET, that you saw in the "movies," the daily papers, etc. Simple to install and operate. Just connect your aerial, ground and phones and you are ready to receive wireless telegraph or telephone messages and music.

A truly wonderful set within the reach of all.

Type S8 (as illustrated), Price.....\$7.50
Type S8A complete (incl. 75 ohm phone, aerial, insulators, blue print and instruction book).....12.50
Type S8B complete, but with Murdock 2000 ohm double headset15.50

Radio Service Apparatus may be obtained at all reliable dealers or sent direct to you on receipt of price

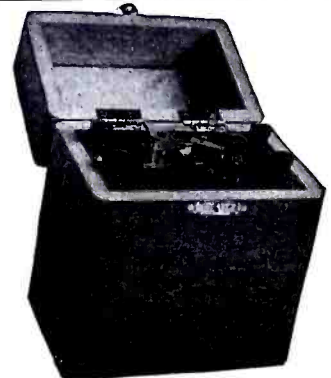

RADIO SERVICE & MFG. CO.

SALES DIVISION — SUITE 1001
110 WEST 40th ST., NEW YORK CITY

→ Mr. Amateur, Dealer and Jobber ←

THE RTS GRID CONDENSERS BRING SATISFIED CUSTOMERS

These condensers are made with heavy fibre, combined with accurately sized separators. Each RTS condenser undergoes the same test as all RTS products.

RTS Tested Grid Condenser, .0005 mf.35c
RTS Tested Grid and Grid Leak Condenser, .0005 mf.50c
RTS Tested Fixed Phone Condenser, .0013 mf.40c



Dealers Get Our Discounts

RADIO TESTING STATION
27 Sturges St., BINGHAMTON, N. Y.

AERIAL WIRE
PURE SOLID COPPER NO. 14
Per 100 ft.\$0.58
Per 500 ft.\$2.75
Per 1000 ft.\$5.50

MONEY for You

Add to your Salary—Make extra Pin Money. Start a lucrative business of your own. Spend an hour each day taking subscriptions for the "Radio News." We'll pay you well and you'll enjoy the work. Write for full particulars. Circulation Dept., RADIO NEWS, 236A Fulton St., New York City.

KEYSTONE WIRE

Wire for every Wireless Purpose

MAGNET WIRE

We are prepared to furnish best grade magnet wire on 1/4 and 1/2 lb. spools at the following revised prices:

PRICE PER 1/4 LB. SPOOL

B&S Ga.	Single Cotton	Double Cotton	Single Silk	Single Enameled
No. 22	\$0.56	\$0.68	\$0.62	\$0.45
No. 24	.60	.77	.67	.47
No. 26	.65	.85	.71	.49
No. 28	.75	1.10	.85	.52
No. 30	.85	1.24	.97	.53
No. 32			1.15	.55
No. 34			1.52	.59
No. 36			1.77	.69

Price on 1/2 lb. spools double above list.

All prices are net and include cost of spool and delivery charges via Parcel Post to any Post Office address in the United States; safe delivery guaranteed.

Send for Circular 21-A giving prices on other sizes, insulations and quantities of Magnet Wire. This circular lists "WIRE FOR EVERY WIRELESS PURPOSE."

KEYSTONE WIRE COMPANY
P.O. BOX 120 SCRANTON, PA.

STORAGE BATTERIES

Special Prices

Volts	Amps.	Price
6	20	\$7.50
6	40	10.00
6	60	13.75
6	80-100	22.50

One year unconditional guarantee, free repair or a new battery at our option, shipped fully charged, ready for use.

Add \$.50 for special crating.

Distributors—Jobbers—Dealers—write for discounts and exclusive territories. If your dealer hasn't it, send check or money order direct.

P. M. DREYFUSS
150 Chambers St. New York City

3000 Ohms \$8 POST-PAID



"RED HEADS"

The Accepted Standard in Radio Receivers.

At the new price of \$8.00 (formerly \$12.50) "Red Heads" are unquestionably the best wireless phone value in the world. Increased production, decreased costs and a sincere desire to promote lower prices prompt this remarkable saving.

SPECIFICATIONS: Aluminum back type with genuine bakelite ear caps, government type head band, extra fine 6 ft. cord with strain loops. Each receiver 1500 ohms (3000 ohms per pair). Sold on a money back guarantee basis and shipped prepaid anywhere on receipt of price. Dealers: Write for complete information.

THE NEWMAN-STERN CO.
Newman-Stern Bldg., Cleveland, Ohio

For the grid potential at "zero" the grid battery must be removed so that the grid is connected directly to the resistor.

The transformer T may be either of the ones used in the test of amplification factor or may be a battery and key. In the latter case the telephones are replaced by galvanometer.

These tests have all been used by the writer in his work on vacuum tubes and with a little care they can be used by any average amateur without a technical training. Those wishing to carry their tests further are referred particularly to Lauer and Brown's "Principles of Radio Engineering," Vol. 2, and Van der Bijl's "The Thermionic Valve."

The writer will be pleased to receive queries or comment on these tests. Address him at East Liberty, Ohio.

The 3 A.W.I. Radiophone

(Continued from page 192)

a complete operating unit in itself.

The circuit used is ostensibly a modification of the one used by the British Aircraft Service during the War with such great success and was incorporated in this apparatus because of its ease of application to the design desired. The constant current or "power modulation" system is used.

No variable condensers or other delicate controls are used and only two adjustments are necessary for various wave-lengths over the range, i. e., adjustment of the inductances in the antenna circuit and the coupling of the grid inductance to the plate inductance.

The high voltage necessary for the plate potential is supplied by a motor generator set at a point remote from the operating room and controlled by a separate set of switches convenient to the operator. This equipment consists of a 1 1/2 h.p., self starting, repulsion motor belted to two 750-volt D.C. generators connected in series and having their fields separately excited by a separate motor generator. The high tension leads from the generator to the operating room are lead overhead on high tension insulators.

An 0-1,500 voltmeter is connected across the line immediately before these leads are brought to the filter panel and its controlling switch. This, in conjunction with the meters described above, assures the operator that proper power supply and correct operating conditions prevail at all times.

Part of the success achieved by this equipment is undoubtedly due to the excellent antenna equipment provided for at 3-AWI. A 50' self-supporting steel tower surmounted by a 30' wooden pole erected on the roof of a four-story house at 2303 North Broad St., Philadelphia, totaling a height of 130' supports one end of a ten-wire 80' span, the other end of which is connected to a 30' pole at the opposite end of the roof, this making an antenna of ideal proportions and of wonderful effectiveness.

At normal filament currents and plate potential of 1,200 volts, when used with the above described antenna, the radiation varies between three and one-half and four amperes at the wave-length of 200 meters and an effective output resistance of approximately 10 ohms, however, the output seems to be fairly constant over the entire range of wave-lengths, i. e., 200 to 550 meters. The modulation is reported as being perfect in most cases, although the percentage of modulation does not seem to be as large as it should be, appearing to be in the neighborhood of 50 per cent.

The successful operation of the set by Mr. Howlett is attested to by hundreds of

SECOND INTRODUCTORY OFFER

Bronx Radio Equipment Co.

687 Courtlandt Ave. BRONX, N. Y.

Variometers and Variocouplers same as advertised at \$7.50 and \$8.50.

Our price \$6.75

Real Two Step Amplifiers—Size of panel—11 1/2" x 7 1/2". Old English Oak Cabinet. Shipping weight—packed—15 lbs. Price each..... 50.00

Regular stock size amplifiers—5 1/2" x 8" panel. Price each..... 40.00

Containing: Federal transformers, plugs and jacks, Paragon rheostats—XX Bakelite.

Special 6 Volt—60 Ampere Storage Battery, price each..... 12.35

B Batteries—Small Type..... .95

B Batteries—Large Type..... 1.75

Navy type electrose insulators, 7 1/2" length, 1/2" column, complete.... .50

Navy type ball electrose insulators, 8" length, 5" diameter, complete. .60

Estimates furnished on receiving, transmitting and phone sets built to your specifications.

FULL LINE OF ALL STANDARD MAKES OF RADIO APPARATUS

Wireless Amateurs ATTENTION!

If you want service, order from us. We carry a large stock of High Grade Wireless Apparatus of our own and other manufacturers.

SPECIAL!

Vacuum Tube Sockets..... \$1.25

Rheostats 1.25

22 1/2 Volt "B" Batteries..... 1.50

Rasco Dials60

Rubber Binding Posts..... .20

Tested Galena40

Lateral Wound Coils. All sizes.

Send 5c for our large illustrated catalog.

J. M. PAQUIN

THE ELECTRICAL SHOP

787 QUEEN ST. WEST
TORONTO, ONT.

WIRELESS CATALOG

JUST OUT 10c in stamps or coin brings new loose-leaf catalog—100 pages, giving C.W. Hook-ups, Regenerative Hook-ups and all instruments needed for wireless receiving and sending sets—a broad range of prices—places you on mailing list to receive regular bulletins, keeping you posted on latest developments in wireless telegraph and telephone. Illustrations and prices on latest radio apparatus. Following is list of firms whose lines we carry in stock:

- | | |
|---------|------------------|
| Acme | Atlantic Radio |
| Brandes | Coto-Coil |
| Burgess | Connecticut |
| Firco | DeForest |
| Pacent | Halbauer |
| Mignon | Magnavox |
| Radisco | Marshall-Gerken |
| Signal | Rhamstine |
| Turney | Ray-di-co |
| Federal | Radio Corp. |
| Murdock | Somerville Radio |

Write today for complete catalog.

THE KUEBLER RADIO CO.

Successors to Retail Dept.,
The Marshall-Gerken Co.

29 Gibbs Bldg., Toledo, Ohio, U. S. A.

CARDBOARD TUBING

In any length up to 25"
3" and 3 1/2" Dia. 2/20 per inch or fraction—
25c per foot; 4" and 4 1/2" Dia. 3c per inch or
fraction—30c per foot; 3", 3 1/2" and 4" has 1/8"
wall; 4" has 5/32" wall.

Postage extra—Shipping weight about 1 1/2 lbs.
per foot. Circular for stamp

JEFFERY-CRAWFORD CO.

2173 Hilltop Ave. Detroit, Mich.

letters and phone calls received from amateurs and enthusiasts from the surrounding states, requesting that he continue to give his concerts and nightly talks for their entertainment and instruction. Music has been supplied by this radiophone on numerous occasions for dances and public audiences.

Awards of \$100 Radio Accessory Prize Contest
(Continued from page 198)

be used with any hook-up in either transmitting or receiving apparatus. In the event of the panel being wired over the tops can be moved around to fit. These would help a great deal those of us who make our own apparatus.

Idea number two, a double binding post. These can be used in any place where ordinarily two binding posts would be used and connected together. These would be especially valuable on an audion panel. The accompanying sketch illustrates the ideas.

Editor's suggestion: Instead of engraving the binding post itself the letters and symbols could be engraved on celluloid caps to fit ordinary binding posts.

THIRD PRIZE.

A New Phone Connecting Jack.

By R. Carsten.

The new Phone-Connecting Jack I designed uses the phone cord tips as plugs. As will be seen from the drawing, it consists of four strips of metal, exactly alike, bent at about a 45° angle, and slightly curved to accommodate the phone cord tips. These are placed, two on each end of a strip of wood (or at same distance on back of a panel), so that the tips press against each other lightly. A hole is drilled so that the phone-cord tip goes straight through and is clamped by the two pieces, as shown in the diagram.

Editor's suggestion: This type of jack could be simplified and made of one piece as in Figs. 2 and 3.

FOURTH PRIZE.

Anti-Capacity Coupling Shaft.

By Malcolm Gager.

My entry in the accessory prize contest is an anti-capacity coupling shaft for variometers, condensers, etc., and is particularly useful in short wave regenerative sets to avoid the effect of the operator's hand when tuning. Using this shaft the instruments may be set far from the panel, and accurate adjustment obtained when receiving C.W. or phone.

It consists of an insulating rod 1/4" in diameter which is set in the dial instead of the shaft of the condenser or variometer, which is itself fixed in the coupling bushing.

The diagram shows clearly how it is mounted and this device is a real improvement which may be used with any type of instruments actually on the market.

FIFTH PRIZE

Inside Mounted Dials.

By Philippe A. Judd.

My idea which is illustrated in the accompanying sketch is to mount the dials inside the cabinets; and have a small window with a hair line drawn in the center, fixed in the panel through which the scale may be seen. This small window could also be used in the amplifiers as observation hole for the filament brightness.

A HARD ONE.

"Yes, 9DUH is a queer bird."

"He sure is. He reminds me of an audion tube."

"How's that?"

"Because he is a cunning ham (Cunningham)."

By MILAN BOEX.



Learn Telegraphy
(Wireless or Morse)

AT HOME

In Half the Usual Time

Let the OMNIGRAPH Teach You Wireless

"Just Listen—The Omnigraph will do the teaching"

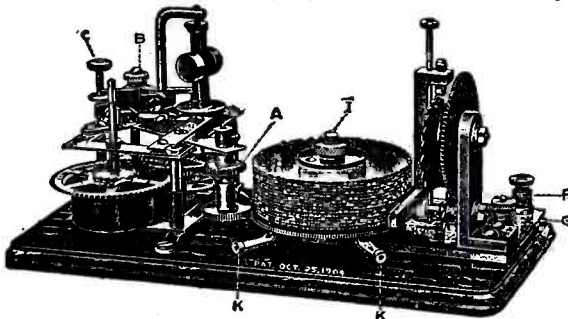

Write for Free Catalogue

For a few dollars you can have a complete outfit that will make you an experienced operator in the shortest possible time. No hard, laborious work—just learn by listening. The omnigraph is adjustable so you can start receiving messages slowly, gradually increasing the speed as you become proficient.

You'll be surprised how quickly you will attain speed. Even if you are already an operator the Omnigraph will help you. It will make you more proficient, more accurate and more confident. Thousands of Omnigraphs are in use today and thousands of operators owe their success to them.

A Complete Receiving Set—Price \$25.00. Guaranteed unconditionally by us. Send for Descriptive Folder.

The Omnigraph Mfg. Co., 26-H Cortlandt St., New York City
DISTRIBUTORS OF THE FAMOUS WESTINGHOUSE AEIROLA JR. RECEIVING SET

The Omnigraph is an Automatic Transmitter that teaches you both the Wireless and Morse Codes, at home, without any expense except the cost of the machine itself. Merely connect to battery and your Buzzer, or Buzzer and Head Phones, or to your Sounder and the Omnigraph will send unlimited messages by the hour, at any speed you desire.

USED BY THE U. S. GOVERNMENT

The Omnigraph Mfg. Co., 26-H Cortlandt St. N.Y.

Gentlemen:—

As per your ad in Radio News please mail me your free catalog of Omnigraphs.

Name.....

Address.....

City..... State.....

LEARN WIRELESS

AT HOME

The Demand for Good Wireless Operators Far Exceeds the Supply

The New York Wireless Institute will make you an operator—AT HOME—in your spare time—quickly, easily and thoroughly. No previous training or experience required. Our Home Study Course has been prepared by Radio Experts. Experts able to impart their practical and technical knowledge to YOU in an easy to understand way. The graded lessons mailed you will prove so fascinating that you will be eager for the next one. The instruments furnished free, will make it as easy to learn the Code as it was to learn to talk. All you will have to do, is to listen.

TRAVEL THE WORLD OVER

A Wireless Operator can visit all parts of the world and receive fine pay and maintenance at the same time. Do you prefer a steady position without travel? There are many opportunities at the numerous land stations or with the Commercial Wireless or Steamship Companies.

FREE INSTRUMENTS AND TEXT BOOKS



This wonderful Set for learning the Code furnished FREE with our Course

We furnish free to all students, during the course, the wonderful receiving and sending set exactly as produced in the illustration. This set is not loaned, but GIVEN to all students completing the Course.

The Transmitter shown is the celebrated Omnigraph used by several Departments of the U. S. Government and by the leading Universities, Colleges, Technical and Telegraph Schools throughout the U. S. and Canada. Start the Omnigraph, place the phone to your ear and this remarkable invention will send you Wireless Messages, the same as though you were receiving them, through the air, from a Wireless Station hundreds of miles away. When you apply for your license, the U. S. Government will test you with the Omnigraph—the same model Omnigraph as we furnish to our students. Ask any U. S. Radio Inspector to verify this.

FREE Post-Graduate Course

A one month's Post-Graduate Course, if you so desire, at one of the largest Wireless Schools in N. Y. City, New York—the Wonder City—the largest port in the World and the Headquarters of every leading Wireless and Steamship Company.

BIG SALARIES

Wireless operators receive salaries from \$125 to \$200 a month and it is only a stepping stone to better positions. There is practically no limit to your earning power. Men who but yesterday were Wireless Operators are now holding positions as Radio Engineers, Radio Inspectors, Radio Salesmen at salaries up to \$5,000 a year.

EASY PAYMENTS

A small payment down will enroll you. We will make the payments so easy that anyone ambitious to enter the fastest growing profession—Wireless—may do so.

Send for FREE Booklet

Without obligating you in any way, send for our booklet "How to Become an Expert Wireless Operator"—it is free. Mail the coupon below, or postal or better—but do it today.

NEW YORK WIRELESS INSTITUTE

Dept. 228, 258 Broadway, New York City

NEW YORK WIRELESS INSTITUTE

Dept. 228, 258 Broadway, New York City

Send me, free of charge, your booklet "How to Become an Expert Wireless Operator," containing full particulars of your Course, including your Free Instrument offer.

Name.....

Address.....

City or Town..... State.....

OPPORTUNITY AD-LETS

Follow these advertisements every month. Reliable advertisers from all over the country offer you their most attractive specials in these columns.

Classified advertising rate six cents a word for each insertion. Ten per cent discount for 6 issues, 20 per cent discount for 12 issues. Name and address must be included at the above rate. Cash should accompany all classified advertisements unless placed by an accredited advertising agency. No advertisement for less than 10 words accepted.

Objectionable or misleading advertisements not accepted. Advertisements for the November issue must reach us not later than October 10.

THE CIRCULATION OF RADIO NEWS IS OVER 42,000

EXPERIMENTER PUBLISHING CO. INC., 233 and 236 Fulton Street, New York, N. Y.

Agents Wanted.

Big Money and fast sales. Every owner buys good initials for his auto. You charge \$1.50; make \$1.35. Ten orders daily easy. Write for particulars and free samples. American Monogram Co., Dept. 133, East Orange, N. J.

Men, Women, Children! Sell hosiery. Big profits. Get samples, instructions. Arthur Moose, Tappan, N. Y.

Fast Selling Goods. Every description. Source of supply. Samples 25c. Harvey Teeple, Decatur, Indiana.

Automobiles.

Automobile Owners, Garagemen, Mechanics, Repairmen, send for free copy of our current issue. It contains helpful, instructive information on overhauling, ignition troubles, wiring, carburetors, storage batteries, etc. Over 120 pages, illustrated. Send for free copy today. Automobile Digest, 528 Butler Bldg., Cincinnati.

Automobile Accessories.

Auto Motors Supplies—Buick, Michigan, Stoddard-Dayton, E. M. F., Cadillac, Overland, Continental and Buda Motors. All types, \$50 each and up. New Dixie magnets, \$20; Splittorf high tension magnets, \$10; Kellogg pumps \$3.50; Auto-Lite generators, new, \$10; air gauges, 65c; Remy ignition coils, new, \$3; electric and gas headlamps, coils, distributor heads, air compressors, etc. Write for catalog. Motor Sales Dept., 16 West End, Pittsburgh, Pa.

Motorcycles—Bicycles.

Don't Buy a bicycle motor attachment until you get our catalog and prices. Shaw Mfg. Co., Dept. 1609 Galesburg, Kans.

Used Parts for all motorcycles. Schuck Cycle Co., 1922 Westlake, Seattle, Wash.

Motors, Generators and Dynamos

Special Garage Motors—Manufactured by the General Electric Co.: 1 H.P., \$78.50; 2 H.P., \$110; 3 H.P., \$128.50; 5 H.P., \$166.50. All sizes both single and polyphase motors for immediate delivery. Special charging generators, all voltages. Write for catalog. Motor Sales, Dept. 16, West End, Pittsburgh, Pa.

Blueprints

Blueprints—Electrical connecting diagrams. Samples 20c. Catalog Free. Charles Chittenden, N 3024 Matthews, Kansas City, Missouri.

Books.

We Buy and Sell back issues of Radio Amateur News and Electrical Experimenter. Boston Magazine Exchange, 109 Mountfort St., Boston, Mass.

Concordia Magazine, Quarterly, 9 Water, York, Penna., prints essays, stories, current events, poetry, formulas and plans. Send \$1 for three-year subscription. Sample copy 10c.

Build Your Bungalow from "The Bungalow Man's Plans. Handsome book containing complete Ink Sketches, floor plans and shrubbery planting of 32 modern homes and bungalows. Postpaid for \$2. "The Bungalow Man," (Walter G. Treutner), 4728 Lisbon Ave., Milwaukee, Wis.

Business Opportunities.

Substantial Manufacturing Corporation wants capable men to establish branch and manage salesmen; \$300 upward necessary. Will allow expenses to Baltimore as explained. Address secretary, 603 N. Eutaw St., Baltimore, Md.

Chemistry

Learn Chemistry at Home—Dr. T. O'Connor Sloane, noted educator and scientific authority, will teach you. Our home study correspondence course fits you to take a position as chemist. See our full page ad on page 180 of this issue. Chemical Institute of New York, 150 Nassau Street, New York City.

Correspondence Courses.

Dollars Saved—Used correspondence courses of all kinds sold, rented and exchanged. List free. (Courses bought.) Lee Mountain, Pisgah, Alabama.

Health.

Tobacco or Snuff Habit Cured or no pay; \$1 if cured. Remedy sent on trial. Superba Co., SE, Baltimore, Md.

Pyorrhea (Rigg's disease—bleeding or swollen gums)—hundreds have been helped by "Pyorrdent" the successful home pyorrhea treatment. Purifying, healing, preventative. Full month's treatment, consisting of a very beneficial massage paste and an antiseptic tooth-cleansing paste to be used in place of your ordinary dentifrice, together with full directions for treatment, \$1 postpaid. Or write for free booklet "R." Pyorrdent Mfg. Co., 439 Seventh St., Brooklyn, N. Y.

Exchange.

For Sale Quick: 9AEA.—1 KW Thordarson transformer. Duplicator condenser, Amrad gap, glass plate condenser, oscillation transformer, key, motor, battery charger. Particulars on request. Edwin Moore, 309 Sherman St., Joliet, Illinois.

Bargain—Detector and amplifier cabinet with bulbs, \$24.00. Daryl McClung, 1221 9th Ave., Huntington, W. Va.

For Sale—Cyclopedia of Applied Electricity, 7 vols., \$10; Cyclopedia of Automobile Engineering, 5 vols., \$12; Cyclopedia of Drawing, 4 vols., \$8. All perfect. G. E. Co. Thompson ammeter, 0-10 Amps., 110 V., \$5; brass steam engine, 7/8" bore, 1 1/4" stroke, with governor, \$7; Duck's No. 16X water motor generator, \$10; K. & D. No. 9 generator, 6v. 6 amp., \$5. Sell or exchange for phonograph or outdoor goods, Colt .45, etc. F. H. Ransford, Dalton, Mass.

Trade—\$85 tenor banjo and base, nearly new, \$60 cash or will trade. Bertram Rogers, 44-A James St., Newark, N. J.

For Sale—1 "N.A.A." Receiving transformer, \$7; 1 fixed condenser, 75c; 1 Jove detector, \$1.75; 1 bell and push button, 75c. Warren E. Wilson, Medford, Oklahoma.

For Sale—1 K.W. Thordarson Type "R" transformer, \$28; Young & McCombs rotary, \$12; Vibroplex (bug) telegraph key and secondary key for use on wireless, \$15; General Radio hot wire meter, 0-10 amps., \$5; Murdock oscillation trans., \$3; C-R-CO. oscill. trans., \$8; Murdock 2000 ohm headset, \$3; NAA loose coupler, \$4.50; Murdock 43 plate variable condenser, \$2.50; DeForest type P-402 audion panel and cabinet, \$9. Kenneth Wright, Corydon, Iowa.

For Sale—Hardwood rotors, 55c, prepaid. Benj. Ainsworth, 561 Grand Street, Brooklyn, N. Y.

Stop—National Radio course, complete, \$50. C. H. Crawford, Box 47, Hastings, Nebr.

Sell or Trade—45 cal. automatic, belt, magazine carrier, holster, extra magazine, cost \$55, sell \$40; brand new Jap 8X binoculars and case, cost \$65, sell \$45; 1 KW Tesla coil, \$10; Murdock fones, \$2.50. Want Grebe CR-3 Baldwin fones, Magnavox, S. L. DuBuclet, 3722 Concord Place, Chicago, Ill.

Memorize Continental Code in one hour. Qualify quickly for amateur license. See our ad on page 260 this issue. C. K. Dodge.

Sell or Trade a 100-9500 meter, damped or undamped wave, audion receiving cabinet, complete with bulb, batteries and phones. Want detector and two-step and regenerator. Edgar Knepper, Maitland, Missouri. 9DUQ.

For Sale—Variometer regenerative receiver, \$15. One step amplifier including B battery, \$18. Ralph Leffler, Tiffin, Ohio.

For Sale—Complete spark and C. W. receptor including 125 ft. 3 wire aerial, ground switch, tuner, detector and two stage amplifier, tickler, Baldwin E phones, loud speaker horn, new B batteries and three new A. P. tubes. Entire outfit encased in oak cabinets, \$100. F.O.B. Hamburg. Worth \$185. Selling out to raise money to go to school. R. L. Lenhart, 21 N. Fourth St., Hamburg, Pa.

Bonwood for Omnigraph or \$15. Nisbet Mayre, Lafayette Drive, Atlanta, Ga.

Cash—Farragon .004 mfd. Cond., \$25; Marconi 2 qt. Leyden jar, \$3; 1 pt. jar, \$1.50; Connecticut variable, \$5; Radio Tron, \$4.50; 2 rolls omnigraph tape, \$2.50 each. All these are new. Following are slightly used: Murdock O.T. \$4; Ford spark coil, \$1.50; antenna switch, \$1.75; Western Union 4 line 2 instrument plug board, \$3.50. Fred A. Blethen, Houlton, Maine.

For Sale—Grebe CR Five with tube, Sixty-five Dollars. Duck Navy tuner, thirty-five hundred meters, Ten Dollars; Federal amplifying transformer, Five Dollars; loading coil, fifteen thousand meters, Five Dollars; Murdock forty-three plate variable condensers, Two-Fifty. Earl Barritt, Care Western Union Telegraph Co., Bowling Green, Ohio.

15,000 Meter Loading Inductance, new, \$4.50; 3,500 meter coupler, \$3.50; Westinghouse type radiophone receiving set complete, \$20. S. M. Boddington, Elmhurst, Pa.

Sell—\$30 omnigraph, perfect condition, 15 dials, first \$20 money order takes it. Harry Baldwin, Union City, Pa.

For Sale—Receiving set with audion detector. Also Ford spark coils. Write for particulars. Dan Brock, Waynesburg, Pa.

Honeycomb Coil Set with audiotron, batteries, etc. Alan Chapman, Decatur, Illinois.

\$185 Moving Picture Outfit—Want wireless telephone. Box 82, Canton, Ohio.

For Sale—Good regenerative set for music, \$10; 1 transmitting button (new), \$3; 1 3/4" spark coil, \$4. \$15 takes all. Noel C. Bronson, 41 Plum St., Greenville, Pa.

Murdock Navy Type Loose Coupler. New style. Almost new, \$12; Lyle Anderson, 5685 17th St., San Francisco, California.

For Sale—Mottograph motion picture machine, model 1A. Good condition, used 3 months, cost \$312, sell \$75. F.O.B. Plainview, Wayman Davenport, Plainview, Texas.

Sale—Cheap, 6 volts battery and radio parts. Diehl, 379 East 162nd St.

Complete Receiving Outfit—3,500 meter crystal set. Brandes phones, Navy type transformer, 53 plate condenser, \$23; Aerial wire, ground set, insulators, \$5. Lyman Drake, Wilmette, Ill.

(Exchange continued)

Sell—2 Clapp-Eastham variometers, without dial, \$4.25 each. Navy coupler, \$7.75. L. Didsbury, 111 Jane St., Bridgeport, Conn.

For Sale—1" coil, \$5; gap, \$.50; key, \$1; Murdock transmitting condenser, \$2; Tron detector panel with potentiometer, \$7; two new audiotron bulbs, \$4 each; 6 Marconi-Victor records, \$5. Clarence Deim, Watermill, N. Y.

For Sale or Trade—18 V., 20 A. D. C. Generator and H-Davidson single cylinder belt drive, magneto engine. Will trade separate—What have you for \$45. Walter deWaal, 3502 Jones, Omaha, Neb.

Bargain—Electro "Tuckerton" receiving outfit. Never used, for \$23.50. Everette Dye, Plainview, Texas.

For Sale—Complete wireless receiving outfit, \$23. Write for particulars. Paul R. Eshelman, Esterly, Pa.

Sale—Thordarson 1/4 K.W., \$10; Murdock rotary, \$12; O. T., \$3.50; 1/4" coil, \$2.50; 1", \$4. Howard Frazier, 5714 Hazel Ave., Philadelphia.

For Sale—Receiving set consists of 3500 meter coupler two variable condenser, potentiometers, detector, price \$15. Audion detector, \$15 extra. Ransford French, Blue Ash, Ohio.

For Sale—DeForest type P-300 Ultra-Audion detector and one step amplifier. Nearly new. Price \$35. Fred A. Gritzer, 282 Steinway Ave., Astoria, L. I.

For Sale—RLC5 Mignon cabinet receiving set, can be used with either audion or crystal detector, tunes to 9000 meters; cost \$45, will sell \$25; General Radio mounted amplifying transformer, \$5; also, one step amplifier mounted on Bakelite panel, \$9; Model 5 Oliver typewriter in good condition, \$20. Ralph Goodspeed, Wilton, Maine.

Sell—1/2 K.W. Acme type F-1, fully mounted, \$20; Saw tooth rotor, \$3.50; loop aerial, \$3. Alfred Gienow, River Edge, N. J.

Sell—Telefunken ship set, receiving. Wavelength 200-2500 meters, \$25. Address Alfred Gienow, River Edge, N. J.

Bargain—Ranger Motorbike. Nearly new, \$35. Roscoe Hanna, 310 Hoy, Wilkesburg, Pa.

Bargain—Gilbert \$65 transmitting and receiving set, \$35. Practically new. E. W. Hoffman, 3221 Chestnut St., Milwaukee, Wis.

For Sale—Triple coil honeycomb DeForest cabinet type. Six D. L. coils, amplifying transformers and other stuff very cheap. Jos. Halperin, 1723 Melville St., Van Nest, Bronx.

Look! 3" spark coil, \$12; heavy, flanged gap, \$2. Trade coil for a good 5-watt power tube. Write, Frank J. Homsher, North Glenside, Pa.

DeForest type panel for eighteen panels, \$5.00; Acme amplifying transformer unmounted, \$2.50; 0-50 Jewell Voltmeter 5" diameter, \$5.00. Leitch, Park Drive, West Orange, N. J.

At Sacrifice—Short wave regenerative set, \$35; detector and 2 stage amplifier, \$40; 1/4 K.W. Acme transformer, \$20; 2-100 AH-6 V. storage batteries, \$14. 50V storage battery with charger, \$10; 3 K.W. oscillation transformer, \$10. All guaranteed and shipped prepaid. R. H. Marshall, Jr., 425 Lincoln Ave., Bellevue, Pa.

New York Wireless Institute Omnigraph, \$26. John Maurer, Spring Valley, Illinois.

For Sale—350 volts Ray-Di-Co motor-generator, \$33, new W. E. VT 2, \$9; socket, \$1. Mack's Phone Shop, 483 Main St., Ansonia, Conn.

Variometer Regenerative Set in mahogany cabinet, \$25; two large loose couplers, \$12 each. Ralph W. Miller, 136 Hudson St., Reading, Pa.

Sell—New Mignon RLC5 Receiving Cabinet, \$25 cash; range 200 to 9000 meters. John Morris, 933 Midland Ave., Syracuse, N. Y.

Sell—Phone set complete unwired, \$100. Write F. Mann, 327 4th Ave., New York City.

Grebe CR-3A Regenerative Receiver, brand new, \$35; DeForest .001 Vernier condenser, \$10. Emanuel Nymann, 525 W. 160th St., New York City.

Trade 1916 Harley and side car A-1 condition with lot of extra. What have you in wireless about \$275 value. Harold W. Noble, Hop River, Conn.

Sell—Colby short wave regenerative tuner and Remier control panel bulb and B-battery. Brand new. Also condensers loose coupler fones, switches, copper aerial wire, loading coils, insulators—all for thirty dollars. E. C. Norton, Hnsdale, New York.

Clapp-Eastham Regenerative, \$25. Place, 350 Sprague, Fall River, Mass.

Long Wave set ready to put in cabinet and connect. A-Bat., aerial and ground, \$38. Send stamp for information and list of other bargains. Carle C. Perkins, Box 55, Sangerville, Me.

Long Wave Cabinet Set, \$22; two receiving transformers, \$8. Phones, switches, condensers. Arlington time set, \$9. James Rich, Hobart, New York.

Multi-Wave Receiving Set, 200-20,000 meters; complete with one-step amplifier and bulbs. All in nice cabinet. Send stamp for photo and description. A real bargain. Radio, Box 1504, Providence, R. I.

For Sale—Complete receiving set, only \$25. Write for particulars. Earl Soesbe, Greene, Iowa.

First Money Order for \$35 takes Radio Type Magnavox. Used once only. O. R. Stevens, 6 Winter St., Framingham Ctr., Mass.

For Sale—Complete one variocoupler and 2 variometers, Murdock, never used, \$16. A. Staud, 601 Morgan Ave., Brooklyn, N. Y.

(Exchange continued)

Bargain—Singerland's course, mandolin and case. \$15. Will trade for radio. Ralph Spielman, Hagersville, Pa.

Bargains—Triple geared honeycomb receiver with audion in mahogany cabinet, \$35; two new 41 plate variables with Corwin dials, each \$4; Remler rheostat, 75c; Bakelite socket, \$1; crystaloi, \$2; Century buzzer, \$1. E. Slemssen, Alden, Minn.

For Sale—Sending station 8QG. 1/2 K.W. Acme transformer, 11,000 volts, cost \$25; Franklin 1 K.W. gap and motor, cost \$33; oscillation transformer (Penna Wireless Co.), cost \$10; glass plate oil condenser, capacity equal six sections of Murdock, cost \$20; Boston key, cost \$7; 1 K.W. change-over switch, cost \$7. Everything for \$75, all goods new and guaranteed. Selling reason—telephone trouble. Harold Smith, Charleroi, Pa.

Wanted—Good regenerative set. Reasonable. Not homo made. Raymond Schlegel, 1118 N. Negley Ave., Pittsburgh, Pa.

For Sale—DeForest fifteen panel long wave set with a few coils, \$125. In good condition. Write for pictures and details. Edward Thurber, 3466 Lincoln Ave., Detroit, Mich.

Sell—First MO for \$12 gets Arlington coupler, Crystaloi detector, buzzer, fixed and variable condensers. Fred Trube, 3110-R, Galveston, Tex.

Opportunity!—Short wave detector and tuner—green weathered oak cabinets; grained bakelite panels, \$21. Details on request. Radiotron, \$4; Murdock 23 variable, \$2.50; Murdock phones, \$3. Fenn Vogt, Acheson Ave., Washington, Penna.

Sell—D-L coils, 25% off. L. Vexler, 70 Lyons Ave., Newark, N. J.

"Looke"—New \$23 5 x 3 printing press outfit complete, \$16. Wanted 1/2 Kilowatt transformer. Lloyd Vickery, 304 West Lincoln, Blackwell, Oklahoma.

For Sale—15 dial omnigraph complete with receiver, buzzer, and key, \$25. Also a rotary spark gap, \$10. Don Wiese, 400 University Ave., Hastings, Nebraska.

Farms, Land, Etc.

Pecan and Orange Orchards on the Gulf. Easy terms. Big quick returns. Dept. R, Suburban Acres Co., Ocean Springs, Miss.

For Advertisers.

Don't Wait for Business.—Advertise and get it. We will help you. Jacobus Service, 41 Bruen, Irvington, N. J.

For Inventors.

Model Making and Experimental Work of every description. Manufacturing. Lamson Model & Experimental Works, 625 W. Jackson Blvd., Chicago.

Help Wanted.

Earn \$25 Weekly, spare time, writing for newspapers, magazines. Experience unnecessary; details free. Press Syndicate, 5665, St. Louis, Mo.

Be a Mirror Expert, \$3-\$10 a day; spare time home at first; no capital; no train, start you making and silvering mirrors, French method. Free prospectus. W. R. Derr, Pres., 579 Decatur St., Brooklyn, N. Y.

Radio Operators—Amateur radio operators wanted to form a communication division 1st Battalion Naval Militia and U. S. N. R. F. Practical work and instruction radio and radio telephones. Many Summer advantages. Week-end and fifteen-day cruises in Eagle boats to West Indian ports. Re-ainer pay while serving, full pay when cruising. No interference with civilian duties. Inquire any Monday evening. Communication Officer, U. S. S. Granite State, foot W. 97th St. (via 96th St. and Broadway), North River, Manhattan.

Detectives Earn Big Money. Excellent opportunity. Travel. Great demand everywhere. Fascinating work. Experience unnecessary. Particulars free. Write, American Detective System, 1968 Broadway, New York.

Instruction.

Learn Chemistry at Home—Dr. T. O'Connor Sloane, noted educator and scientific authority, will teach you. Our home study correspondence course fits you to take a position as chemist. See our full page ad on page 180 of this issue. Chemical Institute of New York, 150 Nassau Street, New York City.

Have You An Operating License?—Let us coach you for the Government Examination. May we send you sample questions and answers. Write for descriptive literature. Consulting Engineers for the Radio Amateur, Box 1654, Washington, D. C.

Manufacturing

Patterns, Wood, and Metal Models, Tools and Dies. Brass and aluminum castings, general machine work. Write Modern Machine & Pattern Co., Terre Haute, Ind.

Small Induction Motor punchings and castings. Robert Vondrau, Preston, Ont., Can.

Miscellaneous.

Former Members Army Radio Section—Would you like to know who your former buddies were? Get complete list of members giving addresses, rank and duties performed. Complete history of section by former officers. Neatly bound printed on good paper. Send \$1 today for copy. Limited number. Floyd Helmick, Beaverdam, Ohio.

News Correspondents

Earn \$25 Weekly, spare time, writing for newspapers, magazines. Experience unnecessary; details free. Press Syndicate, 566 St. Louis, Mo.

Novelties.

Genuine Indian Baskets. Wholesale catalogue. Marion Gilliams, Kelseyville, Calif.

Patents For Sale.

Patent No. 1,378,053. Nonfreezing, lampless poultry fountain. Thoroughly tested, new principle. Chas. G. Peltier, Ontonagon, Mich.

Patent Attorneys.

Patents—Send for free book. Contains valuable information for inventors. Send sketch of your invention for free opinion of its patentable nature. Prompt service, twenty years' experience. Talbert & Talbert, 440 Talbert Bldg., Washington, D. C.

E. T. Brandenburg (former patent expert, Ordnance Division, War Department), Attorney-at-law and Solicitor of Patents, 927 Loan and Trust Bldg., Washington, D. C. Send sketch and description, or model of your invention for careful investigation at Patent Office and unbiased report as to patentability.

Millions Spent Annually for Ideas. Hundreds now wanted! Patent yours and profit! Write today for free books—tell how to protect yourself, how to invent, ideas wanted, how we help you sell, etc., 301 Patent Dept., American Industries, Inc., Washington, D. C.

Phonographs, Needles and Supplies

Bell Hood Semi-Permanent Phonographic Needle. Send 25 cents for sample and information for agency. Wonderful invention. Makes phonograph human. Sells on sight. Appel, 1404 Dixwell Ave., New Haven, Conn.

Build a genuine Choraleon phonograph and save over half. Fine profits building and selling. We furnish motors, tone arms and necessary parts. Send for our catalog and free blueprint offer. Choraleon Phonograph Co., 921 15th St., Elkhart, Indiana.

A Hornless Phonograph (Absolutely new). With the Recreated tone coming from all sides! You can build it for \$5 and sell for \$50. Plans and specifications, \$1. Conafon Co., 102 Grand Ave. W., Eau Claire, Wisconsin.

Photo Developing.

Get Acquainted Offer—Mail us 20c with any size film or six negatives for development and six velvet prints. Twenty-four hour service. Fine work. Roanoke Photo Finishing Co., 324 Bell Ave., Roanoke, Va.

Printing.

Labels, 60c per 1,000 up. Irvin J. Wolf, Station E, Philadelphia.

250 Letterheads or Envelopes, \$1.65. Extra 250, \$1. F. Scott, 211 Eleventh St., Newark, Ohio.

Everything Printed.—Long run specialists. Samples. Quality Printery, Marietta, Ohio.

Your name on 100 cards with case, 60c postpaid. Log Cabin Printer, 289 So. Bayview Ave., Freeport, Long Island.

150 Bond Letterheads, envelopes, noteheads, cards or tags. Mele's Printery, 39 Foxon, East Haven, Conn.

Printing That Pleases, at reasonable prices. Write now for set of attractive samples and prices. They're free. E. W. Spafford Co., L. B., No. 9, Martville, New York.

Scenery for Hire.

Settings for all operas and plays. Catalog. Amelia Grain, Philadelphia.

Song Writers.

Song Writers!—Learn of the public's demand for songs suitable for dancing and the opportunities greatly changed conditions offer new writers, obtainable only in our "Song Writers' Manual and Guide," sent free. Submit your ideas for songs at once for free criticism and advice. We revise poems, compose music, secure copyright and facilitate free publication or outright sale of songs. Knickerbocker Studios, 319 Galety Bldg., New York.

Stammering.

St-Stu-t-t-ering and Stammering cured at home. Instructional booklet free. Walter McDonnell, 121 Potomac Bank Bldg., Washington, D. C.

Stammerers.—You can be permanently cured by my course of private individual lessons. Interesting booklet free. Samuel I. Robbins, 246 Huntington Avenue, Boston.

Stamps and Coins.

1000 Different Stamps, \$3; 500, \$1.25; 200, 25c; 100, 12c. Approvals. Michaels, 5602 Prairie, Chicago.

Telegraphy.

Telegraphy—(Morse and Wireless) and Railway Accounting taught thoroughly. Big salaries. Great opportunities. Oldest, largest school. All expenses low—can earn large part. Catalog free. Dodge's Institute, M St., Valparaiso, Indiana.

Typewriters.

All makes \$15 to \$60; fifteen days free trial. Catalogue mailed. Henry Typewriter Co., 217 West 125th St., New York City.

Wireless.

For A or B Batteries—Edison 150 ampere hour cells, \$6.50 each. W. J. Travers, 815 Humboldt Parkway, Buffalo, N. Y.

Unit Receiving Inductances assure satisfactory, efficient and unparalleled long distance reception of all forms of radio transmission. For long wave work our Bi-Lattice coils (Duo-Internal) need no introduction. For short wave reception a set of single layer coils compares favorably with the best regeneratives; and the cost is but a fraction of the regular regenerative receiver. Send 3c for bulletin. Our prices and service will surprise you. P. J. Stockwell, Box 157-C Reading, Massachusetts.

(Wireless continued)

New Wireless Keys with No. 6 removable contacts, \$3.25, postage prepaid. Radio Supply Co., Westerville, Ohio.

Blue Prints—We put your favorite hook-up on tracing cloth, 9 x 12 inches for 50 cents, three for \$1.25. You can then make all prints you want. Have you obtained our VT diagrams for receiving and phone sets? They are making a hit. 50 cents for either set of 12 separate sheets. Full range of circuits at your finger tips. We prepare drawings, carrying out your ideas for any kind of apparatus. Finest drafting at dirt cheap rates. Cabinet sets planned. Send stamp. Fine wall print of Continental Code, 6 by 28 inches, 25 cents. Readable 30 feet. No stamps with orders. The Plan Bureau, 1929 McCausland Ave., St. Louis, Mo.

Amplifying Transformers—For a limited time we shall give everyone a chance to buy reliable amplifying transformers of correct design at a substantial reduction. We are offering the Clapp-Eastham amplifying transformers, which give results second to none. List price, \$4. Our price is only \$3.45 postpaid. Immediate delivery. Guaranteed. Subject to return if not satisfied. The Radio Distributing Co., Abilene, Kansas.

Audion Detector and Amplifier, V.T. 50 cents. Honeycomb coil mountings, 25 cents. Back mounted rheostats, 40 cents. Composition for molding your own knobs, panels, etc. 35c pound. Send stamp for particulars. Palmers Electrical Equipment Co., Palmers, Minn.

Slab Inductances—Set of eight, tuning with .001 MP condenser from 300 to 30,000 meters. Forward money order, \$4, made payable at Atlantic Road Brixton to Perry 9 Jelf Road Brixton, London, England, and secure a set post free by return.

Power Tubes—With each radiotron U.V. 202 power tube, for radiophone and C.W. transmission. We will supply free of charge your choice of either the latest Murdock improved contact type V.T. socket for use with the above tube or the Radio Corporation of America's special 5000 ohm, size "M" grid leak with midtap at 3,500 ohms, designed by the General Electric Co., for use with the U.V. 202. Price \$8. Our engineering department, upon learning the number and size of the power tubes you are contemplating to operate, will be pleased to recommend the correct capacity and voltage of the motor generator as well as the correct scale readings of the meters. We have excellent motor generators of various capacities and voltages, at reasonable prices, as well as jewel bearing meters, radio frequency, D. C. or A. C. Only new and high grade apparatus carried in stock and all goods guaranteed to arrive in perfect condition. The Kehler Radio Laboratories, Dept. R, Abilene, Kansas.

Variometers—Inside winding, \$3.50; variocouplers on Bakelite tubes, \$3.75. High voltage generators, cabinets, parts. Get our prices. Jerome Haas, 2011 Atlantic Ave., Atlantic City, N. J.

Radiophone Concerts—Would you like to tune in easily and clearly the radiophone concerts in the ether and on the other hand be able to transmit them yourself 10 to 40 miles with practically no more apparatus or power than used to receive them and without the addition of a change-over switch? If so we suggest that you send for the bulletin on the Esco Regenerative Receiver and Radiophone (150 to 600 meters), or send us your order now and take advantage of our special limited offer. List price \$50. Our price for 60 days only \$45. To every purchaser we furnish wiring diagram, full instructions, for operation and wave-length chart. Only new and high grade apparatus carried in stock. Orders filled within 12 hours. The Kehler Radio Laboratories, Dept. R, Abilene, Kansas.

Wireless Apparatus—Variometers, variocouplers, aerial switches, keys, cabinets, made to order apparatus. Marvin Fallgatter, Waupaca, Wis.

Are you thinking of adding a step of amplification to your present set? If you are here's the way. We have amplifier control panels that sell for \$10 and may be used up to three steps. We also have detector control panels for \$5.50. Isn't this worth looking into? Send for our circular describing these panels. Devore Radio Supply Co., Gibson City, Illinois.

Hello! Grebe Special—Type CK-3. The Grebe special short wave regenerative receiver type CR3 (150 to 350 meters, with shunt condenser furnished with set 250 to 680 meters) recognized as the standard among all professional amateurs, will for a limited time be sold at the attractive price of \$58.50. List price \$65. Order now. Only new and high grade apparatus carried in stock. Orders filled within twelve hours. The Kehler Radio Laboratories, Dept. R, Abilene, Kansas.

Receiving Cabinet—V.T. type honeycomb coil receiving cabinet, short and long waves, arcs, radiophones, etc., without tube, battery and phones, first certified check \$15. Value \$45. Photo 25 cents. Broward Electric Co., Fort Lauderdale, Florida.

Service.—The Kehler Radio Laboratories.

Universal Receiver—Unusually complete 15-panel DeForest style receiving cabinet, with two-step amplifier, ultra-honeycomb coil mountings, and short wave variometers, variocoupler and condensers all in one case front and back hinged covers completely enclosing receivers, all large European stations all over room. Especially efficient short-wave phone, spark and relay work. Receives Westinghouse Pittsburgh phone in Florida. Just completed. Must sell. First certified check \$140. Value \$275. Fine photo 25 cents. Broward Electric Co., Fort Lauderdale, Florida.

Service.—The Kehler Radio Laboratories.

Switch Contacts—Manufacturers special opportunity. Neat absolutely uniform brass contacts, new type split body diameter 1/2 inch, length, 3/4 inch, head diameter 7/32 inch. Heavily nickleled and polished, for fine panels. Easily assembled rugged. While they last \$1 per hundred. Not less hundred sold. Add ten cents postage. Broward Electric Co., Fort Lauderdale, Florida.

Orders filled in 12 hours. The Kehler Radio Laboratories.

Bargain—New Cabinet receiver, bakelite panel, honeycomb tuner detector, one-step amplifier, need tube and transformer for second, Brandes fones, five coils, two tubes, \$100. Write for details. Albert Clement, Box 673, Natrona, Penna.

Orders filled in 12 hours. The Kehler Radio Laboratories.

Water Jet Vacuum Pump—Radio experimenter, make vacuum tubes and evacuate them with this efficient pump. Screw to ordinary water faucet. Pump with instructions, \$1. postage 10c. J. Cluzio, North Bergen, N. J.

35% Off Wireless Instruments Slightly Used.—Send 3c for list. A Bauer, 206 Harrison Ave., Harrison, N. J.

(Continued on page 270)

(Continued from page 269)

(Wireless continued)

Station Type Vocaloud—With each station type vocaloud, a faithful loud reproducer for radiophone speech, music and signals, we will include as a present your choice of either an Acme amplifying transformer or Saco Clad. Enclosed in hand rubber mahogany cabinet. Price \$30. Same as distributed by John Firth & Co. Absolutely guaranteed to prove satisfactory or money refunded. The Radio Distributing Co., Abilene, Kansas.

En-Ra-Co.—Just enquire about En-ra-co service. It will interest you. We make and mount sets to suit your needs, and carry a full line of wireless apparatus for the up-to-date radio man. Enfield Radio Laboratories, West Upton, Massachusetts.

\$3 Brings You a Kehler-Smith Panel type hot-wire Ammeter, new, tested, and in perfect condition. Regular price \$13. Range, 0-2.5 Amp. Ideal for small C.W. transmitters. Unusual opportunity. Sent prepaid or parcel post C.O.D. for \$3. Better act today as the quantity is limited. C. J. Goette, 2JU, 1624 Hamilton Ave., Woodhaven, N. Y.

Aluminum Condenser Plates .05.—Parts for 23 plate. \$1.60; 43 plate, \$2.80. .12 brings samples. Gravenstede, 84 Hancock, Jersey City, N. J.

Stop! Look! and Act!—With each radiotron U.V. 200 V.T. detector or A-P Moorhead V.T. detector or radiotron U.V. 201 V.T. amp. or A-P Moorhead V.T. Amp., we will supply free of charge your choice of either a Murdock V.T. socket improved contact type, or a Remler Bakelite smooth running rheostat, latest type. Radiotron U.V. 200, \$5. Radiotron Amp. V.T. U.V. 201, \$6.50. Moorhead A-P detector, \$5. Moorhead A-P Amp. V.T., \$6.50. Note recent reduction in the excellent Moorhead tubes. Remler Bakelite Rheostat, latest type, \$1; Murdock V.T. socket, \$1. We absolutely guarantee the foregoing apparatus. Only new and high grade equipment carried in stock. All orders are filled within twelve hours and shipped postpaid and insured, thereby saving time and money. Remember us. The Kehler Radio Laboratories, Dept. R, Abilene, Kansas.

Fusible Alloy—For mounting crystals, 40c per ounce. Stanley Herbeck, 124 Prospect St., Athol, Mass.

Detector, One-Step, \$25.—Parts cost \$30. Variable and plate condensers, etc. Photograph for stamp. A. K. Lains, Pelham Manor, N. Y.

Milwaukee Radio Laboratory now open for business. Wireless apparatus for sale. New Splittorf 4 inch coil for sale, \$12. Write for price list. Milwaukee Radio Laboratory, 910 Third St., Milwaukee, Wis.

Save \$10!—The \$45 Radio Magnavox's undisputed and recognized as the standard loud speakers on the market for the undistorted reproduction of radiophone speech and music, will be sold at \$35 with the first 25 orders. Telegraph your order and we shall ship C.O.D. if you are one of the lucky 25. Act now before the other fellows does. Absolutely guaranteed. Only new and high grade apparatus carried in stock. Immediate delivery. The Kehler Radio Laboratories, Dept. R, Abilene, Kansas.

Connecticut 360° Variable, hardly used, \$5. Leon Nettleton, South Lee, Mass.

Canadian Amateurs, for sale, transmitting apparatus, and receiving instruments, write for prices. J. Price, 183 Ontario St., St. Catharines, Ontario.

Special Coupler for that 150-3000 meter, single inductance, regenerative set, \$10. Papke Co., Garden St., Medford, Mass.

Mr. Amateur let us help you have a real DX station. We furnish complete set of parts. Ask about our Super DX receiving and transmitting sets. Let our instruction department teach you how to tune your set. Send a dollar with description. Results guaranteed. Everything for the Amateur in stock. Southern Radio Laboratory, Dublin, Texas. Testing Station 5XS.

Oh Boy.—You ought to see the prices on our parts in Bulletin A sent on receipt of a two-cent stamp. Sterling Radio Equipment Company, 2723 Cooper Ave., Brooklyn, N. Y.

Amateurs now is the time to get your station ready for the winter. Audion controls, \$6; Amplifiers, \$12; regenerative sets, \$15 and \$25. C.W. and telephone apparatus at new prices. All apparatus guaranteed to satisfy. Write me your wants. R. D. Tygert, Hyattsville, Md.

Crystal Detectors—75c N. A. A. tested galena box 25c. both 95c Detector worth it alone. Panel type detector, 45c. With galena, 70c. Binding posts 70c doz. All postpaid. Wise Radio Co., 308 N. Shaffer St., Springfield, Ohio.

Supersensitive Brown Phones.—These imported receivers of the tuned reed type were proven in actual test by John Firth & Co., to be even more sensitive than their famous Baldwin Telephones. They surely would be the last persons on earth to admit this. Type A, adjustable, 4000 ohms, \$18; Type D, non-adjustable, 4000 ohms (advisable for Radio Phone Work) \$16.00. Absolutely guaranteed or money refunded. Postpaid and insured. High grade phone condenser free of charge with each order. The Kehler Radio Laboratories, Dept. R, Abilene, Kansas.

Memorize Continental Code in one hour. Qualify quickly for amateur license. See our ad on page 260 this issue. C. K. Dodge.

Audion Renewals. Any type of detector, renewed for \$2.75; any type of amplifier, for reception, \$3 only single stem tubes, no tubular audiotrons accepted. 10 years' experience guarantees results, all tubes tested on our wireless before shipment. Cash with order makes for quick results. Tr'mount Laboratory, Milford, Mass.

QST QST 1 regenerative set mounted on bakelite \$10; 1 pair of Holtzer Cabot phones, \$5; 1 genuine audiotron used 20 hours \$4; 1 Clapp-Eastham variable cond \$3; 1 set of Honeycombs (four) \$8. Sizes on request. Immediate delivery guaranteed. All apparatus in A-1 condition. John C. Blair, Fairview Ave., Shippan Point, Stamford, Conn.

Writers

Amateur Authors Attention! Give your manuscripts of stories a fair chance. We are equipped to typewrite your manuscripts, remail them to you within twenty-four hours—all work is read back and checked. The cost of this service is 25c per page of 250 words, and an additional charge of 10c for each extra copy of the original. Remit with order and enclose return postage. H. Krieger, 231a Fulton Street, New York City.



**FOUR
COLOR
COVER**

**100
PAGES
or MORE**

The Undisputed Authority on Simplified Science and Mechanics

SCIENCE & INVENTION is just chock full of interesting articles and illustrations that appeal to everyone. It will hold your interest from cover to cover because it contains everything new in the field of science, invention and mechanics. Quoted by hundreds of newspapers and magazines all over the world every month.

Its editorial contributors constitute the brains of the scientific world. Just a few of the regular contributors to Science and Invention include such prominent men as

- | | | |
|----------------------------|-----------------------------|-----------------------------|
| Thos. A. Edison | Prof. Jean Bacquerel | Dr. A. O. Rankine |
| Nikola Tesla | Prof. Quirino Majorano | Prof. H. E. Austin |
| Dr. Lee DeForest | Maj. Gen. Geo. O. Squier, | Dr. H. A. Cotton, Medical |
| Rogers D. Rusk, M.A. | Chief Signal Officer, U. S. | Director, N. J. State Hos- |
| James H. Rogers, Ph.D. | Army | pital |
| Isabel M. Lewis, of the U. | Dr. Robert H. Goddard | John J. Furia, M.A. |
| S. Naval Observatory | Hon. Jas. D. Hartness, Gov- | Hereward Carrington, Ph.D. |
| Prof. T. O'Connor Sloane, | ernor State of Vermont | Prof. H. F. Richards, Ph.D. |
| Ph.D., LL.D. | Dr. C. S. Brainin, Ph.D. | William M. Butterfield |
| Prof. Augustus Trowbridge | Prof. F. L. Darrow | G. L. Hoadley, M.E. |
| Dr. Alfred Gradenwitz | Dr. A. W. Hull, Ph.D. | Dr. E. Bade |

Exclusive Radio Articles A Special Feature

Every issue of Science and Invention contains an entire section of exclusive feature radio articles, written by the highest authorities on this timely subject. Profusely illustrated and treated in an entirely different manner than those in any other magazine. This Radio Section is one of the most popular features of Science and Invention.

OTHER REGULAR DEPARTMENTS

"How to Make It"—a department devoted to stimulate experimenters towards accomplishing new things with old apparatus or old material. Three money prizes are offered each month for the most useful, practical and original ideas submitted.

"Wrinkles, Recipes, Formulas"—a section containing interesting information about chemical experiments.

"Latest Patents"—a most interesting department containing illustrations and articles describing the very latest patents.

"Scientific Humor"—this department contains a collection of jokes contributed by our readers for which a money prize is offered each month for the best.

"The Oracle"—a department devoted for the sole benefit of scientific experimenters where questions are answered every month for our readers.

"Motor Hints"—containing many hints of vital interest to the chauffeur and owner alike, together with illustrations. Three money prizes are offered each month to the contributors of the best articles for this department.

"Home Mechanics"—this section contains numerous articles, together with illustrations, showing how to make useful articles for the home from old or unused material.

"Home Electrics"—a most helpful department by G. L. Hoadley, M.E., with its many articles and illustrations showing how one may take advantage of electricity as a labor-saving device, at the minimum possible cost.

"Practical Chemical Experiments"—a department by Professor Floyd L. Darrow, in which he shows by plain wording and illustrations how to make simple food tests.

"The Constructor"—this section contains helpful and practical ideas by H. Johnstone on how the amateur may build or construct useful things in a quick, cheap manner.

"Popular Astronomy"—by Isabel M. Lewis, the well known author on astronomy.

"Fortunes From Little Things"—Charles Frederick Carter writes this department, in which he gives some startling information—how inventors have been made rich quick by inventing simple but useful articles.

**ON SALE AT ALL NEWS STANDS—
25c THE COPY**

Subscribe for a year and save 50c. Get the twelve big interesting issues delivered monthly to your door by mail without further trouble to you. Use the coupon.

**Experimenter Publishing Company
231 Fulton Street New York**

Special Offer for Short Time Only

Gentlemen:

Please enter my subscription for *Science and Invention* for the term of one year for which I enclose herewith \$2.50 (add 50c for postage outside of United States.)

Name..... Town.....

Address..... State.....

SPECIAL 30 DAY OFFER

Save Money—Get a FREE Premium Besides

The subscription price of Science and Invention has been \$3.00 per year. For 30 days, not only will we give you a full year's subscription (12 big numbers), for \$2.50, but we will also give you absolutely FREE, your choice of any of the well known books shown below. Read the special offers. If you want more than one book free take a two or three-year subscription. For each year you can take advantage of one offer.

If you are already a subscriber to one of our magazines, take advantage of this opportunity and send in your renewal subscription, stating what free pre-

mium you prefer; you are at liberty to send as many subscriptions or renewals as you desire, and you can pick out a free premium for each year's subscription.

You may also take subscriptions of your friends and earn the free premium for yourself.

You must act at once—Today.

These sensational offers are made by us at a tremendous sacrifice in the hope that your acceptance will make you a life-long friend of our magazines.

!! Please use order blank below!!

The Experimenter Publishing Co., Inc.

236 FULTON STREET, NEW YORK

Special Free Premium Offer No. 1



The How and Why of Radio Apparatus

By H. W. Secor, E.E.

This newest of Radio Works has 160 pages. 6 x 9 inches.

OFFER No. 1

Above Book, bound in special cloth, flexible, hand sewed. FREE with a year's subscription to Science and Invention for \$2.50.

Special Club Offer



THE 100% WIRELESS MAGAZINE

AND

Science and Invention

ELECTRICAL EXPERIMENTER

THE UNDISPUTED AUTHORITY ON SIMPLIFIED SCIENCE AND MECHANICS

BOTH MAGAZINES

With any one of the FREE Premiums, as described:

\$3.50

- Offer 6A SCIENCE & INVENTION and RADIO NEWS with Premium 1
- Offer 6B " " with Premium 2
- Offer 6C " " with Premium 3
- Offer 6D " " with Premium 4
- Offer 6E " " with Premium 5

The Biggest Clubbing Bargain Ever Offered.

Special Free Premium Offer No. 3

Wireless Course in 20 Lessons

By S. Gernsback, A. Lescarbourea and H. W. Secor, E.E. (10th Edition)

Size of book is 7 x 10 1/4 in., 160 pages, 350 illustrations, 30 tables.

OFFER No. 3

Above Book, bound in special cloth, flexible; hand sewed. FREE with a year's subscription to Science and Invention for \$2.50.



Special Free Premium Offer No. 2



A Thousand and One Formulas

By S. Gernsback

It contains 160 pages. The paper has been especially selected to stand rough handling in laboratories. Size 6 x 9 inches.

OFFER No. 2

Above Book, bound in special cloth, flexible, hand sewed. FREE with a year's subscription to Science and Invention for \$2.50.

Special Free Premium Offer No. 4

Experimental Electricity Course in 20 Lessons

By S. Gernsback and H. W. Secor, E.E.

The book contains 128 pages and more than 400 illustrations. Size of book is 6 x 9 inches.

OFFER No. 4

Above Book, bound in special cloth, flexible; pocket size. FREE with a year's subscription to Science and Invention for \$2.50.

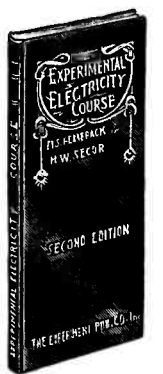

Special Free Premium Offer No. 5



Design and Construction of Audion Amplifying Transformers Radio and Audio Frequency Type

How to Make Wireless Sending Apparatus

How to Make Wireless Receiving Apparatus

OFFER No. 5

Above three Books as described FREE with a Year's Subscription to Science and Invention for \$2.50.

EXPERIMENTER PUBLISHING COMPANY, Inc.
236 Fulton Street, New York City, N. Y.

Gentlemen:

Enclosed find \$..... for which send me:

- Offer No. 1
- Offer No. 2
- Offer No. 3
- Offer No. 4
- Offer No. 5
- Offer No. 6A
- Offer No. 6B
- Offer No. 6C
- Offer No. 6D
- Offer No. 6E

MARK SQUARE ABOVE FOR ITEM WANTED.

Name

Address

Town..... State.....

PARAGON R.A. TEN

Protection Against Regrets Absolutely Guaranteed by Originator's Name



Licensed under original
Marconi & Armstrong patents

READ 2ZL'S LETTER

THIS HEARTY endorsement of Paragon R. A. Ten from so distinguished an amateur as J. O. Smith, of Valley Stream, L. I., deserves your careful attention. Mr. Smith has had ample opportunity for comparisons and his experience in radio lends weight to this expression of approval.

Here Is the Letter :

The Paragon R. A. Ten receiving set which has been in use at 2ZL station for the past two months, has proved to be entirely satisfactory in every way, and has done everything you claimed it would do. It is remarkably efficient and selective on all wave-lengths. It has proved especially satisfactory in C. W. work, because of the *entire absence* of capacity effect.

(Signed)

J. O. SMITH.

Descriptive folders on PARAGON R.A. TEN and PHONETRON, the improved type of loud speaker, sent free on request. Or send 25 cents for the CRECO catalogue,—listing all the worth while equipment in use today.

Ask Your Radio Dealer

Ask your dealer to show you a Paragon R. A. Ten Regenerative Receiver. If he hasn't one in stock, he will quickly get one if you ask him for it. The seals have now been broken on all Paragons to let you see the splendid inside construction.

Examine the details carefully, and you will see that Paragon is well worth its \$85.00 price. Remember, when you buy a Paragon, you get your money's worth in the splendid materials and workmanship. The marvelous selectivity and unequalled amplification cost no more than you pay for inferior engineering principles.

RADIO CLUBS

Be sure to get the details at once about our special offer to recognized radio clubs. For a short time only you can secure a genuine Paragon for your club house, absolutely FREE.

CONTINENTAL RADIO and ELECTRIC CORP.

EXCLUSIVE WHOLESALE DISTRIBUTORS FOR PARAGON R.A. TEN AND PHONETRON

J. DiBlasi,
Sec.

Dept. C38 6 Warren Street New York City

J. Stantley,
Treas.

IF EDISON ASKED YOU

(These) Electrical Questions — How Many Could You Answer?

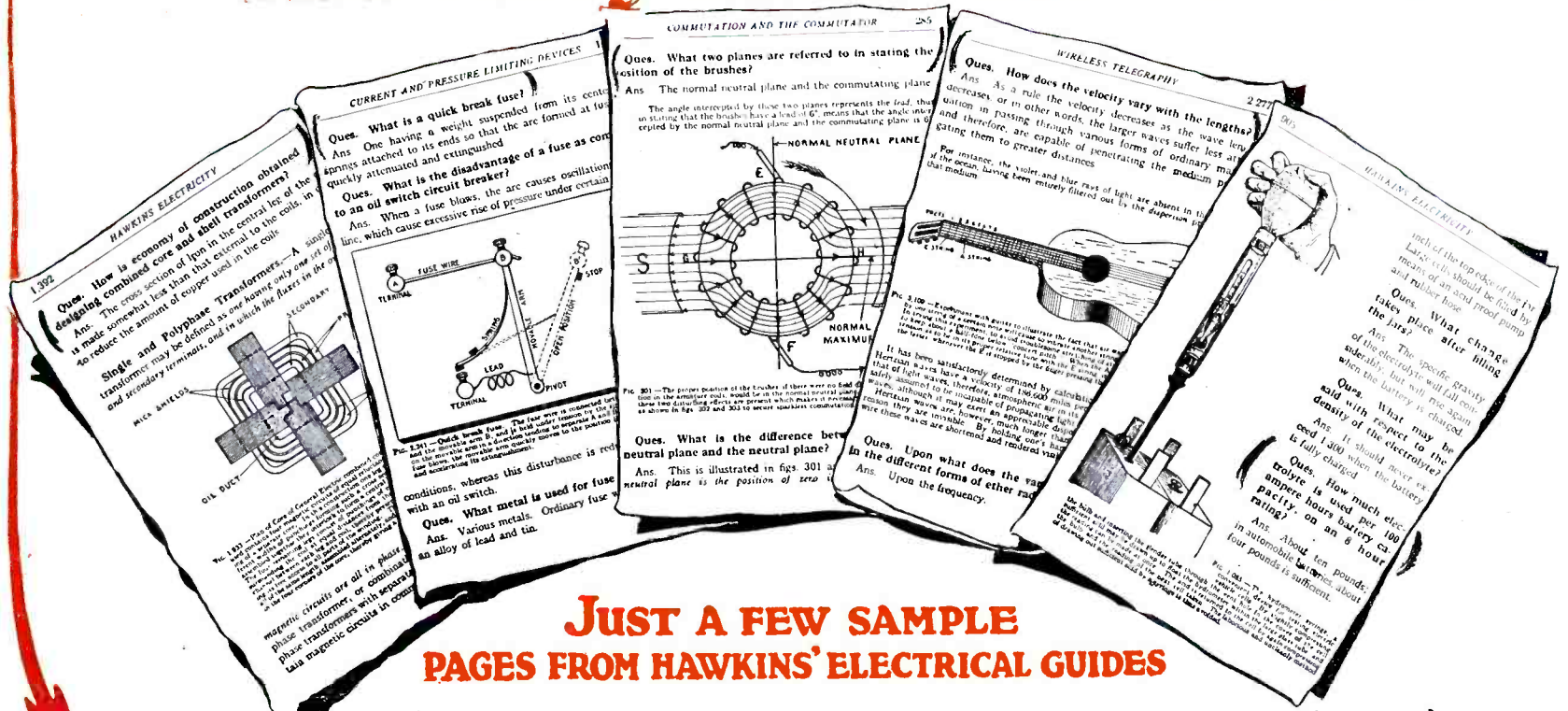

JUST A FEW SAMPLE PAGES FROM HAWKINS' ELECTRICAL GUIDES

- Ques.** What form of core requires the least amount of copper for the field magnetizing coils and why?
(For answer see Guide No. 1, Page 207)
- Ques.** What error is introduced in measuring the pressure of a battery with an ordinary voltmeter?
(For answer see Guide No. 2, Page 467)
- Ques.** What is a kick box?
(For answer see Guide No. 3, Page 776)
- Ques.** What is a compositely excited alternator?
(For answer see Guide No. 4, Page 1191)
- Ques.** What is the character of the constructions of three phase transformers?
(For answer see Guide No. 5, Page 1439)

- Ques.** What are the essential parts of a Watt hour meter?
(For answer see Guide No. 6, Page 1801)
- Ques.** What kind of current is used to ring party bells?
(For answer see Guide No. 7, Page 2148)
- Ques.** (In radio telegraphy) How do the wave lengths of different forms of radiant energy emitted by ordinary matter vary?
(For answer see Guide No. 8, Page 2274)
- Ques.** How is a wire supported in the single catenary construction?
(For answer see Guide No. 9, Page 2624)
- Ques.** (In electro-plating work) What is stripping?
(For answer see Guide No. 10, Page 3145)

Hawkins' Electrical Guides

Flexible Covers—Handy Pocket Size Volumes. 10 Volumes—3500 Pages—4700 Pictures \$1 per Volume—\$1 per month

THESE guides are not only a complete Course in Electricity in Question and Answer Form, but an invaluable reference library that every electrical man should have. Ten volumes, Pocket size, flexible covers, handsomely bound, 3,500 Pages, 4,700 Illustrations.

These books will give you a complete electrical education. Hawkins' Electrical Guides will teach you electricity. With them the student is lead progressively and in such a way that he easily grasps not only the simple fundamentals, but also the more complex problems that will come up in his future work. Thousands of successful electrical men acquired their electrical education from these books.

If you are already a practical electrical man, the Hawkins' Guides are absolutely essential to your success.

WE WILL SHIP THE COMPLETE LIBRARY FREE for YOUR INSPECTION

It will cost you nothing to receive these books—to look them over—ask them all the questions you can think of—use them in your work—study them—pick up some information that will increase your earning ability. We will ship you the entire set of 10 volumes entirely FREE.

This is a sign of our confidence in the guides. Pure gold does not object to being tested. Keep them for seven days and if you do not decide that you can't get along without them, return them to us and owe us nothing.

When you decide to keep them you only have to pay \$1.00 down and remit the balance of \$9.00 on the easy payment of \$1.00 a month till paid for.

Use this coupon to get the books. It will pay you many times over.

Theo. Audel & Co.
72 FIFTH AVENUE
NEW YORK

Please submit me for examination Hawkins' Electrical Guides (price \$1 each). Ship at once, prepaid, the 10 numbers. If satisfactory, I agree to send you \$1 within seven days and to further mail you \$1 each month until paid.

Signature.....
Occupation.....
Employed by.....
Residence.....
Reference.....

THEO. AUDEL & CO.
72 Fifth Ave.
New York, N. Y.

R. N. Sept., '21

SEND NO MONEY—USE COUPON

This Amazing Wireless Book FREE

COMMERCIAL wireless expansion is sweeping over the world like wildfire! Big opportunities are open—and every day get more numerous and attractive. You are in a fine position to cash in big on this growing field. Right at home in spare time you can easily build upon your present knowledge and quickly qualify. Wireless offers you world-wide travel, interesting work, good pay and a fine future. The coupon below will bring you, Free, an interesting illustrated booklet, "Wireless, the Opportunity of Today,"—telling about the splendid opportunities open, and how you can share them. Mail coupon or post-card for booklet today!

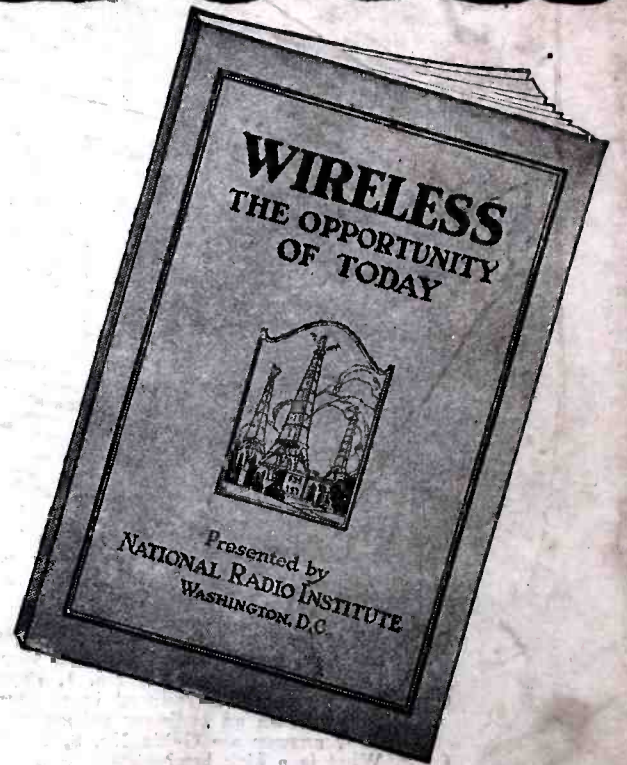

New Method Makes It Easy To Qualify In Spare Time At Home For Fine Wireless Position

What Others Say—

This N. R. I. Graduate Says—

"There is no other profession today offering the opportunity to travel and see the world at the same time paying a good salary, as radio telegraphy. My board, of course, costs me nothing. The work is not hard; in fact it is the most interesting work I have ever been in. We are sailing for Verdo, Norway, and will come back by way of England and France. I will get a chance to see the Land of the Midnight Sun. Lawrence Waring, Jr., Norfolk, Va.

Finishes Course In 8 Weeks

John Hasselberger was graduated from the N. R. I. in 8 weeks. He is now Wireless Operator on the S.S. Paysandu. Just before sailing he wrote, "Just a few words of appreciation for what you did for me. I requested a boat leaving New York for South America. The U. S. Shipping Board immediately placed me. I sail shortly as Radio Operator on the S.S. Paysandu."

None Other Equal to It

"After completing my correspondence course in wireless telegraphy and telephony with the N. R. I., I feel in a position to say that I believe there is not another radio school equal to it. Before taking the study I knew nothing of electricity or wireless.—Gordon W. Calvert, 7th and Chestnut Sts., Lansdale, Penna.

TWO REWARDS

"Thanks for your diploma which I received this morning. Today I also received the result of my examination—a First-Grade Commercial License. P. Gillice, Philadelphia, Pa.

Another Student Says—

"I write this to let you know that I passed my examination for a Commercial First-Grade License and have obtained a position on the S.S. Bulroll. C. H. McDough, Port Arthur, Tex."

These are just a few of the hundreds of letters in our files telling the same story—good positions on land and sea, interesting work and a bright future.

SURELY you have noticed how wireless is spreading over every part of the world. Every day you learn of some new field that is utilizing it—some new firm organized to push it forward. But do you realize that YOU can easily qualify for the wonderful opportunities that are opening? Do you know that you can quickly build upon your present knowledge of Wireless—and be ready any time you wish to for a fine Wireless position, either on land or on sea? Through our special method of home-study instruction a short period of your spare time can be turned into preparation for a worthwhile future in the fastest-growing field in America today—Wireless. No one is in a better position than you to cash in big on the wireless expansion that is sweeping over the world. You have the whole foundation, all ready to build upon. Our new easy method of instruction makes the rest pure fun—but fun that pays big.

Without obligation to yourself we would like to tell you more fully about the future wireless offers you. We would like to tell you about our Institute, which is officially recognized by the U. S. Dept. of Commerce and whose name heads the list of the schools recommended by the U. S. Shipping Board. The government allows our graduates five to ten points credit when taking First Grade Government License examinations.

This method not only includes a comprehensive course of instruction written exclusively for us by some of America's greatest wireless experts (members of our own staff), but also includes, Free, a wonderful new invention patented and controlled only by us. This device, called the Natrometer, teaches you in half the usual time how to send and receive, with speed and accuracy. This Natrometer is superior to any other device of its kind. Without aerials or any outside device it sends you any

one of 600 different messages at a speed which you can vary from 3 to 30 words per minute. It is portable; also very attractive in appearance. It is noiseless; and it sends in a natural manner, not like a mechanical device. You get the messages thru its phones at whatever speed you wish. And this is only one of the features which our new method brings you. Others are listed here. Read them and you will realize why our students quickly qualify and why they step into the fine wireless positions that are waiting!

Mail coupon today for our free illustrated booklet, "Wireless, the Opportunity of Today," and Special Limited Time Offer! Without cost or obligation, we want to tell you more about this field, its big opportunities both on land and on sea, and just how our new method quickly qualifies you. No agent will call upon you. We just want to send you the facts. Mail coupon at once!

National Radio Institute,
Dept. 19, Washington, D. C.

11 Points That Make This School the Best

1. New Easy Method of Instruction.
2. Wonderful Natrometer Given Free.
3. Government Credit and Recognition.
4. Our Location in Washington—Passing New Official Developments on to You.
5. Personal, Individual Attention of Great Experts.
6. Our Service in Obtaining You Employment.
7. Free Training in Wireless Telephony.
8. Unlimited Consultation and Advisory Service.
9. Free Post-Graduate Course in Our Washington Residence School if You Wish.
10. Membership in the Relay League.
11. Low Tuition Cost and Easy Terms of Payment.

The National Radio Institute was the original and is today the oldest and largest school in America teaching Wireless by mail. We have graduates in almost every part of the world.

NATIONAL RADIO INSTITUTE, Dept. 19, Washington, D. C.

Send me your free booklet, "Wireless, the Opportunity of Today." Tell me about the opportunities open in wireless, about your Institute, and about your Special Limited Offer.

Name

Address

City..... State.....

- I am interested in a Sea position.
- I am interested in a Land position.