

CIRCULATION LARGER THAN ALL OTHER RADIO MAGAZINES COMBINED

RADIO NEWS

REG. U.S. PAT. OFF.

20 Cents
June
1921

Over 100 Illustrations
Edited by H. GERNSBACK

MENTAL TELEPATHY
VIA RADIO
SEE PAGE 864



"THE 100% WIRELESS MAGAZINE"

CUNNINGHAM

POWER

Type C-302

5 watt output

Price \$8.00



TUBES

**Demand
Cunningham
Tubes**

**The Name is etched
on the Tube**

**CW TELEGRAPHY AND TELEPHONY WITH CUNNINGHAM TRANSMITTER TUBES OFFERS THE ADVANTAGES OF
COMPACTNESS — RELIABILITY — LONG RANGE — LOW POWER — SHARP TUNING**

TRANSMITTER TUBE SPECIFICATIONS

| Model | Output Conservative Rating | Filament Amps. Volts | Plate Voltage | Price | Delivery Date |
|-------|----------------------------------|-------------------------|------------------|--------|------------------|
| C 302 | 5 watts | 2.35 7.5 | 350-400 | \$8.00 | immediate |
| C 303 | 50 watts | 6.5 10. | 1000 | 30.00 | Mar. 10th |
| C 304 | 250 watts | 15. 12. | 4000 Max. | 110.00 | Mar. 10th |

Price of C 303—C 304 fob. New York or San Francisco

C 302 is mounted on the standard four prong receiving tube base. The larger tubes have special bases.

CUNNINGHAM POWER TUBES

are the latest product of the great Research Laboratory of the General Electric Co. The trade mark GE is the guarantee of their quality. Each tube is built to most rigid specifications. The output ratings are extremely conservative and in actual test deliver greatly in excess of their rated outputs.

GENERAL ELECTRIC QUALITY PLUS CUNNINGHAM SERVICE

Address All Communications to

TRADING AS
AUDIOTRON MFG. COMPANY
35 MONTGOMERY STREET
SAN FRANCISCO, CALIF.



No. 766 Eveready Wireless Station Battery. Standardized for use in U. S. Navy



No. 763 Eveready Airplane Wireless Battery. Standardized for use in U. S. Signal Corps Aviation Section

Four points of superiority in Eveready B No. 766 Wireless Receiving Battery

Long Life

—due to high quality of materials and refinement of process

Perfect Insulation

—due to each cell being coated with paraffin and to separation of cells with waterproof cardboard

Noiseless Operation

—due to efficient depolarization, thorough connection, and prevention of corrosive puncture and leaks

High Voltage Maintenance

—due to right proportioning of high grade ingredients and to insulation

YOU have always wanted a better dry battery with *lasting* power; silent as a desert; stable as a rock. Read over those four points that make Eveready B No. 766 the ideal Battery for your receiving set.

Then go to your dealer, get an Eveready, hitch it up, and enjoy the marked increase in the effectiveness of your equipment.



Every Wireless Operator Has Use for an Eveready Flashlight

AMERICAN EVEREADY WORKS

of National Carbon Company, Inc.

226 Thompson Avenue, Long Island City, New York

Chicago

Atlanta

San Francisco

EVEREADY

VACUUM TUBE BATTERIES
FLASHLIGHTS AND BATTERIES

RADIO NEWS



CONTENTS

VOL. 2

FOR JUNE

No. 12

| PAGE | PAGE |
|---|---|
| Money from Radio...By H. Gernsback 853 | The Radio Compass, By Lt. Com. Frank Luckel 866 |
| Vacation Time Radio, By Arthur H. Lynch 854 | Who's Who in Radio. Professor Edouard Branly 867 |
| Awards of \$100 Portable Radio Prize Contest 855 | Atmospheric Conditions in the Tropics, By Charles A. Reberger 867 |
| A New Use for Radio..... 856 | The Arc and Radiotelephone Transmis- sion.....By John F. Bront 868 |
| The California Theatre Radio Station... 857 | The Efficient Design of Vacuum Tube Telegraf and Telephone Sets, By Jesse Marsten 870 |
| Give Yourself a Radio Vacation, By Armstrong Perry 858 | An Efficient Loading Coil and No Dead End Switch.....By Allen E. Latham 872 |
| The Radio Compass on Airplanes, By S. R. Winters 859 | The Construction of Intervalve and Tele- phone Transformers..By Joseph G. Reed 872 |
| The Washington Air Mail Radio Station, By S. R. Winters 860 | A Universal Receiving Cabinet, By Hilbert R. Moore 873 |
| Church Uses Radiophone..... 860 | Results Accomplish with One Bulb, By Albert R. Champlin 873 |
| A Portable 200 to 900 Meter Regenerative Receiver.....By F. J. Fox 861 | Radio Digest 874 |
| Construction of Ball and Cup Variome- ters.....By Edmund S. Smith 862 | \$100 Radio Accessory Prize Contest.... 875 |
| Audio Frequency Transformer Built from Auto Spark Coil Secondary, By G. H. Stackpole, Jr. 862 | Newspaper Uses Amateur Radio Reporters The Thirteenth Tap, By Bernard S. Greensfelder 876 |
| A. C. for Heating V.-T. Filament, By Professor M. Moyer 863 | Married via Radio..By Erald A. Schivo 877 |
| A Tube Transmitter Using A. C. on the Plate.....By D. S. Basim 863 | With the Amateurs..... 878 |
| A Mental Telegraf, By Maurice Buchbinder 864 | Junior Section 880 |
| Washington's Birthday Relay Results, By H. W. Kirwan 864 | Junior Constructor 881 |
| The Vacuum Tube in Radiotelephony, By John Scott-Taggart 865 | Correspondence from Readers..... 882 |
| | Club Gossip 883 |
| | I-Want-To-Know 884 |
| | A "Scoop" for RADIO NEWS..... 886 |
| | Judge Mayer Sustains Armstrong Patent. 886 |

RADIO NEWS is published on the 25th of each month at 233 Fulton Street, New York. There are 12 numbers per year. Subscription price is \$2.00 a year in U. S. and possessions. Canada and foreign countries, \$2.50 a year. U. S. coin as well as U. S. Stamps accepted (no foreign coins or stamps). Single copies, 20 cents each. A sample copy will be sent gratis on request. Checks and money orders should be drawn to order of EXPERIMENTER PUBLISHING CO., INC. If you should change your address notify us promptly, in order that copies be not mis-carried or lost. No copies sent after expiration.

All communications and contributions to this journal should be ad-drest to: Editor, RADIO NEWS, 233 Fulton Street, New York. Unaccepted contributions cannot be returned unless full postage has been

included. ALL accepted contributions are paid for on publication. A special rate is paid for novel experiments; good photographs accompanying them are highly desirable.

RADIO NEWS. Monthly. Entered as second-class matter June 6th, 1919, at the Post Office at New York, N. Y., under the Act of March 3, 1897. Title registered U. S. Patent Office. Copyright, 1921, by E. P. Co., Inc., New York. The Experimenter Publishing Co., 233 Fulton Street, N. Y., N. Y. The Contents of this magazine are copyrighted and must not be reproduced without giving full credit to the publication.

RADIO NEWS is for sale at all newsstands in the United States and Canada; also at Brentano's, 37 Avenue de l'Opera, Paris.

Publishd by EXPERIMENTER PUBLISHING CO., INC.
H. GERNSBACK, President

S. GERNSBACK, Treasurer

233 Fulton Street, New York City
R. W. DE MOTT, Secretary

"ATLANTIC RADIO"

JUNE BULLETIN

Have YOU Received
particulars of the
new
DE FOREST
"INTERPANEL"
EQUIPMENT?

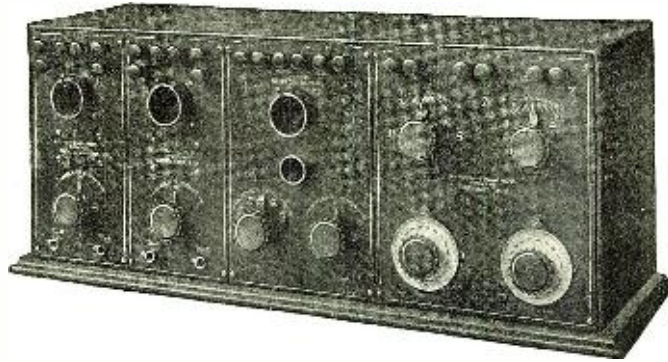

A new idea in Radio Telephone Transmitting and Receiving Apparatus. Panels are all 9 inches high, varying widths. Designed for placing side by side with binding posts in line for convenience in wiring. Adaptable to any operating requirement, — short or long wave reception, — telephone transmission, — one or two stage amplification, — etc., etc. Panels supplied with or without cabinets.

Special bulletin on request.



**De Forest
Hand
Microphone**

Furnished with cord and terminals for connection to binding posts.

Price \$6.00
Shp. Wt. 5 lbs.

The Dubilier Universal Condenser

May be used in audio and Radio frequency circuits, for receiving equipment, self-rectifying circuits, direct current transmitters and other tube transmitters up to 100 watts.

No. 301.....1000 Volts.....0005 mfd.
No. 303.....1000 Volts.....001 mfd.
No. 305.....1000 Volts.....002 mfd.
No. 307.....1000 Volts.....005 mfd.

\$2.00

Shipping Wt. 1 lb.

A New Amplifying Transformer—G. R. 231A

Are you getting the most out of your tube? A complete amplifier is more than a mere assembly of parts. It consists first of the selection of units of correct electrical characteristics. An amplifying transformer must be more than a coil of wire and a core. It must have incorporated in it the results of engineering skill. Type 231A amplifying transformer is designed specifically for the new Radiotron tubes. The design is right, the appearance is right and the price is right.



Price completely mounted, \$5.00

Shipping weight 1 lb.

Transmitting Tube Rheostat



The new five watt Radiotron tubes require a filament current of 2.35 amperes. Type 214A is a 2-ohm transmitting tube rheostat which will carry 2.5 amperes. This resistance is sufficient to regulate the new tubes on as high as a 12 volt supply source. This rheostat does not run hot and may accordingly be mounted inside of enclosed transmitting cabinets where space is often very limited. Like the G. R. receiving tube rheostats

and grid biasing potentiometers, it is made in two styles, 214A for back of panel mounting and 214B for surface mounting.

Price \$2.50

Shipping weight 1 lb.

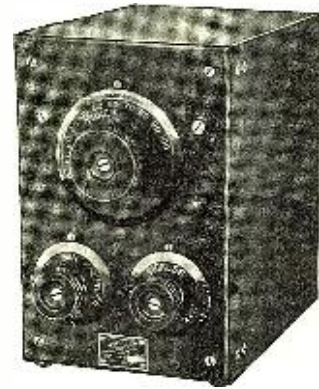

Westinghouse Radio Equipment

Westinghouse Radio Equipment embodies the latest ideas in receiving equipment, providing a most efficient set for telegraph and telephone reception over the amateur and normal ship wave-length ranges.

Type R. A. Short Wave tuner, Style 307189, responds to a wave-length of 180 to 700 meters and is especially selective.

Type D. A. detector-amplifier, style 307190, combines a vacuum tube detector with a two-stage amplifier. Both units are mounted on Micarta panels attached to a polished mahogany cabinet. Simple in design—easy to operate—single-tuning circuit. Highly efficient.

Type R. A. Tuner.....\$65.00
Type D. A. Detector Amplifier..... 65.00
Type R. C. (Combination of above mounted in single cabinet).....125.00

Radio Corporation Interval Transformer

Model U. V. 712

Designed especially for use with the Radiotron U. V. 200 and U. V. 201 Vacuum Tubes.

Price \$7.00
Shipping Wt. 2 lbs.

General Radio "A" Battery Potentiometer

Similar in appearance to Type 214A, but wound to a resistance of 400 ohms. Price \$4.00. (Shipping weight 1 lb.)

SPECIAL

Just a few Roller-Smith Type T-A-W Hot Wire Ammeters, (0-1, 0-2.5, and 0-5 amps) still offered at the remarkable price of \$5.00 each.

VACUUM TUBES

Radiotron UV 200, Receiving Tube..... \$5.00
Radiotron UV 201 Amplifying Tube..... 6.50
Radiotron UV 202 5 watt Transmitter..... 8.00
Radiotron UV 203 50 watt Transmitter..... 30.00



New Pacent Universal Plug

New Pacent Universal Plug consists of three parts; two moulded Bakelite pieces, each with a recessed finger grip, and the plug with its connecting spring clip. The two Bakelite pieces are held together with a screw that fits into a threaded brass insert. This screw is "dead" electrically, a necessary precaution when the plug is used with high potentials or extreme high amplification. The plug may be used to "plug" in a telephone headset, a Microphone transmitter, a manipulating key, a loading inductance, a plate battery, etc. In fact its adaptability renders its name synonymous with its uses.

Price \$2.00

Shipping Wt. 1 lb.

ATLANTIC RADIO COMPANY, Inc.

88 Broad Street
Boston 9, Mass.

REQUEST "BULLETIN 14"

Branch: 15 Temple St.
Portland, Me.



185 Illustrations

A COLOSSAL EVENT

The new RASCO catalog just off the press is one of the greatest events in amateur radio. There are many radio catalogs, but the RASCO catalog is an event by itself for the simple reason that it

Contains 50 Vacuum Tube Hook-Ups

This is the one and only radio catalog containing such wonderful free information. Complete hook-ups of all important vacuum tube circuits are given in clear diagrams with complete explanation. Just to name a few:—The V.T. as a detector; detector and one-step amplifier; regenerative circuit; De Forest ultra-translation; V.T. to receive undamped and spark signals; Armstrong circuits; one step radio frequency amplifier and detector; three stage audio-frequency amplifier; short wave regenerative circuits; V.T. radio telephone; 4-stage radio frequency amplifiers; radio and audio frequency amplifier; inductively coupled amplifier; Armstrong superautodyne; radio frequency amplifier and crystal detector; C.W. transmitters; self-rectifying 2 tube C.W. transmitter; V.T. transmitter with 6 volt battery; radio telephone using plate and grid modulation; one tube radio transmitter and receiver; experimental radiophone; radiophone using Colpitt oscillator circuit.

This list is only a partial one. You must positively see this wonderful book to appreciate it. It is made to fit the pocket—has heavy covers to withstand the wear and tear which it is sure to have at your hands because it will be your constant companion.

And Oh yes! Before we forget it. If you are in need of the following, remember "Rasco has it." These are only a few things contained in this catalog: Lugs, Nuts, Dials, Knobs, Washers, Crystals, Litz Wire, Selenium, Cord Tips, Cap Nuts, Tin Foils, Name Plates, Spring Posts, Switch Parts, Metal Ribbon, Carbon Balls, Binding Posts, Switch Points, Switch Levers, Carbon Grains, Metal Pointers, Contact Points, Low Melting Metal, Carbon Diaphragms, Screws, Copper Strip, "Spaghetti," Name Plates, Sliders, Mica, Switches, Resistance Wire, Variocoupler Rotors, Test Clips, Condenser Plates, Condensers, Antenna Connectors, Threaded Brass Rod, Ground Clamps, Etc., Etc.

The catalog contains 187 illustrations. On account of its great cost, this catalog cannot be distributed free of charge. It will only be mailed upon receipt of

15c in stamps.

THE RASCO "BABY"

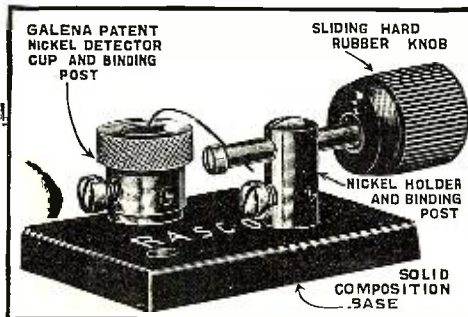

Illustration Full Size

simply unscrew the knurled cap and insert your crystal into the stand, screw home the cap which leaves a goodly portion of the galena exposed. The contact is perfect, while the crystal can be exchanged quickly in less than three seconds. By slightly unscrewing the cap, the crystal can be changed in position, in order to explore other sensitive spots. The catwhisker is of phosphor bronze and is attached to the horizontal bar by means of a filister head screw. Can be readily exchanged in less than two seconds. Wires can be connected to the binding post in a jiffy. All metal parts are nickel plated, and you will be proud of this little masterpiece.

No. 1898 Rasco Baby Detector complete with galena crystal, prepaid..... 50c

No. 1899. The same but furnished with an additional piece of tested radiocite crystal, prepaid..... 75c

Ready for distribution June 30th.

The Rasco "Baby"
Here it is boys! The smallest and most efficient detector in the world—as well as the cheapest. Our illustration is full size, and while the various details can be seen at a glance, we feel so enthusiastic about it that we must tell you all of its good points. First, there is a solid hard rubber composition base, size 1 1/2" x 1 1/2". We have not forgotten two holes to screw down the detector. Then we have the nickel holder and binding post combined which holds the sliding, knurled, hard rubber composition knob. As you see, this knob not only revolves in its holder, but can also be moved back and forward in order to explore each point of the detector crystal. Next we see the patent nickel detector cup and binding post combined. This is a little marvel all by itself and will not fail to evoke your admiration. No clamps, no soft metal to fuss with. You

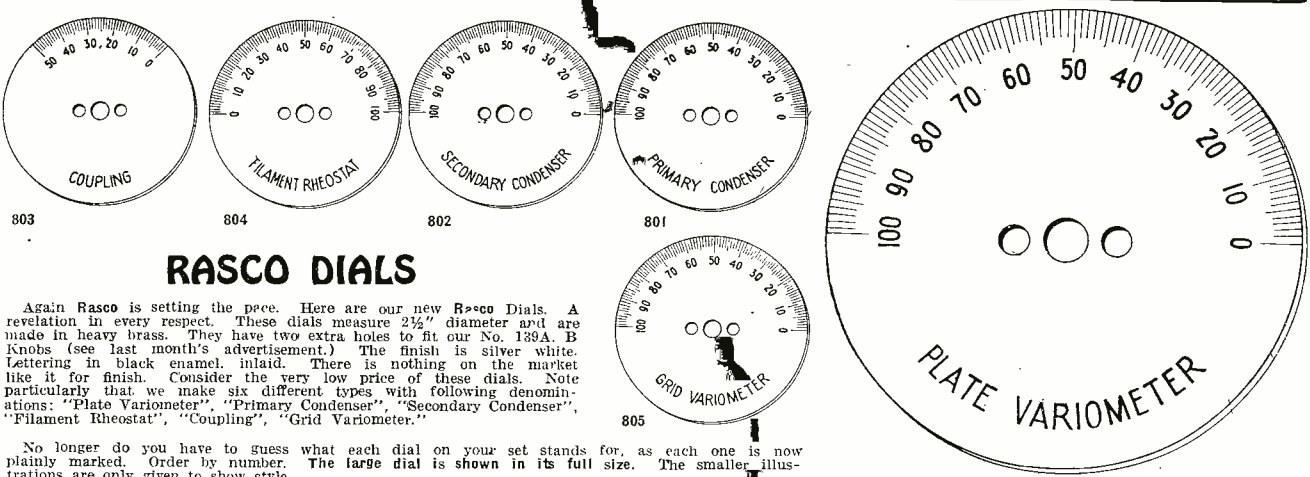

RASCO DIALS

Again Rasco is setting the pace. Here are our new Rasco Dials. A revelation in every respect. These dials measure 2 1/2" diameter and are made in heavy brass. They have two extra holes to fit our No. 139A. B Knobs (see last month's advertisement.) The finish is silver white. Lettering in black enamel, inlaid. There is nothing on the market like it for finish. Consider the very low price of these dials. Note particularly that we make six different types with following denominations: "Plate Variometer", "Primary Condenser", "Secondary Condenser", "Filament Rheostat", "Coupling", "Grid Variometer."

No longer do you have to guess what each dial on your set stands for, as each one is now plainly marked. Order by number. The large dial is shown in its full size. The smaller illustrations are only given to show style.

Prices all styles prepaid ea. 1 30c
A series of 6 dials complete prepaid, \$1.70

Do not compare these dials with some other makes as there is positively no comparison between them. Must be seen to be appreciated. Money back if not satisfied.

DEALERS' GET OUR SPECIAL PROPOSITION

Did you see our full page ad in the May issue? We expected a good deal of business but we were actually snowed under! It shows that Rasco goods are wanted. In one week we filled over 600 orders and each and every order was shipped within 24 hours! Surely a record.

We even filled orders for articles not listed. Our prices are low—our service the quickest—and your small order is never side-tracked as all our orders are small. One trial order will make you a life customer. Try us with a 50c order. We can only "stick" you once!



Radio Specialties Co.

96-98 PARK PLACE, NEW YORK CITY

Factories: Brooklyn, N. Y.—Elkridge, Md.

WE GUARANTEE EVERY ORDER SHIPPED WITHIN 24 HOURS.



RADIO NEWS

H. GERNSBACK—Editor
ROBERT E. LACAULT—Associate Editor

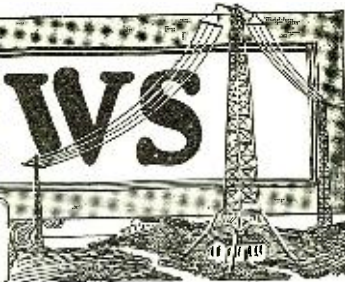

Vol. 2

JUNE, 1921

No. 12

MONEY FROM RADIO

WE have often heard it said that radio is used by the amateur only as a sort of diversion or sport. Unfortunately in most cases this is true. The amateur buys an outfit and being a selfish sort of person, immediately begins to use it for his own personal benefit and instruction, and as a rule that is all that the country at large ever gets out of this particular outfit. It is true that once in a while the amateur condescends to do a little relay work and to give out weather or market reports for someone who might happen to ask for them. But how many amateurs are using radio as a money-maker either directly or indirectly?

Perhaps few realize that there is money in radio at all and for that reason they hardly ever bother their heads about it. For those unenlightened ones, this article has been written. There is indeed quite a good bit of money to be made out of radio. Particularly is this true during vacation time when the average young man or college man has plenty of time on his hands to commercialize his art.

In this country there are thousands of islands located in various lakes, as well as in our oceans, and these islands have not always direct communication with the mainland, either by telephone or telegraf. It should be simple for an intelligent amateur to visit such islands and try to find out what the commercial possibilities are to connect such islands with the mainland, either by radio telegraf, or better, by radio telephone. We lay particular stress on the latter because few hotels or camps can afford to pay a regular telegraf operator. It is, then, up to the amateur to sell not only his temporary services, but to sell the outfit and the installation as well.

As a rule he can make good money in doing so. We know of a few cases where amateurs have made a tidy little sum from such installations. Radio telephone outfits are becoming simplified now and the amateur who knows all the firms manufacturing either complete outfits or the supplies to make an outfit, should have no trouble in disposing of several installations this summer.

Then we have the large excursion autos and excursion boats, such as yachts, motor-boats, river and lake boats, houseboats, etc. If the proprietor of such can be made to see the advantage of carrying a radiofone outfit that does not cost a huge sum, an order will often follow. The trouble with the average layman is that he does not realize how cheaply a low range radiofone outfit can be bought. Most of them have an idea that such an outfit in order to talk over a mile would cost a thousand dollars, or perhaps more. Consequently they never take the trouble to investigate and find out that a two-station radiofone outfit can be bought for a fraction of that sum. It will save its cost many times over, because it usually makes a hit with the public.

Then we have our friend the jeweler. Perhaps he has not a complete radio outfit to give him the exact time by radio. It should be a simple matter for the bright amateur to sell his local jeweler a complete outfit at a very good profit. Of course it means solicitation and a little

talk with the jeweler, because not every jeweler is up-to-date and will see the advantages. An invitation to the amateurs' radio station will perhaps clinch the sale in most cases. If once the jeweler sees how simple it is to work a time receiving radio outfit, he will soon become enthusiastic, and as many of his tribe have done, will even go so far as to put the outfit in a show window in order to attract trade. We know a jeweler in the South who uses a loud talker outside of his window where everyone for half a block around can hear when NAA sends out the time at noon.

Then we have the country factory and the manager's or owner's home usually separated for quite a distance. There is not always a wire connection between them. It should be simple to connect the two by radiofone, because as a rule the distance is not very great, and the innovation would be welcomed by the up-to-date business official.

Here is another wrinkle that may prove a steady income to the amateur. We refer to giving regular weather reports by mail or by fone to a number of subscribers. This idea was recently tried by a young amateur in the southwest, and we understand that he makes quite a little money out of it. He has about 40 subscribers to whom he furnishes daily weather reports either by mail or by telephone. Not only does he give weather reports, but he gives them market news as well, and also press news, if it is of sufficient importance. It works as follows:

The young man in question has a subscription card charging a low rate for mail service and a higher rate for telephone service. The fone service takes more time, is more expensive and as it is prompter for the subscriber, it is worth more money. The mail service is simple: as soon as the weather report is received by the amateur, he typewrites it and makes hectograf copies, which he sends out at once under a one cent postage stamp. It takes him but a few minutes to do this. To those subscribers wishing telephone service, he must of course call up each one separately which necessitates more time and expense. The beauty of the scheme is that it provides a steady income to the amateur and his expenses are very low. It costs him nothing to receive the radio messages and only the stationery and postage is an item to be considered. Usually a yearly contract is made—bills payable monthly. The amateur can make the rates to suit himself and of course the subscriptions should be low enough, otherwise he will not have many. As is the case with any kind of subscription, it is the quantity that counts. If an amateur can get anywhere from 50 to 100 subscribers, he can make a pretty little penny, besides rendering valuable services to the community. The thing of vital necessity is, however, that the service be prompt, because only then will it be beneficial to the subscribers. It need not be mentioned that it is a simple matter these days to obtain such a subscription from farmers or others interested in weather reports where there are no daily papers within reach and where advance weather and crop reports are often of vital importance.

H. GERNSBACK.

Vacation Time Radio

By ARTHUR H. LYNCH

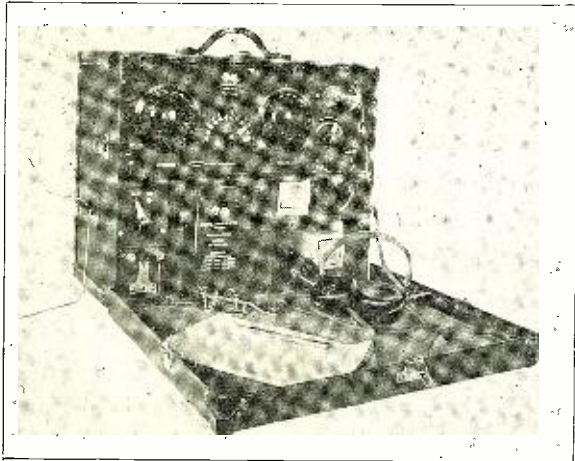

This is a Real, Complete Portable Set, With a Range of Wave-Lengths from 150 to 3,000 Meters. Everything is Included in the Carrying Case.

RADIO manufacturers and dealers have come to look upon the summer time as a period of little business in which they may devote their attention to the formulation of plans for the campaign of new business, which the fall always brings. With the rapid expansion and development which the art has undergone within the past few years and especially the last year, it is very doubtful that such a condition will be found to exist either this summer or the summers which follow.

One method for avoiding this slump is well under way, as may be seen from the accompanying fotos. A very potent, in fact, we may safely say, the most important reason for this seasonal decline is that many of the amateurs spend much of their vacation time in places some distance from their homes. If they do not leave their city residences for the entire summer, or even for part of it, they almost invariably find some sort of outdoor occupation for their leisure hours at the seashore or in the woods, on the golf links, tennis court or what not.

Even present-day radio stations, in most instances, may hardly be termed portable, even tho there is a marked tendency to cast aside the "pillar" inductance and glass-plate condenser and rack of yesteryear for the more compact and efficient concentrated inductances and moulded condensers of today. Many portable receiving sets have been described from time to time, but one does not find the ultimate of satisfaction in listening to others operate without being able to have a word or two himself with the rest of the world. Then, again, we have

seen portable transmitters, of which but very few are really practical. Do you remember ever having seen a portable combination transmitter and receiver, which you felt was really suitable for obtaining anything like the results to which you have been accustomed? Even tho you may be in that fortunate class of radio enthusiasts whose purse limitations have no bearing on the amount of equipment, you have decided that the outlay for such a set, simply for summer time operation,—and not the best of operation at that—was not to be given very serious consideration. Procuring the parts and the time necessitated in assembling them would encroach materially upon the capital which would be needed for the purchase of your canoe, the refitting of your houseboat or the time needed for getting your motor boat or automobile ready for the summer's campaign. You, like so many others, decided that the game was not worth the candle.

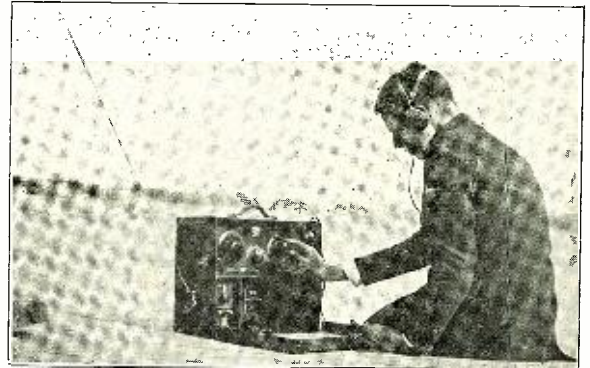

Here is the Shore Station Which is of the Same Type as the One on the Canoe. Note the Size of the Complete Station.

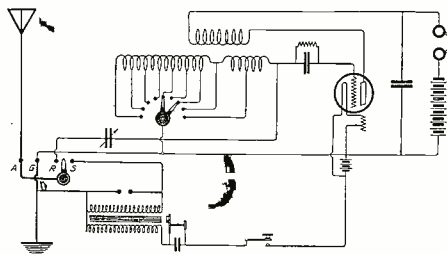

Complete Hook-up of the Portable Set Shown in Fig. 1.

A TRULY PORTABLE SET

A combination transmitting and receiving set, embodying everything that is necessary for good operation, which is economical and which enables you to use most of your present equipment, has been designed for this very purpose. It combines a receiving set which has a wave-length range of 150 to 3,000 meters and a very simple transmitter, with a distance range of several miles or more, depending upon the type of antenna used, as well as the sensitivity of the station at the other end.

It has taken a long time to develop a receiver which would work well on the range of waves mentioned, and tho the demand for it has always been great, caused, no doubt, by the desire to work on amateur waves and still be able to receive the time and news from NAA, there are but few such receivers on the market.

There is little which need be said in connection with the design and con-

struction of this portable set. It is complete, in every detail, as shown in the accompanying fotograf. With the single exception of the antenna, EVERYTHING fits in the small carrying case, and the coil of wire may be strapped to the outside of it with very little trouble. EVERYTHING includes the complete receiver, two receiving tubes, the "A" battery, two 20-volt "B" batteries, telephone receivers with headband, spark coil, spark gap, key and the "send-receive" switch, as well as the antenna insulators, and there is enough space left for a few tools, a pad and pencil. There are but two terminals on the outside of the case and they are for the "ANT" and "GND" connections.

The complete outfit with everything necessary for receiving and sending including the antenna wire, and the power supply for lighting the filament and supplying the transmitter, weighs about twenty-four pounds; then, it is vastly different from any other portable set previously described, in that it does not require such a great duplication of parts or the procuring of new ones. There is a section, in the upper half of the carrying case, as indicated in the fotograf, which is just the proper size to accommodate one of the popular receiving sets. For those who already have a receiver of this type, it is but necessary to procure the remainder of the equipment and for those who are not supplied with such a receiving set the purchase of the entire outfit does not mean that it may be used only for portable purposes. At the end of its career as a portable outfit, the receiving set, which is a complete unit, may be withdrawn from the carrying case and mounted in the usual manner, in the station. The outlay, in any case, above that necessary for the receiving set, is com-

(Continued on page 916)

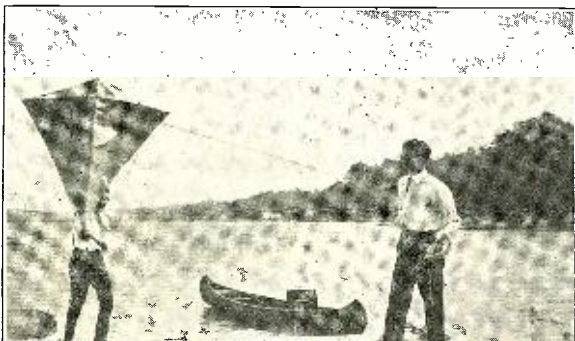

Erecting the Aerial. No Poles are Necessary, Just a Kite and Up Goes the Wire Used as an Antenna.

Photos by courtesy of A. H. Grebe & Co., Inc.



The Op and His Set Aboard the Liner. If You Own Such a Boat You Should Install a Set on Board and Keep in Touch With the Camp During the Trip.

Awards of \$100 Portable Radio Prize Contest

THIRD HONORABLE MENTION



The fotograf on the right shows the inside of the portable set. The coupling is varied by opening the box more or less. On the left is Mr. Dick, designer and builder of this small pocket receiver.

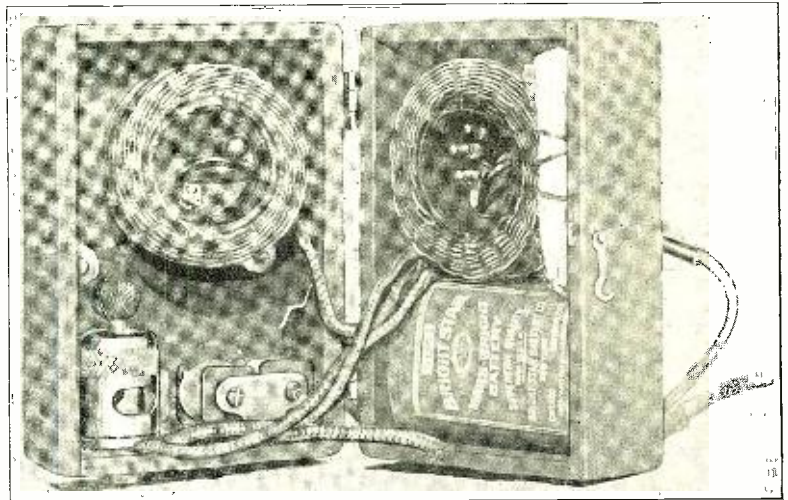

Smallest Portable Radio Outfit

By H. B. DICK

The general enthusiasm for an efficient radio outfit that can be taken on hikes, camping, on visits to friends, etc., is pretty well established. Certainly every one of us has at some time or other wished that he (or she) had a small radio set which could be slipped into a pocket or hand bag and taken with him. For this reason I have designed and built the outfit described below. One which anyone should be able to make and be mighty proud to own.

GENERAL DESCRIPTION

As stated in the title of this article, the outfit is of the smallest size and yet good results are obtained. As may be seen in Figure 1, the fones occupy quite as much space as the set. The dimensions are as follows: $3\frac{3}{4}$ inches long, $2\frac{1}{2}$ inches wide, and $2\frac{1}{2}$ inches deep, thus occupying but little more space than 23 cubic inches.

The case was made of Spanish cedar (cigar box wood) put together carefully so as to avoid cracks and thereby keep out all dust. It was then sanded with fine sandpaper and stained mahogany. After being allowed to dry, two thin coats of damar varnish were put on and these allowed to dry about 36 hours. Then the whole was sanded and waxed. The results obtained were wonderful.

The tuning is accomplished by opening and closing the box on its hinges.

INDUCTANCES

After some little testing with various types of inductances, it was decided to use coils of the honeycomb type. These coils were made $\frac{1}{2}$ inch wide and were wound on cardboard tubing $1\frac{1}{4}$ inches outside diameter. The coils were held in their re-

spective positions in the case by the tubing which was left sticking beyond the coil itself. The primary was wound with 5 layers and the secondary with 7 layers with taps taken off at each layer. The plan used in winding the coils is similar to that described in the December, 1919, issue of RADIO NEWS, there being 24 nails in each row. About $\frac{1}{8}$ of a pound of number 24 D. C. C. was all the wire required for both coils.

The switch points used were $\frac{1}{4}$ " x $\frac{1}{4}$ " head with $\frac{1}{2}$ " shank set in a piece of wood cut to fit the inside of the coil tubing. The taps were soldered to these because the points were too close together to allow the use of nuts. The knobs used were the smallest procurable. These were bot from the J. H. Bunnell & Co. for seven cents each.

DETECTOR

The detector was the familiar Amrad type C-1. It was bot some time ago for \$2.50 and can now be bot for \$2.2: without the base. The size is very convenient for the set, being only $\frac{3}{4}$ " in diameter and $1\frac{1}{2}$ " high. The two binding posts which came with the detector were used for the aerial and ground and two others were bot from Amrad at \$.17 for the telephones.

BUZZER

The buzzer was of the common watch-case type, which can be bot most anywhere for about \$.75. It was taken out of its case and mounted directly to the wood case with two small screws from the outside. Just above the buzzer is the push button which was made from a piece of phosphor bronze $1\frac{1}{4}$ " long and $\frac{3}{4}$ " wide. The buzzer tone regulating screw was screwed into the side of the case directly opposite the buzzer vibrator arm so that adjustments could be made from the outside. The push button, too, could be placed on the outside so as to make the testing easier.

TELEFONE CONDENSER.

The telephone condenser was made of two sheets of heavy tinfoil separated by sheets of waxed paper. The tinfoil was 4" x 5" and the waxed paper was cut a little larger to avoid any possible chance of a short circuit.

WIRING

The wiring diagram is very simple, and I believe it will need no explanation. All the wiring was done with rubber insulated, silk covered, stranded wire. All possible connections were soldered; a very important part of a crystal set.

BATTERY

The battery to supply current to the buzzer can be of any make two cell flashlight battery. The size should not be any larger than $2\frac{3}{8}$ " x $1\frac{1}{4}$ " x $\frac{3}{4}$ ".

AERIAL AND GROUND

The aerial, found to be sufficient, was number 18 annunciator wire 75 feet long. To prevent grounding of the aerial, two small porcelain insulators were used, one on each end of the wire and held away from the tree by short lengths of wire or cord. A very efficient ground connection was obtained by driving spike into the base of a live tree and wrapping the ground lead around it.

During recent tests away from the city, several amateurs were heard QSA. At one time, when I lived in New York State, I heard NAH (600 meters), a remarkable record considering the size of the outfit.

The author would be glad to hear from anyone who should happen to construct a set similar to the one described here or from any one who might be in doubt as to some of the constructional details of the set.

H. B. Dick, 40 Westernview St.,
Springfield, Mass.

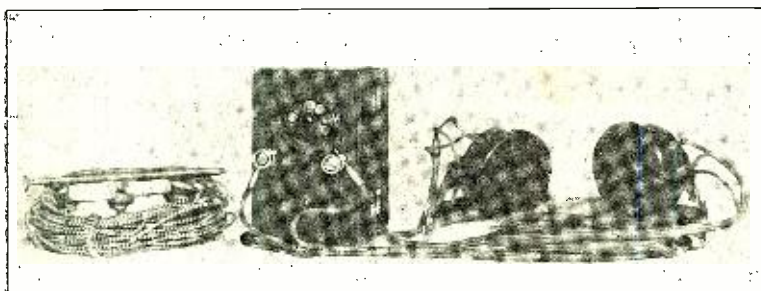

On the left is a view of Mr. Dick's complete portable set, including the aerial, insulators and telephone; while on the right is the complete hook-up of the receiver.

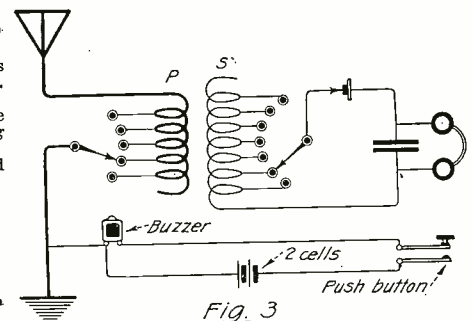

A New Use For Radio

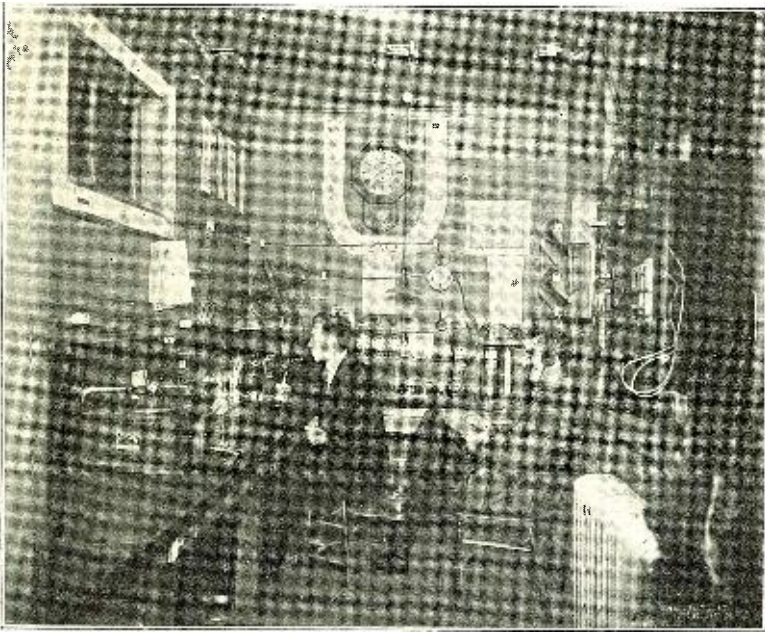

This is a view of the well known Union College Radio Club station. On the left is the six 50-watt tubes set, while on the right, just above the head of the smiling fellow, are two 250-watt tubes mounted on a board.

“EXCUSE me a minute, Officer, till I switch on the wireless music. Then we can leave the baby alone while we go for a stroll.”

Such a statement, coming from a nurse maid, may sound rather far-fetched or the prediction of a scientist of what we may have 25 years hence, but such is not the case in Schenectady, N. Y. It is a reality there; the Union College Radio Club has made such a feat possible. The wireless baby-carriage has already been demonstrated, wheeled thru the principal streets of that city and thru the parks, with lullabys pealing forth from the radio receiving horn attached to the carriage just as plainly as tho coming from a fonograf a few feet away.

The music is sent from the Union College radio station, the sounding tube of a small victrola being attached to the mouth piece of an ordinary telephone, which carries the music to the aeriols, where the sound-waves are sent out thru the ether. It can be picked up in Chicago, in fact in any city within a radius of 1,200 miles, just as easily as by the baby-carriage in Schenectady.

This wireless baby carriage, devised by the college boys, has an antenna of three wires, stretched across the top from two pieces of a bamboo fish pole. Underneath the carriage-body is the storage battery, and hidden under the canopy in such a way that it in no way interferes with the baby the amplifier, which multiplies or adds to the volume of the music as it is sent to the horn, an ordinary megafone secured by wires to the front antenna pole. The tuning box is attached to the rods leading to the handle of the carriage.

After thoroly testing the carriage in the electrical laboratory at the college, the tour of the city was started early in the evening. The music was turned on as the boys with the carriage left the college grounds and it is doubtful if a circus parade ever created more attention and curiosity than this musical baby-carriage as it was pushed thru the streets. After an hour's tour it was stopped in the park.

Some at first thought there was a fonograf hidden somewhere in the carriage, but such ideas were dispelled when, without anyone going near the carriage a voice from the horn would immediately announce upon conclusion of one selection the name of the next, with the information “by the Union

College Radio Club” and then the music would start.

The baby-carriage stunt is not all that the Union College Radio Club has done in Radio. For months it has been giving weekly concerts every Thursday night; and for the last few weeks, sermons, prepared by Dr. C. A. Richmond, president of Union College, have been sent out at 8 o'clock Sunday nights. These are preceded by a hymn played on the fonograf and followed by another, and then the doxology is read—a real church service at home heard by amateur operators in no less than 24 states of the Union, in four provinces of Canada and by ships 700 miles from New York, at sea. This fact is attested by the hundreds of letters and cards received by the Radio Club from amateurs telling of having listened in and complimenting the Club on the clear tone in which the music or sermon are received.

Radio is not a regular study at Union College, but rather a side issue with the boys, most of whom became interested in the science during the war. Equippt with the most modern of apparatus, including six of the new type 50-watt and two 250-watt Radiotrons, the most powerful sending

vacuum tube in use, for amateur work. Union's Radio Club has been heard by more than 2,000 amateurs to date. The sending is done on a 350 meter wave-length, interesting information for those amateurs within a radius of 1,200 miles of Schenectady who have not yet listened in on the concerts or sermons.

Some of the letters received in reference to these concerts are interesting. One from Beloit, Wis., from Glen Franz, said:

“Heard you fine tonight. Using only one tube. Keep up the good work.”

Another from a little town in North Carolina, signed by Taylor M. Simpson, reported that the concert was very loud in that place. C. W. Carter of Shawinigan Falls, Quebec, said:

“I've just been listening to your Radio concert, and it was very good indeed. Wish you could give one every night.”

A little rivalry is evident from another communication sent by R. J. McKnight of Springfield, Ohio. He said he heard the concert and that it came in a good deal louder than either “NSF” or “KDKA”. The former is a Government station at Washington and the other is a station in Pittsburgh.

A correspondent from Fort Wayne, Ind., reported hearing the radiofone concert very distinctly, and a similar report was received from Keyser, West Va. Another report received from Francis Duffey of Cabery, Ill., said:

“Very loud here; heard your concert last night. I could hear you all the time about 10 feet from fones and at times 30 feet from fones.”

Another message from Ontario congratulated the Club, saying:

“Your concert was heard here frightfully loud. This fone is the finest I have heard to date. It beats 2QR and NSF.”

An interesting message came from the steamship Peeksville, 700 miles out of Ambrose Channel. It follows:

“Thanks for your concerts. I never knew that ‘Annie Laurie’ could sound so well.”

Editor's Note:

The little stunt of going around the town with a baby carriage equippt with a Radiofone attracts the attention of the public.

It is hoped that some clubs will find some other use for Radio, so as to gain new members and attract more boys in the game.

Let us hear some more about it.

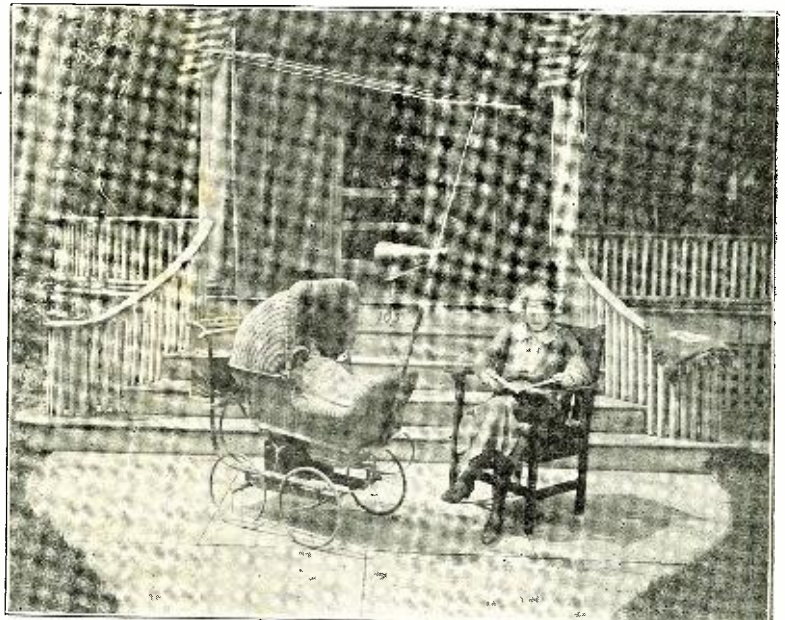

Here is the baby truck equippt with radiofone. The nurse does not need to sing to stop the kid's crying, she has only to switch the receiver on, and music sent by radio comes to keep him quiet.

The California Theatre Radio Station

The DeForest radiofone station operated at the California Theatre, in San Francisco, by the Moorhead Laboratories, Inc., of that city, which is the exclusive distributor of the DeForest Company on the Pacific Coast, has been in operation for over a year and it is thought that a description of same will be found of interest to the readers of RADIO NEWS.

The California Theatre is the largest motion picture house in San Francisco, and is one of three controlled by the Famous Players-Lasky Corporation, the other two being the Imperial and Portola Theatres. A fourth, the Granada, is now under process of construction.

The station was installed early in 1920, thru the courtesy of Directors Roth and Pardington, of the "Big 3" Theatres, and is located in a concrete room in the fly galleries of the theatre. The antenna is fixed on the tower of the Humboldt Bank Building, directly adjoining the theatre.

The transmitting set consists of the standard DeForest 1 kw. radiofone set with additional loading inductance so as to obtain the working wave-length of 1,260 meters. The call letter of this station is 6XC. The antenna current varies from four to five amperes, according to the amount of input energy. Ordinarily, less than a half kilowatt is used for transmission. As the set is essentially an experimental one, various transmitting circuits of the DeForest Company have been tried out. The circuit in use at present is one developed by the engineers of the Moorhead Laboratories, for which patents have been applied. The receiving set is of the standard DeForest type.

For best results in receiving from the California Theatre, the following ultra honeycomb coils should be used: Primary—DL 200, with series condenser on moderate antenna; secondary—DL 200; tickler—DL 150.

In connection with the transmission of music, several interesting methods have been developed thru experimentation. For collecting and transmitting the music from the Theatre's Symphony Orchestra of 50 pieces, a large Magnavox horn is suspended in the fly galleries in such a position as to be clear of the side "drops." At the small

Here is Big Jack, better known under the name of Dempsey, listening in to the radiofone music. He was stung by the bug and is taking lessons in radio now.

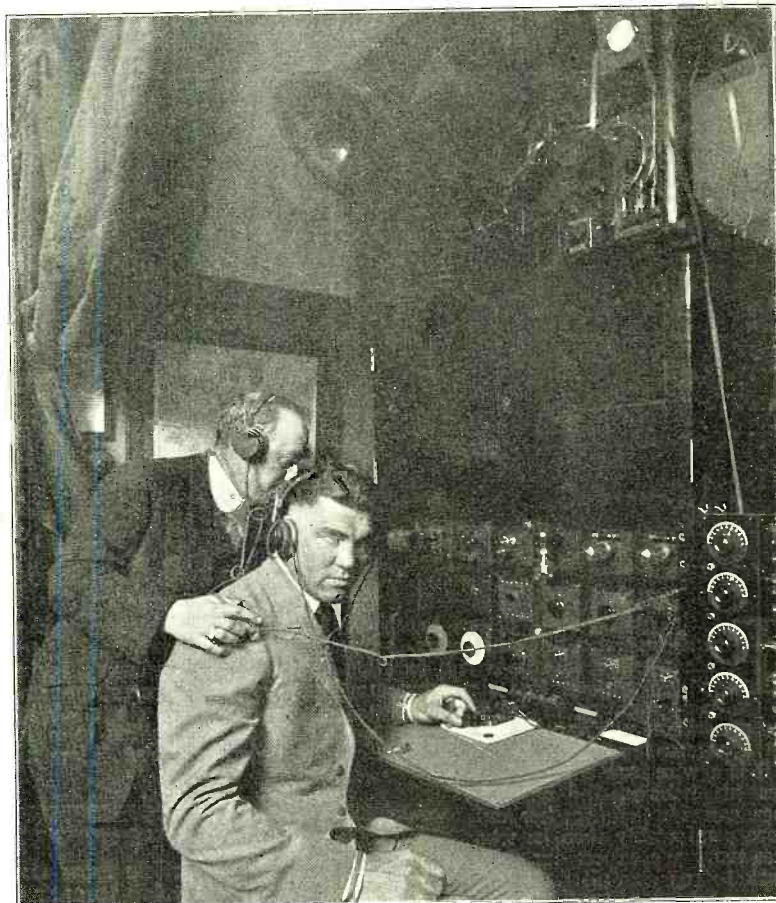

Photo Underwood & Underwood.

end of the horn, a Kellogg microphone transmitter is mounted in a vertical position. From here the usual wires are led to the radio modulating circuit. For the transmission of fonograf records, several devices have been used. One is a standard Magnavox fonograf microphone, consisting of a microphone mounted at the end of the usual fonograf tone-arm. Another method developed by the Moorhead Laboratories is to utilize the steel needle holder so as to

bear directly on the microphone diaphragm in place of the usual fonograf diaphragm.

For special concerts, which are frequently given, a sound proof room in the basement of the theatre is utilized. For small chamber or instrumental music, a Magnavox horn similar to the one suspended in the fly galleries is utilized, but for vocal selections Kellogg desk transmitters are used by each singer. By placing the singers with their backs to the grand piano used for accompaniment, enough of the sound intensity from the piano is obtained thru the singers' microphones so as to obtain a proper blending of the voices and piano.

Harp solos by Miss Jay Clark, piano solos by Mr. Hans Hankc and vocal solos by Miss Mary White, Miss Ruth Williams, and Mr. Ford Rush, of the California Theatre, and Madam Frieda Hempel and Forrest Lamont, stars of the Chicago Grand Opera Company, have been the big features of the special concerts.

The regular concerts, consisting of the Herman Heller Orchestra music and fonograf records, are sent out at 4:00, 7:15, and 9:00 P. M. on week days, lasting for at least one-half hour. Special vocal and instrumental concerts are sent out at 9:00 P. M. on Wednesdays, and a special Sunday concert given by the Herman Heller Orchestra is sent out from 11:00 A. M. until noon.

The transmission of music from the DeForest station at the California Theatre has developed from an experimental standpoint to a worthwhile contribution to the musical progress of the city, and receiving sets for the reception of this music alone have been installed at clubs, hospitals, hotels, and many private homes since the inauguration of this service.

The accompanying photograph shows Dr. Lee DeForest, inventor of the audion, at the radio set, and Miss Mary White singing

(Continued on page 907)

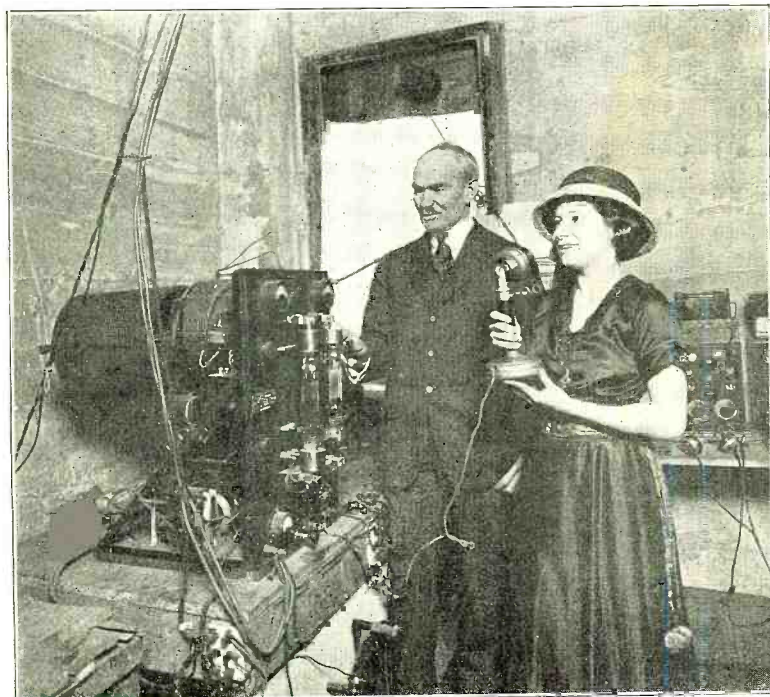

This photograph shows Miss Mary White singing at the radiofone station of the California Theatre, with Dr. DeForest, whose company installed the set. Note the extra inductance fixed behind the panel to tune up to 1,260 meters.

Give Yourself a Radio Vacation

By ARMSTRONG PERRY

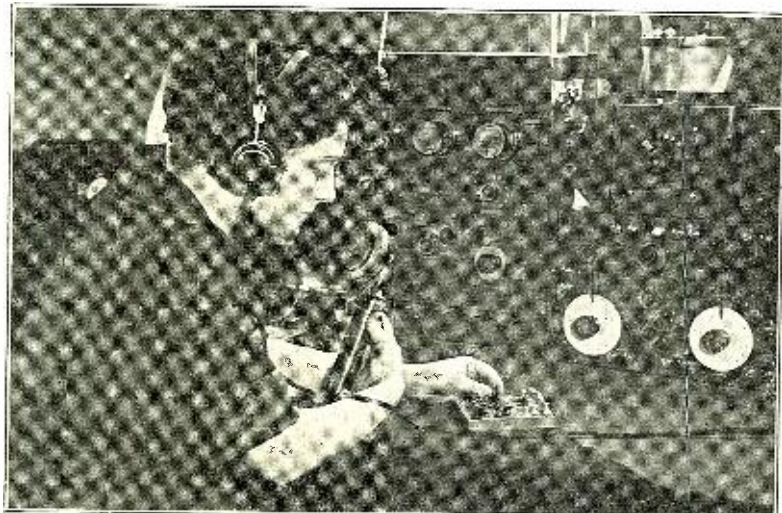

Among the people in the hotel are several who will be interested by radio and take it seriously. A practical demonstration may be made by playing chess with a friend by radio. There will be some players among the spectators who will become interested in radio thru their hobby.

Photo, Underwood & Underwood.

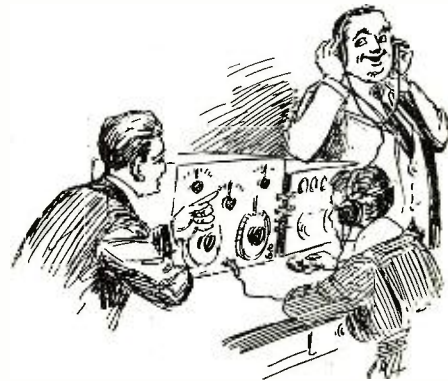

Instruction in radio for boys and girls and adults.

- Radio chess and checker matches.
- Radio press dispatches.
- Information about ships.
- Weather forecasts.

RADIO DANCE.

The radio dance is already an established institution. When a man is dancing it makes little difference where the music comes from so long as it is the right kind of music and he has his arm around the right girl. But the fact that the music comes by radio will be a topic of conversation at the time and in hundreds of homes and clubs later, and the hotel that introduces the novelty will be prominently mentioned where others are forgotten. No successful hotel man is ignorant of the value of such mouth-to-mouth advertising.

EMERGENCY SERVICE.

Free emergency radio service could be furnished by an amateur connected with a Radio Relay League or any other organization maintaining relay stations. Even an amateur could at least equal some of the wire service provided at summer and winter resorts, both in speed and accuracy. Telephone service at many isolated resorts is more of a joke than a reality and serious situations arise sometimes which a radio station would relieve.

DEMONSTRATIONS AND EXPERIMENTS.

We who have stations come to feel that
(Continued on page 924)

TIMES are getting better, but some radio amateurs are still trying to decide whether to take a real vacation and go without that new apparatus they want, or to get the apparatus and go without the vacation. Why not get the apparatus and take the vacation?

It is a wise man who capitalizes his hobbies, for he who does, can ride them farther and more comfortably than he who does not. We expect our daily work to pay for all its accessories and provide a living for ourselves and our families besides. The hobby should at least pay its own way and provide for a vacation.

It is a recognized fact among psychologists and pedagogues that we do best that work in which we are most interested. Is there an amateur who goes to his dry goods counter or his bookkeeping desk, or whatever his regular job leads him to in the morning, with as much zest as he takes up his fones at night? Or switches on the juice and starts the talking machine? By all the laws of mind and matter the radio amateur ought to be able to get a rich man's vacation as easily as a poor man's wages.

The vacation business of seashore, mountain, lake and river resorts depends upon features to a great extent. These resorts multiply annually and competition is keen. A few places maintain their leadership and get the best trade by keeping up to the times. The rest catch the overflow and the cheap

trade. The better the place the more likely the management would be to take an interest in radio service as a feature of its house.

The papers are full of hotel ads and postage stamps are cheap. Why not outline a practical proposition to a few houses and see what happens? Here are a few items

HERE is another article from the pen of Mr. Armstrong Perry that will not fail to enthuse thousands of amateurs all over the country. Not only does Mr. Perry show how the amateur can have a free vacation, but if his suggestions are followed, there is no reason why he cannot make very good money besides.

If only a thousand amateurs were to follow Mr. Perry's plan this summer, this alone would do more for the radio fraternity and would tend to popularize radio more than all the radio magazines combined could ever hope to accomplish.

Let us hear from those amateurs who have taken a free vacation, suggested by this article. The Editor will be glad to pay good rates for such articles, and those with photographs will be especially welcome.—Editor.

- that might be included:
- Radio dances.
- Free emergency radio service.
- Demonstrations and experiments.

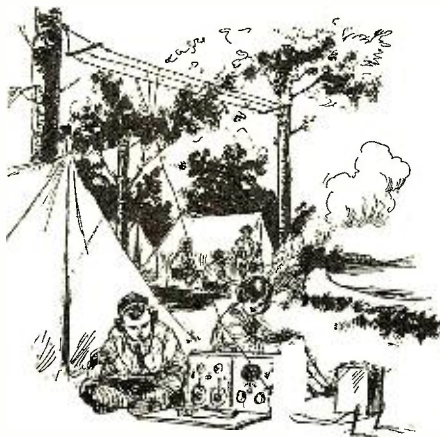

An hotel that introduces the novelty will be prominently mentioned where others are forgotten. During vacation at camp a radio set is also very useful to keep in touch with the town, and receive all the news sent by radio.



The Radio Compass on Airplanes

By S. R. WINTERS

THE establishment and equipment of the 78th Naval aircraft station with radio apparatus emphasizes the swift progress of this form of communication, as applied to operations of the Navy Department. The developments are brot into review by detailed information supplied to the writer by the Radio Division of the Bureau of Engineering. The value of a system of shore radio compass stations as an ally to navigation is subscribed to by hundreds of letters received from the masters of merchant vessels.

The desirability of reducing the extra weight of an airplane to a minimum has necessitated the use of extremely light radio sets for aircraft communication. "Surprisingly good results, however, have been obtained with the sets now in service," says an official of the Navy Department. An example of the communication range is suggested by the efficiency of one of the sets employed during the Trans-Atlantic flight of the NC-4, this particular equipment being heard a distance of 1,400 miles from a shore radio station. The lessening of the noise of the motor and electrical disturbances present in the radio receiver while receiving on board an airplane have been objectionable factors inviting constant research. Aircraft receiving equipment, however, has been developed, which renders it feasible to receive wireless signals on board an airplane at a distance almost as far as from a ship or shore station.

Naval aircraft wireless transmitting sets derive their power in two varying ways, one from a wind-driven propeller with generator connected and the other from a storage battery. The latter method involves the transportation of "excess baggage"—greater weight than is practicable. This determining factor operates toward the discard of storage batteries for all kinds of aircraft radio transmitting apparatus. The Navy Department employs both telephone and telegraf sets, the latter being abandoned for long distance communication, owing to the fact that for the same weight of equipment a telephone set will only transmit half the distance covered by a telegraf set.

The aircraft radio compass is a recent contribution of helpfulness to the naval aviator, when Columbus-like land is beyond

A very complete radio station is installed in all the big planes. This photograph shows on the left the receiver and in the center the amplifier.

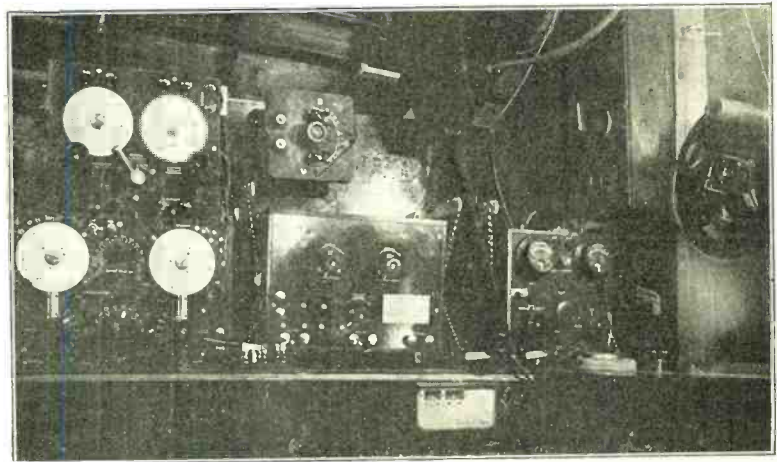

view. Here is an illustration cited by the Radio Division of the Bureau of Engineering in support of this conclusion: A plane has flown out to sea, picked upon the radio signals of a battleship under way at an unknown position, which was afterwards found to be 100 miles from the plane, flown directly to the ship, turned around and flown back to its original station, navigating by means of the wireless signals from that station. Shore radio compasses, or occasionally denominated radio goniometers, consist of a special type of radio receiving equipment coupled with a revolving coil, the outfit being capable of determining the direction of signals emanating from a ship's radio transmitter. Stations have been erected at choice locations along the coast and in the vicinity of principal harbor entrances, maintaining a continuous watch 24 hours a day for 365 days.

A ship at sea, seeking its bearing from one or more of these radio compass stations, calls in the regular way and makes a prearranged radio signal for one minute; the operator at the compass station takes the ship's bearings while it is transmitting, forwarding the bearing by wireless to the ship. A bearing may be obtained simultaneously from any number of these stations within range and by use of two or more bearings the Master can accurately determine his position. Instances are numerous, however, where an ideal location of a radio compass station cannot be made with respect to navigation and military operations. Environments may retard the proper functioning of the compass; for example, the site must be free from surrounding metallic structures. Preferably the location should be on a low, sandy beach, far removed from hills and elevations. Rocky ground, elevations and metallic structures influence the refraction or bending of the wave front, thereby producing objectionable deviation in the observations. A significant feature in the establishment of a radio compass station is the selection of a site permitting the use of an existing radio transmitting station. Otherwise, it is imperative to construct a radio telegraf transmitter, which involves extra expense and also creates interference.

According to the Navy Department, the range of shore radio compass stations is influenced by the following factors: Sensitivity of the radio compass receiving apparatus, power of shore and ship transmitters and accuracy of calibration. Navigational requirements limit the range to 100 miles, since the majority of ship transmitters are ineffectual for compass activities at a greater range. High-powered transmitting outfits, designed for military uses, however, have ranges of 1,000 miles or more. Bear-

ings taken at long distances should be treated as great circles to avoid errors. The American steamship *Eastern Breeze* received a set of bearings from the New York Harbor entrance stations which fixt the vessel's position at 830 miles southeast of New York. Subsequent determinations verified the accuracy of this finding to within one and one-half miles of its actual location. Harbor entrance stations are negotiated in groups of three or more and centrally controlled from a plotting station connected with each compass station by land wire telegraf. To illustrate: A ship approaching New York and desiring her position, would call "NAH," the central control station located in New York City. The latter would notify by land line the compass stations at Montauk, Fire Island, Sandy Hook and Mantoloking, that a vessel (giving call letters) was requesting bearing. When all stations have acknowledged, the control station by distant control using the New York Navy Yard transmitter directs the ship to test, whereupon the ship then transmits her call letters repeatedly for one minute, during which time the compass stations are taking observations to obtain the bearing. The bearings thus recognized are given the control station by land line, the control op-

(Continued on page 908)

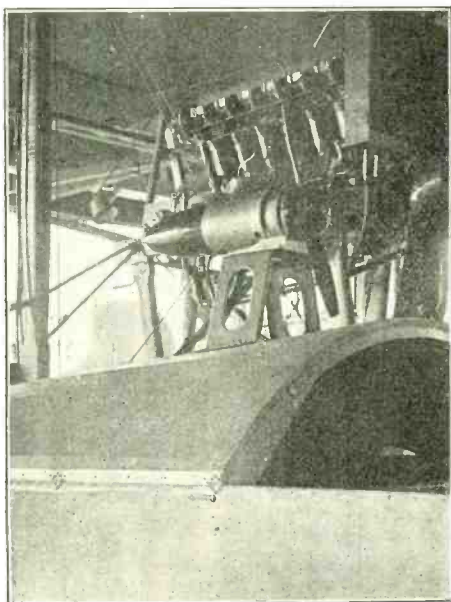

In This View May Be Seen the Air-Propelled Generator Supplying the Power to the Radio Set.

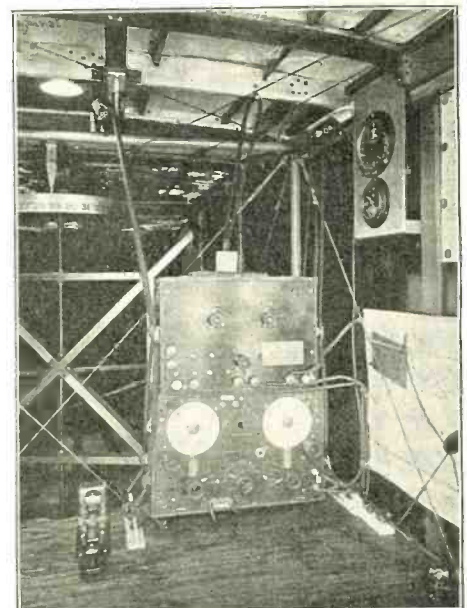

This Fotograf Shows the Radio Compass Installed Aboard a Big N.C. Plane. Note the Loop Aerial and Scale on the Left.

The Washington Air Mail Radio Station

By S. R. WINTERS

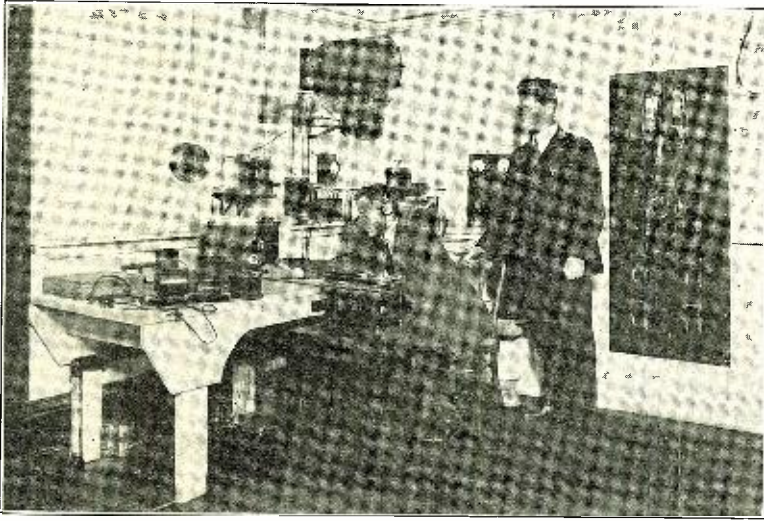

This photograph shows the 2 K.W. arc station installed in the Post Office Building at Washington, D. C., which is used to send information and market reports to farmers, and communicates with the other stations of the air mail service.

WHEN in Washington, D. C., if opportunity should permit, visit the United States Post Office Department building, at Eleventh Street and Pennsylvania Avenue, and once within the ancient-looking structure, ride the dual-purpose elevator, a passenger and cargo-carrying vehicle, for eight stories. Alight and turn sharply to the right, moving straight ahead until you approach a room with the modest identification, "8to E." Having gained admittance, you will be introduced to a Radio Station that assuredly can lay claim to being a novelty, if not one without a duplicate in the United States both in arrangement and in the character of service it renders.

Government owned and operated, the wireless equipment installed in this room, 25' long, 25' wide and 14' high, is employed in the two-fold function of imparting information in conjunction with the operation of

the coast-to-coast air-mail service and in the dissemination of market reports of the United States Department of Agriculture to farmers. The transportation of 200,000 first-class letters daily, involving the use of 65 airplanes, covering a distance of 2,700 miles, suggests the purpose of 15 Radio Stations for spreading information as to inter-station traffic, the distribution of meteorological data, and as an agency for Transcontinental relays from Washington. Such was the specific purpose for which the service was originally established, the broadcasting of news as to market conditions being an additional burden only recently assumed.

Reverting to the wireless equipment and quarters in which it is housed: A 2-kilowatt Federal arc set was so modified as to be the equivalent of 4-kilowatt in strength. The antenna and ground arrangement are of novel design. The former is maintained in

the absence of spreaders, its installation involving the use of four wires spaced by the means of a metallic bridle. The roof of the Post Office Department building serves as a counterpoise. The situation of the station permits a direct lead-in with the antenna. Favorable location likewise facilitates the use of ground leads not exceeding 15' in length.

By way of functioning in a twofold public capacity—the application of wireless communication as a vehicle of immediate service to a large group of people—this radio station lends itself to convenient operation. In the selection of the room and the installation of equipment, special attention was given the desired objective of reducing the moves of the operator to a minimum in the performance of his manifold duties. This end has been achieved, and the change from receiving to transmitting is effected without undue delay. The rate of communication is approximately 400 words an hour for each of the 15 stations. The quarters containing the radio operator and apparatus likewise lends itself to use as a modern government office. J. C. Edgerton, the capable director of the Transcontinental Government Wireless Service, an assistant and a stenographer, comprise the office force necessary to the execution of the duties which intimately relate to the Department of Agriculture and Post Office Department.

Ten of the 15 Radio Stations of the Transcontinental Service were established outright, interlocking with an equal number of flying fields maintained for shifting the postal bureaus from railway trains to mid-air. Army and Navy Radio Stations are employed where practicable, thus avoiding duplication of construction and the elimination of working interference. Government stations already established that share this additional duty are: Cleveland, Chicago, San Francisco, and Cincinnati. The

(Continued on page 94)

Church Uses Radiofone

FOR the first time, so far as is known, radio telephony has been used to transmit services from one church to another, in order that a congregation without a regular pastor could have the benefit of Sunday evening worship. The churches in which this was done successfully were the Calvary Episcopal and the Herron Avenue Presbyterian, both of Pittsburgh, Pennsylvania.

During the last few months the Sunday evening services of the Calvary Episcopal Church have been broadcasted from a radio test station in East Pittsburgh, Pa. These services have been eagerly awaited by radio amateurs all over the United States.

The Herron Avenue congregation has been without the services of a regular pastor for some time. One or two of the congregation being wireless enthusiasts, got in touch with the Westinghouse Company, requesting the installation of a small receiving outfit in the church, in order that the members could hear the Calvary services. This was done and a compact set consisting of a loop antenna, amplifier and condenser was placed upon the rostrum in front of the pulpit; the loud-speaking horn rested directly on the pulpit.

An expectant throng filled the church and was not disappointed, for the voices and music of the Calvary choir, the sermon and the organ were received clearly and distinctly. In spite of the difference between Episcopal and Presbyterian services, the latter

congregation followed the Episcopal pastor through. During the sermon of the Calvary rector, intense interest was maintained at the Herron Avenue church, so clearly and distinctly was the message received.

It is hard to say just what demonstrations like this will do, but certainly it proves

the great flexibility of wireless telephony. There may be in the future a central pastor who will talk to thousands of congregations situated in all parts of the world, but this may take time. The idea is not far-fetched by any means, as the transmitting of the Calvary services proves.

The invisible minister at the pulpit of a Presbyterian Church of Pittsburgh, Pa., giving the Episcopal service to the congregation. On the table may be seen the receiver and amplifier used in conjunction with a loop aerial and a tele-megafone.

(Photo courtesy of the Westinghouse Co.)

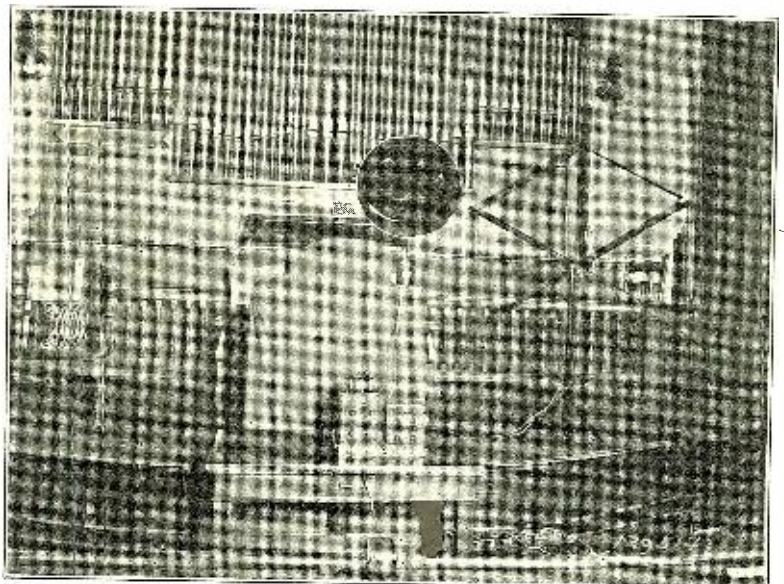

A Portable 200 to 900 Meter Regenerative Receiver

By F. J. FOX

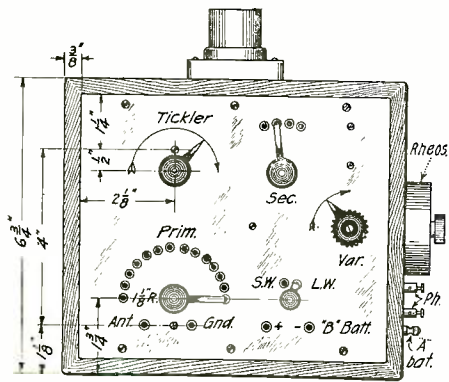
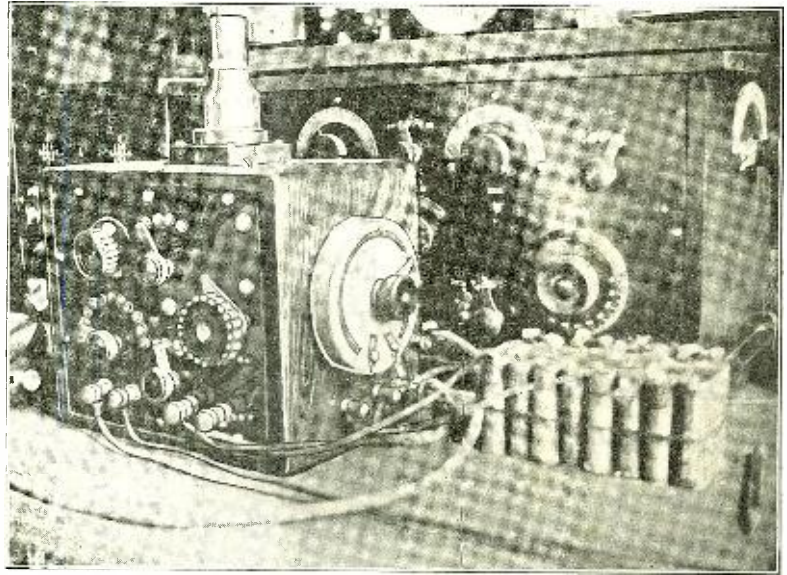

Fig. 2

Front View of the Set Showing the General Layout of the Switches and the Dimensions of the Panel and Cabinet. The Features of this Set Are Its Compactness and Good Design.



On the right is a photograph of the portable set. On the right of the cabinet may be seen the B battery made of flashlight cells. If desired this battery may be fixed inside the set as there is enough room for it.

I HAVE always been in the habit of going away to the shore or woods for my summer vacation, and, being a "ham," I have always found it necessary to insure peace and happiness by taking along some form of a portable radio set. Until this year, because of its conveniences, I have always used some form of galena set. These served very well for commercial stations, but as a rule I had to get along without hearing my "favorite" relay stations, to my great regret. One year I took a two-inch coil with me but because of bad amateur receiving facilities it proved to be useless.

With this in mind, I have designed the following set. I am sure it is the solution of the portable regenerative receiver. Its range is from 200 meters to 900 meters. It regenerates well, is very simple to operate, is extremely selective and is very compact. For portable purposes the short wave condenser in series with the antenna or ground is not required, but if the set is used in a station it is desirable to use it for amateur wave-lengths. A condenser is used across the secondary for commercial waves: it may also be used for amateur work, but usually louder signals are obtained if it is cut out of circuit and the ama-

teurs tuned by use of the secondary taps and the tickler coil. When I constructed the set I had on hand an unmounted De Forest CV-500 variable condenser, which I used. Altho the condenser is very rugged

inside, it would be very convenient to put in the correct amount of "B" Battery. I will, however, describe it as I made it and leave such changes to the individual constructor.

The set has been very thoroly tested. It works almost as well as any of the high-priced regenerative sets now on the market. With it, in March, I have copied numberless 1's, 2's, 3's and 8's (district stations) and quite a few 4's, 5's, and many 9's. I used a tubular audiotron mounted in an old V. T. socket, and no amplifiers. I consider this very good for such a compact set.

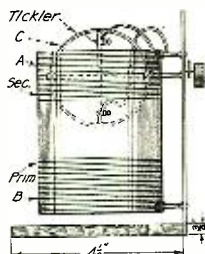

Fig. 3

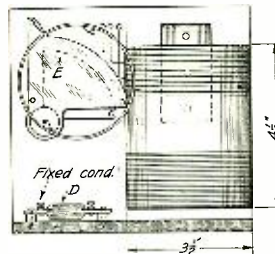

Fig. 4

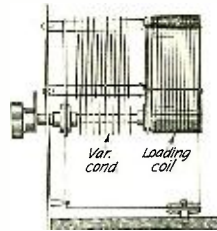
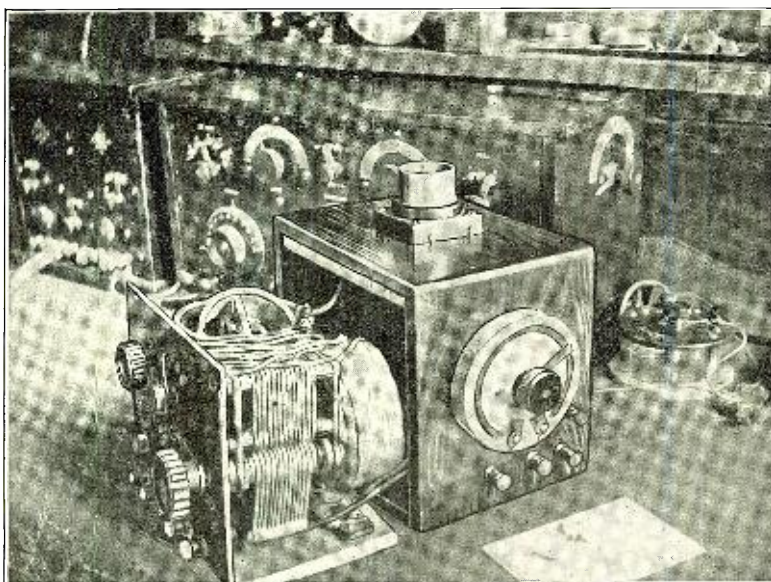

Fig. 5

Details of the Inside of the Set, Showing Arrangement of Coils and Condensers.

I think a smaller condenser of a different make could be used to good advantage. With a small condenser such as a "Connecticut" and a little rearrangement of the panel, the vacuum tube could be mounted inside the panel very nicely. However, I prefer to have the vacuum tube easily accessible for the purpose of removing it while en route. Instead of putting the tube

DESCRIPTION
Procure a piece of formica, bakelite, or fibre to fit snugly into a box 6 3/4" x 7 3/4" x 6" (see Figs. 1 and 2), or as nearly this size as possible. Do not get a smaller box than this, and be sure to fit the panel to the box you are going to use, first. The box may now be prepared or rather finished to suit the individual taste. In my
(Continued on page 920)



The view on the left shows the inside of the set removed from the cabinet. On the right is the diagram of connections of this unique set.

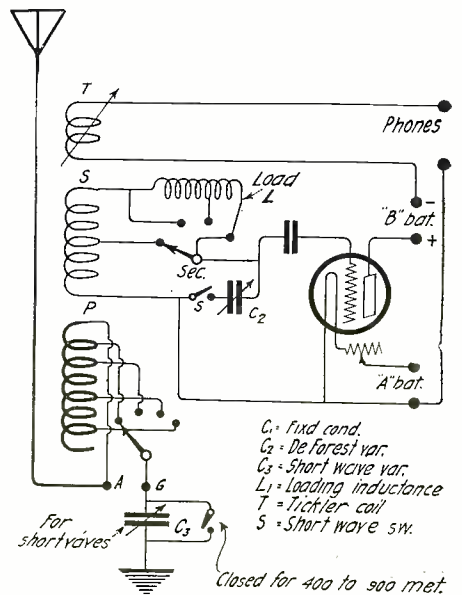

C₁ - Fixed cond.
C₂ - De Forest var.
C₃ - Short wave var.
L₁ - Loading inductance
T = Tickler coil
S = Short wave sw.

Construction of Ball-and-Cup Variometers

By EDMUND S. SMITH

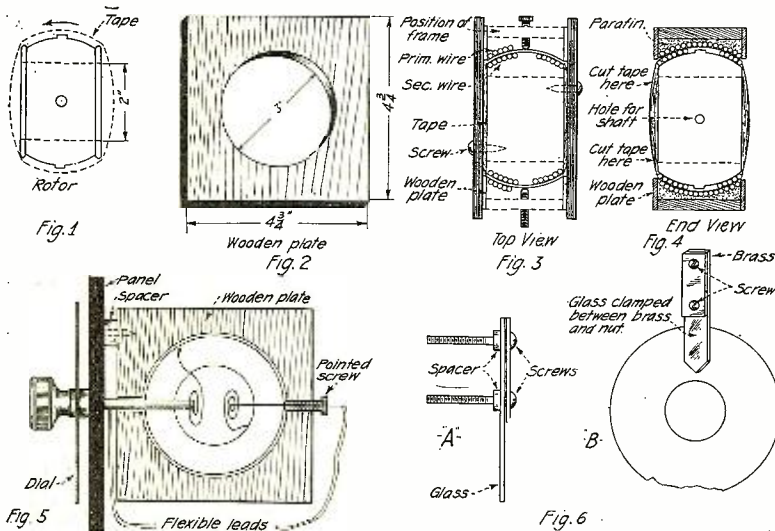

Complete constructional details of the well known type of variometer used in the regenerative sets. Following the instructions given in this interesting article, any amateur may build his own.

It is an admitted fact that this type of variometer is more efficient than any other, due to the close proximity of the two coils, allowing maximum energy to be transferred from one coil to the other and therefore the maximum ratio of inductance is obtained. But owing to the difficulty of constructing this type, amateurs prefer to make their variometers of two cylindrical tubes, in which case, in order to rotate freely, the tubes must be of such different diameters that the efficiency of the variometer is greatly reduced.

Where the usual procedure of constructing ball-and-cup variometers is followed, it is next to impossible for the average experimenter to wind the outside coil, which, for convenience we will call the primary, successfully, as the wire must be wound on the inside of a concave surface. However, if made in the following manner it will be found to be a comparatively simple task.

A rotor, for the secondary, is first procured. It can be turned on a lathe to the shape shown in Fig. 1, or bought directly from a supply house. It should have a diameter of 3 1/2" and a thickness of 2". The size of the large inner hole should be at least 1 1/2" in diameter. It is wound full of No. 24 D. C. magnet wire (about 24 feet), and the ends of the wire passed thru small holes drilled near the faces. The whole is then dipped in paraffine or

some other insulating compound to hold the wire securely in place. When set, a few yards of three-eighths inch cotton tape (do not use friction tape) is wound at right angles to the length of the rotor, so that each turn overlaps its predecessor. This tape is only temporary and will be removed later.

A 3" length of three-sixteenths inch brass rod is shellacked into a hole drilled exactly diametrically in the rotor, extending partly thru the center hole, as shown in Fig. 5. It should be threaded for 3/4" at the exterior end to accommodate a knob and dial. Exactly opposite this shaft a small countersunk hole is drilled. See A, Fig. 5. Drill the same size hole thru a 10-32, or 10-24 machine screw, and sharpen the end opposite the head to a point, which will act as a pivot for the rotor. A fairly heavy copper wire is inserted thru the screw and rotor, to the inner end of which is soldered one connection from the secondary. The other secondary connection is soldered to the shaft. Flexible leads are then soldered to the external ends of the copper wire and the shaft, as illustrated in the cross-sectional view of the variometer, Fig. 5. Due to the proximity of the coils, connections must be taken off in this manner.

A frame of maple or other hard wood is made with outer dimensions of 4 3/4" square by 2" wide, wood about three-

eighths inch thick. Equi-distant from the edges a hole is drilled in two of the sides of the frame. These should be drilled together in order that they may be exactly the same. One hole is threaded for the pointed screw. Two wooden plates are made of dimensions shown in Fig. 2, with holes 3" in diameter in the centers. Two blocks measuring about 5" square (C and D) are temporarily tacked to these plates. C and D are screwed on each side of the rotor as shown in Fig. 3.

The primary is then wound upon the tape on the rotor. When about one-half way across, a space of 1/4" should be left for the bearings, otherwise the rotation of the shaft will wear away the insulation on the primary winding, thereby short-circuiting the two coils. The leads of the primary coil are brought out thru small holes in the wooden plates, one on each side. The inductance of this coil should exactly equal that of the secondary, and this may be brought about by using the same size wire and the same length, 24 feet. After completion, one side of the frame is removed and the rotor with its two windings is inserted, making sure that the shaft projects thru the hole meant for it. C and D are tacked to the frame thru their respective plates. Any small cracks that may be left on any of the edges should be filled with paraffine to make them liquid-tight. The variometer is now ready to be filled with melted paraffine or other insulating compound. Be sure the compound is very well melted so that it will run in between the primary wires and hold them securely in place. When hard, C and D are removed and the wooden plates permanently fastened to the frame. (See Fig. 4.) C and D were only on the frame temporarily in order to prevent the melted compound from leaking out between the coils.

The tape is now cut at places shown in Fig. 4, and by pulling each remaining strip out separately, it will be found an easy matter to remove all the tape. Be sure to wait until the compound has thoroughly hardened, as otherwise the wire will be pulled out of place when removing the tape. You will now have a variometer whose coils have a separation of only about twenty-five thousandths of an inch.

It can be mounted on a panel as shown in Fig. 5, using a spacer, which can be made of several washers, to separate it (Continued on page 892)

AUDIO FREQUENCY TRANSFORMER BUILT FROM AUTO SPARK COIL SECONDARY

By G. H. STACKPOLE, JR.

Here's your chance, amateurs, haul out your antiquated Ford spark coil and make it work for you.

Here's the "how." Cut from stove pipe iron, enough laminations, 3/8" wide by 3" long, to make a closed core transformer. About 15 plates or laminations are enough for each leg of the core. Assemble two legs of the core and tape loosely.

Take a fibre tube, 1/2" in diameter by 1 3/4" long, insert a dowel and mount for winding.

We will take up the secondary next, since we determine the primary from this coil.

Weigh the secondary coil; perhaps it weighs 3 oz., subtract 1 oz. from the total weight and call the remainder the weight of the wire, since the paper on such a tube weighs about an ounce. In a lb. of No. 40

wire there are 33333.33' of wire. No. 39 wire has 26315.79' to the pound.

In 2 oz. or 1/8 of a lb. of No. 40 wire, there is 8 ÷ 33333.33 = 4166.66' per 2 oz.

Now to determine the ratios: A good ratio is :: 4. Dividing 4166.66' by four will give the number of turns in feet to be wound on the primary.

To determine the number of feet of wire in a single layer on the primary tube, may be done in this way.

The formula is:
(D x W x L x n) ÷ 12 = No. ft. in a single layer.

Where: W = 3.1416
D = (Diameter tube) .5"
L = (Length of winding in inches) = 1.5"

(Continued on page 896)

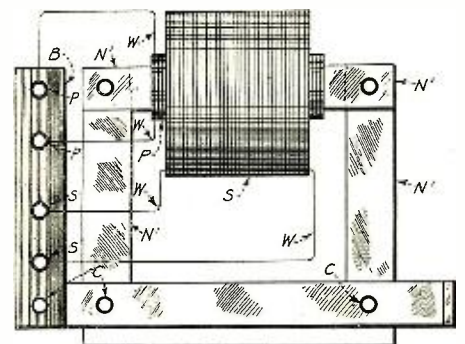

Here Boys is a Cheap Amplifying Transformer That You May Easily Build Yourself.

A. C. for Heating V. T. Filament

By Prof. M. MOYE*

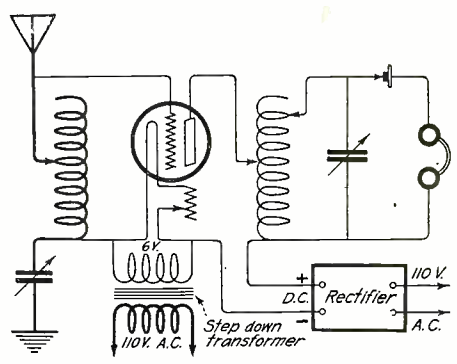
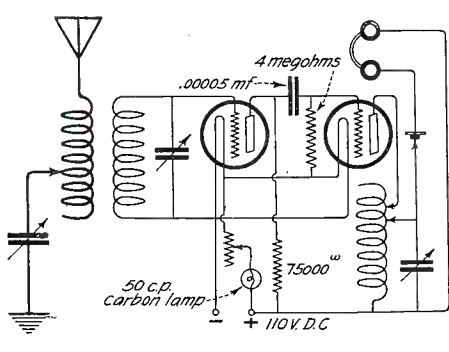
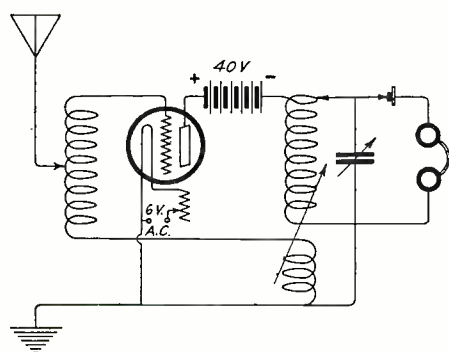

Here is Something New to Experiment With. The Hook-up on the Left Shows a Receiver Using Six Volts A.C. as a Supply for the Filament of the V.T. Without Potentiometer or Other Instrument Than a Crystal Detector. In the Center is a Diagram of a Detector and Resistance Coupled Amplifier Using the 110 V. D.C. On the Right is a V.T. Detector Entirely Supplied With A.C., Which is Rectified for the Plate Only.

WORKING with the hook-up described in RADIO NEWS for January (p. 447), I found I could even dispense with the potentiometer, provided receivers are put, with a galena detector, on shunt to a tuned circuit on the plate side of the valve.

Not the slightest humming is to be heard, while signals come loud and clear, the tuned circuit acting as a further magnification. The explanation is that this circuit responds to the high frequency of wireless signals but remains deaf and dumb to the very low frequency of A. C. (50 periods per second).

for any case of H. F. magnification where a tuned circuit can be provided in the plate side of the last V. T. of the receiving set.

When using a tuned circuit on the plate side of a V. T. working in H. F. amplification, the signals being detected with a crystal in shunt with the tuned circuit, you can dispense not only with the four volts accumulator but even with the "B" battery, drawing any voltage, high or low, from the mains. As explained in a previous note, the tuned circuit effectively drowns any perturbing noise and wireless signals come quite loud and clear.

steps resistance amplification. On the positive lead to the filaments, a carbon filament lamp provides the right voltage for the correct heating. A small rheostat will be useful.

For A. C. work, a rectifying device is needed for the high voltage, but not for heating the filaments of V. T. A very good rectifying device was given in RADIO NEWS, February, 1921, issue, p. 540. A very simple hook-up is given there which is also self-explanatory.

Experimenters can see that no cell nor battery is needed and dispensing with them will be welcome in many cases.

The method seems general and useful

for D. C., the hook-up is very simple, the scheme being self-explanatory, two-

* University of Montpellier, France.

A Tube Transmitter Using A. C. on the Plate

By D. S. BASIM

THERE is no doubt but that tube transmitters are the coming thing, and before the winter is over there will be a large number in use. Straight C. W. is fine for the fellow who can afford it, but a few of us still belong to the "Limited Pocketbook Fraternity," and to this small group this article is directed.

There is no question but that modulated C. W. has it all over pure C. W., for the present at least, and the most efficient way to modulate it is to use A. C. on the plate. The only A. C. that the average amateur has access to is the 60-cycle lighting current; true this gives a low note, but one which is clear and musical and carries thru static very well. Considering the simplicity and low cost of construction and operation of this set it should prove quite popular.

few, if any, have given real constructional data for building a simple and efficient outfit for 200 to 350 meters; also they fail to give any hints on operation or to tell the reader what to do in case the set refuses to work the first thing. In this little article I will endeavor to supply these details.

age transformer thru the plate coil.

The high voltage transformer is not difficult to construct, and as several good articles on their construction have appeared in a number of magazines the writer does not think it necessary to give details on this.

Of the number of articles written on this subject that have come to my attention,

The exact efficiency of the following outfit has not been accurately determined, but five-tenths amps. were put out on a single wire 50-foot antenna using a Western Electric VT-2 tube; no doubt this radiation could be increased by employing a larger antenna.

CONSTRUCTIONAL DATA.

The grid-plate coil consists of 70 turns of No. 20 S. C. C. wire wound on a tube 4" in diameter and 5" long. A well shellacked "Hominy Grits" box will answer the purpose very well.

The filament of the tube may be lighted by a battery, separate transformer or an extra winding on the power transformer. However, if the same transformer is used to supply the high and low voltage, a relay ought to be used to make and break the high voltage circuit while if a separate transformer is used the key may be placed in the 110 side of the step-up transformer.

To accomplish anything at all some form of a hot wire ammeter is necessary; however, if you possess none put a small battery lamp in your antenna lead. This makes a first-class little indicator. When you purchase the bulb, look on the carton and find what the ampere consumption is, in this way a fairly accurate idea of your radiated amperage may be attained. It will be best to start with a 2 or 3 tenths amp. lamp. You may short this lamp when full adjustments have been made.

ADJUSTMENTS.

Slip the antenna coil over the coupling coil a little toward the plate coil side of the center, and place a few turns of wire in the circuit if your antenna is large or nearly all if it is small. Light the filament, press the key and with the insulated grid wire touch the various taps on the grid coil, changing, if necessary, the plate connection to its various binding posts. Next, slip the antenna coil toward the plate coil until best radiation is secured.

If you have no wave-meter the best way to arrive at your wave-length is to have

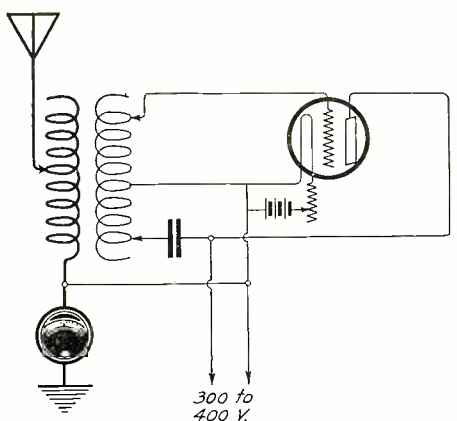

Here is a Simple C.W. Set That Operates on A.C. The Transformer Supplying the H.T. May Easily Be Built.

A tap is taken from the center of this winding and on the side of this center taps are taken every five turns (grid coil) while on the other side of the center a tap every ten turns (plate coil). These taps should be made by leading a loop of the wire thru a small hole in the tube and brot to binding posts on the end of the tube as the antenna coil is to slide over this coupling coil.

The antenna coil consists of 30 turns of No. 20 S. C. C. wire wound on a 2" section of a "Quaker Oats" box. Taps are to be taken every three turns by scraping the wire bare for 1/2" and twisting a small loop. After these coils have been wound they should be shellacked well and put away to dry.

The condenser consists of two sheets of thin brass 2" x 3", separated by a sheet of mica. The whole can then be clamped between two pieces of bakelite. The capacity of this condenser is not critical as it merely prevents the shorting of the high volt-

(Continued on page 892)

A Mental Telegraf

By MAURICE BUCHBINDER

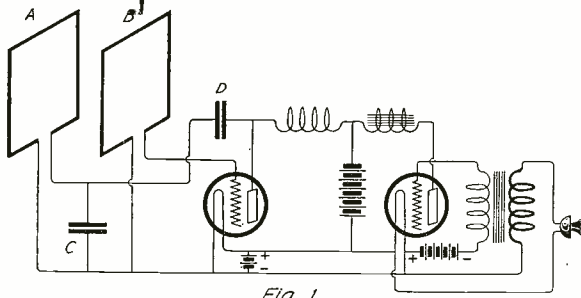

Fig. 1

Description of Items in the Transmitter Unit.

A—10 turns flexible cotton covered wire, No. 18 about, 10"x12" sewed in the plane of back of vest, wires spaced about 1/8". B—10 turns coupling inductance with same dimensions as above and coupled thereto. C—Tuning condenser for 400 M. capacity of which is 0.0005 mf. Can be thin mica with tin foil plates at 3 sq. inches in area. D—Stuffing condenser to keep B battery from short circuiting; capacity 0.01 mf. The high frequency choke is a DeForest L-100 coil. The audio frequency choke can be a single 1000 M. telephone (No. 66A Western Electric Co.). The voice transformer is a 201-C Western Electric. The B battery unit consists of 60 flashlight units. The modulator grid biasing battery is made of five flashlight units. The filament battery is a 4V storage battery.

NEARLY everybody is familiar with the theatrical act wherein somebody in the audience whispers the name of a song to one of the performers and then is greatly surprised and imprest to hear the resounding notes of the called-for melody, from the stage. Or maybe it is the name of a person or of a thing which is thus transferred in utter disregard of space and time.

The superstitious ones in the crowd will, on being confronted with such a phenomenon, be inclined to lay it to mental telepathy, a transference of non-physical thot thru physical space, in spite of the incongruity of the explanation. The skeptical man will say it is all a "put up" job between some pseudo spectators and the performers, but your scientific minded fellow will think hard and try to devise a means of doing the work.

It is the object of this article to describe in a not too detailed way an apparatus which the author will call the "mental telegraf," which is capable of transferring whispers over a range of 150', capable of absolute concealment as to both receiving and transmitting ends,—which has been constructed and operated for the purpose mentioned in the first paragraf. Of particular interest is it to Radio amateurs because it reveals the manifold applications of their hobby. The idea is original, so far as known by the writer, who was largely instrumental in perfecting it.

The first thing that comes to mind when we think of the transmission of intelligence is,—radio waves. Yet second thought will show that for the purposes we have in view, radio waves are not suitable. For a distance of 150' waves of extremely short

length (50' or so) would have to be used before the effect of true radiation could be noticed. Stable transmission of speech by means of an oscillating vacuum tube in a simple circuit is unthinkable at a frequency of twelve million cycles.

The next idea that strikes us, of course, is high frequency induction. Why not build a high frequency transformer of exceedingly loose coupling (150' between primary and secondary), impress the speech on the primary, and pick it up on the

secondary? The beauty of this method, if it works, is that the two circuits, that is, the two people carrying them, can move about freely and yet carry on their intercourse with ease. It was found that with a single vacuum tube receiving and a single tube sending, with the primary a square coil of 10 turns and

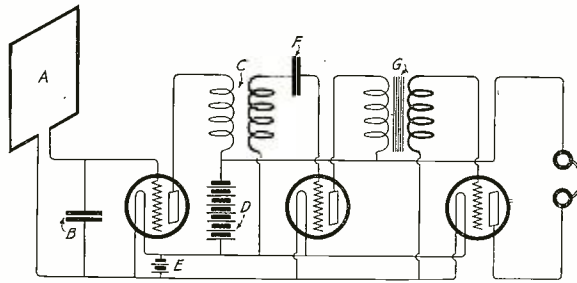

Fig. 2

Diagram of the Receiver Unit and Description of Instruments Used.

A—10 turns coil same as transmitter coil. B—Tuning capacity adjusted to 400 meters with coil A. C—R. F. transformer; honey-comb coils with turns taken off until tuned to 400 meters. D—B battery unit 30 flashlight cells. E—4-volt storage battery. F—Stopping condenser, 0.0005 mf. mica dielectric. G—A. F. transformer; Federal, Acme or Century. The vacuum tubes used are as simple as possible, this being necessary of course to save in weight, space and reliability. No rheostats were found to be necessary and the storage batteries have sufficient capacity to serve thru a reasonable time. A cut out switch for the batteries, which is the single control for the operator is brot out for easy and concealed use. Thus only when bulbs are actually used are they lighted.

body in the plane of the coil did not appear to alter either the tuning or the current in that circuit. With this much found out, the rest was comparatively easy and merely a question of design.

Of course speech transmission is something far more complicated than mere tapping of dots and dashes. It was decided that to receive the signal with suitable audibility, a separate oscillator tube and modulator tube would have to be used in a conventional Hushing circuit. For receiving one-step of radio frequency tuned amplification and one of audio frequency after rectification was used.

The next problem was that of picking up whispers by means of a transmitter concealed on the chest. The ordinary carbon back transmitter, as any amateur knows, is far too sensitive for that purpose. We nearly fell over this stumbling block when working out the problem. Fortunately, we ran across the dictagraf transmitter with its polished spherical carbon balls, and it worked beautifully.

The next and last problem was that of concealment. It was the easiest of all. The coils are sewed into the back of a canvas vest. In the pockets of this vest are placed little "B" batteries (flashlight units) fixt mica tuning condensers, the necessary transformers and chokes, the vacuum tubes, and in the lining, special two-ampere hour lead batteries. The entire apparatus, when arranged in the vest, weighs not more than 15 pounds for either sending or receiving units and is so economical in space that it can be worn under a full dress or business coat with suitable padding. For receiving, head telephones are, of course, necessary. But

(Continued on page 929)

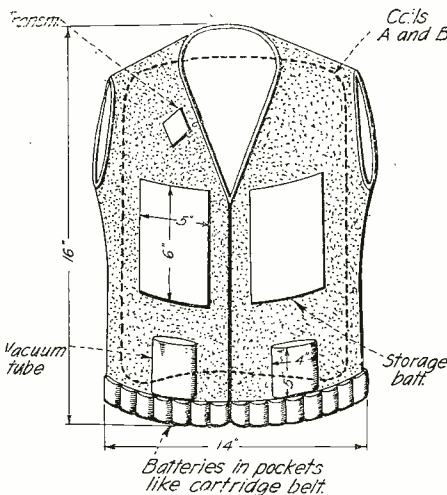

This Sketch Shows How the Various Parts of the Set Are Fixt in Pockets on a Canvas Coat That is Worn Under the Dress of the Operator. Specially Built Storage Batteries Are Used in Two Large Pockets.

12" side, and the secondary identical, signals could be transmitted from one circuit to the next, by tapping the grid, thru a distance of over 150' at a wave-length of 400 meters. Furthermore, the immediate presence of the

WASHINGTON'S BIRTHDAY RELAY RESULTS

By H. W. KIRWAN, 9XE

ON the night of February 21—the biggest free for all relay was run thru-out the United States and Canada. An actual count of the answers received showed that over 7,240 amateurs sent in reports. The message was one from Mr. Harding, now President Harding of the United States. It consisted of 30 words and 14 of them came thru from the Atlantic Coast in great shape, 14 from the Pacific Coast in

better shape, and the other two words were easily copied from the middle west.

COMPLETE CORRECT MESSAGE.

May the spirit of Washington be our guide in all our national aspirations and may the current year mark the return of tranquility, stability, confidence and progress thruout entire world.

Fourteen of these words representing the first, third, fifth, etc., were sent from the Atlantic Coast; fourteen representing the second, fourth, sixth, etc., came from the

Pacific Coast, and the remaining two from the Mississippi Valley. Some perfectly wonderful receiving was done and some real records made and as a whole it was a very creditable performance of the real amateur body. If this magazine were large enough it would publish each and every name of those who participated, but we don't believe that it would be interesting. As far

(Continued on page 929)

The Vacuum Tube In Radiotelephony

By JOHN SCOTT-TAGGART

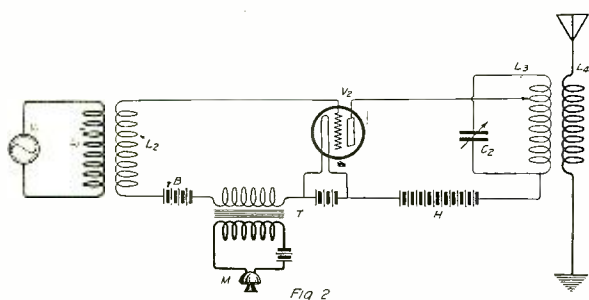

In This Circuit the Variations of Potential of the Microphone Are Impressed Upon the Grid of the Power Amplifier.

THE essence of valve radio telephony lies in the system of modulation. The production of oscillations is an easy matter; the three-electrode valve, the arc and the high-frequency alternator have all been used for the production of the carrier wave which is to be modulated by the microphonic currents. The purity of the waves produced and its adaptability to small power work make the valve an ideal generator. The other sources of high-frequency energy cannot be controlled in the large number of ways that it is possible to modulate the output of a valve, but on the other hand practically any valve modulation system which can be used with an arc or high-frequency alternator can also be used with a valve generator.

THE AMPLIFICATION OF MODULATED ENERGY.

It is not essential to proceed further, once a suitable method of modulating oscillations has been devised. Even if the power thus modulated is very small, yet long range telephony may be obtained by amplifying the weak modulated energy. This method is very old, and is an obvious one. The fundamental circuit is shown in Fig. 1. Across the grid *G* and filament *F* are applied the weak modulated oscillations which will be usually produced by an oscillating valve. The valve *V* will amplify these weak oscillations, and the power output will be developed in the antenna, or in a circuit coupled to the antenna. Several valves may be connected in cascade if the final power is insufficient, the coupling consisting of impedances, or air core (or iron core) high-frequency transformers.

The amplifier arrangement of Fig. 1 which lends itself to all systems of modulation has a high efficiency. The "master oscillator" valve may operate off the same source of filament and anode current as the power valve *V*. The normal potential of the grid *G* may be such that the operating point is half-way along the grid-potential-anode-current curve of the amplifier valve *V*. This curve will usually, and should, lie completely to the left of the grid zero ordi-

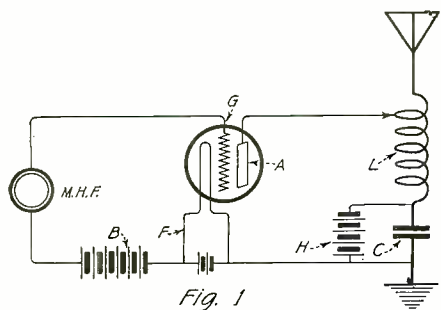

This Diagram Shows the Typical Circuit of a Power Amplifier Tube as Used in Radiophone Hook-ups.

nate. This necessitates a source of e.m.f. *B* to give *G* a negative potential. A battery may be used, but since the radio frequency e.m.f.'s are probably high, it is possible to utilize the potential drop across the grid leak of the master oscillator to give *G* the requisite potential. The grid leak is preferably a wire coil from which a tapping may be taken. It will usually be preferable to operate *V* not half-way along its curve, but at the foot of it. No anode current will now flow thru *V*, except when the modulated oscillations from the master oscillator vary the potential of *G*. Preferably, this latter coupling is effected by inducing the modulated oscillations into an aperiodic coil across *G* and *F*. The coupling between this coil and the oscillator is adjusted to produce the maximum output from *V* without producing distortion. The above amplifier system has the disadvantage that the aerial

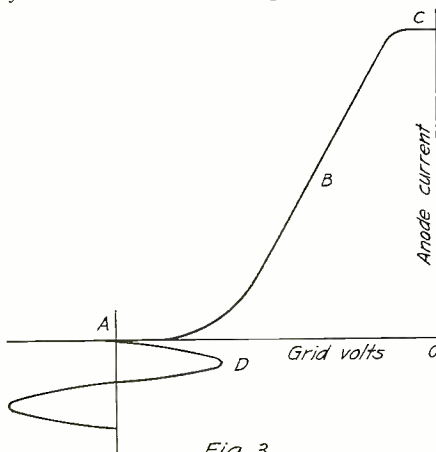

This Curve Shows the Variations of Grid Potential When the Microphone is Spoken Into.

circuit has to be in tune with the frequency of the local oscillator. This disadvantage does not arise if a fixed wave-length is used.

MODULATION SYSTEMS.

We now come to the important problem of providing a modulation system which will give perfect articulation. The following are some of the more important methods of modulating the high-frequency output of a valve:—

1. Grid potential control consists in varying by means of a microphone the normal operating point on the anode current curve of an oscillating valve. The output of the valve depends largely on the normal grid potential. This system is critical in its action and is not to be recommended, tho the principle has been utilized in very many circuits.

2. An amplifying power valve is used in conjunction with a separate source of pure oscillations which excites the grid circuit of the amplifying valve whose output may be modulated by any of the following methods:—

(a) The grid "base-line" potential (or operating voltage) is varied by a microphone arrangement.

(b) The anode voltage is varied microphonically.

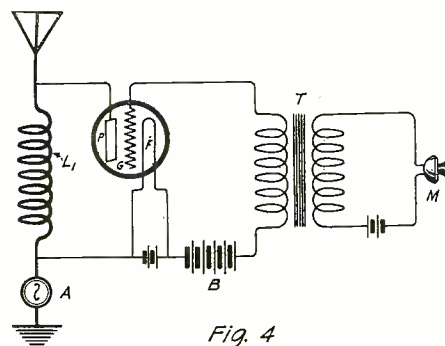

In This System of Modulation the Tube Shunts the Inductance and the Leakage Thru it is Controlled by the Grid Variations.

(c) High frequency energy is absorbed from the input grid circuit by the microphone arrangement.

A form of the 2 (a) system is shown in Fig. 2. A source *V*₁ of pure continuous oscillations induces into the grid circuit *L*₂ of *V*₂. The grid is given a negative potential by a source *B* having an e.m.f. comparable to the e.m.f. of the oscillations in *L*₂. A microphone *M* and microphone transformer *T* will vary the grid base-line potential during speech. Conditions are roughly illustrated in Fig. 3. When not speaking, the grid potential *A* is such that the oscillations *D* do not cause the grid potential to pass beyond the bend in the curve. Consequently, the power developed in the output circuit of *V*₂ (shown this time loosely coupled to the antenna circuit) is very small. When *M* is spoken into, the positive half-cycles of the microphone potentials cause the grid base-line to move towards the bend. The oscillating potentials of the grid pass up the steep portion of the curve to an extent depending on the movement of the grid base-line produced by the microphone. The output of *V*₂ increases greatly, and will be directly proportional to the microphone potentials. This system gives very good speech.

The 2 (b) arrangement differs in that the microphone *M* and transformer *T* are removed from their position in the Fig. 2 circuit, and connected in place of *H*. The power developed by *V*₂ is directly proportionate to the anode voltage. This anode voltage is supplied by *M* and *T*, and the output is consequently proportional to the microphone potentials, which is what is desired for good articulation. Obviously the power developed by *M* and *T* is too small for general use, and valve amplifying arrangements are used to provide a suitable source of e.m.f. for the anode circuit of *V*₂. It will be noted that this arrangement, like the previous one, is a "quiescent aerial" system. No energy is radiated, except when speaking. Sometimes, however, a source of e.m.f.

(Continued on page 898)

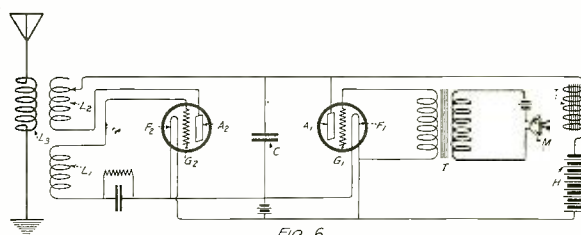

This is the Choke Control or Constant Current Modulation System in Which One Tube is Used as Oscillator and One as Modulator.

The Radio Compass

By LIEUT. COMMANDER FRANK LUCKEL, U. S. NAVY

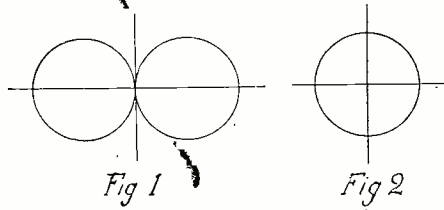

Fig. 1 Shows the Current in a Coil or Loop Aerial, While Fig. 2 Shows Same in a Vertical Aerial.

THE development of the shore radio compass station has been so rapid that comparatively few people have been able to keep themselves informed of the working principle and its application. Many who are otherwise well informed do not know what a radio compass station is and some do not know what it is used for. While these stations have only recently reached a practical development, the compass coil is by no means a new invention. Early in the present century investigators discovered that a coil of a number of wires wound upon a frame picked up a maximum of current when parallel to direction of propagation of a transmitting station which was radiating on a wave-length corresponding to the period of the coil. Conversely, the signal was a minimum when the turns of the coil were at right angles to the bearing of the transmitting station.

No practical application of this principle to determine the direction of a distant transmitting station was at first possible on account of the extremely small currents set up in the coil, even with the largest size loop that it was possible to use. With the advent of the vacuum tube amplifier it was possible to amplify up these faint signals so as to make them readily audible. Rapid strides were made under the stress of the recent war, in the development and amplification of the radio compass on land, at sea and in the air. No practical success has yet been attained in the development of a coil for submarine or subterranean use. What was perhaps the most surprising step in the development of the radio compass was the use of a coil on the German Zeppelins to determine their bearing from a German shore station transmitting intermittently on a certain wave-length. The Allies used the compass to good advantage in determining the position of German submarines.

All radio compass coils in practical operation in the United States operate on the principle that where lines of force cut the coil, currents are induced. These currents are maximum when the greatest number of lines of force cut the coil. When the turns of the coil are parallel with the direction of the propagated waves emitting from the transmitting station, the greatest number of lines collapse upon the coil and the maximum current is induced. As the coil is revolved about a vertical axis the current becomes at first slightly diminished and later the decrease is more rapid as the coil approaches a position at right angles to the transmitting station. This gives a broad maximum and a sharp minimum. In order to understand this, it is necessary to remember that the actual line of a strain in an advancing wave front are at right angles to the direction of propagation. For this reason the maximum number of lines are embraced when the coil lies in the direction of propagation.

The signals will be a maximum when the coil is pointed towards the transmitting

station and they will be a maximum again when the coil has been revolved 180 deg. and the other side is pointed toward the station. There will be two minima at right angles to these two maxima. This is known as the bi-lateral effect. Unless there are practical considerations that limit the working arc to less than 180 deg., or unless several stations are taking bearings at the same time, it is impossible to be certain which of the two bearings is the correct one. This difficulty can be overcome by superimposing the signals of a vertical antenna upon the signals from the coil. This gives what is known as the uni-lateral effect. Without going deeply into the theory, we will plot the signal intensity of a single coil, assuming a maximum value of one. This current value will reach a positive maximum when one end of the coil points toward the sending station and after passing thru the zero position it will reverse and reach a maximum in the opposite direction, when the other end points toward the transmitting station. Both these maxima give a maximum intensity of signal even tho the current flows in one direction in one semi-

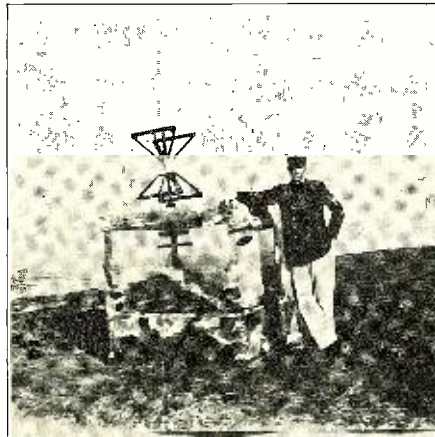

Experimental Type of Radio Compass Station Used to Determine the Best Point to Locate the Station Along the Coast. The Hut in Which Are the Instruments, is Screened With Wire Cloth.

circle and in the opposite direction in the other.

The curve, Fig. 1, shows the current in a coil. In the case of a vertical antenna the signal is positive thruout. If we assume a maximum strength of antenna current of one, we would have the curve of Fig. 2 which always has a positive effect. If we couple the antenna, which is non-directional, to the coil, we have an effect which may be grafically shown by superimposing one of the above curves upon the other. The two components are shown in dotted lines and the resultant in full line, Fig. 3.

It will be noted that this new curve gives a minimum when the coil is pointed at right angles to the direction of the transmitting station, and that this minimum is not very sharp. It does, however, give only one minimum instead of two. In the practical operation of this coil the approximate minimum is first determined using the uni-lateral system. Then the antenna is disconnected and the bi-lateral system used to determine the exact minimum. Two minimum positions may be found, but the preliminary observation will indicate which of these is the correct one.

The practical development of the United

States shore radio compass stations provides for furnishing bearings from a single independent compass station to vessels from 50 to 100 miles at sea. It also provides for accurately determining the position of ships near shore or at harbor entrances by bearings from two or more stations using group control. The group stations are controlled by a control station. Radio, landwire, and submarine cable may be used for communication between the control station and the other stations of the group.

At present the radio compass is used in two ways, insofar as navigation is concerned: In one system, the compass coil is mounted on shore and the ship's bearing is furnished after it is determined by an observation taken on the ship's signals. In the second method, the coil is mounted on board ship and bearings are taken on a shore station or another ship. A similar method is utilized by air craft to take bearings on a shore station, a vessel, or other air craft. Both systems are used in the United States, but our shore radio compass stations are being developed to use the first system. The advantages of each system are as follows:

ADVANTAGES OF COMPASS COIL ON SHORE.

Station can be calibrated and errors carefully plotted.

Not so much metal to distort waves and introduce errors.

Not much electric current in vicinity to cause distortion.

Not necessary to transmit continuously and transmission is only necessary when bearings are being taken.

Power used for transmission can be varied to suit conditions and distances.

Personnel should be more efficient, owing to constant practice and specialization.

Station can usually be located at water's edge and at low elevation.

No extra equipment necessary on board ship, and the ship's radio equipment is all that is needed.

Not so much interference.

Permits present existing shore radio facilities and landwires being used in many instances.

ADVANTAGES OF SYSTEM HAVING COILS ON BOARD SHIP.

Operation of coil is entirely within the control of the ship's personnel, who can take as many bearings as they desire.

Results of bearing will be available sooner than is the case when using the first system.

Not the uncertainty and difficulty which is experienced when it is necessary to call
(Continued on page 894)

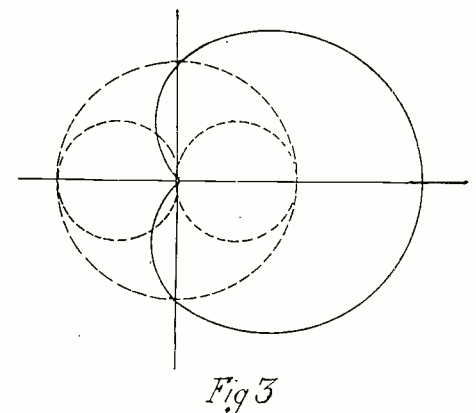

Fig 3

This Diagram Shows the Result When the Two Components Shown in Figs. 1 and 2 Are Added.

Who's Who in Radio

No. 5

PROFESSOR EDOUARD BRANLY

EDOUARD BRANLY, son of a professor of the Paris University, was born in Amiens, France, Oct. 23, 1844.

He made a serious study of literature at the St. Quentin College, until his 17th year, when he turned his attention to science, which attracted him. He entered the Scientific Section of the Ecole Normale Supérieure of Paris in 1863, where he spent three years, leaving in 1863 with a Licentiate's Degree in mathematics and physics.

He was appointed professor at the Bourges College, but was soon called back to Paris as Chief of the Science Faculty's physics laboratory, but his first experimental researches were interrupted by the war between France and Germany in 1870-1871.

Professor Branly, in 1873, was made Doctor in Physic Sciences, and was appointed sub-director of the laboratory.

In the old, shabby building of the Sorbonne Institute, his working facilities were poor, and no help was given to those who devoted their time to the work which was for the benefit of all. For this reason he was glad to accept a position as professor of physics at the newly formed Catholic Scientific University of Paris, in 1875, hoping to be helped materially. The management of the new Institution promised to furnish him with an up-to-date, specially-built laboratory, but this promise was not kept, and a provisory installation which he still uses today, was all he obtained.

Fearing that the new University would have to close, owing to lack of funds, Professor Branly began the study of medicine in order to make a living, in case that misfortune befell him. He studied during his spare time, and consequently could do very little in the way of experimental researches.

In 1882 he received his Medical Doctor's degree, and in 1887 was again able to carry out his experiments.

He first observed the modification of electric losses in darkness, determined by the nature of the electrified conductor, but Professor Branly's researches, that have been called to the attention of the world, are those that led him to the discovery of the imperfect contacts that have an intermittent

conductibility under certain influences, such as the oscillations radiated from an oscillating circuit.

In his books, published in 1890 and 1891, are described several types of the "Radio-conductors, some of which have single contacts and others have multiple contacts. Among the latter, the tubes containing powdered iron, nickel, gold, etc., were considered particularly remarkable, owing to the simplicity of the construction.

FIRST WIRELESS SET.

Nov. 24, 1890, Professor Branly made a demonstration of the phenomenon before the

ceiving sets was 60', and they were separated by several walls, as the experiment was made inside a building.

Professor Branly did not only show the powerful inductive effects caused by an oscillatory discharge at a certain distance, but demonstrated the rôle of what was later called an antenna, and which consisted, in his sets, of long, metallic rods fixed to the electrodes of the spark gap and to the ends of his coherer.

Full details about this were given in several bulletins published in 1891, and the following experiments were described.

If the receiver, composed of a coherer, a battery and a bell, was enclosed in a metal box, it was not effected by powerful discharges near the receiver, while the circuit was closed and the bell made to ring if a small external wire, insulated from the metal box was connected to the coherer and the transmitter placed a distance away.

In Marconi's first experiments, the same circuit and apparatus were used that were designed by Professor Branly, but the distance between the sets was greatly increased and the experiments carried on out of doors.

It must be remembered that Mr. Marconi recognized Professor Branly's invention, when he sent the following telegram March 28, 1890, across the Channel:

"Mr. Marconi sends across the Channel by wireless telegraphy, his compliments to Mr. Branly, as this wonderful achievement is partly due to Mr. Branly's work."

This message was sent by wire to Paris from the receiving station erected at Wimereux and the telegraph office recognized the success of the new system of

telegraphy.

When, at the Universal Exhibition held in Paris in 1900, Professor Branly was awarded a first prize for his instruments, the French Government made the prominent professor Knight of the Legion of Honor, with the mention, "Has discovered the principle of wireless telegraphy."

Professor Branly made possible not only wireless telegraphy, but also carried out some researches in Radio control and designed some apparatus that can be operated at a distance. He used tuning systems and later

(Continued on page 929)



Professor E. Branly, Who Invented the First Wireless Telegraph System, Using Hertzian Waves.

Paris Academy of Science, whereby a small quantity of metallic powder was made conductive, when a spark caused by the discharge of a leyden jar occurred a certain distance away.

The receiving circuit was composed merely of a dry cell and a galvanometer hooked up to the Radioconductor or coherer, which closed the local circuit each time a spark occurred at the sending set. The resistance of the coherer was restored by a light tap on the glass tube containing the metallic powder.

The distance between the sending and re-

ATMOSPHERIC CONDITIONS IN THE TROPICS

By CHARLES A. REBERGER*

I SUPPOSE all amateurs have heard of static, but let me say—the commercial operator who is forced to work in the tropics, especially during the long hot summer months, is the only one who really realizes what static is, and believe me, he knows. How we dread it! Fame and fortune await the radio engineer who can present to the wireless world, a real true static eliminator which will prove efficient for usage aboard ships. We all know that at the present time, a number of our coast stations are using static eliminators to great advantage, but they still confess that static is not eliminated entirely.

Many of the readers have no idea how bad working conditions are during these months. Even during the winter months

* Chief Operator, S. S. Atlantic Sun.

static is very noticeable. Ask any operator who has had cause to work down in this portion of the earth during the summer and he will put up his hand and swear—"never again." For the fellow who has never been to these parts, it is very difficult to realize how bad conditions are. All day long it is a continuous roaring, grinding and crashing in the receivers. During the hours of the night it is worse—far worse. Nine times out of ten the crashes will entirely blot out all signals.

It is very difficult to work thru heavy static. Let me give you an idea. One evening we attempted to establish communication with a station in the Canal Zone, which was about 200 miles away from us, and failed. It was absolutely impossible to even hear his signals, due to the heavy atmospheric conditions. A vessel only 90

miles north of us could not read our signals altho we were then getting twelve amperes radiation and had a fine clear musical spark. Radio engineers claim a musical spark is easily read thru static interference.

A few nights later I had the pleasure of listening to Swan Island working a United fruit liner. After this station had sent each letter twenty times, the vessel informed him that it could not distinguish his characters. Only an hour before he had forwarded his "TR" to Swan Island and was no more than 200 miles south of this land station.

Operators I know personally—strong and healthy—after a year's service in the tropics, were forced to abandon the wireless game due to nervous breakdown. There is

(Continued on page 907)

The Arc and Radiotelephone Transmission

By JOHN F. BRONT

Author's Note:

(The entire object of this paper is to run over the important points of the arc converter and attempt to accelerate the interest of the amateur in the use of the arc for telephonic and telegraphic work, and show the possibilities of the adaptation of the converter to amateur work. As Mr. Gernsback stated at one time, the apparent interest of the average amateur in the development of radio telephonic work has not been quite up to the expectations of many. In the personal opinion of the writer the amateur interest in the radio telephone has been negligible. It is intended that this article may tend to show the real simplicity of the application of the arc to telephonic work and in the main give a few suggestions for construction.)

THE furore caused by the advent of the audion has apparently caused a lapse in the development of other apparatus in the non-professional radio field. The truth of the matter is that the professional field has turned its chief attention to the vacuum tube. The practical application of the amateur to the radio telephone will be looked upon with favor by all those in the non-professional as well as the commercial radio business.

At the time of the late war the trained amateur was of inestimable value to the nation at large, and at the same time a great asset to the commercial world. The value of trained amateur to the radio field of the future in a commercial way will be of incalculable value, especially when, as the present trend shows, the radio telephone will be brot up to an efficient stage of perfection and of daily use in the affairs of the day.

A combination of the arc as an emitter of continuous waves and the audion as a detector and amplifier, is an ideal basis for the perfection of the most desirable communication system. The arc converter far exceeds the audion tube as a transmitter of undamp waves from the standpoint of economy and power. The outstanding feature of the arc is the propagation of radio frequencies directly from a source of direct current, and the stability of the apparatus if constructed, attended and operated with all due regard to mechanical and electrical conventions. When certain rules are followed sympathetically with regard to the requirements of such apparatus, the converter will function with full efficiency and the desired excellence of results.

Arcs have been successfully operated at potentials ranging from 110 volts up to hundreds and thousands. High power stations favor current drawn from 500-volt machines which are designed for the production of large current values. The series or parallel operation of these machines gives a flexibility of operation rendering sufficient current supply for the individual requirements of that particular station.

In almost all types of converters, current is led from the generator thru

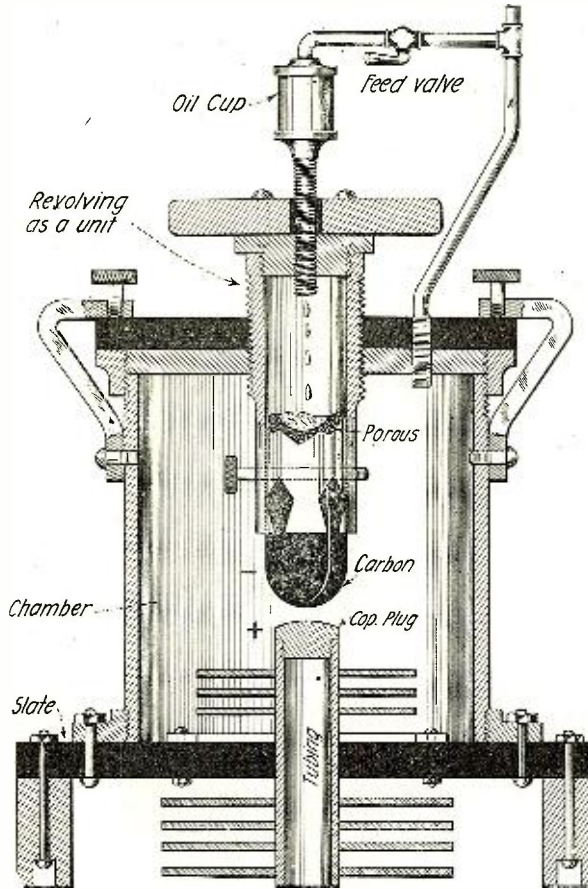

Inside View of a Low-Power Arc Converter. Note the Cooling Flanges of the Copper Electrode.

regulating resistance and iron core choke coils, thence to the arc points thru the blast coils. The functioning of the regulating resistance aids in the power ranges of the arc and at the same time guards against the overloading of the generator at the time the arc points are struck. Damage to the generator by excessive loads is prevented. The current at the arc points is increased as the arc gap is gradually widened for the maximum of power emission while the hot wire ammeter is scrutinized for the maximum of radiation in the antenna system.

In the larger types of converters (and in the smaller, well constructed) solenoids throw a magnetic flux across the gap at the time the latter is functioning. The blast stretches the flame and assists in raising the arc potential. Of further assistance in the raising of the arc potential is the envelopment of the gap in a gaseous surrounding. Steam, and volatilized kerosene, alcohol, and

producer gas, free hydrogen and others have been used in this respect. Steam, however, has failed to give more than negligible results. Producer gas has the ill effect of sooting the arc chamber walls and the electrodes and holders. Being a poor conductor of heat, the soot retards the proper conduction and dissipation of heat from both the chamber walls and the inner chamber space.

In some smaller types of converters, the magnetic blast is omitted and with fairly satisfactory results. There is the matter of expense to be considered by the average amateur, but it is an assured fact that all the pains spent upon the making of a well functioning blast will be amply repaid in the excellence of the obtained results.

It must be kept strictly in mind that in the construction of a converter of any kind whatever, a means of protection must be employed for the exusion of undue gas pressures from the interior of the chamber. In the case of hydrogen especially, the envelope is explosive to a high degree. With the hydrocarbons, explosions have nearly the same effect as those of the internal combustion engine and may be the cause of the bursting of the arc chamber.

Relief for the high gas pressures may be readily provided for by the introduction of pop valves into the sides of the chamber walls, and the adjustment of the former for opening at pressures not to exceed 20 pounds per square inch as shown by gauge. Pressures depend upon the construction of the converter but in the small converter, the pressure should not be allowed to raise above that mentioned.

Carbons of medium size will serve in the small converter. Some copper form of electrode should be employed for the anode. In this regard for the cathode, soft carbons or unknown compositions should be discarded. Considerable effect upon the operation of the arc is due to the burning down or the building up of the electrodes. Proper cooling must be provided for. High temperatures will result in the comparatively swift disintegration of the electrodes and the general poor functioning of the converter. At the same time high temperatures cause the highly accelerated vaporization of hydrocarbon bases and the resultant superheated gas soon comes to the explosive stage.

Producer gas has the quality of building up the negative electrode. The use of alcohol is recommended by the writer as the base employed for the production of a gas envelope. Mixtures of kerosene and alcohol are used with satisfaction. Producer gas is of undefinable mixtures and admission of these mixtures to the arc chamber will cause irregularities of operation, and the refusal of many small arcs to function may be traced to this very cause.

Efficient vaporization of the hydrocarbon bases is a hard matter to realize. The writer advises that in the small transmitter,

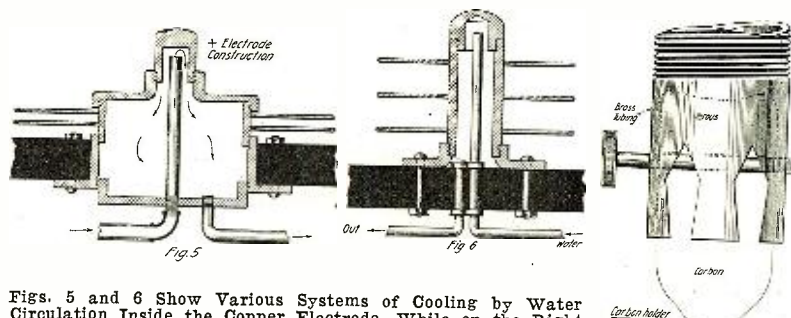

Figs. 5 and 6 Show Various Systems of Cooling by Water Circulation Inside the Copper Electrode, While on the Right is a Detailed Sketch of the Carbon Holder.

a porous material be placed about or adjacent to the negative electrode whereby the heat from the carbon volatilizes the base uniformly and the envelope is formed with little or no difficulty. Efficient cooling of the copper electrode is requisite, else irregular operation and wavering arc potentials will result. Disintegration follows high electrode temperatures.

Revolution of the carbon tends toward the even burning of the latter which is important in radio telephonic work where a steady, sharp, even emission is desired so that efficient modulation may be accomplished.

Water circulation seems the premier means for the anode cooling. Careful planning will result in the possibility of the admission of a large stream of circulating water to the copper electrode. A requisite in this method is proper circulation. This may be effected by the thermosyphon system or by input from the house water supply and outlet to waste drainage. A steady dissipation of heat from the electrodes, as well as that from the jacket, is thereby accomplished. Wide hollowing of the copper electrode will allow the admission of comparatively large quantities of water and the important factor of stabilizing the copper anode at low temperature values will be accomplished.

In this respect the following may be explanatory:

With the primary flow from the generator, current will flow into the condenser until such a time as the gap breaks down. This occurs at a time when the condenser is not at a full state of charge with certain adjustments of the arc gap. There is a division of current between the condenser and the arc circuits. The current across the gap is reduced. This raises the potential and the condenser charging rate is accelerated. At a point near the complete charge of the condenser, a discharge of the latter starts across the arc gap. The excessive current, that of the condenser combined with that of the arc gap, brings the arc points to a state of high temperature. Before the arc points have the opportunity to cool to normal or reduce their hot state

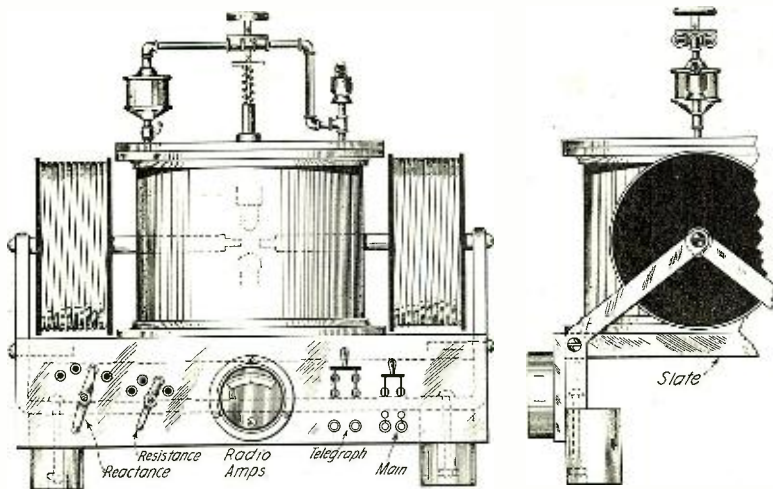

Here is An Arc Converter of the Magnetic Blast Type With All the Necessary Controls Fixt on the Base.

to a small value of temperature, the discharge of the condenser occurs again. There is a lag of the fluctuations of the temperature and the electrical fluctuations in the circuit.

In converters of comparatively low power the water cooling system may be well dispensed with and somewhat satisfactorily. Radiating flanges attached to an extension of the copper electrode thru the base of the converter into the outer air, will dissipate heat with considerable consistency.

Cooling of the arc chamber is mandatory when the heat dissipation from the electrodes is of negligible quantity. By the attachment of radiating flanges to the outer side of the jacket, a fair means of radiation of heat is accomplished, but this means is not readily recommended. The cooling of the chamber and the electrodes cannot be impress too strongly for the correct and efficient operation of the converter. Many low power transmitters after a few scratchy emissions lay down and give up the figurative ghost and refuse to function on this account alone. The matter of heat dissipation effects the vaporization of the gas envelope base, and at the same time the latter and the undue rise in temperature of the anode and cathode directly effect the arc potential, the radiated energy and the working distance of the transmitter.

In this regard, at the period of the discharge of the condenser across the arc, the excessive heat brings the electrodes to a state of high temperature. Necessarily the surrounding gas medium is highly ionized. The conductivity of the arc gap is greatly increased. Oscillations occurring at a high frequency, the electrodes are not allowed sufficient time to cool, as mentioned before, and the potential of the arc at that state is less and resistance of the gap likewise. When the current increases the electrodes have not sufficient time to reheat and consequently the gap resistance at that time is high. There is a lag of the temperature behind that of the oscillations, and the well functioning arc, therefore, must have a steep characteristic curve and consequently a high negative resistance.

The smooth operation of the arc not only depends upon the good functioning of the apparatus beneath the chamber shell, but upon the steady supply of DC to the circuits of the arc and that of the condenser. Good insulation must be maintained in both the DC circuits and the radio frequency, as well as in the base of the converter itself.

The blast bears directly upon certain potential limits of the arc length of the flame and the resultant amount of radiated or transferred energy. The employment of soft Swedish iron in the making of cores is recommended by the writer. The incor-

poration of the cores, as the frame of the apparatus, may well serve to further the compactness and the rigidity of the apparatus as a unit. The strength of the blast depends upon the applied current and upon the extend of the windings. Specifications for the proper construction of the blasts may be found in most text books from the furnish formulae relative to flux and current relations to cores and windings. Proper calculations may make it possible for the formation of the blasts in such form as to serve both as chokes and blast coils at the same time. Thrusting of the core ends thru the walls of the jacket brings the blast in immediate adjacency to the arc gap. In the construction of converters using the magnetic blast, it is important that the chamber be made of other than magnetic material to prevent magnetic shunts from the gap and the inevitable eddies. Copper, aluminum or brass may be employed in almost any kind of converter for the jacket construction. High thermal conductivity is important.

For amateur work on short waves, the insertion of the arc in direct series with the antenna and ground leads is recommended. The employment of the shunt condenser around the arc may serve in the easy adjustment of the apparatus. The condenser referred to previously, regarding the wavering of the arc current is the shunt condenser mentioned here, but in the absence of this latter, the charging and discharging of the antenna, functions almost in exactly the same manner. The shunt condenser with the arc in series with the ground and antenna proper, serves for the easy adjustment of the correct capacity values for the wave length used which is done by the change in the aerial tuning induct-

(Continued on page 892)

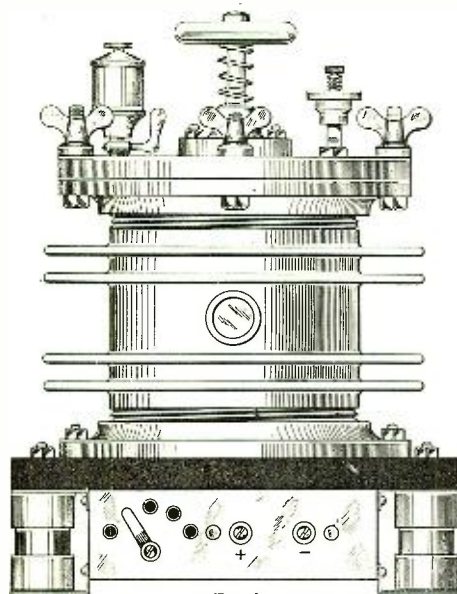

Small Arc Converter of the Amateur Type. The Body is Made of Brass and the Base of Slate; on the Top are Fixt a Pop Valve and an Oil Cup Filled With Alcohol.

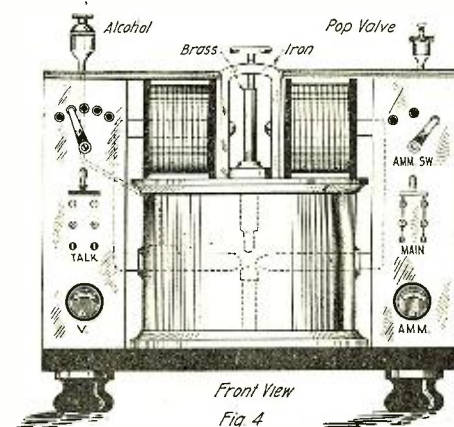
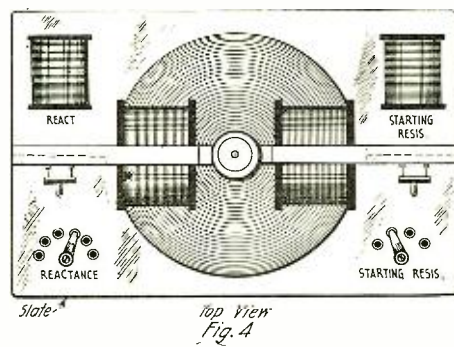

This Arc Set is Designed for Lower Power, But is Also Fitted With a Magnetic Circuit to Blow the Arc.

The Efficient Design of Vacuum Tube Telegraf and Telephone Sets

By JESSE MARSTEN

PREVIOUS to the recent complete development and understanding of the action and theory of the vacuum tube, it is probably true that transmitters were largely designed by the "cut and try method." That is, the circuits associated with the vacuum tube, and their constants were varied until the operation was considered satisfactory. Those constants, circuits and designs were then chosen which were most suitable and gave the best output and efficiency. It is probably also true that the "cut and try" method of design is still much in use in spite of our increased knowledge of the subject, and perhaps justly so. For after all, this is the ages-long method of learning everything, it is the method of experience characterized by the phrase "seeing is believing."

Taken by itself, the "cut and try" method is long, laborious and expensive. But when used in conjunction with an understanding of the tube and its circuits, it becomes a very powerful method. For the knowledge of the theory and action of the circuits, and of the functions of the elements comprising the circuits, enables the predetermination of the less difficult parts of the design. This leaves the more difficult and new parts of the design to the "cut and try" method, which is given more

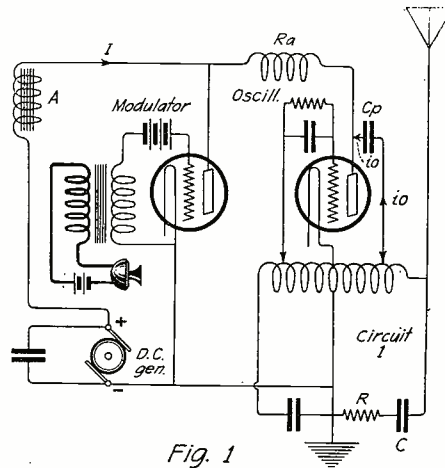

Fig. 1
In This Radiofone Circuit for Short Waves, the Constant Current System of Modulation is Used.

R. F. oscillator may be briefly described as follows: The oscillating circuit and the tube (considered as a variable resistance) are connected in shunt thru the condenser C. The characteristic of this circuit is that the current supplied by the generator is kept constant no matter how the tube resistance varies, or how the plate current thru the tube varies. This is accomplished by means of the choke coils A and R. The supply current delivered by the generator may vary either in radio or audio frequency manner. Choke coils A and R are properly designed to be of such high values that there can be no variation of the supply current (efficient choking action), the A coil preventing any audio variation in supply current in front of the modulator tube, the R coil preventing any radio variation in supply current in front of the oscillator tube. Any audio variation is permitted between modulator and oscillator tube for modulating purposes. The choke coil R at the same time serves to prevent the modulator tube acting as a short circuit (shunt connection) to the radio frequency thru the oscillator valve. Thus, since the supply current, I, to the oscillator valve is held constant, then any variation in the tube resistance, due to a variation of grid voltage, results in a plate current variation which cannot be supplied by the generator. This variation is taken care of by the oscillating current. Thus assume that the grid oscillating voltage at any given instant is such as to decrease the tube resistance, the plate current must then increase, but since I is held constant by the chokes, the increase in plate current must be supplied by the oscillating current i_o thru the condenser C_p .

Similarly the decreases in plate current must be effected by the oscillating circuit. The oscillating current i_o increases and decreases the plate current.

The action of the modulator may be briefly described as follows: The relationship between modulator tube and oscillator tube is identical with the relationship between oscillator tube and R. F. oscillating circuit described in the preceding paragraph. The two tubes are connected in shunt with reference to audio frequency currents. The supply current, I, as before, is maintained constant by means of the choke coils. The modulation tube resistance varies between two extremes due to variations of the speech voltage applied to the grid. Thus the current in the plate circuit of the modulator tube will vary in accordance with the changes in grid voltage due to the speech. But since the audio choke coil A, prevents the supply current from varying considerably in audio frequency manner, it follows that the plate current variations in the modulator must be supplied by the shunt connected oscillator tube, the only other source. Thus the oscillator tube will lose or gain current (which is added to or subtracted from modulator plate current), in accordance with the speech as the resistance of the modulator tube decreases or increases.

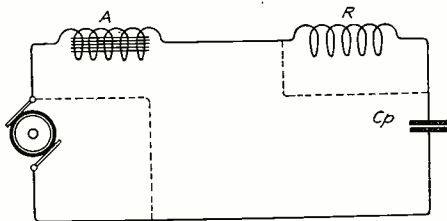

Fig. 1a

The Dotted Lines Show How the Condenser C_p Forms With Audio Frequency Choke Coil a Low Frequency Circuit.

intelligent direction by the knowledge of the theory.

Straight electrical engineering has reached the position where it has sufficient data and verified theory to enable in a large measure the complete predetermination of constants and performances. Radio engineering is fast approaching this stage. It is the object of this paper to indicate in an elementary manner the application of these ideas to the design of telegraf and telephone transmitters of the vacuum tube type.

To make the problem more concrete the discussion will revolve about a definite oscillation circuit and telephone system. The circuit chosen takes in practically any problem which might arise in practice, and the discussion which applies to this circuit will also apply to other circuits with little modification.

The oscillating and telephone modulating circuits to be considered in detail are shown completely in Fig. 1. Modifications of this are shown in Figs. 2, 3 and 4. Consideration will show that these are all practically identical. The oscillating circuit goes by various names, but is best described by "Shunt Circuit" or "Constant Supply Current Circuit." The modulating system is popularly known as the "Heising System," but is better described by the name "Plate Injection System."

Assuming the modulator tube not to be working for the moment, the action of the

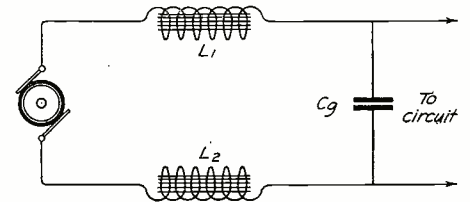

Fig. 5

Here is the Correct Way to Connect the Choke Coils and Capacity to Smooth Out the Current From a D. C. Generator.

Thus the R. F. output of the oscillator will be modulated by speech, by a variation of amplitude.

The design of these circuits will now be taken up element by element, and the conditions and factors determining the choice of design constants, etc., fully considered. It is assumed that the plate voltage is obtained from a D. C. generator of ordinary commercial design, giving the required voltage. The discussion will apply also when the source is rectified A. C., but then we start from the condenser terminals delivering the D. C.

SMOOTHING OUT CIRCUIT.

Starting at the generator, the first element to be considered is the generator condenser C_g . D. C. generators do not give an absolutely straight line voltage. There is always superimposed a small A. C. voltage called "commutator ripple," and the magnitude and frequency of this ripple varies with the design of the generator. This ripple produces a tone modulation of the R. F. oscillations depending on the frequency of the ripple. This tone modulation may be quite strong in the receiver (commutator hum) and it is necessary to eliminate it. This is effected most simply by the generator condenser C_g .

The action of this condenser may be considered as follows: it is placed across the generator terminals, practically parallel with the oscillator tube. (We are considering the R. F. oscillating circuit, and therefore disregard the presence of the

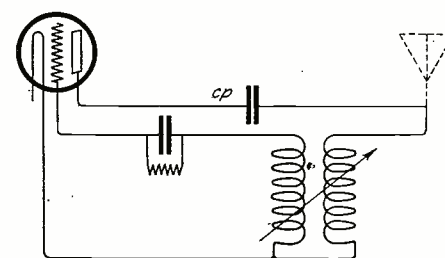

Fig. 3

This Circuit is Merely a Modification of the Hook-up Fig. 1. Two Separate Inductances Are Used for the Grid and Plate Circuits.

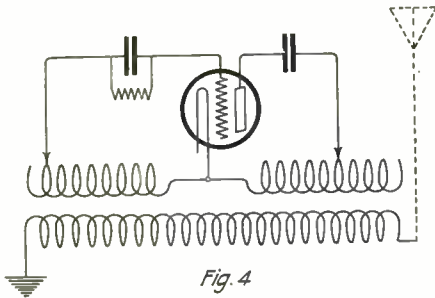

Fig. 4

In This Diagram the Oscillating Circuit is Inductively Coupled to the Aerial Inductance.

audio choke A.) Hence, if the reactance of the condenser is made very low compared with the oscillating tube resistance, most of the A. C. due to the commutator ripple will pass thru the condenser and not the tube, thus having no modulating effect on the R. F. oscillations. Another way of considering the action is to consider the generator and condenser as an alternating current circuit comprised of inductance and capacity, the inductance being internal in the generator. If the reactance of the generator inductance is high and that of the condenser very small, most of the A. C. commutator ripple voltage will be consumed in the internal inductance of the generator and none, or very little, will be available across the condenser, and hence not available for producing the undesirable hum. Both these ways of considering the action mean that the condenser practically short circuits the A. C. voltage (due to its very low reactance to audio frequency currents) and hence renders the ripple ineffective. To produce a low reactance at audio frequency requires the use of relatively large condensers of the order of $\frac{1}{2}$ to 1 microfarad.

Thus consider a tube whose resistance is say 10,000 ohms. Let us assume the frequency of the ripple to average 800 cycles. If we use a 1 microfarad condenser the reactance is

$$X_c = \frac{1}{2\pi fC} = \frac{1}{2\pi \times 800 \times 10^{-6}} = 200 \text{ ohms (approx.)}$$

This is only 2 per cent. of the valve resistance, thus practically all of the A. C. current would flow thru the condenser and none thru the valve, thus producing no hum. In such a case lower capacity condensers could be safely used as $\frac{1}{2}$ or even $\frac{1}{4}$ microfarads. The generator inductance is easily of the order of several henrys in the high voltage type of generators used on these sets, let us say 2 to 4 henrys. The inductive reactance is therefore

$$X_l = 2\pi fL = 2\pi \times 800 \times 2 \text{ (or 4)} = 10,000 \text{ to } 20,000 \text{ ohms.}$$

The capacity reactance is thus only 1 to 2 per cent. of the inductive reactance and therefore only 1 or 2 per cent. of the ripple voltage will be available at the condenser terminals, which produces no harmful effect.

Some generators have a very bad ripple and may require as much as 1 or 2 microfarads to eliminate the hum. In case of very severe ripple the following arrangements (an expansion of the principle underlying the second explanation advanced) will prove effective and sometimes necessary. Heavy choke coils L_1 and L_2 (Fig. 5) are placed in the generator leads and the condenser across them. The choke coils consume still more of the A. C. voltage leaving almost pure D. C. across the condenser. This filter arrangement is sometimes an engineering necessity when the D. C. voltages used are very high. For building a high capacity condenser for use on high D. C. voltages is by no means an easy job, whereas building choke coils is

relatively simple and allows the use of smaller capacity.

RADIO CHOKE.

We pass now to a consideration of the choke coils. As stated in the general discussion of the action of this circuit the function of these coils is to maintain the supply current from the generator practically constant. Later on, another point of view will be given, but at present the one given will suffice, namely the prevention of audio frequency or radio frequency fluctuations of any considerable magnitude. This choking action of the coils is based on the fact that they present a high reactance to these currents, thus reducing the A. C. to a negligible minimum.

On first consideration it might be thought that if the inductance of these chokes were made large enough, the reactance would then be great enough to prevent any kind of fluctuations. Thus, just one choke coil, A, would be sufficient, for if its reactance were large enough to prevent audio fluctuations, it surely could prevent radio fluctuations. Consequently the other choke coil, R, could be dispensed with, in this way simplifying the design problem. This is not so for two reasons. In the first place assume that only coil A were used. This is necessarily an iron core inductance for good audio choking, which means inevitably a high distributed capacity in the winding and between winding and core. This distributed capacity would by-pass the radio currents, and thus render the coil ineffectual as a radio choke. In the second place if only one coil A were used there would be no safeguard against the radio frequency from the oscillator tube kicking back into the modulator tube which is shunted across it. Thus two choke coils are absolutely essential as indicated in Fig. 1.

It might also be thought that the higher the value of inductance in both chokes the more efficient they will be as choke coils. This is not so. There are definite limits to the most efficient values of the choke coil constants, and no advantage is gained by exceeding these limits. It may in fact be disadvantageous to do so. Furthermore, as will be shown, there is another factor in the radio choke besides inductance which must be considered in the choking action. We will consider the radio choke first.

Just as in the audio choke coil, the radio choke may possess distributed capacity, the

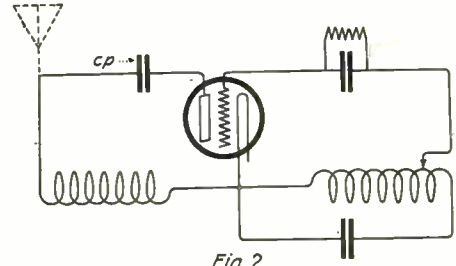

Fig. 2

In This Oscillating Circuit the Plate and Grid Inductances Are Shunted by Condensers and the Plate Inductance is Inserted in the Aerial Circuit.

amount depending on the coil design. This capacity may be sufficient to by-pass the radio currents thus destroying the choking effect of the coil. It is necessary, therefore, to design the radio choke either without any appreciable distributed capacity, if this is possible, or so that the distributed capacity may be used to effectively assist the choking action. This problem is capable of simple mathematical analysis, but will not be given here separately as it is taken up and considered under the sub-heading below: "Design of Oscillating Circuit for Maximum Output and Efficiency." The conclusions to be drawn from that analysis which are pertinent to our present subject, will be here given.

In the analysis mentioned above, the impedance of an inductance shunted by a condenser is derived in terms of the inductance and resistance of the coil, capacity and frequency. In the case of the choke coil the capacity is the distributed capacity of the coil which behaves as though it were shunted across the coil. The analysis shows that if the resistance in the circuit is negligible the impedance is infinite at the natural frequency of the coil, and becomes smaller the more the departure from this frequency. But the resistance of the coil is generally not zero, but by good design may be made very small, and in this case the impedance is shown to be very great to currents of the same period as the coil period. This gives the important conclusion that a coil behaves most efficiently as a choke at its own natural frequency. The more the current-to-be-suppressed departs from this natural frequency the less efficient will be the choking action.

This does not mean that it is essential to have a separate choke coil for each operating wave-length. If a plot is made of the impedance of the choke against frequency a graph similar to Fig. 6 will be obtained. This shows that at ω_0 the impedance is a maximum, being the natural frequency of the coil. On either side of ω_0 there will be a range of frequencies at which the impedance, altho not a maximum, is very high and the choking action good as between ω_1 and ω_2 . Thus a choke coil designed to have a natural period corresponding to ω_0 , would act efficiently as a choke between frequencies corresponding to ω_1 and ω_2 .

The answer then, is a coil having approximately the natural period equal to that of the current to be choked. The question of the design of a choke coil to have any given period, without using a concentrated capacity, is not capable of absolute predetermination, due to the difficulty in calculating the distributed capacity of the coil. Thus, for practical engineering purposes a semi-empirical method such as the following would be employed. Having chosen the best type of coil to be used, designs of coils with given dimensions and with a varying number of turns are made, giving different values of inductance. These coils are measured for natural period and a plot or table is made for this type of coil, showing the relation

(Continued on page 890)

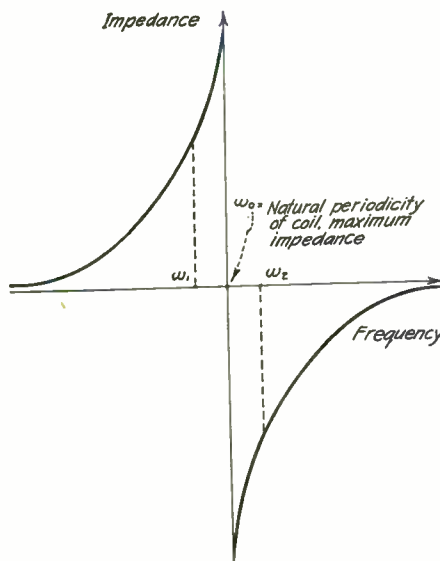
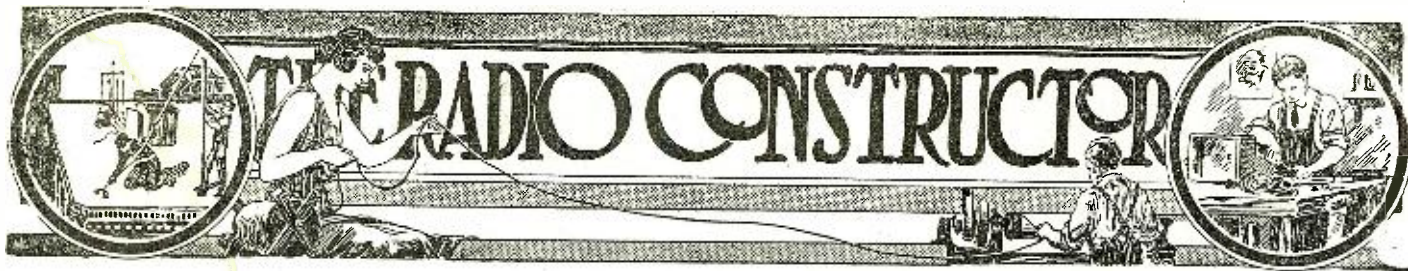

Fig. 6

This Graph Shows the Impedance of the Choke Against the Frequency. On Either Side of ω_0 There is a Range of Frequencies at Which the Impedance is Very High and the Choking Action Good, as Between ω_1 and ω_2 .



An Efficient Loading Coil and no Dead End Switch

By ALLEN E. LATHAM

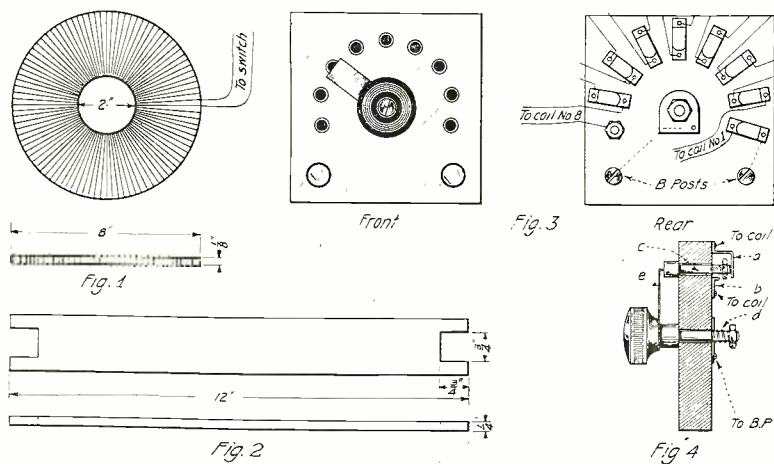

Here is a simple dead end switch, easy to build and efficient in the receiving sets for long waves.

which, if extended, would pass thru the center of the torus. These coils may also be made flatter and larger in diameter, as shown in Fig. 1. This is the shape in which our coils will be made. The forms for these coils may be made from wood, but heavy cardboard is just as good and much easier to handle. The material from which the disks are cut should not be thinner than 1/8". The outside diameter should be 8" and the hole 2". Eight of these disks should be cut to make an inductance which will load about 2,500 meters. No. 20 or 22 S. S. C. wire should be used in winding these coils. They will take two pounds of No. 20. It will be necessary to make a bobbin on which to put the wire, in order to pass it thru the hole when winding the wire on the disks.

The bobbin is simply a stick about a foot long with a notch in each end, see Fig. 2.

Each disk will take about 80' of wire. This amount should be put on the bobbin preparatory to winding the coils. As the bobbin is a foot long 40 turns on it will be approximately 80'. The only difficulty that will be encountered in winding will be the spacing of the wire on the outside and pressing it tightly together on the inside.

When the eight coils are finished, the next step will be to make the no dead end switch. This switch was designed for use with these coils and like the coils, is very efficient and neat looking. Where the switch is to be placed must be decided upon by the builder. It may be put on a panel with other instruments, or it may be on a panel by itself. Bakelite is the best material to use for this purpose, but a piece of hard wood, such as oak, thoroly impregnated by an insulating paint is just as

(Continued on page 905)

IN the receiving circuit, the greatest losses occur in the dead ends of the loading coil. These losses are partly overcome by the use of the various types of no dead end switches. The most efficient of these switches are the ones which cut out the unused portion of the coil entirely, but the types of switch which simply short circuit the unusual portion are far worse than the ordinary switch, for the short circuited sections of the coil form closed oscillatory circuit which uses wastefully a large part of the received current. The only way to overcome the mutual induction between the sections in the ordinary loading coil is to make each section separate and place them at right angles to each other or else place them some distance apart. With these sections connected by a good no dead end switch, a fairly ef-

ficient coil would be obtained, but this would be a clumsy and unsatisfactory arrangement.

In the coil and switch, which I am about to describe, these disadvantages have been overcome, and there is added the advantage of being contained in a small space, as compared with the ordinary tall coil and is therefore useful in making up small portable sets. These coils have no stray magnetic fields so it is not necessary to keep coils in different parts of the circuit separate to prevent their feeding back and causing the circuit to howl.

The coil itself is composed of a number of coils wound in the form of a torus. A throidal coil is usually the shape of a doughnut with the wire wound radially, that is, the wire is wound from the inside to the outside. Each turn forms a line

The Construction of Intervalve and Telephone Transformers

By JOSEPH G. REED

MUCH has been written in connection with audion amplifiers, both for radio and audio frequency, but very little attention has been paid to the correct design of audio frequency transformers for intervalve and telephone purposes.

Before setting out to describe the actual construction of these transformers, let us consider what they have to accomplish. It is their function to extract the maximum amount of energy from the plate circuit, and according to one of the fundamental laws of electrical engineering, this will be the case when the impedance of the load equals that of the generator. In this case the plate-filament path is considered to be the generator, and the primary winding of the transformer the load. From observations I have made with a sensitive milliammeter in the plate circuit of a Marconi Class 1 V. T. I have found that the resistance of the plate to filament path varies between 50,000 and 150,000 ohms, therefore, an average value of 100,000 ohms will

be assumed and a transformer designed to have an impedance of this value at the usual signal frequency will now be considered. The assumed frequency of 800 cycles is that used by telephone engineers for speech work, and is approximately that of the beat note produced by heterodyne reception of undamp't waves.

The impedance of an inductive winding is given by the formula $R_i = VR_p^2 + (2\pi iFL)^2$, but as the $2\pi iFL$ component is the only one which can extract useful energy from the plate circuit, it alone will be considered. At 800 cycles $2\pi iF$ equals 5,000, therefore, 20 henries inductance is required. It is just here that the experimenter strikes trouble because there is no reliable formula to calculate the winding for this value and A. C. bridge measurements are beyond the scope of most amateurs. Having these facilities at my disposal, I was able to develop the following design for a transformer.

Figure 1 gives the size of the bobbin, (Continued on page 906)

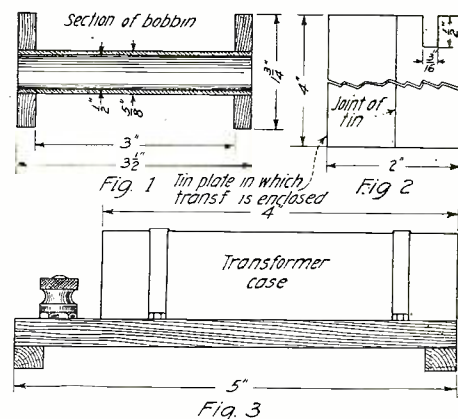

Constructional Details of the Amplifying Transformer Which May be Built by the Amateur Who Has a Few Tools.

A Universal Receiving Cabinet

By HILBERT R. MOORE

ALTHO fully aware of the many advantages of a "universal" receiving set, most amateurs are prevented from owning such a valuable piece of apparatus because of the prohibitive cost. Being in such a financial predicament myself, I set about to design an outfit which would suit both my taste and requirements as well as my purse. The result was that the instrument described herewith was developed.

Despite the fact that it embodies a comparatively wide range of wave-lengths, an audion detector and a two-step amplifier together with the controls necessary, the set is very compact and is readily portable. It is possible with this cabinet to tune from about 200 meters to 7,500 meters, and with the addition of a long wave-length loading coil or coupler, European stations may be readily received.

Flexibility, a point disregarded in the design of most outfits, is a pronounced feature. By means of a four-pole double-throw switch of the anti-capacity key type, instant change may be made from crystal detector to audion or to amplifier. An audion-ultra-audion switch is also provided. Either of two crystal detectors may be used by means of a two-point selective switch.

As the cabinet is to hold the weight of a complete receiving apparatus, it must be made rather strongly. The woodwork is of 1" oak and the case measures 24" x 20". The panel is a sheet of 3/8" formica 18" x 24". As this is a stock size it is cheaper than one cut to another dimension.

Altho bank windings might have been used with much economy in space, the old type of coupler was adhered to because of its superiority in the matter of close tuning.

The primary is wound on a non-shrinkable cardboard tube of 4 1/2" outside diam-

eter, 3/8" wall, and 7 1/2" length with No. 24 S. C. C. or S. S. C. There are 280 turns. Beginning with the first, taps are taken every 30 turns until the 270th. As will be seen in the drawing, the primary has two switches with nine points for each and one in common. The 270th turn is led to this extra point. Then nine taps of one turn each are taken off in the last 10 turns and the lead soldered to the switchpoint. Thus both fine and coarse tuning are provided for.

The secondary is wound on a tube similar to that of the primary, but of 3 3/8" outer diameter. It consists of 360 turns of No. 27 S. S. C. wire. Nine taps are taken off. Beginning with the first and ending with the last a tap is taken off every 45 turns and led to the switchpoint. The secondary has two switches as shown. The corresponding points on the upper and the lower switches are interconnected, in this way providing for the reversal of the secondary connections. As is well known, some signals come in louder in one direction than another.

The loading coil consists of four layers of No. 28 enameled wire on a 4" tube 8" long. The winding itself extends for 7". A tap is taken off at the first and one at the middle and end of each layer, thus giving nine taps. The end of the coil is soldered to both point No. 9 and one of the primary switch levers. Thus when the loaded switch is placed on this point, the whole coil is cut out.

A two-point switch may be located as shown in the drawing for a dead end

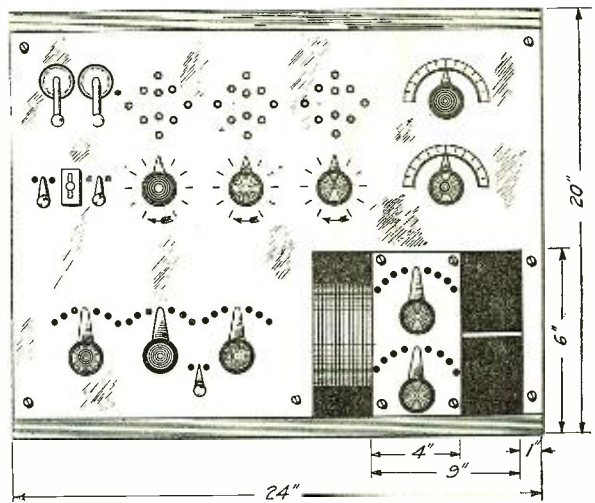

Front View of the Cabinet Type Receiver for Short and Long Waves Described in This Article. This Receiving Set Includes a Detector and Two-Step Amplifier.

switch and the primary cut in half so that when tuning short waves half the coil may be cut out.

Two variable and two fixt condensers are needed. An .0005 M.F. is shunted across the secondary and an .001 M.F. is placed in the ground circuit in series with the primary. They may be purchased unmounted and mounted on the panel or may be constructed. Instructions for the latter are to be found in back issues of RADIO NEWS. The writer purchased his, knocked down and assembled them.

A small fixt condenser is shunted across the receivers to give increased efficiency. A grid condenser is also needed. This may be either fixt or variable. Its capacity should be about .0001 to .00025 M.F. The construction of a simple grid condenser is as follows:

Roll a small wire tightly into one corner of a leadfoil gum wrapper, fold the wrapper double and cut to the size of a 1 1/8" square. Make two of these. Then cut four pieces of 3/32" mica 1 1/2" square. Place two pieces of mica between the foil and one on each side. This small package should then be wrapt tightly and impregnated with insulating compound.

The grid leak is merely a series of pencil lines drawn between two binding posts mounted on a strip of cardboard about two inches long.

(Continued on page 898)

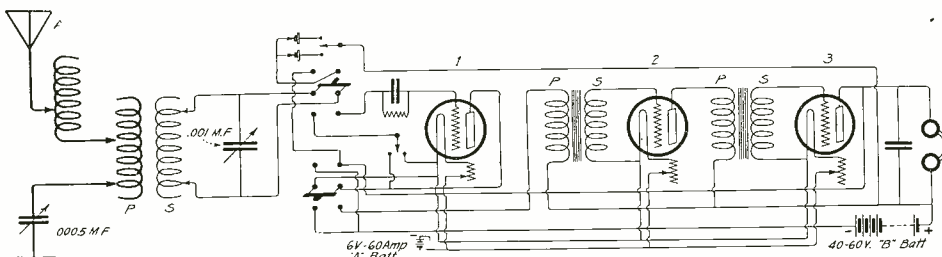

Complete Hook-up of the Receiver. Note the Switches Whereby Crystal or Audion Alone May be Used Without the Use of Plugs and Jacks.

Results Accomplish With One Bulb

By ALBERT R. CHAMPLIN*

For over a year I have been assigned to S.S. Heredia and have been using no more than one bulb or an amplifier for reception of both arc and spark stations. My runs have been in the Gulf and Caribbean waters.

Anyone running in these waters as long as I have in the summer time knows what real STATIC is and the conditions an operator has to put up with. During my experiments with bulbs I have used most every type including the V-T-1 and V-T-2 of the Western Electric Company; Navy Plitrons. Electron Relav. Marconi V-T-1 and V-T-2, some DeForest and French bulbs. These last two are fine detectors.

My experiments were mostly confined to the Western Electric bulbs which are the best for all round work. They are built

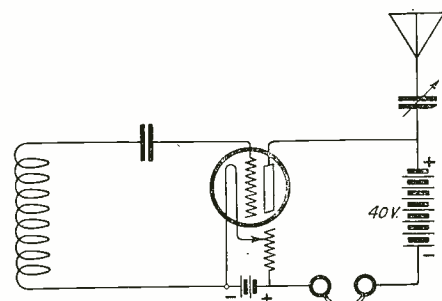

In This Diagram the Secondary Alone is Shown With the Connection From the Aerial for Long-Wave Reception. For Short Waves, the Primary Circuit is Used and the Aerial Switched to it.

ragged and the filament stands much abuse.

As a sensitive detector I found the electron relay to be the best, but the filament life is short and an expensive upkeep for the radio station. Fine results have been accomplished with this bulb and signals over 1,500 miles away have been copied to 15 feet from the fones.

For the last six months I have employed only one bulb and get everything required. This includes both arc and spark stations. I can obtain better results from a detector than any other circuit with amplification during the static months, as the intensity of both signal and static is amplified about the same in an amplifier and makes receiving difficult, so I have confined my circuit to one bulb.

* Chief Radio Operator S.S. Heredia.

Radio Digest

WIRELESS TELEPHONE OUTFIT PROVES A SUCCESS ABOARD A LIGHTSHIP.

By Charles A. Reberger.

A wireless telephone set has been installed aboard the Bar lightship "Liverpool" for the purpose of being in direct communication with the Mersey Dock board offices at Liverpool Pierhead. Weather reports off that port, together with any information pertaining to navigation, which may have been received, will be forwarded hourly by wireless telephone from this light vessel to the above named offices.

At the first demonstration of the system a few days ago, the installation proved to be a great success. Officials "listening in" at the offices reported that the speaker's voice was heard very loudly and distinctly. The lightship is located only 10 miles from the City but the builders of the apparatus claim it has a normal working range of from 40 to 50 miles. It is so simply constructed that it can easily be manipulated by any person without any special training, as simplicity was the keynote in designing the entire set.

This is the first occasion on which the wireless telephone has been utilized for regular commercial purposes in the British Empire. Officials stated that plans would immediately be drawn up for the installation of similar wireless telephone instruments aboard other light vessels located at various points of the Coast line.

It has not been made public what wave-length is used in the transmission nor what system is used.

LONG FONE WEATHER REPORTS.

That wireless telephone and telegraf weather reports sent out from Madison at 12:30 daily are heard in Texas, Kansas, New Jersey, and on the Canadian border is indicated by letters received at the wireless experimental station of the physics department of the University of Wisconsin. Reports show that the wireless telephone messages are clearly heard at these distances. The reports of weather changes that are sent out are received from the United States weather bureau at the university.

FRENCH CLAIM PRIORITY IN WIRELESS PLANE GUIDING.

French aviation experts are flatly denying the assertion made by bankers last March that the invention of a pilotless airplane, or rather a plane guided entirely by wireless, is of American origin and are showing that the French have been experimenting successfully along these lines since September, 1918, when a plane was launched against a strong wind and manoeuvred for more than 50 minutes without accident. Since then machines adapted to various weather conditions have been entirely approved by specialists at the Villacoublay aerodrome near Paris, and have even circled over the capital at a great height when guided by aerial vibrations from the Eiffel Tower.

But the latest development in the argument will give American inventors a surprise, as it was announced recently that demonstrations are to be commenced at Villacoublay which will show that it is possible to send up a pilotless plane equipped with sensitive instruments which under certain weather conditions, such as fog banks or impending storms, will flash back a signal to the guiding station. If the French claims are justified, it will even be possible thru this to revolutionize all ideas of aerial warfare, as the development of mechanical appliances responding only to wireless control could easily be applicable to bomb-dropping

and gas-emitting devices which would endanger whole armies without risking the life of a single pilot. But as one enthusiast suggests, "perhaps it will be better to wait until we are sure we are not dreaming before we claim too much progress."

PROVISIONAL WIRELESS TIME SERVICE.

It is announced for general information that arrangements have been made for a provisional wireless time-service from the standard mean-time clock of the Hector Observatory (latitude $41^{\circ} 17' 03'' .8$ south, longitude $174^{\circ} 45' 04''$ east of Greenwich), Wellington. This service was begun on October 1, 1920.

The time-signals are transmitted by the Wellington Radio-station (latitude $41^{\circ} 16'$ south, longitude $174^{\circ} 46'$ east of Greenwich) on a wave-length of 600 meters. The sending-key at the radio-station is automatically operated by the Observatory clock.

Radio Articles Appearing in the June Number of Science and Invention

S. S. "Aeolus" Works 3,103 Miles with 2 K.w. Arc Set, by Arthur H. Lynch.

Loop Aerials and Their Applications—With Particular Reference to the "Loop" as Used in Connection With Special Audion Amplifier Circuits in the French Army Signal Corps, by Robert E. Lacault.

A "Funny-Tone" Radio Receiver, by E. W. Stuart.

A Motor-Driven "Bug" Key, by Norman H. Allen.

Utilizing Morse Relay as Coil Interrupter, by Penuel E. Ballard.

The Deflecting Wave—A Gripping Story of Radio and Zeppelins, by Herbert L. Moulton.

Question and Answer Column.

CHANGE OF MOON EFFECTS WIRELESS.

The changes of the moon have been found by the radio officers of the small American fleet in the Adriatic Sea to have a striking effect upon the efficiency of the atmosphere for transmitting radio communications. The officers have succeeded in drawing curves and other diagrams based upon months of observation, which, they assert, reliably serve to indicate what atmospheric and celestial conditions affecting radio service will be met at any particular date in the future.

The discovery apparently has special application to the vicinity of the Adriatic, for there the changes in the atmospheric conditions caused by the change in the world's relation to the moon are much more marked than anywhere else in the world, so far as yet discovered.

The Adriatic fleet under Admiral Andrews depends almost entirely for its communications upon radio service, and having only receiving and sending apparatus of moderate efficiency, it has especially benefited from the discoveries. The powerful land wireless stations, such as the new Lafayette station near Bordeaux, manage to overcome unfavorable conditions by using great power, and so are not concerned about which way the moon turns.

NEW RECORDER.

Prof. Lippmann, lecturing at the Academy of Sciences, on May 9, described an

invention of MM. Abraham and Planiol for utilizing ordinary telegraphic apparatus for sending, receiving, and printing wireless messages. Prof. Lippmann said that experiments made before a number of official experts between Paris and Nogent le Rotrou had given brilliant results, and that as many as 7,000 words had been automatically registered in one hour.

SOUTH AFRICA WIRELESS TELEFONY.

The British Government is experimenting with wireless telephony with the view of linking the chief centers. Communication has been successfully established between Johannesburg and Bloemfontein. It is hoped to extend the system gradually, thus lessening the cost of ordinary telegraphic and telephonic working, which is unusually high, owing to maintenance charges over immense distances.—(*Electrical Review.*)

ERRORS OF DIRECTION FINDERS.

By Dr. E. Bellini.

In the early period of the existence of the direction-finder it was generally thought that a well-constructed direction-finder apparatus, installed upon a homogeneous stretch of land and free from local influences, would give exact bearings. Experiments confirmed this idea. At that time, spark transmitter and moderate wave-lengths were used, and, since amplifiers had not been discovered, the distance at which a station could be located was limited.

But the discovery of the amplifier, which enormously extended the range of the direction-finder, and the adoption of undamped waves of very great lengths, completely changed the working conditions of these apparatus. The satisfaction of being able to reach enormous ranges was counterbalanced by the dissatisfaction at finding a new source of errors, errors which could be attributed neither to the conditions of the earth's surface nor to the influence of neighboring bodies. The characteristics of these new errors are their magnitude and their variability. Minimum in the daytime, they become larger at sunset and reach their maximum at night, becoming sometimes enormous, as much as 50, 60 and even 90 degrees. Their rate of change may reach several degrees per minute.

A very interesting study of this subject and its development was published in *The Electrician*, of London, Feb. 18, 1921.

NEW DAILY RADIO WEATHER REPORT.

In co-operation with the Office of Communications of the Navy Department, the U. S. Weather Bureau will issue a special bulletin containing surface weather observations from regular Weather Bureau stations, upper air observations from aerological stations maintained by the Navy, Army and Weather Bureau, and a summary of weather conditions, forecasts and warnings. The bulletin is for the benefit of marine and aviation interests, but is designed especially to meet the needs of the latter. The bulletin will begin June 1, 1921, and will be broadcast from the Naval radio station at Arlington, Va., each morning at 10:30 o'clock (75th meridian time), Sundays and holidays included, on a wave-length of 5,950 meters C. W. This service is in addition to the distribution now being made each night from the Naval Radio stations at Arlington, Va., Key West, Fla., Point Isabel, Texas, Great Lakes, Ill., and San Juan, P. R., as described in Weather Bureau circular of Oct. 26, 1920.

(Continued on page 930)

\$100.00 RADIO ACCESSORY PRIZE CONTEST

HERE is a new contest for our budding radio geniuses. This time the contest is not so much about big sending or receiving outfits, but it centers on radio accessories.

When the automobile business was young, the main thing was the automobile itself. No one thought of manufacturing, advertising and selling accessories. But every city now boasts of one or more stores where nothing but auto accessories are sold, be it a tire, a spark plug, a crank, a horn, a tail-lamp, auto gloves, a pressure gauge, a gasoline tank, a washer or a valve—you can buy them all readily at a low price.

What holds true in the automobile business is now being repeated in the radio field. At first there was nothing but the actual complete outfits or the apparatus. Gradually the radio accessory business came to the front and today dozens of concerns are engaged in selling and manufacturing nothing but little adjuncts. To mention only a few, as can be readily appreciated by glancing at the advertising columns of this journal: Composition knobs, switchpoints, minerals, all sorts of parts, panel switches, dials, sockets, sliders, connection plugs, bulb safety fuses and dozens of others.

There are always new improvements cropping up as everyone can see by looking over the advertising pages of our radio publications.

But there is much room for improvement; there are many little things needed that will make transmission and reception

of radio messages better and easier. There are a thousand such ideas waiting to be exploited by the radio fraternity.

Every once in a while we publish a little stunt that means a small revolution in radio construction. For instance, some years ago a clever "bug" showed us how to put the scale, previously always attached to the panel, right on a rotating dial. Today, there is practically no instrument on the market which does not include a revolving graduated dial and knob attached to it.

That is what we are trying to get at in this contest. **We want ideas on little things that can**

| | | | | |
|------------------|----------------|----------------|----------|----------|
| 1st Prize | \$50.00 | in Gold | | |
| 2nd | 20.00 | " | " | " |
| 3rd | 15.00 | " | " | " |
| 4th | 10.00 | " | " | " |
| 5th | 5.00 | " | " | " |

be readily made by the amateur and can also be manufactured and standardized by the manufacturers. What we want therefore, are *ideas on little improvements* on radio apparatus and it makes no difference whether the improvement is for the transmitting or receiving set, or whether it is a new wrinkle that can be attached to the aerial or to the ground. It **MUST** be a little thing, a *true accessory to existing radio apparatus*.

In other words, no prize will be given to anyone who designs a complete instrument, such as a detector, condenser or the like. For instance, a new plug, a new

dial, a new switch lever, a new panel switch, a new socket, a new switch point, etc., is the kind of idea we desire, *always providing that the idea is new and has not been used before*. It is immaterial from what materials the article is made. This is left to the designer.

While it is not absolutely necessary that a model be submitted with your entry, we venture to say that the judges would rather like to see a model, as it is often much simpler to judge an idea if you have the actual article before you; but as we said before, this is not absolutely necessary, but desirable. In all events a complete sketch must be furnished by the contestant.

No manuscripts entered in this contest can be returned. We reserve ourselves the right to publish all worthy ideas, which did not win a prize by paying regular space rates. In publishing the various ideas, all the rights revert to the publishers. Use only one side of the paper for writing and keep sketches on a separate sheet. No penciled matter can be considered. More than one idea may be entered by contestants. The contest is open to everyone, radio clubs included, except manufacturers of wireless apparatus. All prizes will be paid upon publication.

This contest closes at noon, August 10th, New York, and all entries must be in at that time in order to be qualified. Should two contestants submit the same idea, then in that case the same prize will be paid to both. Address all communications to *Editor Radio Accessory Prize Contest*, care of this publication.

Newspaper Uses Amateur Radio Reporters

IN the last issue of RADIO NEWS, under the title "Government and Amateurs Join," Mr. Winters told how the amateurs can use their receiving sets to pick up the market and weather reports and deliver them to those in their towns who are interested.

The Oakland (Calif.) *Tribune*, under the auspices of the *Bay Counties Radio Club*, recently conducted a test, whereby amateurs sent by Radio the news from their

town, thus acting as Radio reporters for the *Tribune*.

The first amateur Press service has proved successful and further tests will be made to extend the area from where news may be received.

From the time that R. W. Carroll, secretary of the club, sent out, one evening recently, the "QST," or broadcast message to the radio amateurs to "cut out the idle chatter" in order that the *Tribune* news

might be transmitted, the atmosphere was clear of the usual host of conversations between amateurs, and all the operators in the bay district turned their ears to the test work.

Interruptions were few and the transmission was effected with little repetition. Great interest was shown up and down the coast by the tests being staged by the Bay Counties Club, for when midnight came and

(Continued on page 888)

The Thirteenth Tap

By BERNARD S. GREENSFELDER

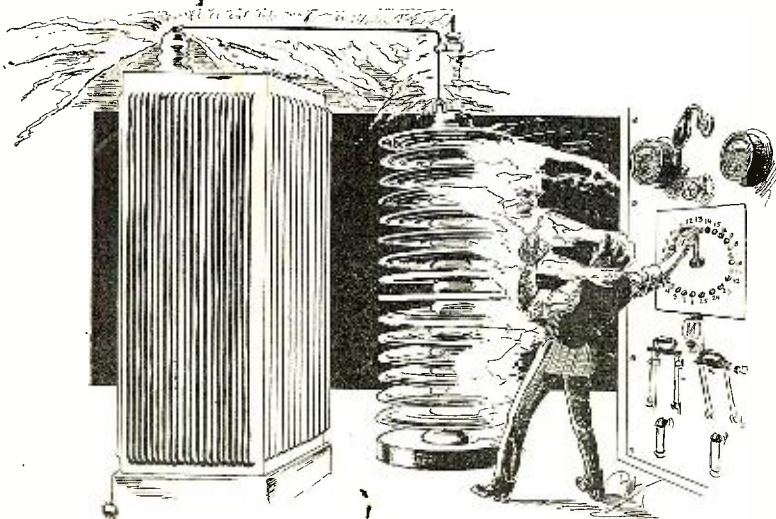

Something, a mysterious force, came over me. The throbbing blood vessels in my body seemed to be on the point of bursting. The rheostat moved slowly. The thirteenth tap! Death! Livid flames sprang forth like demons from the over-charged wires.

JOHN HANSEN walked complacently up the Embarcadero. He had little to worry about, with a pay-check in his uniform pocket for six months' service as radio operator. His ship, the WEST CAMBRIDGE, had docked that morning at San Francisco. It had taken him little time to report, and by noon he was ready to see the sights of the Golden City.

Sauntering along, he was about to enter a café, when a man with the general appearance of a person of forty-five, approached. Two large red scars horribly marred his left cheek, his hair showed tinges of gray, and it could easily be imagined that he had once gone thru some terrible physical and mental test.

Hansen paused for a moment.

"Pardon me, sir," pleaded the stranger, "could you spare an ex-wireless operator the price of a square meal?" With a sorry attempt at a smile he added, "I was once in a position like yours, but—"

His voice broke and he turned his face.

Something unusual in the man's voice struck Hansen as sounding rather odd and tragic. Certainly this man who spoke in refined accents, and who was perhaps fifteen years younger than his disfigurements gave him the first appearance of being, merited investigation. After a minute's thought Hansen replied, "Sure, old man! And what's more I want you to step in here and have chow with me."

The stranger hesitated, conscious of his neat, but worn-out clothing. But he consented, and together they entered the restaurant.

Hansen ordered the food, and then relapsed into a thoughtful silence, which was rather embarrassing to his guest, who ventured a few questions on modern radio practice. Hansen gathered his wits and took upon himself the task of worming the veteran's secret from him.

Over their coffee Hansen asked, "How is it that you are no longer an operator?"

The other gave a slight start. Then, bracing himself as if for a cold shower, he launched forth, "Well, you have certainly treated me white for a chance acquaintance. I have had a premonition that this will be my last opportunity to relate what no other man living knows. I will feel better when I have told it. Will you promise me secrecy?"

With a smile of anticipation Hansen readily agreed.

The stranger continued, "To start at the beginning, I was born in Oregon thirty-one years ago. When I was a boy, in 1907, I developed the love for radio which has not yet left me. After I graduated from a local high school I went to Seattle. There I secured a clerking job. On and off I dabbled in electricity, and the crude wireless apparatus of those days. Finally, in 1912, I took the examination and secured a berth on the S.S. KODIAK, plying between Seattle and Sitka."

"All went well for some time. I made a number of friends and acquaintances at both ports, in particular an adventurer, James Duane. He was apparently greatly interested in the ship's wireless set, and often came to see me while we were in port. During these visits I explained a great deal pertaining to radio to him, and as a reward for my efforts he gave me various Indian trinkets he had collected. After a while I entrusted him with \$250,—over half my meager savings—to be invested in a sure-thing gold mine. Later, as we grew more intimate, I decided not to further encourage his friendship, for he seemed to have certain undesirable petty traits.

"One day, while the boat was docked in Sitka, he came on board. When my back was turned he attempted to slip a small, but very expensive measuring instrument into his pocket.

"As luck would have it, the Marconi inspector was on board, and in the act of coming to see me, when Duane reached for the instrument.

"The inspector coughed, but this didn't bother Duane. He calmly put the meter in his pocket and stepped aside. The inspector had immediately recognized the instrument, as there were few Alaskan ships that had them. He inquired of Duane what it meant.

"The reply was, 'I beg your pardon, but this operator just gave it to me as a personal gift.'

"I was staggered, and the look the inspector gave me must have resulted from the stupefied expression on my face.

"I blurted out, 'He lies!' and then Duane struck me in the face, knocking me over. He was well known in those parts and had somehow been able to keep a good reputation. On the other hand I had once committed a slight irregularity which was brought to the notice of this inspector. That fact, coupled with my foolish stare, put me in a bad light.

"I attempted to struggle to my feet and retaliate, but the inspector prevented me from doing so. Duane, perfectly calm, held out the meter to the inspector, and said, 'Sorry we had to have this unpleasantness; it will be a good lesson for him.' He pointed to me, adding, 'Well, good-day, inspector. Don't be too hard on the poor fellow,' and strolled out.

"I was left alone with the inspector, who was still holding on to my arm. He said, 'I am also very sorry that this has occurred. However, you are a good operator, and we are several men short at present, so I will give you a third and last chance.'

"He would listen to none of my explanations. My thoughts of getting revenge on the return trip subdued my pride, and I grudgingly agreed to stay.

"That afternoon we left for Seattle. During the night all I did was to toss and twist in my bunk, thinking of schemes for revenge.

"For all my thinking I could not find one plan that could be carried out with impunity. Then I remembered the \$250 I had entrusted to him. Another strong reason for punishment!

"Pistols, poisoned food, sawed-off shotguns, daggers, red seas of blood; all passed before my eyes.

"What a fool I had been! To absolutely lose my head in that embarrassing situation!

"By the time daylight arrived I had cooled off somewhat, and determined to wait until some opportunity offered me the fulfillment of my greatest hope—to show up the cur, who, oddly enough, had a good name.

In this state of mind I again made the trip to Sitka. My main object was to square things and escape detection.

"I made inquiry for my enemy as soon as I reached shore, but the most specific information I got was to the effect that Duane had left with three other men to spend the summer in hunting and seal-catching on one of the wooded off-shore islands. No one could state his exact location, tho some said that he had passed thru another town before leaving, obtaining his supplies there.

"My hate for this man soon apparently died out, but later developments proved that it was only slumbering.

"Several months afterward, while midway between Seattle and Sitka, I heard an unfamiliar station, KIF, sign off. I had never heard it before. No such call was in the Call Book, so I got in communication with the nearest naval radio station and sent, 'QRA KIF? PSE.' In a minute I received, 'KIF is a new station—Island—2KW controlled by James Duane.'

"James Duane—radio set—Island—these brief words brot back the forgotten past, and fanned my rage into a fiercer heat than before. My OK to the naval station consisted of a miscellaneous jumble of dots and dashes.

"And so I located him. The ship neared the Alaskan shore until we were about 75 miles from our destination, Sitka. We passed an island with which I was familiar. Two radio masts projected from its top!! This was something new to me, who had sailed on the same route for over two and a half years.

"Night fell. I relieved my mate, who went to his dinner. I tuned around the commercial wave-length of 600 meters. Then, weak for its nearness, came, 'SOS

(Continued on page 910)

Married via Radio

By ERALD A SCHIVO

CHARLES KENNISON was disappointed. Neighboring amateurs invaded the atmosphere in all directions and with evident success. Distant stations were called: the high-pitched sparks of the powerful San Francisco amateurs always received a reply from equally efficient fellow amateurs in other States, but try as he might he didn't seem to be able to locate the trouble in his receiving apparatus, which made him fail to hear the Honolulu station.

Kennison ground his teeth in disgust and contemplated the intricate apparatus before him. Weeks of experiment and hard work had amounted to naught. Altho radio stations within a radius of one hundred miles sounded like the roar of cannon, the distant stations could not be heard, not because of the intermittent interference, but due to the inefficient "hook-up."

He would make one more change in his connections and if satisfactory results were not attained, a popular regenerative circuit which was used by the successful mass of amateurs, would be his alternative.

Midnight was approaching and already the weary "wireless bugs" were bidding good-nights. Kennison quickly made the intended change in the circuit and readjusted his instruments. After the receivers were resting securely against his ears, he closed the circuit which supplied the filaments of two vacuum tubes with necessary current. The dull roar of a near-by amateur sounded in his headset. The operator was calling a station in a Southwestern State. Listening intently, Kennison waited with keen expectation for the Southerner's reply call.

A half minute passed—another. Impatiently Kennison lessened the resistance of the filament rheostat, thus allowing an increase of current to flow. Simultaneous with the brightening of the filaments a shrill spark vibrated in the receivers. An amateur a thousand miles to the southeast was answering the call of the San Francisco station.

Jubilant with success the local amateur again flashed his signals. Communication was established for a period of five minutes. The signals from afar then began to fade and could no longer be heard.

Kennison was not troubled with fading signals which are most detrimental to long distance transmission. Throught the conversation he was able to copy the messages, and also after the near-by station could no longer hear them. The new circuit was

Let's not get into an argument like last night. We are going to get married by radio and that's all there is to it. Are you ready?



now working very satisfactorily.

The air was quiet. No spark interrupted the stillness. Kennison was expecting to hear a remote call at any moment.

Wishing to know if there was still anyone listening in, he changed his aerial switch to the sending position and transmitted the general call. No one answered, doubtless all the enthusiasts had retired for the night, altho a few generally listened into the early hours of the morning.

Kennison was in no hurry. He anticipated excellent results from the new circuit and determined to wait for them. The hands on the clock were slowly nearing the hour of two when, with one last sigh, which sounded like a dull tick, the clock stopped.

The young operator smiled and half rose from his chair with the intention of re-winding the piece of machinery. Synchronous with his grasp on the clock a loud feminine voice caused him to jerk the telephones from his head and stupidly place them upon the table. He stared around the room dumbfounded.

"Charlie, my dear Charlie," laughed a girl's voice. "hello, Charlie, my dear boy, didn't expect me at this late hour, did you?"

Glaring at the receivers, to all appearance innocent of any duplicity with the mysterious voice, Kennison promptly grasped them with the full determination of a man to investigate the matter.

"Charlie, Charlie," reiterated the voice as if chagrined at the possibility that she was not heard. "Charles, why don't you answer me? Your wireless telephone is not out of order?"

Wireless telephone? Kennison had not used the instrument, recently purchased, for three days; in efficiency it was very much lacking. Only neighboring stations responded to his repeated calls. The voice was coming from his receivers, certainly, but who could be calling him? Manipulating a number of switches, his own wireless telephone was soon in working order.

"Hello, hello," he cried into the transmitter. "who is calling me?"

"Why, Charlie," said the girl in surprise, "what do you mean by such foolishness? You know I don't like fooling."

"My dear young lady," Kennison was excited and spoke

loudly, "the question I asked you is not foolish. May I ask to whom I am talking?"

"You are fibbing," sobbed the girl in distress, "you promised—never mind, you needn't call me again, I will have nothing to do with you—so there."

"By Jove!" cried the mystified operator, "you surely have me puzzled; I said nothing impertinent, what in the world do you mean?"

"Do not say another word," the girl was almost crying, "you promised so—so—good-bye."

"Say!" ejaculated Kennison in perplexity, "please wait a minute, I meant no offense."

"Remember, never see me again, unless—unless you change your mind," were the girl's last words and the hissing noise which always accompanies a wireless telephone subsided.

"Hello, hello," called Kennison, but received no answer. After a few moments the low tone of a near-by station called him.

"Go ahead," said Kennison over the telephone.

"Say, old man," transmitted the operator, "I just began listening in when you started that one-sided conversation of yours and believe me you had better see a doctor. Who in the world were you supposed to be talking to? I have five amplifiers and I heard no one but yourself."

Kennison tried to explain the matter to his friend, but being so perplex himself, he said nothing that sounded logical.

"Well, Charlie," replied the spark station, "I'd advise you to see your doctor, I heard no girl's voice; guess you were dreaming and talking in your sleep."

Head swimming with numerous ideas as to the girl's identity Kennison decided to retire. Only after concluding the whole matter as a joke played by some of his friends did he relax and sleep.

All day, Sunday, he visited radio friends; everyone affirmed that they knew nothing and could give no explanation. Discouraged and considering the situation seriously the wireless man gave up the attempt to solve the problem. He would try to communicate with the girl that night.

Several amateurs were aware of his intentions and the air was a bedlam of sparks until far into the night. He would not give a call until a quarter to two, the time the girl's voice had first greeted him. Absolute silence prevailed as the time approached. Kennison decided that at least 50 amateurs were listening in; the news had spread re-

(Continued on page 923)



Kennison Heard the Gruff Voice of a Man Reciting the Marriage Sermon. "Do You Take This Woman as Your Lawful Wife?" Asked the Man.



THIS Department is open to all readers. It matters not whether subscribers or not. All photos are judged for best arrangement and efficiency of the apparatus, neatness of connections and general appearance. In order to increase the interest in this department, we make it a rule not to publish photographs of stations unaccompanied by a picture of the owner. We prefer dark photos to light ones. The prize winning pictures must be on prints not smaller than 5 x 7". We cannot reproduce pictures smaller than 3½ x 3½". All pictures must bear name and address written in ink on the back. A letter of not less than 100 words giving full description of the station, aerial equipment, etc., must accompany the pictures.

PRIZES: One first monthly prize of \$5.00. All other pictures published will be paid for at the rate of \$2.00.

Station 9BY

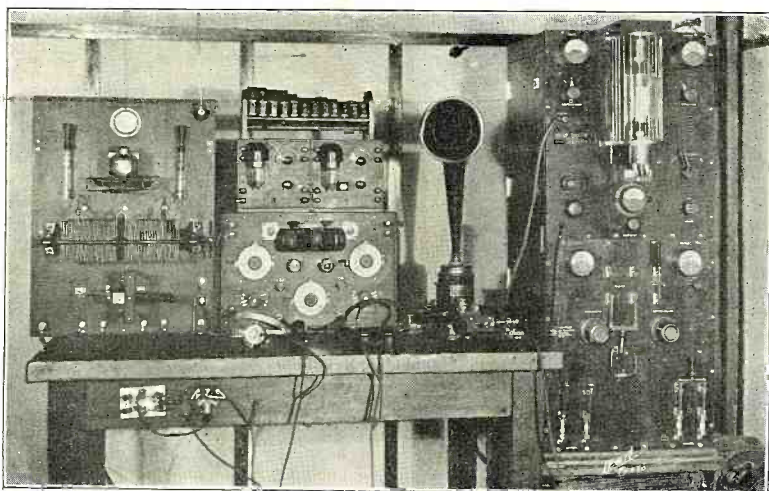

Some station boys! How would you like to own this little radiofone set and the well-designed 1-K.W. spark set? Quite an idea to fix your quencht gap on a panel like the one in this foto.

Every Thursday evening between 8 and 9 o'clock, the amateur station of the Karlowa Radio Corporation, 9BY, at Rock Island, Ill., gives a fone concert which is heard over a 300-mile radius; the voice and I. C. W. signals regularly cover up to 900 miles.

This station is equipt with a ½ k.w. De Forest oscillion transmitter and a 1 k.w. spark set, making available for instant use by means of the proper control, C. W., I. C. W., fone, synchronous rotary spark and 120 cycle quencht spark. Honeycomb coils are used exclusively in receiving, for short and long waves, as tickler regeneration has been found more reliable for their work.

9BY will be glad to receive reports from amateurs who hear the concerts or the D. X. work, and will appreciate a word from distant amateurs who can pick up signals.

Paul Oard's Moving Station

Paul Oard, of Oard Radio Laboratories, Stockton, Calif., has set up a radio apparatus on his automobile, with which he has given some very interesting demonstrations. The accompanying illustrations show Mr. Oard and his unique set.

This traveling station is capable of receiving signals from stations 100 miles away without any trouble, when the car is in motion, in spite of the magneto breaks.

respondent of Stockton, G. E. Reynolds, on a trip in order to prove beyond a doubt that his apparatus was all he had claimed it to be. The first message received was one that had been previously filed by Mr. Reynolds at the local station of Calmo Wiles. What is believed to be a record in amateur transmission and reception under like conditions was made when 7BQ at Eugene, Oregon, and 7ZI, located in Wash-

the special telephone equipment having been adjusted, from station 6FI.

Many experiments are to be carried out in this way to develop a set that can be used on an automobile and render service, especially when help is needed while out in the country far from a garage, and it is expected that in a few years an auto station will be as common as a ship station is today.



Here is a summer type of station. During his vacation, Paul carries his station with him and he is always ready to pick up a call. Note the aviator cap he wears to avoid the noise from the engine, and to keep the receivers tight to his ears.

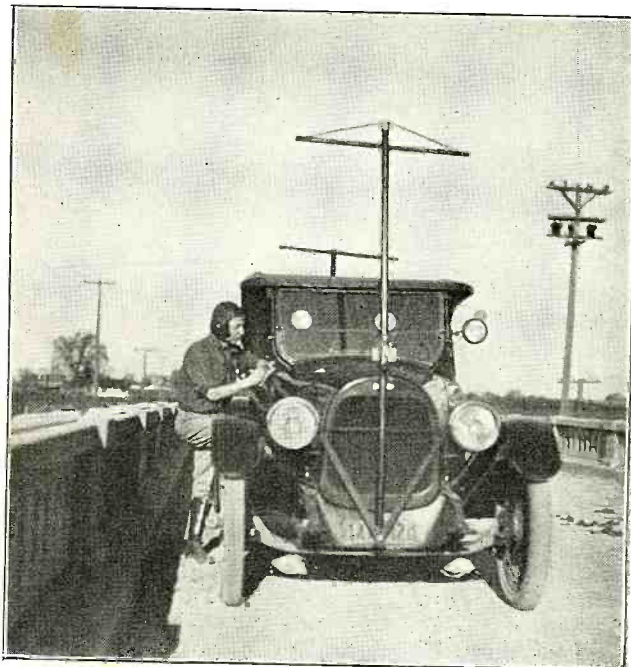

The antenna is suspended directly above the top of the automobile, as shown in the illustrations, and the receiving set, which is of the regenerative type, is fixed behind the operator. The battery of the car is used as an "A" battery and the frame of the car is a counterpoise.

Mr. Oard recently took a newspaper cor-

ington, were also copied from the automobile, when not in motion. These were both copied on a single tube, the latter station using C. W.

As a final test, a musical entertainment was given.

Edgard A. Green's Station

The accompanying fotograf are of myself and my set which I enter in your amateur station contest. The O. T., "B" battery, long wave cabinet, and detector and two step amplifier are of my own manufacture.

My sending set consists of the following: 1/2 k.w. Thordarson type R, glass plate condenser, meteor gap, O. T. and meteor key. I am radiating 3.2 amperes.

My receiving set consists of long wave cabinet using honeycomb coils for stations sending on 600 to 20,000 meters. I also have a Grebe C. R. 2 with detector and two step amplifier. The amplifier is so arranged that it may be used on either set by means of jack and plug. I am using W. E. V. T. 1 and Acme transformers for amplifying. My long wave set was made from instructions furnisht by Mr. Groves, and surely is delivering the goods. When using detector alone, most of the long wave stations can be read with the fones held at arm's length, and when using two steps of amplification, they can be read fully 75' from the fones.

My set is on the second floor, and on good radio nights the music from KDKA, 2XQ and NSF can be heard very plainly downstairs, when using the Grebe with two steps.

My aerial is a four-wire inverted L 75' long and 28' high, wires being spaced 2' apart. For a ground I use a ground plate and water pipes.

The two boxes on the right-hand side of the shelf are my 6 v. "A" battery and 48 v. "B" battery. The "B" battery is the one my assistant operator is sitting on.

I am using W. E. and meteor fones and think the W. E. are best for signals, and meteors best for music.

Under the table may be seen the loose coupler of old age and the tungar rectifier used for charging my batteries.

EDGAR A. GREEN,
825 Cedar St., Hagerstown, Md.



.....
We extend our compliments to Ed. for his neat and nice-looking station. It seems that kewpie dolls are extensively used in radio stations these days; Ed's is on the "B" battery keeping the voltage up.
.....

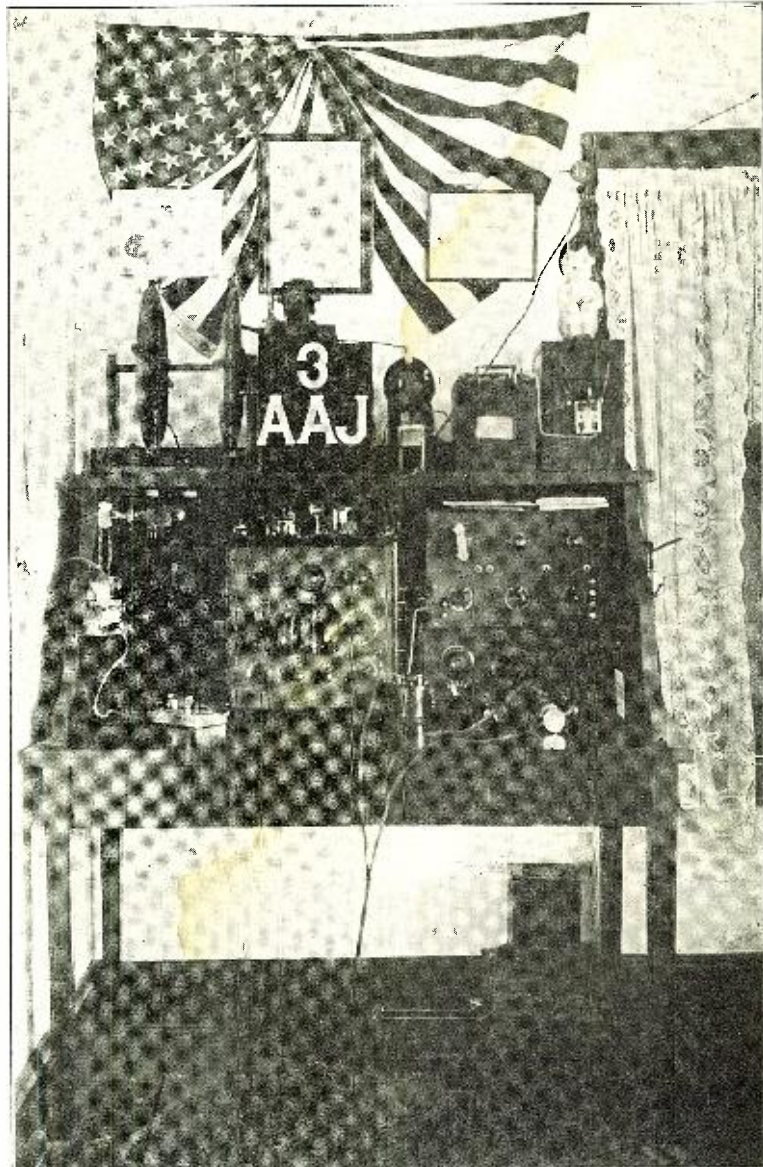

K. H. S. Radio Club Station

The following is a description of our station:

The station is located in a corner of the physics laboratory in the high school and the aerial is on the roof.

The sending set consists of an Acme 1 K.W. transformer, Thordarson oil condenser, Murdock rotary gap, Murdock oscillation transformer, Boston key, and an Amrad wavemeter, which is set on the loose

coupler. Since the picture was taken, a hot wire ammeter has been added. This is mounted to the left of the aerial switch with an s.p.s.t. switch below it for short circuiting. Proper switches are mounted at the right side of the lower switch board.

The receiving set consists of audiotron detector and panel, variometer, 200-1,500 meter loose coupler, 250-5,000 meter navy type loose coupler, either of which can be used by throwing the switches, and a Brandes headset; a Murdock variable condenser is also used for tuning. Since the picture was taken a radiotron and panel has been installed and various experiments have been conducted with one-stage radio frequency amplifier. A long wave set is being planned.

Beneath the table and to the left is a battery charging set.

It is impossible to mention all the stations heard, but among them are NSF, NAA, NAJ, NFN, NAT, WCY, WCG, NRS, NSR, NUD, NAH, etc., ships and amateurs galore.

We would be glad to hear from anyone hearing 9DFH, our official call.

K. H. S. RADIO CLUB,
Kendallville High School,
Kendallville, Ind.

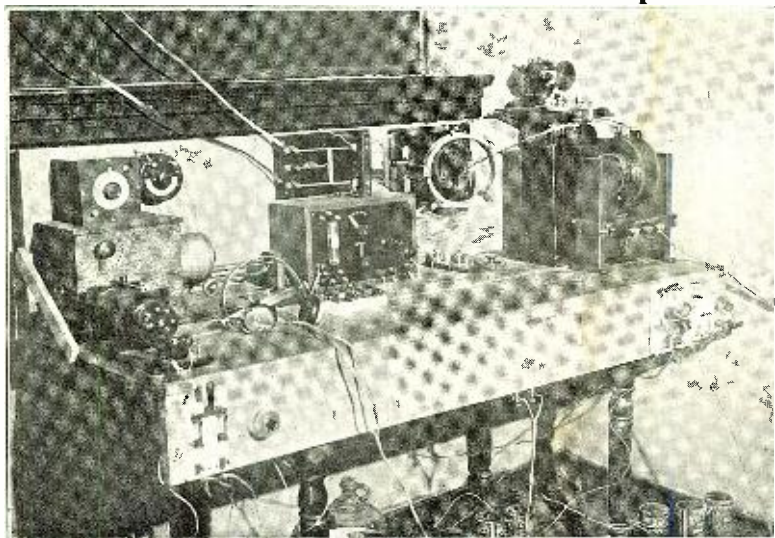

.....
A nice little station you have boys. Compliments for the wavemeter; that is the first thing a radio club should get.
.....



Junior Radio Course

RADIOTELEFONY

IN the last lesson was explained the principle of Radiotelefony and the absorption method of modulation. We now come to the constant current system of modulation which, so far, is the best for the experimenter to use.

The circuit that we shall use to explain the system, is the Heising circuit, in which two tubes are used, one as an oscillator and one as a modulator; see Fig. 1. If more power is to be obtained by the use of several tubes in parallel, the same number of tubes should be used as oscillators and as modulators.

THE CIRCUIT.

In the circuit shown in Fig. 1, some instruments are used that may not be familiar to the average student. H. F. is the Radio frequency choke coil; stopping at high frequency current and keeping them out of the low frequency or modulating circuit, it is merely an inductance having a sufficient value. L. F. is an audio frequency choke coil having an iron core and keeping constant the voltage furnished by the H. T. source. M. T. is the modulation transformer, as described in the previous lesson, and L is a grid leak that must be adjusted in order to impress the proper negative voltage upon the grid of the oscillator tube.

The constant current system of modulation depends upon the fact that if a steady plate voltage is applied on a C. W. transmitter, continuous waves of constant amplitude will be emitted; see Fig. 2A. Any change that occurs in this plate voltage is immediately reflected in the change of amplitude of the emitted oscillations and if the voltage is caused to vary in accordance with the speech, the amplitude of the oscillation will fluctuate in the same manner as in Fig. 2B.

The circuit and the tube on the left side of Fig. 1 form an ordinary C. W. transmitting set, sending continuously, when in working order, a wave of the shape of A in Fig. 2.

The action of the microphone and the modulation transformer, as well as the rôle played by the grid in a vacuum tube, having been described in previous lessons, we will not explain them again, but merely the rôle of the modulator tube, which is as follows:

When the microphone is spoken into, the grid voltage is made to vary, thus varying the plate current. These fluctuations are, however, opposed by the large inductance of the choke coil, and set up across the choke a varying difference of potential. This difference of potential is consequently added to or subtracted from the normal H. T. voltage already active in the circuit.

As a result, the difference of potential across the condenser C varies at vocal fre-

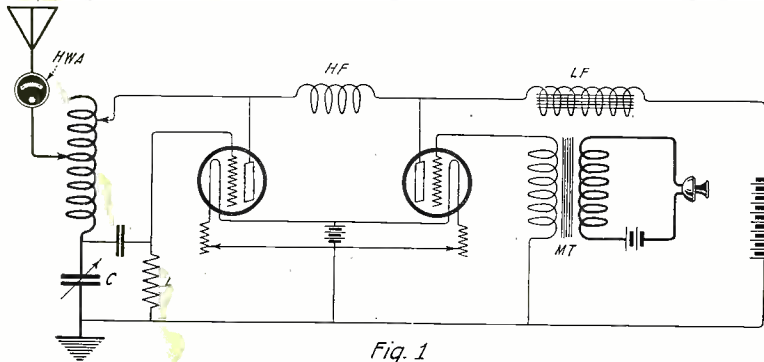

Fig. 1
This is the Typical Circuit for Constant Current Modulation. In This Radiophone Hook-up One Tube is Used as an Oscillator and One as a Modulator. The H. T. May be Supplied by a Battery or a D.C. Generator.

quency and causes the necessary low frequency variations in plate current, and, therefore, of the radiated C. W.

By comparing Fig. 2 with Fig. 3 of the last lesson, the decided advantage of the constant current method of modulation may easily be understood. While with the absorption method, under the best conditions the amplitude of the oscillations is decreased to a minimum, with the constant current it is decreased, but also increased to about double the normal value, as shown at X'. Fig. 2. The output is then completely modulated in a much more efficient way, and the range increased for the same normal output. In fact, it must be remembered that certain sounds, such as "e," produce very little variation in the amplitude of the oscillation, while "o" produces maximum variations.

Since it is necessary to understand the speech, in order to receive all the variations of amplitude, the range of Radiophone set is limited to the distance where the smallest variations act efficiently on the receiver; this is the reason one often hears a "broken voice" in which only certain syllables are understandable in spite of very fine tuning.

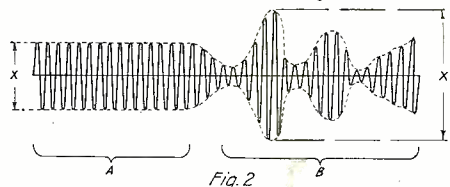

Fig. 2
The Section A of the Curve Shows the Normal Output of the Set. Section B Shows the Variations of Amplitude Produced When the Microphone is Spoken Into. If the Set is Properly Adjusted the Maximum Amplitude Obtained May be Double That Obtained When the Microphone is Not Used.

For the reason explained above, the constant current method of modulation is more efficient, as greater variations of amplitude are obtained than with the other system, thus increasing the range of a set for a given power.

In a Radiophone using this circuit, the intensity in the aerial is not an indication of the range and should not be, except as an indication of the proper functioning of the

set, relied upon as in an ordinary C. W. transmitter.

If maximum modulation is obtained, that is to say, if the emitted oscillations are completely modulated as in XI, Fig. 2, the increase of intensity read at the H. W. ammeter, when the microphone is spoken into, is about 22 per cent. over the normal radiation.

QUESTIONS FOR THIS LESSON.

1. Explain the difference between the absorption and constant current methods of modulation.
2. What is the range limit of a Radiophone set?
3. What is the influence of the modulating system upon the amplitude of the emitted wave?

Dictionary of Technical Terms Used in Radio

Selectivity—Having the power of selecting any particular wavelength from a number to the exclusion of the others.

Selenium—Se. An element closely allied to sulfur. Found in three forms, one a brick-red powder soluble in carbon bisulfide, another as a crystalline dark-grey solid which is not soluble in carbon bisulfide, and a metallic selenium which is also not soluble in carbon bisulfide. The crystalline selenium has S.G. 4.8 and melts at 217° F, and its resistance is materially decreased by light rays.

Self-Excited Dynamo—Machines whose field magnetism is produced by their own generated current.

Self-Induction—When a current is changing in a coil of wire a back E.M.F. is produced tending to stop flow of current being changed. Also known as Electromagnetic Inertia. See Lenz Law.

Separate Touch—Divided Touch. Method of magnetizing a bar of steel by placing opposite poles of two magnets of equal force in centre and drawing each magnet simultaneously towards opposite ends of the bar.

Separators—Materials which are used to separate the positive and negative plates in an accumulator. Take the form of grooved wooden boards, crinkled and perforated celluloid sheets glass rods, etc.

Series—A number of instruments or cells connected up in a circuit having no shunts, that is, current must pass thru each conductor successively.

Series Dynamo—Machines have field so wound that all of the generated current must pass thru field coils. Voltage varies

(Continued on page 914)

Junior Constructor

A NEW SYSTEM OF CONTACT FOR A GALENA DETECTOR.

As shown in the diagram the sharp edge of a Gillette blade is used instead of the common cat-whisker to secure a contact on the crystal. This detector, when set up, cannot get out of adjustment. It is simply made of a copper wire along which a binding post supporting the plate can move. An old spark coil vibrator screw is fixed on the base, and allows a close adjustment of the pressure of the blade against the galena, by means of a cotton thread fixed at the upper end of the copper wire, and which can be wound or unwound around the screw of the vibrator. To adjust this detector, the blade is first fixed so that it is about 1/30 of an inch from the crystal, then by turning the screw of the vibrator, the thread fixed to the wire, which acts as a spring becomes loose and allows the contact to be made on the crystal with the proper pressure. This detector when adjusted is very steady in operation and may be easily built by the average junior constructor.

Contributed by M. DESFORGES.

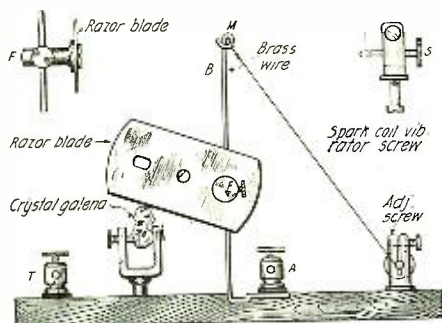

Here is a Use for Dad's Old Razor Blades. They Don't Need to be Stropped for This Use.

SCALES FOR HONEYCOMB COILS.

If the average experimenter was asked to use his variometers without scales or dials, he would throw up his hands in horror. And yet we use honeycombs without any recording device; the result is, of course, that when we want to hear someone whose wave is a little sharper than the average, there is a lot of "feeling around" and much time is wasted before we can tune the station in. All this is at once obviated by the use of scales.

The materials needed are a few square inches of sheet brass, a pair of binding posts and some celluloid or paper. Since the real value of honeycomb coils lies in great range of wave-lengths which may be attained, it is essential that any device used on them does not affect the changing of different coils. Thus the indicating arrows are bolted to the hinged elements. These arrows are made of brass strip about 1/4" wide and 4" to 5" long. One end is pointed, and a 1/8" hole is bored in the other end. The strip is now bent into a right angle, the side containing the hole being about 1" long. Two of these strips are made and bolted to hinged member by the screw which holds the lead wire; the upper screw is preferable. The strips may now be twisted so that the broad side faces the operator.

The scale support may be made in a variety of ways. It is "T" shaped with the upright about half the length of the cross-piece. It is secured to the panel by two binding posts to insure rigidity. The scale itself may be made of celluloid or paper and numbered as the operator desires.

Contributed by JAMES F. ZWEIGHAFT.

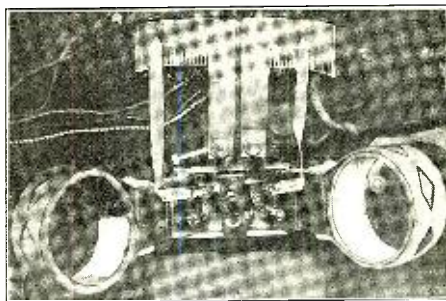

Here are the Honeycomb Coil Coupling Scales You Have Been Looking For.

A VARIABLE CONDENSER FROM TWO CONES.

First make two cones of heavy wrapping paper 12" in diameter at the base, tapering to 1" at the top and 6" high. Fig. 1. Make a wooden base to fit inside one of these and wooden tops for both. Now make a wooden base 14" square and mount the cone base in the center of this. Now, in the center of this base, mount 8" of 1/4" brass rod.

Shellac the cones and mount one on the prepared base. Take the top of this cone and bore a 1/4" hole in it, now slide it down the brass rod and fasten it to the cone top.

Make the top of the other cone fit the rod snugly. Mount this on the outside cone.

Now shellac both cones and apply alternate tinfoil sectors 1" x 7" long, tapered to nothing. Fig. 2. Have these 1" apart at least; use about 18. When dry, connect to two conveniently located switches; see Fig. 3. Now place the outer cone upon the rod.

By raising, lowering and revolving the outer cone, the capacity is changed.

The rod should be notched to form a dial.

To make a grid condenser the measurements must be made to conform to the capacity desired.

By covering the inside cone with empire cloth a fair transmitting condenser can be made. This is for small powers only (spark coils). The sketch is self-explanatory.

Contributed by EDWARD GREENLEE.

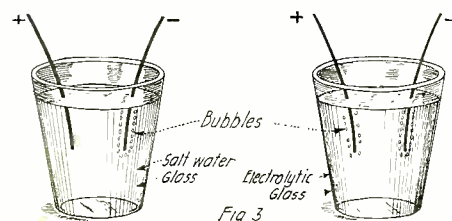
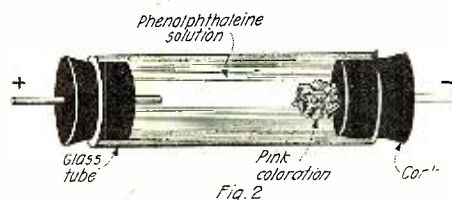
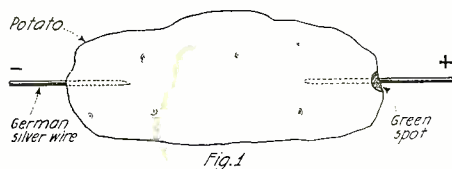

Some Clever Ideas to Make Polarity Indicators. Beat the H. C. L. by Using a Potato as Galvanometer!

A CHEAP "B" BATTERY.

Amateurs can build a very economical high-tension battery using waxed-paper tubes with a cork at the bottom. Inside, put positive sacks from worn-out pocket dry cells, and a little strip of zinc with suitable connections. As exciting solution, dissolve two parts (in weight) of "agar-agar" (a well-known sea-weed) in 100 parts of boiling water, add 20 parts of chloride of ammonium, stir up well and fill, when still hot, the paper tubes. The solution quickly becomes a soft jelly and you have a cell unbreakable, unspilling in any way, quite clean and very constant. With 36 cells in a cardboard box, you easily get 40 volts and 100 milliamperes, invaluable for portable radio sets.

Contributed by PROF. M. MOYE.

SIMPLE POLARITY INDICATORS By B. G. Silberstein

YOU are constructing a three step amplifier, perhaps described in this magazine. Everything is going fine. You have all the connections made and the tubes in place, and you are just about ready to connect your "B" and "A" batteries. You

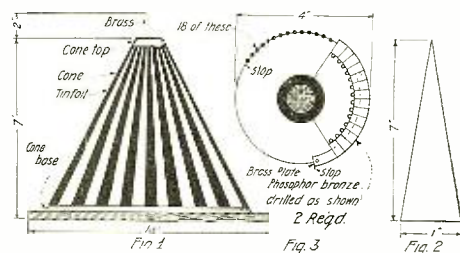

Here is a Merry-Go-Round Type of Variable Condenser Made of Cones That Turn.

connect them, put the fones on your head, light up the filament, and tune up for some station.—No sound in the fones—you wonder what is the matter? You know your connections are right—but—those "B" and "A" batteries. You don't know if their poles are connected right. You work around with the batteries and don't know which pole is which and how to find out. It is because of this and because polarity indicators are used in many other ways in your "Lab." that I am going to describe several types which are easily constructed, which will help "Bugs" out of just such and many other kinds of trouble.

Referring first to Fig. 1, we have the simplest one of all, the potato polarity indicator. A fair sized potato is secured and peeled. Cut two pieces two inches long of No. 28 German-silver wire and stick them into opposite ends of the potato. Binding posts are fastened to the end of the wires and we are ready to test it. Connect the binding posts to the opposite poles of the batteries; a green spot will be seen in a few minutes around the positive wire.

In Fig. 2 we have another type of polarity indicator. Dissolve in a little water a small crystal of sodium sulphate. This is a common medicine in most households under the name of "Glauber's Salts." When dissolved add a drop or two of phenolphthaleine. This is easily obtained from some dispensing chemist as he uses it very frequently, and if the "Bug" is a customer, he would most likely make no charge for such a minute quantity. Now get an inch or two of glass tube about 3/8 or 1/2 inch in diameter; fit it with a couple of good corks (rubber preferably) and pass thru each a short length of No. 28 German-silver wire.

(Continued on page 904)

Correspondence From Readers

MORE ABOUT THE PRICE OF VT'S.

Editor RADIO NEWS:

In the April issue of RADIO NEWS, Mr. Stone, of the Pacific Radio Supply Co., contradicted the article previously published in your magazine.

I wish to make a come-back to Mr. Stone.

Not so many years ago the electric (vacuum) lamp was brot into ordinary use. It was very cheap and as it became more popular, became still cheaper owing to high production.

Now the Audion Bulb had just the opposite sort of a life. When it came out, it was very high in cost, but since has become slightly reasonable. Salesmen were not needed for the bulbs. Are they needed for the V. T.? No! Because use has made them almost a necessity, and then too, is there any firm here in America that has a line of salesmen just for audion tubes? I will admit, and I think Mr. Boddington will also admit, that he forgot about the royalty, the labor and the patent expenses, but even so, should the audion be as high in cost as it is? Now I leave the answer to the Radio amateur! Think it out yourselves, amateurs, and let's hear your answer in the Best Radio Magazine on earth.

CHARLES TIDD, JR.,
Camden, N. J.

DOESN'T LIKE THE STORIES.

Editor RADIO NEWS:

Allow me to congratulate you on your wonderful magazine, especially on your last month's number. You have a real magazine and have the rest of 'em backed off the board. But, "for the luvva Mike," don't give us any more fony fiction stories like that "Martian Madness" and "The Phantom and the Circuit." You have some real serious articles in your magazine, but those "futuristic" stories make it look foolish. Let's have some real radio stories that deal with real stuff. Don't think that I'm an "old fogey," but I do hate to see a "100 per cent. Radio" magazine filled with that kind of bunk. I have talked with several radio men, and they think the same as I do. What do the rest of the gang think about it?

Yours for snappy radio stories,

EDWARD GRIMM, JR.,
5215 Figueroa St.,
Los Angeles, Calif.

(Correct. We too like "snappy radio stories," to be sure. But, sorry to say, we haven't got the time to write 'em. We don't always get good ones—100 per cent. ones—so what can the harassed Editor do? Suppose, Mr. Grimm, you sit down and slam out a good one. We'll print it—Editor.)

HERE IS A SATISFIED ONE.

Editor RADIO NEWS:

I have been a reader of RADIO NEWS for a long time and I take pleasure in saying that I believe it is the best Radio paper published.

It seems to me that the readers of this magazine are making too many complaints about it; I also believe that Mr. Gernsback has far more experience in the publishing work than we have; I believe that he knows more about making the cover designs. He is trying to make his paper attractive to the eye and I believe he is making a success of it.

I agree with Mr. S. M. Boddington, whose article appeared in the April issue, concerning a monthly issue; it takes me more than a month to grasp the printed matter inside its covers. I say let's have it monthly as it is coming now.

I was attracted by one of the covers of RADIO NEWS and will say it seems queer the way they (the amateurs) kick about the covers of this fine paper, and, Mr. Editor, I am well pleased with the whole paper and have not kick, I say, "Keep it up."

Yours for doubling the subscriptions.

ROLLA M. GARDNER,
Eugene, Oregon.

THE "SHIMMY" GAP!

The 19th Assistant Editor,
Spark Gap Design Dept., RADIO NEWS,
New York,
U. S. A.

Honored and Esteemed Mister:—

A copy off yer RADIO NEWS for February, 1921, blew up here on de iceboat express a month ago and I looked at page 527 at the bottom and seed a new kind of squeak box panel transmitter built by Mr. Marion W. Taylor. He got the rite idea about dat shimmying spark gap, but why not do it de way dot I did when I was a

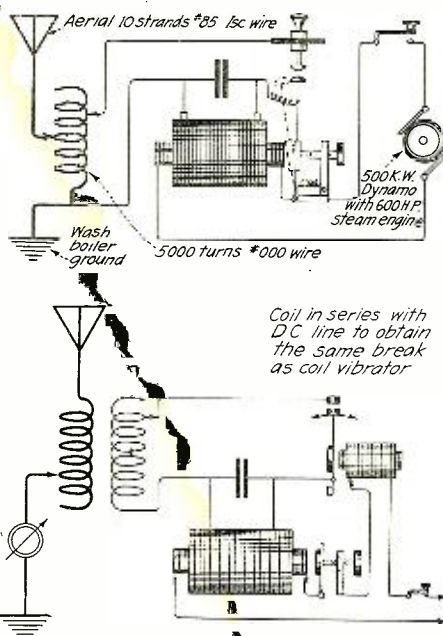

Here Are Some Ideas. A Synchronous Gap May Be Used With a Spark Coil as Shown in These Diagrams. A Movable Electrode May Be Fixed on the Vibrator and the Other One Made Adjustable, so That the Discharge of the Condenser Occurs When it is Fully Charged, or an Electro-Magnet May be Used for the Same Purpose, Provided it is Connected in Series in the Primary Circuit.

honored ham in 1845? I built one jist like Mister Taylor's but I put a *synkernous* gap on ut. The attached skiagram shows how I done it and also how Mister Taylor could fix her transmitter so as to work the saim way. The synkernous gap is more effishent then the nun-synkernous type that he uses as shown by the marvelous activities of the Hon. 2RK who burned out 10 sets of Baldwin fones up hear, this past four months, which none of the non-synkernous gap stations, even the notoriabile 8NH—8ER—8ZL, or 3DH with the 325 long and 988654 broad (meaters) wave can hoap to do.

I am shure that if Miss Taylor will try out my stunt that I will hear her with an audibility uf about 3500, if he isn't any farther north than Mexico.

73 OM.

TES EVITARENEGER.
Operatuh, at Station QRM.
(WR IT CMS PM)
Niki, Greenland.

MORE ABOUT THE COVERS.

Editor RADIO NEWS:

With the exception of one, all the issues of RADIO NEWS, since November last, have contained comments on J. F. Maher's criticism and I wonder why someone has not come to his aid.

In these days of enlightenment (?) it is seldom that you can pick up a magazine without seeing on the front cover a picture of a young lady and gent seeking to discover some new method of kissing; a girl, not clad in winter clothing, trying to turn somersaults or some equally shocking, nonsensical picture, and a fellow has some respect for a magazine that shows none of this.

It is a relief to be able to read a publication from cover to cover without having sex news glaring at you from every second page.

But RADIO NEWS, with the exception of the much discust September issue, has given us sensible, appropriate cover designs, in keeping with its policy of being the best Radio magazine published.

Perhaps Mr. Maher was a wee bit hasty with his criticism, but we notice that, since the publication of the notorious (?) letter, no more osculatory designs have appeared on RADIO NEWS covers.

Well! here's hoping that RADIO NEWS will continue to give "clean" news and no more of the so-called "human interest" pictures.

A well satisfied reader,

JNO. BERRIGAN,
Dunedin, P. E. I., Canada.

SEMI- OR BI-MONTHLY.

Editor RADIO NEWS:

Why all the talk about a bi-monthly? I guess one month is long enough to wait, without waiting two months for RADIO NEWS. Do you realize, all you fellows who have been advocating a bi-monthly paper, that you have been asking for one every two months? I guess maybe it is a semi-monthly you want, or one every two weeks. That's better than a bi-monthly, eh? I second the motion to have a semi-monthly, if it is possible.

R. GERALD WILLIAMS,
56 Academy St.,
Presque Isle, Maine.

ABOUT TRANSFORMERS.

Editor RADIO NEWS:

I wish to object most emphatically to an article in the April issue of the RADIO NEWS, entitled "Construction of Transformers," by Ben H. Woodruff. His article shows a woeful misconception of the meaning of the Underwriters' table of carrying capacity and its scope; also, he fails to realize the most conservative possibilities in flux densities in transformer steels. He may have in mind the use of "stove pipe iron," the grade available at hardware stores, for which his idea of flux density is perhaps correct. However, the kind of iron and also the use of varnisht laminations and a lot of other essentials are left to the imagination.

However, it is in his method of figuring the sizes of wire for his windings that he commits the most unpardonable errors. The most appropriate usage for a transformer built on a basis of about 300 circular mils per ampere would be as an electric radiator or foot warmer. Both No. 18 at 5 amperes and No. 8 at 50 amperes afford about 300 circular mils per ampere at his rating, and no transformer with less than 600 circular

(Continued on page 890)



RADIO CLUB OF BROOKLYN, N. Y., INC.

The members of the club at the last meeting, held on April 27, were honored with the presence of Mr. George Eltz, past president of the Radio Club of America, who gave a lecture on the uses of the Armstrong Super Autodyne System. Mr. Eltz covered the problems of the British signal corps, which were encountered during the World War, which finally led to the designing of the Armstrong Super Auto-dyne receiver by the Americans. Mr. Eltz also covered the subject from the amateurs' point of view, when he pointed out to the members present, some of the tricky parts of the circuit which he believed would be encountered by the average amateur, who contemplated building one of the above sets.

LONG BRANCH AMATEUR RADIO CLUB

The Long Branch Amateur Radio Club held its first regular meeting on April 29, at the home of Eldon Presley. Officers were elected as follows: Kenneth Adams, president; Ellsworth West, secretary, and Eldon Presley, radio instructor and inspector. Since then eight honorary members have joined. The purpose of this radio club is to create an interest in wireless telephony and telegraphy. All of the members have good size receiving sets and small portable sets. At every meeting the members have buzzer contests and this increases their alertness in code work. They are now planning to build a small headquarters so that they can construct a club set. Correspondence from other clubs will be greatly appreciated and should be addressed to Kenneth Adams, 111 Atlantic Ave., Long Branch, N. J.

PLAINFIELD RADIO ASSOCIATION

A radio club, incorporated under the New Jersey State law, as the Plainfield Radio Association, has been organized in Plainfield, N. J.

It is composed of wireless enthusiasts ranging from first-class "hams" to naval operators, and in the very near future a first-class telephone transmitting and receiving station will be installed at the headquarters.

We would like very much to have reports from any stations hearing Plainfield telephone sets, as there is a great variety of testing and experimenting going on. Address reports to Plainfield Radio Association, P. O. Box 204, Plainfield, N. J.

HADDONFIELD RADIO LEAGUE

The Haddonfield Radio League was founded two years ago and boasts of an increasing membership every month. Our meetings occur every two weeks at an appointed member's house for two meetings. At these meetings business is transacted first, followed by lectures on theory and operation of new and complicated apparatus and hook-ups.

Dues are \$2.50 for the term of 10 months; meetings are not held during July and August. With these dues the expenses of the club are paid and apparatus bought for the use of the members. A wave meter is our most recent "buy."

THE RADIO NEWS IS OUR OFFICIAL ORGAN.

The officers are: President, Edward Braddock, 3BAY; vice-president, Jesse McNeal, 3BBH; secretary, John L. Barnes, 3ABW; treasurer, Jared Barnes; and inspector, Jesse J. Haydock, 3AQF. Anyone wishing to communicate with this club should correspond with the secretary, John L. Barnes, 113 Mansion Ave., Haddonfield, N. J.

THE PENN RADIO CLUB

The first meeting of the Penn Radio Club was held at the residence of Mr. Orion G. Albert, 667 N. Preston St., West Philadelphia, Pa., on Thursday, April 21, at 7.30 P. M. The main objects of the club are code practice and theory.

The following officers were elected: President, Robert Little, treasurer, Orion G. Albert; and secretary, Leroy Ritter.

The dues are 15 cents weekly, the proceeds to be used for the purchase of new apparatus and for better headquarters. We expect, in the near future, to install a radiofone, also a two-stage amplifier and a Magnavox, provided we get enough members to enroll. Fellows, if you are interested and have a set, it's up to you to become a member. Kindly address all communications to Leroy Ritter, secretary, 2415 S. Sartain St., Philadelphia, Pa., or call any night at the president's home, 5856 Windsor Place, West Philadelphia, and at the treasurer's home, 667 N. Preston St., West Philadelphia.

NEWARK WIRELESS CLUB

The Newark Wireless Club, organized in May, 1920, is holding meetings every Wednesday night at 8 P. M.

On Wednesday, March 30, in Newark, at the

Rivoli Dance Palace, the club staged the first radio dance to be held in the city. Various C.W. stations along the Atlantic seaboard contributed with music. Mr. Ogborn, of the Westinghouse Electric & Manufacturing Co., is president of the club; Harry Fleetwood, vice-president, and Benjamin Fleetwood, secretary-treasurer. The club is fortunate in having as honorary president and radio executive, Mr. George Bliziotis, radio engineer and director of the Newark Radio School, at which place the meetings of the club are held.

A radiofone and several measuring instruments are nearing completion and will soon be ready for use by the club members.

The club desires to secure as members, amateurs and operators living in the suburbs of Newark. At present we have members from Newark, Belleville, Jersey City, Arlington and Elizabeth.

Persons interested are cordially invited to pay us a visit any Wednesday night at 284 Market St., Newark, N. J.

THE OSHKOSH RADIO CLUB

At a meeting of the Oshkosh Radio Club held recently in the physics laboratory of the Oshkosh Normal School, the following officers were elected: President, J. N. Becker; vice-president, Charles Clemans; secretary and treasurer, Percy Stephensen; corresponding secretary, Vernon Wood.

At present there are seven government licensed stations in this city, two of which operate radio telephone sending stations. An up-to-date radio telephone station is in the process of construction at the Normal School, where experiments conducted have thus far proved promising. E. A. Clemans, of the Normal School faculty, Vernon Woods, Charles Clemans and John Becker, are conducting the experiments.

Other local stations are contemplating installing similar outfits soon and communication between members by the use of radiofone entirely, will then become a simple matter.

LA CROSSE (WIS.) RADIO CLUB

The following program was given at the meeting of the La Crosse Radio Club April 4: "What Other Clubs are Doing," R. Hammersburg.

"Long Distance Stations and Their Records," R. White.

"Kinds and Makes of Receiving Instruments," W. Herbert.

Mr. Prottsmann also gave one of his invaluable instruction series, and the committee on constitutional amendments' report was presented.

It is the desire of all the members that visitors come to the meetings.

THE CHICOPEE RADIO ASSOCIATION

The Chicopee Radio Association has been organized at the Falls with the following officers: Instructor, George Smiley; president, James Duffy; secretary, Edward Benoit; treasurer, Stanley Padykula; house committee, the president, secretary, treasurer; entertainment committee: Stanley Padykula; press committee, Euclide Beaudry; finance committee, Claude Smith, Arthur Fay, Eugene Baker; committee of affiliation with the Amateur Radio Relay League, George Smiley, Arthur Fay and President Duffy.

The club has 15 members and is arousing the interest in wireless thruout Chicopee Falls. It proposes to apply for admission in the Western Massachusetts Traffic League. It is planning to give a radiofone concert for the members and a few invited guests, including Mayor Higgins. At that time music will be heard from various clubs as far south as Washington, D. C., and as far west as Buffalo, N. Y. The members are very much interested and feel that with Mr. Smiley as instructor, they can advance rapidly. He has been studying wireless since Marconi first came into notice. He is a member of the Connecticut Valley Radio Club of Springfield. The club members gathered at the home of Arthur Fay recently and listened to a concert given in Hartford. Mr. Smiley will give a talk at the next meeting of the club on the "Principles of Radiation."

FORDHAM RADIO CLUB

The Fordham Radio Club was organized Nov. 6, 1920, in the Bronx, New York City. At that time conditions in that section of the city were reaching the point where constant communication between stations only a mile apart could very seldom be maintained because of the incessant roar of local interference, a large part of which was unintentional. The pressing need of immediate organization to correct a condition that was destroying amateur radio in the district was recognized by a few of the more advanced men, and the result is the present Fordham Radio Club.

This club's primary object is now the establish-

ment of the "CW" transmitter, as every amateur's sending set. That its progress in this direction has been great is evidenced by the fact that at every meeting it is enrolling new members in the "CW" chapter, and it is now reaching the point where a spark transmitter in the vicinity is becoming a rarity, partly because of its unpopularity, but chiefly because the members recognize the extremely high relative efficiency of the continuous wave transmitter.

Those in and around the Second District, who are hearing 2XK, 2BNL, 2ACT, 2QK and others, regularly, do not have to be apprised of the good work the members have already done.

Meetings are temporarily being held at the home of L. M. Cockaday (2XK), 2674 Bailey Ave., Bronx, every Monday evening at 8 P. M. As yet, attempts have been unsuccessful in locating a desirable meeting room where a radio station can be installed and a word would be appreciated from any one knowing of any such available space.

The club is, of course, open for membership, and this opportunity is taken to extend a cordial invitation to all interested in radio, to attend the meetings held at the above address. Communications are invited, and should be addressed to Mr. Richard Leitner, 1113 Forest Ave., or the secretary, Mr. William Weller, 2156 Webster Ave., Bronx, New York.

THE QUEENS RADIO CLUB

The Queens Radio Club was organized on April 11, 1921, at Long Island City with 20 charter members. The object of this club is to advance all members in radio science. Meetings are held weekly at the industrial branch of the Y. M. C. A., 426 Jackson Ave. (Bridge Plaza), Long Island City. Lectures are given and merits of apparatus and hook-ups discuss. Membership fee is \$1, and dues are 25 cents a month. Any one may become a member regardless of age or education. New members are welcome and may obtain any information from the secretary, Mr. Theodore Holzinger, 481 Grand Ave., Astoria, L. I., New York.

CLARK RADIO CLUB

The annual meeting of the Clark Radio Club, Clark University, Worcester, Mass., was held in the Physics Laboratory on May 4. The meeting was called to order by President Parkes. The chief business conducted was that of electing officers for the ensuing year. A. W. Parkes was re-elected president; R. R. Smith, secretary, and W. R. Francis, treasurer. A committee of five was appointed to take charge of the sub-freshman day celebration. This committee has arranged for another concert to be given by radiofone, and also for numerous other experiments in order to give the men of meager information a more complete knowledge of the operation of the apparatus. Besides this committee, several others were appointed for maintenance of equipment, operating shifts, etc.

After the business session, the members talked over the problems which are to be undertaken during the coming year, especially the erection of an umbrella-type of antenna, 150' high. It was proposed that the individual wires be controlled by a switch so that it could be employed as a goniometer.

ELBERON RADIO CLUB

The Elberon Amateur Radio Club held its first regular meeting on April 27th. Officers were elected as follows: William Bryan, president; J. Calder Scobey, secretary; Henry Hacker, treasurer. The purpose of the club is to bring the amateurs of Elberon together and instruct them in radio telegraphy and radio telephony. All owners of radio sets in Elberon or vicinity are invited to join; also correspondence from other clubs is invited. Address all communications to William Bryan, Elberon, N. J.

HURON RADIO CLUB

At the first official meeting of the Huron Radio Club, of Huron, S. D., the following officers were elected: President, Lewis Terpening, and secretary-treasurer, Arnold Anderson. Prof. Ralph D. Doner, author of the article on "The Hall Air-Jet Radio Relay," which appeared in the February issue of *Science and Invention*, is our instructor-member, as is also Mr. Knapp, formerly an operator in the Navy. The following are the present members: Lewis Terpening, Arnold Anderson, Chester Bailey, William Whorton, Jack Fossburg, Bernold Kyes, Prof. Doner and Mr. Knapp.

We plan to install a complete receiving set as soon as we can find a room. Anyone desiring to join the club will have to pass a test before doing so.

We desire to correspond with other clubs. Please address all letters to the secretary, Arnold Anderson, 1250 Ninth St., Huron, S. D.



THIS Department is conducted for the benefit of our Radio Experimenters. We shall be glad to answer here questions for the benefit of all, but we can only publish such matter of sufficient interest to all.

1. This Department cannot answer more than three questions for each correspondent.
2. Only one side of the sheet should be written upon; all matter should be typewritten or else written in ink. No attention paid to penciled matter.
3. Sketches, diagrams, etc., must be on separate sheets. This Department does not answer questions by mail free of charge.
4. Our Editors will be glad to answer any letter at the rate of 25c for each question. If, however, questions entail considerable research work, intricate calculations, patent research, etc., a special charge will be made. Before we answer such questions, correspondents will be informed as to the price charge. You will do the Editor a personal favor if you make your letter as brief as possible.

A. C. FOR POWER TUBE FILAMENT.

(213) Jack Knebel, of Larchmont, N. Y., asks:

Q. 1. Could A. C. be used for the filament or grid of a 50 watt power tube?

A. 1. A. C. may be used to light the filament of a power tube, but a D. C. voltage is needed for the grid bias voltage.

Q. 2. Could I lawfully use a Radiophone over 200 meters and how?

A. 2. No, you must not use a Radiophone over 200 meters, unless a special license for the use of a longer wave is granted to the station.

Q. 3. Give a Radiophone hook-up to use with a 50 watt Cunningham tube?

A. 3. This hook-up was published on page 796 of the May issue of RADIO NEWS.

Q. 4. What would be the range of this set if the plate voltage is 400 volts?

A. 4. It is difficult to say, for the range depends greatly upon the surroundings of the station, the adjustment of the set and especially upon the type of receiver used at the receiving stations. Under good conditions, it may be about 100 miles.

Q. 5. What should be the height of an aerial 125' in length, to work with this set?

A. 5. About 60' would be suitable.

HOOK-UP FOR THREE HONEYCOMB COILS.

(214) Raymond Drake, of Indianapolis, Ind., asks for the following:

Q. 1. Please show a hook-up for three honeycomb coils, a variable and a fixed condenser, using a crystal detector.

A. 1. The hook-up for these instruments appears on this page. You will note that a variable condenser is necessary in the secondary circuit.

Q. 2. Using this hook-up, would it be possible to catch N. A. A., using a 60' aerial, 30' high, and what honeycomb coils should be used?

A. 2. We are afraid not, the distance being too great and the aerial too small. Some L 400 coils should be used to tune in N. A. A.

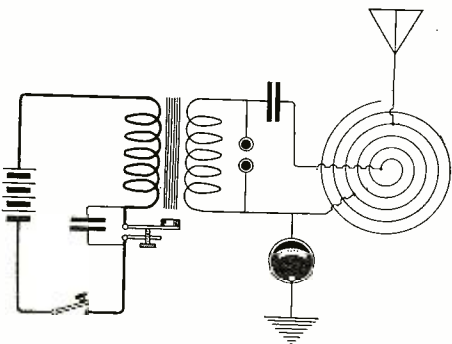

This is the Hook-up for a Spark Coil Using an Auto Transformer with a Quenched Gap.

RADIO FREQUENCY AMPLIFIER.

(215) George W. Jackson, of Alexandria, Va., requests the following information:

Q. 1. Can one step of radio frequency amplification be attached to any type of valve receiving set. Please publish a diagram of a one-step radio frequency amplifier.

A. 1. A one-step frequency amplifier may be used with most receiving circuits. For long waves, resistance coupling may be used as shown on page 596 of the March issue of RADIO NEWS, and for short waves, a tuned circuit, such as the one shown on page 441, of the January issue.

TICKLER COIL.

(216) E. O. Lund, of Vining, Minn., wants to know:

Q. 1. When a tickler coil is used, is it necessary to have it near the receiving coils or loose coupler, or can it be placed anywhere on the panel?

A. 1. The tickler coil should be mounted so that the coupling between this coil and the secondary is adjustable.

Q. 2. Is paraffin wax a good dielectric for soaking coils?

A. 2. Yes, paraffin wax is suitable as insulating material for coils.

SPARK COIL SET.

(217) Grahame H. Hardy, of Ashland, N. H., asks:

Q. 1. Can I use a step down transformer that has steps from three volts to 24 volts for current to operate a spark coil that has a spark length of 1/4", and what voltage shall I use?

A. 1. Yes, a step down transformer may be used with a spark coil, but the vibrator needs a careful adjustment; on a 1/2" coil, about six volts should be used.

Q. 2. Please give hook-up for the following sending set: One 1/2" spark coil; one spark gap; one Helix with two clips; one key; and five dry batteries. I have no condenser; if I need one, how can I make a cheap sending condenser that will do for the above mentioned sending set?

A. 2. A hook-up for your instruments appears on this page. You should use an H. T. condenser in your circuit and also a hot wire ammeter in the ground lead to see your radiation, and if your set is properly tuned.

An H. T. condenser may be made of 41 photographic glass plates 4" x 5", with some 3" x 4" tinfoil armatures; 20 tinfoil sheets are required for each armature, which should be fitted with lugs for connection to the circuit.

COUNTERPOISE.

(218) Francisco Pineda-López, of New York City, would like to know:

Q. 1. Is it absolutely necessary to use a ground for the reception of wireless signals? If so, how do airplanes manage to get them when in flight, with no ground available?

A. 1. A ground is not necessary for the reception of Radio signals or fone messages. A loop or a counterpoise may be used. A loop is a closed circuit which is connected in the same way as the secondary of a loose coupler or other tuning coil. A counterpoise is merely another aerial used as ground; on the airplanes, the counterpoise consists of the motor, guys and other metallic parts connected together.

SPARK COIL DATA

(219) J. G. Schroeder asks:

Q. 1. Can I use 32-volt D. C. from batteries for supplying the plate voltage to a Radiotron U. V. 200 tube?

A. 1. Yes, this H. T. supply is quite suitable, but a potentiometer should be used, for a U. V. 200 tube requires only 20 1/2 v. on the plate.

Q. 2. What is the proper sparking distance for 1 k.w. rotary spark gap?

A. 2. There is no fixed sparking distance for a spark set; the proper length of spark should be found by experimenting, and depends upon the capacity used in the oscillating circuit, and upon the speed of the motor.

Q. 3. Please give me instructions for building a three-inch spark coil to operate on a 32-volt D. C.; size of wire, amount of wire required and size in square inches of condenser.

A. 3. A three-inch spark coil to be used on 32 v. may be built as follows: Length of core, 12 1/2"; diameter of core, 1 3/8"; the primary is wound with No. 14 wire in six layers; the secondary is wound in 16 pies with No. 32 wire. Weight of secondary wire, eight pounds; the condenser consists of 180 tinfoil sheets, 9" x 7"; wall of insulating tube between primary and secondary, 1/4".

VARIABLE CONDENSER CAPACITY.

(220) Erwin W. Schmidt, of Medina, Ohio, inquires:

Q. 1. What is the capacity of a variable condenser which has 22 stationary plates 4" in diameter, No. 24 gauge aluminum.

(Continued on page 904)

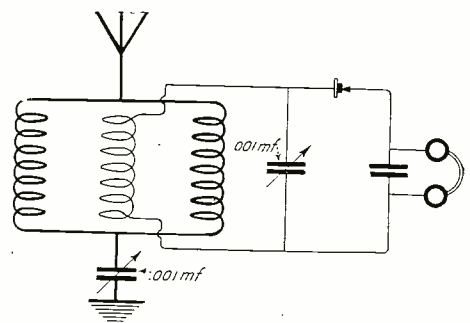

Hook-up for Three Honeycomb Coils with a Crystal Detector.

MURDOCK

THE LATEST VARIOMETER No. 345 VARIOCOUPLER No. 346

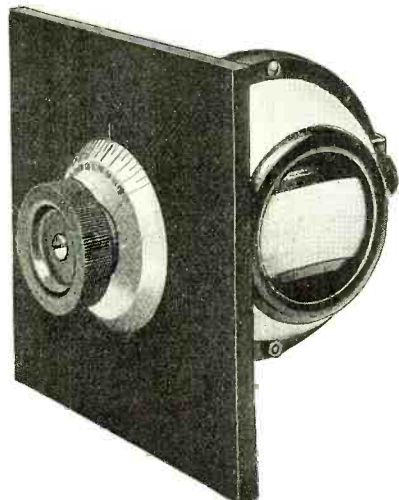

No. 345 Variometer
\$7.50

- No. 345-P Variometer, complete as illustrated with panel, knob and dial and panel mounting brackets.....\$7.50
- No. 345-G Variometer, complete as illustrated with panel, knob and dial and panel mounting brackets.....\$7.50
- No. 345-P or 345-G Variometers without knob and dial.....\$6.75
- No. 346 Variocoupler, as illustrated with panel, knob, dial, and panel mounting brackets and back connected tap off switch.....\$8.50
- No. 346 Variocoupler without knob or dial.....\$7.75

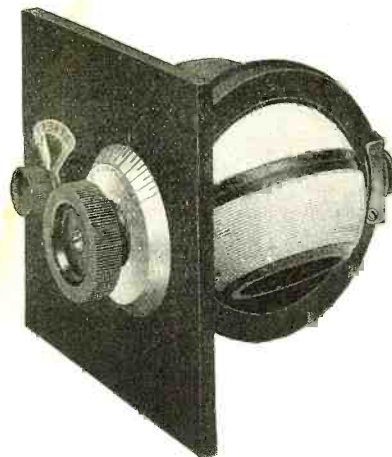

No. 346 Variocoupler
\$8.50

**WINDING FORMS ARE
"MURDOCK MOULDED"**

**"THE PRICE IS UNUSUALLY LOW,
THE QUALITY IS
REMARKABLY HIGH"**

SEE THEM AT YOUR DEALERS

MURDOCK No. 55 RADIO RECEIVERS



**2000
OHM
DOUBLE SET
\$4.50**

**3000
OHM
DOUBLE SET
\$5.50**

MURDOCK Variable Condensers

- No. 366—43 plate .001 mfd. with oil containing case..... \$4.75
- No. 367—43 plate .001 mfd..... 4.50
- No. 368—23 plate .0005 mfd..... 4.00

PANEL MOUNT TYPES

- No. 3660—43 plate .001 mfd.....\$4.00
- No. 3661—43 plate .001 mfd..... 4.25
- No. 3662—43 plate .001 mfd..... 5.00
- No. 3680—23 plate .0005 mfd..... 3.25
- No. 3681—23 plate .0005 mfd..... 3.50
- No. 3682—23 plate .0005 mfd..... 4.25

MURDOCK Variable Condensers

"PERFECT SATISFACTION GUARANTEED OR YOUR MONEY BACK"

**BUY THEM FROM YOUR DEALER
SEND FOR BULLETIN No. 20**

WM. J. MURDOCK CO. 50 CARTER STREET
CHELSEA, MASS.
509 MISSION STREET, SAN FRANCISCO, CALIF.

Crosley Cabinets



The tendency in the radio field today is to put apparatus in cabinets not only for appearance sake, but as a protection from dust, dirt, atmospheric conditions, etc. Realizing the demand for attractive stock cabinets of various sizes, we are building them in quantities in our large wood working plant. These cabinets are all uniform in style. The panels are rabbeted in to the front. As the outside dimensions and inside dimensions are either larger or smaller than the panel itself, we show panel size and also inside dimensions. Prices quoted do not include the panels.

All cabinets are waxed antique mahogany finish. Wood used is either gum, genuine solid mahogany or quartered oak. Lids or tops are hinged. Sizes and prices are shown below:

| For Panel Size | CABINETS | | | Quartered Oak or Mahogany | |
|----------------|----------|------------------|-------|---------------------------|--------|
| | Height | Dimensions Width | Depth | Gum | hogany |
| 6 x 7 | 5½ | 6½ | 7 | \$2.50 | \$3.85 |
| 6 x 10½ | 5½ | 10 | 7 | 2.75 | 4.40 |
| 6 x 21 | 5½ | 20½ | 7 | 3.90 | 7.30 |
| 6 x 14 | 5½ | 13½ | 7 | 3.30 | 5.55 |
| 9 x 14 | 8½ | 13½ | 10 | 3.70 | 6.80 |
| 12 x 14 | 11½ | 13½ | 10 | 4.40 | 8.50 |
| 12 x 21 | 11½ | 20½ | 10 | 5.20 | 10.60 |

Cash must accompany order. No C.O.D.'s. We pay transportation charges.

We can furnish genuine formica panels 3/16" thick, cut to the following dimensions: 6 x 7; 6 x 10½; 7 x 9; 6 x 14; 7 x 12; 6 x 21; 7 x 18; 9 x 14; 12 x 14; 14 x 18; 18 x 21. Price of panels—2½¢ per square inch. For odd sizes order the next largest size; we will trim. We pay the postage.



CROSLY MAGFON

No radio station complete without it. Built in horn: amplifies signals, voice, or music, making head phones unnecessary except on weak signals. Uses one watch case receiver, any make; simply insert it in back of cabinet. Beautiful antique mahogany finish. Price, \$10.00

Dealers wanted. MANUFACTURERS OF RADIO APPARATUS—send us samples or drawings of your cabinets for quantities prices. Get your name on our mailing list to receive latest bulletins of our latest radio specialties.

CROSLY MANUFACTURING CO.
Dept. R. Cincinnati, Ohio

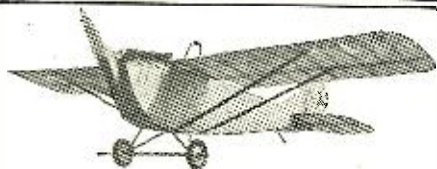

Build Model Planes

Wading River models are exact scale reproductions of real planes, that's why they fly. You can't go wrong with Wading River plans and parts. Send 10 cents for new 56 page catalogue, showing 25 different models that you can easily build.

WADING RIVER MFG. CO.
Dept. H, 672 Broadway, Brooklyn, N. Y.

Electricity

A practical training in this great profession will make your successful future a certainty. We teach all branches of Electrical Science and Engineering.

ELECTRICAL ENGINEERING

With B. S. Degree in 3 Years

Electrotechnics—12 to 36 mos. Electrical & Mechanical Drafting—6 to 12 mos. Automotive Electricity 3 mos. Armature Winding & Motor-Generator Repair, thorough 3 to 6 months' course. Practical Electricity—6 months.

A place for every student. Up-to-date laboratories—faculty of 80 experts; individual instruction. Write for latest catalog; mention age and education. New term soon starting.

SCHOOL of ENGINEERING
Dept. EN-6
373 Broadway, Milwaukee, Wis.



A "SCOOP" FOR RADIO NEWS

WE do not often boast about our achievements, but we think the attention of the radio fraternity should be called to the fact that we scored a clean "scoop" in our May issue, as they say in newspaper parlance.

Our smaller friendly contemporaries are always ready to honk their own horns as to the service which they render to the radio fraternity, but we notice that RADIO NEWS is always there first. Radio Bill H. R. 4132 was printed in full in our May issue. No other notice of this important bill appeared in any of the other May issues of our contemporaries, altho one or two of them came out after us, and therefore had more time to get the information.

We believe that RADIO NEWS is the only radio publication that maintains a representative in Washington for the express purpose of safeguarding the interests of the amateurs. There is no radio bill that does not come to our immediate attention.

Frequently our Washington representative finds it necessary to telegraf us and this happened with bill H. R. 4132. As a matter of fact we were about to go to press and the issue was closed, but by lifting several pages including the Editorial, it was possible to include this important information.

It should be noted that this is not the only radio bill that has been brot to our attention of late. As a matter of fact there has been a regular avalanche, but most of the bills did not concern the amateur directly, so we did not print them.

This notice has not been written in a vain-glorious spirit—it simply calls the attention of the radio fraternity to the fact that RADIO NEWS is on the job at all times. Not only this, but if at any time certain radio legislation should threaten the amateur, even after RADIO NEWS has come out, we would immediately transmit the information by mail to our list of over 50,000 radio amateurs located all over the United States.

JUDGE MAYER SUSTAINS ARMSTRONG PATENT

AS a result of litigation extending over a period of years, the Armstrong radio "feedback" patent, controlled by the Westinghouse Electric & Manufacturing Co., has been held valid by Judge Mayer.

This patent covers what is probably the most important circuit arrangement in use in modern radio. It made possible trans-oceanic radio communication and has contributed much to the art of radio telephone communication.

The feedback circuit magnifies the signals received by wireless instruments thousands of times, so that signals previously inaudible are now easily readable, and it further permits of very great selectivity, making possible reliable communication between two stations regardless of atmospheric conditions and of the transmission of messages by other stations.

Judge Mayer, in his opinion, says: "This case is another contribution to the romance which has so often characterized the history of forward inventions. As a boy of 15, Armstrong became interested in radio and erected a radio station at his home. In the spring of 1912 he began a close study of the fundamental action of the audion and read all the literature on the subject. Some time during this period, he connected a condenser across the telephone of a single audion receiving system, and noticed that on some bulbs an increase in signal strength would result. It is important, at this point, to realize that Armstrong is a remarkably clear thinker. His achievement was not the result of an accident, but the consummation of a thoughtful and imaginative mind. Step by step he proceeded with the study and experiment. He was obtaining what seemed to him remarkable results, and in December, 1912, he had succeeded in improving the sensitiveness of the audion by means of a new connection. The merit of the invention was soon recognized, and the very apparatus of which Armstrong made the invention was subsequently utilized commercially at Sayville, Long Island, shortly after the outbreak of the war in 1914, to overcome difficulties in the reception of signals from Nauen, Germany."

When the United States entered the war, Armstrong, who was then working with Professor Pupin in the Hartley Research Laboratory, Columbia University, was commissioned as Captain in the Army and served in the Signal Corps, A. E. F., where he rose to the rank of Major. The invention, which by that time had become widely known, was used by the Signal Corps of all the armies in the field for receiving radio messages under the difficult conditions of warfare.

The commercial value of the invention

was appreciated at an early date and licenses were taken out by the Atlantic Communication Company, the Goldschmidt Company and the Marconi Company during the years 1914 and 1916.

All radio amateurs are familiar with the circuit. It permits them to receive on a simple small antenna the radio signals transmitted from great distances. Thus it is possible for an amateur in and about New York with his antenna located on his apartment house and using the Armstrong feedback circuit to hear messages from Nauen, Honolulu, Darien, Norway, Philippine Islands, Lyons, and the great Lafayette Station installed by the Americans during the war at Bordeaux, France. It is also depended upon in the delicate work of direction finding, which requires receiving instruments of the utmost delicacy. It was used on the NC Navy planes which crossed the Atlantic.

Prof. M. I. Pupin, of Columbia University, says:

"Edwin H. Armstrong's contribution to the radio art is epoch making. No one who has employed his feedback can fail to appreciate its eminent value and inexhaustible possibilities. Armstrong made his invention when he was about 21 years of age and before he graduated from the Department of Electrical Engineering at Columbia University in 1913. The regenerative receiver and the regenerative oscillator will always figure among the classical inventions and will occupy a foremost position in the research laboratory, as well as in the commercial wireless service. It entitles Armstrong to a very high place among electrical inventors."

The principal defences urged by the De Forest Company and the American Telephone & Telegraph Co. were prior invention by Dr. DeForest and that Armstrong's invention was of a very limited character. Judge Mayer held that Armstrong was the first inventor and that the invention was of a very broad character, covering any feedback arrangement.

SOME LETTER! HUH?

First Am.: Say, did you know that "Q" is the most dangerous letter in the continental code?

Second Am.: No. How so?

First Am.: Why, because it contains T. N. T. (— — —) = Q.

ROBT. E. SNYDER.

FORGOT THE DETECTOR.

Jinks: My wireless set must be worth a lot.

Binks: Why?

Jinks: They say "silence is golden."

RADISCO BETTER "B" BATTERIES

are an investment in satisfaction! To pay less is to sacrifice essential elements of quality. To pay more is unnecessary—a needless use of money which might better be put into other apparatus.

Operating life, - 600 to 1000 hours
 15 cells, - 22½ volts
 No. 1 (3½ x 2 x 2½ in.) - \$1.50
Shipping weight 2 pounds
 No. 2 (6½ x 4 x 3 in.) - \$2.65
Shipping weight 5 pounds.

Larger size has variable voltage feature. Tapped in groups of three cells. Ask your dealer to explain it.

For radio phone work, Radisco Better "B" Batteries provide a reliable source of power, without the disagreeable hum of a motor generator or the rectified 60 cycle tone.

Radio Distributing Co.
 Newark New Jersey

This Mark  Your Guarantee

No batteries at the price are as good.

No batteries at any price are better.



THE RADIO DEALERS listed below are progressive merchants. They are equipped to give you helpful advice and real service in selecting your radio equipment. As an indication of their up-to-date methods, they carry a complete line of Radisco apparatus, including the new vario-coupler, Radisco Coils, Better "B" Batteries, Corwin Dials, etc. Buy from the nearest Radisco agency, and be sure of satisfaction.

- ALBANY, N. Y.
Shotton Radio Mfg. Co.
8 Market St.
- ASHEVILLE, N. C.
Hi-Grade Wireless Instrument Co.
- ATLANTIC CITY, N. J.
Paramour & Radio Supply
Arkansas & Pacific Aves.

- BOSTON, MASS.
Atlantic Radio Co.
88 Broad Street.
- BROOKLYN, N. Y.
Kelly & Phillips
312 Flatbush Ave.
- CHICAGO, ILL.
Chicago Radio Labs.
1316 Carmen Ave.
Branch, Peoria, Ill.
- EUREKA, ILL.
Klaus Radio Co.
- KANSAS CITY, MO.
McCreary Radio Supply
4th and Delaware Sts.
- NEWARK, N. J.
A. H. Corwin & Co.
4 West Park St.
- NEW ORLEANS, LA.
Rose Radio Supply
604 Gravier St.

- NEW BRUNSWICK, N. J.
Geo. N. DeLapaine
306 George St. and
8th and Magnolia Sts.
- OMAHA, NEBRASKA.
O. B. Radio Supply Co.
406 Brown Building.
- PHILADELPHIA, PENN.
Philadelphia School of
Wireless Telegraphy
Broad and Cherry Sts.
- PITTSBURGH, PENN.
Radio Electric Co.
3807 Fifth Ave.
- PORTLAND, ME.
Atlantic Radio Co.
15 Temple St.
- PROVIDENCE, R. I.
Rhode Island Electrical
Equipment Co.
45 Washington St.

- SCRANTON, PENN.
Shotton Radio Mfg. Co.
P. O. Box 3
Branch 8, Kingsbury St.
Jamestown, N. Y.
- SEATTLE, WASH.
Northwest Radio Service
609 Fourth Ave.
- WASHINGTON, D. C.
Eastern Radio and Elec.
Co., 1405 Florida Ave.,
N. W.
- WICHITA, KAN.
The Cosradio Co.
1725 Fairmont Ave.
- Canadian**
- BEINVILLE, QUEBEC.
Canadian Radio Mfg. Co.
- MONTREAL, QUEBEC.
J. B. Miller
136 Vendome Ave.,
N. D. G.
- TORONTO, ONTARIO.
The Vimy Supply Co.
567 College Street.

Radio Distributing Co. Newark, N. J.

To Responsible Dealers
 If you are in a town where there is no Radisco Agency, you will benefit by writing for the Radisco plan.

RADISCO

"Your Assurance of Satisfactory Performance"

WHY ?

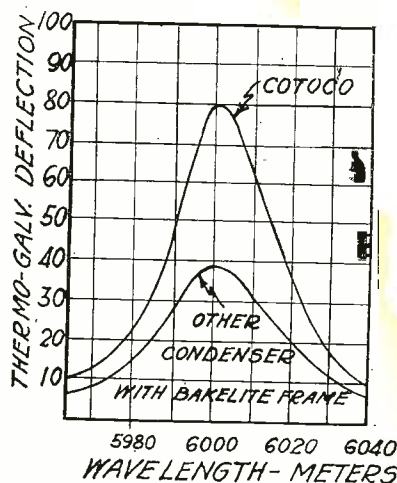

WHY did we start building condensers?
 should you investigate Cotoco condensers?
 should you use a Cotoco condenser?

The curves above were made to compare the sharpness of resonance of our condenser with the usual type assembled between bakelite heads. It gives the essential reason **WHY** this condenser will produce results you want. If this is not sufficient reason, let us send you our descriptive bulletin, which will give you all the details.

Made in three sizes .0005 M.F., .0007 M.F. and 001 M.F. in case as shown, or unmounted.

Get on our mailing list **NOW**

C TO-COIL CO. 87 Willard Avenue
 PROVIDENCE, R. I.

THE ROTARY MODULATOR

A New CW Unit For Tone Transmission With Power Tubes

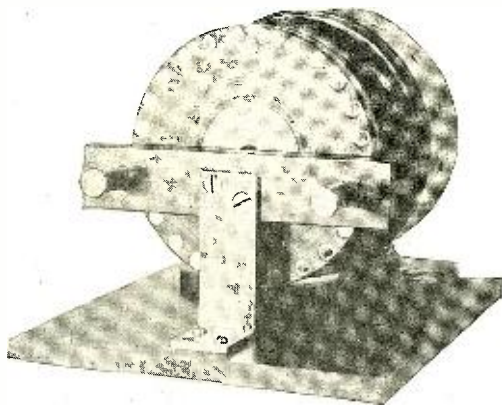

Superior to buzzer modulation as all tubes can be used as power oscillators with 100% modulation. Designed for operation in any CW circuit now in use.

A pure, clear, audio note at any frequency desired is obtained by regulating the motor speed. The rotor is perfectly balanced and can be driven by the smallest motor.

Complete instructions are furnished with each modulator including blue print and data for a self-rectifying transmitter using the new 5 watt tubes.

Price of modulator complete, not including motor\$10.00
 We prepay postage. State size of motor shaft. Order from your dealer or direct from

Northern Electric Company
 SCHENECTADY, NEW YORK
 P. O. Box 371

Newspaper Uses Amateur Radio Reporters

(Continued from page 875)

the transmission of the news was complete, officials of the radio club received messages from stations as far south as Los Angeles and as far north as Portland.

These stations said that they had listened in on the *Tribune* news, many of them up and down the coast copying off the notes of the day's doings in Hayward, Vallejo and the other towns of the district. Several volunteered their services in a test of wider scope, which would embody the entire Pacific Coast, which is now being discussed by the Club as a result of the success of that night's test.

Results of the test were discussed at the meeting of local radio amateurs at the Bay Counties Radio Club the following Friday evening in the Alden branch library and various plans for future tests of wider scope were presented.

Following are some of the *Tribune* despatches received in the press service test, with the names of the operators who sent and received them, and their call letters:

FIRES NOW COME TO RICHMOND FIREMEN

Sent by A. E. Poage, 6HP.
 Received by W. D. Wood, 6KL.
 Richmond, April 19.—A garbage truck while loading waste excelsior at a store at Sixth and McDonald Avenue caught fire today. People were startled by the approach of the truck at full speed and ablaze. The truck was brot to a quick stop in front of the fire station and the fire extinguished. It was later called for by the crew. The blaze was extinguished before serious damage was done to the truck.

It is related that in the early days of Richmond when the fire department was a volunteer organization, and there was some complaint that the department was slow in getting on the job, a city commission made a motion that whenever there was to be a fire the fire department was to be notified and then the fire brot to the fire department.

RANCHERS PROTEST GORDON VALLEY PLAN

Sent by R. J. Eeler, 6IM.
 Received by R. W. Carroll, 6BG.
 Vallejo, April 19.—The formal protest of the Suisun Valley ranchers in regard to the construction of the proposed Gordon Valley reservoir in Napa County was received by the city council Tuesday afternoon and filed.

The city of Vallejo has already filed a request with the State Water Commission to impound some of the waters of Gordon Valley creek in the reservoir to be erected on the Scally ranch in Napa County, and it is expected that the commission will act on the matter during the month of May.

Four men are now at work in Suisun Valley taking water measurements in the Suisun Creek and reports are being forwarded each week to the water commission. The city of Vallejo bonded itself last fall for the sum of \$1,250,000 for the Gordon Valley reservoir project, and today something like \$30,000 has been spent in survey and investigation details.

MT. DIABLO STUDENTS WILL RALLY TONIGHT

Sent by C. S. Mundi, 6AJ.
 Received by R. B. Lohry, 6AN.
 Concord, April 19.—The results of the high school baseball game at Antioch last Saturday were: Mt. Diablo 11; River View, 4.

Mt. Diablo students meet Wednesday night. Yell Leader Ed Drew, of the University of California, will be the speaker and a University quartet will furnish the music. Invitations have been extended to Contra Costa County High School students to attend.

LARGE CROWDS SEE OPENING OF CASINO

Sent by O. F. Willey, 6PR.
 Relayed by C. C. Whysall, 6TV.
 Received by S. C. Houston, 6AVF.
 Santa Cruz, April 19.—Informal opening of the Casino and plunge was held Friday, 15th. Very large crowds attended.

Fine work has been done on the Watsonville and Santa Cruz highway. The highway will be completed in a few weeks. Mountain highways are hoped for completion by middle of July.

This new and useful activity of the Radio amateurs is certainly to be encouraged by other newspapers, which will realize the utility of the amateurs as reporters in each town, especially those deprived of quick means of communication.

"JUST LISTEN" THE OMNIGRAPH WILL DO THE TEACHING

Learn The Code With The OMNIGRAPH

AT HOME—in half usual time—Wireless or Morse

The Omnigraph Automatic Transmitter will teach you either Wireless or Morse Telegraphy—at home—in the shortest possible time and at the least possible expense. Connected with Buzzer or Buzzer and Phone, or with Sounder, the Omnigraph will send you unlimited messages, by the hour, at any speed you desire. It will bring an Expert Operator—right into your home—and will quickly qualify you to pass the examination for a first grade license.

If you should undertake to record on paper tape, all the new messages the OMNIGRAPH will send, you would need a strip long enough to reach around the globe.



Radio Convention,
March 16-19,
1921.
Hotel Pennsylvania
Roof,
New York City.

Exhibit of
Dept. of
Commerce,
Bureau of
Navigation.

Examinations for licenses were given by the Dept., every afternoon and evening with the OMNIGRAPH.

THE OMNIGRAPH is always used to test all applicants applying for a Radio License

The OMNIGRAPH is used by several departments of the U. S. Government and by a large number of the leading Universities, Colleges, Technical and Telegraph Schools throughout the U. S. and Canada.

Practically every leading and reliable Home-Study Radio School furnishes their students with an Omnigraph. The Radio Institute of America, 326 Broadway, New York; The United Y. M. C. A. Schools; Extension Division, 375 Lexington Ave., New York, and the New York Wireless Institute, 258 Broadway, New York, all endorse and use it.

Thousands have learned both the Morse and Wireless Codes with the OMNIGRAPH. Send for free Catalog describing three models—\$14 to \$30, or order direct through any of the following dealers. DO IT TODAY. The OMNIGRAPH is sold under the strongest of guarantees—if not as represented, your money back for the asking.

THE OMNIGRAPH MFG. CO.,
Cortlandt Street, New York.

Gentlemen:—I wish briefly to commend your very excellent Automatic Transmitter. Recently I was successful in obtaining a first-class Commercial Radio license and I believe that the Omnigraph was my principal aid. I took a four weeks course at a Resident Radio School in Theory only. I relied on the Omnigraph to get my Code to the proper speed, and the Omnigraph did it.

I was one of two in a class of eighteen to obtain a first-class License. The stumbling block for the others was CODE. . . . And I know that a short time, receiving Omnigraph messages daily, would have enabled them to pass the examination as easily as I did.

I believe the Omnigraph to be the easiest, quickest and cheapest method to learn the International Morse Code.

Cordially yours
(signed) GEO. E. SELLERS.

4341 Richardson Ave.,
New York City,
Jan. 21, 1920.

OMNIGRAPH MFG. CO.,
26 Cortlandt St.,
New York City.

Gentlemen:—I am glad to inform you that I secured my First Grade Commercial License on April 25th and as far as passing the code test, I owe most all my success to the Omnigraph. I see no reason for any one to go to a resident school to learn the code, when they can have such a wonderful teacher as the Omnigraph right in their own home. Refer any one to me if you so desire.

Yours truly,
(Signed) CHESTER RACKEY

97 Thorne St.,
Jersey City, N. J.,
May 6, 1921.

THE OMNIGRAPH MFG. CO.

Gentlemen:—A few months ago I bought one of your Omnigraphs and I have nothing but praise for it, as it increased my receiving from about five to six words per minute to twenty words, in two or three months' time.

Always a Booster for the Omnigraph.
(Signed) CHAS. F. O'DELL.

Port Aransas, Texas,
May 1, 1921.

- Bunnell & Co., J. H. New York City
- Bamberger & Co., L. Newark, N. J.
- Continental Radio & Elec. Corp. New York City
- Ca'ton, Neill & Co., Ltd. Honolulu, T. H.
- California Electric Supply Co. San Francisco, Calif.
- Duck Co., Wm. B. Toledo, Ohio
- Doubleday-Hill Electric Co. Pittsburgh, Pa.
- Killech Co., David. New York City
- Manhattan Electrical Supply Co. New York City
- Manhattan Electrical Supply Co. Chicago, Ills.
- Manhattan Electrical Supply Co. San Francisco, Calif.
- Meyers Co., Leo J. St. Louis, Mo.
- Manhattan Electrical Supply Co. San Francisco, Calif.
- Newman-Stern Co. Cleveland, Ohio
- Pitts Co., F. D. Boston, Mass.
- Radio Institute of America. New York City
- Rose Radio Supply Co. New Orleans, La.
- Stewart Elec. Co., Frank H. Philadelphia, Pa.
- Schmidt & Co., Rudolph. Rochester, N. Y.
- Southern Elec. Supply Co. San Diego, Calif.
- Southern Calif. Elec. Co. Los Angeles, Calif.
- Williamson Elec. Co., H. E. Seattle, Wash.
- Welfe Electric Co. Omaha, Nebr.
- Zanicki Co., Jos. M. Baltimore, Md.

The Omnigraph Mfg. Co.

26 A Cortlandt Street New York City

The Omnigraph Mfg. Co.
26 A Cortlandt St.,
New York City

Gentlemen:—
As per your ad in RADIO NEWS please mail me your free catalog of Omnigraphs.

Name

Address

City State

ACME C. W. APPARATUS

C. W. Power Transformer

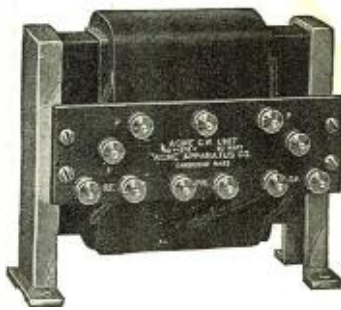

C.W. Power Transformer

For use with rectifying devices or for A. C. directly on the plates of power tubes.

| Output | Filament voltage | Filament current | Plate voltage | Plate current |
|--------|-----------------------|------------------|---------------|---------------|
| 50 | 10 | 2.5 | 350 | 100 |
| | Two filament windings | | | |
| 200 | 12 | 5 | 250-550 | 200 |
| | Two filament windings | | | |
| 500 | 0 | 0 | 1000-1500 | 400 |
| | No Filament windings | | | |

1½ Henry Choke Coils

For use in ironing out pulsations and for modulating single and double 150 MA and 500 MA capacity.

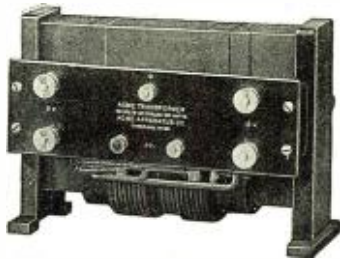

Filament Heating Transformer

Filament Heating Transformers

allow the use of A. C. for power tube filament heating.

| Output | Secondary voltage | Secondary current |
|--------|-------------------|-------------------|
| 75 | 8-10 | 7 |
| 150 | 10-11 | 13 |

Modulation Transformers

give maximum modulation without distortion.

“The Apparatus with a Guarantee”

Your Dealer will be glad to show these

Ask for Bulletins

ACME APPARATUS COMPANY, 188 MASSACHUSETTS AVE., CAMBRIDGE 39, MASS.

Transformer and Radio Engineers and Manufacturers

New “MIRACO” Vacuum Tube Detector

COMPLETE, READY TO USE, (Postpaid) **only**



The new “MIRACO” Detector contains features not found in others at double the price. There is ample space in the hinged covered cabinet for “B” batteries and additional binding posts on the back of panel enable the operator to connect them inside.

\$7.85

CATALOG FREE

WRITE TODAY

MIDWEST RADIO COMPANY

3423 DURY AVENUE, Dept. A.

CINCINNATI, OHIO

It is up to you amateurs to “beat the wire” whenever there is something worth while to send to the local paper, and if you get the big papers interested in amateur Radio, you may be assured of having some big Allies to help you fight any bill that may be put against amateur Radio in the future.

Let's hear more similar ventures.

Correspondence From Readers

(Continued from page 882)

mils. per ampere would stand up long. Indeed, for the type of service he has in mind, generally cooled by plain radiation into the air, 800 or 1000 circular mils per ampere would be far safer and more logical.

At the outset he speaks of “efficient transformers.” At the copper densities he proposed, the I²R losses alone would be nearly 10 per cent. of the input. Horrors! A density of 4,000 amperes per square inch! Underwriters as transformer designers.

I trust this may find a hearing on the page “Correspondence from Readers,” for I think Mr. Woodruff may lead a good many astray, as C. W. is much in vogue and involves transformers very often.

Very much relieved and unburdened.
R. C. KANE.

Warren, Ill.

The Efficient Design of U. T. Telegraf and Telephone Sets

(Continued from page 871)

between inductance, natural period and number of turns. This would enable easy design of coils for future possible requirements. Just as engineers have graphs of inductance against turns which enable the ready design of inductances, so there is no reason why graphs cannot be made to enable the ready design of radio chokes.

The question of which type coil is the best arises. On the low wave lengths up to 400 or 500 say, the optimum inductance of the choke is not very high, making the coil dimensions small with relatively few turns. This means a very low distributed capacity and thus the coil is best made a single layer solenoid of small diameter. The single layer coil would really be the best type of coil for any wave length, except that when the higher wave lengths are reached, the coil becomes too large and unwieldy. Consequently, for purposes of space economy, it becomes necessary to use multiple layer coils. The multiple layer solenoid will be found to be very inefficient, as far as operation and space economy are concerned. A superior type of coil is the circular coil of rectangular cross section. This type of coil can be designed for any wave length range, gives most efficient choking action, and occupies even for very high inductances, a ridiculously small space. As a final word, too much emphasis cannot be laid on the point, that if the choke coil is designed regardless of its distributed capacity, and its inductance is entirely depended upon for choking, multiple layer coils must not be used. They will pass radio frequency currents as easily as any condenser.

(To be continued in July issue.)

WATCH YOUR STEP!

First Ham, (listening in to Radiophone concert)—“The ‘Blue Danube’ doesn't come in very well.”

Second Ham—“No wonder, we are using a two-step amplifier.”—P. S. Poindexter.

READ the CLASSIFIED ADVERTISEMENTS on PAGES 932-934 YOU'LL FIND MANY GOOD THINGS THERE.

CONTINENTAL NEWS

JUNE, 1921

PUBLISHED EVERY MONTH IN RADIO NEWS BY THE CONTINENTAL RADIO AND ELECTRIC CORPORATION

NEW YORK RADIO SERVICE BY MAIL

New York City is the center of radio development. A majority of the big manufacturers are located in or near New York. The latest ideas, the most advanced apparatus usually appears in New York first. The Continental Store, in the Heart of Downtown New York, is in the best position to secure advance news and apparatus. The Continental Mail Order Service puts all these advantages, plus the most complete stock in the world's biggest city, as near to you as the quickest mail express. No matter where you live, Continental can, and will, fill all your radio needs with

Courtesy: Speed: Accuracy.

To avoid delay, please make all remittances by bank draft or P. O. Money Order.

Do You Spend Over \$50.00 a Year for Radio?

THEN YOU can afford a Paragon R.A. Ten Receiver. Although the original price is Eighty-Five Dollars, the iron-clad guarantee protects you from any up-keep expense for two full years!

Combine your radio investment for the next two years now, and invest in a Paragon. In no other way can you get such genuine pleasure, such remarkable results from any equal amount of money. For, every cent you pay for a Paragon represents high quality materials and workmanship. The unequalled design,—the secret of Paragon's marvellous selectivity and amplification,—doesn't add a cent to the cost over what you would pay for inferior engineering principles. In last month's advertisement, we printed unsolicited letters from three operators, (including a Y.M.C.A. radio school), all of whom had made actual tests and comparisons. In each case, the Paragon "fulfilled every advertised superiority." One man said, "Nothing like it ever heard before, especially for strength of signals on detector alone."

Certainly, it pays to buy the best. Order your Paragon R.A. Ten, or send for FREE descriptive booklet today!

C. W.

In the words of Dr. Alfred N. Goldsmith, at the Second District Radio Convention, "Here's to the amateur, continuously may he wave!" If there is anything you want for C. W. work not listed here, write us for information. We have it, or can get it for you quickly.

C. W. Inductances

| | |
|---|--------|
| No. 181 Tuska C. W. Inductance | \$7.50 |
| No. 181 Tuska C. W. Inductance, unassembled | 5.00 |
| No. 182 Tuska C. W. Inductance | 10.00 |
| No. 182 Tuska C. W. Inductance, unassembled | 7.50 |
| No. 183 Tuska C. W. Inductance | 12.50 |
| No. 183 Tuska C. W. Inductance, unassembled | 10.00 |

Choke Coils

| | |
|--|------|
| Acme 1½ Henry, 500, M. A. Single Coil | 6.00 |
| Acme 1½ Henry, 500, M. A. Double Coil | 8.00 |
| Acme 1½ Henry, 150, M. A. Single Coil | 4.00 |
| Acme 1½ Henry, 150, M. A. Double Coil | 6.00 |
| C. E. Co., ZRX .8 Henry, 150 M. A. Single Coil | 3.75 |

Telephone Transmitters

| | |
|---------------------|------|
| Sterling Microphone | 2.50 |
|---------------------|------|

Resistances (Ward Leonard)

| | |
|--|------|
| Ward Leonard Resistance, 5000 ohm | 1.70 |
| Ward Leonard Resistance, 10000 ohm | 2.95 |
| Ward Leonard Resistance, 1500 ohm | 1.50 |
| Ward Leonard Resistance, 12000 ohm | 3.50 |
| Lavite Resistance 48000 ohm for Radio frequency amplifiers | 3.00 |

Modulation Transformers

| | |
|--------------------------------------|------|
| Acme A-3 mounted | 7.00 |
| Acme A-3 semi-mounted | 5.00 |
| Acme A-3 unmounted | 4.50 |
| C. E. CO. ZRM MODULATION TRANSFORMER | 4.50 |

Grid Leaks

| | |
|---|------|
| Marconi 1, 2, 3 or 5 meg-ohms | 1.25 |
| Chelsea Variable ½ to 5 meg-ohms, 10 values | 3.00 |
| Chelsea Oscillator | 3.00 |

Meters (Weston Model 301)

| | |
|-------------------------------------|------|
| Model 301 0-3 amperes flush | 8.50 |
| Model 301 0-5 amperes flush | 8.50 |
| Model 301 0-50 volts flush | 8.50 |
| Model 301 0-100 Milli-amperes flush | 8.50 |
| Model 301 0-300 Milli-amperes flush | 8.50 |
| Model 301 0-500 Milli-amperes flush | 8.50 |
| Model 301 0-800 Milli-amperes flush | 8.50 |

Meters (Hot Wire)

| | |
|-----------------------------------|------|
| No. 127 Gen. Radio flush 0-1 Amp. | 7.75 |
| No. 127 Gen. Radio flush 0-3 Amp. | 7.75 |

Do You Own a Quarter?



25 cents stamps or coin.

If you do,—and you're interested in radio,—the best thing you can do with it is to exchange it for the Creco catalogue.

The Creco catalogue brings you 112 pages, full to the brim with descriptions, illustrations, prices, on radio apparatus for every need. It includes codes, abbreviations, tables for quick calculations, and other valuable material that you will use every day.

And anyway, your quarter is refunded on your first \$5.00 order. Come on, be a sport, risk a quarter. You'll never regret it after you see the Creco catalogue. And you'll be mighty glad you saw this ad after you once experience Continental Mail Order Service.

Just your name and address and 25 cents. But do it now,—the edition is limited

| | | | |
|------------------------------------|------|--|--------|
| No. 127 Gen. Radio flush 0-5 Amp. | 7.75 | Acme, 50 Watt, unmounted | 12.00 |
| No. 127 Gen. Radio flush 0-10 Amp. | 7.75 | Motor Generators | |
| | | International 500 V. 100 Watt A.C. Drive | 99.00 |
| | | International 500 V. 100 Watt D.C. Drive | 110.00 |
| | | Electric Specialty Co., 350 V. 50 Watt A.C. or D.C. | 97.00 |
| | | Condensers | |
| | | WE 21 A A 1 M F D tested at 1000 volt, each | 2.55 |
| | | Dubilier .25 M F D Mica Condenser, tested at 1800 Volts | 6.00 |
| | | Dubilier .0005 Grid Condenser for transmitting sets | 2.00 |
| | | High Voltage Variable Air Condenser will stand 1000 V Capacity .001 M F D. Just the condenser for your Antenna circuit | 29.00 |
| | | Telephones | |
| | | No. 55 Murdocks, 2000 ohms | 4.50 |
| | | No. 55 Murdocks 3000 ohms | 5.50 |
| | | Brandes "Superior" 2000 ohms | 8.00 |
| | | Brandes "Trans-Atlantic" 2800 ohms | 12.00 |
| | | Brandes "Navy" Type 3200 ohms | 14.00 |
| | | Baldwin Type C Navy Standard | 16.50 |
| | | Baldwin's Type E Super-Sensitive | 20.00 |
| | | Century 2200 ohms (Govt. Standard) | 12.50 |
| | | Century 3,200 ohms (Govt. Standard) | 14.00 |
| | | Brown 4000 ohms imported super-sensitive double armature | 20.00 |
| | | Transformers (Acme new type) | |
| | | Acme 250 watt, mounted | 16.00 |
| | | Acme 250 watt, unmounted | 13.00 |
| | | Acme 500 watt, mounted | 22.00 |
| | | Acme 500 watt, unmounted | 18.00 |
| | | Acme 1000 watt, mounted | 33.00 |
| | | Acme 1000 watt, unmounted | 28.00 |
| | | Vacuum Tube Sockets | |
| | | No. R-300 DeForest | 1.50 |
| | | No. M-300 Marconi | 1.50 |
| | | No. 55 Murdock | 1.00 |
| | | No. 156 Gen. Radio | 1.75 |
| | | No. R-400 Inverted Type | 2.40 |
| | | Vacuum Tubes | |
| | | Radiotron U. V. 200 Detector tube, just out | 5.00 |
| | | Radio U. V. 201 Amplifying tube, just out | 6.50 |
| | | Electron relay | 6.00 |
| | | Moorhead Amplifier | 7.00 |
| | | Moorhead extra hard Trans. | 7.50 |
| | | Audiotron | 6.00 |

CONTINENTAL RADIO AND ELECTRIC CORP.

J. DiBlasi, Sec.

J. Stanley, Treas.

Dept. C35 6 Warren St. New York

BUST THRU THE QRN WITH The Benwood "Utility" Spark Gap

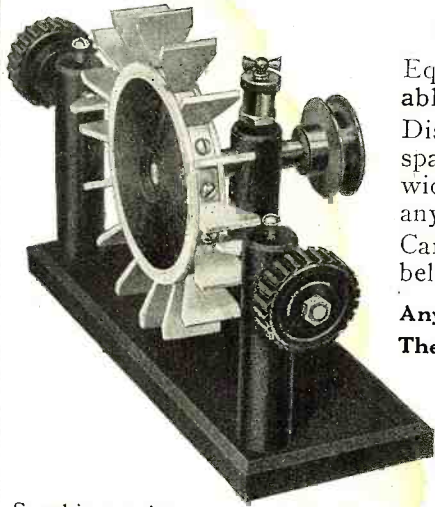

Designed for the experimenter

Equipped with the Benwood Removable Point Disc.

Disc is six inches in diameter and both sparking electrodes are One Inch in width. Is of more than ample size for any 1 KW. installation.

Can be driven by any motor either by belt or direct coupling.

Any Speed Any Note Any Frequency
The best open type rotary spark gap that can be produced.

Price as shown \$19.50

The Benwood Removable Point Disc

Sparking points are variable from 2 to 16. Teeth are Renewable as well as Removable.

Disc is Six Inches in diameter and sparking points are One Inch in width. Complete disc weighs less than half pound absolutely accurate and finely balanced.

This disc enables the operator to vary the frequency of the spark at will regardless of the speed of the motor used. It enables the operator to obtain the maximum radiation from any spark transmitter by being able to change the spark discharge frequency to conform to Any Condenser Capacity and Any Wave Length that is in use at the present time. This disc will absolutely increase the transmitting range of Any spark transmitter because it is at once applicable to any make transformer on the market regardless of the voltage. It is the ultimate in rotary disc design and fills the long felt need of every radio man.

A Clear note can now be had at all times. As soon as the sparking points of this disc become worn and uneven a complete new set can at once be put into service thus assuring the operator of maximum results at all times.

The center of the disc is Moulded Bakelite the best insulation obtainable. Disc is fitted with carefully machined brass bushing and set screw for fastening to the motor shaft. It is also furnished with shaft for use with any of the enclosed Benwood gaps that are now in use.

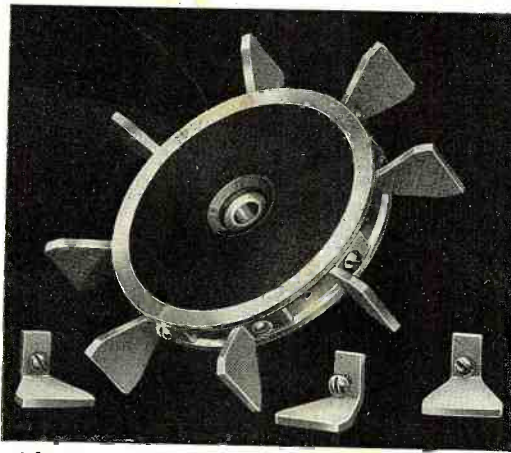

Price complete with 16 sparking points, \$10.00
Specify size of motor shaft when ordering.
Extra sparking points 20 cents each or \$2.50 per set of 16.

THE BENWOOD COMPANY, Inc.

1300 OLIVE STREET,

ST. LOUIS, MO.

DEALERS:—WRITE FOR INFORMATION

WIRE R T S MARKET

NOW IS YOUR OPPORTUNITY TO BUILD YOUR NEW SET
We can furnish you with the following sizes of magnet wire, neatly spooled. This is the highest grade wire obtainable.

| Size | Weight | Double Cotton |
|--------|---------|---------------|
| No. 20 | 1/4 lb. | 49c |
| No. 22 | 1/4 lb. | 52c |
| No. 24 | 1/4 lb. | 58c |
| No. 26 | 1/4 lb. | 72c |
| No. 28 | 1/4 lb. | 92c |

We charge nothing for Spools. When Order-include postage.

DID YOU SEND 10c FOR THE R.T.S. CATALOGUE?

RADIO TESTING STATION

BINGHAMTON, N. Y.

MONEY for You

Spend an hour each day taking subscriptions for the "Radio News." We'll pay you well and you'll enjoy the work. Write for full particulars. Circulation Dept., RADIO NEWS, 236A Fulton St., New York City.

Add to your Salary—Make extra Pin Money. Start a lucrative business of your own.

A Tube Transmitter Using A. C. on the Plate

(Continued from page 863)

a nearby friend "listen in," cautioning him to adjust carefully, for tuning is sharp, and let him estimate your wave-length, which, if above 200 should be decreased by reducing the number of turns in antenna coil, then readjust both plate and grid connections until maximum radiation is noted. There is plenty of room between 180 and 200 meters.

In case the set refuses to function try the following; go over wiring carefully and compare with diagrams, test the condenser to see whether it is shorted, see that the filament is burning at its required brilliancy; if the tube is "bluing" badly reduce the plate voltage, see that the transformer is delivering the juice. Be sure that the antenna is insulated and the ground O. K. and last of all—is your tube all right? Don't be discouraged if the set won't work the first five minutes after it has been assembled. Success is largely a matter of adjustments, so take your time and you will be amply repaid for your patience.

Practically as many tubes may be put in parallel as the builder cares to use, bringing up the output; however, if more than two Western Electric VT-2 tubes, or their equivalent, are to be used, the inductance should be wound with No. 14 bare wire spaced with heavy string. This winding should be shellacked, dried, the string removed and the winding shellacked again.

The antenna and coupling coils may be consolidated but no gain in efficiency is noted, while if they are separated the emitted wave-length may be readily changed over quite a range without having to disturb all the connections and adjustments. This is quite an item when one particular wave-length is badly crowded and you can jump either above or below it by a few meters and have clear sailing.

Once adjustments have been made all connections should be soldered. The set may be mounted in panel or cabinet form or on the table, either of which can be easily done as there are no moving parts.

The Arc and Radio Telephone Transmission

(Continued from page 869)

ance. The producing and radiating circuits are thus reduced to a state of homely simplicity. The tuning of the circuits should be left to the hot wire ammeter after the necessary constants for the required wave are ascertained. With attention to the D.C. supply, proper attendance to the converter along with the proper tuning of the radio frequency circuits, the transmitter may be brot up to the state of maximum radiation and transmission range.

Construction of Ball and Cup Variometers

(Continued from page 862)

from the instrument. This is necessary in order that the flexible lead from the shaft may rotate freely. Due to the extremely sharp tuning made possible with this variometer, the large Navy celluloid dials lend themselves remarkably well for use with it, they being divided into 200 divisions, as well as having a blank smooth surface

Announcing the

VOCALLOUD



Vocaloud
 Laboratory Type
 (Shown above)
 Complete with 6 ft. cord. \$23.00.
 Sound chamber alone. \$12.00.
 Sound chamber, with base, \$15.00.
 Vocaloud reproducer with 6 ft. cord. \$9.00.
 Station Type, \$25.00.
 (Complete as shown in large photo.)

At last— An ideal loud-speaker for \$25.00

Hook a Firco Vocaloud right on to your receiving apparatus, in place of your phones, and get your signals QSA—all over your house! No batteries,—no adjustments, no extra equipment needed whatever! Just hook your Vocaloud in and listen!

Vocaloud reproduces wireless *telephone* perfectly, as well as code. Mr. P. E. Fansler of Stamford, Conn., received wireless telephone from the S.S. "Gloucester" (125 miles distant) with just one tube! He writes, "The conversation was entirely intelligible and perfectly modulated. The reproduction of the human voice was fully equal to that in a phonograph reproducer."

Vocaloud reproduces voice and music just like a high priced phonograph, because the *reproducing elements are the same*.

The reproducer itself employs the famous Baldwin *amplifying* mechanism, with genuine mica diaphragm. The sound chamber is designed and shaped like a *human ear*,—the most perfect sound amplifier known. These *exclusive* features are not duplicated in any other loud speaker at any price. Yet the price of a complete "station type" Vocaloud, (shown above) in an exquisite solid mahogany cabinet is only \$25.00.

Examine a Vocaloud at your radio dealer's. If he should lack a supply, write for leaflet direct to

John Firth & Company, Inc., 18 Broadway, New York



- FIRCO Audion Detectors and Amplifiers
- Radio Frequency Amplifiers
- High Voltage Units
(with any primary voltage)
- Baldwin Phones
- Firco Vocaloud
- Saco-Glad Transformer
- Firco Accessories
- Kolster Decrometer
- United States Bureau of Standards Wavemeter
- Eldredge Meters
(individually calibrated)
- Brownlie Phones
(adjustable)

FIRCO RADIO

EQUIPMENT

"Pioneers—since 1901"

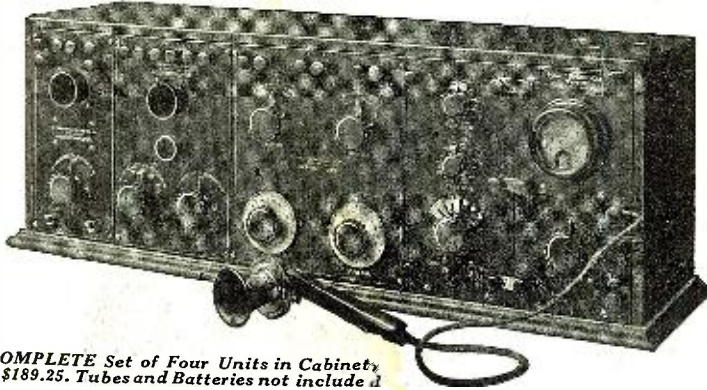
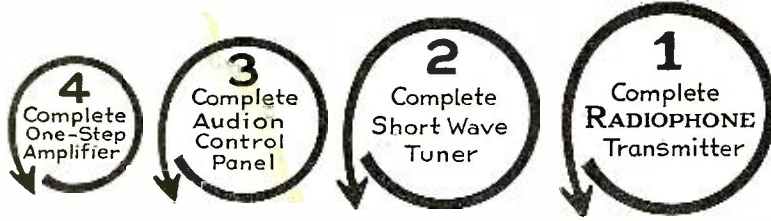

COMPLETE Set of Four Units in Cabinet \$189.25. Tubes and Batteries not included



"INTERPANEL" SET

Provides a complete RADIOPHONE Transmitting and Receiving Set of handsome design and unequalled efficiency. Will transmit speech 30 miles on the average amateur antenna; 500-mile range possible under favorable conditions. Reception possibilities unlimited. One 6-volt battery required for filaments and microphone; power supply may be motor-generator unit, rectifier unit or "B" batteries.

"INTERPANEL" Sets give expansion without discarding previously purchased apparatus. They consist of a series of panels, each panel comprising a complete piece of apparatus in itself. Any desired combination of panels may be had. The equipment is sold completely mounted in cabinets; with legs for horizontal table mounting; or with legs for upright table mounting without cabinet. This is the most advanced idea in Radio apparatus; find out more about it.

Complete Details Mailed Free Send now for Catalogue "E" giving full information and costs on all combinations.

De Forest Radio Telegraph & Telephone Co.
Inventors and Manufacturers of High Grade Radio Apparatus
 1415 Sedgwick Avenue - New York City

Sole Distributors for Pacific Coast.
PACIFIC RADIO SUPPLIES CO., Henry M. Shaw 638 Mission Street, SAN FRANCISCO.



HIGH GRADE MOTOR GENERATORS

Designed for Radiophone and C. W. of various capacities and voltages
 Type "C" Motor Generator 300 volts, 15 watts. Only \$40.00. This type is excellent for 5 watt U. V. 202 power tube
 Send for bulletin describing different types.

THE KEHLER RADIO LABORATORIES, Dept. R, ABILENE, Kansas

VACUUM TUBES REPAIRED

RELIABLE

| | | |
|------------------|----------------------------------|--------------------------|
| Marconi Moorhead | Cash Must \$3.50 Accompany Order | Electron Relay Audiotron |
|------------------|----------------------------------|--------------------------|

SERVICE

EASTERN VACUUM TUBE LABORATORIES
 178 Washington St. Boston, 9, Mass.

A welcome addition to your library! Send \$2.00 today, plus postage for 7 lbs., and your copy of bound volume No. 1 of Radio Amateur News will come forward by return mail.
 Experimenter Publishing Company, Inc. 236a Fulton Street, New York City

upon which the calls of stations received may be conveniently written.

If these dials are used, a special type of fixed pointer must be employed, as the ordinary short scratch in the panel filled with white lead will not be accurate, or have a good appearance. As it was not possible to obtain a suitable pointer, the author constructed two in the following manner: A strip of one-sixteenth inch brass sheet was cut into two pieces, one was one and seven-eighths inches long by one-half inch wide, and the other was the same width but one and five-eighths inches long. An inch and one-half length of glass of the same width and thickness as the brass was ground to a point at an angle of about 45 deg. to its length, as illustrated in Fig. 6, A. Two holes were drilled in the two brass strips three-eighths of an inch from the ends of the longer piece, by placing them together so that one pair of ends met. Thru these, two brass screws were inserted upon each of which a nut or other spacer was threaded. All the brass parts should be nickel-plated, and the glass clamped lightly between the top brass strip and its nut. A scratch made with a glass-cutter or piece of carborundum, equi-distant from the sides, was filled with India ink, and this formed a "hair-line" behind which the values upon the dial could be easily read. Fig. 6, B shows how the parts were assembled. The pointer was then mounted upon the panel, and two more nuts threaded on the screws held it in place.

The author has made two of these variometers and has noticed that greater selectivity and sharper tuning, as well as greater audibility can be obtained with them than is possible with factory-made variometers where the separation of the coils is much greater. The superiority of the results obtained with this type of variometer over those possible with the usual type constructed by experimenters, amply repays the little extra difficulty encountered in its construction.

The Radio Compass

(Continued from page 866)

up the shore station and request a bearing.

Capable of being used by vessels having only a coil receiving set and amplifiers and no expensive transmitter is necessary on board ship.

Would be more satisfactory to navigators who could find it analogous to the present system of taking visual bearings on lighthouses.

Would limit responsibility definitely and exclusively to ship's personnel and obviate any future claim that erroneous bearings were furnished from shore.

Has a considerable strategical value in scouting.

The following interesting features have been noted in radio compass coil operation:

Short waves are sometimes more effective for radio compass operation than long ones.

Bearings over very long distances are objectionable owing to the correction for the curvature of the earth that must be applied. This will be eliminated when gnomonic charts are used.

A wave traveling along more or less parallel to high bluffs will be subject to continuous reflection and the apparent direction as indicated by the compass coil will lie to landward of the true direction.

A wave passing over a mineral bearing country will become distorted.

Experiments indicate that the most erratic results are experienced when it is

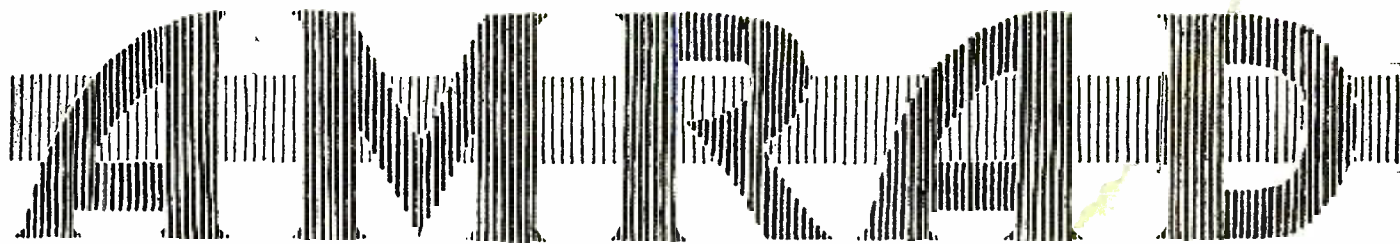

The Recognized Symbol of Superior Performance



VT 1 Stage Amplifier
\$21.00



Amrad VT Detector
\$15.00



B. Bat. Box
\$9.85

EFFICIENCY is the keynote of all Amrad vacuum tube apparatus. Designed by radio engineers of established reputation, it is to be expected that the name AMRAD is recognized as the symbol of efficient operation and rugged construction.



Amrad VT 2 Stage Amplifier
\$39.50

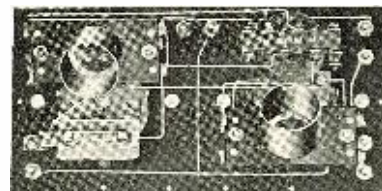

Detector-Amplifier Interior
\$34.50

Send for bulletin V.

SURPLUS GOVT. MATERIAL

WE have a small supply of aeroplane antenna wire—a residue of war contracts. Constructed of 16 strands of No. 28 wire-braided, it makes a wonderfully flexible, highly conductive antenna wire. We will sell this wire at a price way below its actual value. The supply is limited.

200 ft.—\$1.00. *Postage extra. Shipping weight 3 pounds.*

Send 10c. for complete catalog.

AMERICAN RADIO AND RESEARCH CORPORATION

203 College Avenue

Medford Hillside, Massachusetts

No Time Like the Present to Commence Building That Up-to-Date--- Receiving Set or Phone and CW Transmitter

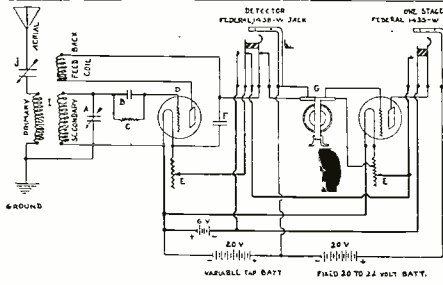

- Federal 1435W Jack \$1.20
- Federal 1438W Jack 1.50
- (New fil. control type.)
- Western Electric Special polished nickel plug, our price 1.35
- Federal open ckt. jack70
- Federal closed ckt. jack85
- Federal double ckt. jack 1.00
- W. E. 4-A brass plug 1.10
- Federal 4-pole, 2-throw Anticapacity switch 2.80
- General Radio 231A amplifying transformer, for UV 201 5.00
- UV 201 Radiotron, 45v. plate 6.53
- Sorala S10 VT socket 1.10
- Radio Service double socket 2.50
- Paragon rheostat, 6 ohm 1.75
- Gen. Radio rheostat, 7 ohm 2.50

The Most Satisfactory "B" Battery on the Market!
The Eveready

44 v. adjustable, \$3.75; 22 v. adjustable, \$2.00

PLEASE NOTE—That these prices include Postage!

WE WILL BUILD DETECTOR OR AMPLIFIER PANELS TO YOUR SPECIFICATIONS, BUS WIRED, or merely ASSEMBLED.

UV200 Radiotron, 22v. plate, \$5.00, unequalled as a detector. For best results use exactly 1 amp. in filament. You'll KNOW if you use a TYPE J meter. 1/2-3 meg. 6 step grid leak, variable, 75c.; .0005 and .00025 grid condensers, 25c.

Bakelite Panels 3/4" thick, 3c per sq. inch, dozen 12c. Insulated binding posts, \$1.25. Black or yellow empire cloth tubing, per in. 1c.

Anticapacity Contacts, threaded shank and tiny 3/16" nut, 4c or 45c per doz. Gen. Radio switch lever, 1 1/2" radius, 95c. Small switch lever, 3/4" radius, 40c. General Radio switch stop, each 5c.

CHELSEA VARIABLE CONDENSERS

Panel type, with bakelite dials which run true and won't warp. Counter-balanced. No. 3bd .0011 mfd., \$4.75; No. 4bd .0006 mfd., \$4.25.

Chelsea Dial Indicator, 3 1/4" d.a., \$1.00

SEND FOR BULLETIN NOW IN PREPARATION covering the new \$2 SOMERVILLE DIAL INDICATOR, and the new 2 1/2" BAKELITE KNOB INDICATOR, to match. Our new line of VOTO LABORATORY CONDENSERS ALSO DESCRIBED.

Western Electric Microphone Transmitter No. 323W, \$4.00. With special nickel-plated bracket, 50c extra. Federal Desk type Microphone Transmitter, with cord, \$6.50. Western Electric No. 326W heavy current airplane type transmitter, with perforated Bakelite front and nickel-plated shell, \$5.50.



No. 323W Variable Air Condenser, specially built to withstand 1000 volts continuously. Bakelite insulation and heavy aluminum plates, cut out of round, to give an even calibration. 1/4" shaft, panel type. .0005 mfd. INTRODUCTORY PRICE, \$7.50.

(Additional capacity may be had by shunting with the following fixed condensers.)
1800 v. .0005 mfd., mica condenser \$5.00
2000 v. .001 mfd., mica condenser90

COMPLETE SET OF NEW BULLETINS SENT FOR 20c. VALUABLE AND TIMELY!

GREATER BOSTON AMATEURS!—If you are in good standing at your radio club, you may take advantage of our discount to radio organizations.

Amateurs in the first, second, third, fourth and fifth zones will receive their shipments postpaid. Other zones take a 50 percent allowance on postage charges.

A BOOST FOR BETTER RADIO

Most everyone now admits that our purchasing manager is gifted at selecting nothing but the best in quality and value in radio apparatus—and just as important, getting it in stock first! You'll say so too when you receive your initial order, well packed, with helpful bulletins and blueprints enclosed, covering the latest developments.

Somerville Radio Laboratory, 102 HEATH STREET, WINTER HILL, 45, MASS.

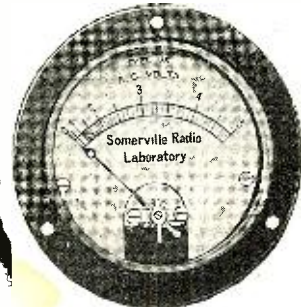

TYPE JX
A. C. 0-15
VOLTMETER
\$8.00 Postpaid
3 3/4" dia.

Jeweled bearings, magnetic vane movement, quick damping. The same value as our TYPE J. D. C. meter and bears the same guarantee. Defective meters replaced and damaged meters repaired at cost. THOUSANDS SOLD. BUT NOT ONE DISSATISFIED CUSTOMER!

A TYPE J, JX, or JT meter provides the best protection for your VT and assures maximum operating efficiency.

TYPE J D. C. Milliammeters, 3/4" d. flush, \$6; 0-50, 0-100, 0-300, 0-500, 0-1500 m. a. ranges
Type J D. C. Voltmeters, 3/4" d. flush, 0-500 v., \$16.00; 0-1000 v., \$24.00; 0-1500 v., \$30.00.
(Above have external resistance boxes)

Type J D. C. 0-1 1/2 and 0-3 Ammeters, \$6
Gen. Radio H. W. Ammeters, 1/4" fl. d. \$7.75
0-1/2, 0-1, 0-2 1/2, 0-5, 0-10 amp. ranges
ALL RADIOTRON POWER TUBES IN STOCK!
Descriptive bulletins free.

BUILT FOR THE RADIOTRON UV202!
General Radio No. 231 modulation transformer, fully mounted, the best yet, \$5.00.
(Descriptive bulletin 907 on request.)

- Ward Leonard 5000 ohm grid leak \$2.25
- Sorala CW Inductance Form, 3 3/4" d. \$3.00
(6" long, of bakelite, 10 threads to inch)
- Radio Service CW Inductance \$8.50
Wound on slotted bakelite form, of No. 9 copper wire, 3 insulated clips provided.

daylight at one station and night at the other.

Abnormalities increase with increase of distances.

A high speed alternator is more efficient for compass work than is either an arc or a spark.

When a compass coil indicates a very broad minimum it will usually be found that the wave front has become inclined from the perpendicular.

Radio compasses are not efficient for getting the bearings of air craft when these are more or less overhead, probably owing to the wave not having become properly lined up.

The higher the frequency the better are the results within practical limits.

A loosely coupled sharp wave is better on which to take bearings than a close coupled broad wave.

A synchronous gap is better for compass work than is a non-synchronous one.

A modulated wave is not as suitable for compass work as is a non-modulated one.

The deviations differ for different waves and consequently a radio compass is not dependable for wave-lengths that are much different from the one for which it is calibrated.

The simplest form of compass station is that in which an existing radio station is used for control purposes, for the charging of batteries, and for the accommodation of the personnel. The policy is to build compass stations upon modest lines at first, with the intention of adding buildings later, when the station has proved its worth.

Present indications point to a very rapid development of these stations. It is probable that after mariners get more confidence in the system, the entire art of navigating in thick weather, will become partially dependent upon our radio compass system. Like any other new development, the compass will be subjected to considerable prejudice from those who always oppose innovations. It has already proved its worth, however. So far as is known no vessels have been lost although some have been saved thru the agency of the compass. Any carelessness in operation that results in a vessel being hazarded will do much to destroy the confidence that is at present being built up. For this reason it is necessary for all concerned to keep abreast of the development of the radio compass, and thus insure its success.

Audio Frequency Transformers Built from Auto Spark Coil Secondary

(Continued from page 862)

$$n = (\text{No. turns wire per inch}) \text{ use a wire table.}$$

$$(.5 \times 1.5 \times 3.1416 \times *205) \div 12$$

Note.—The above winding formula is merely given to show the method. Secondaries vary so widely that no definite information for procedure of determining the number of feet required is necessary (205 turns enameled wire No. 40 to the inch).

Therefore, use this formula:

Number of feet required in primary = (4166.66 ÷ 4) ÷ by number of feet in one layer gives the number of layers needed. Wind the primary and mount primary and secondary upon the core already made, then lay up the rest of the core.

From one of Woolworth's many emporiums, or from a hardware store, secure two shelf brackets as per photograph, and mount the whole business; not forgetting something to mount.

WIRELESS

You should have it even if only superficially interested. Around about you every day you read of some marvelous occurrence in which wireless played a distinguished part. It may not be entirely clear to you. The Manual will explain it. To the student of Wireless Telegraphy, the Manual contains much that is indispensable to a proper understanding of the art.

It contains 200 pages, fully illustrating and describing the many instruments used in Radio. 45 pages cover general instructions, diagrams, station calls, tables, codes and other information.

The book is printed on highly finished paper with a two-color cover and measures 9 x 5 1/2 inches.



MANUAL M12

Containing as it does a fund of valuable information not generally contained in a catalogue, it approaches nearer a text book in the fascinating field of wireless telegraphy. No expense has been spared to make it accurate and reliable.

No Wireless Experimenter Should be Without the MESCO Wireless Manual. We ask 25 cents (25c) for it—give you a coupon receipt which can be applied on any future order.

Send your name and address now, and get one of the most complete, comprehensive and reliable wireless books published.

MANHATTAN ELECTRICAL SUPPLY CO. INC

17 Park Place
New York

114 S. Wells St.
Chicago

1106 Pine St.
St. Louis

604 Mission St.
San Francisco

Insure your copy reaching you each month. Subscribe to Radio News—\$2.00 a year. Experimenter Publishing Co., 236-A Fulton St., N. Y. C.

RADIO APPARATUS

*Distributors of Reliable Radio Apparatus
to Schools, Colleges and Experimenters
All Over the World!*

"PITTSKO"

The sign of service and prompt delivery.
All we ask is a trial!



"Remember"

When You Say
"Pittsco" You Think
of Everything in Radio!

| RECEIVING APPARATUS | | CONDENSERS | | CONDENSERS (Variable) | |
|--|---------|--|---------|--|--------|
| AMPLIFYING TRANSFORMERS | | No. D-100 250 Watts 10,000 V. .007 M.F. | 19.00 | No. 3 Chelsea, .0011 Mfd. unmounted. | 4.75 |
| No. UV-712 Radio Corporation, new type, just out, very efficient. | \$7.00 | No. D-101 500 Watts 14,000 V. .007 M.F. | 30.00 | No. 4 Chelsea, .0006 Mfd. unmounted. | 4.25 |
| No. 231-A General Radio, new type. | 5.00 | No. D-102 1000 Watts 21,000 V. .007 M.F. | 45.00 | No. 182-G General Radio .001 Mfd. unmounted. | 9.75 |
| No. 226-W Federal, mounted. | 7.50 | No. D-103 1000 Watts 25,000 V. .007 M.F. | 50.00 | No. 306-Int. Murdock .001 Mfd. unmounted. | 4.25 |
| AMPLIFIERS | | No. D-112 1000 Watts 21,000 V. .01 M.F. | 50.00 | FILAMENT HEATING TRANSFORMERS | |
| No. RORR Grebe two step with automatic filament control. | 55.00 | No. D-113 1000 Watts 25,000 V. .01 M.F. | 55.00 | Acme 75 Watt, latest type, mounted. | 12.00 |
| No. RORD Grebe Det. and two step with automatic filament control. | 75.00 | No. T-1 Thordarson oil type, .0018 to .009 MF. capacity. | 25.00 | Acme 75 Watt, latest type, unmounted. | 9.00 |
| No. Y-2 Acme in cabinet. | 13.00 | No. 483 Murdock .0017 M.F. | 3.25 | Acme 150 Watt, latest type, mounted. | 16.00 |
| AUDION CONTROL PANELS | | LINE PROTECTORS | | Acme 150 Watt, latest type, unmounted. | 13.00 |
| No. RORH Grebe in cabinet, with tickler connections. | 17.00 | No. AM-888 Dubilier 2000 V. | 4.00 | FILTERS | |
| No. Y-1 Acme in cabinet. | 10.00 | No. CD-888 Dubilier 3000 V. | 6.00 | No. 170 Tuska type. | 16.00 |
| No. P-1 Paragon, moulded type, small and compact. | 6.00 | No. 453 Murdock, rod type. | 7.50 | HIGH VOLTAGE CONDENSERS | |
| "B" BATTERIES | | No. 452 Murdock, condenser type. | 9.00 | No. 21AA Western Elec. 1 MFD. 1000 V. | 2.50 |
| No. 7623 Standard, 22.5 V. small. | 1.50 | SPARK GAPS | | No. 181 Dubilier, .0005 MFD. 1000 V. | 1.00 |
| No. 7625 Standard, 22.5 V. large. | 2.65 | No. P-1 Bell gap, very efficient. | 55.00 | No. 182 Dubilier, .001 MFD. 1000 V. | 1.00 |
| No. 7650 Standard, 22.5 V. variable. | 3.50 | No. 444 Murdock with motor 4000 RPM. | 18.50 | No. 183 Dubilier, .005 MFD. 1000 V. | 1.00 |
| No. 763 Eveready, 22.5 V. small. | 2.25 | No. P-1 Benwood with 4, 8, 10 or 14 point rotor, practically noiseless. | 30.00 | No. 193 Dubilier, .01 MFD. 1000 V. | 2.00 |
| No. 766 Eveready, 22.5 V. large. | 3.50 | No. P-2 Benwood Utility type, just out! | 18.50 | INDUCTANCES, C. W. | |
| No. 766 Eveready, new type 22.5 V. variable. | 3.00 | No. P-3 Benwood Utility rotors, from 2 to 16 points. | 10.00 | No. 181 Tuska, Cap. feed-back circuit. | 7.50 |
| CONDENSERS (Fixed mica type) | | No. P-4 Benwood extra sparking points. | 2.20 | No. 182 Tuska, split filament. | 10.00 |
| No. ROCC Grebe .0002 MF. | 1.00 | No. G-1 Amrad Quench type 1/2 K. W. | 41.50 | No. 183 Tuska Grid tickler. | 12.50 |
| No. ROCC Grebe .0005 MF. | 1.20 | No. G-2 Amrad Quench type 1/4 K. W. | 24.50 | KEYS, (Bunnell) | |
| No. ROCC Grebe .001 MF. | 1.60 | No. G-3 Amrad Quench type 1/2 K. W. | 12.00 | No. 8650 Mascot, lacquered brass. | 3.00 |
| No. ROCC Grebe .005 MF. | 3.80 | OSCILLATION TRANSFORMERS | | No. 7939 Standard, dull nickel. | 4.00 |
| No. ROCA Grebe .002 MF. and 3 meg. leak. | 1.20 | No. T-1 Thordarson, pancake type. | 10.00 | METERS | |
| No. ROCB Grebe .0002 MF. and 3 meg. leak. | 1.20 | No. 424 Murdock. | 5.00 | No. 127 General Radio, Hot wire, flush, .5, 1, 2.5, 5, and 10 Amps. | 7.75 |
| DIALS | | No. TXL-100A International, ideal for 1/2 K. W. sets. | 14.95 | Model 301 Weston, D. C. meters, flush, 0-100, 300, 500 and 800 milli-amps. | 8.50 |
| No. 41 Chelsea bakelite dial, 1/4" or 3/16" shaft. | 1.00 | No. Z-652 Clapp-Eastham, large type for 1 K. W. sets. | 17.50 | 0-1, 2, 3, 5 and 10 Amperes. | 8.50 |
| No. F-800-H Clapp Eastham, new type, just out, bakelite finish, 3/16". | .75 | ANTENNA WIRE | | MICROPHONE TRANSMITTERS | |
| No. T-1 Tuska, 4" dia. Bakelite, new type, just out. | 1.50 | "Pittsco" No. 14 Hard drawn copper, per lb. (80 ft. per lb.) | .50 | No. 323-W Western Electric, with bracket. | 3.95 |
| DETECTORS. (Crystal) | | "Pittsco" 7 strand No. 22 tinned copper, stranded (65 ft. per lb.) per ft. | .01 | No. 5176-A Connecticut, with Adj. arm. | 4.00 |
| No. D-101 Deforest, dustproof. | 2.61 | "Pittsco" 1000 ft. | 8.50 | No. HM-100 De Forest, hand type. | 6.00 |
| No. RPDA Grebe, dustproof. | 2.75 | "Pittsco" 7 strand No. 20 phos. bronze, per ft. 500 ft. | 8.50 | MODULATION TRANSFORMERS | |
| No. 8854 Jove. | 1.80 | GROUND EQUIPMENT | | Acme A-3 semi-mounted. | 5.00 |
| GRID LEAKS | | "Pittsco" 100 Amp. 600 V. ground switch. | 4.50 | Acme A-3 fully mounted. | 7.00 |
| No. MW-1 Radio Corporation, 1/2, 1 1.5, 2, 3 and 5 megohms, complete. | 1.25 | "Pittsco" No. 4 ground wire, per ft. | .08 | No. 231 General Radio, new type. | 5.00 |
| Grid leaks only. | .75 | "Pittsco" Porcelain cleats with screws for ground wire, per pair. | .12 | MOTOR GENERATORS | |
| Bases only. | .50 | "Pittsco" ground clamp. | .25 | International 100 Watts, 500 V. A. C. Drive. | 99.00 |
| REGENERATIVE RECEIVERS | | RADIOPHONE AND C. W. APPARATUS | | International 100 Watts, 500 V. D. C. Drive. | 110.00 |
| No. CR-3 Grebe "Relay Special" 175-680 meters. | 65.00 | C. W. POWER TRANSFORMERS | | RESISTANCES | |
| No. CR-3A Grebe 175-375 meters with tube control, complete set. | 45.50 | Acme 50 Watt 350 Volts, mounted. | \$15.00 | Type HS Ward Leonard 5,000 ohms. | 2.25 |
| No. CR-5 Grebe "Super-special" 150-3000 meters, complete set, ideal for jewelers for time signals. | 80.00 | Acme 50 Watt 350 Volts, unmounted. | 12.00 | Type HS Ward Leonard 10,000 ohms. | 3.50 |
| No. CR-6 Grebe 175-680 meters, Det. and two step amp. self contained complete set. | 200.00 | Acme 200 Watt 350-550 Volts, mounted. | 20.00 | RHEOSTATS | |
| No. CR-7 Grebe 500-20,000 meters "Long Wave Special" complete set. | 210.00 | Acme 200 Watt 350-550 Volts, unmounted. | 15.00 | National Controller type 6.5 amps, easily take 2 UV-202 5 watt tubes. | 5.50 |
| (New England distributors of Grebe apparatus. Always in stock.) | | Acme 500 Watt 1000-1500 Volts, mounted. | 25.00 | No. 214-A General Radio 2.5 Amps, easily take 1 UV-202 5 Watt tube. | 2.50 |
| TRANSMITTING APPARATUS (Spark) | | Acme 500 Watt 1000-1500 Volts unmounted. | 20.00 | VACUUM TUBE SOCKETS | |
| TRANSFORMERS (Transmitting) | | CHOKE COILS | | No. MW-1 Radio Corporation. | 1.50 |
| No. P-1 Thordarson 250 Watt Type R. | \$14.00 | Acme single coil 150 M. A. capacity. | 4.00 | No. 156 Gen. Radio. | 1.75 |
| No. P-2 Thordarson 500 Watt Type R. | 22.00 | Acme single coil 500 M. A. capacity. | 6.00 | No. 550 Murdock. | 1.00 |
| No. P-3 Thordarson 1000 Watt Type R. | 40.00 | Acme double coil 150 M. A. capacity. | 6.00 | VACUUM TUBES (Radiotrons) | |
| No. P-4 Thordarson 1000 Watt Type RS. | 30.00 | Acme double coil 500 M. A. capacity. | 8.00 | No. UV-200 Radiotron detector. | 5.00 |

"Let 'PITTSKO' products, super-service and delivery solve your Radio problems"
SEND US YOUR ORDERS TODAY!

Send ten cents in stamps for Catalog No. 22. Over 100 pages, over 150 illustrations, over 600 items
"PITTSKO" SERVICE REACHES ALL OVER THE WORLD! WHY NOT LET IT REACH YOU!

F. D. PITTS CO., Inc.

12 Park Square

Dept. C

Boston, Mass., U. S. A.

Ready—CORWIN'S 1921 CATALOGUE

Thirty-two pages of up-to-the-minute radio. All Radisco apparatus. Instruments for every part of your station at moderate prices. Tables of codes, abbreviations, etc. Much larger, better illustrated than last year's. And

you can always rely on Corwin Mail Order Service to ship every instrument listed in the catalogue, or in this advertisement, quickly, in perfect condition, and with an unconditional guarantee of satisfaction.

Send us a dime today. We'll mail the catalogue the instant we hear from you.

Universal-Coil Mounting Plugs

Anyone can easily make smooth-running mountings with these plugs. No bending, no filing,—they are made to fit exactly in the first place. Suitable for Radisco and all hand-wound coils. A few minutes' work with these plugs will save you dollars that can be put into better apparatus.

Price 50 cents, postpaid

New Radisco Vario-Coupler

An extremely efficient instrument—accurate to the .002 part of an inch! Materials are special moulded composition, Formica and Brass thruout.

Price, \$7.50 postpaid

VARIABLE CONDENSERS

| | |
|------------------------------|--------|
| A. R. Co., .001..... | \$6.25 |
| A. R. Co., .0005..... | 5.00 |
| With No. 67 Dial add \$1.00. | |
| Murdock 366..... | 4.75 |
| Murdock 367..... | 4.75 |
| Murdock 368..... | 3.75 |
| Clapp-Eastham 800..... | 7.50 |
| Clapp-Eastham 800A..... | 9.50 |
| Clapp-Eastham 800B..... | 11.50 |
| Complete with dial. | |
| Shipping weight One Pound | |

GRID CONDENSERS

| | |
|-------------------------------|-----|
| Radisco, Postage 3 cents..... | .35 |
|-------------------------------|-----|

ANTENNA SWITCHES

| | |
|----------------------------|-------|
| Murdock, 3 lbs..... | 4.50 |
| Clapp-Eastham, 10 lbs..... | 12.50 |

OSCILLATION TRANSFORMERS

| | |
|-----------------------------|------|
| Murdock No. 424, 5 lbs..... | 5.00 |
|-----------------------------|------|

RADIO CRAFT PRODUCTS

| | |
|--------------------------|-------|
| Detector..... | 15.00 |
| Two Step Amplifier..... | 50.00 |
| Detector and 1 step..... | 45.00 |
| Detector and 2 step..... | 70.00 |
| Postage paid. | |

"B" BATTERIES

| | |
|---|------|
| Radisco No. 1, 2 lbs..... | 1.50 |
| Radisco No. 5, 5 lbs..... | 2.65 |
| Eveready Storage battery prices on application. | |

TUSKA C. W. APPARATUS

| | |
|-----------------------|-------|
| 181 Coil, 2 lbs..... | 7.50 |
| 182 Coil, 2 lbs..... | 10.00 |
| 183 Coil, 3 lbs..... | 12.50 |
| 170 Filt., 8 lbs..... | 16.00 |

VACUUM TUBES

| | |
|-------------------------|------|
| Electron Relay..... | 6.00 |
| VT Amplifier, 1 lb..... | 7.00 |
| VT Extra Hard..... | 7.50 |

AMPLIFYING TRANSFORMERS

| | |
|----------------------|------|
| A. R. Co., 1 lb..... | 5.00 |
| Federal, 1 lb..... | 7.50 |

JACKS AND PLUGS

| | |
|-----------------------------|------|
| Federal Closed Circuit..... | .85 |
| Federal Open Circuit..... | .70 |
| Federal Double Circuit..... | 1.00 |
| Federal Plug..... | 2.00 |
| Postpaid. | |

ALL RADISCO COILS

ROTARY SWITCHES

| | |
|-----------------------------|------|
| Clapp-Eastham, No. 19..... | 1.00 |
| Clapp-Eastham, No. 19A..... | .35 |
| Our Own, No. 1..... | .40 |
| Our Own, No. 2..... | .55 |
| Postage..... | .05 |

CORWIN DIALS

| | |
|-------------------------------|------|
| No. 66, 3"..... | .75 |
| No. 67, 3" with knob..... | 1.80 |
| No. 68, 3 3/8"..... | 1.00 |
| No. 69, 3 3/8" with knob..... | 1.70 |
| Postpaid. | |

RECEIVERS

| | |
|-------------------------------|-------|
| Murdock No. 55, 2000 ohm..... | 4.50 |
| Murdock No. 55, 3000 ohm..... | 5.50 |
| Brandes Superior..... | 7.00 |
| Baldwin C..... | 16.50 |
| Baldwin E, improved..... | 20.00 |
| Brownlie, New..... | 12.50 |
| Shipping weight 2 Pounds | |

CONTACT POINTS

| | |
|---------------------------------|-----|
| CP-No. 1 Brass, dozen..... | .25 |
| CP-4 Brass, dozen..... | .35 |
| CP-5, Nickel Plated, dozen..... | .45 |
| Postpaid. | |

All orders for apparatus not listed as postpaid must be accompanied by postage charges.

A. H. CORWIN & COMPANY

Dept. B2

4 West Park Street,

Newark, N. J.

A Universal Receiving Cabinet

(Continued from page 873)

Of course the tubes must be purchased. A iron is excellent for the initial detector, but Marconi V. T.'s are far superior as amplifiers. If a tubular bulb is used, either a variable "B" battery or a high resistance potentiometer is necessary to regulate the voltage. It is much easier to get the critical plate voltage with the potentiometer, and the cells wear out more uniformly than when a variable switch is used.

Nearly all experimenters have several old rheostats which they can readily convert into the back mounted type by the addition of a shaft, a knob and a pointer.

Any crystal detector almost may be mounted on the panel and most "bugs" already have some type. De Forrests and Crystalis are especially adapted for such work, however.

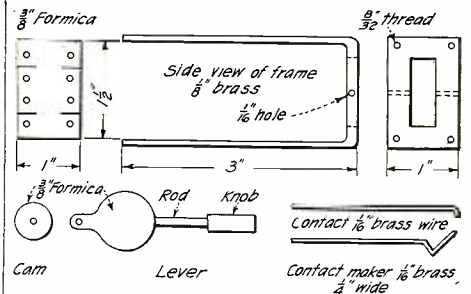

Constructional Details of the Small Telephone Switch Used in the Receiving Cabinet.

The key switch is readily made from the dimensions and specifications given in the drawings. The hole in the panel through which its handle protrudes may be faced by the nickel plate used on telephones where the receiver hook extends thru the case.

Altho the binding posts may be mounted on the main panel, the writer found it more convenient to place them on small formica blocks 2 1/2" x 1" inlaid in the ends of the cabinet. There are two pairs, one for aerial and ground, the other for the fones.

A large size 45-volt "B" battery is mounted on a shelf in the cabinet and posts are provided at the rear for wires from a 6 v. 60 amp. hr. storage battery.

The Vacuum Tube in Radio Telephony

(Continued from page 865)

f. is connected in series with the transformer T. The microphone potentials now increase or decrease this fixed e.m.f., and so vary the output.

In system 2 (c) a valve as a resistance is used to damp the oscillations in the grid oscillatory circuit or anode oscillatory circuit of a Fig. 2 arrangement (with M and T eliminated). The filament and anode of a three-electrode valve are connected across the circuit in question and the energy dissipated in this valve depends on its grid potential which affects the conductivity. The microphone transformer is connected across grid and filament of the dissipation valve, and thus the microphone controls the amount of energy wasted. It is easy to arrange that energy is only absorbed during speech; sometimes, however, energy is always being absorbed, and the amount is varied by the microphone. Obviously, if the energy is absorbed on the input side of V₂, less unnecessary waste will occur than if the energy dissipating valve is connected

OUR MAIL ORDER SERVICE IS RIGHT

We ship same day order is received from our large stock of reliable manufacturers products.

Get your name on our mailing list.

PHILADELPHIA SCHOOL OF WIRELESS TELEGRAPHY

1002 Parkway Building, Broad and Cherry Sts., Philadelphia, Pa.



Reg. U. S. Trademark

READ the CLASSIFIED ADVERTISEMENTS on PAGES 932-934. YOU'LL FIND MANY GOOD THINGS THERE.

There are Reasons — for the popularity of WILCOX Switches

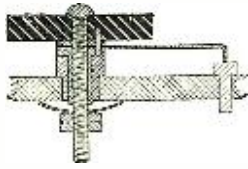

This cross section drawing tells the story. See

1. The large highly polished lathe turned and knurled knob of genuine hard rubber.
2. The polished spring brass lever securely pinned to the knob.
3. The large smooth brass bearing threaded onto the main shaft.
4. The turned brass panel bushing that works on panels up to one half inch thick.
5. The famous WILCOX tension spring that maintains an even and adjustable tension, and holds the switch securely in place.



Type 103

A rotary panel switch which is double pole and double throw. Will change variable condenser from series to parallel, etc. 1 1/2" radius, Brass finish 75c; Nickel finish, 85c.

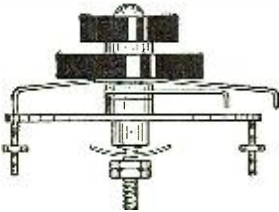

Type 102

A compound switch consisting of two electrically independent switches mounted with concentric knobs. 1 1/2" outside radius, Brass finish, \$1.10; Nickel finish, \$1.25.



Type 101

A beautiful and efficient rotary switch for general use. Furnished in two sizes. 1" radius Brass finish, 40c; Nickel finish, 50c. 1 1/2" radius Brass finish, 50c; Nickel finish, 60c.



Speaking of rheostats — Here are three good ones.

Type 122

This rheostat mounts on the back of your panel and only one hole is needed to put it there. Resistance is 6 ohms, wound on fibre support, and the carrying capacity is 1 1/2 amperes. All off and all on positions are provided. A feature of this rheostat is the long threaded brass bushing which fastens it to the panel and forms the bearing. A smoother running or more perfect working instrument can not be had at any price. Price 90c postpaid.

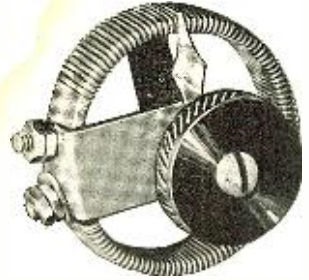

Type 121B

This type of rheostat has the same resistance unit as the one above, but it is mounted in a lathe turned aluminum case which protects it from dust and injury and adds much to its appearance. This instrument is adaptable to either front or back of panel mounting and is so finely made that it is a pleasure to possess and use one. Price \$1.75 postpaid.

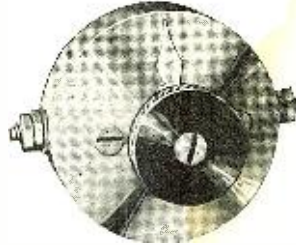

Type 121A

The same as Type 121B except for the dial. This is the finest rheostat made. Price \$2.50 postpaid.

Exposed metal parts are nickel plated on all these rheostats unless otherwise ordered. Resistance units with a carrying capacity of 3 amperes and a resistance of 3 ohms may be had if preferred.



In One — The best and cheapest socket



YOUR LOCAL DEALER probably carries WILCOX products in stock, **IF NOT** Order by mail from us and your order will be shipped **POSTPAID**

Our new catalog is being mailed to our old customers. Others should send 5c for it. **THE WILCOX LABORATORIES** Lansing Michigan

WILCOX ingenuity has made this possible.

Of course we have had to depart from the conventional pattern but by so doing we have designed a socket that combines the advantages of all, the disadvantages of none and a price lower than any. Just think what this means and look over the pointers named below.

STANDARD

Fits all standard four prong bulbs including the new transmitting tubes.

PERFECT INSULATION

The insulation used on audion sockets is of the highest importance. We have chosen Bakelite-dilecto, which, though more expensive is better than the composition or fibre frequently used.

WILL STAND HEAT

Many bulbs, particularly transmitters, develop considerable heat while in operation and much trouble has been caused by its softening effect on the insulation of some sockets. Wilcox sockets will stand this heat.

STRONG

The construction and the materials used in this socket are such that a surprisingly rigid assembly is secured.

PERFECT CONTACT

Plainly marked binding posts make connections easy and long spring brass blades make firm connection to bulb.

EASILY MOUNTED

This socket may be set upright on a base or easily attached to a panel.

NO METAL SHELL

The absence of a metal shell eliminates possibility of noises from this source.

Price **75c Postpaid**

It's easy —

to build your own variometers and regenerative sets with WILCOX parts and you'll save a heap of money too.

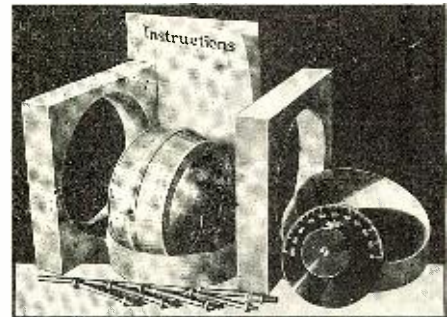

Type 5A Variometer Parts

- | | |
|---|--|
| 5AP2—Complete parts for variometer as illustrated. . . \$4.25 | 5AP1—Wooden parts, including winding form. . . . 2.00 |
| 5AP3—Complete parts less dial 3.00 | 5A—Variometer completely assembled with dial. 6.50 |
| | without dial 5.25 |
- ALL PRICES POSTPAID.

Type 1C Variocoupler Parts

- | |
|---|
| 1CP1—Contains all parts as illustrated \$5.00 |
| 1CP2—Contains all parts wound and assembled ready to mount on your panel 7.00 |
| 1C1—Wooden variocoupler rotor only 1.00 |



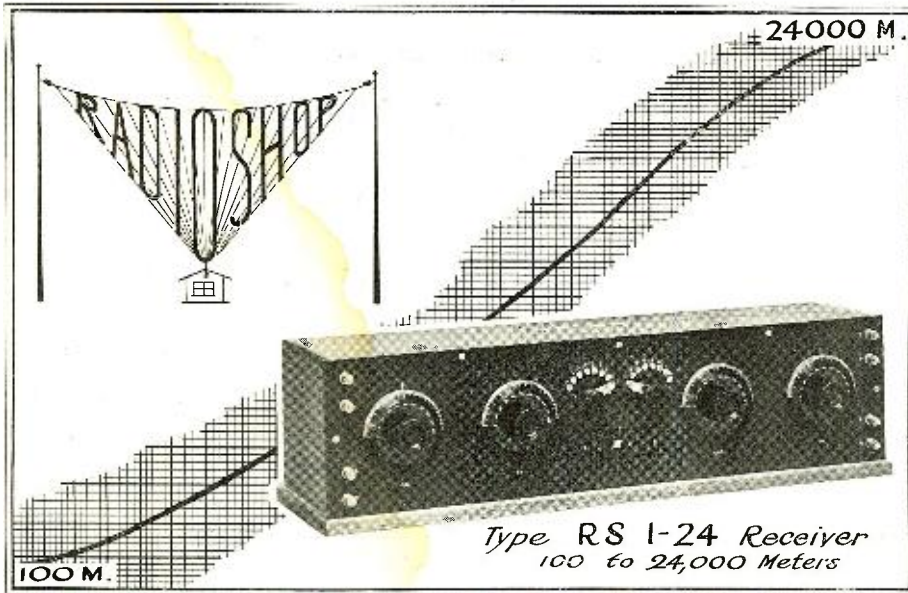

SOMETHING CONCISE:—

Concentrated essence of efficiency, the new RADIO SHOP type RS 1-24 receiver. The latest application of regenerative tuning to a range spanning every wavelength used in radio communication throughout the World.

Haven't you ever tired of the "QRM" on amateur wave-lengths and wished for a receiver that would bring in the commercial ships and long wave damped and undamped stations, without the trouble of changing wires and plugging in and out of numerous coils?

This is it! 100 to 24,000 meters, without a "dead spot," all in one cabinet! Variometer tuning applied to the entire scale with the resultant ease of control of regeneration and oscillation. Circuits so synchronized that troublesome "combinations" of tuning are entirely eliminated, making definite adjustments and reliable reception an assured thing, and the RS 1-24 the ideal receiver for all wave-lengths, with absolutely no sacrifice of efficiency on any particular wave-length. A "stand-by" arrangement is also incorporated that will broaden tuning, when so desired, for general "listening in" work. The very popular RADIO SHOP short wave receiver construction applied to wave-lengths below 1,000 meters assures maximum selectivity and efficiency for amateur and short wave commercial spark and C.W. reception. Wave-lengths from 1,000 to 24,000 meters are taken care of by an entirely new application of the variometer principle which has already been employed in the RADIO SHOP long wave receiver, described in previous advertisements. The result—SATISFACTION.

A few mechanical features that will appeal to the most exacting:—Marked windings. Dials that run true. Heavy bus-bar wiring. Non-shorting variable condensers. Grained, engraved, Formica panel. Interior as well as exterior workmanship of the highest possible order. NO SEALS. We are as proud of our interior as of the outward appearance and want the purchaser to know just as much about the apparatus as we do.

The "RS 1-24" carries the same "money back if not satisfied" guarantee that applies to all RADIO SHOP products. So far we have never had to live up to this guarantee, an enviable record! to say the least.

"THE SET THAT YOU WILL EVENTUALLY BUY"

Licensed under Armstrong's Regenerative Patent and applying this unapproachable circuit to its maximum effectiveness.

THE RADIO SHOP type RS 1-24 Receiver is the most efficient and effective radio tuning device ever built.

Price.F. O. B. San Jose.....\$100.00

In ordering please specify whether Oak or Mahogany cabinet is desired.

DEALERS: We have an interesting proposition to offer you. Write us.

THE RADIO SHOP San Jose, California

Variometers, \$5.75 Vario-couplers, \$4.75 A few still are left

REMLER No. 93 A—BATTERY — POTENTIOMETER

Increases detector sensitiveness and signal audibility.



Pat. Applied For.

- No. 93—Remler A-Battery Potentiometer Unit only, with studs for panel mounting **.75c**
- No. 94—Remler Rotary Lever Switch for use with No. 93 Unit **.45c**

THE plate voltage of any detector tube must be carefully adjusted for maximum sensitiveness and signal audibility. Potentiometer control provides close adjustment with ease of operation. This new Remler Unit with metal inserts provides positive definite electrical contact and eliminates the uncertainty of carbon to graphite contact. This Remler Unit is not brittle and is connected across the A-Battery to control the plate potential over a six volt range by half-volt steps. Circuit diagram furnished with each unit.

"Apparatus that Radiates Quality."

REMLER RADIO MFG. COMPANY

163 Sutter Street

E. T. CUNNINGHAM, Sales Mgr.

San Francisco

across the output circuit. Various arrangements for dissipating energy have been suggested, and will now be discuss.

ABSORPTION METHOD.

It was originally suggested that a gas two-electrode valve could be connected across the aerial circuit of a continuous-wave transmitter, and the leakage thru it controlled by a microphone which produced a transverse magnetic field. The advent of the three-electrode valve made it possible to use this device to absorb energy. Fig. 4 shows a fundamental circuit. A generator A produces continuous oscillations in the antenna; consequently, there will be a high e.m.f. across L_1 . During those half-cycles which make the anode P positive, energy is diverted thru the valve, and will dissipate itself on the anode. The amount of energy dissipated depends on the conductivity of the valve P, which in turn depends on the potential of the grid G. By connecting a microphone transformer as shown, the aerial output is controlled by the speech. The valve may be arranged so that energy is only absorbed when speaking into M, or as is more usual, the valve may be adjusted (by giving G a suitable potential) to absorb about half the output. A resistance is frequently included in the anode circuit. This improves articulation and dissipates energy. At first the valve dissipates most of the energy, but as the valve passes more current the resistance begins to dissipate most of the energy. To prevent the anode potentials affecting G electrostatically, a variable inductance in series with a condenser may be connected directly across G and F.

Such an arrangement only modulates the positive half cycles. The maximum modulation is effected when the other half cycles are also affected. A second valve may be arranged across L_1 so as to conduct. The filament may be connected to P and the anode to F. The secondary of another microphone transformer is connected across grid and filament of the second valve. The primaries of the two transformers are operated by the same microphone. Whichever valve is operative, the output is modulated.

Instead of connecting the valve across the whole of L_1 , two valves may be used with filaments connected together and grids connected together. One anode is connected to one end of L_1 and the other anode to the other end. A middle tapping from L_1 is taken to the filaments. The potential of the grids is varied by the usual microphone transformer. The oscillatory current L_1 makes the anodes alternatively positive and negative. Thus both half-cycles are absorbed but only half the e.m.f. across L_1 is utilized. Special double anode valves may be used in place of the two valves (e.g., those described by the author in British Patent 146,708). Frequently the absorbing valve or valves are connected across an oscillatory circuit coupled to L_1 . The H.F. generator need not be in the position shown, it sufficing that oscillations are produced in L_1 whatever the means employed.

Another absorption arrangement consists in connecting a three-electrode absorbing valve across the grid oscillating circuit of a valve generator. The energy absorbed, which is small, produces large alterations in the output. A resistance is usually connected in the anode circuit of the modulator valve. This improves articulation. The microphone transformer is, as usual, connected across grid and filament of the modulator-tube. It is to be noted that absorption schemes cause a loss of power and also cause a variation in the wave-length emitted since the frequency of an oscillatory circuit is dependent on the resistance, if any, across it. In high-power absorption arrangements, modulating valves are connected in parallel.

"The Greatest Radio Catalog In the World"—

The Universal Verdict of Tens of Thousands of Radio Amateurs

Mail 12 cents

in stamps or coin (not sent otherwise) for the greatest Radio Catalog published.

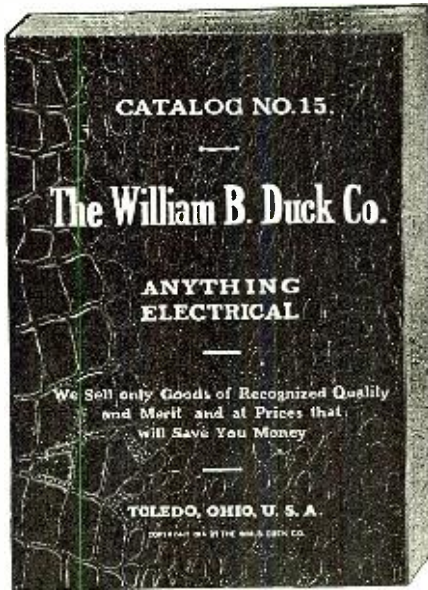

Substantial Reductions on many Radio Instruments that appear in Catalog No. 15

The prices of DeForest Honeycomb Coils and all DeForest instruments as set forth in catalog No. 15 have since been reduced to the previous DeForest list which appears in the first edition of our catalog No. 14.

| | |
|---------------------------------|---------|
| No. R40 Receiving Set | \$22.50 |
| No. R41 Receiving Set | 38.50 |
| No. R41a Receiving Set | 28.50 |
| THORDARSON TRANSFORMERS. | |
| 1 K.W. Type R | 40.00 |
| 3/4 K.W. Type R | 28.00 |
| 1/2 K.W. Type R | 22.00 |
| 1 K.W. Type RS | 30.00 |
| 3/4 K.W. Type RS | 20.00 |
| 1/2 K.W. Type RS | 15.00 |
| No. A1792 Thordarson Condenser | 25.00 |
| Nos. 50, 51, 52 | |
| Switch Contacts, each | .03 |
| No. 1023 Mica Condenser | .60 |
| No. B670 Detector | 2.75 |
| No. A862 Detector | 2.75 |
| No. A1915 Detector | 4.50 |
| No. A367 Murdock Condenser | 1.50 |
| No. A1002 Receiving Set | 9.75 |
| No. A1916 Condenser | 1.65 |
| No. 61x08A Tuning Coil | 2.95 |
| No. 61x10 Tuning Coil | 4.95 |
| No. 14 Aluminum Wire, per lb. | .90 |

Only a few of the many New Instruments in Catalog No. 15

| | |
|----------------------------|------|
| Type C-300 Cunningham Bulb | 5.00 |
| Type C-301 Cunningham Bulb | 6.50 |
| UV-200 Radiotron Bulb | 5.00 |
| UV-201 Radiotron Bulb | 6.50 |

A Complete Line of New Detector, Regenerative and Amplifying Sets.

| | |
|--------------------------------|--------|
| Connecticut Variable Condenser | 6.50 |
| Turney Spider-Web Unit | 6.00 |
| No. 550 Murdock Socket | 1.00 |
| No. 3660 Murdock Condenser | 4.00 |
| No. 3661 Murdock Condenser | 4.25 |
| No. 3662 Murdock Condenser | 5.00 |
| No. 3680 Murdock Condenser | 3.25 |
| No. 3681 Murdock Condenser | 3.50 |
| No. 3682 Murdock Condenser | 4.25 |
| No. 3664 Murdock Dial Assembly | 1.25 |
| MC-1 DeForest Set | 40.00 |
| MC-2 DeForest Set | 50.00 |
| MR-1 DeForest Set | 65.50 |
| MR-2 DeForest Set | 85.50 |
| MR-3 DeForest Set | 105.00 |
| MS-2 DeForest Set | 209.00 |

Note: The above DeForest Sets are just out and constitute panel detectors, amplifiers, regenerative receivers and complete radio telephone transmitting and receiving sets. The various sets above mentioned comprise the various units in cabinets. These units may be bought separately and later added to.

No. MS-2 comprises a complete Midget Radiophone with a thirty-five mile speaking range, regenerative receiver; also receiver for wave lengths of 25,000 meters, and a detector and two-stage amplifier each in separate units but all mounted in a mahogany cabinet.

| | |
|--|---------|
| Type OT-3 Midget Radiophone consisting of antenna circuit panel and power tube panel | \$85.00 |
| Microphone, extra | 6.00 |
| Power Tubes, extra | 22.50 |
| Magnavox Radiophone Hand Transmitter | 22.50 |
| Magnavox Radiophone Transmitter Tone Arm | 37.50 |
| Magnavox Loud Speaker | 45.00 |

DUCK'S No. 15 BIG 225 PAGE WIRELESS CATALOG. JUST OUT

A Veritable Treasure House of Everything Worth While and Dependable in Radio. The largest, most comprehensive, artistic and educational wireless catalog published. The Beacon Light to guide you right in the selection of your radio purchases, and at prices that will command your attention. Every instrument guaranteed with privilege of return if not satisfied.

For 12 Years the Name "DUCK"

has had a meaning all its own to radio amateurs.

Next month we shall reproduce a number of late testimonials out of thousands pouring in upon us, which will tell you why the overwhelming majority of radio amateurs buy from "Duck."

Ever since the year 1909 Duck's catalog has always occupied the foremost rank among radio amateurs; in each succeeding year, with the constant development of radio this catalog blazed the way with most everything new and dependable listed between the covers of all other catalogs. It has truly been a "BEACON LIGHT" to the novice and the expert in radio. In keeping with the size and completeness of this catalog there has always been a stock of radio instruments in our place many times larger than that of any other radio house; in fact we believe several times larger than the next largest. Our many years in this business and the immensity of our stocks is conclusive proof that you are dealing with a big, well-established and dependable concern.

SERVICE

Among many other things, has made our business tremendous, and except for a limited time after the war, when without actively inviting the business we were literally snowed under with orders, our service has always been our pride and the delight of radio amateurs. SERVICE—the most abused word in advertising and the hardest and most complex thing to give to radio experimenters. We do not tell you that we can always ship every item in our catalog immediately, but our records for some time past prove that we are giving our pre-war service and shipping 98% of all orders complete within twenty-four hours after receipt.

New Short Wave Regenerative Set with Detector

Listen in to the Radio Concerts with this wonderful receiver.



For damped and undamped stations from 150 to 600 meters. Variometer and vario coupler construction. Variometer coupling extremely close giving maximum inductance. Vario-coupler primary provided with single and multiple tap switches giving extreme selectivity. Wiring bus bar type insulated with oiled cambric tubing. Brushed Bakelite panel. Beautifully finished mahogany cabinet. Tested before shipment in Toledo for radio music from Pittsburgh and Washington. Absolute certainty of getting what you buy. The maximum range obtained from any type of transmitting station, damped or undamped, using up to 600 meters. We unqualifiedly guarantee that there is nothing like it on the market for the price.

| | |
|--|---------|
| No. A204 New Short Wave Regenerative Set with Detector and "B" Battery | \$65.00 |
| Cunningham or Radiotron Detector Bulb, extra | 5.00 |
| No. A210 Short Wave Regenerative Receiver only (style, construction and appearance same as No. A204, but without detector) | 50.00 |



No. A200

An excellent Audion Control Panel for use with new four-prong bulbs. Grid leak and grid condenser are mounted on rear of panel. New type panel rheostat mounted on center of panel. The formica panel is attached to a wood base, upon which is mounted the tube receptacle.

"B" Battery control permitting of four regulations of "B" Battery. Voltage from 18 volts to 22 1/2 volts in steps of 1/2 volts. A fine adjustment of "B" Battery is necessary for the best results.

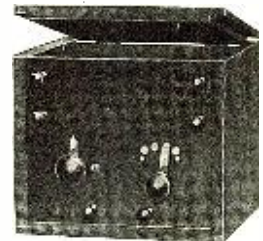

| | |
|--|---------|
| No. A200 Panel Detector Set, less batteries and bulb | \$7.50 |
| No. A201 Cabinet Detector Set, with batteries less bulb | 15.00 |
| No. A202 Cabinet Detector or Amplifier Set, with Batteries less Bulb | \$22.00 |

Send 12 Cents for a copy of Our Big Catalog Today

THE WILLIAM B. DUCK CO., 231-233 Superior St., Toledo, Ohio



EASTERN
RADIO
INSTITUTE
RADIO

899 BOYLSTON ST.
BOSTON, MASS.

TEL.
 BACK BAY
5 9 6 4

RESULTS

If you are interested in studying Commercial Radio, the RESULTS accomplished by The Eastern Radio Institute should merit your immediate enrollment.

FOR INSTANCE:

The Eastern Radio Institute was founded in 1913 and is now over six years older than any other Radio and Telegraph School in New England—We are established!

The Eastern Radio Institute moreover has given instruction at this date to over 4,000 different students, and has enrolled, graduated and placed more Commercial operators than all other schools in New England combined! We have accomplished things!

Graduates of The Eastern Radio Institute have actually secured 90 per cent, 89.9 per cent, 89.8 per cent etc., out of a possible 90 per cent in their Commercial operators first grade examination. We know how to give the student proper training!

Successful graduates of the Eastern Radio Institute are found in responsible radio positions all over the world. Why not be one! It costs no more!

Our latest, illustrated prospectus is free. If you cannot visit the Institute send for one. Remember our organization with over eight years of continued Results and Success is behind every student who enrolls. Send in your enrollment today!

F. D. Pitts,
Director.

BEGINNERS!



It is sad but true that the average beginner gets stuck with a single slide tuner and other junk which he is told is the best thing to learn on. Soon he will want some real apparatus and \$20 worth of useless apparatus is discarded.

After much research we have developed an ideal set consisting of Variometer, Phones, Detector, Condenser, Aerial, and Ground all for \$15. This set may be added to according to our expansion plan in easy steps until it becomes a short wave regenerative and a long wave honeycomb set. And NOTHING will be discarded. We take personal interest in each customer. Catalog and complete information, 5c.

THIS MONTH'S SPECIAL. Grid condenser and leak free with each RADIOTRON UV200, at \$5. Postage extra.

A. K. LAING, RADIO SUPPLIES, Pelham Manor, N. Y.

not in the usual manner, but in such a way that the valves become progressively conductive. This is done by grading the negative potentials on the grids. By this arrangement the energy dissipated is roughly proportional to the square of the number of valves used.

THE TRIODE AS A VARIABLE CONDUCTOR OF CONTINUOUS OSCILLATIONS.

Another form of modulation consists in using a triode as a conductor of continuous oscillations and varying its conductivity by means of microfonic potentials on its grid. Fig. 5 shows a typical arrangement. The source *A* of oscillations is connected in series with the inductance *L*₂ and the tube *V*. Oscillations will only be set up in *L*₂ when *V* conducts. If the grid of *V* is sufficiently negative no current will pass thru *V*. It will be seen that the current thru *L* will be proportional to the microfonic potentials applied to the grid. As the single *V* will only pass half-oscillations (unless a steady positive anode potential is applied), two valves are sometimes employed so as to conduct both half-cycles of oscillating currents. It would appear that the resistance of the conducting valve or valves is too great for efficient results. These circuits may be arranged so as only to radiate when speaking. It has been proposed also to apply high-frequency potentials to the grids of two conducting tubes. These potentials may be obtained from the main source of energy, and are arranged in phase with the anode potentials.

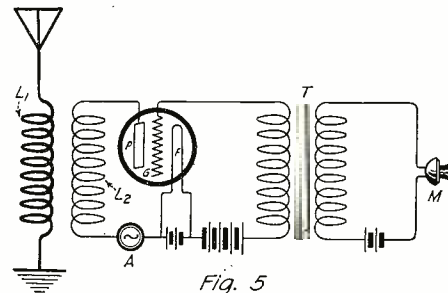

In This Circuit the Source of High Frequency Current *A* May Be a V.T. Oscillator Coupled to the Grid Circuit.

Thus when the anode of one of the triodes is positive the grid is likewise positive. The circuit which passes on these high-frequency potentials contains a microphone which when spoken into, controls their magnitude and so the conductivity of the triodes. This arrangement appears to be difficult to regulate in view of the phase adjustment necessary. All circuits employing a valve as a conductor may be arranged on a small scale and the result magnified by a power amplifier tube coupled to the antenna. To obtain a good system of modulation is the first desideratum. It is usually desirable to give the grid of the amplifier tube a negative potential so that the anode current is normally zero, and only increases when the modulator circuits induce modulated oscillation into the grid circuit of the amplifier. The circuit of Fig. 5 may be modified by replacing *A* by a three-electrode valve, its anode connected to *F*. High-frequency potentials are applied to the grid of this valve.

CHOKE CONTROL.

The commonest modulation system depends for its action on the fact that the output of an oscillating triode is directly proportionate to its anode potential. This fact was utilized in several of the earliest radio telephone sets, as far back as 1914. One arrangement provides for a microphone transformer whose secondary is included in the anode circuit of a tube fitted with the usual oscillation circuits. The anode po-

NOW IS THE TIME TO MAKE BIG MONEY

LEARN WIRELESS

AT HOME

**Know a Dignified
Uncrowded Profession**

**In Shortest Time
At Lowest Cost**

The Demand for Good Wireless Operators Far Exceeds the Supply

The New York Wireless Institute—America's foremost fastest growing Wireless Institute gives you the best instruments, theory, text books and diagrams available. We will MAKE YOU AN EXPERT WIRELESS OPERATOR AT HOME, qualifying you for first grade license, in your spare time, easily, thoroughly, in shortest possible time and at lowest cost. No previous training is necessary. Our Home Study Course is prepared by Mr. L. R. Krumm, formerly Chief Radio Inspector, Bureau Navigation, New York, now in position of greater responsibility with one of the largest Commercial Radio Corporations in the United States. Our Radio Experts, able to impart their practical and technical knowledge to YOU in an easy-to-understand way, will direct your entire Course. The graded lessons mailed you will prove so fascinating that you will be eager for the next one. The instruments furnished free will make it as easy for you to learn the Code as it was to learn to talk. *All you will have to do is to listen.*

BIG SALARIES

Wireless operators receive salaries from \$125 to \$200 a month and it is only a stepping stone to better positions. There is practically no limit to your earning power. Men who but yesterday were Wireless Operators are now holding positions as Radio Engineers, Radio Inspectors, Radio Salesmen at salaries up to \$5,000 a year.

TRAVEL THE WORLD OVER

A Wireless Operator can visit all parts of the world and receive fine pay and maintenance at the same time. Do you prefer a steady position without travel? There will be many opportunities for you at the numerous land stations or with the Commercial Wireless or with the Steamship Companies.

The New Intercity Wireless Company will need hundreds of new operators

INSTRUMENTS AND TEXT BOOKS

We furnish free to all students, during the Course, the wonderful receiving and sending set exactly as shown in the illustration. This set is not loaned, but given to all students completing the Course. One cell of dry battery all that is required. No additional wiring, aerials, etc., needed. The wonderful Receiving and Sending Set, Text Books, etc., all become your property upon completing the course.



FREE

The transmitter pictured is the celebrated Omnigraph, used by several Departments of the U. S. Government and by the leading Universities, Colleges, Wireless and Technical Schools throughout the United States and Canada. Thousands have learned telegraphy with the Omnigraph. Place the phone to your ear and this remarkable invention will send you wireless messages, thousands of different ones, the same as though you were receiving them thru the air from a wireless station hundreds of miles away. When you apply for your license the United States Government will test you with the Omnigraph—the same model Omnigraph as we furnish to our students. Ask any United States Radio Inspector to verify this.

FREE WIRELESS TELEPHONY COURSE

We have incorporated in our Institute an up-to-date and Complete Course in Wireless Telephony, written by our Chief Instructor, Mr. L. R. Krumm.

This Course is included FREE

FREE POST GRADUATE COURSE

A month's Post-Graduate Course, if you so desire, at one of the largest Wireless Schools in N. Y. City—the Wonder City—the largest port in the World and Headquarters of every leading Wireless and Steamship Company.

Endorsed by United States Government

by allowing our graduates highest credit given any Wireless Correspondence School in first grade license examinations.

U. S. SHIPPING BOARD will testify to the value of our instruction.

Medina, N. Y.,
November 28, 1920.

Dear Sirs:—
I have found the Theory Course, the Omnigraph Set and Text Books most satisfactory. I think your Wireless Course is the best and easiest to learn for it's interesting from the beginning to end, and the way the questions are written sets you interested at once.
Yours Truly,
(Signed) S. B.

Sea Cliff, L. I.,
December 6, 1920.

Dear Sirs:—
Received your letter of December 1, and was very pleased to learn of the lessons in Wireless Telephony to be given to the students of your school. It shows you do not overlook any phase in order to furnish the students with "up to date dope in the Radio line". And I am sure it will be as explicit as your Theory course of Wireless Telegraphy. The course is as thorough and explicit as one could ask for and I wouldn't hesitate a moment in recommending it to any of my Radio friends.
Respectfully yours,
(Signed) C. D. H.

Milford, Conn.,
Oct. 25, 1920.

New York Wireless Institute,
New York City.

Dear Sirs:—
I received your letter and am very glad to tell you that I am completely satisfied with your course. It sure is an easy way to learn.
Thanking you for your kind attention,
I am,
Sincerely yours,
(Signed) J. H. A., Jr.

(Names and address gladly furnished on application.)

NEW YORK WIRELESS INSTITUTE

Dept. 204, 258 Broadway New York City

Send me, free of charge, your booklet "How to Become an Expert Wireless Operator," containing full particulars of your Course, including your FREE INSTRUMENT OFFER.

Name

Address

City or Town.....

State

SEND FOR FREE BOOKLET

Without obligating you in any way, send for our booklet "How to Become an Expert Wireless Operator"—it is free. Mail the coupon opposite or postal or letter—but do it today.

NEW YORK WIRELESS INSTITUTE, Dept. 204
258 Broadway
New York City

Getting Every Word



THAT'S the universal experience of wireless operators who use the Brandes Headsets. The two phones are perfectly matched in tone; they deliver signals so faint that other receivers fail to get them. Stress of weather and other conditions of interference are overcome in a wonderful way by these supremely sensitive and mechanically perfect instruments.

Send 5c for Catalog G.

DEALERS—Write for Special Proposition

C. Brandes, Inc.

Dept. 23

32 Union Square, New York City

BRANDES Matched Tone HEADSETS

"ILLINOIS" THE RELIABLE MADE RIGHT - STAYS RIGHT

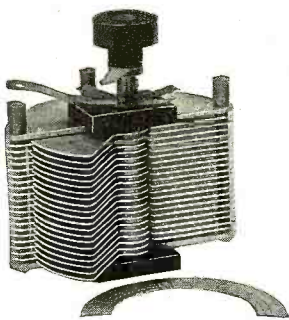

STYLE No. 1

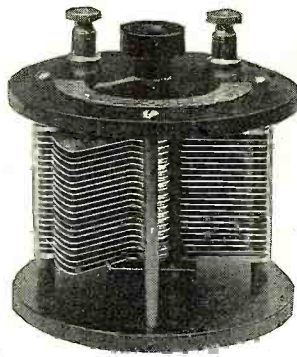

STYLE No. 2

Three Styles: No. 1, Panel; No. 2, Open Type as shown; No. 3, Fully Encased. Anti Profiteer. Less than pre-war prices. Fully assembled and tested.

| | Style No. 1 | No. 2 | No. 3 |
|------------|-------------|--------|--------|
| 67 Plates, | \$7.00 | \$8.00 | \$8.50 |
| 43 " | 3.50 | 4.50 | 4.75 |
| 23 " | 2.75 | 3.75 | 4.00 |
| 13 " | 2.25 | 3.25 | 3.50 |

Money back if not satisfied. Just return condenser within 10 days by insured Parcel Post.

With Style No. 1, we will, if desired, furnish 3 inch Metal Dial with large Knob, instead of Scale and Pointer. Extra Price 75 cents. Or we will, if desired, supply the Condenser with smooth 3-16 inch center staff, without Scale, Knob and Pointer, at 15 cents off the list to those who prefer to supply their own dial.

Vernier with single movable plate applied to 13, 23 or 43 plate condenser, \$3.00 extra.

We allow no discounts except 5 percent on orders of 6 or more.

Sent Prepaid on Receipt of Price

Except: Pacific States, Alaska, Hawaii, Philippines and Canal Zone, add 10c. Canada add 25c.

Foreign Orders other than Canada not solicited.

G.F. JOHNSON, 625 Black Ave., Springfield, Illinois.

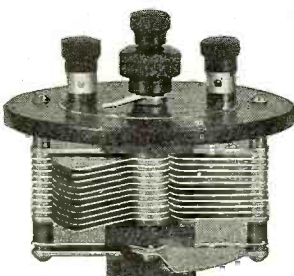

VERNIER

tential is provided by the microfone transformer and is thus zero when not speaking. The system consequently only radiates when the microfone is affected. The arrangement is made more successful when a small steady anode potential, sufficient to maintain weak oscillations, is employed. A more usual tho not "quiescent" system provides for a high steady e.m.f. in the anode circuit. The microfone potentials vary this potential above and below its normal value and thus modulate the H.F. output to the antenna. The microfone potentials are invariably magnified by one or more valves to give increased power. The output circuit of the microfone potential amplifier frequently consists of an iron-core choke coil, which is included in the anode circuit of the generating power valve. The modulator tube derives its anode current from the same source as the power valve and is of the same dimensions as the latter. The modulator when operative is capable of varying the H.F. output between nearly zero and twice the normal output. The modulator thus contributes to the output by producing potential surges in the impedance. A typical circuit employing this "choke control" is shown in Fig. 6. The tube V_1 is the generator and V_2 the modulator; Z is the choke-coil. In this, as in all other circuits, a buzzer may replace the microfone if "tonic-train" effects are desired. A recent arrangement proposes to use the microfone not merely as a modulator, but as a primary source of current. The alternating currents are rectified by a valve, the resultant direct current being fed to the power oscillator. *Abstracted from London "Electrician."*

Junior Constructor

(Continued from page 881)

silver wire. Fill the tube with the prepared solution, and push the corks in tightly so that the inner ends of the wire project about $\frac{1}{4}$ inch into the liquid. It is well, if it leaks, to seal it tightly with some sealing wax. The solution is colorless now, but on current being applied to the wires, a pink coloration begins to form around the wire connected to the negative source of supply, but on shaking the tube this will disappear.

Fill a glass with a salt water solution as in Fig. 3 and place the two wires from the opposite poles in the solution. A discharge of bubbles will rise from the negative wire.

If the "Bug" hasn't any of the materials to make any of the foregoing polarity indicators, he may empty a little of the electrolytic from his storage battery into a glass, and place the wires in it, taking care to keep them well apart. Bubbles will rise from both wires, but a great many more will arise from the negative side than the positive. This test is always dependable.

I Want to Know

(Continued from page 884)

$\frac{3}{8}$ " apart, 21 movable plates 3" diameter. $\frac{3}{8}$ " apart? Also, what is the capacity of an 11-plate condenser, of the same size?

A. 1. The 43-plate condenser has a capacity of about .001 mf., while the 11-plate condenser's capacity is only about .00016 mf.

AMPLIFIER WITH CRYSTAL DETECTOR.

(221) Robert G. Middleton, of Hayward, Cal., wants to know:

Q. 1. How and where may I obtain a license for sending?

A. 1. To obtain a license, you should apply to the Radio Inspector of the Sixth District Customs House, San Francisco, Cal.

Q. 2. Can an amplifier be used in connection with a crystal detector?

A. 2. Yes. In this case the primary of the amplifying transformer is connected in place of the fones in the receiving circuit.

Q. 3. For receiving, is it best to use a single wire or a four-wire aerial, inverted L type?

A. 3. The same results may be obtained with both aerials, provided the same length of wire is used in both.

LOOP AERIAL.

(222) A. F. Wendt, of Tripoli, Iowa, requests the following information:

Q. 1. In making a loop, could I wind more than one layer of wire, separating them by 1", on a 4' loop?

A. 1. It would be better to wind your loop with one layer only of insulated wire, putting the turns close together.

Q. 2. How long should the wire be to receive up to 25,000 meters wave-length?

A. 2. To tune up to 25,000 meters, about 200 turns should be wound on the loop and external inductances used, the whole circuit being shunted by a variable condenser. A dead end switch could be used to advantage to cut out the unused parts of the loop.

UNDAMPED WAVE CIRCUIT.

(223) William Old, of Norfolk, Va., sends the following request:

Q. 1. Please give in the "I-Want-To-Know" Department the best hook-up for undamped wave reception using three honey-comb coils.

A. 1. This hook-up was published on page 462 of January RADIO NEWS.

A. C. FOR V. T. FILAMENT.

(224) L. London, of Philadelphia, Pa., wants to know:

Q. 1. Can I use a three-way bell transformer instead of an "A" battery on a paragon detector unit?

A. 1. Yes, a bell transformer could be used as supply for the filament of a V. T., provided the secondary winding delivering six volts is used with the circuit shown on page 447 of the January, 1921, issue of RADIO NEWS.

An Efficient Loading Coil and No Dead End Switch

(Continued from page 872)

good and much easier to work. The dimensions are not important, but a good size is 3 1/2" x 3 1/2" x 1/2". First the center of the piece should be marked and a half circle drawn, the radius of which should be the length of a switch lever which you may have on hand. The ordinary style of switch point with the shank turned right on the point should be used, as in "C," Fig. 4. Nine of these points will be necessary. Nine holes should be drilled around the half circle at equal distances. These holes should be just large enough for a sliding fit, but not large enough to allow the switch point to move sideways. The next step is to make the two small pieces at a and b in Figs. 3 and 4. They should be made from thin spring brass or phosphor bronze cut and bent to the shape shown. They are fastened to the panel in the positions shown by small brass screws or brass nails. e in Fig. 4 is the switch blade and has 1/8" of the contact end bent down and the corners rounded off so it will pass easily from one tap to the next.



Standardized UNIT Cabinets

EACH ABC Unit is complete in itself for its particular purpose. Yet the series is so designed that any combination of units works as if it were a single set. The photograph below shows three of the units—the Receiving set, the VT Detector, and the Two-step Amplifier—hooked up together into an efficient, smooth-working combination.

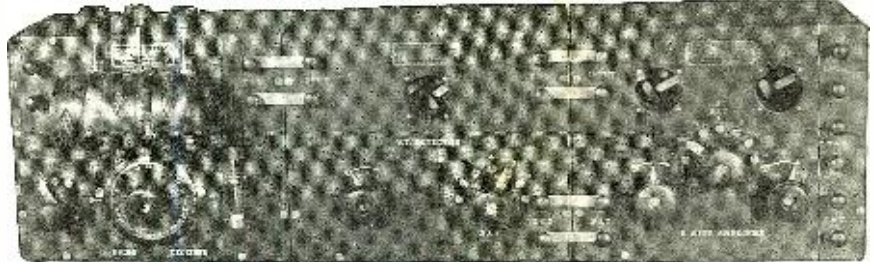

Receiving Set or Radio Receiver. Complete in itself. Equipped with selected galena crystal detector, and three ABC Inductance Coils. Price, \$24.50.

VT Detector. Simply hook up this detector to your ABC receiving unit, disconnect the crystal detector, and the set is ready for operation. Price (less tube), \$10.50.

Two-Step Amplifier. Adds two stages of radio amplification to any previous combination of units, making a smooth-working, long range set. Price (less tubes), \$45.

Receive code and wireless telephone both—at a small initial investment!

ABC Units solve the problem of starting off with a small investment, and gradually increasing your range without discarding a nickel's worth of apparatus as you go along.

Start with the receiving unit (complete in itself). Then you can gradually build up your station to include a VT Detector and three stages of radio amplification. Yet, every new combination of units, as you go along is guaranteed to give satisfactory, dependable performance.

Finally, when you have secured the complete system, you have a commercial grade station—equipped to receive all classes of signals; damped or undamped, code or radio phone, on all known wave-lengths.

The combination shown here is the receiving unit (described above), and the combined VT Detector and one-step amplifier. Further amplification can be secured by adding a one or two-step amplifier at any time. Price of the combined Detector and one-step (less tubes), \$37.50.

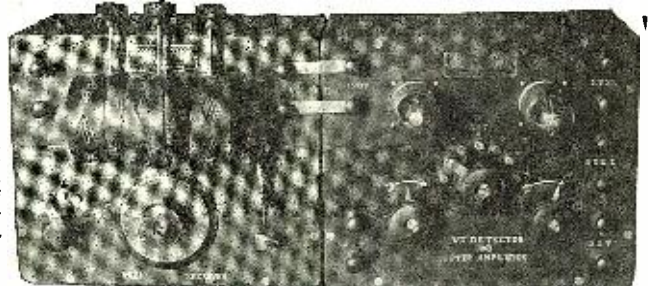

ABC Units are standardized in design, and produced by automatic, machine methods, down to the smallest switch point.

In addition to the progressive, "building up" feature, this standardization offers three distinct advantages:

1st. You can invest in a receiving unit, with perfect confidence that the other units, in the same standard design, ready to hook on, will be ready for you whenever you want them. We took three years of research to make ABC Units right, and the design will remain unchanged in all essentials.

2nd. Every part, even the least important binding post is standardized, and made by unvarying, automatic machines. You can always buy replacement parts that are identical with the original.

3rd. Standardized quantity production in the ABC factory, (the only one of its kind in the world), has brought about economies previously impossible in radio apparatus. That's why we can sell "Professional Radio Equipment at Amateur Prices", and at the same time back up every ABC instrument with our unequalled guarantee, "Your Money's Worth or Your Money Back!"

Professional Radio Equipment at Amateur Prices



WIRELESS EQUIPMENT CO. INC. Pres. **AB Cole**

32 AUSTIN ST.,

NEWARK, N. J.



Dealers—

The ABC line includes a complete assortment of radio apparatus, both assembled and unassembled. It is a fast selling, profitable line, that makes good. Write for discounts.

Amateurs—

The ABC new folder, describes in detail, the five ABC unit cabinets, the ABC variable condensers, the ABC small parts, the ABC "Clarion", the Vibratone, Jr. Transmitter, etc., etc. Slip this coupon and a nickel into an envelope NOW! and your copy will come by return mail.

Wireless Equipment Co., Inc., 32 Austin St., Newark, N. J.

I enclose one nickel. Send me by return mail your new ABC folder.

Name

Address

City State

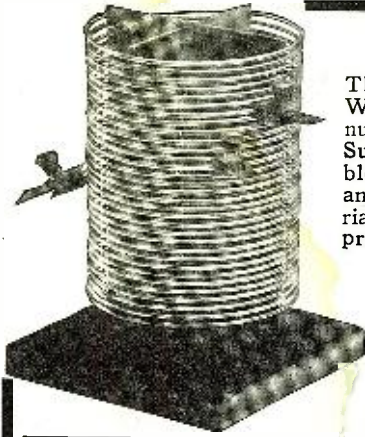

RADIO SERVICE

The Radio Service Type S50 C. W. Inductance is Wound on a slotted bakelite form of 31 turns of number 9 hard drawn copper wire on a 5 inch diam. Supplied with three clips making adjustment variable to any fraction of a turn. Tunes to 350 meters and suitable for panel or bench mounting. Materials and workmanship the finest obtainable and the price is **only \$8.50**

If you are starting to build a C. W. set the Radio Service Inductance will start you on the right track or if you already have a C. W. Set and you are not getting the proper results try one of these inductances and you will be surprised at the increased operating efficiency.

ASK YOUR DEALER TO SHOW YOU ONE OF THESE INDUCTANCES. IF HE CAN'T SUPPLY YOU, WE WILL SHIP YOU ONE POST PAID.

Type S40 Variable Grid Leak (1/2 to 3 Megohms)
Helps to increase your signal audibility
Bakelite Mounted, Moisture Proof..... \$75

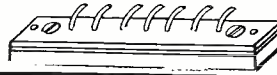

Here's the Wonderful Little Radio Set

that was described in April's Radio News, page 680. Just the thing for Boy Scouts, Campers and for use on bicycles, etc. Complete in every respect and guaranteed to give complete satisfaction. Just connect your aerial, ground and phones and you are ready to receive messages. Tunes to 800 meters.

Mr. Dealer: This little receiving set will help your business over the summer months and obtain new customers for you.

Type S8 (as illustrated) price.....\$7.50
Type S8A complete (incl. phone, aerial, insulators and instruction book).....12.50



RADIO SERVICE & MFG. CO., Lynbrook, L. I., New York

The blade should be some springy material such as thin brass or phosphor bronze. Regarding the action of the switch, see Fig. 4; when the switch lever e is on a contact point it presses it down and disconnects it from piece b which piece a had been hitherto pressing down and making connection to b through the nut. The circuit now is thru a, c and d. When the switch is moved to the next contact the same thing happens there, while a, at the first tap, presses it up and makes contact again with b. The movement of the switch point should be adjusted by tightening or loosening the nut until the movement is about 1/32".

The connections to the coils are shown in Fig. 3. Eight pairs of wires are brought out and numbered as to which coils are to be connected. All the connections should be soldered. Most amateurs neglect to do this and then wonder why their sets don't come in as loud as those of some other fellow who has the same kind of an apparatus, but who solders his connections.

In closing I will say that whoever builds this piece of apparatus will find himself well repaid by its performance and efficiency for the little extra work and time spent on it.

The Construction of Intervalve and Telephone Transformers

(Continued from page 872)

which can be turned out solid from a piece of well-seasoned maple 4" x 2" x 2" or built up from a piece of fiber or bakelite tubing 1/2" internal diameter and 1/8" thick, with end pieces of 3/4" stock glued on with marine glue. The maple bobbin should be sandpapered smooth and impregnated with wax. Drill the ends of the bobbin with a No. 60 drill in four places so disposed to accommodate the lead in and out of the primary and secondary windings.

Set up the bobbin in the lathe chuck, or if this is not available, a small emery grinder with the grinding disc removed can be called into service with a little ingenuity. Cover the core with a layer of paraffin paper, and prepare four pieces of 3/32 B. & S., S. S. C. stranded connections about 12" long for connection to the main winding of 40 B. & S. enamel. For the primary wind on 20,000 turns, and lead out at the end of the bobbin. Now prepare a strip of Empire Cloth 1/2" wide and 30" long, and with this cover the primary winding to insulate it from the secondary. This method of using a tape places less strain on the fine wire underneath, besides making a neater job than the usual method of covering with a single wide strip. The secondary consists of 60,000 turns of the same gage wire. When all is found on, it is covered with another piece of 1/2" Empire Cloth about 48" long. Take the bobbin from the lathe chuck and fill up the core with pieces of thoroly annealed No. 22 iron core wire.

Now procure a small iron-encased tin about 4" long by 2" in diameter, and cut a slot at one side as shown in Fig. 2; then place the coil inside with a disc of cardboard at the bottom to keep the coil clear from the iron casing. Thread the flexible leads thru pieces of bicycle valve rubber about 4" long, and fill the tin with molten paraffin wax so as to thoroly seal the coil from the effects of moisture.

Mount the outfit as shown in Fig. 3, and an extremely efficient intervalve transformer is complete.

Another very useful transformer is one for the telephone circuit, and should be used

ESCO

GENERATORS—MOTOR-GENERATORS—DYNAMOTORS

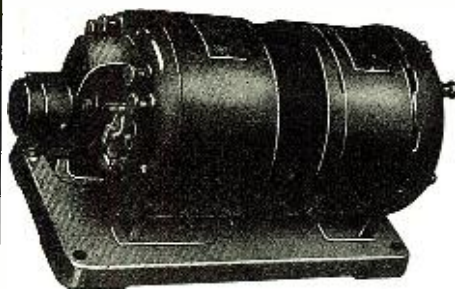

4 to 32 Volts for Filament
350 to 2000 Volts for Plate

Capacity

20 to 2000 Watts

Liberal Ratings

Write for Bulletin 231
which lists
200 Combinations

**Motors and Generators Developed and Built for
Special Purposes**

PIONEERS IN THE MANUFACTURE
of
HIGH VOLTAGE DIRECT CURRENT
RADIO GENERATORS

ELECTRIC SPECIALTY CO.

STAMFORD, CONN., U. S. A.

211 SOUTH STREET

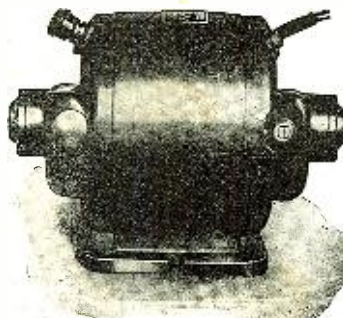

by every experimenter who has any respect for his fones. When it is considered that the fones are liable to be demagnetized or burnt out by their employment in the high voltage plate circuits, its use will be apparent. In addition to this it only takes one jolt thru the top of your dome from an earthen headband to convince you of the "splendid isolation" afforded by the use of a telephone transformer. The constructional details with the exception of the secondary winding are similar to the intervalve pattern. This winding consists of 20,000 turns of No. 36 B. & S. enamel wire, tapt at 5,000, and 12,500 turns respectively, giving a range of secondary impedances to cover all fones from the humble 75 ohm "proletariat" to the Baldwin Mica Diafram "bourgeoisie." The following table will give the reader an idea of the approximate resistances and inductances of the windings of both transformers.

| Transformer. | Primary Resis. | Primary Ind. | Secondary Resis. | Secondary Ind. |
|--|----------------|--------------|------------------|----------------|
| Intervalve | 4000 ω | 21.3H | 18400 ω | 177H |
| Telephone | 4000 ω | 20.7H | 580 ω | 1.23H |
| Actual Bridge Measurements at 800 cycles | | | 1550 ω | 7.70H |
| | | | 2800 ω | 19.4H |

When the telephone transformer is used in an audion circuit, it is absolutely essential that it be shunted by a small fixed or variable condenser, so as to pass the radio frequency component of the plate current which previously passed thru the small condenser formed by the fone cords.

According to some "hear experts" the winding should possess high ohmic resistance, thereby combining a resistance coupling effect with the transformer action. This resistance may be useful in radio frequency transformers to prevent the winding oscillating at its natural frequency, but in the pattern under consideration any undue ohmic resistance merely gives rise to losses which obey the familiar CR law. It should be particularly understood that it is ampere turns alone which transfer the energy from one circuit to another.

The California Theatre Radio Station

(Continued from page 857)

over the set on the occasion of one of the special concerts.

The station is operated under the direction of Lieut. Ellery W. Stone, general manager of the Moorhead Laboratories, Mr. B. F. McNamee, chief engineer, and Mr. J. E. Squires, operator of the station.

Atmospheric Conditions in The Tropics

(Continued from page 867)

nothing, in my estimation, which will tend to make a person more nervous, than attempting to read weak signals thru very heavy static, as it requires great concentration of the mind, which is very hard upon the nervous system.

If one should "listen in," during one of those ugly tropical thunderstorms, I guarantee you would think you were at the battle of Liège or in a boiler factory. If you are not convinced, let me say, honestly, I have heard static four feet from the fones during one of those storms. It is absolutely impossible to read signals 50 miles away. How can one possibly work with such unbelievable interference! What a joy it would be to eliminate this.

"The Promised Land"— YOUR OPPORTUNITY

"The Promised Land" is the name professional operators have given to the New York Central Radio Station of the Radio Corporation of America on Long Island, which, when completed, will be the largest and most powerful radio station in the world.

This immense station which is now in course of erection, is a striking example of the great opportunity radio offers you for a successful, secure future. It will be equipped to work simultaneously with five other nations in widely separated and distant parts of the world and will be epoch-making in the field of international communication.

A large number of trained men will be required for its operation and maintenance. A position at this station is the height of every operator's ambition, for it means unlimited opportunity to succeed and progress to higher, more responsible and better paying positions in the radio industry. So far as opportunity goes the successful future of these men is assured.

HOW ABOUT YOU?

Right now, today, radio offers you big opportunities—if you are properly trained. Radio companies need trained executives, engineers, draftsmen, operators and mechanics. Hundreds of positions in the ever-broadening field—from ship operator to general manager—are open to you, if you have the required training. The Radio Institute of America will give you this training, as it has to thousands of others. If you cannot come to the Institute, the instruction will come to you—to your home.

This new home course of radio training, which has been developed for the benefit of those who cannot attend the Institute personally, is the same course used at the Institute. It includes everything from basic principles of electricity and magnetism, to actual operation of commercial radio equipment. It also includes the same textbooks used in the Institute classes, as well as an Omnigraph set of greatly improved design, with a variable automatic transmitter, for code practice.

What Our Former Students Are Doing

Mr. H. Payne, former student, now Assistant Treasurer of the Radio Corporation of America.

Walter E. Wood, Superintendent in charge of the powerful trans-oceanic radio station at Chatham, Mass.

Irving Ellingham has a greatly prized position in his assignment as radio operator on Vincent Astor's yacht "Cristina."

Raymond Blanqui, although only 20 years old, is now a high salaried operator in trans-oceanic service.

Watson Sidney, Manager of the office of the Radio Corporation of America, Savannah, Ga.

Harry Sadenwater, assistant in research in the world-famed radio laboratories of the General Electric Company.

E. N. Pickrell, manager of the Radio Corporation's shore station for the port of New York.

Leo L. Manly, assistant superintendent of the Maintenance Department of the Radio Corporation.

William S. Fitzpatrick, Assistant Marine Superintendent.

The graduates of the Radio Institute of America enjoy a great and exclusive advantage in the close connection existing between the institute and the Radio Corporation of America, world's largest radio manufacturing and commercial radio company. The Radio Corporation employs thousands of men, in its executive departments on ships and at shore stations and in factories and laboratories. A large percentage of these men are graduates of the Institute.

What the Man Who Employs the Operators Says—

Radio Institute of America, New York.

Gentlemen—I have known the Radio Institute of America so long and so favorably under its present title and its earlier name, Marconi Institute, that it is difficult for me to conceive that anyone can think of instruction in radio without instantly recognizing its leadership. When employing operators, your students are given preference because several thousand of them have proven their ability to me over a long period of years.

Sincerely yours,
(Signed) J. B. DUFFY,
Superintendent, Eastern Division, Radio Corporation of America

The Radio Institute of America has been an established and successful institution for over fifteen years. The year round average attendance in its classrooms is now 298 students per month. It has trained over 6,000 men, 95% of whom have successfully engaged in this new branch of science and industry. You, too, can be successful in this new field if you properly train yourself by means of the Home Study Course of the Institute. Radio offers an unlimited opportunity for future advancement—why not take advantage of it. Write for our booklet and further details.—NOW.

HOME STUDY DIVISION

RADIO INSTITUTE OF AMERICA

(formerly Marconi Institute)

324 BROADWAY, NEW YORK

USE 32 VOLT D. C. FOR YOUR C W PLATE CURRENT HOW?

A Ray-Di-Co "DYNAMOTOR" makes it possible

A combination motor and generator within one frame—

No more space required than for a single unit—

Higher efficiency obtained than from motor generator of same capacity—

Operates on 32 volts, generates 500 volts, compound wound.

TYPE "DY-5" 500 volts 50 watts \$75.00

TYPE "DY-7" 500 volts 75 watts 82.50

For greater capacities the Ray-Di-Co "STANDARD" motor generator unit of the following capacities is recommended:

TYPE "SP-10" 500 volts 100 watts \$115.00

TYPE "SP-17" 500 volts 175 watts 141.00

Motor—32 volts D. C. compound wound Generator—shunt wound

All quotations F. O. B. Chicago.

Quotations for special machines upon request.

RAY-DI-CO

(Ray-Dee-Ko)

2653A N. Clark St. Radio 9AG CHICAGO, ILL.

H. H. BUCKWALTER, 713 Lincoln St., DENVER, COLO.

Representative

Colorado, Wyoming, Utah, Nebraska, Western Kansas, Northern New Mexico, Deadwood and Lead, S. Dak.

"Watch for our next announcement—you'll be surprised"

A New "CINO" Special for DX Men!

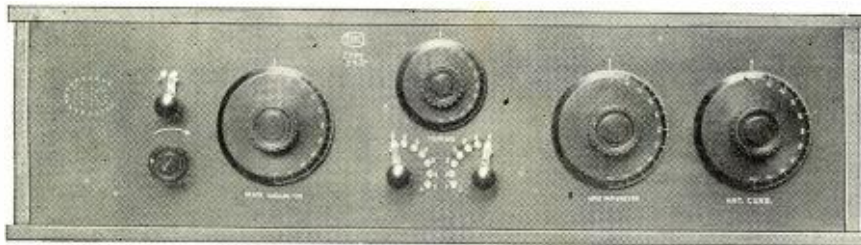

Have you ever wished that the manufacturers of Regenerative Tuners would wake up to the fact that you were right-handed?

Now look at the above illustration and start from left to right: First the detector, with the present day tubes it is seldom necessary to readjust a detector after arriving at the point where your tube works best. Alright, get it out of the road, which is to say, at the extreme left!

Next is the plate variometer: Inasmuch as the plate variometer is used solely for regeneration and does not require that you look at it continually keep it also at the left.

Next is the coupling, and last but of most importance, the Grid or wavelength tuning variometer, and alongside of it the series, or Antenna Condenser!

Now Traffic Men can this arrangement be improved upon? Everything at your right hand, long side of the key!

And finally, will they bring them in? Well, write us for literature and if you wish we will give you a list of satisfied users, distance men and boosters. PRICE \$72.00

We also carry a full line of standard apparatus, Cunningham 300-301-302 Tubes; Somerville Meters; G-R Radiation Ammeters; Chelsea, Murdock, Acme, etc.; Paragon and G-R Rheostats Burgess Batteries; Radioelectric Shop Smoothing-out Condensers 2 1/2 MFD 1500 Volt; Bell Rotary Quenched Gaps.

"CINO" Variometers—Forms, \$3.00; Mounted \$8.00. Postpaid. "CINO" Variocoupler—Parts \$2.50; Mounted \$7.00, Postpaid.

CINO RADIO MANUFACTURING CO.
218 WEST 12th STREET
CINCINNATI, OHIO

SPECIAL PRICE REDUCTIONS

| | |
|--|---------|
| Paragon Control Panel with Radiotron Tube | \$10.50 |
| Audiotron Tubes, Two Filaments | 5.50 |
| Radio Service V.T. Sockets | .98 |
| Cyclone 22.5 volt small B Battery | .98 |
| Cyclone 22.5 volt large B Battery | 1.75 |
| No. 766 Eveready large 22.5 volt B Battery | 2.75 |
| Paragon Rheostats with .0005 mf. Grid Condensers | 1.75 |
| Rubber Cap Binding Posts, per doz. | 1.00 |
| Grid Condensers, .0005 mf. | .25 |

| | |
|--|--------|
| Phone Condensers, .002 mf. | \$2.55 |
| Wireless Practice Sets | 2.70 |
| Skindervikin Buttons | .90 |
| J. J. N. Variometer | 4.25 |
| J. J. N. Variocoupler | 4.75 |
| Murdock 2,000 Ohm Wireless Head Sets | 4.00 |
| Murdock 3,000 Ohm Wireless Head Sets | 5.00 |
| Marko Storage Batteries: | |
| 4 volt 40 to 60 amp. | 10.00 |
| 6 volt 20 to 40 amp. | 10.95 |
| 6 volt 40 to 60 amp. | 16.00 |
| 6 volt 60 to 80 amp. | 20.00 |

Prompt attention given to mail orders.

The above prices are F. O. B. New York

HYGRADE ELECTRICAL NOVELTY CO., 41 W. 125th St., New York

Should you "listen in," any time of the day or night you would be sure to hear some fellow frantically calling for a vessel to relay his traffic. Tho within range of a number of shore stations it is impossible for him to read their signals due to static interference.

Engineers of the various radio concerns are laboring day and night, trying to find a way to eliminate this static for the seagoing operator. Great sums of money are being spent daily in experimenting. Let us only hope that these faithful servants of the wireless game will be rewarded shortly for their labors.

The Radio Compass on Airplanes

(Continued from page 859)

erator roughly plotting them to ascertain the accuracy of the type of fix that has been obtained. The latter being found satisfactory, the bearings are furnished the ship in message form by radio.

Pertinent to this review of the progress of Naval aircraft is the announcement of results of experiments conducted by the Engineering Division of the United States Air Service as to airplane radio direction finding. Wireless was used at McCook flying field in guiding the return of airplanes to the home airdrome. The outstanding conclusion of these observations is that any airplane can be directed with absolute accuracy to any radio transmitting station, even in the absence of an experienced operator. When at an elevation of 2,000' the airplane could be guided immediately over the transmitting station, the feat being accomplished while the man operating the switches in the rear cockpit controlled the rudder and steered the airplane in response to wishes. The experiment was negotiated both with experienced wireless operators in the rear cockpit and with individuals who had no knowledge of radio and who did not know the Morse code. The results were identical—that is, the airplane was piloted directly over the transmitting station in both instances with wireless as the sole guide. Even when scaring at a height of 2,000', the operator could detect the failure of the airplane to hover over the station directly, should the margin be as little as 100'.

The method employed in making the experiments involved the use of two closed loops mounted on the wings of an airplane at right angles to each other, operating upon a maximum signal. The particular installation was mounted on a Curtiss NJ 4-11 airplane, and consisted of two main, or "fore and aft" loops of four turns each, connected in series, one loop being stationed on the outside struts of each wing. The auxiliary loop was of four turns of wire and was mounted at right angles to the main loops, struts numbers four and ten being employed. The fuselage of the air-going machine was enclosed by this loop. The wire was sewed into fabric and the strips of fabric were doped onto the struts and wings of the airplane. Leads were brought from the loops into the rear cockpit of the machine and there connections were made to suitable switches, condensers, amplifiers, etc. The Air Service states that these tests do not embody any departure in radio direction finding in airplanes, the method in part being introduced in England during the war. The results, however, are impressive in revealing the accuracy which is possible when wireless is employed for guiding aircraft.

MAGNAVOX RADIO PRODUCTS

HAND TRANSMITTER \$25.50

Magnavox special transmitter will modulate one ampere of voice current and enable you to cover maximum distance. To increase your transmitting range use this most efficient micro-phone.



RADIO MAGNAVOX \$45.00

This instrument solves the loud speaker problem for all. With a 2-stage amplifier signals voice or music will be reproduced loud enough to be heard over a large room or hall.

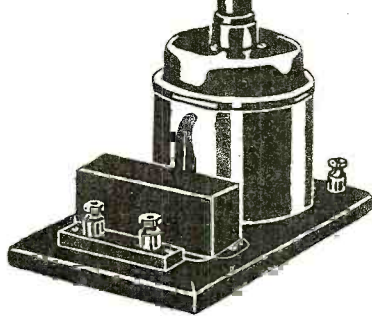

MUSIC TRANSMITTER \$37.50

Use a Magnavox transmitting tone arm for efficient transmission of phonograph music over your Radio phone. Easily attached to any phonograph without removing the regular tone arm.



Immediate delivery. Order from your dealer or send remittance direct to the

MAGNAVOX COMPANY, OAKLAND, CALIFORNIA

For Short-Wave Results—

This combination makes phenomenal distance work an every-day occurrence in your station.

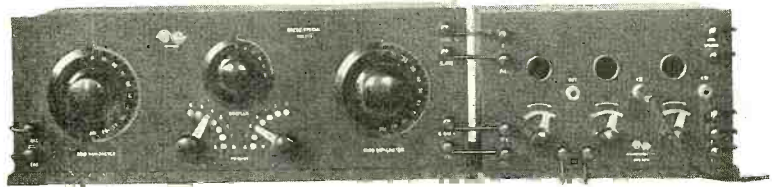
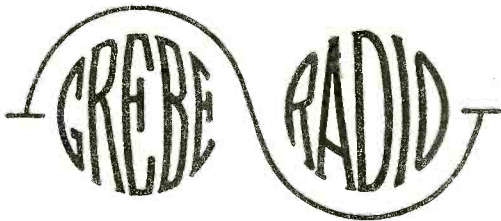

CR-3 Relay Receiver-Detector and 2-Stage Amplifier (RORD)

This is the famous combination that proved its merit in the relay tests some months ago. It makes a wonderful team both for ease and flexibility of operation and what is far more important—real results!

GREBE RADIO apparatus is licensed under the original Armstrong and Marconi patents.

Enterprising radio dealers carry Grebe Radio Apparatus. Ask yours to show you this Combination; if he doesn't carry it in stock write us, mentioning his name, for catalogue.

- Bunnell & Co., J. H., New York City.
- Central Radio Company Inc., Kansas City, Mo.
- Continental Radio and Electric Corp., New York.
- Detroit Electric Co., Detroit, Mich.
- Doubleday-Hill Electric Co., Pittsburgh, Pa.
- Electrical Specialty Co., Columbus, Ohio.
- Holt Electric Utilities Co., Jacksonville, Fla.
- Hurlburt Still Electrical Co., Houston, Texas.

- Kelly and Phillips, Brooklyn, N. Y.
- Klaus Radio Company, Eureka, Ill.
- Manhattan Electrical Supply Co., New York, Chicago, St. Louis.
- Leo. J. Meyberg Co., San Francisco, Cal.
- Newman-Stern Co., Cleveland, Ohio.
- F. D. Pitts Co., Inc., Boston, Mass.
- Philadelphia School of Wireless Telegraphy, Philadelphia, Pa.
- Western Radio Electric Co., Los Angeles, Cal.

A. H. GREBE & CO., Inc., 72 Van Wyck Blvd., Richmond Hill, N. Y.

Announcement

In addition to furnishing the highest possible grade of instruction to wireless men in preparation for their First Grade Commercial License examinations, the MASSACHUSETTS RADIO and TELEGRAPH SCHOOL, INC., wishes to announce their entry into the field of

C-W SALES and SERVICE

We handle a complete line of C-W transmitting and receiving units and accessories.

Let us estimate on and assist you with your C-W problems. Our 14 years' experience in amateur radio activities should be of some VALUE to you.

Summer Classes

Enroll now for our Summer Wireless Course to be given during July and August. High School students can get the proper start during these two months to enable them to finish their course in the regular Fall Classes or at home.

RATES:

Day Classes \$10.00 per month
Evening Classes . . \$ 5.00 per month

To Summer Students only.

Write, 'phone or call for particulars.

MASSACHUSETTS RADIO AND TELEGRAPH SCHOOL, Inc.

18 Boylston Street, Boston, Mass.

R. F. Trop, Treas.

Tel. Beach 7168

G. R. ENTWISTLE, Pres.

The Thirteenth Tap

(Continued from page 876)

SOS SOS DE KIF KIF—attacked by savages on— island—storage batteries going— boat destroyed—help quick—de James Duane—KIF?

"The ether at that moment was being racked by the broad wave of the naval station 50 miles distant. If KIF was almost indistinguishable to me, only five miles off, who else could have heard it thru the naval station's QRM? And the next nearest station was a ship, 40 miles away."

Here the narrator paused and sipped some water. Beads of perspiration dotted his forehead. Hansen, every nerve taut, sat rigid in his chair waiting for the climax of the gripping tale.

"I grasped the situation. The man who had abused, defrauded, and insulted me was in peril of his life. Sweet revenge!! The blood pounded thru my head; my hands shook.

"No station responded to the SOS! With my fones still on, I reached up and jammed the secondary of the O.T. down into the primary, at the same time pressing the generator starter button. As the whirr of the M.G. rose in tone, I heard, even weaker than before, 'SOS SOS—' With trembling fingers. I prest and screwed down the key. Five KW radiated into space, with a logarithmic decrement Lord only knows what! With the fierce interference my set would create, there was not the slightest possibility of KIF being heard.

"Vengeance!! Murdered by natives, ordinarily docile, but for some queer reason inflamed against Duane.

"For an hour I listened to the hiss of the quenched gap. This seemed to be long enough for the Indians to do away with their victims, so I turned off the juice and listened in.

"The minute my spark had ceased, the air was flooded with QRT's and BK's, but not a signal from KIF. I looked at the quenched gap. It showed a dull red. This brot a thot of radio inspectors to me, but I dismissed it for the night.

"One thing I was certain of: I would be fined and lose my position, as my tone was peculiar, and every station knew that it was I who had interrupted traffic. But what matter? My revenge was complete.

"The next morning when we docked, the government officials took me in hand. I lost my license, and was fined the limit for wilful disturbance. I returned, third class on the first boat I could get, and with what money I had left, managed to reach California. During the trip I picked up a Seattle newspaper. A little notice attracted my attention. It read: 'James Duane, well known at Sitka, was killed by natives, along with three companions, on — Island. A radio set was on the island, and it is puzzling to know why it did not summon help.'

"As you can imagine, I expected to be highly gratified at such information. However, the looked-for pleasure did not come to me. A nervous reaction was setting in.

"When I arrived in California I secured a job, thanks to my radio experience, in a large, high-voltage laboratory near San Francisco. I was assigned to the 700,000-volt transformer experimental staff. This work was extremely interesting, tho hazardous at times.

"Often as I lay in bed I would think of that insane Alaskan night. Three innocent men sent to their death by my hands!! And another because of a personal insult which assumed less real importance every time I reviewed it. I would frequently wake up in the middle of the night, eyes

100% FROM YOUR TUBES

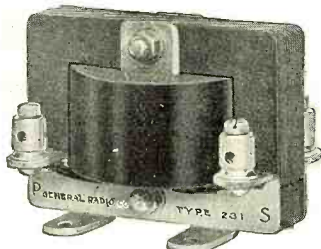

The new Radiotron Vacuum Tubes are accurately designed electrical instruments. To get the maximum results from them, they should be used with apparatus designed specifically to agree with their electrical characteristics. Our new Type 231A Amplifying Transformer is the result of careful engineering design to produce a transformer which will give the maximum amplification of signals using a UV201 tube. The Type 231M Modulation Transformer was designed to give the maximum modulation possible without distortion when used with a UV202 tube. Send for free Bulletin 907N on the operation of amplifying and modulation transformers and completely describing the new Type 231 instruments.

Price, EITHER TRANSFORMER, COMPLETELY MOUNTED, \$5.00

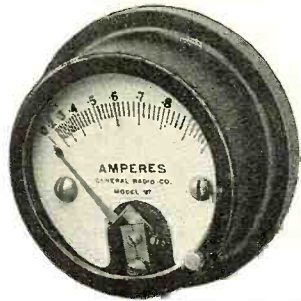

Radiation and Filament Ammeter

Results are not obtained by guessing. They come from the intelligent application of accurate information. If you desire to get the best results from your CW set, it is necessary to make measurements of the various currents. Our Type 127 Hot Wire Ammeters are particularly suited for this service. They are suitable also for measuring the radiation currents of spark stations, and for measuring filament currents, either AC or DC. Supplied in a variety of ranges and for front or board, as illustrated, or flush mounting. Described, and ranges listed in Bulletin 904N.

Price, \$7.75

CARRIED IN STOCK BY LEADING RADIO DEALERS
GENERAL RADIO COMPANY

Massachusetts Avenue and Windsor Street,

Cambridge, 39

Massachusetts

BURGESS "B" BATTERIES

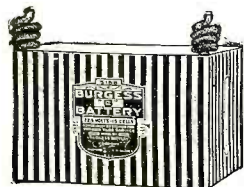

ARE THE NOISELESS KIND—
made with and without taps

Send for catalogue giving sizes and prices

BURGESS BATTERY COMPANY

Harris Trust Building

CHICAGO

—for experimental cw

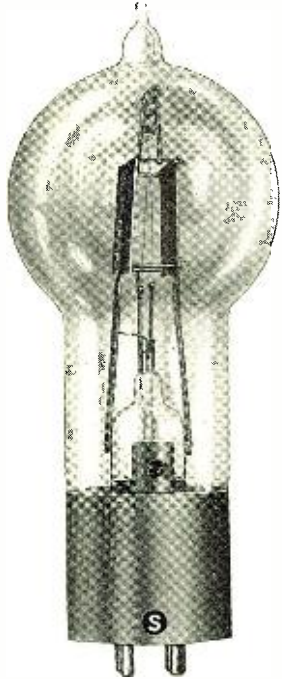

Price \$9.75 each. Order from your dealer, or write direct to either address in this ad.

NEW A-P RECTIFIER TUBE MAKES EXPENSIVE HIGH VOLTAGE D-C GENERATOR UNNECESSARY.

A wonder—this newest A-P tube—a Rectifier that can be used effectively with *any* transmitter tube of *any* voltage up to 750, and *without* a high voltage D-C generator. Step up your 110 V A-C lighting supply to 350, 500, or 750 volts, using a small transformer, and two of the new A-P tubes do everything else, rectifying both halves of the cycle so the plates of your transmitter tubes get all the high potential direct current necessary—*without the use of a high voltage D-C generator.*

The A-P Rectifier has a 75 milliampere carrying capacity, which is sufficient to operate five A-P Transmitting Tubes in parallel. For high power CW transmission, use additional *A-P Rectifier* Tubes in parallel.

A-P Rectifiers used in Type O A-C De Forest Radiophones, equipped with the SHAW standard condensite four-prong base, and licensed under SHAW patents. **Price \$9.75.** Order from your dealer, or direct from either address below.

Diagram of Connections Furnished Free With Each Tube

And for the best book on Radio, ask your dealer for "Elements of Radiotelegraphy," by Lieut. Ellery W. Stone, U. S. N., or order direct from—

ATLANTIC RADIO SUPPLIES CO.
8 KIRK PLACE, NEWARK, NEW JERSEY

PACIFIC RADIO SUPPLIES CO.
638 MISSION ST., SAN FRANCISCO, CAL.

Distributors for Moorhead Laboratories, Inc.,

THE NEW A-P Rectifier Tube

ANOTHER MAGECO TRIUMPH

TYPE R. V. O. VARIOMETER
for MOUNTING

Complete as illustrated

Price, **\$7.00**

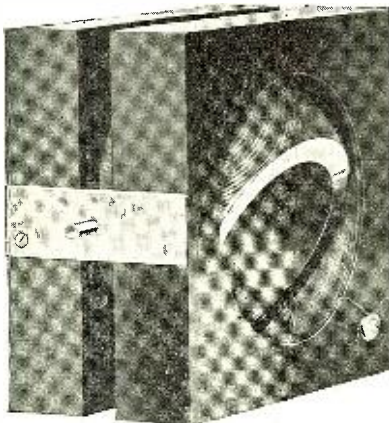

The latest addition to the MAGECO family is our TYPE R. V. O. Variometer adapted for table or panel mounting. Constructed of Hard Maple, nonshrinkable and with green silk wire. Bushings are of brass. Accuracy of assembly prohibits all wobbling.

TYPE R. V. O. VARIOMETER PARTS with Blue-print and Instructions, Complete **\$4.00**

TYPE V. C. O. VARI-COUPLER
for Table or Panel MOUNTING

Complete as illustrated

Price, **\$6.50**

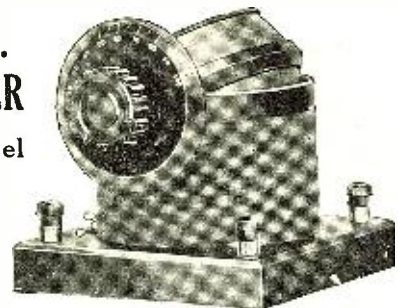

HERE is a true Variable Coupler for the Radio Man who desires an instrument to stand the acid tests of Radio work.

Primary consists of 42 turns of 6 turns and single turns each wound on Formica tubing. Brass bearings support the Hard Maple Rotor revolving with very close coupling. For panel mounting remove the base and mount.

Send us your panels and we will Engrave them for you at, per letter, **6¢**

DEALERS, HAVE YOU OUR PROPOSITION?

Send 10 cents for Catalog

THE MARSHALL-GERKEN CO. 26 Radio Bldg., Toledo, Ohio

CO-OPERATIVE RADIO PURCHASING

Members of this association participate in the profits which have accrued through their own and fellow amateurs' combined purchases. In addition to this dividend our service is unexcelled. You also can secure this service and share in

our profits. Order direct from this ad or send a stamp for full particulars. Remember "We take pride in our service." The items listed below are but a few of the items which are carried in stock.

- RADIOTRON TUBES**
 UV-200 Gas Content Detector \$5.00
 UV-201 Pilotron Amplifier 6.50
 UV-202 5 Watt Transmitter 8.00
 (We supply full directions with either detector or amplifier.)
- AMPLIFYING TRANSFORMERS**
 Clapp-Eastham type QO unmounted 4.00
 Clapp-Eastham type QO mounted 6.50
 Acme A2 with binding posts 5.00
 Acme core & coil assembled 7.00
 Acme A2 fully mounted 7.00
 U. V. 712 List Price 7.00
 Mfg. by Radio Corp. of America.
- CONDENSERS**
 Connecticut .001 encased \$6.50
 Connecticut .001 panel type 6.50
 Chelsea No. 1 encased 5.00
 Chelsea No. 2 encased 4.50
 Chelsea No. 3BD with dial for panel 4.75
 Chelsea No. 4BD with dial for panel 4.25
 Murdock No. 366 .001 encased 4.75
 Murdock No. 367 .0005 encased 4.50

- TELEPHONES**
 Brandes Superior with Navy band \$8.00
 Brandes Trans-Atlantic with Navy band 12.00
 Brandes Navy type with Navy band 14.00
 Western Electric type 1002A 15.00
 Murdock No. 55, 2000 ohms 4.50
 Murdock No. 55, 3000 ohms 5.50
- SHORT WAVE SET MATERIAL**
 Clapp-Eastham ZRY Variometer, without dial \$5.75
 Clapp-Eastham ZRY Variometer, with 3-inch dial 6.50
 Clapp-Eastham ZRC Variocoupler, with knob & dial 7.50
 Clapp-Eastham ZRC Variocoupler, with switch and points 9.00
 J. J. Nightingale Variometer 4.50
 J. J. Nightingale Variocoupler 5.00
 Murdock G or P Variometer No. 345 7.50
 Murdock Variocoupler No. 346 8.50

- AUDION CONTROLS**
 Clapp-Eastham ZRD detector panel \$12.00
 Acme Y-1 detector 10.00
 Adams Morsan No. 70 control 6.00

- C. W. TRANSFORMERS**
 Acme 200 watt mounted \$20.00
 Acme 50 watt mounted 15.00

- MODULATION TRANSFORMERS**
 Acme A-3 semi mounted \$5.00

- CHOKE COILS**
 150 M.A. Single coil \$4.00
 150 M.A. double coil 6.00
 500 M.A. single coil 6.00
 500 M.A. double coil 8.00

- FILAMENT HEATING TRANSFORMERS**
 75 watt mounted \$12.00
 150 watt mounted 16.00

MUTUAL PURCHASERS ASSOCIATION 2 STONE ST., NEW YORK CITY

June **EMPIRE RADIO** Bulletin



TYPE 150

Nickel Plated Switch Series Parallel Switch
 Contacts for above Switch, Each 5c

AUDIOTRONS (TWO FILAMENTS)

\$6.00

EMPIRE

85c



Attractive Discounts To Dealers

Empire Radio Equipment Co.

Manufacturers and Distributors of Radio Apparatus

71 West 125th Street

New York City



New! NEW! New!

Bunnell MULTIPLE RHEOSTAT 28 OHMS

"Bunnell Quality"

Sample by Mail, \$3.00

Get descriptive circular
 Send Stamp for Catalog 42 R.N.
 We Carry High Grade Radio Goods

J. H. BUNNELL & CO.

32 Park Place

New York

starting, breath heaving, from some terrible nightmare in which I was being forced down, down, into some fiery doom."

Again the man hesitated, perspiration standing out in great drops on his agonized brow. With a visible effort he continued: "At the laboratory we rigged up the necessary apparatus for some important high-potential characteristic tests—corona discharge and the like. The ultimate voltage was controlled by a 20-point rheostat near the immense oil transformer.

"One day when I was immersed in my work, which I did all the more energetically to forget my crime, I determined to try out that night a pet hook-up I had long thought of. Five o'clock came, and the chief gave me permission to stay. Upon leaving he said: 'If you value your life, don't turn the rheostat beyond the thirteenth tap—the voltage will break down anything—remember, the thirteenth tap is death!!'

"With this warning ringing in my ears he left me to myself. By the time all was dark everything was in readiness for operation. I snapped off the lights, and kept within the danger fence to more closely observe the brush effects. I moved the large control handle to the sixth point. A weird phosphorescent glow played over the apparatus. Needle-like violet points flickered from the sharp bends in the connecting wires. The depths of the room were pitch-dark.

"Something in this uncanny situation brot back that of a dismal Alaskan island. I recalled myself to the work in hand, but KJF—James Duane—stood in my mind, seared with fire, as I advanced the rheostat to the tenth tap. The discharge intensified, and the resonance indicator moved ten more units.

"By degrees, away at the back of the room, a white, draped figure impressed itself upon my brain! Gradually its distinctiveness increased. Involuntarily my arm and other muscles stiffened, spasm-like. Suddenly some irresistible force overcame my will. My hand pushed the rheostat from the tenth to the eleventh tap, tho my brain struggled against the supernatural power.

"Once more, before my staring eyes my own hand obeyed the force. The twelfth tap!!

"The discharge was now blue, green, violet, scintillating in its cracklings. Long tongues of miniature lightning leapt out on all sides. I knew that the condensers would hold, and the spark would jump to me, the nearest conductive object.

"The spectral image in the background commenced to fade, then reappeared. The words 'James Duane' struggled to my throat, but were strangled. Three other figures appeared to my whizzing brain from out of blank space.

"Something, a mysterious force, came over me. The throbbing blood vessels in my body seemed to be on the point of bursting. The rheostat moved slowly, slowly.

"The THIRTEENTH TAP!!! Death!!!

"The contact was made and livid, searching flames sprang forth like demons from the overcharged high-tension wires!!

"Blinding flashes flew before me—

"I returned to consciousness 30 hours later. It was then I learned that I had miraculously escaped death by pulling back the control knob as I fell. For six months I lay in the hospital, terribly burned.

"My position was not held open for me. Since then I have been an outcast and a pauper."

The man pointed to the two awful blemishes on his face. "These are the only ones you see—the price I paid!!!"

A welcome addition to your library! Send \$2.00 today, plus postage for 7 lbs., and your copy of bound volume No. 1 of Radio Amateur News will come forward by return mail. Experimenter Publishing Company, Inc. 236a Fulton Street, New York City

Pacent Universal Plug Price \$2.00



THE ONLY PLUG FOR RADIO—NO CONNECTIONS TO SOLDER—CONNECTED IN A JIFFY—ESSENTIAL FOR MODERN RADIO—FOR TRANSMISSION AND RECEPTION—APPROVED BY THE NAVY DEPARTMENT—USED BY COMMERCIAL COMPANIES—ENDORSED BY FOREMOST AMATEURS—OBTAINABLE FROM YOUR DEALER

DUBILIER UNIVERSAL CONDENSER

SUPPLIED IN MOST USED CAPACITIES FROM .01 TO .00025—FOR TRANSMISSION AND RECEPTION—ESPECIALLY DESIGNED FOR C. W.—WILL CARRY ONE AMPERE AT 1000 VOLTS—RUGGEDLY CONSTRUCTED—HAS CONSTANT CAPACITY—APPROVED BY OUR GOVERNMENT—EASILY MOUNTED ANYWHERE—OF UNIVERSAL RADIO USE

Price \$2.00

We shall be pleased to send you bulletins describing the above and our other products on receipt of five cents in stamps.

AMATEURS AND EXPERIMENTERS—Get in touch with your dealer. DEALERS—Write immediately for our liberal discounts.



Sole Distributors for
Wicony's Complete Line of "Eventual" Apparatus.
Duo-Lateral Coils
Standard VT Batteries
Pacent Plugs
Dubilier Condensers
Sullivan Apparatus
Seibt Condensers
Special Distributors for Brandes Phones

PACENT ELECTRIC COMPANY, Inc.

150 NASSAU STREET

LOUIS GERARD PACENT, President
Telephone Beekman 5810

NEW YORK CITY

Condenser
No.
3

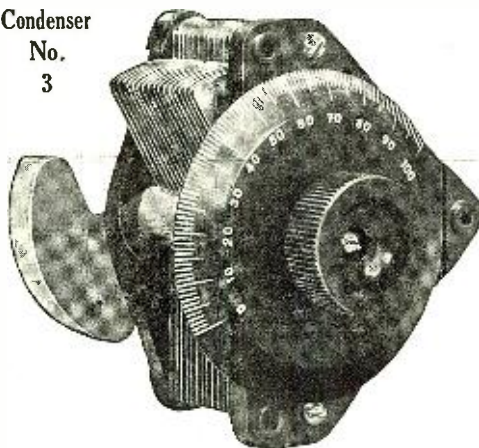

CHELSEA Variable Condensers (Die-Cast Type)

| | |
|---|--------|
| No. 1.—.0011 m. f. mounted..... | \$5.00 |
| No. 2.—.0006 m. f. mounted..... | 4.50 |
| No. 3.—.0011 m. f. unmounted..... | 4.75 |
| No. 3.—.0011 m. f. unmounted, without dial..... | 4.35 |
| No. 4.—.0006 m. f. unmounted..... | 4.25 |
| No. 4.—.0006 m. f. unmounted, without dial..... | 3.85 |

Top, bottom and knob are genuine bakelite, shaft of steel running in bronze bearings, adjustable tension on movable plates, large bakelite dial reading in hundredths, high capacity, amply separated and accurately spaced plates.

Unmounted types will fit any panel and are equipped with counterweight.

Purchase from your dealer; if he does not carry it, send to us.

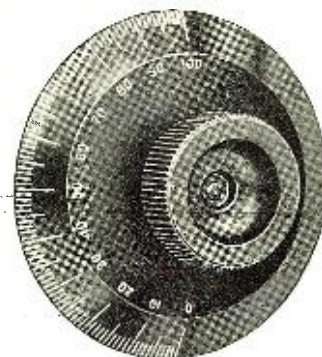

"CHELSEA" BAKELITE DIAL NO. 41.

The Chelsea dials are made of genuine bakelite, beautifully finished, and bear a 100 division semi-circular scale.

The dial is 3/4 inches in diameter, 1/4 inch thick, with a long, sloping, easily read marking. Chelsea bakelite dials run true and will not warp.

The complete dial and knob is made to fit either 3/16, 1/4 or 5/16 inch shaft. Specify size when ordering, otherwise the 1/4 inch hole will be furnished.

Chelsea dials are beautiful in appearance, low in price, accurate and durable in service, unexcelled by any, at any price.

Dial and knob complete..... 1.00
Purchase from your dealer.

VARIABLE GRID LEAK

Permits the selection of the proper leak resistance regardless of the type of tube, or its use as detector, amplifier or oscillator. Ten steps give a range from 1/2 to 5 megohms. Genuine bakelite base and knob.

All our apparatus embodies the highest degree of mechanical construction, electrical efficiency, and good appearance.

Purchase Chelsea Apparatus from your dealer

NEW MARCH BULLETIN SENT UPON REQUEST



PRICE \$3.00

CHELSEA RADIO CO., 17 Fifth Street, Chelsea, Mass.

Manufacturers of Radio Apparatus and Moulders of Bakelite

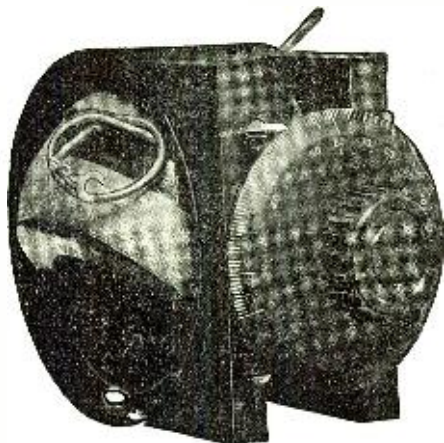

The Variometer

The now famous Z. R. V. Variometer has met with a tremendous sale to *thousands* of discriminating purchasers who know the quality of Clapp-Eastham products.
 Complete with knob and dial . . . \$6.50
 Complete without knob & dial 5-75
 Variocoupler to match, with knob and dial 7-50

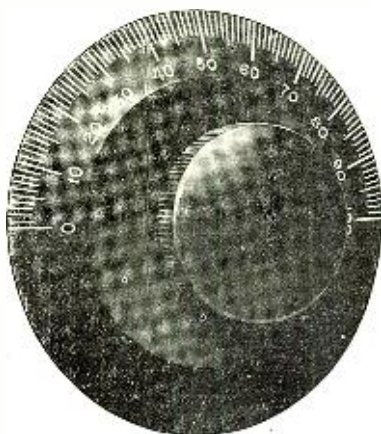

The Dial

This 3" knob and dial is our own product, heavy brass dial, black oxidized finish, composition knob 1 3/8" diameter. Supplied for 1/8" shaft only. This dial can not chip or warp and *will run true*. Its beauty is in keeping with the best products of the instrument maker.
 Price, Dial & Knob F800H complete \$.75
 No. 19 instrument switch to match above 1.00

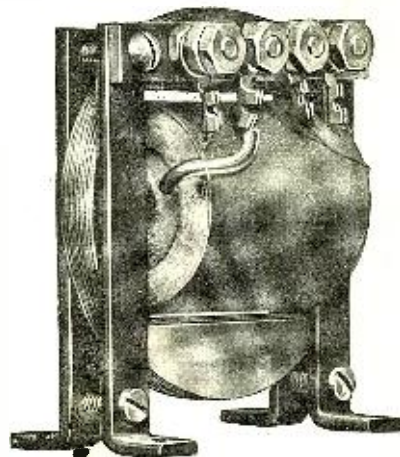

The Amplifying Coil

Our amplifying coils are distinctly different in design and their remarkable power of amplification with the tubes at present on the market can be testified to by several thousand satisfied users. You need not experiment with untried products unless you want to.
 Type Q. O. Amplifying coil as illustrated \$4.00

Complete Catalogs Sent for 6c Stamps
 Patronize your local dealer: If he won't supply our material your order will receive immediate factory attention.

CLAPP-EASTHAM COMPANY

120 Main Street

Cambridge, Massachusetts

HEADQUARTERS FOR RADIOTRON TUBES. ALL TYPES IN STOCK

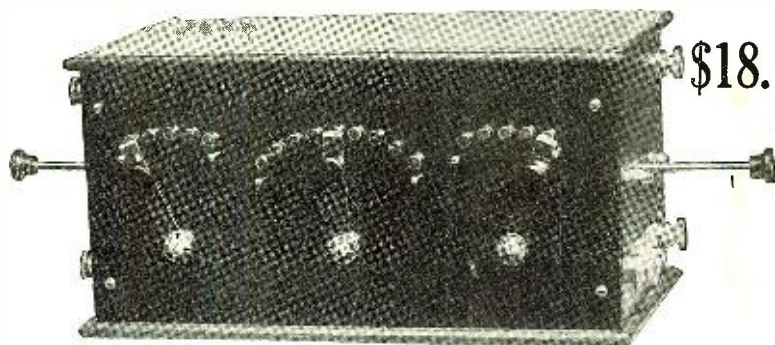

\$18. Enjoy the Summer Months Listen to the Radio Phone Stations

By getting our Short Wave Regenerative Tuner enclosed in a quartered oak cabinet 11 1/4 x 5 3/4 x 5 3/4 inches with hard rubber panel for only \$18.00 you can hear louder signals, cut out considerable interference and improve the efficiency of your set for amateur, commercial and radio phone work.

Albert L. Vanderbilt, Newark, N. Y., says: "I am getting wonderful results from amateur, 600 meter and radio phone stations with your short wave regenerative tuner and one bulb."

Mr. R. B. Moulden, Tuscola, Ill., writes: "I got KDKA very good last night with your short wave regenerative tuner and one bulb."

Tune In Stations Over a Wider Range Get the European Stations Q S A

Because of their unique construction, balanced circuits, variable inductances and variable couplings our Short and Long Wave Regenerative Tuners deliver the goods. They reduce body capacity and other interference to a minimum. They possess many advantages over other tuners.

Price in quartered oak cabinet (Long Wave Tuner) \$34.50
 Price with hard rubber panel, (Long Wave Tuner) 40.00

Mr. Dennis B. Jackson, Matewan, W. Va., says: "Your Long Wave Tuner is a beauty. Although I am in a valley between two high mountains, I am getting good results with one bulb."

Mr. T. W. Jackson, Jamestown College, Jamestown, N. D., writes: "A few days ago I purchased one of your 2,000 to 20,000 meter tuners. It is a daisy. I hear European stations QSA especially POZ. I would consider it worth the money if I got no more."

Send a 2-cent stamp for bulletins

COLBY'S TELEGRAPH SCHOOL, Auburn, N. Y.

\$34.50

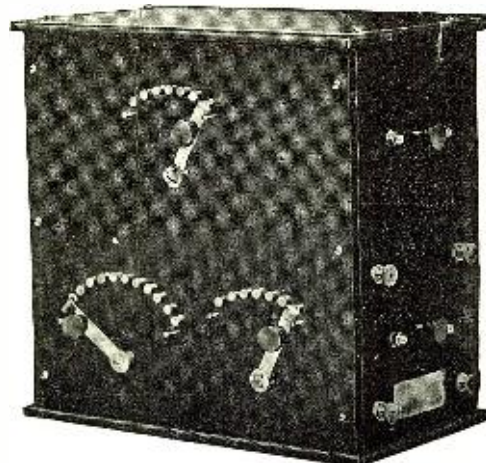

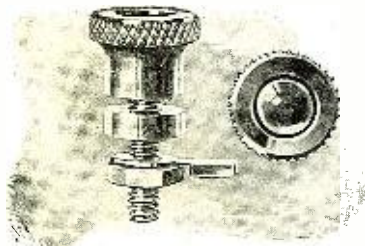

FADA BINDING POST

This post is an original FADA design and is made of brass with a non-removable knurled top 1/2" in diameter. The 6-32 screw post has no screw-driver slot in the top. Very highly hand buffed, nickel plated and polished. No frills, but a sturdy most beautiful appearing binding post that costs only \$0.16 each or \$1.75 per dozen.

AMPLIFYING TRANSFORMERS

Federal unmounted, 1 lb. \$6.00
Intervalve No. 712, the new transformer of the Radio Corporation. The very best one made for Radiotron tubes, 1 lb. 7.00

GENUINE BAKELITE XX

Sold cut right to your particular size. Prices are per square inch postpaid. 1/8" thick, \$0.02; 3/16" thick, \$0.03; 1/4" thick, \$0.04.

CONDENSERS (Fixed Mica Type)

FADA quality—made of Bakelite XX tested mica and copper foil. 2 1/2" x 3/4" x 3/8"
No. 113-A 0.00025 Mfd. \$0.88
No. 114-A 0.0005 Mfd. 0.85
No. 115-A 0.001 Mfd. 1.00
No. 116-A 0.002 Mfd. 1.50
No. 117-A C. W. Phone Work 0.0005 1.00
No. 118-A C. W. Phone Work 0.001 1.50
C. W. Condensers tested at 1000v, 100 watts, overall dimensions 3" x 1" x 3/4"

CONDENSERS (Variable)

No. 1 Chelsea .001 Mfd. mounted \$5.00
No. 2 Chelsea .0006 Mfd. mounted 4.50
No. 3 Chelsea .001 Mfd. with dial 4.75
No. 3 Chelsea .001 Mfd. without dial 4.35
No. 4 Chelsea .0006 Mfd. with dial 4.25
No. 4 Chelsea .0006 Mfd. without dial 3.85
No. 41 Chelsea Dial and Knob, 3/4 inches in dia. for 3/16" or 1/4" shaft. 1.00
Shipping weight 1 pound per condenser

CRYSTAL DETECTORS

FADA No. 101-A \$3.00
FADA Mounted Galena Crystals, each. \$5.00

INDUCTANCE TUBING

Consensite-Celeron tubing with 1/8th inch wall cut to size. Prices are per inch postpaid. Dimensions are outside diameters.
3 inch \$0.25 3 1/2 inch \$0.30
4 inch 0.34 4 1/2 inch 0.36
5 inch 0.40

LITZENDRAHT WIRE

No. 10-38.....per 100 feet \$0.60
No. 20-38.....per 100 feet 0.90
No. 3-16-38.....per 100 feet 2.00

TELEPHONE HEADSETS

The new Murdock with Navy type headband can not be beaten at the price.
No. 56 2000 ohm..... \$5.00
No. 56 3000 ohm..... 6.00
Brandes "Superior" 2000 ohms..... 8.00
Brandes "Trans-Atlantic" 2000 ohms..... 12.00
Brandes "Navy Type" 3200 ohms..... 14.00
Baldwins Type C Navy Standard..... 16.50
Baldwins Super-Sensitive Type E..... 20.00
Shipping Weight each set 1 pound.

VACUUM TUBES

Radiotron UV-200 Detector..... \$5.00
Radiotron UV-201 Amplifier..... 6.50
Radiotron UV-202 5 watt Power Tube..... 8.00
No. 119-A FADA Tube Socket..... 1.75
Shipping weight 1 pound each item.

DETECTOR & AMPLIFIER PANELS

Four FADA instruments that are better than you ever hoped to use. Full automatic control of all filament circuits. Postpaid.
Detector Control.....\$17.50
Detector & 1 stage Amplifier..... 45.00
Detector & 2 stage Amplifier..... 65.00
Two stage Amplifier..... 50.00

All orders for apparatus not listed as postpaid must be accompanied by postage charges.

OUR SERVICE TO EACH OTHER WILL IMPROVE ON ACQUAINTANCE. ORDER YOUR SUPPLIES FROM FADA

Frank A. D. Andrea
1882A Jerome Ave. New York

Vacation Time Radio

(Continued from page 854)

paratively small and the results to be obtained are indeed great. It needs but something of this character to stimulate a summer time interest among the amateur radio bugs, which may compare quite well with the interest previously shown during the winter.

THE SUMMER-TIME ANTENNA

With most vacationists, the erection of the antenna has ever and always been looked upon with some misgiving. It has always meant the erection of temporary masts, or the locating of sufficiently strong chimneys from which to suspend the outdoor components of the set, and it has not infrequently resulted in very serious arguments with neighbors who had the "Lightning Bee" in their bonnets and who felt sure that radio stations were good for nothing other than tempting demon lightning to play havoc with their domiciles. In large cities, where the rapid growth in the number of antennae has been very pronounced, this bugaboo is rapidly dying; he is no dead. I say this with a heart filled with sorrow, because he has shown me that he is still alive, thru the person of my next-door neighbor, who very unceremoniously chopped down one of my masts, without warning, for the very important reason that one of my antenna wires crossed the smallest fraction of a corner of his property, but that is another story. However, in the country the bugaboo is not as dead as he is in the city and many unpleasant words have been spoken in an attempt to melt the hearts of those who have not seen the light and "will not listen to reason."

"There is always a way, where there is a will," said Themistocles, or somebody like that so a method has been tried which has proven entirely satisfactory. In this, I feel sure, you will find interest and in order to be certain of holding your attention to the very end, will mention at the beginning, that signals received by the method to be described, using naught but a detector, are at least as strong as those which are heard with the ordinary method when a single stage of amplification is employed.

IN BY-GONE DAYS

One day Jamaica, L. I., the town where my boyhood was spent, held a celebration for the opening of a subway or something and there were polo matches and wild west shows and hot dogs and lemonade and ticklers and confetti, but most of all there was a kite-flying contest. Off on a high hill, behind the town, they held it, and the winner of one of the events was a man named Poulsen, who lived in Jamaica. From that time on my dad was perpetually dunned for the wherewithall for the purchase of kites, mattress twine and reels and picture wire and percaline. Before the glamor of the hobby had worn off our cellar was bedecked with all manner of kites and kite-equipment.

Then in walked radio. The kites were abandoned and all the neighbors were called in to help in the erection of a pole in the back yard. At that time radio was not such a general hobby for youths as it is today, and my station came to be looked upon with awe by the folk thereabout. It was frequently out of order and the services of one more experienced in the art than myself always had to be sought. In those days it was a very rare thing to hear signals all the way from MCC, the old Marconi station at Cape Cod, Mass.

In Mr. Gernsback's *Modern Electrics*, which circulated about that time and which dealt more or less with radio as it was

10c CHARGES YOUR BATTERY AT HOME WITH AN F-F BATTERY BOOSTER

and your station will never be closed because of a discharged battery. Is it not gratifying to feel that your filament battery will always be ready when you want it and that you will never have to give up in disgust when working a distant station?

F-F Battery Boosters are automatic and operate unattended. Screw plug in lamp socket, snap clips on battery terminals and see the gravity come up.

The ammeter shows you just the amount of current flowing. The full wave of current is rectified thru adjustable carbon electrodes which maintain a constant efficiency and last for thousands of hours. Everything complete in one compact, self-contained unit.

The F-F Battery Booster is a Magnetic Rectifier for 105-125 Volt 60 Cycle Alternating Current.

Bantam Type 6 Charges 6 Volt Battery at 6 amperes. \$15
Type 16 charges 6 Volt Battery at 8 amperes. \$24
Type 166 charges 6 Volt Battery at 12 amperes. \$32
Shipping Weights 10, 12 and 15 lbs.

Also Boosters for 12 Volt Batteries at same prices. Order from your dealer or Send Check for prompt Express Shipment. If via Parcel Post have remittance include Postage and Insurance Charges. Will also ship C.O.D. Also F-F Battery Boosters for charging batteries from Farm Lighting Plants, Direct Current Circuits and Direct Current Generators.

For GROUP CHARGING use the Full Wave. Automatic F-F ROTARY RECTIFIER of 100 Volt, 36 cell capacity. Order now or write today for Free Descriptive Bulletin No. 32 or ROTARY Bulletin No. 32A

THE FRANCE MFG. CO., Office & Works: Cleveland, Ohio

Can. Rep.: Battery Serv. & Sales Co., Hamilton, Ont.

Reynolds Radio Specialty Company

The Largest Exclusive Wireless Supply Store in this section of the Country.

We carry a large stock of the following radio supplies and can make immediate delivery.

- AUDION BULBS
- SOCKETS
- RHEOSTATS
- PHONES
- CONDENSERS
- TUNING COILS
- COUPLERS & VARIO
- COUPLERS
- LIGHTNING GROUND SWITCHES
- DEFOREST COILS
- COTO COILS
- MOTOR GENERATOR
- KEYS
- METERS
- CRYSTAL DETECTORS MOUNTED & UNMOUNTED CRYSTALS
- DIALS
- BUZZERS
- AMPLIFYING TRANSFORMERS
- PLUGS & JACKS
- SWITCHES, POINTS & BINDING POSTS
- DE FOREST UNIT PANELS
- PRACTICE SETS
- WIRELESS BOOKS & MAGAZINES

Complete Stock of De Forest, Murdock, John Firth and Clapp Eastham Supplies.

Send 2 cent stamp for bulletins

REYNOLDS RADIO SPECIALTY CO.
613 19th Street Denver, Colorado

RADIO TELEPHONE & TELEGRAPH APPARATUS OF MERIT

- K20A Rotary Enclosed Gap.....\$25.00
- K20B Same without motor..... 20.00
- K1 Open Rotary Gap..... 16.00
- UV200 Radiotron Detectors..... 5.00
- UV201 Radiotron Amplifiers..... 6.50
- UV202 5-Watt Transmitter..... 8.00

Send 4c for our 55-page Catalog. Full of illustrations, information and prices that will prove attractive

KARLOWA RADIO CO.
611 Best Bldg., Rock Island, Ill.

You can be quickly cured, if you

STAMMER

Send 10 cents for 288-page book on Stammering and Stuttering, "Its Cause and Cure." It tells how I cured myself after stammering 20 yrs. B. N. Bogue, 871 Bogue Bldg., 1147 N. 111. St., Indianapolis.

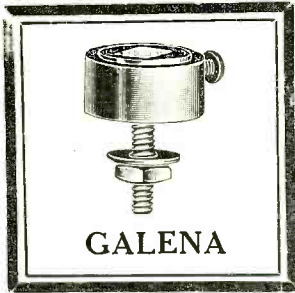

GALENA

TESTED RADIO CRYSTALS

Mounted in Fusible Metal Buttons and inserted in Nickle Plated, Rotary, Detector Cups. Ready for use, with Screw Washers and Nuts

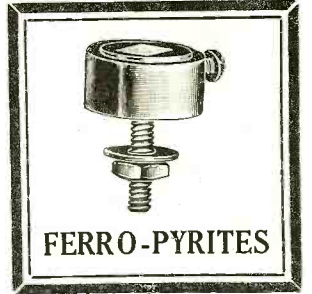

FERRO-PYRITES

- NAVY-YARD TESTED GALENA CRYSTAL 75c
- TESTED ULTRA-SENSITIVE FERRO-PYRITES 75c
- TESTED HIGHGRADE ZINCITE CRYSTAL 75c
- TESTED FUSED SILICON PIECE 75c

Each Mounted Crystal, with its Detector Cup as described above is packed in individual wooden box, stamped with date of testing.

MONEY BACK IF NOT SATISFIED — All Shipments Prepaid

THE SYDNEY SPECIALTY CO., 43 Murray St., NEW YORK

If Your Dealer Cannot Supply You, Send Your Orders Today to:

THE SYDNEY SPECIALTY CO., 43 Murray St., New York
ENCLOSED FIND HEREWITH \$..... FOR WHICH SEND ME

..... GALENA ZINCITE
..... FERRO-PYRITES SILICON

NAME
ADDRESS
TOWN STATE

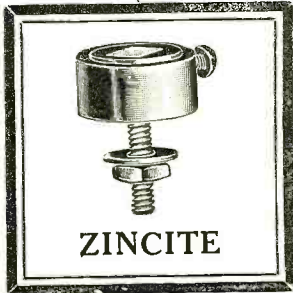

ZINCITE

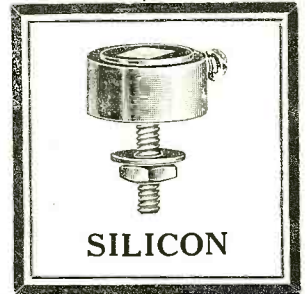

SILICON



STOP! LOOK! and ACT!

FREE! A Plotron V.T. Amplifier, U.V. 201, \$6.50, or an A.P. Navy Type V.T. Amplifier, \$7.00, will be given FREE with each Radio Magnavox purchased from us, not later than June 30th.

THE RADIO MAGNAVOX

The latest development of the Magnavox Company

THE RADIO MAGNAVOX when used with a suitable amplifier will give forth signals of far greater volume than any other receiver.

THE RADIO MAGNAVOX will allow you to have your friends listen to all incoming signals without the necessity for additional apparatus.

THE RADIO MAGNAVOX will reproduce radiophone speech, or music to such a degree that it may be used for dancing if sufficient amplification is available.

THE RADIO MAGNAVOX does away with a continuous watch, allowing the operator to hear what is going on at his station while in another part of the house.

THE RADIO MAGNAVOX is manufactured under the same patents and on the same electrodynamic principle as the MAGNAVOX Radio Telemegafone.

THE RADIO MAGNAVOX will reproduce signals with the same volume as the Radio Telemegafone.

THE RADIO MAGNAVOX can be operated on 2, 3, or 4 dry cells with wonderful results. A six volt storage battery with rheostat is recommended for continuous operation.

QST
WDNT U LIKE TO HR SIGS
QSA
ALL OVER YR HOUSE?
The Price is within reach of all
You need it in your station. **\$45.00**

THE KEHLER RADIO LABORATORIES
Dept. R, ABILENE, KANSAS



Vertical Panel-style mounting, without cabinet. Two legs hold each panel upright. Any number of panels may be joined and mounted this way.

The Newest de Forrest Radio Apparatus Now in Stock

FOR IMMEDIATE DELIVERY

We also carry a full line of all other standard radio and telephone equipment and parts. Our wireless specialists will gladly give you any advice or assistance you need. When in Philadelphia come in to our showrooms and have us demonstrate the newest inventions. No obligation to buy. Our Radio Department has grown to its present size through the same fair and helpful service, for which our general electrical department has been known since 1852.

Sole Distributors in Philadelphia for de Forrest Apparatus

CENTRAL ELECTRIC AND LOCK COMPANY
EST. 1852

1309 ARCH ST., PHILADELPHIA, PA.
Radio and Electrical Supplies

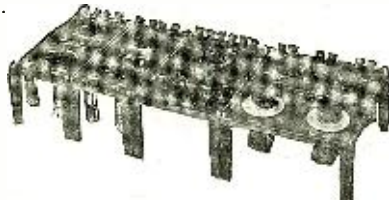

Horizontal Table-style mounting. Legs attached to corners of each panel. Any number of panels can be mounted in this style. Ample space under panels for batteries. A very convenient and inexpensive method of mounting.



TRESCO TEN \$ TUNERS

When you think of tuners say TRESCO.
One for every need and wave length.
CIRCULAR FREE.

This is the tuner.

- AS—Arlington tuner—600M to 5000M.
 - BS—Long Wave tuner—5000M to 25000M.
 - CS—Amateur tuner—200M to 600M.
 - Coils for either.....\$6.00 and P. P.
 - DS—Short Wave tuner.....\$6.00 and P. P.
- All three tuners, AS, BS, CS, same general shape except that the BS tuner has no tickler coil.

Never Silent.
Used During the Summer Static Season

I received one of your NAA tuners and find them very good. Using a forty-foot aerial. NAA comes in like a ton of bricks. I can get NAA on a bed spring Arcs come in good, too. Boys that come to see my set say what good is that little box, but when they hear it working they take their hats off.

JOHN LEHTINEN,
1064 River St., Fitchburg, Mass.

10c for Regular Catalog

TRESCO — DAVENPORT — IOWA

Quality Radio Equipment

RADIO MAGNAVOX TYPE R-3

Latest development in sound amplifiers; constructed on a patent protected electro-dynamic principle. Emits same volume of sound as higher priced Magnavox Telemegafone.

\$45.00

RADIOTRON VACUUM TUBES

Recognized as the amateur's and experimenter's standard for Radio detection, amplification and power work.

- | | |
|---|--|
| Radiotron U. V. 200 detector.....\$5.00 | Radiotron U. V. 203 power tube, 50 watt...\$30.00 |
| Radiotron U. V. 201 amplifier.....6.50 | Special sockets for U. V. 203, now in stock, each.....5.00 |
| Radiotron U. V. 202 power tube, 5 watt...8.00 | (Postage extra on all prices.) |

RADIO SUPPLIES FOR CAMPERS

Receive N. A. A. Time, U. S. Weather Reports, Baseball Scores, Press News, Stock Reports, etc., while in camp by using the new GREBE TYPE CR-5 REGENERATIVE RECEIVER, 150-3000 Meter wave length range. In operation the last word in simplicity.

\$80.00

Dealer's Special Proposition—Mail orders promptly filled

DOUBLEDAY-HILL ELECTRIC CO.

715 Twelfth St., N. W., Washington, D. C. Radio Dept.—Desk B 719-21 Liberty Ave., Pittsburgh, Pa.

then known, stories began to appear of spectacular feats in reception, which included the use of a leader-pipe for an antenna, and the like. So, one day, in keeping up with the age of experimentation, the long-forgotten kites were summoned from the cellar and the mattress twine was substituted by a roll of single cotton covered wire. The kite was flown and the signals which followed were exceptional. The kite was left flying until late at night and before it had been hauled down, old MCC had been heard by all the formerly incredulous neighbors, altho none of them knew what was being transmitted. The increase in the signal intensity over the ordinary antenna was very marked.

A few years afterward, two very good friends of mine spent their vacations in the upper part of New York State and carried portable sets with them, which they used in conjunction with antennae suspended from kites. One had a station on shore and the other put his in a canoe and let the kite pull him out into the lake. They communicated back and forth, much to the astonishment and amusement of the other guests, as well as to their own satisfaction and pleasure. In those days a galena detector was about the best available and therefore the results obtained in the more recent tests, owing to the use of regenerative receivers have proven to be a revelation.

That is the form of antenna, which is very easy to get into the air and which produces results beyond the most optimistic expectations. No need for masts, wrangling with the neighbors or anything of the sort and just about the best of working with little or no trouble.

SOME RECENT TESTS

Two portable sets, such as here shown were recently used with kite antennae and the results were in every way satisfactory. One station was rigged up on shore and the other in a canoe. In the case of the shore station, a kite was flown from the dock at the Bayside Yacht Club and was maintained at a height of approximately three hundred feet. The wire kite string was brot to a small strip of bakelite which was used as an insulator and from it to the terminal of the portable set.

In the canoe, arrangements were made whereby the occupant who acted as operator sat in the bow, facing the stern and having the set strapped to the seat before him. The kite antenna, in this instance, was raised on the dock and then the end of the string (wire) was fastened to insulator which in turn were fastened to the struts of the canoe. This method of securing the antenna served to prevent the occupants from receiving any jolts from the transmitter. The ground, in both cases was provided by simply attaching a piece of wire to a brass rod and throwing it into the water.

By having both antennae of approximately the same length the communicating distance of the naturally limited power of the transmitters was considerably augmented.

THE KITE

It may be said, from observations made by the writer and those with whom he has conferred on this subject, that there are but two types of kites suitable for use in connection with radio work, where the best results are desired, giving the least bother: they are the "Eddy" and the "Aeroplane" or combination kite. The latter is suitable for a strong wind and is very steady in its flight, which is an important factor when C.W. is being received, due to the change in capacity caused by the raising and lowering of the wire to and from the ground. These kites are harder to make than the former ones mentioned, and will not fly so readily in a light breeze; therefore, for all around working it has been found that a 5-foot "Eddy" kite using an S. C. C. copper wire 20 B. & S. is quite superior in every respect.

PARAGON

MEANS

“A PERFECT MODEL OF EXCELLENCE”

RHEOSTATS
RECEIVERS
V. T. CONTROLS

CONDENSERS
VARIOMETERS
DIALS

DETECTORS
KNOBS
SOCKETS

SWITCHES
AND OTHER
SPECIALTIES

Manufactured by

ADAMS-MORGAN CO.

No. 70 Paragon V. T. Control

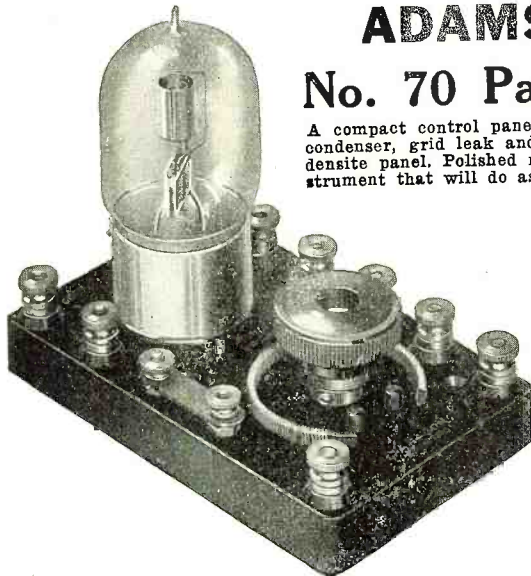

A compact control panel consisting of a standard socket, rheostat, grid condenser, grid leak and nine binding posts mounted on a moulded condensite panel. Polished nickel metal parts. A high-grade inexpensive instrument that will do as good work as the highest priced cabinet.

Price - - - \$6.00

No. 25 Paragon Rheostat



For either panel or table mounting. Moulded condensite base. Resistance six ohms. Smooth operation. Capacity 1½ amperes. The highest grade rheostat on the market.

Price - - - \$1.75

MOST ENTERPRISING DEALERS CARRY PARAGON PRODUCTS AS REGULAR STOCK.

Illustrated Bulletins will be mailed upon receipt of a two cent stamp. Send us your dealers name.

ADAMS-MORGAN CO.
UPPER MONTCLAIR NEW JERSEY

A Better Rheostat

for less money. Quality at a reasonable cost.

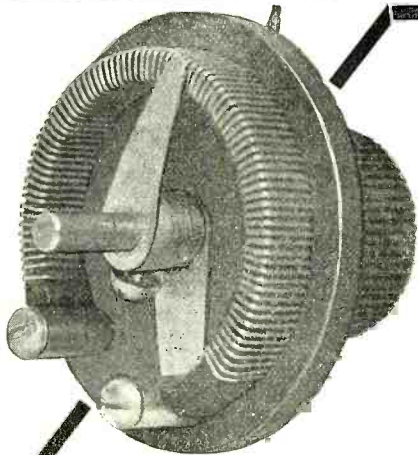

That's what you get when you buy FADA rheostats. And here's the quality—made with a base of Thermoplax (2½ in. dia.) into which is forced a strip of hard fibre wound with Advance resistance wire. Thermoplax is an asbestos-bakelite sheet that resists heat better than genuine bakelite XX. The resistor strip is exposed as much as possible and consequently allows the necessary heat radiation. Can be used for panel mounting on panels up to ½" in thickness. Furnished with a polished nickel-plated pointer and a classy bakelite knob as well as two nickel-plated machine screws and nuts for fastening to panel. The smoothest adjusting 6 ohm rheostat to safely carry 1½ amperes that can be produced.

\$1.25 EACH BY MAIL POSTPAID
OR AT YOUR DEALERS

MR. SUPPLY STORE MAN.—Here is the plain truth. FADA instruments and parts are fast gaining a universal reputation for selling quickly with no come-backs. They are not a collection of bargain store cut-price radio supplies. If you desire to sell the highest quality instruments at a price the buyer gladly pays, write me your plans. My discounts are most liberal—you profit accordingly.



Frank A. D. Andrea
1882 A Jerome Ave. New York City

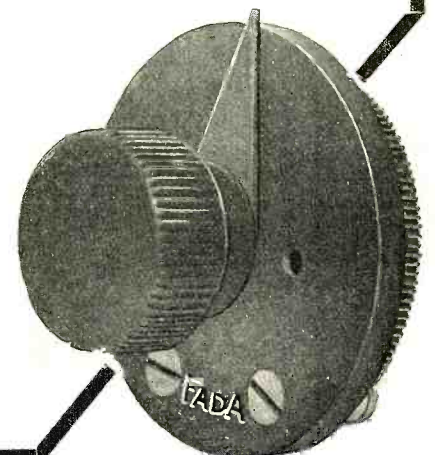



CORWIN DIALS

The distinction Corwin Dials impart to a radio station is only exceeded by their accuracy and ease of operation. Prices are as low as economical production and efficient marketing will permit, with due regard for quality. *Outside of that, there isn't any particular reason for specifying Corwin Dials.*

3" Dial, 75c—with knob, \$1.30
 3½" Dial, \$1.00—with knob, \$1.70

At all Radisco agencies, and other reliable dealers, or sent postpaid anywhere

A. H. CORWIN & CO.
 4 West Park St., Newark, N. J.

A Portable 200 to 900 Meter Regenerative Receiver

(Continued from page 861)

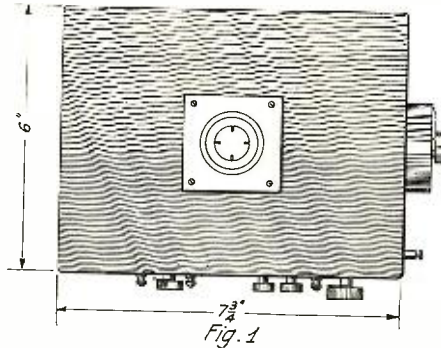

Top View of the Cabinet Showing its Size.

case it is a chestnut box with a natural varnish finish. A strip of wood is fastened to the inside of the box along the top, so that the panel may be secured to it by the wood screws. The arrangement should be followed out as in Fig. 2. If a slightly different arrangement be substituted be sure the parts will fit into the box and will not hit when being worked. The exact kinds of contacts, switches and knobs to use, I leave to the builder, as he knows best what he has laying around the workshop. In the next step, great care must be used, especially in duplicating the secondary and tickler windings.

Take a bakelite tube 3½" in diameter and 4½" long (good stiff cardboard will do also) and drill holes as follows along the length of the tube. (No. 1.) ¼" from top, (No. 2.) ¾" from top and one (No. 3.) diagonally opposite this one on the other side. (No. 4.) 4¼" from top. The upper and lower ones will serve to fasten the tube to the panel, and the other two will allow the rod on which the tickler is mounted to pass thru. Holes must be drilled in the panel to match these. See Fig. 2 and Fig. 3. The latter shows very plainly the method of assembly, the coil and also the tickler. Winding "B" (Fig. 3) is the primary and consists of about 60 turns, and is tapped off evenly to 15 points. This may be reduced to 10 points if so desired but 15 give better results. The winding starts 1¼" up from the bottom and goes down.

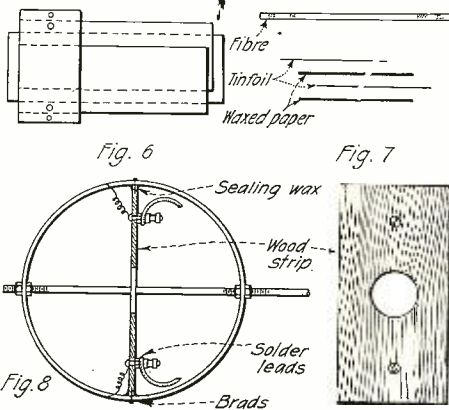

Constructional Details of the Condenser and Coupling of the Tickler Coil.

On the Job— QUALITY SERVICE PRICE

FOR THIS MONTH ONLY

| | |
|---|--------|
| 22½ Volt B-Battery small size..... | \$1.25 |
| 22½ Volt B-Battery large size..... | 2.40 |
| 45 Volt Variable B-Batteries..... | 4.00 |
| CONDENSERS | |
| Chelsea No. 1 Mounted..... | 5.00 |
| Chelsea No. 2 Mounted..... | 4.50 |
| Chelsea No. 3 Unmounted with dial .0012 Mfd..... | 4.75 |
| Chelsea No. 4 Unmounted with dial .0006 Mfd..... | 4.25 |
| VACUUM TUBES | |
| Genuine 2 Filament Audiotron..... | 6.00 |
| UV200 Radiotron Detector Tube..... | 5.00 |
| UV201 Radiotron Amplifier Tube..... | 6.50 |
| UV202 Radiotron 5 Watt Power Tube..... | 8.00 |
| Electron Relay Detector Tube..... | 6.00 |
| Moorhead Amplifier Tubes..... | 7.00 |
| TELEPHONES | |
| Western Electric Telephones..... | 14.75 |
| Baldwin Type C..... | 16.50 |
| Faldwin Type E..... | 20.00 |
| Murdock 2000 Ohm..... | 4.50 |
| Murdock 3000 Ohm..... | 5.50 |
| AMPLIFYING TRANSFORMERS | |
| No. 226 Federal Mounted..... | 7.50 |
| A-2 Acme Mounted..... | 7.00 |
| A-2 Acme Semi-mounted..... | 5.00 |
| A-2 Acme Unmounted..... | 4.50 |
| We have a limited supply of the new Radio Magnavox..... | |
| Radisco Variable Couplers..... | 7.50 |
| Murdock Variable Coupler..... | 8.50 |
| Murdock Moulded Variometer..... | 7.50 |
| Chelsea Moulded Dials..... | 1.00 |
| A. H. Corwin Dials 3"..... | 1.25 |

KELLY & PHILLIPS

Radisco Agency
 312 Flatbush Ave. BROOKLYN, N. Y.

IMMEDIATE DELIVERY

on any standard make of Radio Apparatus. Chicago and Middle West distributors for:

| | | |
|---------|---------------|---------------|
| Acme | Clapp-Eastham | Federal |
| Amrad | Radio Corp. | General Radio |
| Brandes | DeForest | Grebe |
| Burgess | John Firth | Murdock |
| Chelsea | | Thordarson |

Complete stock—every order shipped same day—it is received. New, big catalog ready soon; send now for free bulletins. Blue Print of Radio Telephone and C.W. Transmitter for 10c.

Chicago Amateurs—Come and see our new Radiophone in actual operation.

CHICAGO RADIO APPARATUS CO., Inc.
 50 SSo. Dearborn St. (Room 210) Chicago, Ill.

CHALLENGE "A" BATTERY

(JOHNSON PROCESS)

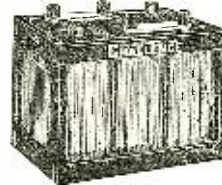

Radio Type 2-Volt Cell
 This battery is designed for filament lighting purposes. Assembled and sealed in glass jars, enabling you to watch the condition of the plates. Lead connecting straps furnished. Each cell 35 A. H. 2 v. with rubber nut terminals. Simple to connect with as many cells as may be required for proper voltage. The best BATTERY for your work boys.

Size of each cell 8¾ high x 6¾ wide x 2¼ long over all.

NONE BETTER

Price in sets of three cells (6 VOLTS) \$11.48

Challenge Battery Co., 16 W. Illinois St., CHICAGO, ILL.

AMATEURS

Our stock of CW and Spark Radio apparatus is complete. Send us your order and it will be filled same day it is received.

T & H RADIO CO.
 ANTHONY, KANSAS

TELEGRAPHY

(Both Morse and Wireless) and RAILWAY ACCOUNTING taught thoroughly and quickly. Big salaries now paid. Great opportunities for advancement. Oldest and largest school; established 46 years. Endorsed by Telegraph, Railway, Radio, and Government officials. Expenses low—opportunities to earn large portion. Catalog free.

DODGE'S INSTITUTE

D Street, Valparaiso, Ind.

KLAUS RADIO CO.

Manufacturers and Designers
 Eureka, Illinois

Authorized Distributors for

Grebe
 De Forest
 Murdock
 Moorhead
 Clapp-Eastham
 Radio Corporation
 Acme
 Amrad
 Brandes
 Baldwin

Send for our Bulletins

1/4 H. P., 110 volts, A. C., 60 cycle, single phase, 1750 R. P. M.

MOTORS

LARGE QUANTITIES NEW WASHING MACHINE MOTORS

These are of standard manufacture and carry the full factory guarantee. Shipped in original boxes. Complete as cut. Suitable for operating Coffee Grinders, Cream Separators, Bottle Washers, Air Compressors, Small Lathes, Etc.

\$22.75 Each

MANUFACTURER'S DISTRIBUTOR
 GRAS. H. JOHNSTON - Box 10 W. E., Pittsburgh, Pa.

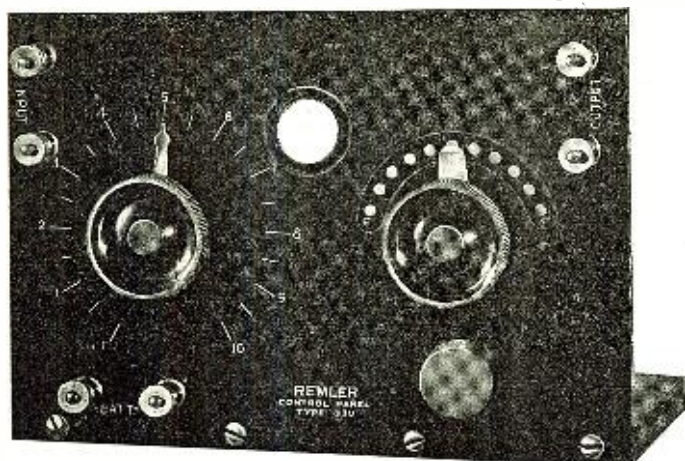

REMLER TYPE 330 VACUUM TUBE CONTROL PANEL

FOR THE NEW TYPE C-300
DETECTOR TUBE

*Maximum Value and Quality Through
Quantity Production*

**THESE SPECIFICATIONS SPEAK
FOR THEMSELVES**

Genuine bakelite, highly polished, 5" x 7¼". White filled engraving. Special smooth running rheostat back mounted. All bakelite VT socket. The new Remler positive metal contact potentiometer for controlling plate voltage. Variable grid leak. Fixed grid condenser. Busbar wiring. Hardwood base. All metal parts polished nickel **Price \$8.00**

DEALERS: Send for our trade proposition on Remler Apparatus.

"Apparatus that Radiates Quality"

REMLER RADIO MFG. COMPANY
163 Sutter Street, San Francisco, Cal.

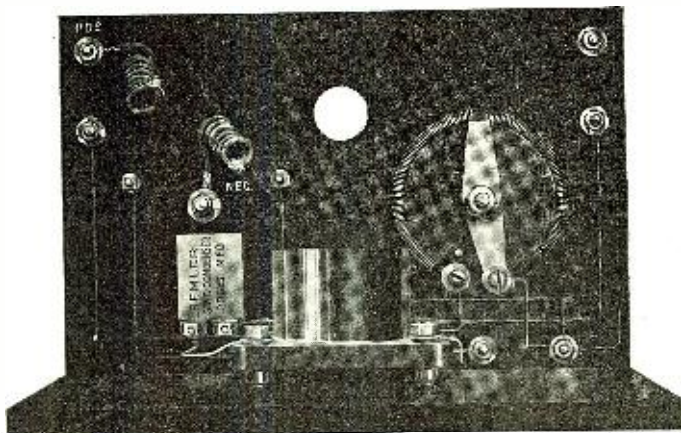

Federal Standard Radio Accessories

ANNOUNCING

A Material Price Reduction
on the Famous Federal
Amplifying Transformer
Price, Effective June 1st, \$7.00

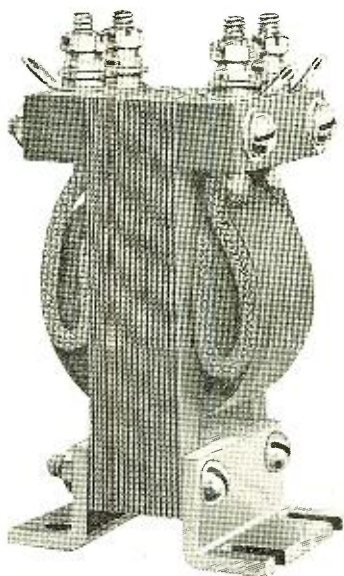

No. 226-W—Type A
Audio Frequency Transformer

Federal 226-W Transformer will give Maximum Amplification with all types of Standard Tubes on the market.

*Write for Bulletin 102-WB and C Circular
describing New C-W Accessories*

Ask Your Dealer for Federal Products. If he does not have them, tell us his name.

Federal Telephone & Telegraph Co.

Buffalo, New York, U. S. A.

MANUFACTURERS OF STANDARD RADIO ACCESSORIES

KEYSTONE WIRE

Wire for every Wireless Purpose

MAGNET WIRE

We are prepared to furnish best grade magnet wire on 1/4 and 1/2 lb. spools at the following revised prices:

PRICE PER 1/4 LB. SPOOL

| B&S Ga. | Single Cotton | Double Cotton | Single Silk | Enameled |
|---------|---------------|---------------|-------------|----------|
| No. 22 | \$0.56 | \$0.68 | \$0.62 | \$0.45 |
| No. 24 | .60 | .77 | .67 | .47 |
| No. 26 | .65 | .88 | .71 | .49 |
| No. 28 | .75 | 1.10 | .85 | .52 |
| No. 30 | .85 | 1.24 | .97 | .53 |
| No. 32 | | | 1.15 | .55 |
| No. 34 | | | 1.52 | .59 |
| No. 36 | | | 1.77 | .69 |

Price on 1/2 lb. spools double above list.
All prices are net and include cost of spool and delivery charges via Parcel Post to any Post Office address in the United States; safe delivery guaranteed.
Send for Circular 21-A giving prices on other sizes, insulations and quantities of Magnet Wire. This circular lists "WIRE FOR EVERY WIRELESS PURPOSE."

KEYSTONE WIRE COMPANY
P.O. BOX 120 SCRANTON, PA.

Canadian Radio Experimenters SPECIAL

Radio Storage Batteries

| | |
|--|---------|
| 40 Ampere hour, 6 volts..... | \$22.00 |
| 60 Ampere hour, 6 volts..... | 25.00 |
| Baldwin Telephones, Type G..... | 24.75 |
| Brandes Telephone, Superior..... | 12.00 |
| THI..... | 18.00 |
| NHI..... | 21.00 |
| Murdock Telephones, 2,000 ohm..... | 6.00 |
| 3,000 ohm..... | 7.20 |
| Lateral Coils to order. | |
| Inductances for Wireless Telephone. | |
| Milliammeter and Hot Wire Meters. | |
| Vario-Couplers and Variometers..... | 4.25 |
| Transmitters for Radio Purposes..... | 3.50 |
| LOOK LOOK LOOK | |
| 1/4 HP 110 volt 25 cycle Menominee Motors | 30.00 |
| 1/5 HP 110 volt 25 cycle Menominee Motors | 25.00 |
| 1/10 HP 110 volt 25 cycle Menominee Motors | 20.00 |

Send 5c for 30 page catalogue

J. M. PAQUIN

The Electrical Shop

787 Queen St. West, Toronto, Ont.

3000 Ohms



\$8 POST-PAID

"RED HEADS"

The Accepted Standard in Radio Receivers.
At the new price of \$8.00 (formerly \$12.50) "Red Heads" are unquestionably the best wireless "phone value in the world. Increased production, decreased costs and a sincere desire to promote lower prices prompt this remarkable saving.
SPECIFICATIONS: Aluminum back type with genuine bakelite ear caps, government type head band, extra fine 6 ft. cord with strain loops. Each receiver (1500 ohms (3000 ohms per pair). Sold on a money back guarantee basis and shipped prepaid anywhere on receipt of price. Dealers: Write for complete information.

THE NEWMAN-STERN CO.
Newman-Stern Bldg., Cleveland, Ohio

Number 28 wire or finer should be used; the kind of insulation used does not matter, single cotton covered is satisfactory. The secondary winding consists of 50 turns of the same size wire as the primary, with one tap taken out. The winding starts about 2" away from the primary winding and a space is left for the rod supporting the tickler coil, to pass between. Figs. 3 and 4 illustrate the windings very clearly. The tickler coil has 40 turns of the same wire and a space is left in the middle of the winding, also, for the brass rod. The tickler is 2 1/2" in diameter, and about 1 1/4" long.

Trouble is often experienced with flexible leads breaking off. Here is a good wrinkle. Find some old telephone receiver cord and cut off two pieces, each about a foot long. Pull back the insulation and wind bare wire around the tinsel on all four ends. Now make a wooden piece as in Fig. 8. This, when drilled, is placed inside the coil and fastened with a couple of brads and sealing wax; the hole in the center is to allow the brass rod to pass thru. The ends of the wire are brot to two brass machine screws, and the prepared tinsel cords are now soldered to the screws, or else fastened with nuts.

A good, efficient and compact fixt condenser may be made by cutting two strips of tinfoil 4" x 1 1/2" and two strips of waxed paper 4 1/2" x 1 1/2", also a piece of fibre 3" long drilled as follows. (Hole No. 1) 1/4" from end, (No. 2) 1/2" from end, (No. 3) 2 1/2" from end, (No. 4) 2 3/4" from end. The sheets are assembled as in Fig. 7, and the whole wrapped around the fibre and bound with string of tape. The tinfoil is pushed thru the two inner holes and a brass screw and nut or a binding post placed there. The two outside holes are used for fastening the condenser to the base-board. The whole condenser may, if desired, be dipped into melted paraffin.

The secondary loading coil is wound on a tube 3" in diameter and 1 1/4" wide. There are 50 turns with a tap taken out at the 25th turn this tap should be about 7" long. In my set the coil is mounted behind my variable condenser to which it is fastened by three copper wires. If the experimenter uses a different condenser he can perhaps mount his coil on the base-board by using a ube of smaller diameter and greater length and of course more turns of wire. Now, a word or two about assembly. The taps of the large tube should be soldered first and then the tube mounted. (All switches, etc., should be on panel). Now the tickler coil is mounted and connections soldered. The first condenser is screwed on next, and then the variable is put in. The loading inductance is put in last. It is advisable to solder up the connections on the short-wave switch before screwing on the variable condenser. Fig. 9 shows the way the different parts are to be connected. You cannot be too careful in putting in the connections.

The socket is mounted on top of the box. Wherever a connection goes from the panel to the box, use a flexible lead about a foot long so that the panel can be pulled out at any time for inspection.

The top of the panel is screwed to the strip in the box and the bottom to a board 4 1/2" x 6 3/4". A hole is bored in the center of the under-side of the box and counter-sunk. A wood screw thru this hole and into the base-board of the panel prevents the bottom of the panel from moving.

I have no handle or strap on my set, as it will go in my suitcase or on my motorcycle. The experimenter can easily screw a leather strap to the sides of the case, much in the manner that is used in attaching a strap to a storage battery.

With these directions and by careful study of the illustrations, I believe any

UTTMARK'S NAUTICAL ACADEMY RADIO SCHOOL

NEW YORK BOSTON

Offers a thorough course in all branches of wireless telegraphy. Radio Operators earn at the start \$125.00 per month, and first class board, etc., free.

Our school prepares you for your license in three to four months. Positions guaranteed to first grade licensed operators. Also MORSE TELEGRAPHY.

Day and evening classes.

The leading Nautical School in U. S. A. Established 1804.

CAPTAIN F. E. UTTMARK, Principal

Write, call or phone for illustrated booklet.

8 STATE ST., NEW YORK, N. Y.

Facing Battery Park, N. Y.

Telephone, Bowling Green 8079

UTTMARK'S for Nautical Education

Canadian Amateurs

ATTENTION

It will save you \$\$\$\$ to keep in touch with us.

We give you QUALITY, SERVICE, and a SQUARE DEAL.

Brown's Famous Receivers

used by, The Admiralty, Air Force, Foreign and Colonial Armies and Navies. Tests lately made show an efficiency of three times that of any other telephonic head gear.

4000 Ohm \$19.25

8000 Ohm 20.50

Shipping weight 2 lbs.

Send .05c for our list

THE VIMY SUPPLY CO.
567 College Street TORONTO, ONT.

PUGET TRANSFORMERS

The last word in transformers that are really designed to put energy into your condenser.

25,000 Volts and Resonant

Gives a clear note with an Amrad gap and excells all makes for long distance.

500 Watts—\$26.75

Northwest Radio Service Co.
609 Fourth Ave. Seattle, Wash.

For Various Reasons—



P articular

R adio

A mateur

C ustomers

O rder from us.

PENN RADIO APPARATUS CO., Inc.
Box 110 Reading, Pa.

experimenter can build for himself this set and I am sure he will be more than pleased with the results. I shall be pleased to answer any questions which may arise about the set, its construction, or operation.

Married Via Radio

(Continued from page 877)

garding Kennison and the mysterious girl. Lighting the transmitting bulbs to a bright incandescence, the excited young man prepared to make the call. The girl was the first to call; she had started fifteen minutes earlier than the night before.

"Hello, Charlie," she greeted, "are you listening?" The wireless operator wondered how he had become a first-class friend again. Likely the dispute of the night before had been settled.

"She's calling me, fellows," Kennison called into the transmitter, then with less emphasis: "Yes, I'm listening, won't you please tell me who you are?" Let it be known here that Kennison was twenty-three years of age.

"Cut the comedy, Charlie," roared an amateur spark, "we don't hear anybody."

"I have three steps working," shrilled another spark.

"Please stand by, fellows," cried Kennison, "she's talking again, 200 meters is the wave."

"You know, Charlie, I love you," the sweet voice was saying. "Please don't ask that question so many times."

"I didn't ask any such question," said Charles in consternation. "I said nothing about love." Numerous ha, ha, hi, hi's, flashed thru the air. The amateurs were making sport of the "loony 'op."

"Let's not get into an argument like last night," said the girl, "we are about to get married by radio and that's all there is to it. Are you ready? The justice of the peace is with me."

"My Lord!" yelled Kennison, "stop, please stop, I don't even know you. How can I marry if I don't know you?"

"Ha, ha, hi, hi, hi," roared thru the air. "It is all settled and you know it," said the determined young woman, "are you ready?"

Kennison said he was and added for the benefit of the amateurs: "I'm about to get married by radio, fellows; stand by, please, and God help me."

Again came the ready laugh of the amateurs.

Kennison heard the gruff voice of a man reciting the marriage sermon. "Do you take this woman as your lawful wife?" asked the man.

"Yes," groaned Kennison. The girl answered a like question in a most sweet and delightful voice. The ceremony was soon terminated.

"Charlie, my husband," laughed the girl happily, "two—." The voice broke off abruptly. Doubtless the girl's transmitter was out of order.

Again and again the excited man called but received no answer. The amateurs were now making a huge joke of the affair and the air was loud with their clamor.

Kennison passed a restless night. Who was the girl he had unwittingly married? He awoke from a troubled dream to hear the ringing of the telephone.

"Hello, that you, Charlie? Byrne speaking; aren't you up yet? Get a move on and buy the latest edition of the *Call*. Page five may interest you. So long, hope you enjoy reading it." The speaker laughed and rang off.

"No doubt pertaining to my marriage," thot the young man hurriedly putting on his clothes. "Oh what a fool I am. She must

SHRAMCO REO

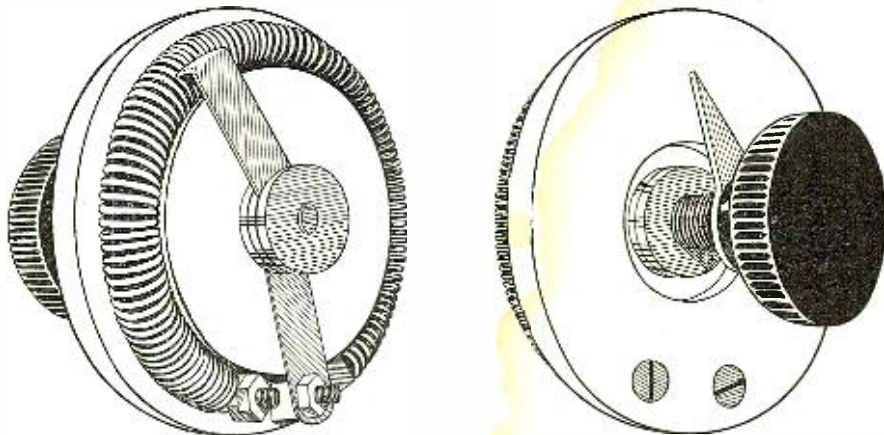

for your power tube—

New type Shramco Reo, No. 90P. 1.5 ohm Nichrome resistance. Current capacity 6 amperes. Price \$2.00, 1 lb. postage.

A BACK MOUNTED panel rheostat, specially designed for the Radiotron U.V. 202 and other transmitting tubes. Resistance element (1.5 ohm) is "Nichrome" wire, mounted on a solid block of asbestos. Allows unusually accurate and delicate variation of the filament current. All metal parts

brass. Spring phosphor bronze blade. Base 3". Overall height 2 1/2". Handsomely finished and accompanied by an unconditional guarantee of complete satisfaction. Get the most out of your expensive power tube by using a good rheostat. Order a Shramco Reo today! Now ready for immediate shipment.

for your VT detector—

and amplifier, use the original Shramco Reo type 90. Similar to the power tube type, but with a "Nichrome" resistance of 6 ohms. Price \$2.00, plus postage for two lbs. Also available—"Midget" type 90A, same construction, but a 5 ohm resistance and 2 1/2" base.

SHOTTON RADIO MFG. COMPANY
P. O. Box 3, Scranton, Pennsylvania

Catalogue "K", listing a complete line of high grade parts at reasonable prices, sent to any reader of Radio News for five cents in stamps.

BAKELITE PANELS

4 1/2" x 6 1/4" x 3/16" **Best Grade** \$.35 ea.
Weight 5 oz. each

WRITE FOR CATALOGUE — READY MAY 15

DAVID KILLOCH COMPANY, 57 MURRAY ST., NEW YORK

Have you something to sell or exchange? A classified ad in Radio News will reach 40,500 for only 6 cents a word.

BACK TO OLD PRICES

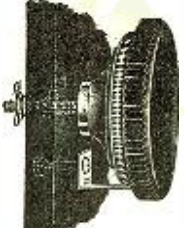

PARKIN RHEOSTAT
5000 sold last year at \$1.00
NOW REDUCED TO **75c**

Due to the general drop in the prices of raw material and to our large production, we have been able to reduce all our prices to their pre-war level, and in some cases even lower.

New Catalog No. 5, listing our complete line, sent free.

Here are a few of the items:

| No. | Postpaid |
|--|----------|
| 31 Audion panel with rheostat and B battery switch | \$8.00 |
| 43 45 volt large B battery | 5.00 |
| 50 PARKIN .001 mf. variable condenser, unit only | 1.50 |
| 51 PARKIN .001 mf. V.C. with knob and pointer | 2.00 |
| 52 PARKIN .001 mf. V.C. with knob and 3" dial | 2.50 |
| 53 PARKIN molded bakelite fixed condenser | .70 |
| UV 200 New Radiotron vacuum tube | 5.00 |

DEALERS—If you are not on our mailing list, write for new catalog and discounts.

PARKIN MFG. CO., San Rafael, Calif.

The original tested crystals



Now 25c
GALENA or SILICON

Be Sure of Results!—Insist Upon Getting **N. A. A. TESTED CRYSTALS**

These exquisitely sensitive minerals are the best that money can buy for radio detector and wave meter work. Each crystal is individually tested, wrapped in foil and packed in a convenient lithographed tin container. N. A. A. (Arlington) Tested Minerals are the original tested crystals. To avoid their many imitations look for the signature of J. S. NEWMAN on each box. Galena or Silicon, 25c.

At good Radio Dealers everywhere, or shipped direct postpaid on receipt of price.

THE NEWMAN-STERN CO.
Newman-Stern Bldg. Cleveland, Ohio

WINO BATTERIES

For Use With Radio Apparatus

BUY DIRECT FROM MANUFACTURER

| | |
|-----------------------|---------|
| 6 Volt—40 ampere hour | \$13.40 |
| 6 Volt—60 ampere hour | 15.58 |
| 6 Volt—80 ampere hour | 19.85 |

War Tax included—Express prepaid.

Fully Guaranteed.

Send Postoffice or Express Money Order.

The Wino Manufacturing Co.
717 Sycamore St. Cincinnati, Ohio

STAMMER

If you stammer attend no stammering school till you get my large FREE book entitled "STAMMERING, Its Origin and The Advanced Natural Method of Cure," bound in cloth and stamped in pure gold. Ask for special tuition rate and a FREE copy of "The Natural Speech Magazine." Largest, best equipped and most successful school in the world for the cure of stammering, stuttering, etc. No sing-song or time beat. Write today.

The North-Western School, 2266 Grand Ave., Milwaukee, Wis

be some long distance from me if no one else heard her. Some 'hook-up' I discovered, that's one consolation."

Fifteen minutes later Kennison was reading page five of the *Call*. His face was flushed to a dark red as he concluded the article.

"Have you read the article in the *Call*?" his sister asked entering the room, then seeing the paper in his hand, "I see you have. Something new, isn't it, getting married by wireless? I hope I'll never be as romantic as that girl in Honolulu. Think of her demanding such a foolish marriage from her fiancé. I suppose she and the Lieutenant on the battleship that it was great fun getting married that way, but I don't think so, do you, Charlie?"

Give Yourself a Radio Vacation

(Continued from page 858)

all the world knows radio, at least by name. It is not so. Not one in a hundred of even our educated people know anything more about it than that a ship in distress can use it in calling for help.

This season I have entertained at my station hundreds of people who are far above the average in knowledge of world affairs—travelers, authors, representatives of big business and learned professions. Not one of them had ever listened to a radio message. To put on the fones, turn a knob and bring in a station was a delightful new experience.

One of these guests, a man who has been in every nook and corner of the globe and has used radio service many times, was astounded at what he heard. The first call he brot in was from a ship on which he had sailed. I read the call letters and showed him how easy it was to identify the ship by looking in the call book.

A few moments later he looked up with astonishment and exclaimed: "I hear someone speaking!" And afterwards: "Now they are talking French!"

I introduced this gentleman to a younger amateur who has a genius for construction. He immediately offered the young man a position in a summer camp. Also he ordered a receiving set and offered to pay cash in advance. He now has his set and is operating it successfully and other sets are being purchased from various concerns as a result of his interest. In the meantime the young operator is looking forward to an interesting radio vacation.

At summer and winter resorts there are many men of affairs who want to keep up to the times but who cannot do all the reading and investigating that they would like to do. To them an hour spent in a radio room with an agreeable operator to show them how to work a set would be far more agreeable recreation than lolling in a wheel chair. From such men flow streams of influence which would be of incalculable value to the science and business of radio and to the hotels which are wise enough to put the demonstrations in their way.

As for the amateur operator, he might receive a good-sized tip if he looked like that kind of a guy; an if he showed a character which won the respect and confidence of his pupil he might discover that he had unconsciously taken his first step toward those larger fields of effort which big men seldom discuss for lack of a listener whose intake will carry the juice without blowing a fuse.

INSTRUCTION.

Even the idle rich whose indolence and vanity are pampered by hotels of a certain class are ambitious that their children should be clever and intelligent. Radio might take the place of many a senseless fad if man-

Special Introductory Offer of the Bronx Radio Equipment Co.

| | |
|---|------------|
| 6 volt—60 ampere Storage Battery same as U. S. Gov't specifications for radio airplane work | \$10.00 |
| 40 Ampere Storage Battery | 8.50 |
| B Batteries, large type | 1.75 |
| B Batteries, small type | .95 |
| "Special" Electrose Insulators, 7 1/2" x 1/2" column, navy type, each | .50 |
| Navy Type Receiving Sets, original price \$245; our price | \$50.00 up |
| Bakelite cut the size you want it. One-quarter inch thick, 3c per square inch. | |

Mail Orders Promptly Filled

BRONX RADIO EQUIPMENT CO.
687 Courtlandt Ave. NEW YORK CITY
Agents for Murdock, Federal, Acme and Others.

NEW ORLEANS RADIO

APPARATUS and SUPPLIES

ROSE RADIO SUPPLY
604 Gravier St., New Orleans, La.
Send 10c for Latest Catalog

PLATE BATTERIES

Always something doing with Erseo Batteries on your plate.

| | |
|----------------------------------|--------|
| Erseo No. 503 22 1/2 volts | \$2.00 |
| Erseo No. 803 36 volts | 3.20 |
| Black Fibre Panels, 1/4 x 20 x 7 | 3.00 |

Or cut to size .02 1/2 per square inch.

ECONOMY RADIO SUPPLIES CO.,
232 Sanford Street East Orange, N. J.

C. W. EQUIPMENT

We stock a complete line of General Electric Power Tubes, Tuska Inductances, Acme Transformers, etc.

Get our literature and prices.

Independent Radio Supply Co.
3716 W. Douglas Blvd. Chicago, Ill.
"BETTER RESULTS WITH LESS EFFORT"

Brass Binding Posts - 5c each
Switch Points, nickle - 4c each
Battery Rheostats - - - \$1.00

No order for less than 6 Binding Posts or 6 Switch Points accepted.

All kinds of Wireless Supplies.

DREYFUSS SALES CORP.
4th Floor, 150-152 Chambers St. New York, N. Y.

CONNECTICUT RADIO EQUIPMENT

Variable Condensers, Transmitters, Head Bands, Panel Switches, Etc.

Connecticut Tel. & Elec. Co., Meriden, Conn.

WIRELESS STORAGE BATTERIES

Get a Good Storage Battery for Your Wireless

| | |
|--------------------------------|--------|
| 4 Volt 40 Ampere hour capacity | \$9.00 |
| 6 Volt 40 Ampere hour capacity | 12.00 |
| 6 Volt 60 Ampere hour capacity | 15.00 |
| 6 Volt 80 Ampere hour capacity | 18.00 |

Cash with order. We make Storage Batteries only

MULTIPLE STORAGE BATTERY CO.
P. O. Box 183 JAMAICA, LONG ISLAND

FOR ONE MONTH ONLY

In order to introduce the Radio Control Panel to the Amateur, we offer these panels complete with tube and B battery for \$15. Add parcel post charges for four pounds. Radio Equipment designed to use apparatus you have on hand. Send specifications for estimate.

A. C. PENFIELD Conneautville, Pa.

aged by an amateur who could grasp the situation. All the Little Willie Billionbucks must have real brains somewhere in their ancestry or there would not be money in the family and herewith, altho the characteristics which it transmits may skip a generation, is governed by fixt laws which produce a genius once in so often if there is any real stuff in the blood.

Also, playing opposite the Little Willies are sometimes chorus girls who are not altogether the fluffy, brainless things they seem. Now, if some Little Willie, escaped from parental guardianship for an hour, should happen to be *tête-a-tête* with some Berenice in a not too brilliantly lighted corridor, and the *zit zit* from a radio room should catch their ears and they should go to investigate; and if in the invisible waves which carry messages between persons on opposite sides of the earth they should happen to see a parallel with those other waves which carry messages from eye to eye and heart to heart of men and women who are with each other; then there might stir within them some long-dormant force which in a remote forebear was developed by the struggle for existence. They might begin to see life as a serious opportunity. They might study radio and it might lead them out into paths of useful endeavor. There might be averted a ship wreck of a family's proud hopes. It might go down in the annals of a nation that He met Her at the Glenaether Hotel, or wherever it was, which always was noted for its unusual features.

Imaginative and improbable tho such a forecast seems, any man who ever amounted to anything can look back to events which were far more improbable before they happened but which shaped his life.

Teaching spoiled children is not a joyous occupation as a rule, but an amateur who succeeded in really interesting a class of teen-age boys or girls of this kind at a hotel would not have to wonder where his next vacation was coming from.

CHESS AND CHECKER MATCHES.

There are enough chess and checker ends in the world to support several magazines and keep the lights burning in many a hotel long after even the dancers have gone decently to bed. A hotel which would advertise facilities for radio chess and checker matches would attract a group of experts who, whatever faults they might exhibit would at least be quiet. And moves in matches are not made with sufficient rapidity to tax the ability of even a ham.

RADIO PRESS.

Many of the best resort hotels are so far from cities that the morning papers are not received until afternoon. A hotel that would give its guests the morning paper's news the night before the paper came out would be popular. This service alone would be worth an operator's room and board in any first-class house. A hotel today cannot justly claim to be first-class if it keeps its patrons waiting half a day for news when it is in the air all the time ready to be picked up. Besides the regular press dispatches an amateur could pick up items about ships at sea which would be of interest to the guests. Very often it would be of vital importance to a business man on vacation to know that a liner was meeting head winds and would be a day late in getting into port.

The weather is always a standard topic of conversation at vacation points as elsewhere and the fact that a certain hotel received the forecasts the very hour they were made up by the United States Weather Bureau would put it in a class by itself.

It is not to be expected of course that hotel managers, ignorant like the general public of the fact that radio is as reliable a means of communication as a wire line and much broader in its reach, are going to fall at once for the arguments of an amateur who wants a vacation. Those who are not from Missouri have entertained guests from

3 \$1 for 1 **PROTECT YOUR VACUUM TUBES INDEFINITELY!**

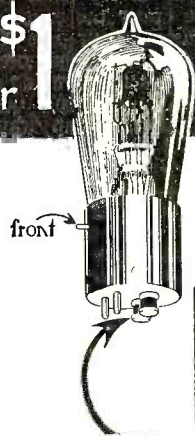

Multiplies the Life of Your Set
Destructive excessive amperage cannot reach the delicate filaments of any vacuum tube if protected by a

Radeco SAFETY FUSE

Carrying Capacity
1 1/4, 1 1/2, 2, 2 1/2 and 3 amp.
Size 1/4 inch over all.

Slips directly on filament terminals of any standard socket without distorting springs or lowering efficiency. **RADECO** Safety Fuses positively protect your tubes indefinitely.
RADECO Safety Fuses are equally valuable in all C.W. work preventing injury to meters resulting from shorts. Send today cash, money order or certified check.

3 For \$1.00
1
35c Each

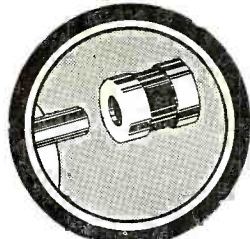

ORDER BY MAIL

ROTARY QUENCHED SPARK GAP, \$20.00 Post-paid

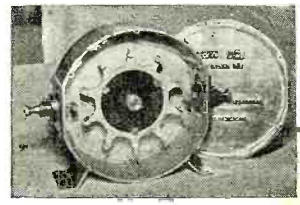

The advantages of a noiseless super-efficient rotary gap are now within the reach of all. The casing is of cast aluminum with the cover machined to make an airtight enclosure for the extremely light weight aluminum rotor with bakelite insulation. Stationary electrodes are of copper with bakelite insulation. The smallest gap motor may be used, but is not supplied with gap. **GET YOURS SET UP AT ONCE, and INCREASE YOUR RADIATION AND RANGE!**

FILAMENT RHEOSTAT



For Back or Front of Panel Mounting. 6 ohms. 1 1/2 amps., 1 1/8" dia.
\$1.75 Post-paid
Immediate Shipment.
Standard VT Socket
Improved Contact Type
\$1.00 Post-paid
Copper foil condenser
35c p.p.

44 V. VARIABLE "B" BATTERY \$3.60

Include postage on 4 lbs. Complete in handy wooden case and adjustable phosphor bronze "jiffy" connectors. Better than block batteries—if one 4.4 V. unit weakens prematurely, it can be removed and replaced—thereby not impairing total voltage, which makes this the best battery value to be had at any price. Set of 10 Renewal Units, 44 Volt, \$3.10 postpaid. Just the thing for C.W. work.

Ground Wire 8c Per Foot
\$7.00 Per 100 Feet

No. 4 solid copper—rubber covered—triple braid—include postage on 20 lbs. per 1000 ft.
100 amp. 600 volt lighting switches, \$4.

Aerial Wire 1c Per Foot

7 strands No. 22 copper—tin plated to prevent oxidation. Maximum radiation and strength. Include postage on 15 lbs. per 1,000 ft.

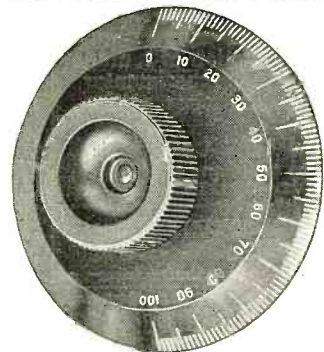

CHELSEA DIAL and KNOB
Made of best grade bakelite runs absolutely true and will not warp. Dia. 3 1/4" in diameter, 1/4" thick. Genuine dial at a genuine price.
Dial....\$-.75
Dial and Knob...1.00
Send Today

RADIO EQUIPMENT CO.

630 Washington Street (4th Floor) Boston

PROUDFOOT SPECIALS

PRE-EMINENT QUALITY—PRICES CANNOT BE DUPLICATED

| | |
|--|---------|
| Vacuum Detector Cabinet, 7 1/2"x5 1/4" | \$12.50 |
| Amplifier Cabinet, 7 1/2"x5 1/4" | 18.00 |
| Detector and One-Stage Amplifier, 7 1/2"x6 1/2" | 25.00 |
| Detector and Two-Stage Amplifier, 7 1/2"x9" | 35.00 |
| Regenerative Set, 7 1/2"x14" | 35.00 |
| Regenerative Set with Detector and One-Stage Amplifier, 7 1/2"x18" | 45.00 |
| Regenerative Set with Detector and Two-Stage Amplifier, 7 1/2"x20" | 55.00 |

ALL INSTRUMENTS ABSOLUTELY GUARANTEED

G. M. PROUDFOOT, 361 E. Ohio St., Chicago, Ill.

ANNOUNCING
EMPYREAN RETAIL SALES
S - E - R - V - I - C - E

Embracing a
Downtown Sales Room
 for the convenience of local fans;
 and a
Mail Order Department
 where quality and service are un-
 excelled. Orders are filled and
 shipments made every hour during
 the day, thus assuring you that
 your order will be on its way
 within an hour or two after it is
 received.

EMPYREAN RADIO COMPANY
MASONIC TEMPLE, CHICAGO

BAKELITE PANELS
(Black or Brown)

Cut the size you want them

| | |
|-------------|------------------|
| 7/8" | .02 per sq. inch |
| 3/16" | .03 per sq. inch |
| 1/4" | .04 per sq. inch |

Include Postage
 Example:
 6" x 10" x 3-16" = 60" x .03 = \$1.80

Send for latest price list.

Michigan's Largest Dealers in
 Radio Supplies.

DETROIT ELECTRIC CO.
 434 Shelby St. Detroit, Mich.

RADIO and MODEL
ENGINEERING
 Edited By M. B. SLEEPER

+
JUNE ISSUE—Unusually good
 ideas for the construction of tuning
 instruments. For the Experimenter
 of average means and shop equip-
 ment.

MAY, JUNE and JULY issues, 25c.
 Did you see the telephone article
 in the May number?
 Published by
The GENERAL APPARATUS CO., Inc.
 570-N West 184th St., New York

DODGE SHORT CUT
MADE IT POSSIBLE
TO MEMORIZE
WIRELESS CODE IN
ABOUT ONE HOUR

WHAT WAS A TIRESOME TASK
IS NOW A PLEASANT PASTIME

Thousands have. So simple everybody can.
 Complete chart 50 cents. Testimonials from
 36 States free. Investigate and profit by
 experience of others.
 C. K. DODGE, Box 200, Mamaroneck, N. Y.



The Midget "FIVE-IN-ONE" Slide Rule is a combination Mannheim, Log-Log, Add and Subtract, Polyphase and Binary Slide Rule. It will instantly add, subtract, multiply and divide any combination involving whole numbers, fractions, decimals and mixed numbers. Gives every possible root and power of every quantity. The graduations are printed on metal coated with white celluloid and are grease and waterproof. While it is the most versatile calculator ever invented, its operation is simple and easily understood. Diameter 4".

Price with 16-page Instruction Book, \$1.50. Leatherette carrying case 50c extra. Catalog free. Your money back if you are not satisfied.

Gilson Slide Rule Co., Niles, Mich.

that State of Doubt. Every hotel room—even the cubby hole under the eaves which would please the radio amateur best of all—has cash value in the season. The hotel man does not know that by merely sending someone to ask the amateur a simple question about QRM or something he can draw him into a discussion which will make him forget his meals and thus eliminate that item of expense. He needs to be shown that the thing is practical and valuable and worth the money. The best way is to get him into your station and let him play with the controls himself. *The next best way is to set up a portable outfit in his office and make something happen.* In either case a brand new impression will be made and it will stick.

COMPENSATION.

A good operator is worth a salary and expenses, especially if he uses his own set. But if he is obliged to accept a proposition covering expenses only, there are ways to secure an income.

Dealers in radio apparatus are glad to have reliable representatives and are willing to pay commissions on sales. It is easy to interest well-to-do vacationers in purchasing sets ranging in price from \$50.00 to \$500.00 if an amateur has salesmanship qualities.

Radio magazines welcome subscription agents and, altho much of their material is too technical for the average man there is always enough of general interest to justify an amateur in selling a subscription to a man who becomes interested in radio in a general way.

Many wealthy women, wives of men high in big business and in government, study stenography and typing in order to handle matters too confidential and important to entrust even to a private secretary. Women of this class would learn radio just as easily and find it equally useful. For competent instruction they gladly pay from \$2.50 to \$5.00 per lesson. Such women must spend some time each season at the first-class hotels in order to maintain social connections which are of importance to them, but they do not spend their time in mere social frivolity. They might be secured as pupils and might help in organizing classes. Women who have helped their husbands to success are sure to be interested in young men who are ambitious and sound as to character. They have longer memories than men and they have an adroit way of mentioning the young fellow whom they are helping at times when it will do him the most good. An amateur who could meet such friendliness with common sense and genuine appreciation, one whose mouth was less ready than his brains, would find valuable friends among the gentler sex at exclusive hotels regardless of his own social position.

VACATIONS IN CAMPS.

Every organized camp needs radio service. Camp managers may not appreciate that fact, but they do need it. Camp physicians usually are medical students or young practitioners. At any moment they may be confronted by a situation in which the prompt assistance of an older man is needed to save a life and to save the reputation of the camp.

Generally speaking, the record of boys' and girls' camps in the care of their campers is good, but the leaders in this as in other fields will be using radio as a further means for safety as soon as they appreciate its value. Some are using it now but too often the sets are inefficient and the operators too inexperienced.

Competent amateurs who will secure vacation positions in camps and give reliable service will make reputations for themselves and do a lot for radio.

POSITIONS ON YACHTS.

Yacht owners need radio. Some of them have it but more have not. Even some big yacht clubs are still asleep on this propo-



AJAX LEARNERS KEY & BUZZER SETS
 "built for service" with code \$1.75
"HYTONE" BUZZERS 60c
 external tone adjustments
 "as good as the best"
 Postpaid
AJAX ELECTRIC CO.
 Palmer St. Cambridge, 38, Mass.

INDICATING DIALS

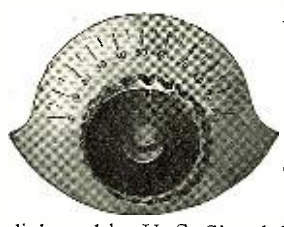

Lacquered brass, 2 1/2" in diameter, genuine bakelite knob 1 1/4" in diameter. Offset shoulders act as stops. Same dial used by U. S. Signal Corps. Your money refunded if not satisfied. Price, three for one dollar, postpaid.

The Factory Distributing Co.
 130 N. Wells Street Chicago, Ill.

CARDBOARD TUBING

In any length up to 25". 3" and 3 1/2" Dia., 2 1/2c per inch, 25c per foot. 4" and 4 1/2" Dia., 3c per inch, 30c per foot. 3", 3 1/2" and 4" Tubing has 1/8" wall. 4 1/2" Tubing has 5/32" wall.

VARIABLE B. BATTERIES

22 1/2 Volts.....\$2.50 45 Volts.....\$5.00
 Postage Extra—Circular for Stamp.

JEFFERY-CRAWFORD CO.
 2173 Hillger Ave. Detroit, Mich.

\$ \$ \$ \$ \$
S A V E D

By ordering thru us
 10% discount on practically all radio goods. Money orders only accepted.

THE AMERICAN RADIO SALES & SERVICE CO.
 Box 356 Mansfield, O

STANDARD RADIO EQUIPMENT
 AGENTS FOR

| | |
|---------------|--------------------|
| MURDOCK | FEDERAL TEL. |
| BRANDES | AMERICAN RADIO |
| BURGESS | AUDIO TRON. |
| GREENE | CHICAGO RADIO LAB. |
| BENWOOD SPEC. | DUBILIER |
| DE-FOREST | TRESCO AND OTHERS |

U. of I. SUPPLY STORE, Inc.
 627-29-31 SOUTH WRIGHT STREET
 CHAMPAIGN, ILLINOIS



LEARN WIRELESS
 at the largest radio school in the Central States. Modern complete equipment. Experienced instructors. Dormitory in connection. Students may earn expenses if necessary. Write today for catalogue and full information.

CENTRAL RADIO SCHOOL
 Independence, Mo

POLES
 (SPRUCE)
 FOR YOUR WIRELESS
 Furnished and erected at reasonable rates
J. F. BYRNES 578 Gates Ave.
 Brooklyn, N.Y.

"The Trans-Pacific Radio Operators Log"

is a fascinating booklet crammed full of press, time, and weather-schedules, distance tables, speed records, LD records, and information of all kinds that you radio "bugs" have been waiting so long for. Your copy will be sent postpaid by return mail upon receipt of 50 cents.

Address
W. BRENNAN
 701 Remington Street Fort Collins, Colo.

sition, not realizing the value of a radio station at the club house. An amateur who likes the water ought to have no difficulty in landing a vacation job on a yacht, especially if he is willing to do other work around the boat besides radio. Here again the acquaintances made may be of greater value even than the recreation.

On fishing boats and sailing craft of all sorts a radio man could earn his passage. He would need to be a rough and ready fellow and he would have a wonderful time if he was.

An op. who likes the sea but not its funny motions could scrape acquaintance with a light keeper and spend a few weeks at the light. Lightkeepers and their families are lonely folk and they like company of the right sort. A radio set would be a wonderful new plaything for them. Lighthouse inspectors are not so agreeable, for reasons which can be appreciated when the necessity for absolutely perfect service at the lights is considered, but I have spent many a day and night at a light station without getting anybody into trouble.

IN THE WOODS.

Forest rangers and fire wardens get lonesome too. A radio man who knows how to get along with country folks could undoubtedly secure an invitation to share a log cabin in the wilds, catch trout and live high on backwoods dainties such as raspberries and blueberries. Or, coming back toward civilization, he might choose a farm or ranch. In many sections guests are invited to spend six months or a year as a matter of course. No man likes to sponge his way or impose upon hospitality, but even tho an operator out of health needed so long a period for rest and recuperation, his set and a willingness to lend a hand in such ways as he could would enable him to accept an invitation with a clear conscience.

AT SUMMER SCHOOLS.

There are schools which would have made arrangements long ago for radio courses if the managing boards had had that such courses within their reach. Even tho appropriations were lacking, citizens might make up a purse of reasonable size or at least provide entertainment for a man who was competent to teach even the elementary principles of radio and help beginners to construct simple receiving sets. School periods vary in different parts of the country and whenever an amateur could take a vacation he would be likely to find an opening somewhere.

Then there are Farmers' Weeks at agricultural colleges and many gatherings lasting for a week or more which would be glad to pay the expenses of a man who could give demonstrations with a radio outfit, if the matter were brot to the attention of the committees in charge.

WHAT WILL I DO?

By the time this story is in print I will be enjoying my own radio vacation. In the little town where I lived when a boy I will have my Grebe CR-7 receiver working and will be endeavoring to show a rural community what radio can do for it. I intend to give the constable the police broadcasts from KUVS so he can catch some o' them slick auto thieves from New York, b'gosh. I am going to try to give the farmers the weather before it happens. They get the forecasts now by visiting the postoffice but the weather always gets there before the forecast!

For the village paper I am going to pick up the Navy Press so that once a week it can crow over the city dailies. I am reliably informed that these government QST's are public property and that publishing them is no violation of the law or of my oath of secrecy as an operator. The jeweler shall have the correct time by radio daily.

Nobody is going to pay me for any of this service, but I will have free board, including

**KENNEDY
EQUIPMENT**

Thousands of Dollars

have been spent by radio amateurs and experimenters for inferior apparatus. There was a time when they could get nothing else.

TODAY it is different. The up-to-date experimenter is no longer content with his former limitations. With the development of the high-grade equipment now available he demands apparatus built according to real professional standards.

IN this development the Colin B. Kennedy Company has been a leader. From its very beginning its policy has been to manufacture apparatus which is "built to a standard, not to a price."

ASK your dealer for a demonstration of Kennedy Receiving Equipment. Give it a thorough examination in comparison with the best of other makes on the market. Form your own opinion of its design, workmanship and performance. Our unreserved guarantee on every item bearing the Kennedy trade-mark is your final protection.

If your dealer has not yet put in a stock send direct for our catalog and price list.

THE COLIN B. KENNEDY COMPANY

RIALTO BUILDING

INCORPORATED

SAN FRANCISCO

GALENA --- SILICON

| | |
|-----------------------------------|------------------------------------|
| Galena Crystal Mounted.....\$0.50 | Silicon Crystal Mounted.....\$0.50 |
| Galena Crystal Unmounted..... .25 | Silicon Crystal Unmounted..... .25 |
| Galena Crystal Mounted in Std. | Silicon Crystal Mounted in Std. |
| Murdock Detector Cup..... .55 | Murdock Detector Cup..... .55 |

Every Crystal Tested Under Actual Working Conditions and **GUARANTEED SENSITIVE**

DEALERS WRITE FOR DISCOUNTS.

ROLAND BROWNLIE, Mfg., 27 Oakland Avenue., EVERETT, MASS.

"EVERYTHING IN RADIO"

WESTERN RADIO ELECTRIC COMPANY

SEND FOR OUR MARCH

STOCK BULLETIN AND PRICE LIST

550 South Flower Street

Los Angeles, Cal.

SPECIAL 30 DAY OFFER

Save Money—Get a FREE Premium Besides

The subscription price of Science and Invention has been \$3.00 per year. For 30 days, not only will we give you a full year's subscription (12 big numbers), for \$2.50, but we will also give you absolutely FREE, your choice of any of the well known books shown below. Read the special offers. If you want more than one book free take a two or three-year subscription. For each year you can take advantage of one offer.

If you are already a subscriber to one of our magazines, take advantage of this opportunity and send in your renewal subscription, stating what free pre-

mium you prefer; you are at liberty to send as many subscriptions or renewals as you desire, and you can pick out a free premium for each year's subscription.

You may also take subscriptions of your friends and earn the free premium for yourself.

You must act at once—Today.

These sensational offers are made by us at a tremendous sacrifice in the hope that your acceptance will make you a life-long friend of our magazines.

!! Please use order blank below!!

The Experimenter Publishing Co., Inc.

236 FULTON STREET, NEW YORK

Special Free Premium Offer No. 1



The How and Why of Radio Apparatus

By H. W. Secor, E.E.

This newest of Radio Works has 160 pages. 6 x 9 inches.

OFFER No. 1

Above Book, bound in special cloth, flexible, hand sewed. FREE with a year's subscription to Science and Invention for \$2.50.

Special Club Offer



THE 100% WIRELESS MAGAZINE

AND



THE UNDISPUTED AUTHORITY ON SIMPLIFIED SCIENCE AND MECHANICS

BOTH MAGAZINES

With any one of the FREE Premiums, as described:

\$3.50

- Offer 6A SCIENCE & INVENTION and RADIO NEWS with Premium 1
- Offer 6B " " with Premium 2
- Offer 6C " " with Premium 3
- Offer 6D " " with Premium 4
- Offer 6E " " with Premium 5

The Biggest Clubbing Bargain Ever Offered.

Special Free Premium Offer No. 3

Wireless Course in 20 Lessons

By S. Gernsback, A. Lescarbourea and H. W. Secor, E.E. (10th Edition)

Size of book is 7 x 10 1/4 in., 160 pages, 350 illustrations, 30 tables.

OFFER No. 3

Above Book, bound in special cloth, flexible; hand sewed. FREE with a year's subscription to Science and Invention for \$2.50.



Special Free Premium Offer No. 2



A Thousand and One Formulas

By S. Gernsback

It contains 160 pages. The paper has been especially selected to stand rough handling in laboratories. Size 6 x 9 inches.

OFFER No. 2

Above Book, bound in special cloth, flexible, hand sewed. FREE with a year's subscription to Science and Invention for \$2.50.

Special Free Premium Offer No. 4

Experimental Electricity Course in 20 Lessons

By S. Gernsback and H. W. Secor, E.E.

The book contains 128 pages and more than 400 illustrations. Size of book is 6 x 9 inches.

OFFER No. 4

Above Book, bound in special cloth, flexible; pocket size. FREE with a year's subscription to Science and Invention for \$2.50.



EXPERIMENTER PUBLISHING COMPANY, Inc.
236 Fulton Street, New York City, N. Y.

Gentlemen:

Enclosed find \$..... for which send me:

- Offer No. 1
- Offer No. 2
- Offer No. 3
- Offer No. 4
- Offer No. 5
- Offer No. 6A
- Offer No. 6B
- Offer No. 6C
- Offer No. 6D
- Offer No. 6E

MARK SQUARE ABOVE FOR ITEM WANTED.

Name

Address

Town..... State.....

Special Free Premium Offer No. 5



Design and Construction of Audion Amplifying Transformers
Radio and Audio Frequency Type

How to Make Wireless Sending Apparatus

How to Make Wireless Receiving Apparatus

OFFER No. 5

Above three Books as described FREE with a Year's Subscription to Science and Invention for \$2.50.

apple pies like mother used to make, griddle cakes and maple syrup, and fish out of the creek. I can eat them in that order if I want to, when and as I please. For I will be stopping with two young people of seventy who have been encouraging me in my hobbies for more'n forty year—my father and mother.

Who's Who in Radio

(Continued from page 867)

perfected the device which prevented interference by other signals sent on the same wave-lengths.

Today Radio control is successfully used in several ways; among which may be mentioned an airplane which, without a pilot, may be sent up and directed entirely by Radio.

Professor Branly has been awarded several prizes in appreciation of his work. In 1899 he was awarded a prize by the Academy of Sciences, and in 1903, he shared with Mrs. Curie the Osiris prize given by the Press. In 1910, the National Society for Industrial Help awarded him its highest prize. Dec. 15, 1910, he was elected associate member of the Belgian Royal Academy, and on Jan. 23, 1911, the Academy of Sciences of the French Institute made him a member in the Physic Section.

Within the last few years Professor Branly has started investigations on the modifications causing the electric conductivity in an imperfect contact, and in spite of his actual material difficulties that are added to the out-of-dateness of his laboratory, he pursues without aid, but with his usual will and perseverance, both his teaching and his experiments.

A Mental Telegraph

(Continued from page 864)

the receiving is done on the stage where concealment is not so necessary. A woman with the most recent head-dress can wear the fones without their showing in the least.

When the sets are completed and in operation, the transmitting units walk about the audience collecting the whispers of the individuals, which are relayed with the velocity of light to the receiving medium on the stage, who is given the appearance of having supernatural power.

Can the idea be used for anything else but mere fruitless mystifying and fun? Yes. It could be used for special detective work, for interviewing personages. The ingenuity of the readers of this article will no doubt suggest further applications.

Washington's Birthday Relay Results

(Continued from page 864)

as getting the message across the country was concerned, no trouble was experienced; but the fact still remains that without, say about six stations, the relay would have been a failure, particularly in the East where there was the most noticeable ORM, QRN, QSS. These stations are NSF, 8XK, 9ZN, 9LR, 5YH, and a few others. Nearly all the reports show that signs were hard to read and the boys waited until either one or the other of these stations sent in order to check up the MSG. A slip-up occurred somewhere between 9LR and 8XK of one word only and even NSF, who could not do otherwise, sent the word as they received it. This caused a lot of stations to get one word not correct and naturally marked for the error, as there was no other way to do it.

INCIDENTS OF THE RELAY.

Hertz, of Washington State, who was to send the relay East, got into trouble at the last minute,

Hear the Message all Over the House



With the Radio Magnavox you can receive the message altho away from your Station. When the Radio Magnavox is used with a suitable amplifier—you will get radiophone music that you can dance by; and the volume is greater than any other receiver.

The Radio Magnavox works on the same electro-dynamic principle as the Magnavox Radio Telemegafone, and will reproduce signals with the same volume.

It has been operated on three or four dry cells with good results, and its success is widespread. Especially desirable for wireless clubs and teachers. Write for Bulletin 27 and get full details, or better, send \$45 and get the Magnavox.

Magnavox

J. O. MORRIS CO., Inc.

1270 BROADWAY

NEW YORK

Eastern Distributors

I enclose \$45 in a money order for which you will send me a Radio Magnavox by express, prepaid. J. O. Morris Co., Inc., 1270 Broadway, New York, N. Y.

Name

Address

STUART "77"



DEALERS WE HAVE AN ATTRACTIVE PROPOSITION FOR YOU

Business is Good on GOOD "B" Batteries — Because GOOD "B" Batteries Make Good Business.

Stuart Batteries bring in the signals until the last bit of energy is gone. Then you realize that Stuart Batteries give you longer life, more PEP and better service at a reasonable cost.

No. 5677. Small price—popular size—tremendous PEP. Size 5" x 3" x 2 1/4". Weight 2 1/4 lbs. Price \$2.25.

Send us the name of your dealer, and receive our latest Bulletin on Radio Batteries postpaid.

STUART PRODUCTS CORPORATION
663 WEST WASHINGTON BLVD., CHICAGO, ILL.

Get a Handy Binder for your RADIO NEWS. Holds and preserves twelve issues, each of which can be inserted or removed at will. Price 65c. Experimenter Pub. Co., Inc., Book Dept., 236-A Fulton St., New York.

TUSKA C. W. INDUCTANCE

Type 181
Unmounted



PRICE
\$5

Use a Tuska C. W. Inductance in your new tube set. Send your dealer's name and 5 cents for our illustrated C. W. Booklet.

THE C. D. TUSKA COMPANY
HARTFORD, 3 - CONN.

Have you something to sell or exchange? A classified ad in *Radio News* will reach 40,500 for only 6c a word.

but we had him covered by 7YS, St. Martins College, Lacey, Wash., who sent in his stead. Bessey, of Sunnyvale, Calif., who was to start the MSG east from California, went fishing and forgot it, but was located thru our frantic efforts and put the southbound MSG thru in great shape.

Personally I want to thank each and every one who helped in this relay for their wonderful assistance and co-operation. I do not believe that there is in this world a body of men or boys that works closer together for the common cause, than our amateur radio workers.

H. P. Maxim's station in Hartford, Conn., started the west-bound MSG and was considerably handicapped by local QRM, but his sigs were clearly read in the Middle West, as the report shows.

The reason that the relay results were not printed sooner, boys, is on account of the magazines wanting the story about two months before you get your magazine, and after crawling thru about two tons of letters and sorting them, reading, checking, tabulating, marking, etc., I found that two months were gone.

RESULTS OF RELAY.

Fourteen Governors of as many States read this message from the amateurs, several of them being called out of bed by the amateurs to sign for the message. A certain Catholic priest got the governor of his State out of bed to sign for the message, and this Governor, who lives in the South, that it was a message from the "night riders," but our friend the priest told him it was the "radio riders."

Two hundred and forty-seven mayors of as many cities were disturbed at all hours to sign for the message and did so like real fellows.

One enterprising amateur had the nerve to give to the then President Wilson at Washington, D. C., a copy of Mr. Harding's message. This was carrying out orders in great shape. Twenty-two United States Senators, 35 State Senators, over 500 Chiefs of Police, Selectmen, City Councilmen, Sheriffs, Postmasters and News Editors, received the message. This was a most wonderful showing and some of the reports sent in were really masterpieces. Some made errors in time of sending stations, call letters, etc., and will have a whole year to improve their receiving in order to get the next national message correctly. Some amateurs worked in pairs, but the results were only put in the name of the one to whom the receipt was given. Everyone in the United States engaged in the wireless business was solicited for prizes and willingly gave to the limit allowed, that was one prize only from each one. All the sending stations that helped in the relay have been sent a complete report of it by the writer and can tell easily who read their signals and just how far they went under the bad conditions prevalent. The tabulated report on the relay was submitted to the Prize Committee, A. N. Goldsmith, Institute of Radio Engineers; E. H. Armstrong, of Yonkers, N. Y., whom you all know, and Hiram Percy Maxim, of Hartford, Conn. All three agreed on awarding the prizes on the basis of speedy and correct reception, together with the marks for the perfect wireless report about the conditions. All of this figured down to miles per minute in receiving and delivering.

Very few of you will be able to comprehend the great amount of work in connection with this relay and hope that the awards will meet with your approval and that you all will thank the many dealers who made the distribution of prizes possible. The first prize winners were consulted as to their pick of the prizes and the others awarded on the basis of their report marks and the relative value of the prizes. The prize winners are listed below without their addresses, which the writer has, and to get your prize merely send a letter to W. H. Kirwan, Box 148, Davenport, Iowa, stating what prize you get and the writer will approve it and send it on to the donor of that prize. If anyone has any trouble getting his prize, merely drop another line and we will get you straightened out. All the possible advertising you can do with your prize please do, as it will show the real world who the co-operative dealer is who takes enough interest in the game to make the relays worth while. Do not judge the prizes by their value, but by the fact that they are prizes.

As stated before, the only lady in the United States who received the message correctly and made good time and turned in a good report was Miss Winnie Dow, of Tacoma Wash. I have not written to anyone yet about the prizes, as the magazine they read is the place to find out all about it. Do hope that the magazines will publish Miss Dow's foto so we can all take a look at her and hear something of her work. Lots of ladies sent in reports but a great many considered the report as a joke and their marks were likewise.

A certain man in the Middle West sent in a report as a lady and used a lady's name, but a little wireless detecting soon found him out and we sent his report back to him to frame and show his children when he grows up, how he nearly won a prize—almost. The first prize was won by Leander L. Hoyt, of Hayward, Calif., whose report decided all the judges. Hoyt worked with S. D. Browning in his city and says that he also deserves credit. Mr. Hoyt also won in 1917 the long wave Chambers coupler as fifth prize. Mr. Hoyt says nothing will satisfy his craving but the Clapp-Eastham ZRF regenerative receiver, and when he complies with the request in the story, we will see that he gets it and tells us all later how it works.

The complete list of the prize winners will be published in the next issue.

Charge Your Own Batteries With a Union Rectifier for Only 10c. to 12c. PER CHARGE

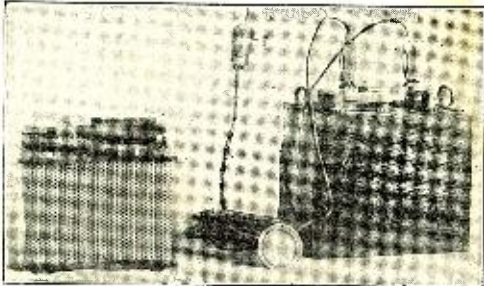

Get a Union Rectifier to charge your filament battery and Magnavox battery and your station will operate at the highest efficiency. Connect rectifier plug to 110 volt 60 cycle A. C. lighting socket and connect clips to battery and turn on current at socket. The ammeter on rectifier shows the current flowing and the rectifier operates automatically and with a little care should last for years.

Type A. Rectifier 6 volts, 5 to 8 amperes, complete with ammeter and battery clips...\$20.00
Type B. Rectifier, 12 volts, 6 amperes, complete with ammeter and battery clips.....\$27.00

Descriptive bulletin on request.

Order one of these rectifiers today and keep your batteries charged.

UNION RECTIFIER COMPANY
MONROE, N. C.

VARIABLE-ACE "B" BATTERIES-PLAIN

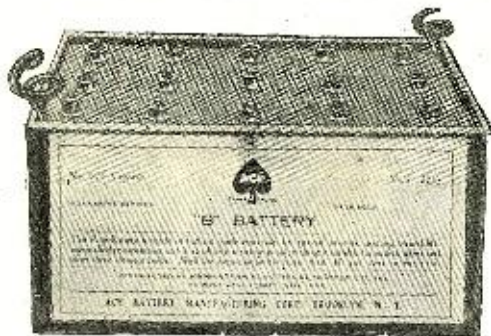

==Use the Best==

Ace "B" Batteries

Dealers
Sell the "Best"
with our Special
Inducements

Write for Catalog No. 15

| Cat. No. | Plain | Size. | Voltage. | Hrs. Ser. | Lbs. Taps. | Price. |
|----------|----------|-------------------|----------|-----------|------------|--------|
| 623 | Plain | 2 1/2 x 2 x 3 3/4 | 22 1/2 | 400 | 1 | \$1.50 |
| 623 | Variable | 2 1/2 x 2 x 3 3/4 | 22 1/2 | 400 | 1 | 1.75 |
| 625 | Plain | 3 x 4 x 6 3/4 | 22 1/2 | 1400 | 5 | 2.50 |
| 625 | Variable | 3 x 4 x 6 3/4 | 22 1/2 | 1400 | 5 | 3.50 |
| 626 | Plain | 3 x 8 x 6 3/4 | 45 | 3000 | 10 | 5.00 |
| 626 | Variable | 3 x 8 x 6 3/4 | 45 | 3000 | 10 | 6.00 |

ACE "B" BATTERIES are made according to government specifications, and are especially adapted for Plate Circuit in Detector or Amplifying Tubes.

Guaranteed not to Depreciate more than 10% in 1 year when not in use Absolutely Moisture proof

A few of the dealers handling Ace "B" Batteries

Am. Electro Tech. Appliance Co., New York.
Continental Radio & Electric Corp., New York.
Drefuss Corporation, New York.
W. B. Duck, Toledo, Ohio.

David Killoch, New York.
Manhattan Elec. Supply Co., New York.
M. Muller, Boston, Mass.
Vimy Supply Co., Toronto, Canada.

Whithall Elec. Co., Springfield, Mass.

ACE BATTERY MFG. CORP.

44 COURT STREET Phone Main 8373 BROOKLYN, NEW YORK

AGENTS WANTED

New Daily Radio Weather Report

(Continued from page 874)

The bulletin is divided into two parts and invariably begins with the letters USWB (U. S. Weather Bureau). The first part consists of surface weather conditions based upon observations taken at 8 a. m., 75th meridian time, and of upper air observations begun at 7 a. m., 75th meridian time, of the date of distribution. The second part of the bulletin consists of synopsis of general atmospheric pressure distribution, including the locations of high and low areas, and the barometer readings at their centers; wind and weather forecasts for Atlantic and east Gulf offshore areas; storm and hurricane warnings for these areas; and flying weather forecasts for each of six aviation zones.

OPPORTUNITY AD-LETS

Follow these advertisements every month. Reliable advertisers from all over the country offer you their most attractive specials in these columns.

Classified advertising rate six cents a word for each insertion. Ten per cent discount for 6 issues, 20 per cent discount for 12 issues. Name and address must be included at the above rate. Cash should accompany all classified advertisements unless placed by an accredited advertising agency. No advertisement for less than 10 words accepted.

Objectionable or misleading advertisements not accepted. Advertisements for the August issue must reach us not later than July 10.

THE CIRCULATION OF RADIO NEWS IS OVER 40,000

EXPERIMENTER PUBLISHING CO. INC., 233 and 236 Fulton Street, New York, N. Y.

Automobile Accessories.

Autoists—"Saviorgas"; easily mixed. Saves gas. Decarbonizer. Recipe, 10c coin. Hawthorne Co., Roslyn, Wash.

Auto Motors Supplies—Buick, Michigan, Standard-Dayton, E. M. F., Cadillac, Overland, Continental and Buda Motors. All types, \$60 each and up. New Dixie magnetos, \$20; Splittorf high tension magnetos, \$10; Kellogg pumps \$3.50; Auto-Lite generators, new, \$10; air gauges, 65c; Remy ignition coils, new \$3; electric and gas headlamps, coils, distributor heads, air compressors, etc. Write for catalog. Motor Sales Dept., 16 West End, Pittsburgh, Pa.

Motorcycles—Bicycles.

Don't Buy a bicycle motor attachment until you get our catalog and prices. Shaw Mfg. Co., Dept. 1606, Galesburg, Kans.

Used Parts for all motorcycles. Schuck Cycle Co., 1922 Westlake, Seattle, Wash.

Motors, Generators and Dynamos

Special Garage Motors—Manufactured by the General Electric Co.: 1 H.P., \$78.50; 2 H.P., \$110; 3 H.P., \$128.50; 5 H.P., \$166.50. All sizes both single and polyphase motors for immediate delivery. Special charging generators, all voltages. Write for catalog. Motor Sales, Dept. 16, West End, Pittsburgh, Pa.

Agents Wanted.

Big Money and fast sales. Every owner buys gold initials for his auto. You charge \$1.50; make \$1.35. Ten orders daily easy. Write for particulars and free samples. American Monogram Co., Dept. 133, East Orange, N. J.

Beginners—Complete mail order system, R. Box 1005, Atlantic City.

Inkechta! Most dependable protector for lady or gent. Saves worry and annoyance. Send 50c for sample and agents' discount. Kerita Specialty Co., 21 Prospect St., Holyoke, Mass.

Help Wanted.

Detectives Earn Big Money. Excellent opportunity. Travel. Great demand everywhere. Fascinating work. Experience unnecessary. Particulars free. Write, American Detective System, 1968 Broadway, New York.

Be a Mirror Expert. \$3-\$10 a day; spare time home at first; no capital; we train, start you making and silvering mirrors, French method. Free prospectus. W. R. Derr, Pres., 579 Decatur St., Brooklyn, N. Y.

Earn \$25 Weekly, spare time, writing for newspapers, magazines. Experience unnecessary; details free. Press Syndicate, 5665, St. Louis, Mo.

Wanted—Experienced amateur operators east of Chicago having or who can rig up for long wave up to 4,000 meter receiving apparatus with 2-stage audio-frequency amplifier, vacuum tube detector, 2 storage batteries A and B. Address G. F. Von Kummer, 116 Nassau St., New York.

Radio Operators—Amateur radio operators wanted to form a communication division 1st Battalion Naval Militia and U. S. N. R. F. Practical work and instruction radio and radio telephones. Many summer advantages. Week-end and fifteen-day cruises in Eagle boats to West Indian ports. Retainer pay while serving, full pay when cruising. No interference with civilian duties. Inquire any Monday evening, Communication Officer, U. S. S. Granite St., foot W. 97th St. (via 96th St. and Broadway), North River, Manhattan.

Health.

Tobacco or Snuff Habit Cured or no pay: \$1 if cured. Remedy sent on trial. Superba Co., SB, Baltimore, Md.

Pyorrhea (Rigg's disease—bleeding or swollen gums)—hundreds have been helped by "Pyorrident" the successful home pyorrhea treatment. Purifying, healing, preventative. Full month's treatment, consisting of a very beneficial massage paste and an antiseptic tooth-cleansing paste to be used in place of your ordinary dentifrice, together with full directions for treatment. \$1 postpaid. Or write for free booklet "R." Pyorrident Mfg. Co., 489 Seventh St., Brooklyn, N. Y.

Electrical Supplies and Appliances.

Navy Test Galena Crystals—Supersensitive, mounted crystals, value 50 cents each. Sale at 30 cents each. Harry T. Gleich, 490 Sixth Ave., New York City.

Electricians—Wiremen, linemen, send your name and address for descriptive literature of our modern blue print chart method of electrical wiring. Over 350 practical diagrams. Electrical Wiring Diagram Co., Box C-173, Altoona, Pa.

Storage Batteries for automobiles. We furnish all parts and moulds for making them. Sample plate, 40c. Foreign countries, 50c. Windsor Specialty Co., 5419 Windsor Ave., Chicago, Ill.

Used Magneto Telephones, thoroughly overhauled, like new, 1,000 ohm bells; will work 12 on a line; instruments guaranteed. Worth twice the money, \$5 each. Two or more \$4 each. G. Walter Varrell, Laconia, N. H.

47 Drullard Ave.,

Lancaster, New York,

February 7, 1921.

Experimenter Publishing Co.,

233-236 Fulton St.,

New York, N. Y.

Gentlemen:

Please put the attached advertisement in the March issue of RADIO NEWS.

It is a ten-word ad-let and I enclose sixty cents in stamps in payment. I would like it to be in the March issue.

My brother received perfect results with ad-let he sent you last month.

Yours truly,

(Signed) KENNETH SWANSON.

Business Opportunities.

Substantial Manufacturing Corporation wants capable men to establish branch and manage salesmen; \$300 to \$2,000 necessary. Will allow expenses to Baltimore as explained. Address Mr. Clemmer, 603 N. Eutaw St., Baltimore, Md.

Make Big Money—Start a business of your own. We give full instruction to succeed. Guaranteed formulas how to manufacture: Silverplating powder, liquid court plaster, straw hat bleach, re-silvering mirrors, dressing and polish for tan shoes, luminous paint, toothpaste for collapsible tubes, soap bubble liquid. All for 50 cents. The Sydney Specialty Co., 43 Murray St., New York City.

Convert Each Spare Moment into cash. My new, dignified methods, requiring no investment, no merchandise nor peddling, will enable you to increase your income 100 per cent immediately, without study or experience. Robert Stokey, 2206 Elm St., Dallas, Texas.

Be Moving Picture Operator—Big pay. My system helps you qualify. Answers to important questions, \$1. Chief Operator Stepanik, 58F West St., New Britain, Conn.

"The Schemer," Alliance, Ohio, prints big profit-producing schemes; one subscriber making \$25,000 from three schemes; another \$10,000 from one. See for yourself. Trial three months, 25c.

Boys—Earn plenty money in spare time. Let us show you how. Write today. Meirock Laboratories, 5129 Marmora Ave., N., Chicago, Ill.

If You Want to Sell or exchange your farm, unimproved land, city property or patent, write me. John J. Black, 194th St., Chippewa Falls, Wis.

Books.

We Buy and Sell back issues of Radio Amateur News and Electrical Experimenter. Boston Magazine Exchange, 109 Mountfort St., Boston, Mass.

The Amateur Electrician—Pocket size, 20c, coin. Joe Tillberg, Proctor, Vermont.

"Ten Days"—Stories from Boccaccio's "Decameron," best you ever read; 35c postpaid. Martin, Box 67R, Pontiac, Mich.

Concordia Magazine, Quarterly, 9 Water, York, Penna., prints essays, stories, current events, poetry, formulas and plans. Send \$1 for three-year subscription.

The How and Why of Radio Apparatus, by H. W. Secor, E. E. This newest book on radio matters fulfills a distinct gap in wireless literature in that, while the treatment is made as understandable and as free from mathematics as possible, it at the same time incorporates a wealth of technique and instruction for the Radio Amateur—the Radio Operator—the Installation and Designing Expert—as well as teachers and students of the subject in general. A very broad field has been covered by the author, at the same time giving a great deal of information not found in other text books. If you are engaged in any branch of the Radio or allied arts at all you will surely need this latest contribution to radio literature, which is destined to be found on every radio man's book shelf before long. A glance at the following list of chapters gives but a very scant idea of the extensive and useful radio knowledge provided in its text: The Induction Coil; The Alternating Current Transformer; Radio Transmitting Condensers; The Spark-Gaps; Radio-Transmitting Inductances; Radio Receiving Tuners; Radio Receiving Condensers; Detectors; Telephone Receivers; Radio Amplifiers; Construction of a Direct Reading Wavemeter and Decimeter; Antenna Construction; The Calculation and Measurement of Inductances; Appendix containing very useful tables, covering all subjects treated in this very unusual book. This newest of Radio Works, cloth bound in Vellum de Luxe, Gold Stamped and Hand Sewed, has 160 pages. Size of book 6x9 inches. The How and Why of Radio Apparatus, Postpaid \$1.75. Experimenter Publishing Co., Book Dept., 236a Fulton St., New York City.

Correspondence Courses.

Dollars Saved—Used correspondence courses of all kinds sold, rented and exchanged. List free. (Courses bought.) Lee Mountain, Pisgah, Alabama.

Motion Pictures

Motion Picture Cameras, \$30; projectors, \$10; particulars, 5c. Werner, High Ridge, Missouri.

Motion Picture Machines and Films. Bargain lists. National Equipment Co., Duluth, Minn.

For Advertisers.

Don't Wait for Business.—Advertise and get it. We will help you. Jacobus Service, 41 Bruen, Irvington, N. J.

Instruction.

Recharge 25 dry cells, no expense except for 10c worth alcohol. Directions, dime. Gilbert, 746 Chenango, Binghamton, N. Y.

Mathematics Taught By Mail—Spare time home study course, including arithmetic, geometry, algebra and trigonometry. J. A. Harding, 76 Brighton Ave., Highland Park, Mich.

Locksmiths—Get valuable chart for cutting tumbler padlock keys, \$1.00. Globe System, 136 Sixth Ave., New York.

Novelties.

Genuine Indian Baskets.—Wholesale catalogue. Marion Gilhams, Highland Springs, California.

News Correspondents

Earn \$25 Weekly, spare time, writing for newspapers, magazines. Experience unnecessary; details free. Press Syndicate, 566 St. Louis, Mo.

Patent Attorneys.

Millions Spent Annually for ideas! Hundreds now wanted! Patent yours and profit! Write today for free books—tell how to protect yourself, how to invent, ideas wanted, how we help you sell, etc. 301 Patent Dept., American Industries, Inc., Washington, D. C.

E. T. Brandenburg (former patent expert, Ordnance Division, War Department), Attorney-at-law and Solicitor of Patents, 927 Loan and Trust Bldg., Washington, D. C. Send sketch and description, or model of your invention for careful investigation at Patent Office and unbiased report as to patentability.

Patents—Send for free book. Contains valuable information for inventors. Send sketch of your invention for free opinion of its patentable nature. Prompt service; twenty years' experience. Talbert & Talbert, 440 Talbert Bldg., Washington, D. C.

Personal.

Astrology—Stars tell life's story. Send birthdate and dime for trial reading. Eddy, Westport Station, Kansas City, Mo., Suite 30.

Phonographs.

Build a genuine Choraleon phonograph and save over half. Fine profits building and selling. We furnish motors, tone arms and necessary parts. Send for our catalog and free blueprint offer. Choraleon Phonograph Co., 621 15th St., Elkhart, Indiana.

Phonographs Direct from Factory—Complete or knockdown. Send today for large circular. Everett Hunter Mfg. Co., McHenry, Ill.

Postcards and Pictures

Ten New York Views which you may return here for mailing. Two dimes. Fullofun, 136 Sixth Ave., New York.

Printing.

Everything Printed.—Long run specialists. Samples. Quality Printery, Marietta, Ohio.

Labels, 60c per 1,000 up. Irvin J. Wolf, Station E, Philadelphia.

100 Letterheads and Envelopes, \$1.50; 100 cards and case, 75c prepaid. Crown Mail Order Print, Station A, Columbus, Ohio.

Stamps and Coins.

1000 Different Stamps, \$3.00; 500, \$1.25; 200, 25c; 100, 12c. Approvals. Michaels, 5602 Prairie, Chicago.

California Gold Quarter size and Colombia nickel coin 30c; Italy 10 Centimes and catalog 10c. Homer Shultz, King City, Mo.

Stammering.

St-Stu-t-tering and Stammering cured at home. Instructive booklet free. Walter McDonnell, 121 Potomac Bank Bldg., Washington, D. C.

Stammerers—My simple and natural method will correct your impediments. Instruction individual. Samuel I. Robbins, 246 Huntington Ave., Boston.

Telegraphy.

Telegraphy (both Morse and Wireless) and Railway Accounting taught quickly. Big salaries. Great opportunities. Oldest and largest school; established 46 years. All expenses low—can earn large part. Catalog free. Dodge's Institute, M. St. Valparaiso, Ind.

Scenery for Hire.

Collapsible Scenery for all plays. Amelia Grain, Philadelphia, Pa.

Song Writers.

Song Writers!—Learn of the public's demand for songs suitable for dancing and the opportunities greatly changed conditions offer new writers, obtainable only in our "Song Writers' Manual and Guide," sent free. Submit your ideas for songs at once for free criticism and advice. We revise poems, compose music, secure copyright and facilitate free publication or outright sale of songs. Knickerbocker Studios, 319 Gaiety Bldg., New York.

Wanted to Buy

It is Like Finding Money when you mail us old or broken watches, false teeth, brooches, bracelets, old or broken jewelry, old gold, silver, platinum, diamonds, magneto points, platinum wire, contact points or crucibles, mercury and anything valuable. We pay the highest prices in cash by return mail. Goods returned in ten days if you're not satisfied. The Ohio Smelting and Refining Co., 207 Lennox Bldg., Cleveland, Ohio.

Want to Hear from party having farm for sale. Give particulars and lowest price. John J. Black, 194th St., Chippewa Falls, Wis.

Wireless.

If This Should Catch the Eye of radio amateurs or experimenters in mechanics; it would be to their advantage to call at 2082 Lexington Ave., near 125th St., New York, and look over the line of wireless apparatus, condensers, cabinets, parts and odds and ends. Also machines, motors, experimental material of every description offered for sale. Only reasonable prices asked. Can be seen all day from 9 A.M. to 8 P.M., Saturday and Sundays included.

Alkaline Storage "B" Batteries equipped with rectifiers and single cell control switches. Thirty-two volts, \$8; 50 volts, \$10; 70 volts, \$12; pictures and further information upon request. Estimates given on unmounted cells. Kimley Electric Mfg. Co., 290 Winslow Ave., Buffalo, N. Y.

Complete Wireless Telephone of 2 W N. Motor-generator gives 350 D.C., operates on 110 A.C. Complete filter system designed for this generator, absolutely no hum. Filament transformer for 4 tubes. Two five-watt tubes. Microphone desk stand. Remote control relays. Weston and Roller-Smith instruments. General Radio sockets, rheostats. Bus wiring. Everything first class. Heising modulation with Acme transformer. This set must be seen and heard to be truly appreciated. Price \$150. Kenneth Bainbridge, 823 Riverside Drive, New York City.

Dodge Short Cut made it possible to memorize and master Continental code in about one hour. Thousands have. So simple everybody can what was tiresome task now pleasant pastime. Send 50 cents for complete chart or ask for free testimonials from thirty-six states. Investigate and profit by experience of others. C. K. Dodge, Dept. N. C., Mamaroneck, N. Y.

Aluminum Condenser Plates 5 cents. Washer 5 cents dozen. 10 cents for samples. Gravenstede, 84 Hancock Ave., Jersey City.

Variocouplers on Bakelite Tubes, \$5.25; variometers, inside windings, \$4.25; complete for panel mounting; also carry all parts for above units, oak cabinets with and without bakelite panels, bakelite tubes, magnet wire, DCC No. 24, ¼ lb., 40c.; No. 26 DCC, 50c., ¼ lb. all other sizes in proportion. Meade Bakelite and Radio Apparatus, 522 Central Ave., Brooklyn, N. Y.

All Kinds of Radio and electrical apparatus. List sent free. Audion control panels with cabinet, \$7. Monte Radio Laboratories, 2221 Hunt Ave., Monterey Park Calif.

Stop! Look and Think! 5 to 30 per cent discount on well-known makes of regenerative sets, variometers, variocouplers, vacuum tubes, radiophones and accessories. Only new and high grade apparatus carried in stock. Remember us whenever you need anything. The Kehler Radio Laboratories, Dept. R, Abilene, Kansas.

Eldredge Meters. These meters are excellent for incorporating in radiophone sets. The Advance "Midget" ammeters and voltmeters, 12 ranges A.C. and D.C. may be used for controlling both direct or alternating current, from transformers, on the filaments of your vacuum tubes or power tubes. The radio frequency ammeters and milli-ammeters are just the thing for the radiation, grid and plate circuits. Each one has hand-calibrated, individually engraved scale dimensions, distinguished by their high polish nickel finish, unvarying accuracy over 25 years of service, and at reasonable prices. Send for a booklet describing these meters. The Kehler Radio Laboratories, Dept. R, Abilene, Kansas.

Blue Prints—We put your favorite hook-up on tracing cloth, 9 x 12 inches for 50 cents, three for \$1.25. You can then make all prints you want. Have you obtained our VT diagrams for receiving and phone sets? They are making a hit. 50 cents for either set of 12 separate sheets. Full range of circuits at your finger tips. We prepare drawings, carrying out your ideas for any kind of apparatus. Finest drafting at dirt cheap rates. Cabinet sets planned. Send stamp. Fine wall print of Continental Code, 6 by 28 inches, 25 cents. Readable 3 feet. No stamps with orders. The Plan Bureau, 1929 McCausland Ave., St. Louis, Mo.

Slab Inductances—Set of eight, tuning with .001 MF condenser from 300 to 30,000 meters. Forward money orders, \$4.00, made payable at Atlantic Road Brixton to Perry 9 Jelf Road Brixton, London, England, and secure a set post free by return.

Pure Hard Drawn copper strips for oscillating transforme primary two inches wide, fifteen feet long; secondary, one inch wide twenty-three feet long. Makes the best of transformer; price per set of two, \$5 F. O. B. factory; shipments ten days direct from factory. C. S. Newcomb, Mars Hill, Maine.

Amateurs' Attention—Full directions for making latest U. S. Navy battleship cage type antenna, free with every order for hard drawn, No. 14 pure copper wire at 90c per hundred feet. Postage prepaid. S. Weiss, 87 South 1st St., Brooklyn, N. Y.

Have Large Quantities of used second hand material at big savings to the amateur. Write for price list. Send 4c postage for list. I. Krieger, 2120 Mapes Ave., New York City.

(Wireless continued)

Must Sell—Clapp-Eastham receiving set, cheap. Complete information sent. allam Meeder, Girard, Pa.

Baldwin Phones—The U. S. Navy, the British, French and several other European governments, in addition to most professional operators and amateurs, have adopted Baldwin phones as their standard of electromagnetic receiver excellence. The reason for this preference is apparent. Exceptional sensitiveness, combined with ruggedness gives Baldwin phones their popularity. The diaphragm is made of the finest quality selected mica with the force concentrated at the exact center as in high grade phonograph reproducers. This feature is highly important in the reception of radio-telephone music. The small armature is pivoted and designed to act as a fulcrum when connected to the diaphragm by a small link. There is no tension or springing of metal as in ordinary receivers. Four pole pieces of a single solenoid act upon both sides of a highly balanced armature. Signals that cannot be heard with the best types of receivers of conventional construction become easily readable with the Baldwin phones. Send for booklet and reasonable prices on these well known receivers. The Kehler Radio Laboratories, Dept. K, Abilene, Kansas.

Audion Detector and Amplifier, V.T., 50 cents. Honeycomb coil mountings, 25 cents. Back mounted rheostats, 40 cents. Composition for molding your own knobs, panels, etc. 35c pound. Send stamp for particulars. Palmers Electrical Equipment Co., Palmers, Minn.

Variometers—You can now have as many as you need. Why spend a lot of money for one variometer when you can have three for the same price if you use our coils and make the other parts easy according to our system. Send two dollars and we will send you four precision "egg-shell" variometer coils, blueprint instructions for completing the variometer, cement for attaching the coils and colored descriptive circular. These coils are something new. They are light, strong, self-supporting and have high efficiency. Money back if you are not delighted! Send two dollars now. Precision Radio Equipment Co., 120 Christie St., Ridgefield Park, N. J.

Introductory Offer—As an inducement to those who are not yet acquainted with our service, we will supply free of charge with each Radiotron detector V.T. \$5, or radiotron amplifier V.T. \$6.50, or A-P V.T. detector \$6, or A-P V.T. amplifier \$7, a Remler bakelite panel mounting rheostat of latest type \$1, or an Amrad panel mounting V.T. socket 90c. All tubes are shipped postpaid and insured and are guaranteed to arrive in perfect condition. The Kehler Radio Laboratories, Dept. R, Abilene, Kansas.

Intermediate Wave Tuners, no extras needed, \$35; description for stamp. C. Phipps, 407 East Eighteenth St., Brooklyn, N. Y.

Radio Phonists' Attention—High voltage generators. We supply motor generator units in various capacities especially designed for radio phone work. Low powered rotary converters, dynamotors. Fractional H.P. motors, storage batteries. Various types of meters, condensers, spark gap rotors. The new synchronous spark gap. Get acquainted with our service. Ray-di-co. 2653A, N. Clark St., Chicago, Ill.

Bargain—New one stage amplifier, \$10. Winston Sizer, Port Washington, N. Y.

Sacrifice large cabinet set, tube detector, one stage amplifier, B batteries, \$6.80; battery table Baldwin phones and transmitting set all mounted on white marble panel having washing basket full of miscellaneous, all for \$100. Also ammeters and milliammeters calibrating set. Call or write. R. Strauss, 1381 Avenue A, between 73d and 74th St., New York.

Regenerative Set for amateurs who cannot afford the variometer type. Use these staggerwound pancake coils with the tickler circuit and obtain greater selectivity and signal strength. Mount on your old panel. Set of 150-375 M, \$7; 600 M, \$7.50; 1 K.W. O.T., \$9; loops, \$4. West Philadelphia Radio Co., 4054 Chestnut St., Philadelphia, Pa.

Variometers (2) and variocoupler in cabinets with bakelite panels, complete but unwired, price \$45. Send stamp for description. We make special apparatus. Stratfield Radio Laboratory, 9 Flushing Ave., R. F. D. 1, Bridgeport, Conn.

Special Sale of Parts for radio apparatus. In order to liquidate a large stock we are offering at practically half price the following sets of complete units ready for assembly. This is an excellent opportunity to make a start in wireless. We have the following ready for immediate shipment by parcel post prepaid, on receipt of remittance: Receiving tuner, 60c; 2,000 meter loose coupler, \$2; variable condenser, .0005 mf., \$3; crystal detector, 70c; No. 14 antenna wire, 100 ft. coil, 60c; transmitting helix, \$2; ½ inch spark coil (complete assembled), \$3.50; zinc spark gap with polished bakelite base, 70c; hand key, 50c. ½ K.W. radio transformer, \$8; 1,000 ohm head phones, single, \$2; 2,000 ohm head phones, double, \$3.75; strain insulators 8c each; mica transmitting condensers .002 mfd., \$2.50. No catalogues. Send orders immediately. Kilbourne & Clark Mfg. Co., Seattle, Wash.

(Continued on page 931)

(Continued from page 933)

(Wireless continued)

Navy Test Galena Crystals. Supersensitive, mounted crystals, value 50 cents each. Sale at 30 cents each. Harry T. Gleich, 490 Sixth Ave., New York City.

Exchange.

Navy Test Galena Crystals.—Supersensitive, mounted crystals, value 50 cents each. Sale at 30 cents each. Harry T. Gleich, 490 Sixth Ave., New York City.

19 Electrostatic Condensers.—Capacity 2 microfarad each. Will stand discharge over a parallel gap of 2.5 mm. (.1 in.) between flat faces 1-16 in. x 3/4 in. Good for high frequency work; \$45 each. Ajax Electrothermic Corporation, Trenton, N. J.

Dirt Cheap.—Cabinet receiving set comprising 2,500 meter loose-coupler, 21 primary switch taps, 11 secondary, high selectivity; 43-plate aluminum variable condenser; 3 point battery switch, rheostat; audiotron-adaptor, \$15 complete. Have heard conversation from Cape Cod, 410 miles away, using indoor aerial L. R. Ferguson, LeRoy, N. Y.

3,000 Meter Coupler, \$6; 600 meter coupler, \$10; spark coil transmitter complete, \$15; buzzer, \$1.75; key, 75c; detector, \$1.50. All good condition. Hawkins, Alden, Minnesota.

Sale.—\$11 Rogers jig-saw, \$6 (f.o.b.); good condition. Kuper, 407 W. 21st St., New York.

Amateurs by a very few changes you can absolutely get rid of all capacity effects of your body when operating your set controls and get louder signals than you ever heard before with no distortion. Results guaranteed. Complete instructions with blue prints how to make or change your set, only \$1. David Monroe, East Orange, N. J.

Bargain.—National Radio Institute correspondence course instruments, \$20. Literature \$25. All, \$42. One-half inch coil (gap), \$3.50. Books, etc., stamp. Charles Moore, Kenton, Ohio.

Sell.—2 Murdock 366, \$3.75; 3 coil mount, \$4.50; Murdock and other apparatus cheap. Ed Page, Baldwinville, N. Y.

Two Inch Spark Coil, \$7; gap, \$1. Both new. Arthur Post, Harrison St., Passaic, N. J.

Sell.—Chicago Radio Laboratory's audion control cabinet, listed \$22; sell \$10; new. Walter Pfeifer, Dodge's Institute, Valparaiso, Ind.

Let's Swap! Buy! Sell!—What'd'ye got? What'd'ye want? Forward price, description and quarter for listing, including year's subscription, Swap Bulletin, New York-Detroit-Wichita Falls, Texas.

Unmounted Long Distance receiving induction coils. These are duo lateral wound coils, each wound at five points. Two coils with a tickler make an unbeatable receiving combination. Range from 200 to 25,000 meters, Arlington to Lafayette. Prices: primary and secondary coils, \$3.50 each. Tickler coil, \$2. Send \$9 for the three coils and diagram, and make a guaranteed receiving set. P. J. Stockwell, Reading, Mass.

Unmounted jig-coil set with audiotron variable, 2000 ohm coils, etc.; dial controls, price \$32. Complete except A and B batteries. D. Shepard, Mantsville, Conn.

Bargain.—New audion control, \$5; amplifier, \$20; generator, 150-600 M., \$15. Money back \$10.00. R. D. Ewert, Hyattsville, Md.

Bargain.—Single cylinder Harley Davidson motor for radio apparatus. Write Warren Meaford, Okla.

Bargain.—Detector and one step, with phones, bulbs, "B" batteries, \$40. Regenerative receiver, \$20. Isadore Wolf, 1829 Evergreen Ave., Chicago.

New Eastham half K.W. Hytone transformer, rotary gap and motor complete, \$50; one Simon 1/2 K.W. 500 cycle generator and transformer combined, \$25; one 1/2 K.W. 500 cycle transformer, \$20. Sinclair Raynor, 8 N. Main St., Freeport, N. Y.

First New and Complete wireless set for sale. Particulars write James Roff, Box 177, Bellaire, Ohio.

For Sale.—1/2 KVA transmitting station, \$20, complete. Robert Champion, 517 Park Ave., Williamsport, Pa.

50 Volt D.C. direct from 110 volts 60 cycle line for radiophone transmission. Capacity 50 watts; price \$30. Order early for quick delivery. J. Fitch, 181 W. Housatonic St., Pittsfield, Mass.

Wireless Apparatus at remarkably low prices. Write me. Earnest Fuller, New York, N. Y.

Rotary Spark Gap, \$12; aerial switch, \$5; enclosed .0115 MFD glass plate condenser, \$3; amplifier panel with tube, "B" batteries and connected, \$15. Raymond Fiedler, 70 Sargent St., Lawrence, Mass.

Potentiometer, \$1.95; Clapp-Eastham 43 plate condenser, \$4.75; Treco 11 plate condenser, assembled, \$1.50; storage battery, 6V, 60 amp., \$12. Everything guaranteed. F. O. B. Edward Beaver, 710 Third St., Milwaukee, Wis.

(Exchange continued)

Sale.—One kilowatt 42 volt 24 ampere Robins & Myers dynamo; cost \$80; guaranteed good as new. Make me an offer. J. W. Thomas, Jr., Shelby, Miss.

For Sale.—Regenerative receiver CR1 style, beautifully made, brand new, \$50 and express. A. P. Southworth, Chestnut St., Wakefield, Mass.

For Sale.—The record breaking receiving set, 3,300 miles, used by 2KF, as illustrated in March issue Radio News, consisting of detector and 3-stage amplifier, hardwood cabinet, bakelite panel. This outfit is a beauty and a bear for long distance. Perfect working condition is guaranteed. Tunes from 175 to 600 meters sharp. Will take \$110 cash, or send \$40, balance C. O. D. Selling because of installing radio-audio set. H. D. Selvaige, 45 Durand Place, Irvington, N. J.

Bargains.—Detector and 2-step amplifier, detector cabinet, 1/2 K.W. sending set; 110 volt motors; aerial wire; everything complete. Enclose three red stamps for photo, if you mean business. Alon Shevman, 682 Highland Ave., Meadville, Pa.

For Sale.—No. 2 Junior omnigraph, perfect condition, \$16. C. H. Tanner, Canton, Ill.

Sell.—Croft elec. Library, new, \$20. W. L. Pucket, Cave City, Ky.

Exchange.—Dealers stock postage stamps and supplies; will catalogue about \$500, for 2-step amplifier with tubes or other high grade radio apparatus in first class condition. Philatelist, 326 High St., Watertown, N. Y.

DeForest Unit Panels.—Variable grid condenser and leak, filament rheostat, single coil mounting, audion socket panel, battery switch and telephone posts, 35 per cent off prices DeForest catalog D; Chelsea variable grid leak, \$2; all good condition. Wanted, Magnavox. Wesley Robinson, Jr., St. Marys, Georgia.

Q.S.T.—1/2 K.W. Acme, \$23; high speed rotary with sawtooth rotor, \$10; oil condenser, .007 mfd. S.A.O.A., Walter McCoy, Dormont, Pittsburgh, Pa.

For Sale.—Honeycomb coil tuner, \$25. Clarence Ott, 2121 Sheffield Ave., Chicago, Ill.

Stamp Collection.—Two collections of 800 stamps each; \$10 each, prepaid. R. Osborn, Darien, Conn.

Stop! Look! and Think!—5 to 30 per cent discount on well-known makes of regenerative sets, variometers, variocouplers, vacuum tubes, radiophones and accessories. Only new and high grade apparatus carried in stock. Remember us, whenever you need anything. The Kehler Radio Laboratories, Dept. R, Abilene, Kansas.

For Sale.—3,500 meter crystal receiving outfit Murdock phones, \$18; 10,000 and 3,500 meter leading coils, \$8; 1920 issue Science and Invention, \$4. Louis London, 3109 Cumberland St., Philadelphia, Pa.

Bargain.—K.W. transmitter. Best distance 1,800 C.V. motor-gen. Kohnitz, Navy Radio, Duluth.

For Sale.—Direct-reading ohm meter 0-1,000; bargain, \$11. E. F. Gard, 24 Cedar Ave., Elizabeth, N. J.

1 Amrad 6 volt induction coil, \$30; 1/2 K.W. quenched gap, \$9. one-inch spark coil, \$3. Items will be sent C.O.D. A. Hubner, 1842 Westwood Ave., Cincinnati, Ohio.

For Sale.—Emerson motor, 3 speed, 110V, 60C, 1/2 HP, \$15; 110 and 6 V portable test set, \$10; 4x5 (Bausch Lomb) rapid shutter and rectilinear lens, \$10. Cash please. Marvin Harold, West Plains, Missouri.

For Sale.—Coil mounting and 5 coils, \$17. Will trade. DeWitt Harris, Clarkdale, Ark.

Will Exchange.—\$100 chemical outfit for wireless apparatus or will sell for \$60. E. P. Johnson, Oakdale, Tenn.

For Sale.—Cameras, rectifier, punching bag, motors, Hawkins guides; send stamp for list. Lawrence Johnston, Fairfield, Ill.

For Sale.—DeForest ten panel set with bulb, \$48. William Kivimaki, 317 Independence, Fairport Harbor, Ohio.

For Sale.—1 K.W. type R Tardaron, new, \$28; glass plate oil condenser, \$10; oscillation transformer, \$3. A transmitting set at a sacrifice. 9YAE, D. O. Kime, Le Mars, Iowa.

Marconi Wireless Records (8), \$4; \$35 Victrola, best offer goes. Pair Murdock phones, \$3; key and buzzer, \$1. P. Krawiec, 15 Woodbine St., Brooklyn, N. Y.

Bargain.—Regenerative receiver, has Corwin dials, tube, tube controls, 4 condensers, bakelite panel, vario-coupler, variometers, \$36; Willard 6 V. 150 A. battery, \$22; 3,000 meter panel receiver, has coupler, tube, tube controls, 4 condensers, \$27.50. Send for list. D. H. S. Cone Association, Dover, Ohio.

Will Trade wireless for high-powered field glass, preferably; or other goods. Have Ducks Arlington loose coupler, Murdock phones, condensers, and complete vacuum tube and crystal detectors; all new. Send particulars for same. Walter Scholz, La Crosse, Wash.

Rotary Condenser; 2 in. coil transmitter complete. J. Swank, R. R. 16, Dayton, Ohio.

(Exchange continued)

For Sale.—Wireless receiving apparatus, audion, coupler, etc., also printing press 5 x 8 in. Call after 7.30 P. M. Leonard Beck, Lafayette, 6211.

Exchange.—Harley twin motorcycle engine, excellent condition, for 1 kilowatt transmitting apparatus. Russell Cronkright, Waseca, Minn.

For Sale.—Treco tuner, amplifying transformer, Eaton oscillator, four volt storage battery, 1/4 kilowatt transmitting set, audion and Holtzer & Cabot phones. C. R. Bradley, 90 Birdsall, Winsted, Conn.

For Sale.—Complete receiving set, \$23. Sam Bronstein, Boston 48, Massachusetts.

Treco Tuners, AS, BS and CS, \$8 each. Lawrence Alden, 5 Clifford St., Binghamton, N. Y.

For Sale.—1 0-125 voltmeter, and 1 0-10 ammeter, Eldridge type, new. Each \$9. Lloyd Berkner, Sleepy Eye, Minn.

Bargain.—New receiving set, \$15; navy coupler, \$10, list. Bill Booth, 1300 Elizabeth Ave., Charlotte, N. C.

For Sale.—Doolittle amplifone, \$12. used about two weeks; reason for selling have large loud speaker. S. W. Brown, Mechanicville, N. Y.

Must Sell.—Unused \$60 short-wave regenerative receiver, \$30; unused \$65 long-wave undamped receiver, \$32; complete parts for \$400 radiophone and complete receiver, \$150; Spalding "Domino" tennis racket, \$3; post-card projector, \$3. Brownie No. 2 camera, \$1.50; Treco variable condenser, \$1. Terms C. O. D. P. H. Craig, 3397 Glenmore Ave., Cincinnati, Ohio.

Complete Wireless Outfit Cheap. List on request. Dehart, 867 McPherson St., Brooklyn.

For Sale.—Detector and two-stage amplifier, including phones and long wave tuner, \$70. Send for picture and description. Wm. Davis, Stanley Ave., Canon City, Colo.

Sell.—Complete tuner detector and one-step panel. Tuner has three variables, \$32. W. Daniel, 430 Cedar St., Owensboro, Ky.

Honeycomb Coils Wanted (plug type); lowest price. Bowers, 531 Madison St., Brooklyn, N. Y.

For Sale or Trade.—New \$35 professional punching bag stand, will trade for two amplifying bulbs and transformer or set of triple honeycomb coils with mounting. C. Halberg, 1445 Rascher Ave., Chicago.

Sell.—Three toy casting forms for \$8; cost \$15. Unused. Investigate. Aaron Vanatta, Houghton Ave., Manistique, Mich.

For Sale.—Complete navy standard receiving set, consisting of 1P-500 tuner, Audion control box, two-stage amplifier and three external loading coil. This navy set has been in use a very little. Price \$500, including 4 AP-tube. Just the kind for school or college. Photograph of set upon request. D. W. Toy, 200 14th St., Milwaukee, Wis.

For Sale.—Ace regenerative, 150 to 600 meters, \$50; Tuska C.W. inductance type 183, \$9. apparatus in good condition. Transportation prepaid. All letters answered. Ray Thompson, Canton, So. Dak.

Sell.—Colby, \$12.50, 200-3,000 meter loose coupler, for \$8.25. Meader Pittington, Aurora, N. Y.

Detector and One-Step Amplifier panel, 0 to 150 voltmeter, oak panel board for 18 DeForest panels, amplifying transformer. Sell cheap or swap. Write Leitch, Park Drive, West Orange, N. J.

Big Bargain.—Browns 4,000 ohm phones, new, \$15; condenser, 43 plate, \$3; audiotron with holder, new, \$4; 6 amplifying bulbs, pilotron type, new, \$8 each; amplifier and detector, home made, works perfect, \$20; navy crystal detector, \$3; Perikon detector, \$1.50; large sounder, \$1.50; one set I. C. S. electric engineering books, \$15; other big bargains. Wireless, 139 Fountain Ave., Brooklyn, N. Y.

Imagine It!—17 plate panel variable condenser, postpaid, \$1.25. Jurek, 2642 Ballou St., Chicago.

Bargain.—Complete receiving, sending set and aerial parts. Stamp for list. W. C. Grubb, Auburn Ict., Indiana.

Sell or Exchange.—Knapp dynamo, \$3; large D.C. fan, \$6.50; water motor, \$2; Edison cylinder phonograph, fine for recording signals, \$7; telephone transmitters, 50c. Postage extra. Write. D. Vallow, 636 W. 38th St., Indianapolis, Ind.

For Sale.—1 K.W. transformer, \$20; 1 K.W. Young & McColb gap, \$12; Dubilier condenser, \$20; oscillation transformer, \$10; rotary gap inclosed in home made box, \$8. You pay postage. Daryl McClung, 1221 Ninth Ave., Huntington, W. Va.

Brand New Colby long wave tuner, \$12.50; Turney spiderweb inductance, \$5.50. Will ship C.O.D. or on receipt of first Postal Money Order. I. Krieger, 2120 Mapes Ave., New York City.

Variable Condensers Cheap, with knob, scale and pointer; suitable for panel or table mounting. 11 plate condensers, \$2.30; 21 plate, \$2.75; 41 plate only \$3.75. Add parcel post for 1 lb. Henry F. Robbins, 93 Mamaroneck Ave., White Plains, N. Y.

Bargain.—Short-wave regenerator, paragon type, fine condition, \$18.75; two navy standard Dubiliers, little used, \$12.50; cabinet type two-step amplifier, Mignon transformers, A1 condition, \$19.50. Other new and slightly used apparatus. Also have some brand new power tubes. Leo Rostenberg, 15 Chestnut Hill Ave., White Plains, N. Y.

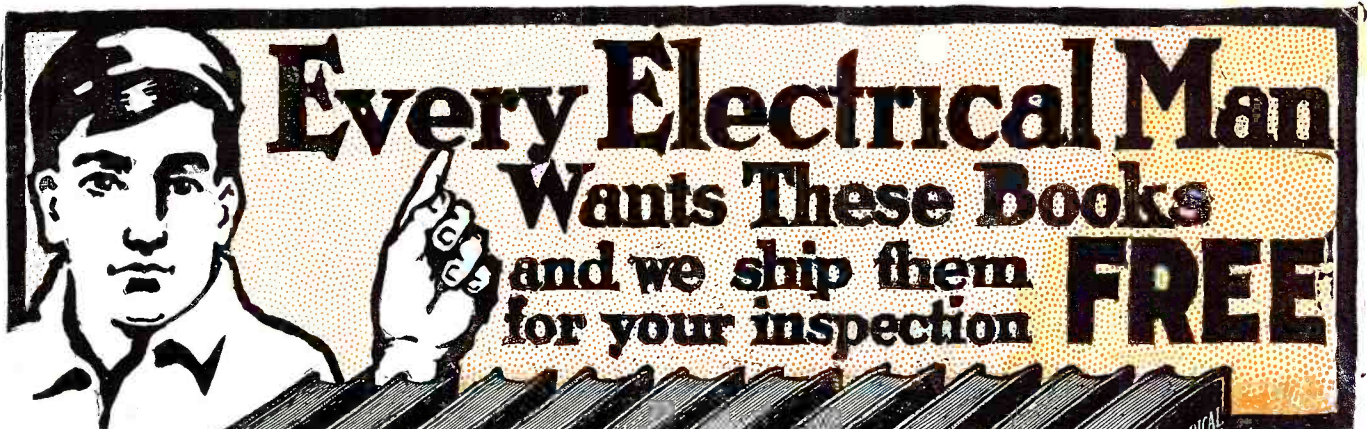

**Every Electrical Man
Wants These Books
and we ship them
FREE
for your inspection**

Flexible
Covers
—
Handy
Pocket-
Size
Volumes

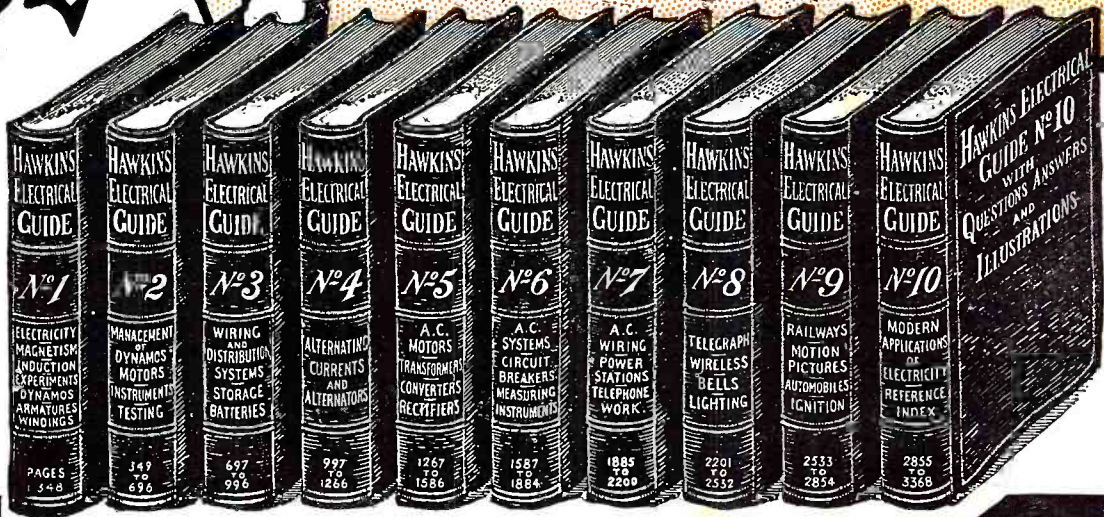

10
Volumes
3500
Pages
4700
Pictures
\$1 Per
Volume
\$1 Per
Month

Just what you need to know to succeed in ELECTRICITY

EVERY electrician, every engineer, every mechanic should know about these wonderfully helpful instructive books, which give in plain words a complete working knowledge of electrical engineering in all its phases.

You run into some new electrical problem almost every day. The information you need to help you in your every day work is in

**HAWKINS
ELECTRICAL GUIDES**

These books place electricity at your finger ends. They cover every imaginable subject, principle, theory, problem, trouble, and way of doing things electrically. Every subject is indexed so that you can turn right to it. They are a study course and a reference guide in one, written in plain every day language—no wasted words—only what you need to know—chock full of up-to-the-minute electrical knowledge. The guides are a complete course in electrical engineering. They will help you in every detail of the day's electrical work. You can't ask an electrical question that Hawkins Guides can't answer.

Pocket-Size Flexible Covers

The books are small enough to slip into your coat pocket—handsomely bound in flexible black covers. You can carry each volume with you until you have mastered its contents. 3,500 pages of actual information and 4,700 illustrations. Once you see these books and put them into actual use you will never again want to be without them. Try it at our expense.

SEND NO MONEY

It will cost you nothing to receive these books—to look them over—ask them all the questions you can think of—use them in your work—study them—pick up some information that will increase your earning ability. We will ship you the entire set of 10 volumes entirely FREE. This is a sign of our confidence in the guides. Pure gold does not object to being tested. Keep them for seven days and if you do not decide that you can't get along without them, return them to us and owe us nothing.

When you decide to keep them you only have to pay \$1.00 down and remit the balance of \$9.00 on the easy payment of \$1.00 a month till paid for. Use this coupon to get the books. It will pay you many times over.

THEO. AUDEL & CO.
72 Fifth Ave. New York, N. Y.

SEND NO MONEY-USE THE COUPON

READ THIS PARTIAL LIST OF CONTENTS

- No. 1** Contains 348 pages, 388 illustrations. Electrical signs and symbols—static and current electricity—primary cells—conductors and insulators—resistance and conductivity—magnetism—induction coils—dynamo principles—classes of dynamos—armatures—windings—commutation—brushes, etc.
- No. 2** Contains 348 pages, 394 illustrations. Motor principles—armature reaction—motor starting—calculations—brake horsepower—selection and installation of dynamo and motors—galvanometers—standard cells—ohm measurement—resistance measurement—voltmeters—wattmeters—watt hour meters—operation of dynamos—operation of motors, etc.
- No. 3** Contains 300 pages, 423 illustrations. Distribution systems—wires and wire calculations—inside, outside and underground wiring—sign flashers—fire alarm protection—rectifiers—storage battery systems, etc.
- No. 4** Contains 270 pages, 379 illustrations. Alternating current principles—alternating current diagrams—the power factor—alternator principles—alternator construction—windings, etc.
- No. 5** Contains 320 pages, 614 illustrations. A. C. Motors—synchronous and induction motor principles—C. commutator motors—induction motors—transformer construction, connections, tests—converters—rectifiers, etc.
- No. 6** Contains 298 pages, 472 illustrations. Alternating current systems—switching devices—circuit breakers—relays—lightning protector apparatus—regulating devices—synchronous condensers—indicating devices—meters—power factor indicators—wave form measurement—switch boards, etc.
- No. 7** Contains 316 pages, 379 illustrations. Alternating current, wiring power stations—turbines—management, selection, location, erection, testing, running, care and repair—telephones, etc.
- No. 8** Contains 332 pages, 436 illustrations. Telegraphy—simultaneous telegraphy and telephony—wireless—electric bells—electric lighting—photometry, etc.
- No. 9** Contains 322 pages, 627 illustrations. Electric railways—electric locomotives—car lighting—trolley car operation—miscellaneous applications—motion pictures—gas engine ignition—automobile self starters and lighting systems—electric vehicles, etc.
- No. 10** Contains 613 pages, 599 illustrations. Elevators—cranes—pumps—air compressors—electric heating—electric welding—soldering and brazing—industrial electroplating—electro-therapeutics—X-rays, etc.

Also a complete 126-page ready reference index of the complete library. This index has been planned to render easily accessible all the vast information contained in the 10 electrical guides. There are over 13,000 cross references. You find what you want to know instantly.

AUDEL & CO.
72 Fifth Ave. New York, N. Y.

Please submit for examination Hawkins Electrical Guides (price \$1 each). Ship at once, we will pay the 10 numbers. If you do not, please return to factory I agree to send you the money within seven days and to pay you \$1 each month until paid.

Signature.....
Occupation.....
Employed by.....
Residence.....
Reference..... R. N.

What Electrical Men Say
Helped Him Make Good

"It is only right for me to recommend highly the Hawkins Guides, for they have been of the greatest assistance to me in placing me in my present position as Superintendent of Construction Department of one of Ohio's largest Electrical Companies. I would like to see every man have a set of Hawkins Guides."
Geo. Knecht, Columbus, Ohio.

In the Naval Electrical Dept.
"The Hawkins Guides are great help to me in the Naval Electrical Department, which they cover very thoroughly."
C. J. Cornell, U. S. Receiving Ship, Brooklyn, N. Y.

Superintendent.
"I am now superintendent of the Dunnville Hydro-Electric Systems, and Hawkins Guides were a great help to me in holding down a responsible position."
W. E. Swartz, Dunnville, Ontario.

Wireless Operators
"I have worked wireless for ten years—but I wish I had these books years ago, as they have saved me a great deal of trouble."
H. Marshall, Steamer M & B No. 2, Walkerville, Ont.

Do Amateurs Realize the Wireless Opportunities that Await Them?

How the President of the National Radio Institute Answered this Question When It Was Put Up to Him. What Would You Have Said? Is the World's Fastest-Growing Field Actually Going to Slip Away From Those Best Able to Cash In Big On It? These Are Questions Which Will Interest Every Radio Amateur.

THAT was one of the questions recently put up to me by a well-known authority visiting Washington. "In your opinion," he said, "do amateurs realize the wireless opportunities that await them?" For a moment I was stumped! Then I replied, "Yes, with just one 'but.' I think that amateurs are well aware of the tremendous expansion of wireless that is daily going on. They realize that it is sweeping the world like wild-fire. BUT I do not think that they realize what this means to them—they do not realize that they can easily get the 'plums' that the field offers. They 'have the jump' on everyone else, and they should realize now

that 'the fastest-growing field in the world' besides being a fascinating hobby is a wonderful, opportunity-filled field offering splendid present advantages—and growing so rapidly that the future is beyond estimation!"

I wonder if many amateurs have ever considered the fact that what is to them a fascinating hobby is also a fascinating profession, filled with big opportunities that they can easily share whenever they are ready to do so. It's only a short step for them now to a splendid field that they can put their hearts into—and offering a bigger future than older businesses which are overcrowded.

Big Opportunities Are Knocking— Are Some of Us Saying "Please Go 'Way and Let Me Sleep?"

After the caller who started me thinking about this matter had left, I jotted down on my pad some of the items which I had recently noted regarding wireless expansion. On land and on sea big opportunities are opening, and even greater uses for wireless are being found every day. No doubt you too have read these items, but I am going to have them printed here because I want to impress upon you what this tremendous expansion can mean to you.

When I read every day how wireless expansion is sweeping over the world I often say to myself, "Big opportunities are knocking—I wonder if amateurs realize that they can cash in big on this growing field. While opportunities knock, I wonder if some aren't saying, 'Please go 'way and let me sleep.'" Of course, they aren't sleeping by any means, but I want all of them to know just how easy it is to fully qualify for a field which is undeniably filled with greater advantages than most others in the world today.

Easy to Qualify In Spare Time—At Home

I want to tell you—without obligation to yourself in any way—more about wireless opportunities and how you can take advantage of them. I would like to tell you about our Institute, which is officially recognized by the U. S. Dept. of Commerce and whose name heads the list of the schools recommended by the U. S. Shipping Board. This National Radio Institute was the original and is today the oldest and largest school in America teaching wireless by mail. The government allows

our graduates five to ten points credit when taking First Grade Government License examinations. We have graduates in almost every part of the world who have quickly qualified through the special method through which we make Wireless amazingly easy for anyone to learn completely at home in spare time.

These are some of the main points about this Institute and I am sorry I haven't room to tell you all of them. I should like to tell you more about our wonderful new methods of teaching, about our remarkable new invention, the "Natrometer," which each student gets free, and which almost cuts in half the time necessary to learn Wireless thoroughly. Then too I'd like to tell you about our free Post-Graduate Course and about "Dots and Dashes," about our Diploma, our Relay League, Employment Service, and about our special easy-payment plan. But there is not enough room here to tell you about all these things so I am going to ask you to write me for a new interesting booklet we have gotten up.

Write Me For Booklet

A little coupon is being put here so that you can save yourself trouble in sending for this illustrated booklet, "Wireless: the Opportunity of Today." By mailing this coupon you will not be obligating yourself in any way and no solicitor will call upon you. But the coupon will bring you some mighty interesting facts about Wireless Opportunities and about how you can quickly and easily qualify for them—at home and in your spare time.

Won't you mail this little coupon at once? Whether you are a junior Radio Amateur and want to learn all about Wireless or whether you are anxious to fully qualify so as to enter the wireless now in one of the fine opportunities open on land or on sea—write me for this booklet. All that I ask is that you write as soon as possible. And—since there is no obligation—why not write me today.

P. S.—By the way, we are making a special short-time offer, for a strictly limited time, in which we are giving all new students, our complete new course in Wireless Telephony FREE. Mail the coupon direct to me, today, and let me tell you about it by return mail. Mr. James E. Smith, President, The National Radio Institute, Dept. 16, Washington, D. C.



Mr. James E. Smith, President, National Radio Institute

What I Jotted Down

Here are the items I jotted down on my pad, showing how Wireless is growing by leaps and bounds all over the world. Let me tell you what this world-wide sweep of wireless expansion means to you and to your future.

A \$20,000,000 American corporation has been formed to establish wireless stations in every part of the globe.

The U. S. Merchant Marine operates over 30,000 vessels. Wireless is now a necessity on ships.

The Chicago Tribune now receives foreign news by wireless. Other papers are calling upon Wireless too.

Huge wireless stations are springing up all over the world. Saint Assise, France; Bordeaux, Ville Juif, and Lyons, France; Peking, China; Geneva, Switzerland; Shanghai, China; Fiji Islands; Warsaw, Poland—and these are but a few.

Many railroads are calling upon wireless to dispatch trains and carry on communication. The Lackawanna, The Louisville & Nashville, The Canadian-Pacific, The Nashville, Chattanooga & St. Louis, are some of them.—New York, Cleveland, Chicago and Detroit are connected by an inter-city wireless service.

Criminals are being intercepted by wireless through the Police Department of New York, Dallas, Chicago, and other cities.

Brokers, Bankers, Merchants, Manufacturers and other business concerns are calling upon wireless. John Wanamaker, Goodyear Rubber Co., Standard Oil Co., New York Stock Exchange, are only a few.

Farmers are getting Market and Weather reports daily by wireless in all sections of the country.

New wireless stations are springing up in every part of America. Belfast, Maine; Cape May, N. J.; East Pittsburgh, Pa.; San Francisco, Cal.; Helena, Montana; Seattle, Washington; Mobile, Alabama—these are but a few.

The Aerial Mail Service of the Post Office Department already has 12 radio stations in operation.

The Japanese are constructing a powerful station in the Orient.

A big new wireless service is being established between England and France.

The Federal Telegraph Co. is establishing a complete chain of stations on the Pacific Coast.

Messages are sent from the Philippine Islands to Washington (10,000 miles) in 3 minutes.

Daily wireless service between the United States and Japan is in full operation.—St. Johns, New Foundland, is operating a large service.

Danzig, in Europe, is carrying on large wireless operations.

Three tremendous stations are operating on Long Island at Easthampton, Port Jefferson, and East Norwich.

South America is planning to establish a chain of stations at Rio de Janeiro, Asuncion, Buenos Aires and Montevideo.

One single American concern offers wireless communication between the United States and France, England, Germany, Norway, Denmark, Sweden, Finland, Poland, Honolulu and Japan.

And these are only a few of the examples showing how Wireless expansion is spreading over the whole earth. It brings you amazing opportunities—and you can now easily grasp them.

MAIL THIS COUPON TODAY

Mr. James E. Smith, President,
National Radio Institute,
Dept. 16, Washington, D. C.

Send me your FREE book, "Wireless, the Opportunity of Today." Tell me about your Institute and your special short-time offer.

Name

Age..... Occupation.....

Address

City..... State.....