

CIRCULATION LARGER THAN ALL OTHER RADIO MAGAZINES COMBINED

# RADIO NEWS

REG. U.S. PAT. OFF.

20 Cents  
M a y  
1921

Over 100 Illustrations  
Edited by H. GERNSBACK



"THE 100% WIRELESS MAGAZINE"



# CUNNINGHAM

## DETECTOR TUBE

**Type C-300**

**General Electric Quality  
Plus Cunningham Service**

**T**YPE C300 invites comparison. Amateur requirements decided its design. Many years' research of vacuum tube properties have made Type C300 the Ideal Amateur Receiving Tube. Detector sensitiveness at low plate voltages requires that gas action be combined with the electron emission and by a wonderful new process of manufacture this gas action is so controlled that the plate voltage for maximum signal audibility is always within the limits 18—22½ volts. This tube is one of the latest products of the great Research Laboratory of the General Electric Company. Only a single block cell is needed in the plate circuit—a big saving in battery investment. Type C300 is completely silent in operation—a decided advantage in receiving weak signals.

Any three member vacuum tube is necessarily an amplifier, but the results obtained from Type C300 as a tone frequency amplifier with only 22½ volt plate battery proved a surprise. Again Type C300 invites comparison. Competitive tests show this tube to excel any tone frequency amplifier previously developed. For power amplification in operating loud speaking telephones and in complex and multi-stage circuits use the special Pliotron amplifier Type C301 for freedom from distortion. Write for special Bulletin C301.

Type C300 is a free and persistent oscillator for regenerative amplification and C. W. reception.

The pleasure and

**DEALERS:** Standard Packages F O. B. Cleveland, San Francisco, New York. Broken Packages F. O. B. San Francisco.

**Type C-300  
\$5.00**

satisfaction from operating Type C300 cannot be described. See your dealer today—or write for his name and a copy of Bulletin C300.



*E. J. Cunningham*

Trading as  
**AUDIOTRON MFG. COMPANY**  
35 Montgomery Street  
San Francisco

# A Real Advance!

150—3000 Meters



**Type CR-5 Regenerative Receiver**

We feel proud of the fact that we were the first manufacturer to adapt the Armstrong Regenerative Circuit to a receiver having a wave-length range of 150-3000 Meters.

We are even more proud of the efficient manner in which this receiver performs at any wave-length within these limits.

Included in its range are amateur, commercial and Navy wave-lengths, special land stations, ship CW stations, Navy low-wave arcs, all radio work and "Time."

Its ease of operation is unparalleled. It is a complete receiver—the only additional equipment needed are phones, batteries, and a detector tube.

See it at your dealer's today.

## For Short-Wave Results—

This combination makes phenomenal distance work an every-day occurrence in your station.

This is the famous combination that proved its merit in the relay tests some months ago. It makes a wonderful team both for ease and flexibility of operation and what is far more important—real results!

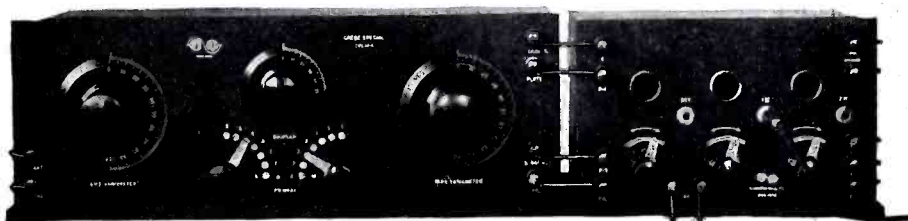

**CR-3 Relay Receiver—Detector and 2-Stage Amplifier (RORD)**

Enterprising Radio Dealers carry  
GREBE RADIO APPARATUS

*GREBE RADIO apparatus is licensed under the original Armstrong and Marconi patents.*

Bunnell & Co., J. H., New York City.  
Central Radio Company, Independence, Mo.  
Continental Radio and Electric Corp., New York.  
Detroit Electric Co., Detroit, Mich.  
Doubleday-Hill Electric Co., Pittsburgh, Pa.  
Electrical Specialty Co., Columbus, Ohio.  
Holt Electric Utilities Co., Jacksonville, Fla.  
Hurlburt Still Electrical Co., Houston, Texas.

Kelly and Phillips, Brooklyn, N. Y.  
Klaus Radio Company, Eureka, Ill.  
Manhattan Electrical Supply Co., New York, Chicago, St. Louis.  
Leo. J. Meyberg Co., San Francisco, Cal.  
Newman-Stern Co., Cleveland, Ohio.  
F. D. Pitts Co., Inc., Boston, Mass.  
Philadelphia School of Wireless Telegraphy, Philadelphia, Pa.  
Western Radio Electric Co., Los Angeles, Cal.

**A. H. GREBE & CO., Inc., 72 Van Wyck Blvd., Richmond Hill, N. Y.**



No batteries  
at the price  
are as good

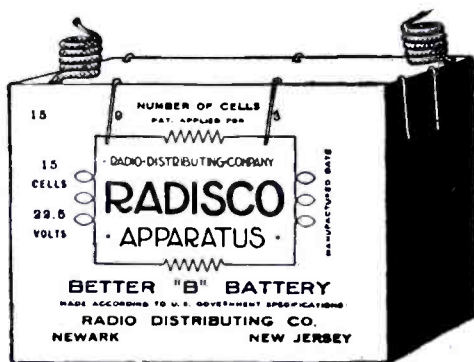

No batteries  
at any price  
are better

# RADISCO BETTER "B" BATTERIES

ARE

*powerful  
sturdy  
long-lived*

Two pages of superlatives  
couldn't promise more.

THESE DEALERS CARRY  
THE RADISCO LINE

ALBANY, N. Y.  
Shotton Radio Mfg. Co.  
8 Market St.

ASHEVILLE, N. C.  
Hi-Grade Wireless In-  
strument Co.

ATLANTIC CITY, N. J.  
Paramount Radio Supply  
518 N. Connecticut Ave.

BEINVILLE, QUEBEC.  
Canadian Radio Mfg. Co.

BOSTON, MASS.  
Atlantic Radio Co.  
88 Broad Street.

BROOKLYN, N. Y.  
Kelly & Phillips  
312 Flatbush Ave.

CHICAGO, ILL.  
Chicago Radio Labs.  
1316 Carmen Ave.  
Branch, Peoria, Ill.

EUREKA, ILL.  
Klaus Radio Co.

KANSAS CITY, MO.  
McCreary Radio Supply  
4th and Delaware Sts.

MONTREAL, QUEBEC.  
J. B. Miller  
136 Vendome Ave.,  
N. D. G.

TORONTO, ONTARIO.  
The Vimv Supply Co.  
567 College Street.

NEW ORLEANS, LA.  
Rose Radio Supply  
604 Gravier St.

THESE DEALERS CARRY  
THE RADISCO LINE

NEW BRUNSWICK, N. J.  
Geo. N. DeLaplaine  
306 George St. and 8th  
and Magnolia Sts.

NEWARK, N. J.  
A. H. Corwin & Co.  
4 West Park St.

OMAHA, NEBRASKA.  
O. B. Radio Supply Co.  
406 Brown Building.

PHILADELPHIA, PENN.  
Philadelphia School of  
Wireless Telegraphy  
Broad and Cherry Sts.

WICHITA, KAN.  
The Cosradio Co.  
1725 Fairmont Ave.

PROVIDENCE, R. I.  
Rhode Island Elec. Equip.  
Co.  
45 Washington St.

PITTSBURGH, PENN.  
Radio Electric Co.  
3807 Fifth Ave.

PORTLAND, ME.  
Atlantic Radio Co.  
15 Temple St.

SEATTLE, WASH.  
Northwest Radio Service  
609 Fourth Ave.

SCRANTON, PENN.  
Shotton Radio Mfg. Co.  
P. O. Box 3  
Branch 8, Kingsbury St.  
Jamestown, N. Y.

WASHINGTON, D. C.  
Eastern Radio and Elec-  
tric Co.  
1405 Florida Ave., N. W.

Since the *still better* Radisco Better "B" Batteries have been at the service of the radio fraternity, amateurs as well as commercial operators, have endorsed them highly, by personal recommendation and by continued use.

Your Radisco dealer has a plentiful supply of these powerful batteries. His name, added to the Radisco trade mark is your guarantee of complete satisfaction.

Operating life, 600 to 1000 hours. 15 cells, 22½ volts.

No. 1 (3¼"x2"x2½") ..... \$1.50  
Shipping weight 2 pounds.

No. 2 (6½"x4"x3") ..... 2.65  
Shipping weight 5 pounds.

Larger size has Variable Voltage feature. Tapped in groups of three cells. Ask your dealer to explain it.

*Use Radisco Better "B" Batteries for C. W. work: A radio phone operating on Radisco batteries is exceptionally quiet, and free from the disagreeable hum of a motor generator, or the rectified 60 cycle tone.*

# RADISCO

RADIO DISTRIBUTING COMPANY, NEWARK, N. J.

This mark



your guarantee

*The name "Radisco" is your assurance of dependable performance.*





# RADIO NEWS

H. GERNSBACK—Editor  
ROBERT E. LACAULT—Associate Editor

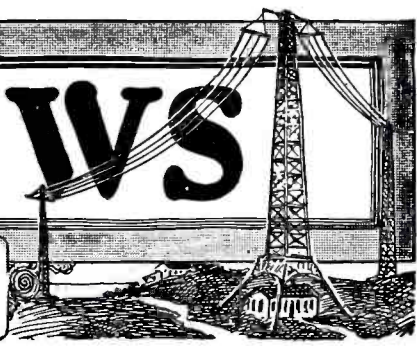

Vol. 2

MAY, 1921

No. 11

## NEW RADIO LEGISLATION

**I**N his first message to Congress, April 12th, President Harding said as follows:

"Practical experience demonstrates the need for effective regulation of both domestic and international radio operation, if this newer means of intercommunication is to be fully utilized. Especially needful is the provision of ample radio facilities for those services where radio only can be used, such as communication with ships at sea, with aircraft, and with out-of-the-way places. International communication by cable and radio requires co-operation between the powers concerned. Whatever the degree of control deemed advisable within the United States, Government licensing of cable landings and of radio stations transmitting and receiving international traffic seems necessary for the protection of American interests and for the securing of satisfactory reciprocal privileges."

Evidently the powers that be in Washington have come to realize that Radio will be one of the coming pillars of the nation. As such it goes without saying that it will be subjected to many forces from various powerful interests. Radio no longer is a plaything. It has come to be recognized as one of the surest and best means for communication, and while radio will never entirely supplant the cable, there is no question that within a very appreciable time, it will dwarf all cable communication as it exists now.

This means naturally that there must be some sort of regulation, and we must not blind ourselves to the fact that sooner or later new radio legislation will be brought about, for at the present time there are many flagrant cases where radio communication is seriously hampered by the lack of co-operation between the various interests concerned.

Following close upon the President's message, Mr. White of Maine, introduced H. R. 4132, a new radio bill, which on account of its importance is printed elsewhere in full. This bill, coming so close upon his message to Congress, our readers may feel certain that President Harding knew about it when he spoke before Congress, and therefore there is every reason to believe that he sponsors it. Knowing that sooner or later new radio legislation is going to come about, we may as well make up our minds that we have to face the music at some time, and we might as well face it now, particularly if the music is agreeable.

As perhaps everyone knows, the writer has always, ever since the inception of amateur radio, fought for the amateurs' rights, and he is doing so now when he actually endorses H. R. 4132. The writer expects that in some quarters, there will be opposition to this bill by certain amateurs who are short-sighted enough, and who are so misguided that they think they can go on with their Q. R. M. until doom's day. The sooner these amateurs come to realize that other people have rights besides themselves, the better it will be for the radio art. We must all co-operate together, amateurs as well as the commercial interests and the Government, or we will get nowhere.

As to H. R. 4132, we have strong reasons to believe that it will pass and become a law. We believe it should become a law. It will be best for all concerned. The writer has been prompted in his decision by long and careful weighing

of all the facts as presented in the new bill, and he believes that if there must be a change, we might as well accept H. R. 4132, because there probably will never be a bill fairer to the various interests than the one in question.

The previous radio bills introduced from time to time by the Navy, or its sponsors, were all opposed vigorously by the writer because nearly every one of them was antagonistic—at least in spirit—to the amateur and to the free development of the radio art as well.

We have no quarrel with the Navy—quite the contrary, for the Navy has helped us amateurs a lot. But the Navy in operating its coast stations and its ships has thought right along that it wanted nothing short of a universal monopoly of the ether. With this, of course, the writer was not in accord, and he knows the amateurs were not.

The new bill H. R. 4132, however, is distinctly a different matter. In the first place it leaves radio amateurs under the influence of the Secretary of Commerce, and nine years of dealings with this department has convinced the amateur that the Department of Commerce not only was more than fair in all its dealings with us, but often went out of its way to help the amateurs, which is well known. It will be noted that an advisory committee is to be created consisting of seven members of whom one each shall be designated by the Secretary of War, the Secretary of the Navy, the Postmaster General, and the Secretary of Commerce to represent these departments respectively. One is to be designated by the Secretary of Commerce from the Bureau of Standards and two persons not otherwise employed in the Navy service, of recognized attainment in radio communication, are to be designated by the Secretary of Commerce. We believe that with such a Board, we shall fare much better than if, for instance, the Navy or any other Department by itself were to make changes as it saw fit at any time such a department desired to do so. If the bill is read carefully from start to finish, it will be found that it is fair to all interests, and we are of the opinion that if it becomes a law tomorrow, the amateur will enjoy exactly the same privileges as he does today. There will, however, be trouble for the Q. R. M. fraternity, but no doubt they will not fare a great deal worse than today, except that they probably will be deprived more quickly of their licenses, if they do not mend their ways.

Of great interest is Section 11, where it says in speaking of various fines: "Providing, that this section shall not apply to the use of radio telephone stations regularly licensed for public service."

The liberal interpretation of this, of course, is that in the future radio telephone stations, even if used by amateurs, will not be apt to be scrutinized so closely as are the present time spark stations. Now this is exactly along the lines upon which the writer has been preaching for many months, even as late as in his Editorial in the March issue entitled: "Amateur Radio Telephony."

Sooner or later we will all be forced to give up our spark stations and operate on CW, and this is as it should be. The sooner the amateurs realize this, the better it will be for us, and when this happens radio laws will become as superfluous as laws about telephone cables are today.

H. GERNSBACK.



# The Resonance Wave Coil

By S. R. WINTERS

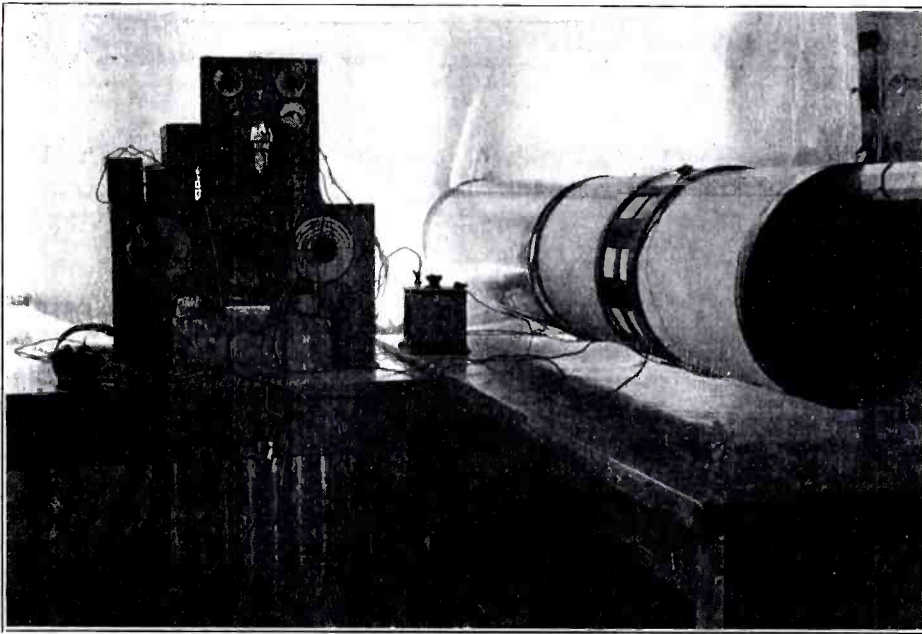

On the left is a resonance wave coil for the reception of long waves. The metal cylinder at the end of the coil may slide over it and act as a capacity. On the right is a complete receiving set; mounted on the tripod is the coil turning horizontally and vertically, thus enabling the operator to find the direction and altitude of an airplane or balloon. Note the amplifier and fone on the ground.



A RADIO antenna taking the form of a walking-cane or thermometer is a possible development of the resonance wave coil, a discovery of Major General George O. Squier, Chief Signal Officer of the United States Army. Its compactness is an outstanding feature, the coil not only being a complete wireless antenna but its use obviates the need for a receiving apparatus other than a detector and a pair of fones. This remarkable device is an outcropping of the discovery of General Squier described as "wired wireless"—whereby expensive cables may be displaced by bare wires for long-distance communication.

The resonance wave coil—fittingly described as the vest-pocket edition of wireless equipment—is devoid of ground connection, either actual or counterpoise. A perfect single-unit direction finder—adaptable to determining the position and altitude of an airplane—is a distinctive virtue claimed for the device. As a transmitter, the coil tunes its own waves. The initial number of a series of resonance wave coils being built by the Signal Corps is a hollow

card-board type, 38" long and  $2\frac{3}{4}$ " in diameter, around which was threaded a single layer of No. 32 gauge insulated wire, affording 100 convolutions to the inch.

Terminal binding posts were subsequently placed at each end of the tube for experimentation with varying connections. The brass band or ring, a fixture of the outfit, is likewise supplied with a binding post. The ring in its formation is interrupted by being split apart  $\frac{1}{4}$ " at a point opposite to the binding post. This break obviates the possibility of disturbing eddy currents. The ring is merely of sufficient capacity to slip securely over the wired tube. The coil is pivoted to swing to any angle in the vertical plane. A dial on the base of the framework denotes the compass direction of the tube. A second dial facing the operator, reflects the degrees of elevation.

#### WAVE POINT AT CENTER OF COIL.

A wave coil of the dimensions outlined will receive signals ranging upward of 1,200 meters' wave-length. In striking contrast to the old style tuning coil, the shortest wave point is at the center of the coil. If the tube is in a position exactly at right angles to incoming waves, the brass ring may be moved toward either end of the coil in order to tune in. Differently expressed, there are two points along the coil, located at equal distances from its center toward either end, where 600-meter waves will be audible; similarly, a short distance farther along, 750 meter waves can be read. When the tube was located in the Washington laboratory, General Squier could hear distinctly signals from the Naval radio station in Cuba. In an antenna of this sort all the electrical constants, inductance, capacity, resistance, and the e.m.f. induced in it by the incoming signal are of a distributed character, thus contributing to an ideal wave conductor.

Incoming signals may be recorded by fastening a single wire to the binding post of the brass ring, forming contact with the other end of that wire with the input grid terminal of an audio detector, or, preferably, a five- or six-stage amplifier, the filament connections to which may be

discarded. The customary head fones are attached for service. The extreme sensitivity of the resonance wave coil to disturbing influences suggests its insulation insofar as practical from metallic objects. The body of the observer may unduly excite the outfit, thereby rendering it advisable for the operator to be located at a suitable distance, negotiating the brass ring by tapping it with a wooden stick instead of using bare hands. The lead from the coil to the amplifier box is built up of a twisted pair of wires, with the upper end of one strand unhampered. Experiments indicate that the addition of a mere one foot of wire to the coil influences it. Consequently, a second wire is twisted around, the main lead to counteract this influence, in much the same fashion that the telephone wires are transposed at frequent intervals along a highway to neutralize their mutual inductances.

(Continued on page 822)



This View Shows How the Connections Are Made to the Coil. One End is Connected Directly to the Amplifier, While the Other Wire is Fastened to a Brass Ring Sliding Along the Coil and Acting as a Condenser.

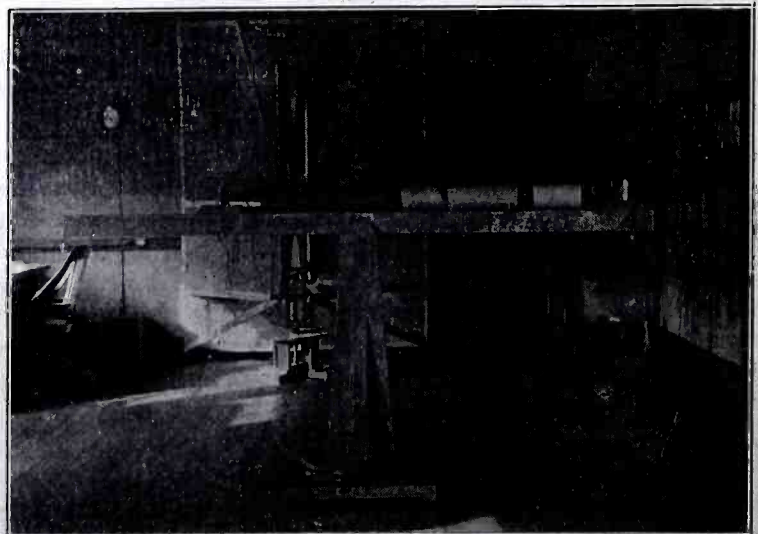

This Photograph Shows a Resonance Coil of Medium Size Used in the Signal Corps Research Laboratory. It revolves in Two Planes, Giving a Double Directional Effect. Note the Screened Loop Aerial in the Background.



# Awards of \$100 Portable Radio Prize Contest

## SECOND HONORABLE MENTION

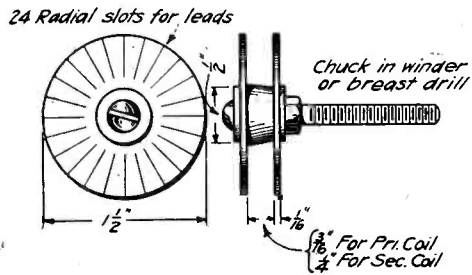

No. 32 D.S.C. Wound Irregularly on Form.

Tap	Pri. Ft.	Sec. Ft.	Tap	Pri. Ft.	Sec. Ft.
Zero contact (1) (Blank - None)			13-14	2.5	4
1 <sup>st</sup> Active tap(2)	1	4	14-15	2.5	4
2-3	1	4	15-16	2.5	4
3-4	1.5	4	16-17	3	4
4-5	1.5	4	17-18	3	4
5-6	1.5	4	18-19	3	4
6-7	2	4	19-20	3	4
7-8	2	4	20-21	3	4
8-9	2	4	21-22	3	8
9-10	2	4	22-23	5	8
10-11	2	4	23-24	10	8
11-12	2.5	4			
12-13	2.5	4			
			Total Feet	62	100

Fig. 3

### A HIGH EFFICIENCY SUPER-PORTABLE RECEIVER.

By Kenneth Richardson.

**W**ELL, here we are. Not merely a pocket radio receiving outfit, but a vest pocket affair, built by the writer in 1918. The accomplishments of this little outfit almost come up to the wildest distortions of the moving pictures and the newspapers concerning dangerous German spies running around the country with wireless stations in their pockets.

Verily, this is the "Black Box," for with it we are enabled to receive the ordinary telephone speech, when hooked to a telephone line; ground buzzer and speech currents when hooked to two spaced grounds; and the usual radio telegraph and telephone signals on any wave from 100 meters to 2,800 meters, either fine loose-coupling or coarse stand-by tuning, using any ordinary elevated aerial, ground antenna, or loop antenna—and all of this without a single change of wire connections in any part of the instrument. This is accomplished by a trick in the hook-up and method of adjustments.

Note that a well protected, small, yet substantial galena detector is used—no

On the right is the front view of the portable receiver open, showing all the elements of this unique light set, while on the left is a table giving the data for the construction of the inductances.

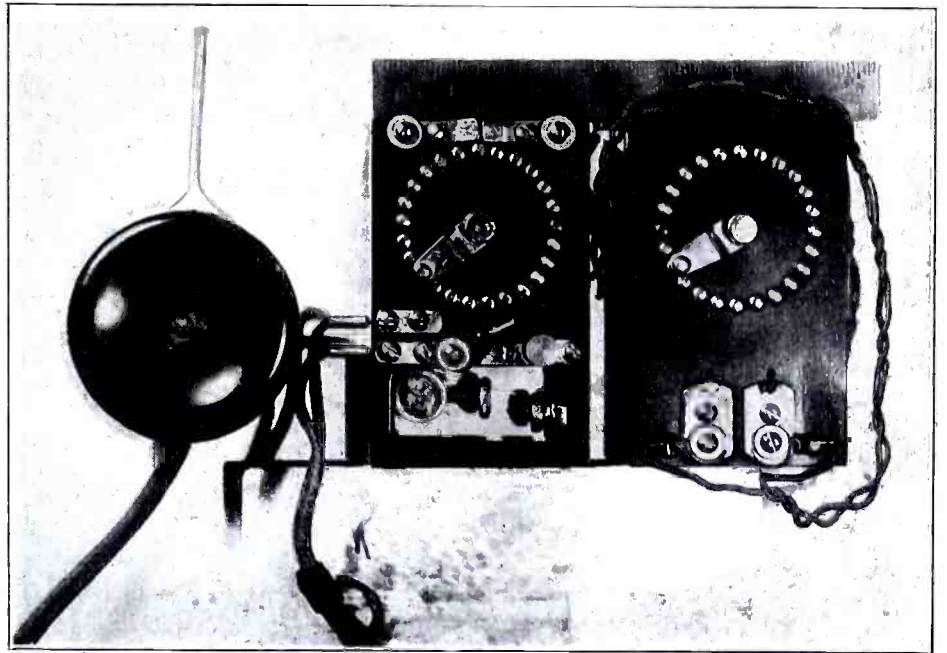

cumbersome batteries needed.

At the writer's former residence in Erie, Pa., using four turns of bell wire stapled to the under side of the attic shingle roof, the ships on Lake Erie could be plainly read, as well as Cleveland, Buffalo, Sarnia, Ont., Toronto, Ont., and amateurs, also as far away as Arlington, Va., day or night.

Using the metal roof of my house in Fort Lauderdale, Florida, Arlington can just be read on 2,500 meters at noon in the summer time (when static free), a distance of 1,000 miles. Key West, Miami, Jupiter, Tampa, and ships reporting up to 200 miles off the coast have been copied in daylight, using the metal roof.

Equally good results may be obtained by using a single bare hard phosphor-bronze wire 200 feet long fastened to a tree, pole or building about 25 feet above ground and slanting down to the instruments. This wire is contained on a small wire spool equipt with a detachable hand crank for quickly winding up the antenna after use. For a ground connection I have used a large spike driven in the base of a trunk of a tree, also a brass rod two feet long pushed in moist earth, with fair success, altho a good water pipe is best.

The overall size of the outfit is 4" long, by 2 1/2" wide, by 7/8" thick, and when the secondary tuner is also used, this measures 4" long, by 2 1/2" wide, by 7/8" thick.

These ranges would indicate that the outfit compares favorably with the best stand-

ard size outfit and that little or no efficiency has been sacrificed in making the parts small.

### THE CIRCUIT AND ADJUSTMENTS.

Refer to the diagram, Figure 1.

When switch "SP" is closed by tightening the thumb screw which closes spring down onto contact, this places the head fones directly between the aerial post and ground post with only the detector intervening. Now turn the primary switch to its zero (blank) contact, likewise turn the secondary switch, or detach the secondary flexible cords altogether from the outfit.

In this condition the outfit may be connected to any ordinary line wire telephone or army field or practice buzzer line wire and ground, or between two spaced grounds as in ground telegraphy and telephony. The signals are as plainly heard as on any telephone or army listening post set (unless amplified). Currents of audible frequency only are concerned here and the detector plays no part except merely to pass the current. The small fixed condenser permanently across fone posts only affects the working of the outfit when currents of radio frequency are concerned, as when tuning the primary switch.

Now turn the primary tune switch off the zero contact and begin cutting in inductance. The condenser, detector and fones are now placed directly across the primary tuner, the ordinary simple tuner hook-up. Connect an aerial, and ground and radio signals may be plainly heard on waves up to approximately 2,500 meters on a medium aerial. This forms an efficient "stand-by" circuit.

If we desire selective loose-coupled tuning, open switch "SP," and plug in the secondary. Adjust the primary and sec-

(Continued on page 832)

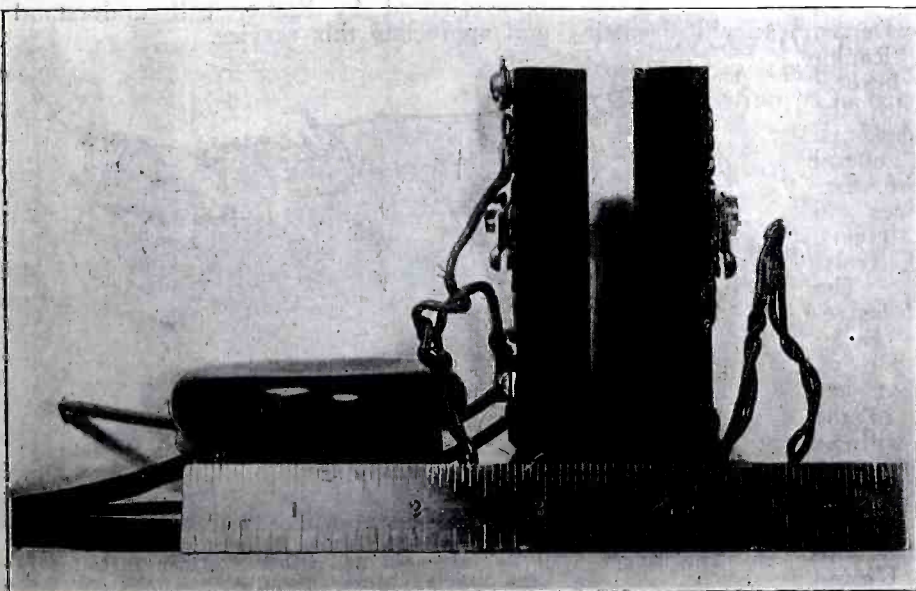

On the left, the photograph shows the side of the receiver. As may be seen the primary and secondary are only one inch thick, the biggest part of the set being the telephone; on the right is the hook-up.

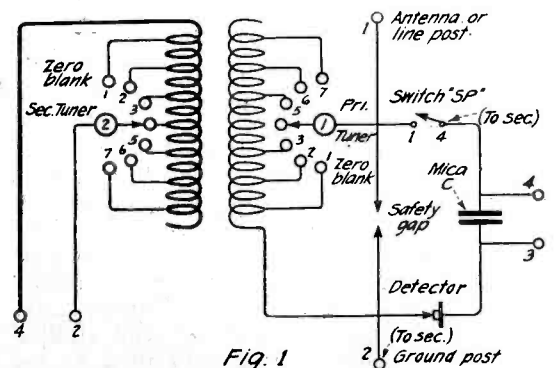
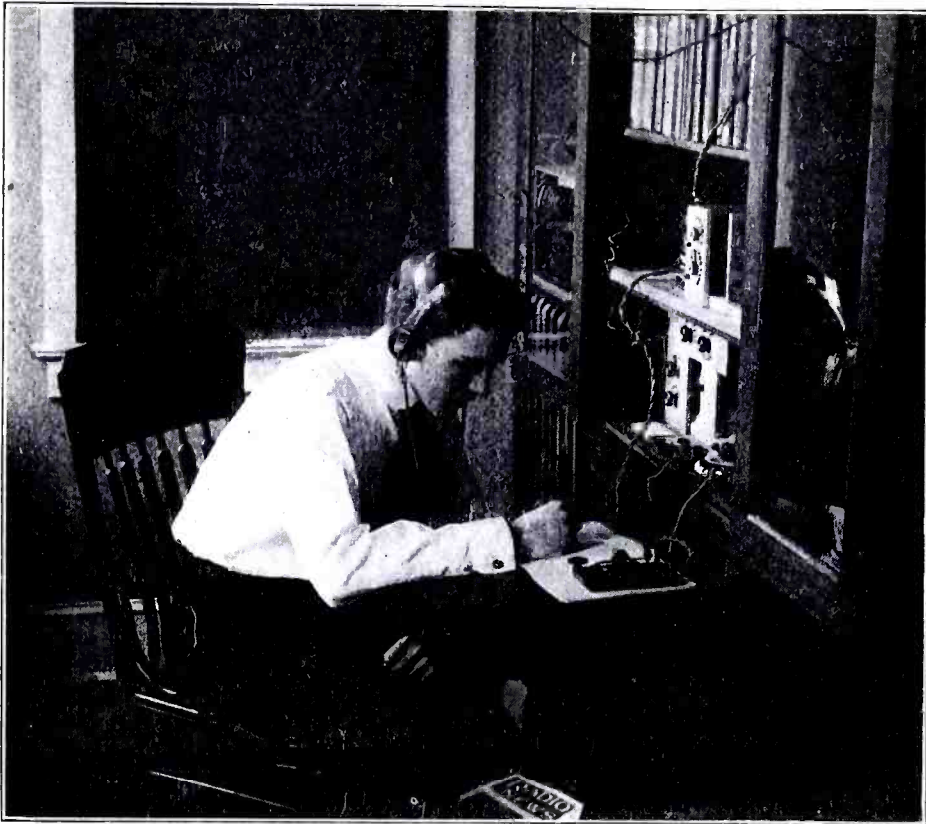

Fig. 1



# Government and Amateurs Join

By S. R. WINTERS



.....  
This photograph showing a receiving radio set installed on a farm, gives an idea of how simple it is. It does not take up much room, being installed in a book case, and yet is sufficient to receive the daily market and weather reports sent by radiofone.  
.....

States constitute a potential agency for effective transmission of market reports by radio, 2,000 of them being located in the area circumscribed by this extended service. These operators are invited to assume the special responsibility of telephoning the information on receipt to producers, newspapers, local telephone exchanges, and display the service on railway, post office, and other bulletin boards.

Radio receiving apparatus adequate to this specific purpose involves an expenditure ranging from \$50 to 150, the operation of which requires no technical training. The anticipated popularity of the service will stimulate the constantly expanding installation and use of radio equipment.

Marketing specialists of the Department of Agriculture are prone to place responsibility for the existing dissatisfaction in the distribution of farm products to the absence of a speedy vehicle for broadcasting information relative to prices and conditions at national agricultural marketing centers. Wireless is a hurry-up agent, and is capable of correcting any tardiness heretofore prevailing in acquainting producers of the fluctuations in trading immediately upon the close of the markets. Other than the licensed amateur operators, already referred to, State agricultural colleges, county agents, and boys' and girls' radio clubs in the process of formation in agricultural districts, are agencies whose support will insure effective distribution of market reports by radio.

## WEATHER REPORTS SENT TO FARMERS BY RADIOFONE.

Another thing that will prove of great interest to the farmers in the States of Missouri and Illinois, is the sending of official weather reports by Radiofone, twice every day. The Department of Science of the St. Louis University sends out these reports, and has requested the Chamber of Commerce of surrounding cities, as well as the Farmers' Organizations within a distance of 150 miles from to take advantage of this

St. Louis service.

The importance of this service will be fully realized by every farmer, once he has heard it, and it is the duty of all amateurs to interest the people by having them listen in their sets to these reports, which are sent by Radiofone. Thus, even those inexperienced in Radio, will understand and appreciate this service.

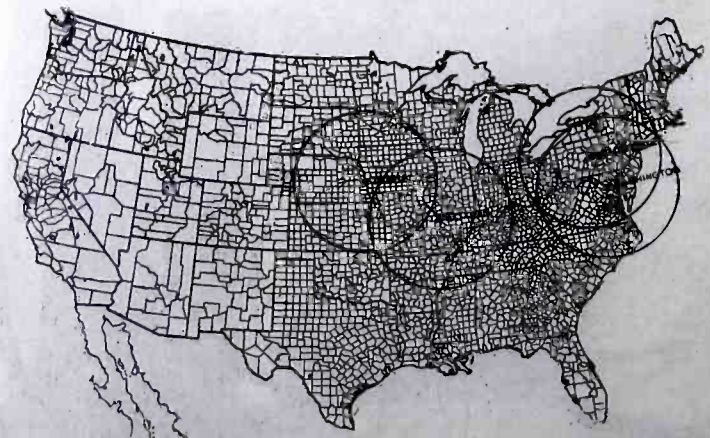

This Map Shows the Actual Range of the Four Stations Sending Market Reports. From Omaha, St. Louis, Bellefonte and Washington, This Range Will Be Increased and Other Stations Installed in the Western States Soon.

**P**RELIMINARY experiments of three months' duration in maintaining a market reporting service by wireless transmission to farmers within a radius of 200 miles of Washington, D. C., justify expansion of this innovation. Effective April 15, the Bureau of Markets, United States Department of Agriculture, will sponsor an extended system of disseminating news of marketing conditions by radio in 10 eastern and 12 central States. Wireless stations at Omaha, Nebraska; St. Louis, Missouri; Bellefonte, Pennsylvania, and Washington, D. C., already in operation by the United States Post Office Department in conjunction with the transportation of mail by airplane, will assume the additional burden of broadcasting agricultural market reports to farmers.

Each mentioned station has a radius covering approximately 300 miles, and agricultural interests in 22 States will be enabled to receive directly or thru centrally-located wireless stations information relating to fluctuations in prices and demands for farm commodities at important trade centers. The news will be imparted daily, and in some instances the market service will be rendered immediately after the close of trading operations. W. A. Wheeler, specialist in charge of marketing information of the Bureau of Markets, expressed an opinion to the writer that this is perhaps the first application of radio communication in rendering a specific and broad service to the masses and farming interests in particular.

The tentative schedule adopted is as follows: From Omaha a complete report of the Omaha live-stock market will be sent at 11:15 a. m. each day, and at 11:45 a. m. a complete report on the Kansas City live-stock market. At 2:15 p. m. a grain and potato report, giving prices and conditions at the Chicago, Minneapolis, Kansas City, and Winnipeg grain markets; and similar information at the Chicago and other potato

markets will be dispatched. At 5 p. m. a daily "Radio-Marketgram" will be sent, cov-

**H**ERE at last is good news for the amateur—and real news. The amateur can now prove that he really has a mission in life. He can now perform the double mission of helping the Government as well as the community at large. By giving the daily market report to farmers, newspapers, local telephone exchanges, etc., the amateur will render a distinct service, and he will now have the best of reasons to carry on his work. Radio will no longer be considered a sport or a plaything—it is now the serious art which we always maintained it would be some day. The day of usefulness for the amateur has dawned. We hope he will at once grasp the wonderful opportunity and make the most of it.—Editor.

ering national market conditions on live stock, fruits and vegetables, grain, hay and feed.

The reports to be sent from St. Louis are a national stock-yards live-stock market report at 11 a. m.; a Chicago live-stock market report at 11:30 a. m.; a grain and potato report at 2 p. m.; and the "Radio-Marketgram" at 7 p. m. The Washington station of the Post Office Department will dispatch the 5 p. m. "Radio-Marketgram," heretofore sent out by the Bureau of Standards, a report giving a general daily summary of eastern market prices on live stock and meats, grain, hay, feed, fruits and vegetables. The same report will be released from the Bellefonte station at 7 p. m. Any changes that are found necessary in the above schedule will be announced by radio in advance of such change.

The 6,000 licensed amateur wireless operators in the United



# A New Type of Variometer

By E. B. LANDON

THE amateur who is without a variometer set in these days of consistent DX reception is behind the times and knows it, but only a favored few can afford these expensive necessities. Still fewer are those who have the tools skill and time to construct the ball type variometer. Most of us have tried following directions of one of the numerous "How to build" articles but we'll say it is decidedly harder than it looks.

Well, the ball type is not the only one I am glad to say. I've made my complete set and probably a glance at the accompanying photographs will start you making yours without the assistance of the further details in this article. Every experimenter has his own ideas on the construction details of a set, and will pay little attention to my methods, but no doubt a few of my ideas will be found useful and some fellows would rather follow data given than take the time for experimenting.

This type of variometer has several advantages over the ball type, for instance, ease of construction, compactness, greater range because the clearance between the two coils can be made very small without very fine workmanship, and the external field is small causing less detuning because of the capacity of the hand.

## FIRST VARIOMETER ENTIRELY HOME-MADE.

Fig. 1 shows the first variometer of this type which I constructed and illustrates the action more clearly perhaps than the photos of the open drums. This one cost nothing as all the parts are either household discards or salvage from the "junk box". The Morton salt box will be recognized. A section of this tube 4" long is blocked at each end with discs cut from a cigar box with a coping saw. This drum supports the inner coil. The outer coil is supported by two pieces of scrap bakelite which are held in place by four sections of 10-cent store curtain rod threaded to 8/32. The shaft is composed of two pieces of the same rod insulated in the middle by a section of fiber rod into which they are threaded. There is a total of 70 turns of No. 28 magnet wire on this variometer. It has a range from 140 to 350 meters when used as a grid variometer.

The set shown in Fig. 2 was designed as a portable one, but few amateurs will care to make the variometers so small or to crowd them so close together altho these have a greater range than the average on the market today and no ill effects have been found due to their proximity to each other.

## TOTAL COST OF SET ONLY \$5.60.

The total cost of this set was \$5.60, not including the Litzendraht wire used, which, of course, is expensive and scarce. No. 24

magnet wire can be substituted without any noticeable difference in signal strength, nor in selectivity. This sum will be greater or smaller depending upon the amount of suitable material which the experimenter has on hand.

Cutting fiber .....	\$0.50
Fiber .....	1.00
1/8" brass rod .....	.50
1/4" brass rod .....	.20
Brass screws rd. & flt. hd., 6/32 .....	.25
Panel bakelite 3 1/2" x 12" ..	.90
Switch, knob and arm .....	.60
Switch points .....	.25
Binding posts .....	1.50

\$5.65

You will probably prefer dials to knobs and pointers as used here. These I had in stock. The discs used were cut by a pattern maker apprentice and only

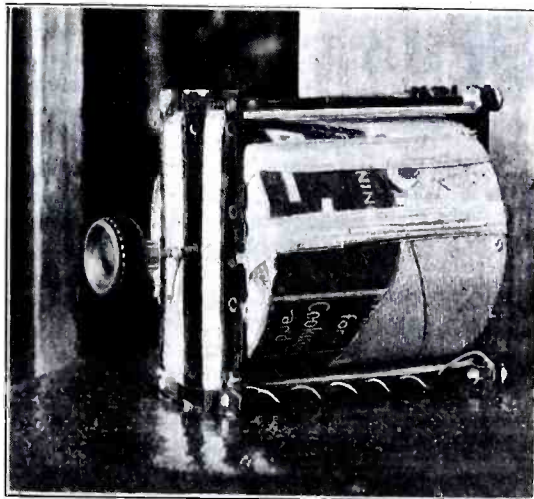

This View Shows Every Detail of a Variometer Built With Material Always Available in Any Lab. This is a Very Efficient and Cheap Instrument That All Amateurs May Build Themselves.

the hourly rate of the apprentice was charged. These discs can be cut almost as well with a coping saw.

## GRID VARIOMETER.

The grid variometer will be described first. The inner coil which is the rotor is wound upon a drum composed of two fiber discs 3/16" thick and 3" in diameter supported by four brass rods 3/16" in diameter. The ends of these rods are drilled and tapt for 6/32 screws. Flat head screws are used and countersunk flush so that they do not scrape on the outer drum.

The shaft which is of 1/4" brass rod can be fitted tightly into the centers of the two discs, thereby eliminating the necessity of special insulation as is necessary on some types. The edges of these discs are slotted for the winding so as to make them flush with the curved surface of the disc. Twenty-six turns of No. 40-30s. Litz wire are wound on each side of the shaft. If no Litz is available No. 24 magnet wire can be substituted. Fiber washers on shaft allow clearance between inner windings and outer discs. There should be no end play. The outer coil is wound on a drum composed of two fiber discs 1/8" thick, 3 1/2" in diameter, supported by a 1/8" rod threaded in each end for 6/32 screws. Round head screws are used in the outer drum. The discs of this drum are slotted as shown in the photo-

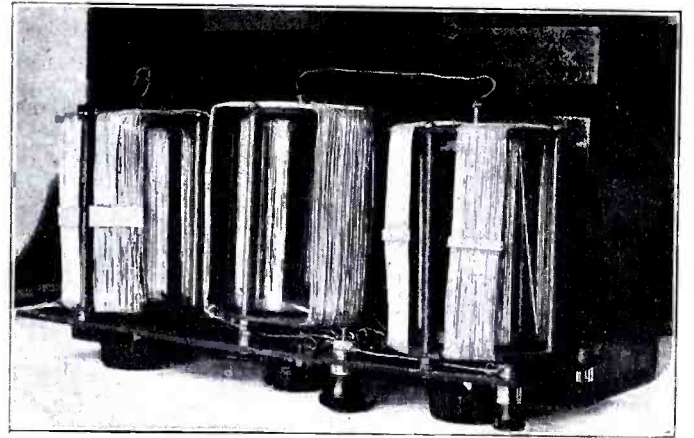

Inside View of a Regenerative Set Using a Coupler and Two Variometers of the New Type Described in This Article.

graphs so that the clearance between the inner and outer winding is 1/8". Even a smaller clearance can be safely used. The outer drum is wound with 25 turns of wire on each side of the shaft. One lead from this winding is then soldered to one end of the shaft. Then the other end of the shaft and the other lead from the outer coil form the leads from this variometer. No attempt was made to make metal bearings, using instead an over size 1/4" hole in the outer discs in which the shaft turns freely. I used 12 strands of No. 36 copper wire twisted together for flexible leads from the bearings. This eliminates the noise which causes so much trouble on many variometers. A spiral of thin brass sheeting would be better than the flexible wire. There is a total of 102 turns of wire on this variometer. It has a range from 145 to 415 meters used in the grid circuit not including the wave-length of the secondary coil.

## CONSTRUCTION OF PLATE VARIOMETER.

The plate variometer is built in the same way except that the inner drum is wound with 62 turns and the outer with 60, making a total of 122 turns for this variometer which has a range from 170 to 600.

The variocoupler is built very much the same as the variometer. The secondary is wound on the inner drum with 24 turns of wire. This seems small but the coupling can be made very close giving the same transfer of energy as on a variocoupler with more turns and looser coupling. When fewer turns are used in the secondary, more turns can be added to the grid variometer which allows the grid circuit to respond over a greater range of wave-lengths. The primary is composed of 50 turns tapt at turns 4-8-13-19-26-34-42 and 50. On the lower wave-lengths closer adjustments are necessary so there are fewer turns between the lower tape. The fundamental of the average amateur antenna usually very nearly approaches 200 meters so that when listening to 200 meter stations very few turns must be used in the primary. Few turns produce a small field so the discs of the primary drum are slotted to bring the first 15 turns into close inductive relation to the secondary.

I found that the 1/16" fiber was rather flexible and due to this the windings were not very smooth and tight, also that the loose wires sometimes sag and scrape on the inner winding. I remedied this by shel-lacking a thin strip of cardboard across each of the outer windings midway between the discs. This makes them very rigid. The inner windings did not need any attention.

The windings were not shel-lacked except at the corners so that the distributed capacity is at a minimum. Possibly this is going to extremes and the moisture which the

(Continued on page 823)



This Small Set Was Built by the Writer and Fitted With Home-Made Variometers, So That the Total Cost Did Not Exceed \$8.



# An Inexpensive C. W. Transmitter

By ARTHUR H. LYNCH

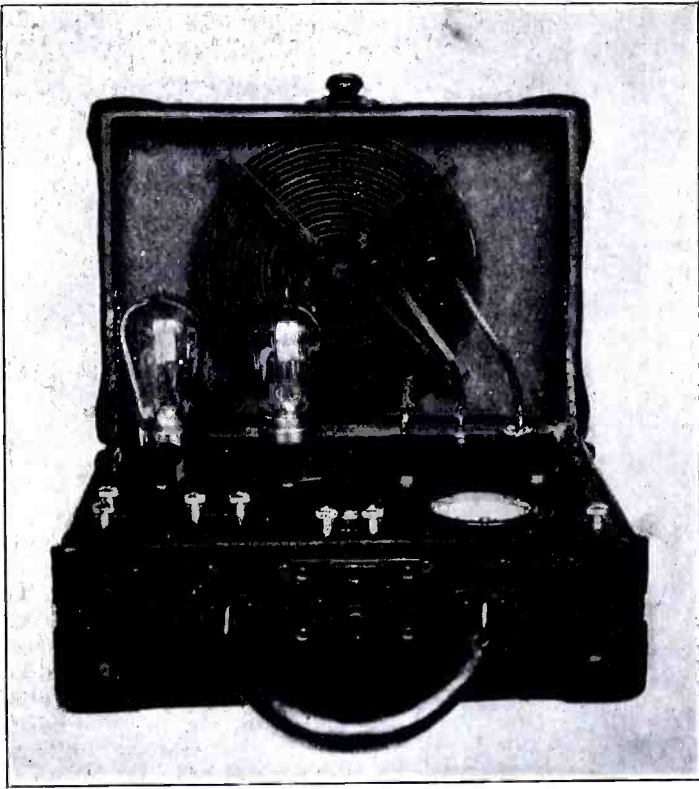

This Photograph Shows a Complete C.W. Set Built in a Carrying Case. Compactness and Ruggedness Are the Keynote of This Unique Set.

**T**HE fact that the spark coil and other inefficient radio transmitters will soon be obsolete has never been more strongly realized than at the recent radio convention and exhibition, held at the Hotel Pennsylvania, New York.

There is little use in reiterating the well-known gospel of the C. W. transmitter and its electrical advantages. However, there are a few facts regarding certain construction features which will be of interest both from an electrical and economic viewpoint. Many amateur workers will find deep interest in the fact that it is now possible for them to have a complete, up-to-the-minute transmitter for a price which is as low, if not lower, than they could have secured the less efficient sets of yesteryear.

An eastern radio corporation has entered the amateur field, with several new devices, which will undoubtedly bring it great returns. This will be aided very considerably by the fact that it is not merely selling apparatus, but is desirous of having every purchaser of such devices secure the greatest benefit therefrom. Needless to say, this far-sighted sort of business is not carried on for the sole purpose of taking the amateur by the hand and leading him to green pastures. It is merely common sense, whereby the consumer will be satisfied with the service he secures from the devices he purchases and the manufacturer will derive a profit, which is generally agreeable to all concerned.

But, as we are more interested, for the moment, in the set to be described, than in the business of the radio corporation, we will continue, remembering, however, that the set is a development of the corporation, for use in demonstrating the outstanding features of its new tubes.

There are several very interesting features which mark this transmitter as being different, so let us consider them: From the illustration, it will be seen that the complete set takes up but very little room, in fact the outside dimensions of the carrying case are 12" x 6" x 10". The arrangement of the switches and other con-

trols has been well planned and adjustment is a very simple matter.

All of the parts used in the assembly may be secured from any radio supply house, from stock, or may be made at home. This is a very important consideration because it eliminates the necessity of securing any specially constructed units, an item which usually causes quite a severe set-back in the average purse.

In considering the design of the apparatus it is well to observe the diagram, so references of that character will be made. It will be seen that there is a phantom antenna circuit, comprising the adjustable capacity (C), the adjustable resistance (R) and the adjustable inductance (I). The capacity is adjusted in steps of .001 mfd., by the switch (S), which also serves the purpose of transferring the energy from the tubes to either the phantom or regular antenna circuit. The resistance values are four, eight and ten ohms, respectively, adjusted by the switch (S'). It will be observed that the same inductance

is used both in the phantom and the regular antenna circuit, depending upon the position of the switch (S).

The ammeter (A), shown in series with the ground lead is a Weston, thermocouple, 0-2 amperes. The adjustable condensers, shown in the feed back circuit are of the capacities indicated, which, when the switch (S2) is rotated from right to left, result in a capacity of .001, .0008, .0006 and .00034 mfd., respectively. The grid leak (R') is a standard Ward, Leonard and is in series with the key (K). The rheostats which control the filament lighting circuits are made of a special resistance wire and are attached to an asbestos base. They are made by a Scranton Radio Co. The voltage for both filament and plate circuits is supplied by a transformer having one primary and two secondaries. The primary is directly connected to any 110 volt source (A. C.) and one secondary delivers 7.5 volts for the filament circuit, while the other secondary steps the voltage up for use with the plate circuit.

Two binding posts are provided in the filament circuit, to which it is possible to connect an A. C. voltmeter for observing

the filament voltage. This voltmeter should be provided with a scale of from 0-10, and it has been found that keeping the voltage adjusted in this circuit, rather than adjusting the brilliancy of the filaments by means of an ammeter in series with the supply, increases the life of the tubes in the ratio of three to one. Such a saving in tubes would soon pay for the voltmeter and is not to be overlooked.

This set was designed for use with two U. V. 202, five watt tubes, but the circuits are so well proportioned that an overload of 100 per cent. is possible without noticeable heating and it has repeatedly been used to deliver 20 watts to the antenna for demonstration purposes.

It should be borne in mind that the set is of the self-rectification type and has been designed for telegraphy alone, tho it may be used for telephony by employing Kenotron rectifiers and the other essentials, such as the microphone transmitter, magnetic modulator, and "smoothing out" chokes and capacities.

Several sets of this character are being built for other companies and they are to be used by sales representatives of the organizations for demonstrating tubes. They are so small that it is possible to carry them around without difficulty and nothing is necessary for operation other than the A. C. supply. Summer camps and other summer activities will find many similar sets in operation.

Some very favorable reports, concerning the operation of the Radiotron power tubes have been circulated. One of the most noteworthy being that of I. D. H., Mr. Whittier of Boston, who has carried on daylight communication with I. D. C., of York Harbor, Maine. The distance between these two points is 65 miles. Two U. V. 202 Radiotrons were employed, but the most remarkable part of the feat is that the antenna, which was 27' long, four wire and flat top, was but one foot above the roof.

Others, who have used the tubes, tell of using as high as 750 volts on the plates and drawing 20 watts per tube, which is a 400 per cent. overload. This is not conducive to long tube operating life, but it shows that there is a very broad field open for increasing power for special purposes.

All the condensers used in the set are made by the Dubilier Company and are of the regular copper and ruby mica type. Where the capacity used in the feed back circuit does not necessitate the use of more than .0005 mfd., it is possible to substitute a variable condenser for the

(Continued on page 843)

Complete hook-up of the set enclosed in the suitcase shown in Fig. 1. In this circuit the two power tubes are supplied with A.C. thru a transformer. A dummy antenna is part of the set and may be used for tuning or experimental work.

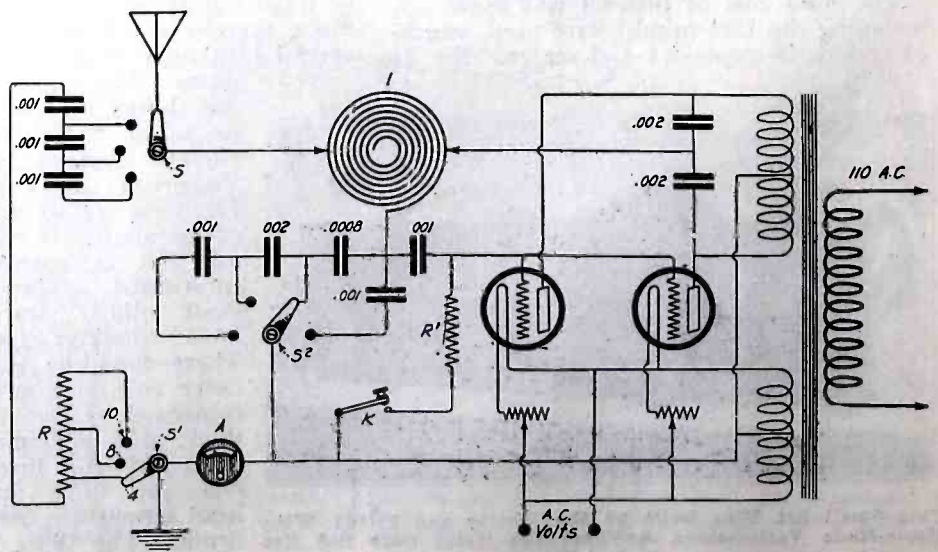



# New Device to Obtain A. C. From a D. C. Source

By D. R. CLEMONS

WHERE enthusiastic radio men encounter direct current power supply, there is generally recourse to interrupted current apparatus of moderate power and doubtful efficiency. This subject brings reminiscences of vibrating contacts, mercurial and electrolytic interrupters, for the writer once labored to handle sufficient power where direct current was the only supply in his city. Such circumstances create an earnest desire for a real power transformer with a musical discharger, and also causes one to fully appreciate alternating current when finally it is available. With these memories as incentives the apparatus described was designed and is offered as a solution of this problem.

The ideal method of handling direct current for transformers would involve a rather expensive motor-generator or converter. The following instrument described will convert direct current of 110 volts into alternating current of 60 cycles, and is yet economically and readily assembled.

This method of converting direct into alternating currents possessing accurate sine characteristics may be more clearly understood by the diagram in Fig. 1, in which a resistance of 200 ohms is connected across 100 volts direct current. The contacts A and B may be moved over the resistor. If contacts A and B were in the center of the coil, the potential across them would be zero; but on moving them away to opposite extremities of the coil, the voltage across A and B rises to 100 with the change. Thus, on moving the contacts to the ends of the resistor and again to the center, there will have been one pulsation of direct current that rose to 100 volts and again decreased at the same rate. If A and B reversed positions on passing thru the resistance center, and continued on to the coil ends, the polarity would have reversed on crossing the center, but the potential increment is the same as before. In this manner two oppositely polarized pulsations corresponding to one cycle of alternating current have been produced. If points A and B were revolving brushes connected thru slip rings and revolving in a complete circle, the same effect as before could be produced. It is now clear that sixty revolutions per sec-

This simple and clever converter produces A.C. when supplied with D.C. It will be found useful in several cases where a source of A.C. is not available.

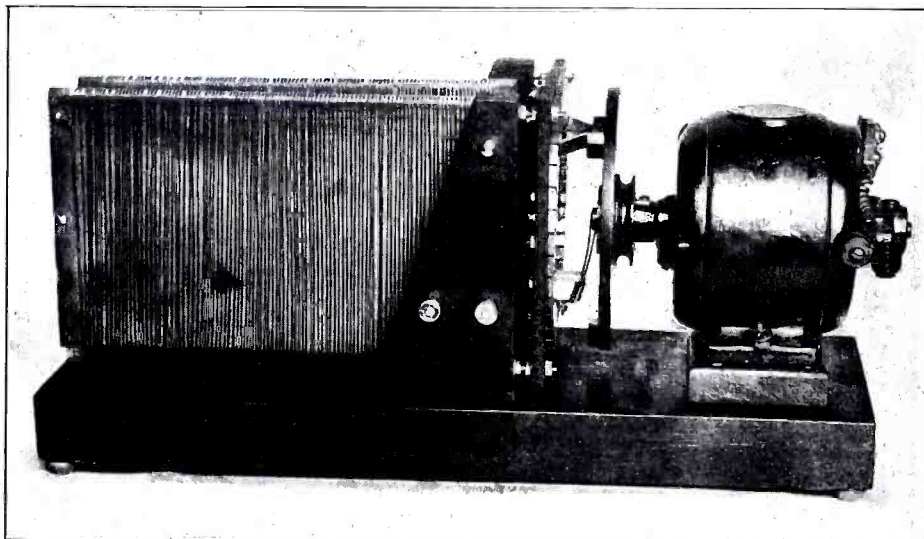

ond would be required to produce a desirable frequency. This speed is far too great for accurate commutation. Moreover, the contacts rubbing over the bare wire of the resistor would not be a correct principle mechanically. If consecutive resistance values were led to a well designed commutator, this latter objection is removed. Then by cross wiring the segmented commutator and

ed at the disc center. A counterbalance mounted opposite the brushes prevents any vibration.

A motor can not conveniently be mounted with its shaft exactly perpendicular to the commutator plane. However, it is very important that the disc should be exactly parallel with the commutator; and in this instrument such adjustment is made by utilizing the four threaded supports that protrude thru the panel corners. These supports are secured into wooden braces. Adjustment is made by hexagonal nuts at the panel corners.

A 1/15 horse power series wound motor furnishes ample power for the converter. The maximum speed is 2,400, at which the converter delivers 80 cycles. The speed may be reduced to 1,800 for 60 cycles if desired. In operation, direct current is connected to the resistance at the commutator as shown in the diagram. Alternating current is taken from the brushes and revolving member. Binding posts for the input and output are provided on either side of the machine as shown.

The commutator is machined of hard brass 6" in diameter and 1/8" in thickness. It was constructed as follows: A ring 6" in diameter and 1" wide was sawed from a hard brass sheet 1/8" thick. An accurate pattern of the commutator was instrument drawn as shown in Fig. 4. This pattern was then cut out and pasted upon the brass ring. Then all holes to be drilled, and separation lines are indicated with a prick punch. All segment holes are drilled 3/32" and tapt 4-36. A duplicate pattern is then placed upon a Formica sheet 6" x 6" x 1/4", and corresponding holes indicated and drilled 1/8" for all segment holes. Each segment is sawed from the ring along the dividing lines marked by the pattern. Each segment is firmly attached to the panel by receiving one countersunk 4-36 flat head and one 3/4" 4-36 machine screw. This longer screw is provided a hexagonal nut, allowing an extra length for connections on the panel back. Each segment is similarly mounted. The commutator is the greatest difficulty; but it is easily assembled if accurate patterns are first made and used. Such a pattern is shown in Fig. 4. However, when making the stampings upon the panel, all points for the supporting rods, and holes for the A. C. brush bases should be struck with the segment marking operation. The sketch shows a portion of the ring sawed into segments, dotted lines show the position of the hack saw blade.

(Continued on page 826)

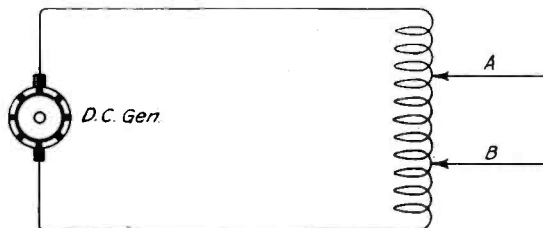

Fig. 2

This Diagram Shows the Principle of the Converter. A and B are the Brushes Moving Along the Resistance Made Alternately Positive or Negative as They Reach One or the Other End of the Resistance.

moving the contacts in quadrature so that two cycles are produced for each revolution, the speed required becomes 1,800 a minute,—which is practical. This principle is here used; the diagram for wiring is shown in Fig. 3.

A segment for each resistance turn would be ideal, but for powers in the order of 1,000 watts, larger values graduated into five calculated steps are brot to ten segments for each half cycle. Between each current reversal there is a complete interval during which no potential is delivered. Segments for this are not in the electric circuit, but provide carry-overs as shown in Fig. 3.

Each resistor is 100 turns of bare resistance wire wound upon rectangular slate forms. Each coil is of 50 ohms tapt at 6, 12, 24 and 50 ohms. These values are carried to the consecutive commutator segments thru heavy rigid copper wire.

### CONSTRUCTION OF COMMUTATOR.

The commutator is of 40 segments mounted radially upon a Formica panel that also supports brushes for collecting the alternating current from the rotary member. Two revolving brushes and collector rings are carried upon a Formica disc driven by an electric motor. Each brush is 4-ply phosphor bronze strip attached to solid brass bases upon the rotor. Each brush is displaced 90 degrees and connected thru narrow bronze strips to distributor rings mount-

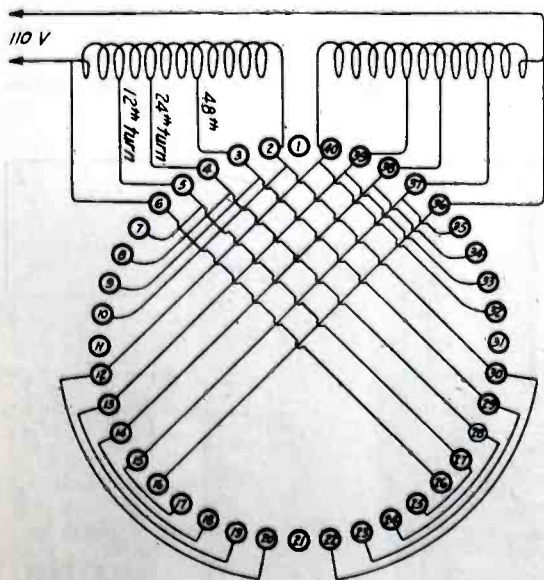

Fig. 3

Complete Diagram of Connection Showing How the Contacts Are Connected Two by Two to the Resistance, Acting as a Potentiometer.



# The Design and Construction of an Efficient Detector Amplifier

By CYRIL T. ATKINSON

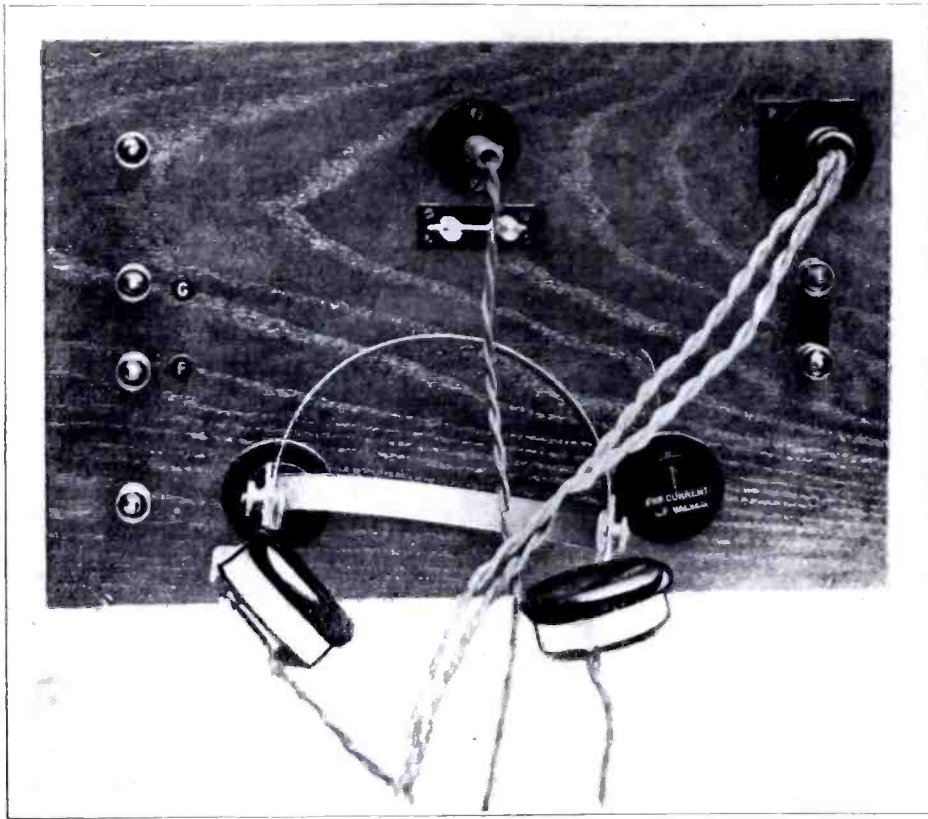

This amplifier is a real amateur's instrument. Easy to build and inexpensive, it will appeal to many who cannot afford the ready-made ones. Being of the radio frequency type it will be useful for reception on a loop. Used in conjunction with an audio frequency amplifier, it will grind out European stations by the yard.

ductors will render the set unstable, and cause it to oscillate when it is not intended to do so. The rheostats are mounted on porcelain bases and should have a resistance of about 5<sup>w</sup> maximum. The writer made slight alterations to those used by him in order that they might be mounted inside the case, the adjusting knobs only being outside. They may, however, be mounted outside on the front, exactly as purchased. The valve sockets had also better be purchased from one of the well-known supply houses.

Two condensers now claim our attention. These are used, one in series with the grid of valve No. 3 and the other across the telephones and HT battery, the only difference being that the telephone condenser is of a larger capacity, and therefore, has more plates. The leak, which is connected across the grid condenser, can easily be made by filling a groove in a piece of ebonite with pencil graphite, suitable connections being made at the ends. Condenser sizes are clearly given in Fig. 3. And now for the two coupling transformers which transfer the energy from the plate of one valve to the subsequent grid; these are wound with a ratio of 1 to 1 and, therefore, have a primary and secondary of equal turns. The bobbin consists of a piece of ebonite rod 3 1/2" long, the ends of which should first be reduced to 1/2" diameter for a length of 3/8". The unreduced part should now have eight slots 1/2" deep by 1/8" wide turned in it, each slot being separated from the next by a distance of 1/4". The total length of the unreduced part should obviously be 2 3/4".

These slots should each be wound with 500 turns of 40's wire, and alternate slots connected in series. Great care should be taken that the coils all act in the same direction so that each winding is electrically continuous. Brackets should be next cut from ebonite as shown in Fig. 6, and fitted to the reduced ends of the bobbin. There now only remains a

**T**HE following article deals with the construction of a very efficient amplifier of the high, or radio frequency type, which has been constructed by the writer and used with great success in his own station.

One of the great advantages of this set is that, by amplifying the original energy before applying it to the detecting valve, much greater efficiency is obtained for weak signals.

Taking the design in detail, it will be seen that the first two valves are used purely as amplifiers of the radio frequency oscillations, the third valve then rectifying on the cumulative leaky grid condenser principle. This was found to be the most efficient combination, as the original oscillations received on the average amateur aerial, from all but the most powerful stations, are far too weak to effectively operate any rectifying device without some strengthening. "R" type valves, supplied by the (English) Edison Swan Electric Co., were used, the writer being familiar with their characteristic curves, and the parts were designed for use with these particular tubes. There seems no reason why American tubes should not function quite well, however. We will now take the actual construction in detail, beginning with the case. This can be constructed of any well-seasoned hardwood, such as mahogany or teak. The actual finish depends upon the skill and fancy of the constructor. The various sizes are given in diagram 1 which clearly shows the method of construction. It will be seen that by removing the eight screws holding the front, the entire inside can be removed "en-block," thus greatly facilitating wiring up, etc.

Normally, for the removal of the valves, the top portion of the back only is opened, it being hinged at a and b for this pur-

pose. The front panel should be carefully marked with the position of all holes and carefully drilled. The shelf (A) should also be prepared for the valve holders and transformers at the same time. As the case is designed of ample size, there is no

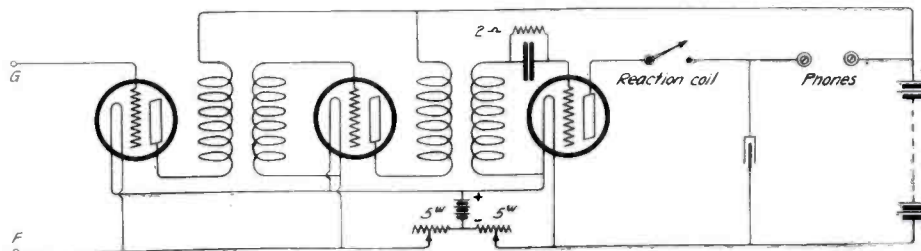

Complete Hook-up of the Radio Frequency Amplifier.

reason why the position of some of the holes should not be slightly altered, if the rheostats should happen to be of different sizes, but great reserve should be exercised with the other parts, as a very slight variation in the position of certain con-

few small items to consider. They consist of an ebonite plate carrying four terminals for the attachment of the filament and plate batteries, another for the two terminals for the telephones, and four ebonite bushes (Continued on page 824)

This sketch shows the different parts with their dimensions, and the special construction of the condensers and transformers.

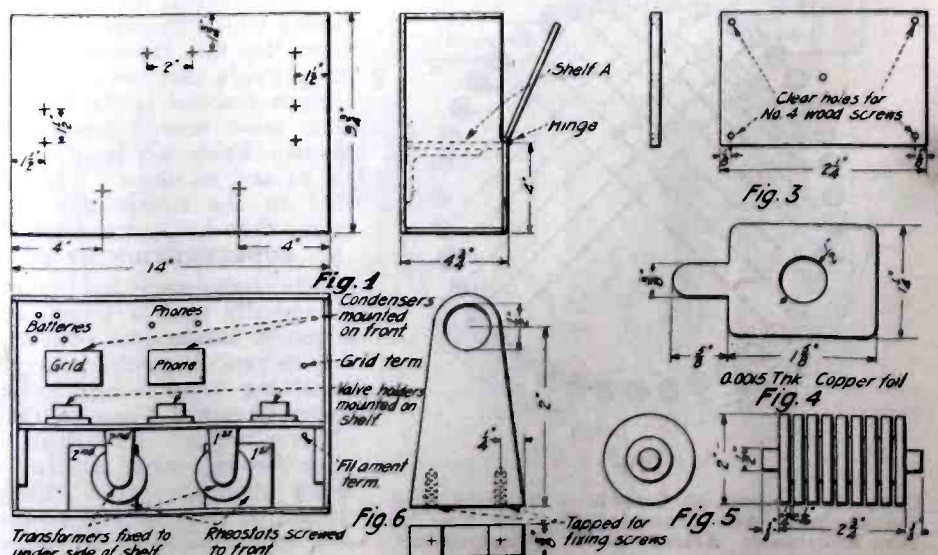



# Marconi Patent Expires

By THOMAS APPLEBY

**M**ARCONI'S "four-circuit-tuning" patent, U. S. No. 763,772, expires June 28, 1921, and is not renewable. This invention then becomes public property for anyone to make, use or sell.

This dedication of the invention to the public is a provision of the patent statutes in return for the seventeen-year monopoly granted the inventor or his assigns.

The scope of Marconi's "four-circuit-tuning" patent may be somewhat ascertained by examination of its drawings, Figs. 1 and 2, and its twenty claims. A few of the claims are reprinted herewith.

After considerable litigation this patent was sustained by the higher courts and for many years gave Marconi a monopoly on the radio business. It was due to this patent that Marconi or his assigns, for a number of years, demanded 10 per cent. royalty on all amateur radio apparatus entering into the circuit arrangements shown and claimed in the patent, whether or not such apparatus was in itself ancient and originally designed for other usage.

For instance, for transmitting we may have used an ordinary telegraph key whose own patent had expired long before, but the fact that the key in itself was old did not prevent infringement of Marconi's patent, for in claim 11 we find, "a signaling instrument in circuit with the primary of the induction coil"; this signaling instrument could therefore be a telegraph-key, a relay, a push-button, or what-not.

Or perhaps we used an ordinary telephone receiver in our receiving circuit, again we infringed on Marconi, for in claim 20 is written, "and a receiving instrument connected with the wave-responsive device."

Transformers and induction coils were old apparatus at the time Marconi applied for his patent, but these in turn were included in his claims 1 and 20, respectively, "a signaling instrument comprising an induction coil," and "a coil for charging the condenser."

From the foregoing we may rightly assume that when old apparatus is used in a new combination for new and useful purpose such apparatus, or its equivalent, may be rightfully included in our patent claims and unauthorized use of such combinations for the purpose outlined in our patents may constitute infringement and subject the maker, the seller, and the user thereof to payment of damages for his infringement and compel him to discontinue such unlawful acts and, if agreeable to the

Here is the hook-up used by Sr. Marconi in his early experiments. Compare this circuit with our multi-stage amplifiers of today and judge of the progress during the last 20 years.

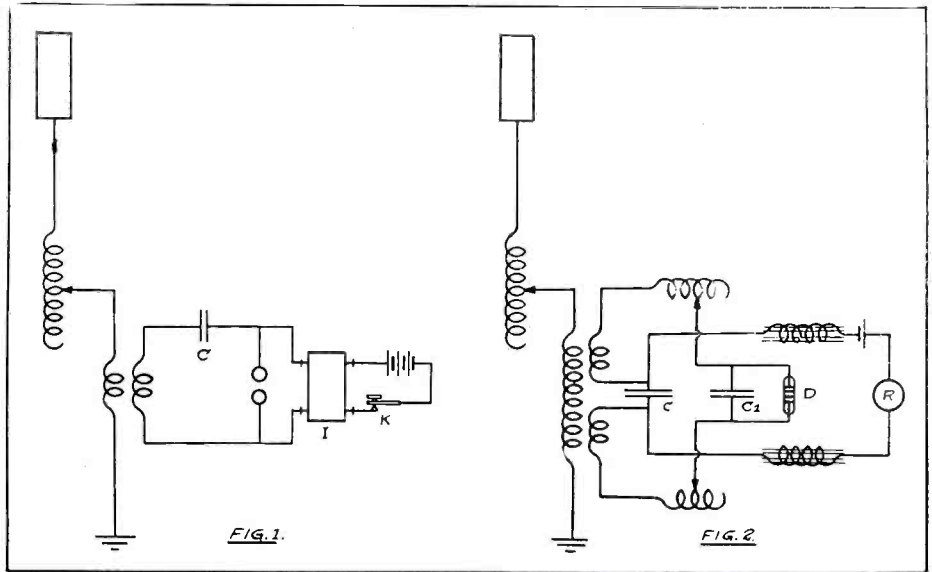

patentee or his assigns, require that a license be taken and such royalties paid as may be right and just.

Amateurs and the commercial radio companies together will welcome the expiration of Marconi's patent, not because they begrudged the inventor a full return for his efforts, but so that a new impetus, which naturally follows the lifting of restrictions, will be given to this rapidly advancing art.

Here are several of the more important claims in the Marconi patent:

Claim 1. At a station employed in a wireless-telegraph system, a signaling instrument comprising an induction-coil, the secondary circuit of which includes a condenser discharging through a means which automatically causes oscillations of the desired frequency; an open circuit electrically connected with the oscillation-producer aforesaid and a variable inductance included in the open circuit, substantially as and for the purpose described.

Claim 2. At a station employed in a wireless-telegraph system, an oscillation-receiving conductor, a variable inductance connected with said conductor; a wave-responsive device electrically connected with said conductor and in circuit with a condenser, substantially as and for the purpose described.

Claim 11. In apparatus for communicating electrical signals, the combination, with an oscillation-transformer, at a transmitting-station, of an induction-coil; an

electric circuit containing the secondary of said coil, a condenser and the primary coil of the oscillation-transformer; a producer of electric waves of high frequency electrically connected with the secondary of the induction-coil; a signaling instrument in circuit with the primary of the induction-coil; the secondary coil of the oscillation-transformer electrically connected, at one end to capacity and, at the other end, to an inductance, and an aerial conductor connected to the inductance, substantially as and for the purpose described.

Claim 20. In a system of wireless telegraphy, a transmitting-station containing an oscillation-transformer, the primary of which is connected to a condenser-circuit discharging through a spark-gap which automatically causes electric waves of the desired frequency, the secondary of said transformer connected to an open circuit including a radiating-conductor, and with a capacity and a coil for charging the condenser aforesaid; a receiving-station containing an oscillation-transformer, the primary of which is connected with an oscillation-receiving conductor and with a capacity, a wave-responsive device connected with the secondary of said transformer, and a receiving instrument connected with the wave-responsive device, all in combination with means for bringing the four transformer-circuits, two at each station, into electrical resonance with each other, substantially as described.

Copyrighted, 1921, by the Author.

## THE LATEST IN AUTOMATIC TRANSMITTERS

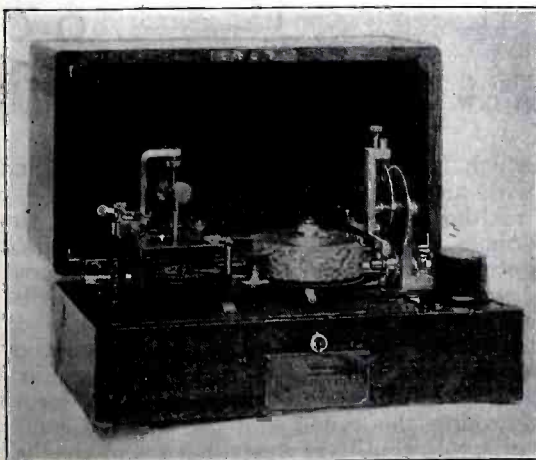

This Automatic Transmitter Involves Some Interesting Features, and is Especially Adapted for Schools and Clubs for Code Practice.

The accompanying illustration shows the Government type of automatic transmitter, used by the Bureau of Navigation, of the Department of Commerce, to test all applicants applying for a Radio license. Up to the present time this apparatus has been used exclusively by the Government, but recently permission has been granted to the manufacturer to sell this particular instrument to the public for use in Radio schools, clubs and by amateurs desirous of learning the code.

The apparatus comprises a strong clock-work movement running at any desired speed for a very long time, and is equipped with 15 dials, a high frequency buzzer and two switches. The dials have five movable message changers, allowing the examiner to transpose the messages at will. Thousands of combinations of messages can be made with one set of dials. In

addition, the dials can be removed from the spindle and shuffled up before replacing, making it still harder to anticipate the message, in case the students have already practiced with these dials.

By means of the switches, the instrument will send messages or signals thru the buzzer direct, or thru one or more fones, as desired, a feature particularly useful for Radio schools or clubs, where the students bring their own fones for code practice. There is a compartment under the base to hold a dry battery and an extra set of dials, also a specially made sound control, and the complete set is enclosed in a carrying case allowing easy transportation.

In a word, this automatic transmitter, embodying new features, is today the most up-to-date machine of this kind on the market and was for this reason adopted by the Government.

(Photo courtesy the Omnigraph Co.)



# Some New Circuits for Radio-Telegraphy Employing a Double-Grid Vacuum Tube

By JOHN SCOTT-TAGGART

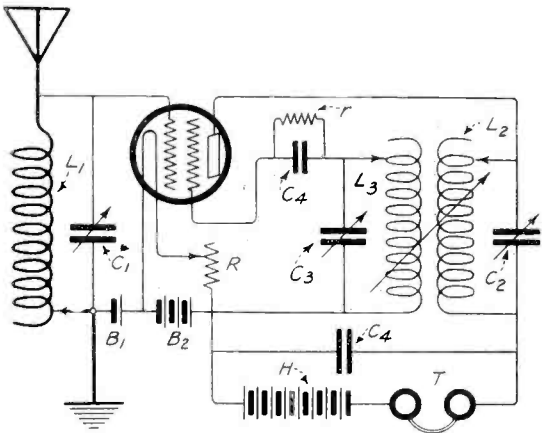

Fig. 3. When Connected in Such a Circuit the Tube Performs Three Roles. It Amplifies at Radio and Audio Frequency and Also Acts as Detector.

THE present writer about two years ago devised a number of new receiving circuits of great practical utility, and as the patent for these (No. 153,681) has now been published, it is possible to give a description of some of them.

A special vacuum tube is used, which consists of a filament, an anode and two grids both arranged so as to control the electron current from filament to anode. One type of this tube—produced while the author was in charge of the design and production of valves at the works of the Edison Swan Electric Company—is shown in Fig. 1. The valve was designed on the lines of the ES 2 and ES 4 tubes, but an additional grid was placed around the inner grid. The anode is slightly larger than the ES 4 anode (9 mm.), and the second grid, G 2, is supported by an addition a 1 "pinch" in the stem. A flexible lead is taken from this grid to a fish-tail clip thru the center of the ebonite base of the usual four-pin cap.

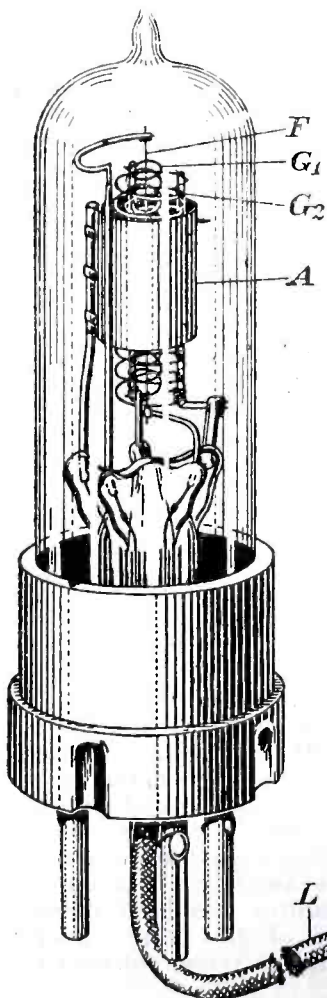

Fig. 1. Full size view of the new type of V.T. two grids.

AMPLIFICATION OF LOW-FREQUENCY IMPULSES.  
One of the uses to which this valve may be put is shown in ig. 2. The leads from

the condenser  $C_1$  are taken to the grid  $G_1$  and to the filament  $F$  of the four-electrode valve. The anode circuit contains an aperiodic inductance coil,  $L_2$ , preferably possessing a fairly high resistance coupled to a tuned circuit,  $L_3C_2$ , adjusted to the incoming wave-length. The incoming oscillations are amplified by the tube, the magnified current being passed on to the circuit  $L_3C_2$ . A crystal detector  $D$  is connected as shown and the condenser  $C_3$  accumulates the rectified pulses. These audio frequency currents are now passed on to the grid  $G_2$  which also controls the main anode current. The valve now amplifies the low-frequency impulses which influence the telephone receivers  $T$  in the anode circuit. A blocking condenser  $C_4$  is connected across telephones and anode battery  $H$  to by-pass the high-frequency component of the anode current. In this case, the vacuum tube carries out the dual rôle of high-frequency amplifier and low-frequency magnifier. The result is that a highly sensitive and stable circuit is obtained, which, moreover, possesses great selectivity, especially if the coupling between  $L_2$  and  $L_3$  is loose.

Another circuit of special utility is shown in Fig. 3. An aerial circuit,  $L_1C_1$  is coupled to a closed circuit  $L_2C_2$ , connected across grid and filament of the four-electrode tube. The amplified oscillations now appear in the tuned anode circuit  $L_3C_3$  and are passed on to a grid coil  $L_4$ , which may be aperiodic. This coil  $L_4$  is placed across the negative side of the filament  $F$  and the grid  $G_2$ . Telephones  $T$  and anode battery  $H$  also form part of the anode circuit. When receiving spark signals the circuit  $L_3C_3$  is tuned to the incoming waves and the coupling between  $L_3$  and  $L_4$  is adjusted to give the best results. Retroaction is thus obtained, not in the main grid circuit, but in the output and secondary input circuits. Rectification will usually take place on the grid  $G_2$  and a leaky grid condenser might be included in the  $G_2$  grid circuit. In this circuit we have a form of retroaction, high-frequency amplification detection and low-frequency magnification.

RECEPTION OF CONTINUOUS-WAVE

If the coupling between  $L_4$  and  $L_3$  be increased beyond a certain limit, the four-electrode tubes will commence to generate oscillations in the circuit  $L_3C_3$ , the frequency of these oscillations depending chiefly on the value of  $C_3$ . If incoming continuous waves are received they will be amplified unchanged in wave-form and will form beats in the anode oscillatory circuit  $L_3C_3$  which is slightly tuned to one side; these beats are passed on to the coil  $L_4$  rectified by the valve action of  $G_2$  and amplified by the tube, the resultant signals affecting the telephones  $T$ .

Remarkably good results are obtained with this circuit. It is to be noted that the beats are not formed in the circuit  $L_2C_2$  nor do they affect that circuit. The oscillations are of ordinary form in the circuit  $L_3C_3$ . It is possible that the electrostatic fields of the two grids combine to produce the heterodyne effect on the electron flow to the anode.

A TRAP ACTION.

The fact that the oscillations produced by the tube only take place in the circuits  $L_3C_3$  and  $L_4$  is of importance. The circuit is the only existing one employing one valve which does not radiate continuous waves from the aerial when receiving in-

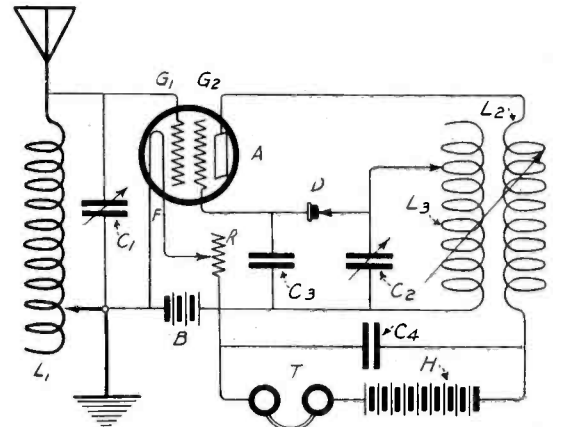

Fig. 2. In This Circuit the Four Electrode Tubes Acts as a Radio and Audio Frequency Amplifier, the Oscillation Being Rectified by a Crystal Detector.

coming undamp waves. The special vacuum tube thus acts as a trap which allows incoming oscillations to pass thru to be heterodyned, but does not allow the local oscillations to pass the other way and set up oscillations in the aerial. Another feature which in this case affects the strength of signals is that the receiver circuit  $L_2C_2$  is tuned to the incoming signal and not detuned as in the case of the ordinary self-heterodyne circuit. The arrangement possesses all the advantages of the autodyne, together with those of the external heterodyne circuit, which latter, however, is very much less sensitive than the author's present circuit, even in the case of very strong signals. As an indication of the sensitivity of the vacuum tube under these conditions, the station of Annapolis is readable in this country on an aerial 100 ft. l. and 30 ft. h.

The last figure (Fig. 4) shows a circuit which has been found of special use for the reception of spark signals. Both anode and secondary grid circuits are preferably tuned and the coil  $L_3$  should be connected the right way round. The coupling, if loose, results in a very high selectivity,

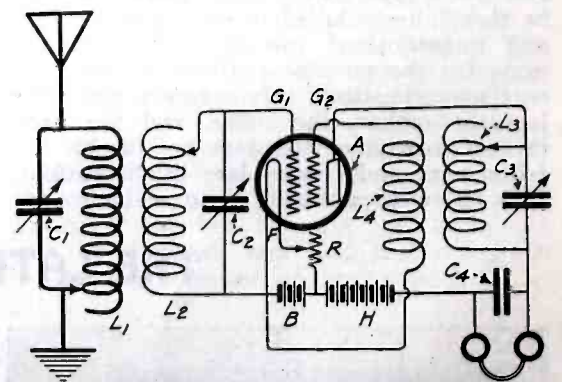

Fig. 4. This Hook-up is Suitable for Reception of C.W. as a Reaction is Obtained Between the Grid and the Plate Circuits.

which is much greater than that obtained with any ordinary valve circuit.

Altho some of the circuits employing the double-grid vacuum tube are described here, yet there are other applications and developments which it is proposed to disclose at an early date. The circuits given may themselves be modified in many ways, as for example by coupling the primary grid circuit to one of the others or by interchanging the tuned and the aperiodic circuits. Preliminary tests have shown that the double grid valve with two input circuits, which constitutes the writer's invention, proves a very convenient receiver for general ship installations.



# Recent Developments in Loop Aerial

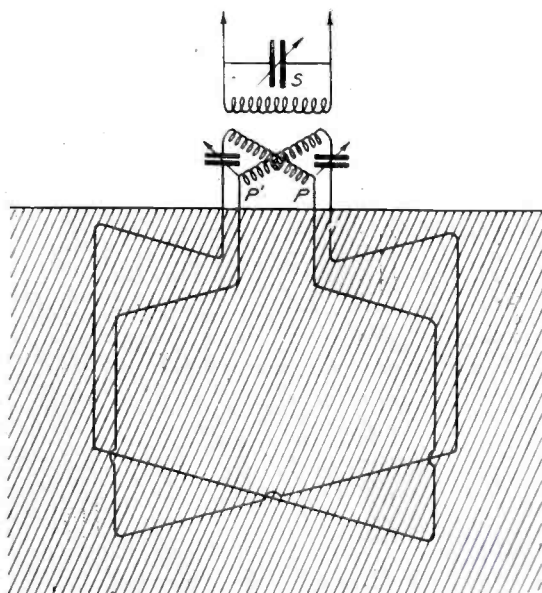

**Fig. 1**  
Instead of a Movable Loop, Two Fixed Loops May Be Buried at Right Angle as Shown, and Connected in Serie With an Inductance Forming the Primary of a Coupler as in the Well-Known Bellini Tosi System.

FOR the past few years the loop aerial has been greatly developed, thanks to the sensitive receivers now in use. During the World War, this form of aerial was found useful for several purposes, and the Signal Corps, as well as the Navy, designed several types of loops for Government use.

The Bureau of Standards is also to be credited with interesting experiments which were carried out to determine the characteristics and constants of this form of antenna.

The loop aerial has been successfully adapted to direction finding work and at the present time, radio compass stations are erected all along the Coast of the United States, and other countries also, enabling ships to determine their exact positions at any time, in a fog or heavy storm, in which they might be carried out of their courses.

The same system is used on airplanes to enable the airmen to know their routes when they are flying in the clouds, or at night, and at the present time this device is being used with success aboard several air crafts.

Undoubtedly, owing to its advantages over the ordinary type of antenna, the loop aerial is the aerial of the future, but further improvements are to be made in order to perfect this wave collector.

One question, the most important perhaps, is how to eliminate statics and at-

mospheric disturbances, which affect the loop antenna as much as the others, causing the same trouble to the operator, who has to receive the signals from a distant station.

Several devices have been proposed to avoid statics; these have given more or less good results; among the latest is one for which a patent has been granted to Messrs. T. Appleby and L. M. Knoll, in which are used underground and screened loops for sending and receiving.

In order to obtain accurate readings with a compass station, it is necessary that the station be erected far enough away from metallic structures, or any larger masses acting as screens and causing refraction of the waves received.

In the new patent heretofore mentioned, there are various means of cutting out interference by the use of buried loops; the first one consists of two loops at right angles connected to an inductance, acting as the primary of a receiver, Fig. 1. A movable coil rotating inside the two primaries is

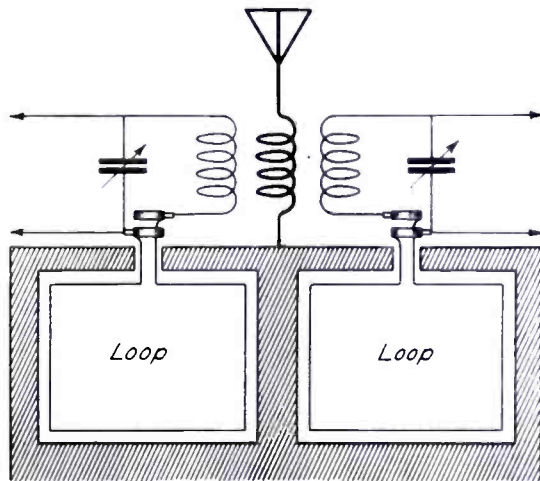

**Fig. 4** Shows How Multiplex Sending or Receiving May be Accomplish by the Use of an Aerial With Several Loop Circuits Coupled to it. Each of These Having a Directional Effect.

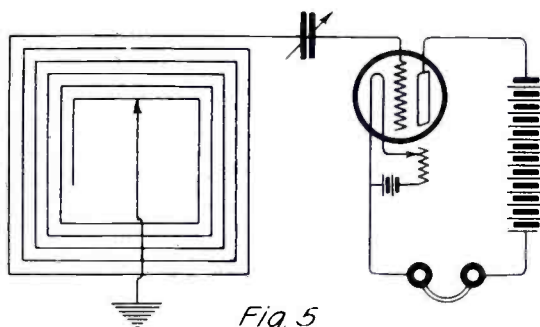

**Fig. 5** is a Grounded Loop. This Hook-up Has Very Sharp Selective Qualities in Direction Finding Work.

used as a secondary, as in the well-known Bellini and Tosi direction finder of the early ages. The other systems are of the movable loop type and revolve inside an underground room, the receiving instruments being placed at will outside of, or in the room.

Fig. 2 shows the revolving loop with the shaft extending outside; the two ends of the loop are connected to two rings on which contact is made by brushes hooked up to the receiving or sending apparatus.

The screening effect obtained by burying the loop is the same as that obtained with buried aeriels of the Rogers type. The static disturbances are cut out and the tuning is sharper, with the advantage that the directional effect is more marked, and allows some very accurate bearings to be taken.

The inventors have also used screened loops in conjunction with the ordinary type of aerial, the loop being inserted in the

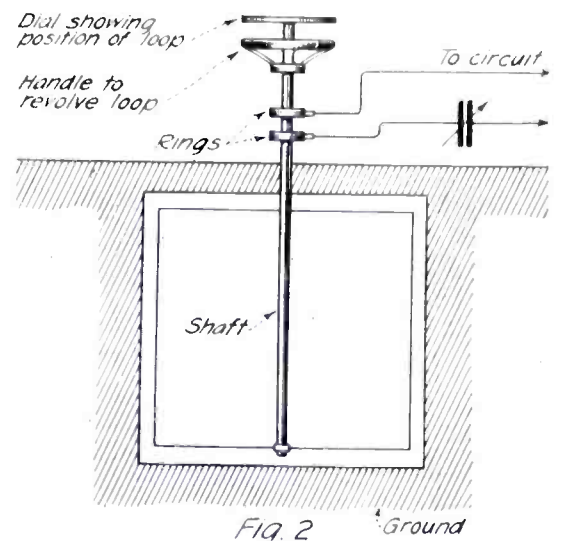

**Fig. 2**  
By the Use of Underground Loops a Sharp Directional Effect is Obtained and the Statics are Entirely Cut Out. The Loop Alone May be Built Underground, the Receiving Apparatus Being Installed Outside.

secondary circuit, thus containing the advantages of both aeriels, viz., directivity and efficient radiation and absorption of energy.

Fig. 3 is a diagram showing the combination of the two aeriels used with a single receiving set. Using several loops similarly connected with a number of sets and only one normal aerial, directive multiplex telegraphy may be carried on as shown in Fig. 4. In this case, all the sets are coupled to the aerial circuit by means of separate couplers.

It is to be noted that the loops may be used under water as well as under ground, the water acting as the screen and having the same effect as the earth.

### GROUNDING LOOPS.

Another circuit, patented by Mr. Henry K. Sandell, is shown in Fig. 5. In this circuit a loop or pancake aerial has a single connection to the grid of the V. T., the other contact, which is variable, being grounded. This device, it is claimed, has very sharp directive properties.

For the reception of undamp waves, two loops are used; one connected in the plate circuit of the V. T. can revolve and may be coupled to the other loop, thus giving a regenerative, or making the tube oscillate, if the coupling is sufficient.

In Fig. 6 only one V. T. is shown, but several stages of radio or audio frequency amplification may be used.

These improvements in the use and construction of loops are discussed on page 820.

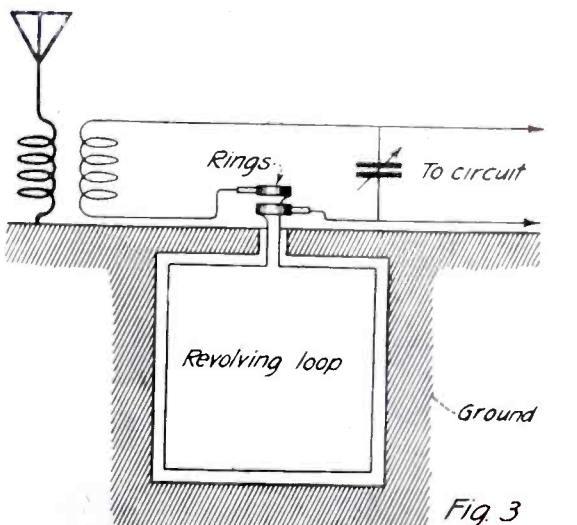

**Fig. 3**  
The Combination of an ordinary Aerial and a Loop Gives the Advantage of a Large Wave Collector Having a Directional Effect. In This Case the Loop is Connected in Serie With the Secondary of the Receiver.

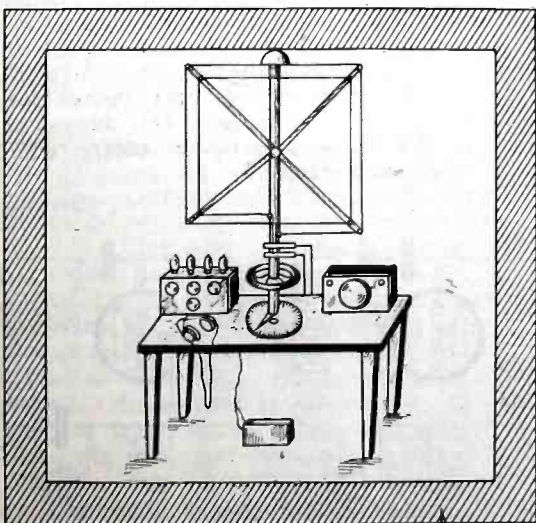
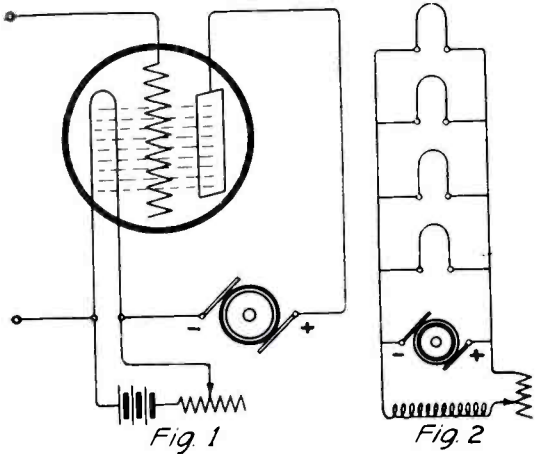

**Fig. 4A**  
This Sketch Shows How a Complete Set May Be Installed in an Underground Room to Avoid Statics and Obtain a Sharper Directional Effect.



# Some Operating Characteristics of Electron Tubes\*

By W. C. WHITE, E. E.†



When the Filament of a Power Tube is Operated From a D.C. Source Thru a Resistance, One End of the Filament Carries More Total Current Than the Other End; it is Therefore Better to Supply the Filaments With a D.C. Generator and Regulate the Field.

THE three-element vacuum tube is becoming a fairly common tool to the physicist, electrical engineer and experimenter, and the literature on the subject has grown rapidly, so that at the present time it is really voluminous.

Its theory of operation is quite widely known and is found in most modern textbooks on physics and radio communication. Radio literature is usually generously sprinkled with vacuum-tube circuit diagrams.

It is not the purpose of this paper to take up any of the fundamental theories of operation of the tube or its circuits, but to furnish information and give help to those who professionally, or for pleasure, experiment with these devices.

It is also not the intention to attempt to cover the field of tube operation, but merely to call attention to certain phases of the subject not widely known or appreciated.

It is a rather usual occurrence to those working with vacuum tubes in an experimental way to encounter unlooked-for difficulties and obtain unexpected results.

A number of these more unusual effects will be discussed; first those of a general nature, next those occurring when the tube is used as an oscillator, and finally a few when the tube is used for a number of other purposes.

A tungsten filament type of tube is assumed in the paragraphs to follow, and most of the discussion relates to power tubes.

Certain properties of a tungsten filament as an electron emitting source will first be mentioned, for although these are simple and probably well known, they will bear repetition because of their importance in obtaining satisfactory results with such a type of tube.

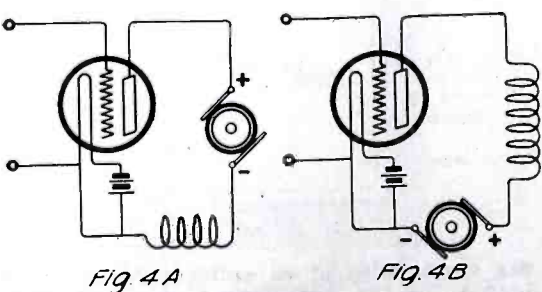

No Choke Coil Should Be Connected Between the H.T. Generator and the Filament as in Fig. 4A. Fig. 4B Shows the Correct Place to Connect the Coil.

The electron emission and life of a filament are quite sensitive to changes of filament current. A 1 per cent. change in filament current causes about a 25 per cent. change in life and approximately a 10 per cent. change in total electron emission. An increasing filament current decreases the life and increases the emission.

Owing to the fact that, like most other metals, tungsten has a positive temperature coefficient of resistance, a certain percentage change of current gives a correspondingly greater change of voltage. Numerically this amounts to a 1 3/4 per cent. change of voltage for a 1 per cent. change of current. Therefore life and electron emission from a tungsten filament are more subject to filament current change than voltage change of the filament.

Although in the past it has usually been the custom to operate the tungsten filaments of vacuum tubes at an approximately constant current by means of an ammeter, operation at constant voltage is to be recommended as giving a much longer life to the filament in about the ratio of three to one.

In operating tungsten filaments in vacuum tubes, observance of the three following rules will greatly increase the useful life of the tube:

- (1) The most favorable adjustment of the set, of which the tube is a part, is the one which gives the desired result with the lowest value of plate current.
- (2) The filament current or temperature

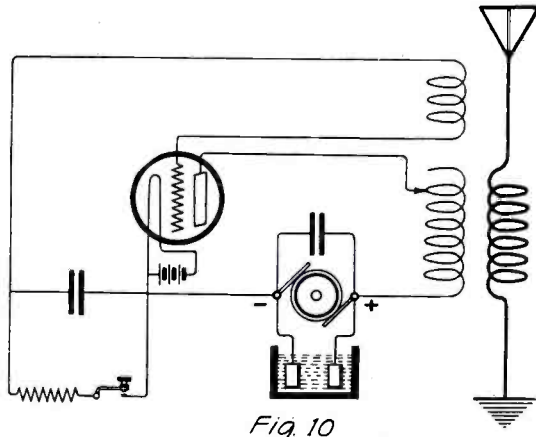

When a Plate Voltage Above 500 Volts and a Power Over 50 Watts is Used, a Protective Device Such as Aluminum Cell Lightning Arresters Should Shunt the D.C. Generator and the Condenser Connected Across.

should not be materially raised to give a slightly increased output or signal which is not vitally necessary.

- (3) Do not, for any length of time, exceed the maximum filament rating, and in all cases reduce the filament temperature to as low a value as is consistent with satisfactory operation of the apparatus.

Most tubes are designed for operation in one or two designated positions: that is, vertically or horizontally, with a certain side or end up. It is advisable to observe this feature because a hot tungsten filament has a tendency to very slowly sag, and if this is not prevented or compensated by operation in a certain designated position, there are liable to be changes in the electrical constants of the tube, caused by changes in distance between the electrodes.

If for some reason the vacuum in a tube becomes faulty, it is usually noted by the characteristic glow due to ionization of the gases present. If gases evolved from the metal parts or glass, due usually to the heat from an overload, are the cause of this glow, it will be blue in color; whereas, if

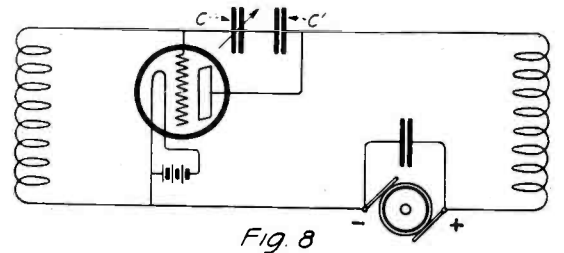

Fig. 8

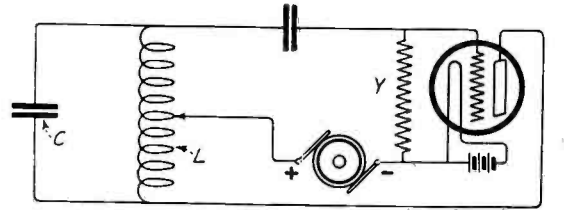

Fig. 9

Fig. 8 Shows How a Protective Condenser C1 is Inserted in Series With the Variable Tuning One to Prevent the Latter From Breaking Down. Fig. 9 is a Simple Hook-up for Low Power in Which a Higher Capacity C May be Used and Still Maintain Oscillation.

it is due to air leakage, it will appear purple or pink.

Occasionally a tube will be met with which, when the filament is energized, shows a sort of yellowish-white smoke in the interior near the filament or it fails to come up to normal brilliancy at rated ampères and a dark-blue powder forms on the plate and grid. Both these effects are due to considerable amounts of leakage air, but formed under different conditions.

The smoke or powder formed is an oxide of tungsten which exists in several forms and varies in color from a very light yellow to a very dark blue, depending upon the conditions at the time of its formation.

One limit to the possible output of a tube as an oscillator is the amount of energy that can be dissipated safely in the form of heat. If it is attempted to dissipate too much energy, the glass and electrodes will be liable to evolve gas which reduces the vacuum. If the tube is enclosed in a small unventilated space, normal operation may overheat the glass of the bulb and cause it to evolve gas. This is most likely to occur where a number of tubes are operated in parallel, thus causing a considerable energy dissipation in a small area.

When the filament of a power tube is operated from a direct current source through a regulating resistance, the plate current causes an inequality in the filament current. This action is represented in Fig. 1. The electron emission occurs along the length of the filament and therefore one end of the filament will carry more total current than the other end; this causes one end of the filament to be the hotter, which for the same amount of emission will shorten the life. The relative resistance

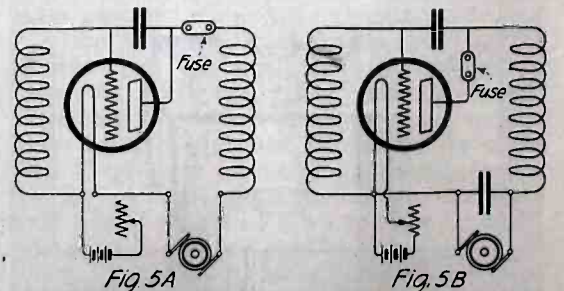

Fig. 5A

Fig. 5B

Fig. 5A Shows Three Common Errors That Are Often Found in O.W. Circuits. Fig. 5B Shows the Right Connection to the Filament, and How to Avoid Resistance in the H.F. Circuit by Shunting the Generator With a Condenser and Inserting the Fuse in the Plate Connection.

†Research Laboratory, General Electric Company, Schenectady, N. Y.

\*Presented at the Stated Meeting of the Institute.



values of the regulating rheostat and the filament, and also the location of the point of connection between the filament and plate circuits, determine the amount and direction of this effect. As shown in Fig. 1, the plate current causes the filament temperature to decrease at the positive filament terminal. This is the safest and best mode of connection.

If, however, the filament is operated from a few cells of storage battery or directly from a low-voltage direct-current generator so that the resistance in series with the filament is small, it is immaterial whether the return from the plate circuit

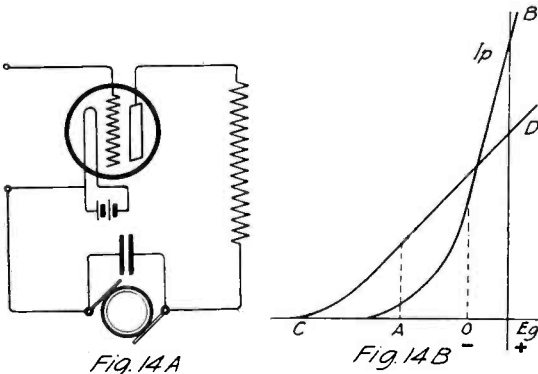
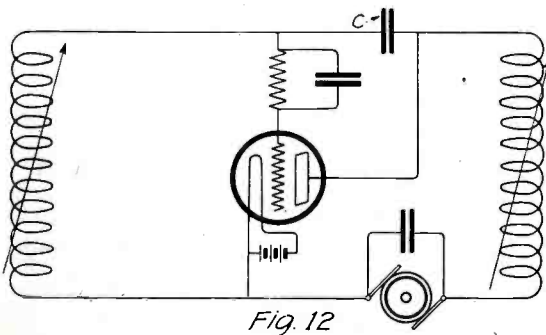

Fig. 14A Shows an Amplifying Circuit Where a Resistance is Connected in the Plate Circuit, While Fig. 14B Represents the Electrical Characteristics of a 3-Element Tube.

is made to the positive or negative terminal of the filament; the heating current in the negative side of the filament is increased by the same amount. A considerable resistance in series with the filament is essential to any alteration in the distribution of the flow of plate current through the filament circuit as a safety precaution. As the plate current is usually in the neighborhood of 2 per cent. to 7 per cent. of the filament current, and as a 3 per cent. increase of filament current halves the life of a tungsten filament, the importance of this effect is evident.

If a low-voltage direct-current generator is used for filament lighting, it is usually connected in circuit as shown in Fig. 2, the filaments being directly connected to the armature leads, the adjustment of filament



When an Oscillating Circuit is Used for Measurement Work, in Order to Keep the Frequency Variation, Due to Voltage Variations of the Power Source as Small as Possible, a Grid Leak of Very High Value Should be Used.

temperature being made by a rheostat in the field circuit of the generator. With such an arrangement difficulty may be experienced with the generator not building up if the filaments are left in circuit. This is owing to the fact that the cold resistance of a tungsten filament is very low, only one-thirteenth to one-sixteenth of its normal operating resistance. Therefore, if a small low-voltage direct-current generator is used at full load to supply tungsten filaments, the cold resistance of the filaments may be so low that it acts as practically a short circuit on the armature and prevents the generator from building up.

On power tubes it is preferable to use alternating current for filament excitation. The chief reason for

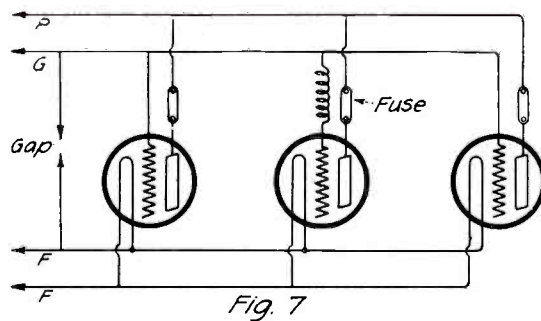

To Avoid the Production of Ultra High Frequency Oscillations When Several Tubes Are Used, a Small Inductance Should be Inserted in the Grid Circuit of One Tube as Shown.

using A.C. is that it obviates the unbalanced condition of a D.C. filament current, as described in a previous paragraph. It is also more practical to generate and distribute the low-voltage high-current energy for filament operation by means of A.C.

In using A.C. for filament excitation the filament terminals should be connected directly to the transformer low-voltage terminals, the regulating resistance being placed on the power side. Also the return of the grid and plate circuit should be made to a center tap of the coil supplying the filament. This mode of connection assures minimum disturbance in the plate and grid circuits from the frequency of the filament source. Both these points are shown in Fig. 3.

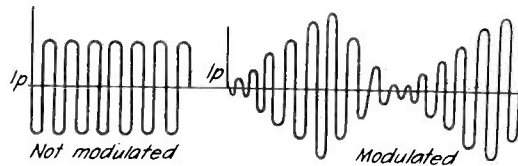

Fig. 15b

When the Circuit of Fig. 15A is Used for Radiotelephony the Amplitude of the Oscillations Increases Above the Normal Value and Decreases to the Minimum Possible, Insuring Perfect Modulation.

Some points in connection with the use of tubes as oscillators will next be taken up.

In the various diagrams of connections which are shown in this paper, each one is simplified so as to more clearly show the point under discussion. For this reason many diagrams for clearness or simplicity omit features which in another paragraph are shown to be advisable.

In all tube oscillator circuits there is an inductance in the plate circuit across which the high-frequency voltage is set up. Care should be taken that this inductance is not placed between the filament energy source and the plate energy source, as shown in Fig. 4a. Both of these sources have usually a large capacity or a certain resistance to ground, so that a circulating current will flow through the coil and through each source to ground. For the type of circuit shown the correct arrangement is shown in Fig. 4b. The importance of having the circuit correct in this respect is greater the greater the power and the higher the voltage used.

In arranging an oscillating circuit to deliver high-frequency energy, it is important to reduce to a minimum the losses in the high-frequency circuits. Not only should

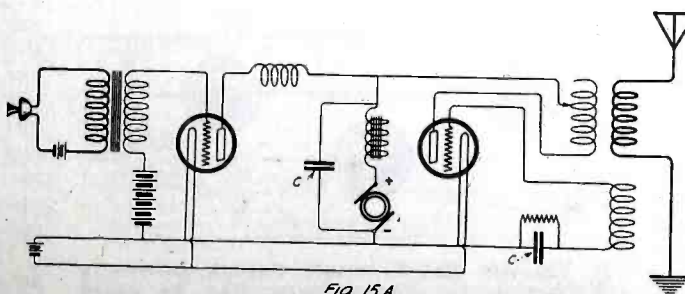

This is the Typical Radiofone Circuit Using One Tube as Modulator and One as Oscillator. This Hook-up is the Most Efficient When Only Two Tubes Are Used.

the wires used be of low resistance and the condensers have low losses, but it is best to trace through the circuits carrying high-frequency currents to be sure that the resistance is a minimum.

Three common errors in this respect are shown in Fig. 5a which represents a capacity coupled oscillator circuit. In this diagram the high-frequency current of the oscillating circuit must pass through a resistance path comprising the filament and battery source. Also it must pass through a fuse in the plate circuit and through the plate voltage source. In Fig. 5b the same circuit

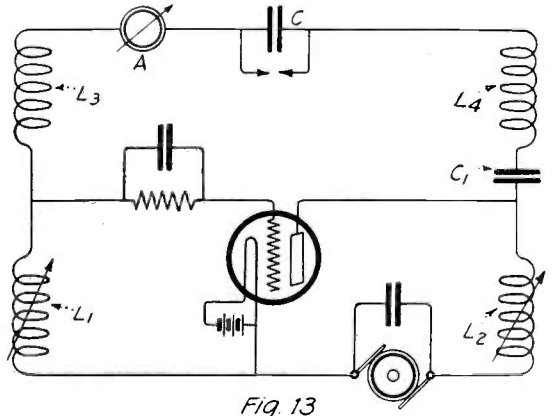

This Circuit is Particularly Efficient When it is Desired to Obtain High Voltage, High Frequency Energy to Test Dielectrics and Measure Dielectric Losses.

is shown with these three errors corrected, the first, by changing the wiring so that the return of the grid and plate circuits is brought back to the same filament terminal, the second, by change of the fuse position, and the third, by shunting the plate circuit generator with a by-pass condenser.

For miscellaneous laboratory work the capacity coupled type of circuit is a very convenient one to set up and operate, usually giving little trouble. However if the circuit happens to be set up in a certain peculiar way, very puzzling results and failure to operate may sometimes occur, particularly if a tube of low impedance is used or several tubes in parallel.

This arrangement is shown in Fig. 6a. If, as shown in this diagram, the leads from the coupling condenser C are connected to the plate and grid coil terminals rather than to the corresponding tube term-

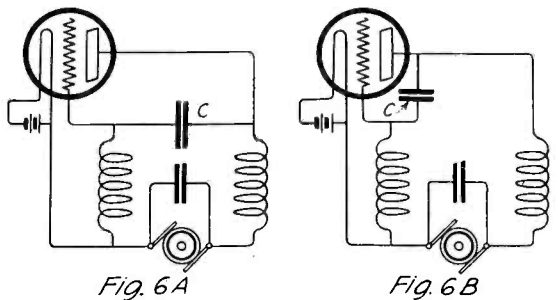

To Avoid Capacity Effects From Long Leads to the Grid and Plate, the Condenser Should Be Connected as in Fig. 6B.

inals, as shown in Fig. 6b very high-frequency oscillations may occur, a second capacity coupled circuit being formed, the capacity between the electrodes acting as the coupling condenser and the leads between the grid and plate coils and the corresponding tube terminals acting as the grid and plate inductances. This condition is accentuated by having these leads long and the leads to the coupling capacity short.

This unexpected production of ultra high-frequency oscillations is often a very troublesome problem in high-power tube apparatus when a considerable number of tubes are operated in parallel. The low impedance of the tubes in parallel accentuates the effect. One expedient which

(Continued on page 800)



# Simple Measurements and Calculations for the Amateur Station Owner

By P. F. GEAGAN

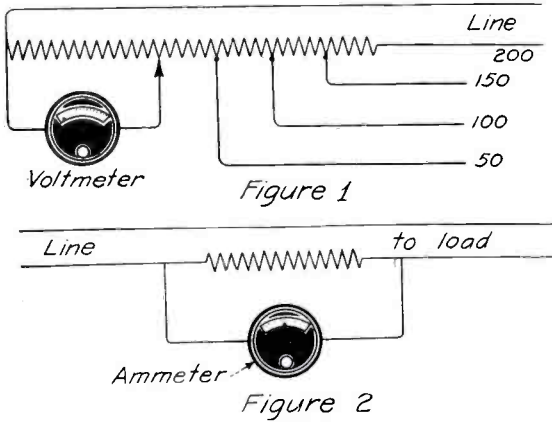

These Diagrams Show How to Use Low Readings Voltmeters With Shunts to Measure High Potential.

IN a past issue of RADIO NEWS a method of constructing and calibrating a cheap wave-meter for amateur station use was described, also a number of measurements that might be taken with it. The purpose of this article is to describe a few methods of obtaining measurements without going to the expense of purchasing costly instruments. It must be stated at the beginning that the only way to obtain absolutely correct values is to have at hand standard instruments of laboratory calibration, and in the methods to be described here, there will be an error more or less pronounced. The experiments will be interesting however and the results suffice where approximation is sufficient.

Perhaps the term most commonly used among electrical experimenters is the volt. A means of measuring the volt may be constructed cheaply at home as follows. A small pocket battery voltmeter and a quantity of fine resistance wire wound on a small cylinder and provided with a sliding contact will do the work, in short a potentiometer and low reading voltmeter, to read the drop across the sliding contact and one end of the coil. The meter may be purchased for a few dollars and the cost of the wire will be very little. The resistance of the coil must be sufficient to keep the current flow at a low value. The best plan is to construct the coil of high enough resistance to measure two hundred volts and bring out taps to binding posts at points on the coil for, let us say, one hundred and fifty, one hundred, and fifty volts respectively. The insulation must be bared for contact with the slider. The total resistance in this case would have to be by Ohm's law,  $C = \frac{E}{R}$ , two thousand

ohms if we wish to keep the current flow down to one-tenth of an ampere. The number of feet of wire necessary may be found by dividing the resistance per foot, which may be ascertained where the wire is purchased, into two thousand, the total resistance. The wire must be insulated turn from turn except where the sliding contact runs, and wound uniformly on a cylinder of about one inch in diameter; a larger cylinder may be used but the smaller the turns the less the error is apt to be. Both ends should be brot out to binding posts, and a binding post connection to the sliding contact also provided. If our wire runs, let us say, four ohms to the foot we will require five hundred feet to make the necessary resistance of two thousand

ohms, and if our cylinder is one inch in diameter we will have  $\frac{12'' \times 500'}{6000} = \frac{1'' \times 3.1416}{3.1416}$  or roughly two thousand turns to our coil. If we assume for example a two hundred volt line the total drop across the coil will be two hundred volts, therefore the drop per turn will be  $\frac{200}{2000}$  or .1 volt. Our tap

for one hundred and fifty volts should then be taken off at fifteen hundred turns, the one hundred volt tap at one thousand turns, and the fifty volt tap at five hundred turns. The sliding contact should carry a pointer or marker of some kind and there should be a strip of paper pasted so that the pointer will run over it. Starting from one end of the coil mark every ten turns on the paper strip, this will mean that between marks there will be a drop of one volt. Most pocket meters of the kind I have in mind read three volts at full scale, and such a one connected across one end of the coil and the sliding contact will read three volts when the sliding contact cuts in thirty turns or three divisions on the paper strip if the voltage be two hundred, one hundred and fifty, one hundred, or fifty volts, according to whatever tap we are connected to.

Let us say that we connect one end of the coil to one side of a one hundred volt line, the one hundred volt binding post to the other side of the line with the meter connected to the end post and the sliding contact post as in Fig. 1. If we now read three volts at thirty-six turns it means that the drop per turn is .083 volts and the total line voltage is 83 volts, since we have cut in one thousand turns. If an hour later we read three volts at twenty-eight turns it means that the drop per turn is now .107 and the total line voltage is 107. When using a circuit of fifty volts connect to the fifty volt binding post, and the same at one hundred, one hundred and fifty, and two hundred volts and the per cent. drop per turn remains the same.

The foregoing is true only for direct

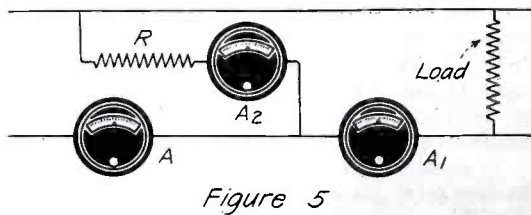

Figure 5

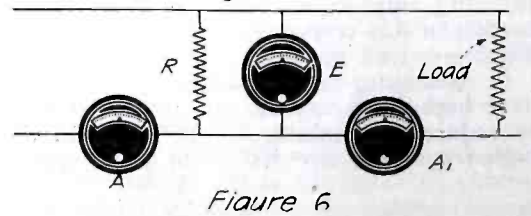

Figure 6

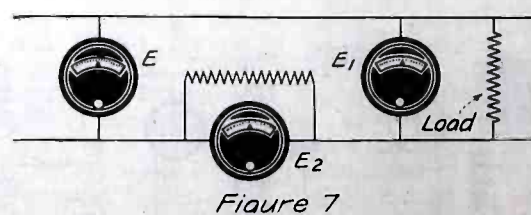

Figure 7

If You Are Not Fortunate Enough to Own a Wattmeter, the Power Factor May Be Found by the Use of Volt and Ammeters as Shown in These Diagrams.

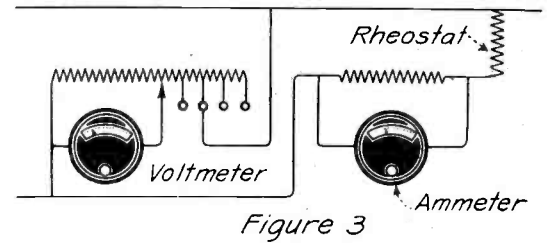

Figure 3

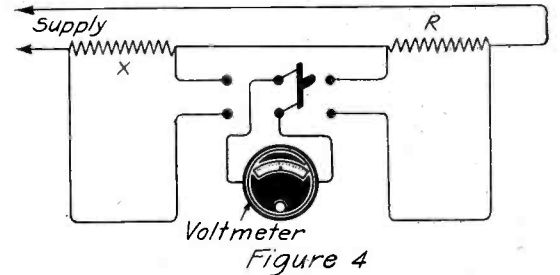

Figure 4

The Hook-up in Fig. 3 May Be Used to Find the Resistance of a Rheostat or Other Unknown Resistance, While the Hook-up in Fig. 4 May Be Used When a Very Low or Very High Resistance is to be Measured.

current, for alternating current it is not enough to know the resistance, we must know the impedance; if, however, after the coil is wound a means is at hand for determining the line voltage and the frequency, also the amount of current the coil allows to flow, the impedance will be equal to the voltage divided by the current. We can then mark off the coil as in the case of direct current and read the same. Since the impedance varies with the frequency however, it being numerically equal to  $\sqrt{R^2 + (2\pi NL)^2}$  the error will vary with any change in frequency. In the case of twenty-five cycle power lines the variation in the frequency is very little and may be neglected, but if the impedance of the coil were to be obtained at twenty-five cycles and later the coil used to measure at sixty cycles the error would be large. Such an arrangement is not costly and will be found satisfactory where accurate measurements are not required.

For obtaining a measurement of the current flow or amperes, cheap pocket ammeters similar to the voltmeter described above are to be had at a moderate cost and usually read up to twenty-five amperes. If, however, it is desired to measure heavier currents the same meter may be used by making a shunt resistance to use in connection with it. This is a simple matter of divided circuits; if for instance, it is desired to read up to one hundred amperes with a meter having a full scale reading of twenty-five, it is only necessary to construct a shunt having one-third the resistance of the meter and connect it as in Fig. 2, the current flowing then will be equal to four times the reading of the meter. For example, if our meter in such a case reads seventeen the current flowing equals  $4 \times 17$  or 68 amperes. The resistance of the meter if not known and also the value of the shunt may be determined as described in the paragraph under resistance which follows. As in the case of our voltmeter if it is desired to measure alternating current values, the impedances instead of the resistances must be known, also in both cases the meters must be capable of reading A. C.

Having at hand now a voltmeter and an ammeter we can ascertain resistances within certain limits by simply applying Ohm's (Continued on page 808)



# Remote Control Antenna Switch

By NORMAN A NYQUIST

**A**T a particular New England station, located in an apartment house, it was necessary to eliminate the noise of the non-synchronous rotary spark gap, on account of disturbing the other tenants of this apartment. Experiments were made with noise proof boxes, but it was concluded to be impossible to construct anything suitable and still have short primary circuit leads so as to secure satisfactory and efficient operation on 200 meters.

As an alternative it was decided to locate the transmitting apparatus in the cellar of the apartment house. The receiving apparatus was located on the second floor. Referring to the Schematic wiring diagram of the proposed idea, you will note that the antenna transfer from the transmitting apparatus to the receiving apparatus is manipulated by a solenoid.

When this switch was in the receiving position, the current was not connected to the solenoid and a spring held the moving rod holding all the contactors, in the up

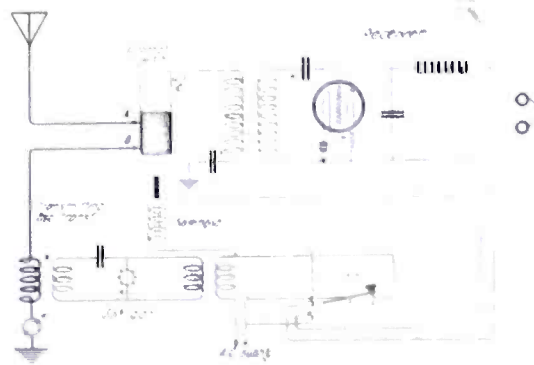

Hook-up of the Complete Set Showing the Connections From the Extra Contacts Fixed on the Key.

parent now, is that this arrangement enables an operator to listen for signals when the key is open between words or pauses while transmitting, in other words a break-in system, without an anchor gap.

Referring now to the drawing of the complete switch shown cross-sectionally in the transmitting position.

The most important part is the solenoid, a brass tube 1" inside diameter and 1 1/4" outside diameter and 3 1/2" long is required. This is set on a mandrel in a lathe, two temporary pieces of sheet brass 4" in diameter and 3/8" thick are pressed on each end flush with the ends. Over the brass tube, two turns of .010" Empire Cloth are shellacked. Using No. 22 B. & S. D. C. C. wire the form is then wound full, placing one turn of .010" Manila paper between turns. Flexible leads of lamp cord are brot out at the start and finish. The brass end pieces are carefully taken off after finishing the winding, and the end of the layers are varnished with an armature varnish to prevent them from unwinding before mounting in the cast iron case.

The cast iron case consists of a dish shaped casting having a side and a bottom, the center of the bottom being in the shape of a boss, as shown in the drawing. The other casting is simply a round plate, for the other end of the shell. The round plate is drilled in six places or placed on the other casting which is drilled and tapt in six places to correspond with the plate holes. When these two pieces are placed together, a hole 1 1/4" is drilled thru the exact center of both pieces. It is then apparent that the coil will be placed in the bossed end from the large open end, and the cover placed on. The brass tube should fit in these holes tightly, a press fit. On the sides of the shell shaped casting some large holes should be bored to give the coil ventilation.

The next important item is the sliding rod which has all the contactors. This

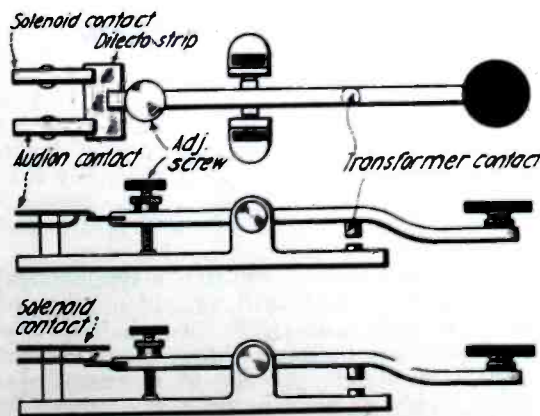

This Shows How the Additional Contacts Are Fixed on the Key to Close the Solenoid Circuit and Cut Out the V.T. at the Same Time.

starts with a piece of soft iron 1" in diameter and 3 1/2" long. This piece should be a good running fit in the brass tube of the solenoid. At the upper end of this piece a shank 1/2" long is turned down to 1/2" in diameter. A piece of dilecto rod 7" long and 1" in diameter having a hole 1/2" in diameter and 1/2" deep is the main part of the rod. The soft iron piece with the shank is pressed in the hole of the dilecto rod. At the other end of the dilecto rod, for a distance of 1 1/2" a cut is taken to reduce the diameter 1/4". A piece of brass tube 3/4" inside diameter and 1" outside diameter and 1 1/2" long is pressed on this reduced diameter part of the dilecto rod. This gives a good bearing surface for the upper end of the rod. In the middle of the dilecto rod a piece of copper tube is pressed on. This tube is 2" long, 1" inside diameter and 1 1/2" outside diameter. A steel spring is shown holding the rod thru a pin against the motion of transmitting position.

When the current is cut from going thru

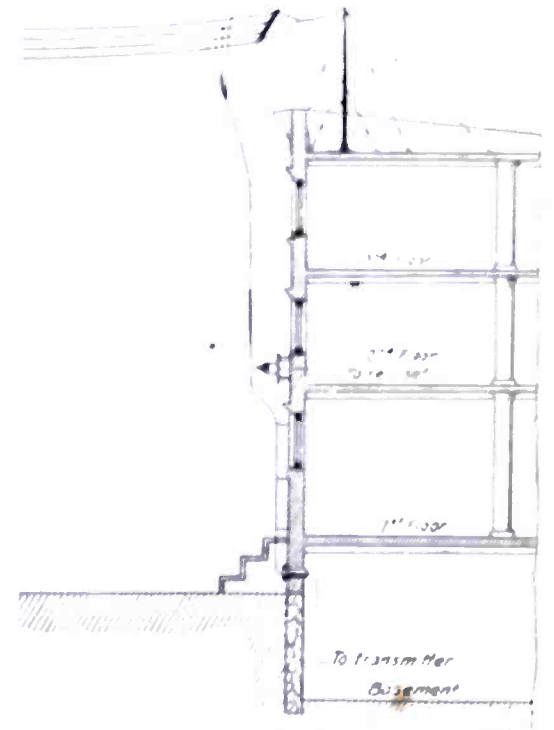

Sketch Showing the Disposition of the Automatic Transfer Switch and Sending and Receiving Sets.

the solenoid, this spring throws the contact tube in the upper position connecting the antenna to the receiver.

This pretty well covers the entire construction. The contacts made on the copper tube are not really as important as they seem. Contacts A and B need not be more than 1/4" apart when the switch is in the receiving position. When in the transmitting position contact C does not have to be more than 3/4" from the copper tube for a 1 K.W. set and less than that for most stations only having about eight or ten thousand volt transformers. This means that for the average, a solenoid plunger motion of 3/4" maximum is all that is required. In view of this the problem is of easy solution. However, to adapt that system to a high power station would be impossible on account of the high voltages developed in the antenna, and the long plunger motion that would be necessary to give sufficient insulation at the transmitting position.

This particular switch was mounted in a wooden case and mounted right outside

(Continued on page 814)

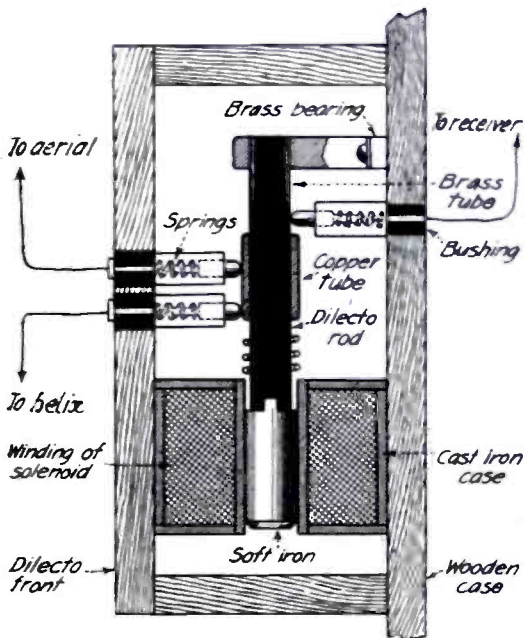

Details of the Automatic Switch. When the Solenoid is Energized, the Core is Pulled Down Connecting the Aerial to the Sending Helix. When the Current is Cut Out the Spring Pushes the Core up, Connecting the Aerial to the Receiver.

position. In this position contacts A and C were connected together thru the copper tube on the moving rod. The antenna was then of course connected directly to the receiver primary. The ground terminal of the receiver was permanently grounded.

It will be further noted that when the transmitting key is depressed the current is connected thru the transmitting condenser in the regular way. However, there are two auxiliary contacts on the rear of the key. Before the key is fully depressed one of the contacts opens the audion filament circuit and the other contact closes the solenoid circuit of the automatic antenna transfer switch. Thus, before the transmitter is closed, the antenna is switched to the transmitting position and the audion circuit is opened so that no sounds will be heard in the receiver while transmitting.

This system worked very successfully altho a transmitting speed in excess of 25 words per minute could not be obtained with good results. In view of the fact that most operators work at a rate of speed less than 25 words a minute it is that this system could be applied to advantage by many station owners. A decided advantage of this system, which should be ap-



## 2 AD Explains

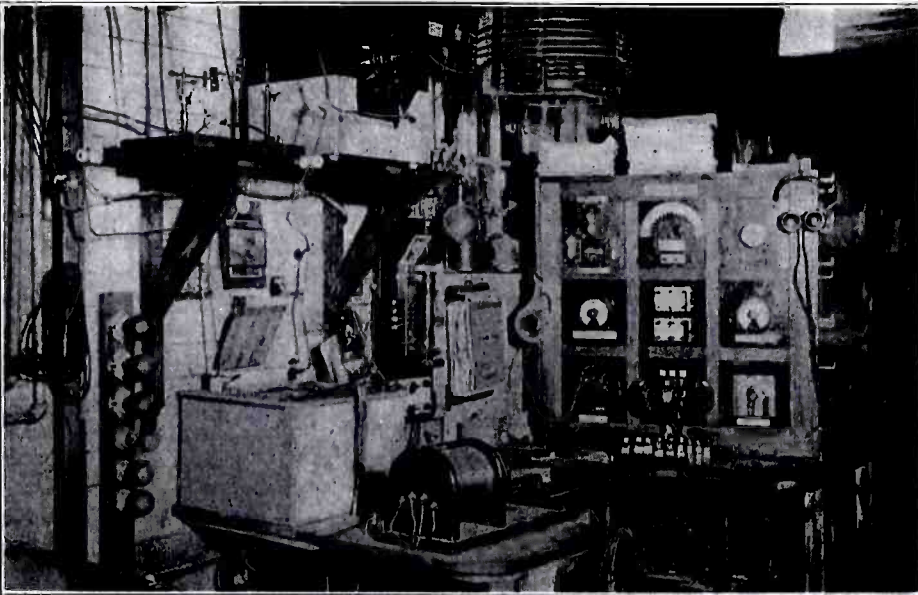

This photograph shows Mr. Telmosse's station which is entirely home-made. Upon request of several amateurs for constructional details, Mr. Telmosse sent in this description for the benefit of those interested.

EVER since you published the photo of my station—2AD—in your February issue of the RADIO NEWS, and for which you will please accept my sincere thanks, I have received from amateurs all over the United States letters asking for details concerning circuit and construction of same.

As my time is quite limited, I cannot answer individual inquiries in a satisfactory way, therefore I thought that in sending you the circuit with explanatory notes you might publish same for the benefit of all those who had inquired.

First of all I may say that the results achieved were obtained only by experimentation, testing and a great deal of patience and work; no theory nor technical knowledge have helped me.

My receiving cabinet, which is home-made, is composed of nine panels, three on a side; on the first one, upper left, I have my detector valve V24, and below two step-down coils, also V24.

On the second panel, upper center, is my loading coil, composed of 4,050 turns in cakes wound on a roller of 2" diameter, and  $\frac{3}{8}$ " thick with S. C. C. wire No. 26 paraffined in a bath of boiling wax divided into 16 sections with cakes of 100-200-250 and 400 turns each and I think I should have had about 1,000 turns more. Also I have a single pole switch to cut it off when not needed.

I may say that for waves less than 1,800 I never use this loading. Great care should be taken in connecting up these cakes, which should be separated by one layer of empire cloth, so that the winding goes from the start to the end, in one direction, the same connections as the secondary of

a step up transformer, a lead to be taped on a contact between sections to the scale of the 16 sections, I have used for these contacts, paper fasteners.

On the third panel, upper right, I have a D. C. amp. meter connected on the filament circuit of the three valves, indicating the direction of current in using the set as well as in charging up the storage batteries; behind this panel, I have hooked up the two amplifying transformers.

On the left center panel I have the resistance of the two amplifying valves.

On the center panel of the cabinet I have the two P. D. switches to change circuit from detector only to detector and amplifiers together and vice versa.

On the right center panel, I have resistance of the detector valve only.

On the left lower panel, I have the ground variable condenser .005 with an S. P. switch to cut it off when necessary. I also

By means of Two DPDT switches the fones may be connected to the detector tube, or the two-step amplifier at will. For radio-telephony, the receiver is used as oscillating circuit and the microphone connected in the ground lead.

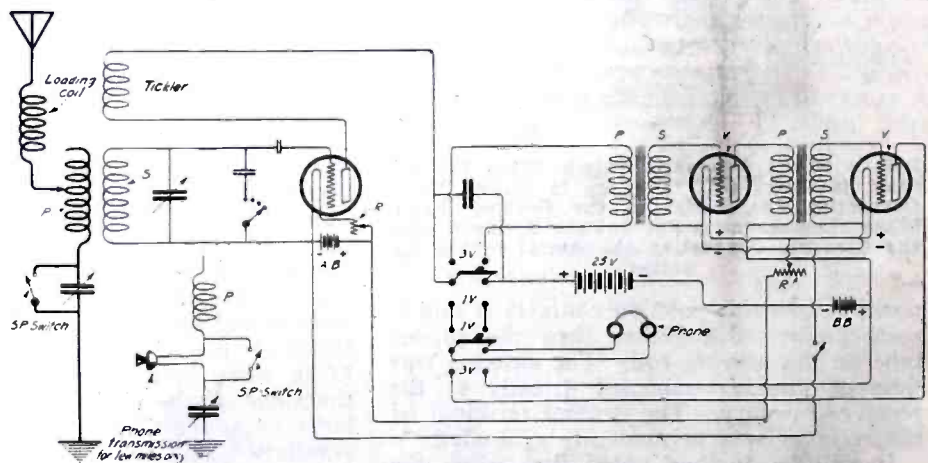

## WINDING DUO-LATERAL COILS

By VICTOR ANDREW

Upon reading Mr. Prather's article on hand winding of duos I believe I can give further information of value. I have wound many coils from 20 to 1,750 turns on the same type of winder that he describes, and have tried many slightly different systems, including his.

First, retarded winding is slightly more efficient than advanced winding, that is each time a turn is completed bring the wire to the second peg before the one it last went around, instead of to the second peg following.

Using an even number of pegs on each side, as he recommends, is satisfactory, but at the end of each layer it is necessary to

change to the other set of pegs. If you are trying to keep count of the number of turns by the number of turns to a layer, this is very likely to confuse you, for it is necessary to change back to the other set of pegs at the end of one layer, and change ahead at the end of the next.

Recently I have found that a symmetrical coil can be wound with an odd number of pegs in each row, if the pegs in one row are halfway between those in the other row, instead of opposite, as is customary. Thus, with 49 pegs in each row, those in one row are 1, 2, 3, 4, etc., while those in the other are  $\frac{1}{2}$ ,  $1\frac{1}{2}$ ,  $2\frac{1}{2}$ , etc.

Advance each time  $2\frac{1}{2}$  spaces. Starting

have the telephone transmission (ordinary telephone transmitter). This circuit shows how connections are made, but since this blueprint has been drafted I have found that in making connections between the ground and the variable condenser it gives better results.

The center lower panel is the most interesting one; it is the primary-secondary and tickler connections, made with 60 amp. cartridge fuses spring contacts.

The system I have is similar to the De Forest honeycomb coils, of 26-51-75-110-225-360 and 660 turns each, of a different number of turns; I have wound 21 coils by sets of three similar ones, which are made of No. 26 S. C. C. wire. The 26 turns set is of No. 18 S. C. C. wire. I can tune down to 50 meters for the telephone transmission; sets of 51 and 75 turns are also satisfactory for the telephone.

I have used a simple hand turned rotary to wind these coils, and  $2\frac{1}{2}$ " nails cut as screws at the end; I have followed as nearly as possible the manner described in your February issue of RADIO NEWS given by Mr. Wm. F. Brother. If I had had this description before doing my work, my coils would have been perfect.

The last panel, the lower left-hand one, is the secondary variable condenser .01 with three fixed ones of different capacities, connected in parallel with the variable, with three contacts switch to take different sizes at a time. The first point is made with one sheet on each side, of  $\frac{1}{2}$ " x 1"; the second point 1" x 1" and the third point  $1\frac{1}{2}$ " x  $1\frac{1}{2}$ ", each separated by a mica sheet and dipped in hot sealing wax. My intention was to increase the capacity of the secondary variable condenser and with my 660 turns set, I have oscillations up to about 22,000 meters wavelength.

The mounting of the coils is made with

(Continued on page 823)

on peg 1, go to  $24\frac{1}{2}$ , 48,  $22\frac{1}{2}$ , 46,  $20\frac{1}{2}$ , etc. This way the winding will automatically go onto the alternate pegs for the second layer.

When two layers are completed there will be 47 turns on the coil. To make a general formula:

$$T = t \times (p - 2)$$

T = total turns on coil.  
t = turns on one peg.  
p = pegs in one row.

For advanced winding:

$$T = t \times (p + 2)$$

For honeycombs substitute 1 for 2 in the formulas.



# A Long Range Receiver

By JOSEPH G. REED

**T**O introduce myself to brother "hams" I might state that my station is located at Summer Hill, Sydney, Australia, and compared with reports of long distance reception often published in RADIO NEWS it has accomplished some remarkable work for an amateur outfit.

The aerial is 42' high and 90' long, consisting of two strands of 7/20 copper wire. To get down to brass tacks, Fig. 1 is a view of the layout with a few dimensions to guide the prospective builder. The set comprises a short wave amateur set—150 to 450 meters (at present useless owing to the enforced absence of amateur transmitters in Australia), a medium wave tuner for work between 600 and 2,000 meters, and inside the main case is the set of long wave layer wound coils which cover a range from 2,000 to 18,000 meters.

When I was building this set, the problem of switching over quickly from one set to another seemed a difficult one to accomplish by a small and neat switch, but by the aid of a five point Ericsson combination telephone plug everything turned out O. K. If the reader is unable to purchase this article from his local supply house, one after the pattern shown in Fig. 2 will suit.

Firstly we will deal with the coils for the long wave set. Construct three forms as shown in Fig. 3. A built up construction is better than turning one out of a solid block as it is stronger. In one corner of the side piece of each form drill a 1/4" hole for lead in and out wires, and proceed to wind as follows. For the primary use No. 24 D. C. C. wire, while for the secondary and tickler coils No. 28 will do. The primary consists of 1,200 turns, the secondary has 2,000, and the tickler 1,600 turns. Beginning with the primary, place one end of the wire thru the hole in the side of the form, and wind on from left to right, 40 turns, which just fill one layer. Now take a strip of paper about 1 3/8" wide and 4 mils thick, and cover the wire with two layers of this paper. Between the first and second layer bring back the wire to the left hand side, and repeat the process until six layers have been put on, then lead the wire out thru the hole provided after pushing it back between the layers of paper to the left hand side. Repeat this process until 30 layers have been put on.

The secondary is wound in a similar

This sketch shows the general arrangement of the panels on which are constructed the parts of the various tuners. Figs. 4 and 5 are the constructional details of the couplers. Fig. 2 shows the details of the plug and Fig. 3 the dimensions of the coil forms. Fig. 6 is the complete diagram of the set.

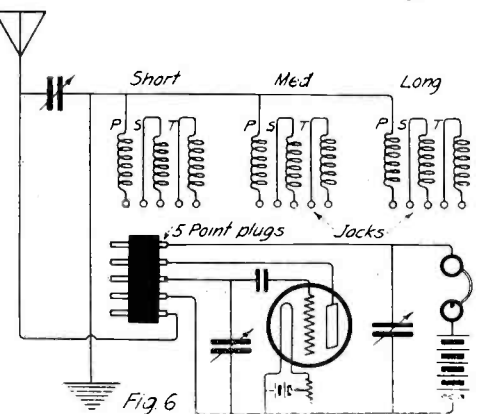
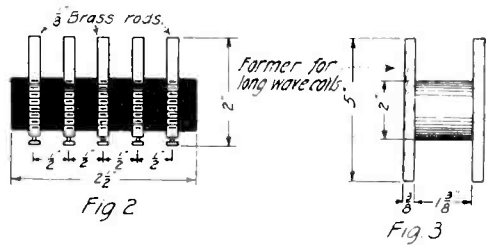
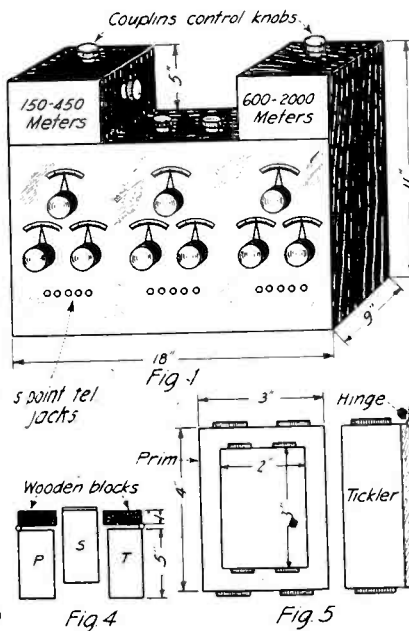

manner with 57 turns per layer of 28 D. C. C., for 35 layers dividing it into five seven-layer sections. The tickler consists of five six-layer sections. This method of winding reduces the distributed capacity and in addition the double cotton insulation helps greatly in this direction owing to the thickness of the dielectric. Stick down the layers of paper with a little hot paraffin or beeswax; do not use shellac on the wire or paper as it introduces dielectric losses in addition to an acid reaction caused by the drying of the alcohol. The dividing of the coils provides for deadening the unused sections, and enables the tuner to get down as low as 2,000 meters very efficiently. The dead end switch is of the pattern described by E. E. Bucher in "Practical Wireless Telegraphy," but any other can be employed, and I leave it to the discretion of the builder, fully realizing that everybody has his best method of accomplishing this operation. The coupling of the primary and tickler coils to the secondary is accomplished by hinging the former coils in such a position that when at 90 degrees to the secondary they are at very nearly zero mutual inductance. How this is accomplished is evident from Fig. 4.

With this receiver employing a one step amplifier, I have been able to copy MUU,

POZ, YN, NPO, NPM, NPG, NSS, NFF, NPU and NBA. On the 600 meter tuner using one tube, I get VIM, VIH, VIP, VII, VLA, VIA, etc., very loudly, using a two wire aerial 90 ft. long and 42 ft. high.

The 600 meter set is another novel feature using variometer coupling between the primary and secondary and hinged coupling between the secondary and tickler coil. The primary is wound on the inner coil and consists of 120 turns of No. 24 D. C. C. wire. The secondary has 220 turns of No. 28 D. C. C. wire and the tickler 200 turns of a similar gauge. (Coils are layer wound.)

Similar dimensions hold good for the 150-450 meter coupler with the exception of 40 turns of No. 22 for the primary and 80 turns for the secondary and tickler coils of No. 24 wire. The coils on both tuners are tapt out to five point switches using miniature electric light flexible cord for the purpose. No dead ending is necessary for these tuners as the distributed capacity effect is negligible.

When using these tuners the inductance should be kept as high as possible in the secondary circuits, to obtain the high potential necessary for the efficient operation of an audion detector.

## Long Distance Hook-Up

By WILLIAM BESSEY

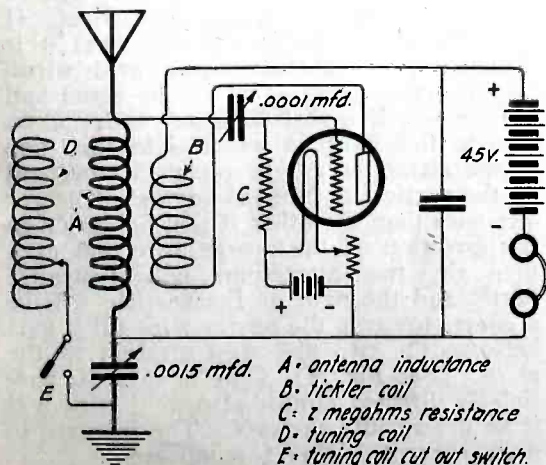

Boys, Here is Another One. Try it for Long Waves With Various Aerials and See What You Get.

For the benefit of the amateur who is trying to cover a good distance with one V. T. and a medium sized aerial, I will relate a few experiments and describe my hook-up. The diagram shows my hook-up. "A" is the antenna inductance and "B," the tickler coil. I use honeycomb coils for both "A" and "B." "C" is a resistance of two megohms. A lower resistance than one megohm will give very poor results. "D" is a tuning coil which aids in tuning in small wave-lengths. It is also a great help in tuning wireless telephone. I use a variable grid condenser. This is not absolutely necessary, but I advise it for sharp and close tuning. I use a Marconi V. T. with four dry cells in series for filament lighting.

Using honeycomb coils—L750 for antenna inductance and L400 for tickler, I

can hear—Balboa, CZ, NBA; Charleston, S. C., NAO; Guantanamo, Cuba, NAW; Sayville, L. I.; NDD; Bermuda, W. I., BZR; Demerara, British Guiana, BZL; and San Diego, Cal., NPL. All come in plain and readable. Using L400 as antenna inductance and L200 as tickler I can hear Washington, Key West and New Orleans. Then by switching in the tuning coil I can hear wireless telephone concerts.

By cutting out the ground and aerial and by touching lightly the ground and aerial connections with my hand I can hear Sayville, L. I.—readable.

I have a small aerial one foot square wound with about 600 feet of No. 35 silk covered wire which I can switch in at will, and in the place of or with the large aerial. Using it alone I have heard several sta-

(Continued on page 816)



# Conduction of Electricity Thru Vacuum and Gases | With Applications to Design of Radio Apparatus

By E. M. SARGENT

## Part Two

### THE ELECTRIC ARC.

With the spark the voltage is usually several hundred volts and the current is small. With the arc the voltage is small and the current may be several amperes. In the carbon arc the temperature of the positive terminal is much higher than that of the negative, the positive being about  $3,500^{\circ}$  C. and the negative  $2,700^{\circ}$  C. The temperature of the arc itself is higher than that of either electrode.

After an arc has been in operation for some time the positive electrode becomes hollowed out on the end, a crater being formed, while the negative becomes pointed. Both electrodes lose material, the positive wearing out faster.

With some electrodes the arc will be intermittent, and if the terminals are of different material the voltage may depend on the direction of the current, especially with electrodes of carbon and a metal. The arc passes much more easily with the carbon negative and the metal positive.

Some metals are termed non-arc-ing, meaning that they are not heat maintaining and tend to make the arc go out. It is hard to get a good arc in hydrogen gas with any metal, and no arc can be maintained in nitrogen between silver electrodes.

There are some interesting applications of the facts outlined above in connection with the design of the radio arc transmitter. When the arc operates at radio frequencies it is necessary to have it make and break several hundred thousand times per second, and consequently substances that maintain an arc easily cannot be used. The Federal Telegraph Co. uses hydrogen gas in some of their arc chambers, and uses large electromagnets in order to make the arc break quickly. Up to date arcs have not been made to work satisfactorily much below 3,000 meters, the frequency at this wave-length being 100,000 cycles per second. The Federal Co. uses 3,100 meters as the commercial wave-length for their ship stations while the Navy uses 3,600 meters as the lowest.

### THE COMPRESST AIR CONDENSER.

This condenser consists of a number of plates arranged as in the common air condenser, the whole being put in a container that will stand very high pressure. The condenser is then subjected to high air pressure, the object being to retain the advantages of the air condenser and still be able to apply high voltage to it. The spark potential between two plates in air varies almost directly as the pressure, so that with the compressed air condenser large voltages may be applied without breakdown of the dielectric. At the same time the leakage between the two plates varies directly as the pressure so that losses increase with the pressure from that source. Ionization in a gas is less at high pressure than at low so that corona from sharp edges, etc., will be greatly reduced. Taken altogether the compressed air condenser is very good electrically, its chief disadvantage being its bulkiness.

### THE QUENCHED SPARK GAP.

The ideal spark gap is one that will be a perfect conductor while the spark is passing and a perfect insulator immediately after the spark breaks. The passage of the spark creates a good many ions in the field between the electrodes and while these remain the gap will be a poor insulator and will break down at potentials much lower

than it is supposed to. These ions can be eliminated either by an air blast on a stationary gap, or by circulation of air in a rotary gap. A combined rotary gap and air blast gets the ions out of the way quickly, but the air blast is cumbersome and unsatisfactory. A quenched gap consists of a series of very short gaps, about .01 inch each, in series, the gaps being in air tight chambers and the electrodes being of heavy metal with silver at the sparking surface. The electrodes must be kept cool. When the spark passes ions are produced. The ions are attracted to the cold metal surfaces and discharged by them before the next spark takes place. The first few sparks eliminate all the oxygen from the chamber by combining it with the silver electrodes to form a thin film of silver oxide over the surface of the electrodes. This leaves only nitrogen in the sparking space, and it is impossible to maintain an arc in nitrogen between silver electrodes so the spark is quickly quenched out. The electrodes are kept cool with a fan. If they are allowed to get hot they may reach the ionizing temperature and then the quench-

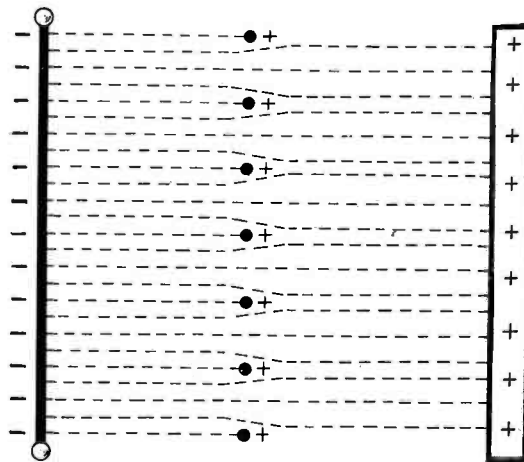

Figure 2

This Diagram Shows the Inside of a V.T. As May Be Seen, the Electrons Attracted by the Plate, Which is Positive, Are Deflected in Their Course, Due to the Attraction Caused by the Grid When the Latter is at a Low Positive Potential.

ing action of the gap will cease. Temperatures as high as  $100^{\circ}$  Centigrade are allowable. Copper electrodes can be used instead of silver but danger of arcing is greater. Other metals besides copper and silver all maintain arcs in nitrogen easier than in air, and hence cannot be used.

### THE VACUUM TUBE.

There are many important applications of the principles outlined in this paper in connection with the design of vacuum tubes. A vacuum tube consists essentially of three elements, filament, grid, and plate, arranged in that order and enclosed in an evacuated glass container. The device is too well known to necessitate a physical description.

The filament is heated to incandescence by passing an electric current thru it. At this temperature the kinetic energy of the negative particles becomes so great that some of them acquire sufficient velocity to break thru the surface tension of the metal, and are projected out into the space around the wire. If the wire was formerly electrically neutral this loss of negative particles has the effect of producing a positive charge on the filament and an attraction is immediately set up between this positive charge and the negative charges on

the particles. This force tends to draw them back into the wire.

If now a positive charge is put on the plate the particles which leave the filament are subjected to two attractions, one back to the filament and the other to the plate. There will obviously be some point between the filament and plate at which these two attractions will be equal in magnitude and opposite in direction. In the ordinary vacuum tube this "point" will be a plane parallel to the plate and situated between the plate and filament. The higher the plate voltage the nearer this plane of equal attraction will be to the filament. Every projected particle from the filament that crosses this plane will continue to the plate and every one that does not cross it will be drawn back to the filament. The nearer the plane is to the filament the more particles will cross it, and the larger the plate current will be. When the position of the plane is very close to the filament a large increase in plate voltage should be required to make any appreciable change in the position of the plane and therefore in plate current, so that the plate current-plate voltage curve should flatten out when the plate voltage gets high. The value of plate current in the flat part of the curve is called the saturation current. The saturation current depends only upon the number of particles shot off from the filament. For a given filament temperature then the value of this saturation current is independent of the spacing between plate and filament, but with large spacing more plate voltage must be applied to reach the saturation point.

The grid when charged positively acts in a similar manner to the plate and its action for a given condition may be predicted from the same rules. When a positive charge is put on the grid a small current flows between the grid and filament, but at the same time instead of robbing the plate of current the plate current shows an increase. This is hard to understand at first glance but may be explained as follows. A positive charge on the grid has the effect of aiding the field of the plate and of pushing the plane of equal attraction nearer to the filament if it is not already at the saturation point. This makes an increase in the number of particles that start in the general direction of the plate and grid. The grid consists of a number of spaced wires all having the same electric charge by reason of being connected together. When a negative particle comes near the grid it is attracted by the charges on all the wires, and as it gets very near will be attracted by the two nearest grid wires. If the path of the particle is such that it is directed exactly between two grid wires, the attraction from each will be equal and the two will counterbalance each other. The particle will go on straight thru due to the attraction of the plate. If the path of the particle is directed somewhat nearer one wire than the other it will be drawn in the direction of the nearer wire, but even then the two attractions will neutralize partly and the path of the particle will be a curve, towards the nearer wire till it gets between the two and then straight to the plate. (See Fig. 2.) Only in case the particle is directed almost at a grid wire will it be drawn into the grid. The increase in plate current is therefore apparent.

When a negative charge is put on the grid its effect is to counteract part of the

(Continued on page 816)



# RADIO DIGEST

## RADIO MARKET SERVICE STARTED APRIL 15.

Arrangements were completed and the radio market reports for farmers were started April 15. In the beginning reports were sent from Omaha, St. Louis, Bellefonte, Pa., and Washington.

The tentative schedule is as follows:

From Omaha a complete report of the Omaha live-stock market will be sent at 11:15 a. m. each day, and at 11:45 a. m. a complete report on the Kansas City live-stock market. At 2:15 p. m. a grain and potato report, giving prices and conditions at the Chicago, Minneapolis, Kansas City and Winnipeg grain markets, and similar information at the Chicago and other potato markets, will be dispatched. At 5 p. m. a daily radio-marketgram will be sent, covering national market conditions on live-stock, fruits and vegetables, grain, hay and feed.

The reports to be sent from St. Louis are a national stockyard live-stock market report at 11 a. m., a Chicago live-stock market report at 11:30 a. m., a grain and potato report at 2 p. m., and the radio-marketgram at 7 p. m.

The Washington station at the post office department will dispatch the 5 p. m., radio-marketgram heretofore sent out by the Bureau of Standards, a report that gives a general daily summary of eastern market prices on live-stock and meats, grain, hay, feed, fruits and vegetables. The same report will be released from the Bellefonte station at 7 p. m. Any changes that are found necessary in the above schedule will be announced by radio in advance of such changes.

## SPAIN-NAUEN RADIO OPENED.

Regular wireless telephonic communication was opened April 16, between the military stations at Carabancel, just south of Madrid, and Nauen, Germany, a distance of approximately 1,175 miles.

This is the first long distance regular Radiofonic service opened. It will be followed by several others between Paris and London, and other European Capitals.

## BUILDING PISA WIRELESS TO CONNECT WITH U. S.

Work will shortly begin on a powerful wireless station to be constructed near Pisa, for regular communication with the United States.

This announcement was made in a lecture by Marquis di Solari, who collaborated with Marconi in his wireless experiments before the Italo-American Association in Rome. The Marquis said it was hoped to begin operation of the plant in 1922.

## CARRIER CURRENT TELEFONY AND TELEGRAPHY.

By E. H. Colpitts and O. B. Blackwell.

This paper briefly outlines first the history of the development of carrier multiplex telegraphy and telephony. The fundamental principles underlying particularly the newer developments of the art are then discussed. Consideration is likewise given to the propagation characteristics of open wire lines, including those containing intermediate lengths of cable. Commercial types of apparatus and actual installations are then described and a brief statement made as to further applications of the art. (Journal of A.I.F.E., April, 1921.)

## AN ORDINARY TRIODE USED AS A NEGATIVE RESISTANCE OSCILLATOR

By John Scott-Taggart and J. Ree.

Altho it is not generally known, the ordinary E. S. 4, R, or French valve, as commonly used, may be employed as a negative

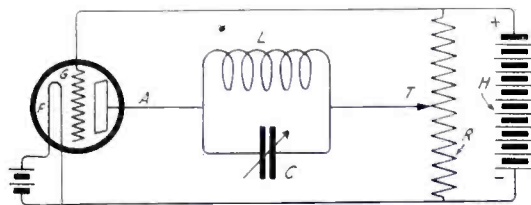

In This Oscillating Circuit the Anode Voltage is Less Than the Grid One.

resistance oscillator, by virtue of the phenomenon of secondary electron emission utilized by Dr. Hull.

A suitable circuit is reproduced in the accompanying figure. A potentiometer R is connected across a source of E. M. F., which may be a battery H, or 110-volt or 200-volt D. C. mains. The actual voltage is not very material, nor is the value of the resistance important. The grid G is connected directly to the positive end of the potentiometer R, the negative end of which goes to the fila-

## List of Radio Articles Appearing in May Issue, Science & Invention

- New York's Radio Convention and Exhibition.
- Ship Line Finds Use for Telemegafone—Arthur H. Lynch.
- Radiofane and Vaudeville Concert.
- A New Binding Post for Radio Sets.
- A Decremeter for the Amateur.
- Compact Audion Control Unit.

ment. The anode P is connected thru the oscillatory circuit LC to a sliding tapping T the anode potential may thus be varied and will be usually considerably less than that of the grid. When this circuit is connected up, a suitable adjustment of T will establish continuous oscillations in LC. The explanation is that the anode current decreases as the anode potential is increased, thus producing a negative resistance in the circuit containing LC. The very high positive potential of the grid causes the electrons to strike A with a sufficiently high velocity to liberate more secondary electrons than the number of primary ones which strike this electrode. These secondary electrons would normally return again to the anode, but the higher potential of the grid draws them away. As the potential of A is increased, the number of secondary electrons (which are immediately drawn away by the grid) increases very rapidly, altho the primary electrons increase hardly at all. The anode thus loses more electrons than it gains. Hence the negative resistance effect which will set up oscillations in any kind of oscillatory circuit placed between A and T. An iron-core low-frequency circuit is "oscillated" as easily as a circuit of the highest frequency. Moreover, the frequency of the oscillations is practically equal to the natural frequency of the circuit. No troublesome retractor coils are used, and the arrangement provides a means of obtaining alternations of any frequency.

Abstracted from the Electrical Review, 1920.

## THE EFFECT OF IMPURITIES ON THE IONISATION POTENTIALS MEASURED IN THERMIONIC VALVES\*

By L. S. Palmer, M.Sc.

This work was undertaken with the object of determining the causes of the low value obtained for the ionization of helium by a valve method recently described in the Radio Review (Aug., 1920) by Dr. Hodgson in conjunction with the author. Since the publication of this paper Stead and Gossling (Philosophical Magazine, Oct., 1920) have, by a different valve method, obtained a similarly low value. They also obtained a value of 12.5 volts for the ionizing potential of argon, which value is 4.1 volts less than that obtained by Hodges and Palmer in the work previously mentioned.

Professor Horton and Miss Bailey (Philosophical Magazine, Oct., 1920) have shown that the addition of a trace of mercury vapor to helium is sufficient to cause ionization phenomena of voltages varying from about 20 to 25, but that true ionization of the helium does not occur with voltages less than 25. These effects were accounted for by the fact that 2.5 volt radiation of helium can ionize the impurities of low ionization potential that may be present in the tube.

\*Radio Review, March, 1921.

## WEATHER REPORTS BY RADIO.

The United States Weather Bureau has arranged with the Department of Science of St. Louis University for the latter to send broadcast by radio-telephone twice each day the official weather forecast for Missouri and Illinois, and also the reports of the water stages of the Mississippi, Missouri and Illinois Rivers and their tributary streams.

This service will start on April 15 and the weather forecasts will be sent out at 10:00 a. m. and 10:00 p. m. of each day from the powerful wireless station of the University, which until the completion of the Government wireless station at the Chain of Rocks also was used to direct the aerial mail between St. Louis and Chicago. In that service, however, the key was used, and in the Weather Bureau Service the radio telephone, to which anyone with a proper receiving apparatus can "listen in," will be the medium of communication.

The arrangements for the service were made by Montrose Hayes, Chief of the Weather Bureau of St. Louis, of which the St. Louis University Observatory is a co-operating unit and with the approval of the Department in Washington. The service will send the official Government forecasts, and the Department of Agriculture requests the newspapers and the Chambers of Commerce of the various cities and the Farmers Organizations within a radius of at least 150 miles in every direction from St. Louis, to make preparations to take advantage of the service, which St. Louis University will give gratuitously for the benefit of the public of that section of the United States.

The Department of Science of the University will be glad to receive any suggestions from individuals or organizations who are willing to co-operate in the service, and who will look after the local distribution or publication of the wireless reports.

## NEW WIRELESS STATIONS.

The Federal Wireless Telegraph Co., of San Francisco, has signed a contract to erect powerful wireless stations at Shanghai, Peking and Harbin at a cost of \$4,200,000. It will be controlled by the Ministry of Communications.



# Who's Who in Radio

No. 4

## GREENLEAF WHITTIER PICKARD, A.A.S.

**G**REENLEAF WHITTIER PICKARD was born Feb. 14, 1877, in Portland, Maine. He was educated at Westbrook Seminary and Lawrence Scientific School, and later attended Harvard University and the Massachusetts Institute of Technology.

Having taken up the special study of wireless telegraphy and telephony, he devoted most of his time to researches, which led him to several discoveries for which he secured patents, the best known of which are, without doubt, the Crystal Detector and the Radio Compass or Direction Finder.

Mr. Pickard is perhaps best known as the inventor of the silicon detector, the molybdenite detector and the perikon and galena detectors.

Mr. Pickard began his radio work in 1899 at the Blue Hill Observatory, Milton, Mass., under a grant from the Smithsonian Institute. He then became associated with Harry Shoemaker in 1901, and in 1902 joined the engineering staff of the American Telephone & Telegraph Company, there developing a system of wireless telephony which gave good results. In the fall of 1902 successful experiments of this Radiotelephone proved that the transmission of speech without wires was a possibility, but it had very little practical application at the time, owing to the lack of a satisfactory source of sustained oscillations for the transmitter, and an operative amplifier for the receiver.

His next invention, the most important perhaps, since it opened up an entirely new era in Radio, was made in 1902 and perfected during the following years. This invention was made while he was trying to improve the coherer; it was found that a single contact such as is formed by a steel needle resting lightly on a carbon block and connected in series with a battery and a telephone, formed a most effective detector exceeding the coherer in sensitiveness, speed and working reliability.

It was also found that this combination permitted a considerable degree of discrimination between the Morse signals and statics, which was not possible at all by the coherer-relay-recorder combination.



Mr. G. W. Pickard, Inventor of the Crystal Detector.

This uncontact detector still used a local current, but during some experiments carried out in May, 1902, Mr. Pickard

discovered accidentally that the detector could be operated solely by the energy of the received signals, and this led to his invention of the crystal detector.

While working for the American Telephone and Telegraph Co., in Boston, Mass., Mr. Pickard tried various crystals and substances as substitutes for the carbon of the former detector, and also tested two crystals in contact with each other.

During the period of 1902-1906, 250 minerals were tried in contact with each other, or with metallic contacts, giving altogether 31,250 combinations, which were all tested by Mr. Pickard or his assistants, and many hundreds were found to be very sensitive as detectors.

From a present day standpoint, Mr. Pickard's most important invention is that of the loop or coil aerial direction finder, which he demonstrated for the U. S. Navy at Dorchester, Mass., in 1907, then obtaining the bearing, to within a degree of arc, of a station over 40 miles distant.

From 1906 until the present time, Mr. Pickard has been connected with the Wireless Specialty Apparatus Co., as consulting engineer and has spent a great deal of his time in research work on his loop aerial or Radio compass.

During the years from 1909 to 1918, he carried out extensive experiments on the elimination of statics by the use of loop, and screened aerials, culminating, in 1918, in the Transatlantic reception system used at Otter Cliffs. These experiments and their results were described in a very interesting article written by Mr. Pickard, and published in this magazine.

Mr. Pickard has also been able to make a crystal detector oscillate and operate as a beat receiver for undamped waves; a thing generally supposed to be limited to the audion.

At the present time, this prominent engineer practices extensively as a patent expert, and is engaged in radio research. (Continued on page 841)

## Unnecessary Interference

By CHARLES REBERGER

**I**F we look back to the old days when the wireless stations at Sea Gate and Siasconsett were the only coast stations by which we could forward our traffic, and then think of the number of stations situated along the entire Atlantic coast at the present date, we can readily see what wonderful advancements radio has made. If coastal stations continue to be erected at the rate they were following the termination of the great world war, the sea-going operator might just as well get busy and learn navigation so as to be able to find his latitude and longitude (when at sea) and so determine which is really his nearest coast station in order to conform with international rules and regulations. With this great number of stations, we are bound to encounter an enormous amount of interference. It is hard to realize the tremendous volume of QRM which is encountered in the vicinity of New York and Long Island. Most experienced commercial radio men will agree

that it is due to the large number of coast stations located in these regions.

As an example, take conditions around New York harbor; here we have four powerful stations located within a radius of about 10 miles. How can one possibly work with all these different stations working at nearly the same periods 24 hours a day. We can plainly see that an incoming or outward bound liner is forced to work thru the interference from these four stations, together with an enormous amount caused by other ships nearby. This continuous unnecessary interference is not only noticeable in these districts. Whether we be in the Gulf of Mexico or off Newfoundland the working conditions are nearly the same, and to come to the point nine-tenths of it all is caused by the heartless operator who well deserves to be termed a "ham."

Personally I do not see why the poor amateur radio enthusiast should always be referred to as a "ham", for I will wager,

and I am sure you will agree with me, when I say about 50 per cent. of the sea-going commercial operators of today know less about the radio art than the fellow who has a station of his own set up in his home. We all will quickly agree that the present day amateur is not to be considered in the same class as the amateur of five years ago.

There are no waters discussed so much as those in the northern part of the Atlantic Ocean, which might be called the "ham's playground". Here international rules and regulations are ignored and unmercifully broken. Here is where the novice receives his practice in sending and receiving. All day long, for hours at a time, "chewing matches" are carried on with never a thought for the poor soul who is trying to send some traffic to a distant coast station whose sigs are very weak. All thru the hours of the day any number of ships may be heard exchanging "tr's" which are of (Continued on page 836)



# Correspondence from Readers

## TAKES EXCEPTION TO VERNON'S STATEMENTS.

Editor RADIO NEWS:

In regard to an article appearing in the December issue of RADIO NEWS contributed by one Phil Vernon, I wish to register a distinct kick (he needs kicking anyhow).

As a Navy operator with three years' experience in Compass Work, I take exception to his statements when he says that maximum power and broad coupling with a low decrement should be used. A Navy "op" should know better than to make such a statement. A maximum of power may be O.K. in bad weather, but broad coupling should never be used. Experience at this station has shown that accurate bearings can be taken on vessels within 200 miles whose "ops" loosen their coupling as far as possible and not connect their spark gap in series with the antenna and the ground. He may be able to raise more RC stations in that manner but he will never get an accurate bearing. The law of "minimum power necessary for communication" always goes, no matter where. A compass station operator can always judge the kind and type of operator on a ship just by the sound of his spark and the width of his wave and minima. Also, his sending amounts to a great deal.

Vessels having only a  $\frac{1}{4}$ -K.W. set have been able to reach us from a distance of 250 miles (winter) and we tell them "K." If their wave is broad (consequently a broad minim) we tell them nothing doing, but if they are any kind of operators and have a sharp tune and high decrement we are able to give them QTE's that will be accurate to within one degree of the arc.

PAUL MANSFIELD, U. S. N.,  
Bar Harbor, Maine.

## "LIMIE" OPERATORS PRAISED.

Editor RADIO NEWS:

Your comment on Mr. Frey, 2AJK's letter in the February issue hit my antenna just at a time when my pipe was red-hot, and my typewriter hadn't seen a sheet of letter paper in weeks. Bang! Up started the old rotary, and here's a few flashes, the value of which you may determine. We've had a whole lot of false hollering in RADIO NEWS from some readers, so I'll go easy, and try not to make any breaks of my own. To make it short and snappy, altho I'd like a bi-monthly, I know it can't be did just now, and have a heck of a time digesting all of one issue before the next, so let 'er ride. Would like some of the Radio Digest articles expanded, but see no use in publishing any calls received, as this field is covered by another publication. Why dupe such matter? Now, for a little holler: Every once in a while, some guy takes a crack at the Limie operators. I worked them for nine months, using their own procedure, during the war, and when a man tells me they can't operate, he's got an argument on his hands. Have opened up on one gap, field of generator open entirely, using residual magnetism only, 200 miles from at least three Limie shore stations, out in the ole burg, and chopped up my sending, rotten as it was, to see how much cut they got. Shooting code, repeated not at all, at about thirty per with a bug should be a good test of an op. In the nine months, I never had one of the "rotten Limies" ask for a repeat when it wasn't my fault, or I knew interference had got 'em. And, believe me, when a man learns their procedure, he knows something! Ask any man who served with the Grand Fleet during the war. 'Nuf!

Now for a little info. If anybody knows how to cut out interference from arc light-

ing systems, wish he would send me the dope. Can only work about five hours per month on short waves on account of the awful noise the ones in this city put out. Can hear 'em ten feet from the fones on one tube on 600. Have often been tempted to take my gat and shoot the blame things off the poles. The one on the corner grins at me in fiendish delight every night.

One thing more, and . . . — I agree thoroly with Mr. Crone in regard to getting R. C. bearings with the minimum of power. Have been told to QRP several times during the past two summers when getting bearings. Usually worked NBS with about  $\frac{1}{2}$ -K.W.

RADIO NEWS fills a very great need in the radio field. More of it, please! All the matter publisht is very good, and always timely.

R. N. OAKLEY, 5YB,  
408 East College Street, Jackson, Tenn.

## WHY NOT "CALLS SENT"?

Editor RADIO NEWS:

If your readers insist on the publication of calls heard, may I suggest that the list be limited to calls heard from C. W. transmitting sets? Nobody has suggested publishing a list of calls *sent*, yet how much more ether is jammed nightly by calls sent than by calls *heard*! How sad but interesting a list could be publisht of C. W. signals that were *about* to be heard, when nearby spark stations, trying to reach points a thousand miles away, broke in and "upset the works"!

The necessity for so much spark interference, which comes mostly from those newcomers to the wireless field who are so unwise as to start in with spark instead of C. W. sets, is fast disappearing. The average amateur would no doubt find a great deal more pleasure in copying signals from distant government and commercial stations, especially foreign stations, than he does in sending that famous message, "How's my spark, O. M.?" but to attain the necessary receiving speed to copy these stations requires a good six months' practice, whereas he can gain ten or fifteen words a minute transmitting speed in about a week. So he joins the "Order of Fish with Lightning Fins and Tin Ears," and operates a "One-way" station, that is, a station which does a large amount of sending and hardly any receiving.

But now the wireless telephone is here to make receiving a hundred times more pleasurable than key-pounding. Who would prefer calling every amateur in the call book, in the vain hope of being heard in Honolulu, to an evening spent in listening to the Duncan Sisters? The radiofone brings music, vaudeville, lectures—the country's best talent—right into the home. On Sundays, if father refuses to go to church, put a set of fones on his head, and presto! he hears a sermon from one of Pittsburgh's noted divines without losing a puff from his evening cigar.

On the other hand, what will turn a man's mind from thoughts of God to dreams of hate quicker than a rasping spark note, breaking in and completely drowning out all sounds of speech? In our town are several young men who take delight in telegraphing to one another, during sermon or concert, with enough power to reach the coast. How I should like to be turned loose on their sets with sledgehammer! No doubt there are many such ardent young brass pounders in nearly every community, and so I suggest, Mr. Editor, that you ask these enthusiastic Knights of the Key, from the pages of your magazine, please to use the land wire telephone during the hours in which the ra-

diofones are broadcasting. Courtesy demands that they use their transmitters during these periods only when necessary, and that they use the *minimum* power necessary for each communication.

By announcing in the RADIO NEWS the admirable programs now being broadcasted regularly by the Navy, the Westinghouse Company and the DeForest Company, you have performed a great service for the amateur world. Through these programs, and through the interest developed in vacuum tube transmitting sets by the articles in your pages and elsewhere, the spark is fast being supplanted by the sharply tuned and much less interfering C. W. outfit. More listening and less spark sending will have a more favorable effect on government attitude than anything else the amateur could do, and give him increased pleasure in the bargain.

N. W. THUL,  
Fort Wayne, Indiana.

(Yes; slowly but surely the C. W. tide is sweeping onward engulfing the prehistoric spark sets. The editor is glad to see that his preachings, started ten years ago, are finally converting the amateur!—Editor.)

## WANT CALLS HEARD.

Editor RADIO NEWS:

Dear Sir:

In glancing over the March issue of RADIO NEWS we note a discussion as to whether or not the "Calls Heard" by various amateurs should be publisht.

A letter by a New York amateur saying that the "Call Heard" columns are useless TRUCK certainly made us spit on the cat and look around for the old man's Wouff Hong, which we hope New York amateurs will use on him.

We are intensely interested in relay work, as are all the REAL amateurs in the country and believe us one of the first things a real DX man looks for on obtaining a radio magazine, is the "Calls Heard" column. The other radio magazines publish some but not enough of them.

Hoping to see calls heard publisht in RADIO NEWS in the near future are the hopes of two DX men.

Very truly yours,  
JOHN F. SCHOLTER,  
C. H. ZELLER,

Operators.  
Tribune Radio Station,  
Foreign News Service.

## RE CANADIAN AMATEURS.

Editor RADIO NEWS:

An idea seems to prevail thruout the United States that the Canadian amateur is limited to 50 meters wave-length. Some are and some are not, as the quotation from the "Radiotelegraph Act," part 2, paragraph 20, shown below, says:

20: "The wave-lengths which may be used vary with the distance between the licensed station and any commercial coast or land station or a route of navigation as follows:

For Transmission—

Class 1—Stations located within five miles of a commercial coast or land station or a route of navigation shall not use a transmission wave-length greater than 50 meters;

Class 2—Stations located more than five but less than 25 miles from a commercial coast or land station or a route of navigation, shall not use a transmitting wave-length greater than 100 meters;

Class 3—Stations located more than 25 but less than 75 miles from a commercial  
(Continued on page 816)



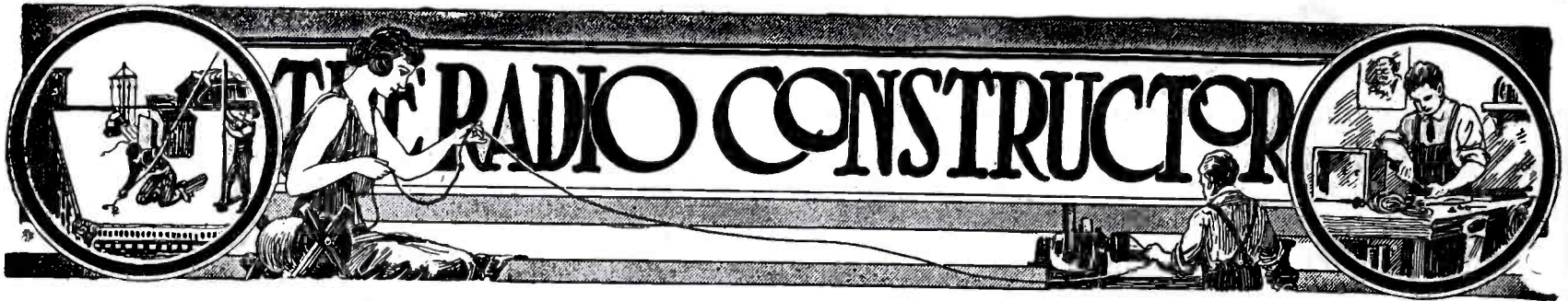

## A Honeycomb Coil Tuner

By PAUL G. WATSON

AS many requests for details of the "honeycomb coil" tuner shown in the picture of my station in the December, 1920 issue of this paper have been received, I have tried to make them as plain as possible in accompanying drawings, as the number of requests makes individual answers impossible.

As I could not possibly lay down a set of plans that every amateur would follow, I have left out or drawn attention to places where substitutes may be used for the ones used in constructing the original tuner. In constructing the original, Atlantic Radio Co.'s "ARCO", unmounted condensers were used, but Murdock or other condensers of .001 mf. capacity might be used with equal results. The 3" standard "Corwin" black dials, with knobs, were used on the condensers, to avoid the necessity of engraving, or fastening graduations on the panel. The shaft of the ARCO condensers is the proper diameter for the 3" dials. A condenser of .0015 mf. may be used as a primary condenser, but was not used in the first case.

In boring the hole for the condenser shaft it is recommended that the hole be made  $\frac{1}{16}$ " larger than the shaft of the condenser, to allow free movement of the rotary plates, and to allow for slight error in setting the screw holes in mounting. The larger hole is completely covered by the indicating dial and does not show. In mounting the coil mount, the center line of the upper set of holes should be about 2" from the top of the panel, to give proper proportion to the panel. As many amateurs construct their own mounts the dimensions of these holes are omitted. A De Forest type "LC-100" was used on the original. In any case a mount with gears for turning the movable coils should be used, as placing the hands on the coils, when tuning, will greatly change the capacity.

Three  $\frac{1}{8}$ " wood screws, round head brass, should be used to fasten the panel in the oak cabinet. Screws  $\frac{3}{4}$ " long are sufficient. The cabinet should be well fitted, then screwed and glued together, and the back fastened permanently on, as all the apparatus is mounted on the panel itself.

A scratch mark can be made on the front

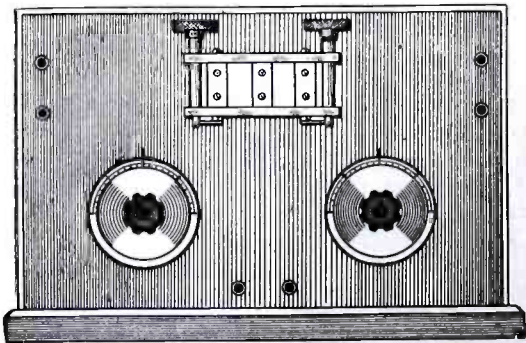

Front View of the Finished Cabinet. If Desired a Serie Parallel Switch for the Primary Condenser May be Mounted on the Panel.

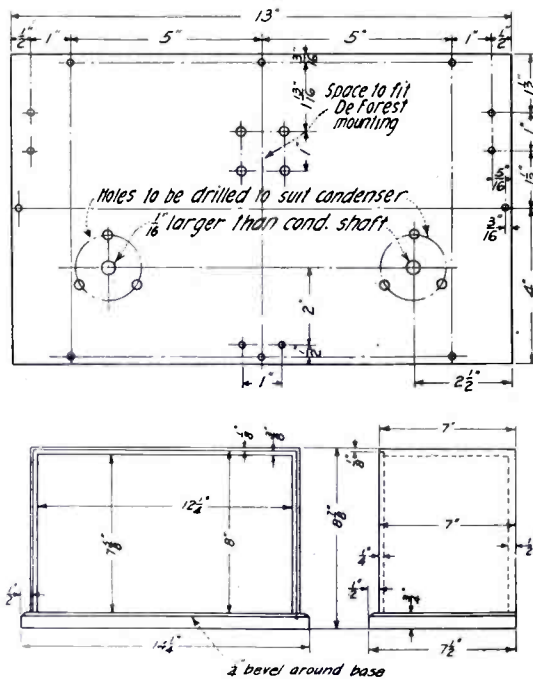

Dimensions of the Front Panel and Cabinet in Which a Shelf Could be Fixed to Support a Detector Tube and B Battery if Desired.

of the panel, at the point where the condenser is turned to a zero capacity, preferably at the top, and then scratched carefully several times, using a divider point to make the scratch. Several light scratches in the same place will make a very much neater line than one heavy mark, as the heavy line will chip out along its edges. The line should be rubbed full of white lead, and the surplus carefully wiped off.

In case the bakelite panel is badly scratched when finished drilling the holes for mounting the apparatus, it can be smoothed off with a very fine emery paper and oil, and then polished with "Crocus Cloth" and oil. This will give a nice "grain" to the panel.

Binding posts with insulating tops are preferred as a chance contact with them will not effect the adjustment of the apparatus as much as if contact were made with a metal post. In wiring this set, a heavy stranded lamp cord, or stiff wire, at least No. 16 gauge should be used. By arranging the tickler at the bottom and the other two sets of posts on the same sides as their respective coils, a minimum length of connections in the tuner can be had. All joints in the wire should be soldered, and the wire soldered to the binding post screws.

In mounting the dials on the condenser shaft, a very small space should be left, about  $\frac{1}{32}$ ", between the back of the dial and the front of the panel, to eliminate a grinding sound which is heard when the two touch.

In using this tuner, especially on long sustained wave, the adjustments must be made close, and a slight variation of either tickler or secondary coil, or condenser will change the wave-length of the set sufficient-

ly to lose a distant station, and to make a nearby station unreadable. I have found that for maximum efficiency a minimum of condenser capacity must be used, in both arc and spark work, and a coil of the largest possible size be used to give the desired wave-length. The reason for this is self-evident. In arc work I have found coils for the tickler socket to be somewhat larger than recommended by the De Forest concern, for instance many arcs are heard on my set, using a 600 primary, 750 secondary, and a 600 tickler. I have tried all combinations of these coils and find that a tickler and primary coil run nearly in the same sizes, which is contrary to modern practice. Exception to this was found in the extreme long wave coils, 1,250 primary, 1,500 secondary and 600 tickler. This was the only case however where the difference was much over 10 or 15 per cent. of the number of the coil (Primary). In adjusting the coupling of the coils the hands should be kept as far from the coils as possible as the capacity of the hands will effect the coils, and when removed will detune the set. The apparatus used in connection with the original tuner was a De Forest "Ultraudion," and was rebuilt, using the original circuit, but with new grid leak and condenser. All the apparatus, with the exception of the fone circuit, is wired with "Packard" cable, giving a minimum of resistance.

If sufficient funds are at hand, and in order to make of this cabinet a precision receiver, some Verniers condensers could be used, as they help a great deal in tuning C.W. or Radiofone; they should be of .001 mf. capacity.

An addition that may be made also is a serie parallel switch for the primary condenser; this switch may be either of the well known De Forest type or a D.P./D.T. telephone switch, taking much less room on the panel.

In the space left, between the condensers in the center of the panel, a filament rheostat could be mounted above the serie parallel switch, if a V.T. detector is to be installed in the cabinet where there is plenty of room for a tube and a "B" battery.

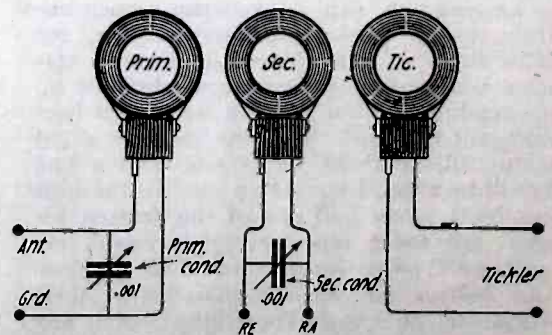
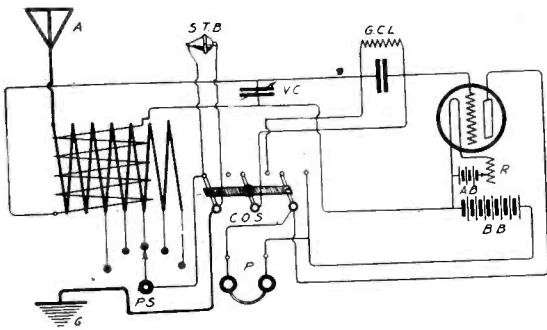

Diagram of Connections of the Honeycomb Coil Tuner. This Hook-up Which is Very Simple Should be Studied by the 178 Amateurs Who Asked for it.—The Editors.



# Portable Radiofone Set

By ROBERT I. TORAN



**T**HE accompanying sketches and one hook-up are of a portable Radiofone set which I am making to install on my motorcycle. It is very simple and easy to construct and any amateur can build one at a small cost. This set is for transmission and reception of Radiofone messages, employing one audiotron for both uses.

The one I am making is 8" x 6" x 4 1/2", when all assembled in an oak box mahogany furnisht. The panel is of bakelite, 7 1/2" x 5 1/2" x 1/8", but it can be made larger or smaller to please the constructor, so I am going to omit sizes, except that of

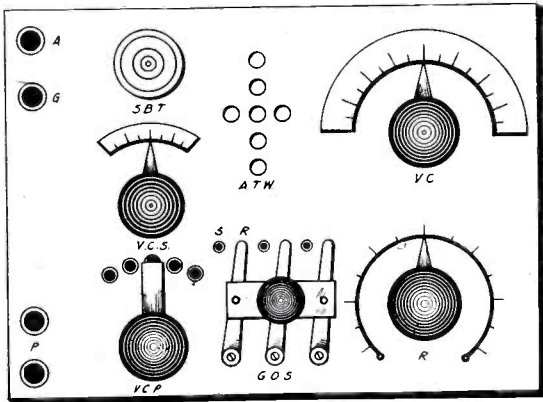

Fig. 1

General Layout of the Panel. In the Center is the General Change Over Switch, Making All Necessary Connections for Sending or Receiving.

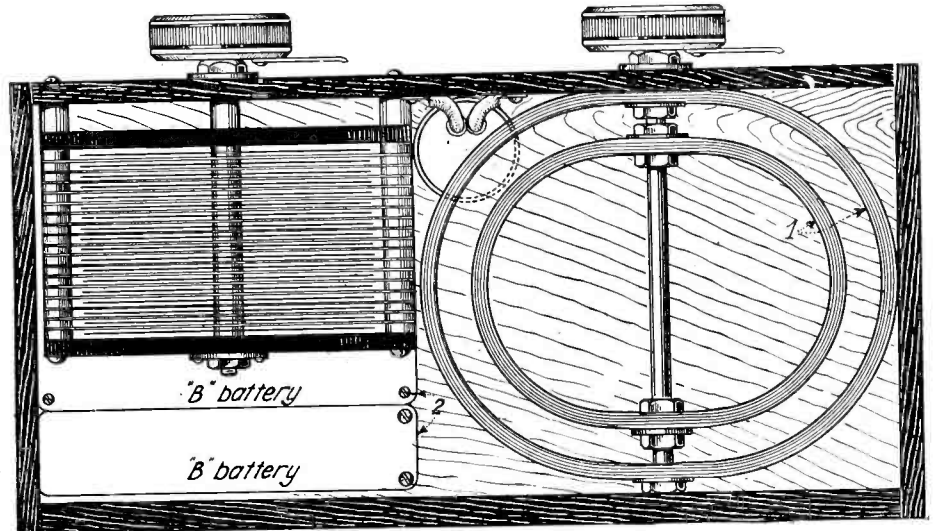

Figure 3

On the left is the complete diagram of connections of the telephone set, while on the right Fig. 3 shows the inside of the cabinet. Note the special vario coupler and the disposition of the "B" battery.

the variometer coupler which is of my own design.

Referring to Fig. 1, it shows the front view of the panel with its dials, switches and transmitter in place. S. B. T. is a Skinderviken transmitter button; V. C. S., secondary of vario-coupler; V. C. P., vario-coupler primary switch; A. T. W., audiotron window; C. O. S., change over switch; V. C., variable condenser; R., paragon rheostat; A., aerial binding post; G., ground binding post; P., fones binding post. Fig. 2 shows the back view of the panel with the parts in place.

I will now describe the variometer coupler, 5, Fig. 2, as it is novel. The primary 4, is 4" diameter by 4" long, 1/8" wall, wound with No. 24 wire, S. C. C. as follows: Start 3/8" from bottom up to 2 7/8", taking four taps for first 2" and one tap at 7/8"; leave 1/2" and continue to 1/8" from top. Leave leads long enough for connections, shellac well and let it dry.

The secondary, 2, is 3 1/4" diameter by 2" long, 1/8" wall wound with No. 24 wire as follows: 1/8" from bottom up to 7/8", leave

1/4" space and continue up to 1/8" from top. Leave leads long enough at each end for connections. Shellac well and let it dry.

Now by this time the primary is dry. Drill a hole 1/8" diameter between the center of the 1/4" space, to allow a rod 3/32" in diameter to pass thru to revolve the sec- (Continued on page 798)

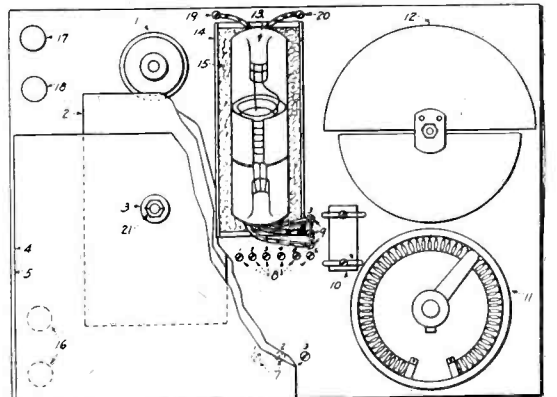

Fig 2

Back View of the Panel Supporting the Complete Set of Parts.

## Improved Homemade "B" Battery

By ADAM KRISTINIAC, Jr.

Regular "B" batteries cannot always be obtained and sometimes the prices are too high. Another thing is that sometimes there are a few dead ones in with the good ones and these dead ones will spoil the rest.

As all those who make their own "B" batteries know, the hardest part is soldering them together. My experience was that when I soldered them the heat of the iron evaporated the acid and made the cells dead. Then I had to disconnect it and put a new one on more carefully, but still some would be dead. After I got all good cells connected I had to squeeze the cells tight to obtain a current for my set. This I had to repeat every time I "listened in." This didn't satisfy me so I made several experiments until I finally succeeded with the following one.

This case will hold ten batteries which give twenty-five volts. The wiring may be hidden or may be as I have it on the outside. Batteries of different dimensions may be used providing the inside measurements

are equal to the sum of the batteries plus the springs. The batteries I have used are 1" x 3" and 7/8" long. The springs are 1" or 1 1/4".

The materials necessary for construction of case are as follows:

- 1 Top piece—10" x 1 1/2" x 1/2".
- 1 Bottom piece—10" x 1 1/2" x 1/2".
- 1 Back piece—10" x 4 1/2" x 1/2".
- 2 Ends—5 1/2" x 1 1/2" x 1/2".
- 10 Springs about 1 1/4" long x 5/8".

The wood is all of 1/2" stock altho a little lighter will not hurt. Hard wood is prefer-

able. If one wishes to get springs the best way is to take the spring from an old curtain rod and stretch it so that the turns are each about 1/4" apart and they may be clipped at every fifth turn.

The wire for connections should be about No. 24. A few turns so that a flat coil is obtained and when scraped it should be pushed thru the top piece from the inside. Then it should be brought around and soldered to the spring of the one before. The spring should then be nailed to the bottom piece and in turn the bottom piece nailed to the back piece. Be sure that the wiring goes from negative of one cell to positive of another. The first positive is connected to a binding post and the last negative to the second binding post. The placing of the cells is very simple.

Take the cell and press it on the spring and then shove it in to make contact with the coil above. This case will enable you to make quick changes and tests and will last for a long time.

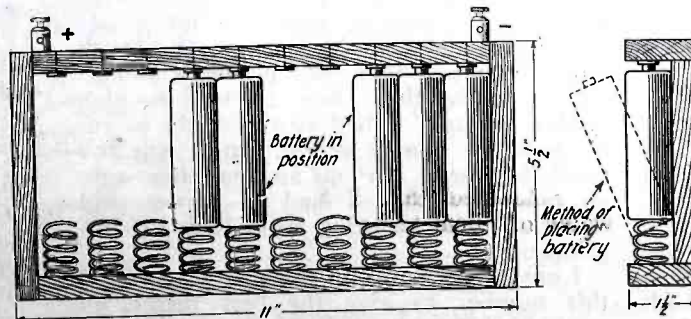

A Clever Idea to Make a "B" Battery. Each Element May be Easily Changed if it is Down and Replaced by a New One.



# Some Practical Radiofone Experiments

By G. RIDLEAK, U. T.\*  
Authorized by Fred Burgess, Keeper

I THOUGHT I would write you again and let you know the troubles I have had with radio telephony. I always had a vague suspicion that the name wasn't the only foney thing about radio telephony, but now, after several months of experimenting, I feel quite sure of it. My first investigations were carried out with an alleged half kilowatt arc as the victim. In a moment of weakness I yielded to a rash impulse and built a hand-pump style of arc, as described with great fluency in the January, 1920, issue of RADIO NEWS. I had previously insured my life against fire and burglary and had also imported specially designed silver fuses, practically non-blowable, from Tierra del Fuego, so I felt I was fairly well prepared to cope with the fiendish device that I had constructed.

At last it was ready for its trial trip. With feverish haste I tied down the safety valve, having first poured in a gallon of eau-de-what-ever-they-call-it. This stuff, which was a variety of home-brew and had a kick like the front foot of an ostrich, consisted of equal parts of alcohol and liquid oxygen and was intended to trickle into the machine a drop at a time. The alcohol was, I suppose, to keep the arc "lit up," and the oxygen was merely used to dilute the alcohol. Full of great expectations and as much of the alcohol as was left over, I flooded the carburetor and stepped on the starter. Nothing doing. I tried again. Still no results. Plainly there was something wrong with the ignition system. I got out, removed the hood and started to test the spark plugs. Then I suddenly remembered that if an arc refused to do its duty the customary procedure was to strike it, not roughly, mind you, but nevertheless quite sternly. If this had no effect you were even allowed to spank it.

I gazed at it and my heart failed me. It seemed so small and defenseless that I couldn't find it in me to strike it. However, I decided to sacrifice my personal emotions for the advancement of science, and closing my eyes, I tapt it timidly on the nose. It coughed, wagged its tail and began to hit on one cylinder. Encouraged by this apparent good-will I opened the throttle and—the fireworks began. The arc hit on all eight cylinders at once and then went out. In its hurry, it didn't bother to open the window but took part of the window sash out with it. I guess I must have got the mixture too rich. Incidentally I was able to get out of bed two weeks later, but I still had one eye in a sling. Since then I have confined my attention to a bulb transmitter and receiver which I shall attempt to describe.

The fundamental principles of this set were gleaned from an article entitled "A Three Tube Combination Transmitter and Receiver" which appeared in the December, 1920, issue of RADIO NEWS, but I added a few variations of my own. For instance, I included several more switches and thus gave the set the ability to transmit both damp and undamp waves in addition to its original versatility of being able to talk in four languages and Chinese, which is just a gurgle. With this set I could re-

ceive spark stations, and by throwing a switch I could change to C. W. stations. Throwing another switch allowed me to use the set as a telephone while still another switch connected it up for straight C. W. or moderated buzzer transmission. Had it not been for the fact that I ran out of switches at this point I might have been able to make the set clean the windows and cut the grass or even bathe the baby. However, I had to be very careful where I "threw" all these switches because I once hurled one thru a window and hit a policeman, who was standing just outside.

When I bought the bulbs for this set I did not take the precaution of pinching them to make sure they weren't soft and

My latest invention in high potential batteries is a real fruity one. To supply the necessary juice for the plate circuit I bought a carload of fresh lemons, reduced them to their lowest common denominator and extracted the square root. I then trisected each one into two equal parts, placed a piece of copper and a piece of zinc in each part and connected them up in series-parallel, taking care to keep their poles all pointing in the same direction. With this battery it is necessary to run the connecting wires thru several feet of cheesecloth or mosquito netting. This is called a filter system and is used to strain the juice in order that no lemon seeds may get into the bulbs and clog them up.

The microfone is of the carbon grain variety and is entirely home-made. The case consists of a small round salmon tin with grains of carbon substituted for the salmon. None of these carbon grains are larger than walnuts and all are carefully covered with shellac. For a diafram I use a piece of sheet brass. Speaking of diaframs, I have found that for best results they should never be more than a quarter of an inch thick, or they will make the voice sound rather muffled.

With this set I give a wireless concert every Saturday night on a wave-length of .001 microfarad. The concert begins at 9:75 P. X. and continues until I get tired of singing. This usually takes from two to three hours. Unfortunately, several weeks ago while singing the aria from Paderwhiskey's Minuet nearly half a gallon of it got stuck in my throat and brought on an attack of house-maid's knee. Since then I have been unable to sing, but I bought a phonograph record and kept on with the concerts. On one side of this record is that beautiful solo "Locked in the Cradle with the Sheep" while on the other side is the well-known love song "I Fear You're Stalling Me." I play this record on the sewing machine, and find that I only have to change the needle about every three weeks. Needless to say, the best musical effects are produced on a Singer sewing machine. A friend of mine who also gives a weekly wireless concert confines himself to organ recitals. He plays these on a thing which I believe is called the "QRT." This instrument, or whatever it is, is said to be the official organ of the Awful Racket Raisers' League. From what I've seen, it sure takes a lot of wind to run an organ.

But to return to my own wireless concerts, I may say that they are enjoyed every week by a large number of my local radio brothers. On concert nights they all come over to my station and make themselves at home. When they are all assembled I get the wireless telephone set working and begin to play the phonograph, or rather, the sewing machine. Without boasting I can say that the music is distinctly audible all over the room. Wireless telephony is certainly marvelous, isn't it?

In closing I would like to add that if any of my fellow amateurs who find it difficult to understand technical questions, such as "Why does a spark gap," will send

(Continued on page 836)

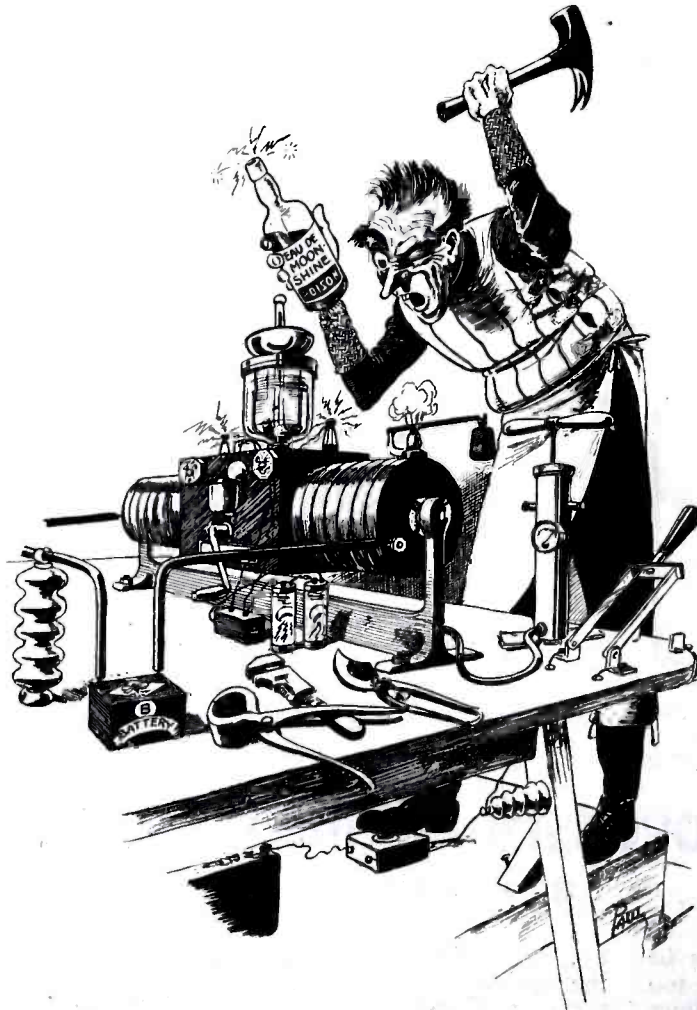

Here is a Photograph of Mr. G. Ridleak in His Radio Laboratory, Taken During Some Experiments With the New Arc He Has Invented.

consequently when I got them home I found they were too ripe to be of much use. As you all know, a transmitter bulb should be highly exhausted, so I endeavored to find a method of exhausting these bulbs. To my dismay they seemed to be full of pep and vigor and absolutely inexhaustible. However, taking a mean advantage of the fact that they were French bulbs I hooked them up, placed a phonograph beside them and started to play Scotch records. They strove nobly to reproduce the Scotch accent, but it was too much for them. In half an hour they were so exhausted that I had to throw cold water on them to bring them back to consciousness.

I use two of these bulbs, as I have found this number to give the best results in moderated buzzer and C. W. telegraphy. One bulb handles the dots and the other the dashes and by this means the speed of transmission can be doubled.

\*Chief Radio Engineer, Toronto Lunatic Asylum.



# The Death Dash

By "SPARKS"

IT was a cold bleak evening in late September and Bill Fenwick was feeling rather fed-up as he sat on duty at the little 5 K.W. station at Windy Bay. Windy Bay is a small town hidden away on the Great North West coast. The wireless station is perched on the top of a cliff which forms a circle around the harbor and from the station to the shore there is a sheer drop of some 300 feet or more. Bill, having nothing better to do, was ruminating on the queerness of people in general, and Mr. Ralph Conway in particular. Mr. Conway, who was commonly known as the "Old Man", was the officer in charge of the station. He apparently lived in perpetual fear, and Bill was often tempted to ask him why he always carried an automatic pistol in a peaceful little place like Windy Bay, but his manner precluded familiarity, and, moreover, one's past is one's own in the Great North West.

The "Old Man" was a tall, heavily built fellow, a little past the prime of life, but his features made him look older than he really was. Imprinted on his face was the unmistakable mark of the hunted, the mark of one who dwells in constant fear for his life. He had a peculiar habit of suddenly glancing backward, over his shoulder, and so great was his terror lest anyone should come upon him from behind, that he had placed a large mirror over the operating table in order to command a full view of the room while he was on duty. In addition to this he always bolted the door on the inside while he was working at night and never allowed anyone to enter until the next operator came to relieve him in the morning. The only courage he knew was the kind that he bought by the flask and drank when he needed it, which was quite often. Although a drink or two made him a corking good sender, it had a disastrous effect upon his temper, a fact which Bill, and Edgar Sloan, the third operator, knew only too well, to their sorrow. Just two days before, while in a drunken rage at some imaginary negligence on the part of one of the operators, the "Old Man" had

picked up the fones, ripped them from the receiving set, and hurled them at Edgar's head. Luckily they missed

At ten minutes past three I started the engine and then held my key down as the engine gained in speed and the power increased. At three fifteen I released the key and shut off the engine for I knew that Nesbitt was dead.

their objective, but smashed themselves hopelessly against the wall. A brand new pair was now in use at the station.

Bill was pondering on all these things and wondering what would happen next, when he realized that he was being called. The call was quite loud and sounded like a spark coil, which struck him as being rather strange, since there were no amateur stations within hundreds of miles. However he replied with a string of QRA's and the answer came buzzing back:

"This is the yacht *Ventura*, arriving at Windy Bay. Is John Nesbitt the chief operator at that station?"

John Nesbitt! Bill suddenly remembered that only a few weeks ago he had seen one of the "Old Man's" books with that very name written on the fly-leaf. Could he be living under an assumed name?

"No", he flashed back, "his name is Ralph Conway. QTC? QTC?"

"Has he a slight scar on his left cheek?" Bill was startled. "Yes", he replied, for as a matter of fact the "Old Man" did have a scar on the cheek indicated. "Is he at the station now? If not where is he and when will he be back?" asked the unseen interrogator on the *Ventura*.

The other operator's curiosity caused Bill some surprise, but he replied.

"No, he is down in the town, probably at the Golden Eagle saloon. He won't be back until about midnight, when he goes on duty."

"Thanks. Can you let me have some carborundum if I come up to the station for it?"

"Sure," replied Bill, "come right up."

Inside one of the fones was a small steel tube containing a charge of gun powder and a .22 calibre bullet with a fine resistance wire running thru the tube. The strong signal from the *Ventura* had heated the wire igniting the powder and discharging the bullet into Nesbitt's head.

He went to the window and in the gathering twilight he saw a 75-foot yacht lying at anchor almost beneath the station. It was equipped with a large four-wire aerial, which extended from the bow of the boat up to the masts and down again to the stern. Even

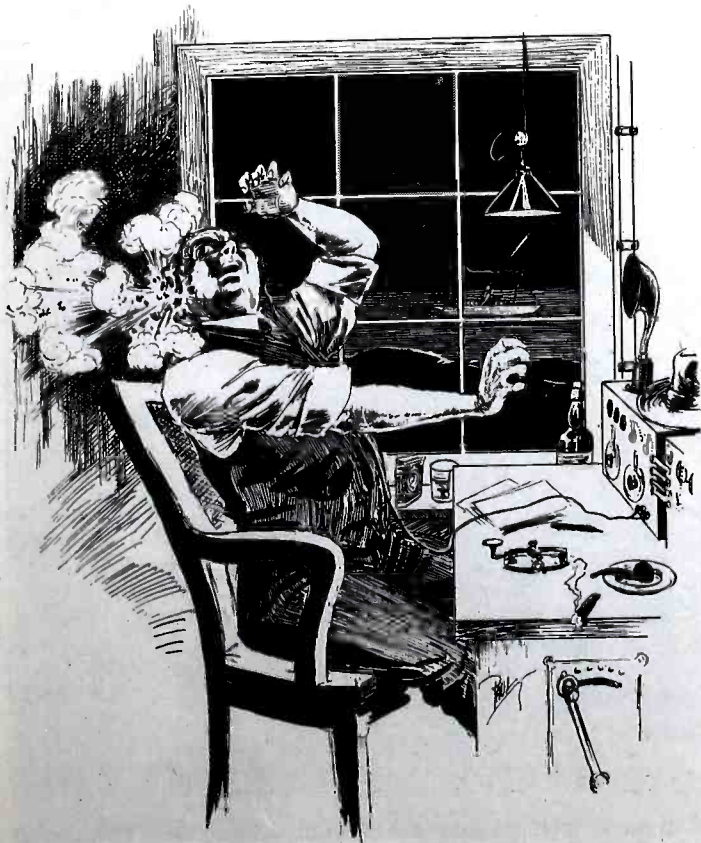
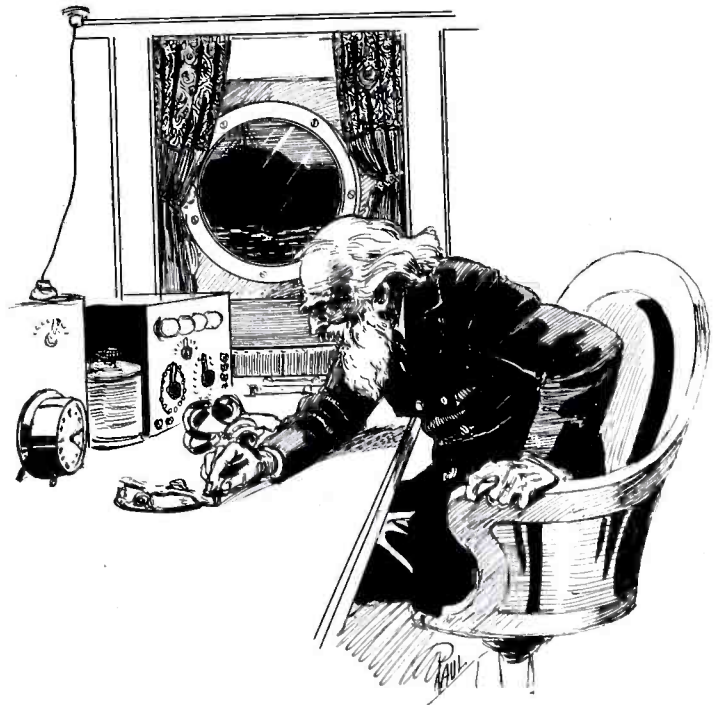

as he watched, a dory was lowered and two men got in and rowed to the shore. One jumped out and walked along the beach while the other waited in the dory. Twenty minutes later there was a slight knock at the door and Bill, upon opening it, received quite a surprise, for his visitor was a little old man with long white hair and a white beard. He wore a furtive, cunning look, but when he spoke his rather pleasant voice dispelled the bad impression which his appearance created. No amount of pleasantness, however, could counteract the almost maniacal glint that crept into his eyes from time to time.

"Good evening, young man", he said as he stepped into the station, "I am Robert Strathroy, of the *Ventura*. Nice little set you've got here. Those are good looking fones."

With these words he stepped to the table, picked up the fones and examined them intently.

"Yes", replied Bill, "they were just new two days ago. You seem to be quite a radio enthusiast, Mr. Strathroy."

The other laughed a short, unpleasant laugh and a wild, half-crazy light shone in his eyes.

"My boy," he said, "wireless has occupied my time and attention for many years. It has brought me great pleasure and will bring me more pleasure yet."

Then they talked for nearly half an hour, during which Mr. Strathroy asked a great many questions as to the appearance and habits of the "Old Man." At last he arose to go, and while Bill was getting him the carborundum he carefully examined the fones once more. On the door-step he paused.

"I guess you find life rather dull up here, eh? How would you like me to bring up some magazines? I've got a whole pile of them down in the boat."

"Well, they would be acceptable," agreed Bill, "I've read pretty nearly everything in the station."

"All right, I'll be back with them in a little while. See you later."

"So long. Don't get lost in the dark."

More than an hour elapsed before there was another knock at the door and Mr. Strathroy stepped into the room, carrying a bundle of magazines and a tin can.

"Here are your magazines. Sorry I kept you waiting so long, but I had to do some work on the boat. I brought this can to see if you could let me have some coal-oil."

"Oh, thanks," said Bill. "Wait a minute and I'll get you some."

(Continued on page 824)





**T**HIS Department is open to all readers. It matters not whether subscribers or not. All photos are judged for best arrangement and efficiency of the apparatus, neatness of connections and general appearance. In order to increase the interest in this department, we make it a rule not to publish photographs of stations unaccompanied by a picture of the owner.

We prefer dark photos to light ones. The prize winning pictures must be on prints not smaller than 5 x 7". We cannot reproduce pictures smaller than 3½ x 3½". All pictures must bear name and address written in ink on the back. A letter of not less than 100 words giving full description of the station, aerial equipment, etc., must accompany the pictures.

**PRIZES:** One first monthly prize of \$5.00. All other pictures published will be paid for at the rate of \$2.00.

## J. E. Brown's Station THIS MONTH'S PRIZE WINNER



Here is a Modern Amateur Station. A Radiofone and C.W. Sending Set, and an Efficient Short-wave Receiver, as Shown in This Photograph, Are All That Are Necessary to do Some Interesting DX Work.

The accompanying photograph shows Mr. Brown's station (INBA) at Glenbrook, Conn.

It is this station which is represented on

the front cover of this magazine, with Mr. Brown's dog, Lassie, listening to her master's voice during some Radiofone experiments.



In a letter sent with the photograph of his dog, Mr. Brown says: "The intelligent animal enjoys the music as much as her master!"

(Continued on page 843)

## Radio Station 8FN

In the large photo from left to right are the De Forest radiofone type O, radiation in ground circuit 1¾ amperes, long-wave receiving tuner which copies all foreign stations, audion ultra-audion detector, one step amplifier cabinet and two step amplifier cabinet. Above the detector and amplifier cabinets is a Grebe CR2 regenerative receiver for short waves. The horn above is a loud speaker. On the CR2 is a wave meter and on the wall at the extreme right is an assortment of honeycomb coils for amateur, commercial, NAA time and power coils. On the bench at the right may be seen the transmitting key capacity 50 amperes. Above the long wave tuner are two variable condensers.

The transmitter is a three-quarter kilowatt, Thordarson type R transformer. Two one MF condensers are shunted across the primary and the middle terminal grounded. To take care of the kick back two non-inductive high resistance coils were inserted between the transformer secondary and the condenser. The condenser is the well-known old standby Dubilier, which has a capacity of .004 MF. The spark gap will be noted as a common type. Murdock OT and Eldredge HWA. This set radiated 4½ amperes.

Note the good arrangement of the apparatus and short leads. This compact transmitter stands only 28" high. Some of

you "hams" with your transformers on the floor and your OT's on the wall had better copy after this idea. Wm. C. BARCOCK.



This Station is a Very Complete One With a Well Planned Spark Transmitter. The Photograph on the Right, Which Was Designed to Have Very Short Connections, Shows the Details of the Spark Set.



## LeRoy Paslay's Station

When the flu first came to Manhattan, Kansas, LeRoy Paslay, twelve-year-old, was one of many who was confined at home with nothing to do and no place to go because of the quarantine. Like most boys of his age he was restless and couldn't be idle long, so he went to the library on the sly and procured some reading material which he found to be dry. Ordinary books were distasteful, but luckily he stumbled upon a little pamphlet telling what wonders a simple wireless telegraph outfit would do. The book has changed the destiny of his entire life.

Becoming interested immediately in the new science, he read eagerly everything he could find on the subject and finally constructed a simple outfit in the back room of his father's studio, using an iron wire aerial and utilizing such materials as he could find about the town. But the war was on and the current was off most of the time, so the eager youngster had little success. However he continued his studies and added material to his station from time to time until now he has an outfit worth more than \$150 and is still adding whenever he gets some spare money.

The outfit he has now is capable of receiving communications from all over the

Boys, here is one who built his own, and it is a real fine one with two-step amplifier 'n' everything. Note the roll of paper used to write the long press messages in the right hand corner.

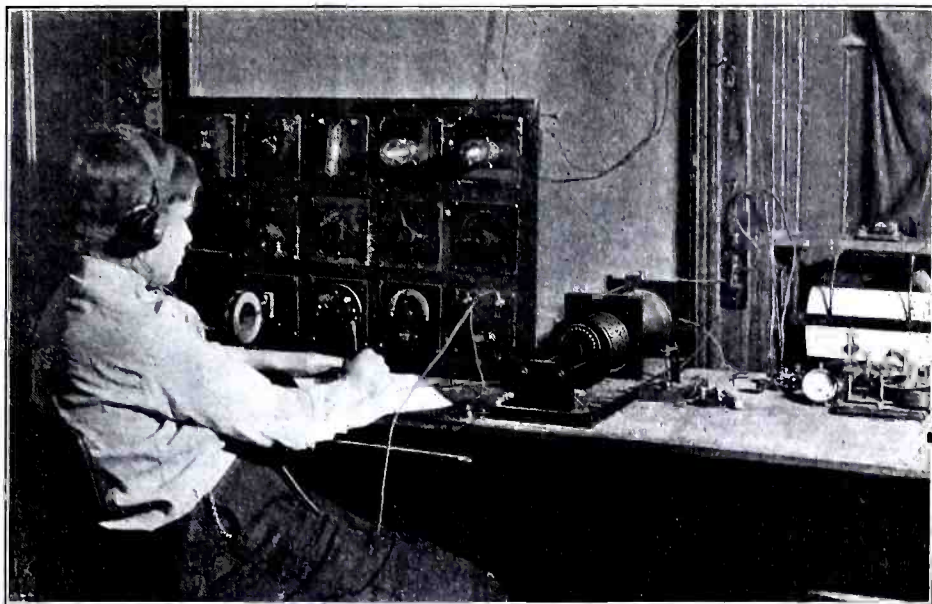

United States and even further. At any time of the day messages are picked up from Arlington, San Diego or New Brunswick. The most distant message he ever received was from POZ, Germany, at a time when the Atlantic was said to have been quiet. The operator at the Kansas State College station received the same communication. Last year young Paslay

picked up a "Q. S. T." or general call from Cincinnati, Ohio, giving the detailed report of one of the world series' baseball games.

During the summers and on Saturdays the young operator sends the daily weather forecast from the station at the Kansas State College to the different stations over the state.

## T. E. Olson's Station

I am sending you two pictures of my wireless station, 7KR.

The sending set consists of a 1/4 K. W. Thordarson Benwood rotary disc using 3400 R.P.M. induction motor. Murdock oscillation transformer and oil immersed condensers.

The complete sending set is fixed upon a shelf above the receiver and is shown in one of the photographs.

The receiving set consists of a Wireless Specialty Co.'s IP500 receiver and a homemade one-step amplifier. Three General Radio Co.'s long-wave inductances are used to tune in the big sta-

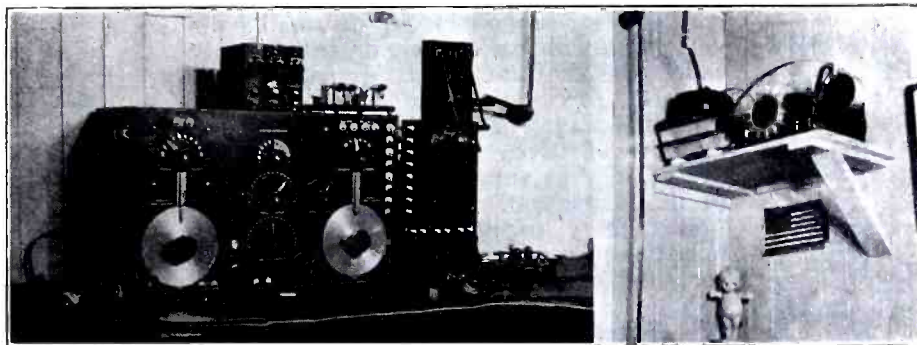

What Do You Think of This Receiver? Fine, eh! But Teddy Had to Fix the High Tension Apparatus on a Shelf, for His Little Brother, Who May Be Seen on the Right, Used to Hide in the Condenser, and This Caused Trouble When Sending.

tions; Brandes and Holtzer-Cabot fones are used.

I have had very good results with the

above receiving set. All ships on the coast and far out at sea are copied, as well as all the high powered stations of the U. S.

I am going to install a Paragon regenerator for short wave-lengths, with which I expect to obtain much better results for short waves, and especially for D.X. work.

My aerial is of the usual flat top type composed of four wires and erected over the house.

The ground connection was carefully made and contributes much to the efficiency of my set.

T. E. OLSON, 528 Market St., Portland, Ore.

## A. Brook's Station



Boys, see how young they start in the game! No wonder that some of them are such good ops.

This is a picture of little Mary Brooks, nine years of age, seated at her amateur wireless station in her home in Santiago de Cuba. She can receive ten words per minute. The receiving tuner on the left is homemade. Waves from 100 up to 20,000 meters can be heard in combination with honeycomb coils and condensers. In the center is a De Forest two step amplifier in combination with another step and audion. NAA comes in very clearly with audion alone, a distance of 1,000 miles, while with the three steps it is heard in any part of the room through the loud speaking receiver shown at the top of the photograph. Many other stations 50 to 500 miles around here are heard very clearly. NAW comes in like a 45 caliber pistol shot, and with the two step, it can be heard all thru the house, or 70 feet from the horn. Some European stations are also copied and several amateurs are heard here very plainly.

To avoid the usual troubles caused by the use of small "B" batteries, a large one composed of standard cells is used and may be seen under the table.

ALFRED BROOKS,  
Santiago de Cuba.





# Junior Radio Course

## RADIOTELEFONY

**T**HE essential requirements of a circuit for transmitting speech sounds by Radio may be summarized as follows:

1. A means of producing continuous oscillations (undamped waves) during the whole time the set is working. This is called the carrier wave and may be compared to a "line."
2. A means of modifying the amplitude of these oscillations by the sound waves produced by the voice or musical instruments.

### EARLY SYSTEMS.

The first source of undamped waves used for Radiotelephony was an arc connected with an oscillating circuit, Fig. 1, supplied with D. C., but owing to the difficulty of

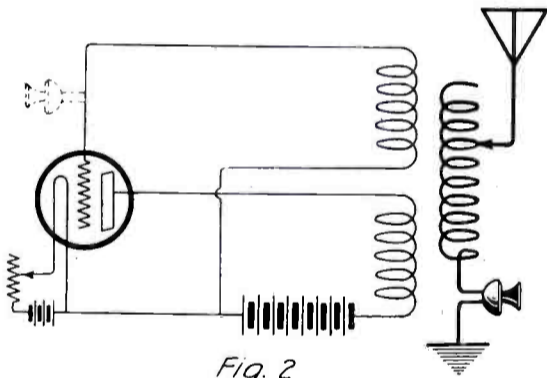

Fig. 2

This Hook-up Shows the Principle of the Radiophone. One V.T. is Used as Source of Continuous Oscillations and This Continuous Wave is Modulated by an Ordinary Microphone Connected Either in the Aerial or the Grid Circuit.

keeping the arc steady in operation, also to the machinery required, this source of undamped wave for Radiofony has not been developed to a great extent.

The other generator which was used in the experiments to send the voice thru the ether, is the high frequency alternator. Several engineers spent their efforts in the construction of an efficient machine; among them are Messrs. Goldsmith, Latour and Alexanderson.

They succeeded in this way and today practically all the new high powered stations are equipt with high frequency alternators.

These alternators are directly connected with the aerial and are the most economical source of undamped waves, especially for high power.

The third instrument used to produce continuous oscillations is the vacuum tube, which, when used as an oscillator in a properly designed circuit, generates waves of any desired frequency with a power rating from five to several thousand watts.

Due to its flexibility and steadiness in operation, the V. T. are today extensively used for Radiotelephony and it is with this source of undamped waves that we shall deal in the following explanation of speech transmission by radio.

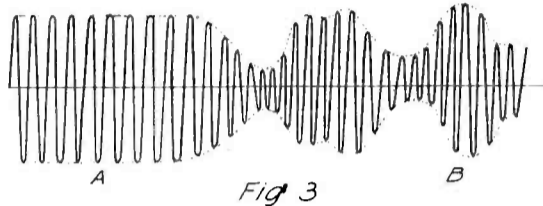

Fig. 3

The Portion A of This Curve Shows the Continuous Oscillations Produced by the Source of High Frequency Current, While the Portion B Shows the Variations of Amplitude of the Wave When Modulated by the Speech When Microphone is Spoken Into.

### THE MICROPHONE.

The microphone is merely a sensitive variable resistance, the value of which varies under very little change; it is generally composed of carbon blocks or small balls in contact with each other, or with a plate called the diafram. This diafram, when subjected to vibrations such as those caused by sound waves produced near it, vary the pressures between the carbon blocks first behind it, thus varying the total resistance of the instrument.

It is easy to understand that if this microphone is connected into a circuit the current flowing in the circuit will vary according to the changes of resistance of the microphone.

At the receiving station, the variable current received causes the telephone receiver to vibrate with a variable amplitude, reproducing all sounds produced in front of the microphone.

### THE GENERATING CIRCUIT.

The use of a vacuum tube as oscillator has been explained in detail in a previous lesson which was published in the February issue of this magazine, and the fundamental circuit was shown. If such a circuit is coupled to an aerial, Fig. 2, undamped waves of constant amplitude will be sent continuously as long as the vacuum tube is kept in operation. These waves will be of the shape shown in Fig. 3A.

If we now connect a microphone in the aerial circuit and speak in front of it, the resistance of this circuit will vary, as ex-

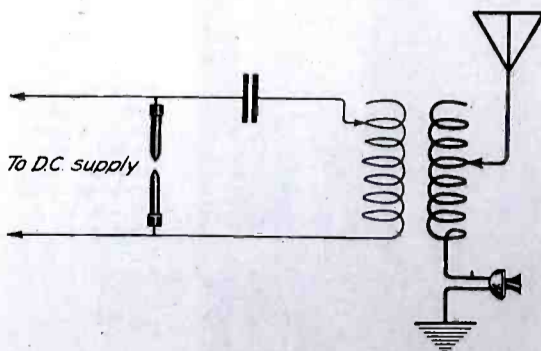

When an Arc is Used as a Source of Undamped Oscillations it is Connected in Place of the Spark Gap in the Oscillating Circuit. For Low Power, the Microphone May be Directly Connected in the Aerial Circuit, But it is Preferable to Connect it to the Coupled Circuit.

plained, and the current induced will vary as in an ordinary telephone line. The amplitude of the oscillations then decreases, as shown in Fig. 3B, and the wave is "modulated," following all the variations of the voice.

### MODULATION.

This system of modulating the whole antenna current is not the best, and is given only to demonstrate the principle. It may be used only for very small power because the microphone cannot pass great intensity without heating, and the use of several microphones in parallel has several disadvantages.

The best modulation system to use when only one tube is employed, is the grid modulation; it consists of varying the grid potential.

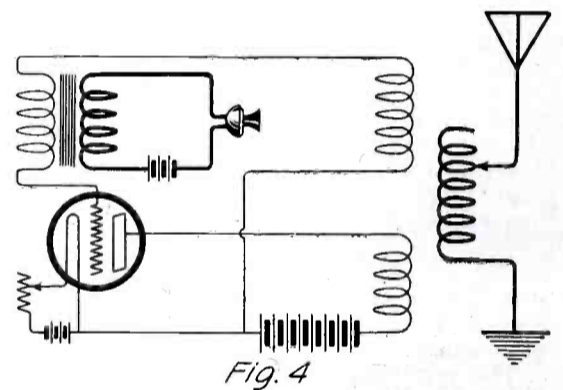

Fig. 4

In This Radiophone Circuit a Modulation Transformer is Used to Boost up the Small Variations of Current of the Microphone Circuit, and Impress These Variations Upon the Grid, Which in Turn Varies the Plate Current.

Since a small change in the grid voltage causes a great variation of the electron flow from the filament to the plate, it is best to use this variation for speech transmission by connecting the microphone in the grid circuit, as shown by the dotted lines in Fig. 2, thus causing the plate current to follow the slightest variation of grid potential.

Another improvement consists in the use of a transformer having a high ratio to boost up the small variations of current caused by the microphone in the circuit, the microphone being connected in series with the primary of the transformer and a battery, and the secondary being connected in the grid circuit, as shown in Fig. 4.

This method of modulation is called the absorption system. In the next lesson we shall explain the constant current modulation system and the improvements applied to the radiophone circuits.

### QUESTIONS FOR THIS LESSON.

1. Explain the functioning of the microphone.
2. Explain how the voice impulses are carried thru the ether.
3. Which is the most efficient method of connecting the microphone in a Radiophone circuit?
4. Draw from memory a simple Radiophone circuit.



# Junior Constructor

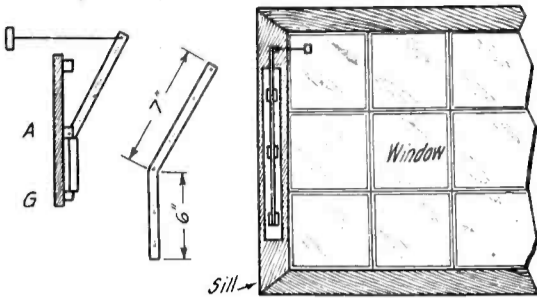

With This Device You Don't Need to Look Outside to See if Your Aerial Switch is On; Just Pull the Rod and Send.

## AN IMPROVED LIGHTNING SWITCH.

Obtain a bar of copper the same thickness and width as those of the switch, but having a length of 13". Six inches from one end bend the bar edgewise to form a large letter K or an elbow. The amount of bending can easily be determined. When half of the bar connects two of the switch terminals the other end should be three to four inches from the third switch terminal. A hole is drilled at the bend and one near the end of the long end of the bar. This bar is placed in the switch and a bakelite or other piece of insulation is fastened to the long end of the bar. To the end of the bakelite is fastened a small rod which goes inside the operating room thru a hole in the window frame. To operate the switch all it requires is a push for ground and a pull for operating.

Contributed by  
**ALON WATSON SHEWMAN.**

## PANEL SWITCH.

Many amateurs need a switch by which they can change their crystal detector from series to parallel with the fones.

In Figs. 1 and 2 are given the drawings and connections for a switch of this type. Cut two pieces of metal into the shape shown in Fig. 1a. Drill a hole, large enough to accommodate the bolt taken from a dry battery, thru the center of a black ivory checker. Clamp the two pieces of metal, taking care that they do not touch, between two pieces of insulating material and the checker. Fasten the switch to the panel with a battery nut. Put a drop of solder on the bolt to prevent the nut's coming loose.

As switch points, use eight paper fasteners, as the arms slide over them easily. The circuit diagram is given in Fig. 1.

When the switch is turned to the right, the detector is in parallel with the fones; when to the left it is in series with them. In the central position shown, the detector is short-circuited. This switch is especially recommended for use on a panel for changing the variable condenser from series to parallel with the primary of your loose coupler of honeycomb coils. This is accomplished by substituting the primary inductance for the fones and a variable condenser for the detector.

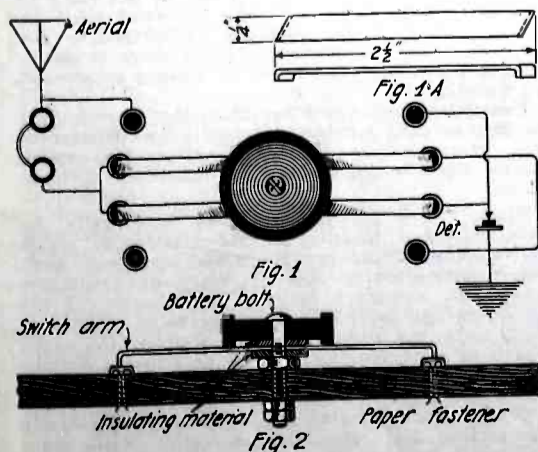

Boys, You May Build This DeForest Style Serie Parallel Switch With a Few Pieces of Junk and Black Ivory Checker.

ing the variable condenser from series to parallel with the primary of your loose coupler of honeycomb coils. This is accomplished by substituting the primary inductance for the fones and a variable condenser for the detector.

Contributed by **FRANK McKEGNEY.**  
(2ANR).

## TUNING RECORD.

If you use the honeycomb inductances and receive from several different stations, you will realize what "fussing" is sometimes necessary before the correct coil is inserted in the coil mounting.

With the chart described, I have found it quite easy to tune in any station in short time.

As will be seen from the illustration, the condenser readings and the relative positions of the coils are also taken down.

These charts are made when the coils are connected which receive the respective stations loudest.

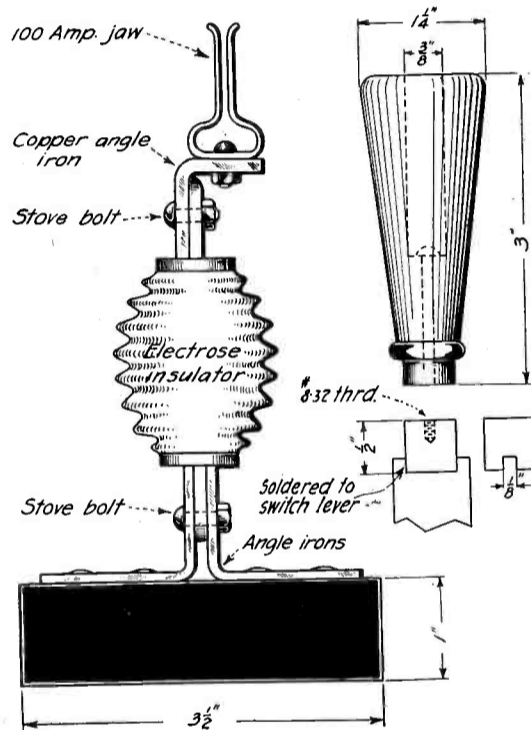

If You Cannot Obtain an Insulating Base for Your Lightning Switch You May Build a Fine One, Using Some Ball Insulators to Support the Jaws and Switch Arm.

## NAA

Arlington, Va. ....	2,500 M.
Primary .....	L- 750
Secondary .....	L-1000
Tickler .....	L- 400

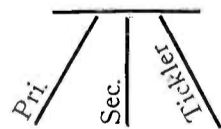

Primary Condenser .....	80
Secondary Condenser .....	160

Notes:

Contributed by **OSCAR W. LUEDERS.**

## DOUBLE SPEED KEY.

This double speed key will give entire satisfaction to the average "Ham." It is a bit more complicated than the ones shown in the later issues of RADIO NEWS, but it is more speedy and very easy to operate.

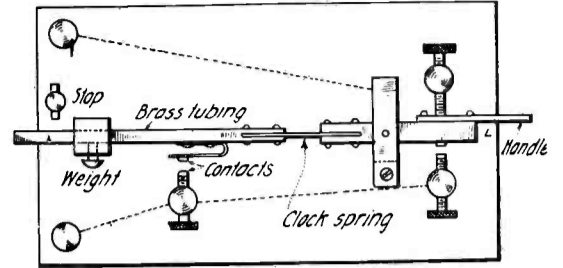

If You Enjoy Speedy Transmission and if the Other Boys Can Read It Thru the QRM, You May Build This Key Convenient for Summer, Since it Saves You From Making the Dots. Thus a Lot of Work.

The diagram shows most of the constructional details. The lever "L" and the U-shaped piece X are made of 1/8" x 1/4" brass rod. The adjusting weight and the tungsten contacts are taken from a Ford coil. The shafts I made from a 2" American Model Builder axle pointed with a file. If the handle is made of fibre your fingers will not perspire as they will if hard rubber is used. CS is the contact adjusting screw. AS is the screw which makes the dashes longer or shorter. A'S' is the pivot adjusting screw. Slit the brass tube and lever L, with a hacksaw and either rivet or solder the piece of clock spring in after straightening it. Pressing to the left makes a dash; to the right it will give any number of dots desired.

Contributed by **AL BLODGETT.**

## SWITCH POINTS FROM .22 CALIBRE RIFLE SHELLS.

Having use for about a dozen switch points for a rheostat, I conceived the idea of using .22 long empty rifle shells for that purpose. I took a 1/2" board for control panel of the rheostat, and drilled the holes for the switch points with a 1/4" drill. The empty shells fitted nicely into these holes, protruding about 1/8" on the other side of the panel. The wires were put down into the shells, which were then filled with melted solder, thus making a good, strong connection. The .22 short shells were used for "off" and "dead-end" points, thus eliminating the confusion, which sometimes results if wires are connected to "dead-end" points; the reason for this, of course, is that the "short" shells do not protrude thru the panel, so no connection can be made to them. These switch points have given good service on my rheostat for about four years.

Contributed by **CORWIN U. ECKEL.**

## RADIO LIGHTING SWITCH.

Having broken the slate base of my lightning switch and not wanting to buy another, I decided to try to mount the switch on Electro-se Insulators.

(Continued on page 816)

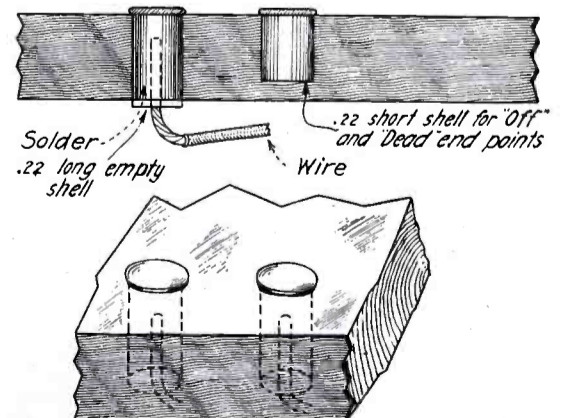

Rifle Shells Make Very Neat Switch Points. This is a Real Good Idea for the Fellow With Little Money.



# A New Radio Bill

SIXTY-SEVENTH CONGRESS,  
First Session.

H. R. 4132

IN THE HOUSE OF REPRESENTATIVES,  
April 18, 1921.

Mr. White, of Maine, introduced the following bill; which was referred to the Committee on the Merchant Marine and Fisheries and ordered to be printed.

## A BILL

To regulate the operation of and to encourage the development of radio communication in the United States.

*Be it enacted by the Senate and House of Representatives of the United States of America in Congress assembled,* That wherever used in this Act the term "radio communication" shall be construed to mean communication by an electrical system or method, without the aid of conducting connections or with the aid of wires or other conducting connections from which radio frequencies can be intercepted at a distance of one-half of one mile; the word "apparatus" to mean machines, devices, and all other equipment used in radio communication; the word "radiogram" to mean any message, communication, or signal transmitted or received in radio communication; the term "public correspondence" to mean the transmission or reception of radiograms of a private nature as differentiated from radiograms of a Government nature; the term "radio station" to mean a place where apparatus is used for transmitting, receiving, or for transmitting and receiving, the signals used in radio communication; and the term "Territory of the United States" or the word "Territory" to mean any Territory, District, zone, insular possession, water, or other place subject to the jurisdiction of the United States and not within any State.

The word "person" as used in this Act shall be construed to import both the plural and the singular, and to include a natural person, a corporation, copartnership, company, or association; and when construing and enforcing the provisions of this Act, the act, omission, or failure of any director, officer, agent, or employee of such person, corporation, copartnership, company, or association acting within the scope of his employment or office shall in every case be deemed the act, omission, or failure of such person, corporation, copartnership, company, or association, as well as that of the person acting for or in behalf thereof.

SEC. 2. That nothing in this Act shall be construed to apply to the transmission, reception, or exchange of radiograms or signals between points in the same State, if said transmission, reception, or exchange shall not interfere with the transmission, reception, or exchange of radiograms or signals from beyond the jurisdiction of the said State or the effect thereof shall not extend beyond said jurisdiction.

SEC. 3. That the Secretary of Commerce shall have full power to regulate radio communication in the United States and its Territories in accordance with the provisions of this Act, and of the provisions of such international radio communication conventions as have heretofore been ratified or adhered to by the United States, and of the provisions not in conflict with this Act, of such international radio conventions as may be hereafter ratified or adhered to by the United States.

For the purposes of this Act the Secretary of Commerce shall divide radio stations into such classes and subclasses as from time to time he may deem necessary and shall formulate and publish regulations not inconsistent herewith, concerning methods and times of operating, wave lengths, radio interference and power used by the various classes of radio stations so established by him. These regulations shall be based, so far as practicable, upon the regulations of international radio telegraph conventions, and shall be of such a nature as to afford protection to the various services involved and shall conform to the technical developments of radio communication.

The Secretary of Commerce shall grant licenses for radio stations and operators in accordance with the provisions of this Act. He shall assign bands of wave lengths for the use of the classes of stations established by him which band shall correspond so far as practicable to those prescribed by present or future international radio conventions ratified or adhered to by the United States. So far as practicable he shall assign to each separate station a wave length or wave lengths such as to enable it to accomplish the purpose for which the license is issued.

The Secretary of Commerce shall enforce his regulations and the provisions of this Act, through collectors of customs and such other officers as he may designate; and he shall in the same manner enforce the provisions of such international radio conventions as have been or may hereafter be ratified or adhered to by the United States; except that provisions thereof relating to Government radio stations shall be enforced by the departments controlling such stations.

The Secretary of Commerce shall advise with and assist persons of United States citizenship in the establishment of radio communication facilities with foreign countries and shall represent the Government and persons of United States citizenship in matters pertaining to international regulations of radio communication. The Secretary of Commerce shall be represented at international conferences in which subjects pertaining to radio or other methods of communication are to be discussed.

The Secretary of Commerce is authorized to advise and assist persons licensed in the United States to operate trans-oceanic radio stations between the United States and a foreign country, or countries, in matters pertaining to trans-oceanic radio communications, but no such advice or assistance on the part of the Secretary of Commerce shall be of such a nature as to constitute an obligation on the part of the Government of the United States to support financially or politically any action taken by such person.

The Secretary of Commerce is hereby authorized to mitigate or remit any fine, penalty, or forfeiture (other than penalty of imprisonment) incurred under the provisions of section 5, section 8, section 11, section 12, section 13, section 15, and section 21 hereof, if in his opinion such fine, penalty, or forfeiture was incurred without willful negligence or without intention to violate the provisions of this Act, or if he finds on investigation that the fine, penalty, or forfeiture, was illegally, improperly, or excessively imposed.

SEC. 4. That an advisory committee for radio communication is hereby established to whom the Secretary of Commerce shall refer for examination and report such matters as he may deem proper relating to—

(a) The administration or improvement of the laws, regulations, and treaties of the United States relating to radio communication.

(b) The study of the scientific problems involved therein in view of present conditions and future development;

(c) The scientific progress and commercial use of radio communication as related to the use of radio communication by the several branches of the Government.

The advisory committee shall consist of seven members, of whom one each shall be designated by the Secretary of War, the Secretary of the Navy, the Postmaster General, and the Secretary of Commerce, to represent those departments, respectively; one shall be designated by the Secretary of Commerce from the Bureau of Standards to represent the technical staffs of the Government engaged in research and experiment in radio communication; and two persons not otherwise employed in the Government service, of recognized attainment in radio communication, to be designated by the Secretary of Commerce.

The necessary expenses of the members of the committee in going to, returning from, and while attending the meetings, including clerical expenses in Washington, District of Columbia, or elsewhere, and cost of supplies, together with a per diem of \$25 to each of the two members not otherwise employed in the Government service for attendance at such meetings, shall be paid from appropriations made to the Department of Commerce for the purpose.

SEC. 5. That no radio stations other than those belonging to or operated by the United States shall be used by any person within the jurisdiction of the United States to transmit or receive any radiogram by the apparatus and methods of radio communication except under and in accordance with a station license or licenses issued by the Secretary of Commerce. In the case of stations not actually under construction or the construction of which is not completed at the date of the passage of this Act the license or licenses herein provided for must be secured before the commencement of or before proceeding further with the construction of such stations. Any person who shall operate any radio station in violation of this section shall be punished by a fine not exceeding \$500 for the first offense, and by a fine not exceeding \$1,000 or imprisonment for not more than one year, or both, for each offense thereafter, and the license issued to such station and the license issued to such operator, either or both, may be revoked by the Secretary of Commerce. *Licenses for amateur radio stations, and for stations used exclusively in experimental work and operation, and for the operators thereof, shall be issued without cost to the licensees, but reasonable fees, to be fixed by the Secretary of Commerce, may be charged for issuing all other licenses.*

SEC. 6. That the station license required by section 5 hereof shall not be granted to, nor shall the station so licensed be managed, operated, owned, or controlled by or in the interest of or transferred to or to the management, operation, or control of any alien or aliens or representatives thereof, nor to any foreign Government or representatives thereof, nor to any company, corporation, or association organized under the laws of any foreign Government; nor to any company, corporation, or association of which any officer or any director is an alien, or of which more than one-

fifth of the voting capital stock is owned or controlled by aliens or their representatives, or by a foreign Government or representative thereof, or by any company, corporation, or association organized under the laws of a foreign country; nor to any company, corporation, or association which is dominated or controlled by alien interests, nor to any corporation unless it agrees that a representative of the Secretary of Commerce may attend any meeting of its stockholders or directors, and the acceptance of a license shall be held to constitute such agreement; and a license may be revoked by the Secretary of Commerce on violation hereof.

SEC. 7. That no license shall be granted to any station the operation of which will, in the judgment of the Secretary of Commerce, unduly interfere with the operation of existing Government or licensed stations, nor to any station which is not, or is not to be, open to general public correspondence, nor to any station which is not in the interest of the general public service, *but the Secretary of Commerce shall grant licenses to such experimental stations as in his judgment may be useful in the development of the art and to technical and training-school stations used for purposes of instruction and to amateur stations not operated for financial profit or as a part of a business, such licenses to be issued with such restrictions as in the judgment of the Secretary of Commerce will prevent the above-mentioned interference with the operation of existing Government or licensed stations open for general public correspondence and prevent the efficient utilization in the public interest of available bands of wave lengths.*

SEC. 8. That the station license prescribed by section 5 hereof shall be issued or amended only upon written application therefor addressed to the Secretary of Commerce, which shall set forth such facts as the Secretary of Commerce by regulation may prescribe as to the character, citizenship, and the financial, technical, and other ability of the applicant to construct and operate the station; the ownership and location of the proposed station and of the station with which it is proposed to communicate; the wave length desired to be used; the period during which it is proposed to operate the station; the purposes for which the station is to be used; the date upon which the station is expected to be completed and in operation; and such other pertinent information as the Secretary of Commerce may require.

Every application shall be signed by the applicant upon oath or affirmation. If the applicant is a corporation, the application shall be signed upon oath or affirmation of a duly authorized officer thereof.

Whoever shall knowingly make any untrue statement in the application for a license prescribed by this section shall be guilty of perjury, and shall be punished by a fine not exceeding \$2,000, or by imprisonment for not more than five years, or both.

Whenever application is made for the grant of a license for a radio station the operation of which, in the judgment of the Secretary of Commerce, may interfere with the operation of then existing Government or licensed stations, notice of such application shall be given forthwith to the department of the Government and/or to the owner or owners of such existing or licensed stations, and an opportunity afforded them to be heard by and to submit evidence to the Secretary of Commerce in opposition to the granting of such application for license.

SEC. 9. That station licenses shall be in such form as the Secretary of Commerce shall prescribe, and shall contain a statement of the following conditions, to which such licenses shall be subject:

First. The station shall be at all times subject to inspection by officials of the Department of Commerce.

Second. The ownership or management of the station or apparatus shall not be transferred in violation of section 6 of this Act.

Third. Such books and records of the licensee as contain entries showing whether or not the provisions of this Act are being observed shall be open at all times to inspection by officials of the Department of Commerce to assist them to determine whether such violation or failure to observe has occurred.

Fourth. Apparatus other than that specified in the license shall not be used for radio communication, except in case of emergency or for experimental work, authorized by the Secretary of Commerce.

Fifth. Such license shall show specifically the ownership and location of the station in which the specified apparatus is to be used and such other particulars as the Secretary of Commerce may deem necessary for the identification of the apparatus and to enable its range to be estimated; shall show the purpose of the station; the wave length or wave lengths and the decrements authorized for use by the stations; and the hours for which the station is licensed to work.

Sixth. Such licenses shall also show specifically the earliest and latest date operation shall begin and shall indicate that the license will be automatically forfeited if the station is not operated by the time set.

(Continued on page 828)



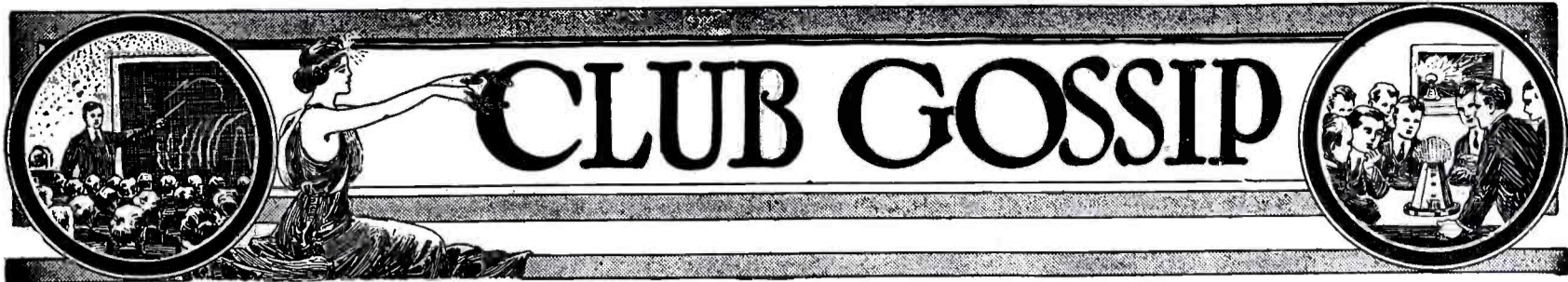

#### RADIO CLUB OF BROOKLYN, INC.

A package party and second annual dance of the Radio Club of Brooklyn, Inc., will be held Saturday, May 28, 1921, at the Club's headquarters, 2211 Bedford Ave. Tickets are 50 cents, admitting lady and gentleman, and may be purchased from J. H. Bunnell Co., 32 Park Place, New York City, and Kelly & Phillips, 312 Flatbush Ave., Brooklyn, or from members of the club.

Mr. Charles Porter has resigned from the club and Board of Directors and Mr. Joseph Le Claire has been elected to fill his place.

#### THE NEWTON, MASS., RADIO CLUB.

On Feb. 9, 1921, a few amateurs of Newtonville met at the home of Mr. O. L. Paquette, 95 Norwood Ave., and organized the Newton Radio Club. The following officers were elected: President, D. R. Hull; vice-president, H. J. Morgan; secretary and treasurer, W. Richards. The meetings are held every Wednesday evening from 7 to 9 o'clock. Under the leadership of Mr. Paquette the club receives instruction in code and theory. Correspondence is invited by the secretary.

#### UNIVERSITY OF KENTUCKY RADIO CLUB.

The radio station at the University of Kentucky, Lexington, Ky., has the call 9YC. For some reason we are listed in the call book as 9YB, when 9YB is in reality the Agricultural College of North Dakota. We will be very glad to hear from anyone who has heard our signals, and we will Q.R.S. anytime.

#### BETHLEHEM, PA., RADIO CLUB

A very enthusiastic meeting of the wireless men in Bethlehem, Allentown, Easton and vicinity, was held March 10 at the Chamber of Commerce rooms in the Wilbur Trust Building. This was the largest and most interesting meeting of wireless men ever held in this vicinity. F. Clifford Estey, president of the Essex County (Massachusetts) Radio Association gave a talk on club organization and the experiences on his recent trip through the West and South in the interests of wireless.

After Mr. Estey's talk, a business meeting was held at which it was voted to form a new association to be known as the Lehigh Valley Radio Association with a section, or club in each of the cities and towns in the valley, all running as separate clubs yet bonded together in the larger association and meeting in one of the cities once each month and the separate sections holding meetings once each week or as often as desirable. Each section will elect its own officers and the president of each section will be a vice-president of the Lehigh Valley Association; beside these vice-presidents, the association will have a president and chairman of the advisory board and these officers will be the governing body of the entire association.

K. F. Gray, of Easton, was elected president of the association and Arthur F. Breisch, of Bethlehem, was elected chairman of the advisory board. A committee of three men was appointed by the president to call the wireless men together in the other cities and conduct the local elections. Edwin Hartman, Alan Chamberlain and Elton Roeder were appointed from Bethlehem; Richard Bright, Clyde Moser and Lester Gares were appointed from Easton, and Kenneth Keck, J. C. Meighan and Nelson Meitzler were appointed from Allentown.

#### KINGSTON RADIO ASSOCIATION.

The long looked for club in Kingston, Ontario, has been formed and a most successful association is looked for. At the first meeting, the energies of all present were put into making rules and to drawing up the constitution and by-laws. After considerable discussion regarding the need of such a club in Kingston, officers were elected as follows:

Honorary president, Capt. S. A. Lee, M.C.; president, Orton H. Donnelly; vice-president, Robert M. Davis; secretary-treasurer, S. Sergt. T. G. Brown; traffic managers, Harold Stewart and Gordon A. Thompson.

Traffic rules were also brought up and adopted and these are to be looked after by the traffic managers. All the members with transmitting sets are taking turns to transmit the Q.S.T. each and every evening at 7 P. M. This Q.S.T. is sent out with the purpose of letting all amateurs know of any special news regarding the club and it also affords practice for them. First transmission is at fifteen words per minute and the second at eight words per minute.

When the new club rooms are made ready, a

transmitting and receiving set will be installed and operated by the association. Meetings are held every Friday evening at 7.30 and in the future there will be time for lectures by prominent radio men in Kingston. Altogether, this will be a live wire organization, as all the members are doing their best to make this one of the live wire radio clubs of the country.

Code practice will also be taken up. There are about 25 members in the association. On account of the wave-length which the government has in force, amateurs are compelled to transmit only on 50 meters, and all sets are tuned to this length.

Communications are solicited from other clubs. Will let you know later our call and all information regarding our set. Now boys, hold on till you hear our call careering thru the ether and then listen in. This is going to be "some association."

#### THE RADIO CLUB OF THE BRONX.

The Radio Club of the Bronx has been fortunate in recently acquiring a large meeting room and also an operating room in the Bronx Y. M. H. A. Due to these increased facilities it will be able to accommodate a much larger membership. To those who wish to join, every advantage associated with a strong and growing radio club is extended. Visitors are cordially invited and a pleasant and enjoyable evening is promised to those who are sufficiently interested to attend any of the meetings. The club meets every Wednesday evening at 7.30 o'clock at the Bronx Y. M. H. A. The newly elected officers of the club are Sam Ellner, president; Nat Sauberman, secretary; Michael Levine, treasurer. Address all communications to the secretary, 789 East 163rd St., New York City.

#### TOTTENVILLE RADIO CLUB, TOTTENVILLE, STATEN ISLAND.

The recently organized Tottenville Radio Club, at a meeting held with Carl Young, elected the host president and Floyd Van Pelt secretary-treasurer. The club is planning for permanent headquarters where radio apparatus can be installed and meetings held. At present the members meet Tuesday evenings. Any young man in Tottenville and suburbs who is interested in radio practice, is invited to join by communicating with Carl Young, Roy Raguse, or Allen Nahamacher. The club is affiliated with the Radio League of America.

#### MIDDLETOWN RADIO CLUB, MIDDLETOWN, N. Y.

On Sunday afternoon March 6, 1921, a meeting of the Middletown Radio Club was held at the home of Harold Anderson and an interesting talk on the different kinds of electrical currents was given by Richard Buck.

At present the club has the following members, Harold Anderson, Richard Buck, Floyd Buck, David Buell, Loyal Cross, Cecil Davis, William Dempsey, Raymond DuVall, Richard Gould, Lionel Knight, LaVern Peck and Richard Woodhams.

Meetings are held every other Sunday at the homes of the members. The meetings are held on Sunday so all the members can be present.

The officers elected by the members of the club are as follows: President, Richard Buck; vice-president, Harold Anderson; secretary, Loyal Cross; treasurer, Raymond DuVall; inspector, Cecil Davis. The inspector looks over the stations of the members from time to time to see if they are keeping within the 200 meter limit.

The most powerful transmitting set in operation at present is owned by Harold Anderson, his call being 2OI. He will be glad to communicate with any of the other clubs within his range.

We would like to hear from some of the other radio clubs in our vicinity. Address any communications to the Middletown Radio Club, care Loyal Cross, 184 Linden Ave, Middletown, N. Y.

#### THE KITSAP COUNTY RADIO ASSOCIATION, BREMERTON, WASH.

At a preliminary meeting of all interested, on the evening of February 24th, the Kitsap County Radio Association was formed with an initial membership of 24 boys and young men all of whom were enthusiastic over the proposed activity.

A president and secretary-treasurer were elected, the former being George Dewey, and the latter Travers Campbell, both of Bremerton.

Two committees were appointed: a rules and regulations committee, to draw up a suitable constitution; and a housing committee to investigate the possibility of obtaining a suitable meeting place.

Two licensed commercial operators of long experience, H. S. Pyle and H. R. Andrews, will serve as an advisory board and present papers dealing with the practical operation and construction of various pieces of apparatus from time to time. They are also at the service of the club in the capacity of consulting engineers.

A cordial invitation is extended to all Kitsap County men and boys who are interested, to attend the meetings and become members. The secretary will be glad to answer inquiries as to where meetings will be held. The club will also be glad to welcome visitors from other radio clubs, and solicit their correspondence.

Address inquiries and correspondence to the secretary, Travers Campbell, 1534 Elizabeth Ave., Bremerton, Wash.

#### APPLETON Y RADIO CLUB.

The Appleton Y. Radio Club has been reorganized this year. The regular weekly meetings are held at the Y. M. C. A. building every Wednesday night. Iner Erickson, who has a large station at Racine, Wis., is the original organizer, and the present instructor.

At the first regular meeting Antone Rank (9ALT), was elected president; Robert Thompson (9AUF), vice-president; John Harriman, secretary; and Harry Leith, treasurer.

Mr. Whitaker, of the Western Union Telegraph Co., granted the club the use of his receiving and transmitting sets, which will be set up as soon as possible; the aerial is already up. Mr. Whitaker is erecting a station in Neenah and expects to have it in working order soon.

The first part of the evening is usually given over to the instructor, to explain important theories and new instruments. A short business meeting is then held and later code is practiced. Meetings are often held at the homes of members, when their sets are used and examined.

The members are now preparing for a test to be held in the near future. The members who successfully pass this test will be awarded a certificate, which will entitle them to the use of the club set. The examination is to cover all phases of radio communication.

Three members of the club, Antone Rank, Robert Thompson and Harvey Schroeder, are obtaining fine results with their sets, hearing radiofane messages from Pittsburgh, Pa. They also hear Arlington, Key West and other distant stations.

#### JUNIOR RADIO CLUB OF ELIZABETH ENTERTAINS.

At the weekly meeting of the Junior Radio Club of Elizabeth, N. J., a radiofane concert was held for the members and their friends.

The concert was held at the home of the club's president, and A. V. Bremer (2IA), of Jersey City, N. J., furnished the concert with his telephone set. The club plans to give another entertainment via radiofane at its next meeting.

At the last meeting the following officers were elected: President, E. Gundrum, and secretary, H. Zimmerman.

The club would like to have more Elizabeth amateurs as members. Meetings are held every Friday evening at 7.30 o'clock at the secretary's home, 26 Lyon Place, Elizabeth. Address all communications to the secretary, H. Zimmerman, at that address.

#### RUSS RADIO CLUB.

At a recent meeting of the Russ Radio Club the following officers were elected: President, D. Chambers; vice-president, E. Kinney; secretary-treasurer, E. Broezel. The following committees were formed: Library Committee, L. Picker, chairman; George Hulstede and Harley Iams; Electrical Committee, Raymond Jacobs, chairman; Robert Rogers and Brian Smith; Program Committee, L. Stewart, chairman; C. Camp and C. Rogers.

Meetings are held every Wednesday evening at the high school. The present membership is about 30 but others are invited to join.

The club hopes to build a large set from the proceeds obtained from the spring high school carnival. It now has several practice sets that were donated by members.

Address all communications to the secretary, care of San Diego High School.

#### PELHAM RADIO CLUB.

The Pelham Radio Club was founded in April by the present officers. There are many amateurs in the town and it was for the purpose of bringing these together and assisting them that the club was formed. The object of the club is to promote interest and knowledge in radio.

The officers of the club are Walter Kolb, president; Morrell Crawford, vice-president and secretary; Sherman Peticolas, treasurer.





**T**HIS Department is conducted for the benefit of our Radio Experimenter. We shall be glad to answer here questions for the benefit of all, but we can only publish such matter of sufficient interest to all.

1. This Department cannot answer more than three questions for each correspondent.
2. Only one side of the sheet should be written upon; all matter should be typewritten or else written in ink. No attention paid to penciled matter.
3. Sketches, diagrams, etc., must be on separate sheets. This Department does not answer questions by mail free of charge.
4. Our Editors will be glad to answer any letter at the rate of 25c for each question. If, however, questions entail considerable research work, intricate calculations, patent research, etc., a special charge will be made. Before we answer such questions, correspondents will be informed as to the price charge. You will do the Editor a personal favor if you make your letter as brief as possible.

**USE OF WAVE-METER.**

(197) Howard Taft, of Perth Amboy, N. J., asks:

Q. 1. What is the correct way to tune or adjust the wave-length of a 1/2 k.w. sending set with an Amrad wave-meter?

A. 1. To tune a transmitting set with a wave-meter of the type you mention, the aerial should be disconnected and the wave-meter brot near the O. T. The key is then presst and the knob of the wave-meter turned slowly until the lamp gleams at maximum brilliancy. By moving the wave-meter away from the O. T., this may be determined very accurately. At this point the engraved white mark in front of the dial shows the wave-length of the primary circuit. The aerial is then connected to the secondary of the O. T. at the point giving maximum intensity at the aerial ammeter. The two circuits are then in tune and emit only one wave-length.

Q. 2. Where can I purchase resistance wire to reduce the speed of a motor that requires 110 volts?

A. 2. Resistance wire may be obtained from several Radio dealers or electrical shops, one of which is the American Steel & Wire Co., 59 Barclay St., New York City, N. Y.

Q. 3. Is it possible to transmit with an ordinary buzzer? If so, where can I get a hook-up for same?

A. 3. Yes, transmission may be accomplished with a buzzer; a hook-up for such a set was published on page 540 of the February, 1921, issue of RADIO NEWS.

**SIGNAL CORPS AMPLIFIER.**

(198) Edward Herold, of Newark, N. J., asks:

Q. 1. Please give me a diagram for the Signal Corps amplifier in which four tubes

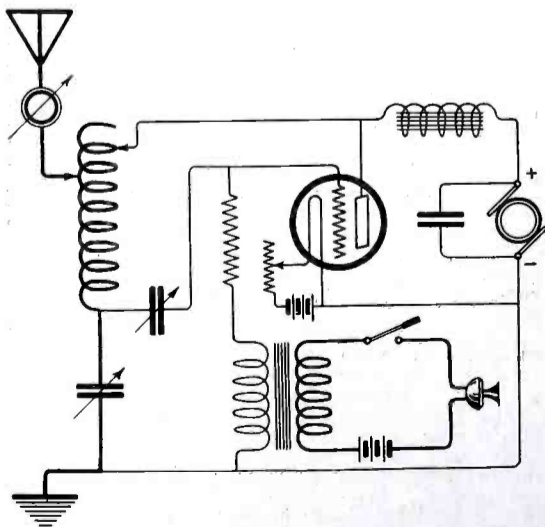

This Radiofone Hook-up, When Properly Adjusted, Will Give You the Best Results With One Tube.

are used, and the second and third tubes used over again to give the equivalent of six tubes, as published in the April, 1920, issue of RADIO NEWS.

A. 1. A diagram of the connection of the L. 3 amplifier, appears on this page.

**H. T. CONDENSER.**

(199) E. H. Joscelyn, of San Francisco, Calif., requests:

Q. 1. Will you kindly publish data regarding the construction of 1/2 k.w. oil-immersed metal plate condenser suitable for use on a panel set?

A. 1. An H. T. condenser for 1/2-k.w. set

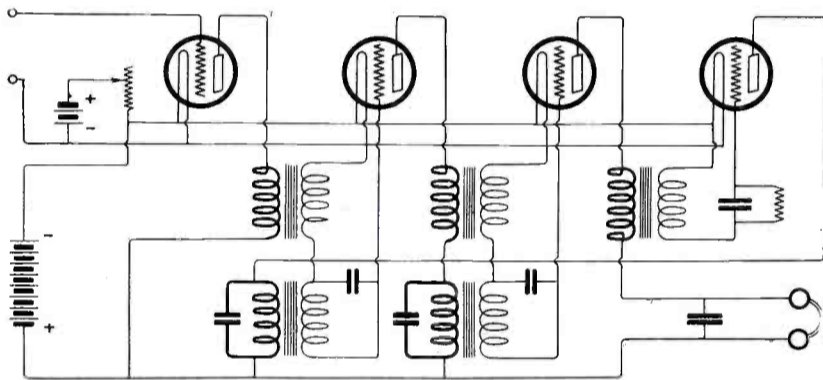

This is the L.3 Amplifier Used by the Signal Corps; the Same Tubes Are Used to Amplify at Radio and Audio Frequency, Giving Five Stages of Amplification, With Only Four Tubes, One of These Being Used as Detector.

may be made of 41 photographic glass plates 8" x 10" and the armatures made of tinfoil 6" x 8", with a lug 3" long. The corners of the tinfoil sheets should be cut round and the armatures applied on the glass plates with vaseline. The film may easily be removed from the glass plates with hot water and a brush.

**"B" BATTERY.**

(200) S. Y. Alexander, of Dorchester, Mass., wants to know:

Q. 1. I wish you would tell me thro the "I-Want-To-Know" columns in what issue an article on "B" battery, by Mr. Joseph G. Reed, was published.

A. 1. Mr. Reed's article on a "B" battery was published on page 229 of the November, 1919, issue of RADIO NEWS.

**RADIO FREQUENCY AMPLIFIER.**

(201) L. R. Fletcher, of Los Angeles, Calif., inquires:

Q. 1. What are the connections for a radio frequency amplifier, to be used with a cabinet containing inclosed detector circuit and separate "B" batteries?

A. 1. The hook-up for the Radio frequency amplifier for long wave was given on page 596 of the March, 1921, issue of RADIO NEWS, and that for a short wave was given on page 441 of the January, 1921, issue.

Q. 2. What are the windings and approximate working dimensions of the loud talking machine shown in the article "The

Electro-Dynamic Receiver," which appeared on page 434, January, 1921, issue of RADIO NEWS?

A. 2. Complete data for the construction of a telemegafone was given on page 211 of the October, 1920, issue of this magazine.

**SPARK COIL USED FOR RADIOFONE.**

(202) James Corn, of Palmer, Ill., requests the following information:

Q. 1. Can a small spark coil with a secondary voltage of 200 be used as a "B" battery for a Radiofone?

A. 1. No, such a spark coil could be used in conjunction with rectifier tubes to supply the H. T. to the plate of a C. W. set, but the current obtained would not be suitable for Radiofone work.

Q. 2. What class V. T. is use in the Radiofone hook-up which you published on the "I-Want-To-Know" page of the July RADIO NEWS?

A. 2. The tubes used in this circuit were V. T. 2 tubes, but we advise you to use some Radiotrons U. V. 202 instead, with the hook-up given on page 690 of the June, 1920, issue of RADIO NEWS.

Q. 3. Can an ordinary telephone inductance coil be used instead of the modulation transformer in said hook-up.

A. 3. No, the ratio of number of turns in a telephone coil is too small for good results. As a modulation transformer, a Ford spark coil will give you much better results.

**VARIOMETER CONSTRUCTION.**

(203) Henry John English, of Jacksonville, Ill., would like to know:

Q. 1. What is the difference between a variometer and a variocoupler, and how can a variometer be made?

(Continued on page 820)

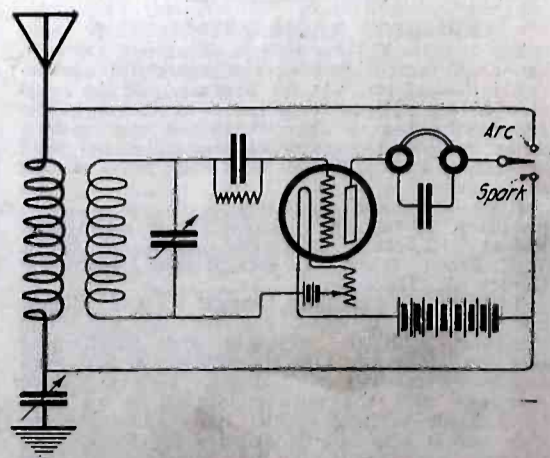

Here is a Simple Arc-Spark Hook-up to Use With a Loose Coupler. The Primary is Used as Plate Coil When the Switch is on Arc.



# MURDOCK

## THE LATEST VARIOMETER No. 345 VARIOCOUPLER No. 346

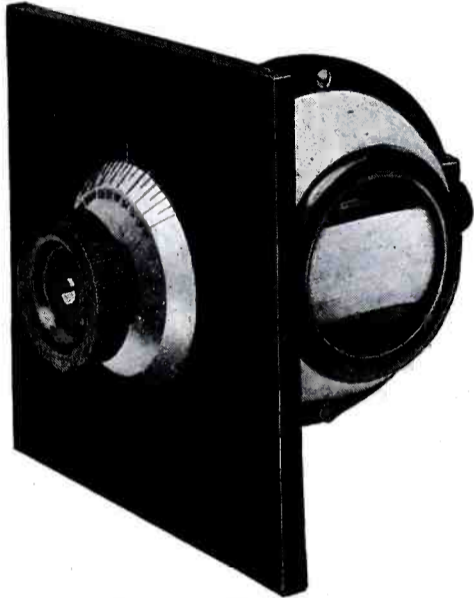

No. 345 Variometer  
**\$7.50**

- No. 345-P Variometer, complete as illustrated with panel, knob and dial and panel mounting brackets.....\$7.50
- No. 345-G Variometer, complete as illustrated with panel, knob and dial and panel mounting brackets.....\$7.50
- No. 345-P or 345-G Variometers without knob and dial.....\$6.75
- No. 346 Variocoupler, as illustrated with panel, knob, dial, and panel mounting brackets and back connected tap off switch.....\$8.50
- No. 346 Variocoupler without knob or dial.....\$7.75

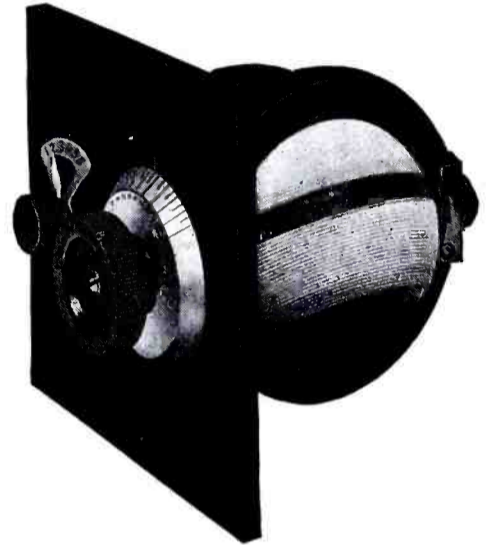

No. 346 Variocoupler  
**\$8.50**

**WINDING FORMS ARE  
"MURDOCK MOULDED"**

**"THE PRICE IS UNUSUALLY LOW,  
THE QUALITY IS  
REMARKABLY HIGH"**

SEE THEM AT YOUR DEALERS

### MURDOCK No. 55 RADIO RECEIVERS



**2000  
OHM  
DOUBLE SET  
\$4.50**

**3000  
OHM  
DOUBLE SET  
\$5.50**

### MURDOCK Variable Condensers

- No. 366—43 plate .001 mfd. with oil containing case.....\$4.75
- No. 367—43 plate .001 mfd.....4.50
- No. 368—23 plate .0005 mfd.....4.00

#### PANEL MOUNT TYPES

- No. 3660—43 plate .001 mfd.....\$4.00
- No. 3661—43 plate .001 mfd.....4.25
- No. 3662—43 plate .001 mfd.....5.00
- No. 3680—23 plate .0005 mfd.....3.25
- No. 3681—23 plate .0005 mfd.....3.50
- No. 3682—23 plate .0005 mfd.....4.25

### MURDOCK Variable Condensers

**"PERFECT SATISFACTION GUARANTEED OR YOUR MONEY BACK"**

**BUY THEM FROM YOUR DEALER  
SEND FOR BULLETIN No. 20**

**WM. J. MURDOCK CO.** 50 CARTER STREET  
CHELSEA, MASS.  
509 MISSION STREET, SAN FRANCISCO, CALIF.



# Crosley Cabinets

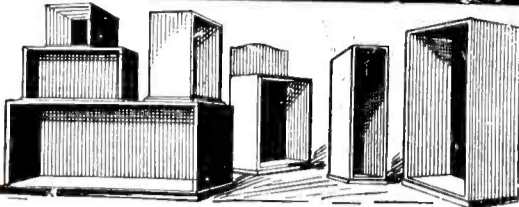

The tendency in the radio field today is to put apparatus in cabinets not only for appearance sake, but as a protection from dust, dirt, atmospheric conditions, etc. Realizing the demand for attractive stock cabinets of various sizes, we are building them in quantities in our large wood working plant. These cabinets are all uniform in style. The panels are rabbeted in to the front. As the outside dimensions and inside dimensions are either larger or smaller than the panel itself, we show panel size and also inside dimensions. Prices quoted do not include the panels.

All cabinets are waxed antique mahogany finish. Wood used is either gum, genuine solid mahogany or quartered oak. Lids or tops are hinged. Sizes and prices are shown below:

For Panel Size	CABINETS			Quartered Oak or Mahogany	
	Inside Height	Inside Width	Inside Depth	Gum	hogany
6 x 7	5 1/2	6 1/2	7	\$2.50	\$3.85
6 x 10 1/2	5 1/2	10	7	2.75	4.40
6 x 21	5 1/2	13 1/2	7	3.30	5.55
6 x 14	5 1/2	20 1/2	7	3.90	7.30
9 x 14	8 1/2	13 1/2	10	3.70	6.80
12 x 14	11 1/2	13 1/2	10	4.40	8.50
12 x 21	11 1/2	20 1/2	10	5.25	10.60

Cash must accompany order. No C.O.D's. Shipments via express only transportation charges collect.

We can furnish genuine formica panels 3/16" thick, cut to the following dimensions. 6 x 7; 6 x 10 1/2; 7 x 9; 6 x 14; 7 x 12; 6 x 21; 7 x 18; 9 x 14; 12 x 14; 14 x 18; 18 x 21. Price of panels—2 1/2c. per square inch. For odd sizes order the next largest size; we will trim. If you desire panels shipped via parcel post include postage. Shipping weight approximately 1/2 ounce to the square inch. If postage is not included shipments will be made via express collect. If you send more postage than is necessary we will refund.

Dealers wanted. MANUFACTURERS OF RADIO APPARATUS—send us samples or drawings of your cabinets for quantities prices.

**CROSLY MANUFACTURING CO.**  
Dept. R. Cincinnati, Ohio

# Electricity

A practical training in this great profession will make your successful future a certainty. We teach all branches of Electrical Science and Engineering.

## ELECTRICAL ENGINEERING

With B. S. Degree in 3 Years

Electrotechnics—12 to 36 mos. Electrical & Mechanical Drafting—6 to 12 mos. Automotive Electricity 3 mos. Armature Winding & Motor-Generator Repair, thorough 3 to 6 months' course. Practical Electricity—6 months.

A place for every student. Up-to-date laboratories—faculty of 90 experts; individual instruction. Write for latest catalog; mention age and education. New term soon starting.

**SCHOOL OF ENGINEERING**  
Dept. RN-5  
373 Broadway, Milwaukee, Wis.



## Build Model Planes

Wading River models are exact scale reproductions of real planes, that's why they fly. You can't go wrong with Wading River plans and parts. Send 10 cents for new 56 page catalogue, showing 25 different models that you can easily build.

**WADING RIVER MFG. CO.**

Dept. H, 672 Broadway, Brooklyn, N. Y.

## 30 Days Free Trial

Select from 44 Styles, colors and sizes, famous **Ranger** bicycles. Delivered free on approval, from maker - direct - to - rider - at factory prices. Save \$10 to \$25 on your bicycle.

**12 Months to Pay** Immediate possession on our liberal Easy Payment plan. Parents often advance first deposit. Energetic boys earn the small monthly payments themselves.

**Tires** Horns, wheels, lamps, parts and equipment at half usual prices. SEND NO MONEY—Ask for big free Ranger Catalog, marvelous prices and terms.

**Mead Cycle Company**  
Dept. A116 Chicago

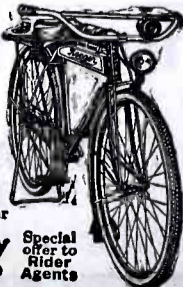

Special offer to Rider Agents

IF "RECEIVING SETS" CONTINUE TO DIMINISH IN SIZE AND WEIGHT, THE FUTURE RADIO-BUG WILL DO WELL TO KEEP A SHARP LOOKOUT ON HIS APPARATUS



This Illustration Shows a Loop Aerial on the Microbe Set. It is Used for Short Waves; for Long Waves an Aerial Wound on a Toothpick is More Efficient, But in Case of Fading of Signals the Operator Will Have to See if it is Not for the Reason Here Illustrated.

## PORTABLE RADIOFONE SET

(Continued from page 787)

many the same as in a regular variometer only that when tying down the nuts, tie them so as to have primary and secondary oval-shaped.

Fig. 3, No. 1, measuring 3 1/2" at small sides. The variometer coupler is shaped like this so it will occupy a smaller space in thickness; furthermore the secondary is put in the primary so as to use the variometer coupler as a variometer for transmission and as a vario-coupler for reception.

The taps taken from the primary are soldered to the five switch points, V. C. P., Fig. 1. When sending messages turn lever on switch point S and you will have the variometer for transmission. For reception turn lever on any switch point. The audiotron 13 which is used in the set is enclosed in a cylindrical cardboard box 14, Fig. 2, with cotton or felt, 15 to fill the space between the box 14 and audiotron 13 so as to prevent breakage from rough handling and to insure the life of the precious "Aladdin's Lamp." The filament leads are taken thru holes cut in the cardboard box and connected to screws 1, 2, 3, No. 9. The plate lead 20 and the grid 19 are taken the same way and connected to the respective screws 20 and 19.

I have described the variometer coupler

and the safety vault for the audiotron because as I have said before they are novel. The others are all old ideas and understood by any amateur.

Fig. 2 is the Skinderviken transmitter button, 12, variable condenser of .0005 mf. or .001 mf.; 11 may be a Paragon rheostat; 10, grid condenser and leakage; 8 is the back of the six point change over switch; 7 is the three screws for the three levers of the C. O. S.; 16 is two binding posts for fones; 17, binding post for aerial; 18, for ground. The "A" and "B" batteries are placed behind the rheostat. The "A" battery is composed of two flashlight batteries and the "B" battery may be a 22-volt one or more.

All is then inclosed in a neat oak box, mahogany finish, with a cover to protect the exposed parts.

If a window is wanted to see the audiotron glow as shown in Fig. 1, drill seven holes 1/4" in diameter, crosswise and cut out the cylindrical box to allow a small part of the audiotron to protrude.

This set will be just the thing to carry around this spring and summer and on your vacation. A strap or handle can be attached to the box to either carry it in your hand or around your neck, down to the side



# Maximum receiving satisfaction is assured by Brandes Headsets

A headset which may be depended on to give 100-per-cent receiving satisfaction must have the two vital features of high impedance and super sensitiveness. These qualities are found in the Brandes Navy Type Headset and the Brandes Superior Headset; built into them by wireless headset specialists and guaranteed to be there and to stay there.



"Navy Type"—50,000 ohms A. C., weight 11 oz., complete with head band and polarity indicating cord. Price \$14.00.

## BRANDES Matched-Tone Headsets



"Superior"—2,000 ohms, D.C., weight 14 oz., complete with head band and polarity indicating cord. Price \$8.00.

### Impedance

To get maximum results in vacuum-tube reception, the headset must have an impedance approximating that of the V. T. The Navy Type N. H. I. is designed for this purpose. It has an impedance of 50,000 ohms at 800 cycles—over twice that of any other headset.

### High Pitch

It is very desirable in beat reception to be able to hear the highest-pitched notes. This allows a far greater zone of tuning and results in quicker tuning. It also allows reception at a pitch which makes interference negligible. Many headsets will not respond at all to very high-pitch tones even though the signal strength is many times that necessary to cause loud signals at 500 cycles. The Navy Type N. H. I. will respond clearly to a wider range of frequencies than any other headset and yet be superior in audibility.

### Matched Tone

It is of the utmost importance for both telephones to be so matched in tone that they emit *exactly* the same note. Nothing is so apt to hamper the reception of weak signals, especially through interference, as badly-matched telephones. The Navy Type N. H. I., being a "BRANDES" product, is, of course, carefully matched in tone.

### Polarity

In order that the sensitiveness of the telephones may not, in time, be impaired by the demagnetization of the permanent magnets, it is desirable that the d. c. pass through the receiver in the proper direction. The Navy Type N. H. I. is equipped with a marked conducting cord. The terminal with the *red* thread should be connected to the positive side. Connected in this manner, the headset will retain its original superiority indefinitely.

### "Navy Type" Specifications

Cases of hard drawn aluminum. Ear caps of hard rubber, large enough to cover the ears and perforated with small holes, in place of the single large hole in center, as an added protection to the diaphragms. Diaphragms of special tungsten steel. Headband, the new improved Brandes type, the best-fitting headband ever devised. Polarity indicating. Cords six feet in length. The weight of the headset complete with headband and cord is only 11 ounces. Resistance 50,000 ohms a. c.

### Durability

The Superior Type headset was originally designed for amateur use. As such it has been used by tens of thousands of wireless enthusiasts. But so skillfully had this headset been designed, from the standpoints of both efficiency and durability, that it soon was adopted by commercial wireless companies and issued by them to their operators.

Brandes Headsets are so well built that they will retain their original efficiency for years, in spite of the roughest handling and abuse. We know of Superior Headsets, purchased in 1910, which are still in use and giving the same good service as on the day they were bought.

### Sensitiveness

The sensitiveness of the Superior Headset is remarkable, considering the low price for which it is sold. It is safe to say that no other headset at this price can approach it. Our files contain many hundreds of letters from purchasers of this headset who are not only loud in their praises but even assert that the "Superior" is better, in their opinion, than other makes costing much more.

### For Beginners

For the beginner in wireless, whether he intends to continue as a professional or to derive pleasure merely as an amateur, no better wireless headset is available today than the Brandes "Superior." Light and rigid in construction, it utilizes materials which will give the best service under both ordinary and trying conditions. We can refer to thousands of users who attest to its substantial construction, handsome appearance and efficient service.

### Construction of "Superior"

"Superior" cases are of aluminum; interior parts nickel-plated and highly polished; caps, of hard rubber; cores of annealed Norway iron, wound with No. 40 enameled copper wire to an approximate resistance of 2,000 ohms per set; headband is the new improved Brandes type. Equipped with polarity indicating cord, six feet long. Weight in use, 15 ounces. The two receivers are carefully matched in tone, the same as in the "Navy" type.

### Trial Offer

Send \$14 for a Navy Type; or \$8 for a Superior Headset. Try it for 10 days. If you don't find it the best headset you ever tried and are not entirely satisfied with it, send it back and your money will be refunded promptly.

**C. BRANDES, Inc.** Room 823, 32 Union Square, New York City  
Send 5c for Catalogue "G"

**LEO. J. MEYBERG CO.**  
428 Market St., San Francisco, Cal.  
Pacific Coast Distributors



# ACME APPARATUS

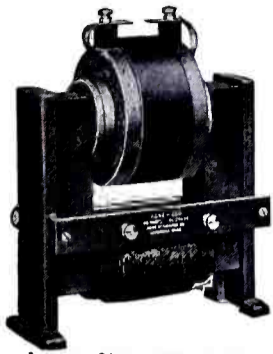

Acme 250, 500, 1000

Spark Transformers  
C. W. Power Transformers  
Modulation Transformers  
Amplifying Transformers  
Filament Heating Transformers  
Special Transformers  
Amplifiers  
Detectors  
1½ Henry Choke Coils  
Anti-Light Blinkers

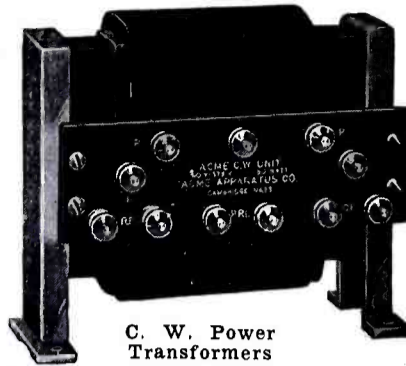

C. W. Power Transformers

The ACME SPARK TRANSFORMERS have the highest efficiency, highest power factor, highest spark frequency and lowest price of any on the market. Acme 250, Acme 500, Acme 1,000.

The ACME C. W. POWER TRANSFORMERS are for use with rectifying devices or for A. C. directly on the plates of power tubes. 50 watt, 200 watt, 500 watt.

The ACME MODULATION TRANSFORMERS give maximum modulation without distortion. Type A-3.

The ACME AMPLIFYING TRANSFORMERS are the result of experiments by transformer and radio engineers. Correct ratio and impedance. Type A-2

The ACME FILAMENT TRANSFORMERS allow the use of A. C. for power tube filament heating with easy control. 75 watt, 150 watt.

The ACME AMPLIFIER AND ACME DETECTOR contain in a small space what so often requires considerably more.

The ACME CHOKE COILS are 1½ Henries for use in ironing out and for modulation.

The ACME ANTI-LIGHT BLINKERS eliminate blinking of lights when transmitting.

Ask your dealer to show you

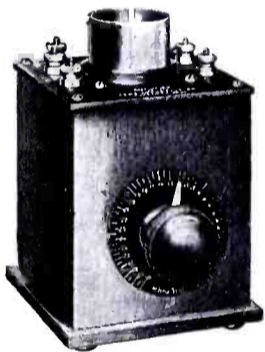

Amplifier Detector

## Acme Apparatus

Bulletins describing the above apparatus sent on request.

"The Apparatus With a Guarantee"

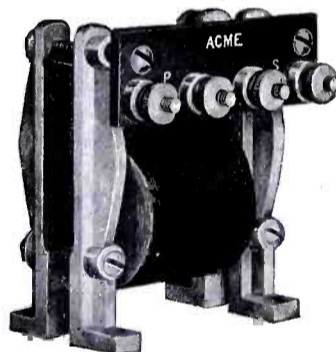

Amplifying Transformer

**Acme Apparatus Co.** 188 Massachusetts Ave., Cambridge, 39 MASS.

Transformers and Radio Engineers and Manufacturers

### Some Operating Characteristics of Electron Tubes

(Continued from page 777)

often aids in overcoming this difficulty is the insertion of a very small inductance (a few microhenries) in one or more of the grid leads close to a tube grid terminal.

This coil is shown in Fig. 7. This figure also shows fuses in the plate circuit of each individual tube, a very desirable feature on high-power high-voltage tubes. This fuse should blow at two to four times the rated plate current of the tube.

This Fig. 7 also shows another desirable feature for high-voltage power-tube circuits. In experimental work with oscillating circuits unusual conditions may occur which will cause transient voltages to be set up between the grid and filament which will reach peak values many times higher than that set up in normal operation. It is impractical to design and construct a tube and its base to stand up under this very abnormal voltage, which only occasionally occurs, due to incorrect adjustment.

A safety spark gap should therefore be provided between the grid and filament terminals at or near the tube socket or mounting. This gap should be adjusted to between one-thirty-second and one-quarter inch, depending upon the plate voltage employed and the number and type of tubes used. This precaution should be taken on any tube or group of tubes delivering over 50 watts of alternating current energy or operating at a plate potential above 2,000 volts.

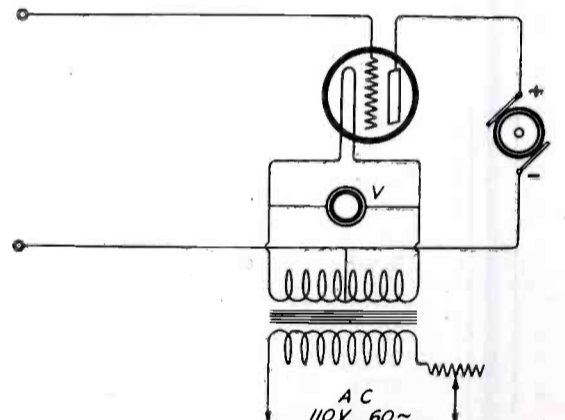

Fig 3

On Power Tubes it is Preferable to Use A.C. to Light the Filaments. This Diagram Shows How the Connection From the Plate Circuit is Made in the Center of the Transformer Winding.

In one of the simplest and most frequently used forms of capacity coupled circuit there is a precaution that should be observed.

This is illustrated in Fig. 8. It will be noted that the coupling capacity *C* has one of its terminals connected thru the grid coil to the negative terminal of the high-voltage plate source, while the other side of this capacity is connected thru the plate coil to the positive terminal of the high-voltage source. Very often this capacity *C* is a valuable air or oil dielectric condenser, and its breakdown due to high frequency high voltage will therefore short-circuit the generator on D.C. source. The resultant arcing inside the condenser may also burn the plates badly.

This possibility may be prevented by the use of a second capacity *C*<sub>1</sub>, which should be large in capacity in comparison with *C*. The condenser *C*<sub>1</sub>, if it is at least one hundred times the value of *C*, need not be a low loss condenser. It is necessary, of course, that the condenser *C*<sub>1</sub> safely stand the voltage of the D.C. source.

In a typical form of oscillating circuit,

## "Old Town Canoes"

OLD TOWN CANOE CO.

135 Fourth Street  
Old Town, Maine, U. S. A.



STEAL along in the reflections of the shore. An occasional dip of the blade keeps you moving. For an "Old Town Canoe" floats as lightly as a shadow. It responds instantly to the slightest pressure of the paddle. And built into every "Old Town" is a strength that makes it last for years. Write for catalog. 3,000 canoes in stock. \$67 up from dealer or factory.

### MONEY for You

Add to your Salary—Make extra Pin Money. Start a lucrative business of your own. Spend an hour each day taking subscriptions for the "Radio News." We'll pay you well and you'll enjoy the work. Write for full particulars. Circulation Dept., RADIO NEWS, 236A Fulton St., New York City.





Specify No. 766, Eveready Wireless Station Battery. Standardized for use in the U. S. Navy



Specify No. 763, Eveready Airplane Wireless Battery. Standardized for use in the U. S. Signal Corps Aviation Section

## Hitch your outfit to an Eveready Battery

**T**HE Eveready Vacuum Tube Plate Battery is the ideal battery for your wireless receiving set.

Standardized for U. S. Government use, Eveready inevitably possesses the very qualities you need for effective working of your own apparatus:

1. Thoroughly moisture proof.
2. Correct and sustained voltage.
3. Suspended action while not in use.
4. Light and compact.
5. Low in cost.

As regards sensitiveness, no receiving set is to be considered as merely "amateur"—it either receives or it doesn't.

The high efficiency of the Eveready Battery will increase the effectiveness of your apparatus amazingly; will stimulate your interest and enjoyment in your work; and will insure your operating a long professional standards.

Go to your dealer today for a new Eveready Vacuum Tube Plate Battery.

AMERICAN EVER READY WORKS  
of National Carbon Company, Inc.

226 Thompson Avenue, Long Island City, New York  
Chicago Atlanta San Francisco

# EVEREADY

VACUUM TUBE PLATE BATTERIES

FLASHLIGHTS AND BATTERIES

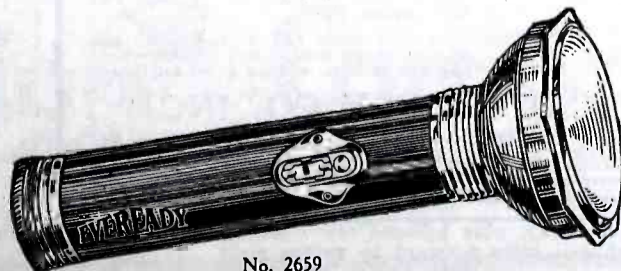

No. 2659

Eveready Flashlight  
for wireless operators

A-20-TE



# BUST THRU THE QRN WITH The Benwood "Utility" Spark Gap

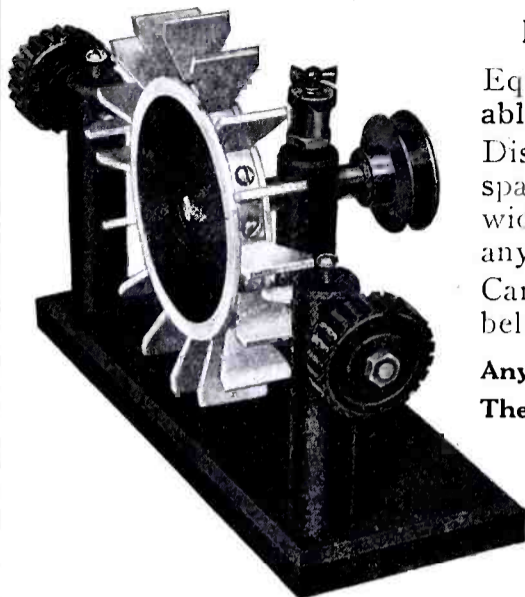

Designed for the experimenter

Equipped with the Benwood Removable Point Disc.

Disc is six inches in diameter and both sparking electrodes are One Inch in width. Is of more than ample size for any 1 KW. installation.

Can be driven by any motor either by belt or direct coupling.

**Any Speed Any Note Any Frequency**  
The best open type rotary spark gap that can be produced.

Price as shown \$19.50

## The Benwood Removable Point Disc

Sparking points are variable from 2 to 16. Teeth are Renewable as well as Removable.

Disc is Six Inches in diameter and sparking points are One Inch in width. Complete disc weighs less than half pound absolutely accurate and finely balanced.

This disc enables the operator to vary the frequency of the spark at will regardless of the speed of the motor used. It enables the operator to obtain the maximum radiation from any spark transmitter by being able to change the spark discharge frequency to conform to Any Condenser Capacity and Any Wave Length that is in use at the present time. This disc will absolutely increase the transmitting range of Any spark transmitter because it is at once applicable to any make transformer on the market regardless of the voltage. It is the ultimate in rotary disc design and fills the long felt need of every radio man.

A Clear note can now be had at all times. As soon as the sparking points of this disc become worn and uneven a complete new set can at once be put into service thus assuring the operator of maximum results at all times.

The center of the disc is Moulded Bakelite the best insulation obtainable. Disc is fitted with carefully machined brass bushing and set screw for fastening to the motor shaft. It is also furnished with shaft for use with any of the enclosed Benwood gaps that are now in use.

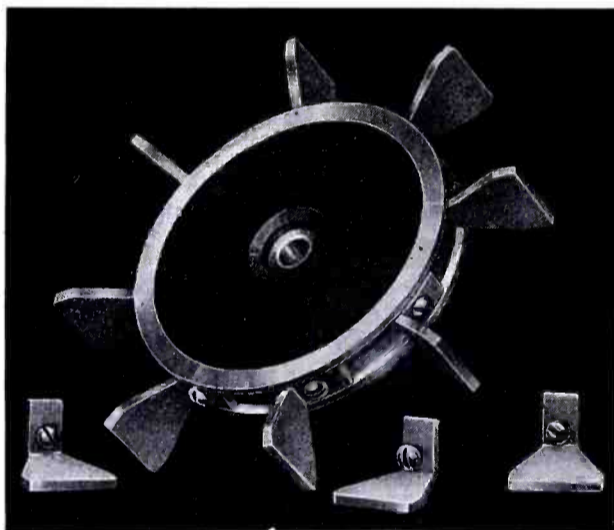

Price complete with 16 sparking points, \$10.00  
Specify size of motor shaft when ordering.  
Extra sparking points 20 cents each or \$2.50 per set of 16.

## THE BENWOOD COMPANY, Inc.

1300 OLIVE STREET,

ST. LOUIS, MO.

DEALERS:—WRITE FOR INFORMATION

## WIRELESS

You should have it even if only superficially interested. Around about you every day you read of some marvelous occurrence in which wireless played a distinguished part. It may not be entirely clear to you. The Manual will explain it. To the student of Wireless Telegraphy, the Manual contains much that is indispensable to a proper understanding of the art.

It contains 200 pages, fully illustrating and describing the many instruments used in Radio. 45 pages cover general instructions, diagrams, station calls, tables, codes and other information.

The book is printed on highly finished paper with a two-color cover and measures 9 x 5 1/2 inches.



## MANUAL M12

Containing as it does a fund of valuable information not generally contained in a catalogue, it approaches nearer a text book in the fascinating field of wireless telegraphy. No expense has been spared to make it accurate and reliable.

No Wireless Experimenter should be without the Mesco Wireless Manual. We ask 25 cents (25c) for it—give you a coupon receipt which can be applied on any future order.

Send your name and address now, and get one of the most complete, comprehensive and reliable wireless books published.

## MANHATTAN ELECTRICAL SUPPLY CO. INC.

17 Park Place  
New York

114 S. Wells St.  
Chicago

1106 Pine St.  
St. Louis

604 Mission St.  
San Francisco

A welcome addition to your library! Send \$2.00 today, plus postage for 7 lbs., and your copy of bound volume No. 1 of Radio Amateur News will come forward by return mail.  
Experimenter Publishing Company 236a Fulton Street, New York City

as shown in Fig. 9, the frequency of oscillations is principally determined by the value of the capacity  $C$  and inductance  $L$ .

As far as the natural frequency of oscillation is concerned, it will remain constant as long as the product of  $L$  and  $C$  is constant. However, it will be found that the type of circuit shown in Fig. 9 will only oscillate at a given frequency in a satisfactory manner when the capacity  $C$  is under a certain limiting value. This is explained by the fact that certain values of high-frequency voltage are necessary on the grid and plate. If the capacity  $C$  is very large the tube will not supply sufficient energy to pass enough current through  $C$  to set up across it the necessary grid and plate high-frequency voltage. The lower the value of resistance and the lower the losses in the oscillating circuit the larger the value of  $C$  that may be used and still maintain oscillations.

For the type of circuit shown in Fig. 9, the limiting value of  $C$ , for the usual types of small tubes running at reasonable values of plate voltage, is in the neighborhood of a maximum of .001 microfarad for a frequency of one million cycles (300 metre wave-length). This is necessarily a very approximate figure because of the many factors which are involved, but it at least gives the experimenter an idea of what not to use.

In the use of high-voltage direct-current generators operated singly or in series, it has been found that when they are employed for supplying energy for tube-plate circuits a considerable strain is imposed on the insulation of the armatures. This is

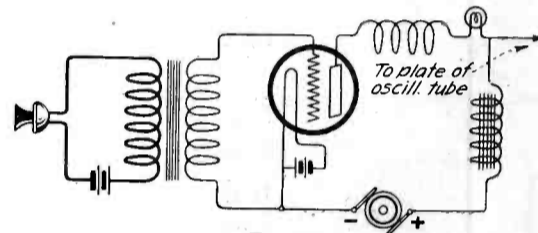

Fig. 16

A Simple Device to Control the Modulation in a Radio; A Small Lamp is Connected in the Plate Circuit of the Modulator Tube. It Flashes When the Microphone is Spoken Into if the Circuit is Properly Adjusted.

particularly accentuated when the tubes are used for radio telegraphy and telephony where the load fluctuates rapidly, or is switched off and on suddenly. For the used for radio telegraphy and telephony where the load fluctuates rapidly, or is generator is practically at ground potential.

This strain which is imposed on the machine is in the form of a voltage surge which momentarily raises the generator voltage several fold. One terminal being grounded, the strain occurs on the insulation between the frame or armature core and an armature conductor which at the instant is near the positive terminal or brush.

A condenser shunted across the generator terminals, described in a previous paragraph, also acts as a sufficient protection against these voltage strains in the case of very small machines. In the case of generators, singly or in series, for voltages above 500 and power outputs above 50 watts, some sort of protective device to safely limit and discharge this voltage should be used. For this service aluminum cell lightning arresters are very suitable. They should be connected across the generator terminals. In Fig. 10 one protective cell is shown in circuit.

These cells consist of a pair of oxidized aluminum plates immersed in an electrolyte. Many different electrolytes are used to meet special requirements, but for experimental purposes covering a short period of time a saturated solution of borax is satisfactory. These cells are connected in series, and when the oxide film is properly formed one cell should be used for each 300



# RADIOTRON TRANSMISSION

## Two high-power transmitter tubes

The era of C.W. transmission is here. Colleges, Laboratories, relay stations and experimenters can use these new tubes to help establish long distance records.

Radiotron U. V. 203 is rated at 50 watts. Its filament requires 10 volts at 6.5 amperes while the normal plate voltage is 1000, at .15 ampere. The tube is 2" by 7½" and is fitted with a special 4-prong porcelain base.

Radiotron U. V. 204 is a 250 watt tube of exceptionally long life. Filament requires 12 volts at 15 amperes and 2000 volts on its plate at .25 ampere. Overall dimensions 5" by 14½". Tube is supported by special end mountings. Especially recommended for laboratory and other experimental work.



Special Socket for this Tube \$4.25 Each

Radiotron U. V. 203 50 Watts

Price \$30.00

The Radio Corporation's tubes are covered by patents dated November 7th, 1905, January 15th, 1907, and February 18th, 1908, as well as by other patents issued and pending. Tubes licensed for amateur and experimental use only. Any other use will constitute an infringement.



Radiotron U. V. 204 250 Watts

Price \$110.00

End Mountings for this Tube \$2.00 Per Pair

For detailed data see your nearest dealer or write direct to SALES DIVISION, COMMERCIAL DEPARTMENT, Suite 1802

# Radio Corporation of America



233 BROADWAY ~ NEW YORK CITY



# Didn't you know?

WE supposed everybody knew that any apparatus ordered from Corwin Mail Order Service is *guaranteed*—to be shipped at once,—to arrive in perfect condition,—and to give *complete satisfaction*. If you didn't know that, now go ahead and order from Corwin with perfect confidence.

## Universal-Coil Mounting Plugs

Anyone can easily make smooth-running mountings with these plugs. No bending, no filing,—they are made to fit exactly in the first place. Suitable for Radisco and all hand-wound coils. A few minutes' work with these plugs will save you dollars that can be put into better apparatus.

Price, 80 cents, postpaid

## New Radisco Vario-Coupler

Described on the center page spread of last month's issue, now in stock. It's an extremely efficient instrument, accurate to the .002 part of an inch! Materials are special moulded composition, Formica and Brass thruout.

Price, \$7.50 postpaid

### VARIABLE CONDENSERS

A. R. Co., .001.....	\$6.25
A. R. Co., .0005.....	5.00
With No. 67 Dial add \$1.00.	
Murdock 366 .....	4.75
Murdock 367 .....	4.75
Murdock 368 .....	3.75
Clapp-Eastham 800 .....	7.50
Clapp-Eastham 800A .....	9.50
Clapp-Eastham 800B .....	11.50
Complete with dial.	
Shipping weight One Pound	

### GRID CONDENSERS

Radisco, Postage 3 cents.....	.35
-------------------------------	-----

### ANTENNA SWITCHES

Murdock, 3 lbs.....	4.50
Clapp-Eastham, 10 lbs.....	12.50

### OSCILLATION TRANSFORMERS

Murdock No. 424, 5 lbs.....	5.00
-----------------------------	------

### RADIO CRAFT PRODUCTS

Detector .....	15.00
Two Step Amplifier .....	50.00
Detector and 1 step.....	45.00
Detector and 2 step.....	70.00
Postage paid.	

### "B" BATTERIES

Radisco No. 1, 2 lbs.....	1.50
Radisco No. 5, 5 lbs.....	2.65
Eveready Storage battery prices on application.	

### TUSKA C. W. APPARATUS

181 Coil, 2 lbs. ....	7.50
182 Coil, 2 lbs. ....	10.00
183 Coil, 3 lbs. ....	12.50
170 Filt., 8 lbs. ....	16.00

### VACUUM TUBES

Electron Relay .....	6.00
VT Amplifier, 1 lb.....	7.00
VT Extra Hard .....	7.50

### AMPLIFYING TRANSFORMERS

A. R. Co., 1 lb. ....	5.00
Federal, 1 lb. ....	7.50

### JACKS AND PLUGS

Federal Closed Circuit .....	.85
Federal Open Circuit.....	.70
Federal Double Circuit.....	1.00
Federal Plug .....	2.00
Postpaid.	

### ALL RADISCO COILS

### ROTARY SWITCHES

Clapp-Eastham, No. 19.....	1.00
Clapp-Eastham, No. 19A.....	.85
Our Own, No. 1 .....	.40
Our Own, No. 2 .....	.55
Postage .....	
.05	

### CORWIN DIALS

No. 66, 3" .....	.75
No. 67, 3" with knob.....	1.30
No. 68, 3 3/8" .....	1.00
No. 69, 3 3/8" with knob.....	1.70
Postpaid.	

### RECEIVERS

Murdock No. 55, 2000 ohm.....	4.50
Murdock, No. 55, 3000 ohm.....	5.50
Brandes Superior .....	7.00
Baldwin C.....	16.50
Baldwin E, improved.....	20.00
Brownlie, New .....	12.50
Shipping weight 2 Pounds	

### CONTACT POINTS

CP-No. 1 Brass, dozen .....	.25
CP-4 Brass, dozen .....	.35
CP-5, Nickel Plated, dozen.....	.45
Postpaid.	

All orders for apparatus not listed as postpaid must be accompanied by postage charges. Send 10c for new catalogue, just off the press.

# A. H. CORWIN & COMPANY

Dept. B2                      4 West Park Street,                      Newark, N. J.

volts of rated generator voltage. These cells involve the same general principles as the familiar type of electrolytic rectifier.

These cells, owing to the thin oxide film acting as a dielectric, have considerable electrostatic capacity between electrodes, which is an added advantage in their use as protective devices on generators supplying oscillating vacuum tubes.

In certain experiments it is often desired to keep the frequency variation of a tube acting as a high-frequency oscillator as small as possible. This is particularly desirable in the calibration of wave-meters and in measurement work. The variation of frequency due to voltage variations of the power sources can be greatly minimized by using a very high value of grid leak resistance *R*, as shown in Fig. 12. This applies to practically all types of oscillating circuits.

It is often desired to obtain high-voltage high-frequency energy to test dielectrics and measure dielectric losses. Fig. 13 shows a type of circuit very suitable for using an oscillating tube for this purpose. The frequency of oscillation is largely determined by the period of the simple series circuit comprising *L*<sub>1</sub>, *L*<sub>2</sub>, *L*<sub>3</sub>, *L*<sub>4</sub>, and *C*. The condenser *C*<sub>1</sub> is merely for safety, as explained in a previous paragraph, and is large in comparison with *C*. Maximum output is obtained by variation of *L*<sub>1</sub> and *L*<sub>2</sub>. The voltage obtained may be computed by measuring the frequency with a wave-meter and reading the current at *A*, passing through the condenser *C* of known capacity value. A spark gap across *C* may also be used to check the value of voltage obtained.

For high voltages the capacity *C* should be small and the inductance in circuit large. It is also important to have the losses low in the inductances and capacity.

In most power tubes the higher the plate voltage that can be used the greater the output. Tubes may fail to stand up under an increased voltage for many reasons, but there is one factor in connection with this limitation that is usually overlooked. This factor is electrolysis of the glass. In most of the types of small-power tubes all the lead-in wires are usually carried through a common stem and seal. When this is the case the plate voltage that may be used is limited by electrolytic action in the glass of this seal between the plate and grid leads. Hot glass is an electrolytic conductor; that is, the metallic elements in the glass appear at the negative pole. This electrolysis in the course of time, if continued, will ruin the seal, making it leak air, and sometimes even cracking it. An early indication of this electrolysis which appears long before leakage occurs is a blackening of the grid leads in the glass of the seal near the vacuum end. This action takes place at the grid lead, because this is usually the most negative one when the tube is oscillating.

Therefore, if tubes of this type are operated considerably above their rated plate voltage the life is liable to be terminated by leakage of air into the bulb through the seal rather than filament burnout.

In the various circuits described, the source of *D.C.* potential for the plate has been shown in series with the plate inductance. The shunt feed method of connection is just as satisfactory, but is sometimes not quite so convenient for the experimenter with limited apparatus.

Also the various circuit diagrams in this paper have for the most part shown, for the sake of simplicity, a battery as a filament source and a *D.C.* generator as a plate source. The filament battery may, of course, be replaced by a generator or transformer and the plate generator by a battery or a rectifier system for producing *D.C.* from *A.C.* at commercial frequencies.

There are a few points of interest that arise when a tube is used as an amplifier

# BURGESS "B" BATTERIES

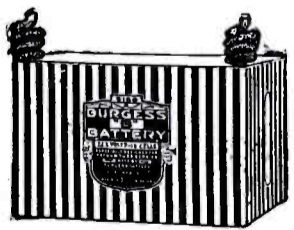

ARE THE NOISELESS KIND—  
made with and without taps

Send for catalogue giving sizes and prices

## BURGESS BATTERY COMPANY

Harris Trust Building

CHICAGO

READ the CLASSIFIED ADVERTISEMENTS on PAGES 844-847. YOU'LL FIND MANY GOOD THINGS THERE.



# THE "ILLINOIS" VARIABLE CONDENSER

*The Condenser With "Star Spring" Tension*

**Made Right - Stays Right**

*Hard Rolled Aluminum Plates*

These condensers are made by a watch mechanic schooled in accurate workmanship and who can't get over the habit of critical inspection.

Three styles: No. 1, panel; No. 2, open type as shown; No. 3, fully incased. Anti-Profiteer. Less than pre-war prices. Fully assembled and tested.

Style	No. 1	No. 2	No. 3
67 Plates.....	\$7.00	\$8.00	\$8.50
43 Plates.....	3.50	4.50	4.75
23 Plates.....	2.75	3.75	4.00
13 Plates.....	2.25	3.25	3.50

*Money back if not satisfied. Just return condenser within 10 days by insured P. P.*

With Style No. 1 we will, if desired, furnish 3 inch metal dial with large knob instead of scale and pointer.

Extra price, 75 cents: Or we will, if desired, supply the Condenser with smooth 3/16" center staff, without Scale, Knob and Pointer, at 15 cents off the list, to those who prefer to supply their own dial.

NOTE: We do not fit dial to our regular, threaded center staff.

Vernier with single movable plate applied to 13-23 or 43 plate condenser, \$3.00 extra.

**Sent Prepaid on Receipt of Price**

*Except: Pacific States, Alaska Hawaii, Philippines and Canal Zone, add 10c. Canada add 25c. Foreign orders other than Canada not solicited.*



STYLE No. 1.

STYLE No. 2.

VERNIER.

The "ILLINOIS" Variable Condenser during the time it has been before the wireless public, has achieved a remarkable success. It has had a wide distribution in the United States and Canada, and has made friends wherever it has been placed.

Every instrument sent to a new locality has brought numerous orders from its vicinity, demonstrating the fact that a good thing will advertise itself.

We attribute this success to two things: First, good design, and secondly, conscientious work in construction and adjustment.

We call attention to some features of our construction. First, we use hard rolled, springy aluminum plates, and take no chances of making them soft and depriving them of their resilient quality by subjecting them to any "casting" process. Second, we use large separating washers in the "stator," thus giving stability. Third, the plates are properly centered and spaced by construction, so that there is no subsequent necessity for adjustment, either for "end-shake" or "side-shake." Once right, always right. Fourth, we use for plates, metal that we think is of ideal thickness. If we thought any other thickness better, we should certainly use it. Thicker plates, we think, would not be an advantage, but otherwise. It is a recognized fact, among watch makers and mechanics, that a thin spring will suffer greater deflection, without permanent "set" than a thicker one. In a condenser a thick plate is as likely to get bent accidentally as a thin one, and once bent is more difficult to "true." Fifth, and not least by any means, we mention our Patented Star Spring feature, which accomplishes the dual function of keeping the end-shake always right, and

maintaining a friction sufficient to hold the condenser in any position on the panel to which it may be set, without the use of a "counter-balance" which would increase the minimum capacity.

NOTE—A cardboard "Template" which we send with each Condenser, will be found convenient for locating holes in panel.

Our plan of business is "direct dealing" with the consumer and no discounts except 5% on orders of six or more, cash with order. In this way we can make prices that would be impossible if our product was handled on commission.

Answering the question, often asked as to the capacity of our regular units, we will say that the minimum and maximum capacities are as follows:

13 plate, Min. 21, Max. 291; 23 plate, Min. 30, Max. 528; 43 plate, Min. 39, Max. 999. All in MMFds.

These units were calibrated by the Bureau of Standards.

Our 67 plate unit has never been tested, but computed proportionally by the lesser units, or by formula, the maximum capacity is doubtless a little in excess of 1500 MMFds.

The following 20 point test, also by the Bureau of Standards, may be found useful. On a scale of 180 degrees, the maximum capacities of our 43 plate unit are as follows:

0. 39.—5 deg. 45. 10. 64.—20. 118.—30. 174.—40. 230.—50. 286.—60. 341.—70. 396.—80. 451.—90. 506.—100. 562.—110. 617.—120. 672.—130.— 727.—140. 782.—150. 839.—160. 894.—170. 948.—175. 976.—180. 999. MMFds.

**G. F. JOHNSON, 625 Black Avenue, SPRINGFIELD, ILLINOIS**



# WHY?

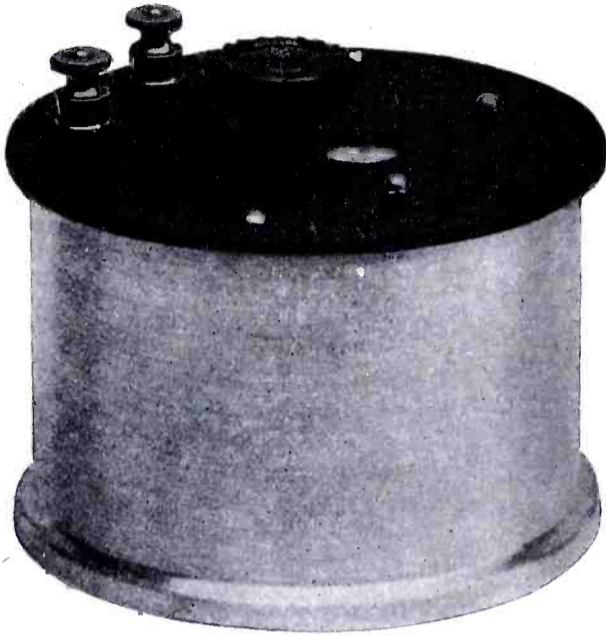
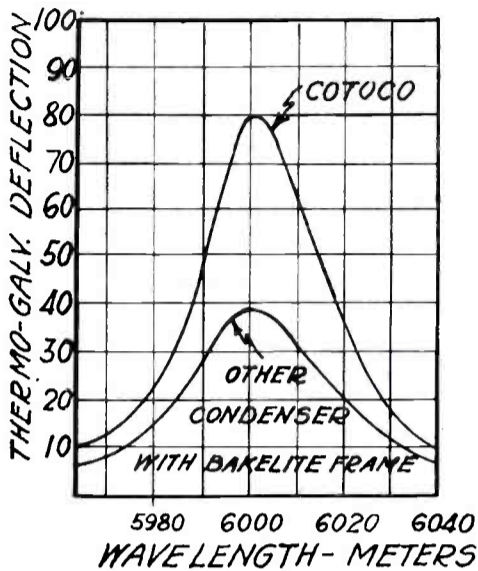

**WHY** did we start building condensers?  
 should you investigate Cotoco condensers?  
 should you use a Cotoco condenser?

The curves above were made to compare the sharpness of resonance of our condenser with the usual type assembled between bakelite heads. It gives the essential reason **WHY** this condenser will produce results you want. If this is not sufficient reason, let us send you our descriptive bulletin, which will give you all the details.

Made in three sizes .0005 M.F., .0007 M.F. and 001 M.F. in case as shown, or unmounted.

Get on our mailing list **NOW**

**COTO-COIL CO.** 87 Willard Avenue  
 PROVIDENCE, R. I.

## New "MIRACO" Vacuum Tube Detector

COMPLETE, READY TO USE, (Postpaid) *only*



The new "MIRACO" Detector contains features not found in others at double the price. There is ample space in the hinged covered cabinet for "B" batteries and additional binding posts on the back of panel enable the operator to connect them inside.

**\$7.85**

CATALOG FREE WRITE TODAY

**MIDWEST RADIO COMPANY**

3422 DURY AVENUE, Dept. A. CINCINNATI, OHIO

for alternating currents of appreciable energy (several watts at least), and when it is used as a voice current amplifier and modulator in radio-telephony.

A very common form of graphical plot employed to show one of the electrical characteristics of a three-element tube is given in Fig. 14b. The curve *A-B* illustrates the well-known relation between grid voltage and plate current. This curve assumes a constant plate voltage. However, in many amplifying circuits a resistance, as in Fig. 14a, is included in the plate circuit.

When an alternating E.M.F. is connected between filament and grid a corresponding variation in plate current occurs. Therefore an alternating voltage is set up across the resistance in the plate circuit and the voltage of the plate is no longer constant, being higher than normal voltage while the resistance is discharging and lower when it is charging. For this reason the grid voltage and plate current will not follow the curve *A-B*. They will, however, follow a curve of the type *C-D*, because at the low-plate current the plate voltage is higher than normal and therefore a higher negative voltage is required to bring the plate current to zero, while at the higher plate-current end the actual plate voltage is lower and so the plate current is lower.

In most amplifying circuits it is usually desired to keep the grid negative during practically the entire cycle of operation, and therefore the grid is made normally negative by a so-called biasing potential. It is also usually desirable to make this normal negative potential of a value equal to half the grid voltage required to bring the plate current to zero. This value of normal negative grid voltage should be computed from the curve *C-D* rather than the static curve *A-B*. In other words, the best value of negative biasing grid voltage should reduce the plate current to much less than half the value obtained at zero volts on the grid. A negative voltage that reduces it to about one-quarter value is approximately the best.

The foregoing, of course, does not apply to receiving amplifiers or cases where the amount of plate-current fluctuation is small.

The most usual method of modulation employed for vacuum-tube radio-telephone transmitters is shown in Fig. 15. In this arrangement the output of the oscillator tube is varied above and below its normal amount by variations in plate voltage set up by the amplified microphone voltages. Therefore the peak of plate current in the modulated oscillator tube is considerably higher than in a straight oscillator circuit. More electron emission is therefore required for the modulated tube than for a simple oscillator tube. Very often poor articulation in a radio-telephone transmitter is due to insufficient electron emission in the oscillator tube.

In a radio-telephone transmitter correct wave-length and normal antenna current are not, as in telegraphy, indications that the set is functioning properly. Neither of these factors give any information as to the degree of modulation. The amount of modulation is most satisfactorily obtained by means of an oscillograph, but this is seldom available for use when desired.

A simple device to indicate modulation is a miniature tungsten filament lamp in the plate circuit of the modulator tube. This should be chosen of such a rating or so shunted that normally it burns at a dull red. When the microphone is spoken into, it should flash up and the degree of this brightening soon becomes a very good indication to the operator as to whether the modulation is normal or not. This arrangement is shown in Fig. 16.

There are so many things that may prevent a radio-telephone transmitter from properly functioning while showing full radiation current, that an indicator, as described above, is very useful.

Insure your copy reaching you each month. Subscribe to Radio News—\$2.00 a year. Experimenter Pub. Co., 236-A Fulton St., N. Y. C.





*The Recognized Symbol of Superior Performance*

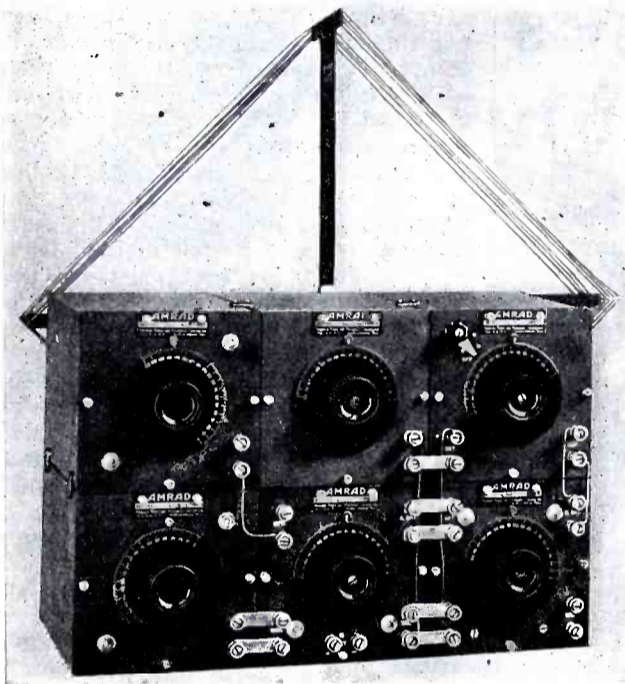

**Amrad SELECTOR Set  
Consists of:**

Amrad Grid Variometer .....	\$14.50
Amrad Plate Variometer.....	14.50
Amrad Variable Condenser....	9.85
Amrad VT Detector .....	15.00
Amrad 1 Stage Amplifier.....	21.00
Amrad B Battery Box.....	9.85

**USE a LOOP for RECEIVING—**  
 All Local Spark Stations  
 Local Radio Telephone  
 Medium Distance C. W.  
 Local Press Reports  
 Ship-Shore Traffic

## Loop Reception Here!

**L** OOP RECEPTION has been reduced to a certainty. The Amrad SELECTOR Set is the first standardized and perfected short-wave Loop Receiver which combines the four essentials—Sensitiveness, Dependability, Simplicity and Portability.

Used with a seven-turn loop wound on a four foot diameter the Amrad SELECTOR Set responds to wave-lengths from 175 to 350 meters with unparalleled efficiency. Higher wave-lengths up to 1500 meters may be tuned in by connecting a small fixed condenser across the Detector Unit binding posts.

The selectivity of the Amrad SELECTOR Set is surprising especially as tuning is accomplished by varying only two adjustments—Grid Variometer and shunt Variable Condenser. The unusual selectivity of the set itself is still further increased by rotating the loop. Many unwanted signals are completely eliminated in this manner.

The most amazing feature in operating the Amrad SELECTOR Set is the absence of Static, even when this disturbance is of considerable intensity. On numerous occasions when static has prevented the reception of radio telephone signals with the usual receiver connected to an antenna, the Amrad SELECTOR Set used with a Loop has brought in music and speech with great distinctness and *no* interference from static.

Amrad Cabinet connectors link together the six units composing the Amrad SELECTOR Set into one rigid composite 15 inches wide, 10 inches high and 7½ inches deep overall. Weight, complete with two B batteries, is only 13 pounds. The Set may be used with an antenna if desired. Any standard vacuum tubes and B batteries may be fitted.

The actual set illustrated used with the loop described has received radio telephone speech and music from numerous stations within a radius of over 40 miles and has received signals from amateur spark stations 100, 300 and 400 miles on several occasions. Ask your dealer to show you the Amrad SELECTOR Set or send for free Bulletin V describing all the Units comprising it. Complete Amrad catalog, 10c stamps.

# AMERICAN RADIO AND RESEARCH CORPORATION

203 College Avenue

Medford Hillside, Massachusetts



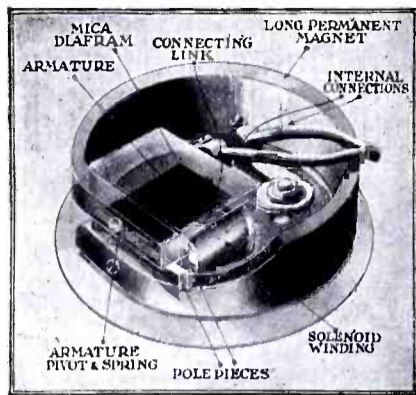

This illustration shows the amplifying mechanism in a Baldwin unit. Note that four pole pieces of single solenoid act on the armature, which in turn connects with the super-sensitive mica diaphragm.

Type "C" Navy standard . . . \$16.50  
 Type "E" Super-sensitive . . . 20.00  
 Type "F" light weight . . . . . 21.00  
 Units for loud speakers.  
 Type "C" . . . . . \$8.50  
 Type "E" . . . . . 10.00

# Equal to two stages of radio amplification

THE experience of leading radio operators,—who have found Baldy Phones "equal to two stages of radio amplification"—clearly indicates the outstanding advantages of using good phones. From a standpoint of radio efficiency, you will get "more value per dollar" from your investment in Baldwin Amplifying Phones than from any other item of your equipment.

Here are the actual (un-asked-for) letters from experienced radio men, telling of their results with Baldys. They're worth careful reading!

"Have used a pair of Type 'C' Baldys for some time, in naval communication and commercial service. Consider them the most sensitive telephone on the market." (Name on request.)

"I faithfully believe the use of Baldwin Phones will improve any receiving set at least 50%." (Name on request.)

"Have found your Baldwin Telephones equal to one and two stages of radio amplification." (Name on request.)

"In our station it is a common occurrence to place the receivers (Baldys) on the table and copy in daylight the long undamp't wave stations with but one V.T." (Name on request.)

"Equal to one and two stages of radio amplification": Of course Baldys cost more,—but where can you get better value? Where else can you buy amplification equal to the super-sensitive Baldwin mechanism, for so little?

And, the more limited your investment in radio must be, that much more important becomes the use of a super-sensitive and selective Baldwin head set!

The best radio dealer in your town, undoubtedly has a supply of booklets explaining the superior construction of Baldwin Phones, Eldredge Meters, and other Firth Specialties. If he does lack a supply, write, mentioning his name and address, direct to

**John Firth & Co. Inc., 18 Broadway, New York**

Distributors for

Baldwin Phones U. S. Bureau of Standards  
 Eldredge Meters Wavemeter  
 Kolster Decremeter Brownlie Adjustable Phones.

Dealers: Write for advance information on new popular-priced loud speaker.

# BALDY FOR LAND SEA AND IN THE AIR PHONES

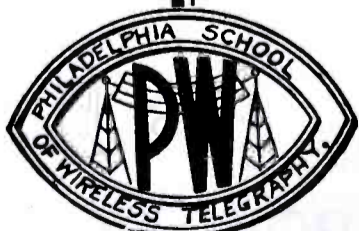

Reg. U. S.

Trademark

## OUR MAIL ORDER SERVICE IS RIGHT

We ship same day order is received from our large stock of reliable manufacturers products.

Get your name on our mailing list.

**PHILADELPHIA SCHOOL OF WIRELESS TELEGRAPHY**

1002 Parkway Building, Broad and Cherry Sts., Philadelphia, Pa.

## Simple Measurements and Calculations for the Amateur Station Owner

(Continued from page 778)

Law  $R = \frac{E}{C}$ , or the resistance is equal to

the voltage divided by the current flowing. If the resistance value to be measured be such that it will allow a very large or a very small current to flow we must use another method; a moment's thought however will enable one to decide whether or not this method is applicable. If, for instance, we wish to ascertain the resistance of a motor starting rheostat, we connect it in series with the ammeter across the power line, and connect the voltmeter across the line as in Fig. 3. If then the ammeter reads twenty amperes, and the voltmeter one hundred volts the resistance is equal to one hundred divided by twenty or five ohms. If the resistance be quite low or quite high it may be measured by the voltmeter alone as follows: A known resistance must be at hand and it should be of approximately the same resistance as that to be measured, that is if the resistance to be measured is in the vicinity of ten thousand ohms, then a known resistance of six, eight, ten, or twelve thousand ohms would be suitable, and if it were in the vicinity of one ohm, a known resistance of one to ten ohms would suffice. Connect the known resistance and the resistance to be measured in series and across a source of supply, with the voltmeter connected thru a switch so that it may be thrown across either of the resistances as in Fig. 4.

If the resistances be of low value a few dry cells connected in series will be sufficient, if very high, the power line may be used as a source of supply if the voltage is steady. Throw the switch so as to read the voltage first across and then across the other resistance, then if we denote the known resistance by R and the unknown or the one being measured by X, we have only to perform a simple proportion, since the drop is proportional to the resistance, the drop across one must be in proportion to the drop across the other as the resistances are in proportion to each other, or  $X : R :: \text{drop } X : \text{drop } R$ . For example, we wish to measure the resistance of an ammeter shunt. We connect as in Fig. 4 with a resistance having a known value of four ohms, and use three dry cells or six volts as a source of supply, then read across X two volts and across R four volts. Then  $X : 4 :: 2 : 4$  or  $X = 2$  ohms. Again, we wish to know the resistance of a pair of telephones. Connect with a known resistance of, let us say, ten thousand ohms, to a source of supply of one hundred volts. If then we read across X forty-five volts, and across R fifty-five volts,  $X : 10000 :: 45 : 55$  or 8181 ohms. In using the power or lighting circuit care must be taken that the voltage is not fluctuating as this will cause error. Again, if we wish to build a resistance for use in charging a storage battery of forty volts from a one hundred volt line at a rate of ten amperes. we must first find the size of wire that will carry ten amperes continuously without undue heating. Having obtained this we can find the resistance per foot if it is not already known as described above. It is now required to know the number of feet of wire necessary.

The loss in watts in any direct current circuit is equal to the current squared times the resistance or  $C^2R$ . Since the voltage of our battery to be charged is





(Illustration exact full size)

Z. R. S. Miniature knife switch is supplied unmounted only, for panel mounting and will harmonize with other fine products of the instrument maker. There is nothing else like it on the market.

- Double pole, single throw - - - - 80c
- Double pole, double throw - - - - 90c

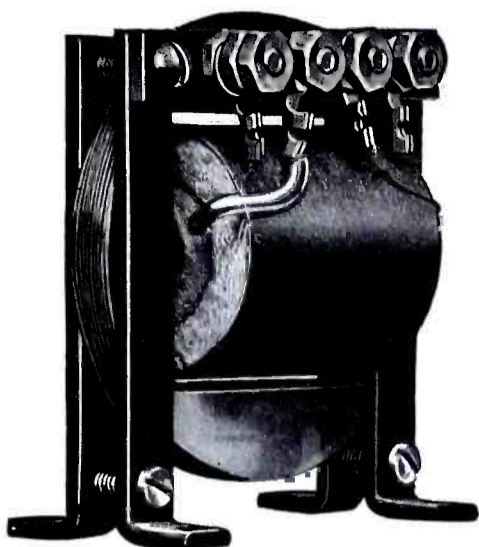

- Modulation transformer - - - - \$4.50
- Choke coil .8 Henry - - - - \$3.75
- Amplifying transformer - - - - \$4.00

All these are mounted as shown in the illustration and will give you results second to none.

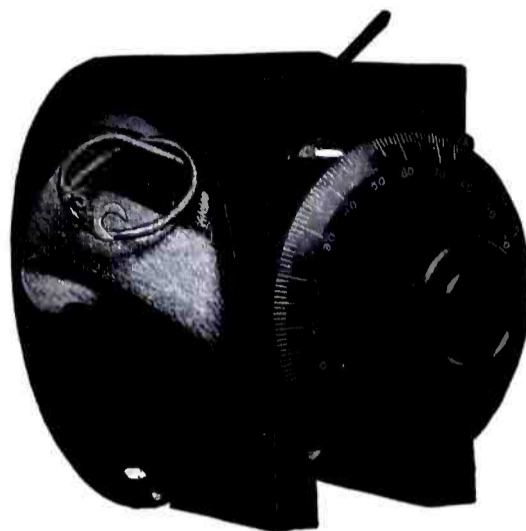

Type Z.R.V. Variometer has unit construction with bakelite shell and hard wood ball. Has low dielectric losses and a range of inductance of 1.25 mil henry maximum to .1 mil henry minimum. Is readily used on table or mounted on panels.

- Complete with 3" dial and knob - \$6.50
- Without dial or knob - - - - \$5.75
- Variocoupler of same construction - \$7.50
- Complete Regenerative set - - - \$38.00
- Regenerative panel set with detector - \$85.00
- Regenerative set detector and 2 stage amplifier, combined panel - \$140.00

**Complete Catalogs  
6c Stamps**

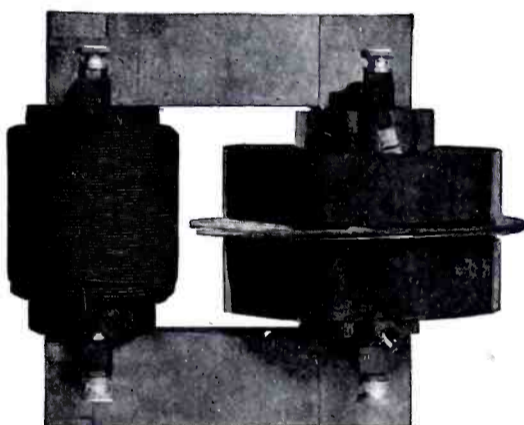

**Type ZRL Transformer**  
For use with Rotary Spark Gaps  
400 Watts. 110 Volts-60 Cycles

- Unmounted Price - - - - - \$14.00
- Mounted on Iron Frame - - - - - \$15.00
- The "Cambridge" Rotary Spark Gap Complete with Variable Speed Motor - - - - - \$50.00
- The "Boston" Key - - - - - \$7.50



A combination of beauty and convenience. One stage amplifier has binding posts for connecting two as a two stage amplifier. All binding posts on detector, amplifier and Regenerative set correspond for jumper connection.

- Tube Control Detector Panel, Z. R. D. - - - \$12.00
- One Stage Amplifier Panel, Z. R. A. - - - \$18.00
- Rheostat only - - - - - \$1.20



Z.R.F. Regenerative Receiver consists of two Z.R.V. Variometers and a Coupler of similar construction, together with Grid Condenser and Grid Leak with Bakelite Panel machine engraved. Licensed under Armstrong U. S. Patent No. 1,113,149. This exactly matches our Tube Control and Amplifier panels with which it may be harmoniously used. Its range of wave length is 175 to 600 meters.

Price - - - \$38.00

**CLAPP EASTHAM COMPANY**

120 Main Street

Cambridge, Mass.

ALL GOOD DEALERS CARRY OUR PRODUCTS IN STOCK



# WORK THRU SUMMER STATIC! WITH SOMERVILLE RADIO EQUIPMENT!

HAVE YOU NOTICED OUR PHENOMINAL GROWTH? THERE'S A REASON! 90% OF OUR SHIPMENTS ARE MADE WITHIN 48 HOURS AND POSTPAID!

"GREATER BOSTON AMATEURS"! OUR LOCATION MEANS LOW OVERHEAD AND OUR SHOP AT YOUR DISPOSAL MEANS BETTER SERVICE. OPEN FRIDAY NIGHTS 8 TO 11 P. M.



### Chelsea Variable Condensers

No. 3 BD \$4.75  
.0011 MFD. With Dial  
No. 4 BD \$4.25  
.0006 MFD. With Dial.  
Dial Only.  
70c  
Made of real bakelite. 3 1/2" Dia. Accurately Moulded - won't warp.

**NEW! CHELSEA DIAL INDICATOR, \$1.00**  
Consists of knob and dial moulded in one piece, with 1/2" or 3/16" bushing and set screw.

### SOMERVILLE DIAL INDICATOR, \$2.00

Dia. 4", 16 gauge brass, silverplated, grained and lacquered. 180° scale on upper half, clockwise rotation increases reading. Lower half divided in three sectors for calibration. Substantial 2" Navy knob. The FINEST dial on the market.

RADIOTRON UV 200, \$5.00 POSTPAID  
RADIOTRON UV 201, \$6.50 POSTPAID  
"Four-page booklet given with each VT."  
GRID CONDENSERS, .0005 and .0025, 25c.

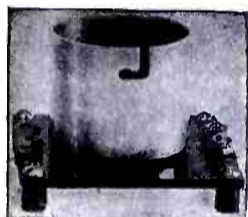

### SORALA S10 VT SOCKET \$1.10

Spun aluminum shell, 2 1/4" x 2 1/4" bakelite base, engraved in white, to designate connections. Contacts of nicked bronze for panel mounting. Won't warp or melt.

**RADIO SERVICE SOCKETS**  
Double \$2.50 Triple \$3.50  
6-step Grid Leak \$0.75  
(1/2-3 meg., Bakelite mtng.)

**GENERAL RADIO, RADIOTRON TYPE FULLY MOUNTED AMPLIFYING TRANSFORMER-231A \$5 POSTPAID**  
(Bulletin on request.)

**WESTERN ELECTRIC NAVY 2200 ohm FONES \$12.75**

22 volt EVEREADY adjustable B Battery \$2.00  
44 volt EVEREADY adjustable B Battery \$3.75  
(The most satisfactory battery on the market!)

DOZEN 12c INSULATED BINDING POSTS \$1.25  
Black or Yellow Empire Cloth tubing, per in. \$0.01

**TRANSMITTING MICA GRID CONDENSER.. 1.00**  
(.0005 mfd. 1800 volts mounted in Bakelite.)  
Above grid condenser, UNMOUNTED... .50  
UV202 RADIOTRON POWER TUBE 5 watt, 350 v., 45 M. A. 8.00  
UV203 RADIOTRON POWER TUBE 80 watt, 1000 v., 150 M. A. 30.00  
UV204 RADIOTRON POWER TUBE 250 watt, 2000 v., 250 M. A. 110.00  
(Operating data given with each tube.)

Watch for our new COMPLETE FONE TRANSMITTER.

### "NUCLEUS PLUS"

Uses two UV 202's 50-100 mile range possible.

**SOMERVILLE RADIO LAB.**

**102 HEATH STREET WINTERHILL, 45, MASS.**



Type J Milli-ammeters, \$6.00

0-50; 0-100;  
0-300; 0-500 m. a. ranges.

Also 0-3 amp. for filament economy and efficiency.

Type J 0-100 Voltmeters \$8.00  
Type J 0-500 Voltmeters 16.00  
Type J 0-1000 Voltmeters 24.00  
These include external resistances and are of the D'Arsonval type.

**GENERAL RADIO FLUSH TYPE A.C. HOT WIRE AMMETERS \$7.75**  
Ranges, 0-1/4, 0-1/2, 0-1, 0-2 1/2, 0-5 and 0-10 amperes.

### TYPE JX A.C. 0-15 VOLTMETER \$8.00

(For power tube filament regulation.)  
Dia. 3 1/2" flush-similar to Type J—magnetic vane movement—level bearings. For expensive power tube will last twice as long with A.C. on filaments and using PROPER VOLTAGE.

GENERAL RADIO 2 1/2 amp. panel rheo. \$2.50  
(For UV 202 RADIOTRON, 10-12 V. source.)

**NEW MODULATION TRANSFORMER, mounted \$5.00**  
(Same type as 231A GENERAL RADIO amp. trans.)



**ACME FILAMENT HEATING TRANSFORMERS INDISPENSIBLE FOR LARGE POWER TUBES**  
75 watt, fully mounted, \$12; Unmounted \$9.00  
150 watt, fully mounted, \$16; Unmounted \$13.00  
Bulletin on request.

**ACME 200 WATT CW TRANSFORMER**  
Unmounted, \$16.00—Mounted, \$20.00  
Has 350 V. and 500 V. windings and 2 1/2 V. Fil. heating windings.

Blue print and directions given with each one on how to pass 200 M. A. of plate current, with a chemical rectifier. "Simplest thing in the world, and very inexpensive." Shipping weight, 20 lbs.  
BULLETIN ON REQUEST.

RADIO SERVICE "CW" INDUCTANCE \$8.50  
SORALA CW INDUCTANCE FORM \$3.00  
(Threaded BAKELITE tube, 6" x 3 1/2")  
W. E. 21AA 1,000 V. Condenser, 1 mfd. 2.50  
323W WEST ELEC. MICROPHONE 4.00  
(With mounting bracket, 50c extra.)

forty volts we will require about fifty volts to maintain the rate and charge fully, thus fifty volts subtracted from the line voltage of one hundred leaves fifty volts which must be the drop across the resistance. This fifty volts multiplied by the current rate of flow, ten amperes, gives us five hundred watts which is equal to C<sup>2</sup>R. The current squared or one hundred divided

$$\frac{500}{100} = 5. \text{ Therefore}$$

our resistance must have five ohms value, and if the wire selected runs .2 ohms to the foot we will require twenty-five feet.

The watts or power in any circuit of direct current is equal to the volts multiplied by the amperes, but in alternating currents we must take into consideration the power factor, that is to say the angle of lag, as the power in the circuit at any time is equal to the instantaneous values of volts and amperes, and there is always a difference in phase between the voltage curve and the current curve. Alternating current meters read the root-mean-square values of both current and voltage, and to obtain the true power therefore we must multiply the apparent watts, or the product of volts and amperes as read on the meters by the power factor or the cosine of the angle of lag. In alternating current wattmeters the current coil torque and the voltage coil torque act on the moving part simultaneously and so we read the product of their instantaneous values directly on the scale. The wattmeter is an expensive instrument and beyond the reach of most experimenters. There are several ways, more or less roundabout, however, in which the true watts, power factor, and angle of lag may be obtained without a wattmeter. If we are equipt to determine the voltage, the amperes, and the resistance of the circuit we may find the power in the transformer for instance as follows: The current flow or amperes is equal to the electromotive force over the impedance, and the impedance is equal to  $\sqrt{R^2 + (2\pi N L)^2}$ , N denoting frequency and L the inductance, therefore  $C = \frac{E}{\sqrt{R^2 + (2\pi N L)^2}}$ , so

$$C = \frac{E}{\sqrt{R^2 + (2\pi N L)^2}} \text{ or } \frac{E}{C} = \sqrt{R^2 + (2\pi N L)^2}$$

The next step is to find the resistance of the circuit. This may be measured across the key points as described above under resistance. Having found this we may determine the reactance which is equal to  $2\pi N L$ , from the impedance which we know and which is equal to the square root of the sum of the squares of resistance and reactance. If we denote the impedance by X and the resistance by Y, then  $X = \sqrt{Y^2 + (2\pi N L)^2}$  or  $X^2 = Y^2 + (2\pi N L)^2$  or  $\sqrt{X^2 - Y^2} = 2\pi N L$ , the reactance. This reactance divided by the resistance, or  $\frac{2\pi N L}{R}$  is equal to the tangent of the angle

$$\frac{X^2 - Y^2}{Y} = \text{tang. } \Phi. \text{ By referring to a table of sines, cosines and tangents we get the angle of lag from the tangent, and also the cosine of the angle or the power factor. Clear as mud, isn't it?}$$

If a station owner be fortunate enough to possess several ammeters or voltmeters, there are a number of much simpler ways of getting the power factor by first getting the true watts. Fig. 5 shows the connec-

## RTS GUARANTEED TESTED MINERALS

WHY YOU SHOULD BUY RTS TESTED MINERALS.

- 1.—Because—They are better than any obtainable.
- 2.—Because—They are made to pass 3 tests before accepted.
- 3.—Because—RTS crystals are 85% sensitive in the bulk.
- 4.—Because—RTS Crystals are individually tested.
- 5.—Because—Quality and price cannot be equalled.

RTS—Tested Galena in sealed container... \$25  
RTS—Tested Silicon in sealed container... .25

**RADIO TESTING STATION**

## RTS GUARANTEED GRID CONDENSERS

Below we quote one of the hundreds of letters received by us concerning our condensers.

Ocean Grove, N. J.  
Enclosed find money order for which please send us another RTS Grid Condenser. The first brought in signals fully 100% louder.

C. E. Goodwin.  
RTS—Grid Condenser .0005 MF... \$35  
RTS—Fixed Phone Condenser .0013 MF... .40  
RTS—Grid Leak & Grid Con... .0005 MF... .50

Amateurs, send 10c for our new catalogue. We will surprise you.

DEALERS Get our new discount sheet on Condensers, Minerals, Switch Points, etc.

**BINGHAMTON, N. Y.**

Insure your copy reaching you each month. Subscribe to Radio News—\$2.00 a year. Experimenter Pub. Co., 236-A Fulton St., N. Y. C.



# RADIO APPARATUS

*Distributors of Reliable Radio Apparatus  
to Schools, Colleges and Experimenters  
All Over the World!*

## "PITTSO"

The sign of service and prompt delivery.

Why not let us prove it!



## "SPECIAL"

Our New Catalog No. 22 is out.

Insist upon your copy!

AMPLIFYING TRANSFORMERS	
Amrad unmounted	\$5.00
Amrad mounted	7.00
No. Z7392 Clapp Eastham unmounted	4.00
No. Z7392A Clapp Eastham mounted	6.50
No. 226-W Federal, mounted	7.50

AUDION CONTROL PANELS	
No. RORA Grebe in cabinet with hinged cover, splendid value	12.50
No. RORH Grebe in cabinet with tickler connections	17.00
Amrad Type A in cabinet	15.00
No. ZRD Clapp Eastham	12.00
No. Y-1 Acme in cabinet	10.00
No. P-1 Paragon, "Adams Morgan" special, moulded, very compact	6.00

"B" BATTERIES	
No. 7623 Standard 22.5 V. small	1.50
No. 7625 Standard 22.5 V. large	2.65
No. 7650 Standard 22.5 V. Variable	3.50
No. 763 Everready 22.5 V. small	2.25
No. 766 Everready 22.5 V. large	3.50

CONDENSERS (Vernier De Forest)	
No. CV-1010 .001 without vernier in glass case	17.50
No. CV-1013 .001 with vernier in glass case	19.50
No. CV-1500 .0015 unmounted without vernier attachment	13.95
No. CV 1510 .0015 without vernier in glass case	18.95
No. CV-1513 .0015 with vernier in glass case	20.60

*Note.*—Any of the above vernier condensers are admirably adapted for radio-telephone work.

CONDENSERS (Variable)	
No. C-1 Connecticut .001 Mfd. mounted	6.50
No. C-2 Connecticut .001 Mfd. panel mtr.	6.50
No. 1 Chelsea .0012 Mfd. mounted	5.00
No. 2 Chelsea .0012 Mfd. unmounted	4.75
No. 3 Chelsea .0006 Mfd. mounted	4.50
No. 4 Chelsea .0006 Mfd. unmounted	4.25
No. 5 Chelsea dial 1/4" or 3/16" shaft, 180°, pure bakelite	1.00

CONDENSERS (Fixed mica type)	
No. ROCC Grebe .0002 Mfd.	1.00
No. ROCD Grebe .0005 Mfd.	1.20
No. ROCE Grebe .001 Mfd.	1.60
No. ROCF Grebe .005 Mfd.	3.80
No. ROCA Grebe .0002 Mfd. & .5 megohm leak	1.20
No. ROCB Grebe .0002 Mfd. & 3 megohm leak	1.20

CONDENSERS (Low Voltage)	
No. ES-355 1 MF 500 Volts	1.25
No. ES-356 2 MF 500 Volts	1.25
No. 21AA Western Elec. 1 MF. 1000 V. AC	2.50

WESTON METERS (Model 301)	
0-100 Milli-Amps flush	8.50
0-300 Milli-Amps flush	8.50
0-500 Milli-Amps flush	8.50
0-1 Ampere flush	8.50
0-3 Ampere flush	8.50
0-5 Ampere flush	8.50
0-50 Volts flush	8.50
0-500 Volts flush	21.25

HOT WIRE METERS (Flush or Front Mtg.)	
No. 127 Gen. Radio 1/2 ampere	7.75
No. 127 Gen. Radio 1 ampere	7.75
No. 127 Gen. Radio 2 1/2 ampere	7.75
No. 127 Gen. Radio 5 ampere	7.75
No. 127 Gen. Radio 10 ampere	7.75

REGENERATIVE RECEIVERS	
No. CR-2 Grebe 175-680 meters	51.00
No. CR-3 Grebe "Relay Special" 175-680 meters	65.00
No. CR-3A Grebe with tube control 175-375 meters	45.50
No. CR-5 Grebe's "Super-special" 175-3000 meters. Tube control self contained. Ideal for jewelers	80.00
No. CR-6 Grebe 175-680 meters, Detector and two-step amplifier self contained. A complete set	200.00
No. CR-7 Grebe 500-20000 meters "Long Wave Special", complete set	210.00

TELEPHONES	
Baldwin's Type C Navy Standard	16.50
Baldwin's Type E "Super-sensitive"	20.00
Baldwin's Type F very small, light	21.00
Brandes "Superiors" New Headband	8.00
Brandes "Trans-Atlantics" New Headband	12.00
Brandes "Navy Type" New Headband	14.00
No. CW-834 Western Elec. 2200 ohms	14.00

MAGNAVOXES	
Type R-3 Magnavox loud speaker, latest model just out	45.00
Magnavox Radiophone hand transmitter	25.50
Magnavox Radiophone transmitter tone-arm	37.50

VACUUM TUBES	
No. UV-200 Radiotron (Detector)	5.00
No. UV-201 Radiotron (Amplifier)	6.50
No. UV-202 Radiotron 5 Watt Transmitter	8.00
No. UV-203 Radiotron 50 Watt Transmitter	30.00
No. UV-204 Radiotron 250 Watt Transmitter	110.00

(Radiotrons always in stock. Send US your orders.)

TRANSFORMERS (Transmitting)	
No. P-1 Thordarson 250 Watt Type "R"	14.00
No. P-2 Thordarson 500 Watt Type "R"	22.00
No. F-1 Acme 500 Watt with bakelite panel completely mounted	30.00

CONDENSERS (Transmitting Dubiller)	
No. D-100 250 W. 10,000 V. .007 Mf.	19.00
No. D-101 500 W. 14,000 V. .007 Mf.	30.00

No. D-102 1000 W. 21,000 V. .007 Mf.	45.00
No. D-103 1000 W. 25,000 V. .007 Mf.	50.00

ROTARY GAPS	
No. 443 Murdock, 4000 RPM	18.50
No. 124 Klitzen, latest model	25.00
No. B-1 Benwood, Bakelite model	25.00

ROTORS	
No. 443 Murdock, 3/16, 1/4 or 5/16" shaft	3.00
No. T-1 Thordarson, 8 or 16 point	5.00
No. B-1 Benwood, Original 8, 10 or 14 pt.	8.00
No. H-1 Hyrad 10 point 9ZN type	9.95

OSCILLATION TRANSFORMERS	
No. T-1 Thordarson "Special"	10.00
No. TXL-100A International, Ideal for 1/2 K.W. sets, splendid value	14.95
No. Z-652 Clapp Eastham Large 1 K.W. size, very efficient	17.50

C. W. INDUCTANCES (Phone Work)	
Type 181 Tuska	7.50
Type 181 Tuska knockdown	5.00
Type 182 Tuska (Magnetic type)	10.00
Type 183 Tuska (Tickler type)	12.50
Type 170 Tuska Filter	16.00

C. W. TRANSFORMERS (Phone Work)	
Acme 200 Watt mounted	20.00
Acme 200 Watt unmounted	16.00
Acme 50 Watt mounted	15.00
Acme 50 Watt unmounted	12.00

CHOKE COILS (Phone Work)	
Acme 1 1/2 Henry 500 MA double coil	8.00
Acme 1 1/2 Henry 500 MA single coil	6.00
Acme 1 1/2 Henry 150 MA double coil	6.00
Acme 1 1/2 Henry 150 MA single coil	4.00

RESISTANCES (Phone Work)	
No. 1 Ward Leonard 5,000 ohms	2.25
No. 2 Ward Leonard 10,000 ohms	3.50

TELEPHONE TRANSMITTERS	
No. 329-W Western Electric	4.25
No. 5175-A Connecticut	4.25
No. 5176-A Connecticut with short adj. arm	5.25

VARIOMETERS	
No. M-1 Murdock, complete with knob, dial and panel	7.50
No. M-2 Murdock, Vario-coupler complete with knob, dial and panel	8.50
No. XRV-Clapp-Eastham Variometer complete with dial	6.50
No. ZRU Clapp-Eastham Vario-coupler complete with dial	7.50

**Important!** Our new catalogue No. 22 illustrating, describing and pricing our immense stock of radio apparatus sent upon receipt of 10 cents. Insist upon receiving your copy! "Over 100 Pages, Over 150 Illustrations, Over 600 Items."

Pittsco service reaches all over the world! Why not let it reach you!

**F. D. PITTS CO., Inc.**

12 Park Square

Dept. C

Boston, Mass., U. S. A.

Cable address "PITTSO" Boston





TEL. BACK BAY  
5 9 6 4

**EASTERN  
RADIO**

899 BOYLSTON ST.  
BOSTON, MASS.

**INSTITUTE  
RADIO**



# RESULTS

If you are interested in studying Commercial Radio, the RESULTS accomplished by The Eastern Radio Institute should merit your immediate enrollment.

### FOR INSTANCE:

The Eastern Radio Institute was founded in 1913 and is now over six years older than any other Radio and Telegraph School in New England—We are established!

The Eastern Radio Institute moreover has given instruction at this date to over 4,000 different students, and has enrolled, graduated and placed more Commercial operators than all other schools in New England combined! We have accomplished things!

Graduates of The Eastern Radio Institute have actually secured 90 per cent, 89.9 per cent, 89.8 per cent etc., out of a possible 90 per cent in their Commercial operators first grade examination. We know how to give the student proper training!

Successful graduates of the Eastern Radio Institute are found in responsible radio positions all over the world. Why not be one! It costs no more!

Our latest, illustrated prospectus is free. If you cannot visit the Institute send for one. Remember our organization with over eight years of continued Results and Success is behind every student who enrolls. Send in your enrollment today!

F. D. Pitts,  
Director.

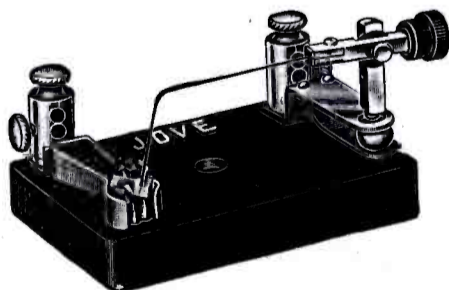

(GHEGAN PATENT)

**Bunnell** INSTRUMENTS  
Always Reliable

**JOVE DETECTOR**  
Handiest, Handsomest, Best  
Sample by Mail, \$2.00  
Tested Galena Crystal, 25c

We are distributors of the Standard Electric Novelty Co.'s Type B "Cyclone" Audion Batteries. Also of De Forest and all the leading manufacturers of High Class Wireless Apparatus. Send stamp for new edition 42RN Catalog.

**J. H. BUNNELL & CO., 32 Park Place, New York**

**POLES**  
(SPRUCE)  
FOR YOUR WIRELESS  
Furnished and erected at reasonable rates  
**J. F. BYRNES** 578 Gates Ave.  
Brooklyn, N.Y.

**CONNECTICUT**  
RADIO EQUIPMENT  
Variable Condensers, Transmitters, Head Bands, Panel Switches, Etc.  
Connecticut Tel. & Elec. Co., Meriden, Conn.

tion for the three ammeter method,  $A_1$ ,  $A_2$ , and  $A_3$  representing the three different ammeter readings, and  $R$  a known resistance, the formula being  $W = \frac{R}{2} (A^2 - A_1^2 - A_2^2)$

which are the true watts, and this divided by the apparent watts, or the product of volts and amperes as read on the meters as usually connected, gives the power factor. Fig. 6 shows a two ammeter and one volt-meter method using the formula

$$W = \frac{R}{2} \left( A^2 - A_1^2 \left[ \frac{E}{R} \right]^2 \right),$$

$E$  being the voltage drop across  $R$ .

Fig. 7 shows a three voltmeter method where  $E$  represents the line voltage, and  $E_1$  the drop across the known resistance, and  $E_2$  the voltage on the load side of the resistance, the formula being  $W = \frac{E^2 - E_1^2 - E_2^2}{2R}$ . All readings being taken in every case without any variation in the load, otherwise there will be error. The above applies only to single phase circuits. If it were desired, for instance, to find the power delivered to a three phase motor it would be necessary to multiply the power in each phase by the square root of three, the formula then becomes  $W = V \times A \times P. F. \times 1.732$ .

To determine the frequency of a generator it is necessary only to know the revolutions per minute of the machine and the number of poles, the formula being, frequency equals  $\frac{R.P.M. \times \text{No. of poles}}{120}$ .

For example, a machine making twelve hundred revolutions per minute and having eight poles,  $\frac{1200 \times 8}{120} = 80$  cycles per second. If however it is desired to find the frequency of a feed line, for instance, we will require something in the way of measurements. If a generator is at hand having the same voltage as that of the line, and a means of bringing it up to speed such as another motor, we have only to run it on the line as a synchronous motor and take the revolutions per minute. The line frequency then will equal the revolutions per minute divided by sixty and multiplied by half the number of poles, or

$$N = R.P.S. \times \frac{\text{Poles}}{2},$$

that is to say the frequency at which the machine runs is the frequency of the line. A means of bringing the machine up to something near speed or synchronism is necessary as it would take a high current if thrown on the line when at a standstill. If such means are not at hand we may determine the frequency in a roundabout way by the use of an ammeter, a voltmeter and an impedance. Let us construct an impedance by winding on an iron core, preferably laminated, say one hundred turns of quite heavy insulated wire and measure the resistance. If difficulty is encountered in doing this, due to the very low resistance which it will have, it may be neglected as it will be a very small factor in the impedance. Now connect this coil across a line of which the frequency is known in series with an ammeter and observe the current reading, also the line voltage. It may be necessary to bring the coil to some station or power plant equip with meters to get these measurements. From these readings as explained under power factor we may obtain the value of the reactance of the coil, viz.:

$$C = \frac{E}{\sqrt{R^2 + (2\pi N L)^2}} \text{ or } \frac{E}{C} = \sqrt{R^2 + (2\pi N L)^2}$$

$$\text{or } \left( \frac{E}{C} \right)^2 = R^2 + (2\pi N L)^2$$

that is to say the frequency at which the machine runs is the frequency of the line. A means of bringing the machine up to something near speed or synchronism is necessary as it would take a high current if thrown on the line when at a standstill. If such means are not at hand we may determine the frequency in a roundabout way by the use of an ammeter, a voltmeter and an impedance. Let us construct an impedance by winding on an iron core, preferably laminated, say one hundred turns of quite heavy insulated wire and measure the resistance. If difficulty is encountered in doing this, due to the very low resistance which it will have, it may be neglected as it will be a very small factor in the impedance. Now connect this coil across a line of which the frequency is known in series with an ammeter and observe the current reading, also the line voltage. It may be necessary to bring the coil to some station or power plant equip with meters to get these measurements. From these readings as explained under power factor we may obtain the value of the reactance of the coil, viz.:

$$C = \frac{E}{\sqrt{R^2 + (2\pi N L)^2}} \text{ or } \frac{E}{C} = \sqrt{R^2 + (2\pi N L)^2}$$

$$\text{or } \left( \frac{E}{C} \right)^2 = R^2 + (2\pi N L)^2$$



# NOW IS THE TIME TO MAKE BIG MONEY LEARN WIRELESS

**Know a Dignified  
Uncrowded Profession**

## AT HOME

**In Shortest Time  
At Lowest Cost**

*The Demand for Good Wireless Operators Far Exceeds the Supply*

The New York Wireless Institute—America's foremost fastest growing Wireless Institute gives you the best instruments, theory, text books and diagrams available. We will MAKE YOU AN EXPERT WIRELESS OPERATOR AT HOME, qualifying you for first grade license, in your spare time, easily, thoroughly, in shortest possible time and at lowest cost. No previous training is necessary. Our Home Study Course is prepared by Mr. L. R. Krumm, formerly Chief Radio Inspector, Bureau Navigation, New York, now in position of greater responsibility with one of the largest Commercial Radio Corporations in the United States. Our Radio Experts, able to impart their practical and technical knowledge to YOU in an easy-to-understand way, will direct your entire Course. The graded lessons mailed you will prove so fascinating that you will be eager for the next one. The instruments furnished free will make it as easy for you to learn the Code as it was to learn to talk. *All you will have to do is to listen.*

## BIG SALARIES

Wireless operators receive salaries from \$125 to \$200 a month and it is only a stepping stone to better positions. There is practically no limit to your earning power. Men who but yesterday were Wireless Operators are now holding positions as Radio Engineers, Radio Inspectors, Radio Salesmen at salaries up to \$5,000 a year.

## TRAVEL THE WORLD OVER

A Wireless Operator can visit all parts of the world and receive fine pay and maintenance at the same time. Do you prefer a steady position without travel? There will be many opportunities for you at the numerous land stations or with the Commercial Wireless or with the Steamship Companies.

*The New Intercity Wireless Company will need hundreds of new operators*



# FREE

## INSTRUMENTS AND TEXT BOOKS

We furnish free to all students, during the Course, the wonderful receiving and sending set exactly as shown in the illustration. This set is not loaned, but given to all students completing the Course. One cell of dry battery all that is required. No additional wiring, aerials, etc., needed. The wonderful Receiving and Sending Set, Text Books, etc., all become your property upon completing the course.

The transmitter pictured is the celebrated Omnigraph, used by several Departments of the U. S. Government and by the leading Universities, Colleges, Wireless and Technical Schools throughout the United States and Canada. Thousands have learned telegraphy with the Omnigraph. Place the phone to your ear and this remarkable invention will send you wireless messages, thousands of different ones, the same as though you were receiving them thru the air from a wireless station hundreds of miles away. When you apply for your license the United States Government will test you with the Omnigraph—the same model Omnigraph as we furnish to our students. Ask any United States Radio Inspector to verify this.

## FREE WIRELESS TELEPHONY COURSE

We have incorporated in our Institute an up to-date and Complete Course in Wireless Telephony, written by our Chief Instructor, Mr. L. R. Krumm.

*This Course is included FREE*

## FREE POST GRADUATE COURSE

A month's Post-Graduate Course, if you so desire, at one of the largest Wireless Schools in N. Y. City—the Wonder City—the largest port in the World and Headquarters of every leading Wireless and Steamship Company.

## Endorsed by United States Government

by allowing our graduates highest credit given any Wireless Correspondence School in first grade license examinations.

**U. S. SHIPPING BOARD will testify to the value of our instruction.**

Medina, N. Y.,  
November 28, 1920.  
Dear Sirs:—  
I have found the Theory Course, the Omnigraph Set and Text Books most satisfactory. I think your Wireless Course is the best and easiest to learn for it's interesting from the beginning to end, and the way the questions are written gets you interested at once.  
Yours Truly,  
(Signed) S. B.

Sea Cliff, L. I.,  
December 6, 1920.  
Dear Sirs:—  
Received your letter of December 1, and was very pleased to learn of the lessons in Wireless Telephony to be given to the students of your school. It shows you do not overlook any phase in order to furnish the students with "up to date dope in the Radio line". And I am sure it will be as explicit as your Theory course of Wireless Telegraphy. The course is as thorough and explicit as one could ask for and I wouldn't hesitate a moment in recommending it to any of my Radio friends.  
Respectfully yours,  
(Signed) C. D. H.

Milford, Conn.,  
Oct. 25, 1920.  
New York Wireless Institute,  
New York City.  
Dear Sirs:—  
I received your letter and am very glad to tell you that I am completely satisfied with your course. It sure is an easy way to learn.  
Thanking you for your kind attention, I am,  
Sincerely yours,  
(Signed) J. H. A., Jr.

(Names and address gladly furnished on application.)

## SEND FOR FREE BOOKLET

*Without obligating you in any way, send for our booklet "How to Become an Expert Wireless Operator"—it is free. Mail the coupon opposite or postal or letter—but do it today.*

**NEW YORK WIRELESS INSTITUTE**, Dept. 203, 258 Broadway, New York City

## NEW YORK WIRELESS INSTITUTE

Dept. 203, 258 Broadway New York City  
Send me, free of charge, your booklet "How to Become an Expert Wireless Operator," containing full particulars of your Course, including your FREE INSTRUMENT OFFER.

Name .....  
Address .....  
City or Town.....  
State .....



# UNWIRED RADIO EQUIPMENT

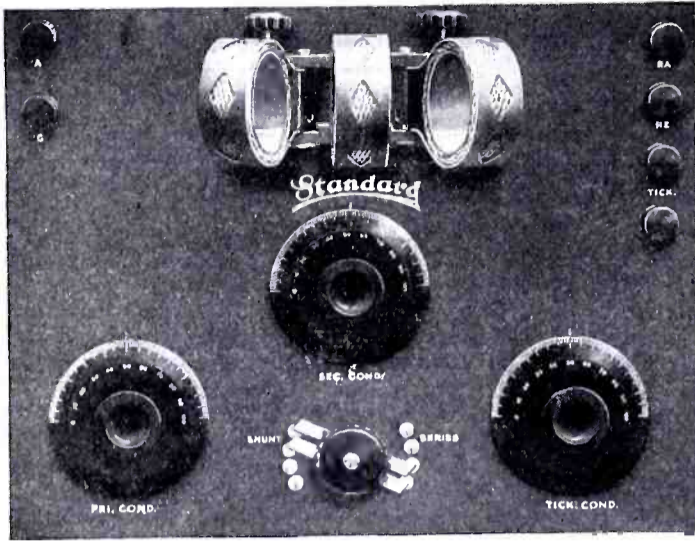

The Multi-Wave Tuner illustrated is one of a complete line of radio instruments we are offering discriminating experimenters.

This instrument, as well as our Radiophones, Regenerative Receivers, Audion Controls, Amplifiers, and other standard units, is supplied both wired and unwired. You can use your own circuit with our unwired units or connect the units in accordance with blueprints supplied by us.

This tuner is constructed of the best grade standard parts, neatly mounted on a 3/16" grained Formica panel size 11 1/4" x 14".

The coil holder is of the DeForest geared type providing critical coupling between honey-comb coils with a range of wave lengths from 150 to 20,000 meters.

Chelsea dials with a one-thousandth inch thick bearing eliminate warping and scraping common to other dials. The primary and secondary condensers are also of Chelsea make, capacity .0011 mfd. The Chelsea .0006 mfd. condenser is used for tickler tuning.

DeForest condenser switch is provided for throwing the primary condenser in series, with the primary coil, out, or in shunt.

The panel is neatly engraved in the pantograph style, the lettering being filled with a white enamel that will not crack or fall out.

The tuner is encased in a well made, black mission finished, oak cabinet.

The cost of our completely assembled, unwired instruments is but little more than the retail price of the standard parts and raw materials. Write for free booklet describing our complete line of unwired, assembled instruments.

Model No. 2	Price
Wired	\$50.00
Unwired	\$45.00
(without coils)	

**STANDARD ASSEMBLING CO., 19 BRIDGE STREET NEW YORK**



## RADIO SERVICE

The Radio Service Type S50 C. W. Inductance is Wound on a slotted bakelite form of 31 turns of number 9 hard drawn copper wire on a 5 inch diam. Supplied with three clips making adjustment variable to any fraction of a turn. Tunes to 350 meters and suitable for panel or bench mounting. Materials and workmanship the finest obtainable and the price is **only \$8.50**

If you are starting to build a C. W. set the Radio Service Inductance will start you on the right track or if you already have a C. W. Set and you are not getting the proper results try one of these inductances and you will be surprised at the increased operating efficiency.

ASK YOUR DEALER TO SHOW YOU ONE OF THESE INDUCTANCES. IF HE CAN'T SUPPLY YOU, WE WILL SHIP YOU ONE POST PAID.

Type S40 Variable Grid Leak (1/2 to 3 Megohms) Helps to increase your signal audibility Bakelite Mounted, Moisture Proof..... \$75

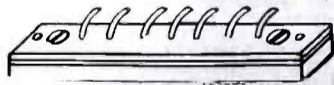

### Here's the Wonderful Little Radio Set

that was described in April's Radio News, page 680. Just the thing for Boy Scouts, Campers and for use on bicycles, etc. Complete in every respect and guaranteed to give complete satisfaction. Just connect your aerial, ground and phones and you are ready to receive messages. Tunes to 800 meters.

Mr. Dealer: This little receiving set will help your business over the summer months and obtain new customers for you.

Type S8 (as illustrated) price.....\$7.50  
Type S8A complete (incl. phone, aerial, insulators and instruction book) .....12.50

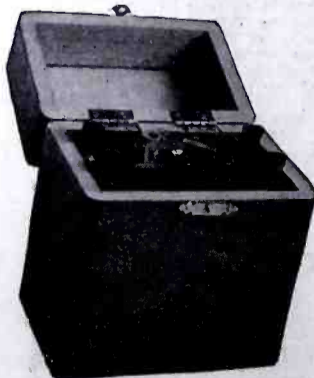

**RADIO SERVICE & MFG. CO., Lynbrook, L. I., New York**

$$\text{or } \left(\frac{E}{C}\right)^2 - R^2 = (2\pi NL)^2$$

$$\text{or } \left(\left(\frac{E}{C}\right)^2 - R^2\right)^2 = 2\pi NL$$

If we know the value of the frequency at which the measurements were taken to be, let us say, sixty cycles, then the value of L, or the inductance, is equal to  $2\pi NL$

We now have left only one  $6.2832 \times 60$

unknown quantity in the impedance of the coil, namely, the frequency, and it will be an easy matter to abstract this. We connect the impedance with ammeter and voltmeter as before to the circuit of which we desire to obtain the frequency and proceed in the same manner. Having found the reactance of the coil on this circuit and knowing the inductance of it, the frequency

$$N \text{ must be equal to } \frac{2\pi NL}{2\pi L}$$

To make it clearer let us work out a problem. We will suppose for our first set of measurements a line voltage of one hundred volts, a current of five amperes, a resistance of .1 ohm, and a frequency of sixty cycles. Then

$$S = \frac{100}{\sqrt{.01 + (6.2832 \times 60 \times L)^2}}$$

$$\text{or } \frac{5}{400} = \frac{\sqrt{.01 + (377L)^2}}{.01 + (377L)^2}$$

$$\text{or } 400 - .01 = (377L)^2$$

$$\text{or } \sqrt{399.99} = 377L$$

$$\text{or } L = \frac{19.9}{377} = .05278 \text{ henries}$$

and if the second circuit, or the one of which we are to find the frequency reads one hundred and twenty volts and eight

$$\text{amperes, then } 8 = \frac{120}{\sqrt{.01 + (.3316N)^2}}$$

$$\text{or } \left(\frac{120}{8}\right)^2 - .01 = (.3316N)^2$$

$$\text{or } .3316N = \sqrt{224.99}$$

$$\text{or } N = \frac{14.99}{.3316} = 45 \text{ cycles.}$$

Station owners who will go to the trouble of working out these measurements will find that it will give them a better understanding of what they are handling and why things work as they do.

## Remote Control Antenna Switch

(Continued from page 779)

a wooden case and mounted right outside the window on the second floor. The helix lead was brot from the cellar along the outside of the house up to the switch. The antenna was lead right to the switch. The front of the box carrying these two leads was made of dilecto. The receiving antenna lead was brot thru a small dilecto bushing thru a small hole in the window to the receiving apparatus. The solenoids were brot from the box into the house thru a small hole under the window sill.

The drawing showing the general arrangement of the set gives a good idea of how simple this system was. The rotary gap is controlled by a push button switch having a red light to show when it was running.

The auxiliary contacts on the key, one to open the audion circuit and the other to close the solenoid, are self explanatory in the sketches.



# "The Greatest Radio Catalog In the World" —

The Universal Verdict of Tens of Thousands of Radio Amateurs

Mail 12 cents

in stamps or coin (not sent otherwise) for the greatest Radio Catalog published.

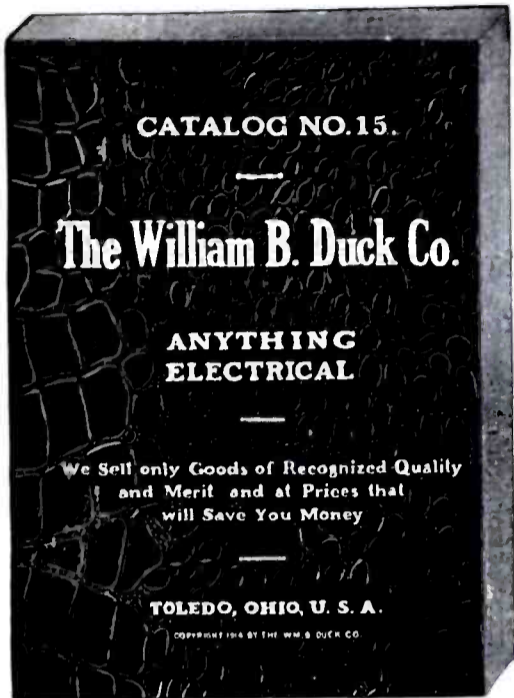

## DUCK'S No. 15 BIG 225 PAGE WIRELESS CATALOG. JUST OUT

A Veritable Treasure House of Everything Worth While and Dependable in Radio. The largest, most comprehensive, artistic and educational wireless catalog published. The Beacon Light to guide you right in the selection of your radio purchases, and at prices that will command your attention. Every instrument guaranteed with privilege of return if not satisfied.

For 12 Years the Name "DUCK"

has had a meaning all its own to radio amateurs.

Next month we shall reproduce a number of late testimonials out of thousands pouring in upon us, which will tell you why the overwhelming majority of radio amateurs buy from "Duck."

Ever since the year 1909 Duck's catalog has always occupied the foremost rank among radio amateurs; in each succeeding year, with the constant development of radio this catalog blazed the way with most everything new and dependable listed between the covers of all other catalogs. It has truly been a "BEACON LIGHT" to the novice and the expert in radio. In keeping with the size and completeness of this catalog there has always been a stock of radio instruments in our place many times larger than that of any other radio house; in fact we believe several times larger than the next largest. Our many years in this business and the immensity of our stocks is conclusive proof that you are dealing with a big, well-established and dependable concern.

## SERVICE

Among many other things, has made our business tremendous, and except for a limited time after the war, when without actively inviting the business we were literally snowed under with orders, our service has always been our pride and the delight of radio amateurs. SERVICE—the most abused word in advertising and the hardest and most complex thing to give to radio experimenters. We do not tell you that we can always ship every item in our catalog immediately, but our records for some time past prove that we are giving our pre-war service and shipping 98% of all orders complete within twenty-four hours after receipt.

### Substantial Reductions on many Radio Instruments that appear in Catalog No. 15

The prices of DeForest Honeycomb Coils and all DeForest instruments as set forth in catalog No. 15 have since been reduced to the previous DeForest list which appears in the first edition of our catalog No. 14.

No. R40 Receiving Set	\$22.50
No. R41 Receiving Set	38.50
No. R41a Receiving Set	28.50

#### THORDARSON TRANSFORMERS

1 K.W. Type R	40.00
1/2 K.W. Type R	28.00
1/4 K.W. Type R	22.00
1 K.W. Type RS	30.00
1/2 K.W. Type RS	20.00
1/4 K.W. Type RS	15.00
No. A1792 Thordarson Condenser	25.00

Switch Contacts, each	.03
No. 1023 Mica Condenser	.60
No. B670 Detector	2.75
No. A862 Detector	2.75
No. A1915 Detector	1.50
No. A367 Murdock Condenser	4.50
No. A1002 Receiving Set	9.75
No. A1916 Condenser	1.65
No. 61x08A Tuning Coil	2.95
No. 61x10 Tuning Coil	4.95
No. 14 Aluminum Wire, per lb.	.90

### Only a few of the many New Instruments in Catalog No. 15

Type C-300 Cunningham Bulb	5.00
Type C-301 Cunningham Bulb	6.50
UV-200 Radiotron Bulb	5.00
UV-201 Radiotron Bulb	6.50

### A Complete Line of New Detector, Regenerative and Amplifying Sets.

Connecticut Variable Condenser	6.50
Turney Spider-Web Unit	6.00
No. 550 Murdock Socket	1.00
No. 3660 Murdock Condenser	4.00
No. 3661 Murdock Condenser	4.25
No. 3662 Murdock Condenser	5.00
No. 3660 Murdock Condenser	3.25
No. 3681 Murdock Condenser	3.50
No. 3682 Murdock Condenser	4.25
No. 3664 Murdock Dial Assembly	1.25
MC-1 DeForest Set	40.00
MC-2 DeForest Set	59.00
MR-1 DeForest Set	65.50
MR-2 DeForest Set	85.50
MR-3 DeForest Set	105.00
MS-2 DeForest Set	209.00

Note: The above DeForest Sets are just out and constitute panel detectors, amplifiers, regenerative receivers and complete radio telephone transmitting and receiving sets. The various sets above mentioned comprise the various units in cabinets. These units may be bought separately and later added to.

No. MS-2 comprises a complete Midget Radiophone with a thirty-five millio speaking range, regenerative receiver; also receiver for wave lengths of 25,000 meters, and a detector and two-stage amplifier each in separate units but all mounted in a mahogany cabinet.

Type OT-3 Midget Radiophone consisting of antenna circuit panel and power tube panel	\$95.00
Microphone, extra	6.00
Power Tubes, extra	22.50
Magnavox Radiophone Hand Transmitter	22.50
Magnavox Radiophone Transmitter Tone Arm	37.50
Magnavox Loud Speaker	45.00

### New Short Wave Regenerative Set with Detector

Listen in to the Radio Concerts with this wonderful receiver.



For damped and undamped stations from 150 to 600 meters. Variometer and vario coupler construction. Variometer coupling extremely close giving maximum inductance. Variometer primary provided with single and multiple tap switches giving extreme selectivity. Wiring bus bar type insulated with oiled cambric tubing. Brushed Bakelite panel. Beautifully finished mahogany cabinet. Tested before shipment in Toledo for radio music from Pittsburgh and Washington. Absolute certainty of getting what you buy. The maximum range obtained from any type of transmitting station, damped or undamped, using up to 600 meters. We unqualifiedly guarantee that there is nothing like it on the market for the price.

No. A204 New Short Wave Regenerative Set with Detector and "B" Battery	\$65.00
Cunningham or Radiotron Detector Bulb, extra	5.00
No. A210 Short Wave Regenerative Receiver only (style, construction and appearance same as No. A204, but without detector)	50.00



No. A200

An excellent Audion Control Panel for use with new four-prong bulbs. Grid leak and grid condenser are mounted on rear of panel. New type panel rheostat mounted on center of panel. The formica panel is attached to a wood base, upon which is mounted the tube receptacle.

"B" Battery control permitting of four regulations of "B" Battery. Voltage from 18 volts to 22 1/2 volts in steps of 1/2 volts. A fine adjustment of "B" Battery is necessary for the best results.



No. A201

No. A200 Panel Detector Set, less batteries and bulb	\$7.50
No. A201 Cabinet Detector Set, less batteries and bulb	15.00
No. A202 Cabinet Detector of Amplifier Set, Less Batteries and Bulb	\$22.00

Send 12 Cents for a copy of Our Big Catalog Today

THE WILLIAM B. DUCK CO., 231-233 Superior St., Toledo, Ohio



## The QRN Season Is Almost Upon Us!

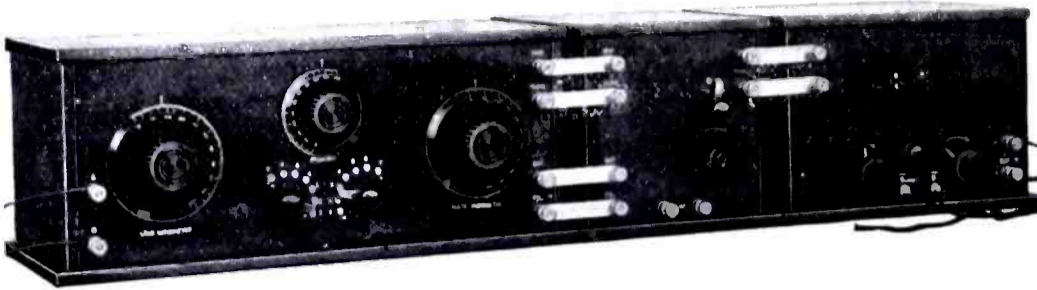

Do you want to work distance all summer? Why not equip your station with the very latest design in the Variometer type of regenerative tuner, at a price which places this improved apparatus within the reach of all! This short wave regenerative tuner, fundamentally correct in design, covers a wave length range of from 180 to 550 meters, giving the highest amplification yet attained in this type of tuner, without changing the spark tone, and is unexcelled for radiophone reception. The parts are mounted on a velvet finished formica panel and inclosed in a solid mahogany cabinet finished in "Flemish" as beautiful in its appearance as it is efficient in its operation. Price \$50.00



The Detector Cabinet contains the new general radio rheostat, its large smooth surface giving the critical filament adjustment required by the

**CINO RADIO MANUFACTURING CO.**  
218 West 12th Street

present-day tubes. There is ample room for the "B" Batteries, a control switch for which is contained on the panel, enabling the operator to cut out his phones while transmitting. Price \$18.50

A two-step amplifier which gives an amplification equivalent to 400 times that of the detector and is equipped with anti-capacity switches enabling the operator to change the phones from detector to one or two steps without adjusting the filaments as they are automatically cut in and out with the one operation. Price \$40.00

We invite competitive comparisons with any regenerative tuner now on the market.

Write for descriptive literature. We also handle all standard makes of apparatus.

We build C-W apparatus. Have you heard our phone? Call RXY ex 8AJ.

**CINO RADIO MANUFACTURING CO.**  
Cincinnati, Ohio

## Long Distance Hook-up

(Continued from page 781)

tions which were quite faint altho readable. When hearing wireless telephone I tune in without it and then with it. I find that it makes the telephone louder and plainer. (Perhaps the editor could tell you why better than I.) When receiving spark stations, if I switch in this small aerial, it makes the signals fainter.

With one No. 20 copper wire, eighty feet long and ten feet high I can hear NAA almost as clearly as with my large aerial which is one hundred feet long and thirty feet high—five wires. A one-step amplifier will make European stations possible.

## Conduction of Electricity Thru Vacuum and Gases with Application to Design of Radio Apparatus

(Continued from page 782)

grid its effect is to counteract part of the positive charge on the plate, move the plane of equal attraction out from the filament and decrease the plate to filament current.

In some types of radio apparatus, particularly in radio telephones, it is desirable to have no leakage from the grid thru the tube with a negative charge on the grid and this is one reason for using an oxide filament in these tubes. An incandescent oxide will not discharge a negatively electrified body.

## Correspondence From Readers

(Continued from page 785)

coast or land station or route of navigation, shall not use a transmitting wavelength greater than 150 meters;

Class 4—Stations located more than 75 miles from a commercial coast or land station or route of navigation, shall not use a transmitting wave length greater than 200 meters.

Maximum power— $\frac{1}{2}$  k.w.; maximum decrement, .2.

During the season of closed navigation, for the past two winters, the Government has given all amateurs permission to use 200 meters, to see how the amateurs tune their transmitters. If the amateurs will keep their waves sharp enough to prevent QRM to the Government stations, permission may be granted to all amateurs to operate on 200 the whole year round.

H. S. GOWAN, 3DS,  
Kitchener, Ont., Canada.

## Junior Constructor

(Continued from page 793)

The base of the switch is made of a piece of wood 16" x 3 $\frac{1}{2}$ " x 1". The switch lever is of copper 9" x 1" x  $\frac{1}{8}$ ". The switch jaws are standard 100 ampere ones. The insulators are mounted by means of two angle irons screwed to the base—one on either side of the eye of the insulator—and a screw passed thru the two angle irons and the eye of the insulator. The

## REMLER No. 93 A—BATTERY — POTENTIOMETER



Pat. Applied For.

Increases detector sensitiveness and signal audibility.

THE plate voltage of any detector tube must be carefully adjusted for maximum sensitiveness and signal audibility. Potentiometer control provides close adjustment with ease of operation. This new Remler Unit with metal inserts provides positive definite electrical contact and eliminates the uncertainty of carbon to graphite contact. This Remler Unit is hot brittle and is connected across the A-Battery to control the plate potential over a six volt range by half-volt steps. Circuit diagram furnished with each unit.

"Apparatus that Radiates Quality."

- No. 93—Remler A-Battery Potentiometer Unit only, with studs for panel mounting ..... **.75c**
- No. 94—Remler Rotary Lever Switch for use with No. 93 Unit ..... **.45c**

## REMLER RADIO MFG. COMPANY

163 Sutter Street      E. T. CUNNINGHAM, Sales Mgr.      San Francisco

## QUALITY RADIO EQUIPMENT

**RADIO MAGNAVOX**  
Type R-3

Latest development in sound amplifiers; constructed on a patent protected electro-dynamic principle. Emits same volume of sound as higher priced Magnavox Tele-megafone.

**THORDARSON TYPE R—1 KW TRANSFORMERS—SPECIAL PRICE \$35.00**

Regular Price, \$40.00 Overstock causes reduction Full supply of quality Vacuum Tubes, Controls and Parts. Special Dealers' offer. Mail orders filled promptly.

\$45.00

Write for Radio Catalog No. 2.

**RADIOTRON**  
U. V. 202

New type Power Tube of improved operating characteristics. Provides long operating life. Rated at 5 watts. Filament voltage 7.5 V. Filament current 2.35 amps. Plate voltage 350-400 V.



\$8.00

(postage extra)

## DOUBLEDAY-HILL ELECTRIC CO.

715 Twelfth St., N. W., Washington, D. C.      Radio Dept.—Desk B      719-21 Liberty Ave., Pittsburgh, Pa.



**YOUR LOCAL DEALER**

probably carries WILCOX products in stock,

**IF NOT**

Order by mail from us and your order will be shipped **POSTPAID**

Our new catalog is being mailed to our old customers. Others should send 5c for it.



**WE SELL**

other makes of Radio Apparatus and will be glad to receive your orders for anything you need at regular prices. Postage extra.

We specialize in raw materials. See our ad in last month's Radio News.

**Reduced Prices**

on **WILCOX Variometer and regenerative receiver parts.**

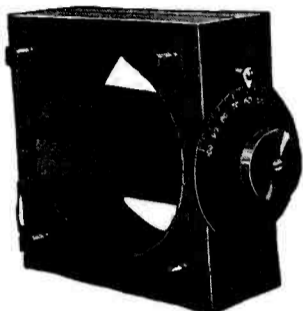

5AP1 Wooden parts for above variometer including winding form .....\$2.00

5AP2 Complete parts including dial, assembling instructions, etc. ....\$4.25

5AP3 Complete parts less dial, \$3.00; 5A Assembled variometer, with dial, \$6.50; without dial, \$5.25.

These are the same high grade parts that have helped thousands of amateurs to build their own variometers. Increased production and improved methods and machinery have enabled us to make these reductions.

**Variocoupler Rotor**



1C1 Variocoupler Rotor...\$1.00 This is a carefully turned hardwood rotor for secondary coil of variocouplers, etc. Size is 3 1/2" diam. and 2" thick.

1C Variocoupler Parts.....\$5.00 This set includes all parts for the variocoupler illustrated in the next column except the panel. Instructions for assembling are furnished.

**Type 126 Tube Socket**

Made of genuine bakelite dielectric and solid brass. Is small and convenient for back of panel mounting.

No. 126A Audlon Socket 75c.

**Type 131 Binding Posts**

A high grade binding post for use on panels, etc. Has moulded composition top with brass collar and screw.

No. 131A small size, suitable for receiving sets, 10c. No. 131B large size, suitable for power work 20c. State thickness of panel and whether brass or nickel finish is desired.

**Switch Contacts**

Heads 1/4" x 1/8", Shanks 6-32 x 3/8", 112A Brass, 8c; 112 B Nickel, 4/10c; Heads 3/16" x 1/8", Shanks 6-32 x 3/8", 112E Brass, 2 1/2c; 112F Nickel, 4c; Heads 1/4" x 1/8", Shanks 6-32 x 3/8", 112C Brass, 8 1/2c; 112D Nickel, 5c; Heads 3/16" x 1/8", Shanks 6-32 x 3/8", 112G Brass, 8c; 112H Nickel, 4 1/2c.

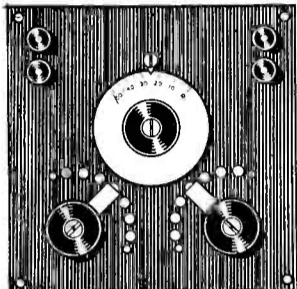

**Type IC Variocoupler**

This instrument is carefully assembled from standard WILCOX parts on a five-inch square panel of grained Bakelite. It is designed to be combined with the variometers shown below to make an efficient short wave regenerative receiver. Price, \$8.00, Postpaid.

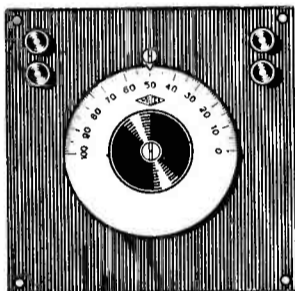

**Type 5B Variometer**

This variometer is designed for use in the grid circuit and when used with the variocoupler shown above will give a secondary wavelength range of 175 to 450 meters. Price \$8.00, Postpaid.

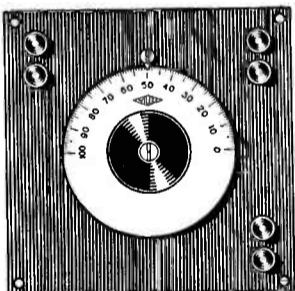

**Type 5C Variometer**

This is the plate variometer and is designed to operate with the instruments shown above. The binding posts are so arranged on these instruments that it is only necessary to connect from one to the other with brass strips, which are furnished free if requested with order. Price \$8.00, Postpaid.



**Type 14B Rotary Disk**

The same style rotor as used on our famous belt driven gap, only with bakelite center and brass bushing to fit your motor shaft. Size is 4 1/2" diam. and 9/16" thick. This rotor being light and perfectly balanced will give excellent results on any small high speed motor. State size of shaft when ordering. No. 14B Rotary Disk \$6.00

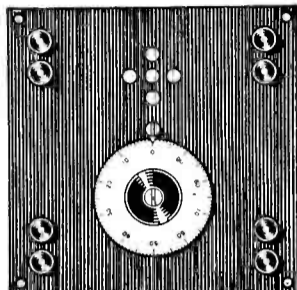

**Type 3D V. T. Control**

This panel includes a tube socket, rheostat, grid condenser and grid leak. It is arranged for connection in any circuit but is especially desirable for use with other instruments illustrated on this page because of its standardized construction. Price \$7.00 Postpaid.

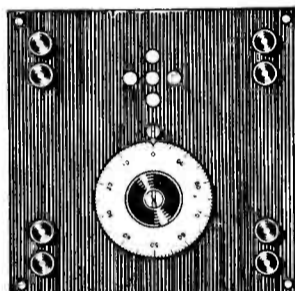

**Type 6A Amplifier**

This amplifier panel is arranged so that it may be conveniently connected to the detector panel shown above or additional stages, connected to it by means of connecting straps. Price \$12.00, Postpaid.

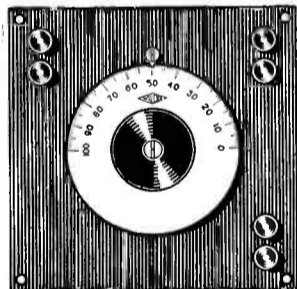

**Type 4B-C Condensers**

These condensers may be conveniently used in connection with any of the other standardized instruments shown on this page at any point where a variable capacity is required.

No. 4B Capacity .001 \$7.50 Postpaid.  
No. 4C Capacity .0005 6.75 Postpaid

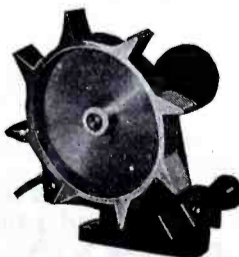

**Type 14A Rotary Gap**

Belt driven, solid balanced rotor of special aluminum alloy, large steel shaft, long brass bearing, well quenched, short leading spark, clear tone, high efficiency. Price \$10.00.

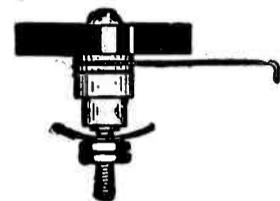

**Type 101 Panel Switch**

A beautiful and efficient rotary switch for general use. Furnished in two sizes. 1" radius brass finish 40c. Nickel finish 50c. 1 1/2" radius brass finish 50c. Nickel finish 60c.

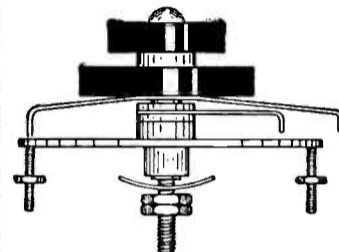

**Type 102 Panel Switch**

A compound switch consisting of two electrically independent switches mounted with concentric knobs. 1 1/2" radius brass finish \$1.10. Nickel finish \$1.25.

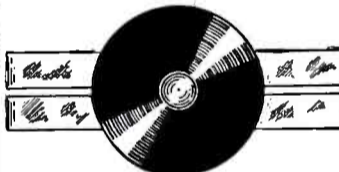

**Type 103 Panel Switch**

A rotary panel switch which is double pole and double throw. will change variable condenser from series to parallel, etc. 1 1/2" radius brass finish 75c. Nickel finish 85c.



**Type 104 Panel Switch**

A complete unit for back of panel mounting. The latest and best in rotary panel switches. Better looking, more efficient and easier to mount. Complete with Type 116 Dial and 6 contacts \$2.25. Complete with Type 116 Dial and 11 contacts \$2.50.



**Type 121 Rheostat**

Suitable for table or back of panel mounting. Has turned aluminum case, convenient binding posts and 6 ohm resistance unit with all off and all on positions. Long bearing and special designed blade insure smooth running and positive contact. Only occupies space 2" in diam. on your panel. No. 121A with Type 116 Dial \$2.50. No. 121B with Knob and Pointer \$1.75.



**A  
ACE  
E**

**SAVE THAT  
DOLLAR**

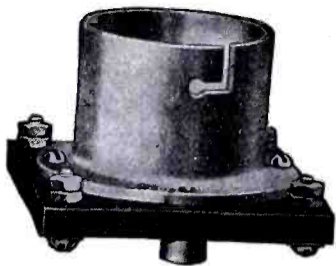

You intend spending for a grid leak. Buy the "Ace" Vacuum Tube Socket complete with Grid Leak mounted on base.

- Ace V. T. Socket with grid leak..... \$1.50
- Ace V. T. 4 tube socket mounting for C. W. Units..... 6.00
- Ace V. T. Die Casting only without base..... .55

Specify whether panel or table type is desired. If your dealer cannot supply you order direct from us. Dealers solicited. Mail orders given prompt attention.

Send 3 cents in stamps for SPECIAL PRICE BULLETIN No. 102

**THE PRECISION EQUIPMENT CO.**

*Mfrs. and Distrs. of Radio Equipment*

Dept. A, 2437-2439 GILBERT AVENUE, CINCINNATI, OHIO

*"You May Pay More But You Can't Buy Better"*

Member A.R.R.L. Radio Call "8xB"



**TRESCO TEN \$ TUNERS**

When you think of tuners say TRESCO.  
One for every need and wave length.  
CIRCULAR FREE.

This is the tuner.

- AS—Arlington tuner—600M to 5000M.
- BS—Long Wave tuner—5000M to 25000M.
- CS—Amateur tuner—200M to 600M.
- Coils for either..... \$6.00 and P. P.
- DS—Short Wave tuner..... \$6.00 and P. P.
- All three tuners, AS, BS, CS, same general shape except that the BS tuner has no tickler coil.

**Never Silent.  
Used During the  
Summer  
Static Season**

I received one of your NAA tuners and find them very good. Using a forty-foot aerial. NAA comes in like a ton of bricks. I can get NAA on a bed spring Arcs come in good, too. Boys that come to see my set say what good is that little box, but when they hear it working they take their hats off.

JOHN LEHTINEN,  
1064 River St., Fitchburg, Mass.

10c for Regular Catalog

**TRESCO — DAVENPORT — IOWA**

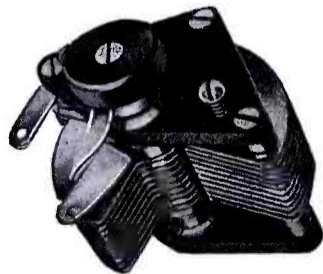

**Going to build a new Set?**

Make sure that it will operate at maximum efficiency by installing

**- EMPYREAN VARIABLE CONDENSERS -**

Designed for amateur radio telephone and telegraph work—built like commercial equipment.

*They consistently bring in  
the long distance signals.*

No insulation break-downs; extremely low energy losses; no short circuits; utilizes the maximum received energy.

You can't go wrong with Empyrean Condensers as they are fully guaranteed to give satisfaction or we will cheerfully refund your money.

**PRICES :**

Size	Panel Mounting Type	Portable Type
43 plate.....	\$4.50	\$5.75
21 plate.....	3.65	5.00

(Enclose postage for 2 pounds.)

Send for bulletin describing these and other radio instruments.

**EMPYREAN RADIO CO.,** Masonic Temple Bldg., CHICAGO, ILLINOIS

holes in the angle iron will have to be made large enough to allow a 1/4" round head stove bolt to go thru. One side of the angle irons will have to be sawed off as it must fit tightly against the flat part of the insulator. In this way they are held rigid. (See illustration 1.)

The angle irons that support the switch jaws and switch lever are fastened in a somewhat similar way, except that only one angle iron is used for each.

The angle irons for the top are preferably of copper, the same width and thickness as the switch lever, and they must fit tightly to the insulators as in the case of the others.

The switch jaws are fastened to the copper angle irons by machine screws (see illustration 2), about 10-24 is a good size. It is a good idea to put lock washers on these screws.

The leads may be taken from the angle iron either where it is fastened to the insulator or where the switch jaw is fastened.

The handle may be turned on a lathe or whittled from a piece of hard wood. It is fastened to the switch lever by a piece of brass rod. (See illustration 3.)

I do not think there will be any difficulty encountered in constructing this, altho care must be used to have the angle irons fit tightly against the insulators.

Contributed by REVILLE L. TURK.

**STATEMENT.**

Of the Ownership, Management, Circulation, Etc., Required by the Act of Congress of August 24, 1912, of Radio News, published monthly at New York, N. Y., for April 1, 1921.

State of New York } ss.  
County of New York }

Before me, a notary public in and for the State and county aforesaid, personally appeared Hugo Gernsback, who, having been duly sworn according to law, deposes and says that he is the Editor of the Radio News, and that the following is, to the best of his knowledge and belief, a true statement of the ownership, management (and if a daily paper, the circulation), etc., of the aforesaid publication for the date shown in the above caption, required by the Act of August 24, 1912, embodied in section 443, Postal Laws and Regulations, printed on the reverse of this form, to wit:

1. That the names and addresses of the publisher, editor, managing editor, and business managers are: Publisher, Experimenter Publishing Co., 233 Fulton St., New York City, N. Y.; Editor, Hugo Gernsback, 233 Fulton St., New York City, N. Y.; Managing Editor, Robert E. Lacault, 233 Fulton St., New York City, N. Y.; Business Manager, R. W. DeMott, 233 Fulton St., New York City, N. Y.

2. That the owners are: (Give names and addresses of individual owners, or, if a corporation, give its name and the names and addresses of stockholders owning or holding 1 per cent or more of the total amount of stock.) Experimenter Pub. Co., 233 Fulton St., New York City, N. Y.; Hugo Gernsback, 233 Fulton St., New York City, N. Y.; Sidney Gernsback 233 Fulton St., New York City, N. Y.; Harry Winfield Secor, 233 Fulton St., New York City, N. Y.; R. W. DeMott, 233 Fulton St., New York City, N. Y.

3. That the known bondholders, mortgagees, and other security holders owning or holding 1 per cent or more of total amount of bonds, mortgages or other securities are: (If there are none, so state.) None.

4. That the two paragraphs next above, giving the names of the owners, stockholders, and security holders, if any, contain not only the list of stockholders and security holders as they appear upon the books of the company but also, in cases where the stockholder or security holder appears upon the books of the company as trustee or in any other fiduciary relation, the name of the person or corporation for whom such trustee is acting, is given; also that the said two paragraphs contain statements embracing affiant's full knowledge and belief as to the circumstances and conditions under which stockholders and security holders who do not appear upon the books of the company as trustee, hold stock and securities in a capacity other than that of a bona fide owner; and this affiant has no reason to believe that any other person, association, or corporation has any interest direct or indirect in the said stock, bonds, or other securities than as so stated by him.

5. That the average number of copies of each issue of this publication sold or distributed, through the mails or otherwise, to paid subscribers during the six months preceding the date shown above is (This information is required from daily publications only.)

HUGO GERNSBACK,

Sworn to and subscribed before me this 26th day of March 1921.

[SEAL] BEATRICE K. OWER,  
(My commission expires March 31, 1921.)



# "ATLANTIC RADIO" MAY BULLETIN

## T-A-W HOT WIRE AMMETERS

0-1, 0-2½, 0-5

A FEW LEFT AT

An Exceptional **\$5** Opportunity

Radiotron UV 200 .....	\$5.00
Radiotron UV 201 .....	6.50
Paragon V. T. Control.....	6.00
Paragon 6 ohm Rheostat.....	1.75
Radisco "B" Battery (small).....	1.50
Radisco "B" Battery (large).....	2.65
G. E. Variometer .....	6.50
G. E. Variocoupler .....	7.50
"ZRF" Regenerative Set.....	38.00
Murdock Variometer, complete with wood panel, dial and knob.....	7.50
Murdock Variocoupler, complete with panel and 6-point switch.....	8.50
Murdock No. 366 V. Condenser.....	4.75
Interior only .....	4.25
Murdock No. 367 V. Condenser, transparent case .....	4.75
Murdock No. 368 V. Condenser.....	3.75
Interior only .....	3.25
Murdock No. 55 Telephone Headset, 2000 ohms .....	4.50
Murdock No. 55 Telephone Headset, 3000 ohms .....	5.50



**"RADIOTRON" UV-202**

5 Watt Transmitting Tube

Specifications

Filament current: 2.35 amps.  
 Filament voltage: 7.5 volts  
 Normal life: 250 hours  
 Plate current: 50 milli-amps.  
 Plate voltage: 350-400 volts  
 Rated output: 5, normal.

**Price, \$8.00 each**

Include Postage on 1 Pound

## Use the "EVEREADY" Six "I" G 60 "A" BATTERY

6 Volt

60 Ampere Hour Capacity  
**GUARANTEE—18 MONTHS**

### CHELSEA VARIABLE CONDENSERS

No. 1—.0011 m.f. mounted.....	\$5.00
No. 2—.0006 m.f. mounted.....	4.50
No. 3 B. D. .0011 m.f. unmounted...	4.75
No. 4 B.D. .0006 m.f. unmounted....	4.25
Radisco Grid Condenser .0005 m.f....	.35
G. R. Grid Condenser .0005 m.f....	.25
Turney Spider-Web Inductance.....	6.00
"Ajax" Buzzer Practice Set.....	1.75
"Ajax" High Tone Buzzer.....	.50

### EVERYTHING FOR THE AMATEUR

We carry at all times a complete line of the *best* in Radio Equipment.

Our service department will cheerfully answer your questions or give you advice—this service is **FREE**.

Let us solve your problems!

*The new Radio Magnavox loud speaker, \$45.00*

# C. W. EQUIPMENT

"National" Rheostat, back mt'd, 6 ampere current carrying capacity .....	\$5.50
Tuska Inductance Type 181 (capacity feed-back circuit).....	2 lbs. 7.50
Tuska Inductance Type 182 (split-filament type feed-back).....	2 lbs. 10.00
Tuska Inductance Type 183 (grid-tickler feed-back) .....	2 lbs. 12.50
Tuska Filter, Type 170.....	3 lbs. 16.00
Weston Model 301 milliammeter (plate meter 0-100ma).....	2 lbs. 8.50
Weston Model 301 ammeter 0-5A.....	2 lbs. 8.50
G.R. Hot Wire Ammeter, 0-½, 0-1, 0-2½, 0-5A .....	2 lbs. 7.75
G. R. Tube Socket.....	1 lb. 1.75
"Eldredge" 60-A.C. Ammeter, 0-10A.....	2 lbs. 9.50
"Hoyt" Flush, Black, A.C. Voltmeter 0-15V .....	2 lbs. 8.00

Acme C.W. Power Transformers	
200 watt mt'd, \$20.00; unmt'd.....	5 lbs. 16.00
50 watt mt'd, \$15.00; unmt'd.....	5 lbs. 12.00
Acme Choke Coil, 500 MA capacity.....	3 lbs. 6.00
Acme Choke Coil, 150 MA capacity.....	3 lbs. 4.00
Acme Type A-3 Modulation Transformer .....	2 lbs. 7.00
Acme Filament Transformers, fully mounted, 50 watt.....	2 lbs 12.00
Acme Filament transformers, core and coils assembled, 50 watt.....	2 lbs. 9.00
Acme Filament Transformers, fully mounted, 150 watt.....	2 lbs. 16.00
Acme Filament transformers, core and coils assembled, 150 watt....	2 lbs. 13.00
W.E. Microphone, with bracket....	2 lbs. 4.05
Connecticut Microphone .....	2 lbs. 3.95
Connecticut Microphone, with long arm .....	3 lbs. 4.25

## ATLANTIC RADIO COMPANY, Inc.

88 Broad Street  
 Boston 9, Mass.

REQUEST "BULLETIN 14"

Branch: 15 Temple St.  
 Portland, Me.



R  
KLAUS  
D  
I  
O
"B" BATTERIES
R  
KLAUS  
D  
I  
O

One More KLAUS Specialty

Consider these facts before buying your "B" Batteries

Klaus No. 5763 Radio Battery—size 2½ x 3¾ x 2 inches. Initial voltage 22½. In actual tests, when operating thru resistance equal to amateur vacuum tubes, this battery gave 450 hours' continuous service before reaching its cut-off point of 17 volts.

Price \$2.25

Klaus No. 5766 Radio Battery—3 x 6¾ x 4 inches. Initial voltage 22½. Operating under the same conditions as above this battery delivered upwards of 2400 hours' continuous service. After reaching 17 volts it can be connected in series with another battery and used until run down to 12 volts.

Price \$3.50

WATCH THIS SPACE FOR OTHER ANNOUNCEMENTS

Order direct or thru your dealer

KLAUS RADIO COMPANY  
EUREKA, ILLINOIS

Recent Development in  
Loop Aerials

(Continued from page 775)

nections of loop aerials make one more step on the way which leads to the exclusive use of this type of aerial, and it is ex-

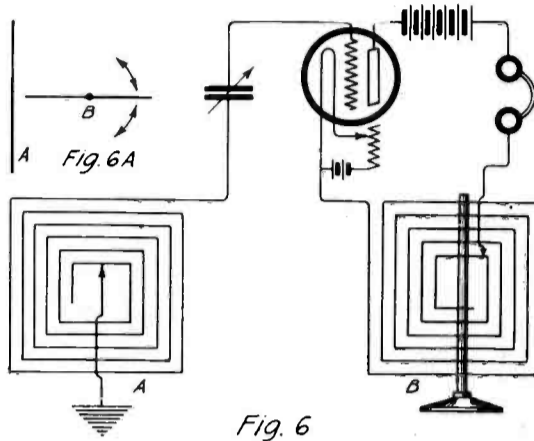

C.W. May Be Received With a Grounded Loop by Using Another One as Plate Circuit Coupled to the First One. Their Position is Shown in Fig. 6A.

pected that in a few years' time, thanks to the actual sensitive and efficient receiving and sending apparatus, the loops will be as popular and extensively used as is the ordinary aerial of today.

I Want to Know

(Continued from page 795)

A. 1. A variometer is a continually variable inductance, the same as a variable condenser is a continuously variable capacity. You will find in this issue directions for the construction of variometers. A variocoupler is merely a loose coupler.

LOOP AERIAL.

(204) George A. Abell, of Lebanon, Ky., requests answers to the following:

Q. 1. Can a loose coupler be wound with enameled wire and will it give the same service as D. S. C. wire?

A. 1. Yes, enameled wire may be used for the construction of a loose coupler without reducing the efficiency.

Q. 2. What is the wave-length of a loose coupler made as follows: primary, diameter 3¼", length 4", 184 turns, No. 24 enameled wire; secondary, diameter 2½", length 3¾", 244 turns, No. 28 enameled wire?

A. 2. The wave-length you could tune with such an L. C. is about 700 meters without any capacity and about 1,800 meters when the secondary is shunted with a .0005 mf. variable condenser.

Q. 3. Can aluminum wire, No. 12, be used for loop aerials? If so, how many turns must be wound on a frame 10' square to receive signals up to 2,500 meters, and how should the taps be made for different wave-lengths?

A. 3. Aluminum wire is suitable for the construction of a loop aerial. To tune in this wave-length, 12 turns spaced ½" apart should be wound and shunted by a .001 mf. variable condenser. For shorter waves, the contact on the loop may be made with a clip allowing any number of turns to be connected.

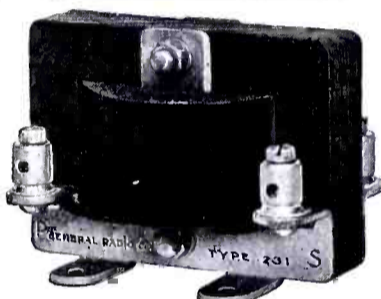

Described in Bulletin 907N

Correct C-W Modulation

The success of a radio telephone installation depends not only on the value of the antenna current, but also on how completely that current is modulated. Quality is also a very important feature. Now that satisfactory transmitting tubes are available, we have designed a modulation transformer particularly for these Radiotron UV202 tubes. This transformer, which is similar in appearance to our new Type 231A Amplifying Transformer, is designed to give the maximum modulation which is possible without distortion. If you desire real results with your C-W set, we recommend that you try our Type 231M Modulation Transformer.

PRICE COMPLETELY MOUNTED \$5.00

FILAMENT BATTERY POTENTIOMETER

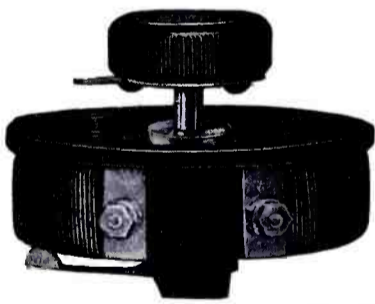

For best detector operation, the Radiotron UV200 tubes should have a grid biasing A battery potentiometer. We have adapted our already well known Type 214 rheostat for this service. It has a resistance of 400 ohms and is equipped with extra terminal for potentiometer connection. Like the rheostats, it is made in back of panel, as illustrated, and front of panel models. Price, either model, \$4.00. Do not forget that these rheostats are now made for the UV202 transmitting tube as well as for receiving tubes. Transmitting tube rheostat 2 ohms (sufficient for regulation on a 12 volt supply source), 2.5 amperes; receiving tube rheostat 7 ohms 1.5 amperes. Price, either size, \$2.50.

Described in Bulletin 904N

CARRIED IN STOCK BY LEADING RADIO DEALERS

GENERAL RADIO COMPANY

Massachusetts Avenue and Windsor Street,

Cambridge, 39

Massachusetts

Canadian  
Amateurs

Write to our nearest branch for  
Price List "B" of Radio Apparatus,  
Supplies and Publications.

Scientific Experimenter Limited

Dominion Bldg.,  
Vancouver, B. C.

Arcade Bldg.,  
Halifax, N. S.

Head Office,  
11 St. Sacrament St.

Confederation Life Bldg.,  
Winnipeg, Man.

Vaughan Electric Co.,  
94 Germain Street  
St. John, N. B.

MONTREAL, QUEBEC

98 King St. E.,  
Toronto, Ont.

Board of Trade,  
St. John's, Nfld

Show Rooms,  
88 McGill College Avenue

A welcome addition to your library! Send \$2.00 today, plus postage for 7 lbs., and your copy of bound volume No. 1 of Radio Amateur News will come forward by return mail.  
Experimenter Publishing Company 238a Fulton Street, New York City



**SPARK AND ARC HOOK UP.**

(205) J. C. Burns, Jr., of Greenwood, S. C., requests:

Q. 1. Please publish a diagram of a circuit that will receive arc, spark and radiotelephone, using two inductances, one of which is the tickler coil.

A. 1. Such a hook-up appears on this page.

**AERIAL WAVE-LENGTH.**

(206) Everette L. Dye, of Plainview, Texas, would like to know:

Q. 1. What is the wave length of an aerial 75' long, 20' high at one end, and 60' at the other and composed of two No. 14 wires 6' apart and a lead of about 25'?

A. 1. The wave-length of such an aerial is about 135 meters.

Q. 2. What sized tubes and how many should I use in a C. W. set with 1,100 or 650 volts input?

A. 2. The tubes suitable for such a set are the 50 w. Radiotrons tubes U. V. 203, sold by the Radio Corporation of America. The most efficient way to use them is to use one as oscillator and one as modulator.

Q. 3. Are the new Universal audions manufactured by the Radio Audion Co., as responsive as the regular audion for use?

A. 3. The new audions are especially efficient as amplifiers, but require a little higher voltage on the plate as detectors, than the other make of tubes.

**HARD TUBE USED IN TRANSMITTER.**

(207) Ellsworth Williams, of Lancaster, Pa., asks:

Q. 1. Is there a soft or hard tube used in the transmitter described on page 286, November, 1920, issue of RADIO NEWS, and of what make is it?

A. 1. The tube used is the V. T. transmitter you mention is a hard tube. Any power tube actually on the market may be used for this set.

**LOOSE COUPLER WITH AUDION DETECTOR.**

(208) Mark M. Morris, of Berkeley, Calif., requests:

Q. 1. Please draw a diagram of a loose coupler audion detector using A. C. for filament without a rectifier.

A. 1. The hook-up you request was published on page 447 of the January, 1921, issue of RADIO NEWS. If you use only a loose coupler the plate is directly connected to the fones instead of to the tickler coil.

**PORTABLE RECEIVER COILS.**

(209) K. R. Barber, of Swift Current, Sask., Canada, wants to know:

Q. 1. Where can Radisco coils, mentioned in article describing portable receiving outfit, page 595 of the March, 1921, issue of RADIO NEWS, be purchased?

A. 1. You may obtain the coils mentioned at the Vimy Supply Co., 567 College St., Toronto, Ont., Canada. That company carries a full line of Radisco instruments.

**WAVE LENGTH OF COIL.**

(210) Frank R. Knowles, of Cleveland, Ohio, would like to know:

Q. 1. How many meters, wave-length, are there in a coil 6" in diameter, 11" long, wound closely with No. 24 B. S. enameled copper wire? Please send equation if there is one.

A. 1. The natural period of this coil is about 4,000 meters. The formula for the inductance of a coil may be found in any

# A Regenerative Receiver & Radiophone



THE SET

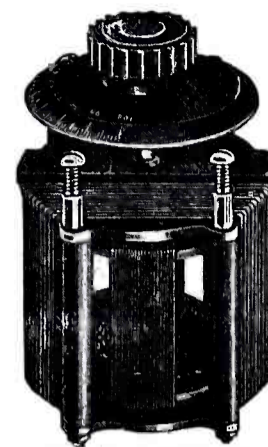

THE VARIOMETER

Our  
**Esco**

## Regenerative Receiver

has already been advertised in the March and April issues of this magazine and in the meanwhile has gained a national reputation. It is conceded to be the best set of its kind for all kinds of reception and is especially adapted for CW and all Radiophone reception due to the fact that it tunes very sharply. For long distance work it is unexcelled.

Our laboratory force during the past few months have been experimenting upon a new use of the ESCO REGENERATIVE RECEIVER and have finally perfected a method whereby with the use of a microphone and simple detector unit, speech and music can be transmitted over distances ranging from 10 to 45 miles. This is not mere idle talk but an accomplished fact. Of course, we consider the hook-up of value and it will be available only to each purchaser of an ESCO set.

Summer is practically here, the season when Radio operations begin to wane. However it has been found that atmospheric disturbances during the hot season do not effect CW nearly so much as spark transmission and reception. In fact, many experts claim that Radiophone work can be carried on almost as well as during the cold weather. Here, then, is where the ESCO receiver will show its manifold abilities. For the set is beyond comparison at receiving all CW stuff, bringing in the messages loudly and clearly over long distances. In addition it can be used as a Radiophone. Hence we have a combination sending and receiving outfit at a moderate price of \$50.00, f. o. b. Columbus, O. Is it not worth your while to consider the purchase of one of these marvelous sets?

ESCO variometers and vario-couplers sell at the following prices:

Variometer with dial .....	\$9.50
Variometer without dial .....	8.50
Vario-coupler with dial .....	10.00
Vario-coupler without dial .....	9.00

### Special Until Sept. 1st, 1921

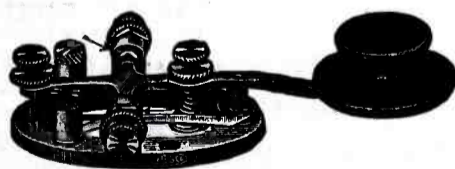

During the summer months we offer our regular 1 K.W. transmitting key with the 1/4-inch contacts of Sterling silver at the reduced price of \$3.29 postage prepaid. This key is very sturdily built and will hold up to and including 1 K.W. very easily. The special price holds good only to Sept. 1st.

Send 15c for our large illustrated catalogue with supplement and also literature of our ESCO REGENERATIVE RECEIVER. This amount will be refunded on your first order for \$1.50 or over. High printing costs makes free distribution impossible.

## The Electrical Specialty Company

Dept. M-48-50 So. Front St.

COLUMBUS, OHIO



## PROUDFOOT DETECTOR AND TWO STEP AMPLIFIER



FRONT VIEW

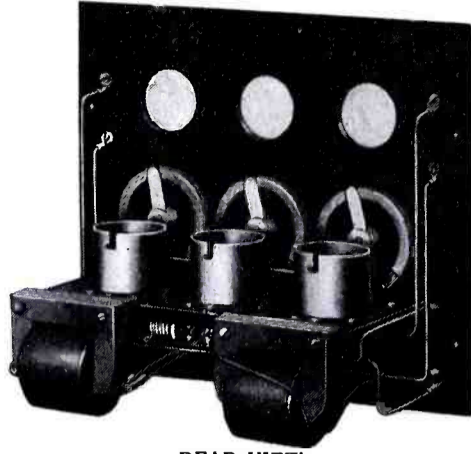

REAR VIEW

The operating characteristics of this instrument are equal to any on the market regardless of price.

\$35.00

The Design and Construction are such that Maximum Amplification is Obtained and No Howling.  
Panel 3/16". Bakelite is 7-1/2" x 8-3/4".  
Cabinet, Waxed Oak Finish, 5" Deep.

"Notice Clean Cut Wiring." Plug for Fones Furnished with Each Instrument.

ALL INSTRUMENTS ABSOLUTELY GUARANTEED

361 E. Ohio St. **G. M. PROUDFOOT** CHICAGO, ILL.

## VARIABLE-ACE "B" BATTERIES-PLAIN

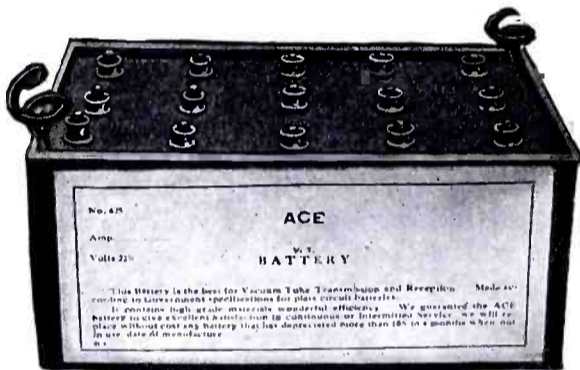

—Use the 'Best'—  
**Ace "B" Batteries**

*Dealers*  
Sell the "Best"  
with our Special  
Inducements

Write for Catalog No. 15

Cat. No.	Size.	Voltage.	Hrs. Ser.	Lbs.	Price.
623	Plain 2½ x 2 x 3¾	22½	400	1	\$1.50
623	Variable 2½ x 2 x 3¾	22½	400	1	1.75
625	Plain 3 x 4 x 6¾	22½	1400	5	2.50
625	Variable 3 x 4 x 6¾	22½	1400	5	3.00
626	Plain 3 x 8 x 6¾	45	3000	10	5.00
626	Variable 3 x 8 x 6¾	45	3000	10	6.00

ACE "B" BATTERIES are made according to government specifications, and are especially adapted for Plate Circuit, Detector and Amplifying Tubes.

*Guaranteed not to Depreciate more than 10% in 1 year when not in use. Absolutely Moisture proof.*

### ACE BATTERY MFG. CORP.

44 COURT STREET Phone Main 8379 BROOKLYN, NEW YORK

### ANNOUNCEMENT

### ANNOUNCEMENT

**THE KARLOWA RADIO CORP.**  
STOCK ROOMS, 5TH FLOOR BEST BLDG.  
MAIN OFFICE, 611 BEST BLDG., ROCK ISLAND, ILL.

**HAS PURCHASED THE ENTIRE RADIO BUSINESS OF  
THE YOUNG & McCOMBS CO., OF ROCK ISLAND, ILL.**

The new organization solicits your orders as they have heretofore been placed with the old company. A new catalog is in preparation, and until it is issued, you are requested to make your selections from Catalog B and Supplements of the former Young & McCombs Co. Immediate deliveries are guaranteed on all items. Address all orders and correspondence to

**THE KARLOWA RADIO CORPORATION**

611 BEST BUILDING ROCK ISLAND, ILL.

Insure your copy reaching you each month. Subscribe to Radio News—\$2.00 a year. Experimenter Publishing Co., 236-A Fulton St., N. Y. C.

good text book on Radio, and in the Wireless Course published by the Experimenter Publishing Co., 233 Fulton St., New York City.

### DATA FOR ARLINGTON COUPLER

(211) Everett J. Coulson, of Whitman, Mass., wants to know:

Q. 1. What size wire must be used for a 2,500 meter loose coupler? What is the size of the tubing and how many tapes for 200 meters or more on the same coupler?

A. 1. A loose coupler able to tune up to 2,500 meters should be made as follows: Primary, 5½" long, 4" diameter, wound with 247 turns of No. 26 D. S. C. wire; secondary, 5½" long, 3½" diameter, wound with 380 turns of No. 32 D. S. C. wire. The secondary should be shunted with a variable condenser of .0005 mf. and tapped every 19 turns.

### RADIOFONE RECEIVED ON CRYSTAL SET.

(212) Norman Dow, of Warren, R. I., asks the following:

Q. 1. Can Radiofone be heard on the crystal detector?

A. 1. Certainly, Radiofone may be received on any receiving set without any change.

Q. 2. Is there a hook-up for two crystal detectors, one being used as an amplifier?

A. 2. No, the crystal detector cannot be used as an amplifier and there is no hook-up for same.

## The Resonance Wave Coil

(Continued from page 766)

### REDUCES STATIC TO MINIMUM.

"Atmospherics" or static—a bugaboo of wireless transmission—is reduced to a minimum, according to claims, by use of the resonance wave coil. Amplification is increased, resulting in the magnification of incoming signals to a greater degree than static sounds. The Signal Corps is employing multiamplifiers, ordinarily of six stages, for long-distance receiving. Tests indicate, however, that in a measure the same ratio of sound increase is obtainable by connecting two or more similarly constructed resonance wave coils in parallel. Each coil is in the same position with respect to the angle of the incoming waves. Also each unit is tuned separately, the several lead-in wires from the brass rings being joined at the detector grid terminal.

Still another virtue claimed for the resonance wave coil is its capacity as a direction finder. The Signal Corps illustrates its effectiveness in this fashion: Let "A" be the transmitting radio station whose direction is sought by station "B". The wave coil at the latter is tuned by sliding its brass ring toward one end of the tube and the latter swung at the same time until the sounds attain maximum loudness. Here the wave coil is precisely at right angles to the direction of the impulses, and the sounds are most audible owing to the fact that the coil is absorbing every wave that it can. Presuming that the brass ring has been tuned to the right of the operator, the tube is gradually turned upon its axis in a counter-clockwise position. Less and less waves are being cut by the tube, the sounds thus diminishing. There is a variation of power loss between the electromotive force acting on each element of the coil owing to the difference in time—indeed, brief—necessary for the waves to reach the various elements of the coil.

When the coil has been rotated to a point where the sounds are faint or weakest it



is parallel with a line drawn between "A" and "B." As yet, however, the operator is uninformed whether "A" is in front or behind him. The tube is reversed slowly past the maximum point until, when in the same parallel as before it will be found that there exists a zone of deathlike silence. This condition reveals the fact that the ring is at the end of the tube farthest from the distant station "A", indicating that the free end is pointing directly toward it. The compass dial verifies the find. When locating an airplane, the wave coil is pointed toward the heavens, the search being made for the position of least sound.

The foremost radio authority of England has recognized the eminent achievements in wireless equipment by the Signal Corps, General Squier revealing to the writer an authoritative expression from overseas extolling the accomplishments of America. Of the promising future, General Squier says: "The development of types of resonance wave coils, both open at one end and at both ends, for general radio work offers an interesting field for investigation. This involves the study of the electron tube as a potentially operated device. The application of such coils properly designed for specific purposes may lead to the practical solution of a number of radio problems such as directional effects, and wave coils antennas of very small dimensions."

## A New Type of Variometer

(Continued from page 769)

shellac might keep out may cause a loss which will more than overbalance the good effected by the decreased distributed capacity.

This complete set of two variometers and variocoupler are mounted on a bakelite panel 3½" x 12". The cabinet is 5" deep inside diameter. This is certainly small and many will probably say too small for efficiency. However, it will tune from 165 to 435 meters and with a small loading coil in series with the grid circuit or a very small condenser across the secondary and grid variometer it will tune up to 700 meters or above. The loading coil is much better than the shunt condenser. The primary connected to an amateur antenna will tune to about 700 meters and the plate variometer will cause the set to oscillate from 165 meters to 700. The set has been tested with several other makes and is decidedly better in every way than the average.

## 2 AD Explains

(Continued from page 780)

old burnt 60 amp. cartridge fuses, making a curve cut in the center to take the coil and the ends of wire; they are then passed inside and soldered to the top and low fuse contact. Great care should be taken to always wind in the same direction. I have connected the center wire of each coil to the aerial side of the circuit.

With these different size coils you will see that I can have all kinds of wavelengths, from 50 to 20,000 damp and undamp and also telephone receptions.

My transmission and aerial is described in your issue RADIO NEWS, February, 1921, page 535, except that now I have installed a rotary gap, which gives good results.

The illustrations clearly show the circuit as above stated.

# LEARN RADIO RIGHT

**R**IGHT now, *today*, radio offers you the opportunity of a pleasant, secure future, if you are properly trained. Radio companies need trained executives, engineers, draftsman, operators and mechanics. Hundreds of positions in all branches are open to you, from operator on a ship to general manager, if you have the required training.

**T**HE Radio Institute of America will give you this training, as it has to thousands of others. If you cannot come to the Institute, the instruction will come to you—to your home. Your training at home will be the same efficient complete training given at the Institute, and will prepare you for a United States Government certificate testifying to

### What the Man Who Employs the Operators Says:—

Radio Institute of America, New York.

Gentlemen—I have known the Radio Institute of America so long and so favorably under its present title and its earlier name, Marconi Institute, that it is difficult for me to conceive that anyone can think of instruction in radio without instantly recognizing its leadership. When employing operators, your students are given preference because several thousand of them have proven their ability to me over a long period of years.

Sincerely yours,

(Signed) J. B. DUFFY,

Superintendent, Eastern Division, Radio Corporation of America

your ability as a radio expert and giving you a license to engage in a business where the opportunities exceed anything ever before known.

**T**HIS new home course of radio training includes all of the subjects treated at the Institute, and the same care for the success of the individual student is given to all who enroll. The home course includes everything from basic principles of electricity and magnetism to actual operation of commercial radio equipment!

### What Our Former Students Are Doing

Mr. H. Payne, former student, now Assistant Treasurer of the Radio Corporation of America.  
Walter E. Wood, Superintendent in charge of the powerful trans-oceanic radio station at Chatham, Mass.

Irving Ellingham has a greatly prized position in his assignment as radio operator on Vincent Astor's yacht "Cristina."

Raymond Blanqui, although only 20 years old, is now a high salaried operator in trans-oceanic service.

Watson Sidney, Manager of the office of the Radio Corporation of America, Savannah, Ga.

Harry Sadenwater, assistant in research in the world-famed radio laboratories of the General Electric Company.

E. N. Pickerell, manager of the Radio Corporation's shore station for the port of New York.

Lee L. Manly, assistant superintendent of the Maintenance Department of the Radio Corporation.

William S. Fitzpatrick, Assistant Marine Superintendent.

**T**HE home study course of the Radio Institute of America, will come to you in progressive lessons. You can complete the course and graduate in a few months, or take your time. Your examination papers will be carefully checked and will be returned to you with a definite percentage for correctness indicated on them, and this grading will be the same as given by the world's leading instructors in radio to thousands of successful graduates. You can ask questions with your replies to each lesson, on any points not clear, just as if you were in the lecture room.

**I**N every way, the home course is of equal value to attendance at the classes. The Radio Institute of America is not an experiment; it has been an established and successful institution for over fifteen years. The year round average attendance in its great classrooms is 298 students per month. It has trained over 6,000 men, 95% of whom have successfully engaged in this new branch of science and industry.

**T**HE graduates of the Radio Institute of America enjoy a great and exclusive advantage in the close connection existing between the Institute and the Radio Corporation of America, the world's largest radio manufacturing and commercial radio company. The close association of the Radio Corporation of America with the great General Electric Company still further widens the field of opportunity. These advantages make available a great amount of special practical operating information, which is included in the home course, and the world-wide service of the Radio Corporation, both afloat and ashore, offers good prospects of immediate employment to all graduates of the Institute.

**T**HE home course of the Radio Institute of America is founded upon a record of solid accomplishment and practical radio experience. The 6,000 graduates of the Institute are scattered all over the face of the earth, many of them now hold big, responsible positions with foreign governments and commercial concerns. Many of them have repeatedly circled the globe on ships, and still many others are employed in various capacities by the commercial companies, as engineers, operators, mechanics, and executives at the shore and transatlantic stations now so indispensable to present-day civilization. The training of the Institute has assured these graduates a secure, prosperous future. Insure and protect your future! The training of the Institute will do it—right in your own home. Write for our booklet and terms.

## RADIO INSTITUTE OF AMERICA

(Formerly Marconi Institute)

324 BROADWAY

NEW YORK



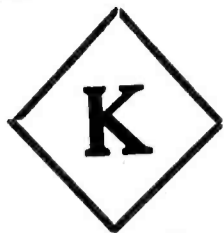

# =B=A=N=G= PRICES HIT BOTTOM

Reduced

	From	To
Arnold V.T. Control . . . . .	\$21.00	\$19.50
Arnold Loose Coupler, (Navy Type) . . . . .	25.00	20.00
Thordarson Transformers, 1/2 KW . . . . .	27.00	22.00
"                    "      3/4 KW . . . . .	33.00	28.00
"                    "      1 KW . . . . .	45.00	40.00

Watch for announcement next month

## DAVID KILLOCK COMPANY

57 MURRAY STREET

NEW YORK CITY

May

### EMPIRE RADIO

Bulletin

TYPE D-11

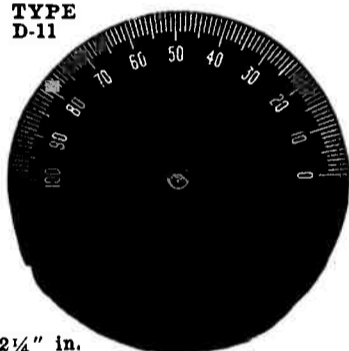

2 1/4" in. diameter

### AUDIOTRONS

The Original

\$6.00

EMPIRE  
Indicating Dial

25c



Attractive Offer To  
Dealers On All Our Parts

### Empire Radio Equipment Co.

Manufacturers and Distributors of Radio Apparatus

271 West 125th Street

New York City

## MIGNON-SYSTEM WIRELESS TELEPHONE

Write for Literature describing

LATEST DEVELOPED  
RADIO APPARATUS

IT'S FREE

MIGNON SYSTEM MFG. CO.  
BUFFALO, N. Y., U. S. A.



### MONEY for You

Add to your Salary—Make extra Pin Money. Start a lucrative business of your own. Spend an hour each day taking subscriptions for the "Radio News." We'll pay you well and you'll enjoy the work. Write for full particulars. Circulation Dept., RADIO NEWS, 236A Fulton St., New York City.

### The Design and Construction of an Efficient Detector Amplifier

(Continued from page 772)

for the tuner and reaction coil terminals. A rough drawing of the internal layout coupled with a diagram of connections should furnish all the further detail required. Note particularly that none of the metal portions touch the wood which should be cut away from them. The wiring up should be carried out with 18's copper wire, preferably tinned and insulated with a prepared tubing now sold for the purpose. All the wires should be as short and straight as is consistent with decent separation, and every joint should be well soldered.

In conclusion, first connect the tuner to terminals G and F. If spark signals are to be received, the reaction coil terminals should be kept "shorted." For continuous waves, connect reaction coil to these terminals, removing the shorting link. With a plate battery of 30 volts and a filament battery of four volts, very good signals can be received, and in the writer's hands has rendered the big European stations audible all over the room. Probably a slightly higher plate voltage would be of advantage, but up to the present this has not been tried.

The writer feels sure that any amateur will be well paid for the time and trouble expended in the construction of this amplifier, which will enable him to increase his knowledge of the thermionic-tube. The photograph shows the complete amplifier. In this particular model the battery connections and also the head-gear are made by means of plugs fitting into corresponding sockets on the front of the case.

### The Death Dash

(Continued from page 789)

He took the can and went out into the engine room. It took him several minutes to remove the cork and even then he broke it and had to look for another one so that fully ten minutes must have elapsed before he returned to the operating room. When he entered he found his visitor standing by the table holding the fones in his hand, and on his face was the most diabolical expression that Bill had ever seen. It passed so quickly, though, that he could scarcely be sure whether his eyes had deceived him or not. All he could think to say was:

"Here is your coal-oil, Mr. Strathroy."

"Oh, all right," the latter replied. "Thanks very much. I guess I had better be getting back to the boat now. By the way, young man, please say nothing about me to Mr. Nesbitt, or rather Ralph Conway as you call him. I'm an old friend of his and I want to give him a surprise in the morning."

Bill promised to keep his mouth shut and showed his visitor out. He then returned to his post, little suspecting the ghastly surprise that was in store for the "Old Man." At about a quarter to twelve the "Old Man" returned, apparently quite sober, but Bill knew him too well to be deceived. He came into the room, examined all the window-locks carefully, and then told Bill he could go. As Bill left he heard the "Old Man" slide the bolt on the inside of the door and thus completely lock himself into the room.



Next morning when Edgar went to relieve him he found the door locked, as usual, but no amount of knocking brought an answer. Alarmed, he awoke Bill and together they broke down the door with an axe. What a sight met their eyes! There on the floor by the table lay the "Old Man," surrounded by a pool of blood that had trickled from a small bullet hole in his right ear. Beside him lay the fones, one of which was smashed to atoms as though the bullet had first struck it before it had penetrated the unfortunate man's head. Horror-stricken, Bill foned for the police and then started to search the room. The "Old Man's" hair was badly singed so that the shot must have been fired only a few inches from his head. However, the most diligent search failed to reveal any weapon, which made the verdict of suicide impossible. Yet how could it have been murder? Every window was locked and the door had been bolted from the inside all night. Suddenly Bill thought of his visitor. He rushed to the window. The *Ventura* was gone!

When the police arrived Bill told them all he knew. Together they searched the body. In his fall the "Old Man" had struck his wrist watch against the edge of the table and now the hands stood jammed, pointing to 3:15. This was a clue. Inquiries telephoned to the lighthouse revealed the fact that a yacht answering the *Ventura's* description had pulled out at about 3:40 o'clock. Circumstantial evidence now all pointed toward the mysterious Mr. Strathroy. But how had he gained access to the room in the first place? And how, moreover, had he left the door and all the windows securely bolted when he had departed after committing the crime? Apparently he alone could answer.

Acting upon instructions from the chief of police, Bill broadcasted a description of the *Ventura*, and asked all vessels to keep a look out for her, since her occupants were wanted on a charge of murder. He then sent out a short account of the crime and the mystery surrounding it. Almost immediately he received the following message from the operator on the S.S. *John Hanlan*:

"Passed Windy Bay last night at 3:00 A. M. Noticed peculiar occurrence about time of murder. At 3:10 heard rumbling sound in fones. This slowly increased in volume and pitch until it became a loud shriek. It suddenly stopped at 3:15."

Bill immediately communicated this information to police headquarters but they decided that it could only be a coincidence and had no bearing on the case.

Nine days later the destroyer *Nimrod* overtook and arrested the yacht *Ventura* half way across the Pacific, headed for China. The sole occupants were three men, old Mr. Strathroy and two sailors. On board the yacht was found a very complete radio laboratory, including a two kilowatt transmitter. Upon being accused of the murder Strathroy broke down and confessed. His story, as it appeared in all the newspapers on the Continent, ran as follows:

"Ten years ago a man named John Nesbitt defiled my daughter—my only child. I swore I would never rest until I had brought about his death. I bought a yacht and cruised around the world in quest of him. A month ago I accidentally learned that he was chief operator at the Windy Bay station and was living under the name of Ralph Conway. I immediately set out for Windy Bay and visited the wireless station during his absence. While the operator on duty was out of the room getting me some coal-oil I changed the fones for a pair I had brought with me. Inside one of these fones there was a small steel tube containing a .22 calibre bullet and a charge of gunpowder. Through the powder there

# A NEW WIRELESS SHOP PRODUCT

HERE'S THE COMBINATION YOU HAVE BEEN LOOKING FOR

HIGHEST QUALITY, BEST RESULTS AND LOWER PRICE

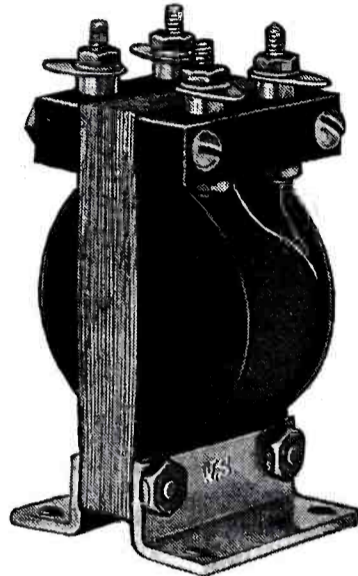

All of these three features are incorporated into the NEW WIRELESS SHOP AUDIO FREQUENCY AMPLIFYING TRANSFORMER.

**QUALITY.**—Best silicon steel core, die cut. A special type of lamination of our own design. Shell core construction insures results.

**WINDINGS.**—Standard Navy Specifications. Wound with best grade of pure enameled copper wire, perfectly insulated between layers. Windings are protected from laminations on each by die cut Formica washer. Terminals are mounted on Formica strip, and solder lugs are provided. Transformer is secured to your panel by aluminum angles.

**RESULTS.**—Fully guaranteed to be equal to the best. Entire satisfaction is the policy of everything manufactured and sold by "THE WIRELESS SHOP."

**PRICE.**—And BEST OF ALL, the price is ONLY \$6.50, fully mounted as shown. The unmounted type, without aluminum mounting angles sells for \$5.50, and with angles, attached, at \$5.80.

Postage and insurance extra. Shipping weight 1 lb.



511 West Washington Street

Los Angeles, Cal.

"EVERYTHING IN RADIO"

**WESTERN RADIO ELECTRIC COMPANY**

SEND FOR OUR MARCH

**STOCK BULLETIN AND PRICE LIST**

550 South Flower Street

Los Angeles, Cal.

Brass Binding Posts - 5c each  
Switch Points, nickle - 4c each  
Battery Rheostats - - - \$1.00

No order for less than 6 Binding Posts or 6 Switch Points accepted.  
All kinds of Wireless Supplies.

**DREYFUSS SALES CORP.**

4th Floor, 150-152 Chambers St. New York, N. Y.

**RADIO CLUB PINS**

Special folder of designs and prices in addition to regular school pin and ring catalog free on request. Be sure to see these new numbers which will put new life in your club  
Metal Art's Co., Dept. 11, Rochester, N. Y.



Have you something to sell or exchange? A classified ad in *Radio News* will reach 40,000 for only 6 cents a word.



## RHAMSTINE ★

RADIO PRODUCTS



**AUDIO FREQUENCY  
AMPLIFYING TRANSFORMER  
Mounted \$3.50**

ADD 10¢ FOR POSTAGE AND PACKING

Made of the very best materials.—laminated core of silicon steel, bakelite binding post supports, ratio of primary and secondary turns of the machine made coil accurately determined and thoroughly tested. The one-piece base is swivel mounted. All brass parts nickel plated and polished. Circular completely describing the transformer upon request.

**GUARANTEED SATISFACTORY.**  
**ORDER YOURS TODAY!**  
Dealers write for discount.

**J. THOS. RHAMSTINE★**  
2152 E. Larned St. Detroit, Mich.

Amplifying Transformers—Plugs and Jacks.

## New Device to Obtain AC from a DC Source

(Continued from page 771)

**A. C. COLLECTOR BRUSHES.**

The alternating current collector brushes are each of 3-ply 30 gauge bronze strip mounted upon inclined bases or standards, as shown in Figs. 4 and 5. The two resistors are made separately—each of No. 20 bare alloy No. 193 resistance wire wound into shallow slots cut along the edges of slate forms measuring  $5\frac{3}{4}$ " x  $9\frac{1}{2}$ " x  $\frac{3}{8}$ ". These slate panels are damaged school black-boards. Twelve slots for each inch of length were cut into the edges with a 23 gauge fine toothed hack saw. Machine screw terminals are mounted at each end. The coil is tapt on the twelfth, twenty-fourth, forty-eighth and last turn by twisting out a small loop of resistance wire and soldering in a short length of heavy copper wire. Both slate panels are bound by brass tie-rods, one of which passes thru the wooden brackets, while two angle braces support the outer ends upon the base.

The rotary brushes are mounted upon a Formica disc  $5\frac{1}{2}$ " x  $\frac{1}{4}$ ". The disc is attached directly to the pulley face with three 8-32 machine screws, the heads of which are countersunk  $\frac{1}{16}$ " below the panel or

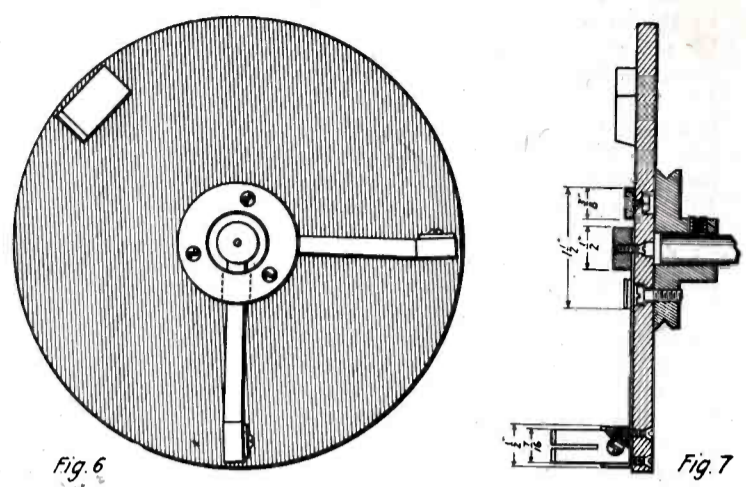

Sketch of the Revolving Disc on Which Are Fixed the Brushes.

disc surface. The revolving brushes are carried upon strong brass bases each  $\frac{3}{8}$ " high,  $\frac{1}{2}$ " long and  $\frac{1}{4}$ " thick. These are secured by two 4-36 machine screws, and connected to the central distributing rings by narrow strips of bronze. One distributing point is a cylinder of brass  $\frac{1}{2}$ " wide and  $\frac{1}{4}$ " high. This is attached by a strong machine screw from the disc center. A ring of brass  $1\frac{1}{2}$ " in diameter is also mounted about the center and connects with the remaining brush. An opening in the under side of this ring passes the bronze strip leading to the central contact point as shown by the dotted lines in Fig. 6. Sketches of the rotary parts are included in Figs. 6 and 7. The rotary commutator brushes are 4-ply 36 gauge phosphor bronze strip. All are soldered at one end to prevent spreading.

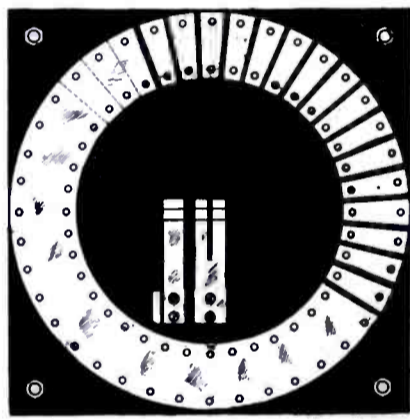

This Drawing Shows the Heavy Copper Contacts Fixed on an Insulating Panel.

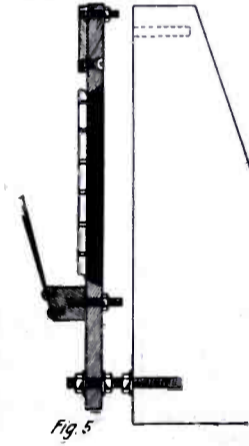

This converter was designed to function efficiently at 500 watts output. Consequently the design is for application to transformers of  $\frac{1}{2}$  KVA or less. This efficiency limitation may be clearly understood

(Continued on page 834)

## Learn Mechanical DRAWING

**EARN \$35 TO \$100 A WEEK**

Are you earning less than this amount? If so my offer will interest you. I offer to give you a thorough, practical training in mechanical drawing by mail, in your spare time, at home. Course includes highest quality set of instruments and Drafting equipment. I guarantee to give you a thorough, practical training that qualifies you for a high salaried position as a professional Draftsman. My graduates are making good with big concerns everywhere. Write for free book of information "Your Future in Drafting". Roy C. Clatun, Pres.

Columbia School of Drafting, Dept. 1459,  
14th and T Sts., Washington, D. C.

You can be quickly cured, if you

## STAMMER

Send 10 cents for 288-page book on Stammering and Stuttering. "Its Cause and Cure." It tells how I cured myself after stammering 20 yrs. B. N. Bogue, 870 Bogue Bldg., 1147 N. Ill. St., Indianapolis.

## THE TURNEY SPIDER-WEB INDUCTANCE

**A compact, efficient short wave coil set**



**WHAT WE CLAIM—**

- 1 Practically no magnetic leakage, which means more mutual inductance and stronger signals.
- 2 Less distributed capacity than any form of lattice winding which means finer tuning.
- 3 Occupies much less space than any other form of winding.

**PRICE NOW \$8.00**  
The Best \$8.00 Worth of Radio You Ever Saw.

PACIFIC COAST AGENTS  
**HERROLD LABORATORIES**  
SAN JOSE CALIF.

Tunes 180-400 Meters

Illustration shows front of cabinet removed.  
Patent Pending  
Dimensions,  $4\frac{1}{2}$  x 5 x  $1\frac{1}{4}$

Ask Your Dealer to Show You ONE or Send Us \$8.00 plus Postage and We Will Ship Same Day Order is Received.

**Eugene T. Turney Laboratories, Inc.,** RADIO HILL, HOLMES, NEW YORK

## The Death Dash

(Continued from page 825)

ran a very fine resistance wire. Wireless signals of average strength would pass through harmlessly but any extremely loud ones would heat the resistance wire. If these signals were continued for several minutes in the form of a long, unbroken dash, the wire would become sufficiently heated to ignite the powder. This would discharge the bullet into the head of any person who happened to be wearing the fones at the time. The force of the explosion would also wreck the fones, thus destroying all evidence. I went back to my yacht, which was lying at anchor almost directly beneath the wireless station. There I waited, for I had learned that Nesbitt, or Conway as he called himself, would be on duty that night from midnight till eight in the morning. At ten minutes past three I started the engine that supplies power for the two kilowatt transmitter. I then held my key down and as the engine gained in speed the power increased. At three fifteen I released the key and shut off the engine. For I knew that Nesbitt was dead. I then weighed anchor and set out for China. That is all I have to confess. You can do what you like with me now, my mission is accomplished."



# ANOTHER *MAGECO* TRIUMPH

**TYPE R. V. O.  
VARIOMETER  
for  
MOUNTING**

Complete as  
illustrated

**Price, \$7.00**

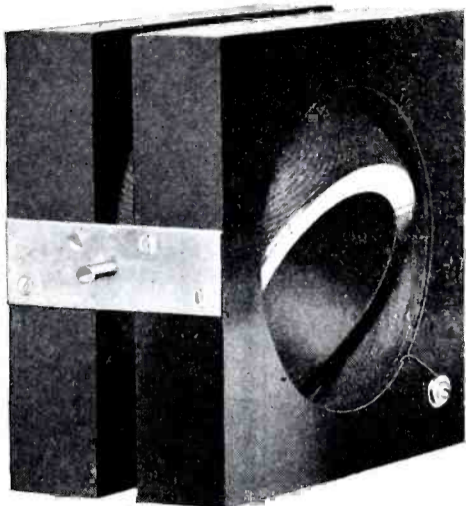

The latest addition to the MAGECO family is our TYPE R. V. O. Variometer adapted for table or panel mounting. Constructed of Hard Maple, nonshrinkable and with green silk wire. Bushings are of brass. Accuracy of assembly prohibits all wobbling.

**TYPE R. V. O. VARIOMETER PARTS** \$4.00  
with Blue-print and Instructions, Complete

**TYPE V. C. O.  
VARI-COUPLER  
for Table or Panel  
MOUNTING**

Complete as  
illustrated

**Price, \$6.50**

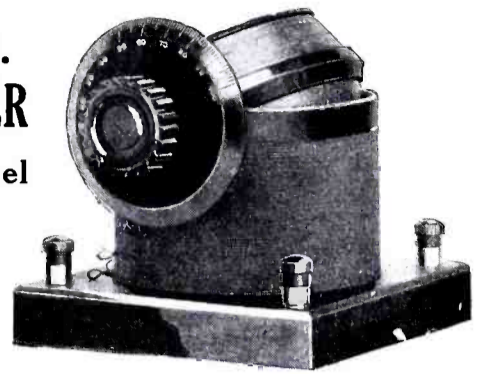

HERE is a true Variable Coupler for the Radio Man who desires an instrument to stand the acid tests of Radio work.

Primary consists of 42 turns of 6 turns and single turns each wound on Formica tubing. Brass bearings support the Hard Maple Rotor revolving with very close coupling. For panel mounting remove the base and mount.

Send us your panels and we will Engrave them for you at, per letter, **6¢**

**DEALERS, HAVE YOU OUR PROPOSITION?**

*Send 10 cents for Catalog*

**THE MARSHALL-GERKEN CO. 25 Radio Bldg., Toledo, Ohio**

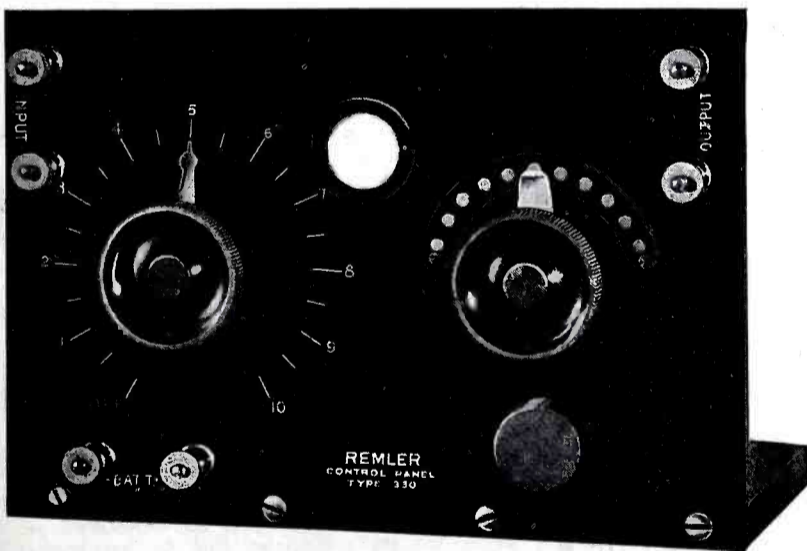

## REMLER TYPE 330 VACUUM TUBE CONTROL PANEL

**FOR THE NEW TYPE C-300  
DETECTOR TUBE**

*Maximum Value and Quality Through  
Quantity Production*

**THESE SPECIFICATIONS SPEAK  
FOR THEMSELVES**

Genuine bakelite, highly polished, 5" x 7 1/4". White filled engraving. Special smooth running rheostat back mounted. All bakelite VT socket. The new Remler positive metal contact potentiometer for controlling plate voltage. Variable grid leak. Fixed grid condenser. Busbar wiring. Hardwood base. All metal parts polished nickel ..... **Price \$8.00**

**DEALERS:** Send for our trade proposition on Remler Apparatus.

*"Apparatus that Radiates Quality"*

**REMLER RADIO MFG. COMPANY**  
163 Sutter Street, San Francisco, Cal.

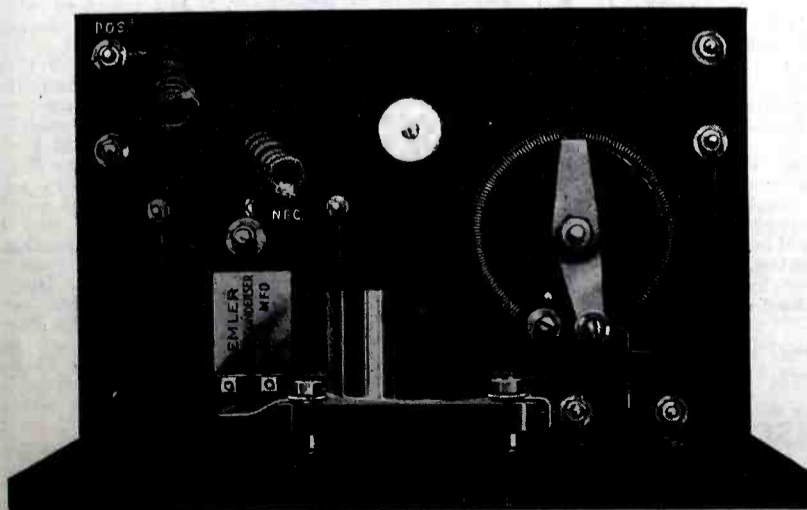



## CO-OPERATIVE RADIO PURCHASING

Members of this association participate in the profits which have accrued through their own and fellow amateurs' combined purchases. In addition to this dividend our service is unexcelled. You also can secure this service and share in

our profits. Order direct from this ad or send a stamp for full particulars. Remember "We take pride in our service." The items listed below are but a few of the items which are carried in stock.

- RADIOTRON TUBES**  
 UV-200 Gas Content Detector \$5.00  
 UV-201 Pilotron Amplifier 6.50  
 UV-202 5 Watt Transmitter 8.00  
 (We supply full directions with either detector or amplifier.)
- AMPLIFYING TRANSFORMERS**  
 Clapp-Eastham type QO unmounted 4.00  
 Clapp-Eastham type QO mounted 6.50  
 Acme A2 with binding posts 5.00  
 Acme core & coil assembled 4.50  
 Acme A2 fully mounted 7.00  
 U. V. 712 1st Price 7.00  
 Mfg. by Radio Corp. of America.
- CONDENSERS**  
 Connecticut .001 encased \$6.50  
 Connecticut .001 panel type 6.50  
 Chelsea No. 1 encased 5.00  
 Chelsea No. 2 encased 4.50  
 Chelsea No. 3BD with dial for panel 4.75  
 Chelsea No. 4BD with dial for panel 4.25  
 Murdock No. 366 .001 encased 4.75  
 Murdock No. 367 .0005 encased 4.50

- TELEPHONES**  
 Brandes Superior with Navy band \$8.10  
 Brandes Trans-Atlantic with Navy band 12.00  
 Brandes Navy type with Navy band 14.00  
 Western Electric type 1002A 15.00  
 Murdock No. 55, 2000 ohms 4.50  
 Murdock No. 55, 3000 ohms 5.50
- AUDION CONTROLS**  
 Clapp-Eastham ZRD detector panel \$12.00  
 Acme Y-1 detector 10.00  
 Adams Morgan No. 70 control 6.00
- SHORT WAVE SET MATERIAL**  
 Clapp-Eastham ZRV Variometer, without dial \$5.75  
 Clapp-Eastham ZRV Variometer, with 3-inch dial 6.50  
 Clapp-Eastham ZRC Variocoupler, with knob & dial 7.50  
 Clapp-Eastham ZRC Variocoupler, with switch and points 9.00  
 J. J. Nightingale Variometer 4.50  
 J. J. Nightingale Variocoupler 5.00

- Murdock G or P Variometer No. 345 7.50  
 Murdock Variocoupler No. 346 8.50
- STORAGE BATTERIES**  
 Marko 6 volt 20-40 ampere hour \$14.60  
 Marko 6 volt 40-60 ampere hour 18.00  
 Marko 6 V. 60 A. H. Ford type 17.10  
 Marko 6 V. 80 A. H. Ford type 21.60  
 Marko 8 volt 20-40 ampere hour 18.70  
 Marko 8 volt 40-60 ampere hour 25.40  
 Marko 12 volt 20-40 ampere hour 29.30  
 Marko 12 Volt 40-60 ampere hour 36.00  
 (On all storage batteries add Excise Tax of 5%)
- "B" BATTERIES**  
 Standard 22½ volts, small \$1.50  
 Standard 22½ volts, large 2.65  
 Standard 22½ volts, large variable 3.50  
 Cyclone 22½ volts, small 1.25  
 Cyclone 22½ volts, large 2.40

**MUTUAL PURCHASERS ASSOCIATION** 2 STONE ST., NEW YORK CITY

## A "DX" COMBINATION RAY-DI-CO "HYLO"

The Radiotron U. V. 202 tubes and a

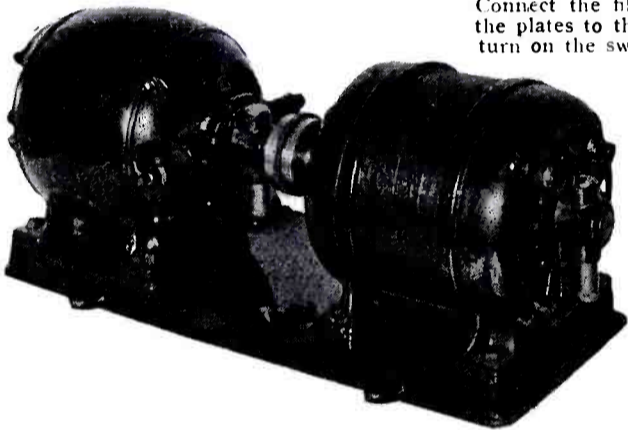

Connect the filaments to the low voltage side and the plates to the high voltage side of the "HYLO," turn on the switch and watch the "calls heard" list.

Motor—110 volts A.C. or D.C. as desired.

Made in capacities from 30 watt 375 volts for \$93.30, to 175 watt 500 volts at \$154.00, f.o.b. Chicago.

The "HYLO" generator can now be supplied separately.

All RAY-DI-CO motor generator products are FOUR BEARING machines, manufactured and designed in full accordance with A. I. E. E. specifications.

Rated Voltage Delivered at Full Load, Continuous Service

**RAY-DI-CO**

(Ray-Dee-Ko)

2653A N. Clark St.

Radio 9 AG

Chicago, Ill.

H. H. Buckwalter, 713 Lincoln Street, Denver, Colo.

Representative for

Colorado, Wyoming, Utah, Nebraska, western Kansas and northern part of New Mexico, Deadwood and Lead, South Dakota.

## Averaged 82% out of a possible 90%

The 13 students who made this record were not "picked" or specially "coached," but taken in the order in which they graduated and appeared for government examination.

Thirteen graduates of the MASSACHUSETTS RADIO and TELEGRAPH SCHOOL during the Six Weeks' examination period between November 1st and December 15th, 1920, established this record on their U. S. Government Examinations for First Grade Commercial Operator's license. Their average attendance was 5.1 Months.

The fact that a new United States Radio Inspector did the examining, using new and original questions unfamiliar to the graduates, speaks all the more favorably of our system and methods.

To produce Thirteen graduates, who, within the short period averaging a little Over Five Months, obtained such a high average, is the best way we know of to convince you of the merits of this school. Results Count.

Names, addresses and full data sent on request to anyone.

Why not avail yourself of this service. It costs no more. SEND FOR FREE LITERATURE.

**MASSACHUSETTS RADIO AND TELEGRAPH SCHOOL**  
 18 Boylston Street, Boston, Mass. Tel. Beach 7168

R. F. TROP

G. R. ENTWISTLE

## A New Radio Bill

(Continued from page 795)

Seventh. Such licenses shall contain such other conditions, not inconsistent with this Act, as the Secretary of Commerce may prescribe.

Sec. 10. That any station licenses shall be revocable by the Secretary of Commerce for failure to operate service substantially as proposed in the application and the license; or for violation of or failure to observe any of the restrictions and conditions mentioned in the preceding section or other provisions of this Act or regulation of the Secretary of Commerce and such books and records of the licensee as contain entries showing whether or not the provisions of this Act are being observed shall be open at all times to inspection by officials of the Department of Commerce to assist them to determine whether such violation or failure to observe has occurred: *Provided*, That before a license is revoked the licensee shall be afforded opportunity to present evidence in his behalf to the Secretary of Commerce. Upon revocation of a license the Secretary of Commerce shall issue a statement to the licensee assigning the reasons for such revocation.

Sec. 11. That the actual operation of every radio station for which a station license is required by this Act shall be carried on only by a person to whom an operator's license shall have been issued hereunder. No person shall operate any such station except under and in accordance with an operator's license issued him by the Secretary of Commerce. The Secretary of Commerce, in his discretion, may grant special temporary licenses in such form and upon such conditions as he may prescribe, to operators of radio apparatus when an emergency arises requiring prompt employment of such an operator. Whoever shall employ any unlicensed person in the operation of any licensed radio station, or whoever without an operator's license shall operate such a station, shall be punished by a fine not exceeding \$100 for the first offense, and by a fine not exceeding \$200 or imprisonment for not more than two years, or both, for each offense thereafter: *Provided*, That this section shall not apply to the use of radio telephone stations regularly licensed for public service.

Sec. 12. That an operator's license shall be issued only in response to a written application therefor addressed to the Secretary of Commerce, which shall set forth the name, age and address of the applicant, date and place of birth, the country of which he is a citizen, and, if a naturalized citizen of the United States, the date and place of naturalization. The application shall also state the previous experience of applicant in operating radio apparatus and such further pertinent facts or information as may be required by the Secretary of Commerce. Every application shall be signed by the applicant upon oath or affirmation. An operator's license shall be issued only to a person who, in the judgment of the Secretary of Commerce, is shown to be proficient in the use and operation of radio apparatus and in the transmission and receipt of radiograms. Except for the operation of a station on shipboard, an operator's license shall not be granted to any alien, nor shall such a license be granted to a representative of a foreign Government for the operation of any radio station. Whoever shall knowingly make any untrue statement in an application for an operator's license shall be guilty of perjury, and shall be punished by a fine of not exceeding \$2,000, or by imprisonment for not more than five years, or both.

Sec. 13. That an operator's license shall be in such form as the Secretary of Commerce shall prescribe, and may be suspended by him for a period not exceeding two years, upon proof sufficient to satisfy him that the licensee has violated any provision of this Act or regulation of the Secretary of Commerce, or that he has failed to comply therewith by an unlicensed person under his supervision, or that he has been willfully negligent, or has failed in carrying out the lawful orders of the master of the vessel on which he is employed, or that he has willfully damaged or permitted apparatus to be damaged. The license may be revoked by the Secretary of Commerce upon proof sufficient to satisfy him that the licensee was at the date his license was granted to him or is ineligible for a license.

Sec. 14. That during any war in which the United States shall be a neutral nation, the President by appropriate regulations may establish such control over the operation of radio stations within the jurisdiction of the United States as may be necessary to prevent violation of the international obligations of the United States and in time of threatened or actual war in which the United States may be a party, or in time of public peril or disaster, upon proclamation thereof, the President may cause the temporary closing of any radio station within the jurisdiction of the United States and the temporary removal therefrom of any radio apparatus for the period of the war or the time of such public peril or disaster, or he may authorize the temporary use of the station or the apparatus by any department of the Government for the like period. In case of any action under this section, just compensation shall be paid to the owners, lessees, licensees, and others interested, as their several interests may be determined.



Condenser  
No.  
3

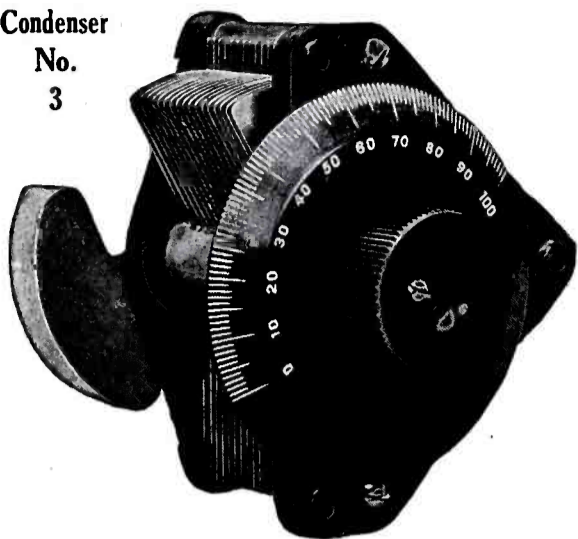

# CHELSEA

Variable Condensers  
(Die-Cast Type)

No. 1.—.0011 m. f. mounted.....	\$5.00
No. 2.—.0006 m. f. mounted.....	4.50
No. 3.—.0011 m. f. unmounted.....	4.75
No. 3.—.0011 m. f. unmounted, without dial .....	4.35
No. 4.—.0006 m. f. unmounted.....	4.25
No. 4.—.0006 m. f. unmounted, without dial .....	3.85

Top, bottom and knob are genuine bakelite, shaft of steel running in bronze bearings, adjustable tension on movable plates, large bakelite dial reading in hundredths, high capacity, amply separated and accurately spaced plates.

Unmounted types will fit any panel and are equipped with counterweight. Purchase from your dealer; if he does not carry it, send to us.

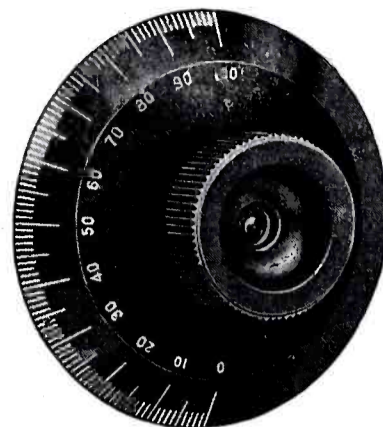

"CHELSEA" BAKELITE DIAL NO. 41.

The Chelsea dials are made of genuine bakelite, beautifully finished, and bear a 100 division semi-circular scale.

The dial is 3 3/4 inches in diameter, 1/4 inch thick, with a long, sloping, easily read marking. Chelsea bakelite dials run true and will not warp.

The complete dial and knob is made to fit either 3/16, 1/4 or 5/16 inch shaft. Specify size when ordering, otherwise the 1/4 inch hole will be furnished.

Chelsea dials are beautiful in appearance, low in price, accurate and durable in service, unexcelled by any, at any price.

Dial and knob complete..... 1.00

Purchase from your dealer.

## VARIABLE GRID LEAK

Permits the selection of the proper leak resistance regardless of the type of tube, or its use as detector, amplifier or oscillator. Ten steps give a range from 1/2 to 5 megohms. Genuine bakelite base and knob.

All our apparatus embodies the highest degree of mechanical construction, electrical efficiency, and good appearance.

Purchase Chelsea Apparatus from your dealer

NEW MARCH BULLETIN SENT UPON REQUEST



PRICE \$3.00

# CHELSEA RADIO CO., 17 Fifth Street, Chelsea, Mass.

Manufacturers of Radio Apparatus and Moulders of Bakelite

All your friends <sup>WANT</sup> <sub>TO</sub> hear that Radiophone Music

—But So Many Phones Cannot Be Placed In One Circuit

## THE RADIO MAGNAVOX

will solve your problem and allow everyone to listen in. With suitable amplifiers the signals and music can easily be heard by all. Remember that full field current need not be used except for the very weakest signals, or when extreme volume is necessary.

Price \$45 at your Dealers

Don't forget that Magnavox radiophone transmitters will enable you to utilize the full power of your set.

**THE MAGNAVOX COMPANY**  
OAKLAND, CALIFORNIA





# AT EASE!!

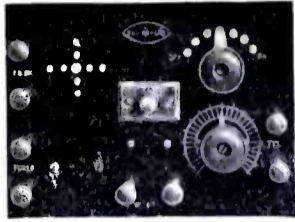

Type 2D—\$10.50



Eveready B Bat.—\$5.00

Why worry about the High Cost of Apparatus, when we are on duty to supply you? We have placed this panel on the market with a view to supplying the amateur with a panel which combines low price and high quality. This panel has all the good features of the old Type D and many others, including smaller size, and a filament fuse.

We also offer the Eveready tapped B battery, which is put up in a wooden moisture-proof case. This greatly lengthens the life of the battery. Has six taps brought out to binding posts on the front. It is very convenient for use with the new soft tubes on the market.

Dealers write us for sales proposition  
Send for bulletin

**EVANSVILLE RADIO LABORATORY**  
1103 S. THIRD STREET  
EVANSVILLE INDIANA

## All Parts for the Amateur

ORDER NOW

- DL Coils, unmounted, 1/2 price.
- Federal Ampl. Transformers, \$7.50; Acme semi-mounted, \$5.00.
- Bakelite, cut to order. Quotations given.
- Panel Rotary Switches 20c, 50c, 60c, and 75c All the best made.
- Series—Parallel Switches, nickel 85c.
- Contact Points 1/4" x 1/4" nickel, threaded shank with nut, 50c doz.
- Contact Points 7/16" x 7/16" brass, with screw, 20c doz.
- CW Tuska Coils, \$7.00, \$9.00, \$11.00.
- Murdock Osc. Transformers, \$5.00
- Paragon Audion Panel, \$6.00; with bulb, "B" battery, grid condenser and leak—most complete outfit for \$12.00.

*We have everything in stock that  
is wanted by Radio Enthusiasts.*

**American Electro Technical Appliance Co.**  
Dept. R. 235 Fulton Street New York City

### Special Introductory Offer of the Bronx Radio Equipment Co.

- 6 volt—60 ampere Storage Battery same as U. S. Gov't specifications for radio airplane work.....\$10.00
- 40 Ampere Storage Battery..... 8.50
- B Batteries, large type..... 1.75
- B Batteries, small type..... .95
- "Special" Electrode Insulators, 7 1/2" x 1/2" column, navy type, each .50
- Navy Type Receiving Sets, original price \$245; our price.....\$50.00 up
- Bakelite cut the size you want it. One-quarter inch thick, 8c per square inch.

Mail Orders Promptly Filled

**BRONX RADIO EQUIPMENT CO.**  
687 Courtlandt Ave. NEW YORK CITY  
Agents for Murdock, Federal, Acme and Others.

### SOUND METHOD FOR MEMORIZING THE CODE

NEW METHOD BETTER RESULTS

Easiest, quickest and most thorough ever devised for learning without instruments.

If you want to learn the code—

If you want to "clinch" the signals you can't remember easily—

If you want to help some one else learn the code—

GET ONE OF THESE CARDS.

Don't try to teach the Ears through the Eyes. This system teaches the signals as they come through the Head Phones. Contain both Continental and American Morse—Printed on Celluloid—Fit Your Pocket.

Price 50c

**WIRELESS PRESS, Inc., 326-A BWAY, NEW YORK**

SEC. 15 (a) Whoever shall maliciously or willfully interfere with or cause interference with radio communication carried on or sought to be carried on by any duly licensed or Government radio station or apparatus shall be punished by a fine not exceeding \$500 for the first offense, and by a fine not exceeding \$1,000 for each offense thereafter.

(b) Whoever shall receive or assist in receiving, with intent to divulge or publish, the contents, substance, purport, effect, or meaning of any radiogram, or any part thereof, so received, to any person other than the addressee thereof, his agent or attorney, or in the case of intercepted messages which the person receiving was not authorized by the sender to receive and deliver to the addressee thereof, his agent or attorney, except to a telegraph or radio station employed to forward such radiogram to its destination, or to proper accounting or distributing officers of the various communicating centers over which the radiogram may be passed, or to the master of a ship under which he is serving, or in response to a subpoena issued by a court of competent jurisdiction, or on demand of other lawful authority; and whoever, not being entitled thereto, shall receive or assist in receiving any radiogram with the intent to use the same or any information therein contained for his own benefit or for the benefit of another; and whoever, having received such radiogram or become acquainted with the contents, substance, purport, effect, or meaning of the same or any part thereof, knowing that such information was so obtained, shall so willfully divulge or publish the contents, substance, purport, effect or meaning of the same or any part thereof, or use the same or any information therein contained for his own benefit or for the benefit of another not entitled thereto, shall be punished by a fine not exceeding \$500 for the first offense and by a fine not exceeding \$1,000 or one year's imprisonment, or both, for each offense thereafter: *Provided*, That this section shall not apply to the receiving, divulging, publishing, or utilizing of the contents of any radiogram intended for the use of the general public or relating to ships in distress.

SEC. 16. That no person owning, controlling, or operating a licensed radio station or stations, shall form a partnership, combination, or association with any person owning, controlling, or operating submarine cables or land telegraph or telephone systems in or touching the United States or its Territories in such a way as to limit competition in communication from and to the United States, without the consent of the Secretary of Commerce.

Nothing herein contained shall prevent co-operative agreements made with the consent of the Secretary of Commerce which without undue restraint of competition, tend to further and improve the radio service.

SEC. 17. That all stations operating between ship and shore shall give priority over all other radiograms to radiograms relating to ships in distress, shall discontinue all sending on hearing a distress signal, and, except when answering or aiding a ship in distress, shall refrain from sending until all radiograms relating to the ship or ships in distress shall have been completed.

SEC. 18. That no radio station other than one belonging to or operated by the United States or by the government of the Philippine Islands shall be operated on land or on a permanently moored vessel in the Philippine Island without the consent of the government of the Philippine Islands, and no radio station other than one belonging to or operated by the United States shall be operated on land or on a permanently moored vessel in the Panama Canal Zone or in the United States territory in the Pacific Ocean west of the one hundred and sixty-first meridian of longitude west of Greenwich and south of the fortieth parallel of north longitude, or in any territory of the United States in the West India Islands, without authorization by the Secretary of Commerce.

SEC. 19. That whoever, including any person in the service of the Government, shall knowingly transmit or publish, or knowingly cause to be transmitted or published, any false or fraudulent distress radiogram, or who, when engaged in radio communication, shall transmit or publish, or cause to be transmitted or published any other radiogram for the purpose of defrauding or deceiving the Government, shall be punished by a fine not exceeding \$2,000 or imprisonment for not more than five years, or both.

SEC. 20. That no person shall use or operate any radio apparatus on a foreign ship when within the jurisdiction of the United States otherwise than in accordance with the provisions of sections 14, 15 and 17 of this Act, and all provisions of said sections and penalties thereto attaching are hereby made applicable to such apparatus: *Provided, however*, That in no other respect shall anything in this Act apply to public vessels of foreign governments otherwise than by a general proclamation of the President.

SEC. 21. That in all cases of violation of any provisions of this Act for which no penalty is otherwise prescribed, or of any regulation of the Secretary of Commerce, the Secretary of Commerce may impose a penalty of \$100 upon the owner of the apparatus by means of which such violation was effected or a penalty of \$25, upon the offending operator, or both but such penalties may be reduced or remitted by the Secretary of Commerce in his discretion, and, in addition, the Secretary of Commerce, in his discretion, may



# INTRODUCING THE PACENT UNIVERSAL PLUG



No Connections to Solder, Price \$2.00

The Only Plug *Designed* for Radio Work

(Pat. Applied for)

THE PACENT UNIVERSAL PLUG, now obtainable from your dealer, is the plug for which you have been waiting. It consists of three parts; two moulded bakelite pieces, each with a recessed finger grip, and the plug with its connecting spring clips. The two moulded pieces are held together with a single screw which fits into a threaded brass insert.

In addition to telephone headset work, the PACENT UNIVERSAL PLUG may be used very effectively for "plugging in" a microphone transmitter, manipulating

key, a loading inductance, the search coil of a wave-meter, a remote control switch, a plate battery or high voltage generator, in fact its adaptability renders its name synonymous with its uses.

The effective and practical design of the PACENT UNIVERSAL PLUG was so appreciated by the United States Navy Department, that the plug was officially approved and a most gratifying letter was received from them commending its many desirable features.

**Catalog No. 50 PACENT UNIVERSAL PLUG Price \$2.00**

Bulletin P 11 describing the PACENT UNIVERSAL PLUG and other literature describing other unique apparatus will be sent you on receipt of five cents in stamps.

Dealers—Write immediately for our liberal discounts.

SOLE DISTRIBUTORS FOR

Wicony's Complete Line of "Eventual" Apparatus

Duo-Lateral Coils

Pacent Plugs

Sullivan Apparatus

Standard VT Batteries

Dubilier Condensers

Rawson Instruments

Special Distributors for Brandes Phones

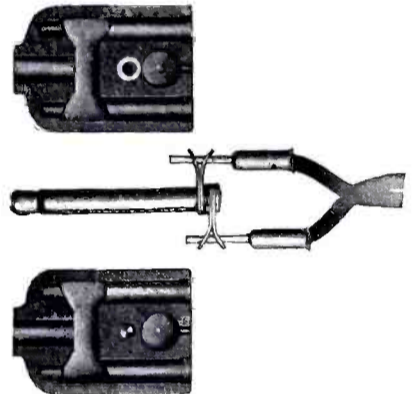

## Pacent Electric Company, Inc.

Louis Gerard Pacent, President.

150 Nassau Street

Phone Beekman 5810

New York City

# PARAGON

MEANS

"A PERFECT MODEL OF EXCELLENCE"

AND IT IS FOUND ONLY ON

RHEOSTATS  
RECEIVERS  
V. T. CONTROLS

CONDENSERS  
VARIOMETERS  
DIALS

DETECTORS  
KNOBS  
SOCKETS

SWITCHES  
AND OTHER  
SPECIALTIES

Manufactured by

## ADAMS-MORGAN CO.

### No. 70 Paragon V. T. Control

A compact control panel consisting of a standard socket, rheostat, grid condenser, grid leak and nine binding posts mounted on a moulded condensite panel. Polished nickel metal parts. A high-grade inexpensive instrument that will do as good work as the highest priced cabinet.

Price - - - \$6.00

### No. 25 Paragon Rheostat

For either panel or table mounting. Moulded condensite base. Resistance six ohms. Smooth operation. Capacity 1½ amperes. The highest grade rheostat on the market.

Price - - - \$1.75

MOST ENTERPRISING DEALERS CARRY PARAGON PRODUCTS AS REGULAR STOCK.

Illustrated Bulletins will be mailed upon receipt of a two cent stamp. Send us your dealers name.

## ADAMS-MORGAN CO.

UPPER MONTCLAIR

NEW JERSEY

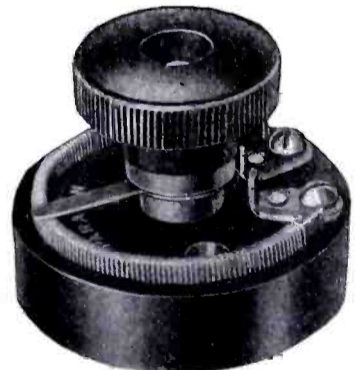
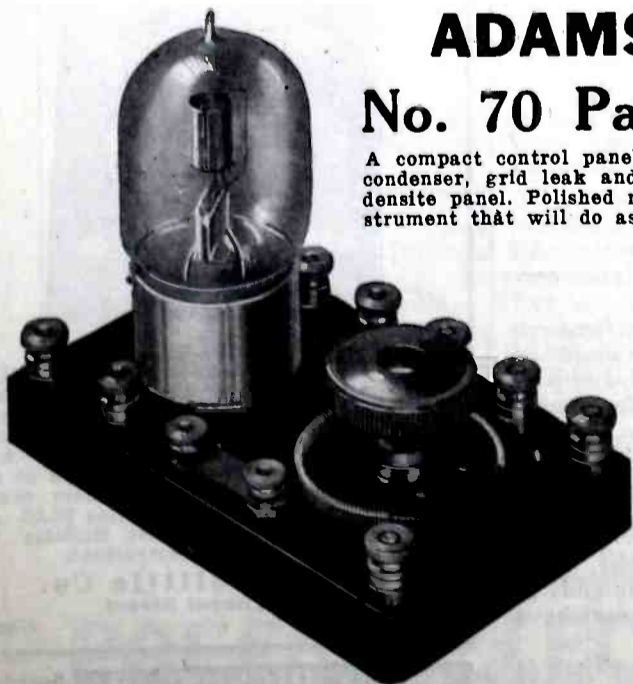



## PLATE BATTERIES! Give Your Bulb a Chance!

Economy Radioplate Batteries are genuine lighting flashlight batteries soldered together with 1/4-inch brass strip connectors which also serve as taps. We are proud of having put this battery on the market. It represents our effort to give you **Maximum Battery Quality** for your money.

Two sizes, you know best if you need either or both.

Ersco No. 503 22 1/2 Volts, Price \$2.00

Ersco No. 803 36 Volts, Price \$3.20

Made for Long Life and Heavy Duty.

"Always Something Doing" with

Ersco Batteries on your plate.

Don't forget our Black Fiber Panels.

Paragon size 7 x 20 x 1/4 inches, price

\$3.00 or cut to any reasonable size at

2 1/2 cents per square inch.

Make a one-step amplifier complete for

\$22. You need 1 Paragon Moulded VT

Control Panel (has socket, rheostat,

grid condenser and leak all on a base

about 5 by 3 inches), price \$6; 1 VT,

price \$7; 1 amplifying transformer,

price \$5; and 2 Ersco Radioplate Bat-

teries No. 503, price \$4. Total \$22.

We will supply these parts separately or altogether at the prices listed.

We ship parcel post paid anywhere in the United States.

Mail orders should be accompanied by remittance. Reference, Merchants and Manufacturers National Bank, Newark, N. J.

**ECONOMY RADIO SUPPLIES CO.**  
232 1/2 Sanford Street East Orange, N. J.  
"Always Something Doing"

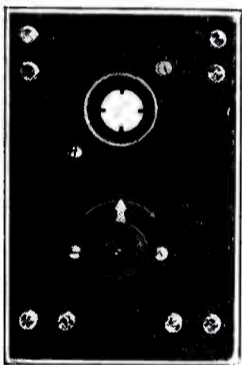

### VACUUM TUBE CONTROL UNITS

Detector unit can be adapted to any standard circuit.

Panels are of polished Formica.

Amplifier unit same size as detector. A T & H detector unit and one or two amplifier units make a combination that can't be beat. Immediate deliveries.

Prices without tubes or batteries:  
Detector, \$8.00; Amplifier, \$13.00

**T & H Radio Co., ANTHONY, KANSAS**  
Catalog on request

1/4 H. P., 110 volts, A. C., 60 cycle, single phase, 1750 R. P. M.

## MOTORS

LARGE QUANTITIES NEW WASHING MACHINE MOTORS

Shipped in original boxes. Complete as cut. Suitable for operating Office Grinders, Cream Separators, Dottle Washers, Air Compressors, Small Lathes, Etc.

Mail \$1.00 cash or Money order. We will send C.O.D. subject to full examination. Money Back Guarantee.

**\$22.75 Each**

MANUFACTURER'S DISTRIBUTOR  
CHAS. H. JOHNSTON - Box 16 W. E., Pittsburgh, Pa.

# STAMMER

If you stammer attend no stammering school till you get my large FREE book entitled "STAMMERING, Its Origin and The Advanced Natural Method of Cure," bound in cloth and stamped in pure gold. Ask for special tuition rate and a FREE copy of "The Natural Speech Magazine." Largest, best equipped and most successful school in the world for the cure of stammering, stuttering, etc. No sing-song or time beat. Write today. The North-Western School, 2266 Grand Ave., Milwaukee, Wis

revoke the station license of such owner and revoke or suspend the license of such operator, as provided in sections 10 and 13 of this Act.

Sec. 22. That all Government stations and all apparatus therein may be used for transmitting and receiving messages relating to Government business, compass reports, and the safety of ships.

Sec. 23. That any department of the United States Government is authorized to dispose of radio patent rights acquired by such department and to enter into reciprocal agreements with

(Continued on page 838)

## Awards of \$100 Portable Radio Prize Contest

(Continued from page 767)

ondary for the desired wave length, and place the two tuners bottom to bottom to magnetically couple the primary and secondary coils. When the two are squarely together we have close coupling. The coupling may then be loosened by sliding or hinging the two tuners apart, and the tuners readjusted until the desired stations are received loudly, without interference. This is the usual loose coupled connection. Waves up to 2,500 meters may be received on this adjustment, on a medium aerial.

For still longer waves keep switch "SP" open, turn primary to zero and tune with the secondary switch alone. Note that this cuts out the regular primary coil, and cuts in the secondary across condenser, detector, and fones, making the secondary now serve as a simple tuner in place of the primary. The secondary has a larger number of turns of wire than the primary and thus allows tuning up to approximately 2,800 meters, using a medium aerial.

Another way to receive longer waves is to connect the secondary in series with the aerial and primary, thus serving to load the primary. But who wants to tune over 2,500 meters spark anyway?

The outfit is made in two parts: one containing aerial and ground posts, safety gap, fone posts, posts for plugging in the secondary, primary coil and switch, a single contact switch, a mica stopping condenser and a galena detector, which are all mounted in and on a 1/2" x 2 1/2" x 4" block of hard rubber. The second part of the outfit consists of a secondary coil, and switch, posts and a flexible cord for connecting to the primary outfit, also mounted in and on a block of the same size as the first. No part of the instruments projects more than 1/8" above the surface. The first part is complete in itself and may be efficiently used alone. The second part is used usually for extreme selectivity. This design is radically new.

One face of each piece of rubber (or bakelite) is milled out, leaving a hollow 5/16" deep x 2" wide x 2 3/8" long, one-quarter inch from one end. The first piece is also milled out entirely thru leaving an opening 3/4" wide by 1 3/4" long, three-eighths inch from end, for the detector. All outer walls contain radii at their inner corners for strength.

Drill the blocks for 24 contacts for each tuner, radius 7/8". The circle should be placed as near the end of the hollowed portion of each block as possible. Very small round head copper rivets will do for contacts, if split close to the head with a thin jeweler's saw.

The construction of the small switch parts, posts, safety-gap and detector may be clearly seen from the photographs. The post screws are "upsetted" on their ends to prevent loss by unscrewing. They may have knurled heads if desired.

The center stud of each tuning switch is screwed into a hole tapped in the block, and secured by means of a 2-56 screw put half in the rubber and half in the stud.

## MAGNET WIRE

We are prepared to furnish best grade magnet wire on 1/4 and 1/2 lb. spools at the following revised prices:

### PRICE PER 1/4 LB. SPOOL

B&SGa.	Single Cotton	Double Cotton	Single Silk	Single Enameled
No. 22	\$0.58	\$0.68	\$0.82	\$0.45
No. 24	.60	.77	.67	.47
No. 26	.65	.88	.71	.49
No. 28	.75	1.10	.85	.52
No. 30	.85	1.24	.97	.53
No. 32			1.15	.55
No. 34			1.52	.59
No. 36			1.77	.69

Price on 1/2 lb. spools double above list.

All prices are net and include cost of spool and delivery charges via Parcel Post to any Post Office address in the United States; safe delivery guaranteed.

Send for Circular 21-A giving prices on other sizes, insulations and quantities of Magnet Wire. This circular lists "WIRE FOR EVERY WIRELESS PURPOSE."

**KEYSTONE WIRE COMPANY**  
P. O. Box 120 SCRANTON, PA.

## W H O

MASTERED  
CONTINENTAL CODE  
IN ONE HOUR BY  
DODGE SHORT CUT  
HALF \$ METHOD  
AND SAVED 50 DOLLARS TIME

## W H O

Our testimonial sheet gives names and addresses. Ask for free copy and investigate.

**C. K. DODGE**  
Box 200 MAMARONECK, N. Y.



### SENDING DUPLEX GAP RECEIVING

An air tight micrometer gap which makes it possible to "Break" as on a land telegraph wire. You can hear the man you are working with through your own sending. Absolutely safe and automatic—no relays on contacts. Just the thing for remote control system. Full instructions. Price \$8.00. Add postage for 1 lb. Request Bulletin 109, which describes this instrument.

**F. M. Doolittle Co.**  
817 Chapel Street  
New Haven, Conn.

**PIGEONS PAY** Easy raised, any small building, very little space required. Build their own nests, feed their own young. Very profitable business. Get your start with a few good pairs. Write today for 1921 Circular. Pigeon Supply House, Hanover, Pa.



# A-P Leads Again

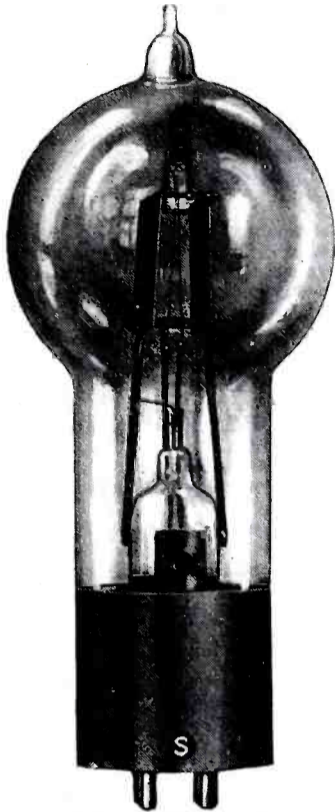

Price \$9.75 each. Order from your dealer, or write direct to either address in this ad.

## NEW RECTIFIER TUBE FOR EXPERIMENTAL CW

Come on, you CW enthusiasts! It's for you—a brand new rectifier tube for your experimental CW, which **makes the expensive high voltage DC Generator unnecessary.** Simply step up your 110 V A-C lighting supply with a small transformer to 350, 500, or 750 volts, and two of the new tubes do the rest, rectifying both halves of the cycle so the plates of your transmitting tubes get all the high potential direct current necessary—**without the use of a high voltage generator.**

**The A-P Rectifier** has a 75 milliamperere carrying capacity, which is sufficient to operate five A-P Transmitting Tubes in parallel. For high power CW transmission, use additional **A-P Rectifier** Tubes in parallel.

**A-P Rectifiers** used in Type O A-C De Forest Radiophones, equipped with the SHAW standard condensite four-prong base, and licensed under SHAW patents. **Price \$9.75.** Order from your dealer, or direct from either address below.

## DIAGRAM OF CONNECTIONS FURNISHED FREE WITH EACH TUBE

And for the best book on Radio, ask your dealer for "Elements of Radiotelegraphy," by Lieut. Stone, U. S. N., or order direct from—

ATLANTIC RADIO SUPPLIES CO.  
8 KIRK PLACE, NEWARK, NEW JERSEY

PACIFIC RADIO SUPPLIES CO.  
638 MISSION ST., SAN FRANCISCO, CAL.

Distributors for Moorhead Laboratories, Inc., Manufacturers of

# THE NEW A-P Rectifier Tube

## INTRODUCING THE DUBILIER UNIVERSAL CONDENSER

Type  
577



Price  
\$2.00

## Suitable for Transmission and Reception

Will handle 100 watts of C. W. Energy

THE DUBILIER UNIVERSAL CONDENSER is the first condenser especially designed for low power continuous wave transmitters which will also prove suitable for reception work. This condenser is made of the finest clear India Mica. Its capacity is absolutely constant and is so maintained by special spring clamps which slide on the pressure plates. This unique construction permits an extremely compact unit and the losses are so small as to be immeasurable. They are tested at 1500 volts and rated at 1000 volts so that they can be used on C.W. sets up to and including 100 watts.

The No. 577 DUBILIER UNIVERSAL CONDENSER can be supplied in practically all capacities at \$2.00 each. Bulletin D-2 Describing the DUBILIER UNIVERSAL CONDENSER, together with literature describing other high grade apparatus will be sent you on receipt of five cents in stamps.

Dealers—Write immediately for our liberal discounts

Sole Distributors for  
Wicony's Complete Line of "Eventual" Apparatus.  
Duo-Lateral Coils  
Standard VT Batteries  
Dubilier Condensers  
Pacent Plugs  
Sullivan Apparatus  
Rawson Instruments  
and Special Distributors for Brandes Phones

# PACENT ELECTRIC COMPANY, Inc.

150 NASSAU STREET

LOUIS GERARD PACENT, President  
Telephone Beekman 5810

NEW YORK CITY





**CORWIN DIALS**

The distinction Corwin Dials impart to a radio station is only exceeded by their accuracy and ease of operation. Prices are as low as economical production and efficient marketing will permit, with due regard for quality. *Outside of that, there isn't any particular reason for specifying Corwin Dials.*

3" Dial, 75c—with knob, \$1.30  
 3 3/4" Dial, \$1.00—with knob, \$1.70

*At all Radisco agencies, and other reliable dealers, or sent postpaid anywhere*

**A. H. CORWIN & CO.**  
 4 West Park St., Newark, N. J.

**mica grid condenser**

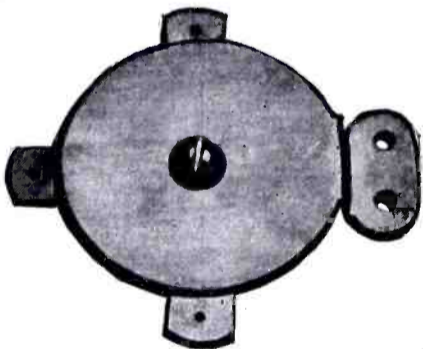

**SCRAP** your old-fashioned paper condenser. Put in an **ABC** Genuine mica grid condenser. The Navy barred paper in favor of mica years ago!

The mica condenser shown cuts dielectric loss to a minimum. Besides, it gives you **3 capacities**—an exclusive feature. Yet the price is only

**75 cents postpaid**

It's an **ABC** Standardized product,—an example of "Professional equipment at amateur prices." It's backed by the **ABC** guarantee,—"Your money's worth or your money back!"

Cut out inefficiency! Get a mica condenser. **Mail the coupon today!**

Wireless Equipment Co., Inc.,  
 32 Austin St., Newark, N. J.  
 Enclosed find 75 cents. Send me by return mail one of your guaranteed, genuine mica grid condensers.  
 Name .....  
 Address .....  
 City ..... State .....

The condenser is composed of 20 leaves of mica approximately .002" thick by 3/8" wide by 1 1/8" long with lead-foil intervening. The margin should be 1/16". Assemble in hollow at one edge of first block.

The coils are pancake shaped, irregularly wound to secure the advantage of low distributed capacity between turns as in the honeycomb coils. The leads are brought out very easily at the proper location relative to the contacts with which they are soldered, by winding the coil on the form, see Fig. 2.

The form is placed in a breast drill which is held in a vise. See Table, Fig. 3.

After winding, place in a pan of hot paraffin wax. After letting it get cold remove from form and we have a solid block coil 1/2" diameter inside, 1 1/2" diameter outside, 3/16" thick for the primary and 1/4" thick for secondary.

Place coils in the corresponding blocks with leads outermost and carefully solder to contacts. The leads should not cross if properly wound. The coil rests inside the circle of contacts.

After connecting all parts, screw on a bottom of hard rubber or transparent celluloid 1/16" to each block. On the primary block this bottom should not cover the opening under the detector. The inside of each block may be filled with wax if desired. This will make the outfit water proof.

All metal parts should be nickel, silver or gold plated before assembling. A single head receiver may be used without headband for extreme compactness.

If desired, an audio frequency amplifier may be connected in place of fones, or a miniature audion detector used in place of mineral detector for still further ranges. The secondary turner may be used to form an amplifying regenerator. This, however, defeats the main purposes of the outfit.

These turners may be wound for waves from approximately 1,200 meters to 4,800 meters by using wire No. 36 S.S.C. in the coils.

**New Device to Obtain AC From a DC Source**

*(Continued from page 826)*

where one understands the co-ordination of primary reactance and resistance. To deliver impulses of progressive values, the resistances of the converter must be calculated in conjunction with the impedance factors used for a specific power in order that the cyclic increments may be uniform. Hence, for one kilowatt transformers, best operation would require minor changes in the resistance values of the converter. This converter has been used successfully with 1/4, 1/2, and one kilowatt transformers. The spark is remarkably clear, steady and musical. A rotary synchronized discharger gives a powerful even musical note. A very efficient synchronous transmitter could be built upon this principle by also revolving a four point disc discharger with the converter rotor. In all tests, the antenna current is the same either for commercial or converted alternating current from the machine.

Before beginning work upon this set, it was assumed that others might be limited to very few tools. Every part has been built without recourse to a machine shop or powered tools. In conclusion I might add that the possibilities of such a converter principle are not limited to 60 cycle current; for with greater commutator circumference and greater power at the motor, 500 cycle could be very easily produced by a similar machine. This could find practical application to tube transmitters.

**BACK TO OLD PRICES**

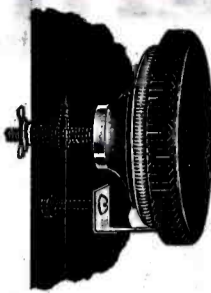

**PARKIN RHEOSTAT**

5000 sold last year at \$1.00

NOW REDUCED TO

**75c**

Due to the general drop in the prices of raw material and to our large production, we have been able to reduce all our prices to their pre-war level, and in some cases even lower.

New Catalog No. 5, listing our complete line, sent free.

Here are a few of the items:

No.	Postpaid
31 Audion panel with rheostat and B battery switch	\$8.00
43 45 volt large B battery	5.00
50 PARKIN .001 mf. variable condenser, unit only	1.50
51 PARKIN .001 mf. V.C. with knob and pointer	2.00
52 PARKIN .001 mf. V.C. with knob and 3" dial	2.50
53 PARKIN molded bakelite fixed condenser	.70
UV 200 New Radiotron vacuum tube	5.00

DEALERS—If you are not on our mailing list, write for new catalog and discounts.

**PARKIN MFG. CO., San Rafael, Calif**



**AJAX LEARNERS KEY & BUZZER SETS**

"built for service" with code \$1.75

"HYTONE" BUZZERS 60c

external tone adjustments  
 "as good as the best"

**AJAX ELECTRIC CO.**  
 Palmer St. Cambridge, 38, Mass.

**RADIO and MODEL ENGINEERING**

Edited By M. B. SLEEPER

A bulletin of designs and data for the radio experimenter of average means and shop equipment.

Out on the First of Each Month

Send Twenty-five Cents for May, June and July Issues

Published by  
**GENERAL APPARATUS CO., Inc.**  
 570-N West 184th St., New York



**LEARN WIRELESS**

at the largest radio school in the Central States. Modern complete equipment. Experienced instructors. Dormitory in connection. Students may earn expenses if necessary. Write today for catalogue and full information.

**CENTRAL RADIO SCHOOL**  
 Independence, Mo

**FOR ONE MONTH ONLY**

In order to introduce the Radeq Control Panel to the Amateur, we offer these panels complete with tube and B battery for \$15. Add parcel post charges for four pounds. Radio Equipment designed to use apparatus you have on hand. Send specifications for estimate.

**A. C. PENFIELD** Conneautville, Pa.







# More Amplification for less Money



Price \$5.00

"Saco-clad" Amplifying Transformers are of the totally enclosed Shielded Shell Type. Primary and secondary winding ratio 1 to 4.75, giving a far greater voltage amplification than with existing marketed Transformers. The Primary impedance is equal to the filament-plate impedance of the standard market three element Vacuum tube.

You can now build Multi-Stage Amplifiers without howling or squealing. The "Saco-clad" amplifying transformer is the smallest transformer made, its physical dimensions being 1-5/16" in diameter and 1 1/2" in height. Shipping weight, 1 lb.

**Hudson Radio Company**  
182 Pulaski Street Brooklyn, N. Y.  
Manufacturers and Distributors of Superior Radio, Electrical and Laboratory Apparatus.  
SOLE DISTRIBUTORS OF "SACO" PRODUCTS

## Concerts Every Night!

Easy when you know how. Ask us. Our special offer during May and June on parts for DETECTOR AND 2-STEP AMPLIFIER, is what you need.

- 10% DISCOUNT
- 2 Federal Amp. Transformers... \$15.00
  - 1 Radiotron UV200..... 5.00
  - 2 Radiotron UV201..... 13.00
  - 2 Navy Cage Type Rheostats... 4.00
  - 3 Rhamstine Jacks and Plugs... 4.50
  - 10 Nickle Binding Posts..... 1.50
  - 50 Soldering Lugs..... .50
  - 1 L. P. F. Panel 10x7 1/2"..... 1.50
  - 1 G. A. Grid Condenser..... .35

VALUE \$48.85

OUR PRICE NOW \$44.00 PREPAID

10% Discount on any of above items if you send us names of 5 Amateurs not in Call Book. Order today. Send stamp for latest Bulletin.

Write us your troubles. Free advice from our experts. 12 years Radio experience

**RADIO SUPPLY SERVICE**  
Specialists in Reception Apparatus and Parts  
46 Clinton Place Mt. Vernon, N. Y.



## FADA Crystal Detector

Just the dope for your portable receiver.—send your order today.

Type 101A \$3.00 each

Frank A. D. Andrea  
1882A Jerome Ave., New York

Transformers rated at 1/4, 1/2, and one KVA have been tested thoroly for long periods of time. There was no overheating or sparking at the commutator, and from tests thus far given, I conclude that the reliability of the instrument is without question. Its life is limited by the wear of the rotating brushes. From tests, one pair of brushes must certainly last 50 hours working continuously. They may be replaced within four minutes at a cost of several cents. There is positively no heating within the resistors. Singly, or with a rotary discharger it will produce a remarkably clear spark tone. It is thoroly practical and efficient, and is worthy of one's best efforts to provide an economical converter for application to transformer stations operated from direct current source.

## Some Practical Radio-fone Experiments

(Continued from page 788)

me a postcard describing their troubles, I shall be pleased to help them to the best of my ability.

## Credit Given

The illustration of the "New Code Teacher" was published on page 594 of the March issue of RADIO NEWS, by courtesy of the National Radio Institute.

In our last issue, the photographs illustrating the article entitled "Get Your Friends Interested," were obtained from J. Sussman.

On page 681, the views of the British instruments, was published by courtesy of Burnham Co., London.

## Unnecessary Interference

(Continued from page 784)

no vital importance whatever. Here is where the real "ham" has his fun testing for half an hour or more and then asks to be excused for the QRM. One night the British Liner "Adriatic" and the station at Rockland, Maine, were compelled to standby, thereby delaying an enormous amount of traffic, until a fellow on one of the Lake steamers finished re-transmitting (on 600 meters) Arlington press reports.

Even if we be off the Grand Banks it is not surprising to hear operators continuously calling every coast station from Bar Harbor right down to Miami with their noon positions. Fellows attempting to establish record breaking sending distances, will use very high power and call some ship they might happen to hear working Colon, just to see if they get any acknowledgment, thus causing very great unnecessary interference. Thanks to the government, these QRM birds are being carefully watched and sooner or later are bound to be thrown out of the wireless game.

Such conditions, that is concerning unnecessary interference, seem to be the same, no matter what waters we are navigating. Tho we be in the North Sea, the English Channel or in the Caribbean, the "ham" is sure to be there to play his part. I recall an incident which ought to make the guilty persons bow their heads in shame:

## 10c CHARGES YOUR BATTERY

### AT HOME WITH AN F-F BATTERY BOOSTER

and your station will never be closed because of a discharged battery. Is it not gratifying to feel that your filament battery will always be ready when you want it and that you will never have to give up in disgust when working a distant station?

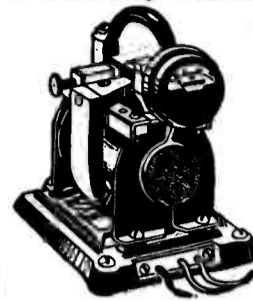

F-F Battery Boosters are automatic and operate unattended. Screw plug in lamp socket, snap clips on battery terminals and see the gravity come up.

The ammeter shows you just the amount of current flowing. The full wave of current is rectified thru adjustable carbon electrodes which maintain a constant efficiency and last for thousands of hours. Everything complete in one compact, self-contained unit.

The F-F Battery Booster is a Magnetic Rectifier for 105-125 Volt 60 Cycle Alternating Current.

Bantam Type 6 Charges 6 Volt Battery at 6 amperes... \$15  
Type 16 charges 6 Volt Battery at 8 amperes... \$24  
Type 166 charges 6 Volt Battery at 12 amperes... \$32

Shipping Weights 10, 12 and 15 lbs.

Also Boosters for 12 Volt Batteries at same prices. Order from your dealer or Send Check for prompt Express Shipment. If via Parcel Post have remittance include Postage and Insurance Charges. Will also ship C.O.D. Also F-F Battery Boosters for charging batteries from Farm Lighting Plants, Direct Current Circuits and Direct Current Generators.

For Group Charging use the Full Wave, Automatic F-F ROTARY RECTIFIER of 100 Volt, 36 cell capacity.

Order now or write today for Free Descriptive Bulletin No. 32 or ROTARY Bulletin No. 32A

Office & Works:  
**THE FRANCE MFG. CO.,** Cleveland Ohio

## TUSKA C. W. INDUCTANCE

Type 181  
Unmounted

PRICE  
\$5

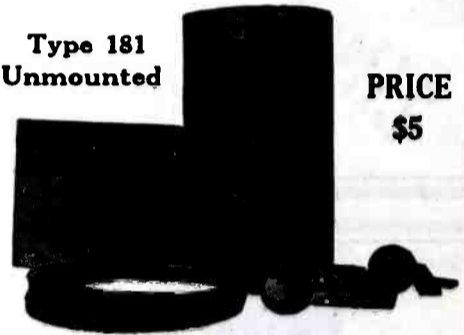

Use a Tuska C. W. Inductance in your new tube set. Send your dealer's name and 5 cents for our illustrated C. W. Booklet.

**THE C. D. TUSKA COMPANY**  
HARTFORD, 3 - CONN.

## Announcing New Location

**REYNOLDS RADIO SPECIALTY CO.**  
613-19th STREET  
DENVER, COLORADO

OUR NEW LOCATION WILL ENABLE US TO CARRY A COMPLETE STOCK OF THE LEADING MAKES OF RADIO GOODS.

Inquire about our new Reynrad Short-wave Coils.

## TELEGRAPHY

(Both Morse and Wireless) and RAILWAY ACCOUNTING taught thoroughly and quickly. Big salaries now paid. Great opportunities for advancement. Oldest and largest school; established 46 years. Endorsed by Telegraph, Railway, Radio, and Government officials. Expenses low—opportunities to earn large portion. Catalog free.

DODGE'S INSTITUTE D Street, Valparaiso, Ind.

**MAGNET WIRE  
TIN FOIL  
MICA  
ELECTRICAL  
RADIO SUPPLIES**

**HARRY T. GLEICH CO.**  
490 Sixth Ave., Dept. WI New York City





# "INTERPANEL" SET

**Complete Radio Telephone Transmitting and Receiving Apparatus Within Reach of Every Amateur**

**C**OMPLETE Set, as illustrated, comprises "RADIO-PHONE," transmitting speech 30 miles minimum; 500 mile range possible under favorable conditions. SHORT WAVE TUNER; AUDION CONTROL panel specially designed for gaseous type tubes; and ONE-STEP AMPLIFIER. Additional Steps of Amplification may be Added. Equally efficient for telephone or telegraph transmission. Only one 6-volt storage battery required. Motor-generator, "B" battery or rectifier power supply may be used. Unlimited reception possibilities.



The "INTERPANEL" system is the most convenient and least expensive way to buy Radio Apparatus. Each panel a complete unit designed for combination with other panels to form an entire set. Panels are sold in four ways, viz: (1) in complete sets of any combination of panels desired, ready mounted in cabinet; (2) individual panels for mounting in home constructed cabinet; (3) individual panels for Vertical mounting without cabinet; and (4) individual panels with legs for Horizontal Table-style mounting without cabinet.

Complete "RADIOPHONE" Transmitting and Receiving Set of Five Panels in cabinet, as shown above, without batteries or tubes, Type MS-1, \$189.25. Also sold separate without cabinet, and for Vertical or Horizontal mounting.

Ask Your Dealer for the New "INTERPANEL" Catalogue or write direct for further information and prices on this newest development in Radio Apparatus.

## De Forest Radio Telephone & Telegraph Company

Inventors and Manufacturers of High Grade Radio Apparatus.  
1415 Sedgwick Avenue, New York City

Sole Distributors for Pacific Coast States:  
Henry M. Shaw,  
Pacific Radio Supplies Co.,  
638 Mission Street  
San Francisco, Calif.

## THE THIRD EDITION OF THE CONSOLIDATED RADIO CALL BOOK

Very Greatly Enlarged

192 pages. 32 pages more than 2nd edition, better paper, stiff covers, etc.

Some of the special information contained in the new book: Radio rate sheet (charges to and from vessels, etc.); Cable rates; Table for finding cable charges to various points; Weather reports and hydrographic reports of the world; Time signal section of the world; American radio compass stations; French radio compass stations; British radio compass stations; Canadian radio compass stations; General information section; International abbreviations; High power radio stations of the world; Press schedules of spark stations.

The Consolidated Radio Call Book is the only book in print officially listing all the Radio calls as issued by the Bureau of Commerce. Every vessel and land station in the world is represented and listed alphabetically, according to names of vessels or land stations, and according to call letters; Revision of American coastal stations under U. S. Naval control, and their new calls.

### Every New Amateur Call Is Listed

SPECIAL—Wireless Map of the World in Colors Given Free With Each Copy

Price \$1.50 Prepaid

Either Direct from us or for sale by the following responsible Dealers:

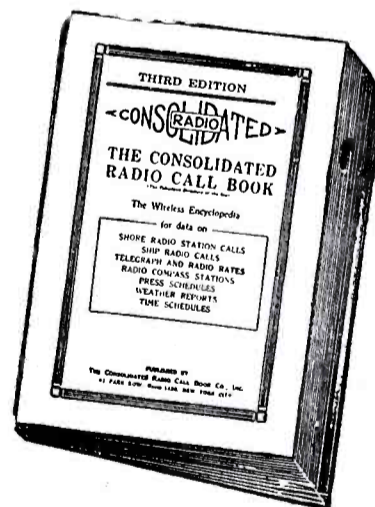

- American Electro Tech. Appliance Co., New York City
- American Hardware Stores, Bridgeport, Conn.
- Atlantic Radio Co., Boston, Mass.
- Bamberger & Co., L., Newark, N. J.
- Benwood Specialty Co., St. Louis, Mo.
- Brode Electric Co., Los Angeles, Cal.
- Bunnell & Co., J. H., New York City
- California Electric Co., San Francisco, Cal.
- Catton, Nell & Co., Honolulu, T. H.
- Central Radio Co., Independence, Mo.
- Chicago Radio Apparatus Co., Chicago, Ill.
- Continental Radio & Electric Corp., New York City
- Cutting & Washington Radio Corp., New York City
- Detroit Radio Laboratories, Detroit, Mich.
- Dewey Sporting Goods Co., Milwaukee, Wis.
- Doubleday-Hill Electric Co., Pittsburgh, Pa.
- Electro Importing Co., New York City
- Findley Electric Co., Minneapolis, Minn.
- Fuller Co., Seth W., Boston, Mass.
- Gurd & Co., Wm., London, Canada
- Hico Wireless Supply Co., Marion, Ill.
- Holt Electric Utilites Co., Jacksonville, Fla.
- Jenkins, Lester I., New Bedford, Mass.
- Katzenbach & Co., F. S., Trenton, N. J.
- Kendall Co., W. D., Worcester, Mass.
- Killoch Co., David, New York City
- Kluge, Arno A., Los Angeles, Cal.
- Krause & Co., A. F., Detroit, Mich.

- Lehigh Radio Co., Philadelphia, Pa.
- Lunze Electrical Supply Co., St. Louis, Mo.
- McCarthy Bros. & Ford, Buffalo, N. Y.
- McClurg & Co., A. C., Chicago, Ill.
- Manhattan Electric Supply Co., New York, Chicago
- Meter Electrical Construction Co., Oshkosh, Wis.
- Meyberg Co., Leo J., San Francisco, Cal.
- Mohawk Electrical Supply Co., Syracuse, N. Y.
- New Era Shop, Milwaukee, Wis.
- Newman-Stern Co., Cleveland, Ohio
- Nola Radio Co., New Orleans, La.
- Noll & Co., E. P., Philadelphia, Pa.
- Northwest Radio Service Co., Seattle, Wash.
- N. S. W. Bookstall Co., Sydney, Australia
- Pacent Electric Co., New York City
- Paramount Radio Supply So., Atlantic City, N. J.
- Parks, Henry Francis, Butte, Mont.
- Pearlman's Book Shop, Washington, D. C.
- Penn Radio Apparatus Co., Reading, Pa.
- Pennsylvania Marconi Wireless School, Philadelphia, Pa.
- Philadelphia School of Wireless Telegraphy, Philadelphia, Pa.
- Piedmont Electric Co., Asheville, N. C.
- Pioneer Electric Co., St. Paul, Minn.
- Pitts Co., F. D., Boston, Mass.
- Post Office News Co., Chicago, Ill.
- Precision Equipment Co., Cincinnati, Ohio
- Radio Distributing Co., Newark, N. J.

- Bethlehem, Pa.
- St. Louis, Mo.
- Buffalo, N. Y.
- Chicago, Ill.
- New York, Chicago
- Oshkosh, Wis.
- San Francisco, Cal.
- Syracuse, N. Y.
- Milwaukee, Wis.
- Cleveland, Ohio
- New Orleans, La.
- Philadelphia, Pa.
- Seattle, Wash.
- Sydney, Australia
- New York City
- Atlantic City, N. J.
- Butte, Mont.
- Washington, D. C.
- Reading, Pa.
- Philadelphia, Pa.
- Philadelphia, Pa.
- Asheville, N. C.
- St. Paul, Minn.
- Boston, Mass.
- Chicago, Ill.
- Cincinnati, Ohio
- Newark, N. J.

- Radio Electric Co.,
- Radio Equipment Co.,
- Radioelectric Shop,
- Ray-Di-Co.,
- Reuter Electric Co.,
- Riverside Laboratory,
- Rose Radio Supply,
- Saunders Co., Geo. S.,
- Schmidt & Co., Rudolph,
- Sears, Roebuck & Co.,
- Service Radio School,
- Shaffers',
- Shotton Radio Mfg. Co.,
- Smith Bros.,
- Smith Novotoy Electric, Inc.,
- Southern Electrical Supply Co.,
- United Radio Telegraphers' Assoc.,
- Western Radio Electric Co.,
- Whitall Electric Co.,
- White Co., The,
- White & Boyer Co.,
- Williamson Electric Co., H. E.,
- Wilmington Electrical Specialty Co.,
- Wireless Mfg. Co.,
- Wireless Press,
- Young & McCombs,
- Young Men's Christian Assoc.,
- Zamolski Co., Jos. M.,

- Pittsburgh, Pa.
- Boston, Mass.
- Cleveland, Ohio
- Chicago, Ill.
- Cincinnati, Ohio
- Milwaukee, Wis.
- New Orleans, La.
- Boston, Mass.
- Rochester, N. Y.
- Chicago, Ill.
- Washington, D. C.
- Norfolk, Va.
- Seranton, Pa.
- Sarnia Ont., Canada
- Charlotte, N. C.
- San Diego, Cal.
- Baltimore, Md.
- Los Angeles, Cal.
- Westerly, R. I.
- Columbus, Ga.
- Washington, D. C.
- Seattle, Wash.
- Wilmington, Del.
- Canton, Ohio
- New York City
- Rock Island, Ill.
- Los Angeles, Cal.
- Baltimore, Md.

**Consolidated Radio Call Book Co., Inc., 98 Park Place, New York City**



**HERE'S GOOD NEWS!**



**RED - HEAD** N O \$ **8.00**  
**RADIO PHONES** W PRE-PAID

**1921 Model 3000 Ohms**

Incomparably the World's Greatest Phone Value. Guaranteed identically the same head-set as previously sold for \$12.50. Increased production and decreased manufacturing costs make the new low price possible.

**EXQUISITELY SENSITIVE RUGGED AND STURDY**

Aluminum backs, military type head-band, bakelite ear caps, strain loops and posts, extra thin diaphragm, superb workmanship, beautiful appearance, 3,000 ohms resistance—these are a few of the features which have made Red-Heads a triumph in radio phone building. Send us \$8.00 for Red-Heads today. You take no risk. If Red-Heads do not satisfy we will refund your money.

**EIGHT DOLLARS, COMPLETE, PREPAID**

Furnished with braid covered military type or genuine phosphor-bronze split head-band. Illustration shows phosphor-bronze type.

Price subject to change without notice.

**DEALERS:** Be sure to stock the new Red Head Phones. Be prepared for the big demand.

**THE NEWMAN-STERN CO.**

Newman-Stern Bldg. Cleveland, O.  
 Write for Free Catalogue.

**Special offer on**

**MARKO**

**STORAGE BATTERIES**

4T2 4V. 40A.H. (List \$10.75).....\$10.00

6T4 6V. 60A.H. (List \$20.00).....\$18.50

Add 5% excise tax to these prices.

Shipped with acid express charges collect, F. O. B. Brooklyn Warehouse.

**XX Bakelite Dilecto**

3/16" thick.....2¼c per sq. in.

Postage Extra

**A. K. LAING, RADIO SUPPLIES**

Pelham Manor, N. Y.

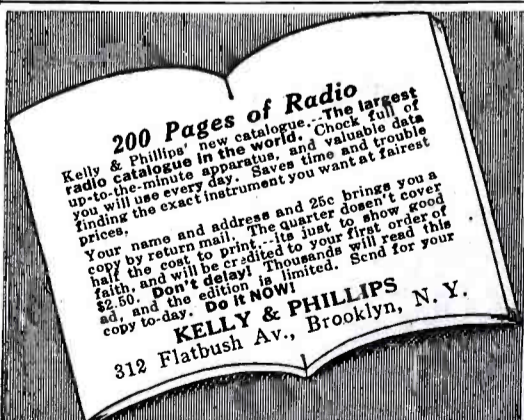

**200 Pages of Radio**

Kelly & Phillips' new catalogue. The largest radio catalogue in the world. Check full of up-to-the-minute apparatus, and valuable data you will use every day. Saves time and trouble finding the exact instrument you want at fairest prices.

Your name and address and 25c brings you a copy by return mail. The quarter doesn't cover half the cost to print...its just to show good faith, and will be credited to your first order of \$2.50. Don't delay! Thousands will read this ad, and the edition is limited. Send for your copy to-day. **DO IT NOW!**

**KELLY & PHILLIPS**  
 312 Flatbush Av., Brooklyn, N. Y.

**STANDARD RADIO EQUIPMENT**

AGENTS FOR

MURDOCK FEDERAL TEL.  
 BRANDES AMERICAN RADIO  
 BURGESS AUDIO TRON.  
 GURBE CHICAGO RADIO LAB.  
 BENWOOD SPEC. DUBILIER  
 DE-FOREST TRESCO AND OTHERS  
 U. of I. SUPPLY STORE, Inc.  
 827-29-31 SOUTH WRIGHT STREET  
 CHAMPAIGN, ILLINOIS

An "SOS" had been sent out by a Spanish steamer which was afire and in a sinking condition about 100 miles southwest of Bishops Rock, England. The operator abroad attempted to get in communication with the Naval Radio Station at Lands End, but owing to the tremendous amount of interference, both stations were unable to hear each others signals. As soon as the steamer had broadcasted her position, a number of operators within range, instead of keeping quiet and letting the fellow obtain assistance, immediately began calling each other and asking all sorts of questions regarding the unfortunante fellow. It is hard to believe that an operator would cause interference at such a critical time. Right here we can see where one of the most important International rules was absolutely broken.

At another date, exactly the same thing occurred when an Italian vessel ran ashore near Key West. This time, thanks to the ever watchful government radio inspectors, the fellows responsible for the terrific interference were reported to Washington Headquarters and their licenses cancelled for a period of six month or more. They were paid in full and deserved it.

We realize there is bound to be a great deal of interference in the vicinity of coast stations, but 50 per cent. of it could easily be eliminated if the ship operators would use plain common sense. I firmly believe that if the young men would adhere to the training they received while attending their wireless schools, they would know how to handle their traffic easily and without the necessity of causing considerable unnecessary interference.

The blame cannot be put on one nationality alone, as the foreign operators are just as bad, if not worse, than our American operators. Many times we are forced to standby until some British operator tells his friend about his visit to Egypt or two Spanish operators tell their family history to each other. It can easily be seen that the young operator's ignorance of the International laws is mostly the cause of all this interference, for the fellows on the big liners had to have years of experience (which we know) to obtain this position and so strictly conform to rules and regulations. This is the reason we never hear these fellows engage in unnecessary conversations or call a land station about 20 times.

The present day amateur radio man is the commercial operator of the future. It is up to him to show better qualities as an operator than many of our commercial men of today. Let him take notice of the above occurrences and prepare to overcome them all and make it a joy to be in the commercial end of the wireless game. It is the fellow just entering the game that needs the hints and pointers, which will assist him in fulfilling the requirements of a real good operator, an operator who can stand up and call himself an operator and not feel apologetic.

**A New Radio Bill**

(Continued from page 832)

"persons" relative to the use of such radio patents: *Provided*, That the use of all such patents shall be subject to all the provisions of this Act so far as applicable.

SEC. 24. That except as otherwise specifically provided in this Act, the provisions of this Act shall extend to all places subject to the jurisdiction of the United States. The several courts of first instance in the Philippine Islands and the District Court of the Panama Canal Zone shall have jurisdiction of offenses committed within their respective districts, and of conspiracies to commit such offenses, as defined by section 87 of the Act to codify, revise, and amend the



**NEW YORK BOSTON**

Offers a thorough course in all branches of wireless telegraphy. Radio Operators earn at the start \$125.00 per month, and first class board, etc., free.

Our school prepares you for your license in three to four months. Positions guaranteed to first grade licensed operators. Also MORSE TELEGRAPHY.

Day and evening classes.

The leading Nautical School in U. S. A. Established 1804.

**CAPTAIN F. E. UTTMARK, Principal**

Write, call or phone for illustrated booklet.

**8 STATE ST., NEW YORK, N. Y.**

Facing Battery Park, N. Y.

Telephone, Bowling Green 8079

**UTTMARK'S for Nautical Education**

**Canadian Amateurs**

**BUY in CANADA and save \$\$\$\$\$\$**

Here are a few additions to our stock Variometers and Variocouplers.

Transmitters for Wireless Telephone ..... \$2.50

Transmitters, Spoon type..... 7.25

**Brown's Famous Receivers**

4000 Ohm with cord.....\$19.25

8000 Ohm with cord..... 20.50

Shipping weight 2 lbs.

Send for our list .05c

**THE VIMY SUPPLY CO.**

567 College Street TORONTO, ONT.

**Canadian Radio Experimenters**

**Lateral Wound Coils.**

Turns	App. Wave-Length	Price
25	180— 375	\$0.55
40	225— 575	.80
75	240— 740	.70
100	480— 1480	.80
175	750— 2400	1.00
325	1375— 4500	1.25
550	2250— 7700	1.50
750	3000—11200	1.75
1200	6000—20900	2.50

**Special Sizes to order**

Special discount to dealers

Plugs and Bands with screws for coils	.75
C.W. Inductances	2.00
C.W. Inductances	7.50
Transmitters for radio purposes	3.50
Vario-Couplers and Variometers	4.25
Milliammeter and Hot Wire Meters	

Send 5c for 30 page catalogue

**J. M. PAQUIN**

The Electrical Shop

787 Queen St., West, Toronto, Ont.





# STOP! LOOK! and ACT!

**FREE!** A Plotron V.T. Amplifier, U.V. 201, \$6.50, or an A.P. Navy Type V.T. Amplifier, \$7.00, will be given **FREE** with each Radio Magnavox purchased from us, not later than June 30th.

## THE RADIO MAGNAVOX

*The latest development of the Magnavox Company*

**THE RADIO MAGNAVOX** when used with a suitable amplifier will give forth signals of far greater volume than any other receiver.

**THE RADIO MAGNAVOX** will allow you to have your friends listen to all incoming signals without the necessity for additional apparatus.

**THE RADIO MAGNAVOX** will reproduce radiophone speech, or music to such a degree that it may be used for dancing if sufficient amplification is available.

**THE RADIO MAGNAVOX** does away with a continuous watch, allowing the operator to hear what is going on at his station while in another part of the house.

**THE RADIO MAGNAVOX** is manufactured under the same patents and on the same electrodynamic principle as the MAGNAVOX Radio Telemegafone.

**THE RADIO MAGNAVOX** will reproduce signals with the same volume as the Radio Telemegafone.

**THE RADIO MAGNAVOX** can be operated on 2, 3, or 4 dry cells with wonderful results. A six volt storage battery with rheostat is recommended for continuous operation.

QST  
WDNT U LIKE TO HR SIGS  
QSA  
ALL OVER YR HOUSE?  
The Price is within reach of all **\$45.00**  
You need it in your station.

**THE KEHLER RADIO LABORATORIES**  
Dept. R, ABILENE, KANSAS

# WANTED—FOR CASH

**Used Radio Apparatus of All Standard Makes**

Our used wireless apparatus department, connected with our local retail store at 233 Fulton Street, New York City, is anxious to buy any radio instruments you may have for sale. These goods are for our New York customers only—we sell no used radio apparatus by mail. But we do have a tremendous call at our store for fine class goods and we will be glad to hear from you if you have any that you would like to dispose of.

## WE PAY CASH

for all such merchandise that we buy, and this is an invitation extended to the radio fraternity to sell us their radio apparatus for which they have no further use. Write us in your first letter what make apparatus you have to sell, and your lowest spot cash price. It must be understood that all transportation is to be paid for by you. All goods to be sent to us prepaid either by parcelpost, express, or freight.

We can use only standard apparatus, no obscure instruments or home-made apparatus can be considered in any event.

If you have friends who wish to dispose of such apparatus, show them this advertisement. Also please note that your letter must state in just what condition the instruments are and that no goods must be sent to us unless we send you a written order to do so.

We invite amateurs residing in New York or vicinity to call at our store and inspect the used radio apparatus which will be placed on sale shortly after this advertisement appears.

*Address all letters to*

**Used Apparatus Department**  
**ELECTRO IMPORTING COMPANY**  
(Established 1904)

**231 Fulton Street**

**New York City**





## THE WIZARD "B" BATTERY

Attention Amateurs  
15% OFF LIST PRICES

	List Price
No. 1623 Small B Battery, 22½ volts.....	\$1.50
No. 1625 Large B Battery, 22½ volts.....	2.50
No. 1625 Variable B Battery, 1½ to 22½ volts. ...	3.00

The above batteries are manufactured according to government specifications. Sent free of parcel post charges. Money back if not satisfactory.

1315 42ND STREET

DEPT. R.

BROOKLYN, N. Y.

## NEW AND POPULAR BOOKS

### The How and Why of Radio Apparatus

By H. W. SECOR, E. E.



The newest book on radio matters. The treatment is made as understandable and as free from mathematics as possible, it at the same time, incorporates a wealth of technique and instruction for the Radio Amateur—the Radio Operator—the Installation and Designing Expert—as well as teachers and students of the subject in general.

Cloth bound in Velum de Luxe. Gold stamped and Hand Sewed has 160 pages. Size of Book 6 x 9 inches. The How and Why of Radio Apparatus.

Postpaid ..... \$1.75

### A Thousand and One Formulas

By S. GERNSBACK



A Laboratory Hand Book for the Experimenter and for Everybody who wants to "do things."

The recipes and formulas are classified in such a manner as to be available at once, without long research.

Besides there are a score of tables and hundreds of illustrations and Diagrams. Book is cloth bound in Velum de Luxe, Gold stamped and hand sewed. It contains 160 pages. The paper has been especially selected to stand rough handling in laboratories. Size 6 x 9 inches. A Thousand and One Formulas as Described.

Postpaid ..... \$1.75

## The Experimenter Publishing Co.

Book Dept.

236A Fulton St.

New York City

penal laws of the United States, approved March 4, 1909, and the provisions of said section, for the purposes of this Act, are hereby extended to the Philippine Islands and to the Panama Canal Zone.

SEC. 25 That the Act approved August 13, 1912, entitled "An Act to regulate radio communication," and Acts amendatory thereof, insofar as inconsistent herewith, are hereby repealed. Such repeal, however, shall not affect any act done or any right accruing or accrued or any suit or proceeding had or commenced in any civil cause prior to said repeal, but all liabilities under said laws shall continue and may be enforced in the same manner as if committed, and all penalties, forfeitures or liabilities incurred prior to taking effect hereof, under any law embraced in, changed or repealed by this Act, may be prosecuted and punished in the same manner and with the same effect as if this Act had not been passed.

### Amateur Broadcast

- Mar. 1—English—Following received from Boy Scouts of America: "Chief Seascout urges all troops and local councils to arrange for receipt of scout messages. Further information from Seascout Radio Commodore, 200 Fifth Ave., New York City."
- Mar. 2—Following received from Boy Scouts of America: "Chief Seascout requested that all radio stations licensed and receiving only, register at once through Seascout Radio Commodore, 200 Fifth Ave., New York City."
- Mar. 3—English—President Elect Harding's inaugural speech will be broadcast by radio immediately after noon, Washington time, March 4, on 2,500 meter Arlington spark set and 7,800 meter Sayville arc. Signed, Radio Amateur Bureau.
- Mar. 4—No amateur broadcast sent owing to Government official business.
- Mar. 5—English—In the future the amateur broadcast will invariably be sent in code. All amateurs desiring a code chart can obtain same by writing to the "Radio Amateur Bureau, 44 Whitehall St., New York City."
- Mar. 6—English—Following received from Boy Scouts of America: "Chief Seascout requested that all troops and seascout ships report radio activities to Seascout Radio Commodore 200 Fifth Ave., New York City."
- Mar. 7—Code 2—U. S. S. Tacoma transferred from navy to war department for use in coast guard service in Philippine Islands.

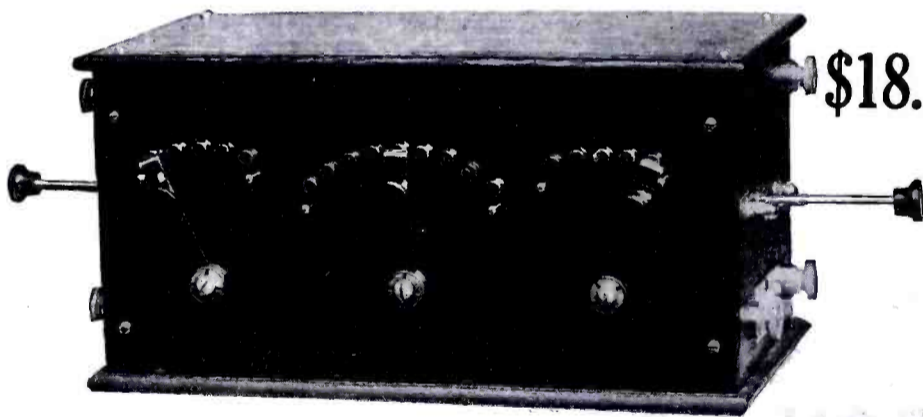

\$18.

## Have More Joy and Pleasure Get the Radio Phone Concerts

If you could hear the 200-600 meter stations including the Radio Phone Concerts, as the users of this Wonderful Short Wave Regenerative Tuner are getting them, you would order one today. It is really marvelous what you can do with one of these tuners. You can pick up distant stations through interference, that heretofore have been beyond your control. This tuner is finished in quartered oak with a hard rubber panel for \$18.00. We can also furnish vacuum tube detector complete, Headset and the necessary condensers for only \$29.95 additional.

Mr. F. H. Calhoun, Charlottesville, Va., says: "Short Wave Regenerative Tuner working fine. Am getting radio phone stations and am highly pleased."

\$34.50

## Eliminate Some of Your Interference. Read That Particular Station Thousands of Miles Away

Our idea in the manufacture of radio tuners is just this—the customer wants a tuner that is mechanically correct, compact, rigid and efficient for a small sum of money. Our tuners have the desired features of a variable primary, a variable secondary and a variable tickler coil and possess tuning advantages not possible with other tuning instruments.

Mr. H. D. Titus, 24 Grover St., Auburn, N. Y., says: "Your New Short and Long Wave Tuners are very fine instruments. My aerial is only 50 ft long, just one No. 14 galvanized iron wire tied to the chimneys on the roof of my house, and I hear loud clear signals any time I wish to listen in. Also get radio phone stations with short wave tuner."

Send a 2-cent stamp for bulletins

COLBY'S TELEGRAPH SCHOOL, Auburn, N. Y.

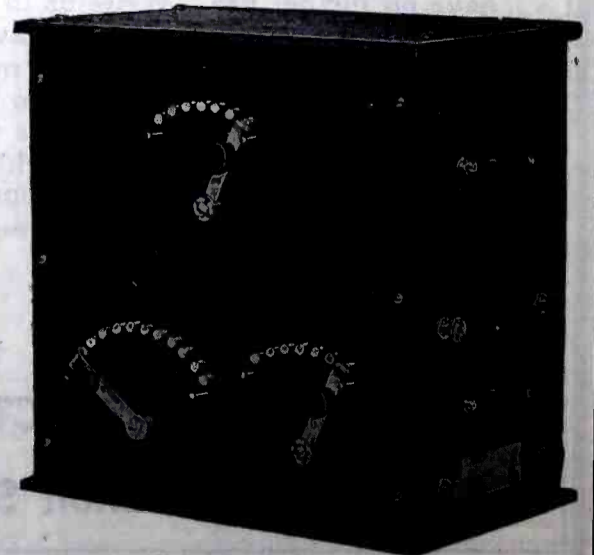



- Mar. 8—English—Radio amateur No. 2646 acknowledges letter March 7. Permission to visit naval stations must be obtained from Navy Department Washington.
- Mar. 9—English—Press dispatch states Secretary of War announced today American Forces not to be withdrawn from Rhine at this time.
- Mar. 10—English—Following received from Boy Scouts of America: "All Boy Scout radio stations should arrange to secure local publicity for radio broadcasts, particularly in small towns and through the Pioneer Scouts."
- Mar. 11—English—Report received that amateur broadcast messages from this station are being copied in Southern California and on ships off the Pacific Coast of Mexico.
- Mar. 12-13—No amateur broadcast sent.
- Mar. 14—English—Following received from Executive Council, Second Amateur District: "Do not forget the second district radio amateur convention exhibit to be held at the Hotel Pennsylvania, New York City, March 16, 17, 18, 19. On Friday, 7 P.M., there will be held a general convention meeting in the convention hall to discuss the Q.R.M. situation. At 6.30 P.M. on Saturday there will be a grand banquet in the main ballroom of the hotel. Come one, come all. Do not fail to attend the convention meeting on Friday night. Signed, Executive Radio Council, Second District."
- Mar. 15—No amateur broadcast sent.
- Mar. 16—Code 2—Press dispatch: "Washington, March 15—Motor cars registered in the United States last year numbered 9,211,295; the registration and license fees amounted to \$102,034,106."
- Mar. 17—No amateur broadcast sent.
- Mar. 18—Code 4—Press dispatch: "Havana, Cuba, March 17.—A captive balloon with three men in the basket broke loose from its moorings today at the American Naval Station at Guantanamo, Cuba. Several aeroplanes are in pursuit, but it is believed that the balloon has been lost."
- Mar. 19—English—Following received from Boy Scouts of America: "Chief Seascout urges all troops and local councils to arrange for receipt of scout messages. Further information from Seascout Radio Commodore, 200 Fifth Ave., New York City."
- Mar. 20—No amateur broadcast sent.
- Mar. 21—English—All radio amateurs who have not received or have not been notified of their registration number will be immediately notified of same by addressing Radio Amateur Bureau, 44 Whitehall St., New York City, care of District Communication Superintendent, U. S. Navy.
- Mar. 24—English—Press dispatch: "Indianapolis, March 23—Patriotic mass meetings in every State are planned by the American Legion for the near future, starting with one at Philadelphia on April 4."
- Mar. 25-26-27—None sent.
- Mar. 28—English—Press dispatch: "Dr. E. A. Eckhart and Dr. J. C. Karcher, of the Bureau of Standards, have succeeded in recording radio signals autographically. When this invention is perfected receiving operators will be unnecessary, it is said; the radio writing its own message."
- Mar. 29—No amateur broadcast sent.
- Mar. 30—English—Press dispatch: "Students of architecture of proven ability from American colleges are to be sent to France in groups during the yearly vacation periods to aid the French people in the work of reconstruction."
- Mar. 31—English—Press dispatch: "Ithica, New York, March 30—Falling 9,000 feet in a disabled airplane and escaping with only a few bruises, while the machine was wrecked, was the experience today of Lieut. J. A. MacReady, of Dayton, Chief Test Pilot of the U. S. Army."

**3 \$1 for 1** **PROTECT YOUR VACUUM TUBES INDEFINITELY!**

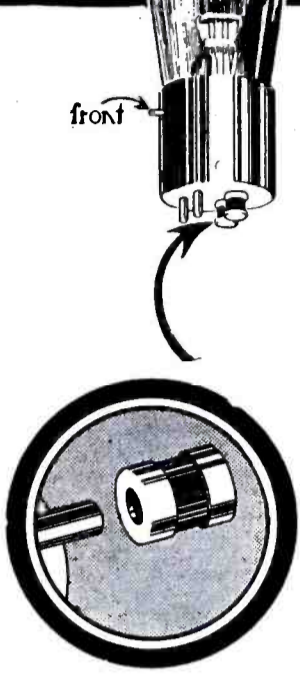

**A Bulb Worth Having is Worth Saving**

Because it is impossible for destructive amperage to reach the delicate filaments of your expensive vacuum tube a few cents protects the heart of your set when equipped with the

**RADECO SAFETY FUSE**

Pat. Pending

**For Vacuum Tubes**

Slips directly on filament terminals of any standard bulb and does not distort springs of your socket. It does not interfere with efficiency of your set but protects it indefinitely.

**Carrying Capacity**  
1 1/4, 1 1/2, 2, 2 1/2 and 3 amp.  
Size 1/4 inch over all.

**Radeco Safety Fuses**

are equally valuable in C. W. Work, preventing injury to meters or filaments resulting from shorts or abnormal conditions.

**Three For**

**\$1.00**  
35c Each

**ORDER BY MAIL**

If your dealer cannot supply you, send cash, certified check or money order. Your order filled by return mail.

**Rotary Quenched Spark Gap—\$20.00 Postpaid**

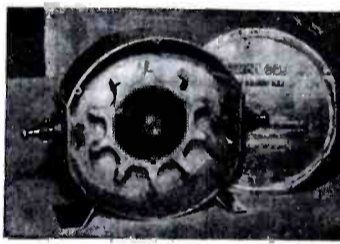

The advantages of a noiseless, super-efficient rotary gap are now within the reach of all. The casing is of cast aluminum with the cover machined to make an airtight enclosure for the extremely light weight aluminum rotor, with bakelite insulation. Stationary electrodes are of copper with bakelite insulation. The smallest gap motor may be used, but is not supplied with gap. **GET YOURS SET UP AT ONCE, and INCREASE YOUR RADIATION AND RANGE!**

**44 V. VARIABLE "B" BATTERY \$3.60**

Include postage on 4 lbs. Complete in handy wooden case and adjustable phosphor bronze "jiffy" connectors. Better than block batteries—if one 4.4 V. unit weakens prematurely, it can be removed and replaced—thereby not impairing total voltage, which makes this the best battery value to be had at any price. Set of 10 Renewal Units, 44 Volt, \$8.10 postpaid. Just the thing for C.W. work.

**Ground Wire 8c Per Foot**

\$7.00 Per 100 Feet  
No. 4 solid copper—rubber covered—triple braid—include postage on 20 lbs. per 100 ft.  
100 amp. 600 volt lighting switches, \$4.

**Aerial Wire 1c Per Foot**

7 strands No. 22 copper—tin plated to prevent oxidation. Maximum radiation and strength. Include postage on 15 lbs. per 1,000 ft.

**FILAMENT RHEOSTAT**



For Back or Front of Panel Mounting. 6 ohms, 1 1/2 amps., 1 1/8" dia.

**\$1.75 Postpaid**  
Immediate Shipment.

Standard VT Socket Improved Contact Type

**\$1.00 Postpaid**  
Copper foil condenser 35c p.p

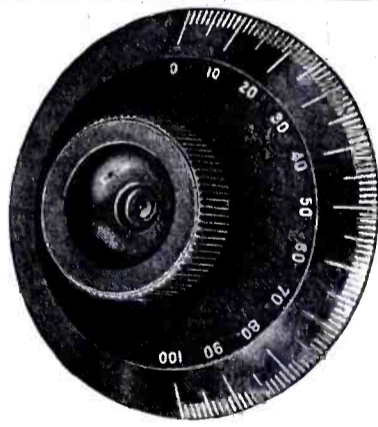

**CHELSEA DIAL and KNOB**

Made of best grade bakelite lens absolutely true and will not warp. Dial 3 1/4" in diameter, 1/4" thick. Genuine dial at a genuine price.

Dial....\$.75  
Dial and Knob...\$1.00

Send Today

**RADIO EQUIPMENT CO. 630 WASHINGTON ST., Boston, Mass. 4th Floor**

**Who's Who in Radio**  
(Continued from page 784)

search work, and no doubt some day the Radio world will hear of some new invention, the result of his work.  
Mr. Pickard is Past President and Fellow of the Institute of Radio Engineers, a Fellow of the American Institute of Electrical Engineers, Member of the American Electrochemical Society, the American Chemical Society, the American Society of Mechanical Engineers, the American Institute of Mining and Metallurgical Engineers, the Society of Chemical Industry, the American Meteorological Society and the American Association for the Advancement of Science.

**NEW ORLEANS RADIO APPARATUS and SUPPLIES**  
**ROSE RADIO SUPPLY**  
604 Gravier St., New Orleans, La.  
Send 10c for Latest Catalog

**IMMEDIATE DELIVERY**  
on any standard make of Radio Apparatus. Chicago, and Middle West distributors for:

Acme	Clapp-Eastham	Federal
Amrad	Radio Corp.	General Radio
Brandes	DeForest	Grebe
Burgess	John Firth	Murdock
Chelsea		Thordarson

Complete stock—every order shipped same day it is received. New, big catalog ready soon; send now for free bulletins. Blue Print of Radio Telephone and C.W. Transmitter for 10c.  
Chicago Amateurs—Come and see our new Radiophone in actual operation.  
**CHICAGO RADIO APPARATUS CO., Inc.**  
508 So. Dearborn St. (Room 210) Chicago, Ill.



**RADIO NEWS**

**The 100% Wireless Magazine**

Radio News is the greatest radio magazine in print today. In point of circulation, number of articles, illustrations, it leads all other wireless magazines. Each issue of the Radio News contains over 88 pages and an artistic cover in two colors. The illustrations average 150 every month and there are from 40 to 50 up-to-date articles, some by our biggest radio scientists, in every issue.

The only independent monthly wireless magazine in existence. It caters to no commercial interests—it has no boss save its readers. It is "different"—it has the latest radio news. It is a scientific magazine but it caters largely to the Radio Amateur.

**\$2.00 a Year**

*New York City, Canada and Foreign, 50c extra*

# ANNOUNCEMENT

We have reduced the Subscription Price of **SCIENCE & INVENTION** to the pre-war rate of \$2.50. This reduction to take place with our June, 1921 Number.

## \$2.50

## SPECIAL PREMIUM OFFER

**Offer A**  
"Science and Invention"  
for one (1) year with  
**The How and Why of  
Radio Apparatus**  
**\$3.25**

**Offer B**  
"Radio News"  
for one (1) year with  
**The How and Why of  
Radio Apparatus**  
**\$2.75**

**Offer C**  
"Science and Invention"  
for one (1) year with  
**A Thousand and  
One Formulas**  
**\$3.25**

**Offer D**  
"Radio News"  
for one (1) year with  
**A Thousand and  
One Formulas**  
**\$2.75**

**Offer E**  
"Science and Invention"  
for one (1) year with  
**Wireless Course in  
20 Lessons**  
**\$3.25**

**Offer F**  
"Radio News"  
for one (1) year with  
**Wireless Course in  
20 Lessons**  
**\$2.75**

**Offer G**  
"Science and Invention"  
for one (1) year with  
**Experimental  
Electricity Course**  
**\$3.25**

**Offer H**  
"Radio News"  
for one (1) year with  
**Experimental  
Electricity Course**  
**\$2.75**

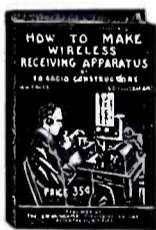

**Offer K**  
"Science and Invention"  
for one (1) year with  
**Design and Construction of  
Audion Amplifying-Trans-  
formers.**  
**How to Make Wireless Send-  
ing Apparatus.**  
**How to Make Wireless Re-  
ceiving Apparatus.**  
**\$2.90**

**Offer L**  
"Radio News"  
for one (1) year with  
**Same Books as offer (K)**  
**\$2.40**

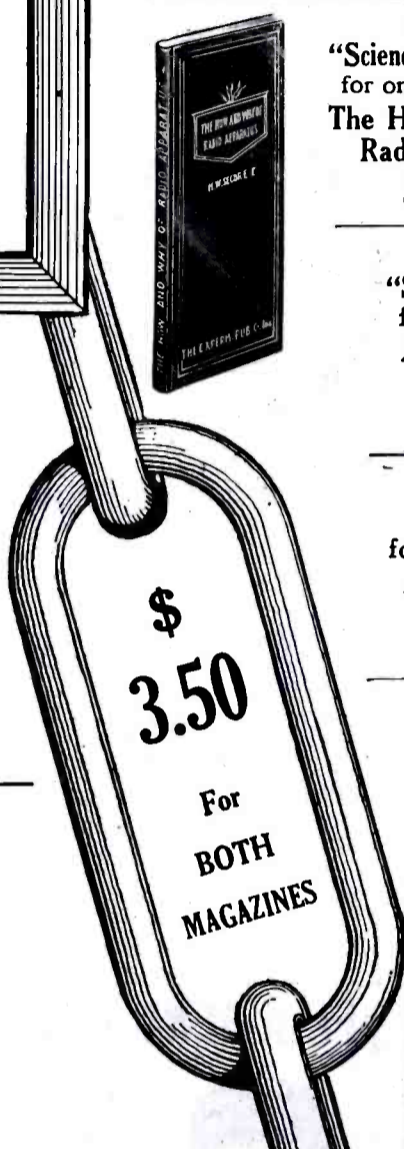

**EXPERIMENTER PUBLISHING COMPANY, Inc.**  
236 Fulton Street, New York City, N. Y.

Gentlemen:

Enclosed find \$..... for which send me:

- Science and Invention.
- Radio News.
- Science and Invention, and Radio News.
- Offer A       Offer D       Offer H
- Offer B       Offer E       Offer K
- Offer C       Offer F       Offer L
- Offer G

MARK SQUARE ABOVE FOR ITEM WANTED.

Name .....

Address .....

Town..... State.....

R. N. 5-21

**Science and Invention**

ELECTRICAL EXPERIMENTER

**THE UNDISPUTED AUTHORITY ON SIMPLIFIED SCIENCE AND MECHANICS**

SCIENCE AND INVENTION (formerly Electrical Experimenter) faithfully reports every phase of science and invention in plain, non-technical language. You'll enjoy every issue.

**PROFUSELY ILLUSTRATED**

Not merely a press clipping bureau, but a magazine of original ideas and a recognized authority.

Timely and exclusive articles by leaders in every branch of science. Regular departmental features include Electrical subjects in general, Wireless, Mechanics, Chemistry, Inventions, Patents, Physics, Astronomy, etc., etc.

**\$2.50 a Year**

*New York City, Canada and Foreign, 50c Extra*



### Dictionary of Technical Terms Used in Radio

**Saddles**—Screw-on clips for wiring. (See Brass Saddles.)  
**Saturated Solution**—A liquid which contains so much of a certain substance that it can dissolve no more.  
**Sb**—See Antimony.  
**Se**—See Selenium.  
**Sec**—See Secant.  
**Secant**—The diameter of a circle passing thru one end of an arc and produced until it meets the Tangent.  
**Secant of Angle**—Diameter forming secant of the Arc contained in that angle. Equals Coscant of the complement.  
**Secondary Cell**—Accumulator. One whose plates require "forming" by passing a current thru cell before it is capable of producing a current. Plates require "re-forming" after each discharge of a cell. See Faure, Plante, and Tudor Plates. In an ordinary cell, both plates are lead sulfate, after charging they become lead peroxide on the negative. Both sides of positive plates are used, therefore one extra negative plate is placed in the cell. Fully charged, the voltage is 2.5, which falls rapidly to 2.2, thence steadily down to 2, after which rapidly to 1.180, when they require recharging. Specific gravity of acid when cell is charged should be at least 1.200, and when discharged should be from 1.170 to 1.185.  
**Secondary Circuit**—One which relies upon its current being supplied by another called the Primary Circuit.  
**Sector**—Any part of a circle enclosed between two radii and their included arc.  
**Secular Variation**—Irregular variations of Dip and Inclination which take place at any given point on the earth.  
**Segment of Circle**—Portion cut off by a chord.  
**Seizing**—The binding which holds a Bight in position. A moveable piece of gear is said to be "seized" when it is stuck by rust or heat.

### J. E. Brown's Station

(Continued from page 790)

The Editors wish here to express their thanks to Mr. Brown for this photograph which was kindly offered to RADIO NEWS, to be used as a front page for this issue.

As may be seen, the station is a pretty good one, equipt with the most up-to-date instruments. On the table may be seen the De Forest Radiofone, on which Mr. Brown has replaced the four 5-watt tubes by two 35-watt "Singer" ones. On the right of the Radiofone is the paragon receiver with a two-stage radio frequency amplifier.

**Editors' Note:**

The photograph of Mr. Brown's dog was not entered in the "idea for cover contest."

It was sent to RADIO NEWS on February 2d for use as a front page and it is from this suggestion that the contest "ideas for covers" was started for the future issues.

### An Inexpensive C. W. Transmitter

(Continued from page 770)

switching arrangement, shown in Fig. 2. From the above, it will be seen that this is an entirely practical set, which may be built for a very reasonable figure from apparatus now actually available on the market, and will be found in every way satisfactory.

# SHRAMCO SPECIALTIES

Get a Shramco Reo for use with your VT. You have probably heard from other amateurs of the accuracy and easy operation of this famous "Nicrome" resistance, panel type rheostat. At the low price, you can hardly afford to be without one yourself.

No. 90, 6 ohm, \$2.00

On May 15, we will have ready for delivery, a new type Shramco Reo, with a "Nicrome" resistance of 1.5 ohms, for use with 5 ampere power tubes. No. 90P, Price \$2.00. Order now, or write for advance information.

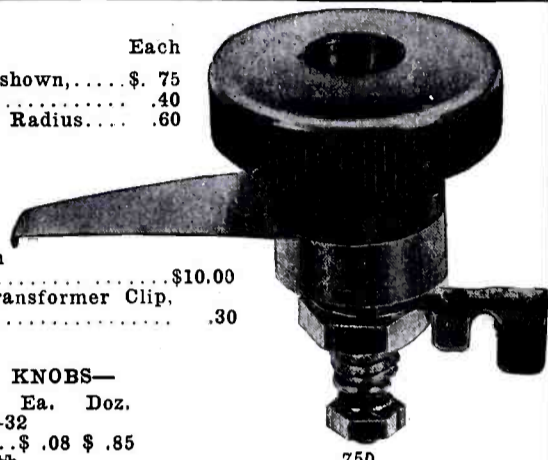

PANEL SWITCHES		Each
No. 750—Bushing Type, 1 1/2" Radius as shown, . . . . .		\$ .75
No. 751—Brass Finish, 1 3/4" Radius, . . . . .		.40
No. 530—N. P. Finish, bushing type, 1" Radius, . . . . .		.60

SPECIAL		
No. 60—Shramco Oscillation Transform er, with four shielded clips, each . . . . .		\$10.00
No. 61—Shramco Shielded Oscillation Transformer Clip, each . . . . .		.30

COMPOSITION KNOBS—		
	Ea.	Doz.
No. 602—1" dia. with 8-32 brass bushing . . . . .	\$.08	\$ .85
No. 618—1" dia. with 8-32 brass shank 1" long . . . . .	.10	1.10
No. 606—1 1/4" dia. as used on No. 750 Switch . . . . .	.15	1.65
15 Other Styles in Stock		



BRASS SWITCH POINTS			
	Doz.	50	100
No. 626—1/4" dia. x 3/8" high, with brass screw . . . . .	\$.30	\$1.10	\$2.00
No. 627—1/4" dia. x 1/2" high, with 3/8" threaded shank fitted with nut and washer . . . . .	.36	1.25	2.25
No. 628—1/4" dia. x 1/4" high, with brass screw . . . . .	.30	1.00	1.75
No. 630—1/4" dia. x 1/8" high, with 1/2" threaded shank fitted with nut and washer . . . . .	.36	1.25	2.25



**BINDING POSTS**  
 No. 800—Panel Type, complete as shown, each, 10c; doz., \$1.10  
 No. 600—1/2" Brass Type with brass screw and washer; each, 6c; doz. 65c.

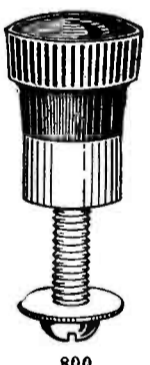

VACUUM TUBES AND SUPPLIES.		Each
No. 180—Electron Relay Detector Tube . . . . .		\$6.00
No. 181—Moorehead Amplifier Tube . . . . .		7.00
No. 165—V. T. Socket for 4-prong base tubes . . . . .		1.00
No. 101—Grid Leak and Grid Condenser combined . . . . .		.50
No. 102—Grid Condenser, .0005 Mfd. . . . .		.35

We have a generous stock of all these Shramco specialties on hand and will make immediate shipments. Postage extra. Send 5c in stamps for Catalogue "K," listing complete line of high grade radio apparatus at moderate prices.

## SHOTTON RADIO MANUFACTURING CO.

P. O. Box 3 SCRANTON, PENNSYLVANIA

**VACUUM TUBES REPAIRED**

<b>RELIABLE</b>	Marconi	Cash Must	Electron Relay	<b>SERVICE</b>
	Moorhead	\$3.50	Audiotron	
		Accompany Order		

**EASTERN VACUUM TUBE LABORATORIES**  
 178 Washington St. Boston, 9, Mass.

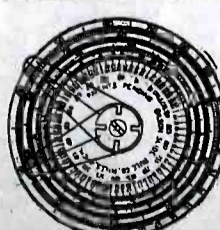

The Midget "FIVE-IN-ONE" Slide Rule is a combination Mannheim, Log-Log, Add and Subtract, Polyphase and Binary Slide Rule. It will instantly add, subtract, multiply and divide any combination involving whole numbers, fractions, decimals and mixed numbers. Gives every possible root and power of every quantity. The graduations are printed on metal coated with white celluloid and are grease and waterproof. While it is the most versatile calculator ever invented, its operation is simple and easily understood. Diameter 4".

Price with 16-page Instruction Book, \$1.50. Leatherette carrying case 50c extra. Catalog free. Your money back if you are not satisfied. Gilson Slide Rule Co., Niles, Mich.

### For Various Reasons—



P articular  
 R adio  
 A amateur  
 C ustomers  
 O rder from us.

**PENN RADIO APPARATUS CO., Inc.**  
 Box 110 Reading, Pa.



# OPPORTUNITY AD-LETS

Follow these advertisements every month. Reliable advertisers from all over the country offer you their most attractive specials in these columns.

Classified advertising rate six cents a word for each insertion. Ten per cent discount for 6 issues. 20 per cent discount for 12 issues. Name and address must be included at the above rate. Cash should accompany all classified advertisements unless placed by an accredited advertising agency. No advertisement for less than 10 words accepted.

Objectionable or misleading advertisements not accepted. Advertisements for the July issue must reach us not later than June 10.

## THE CIRCULATION OF RADIO NEWS IS OVER 40,000

EXPERIMENTER PUBLISHING CO. INC., 233 and 236 Fulton Street, New York, N. Y.

### Automobile Accessories.

**Autoists—"Saviorgas";** easily mixed. Saves gas. Decarbonizer. Recipe, 10c coin. Hawthorne Co., Roslyn, Wash.

**Auto Motors Supplies**—Buick, Michigan, Standard-Dayton, E. M. F., Cadillac, Overland, Continental and Buda Motors. All types, \$50 each and up. New Dixie magnetos, \$20; Splittorf high tension magnetos, \$10; Kellogg pumps \$3.50; Auto-Lite generators, new, \$10; air gauges, 65c; Remy ignition coils, new \$3; electric and gas headlamps, coils, distributor heads, air compressors, etc. Write for catalog. Motor Sales Dept., 16 West End, Pittsburgh, Pa.

### Motorcycles—Bicycles.

**Don't Buy** a bicycle motor attachment until you get our catalog and prices. Shaw Mfg. Co., Dept. 1605, Galesburg, Kans.

**Used Parts** for all motorcycles. Schuck Cycle Co., 1922 Westlake, Seattle, Wash.

### Motor Engines and Dynamos.

**Special Garage Motors**—Manufactured by the General Electric Co.: 1 H.P., \$78.50; 2 H.P., \$110; 3 H.P., \$128.50; 5 H.P., \$166.50. All sizes both single and polyphase motors for immediate delivery. Special charging generators, all voltages. Write for catalog. Motor Sales, Dept. 16, West End, Pittsburgh, Pa.

### Machinery and Tools

**Seven Inch Bench Lathe** with carriage, \$35; also small aluminum gasoline engines, two lbs. Mechanical Lathe Co., 2411 S. Springfield Ave., Chicago.

### Agents Wanted.

**Big Money** and fast sales. Every owner buys gold initials for his auto. You charge \$1.50; make \$1.35. Ten orders daily easy. Write for particulars and free samples. American Monogram Co., Dept. 133, East Orange, N. J.

**Beginners**—Complete mail order system, R. Box 1005, Atlantic City.

### Help Wanted.

**Detectives Earn Big Money.** Excellent opportunity. Travel. Great demand everywhere. Fascinating work. Experience unnecessary. Particulars free. Write, American Detective System, 1968 Broadway, New York.

**Be a Mirror Expert.** \$3-\$10 a day; spare time home at first; no capital; we train, start you making and silvering mirrors, French method. Free prospectus. W. R. Derr, Pres., 579 Decatur St., Brooklyn, N. Y.

**Wanted**—Radio instructor to take charge of school, A-1 man preferably with teaching experience and college education. Box 100, RADIO NEWS.

**Earn \$25 Weekly,** spare time, writing for newspapers, magazines. Experience unnecessary; details free. Press Syndicate, 5665, St. Louis, Mo.

### Health.

**Tobacco or Snuff Habit Cured** or no pay; \$1 if cured. Remedy sent on trial. Superba Co., SB, Baltimore, Md.

**Pyorrhoea (Rigg's disease—bleeding or swollen gums)**—hundreds have been helped by "Pyorrdent", the successful home pyorrhoea treatment. Purifying, healing, preventative. Full month's treatment, consisting of a very beneficial massage paste and an antiseptic tooth-cleansing paste to be used in place of your ordinary dentifrice, together with full directions for treatment. \$1 postpaid. Or write for free booklet "R." Pyorrdent Mfg. Co., 439 Seventh St., Brooklyn, N. Y.

### Stamps and Coins.

**1000 Different Stamps,** \$3.00; 500, \$1.25; 200, 25c; 100, 12c. Approvals. Michaels, 5602 Prairie, Chicago.

**California Gold Quarter** size and Colombia nickel coin 30c; Italy 10 Centimes and catalog 10c. Homer Shultz, King City, Mo.

### For Advertisers.

**Advertise in 100 Magazines.** Words 9c each; three times 18c each. Concordia Magazine, 9A Water, York, Penna.

**Don't Wait for Business.**—Advertise and get it. We will help you. Jacobus Service, 41 Bruen, Irvington, N. J.

### For Inventors.

**Designing, developing, working models;** 22 years experience. E. Porsberg, Box 47 Northfield, O.

### Office Devices

**Used Checkwriters,** all makes, wholesale, retail; furnish one to fifty. Write me. Allen, 519 Farnham Bldg., Omaha, Nebr.

## This Is What They All Say

900 Riverside Drive,  
New York, February 8, 1921.

Dear Sir:

Kindly enter my ad in RADIO NEWS for March. I always get good results from your ads.

(Signed) HAROLD ISAACSON.

70 Arlington Street,  
Hyde Park, Mass.

February 9th, 1921.

Gentlemen:

Enclosed find eighty-four cents (\$0.84) in stamps for an advertisement I would like to have put in the March RADIO NEWS.

May I add that I have gotten better results from RADIO NEWS than I could ever have thought of getting from my other advertisements.

(Signed) CHARLES M. BUTLER.

### Business Opportunities.

**If You Want to Sell** or exchange your farm, unimproved land, city property or patent, write me. John J. Black, 194th St., Chippewa Falls, Wis.

**Substantial Manufacturing Corporation** wants capable men to establish branch and manage salesmen; \$800 to \$2,000 necessary. Will allow expenses to Baltimore as explained. Address Mr. Clemmer, 603 N. Eutaw St., Baltimore, Md.

**Make Big Money**—Start a business of your own. We give full instruction to succeed. Guaranteed formulas how to manufacture: Silverplating powder, liquid court plaster, straw hat bleach, re-silvering mirrors, dressing and polish for tan shoes, luminous paint, toothpaste for collapsible tubes, soap bubble liquid. All for 50 cents. The Sydney Specialty Co., 43 Murray St., New York City.

**Make More Money**—Start manufacturing kewpie dolls and novelties; 45 cents worth plaster Paris makes dozen dolls worth \$12. List of buyers, special formula, instructions complete, \$1. Seyvis, Sta. C. Box 43, Buffalo, N. Y.

**Let Us Be Your Factory.** Write today. Logan Machine Co., 222 S. Clinton St., Chicago, Ill.

**Complete Machines** or parts manufactured. Tools and special machinery designed and built. Patents perfected. E. Bieber, Reading Pa.

### Books.

**We Buy and Sell** back issues of Radio Amateur News and Electrical Experimenter. Boston Magazine Exchange, 109 Mountfort St., Boston, Mass.

**The Amateur Electrician**—Pocket size, 20c, coin. Joe Tillberg, Proctor, Vermont.

**Books, Novelties,** classy photos, magical goods; catalogue 10c. J. M. Northen & Co., Walnut Ridge, Ark.

**Wireless Course in 20 Lessons.** By S. Gernsback, A. Lescarbours and H. W. Secor, E. E. Tells you everything you want to know about "Wireless"—theory, practice and history. A clear, concise course on every phase of this subject. 160 pages—350 illustrations, 30 tables. Flexible cloth cover, 75c postpaid. Stiff cloth cover, \$1.25 postpaid. Experimenter Publishing Co., Book Dept., 236-A Fulton St., New York.

**Just Off the Press.** Design and Construction of Audion Amplifying Transformers (Radio and Audio-Frequency Types). By Edward T. Jones, late Associate Editor Radio Amateur News. The transformers shown in this book have never been described in print before and have usually been considered a manufacturer's secret. The designs are very rugged and simple. A book that every radio "bug" should have. Written so you will understand every word. Price 25c postpaid. Experimenter Publishing Co., Book Dept., 236-A Fulton St., New York City.

**How to Make Wireless Receiving Apparatus.** 100 pages—90 illustrations. Only strictly modern radio apparatus are described in this book and the illustrations and descriptions are so clear and simple that no trouble will be experienced in making the instruments. Paper covered, 35c postpaid. Experimenter Publishing Co., Book Dept., 236-A Fulton St., New York City.

**Experimental Electricity Course in 20 Lessons.** By S. Gernsback and H. W. Secor, E. E. A course of the theory and practice of Electricity for the Experimenter. Every phase of experimental electricity is treated comprehensively in plain English. New experiments are described and explained and nearly every application of Electricity in modern life is given. 160 pages—400 illustrations. Flexible cloth cover, 75c postpaid. Stiff cloth cover, \$1.25 postpaid. Experimenter Publishing Co., Book Dept., 236-A Fulton Street, New York.

### Patent Attorneys.

**Patents**—Send for free book. Contains valuable information for inventors. Send sketch of your invention for free opinion of its patentable nature. Prompt service. Twenty years' experience. Talbert & Talbert, 4927 Talbert Bldg., Washington, D. C.

**Millions Spent Annually** for ideas. Hundreds now wanted! Patent yours and profit! Write today for free books—tell how to protect yourself, how to invent, ideas wanted, how we help you sell, etc. 301 Patent Dept., American Industries, Inc., Washington, D. C.

**Patents Secured**—Prompt service. Avoid dangerous delays. Send for our "Record of Invention" form and free book telling How to Obtain a Patent. Send sketch or model for examination. Preliminary advice without charge. Highest references. Write today. J. L. Jackson & Co., 133 Ouray Bldg., Washington, D. C.

**E. T. Brandenburg** (former patent expert, Ordnance Division, War Department), Attorney-at-law and Solicitor of Patents, 927 Loan and Trust Bldg., Washington, D. C. Send sketch and description, or model of your invention for careful investigation at Patent Office and unbiased report as to patentability.

### Phonographs.

**Build a genuine Choraleon phonograph** and save over half. Fine profits building and selling. We furnish motors, tone arms and necessary parts. Send for our catalog and free blueprint offer. Choraleon Phonograph Co., 521 15th St., Elkhart, Indiana.

### Correspondence Courses.

**Dollars Saved.** All kinds of used correspondence courses sold. (Courses bought). Lee Mountain, Pisgah, Alabama.



**Guns, Sporting Goods, Etc.**

**Brownie Semi-Automatic**—Safest pistol made; shoots all sizes .22 cal. cartridges, \$10.50. Bayard Midget Automatic .25 cal., \$15.50; .32 cal., \$17.50 postpaid. Lowest prices in America on Colt, Smith & Wesson, Savage, others. Booklet mailed free. Standard, 843-5 Broad St., Newark, N. J.

**Johnny Get Your Gun**—Lowest existing prices on all kinds of guns, new and second hand. Re-loading tools, gun implements, powder, solvents, sights, stocks, recoil pads, etc., at prices that will save you money. Red stamp brings complete price list. Good Scout brand sporting goods are proven second to none. Six cents in stamps brings complete athletic goods catalog. Dealers write. Bullock's Sporting Goods, Dept. 6, York, Nebr.

**Miscellaneous.**

**Still for Water**, oils, liquids, all drinking purposes, gallon hourly, \$15 up prepaid; circular free. European Supply Co., Box 1682, Dept. S, Pittsburgh, Pa.

**News Correspondents**

**Earn \$25 Weekly**, spare time, writing for newspapers, magazines. Experience unnecessary; details free. Press Syndicate, 566 St. Louis, Mo.

**Novelties.**

**Genuine Indian Baskets**.—Wholesale catalogue. Marion Gilhams, Highland Springs, California.

**Personal.**

**Attention!**—Do you want that powerful, conscious, magnetic personality that draws people to you and gives you success and supremacy? I have a principle which when consciously used will give you wonderful power. Send \$2 for copy of "The Mighty Powers of Self." Money refunded if not satisfied. C. Swanson, R. R. 1, Lenoir, N. C.

**Printing.**

**Labels**, 60c per 1,000 up. Irvin J. Wolf, Station E, Philadelphia.

**Everything Printed**.—Long run specialists. Samples. Quality Printery, Marietta, Ohio.

**250 Bond Letter Heads**, bill heads, envelopes and cards, complete \$5.00. 250 letter heads and envelopes, \$2.75. Balkow Printing Co., Meridan, Conn.

**Printing of All Kind** done at reasonable prices. Agents wanted. Write W. J. Dembiczak, 62 Cedar St., Bridgeport, Conn.

**100 Envelopes and 100 Noteheads** printed \$1. Postpaid. Samples free. P. Donaldson, Kemp, Texas.

**Farms and Orchards.**

**Acres Pecans** and oranges with beach club lot, \$100. Easy terms; big returns. Dept. S, Suburban Acres Co., Ocean Springs, Miss.

**Postcards and Pictures**

**Photograph Art Books**, 25c. Special art, \$1; Miniature card, 10c. European Supply, Box 12, Dept. S, Uptown Station, Pittsburgh, Pa.

**Stammering.**

**Stammerers**—My simple and natural method will correct your impediments. Instruction individual. Samuel I. Robbins, 246 Huntington Ave., Boston.

**St-Stu-t-t-ering and Stammering** cured at home. Instructive booklet free. Walter McDonnell, 121 Potomac Bank Bldg., Washington, D. C.

**Song Writers.**

**Song Writers!**—Learn of the public's demand for songs suitable for dancing and the opportunities greatly changed conditions offer new writers, obtainable only in our "Song Writers' Manual and Guide," sent free. Submit your ideas for songs at once for free criticism and advice. We revise poems, compose music, secure copyright and facilitate free publication or outright sale of songs. Knickerbocker Studios, 819 Gaiety Bldg., New York.

**Scenery for Hire.**

**Collapsible Scenery** for all plays. Amelia Grain, Philadelphia, Pa.

**Telegraphy.**

**Telegraphy** (both Morse and Wireless) and Railway Accounting taught quickly. Big salaries. Great opportunities. Oldest and largest school; established 46 years. All expenses low—can earn large part. Catalog free. Dodge's Institute, M. St. Valparaiso, Ind.

**Chemistry**

**Chemical Magic** experiments, 10c coin. Box 335 Swedesboro, N. J.

**Chemistry**—Learn qualitative analysis by the modern simplified chart method. U. S. \$1. Foreign countries \$2. Technical Charts, Dept. C-3, 1038 W. Chicago, Ave., Chicago, Ill.

**Chemical Science**—Sample 10c. coin. Walter Molitor, Swedesboro, N. J.

**Electrical Supplies and Appliances.**

**Electricians**—Wiremen, linemen, send your name and address for descriptive literature of our modern blue print chart method of electrical wiring. Over 350 practical diagrams. Electrical Wiring Diagram Co., Box C-173, Altoona, Pa.

**Storage Batteries** for automobiles. We furnish all parts and moulds for making them. Sample plate, 40c. Foreign countries, 50c. Windsor Specialty Co., 5419 Windsor Ave., Chicago, Ill.

**Magnet Wire**—To introduce ourselves we are making a special price for a short while. Quotations for 1/4 lb. spools. Postage extra. No. 24 S.C., 50c; No. 26 S.C., 54c; No. 28 S.C., 63c; No. 32 S.S., \$1.03; No. 36 S.S., \$1.65. Prices on other sizes on application Tin foil 25c per lb. Postage extra. Grid condensers 28c. Harry T. Gleich Co., 490 Sixth Ave., New York City, Dept. W1.

**Bargains in storage batteries**, list 2c. D. Nelson, 403 Beacon St., Lowell, Mass.

**Wireless.**

**Variocouplers**, bakelite tubes, \$5.25; variometers, inside windings, \$4.25; transmitter microphones, \$3; oak cabinets with and without bakelite panels. Meade Bakelite Radio Apparatus, 975 Putnam Ave., Brooklyn, N. Y.

**Swap**—New 15-jewel, 20 year case wrist watch for radio apparatus. Make offer. Joe Fleming, 100 Powell St., Atlanta, Ga.

**New Duck Navy coupler**, \$14. Edward Hopper, Hawthorne, N. J.

**Slab Inductances**—Set of eight, tuning with .001 MF condenser from 300 to 30,000 meters. Forward money orders, \$4.00, made payable at Atlantic Road Brixton to Perry 9 Jelf Road Brixton, London, England, and secure a set post free by return.

**Alkaline Storage B** batteries last indefinitely. Pictures and further information upon request. 32 volts, \$8; 50 volts, \$10; 70 volts, \$12. Kimley Mfg. Co., 290 Winslow Ave., Buffalo, N. Y.

**For Sale**—One 10 K.W. wireless transformer, \$70; and one-step regenerative cabinet, \$30. Harold W. Nogle, Hop River Conn.

**Special for May**—Western Electric 1 mfd. phone condensers postpaid \$2.50; also handle all standard instruments catalog prices. Send stamp for monthly bargain sheet. Excellent service. Satisfaction guaranteed. Arthur Post 329 Harrison St., Passaic N. J.

**Blue Prints**—We put your favorite hook-up on tracing cloth, 9 x 12 inches for 50 cents, three for \$1.25. You can then make all prints you want. Have you obtained our VT diagrams for receiving and phone sets? They are making a hit. 50 cents for either set of 12 separate sheets. Full range of circuits at your finger tips. We prepare drawings, carrying out your ideas for any kind of apparatus. Finest drafting at dirt cheap rates. Cabinet sets planned. Send stamp. Fine wall print of Continental Code, 6 by 28 inches, 25 cents. Readable 30 feet. No stamps with orders. The Plan Bureau, 1929 McCausland Ave., St. Louis, Mo.

**Audion Detector and Amplifier**, V.T., 50 cents. Honeycomb coil mountings, 25 cents. Back mounted rheostats, 40 cents. Composition for molding your own knobs, panels, etc. 35c pound. Send stamp for particulars. Palmers Electrical Equipment Co., Palmers, Minn.

**A Central Distributing Point** for all standard makes of wireless supplies. We carry a full stock of everything that is desirable in the way of wireless equipment. Quantity buying enables us to make low prices. An absolute guarantee on every article sold. Write us your wants; every letter answered promptly. Bullock's Sporting Goods, Dept. 6, York, Nebr.

**Must Be Sold at Once**—Limited supply switch levers, 1 1/2 inch radius; nickel plated large Marconi knob, regular price 85c; closing out at 52c each. Only 500 in stock. Radio Testing Station, Binghamton, N. Y.

**Radio Phonists' Attention**—High voltage generators. We supply motor generator units in various capacities especially designed for radio phone work. Low powered rotary converters, dynamotors, fractional H.P. motors, storage batteries. Various types of meters, condensers, spark gap rotors. The new synchronous spark gap. Get acquainted with our service. Ray-di-co. 2653A, N. Clark St., Chicago, Ill.

**Switch Points**—7/32 x 7/32 x 1/4 inch high, complete with screws Regular price 36c per dozen. Closing out at 28c per dozen Radio Testing Station Binghamton, N. Y.

**(Wireless continued)**

**Amplifiers**—Single steps can be hooked up to 3 steps. Bakelite panel, hardwood base Buss wiring. Buy direct from manufacturer. Save \$2.50. Price \$14.00. Also detector units to match, \$6.00. Guaranteed. Send money order. Postpaid. C. Smith, 235A Windsor Pl, Brooklyn, N. Y.

**Bulk Galena** closing out at 16c per oz. RTS tested galena, large piece, 25c per box. Radio Testing Station, Binghamton, N. Y.

**Ammeters**, new, read 5 amperes charge and discharge, \$1. Postpaid. The Recto Mfg. Co., Inc., 23 W. Third St., Cincinnati, Ohio.

**Regenerative Set** for amateurs who cannot afford the variometer type. Use these stagger wound pancake coils with the tickler circuit and obtain greater selectivity and signal strength. Mount on your old panel. Set of three coils 200 meters, \$6; 600 meters, \$7; 1 K.W. O. T., \$3; loops, \$1. West Philadelphia Radio Co., 4054 Chestnut St., Philadelphia, Pa.

**Marconi Knobs**—1 1/4 inch diameter, closing out at 12c each. Radio Testing Station, Binghamton, N. Y.

**Engraving of Bakelite**—5c per letter. We handle all makes of wireless apparatus. Radio Supply Co., 43 Carlisle St., Springfield, Mass.

**See Our Display Ad** on page 810. Radio Testing Station, Binghamton, N. Y.

**Build Your Own** fixed condensers and save money. Will send you tin foil and mica enough to build grid, plate and bridging condensers, together with complete set of instructions for making them, for 50c. Harry T. Gleich Co., 490 Sixth Ave., New York City, Dept. W1.

**Demand the Genuine** RTS grid condensers. Do not be deceived by imitators. RTS grid condensers, .0005 MF each, 35c; RTS phone condensers, .0013 MF, 40c; RTS grid condenser and grid leak, .0005 MF, 50c. Radio Testing Station, Binghamton, N. Y.

**Make Your Receiving Condensers**—Quarter pound 4 inch foil with paper attached makes 40 .001 mf. condensers. 25c excluding postage. Lester Gruver, 2907 Scottwood Ave., Toledo, Ohio.

**Electrolytic Rectifiers** will operate your audion plate circuits on A.C. perfectly when used with ordinary filter circuit. Half pint size, extra charge of chemicals, renewal electrodes, per set of four, \$2. No objectionable noise even in amplifier sets. Satisfaction guaranteed. Free circular. Geo. M. Gilbert, 746 Chenango St., Binghamton, N. Y.

**Get Your Catalogue Now**—If you haven't already the new RTS catalogue, send 10c at once. This amount deducted on your first order. We save you money. "You'll be surprised." Radio Testing Station, Binghamton, N. Y.

**Have You Heard** the clear, powerful, musical note of the harmonic disc? Gives three notes at once which blend into a chord. Tests have proven that the note produced, is far superior in carrying power to the note produced by the ordinary disc. Very simple to construct. Be first in your town to own one. Blue print and complete instructions sent promptly upon receipt of \$2. Earl Lester, Box A-111, Houston, Texas.

**Something New**—220 V. D.C. direct from any 110 V. A.C. circuit at a practically constant potential suitable for C.W. or radiophone transmission. This little instrument is only 3 1/2 x 6 1/2 x 5 inches high and will take up to 150 V. A.C. and deliver up to 300 V. D.C. Amply supplies three tubes. Noiseless in operation. Requires no attention. Lasts forever. In handsomely finished oak box with bakelite cover. Price \$20 postpaid. C. J. Fitch, 181 W. Housatonic St., Pittsfield, Mass.

**Order Now**—By Mail.—New apparatus at prices below list: Grebe, DeForest and others. New V.T. 2's, \$12; used apparatus at reasonable rates. State your wants. W. W. Freeland, 34 Baldwin Ave., Newark, N. J.

**Overstock** of No. 35 enamelled magnet wire suitable for radio transformers, spark coils, etc., at cost. One pound, \$1.15 postpaid. No. 16 enamelled, 90c pound, postpaid. Specialties Mfg. Co., 1436 12th Avenue, San Francisco.

**Write for Our Big Free Price List**—First class apparatus. Quality and service. Satisfaction guaranteed. Wireless Amateur's Supply Lab., 1315 E. High St., Davenport, Iowa.

**Variometers**—You can now have as many variometers as you need to try out the complicated modern receiving circuits. There is nothing hard to make in a variometer except the ball shaped windings and supports. We furnish sets of wonderful self-supporting ball shaped coils which are marvels of efficiency and you build the rest easy according to instructions we furnish. Coils 50 and 75c each. Blueprint instructions 10c (free with set of four coils). Colored circular 2c. See our display ad next month. Precision Radio Equipment Co., 118-120 Christie St., Ridgefield Park, N. J.

**Wireless Course in 20 Lessons.** By S. Gernsback, A. Lescarboua and H. W. Secor. E. E. Tells you everything you want to know about "Wireless"—theory, practice and history. A clear, concise course on every phase of this subject; 160 pages—350 illustrations, 30 tables. Flexible cloth cover, 75c. postpaid. Stiff cloth cover, \$1.25 postpaid. Experimenter Publishing Co., Book Dept., 236-A Fulton St., New York.

(Continued on page 846)



(Continued from page 845)

## (Wireless continued)

**How to Make Wireless Sending Apparatus.** 100 pages—88 illustrations. Written and published entirely for the wireless enthusiast who wants to make his own radio apparatus. Contains more information on "how to make it" than any other book we know of. Paper bound, 35c. postpaid. Experimenter Publishing Co., Book Dept., 236-A Fulton St., New York City.

**How to Make Wireless Receiving Apparatus.** 100 pages—90 illustrations. Only strictly modern radio apparatus are described in this book and the illustrations and descriptions are so clear and simple that no trouble will be experienced in making the instruments. Paper covered, 35c. postpaid. Experimenter Publishing Co., Book Dept., 236-A Fulton St., New York City.

**Experimental Electricity Course in 20 Lessons.** By S. Gernsback and H. W. Secor, E. E. A course of the theory and practice of Electricity for the Experimenter. Every phase of experimental electricity is treated comprehensively in plain English. New experiments are described and explained and nearly every application of Electricity in modern life is given. 160 pages—400 illustration. Flexible cloth cover, 75c. postpaid. Stiff cloth cover, \$1.25 postpaid. Experimenter Publishing Co., Book Dept., 236-A Fulton St., New York.

**Just Off the Press—Design and Construction of Audion Amplifying Transformers (Radio and Audio-Frequency Types).** By Edward T. Jones late Associate Editor Radio Amateur News. The transformers shown in this book have never been described in print before and have usually been considered a manufacturer's secret. The designs are very rugged and simple. A book that every radio "bug" should have. Written so you will understand every word. Price 25c postpaid. Experimenter Publishing Co., Book Dept., 236-A Fulton St., New York City.

**The How and Why of Radio Apparatus,** by H. W. Secor, E. E. This newest book on radio matters fulfills a distinct gap in wireless literature in that, while the treatment is made as understandable and as free from mathematics as possible, it at the same time incorporates a wealth of technique and instruction for the Radio Amateur—the Radio Operator—the Installation and Designing Expert—as well as teachers and students of the subject in general. A very broad field has been covered by the author, at the same time giving a great deal of information not found in other text books. If you are engaged in any branch of the Radio or allied arts at all you will surely need this latest contribution to radio literature, which is destined to be found on every radio man's book shelf before long. A glance at the following list of chapters gives but a very scant idea of the extensive and useful radio knowledge provided in its text: The Induction Coil; The Alternating Current Transformer; Radio Transmitting Condensers; The Spark-Gaps; Radio-Transmitting Inductances; Radio Receiving Tuners; Radio Receiving Condensers; Detectors; Telephone Receivers; Radio Amplifiers; Construction of a Direct Reading Wavemeter and Decimeter; Antenna Construction; The Calculation and Measurement of Inductances; Appendix containing very useful tables, covering all subjects treated in this very unusual book. This newest of Radio Works, cloth bound in Vellum de Luxe, Gold Stamped and Hand Sewed, has 160 pages. Size of book 6x9 inches. The How and Why of Radio Apparatus, Postpaid \$1.75. Experimenter Publishing Co., Book Dept., 236-A Fulton St., New York City.

## Wanted to Buy

Send to Cleveland by mail or express any old or broken watches, false teeth, old or broken jewelry, brooches, bracelets, old gold, silver, platinum, diamonds, magneto points, platinum wire, contact points or crucibles, mercury, and anything valuable. We pay the highest prices in cash by return mail. Goods returned in ten days if you're not satisfied. The Ohio Smelting & Refining Co. 207 Lennox Bldg. Cleveland Ohio.

## Exchange.

**For Sale—A one-step radio frequency receiver, \$30; one audion control cabinet \$15; one inductance cabinet, \$15; one A.P. amplifier tube, used five hours, \$5.50; one Federal audio frequency transformer. A1 condition, \$5; one choke coil, \$1; one Arlington receiving transformer in A1 condition \$5; and the following mounted honeycomb coils: L75, L200, L400, L750, all for \$6. Write for full description of any or all of these items. Walter Kohr, Lancaster, Pa.**

**For Sale—Set of honeycomb coils, 12 coils, range from 500 to 25,000 meters; also triple geared pedestal mounting, almost new, price \$30 c. o. d. One new audiotron double filament, with four-prong adapter, \$4.50; Federal transformer, new, \$8.50; two Federal anti-capacity switches, 12 spring, new, \$2.25 each. Murdock 43 plate condenser, almost new, \$4; multiaudifone, like new, \$10. V. J. Coughenour, Plattsburg, Ohio.**

**For Sale—One Turney spider web inductance. Sell \$5.50, new. I. Krieger, 2120 Mapes Ave., New York City, N. Y.**

**Swap—Type F Baldwins for banjo or Banjo-mandolin. Also typewriter and others. Albert Toth, 1628 First Avenue, New York City.**

(Exchange continued)

**Fore Sale—Wireless material; send for list. Want twin-cylinder motorcycle engine. J. Zied, 530 Callowhill St., Philadelphia, Pa.**

**For Sale—Back numbers of the Electrical Experimenter from April, 1918, to March, 1921. Write for prices. Harold Tornquist, Caribou, Maine.**

**Through Death of Son wish to sell all his wireless outfit. Write for particulars. Mrs. S. Victor, 654 Burke Ave., Bronx, New York City.**

**Generators—Two 80 watt H. R. S.; type "S"; radioson detector, perfect condition; two motorcycle engines, just overhauled; Brandes navy phones; two variable condensers, ground switch. Many other things; all good condition. Sacrifice. Harold Walker, 41 St. John Ave., Binghamton, N. Y.**

**Bargains—Prize winning set in January, 1920, R. A. N. Short wave regenerative set. Both A1 condition. Must sell. What am I offered? Urban Worner, 1052 City Park Ave, New Orleans**

**For Sale—5 dial omnigraph, \$15; DeForest 3-coil mounting, with gears, \$7. E. Saul, 187 St. Marks Ave., Brooklyn, N. Y.**

**Quitting Wireless—20,000 meter coupler, \$20; 3,000 meter coupler, \$6; detector, one-step variable, etc., \$15; 43-plate variable, dial, hard rubber panel, \$5, or first \$40 money order. Roy Schilling, 3956 Zerni, Denver, Colo.**

**A Bargain—DeForest six-panel ultra-audion unit set and one-step amplifier, with phones, eight coils, tubes and B battery. In neat cabinet. Write for particulars. John W. Slayden Waverly, Tenn.**

**For Sale—Transmitting set complete, owner must sacrifice; transmitter includes open core transformer, condenser, oscillation transformer, impedance coil, rotary gap (marble base), rheostat, key, large changeover switch, thermol couple meter, lightning switch. A real set for someone wanting something worth while. \$100 for quick cash sale. Also Clapp-Eastham BQ wavemeter Weston thermo galvanometer for same, \$35; short wave variometer regenerative set, \$30. Box 50, care of RADIO NEWS.**

**For Sale—1 set Victor-Marconi wireless code records, \$2.75; 1 Standard key, \$2.50; 1 ¼ inch spark coil with gap, \$2; 1 No. 2 Junior omnigraph with 5 sets wireless dials, \$19. All good condition. Wesley Robinson, Jr., St. Marys, Ga.**

**For Sale—Sending and receiving set, \$18. C. Roebing, 2748 Fulton St., Brooklyn, N. Y.**

**For Sale—DeForest 6 panel unit set complete with 5 coils (less bulb). Has tuning condenser equipped with vernier. Set used three months. Guaranteed to be as good as new. Selling out. First money order for \$40 takes it. Emerson Rossberg, 52 Vine St., New Britain, Conn.**

**Must Sell—Complete regenerative receiving set. Genuine mahogany cabinet 14 x 10 inches with bakelite front. Photograph sent on request. Bargain at \$54 prepaid with audion bulb. Glenn Shockley, Silvertown, Oregon.**

**For Sale—Five disk omnigraph, absolutely new, with sounder, \$15. I. Schinck, New Milford, N. J.**

**Audiotron Cabinet—With bulb, \$9.50; with "B" batteries, \$11.50; panel only, \$5; Murdock variable, \$4.25. Allen Grower, Luverne, Minn.**

**Wanted—Acme 200 watt C.W. power transformer, mounted. Sell one ½ K.W. open core transformer, \$5; one pancake oscillation transformer, \$3. Address Alfred Gienow, River Edge, New Jersey.**

**Arc Generator—½ K.W., water-cooled. First check for \$15 gets it postpaid. A. Greenberg, R2, Hackensack, N. J.**

**Complete Receiving Set—3500 meter, \$30. Send for description Pvt. Al Huson Camp Morgan, N. J.**

**Electrical Engineering course complete; 36 text books in perfect condition; worth \$40; first reasonable offer takes them. P. O. Box 1104, New Orleans, La.**

**For Sale—¼ K.W. sending set, Thoradson transformer, rotary, 4 sections of condenser with rack, lighting switch, oscillation transformer, key, kick-back preventer, changeover switch, \$50; detector and two-step amplifier, batteries, bulbs, fones, \$55; Murdock loose coupler, \$14; Crystal receiving set with two variables \$32; Holtzer-Cabot fones \$13; Grebe detector cabinet, \$16; Arnold detector cabinet \$15; Adams-Morgan coupler, regular \$40, sale price \$30; detector and one-stage amplifier, bulbs, \$25; key, \$2; Western Electric fones, \$7. All apparatus in A1 condition. John Kennell, Rox 102, Passaic, N. J.**

**Sale—Complete ¼ K.W. transmitting set comprising Clapp-Eastham ¼ K.W. transformer, 2 sections condenser, rotary gap and key, \$22; also complete loose coupler receiver in panel, condenser and coil in panel, \$15. George Korper, 639 East 18th St., Brooklyn, N. Y.**

**Transformer—½ K.W., 50 V. Jewell meter. Edison home moving picture machine, analytical balance scale, 6 V. alkaline storage battery. 2QO.**

**Swap! Sell! DeForest audion receiver cheap! Transformers, condensers, fifty other articles; want 4 inch spark coil. Floyd Daisey, Cape Charles, Va.**

**Will Swap short wave receiver, CR 2 Grebe, first class condition, for long wave receiver. Won't ship. Wm. J. Callahan, 158 9th St., Long Island City, N. Y.**

(Exchange continued)

**Sale or Exchange electro-plating apparatus anodes, wheels and solution worth at least \$25; or swap Baldwin phones, transformer or what have you? Fred Gampert, Kirkland, Illinois.**

**Exchange—Mignon U.W. 1 undamped wave tuner and B.D. 1 detector, \$45; want regenerative receiver Joe W. Key, Charleston, Wash.**

**Bargain—Have two Colby long-wave tuners, worth \$17.50, sell \$12.50; one DeForest control panel, worth \$13.75, sell for \$9; Amrad quench gap ½ K.W., worth \$24.50. sell for \$18; 1 Edison primary battery, 300 amps. \$5. I. Krieger, 2120 Mapes Ave., Bronx, New York.**

**Bargain—Honeycomb coil panel with gear, 2 coils and 31 plate variable air condenser with Vernier attachment; all DeForest make. Cost. new, \$32; will sell for \$15. N. Mitchell, 235 South 25th St., Paris, Texas.**

**Wanted—Best radiophone \$30 will buy. Spot cash. Zachary Miller, 87 Gordon St., Perth Amboy, N. J.**

**Variocouplers, bakelite tubes, \$5.25; variometers inside windings, \$4.25; transmitter microphones, \$3; oak cabinets with and without bakelite panels. Meade Bakelite Radio Apparatus, 975 Putnam Ave., Brooklyn, N. Y.**

**First \$25 takes my receiver. Navy panel coupler, audion panel, "B" battery. Write for description. Want one K.W. set and one-inch coil. E. Siemssen, Alden, Minn.**

**Let's Swap! Buy! Sell!—Whatd'ye got? Whatd'ye want? Forward price, description and quarter for listing, including year's subscription, Swap Bulletin, New York-Detroit-Wichita Falls, Texas.**

**For Sale Cheap—Murdock coupler, Murdock condenser, audiotron, panel outfit, DeForest detector, jacks and plug, omnigraph, Hawkins guides, Robbins Meyer motor, Danditoy transformer, Fleming tube, switches. Palmore Lehnhoff, Clarksville, Texas.**

**For Sale—Five Edison storage batteries—5 cells each 7½ volts, 24 amp. hrs. rating, steel containers, price \$5, worth \$15; also one ¼ K.W. dynamo, no windings, fine for C.W. work, will exchange for pair phones and bulb. All letters answered. C. Morgan, Box 135, Tamaqua, Pa.**

**Complete Sending Set \$5; 3,000 meter navy type coupler, \$12; 800 meter coupler in cabinet type, \$8. Ralph W. Miller, 136 Hudson St., Reading, Pa.**

**For Sale—500 volt D.C. generator, rheostat, all for \$30. O. Mogler, 2840 Benton St., St. Louis, Mo.**

**Bargain—Triple honeycomb regenerative receiver with both audion and crystal detector and one-stage amplifier, all mounted in portable cabinet of my own design. Works excellent on radio-phone reception. Set includes eleven coils and "B" batteries, but no tubes. Costs \$112, sacrifice for \$65. Frederick J. Petrequin, Ste. Genevieve, Mo.**

**For Sale—An Acme 1 K.W. transmitting transformer in same good condition as when shipped from factory. Never used; will sell for \$32; also Super-Benwood twelve-stud rotary quenched gap, never used, will sell for \$24. P. O. money orders only accepted. Address all letters to the undersigned. C. O. Amos, 3011 Spruce Ave., Altoona, Pa.**

**Will Exchange 273 shares Uncle Sam oil stock, series A, par value of same is \$273, for audion or audion amplifying cabinet receiving set with bulbs and phones. Write, John F. Barry, Sabattis, N. Y.**

**½ K.W. Z. R. L. Transformer, \$12; rotary gap, \$8; condenser, \$1; ¼ K.W. transformer, \$9; key, \$2.50; condenser, \$1.50 rotor, \$1; rotary motor \$4. Floyd Buck, 15 Crescent Place Middletown, N. Y.**

**Bargain—Omnigraph, extra dials, new Mesco 55 buzzer, phones, key, copies Bluchers Wireless Telegraphy, Government examination questions, new, everything, \$16, or sell separate. Butler, 2180 Fulton St., Brooklyn, N. Y.**

**Audion Control Panel with bulb, \$14, also other instruments. Write for free list. A. Bardush, 532 Hall St., S. W., Grand Rapids, Mich.**

**Sell—Transmitting set; inch coil, helix, condenser, gap, key, price \$7. J. Burke, Geldard St., Valley Falls, R. I.**

**3 Inch Spark Coil, \$9.50; 1,500-15,000 meter loading coil, \$4.50. Edward Beaver, 910 Third St., Milwaukee, Wis.**

**Sale—One long distance cabinet wireless set with phones. Emmet Crowe, 728 South 60th St., Philadelphia.**

**Bargains—DeForest P-300, \$50; T-200, \$60; 12-coils, \$20; tubes, \$8; Baldwin telephones, \$14; new. Church of Jehovah, Long Island, Alabama.**

**Trade—Black Beauty bicycle, \$52 new, for a good rotary gap. Will sell for \$25. Write, Ward Drill, 1225 Wheeler St., Woodstock, Ill.**

**DeForest O T 5 phone set. First class condition, \$1. Frey, 208 Freeman Ave., Jersey City.**

**1 Short Wave regenerative set minus bulb, \$15. Also noiseless ¼ K.W. transmitter complete mounted in a cabinet with glass doors. Must be seen to be appreciated. Will sell at a reasonable price or consider in a trade for a new bicycle. Can be seen between 6 and 7.30 P. M. or Sunday mornings. Jerome M. Mandl, 533 W. 150th St., New York City.**

(Continued on page 847)



(Continued from page 846)

(Exchange continued)

**Will Sell** three small dynamos, high frequency, wireless, chemicals, etc. Send 5 cents. Karl Peterson, Weldon, Ill.

**For Trade**—Marlin rifle 30-30 10 shot repeater new, 28 steel Victor traps, various sizes, new last fall, photo finishing outfit complete. Want radio apparatus. Alfred Rusten, Osabrock, North Dakota.

**For Sale**—Benwood rotary, practically new with motor running at a speed of 4,000 R.P.M. First \$18 takes it. All letters answered. Radio 9ACM, 1611 North 8th St., Sheboygan, Wisconsin.

**Twelve Volt Tungsten Lamps**—Fit 110 volt sockets, 2½ and 5 watt. One 60c; two for \$1. Postpaid. Karl L. Peterson Laboratories, Weldon, Illinois.

**Sell Complete Receiving Outfit**—Also storage battery and other junk. Charles Spencer, 294 Central Park West, New York City

**Complete Wireess Outfit**—Will sell cheap. Used three weeks. Joseph Brozik, Waseca, Minn.

**For Sale**—5 ER'S 1 K.W. transmitting set. Have record of 1,500 miles, or ask any amateur how my signals were during last radio season. First M. O. for \$60 takes it. John Cain R. R. No. 9, Nashville, Tenn.

**For Sale**—Cabinet receiving set, bakelite panel, hinged top, audion control incorporated, 100 to 2,500 meters, ideal portable set. \$25.00. Davidson, 347 West 122nd St., New York City.

**For Sale**—Complete amateur receiving set cheap. Samuel Hoy, 24 Rhodes Ave., Collingdale, Pennsylvania.

**Wanted**—DeForest units or other standard apparatus; exchange for Automobile Engineering Cyclopaedia, 5 volumes; Modern Shop Practice, 6 vols.; Practical Aviation, Automobile Ignition, Lighting, Starting, 1 volume each, or cash. C. B. Hayward, Great Neck, N. Y.

**For Sale**—Stock of brand new technical books, best obtainable, for half price. Also tools and instruments. Send for list. Henry Francis Parks, Butte, Montana.

**Sell**—1 K.W. transformer, new, \$20. Val Lehmann, 231 Shuler Ave., Hamilton, Ohio.

**For Sale**—Omnigraph, 15 dial Morse and Continental, \$15. F. Richter, 1445 Boyd Ave., Woodhaven, N. Y.

**Wanted**—Omnigraph, state model, price and full particulars. Waterman, 192 Ainslie St., Brooklyn, N. Y.

**For Sale**—New \$40 audiotron cabinet detector for \$30. Contains "A" and "B" battery controls, variable grid condenser, secondary loading coil, besides double filament audiotron. Write Fred Morton, Kalispell, Montana.

**Selling Out**—One loose coupler, \$3; one Murdock variable condenser, \$3.25; one DeForest P-401 audion control, \$9.50; one two-step amp. in cabinet made with jack control, \$31; one pair Murdock phones, \$3.25; one loading coil \$5, and a bunch of smaller articles cheap. All inquiries answered. Leon Lavinthal, 504 Riverside Ave., Trenton, N. J.

**For Sale**—Radiocraft two-stage amplifier. Hardly used. Cost \$50. Sell \$35. Money order, Sam'l H. Horowitz, 71 E. 96th St., New York City.

**DeForest P-500 Detector**—\$10; Duck's navy transformer, \$10. Both in fine condition. Jay Edmondson, Milton, Iowa.

3,000 Murdock Phones, \$4.50. M. Rollberg, 5440 Lake Park Ave., Chicago, Ill.

**For Sale**—Sending and receiving set, and other apparatus. Henry Nalbach, Moweaqua, Ill.

**Sell Apparatus and Books**—List free. Robert Holman, 637 East Mahanoy St., Mahanoy City, Pa.

**Have For Sale** several pair of used phones, including Brandes Trans-Atlantic, \$9; Brandes navy type, \$10; Connecticut, \$8; a few Century buzzers at \$1.75; one Federal amplifying transformer, \$6; two Acme choke coils, at \$6 each and one (army-type) service buzzer transmitter and phone in leather case, \$20. First postoffice money order takes pick of lot. I. Krieger, 2120 Mapes Ave., New York City.

**A COMPLETE TUNER**

and Audion Detector that gets everything from 150 to 800 meters. All enclosed in walnut finished cabinet with bakelite panel and 40 volt B. battery.

Price ..... \$35.00

**VARIABLE B. BATTERIES**

22½ volt.....\$2.50      45 volt.....\$5.00

3,500-meter loose couplers.....\$9.00 up

Postage extra.      Circular for stamp

Jeffery, Crawford Co., 2173 Hilltop Ave., Detroit, Mich.

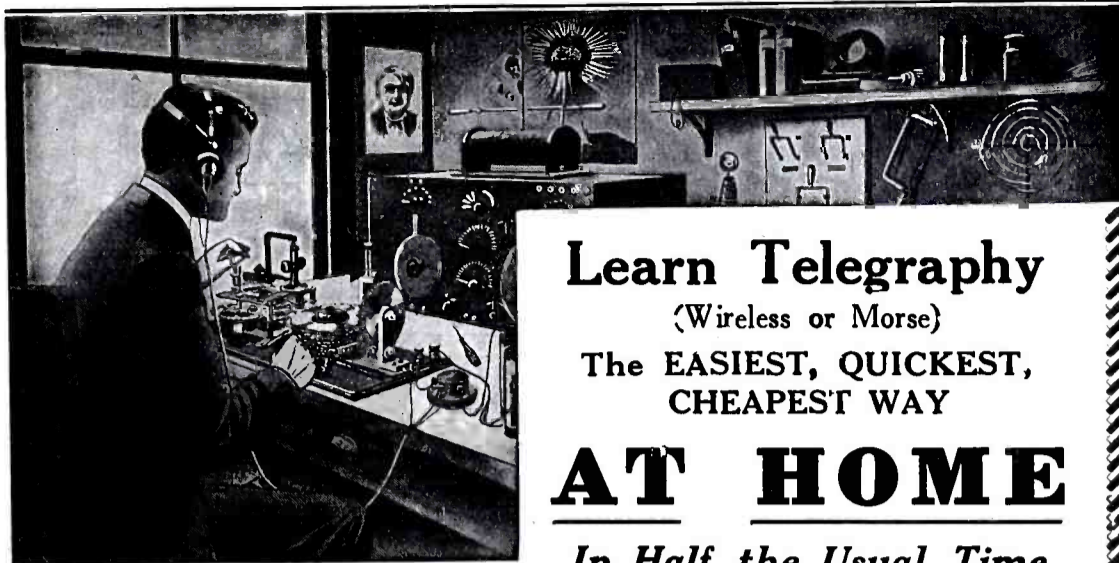

**Learn Telegraphy**

(Wireless or Morse)

The **EASIEST, QUICKEST, CHEAPEST WAY**

**AT HOME**

In Half the Usual Time

**WITH THE OMNIGRAPH**

"Just Listen—The Omnigraph will do the teaching"

The Omnigraph is an *Automatic Transmitter* that teaches you both the Wireless and Morse Codes, at home, without any expense except the cost of the machine itself. Merely connect to battery and your Buzzer, or Buzzer and Head Phones, or to your Sounder and the Omnigraph will send unlimited messages by the hour, at any speed you desire.

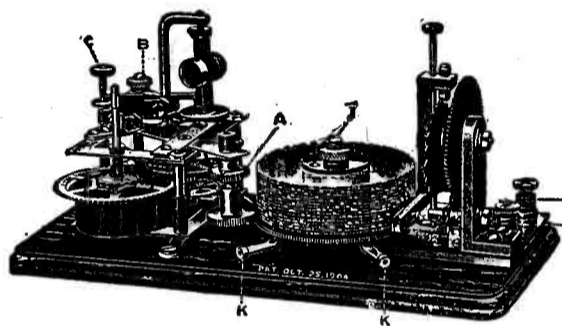

**USED BY THE U. S. GOVERNMENT**

The Omnigraph is used by the Government in testing all applicants applying for a Radio License. It is also used extensively by the large Universities, Colleges and Telegraph Schools throughout the Country for teaching Wireless and Morse. Hundreds of the Army's skilled operators who served during the war learned with the Omnigraph.

**Let The OMNIGRAPH Teach You Wireless**

For a few dollars you can have a complete outfit that will make you an experienced operator in the shortest possible time. No hard, laborious work—just learn by listening. The Omnigraph is adjustable so you can start receiving messages slowly, gradually increasing the speed as you become proficient.

You'll be surprised how quickly you will attain speed. Even if you are already an operator the Omnigraph will help you. It will make you more proficient, more accurate and more confident. Thousands of Omnigraphs are in use today and thousands of operators owe their success to them.

**Write for Free Catalog**

Send for a catalog today, showing the 3 different models, \$14 to \$30. Every Omnigraph is sold with the absolute guarantee that you must be satisfied or your money back for the asking. Mail the coupon today—the catalog will come to you by return mail.

**The Omnigraph Mfg. Co.**  
26 F Cortlandt St.,  
New York City

Gentlemen:—

As per your ad in RADIO NEWS please mail me your free catalog of Omnigraphs.

Name .....

Address .....

City..... State.....

**The Omnigraph Mfg. Co.**  
26 F. Cortlandt St., New York City

**PUGET TRANSFORMERS**

The last word in transformers that are really designed to put energy into your condenser.

**25,000 Volts and Resonant**

Gives a clear note with an Amrad gap and excels all makes for long distance.

**500 Watts—\$26.75**

**Northwest Radio Service Co.**  
609 Fourth Ave.      Seattle, Wash.

**The Smallest Audion Control Panel Made**



No. AC-5. Equipped with a socket, rheostat, eight binding posts and a grid leak condenser mounted on a hand engraved hard rubber panel, size 4½" x 2¼". Price..... \$6.50  
At your nearest dealer or from the

**WORTH RADIO CO.**

1843 East 12th St.      BROOKLYN, N. Y.

A welcome addition to your library! Send \$2.00 today, plus postage for 7 lbs., and your copy of bound volume No. 1 of Radio Amateur News will come forward by return mail.  
Experimenter Publishing Company      236a Fulton Street, New York City



# CONTINENTAL NEWS

MAY, 1921

PUBLISHED EVERY MONTH IN RADIO NEWS BY THE CONTINENTAL RADIO AND ELECTRIC CORPORATION

## PARAGON RECEIVERS MAKE GOOD IN USERS OWN TESTS

View of Paragon R. A. Ten Amplifying Short Wave Regenerative Receiver — identical with the sets used in these tests.

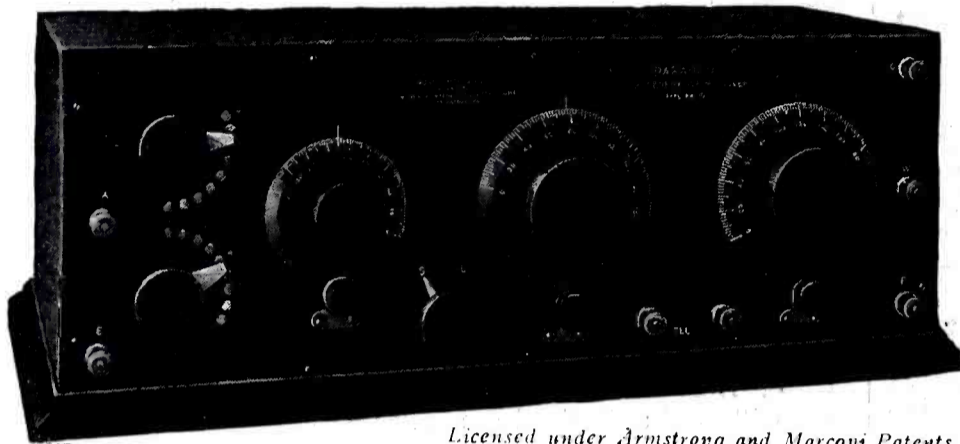

Licensed under Armstrong and Marconi Patents.

**Prominent Amateurs endorse Paragons after thoro tests and comparisons. "Comes up to all advertised requirements" says Y. M. C. A. Radio School.**

MANY genuine Paragon R. A. Ten Regenerative Receiving Sets are now in actual use, more than fulfilling every advertised superiority. Mr. J. L. Hornung, of the Department of Education, East Side Y. M. C. A., writes:

Gentlemen: We are in receipt of your Paragon R. A. Ten regenerative receiver and wish to extend a few words of appreciation.

The receiver has been given a due trial, in which comparative tests have been made with the best types of regenerative receivers now on the market. We find that it comes up to all of the specified requirements made in your advertisements without any contradictions whatever!

Very truly yours,  
Y. M. C. A. RADIO SCHOOL,  
By J. L. Hornung.

"Heard stations never heard before."

A recent advertisement for Paragons carried the headline, "You'll hear stations you never heard before." In this connection this letter from J. Edw. Brown is interesting.

Glenbrook, Conn.  
Gentlemen:

I thought it may be of interest to you to know about the Paragon R. A. Ten Receiver just installed a short time ago.

I hooked this up on the evening of Jan. 6. The first thing I picked up was Wisconsin. From that time on we "heard stations that had never been heard before" in this section.

Continental Radio & Electric Corp.,  
Dept. C34, 6 Warren Street,  
New York.

Enclosed find remittance for Eighty-five Dollars. Ship me at once one Paragon R. A. Ten.

Send me your free illustrated booklet, containing complete description of the Paragon R. A. Ten.

Name .....

Address .....

City..... State.....

I picked up the steamer Gloucester (KQG) off Barnegat, talking to Asbury Park on detector alone, as the first stage amplifier was uncomfortable for the ears.

Another surprise was that the instrument seems to be protected, as I failed to get any body capacity whatever.

This is the best by far that I have ever heard,—especially for strength of signals on detector alone.

I congratulate you on having such a wonderful machine,—and at the price of \$85.00,—for at this amount it places the instrument within the reach of most amateurs.

Very truly,  
J. Edw. Brown.

Another amateur with a similar experience writes:

Bayshore, New York.

Gentlemen:

I have recently had the pleasure of trying out one of your Paragon R. A. Tens, and I am taking this time to congratulate you upon the design and construction of a tuner that, in my opinion, is the best thing that ever was placed on the market. Stations that, before the R. A.'s installation, were QRZ, or not heard at all, pounded in as though a two-step had been added to the set; and the tuning was sharp—much sharper than I had hitherto ever experienced.

There are two points that are especially to be commended: The ability to tune down to 150 meters with no loss of amplification; and the insensitiveness of the tuner to external capacity effects. These two points render it entirely possible to handle traffic by long jumps under the jam on 200 and up.

Outstanding features of the Genuine

PARAGON R. A. TEN  
(Reg. U.S. Pat. Off.)

Amplifying Short Wave Receiver

Wave length, 160 to 1000 meters; amplification 100 times; no dead end losses whatever; vernier attachments on all controls; coupling has scale of 180°; free from all body capacity effects; guaranteed for two years. "The weaker the signal, the stronger the amplification" .....\$85.00

I trust that you may be interested in the results as enumerated, and in the points of superiority, over other tuners, that struck me forcibly.

Very truly yours,  
Tremaine Hulse.

2 BGR.

The letters quoted here, as well as many others of a similar nature, are on file at our office. Such wholehearted endorsement from experienced operators should guide you in your radio work. A Paragon Receiver may cost \$85, to be sure—But, a genuine Paragon is nevertheless the best "buy" per dollar, on the market. Remember, also, the guarantee is for Two Years. The instrument is built to long outlast the guarantee.

Order a Paragon R. A. Ten, or get our descriptive booklet by using the coupon at the left.

The Continental Store in New York has built up a reputation for "extraordinary service at ordinary prices." The mail order department has earned a similar reputation and standing through its unvarying standards of Courtesy; Accuracy; Promptness. Send your next order to Continental, "Where the promise is performed." Please make remittance by P. O. Money Order or Bank Draft, to avoid any delay.

### Telephones

No. 55 Murdocks, 2000 ohms .....	\$4.50
No. 55 Murdock 3,000 ohms .....	5.50
Brandes "Superior" 2000 ohms .....	8.00
Brandes "Trans-Atlantic" 2800 ohms .....	12.00
Brandes "Navy Type" 3200 ohms .....	14.00
Baldwins Type C Navy Standard .....	16.50
Baldwins Type E Super-Sensitive .....	20.00
Century 2200 ohms (Govt. Standard) .....	12.50
Century 3200 ohms (Govt. Standard) .....	14.00
Brown 4000 ohms imported super-sensitive double armature .....	20.00

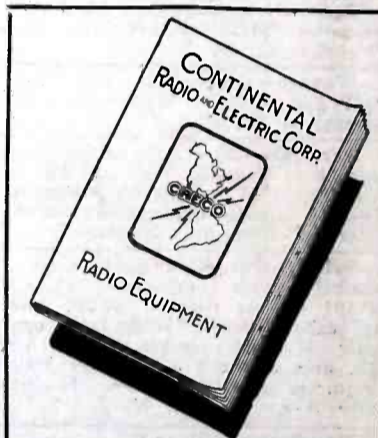

The Continental 112 page catalogue contains complete listings of all radio apparatus, including a comprehensive line of C. W. equipment. Mailed anywhere in the world for 25 cents. Send for your copy today.

### Variometers

Radio Craft Variometers	6.00
Nightingale Variometers (small) .....	4.50
Nightingale Variometers (large) .....	5.50
Rebe Variometers .....	8.50
Clapp-Eastham Variometer with knob and dial .....	6.50
Clapp-Eastham Variometer, less knob and dial .....	5.75
Vacuum Tube Sockets	
No. R-300 DeForest .....	1.50
No. M-300 Marconi .....	1.50
No. 55 Murdock .....	1.00
No. 156 Gen. Radio .....	1.75
No. R-400 Inverted Type .....	2.40

Vacuum Tubes	
Radiotron U. V. 200 Detector tube, just out .....	5.00
Radiotron U. V. 201 Amplifying tube, just out .....	6.50
Electron relay .....	6.00
Moprehead Amplifier .....	7.00
Moprehead extra hard Transmitter .....	7.50
Audiotron .....	6.00

## CONTINENTAL RADIO AND ELECTRIC CORP.

J. DiBlasi, Sec.

J. Stantley, Treas.

Dept. C 34—6 Warren St., New York





Flexible Covers  
—  
Handy Pocket-Size Volumes

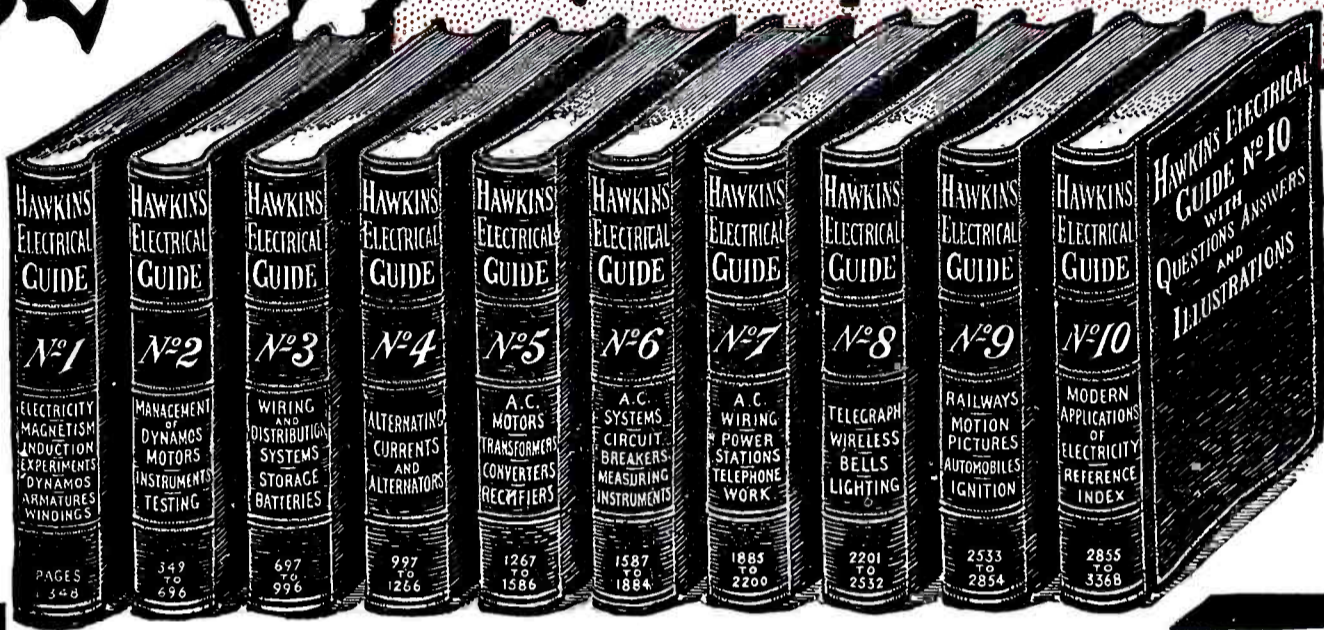

10 Volumes  
3500 Pages  
4700 Pictures  
\$1 Per Volume  
\$1 Per Month

## Just what you need to know to succeed in ELECTRICITY

EVERY electrician, every engineer, every mechanic should know about these wonderfully helpful instructive books, which give in plain words a complete working knowledge of electrical engineering in all its phases.

You run into some new electrical problem almost every day. The information you need to help you in your every day work is in

# HAWKINS ELECTRICAL GUIDES

These books place electricity at your finger ends. They cover every imaginable subject, principle, theory, problem, trouble, and way of doing things electrically. Every subject is indexed so that you can turn right to it. They are a study course and a reference guide in one, written in plain every day language—no wasted words—only what you need to know—chock full of up-to-the-minute electrical knowledge. The guides are a complete course in electrical engineering. They will help you in every detail of the day's electrical work. You can't ask an electrical question that Hawkins Guides can't answer.

### Pocket-Size Flexible Covers

The books are small enough to slip into your coat pocket—handsomely bound in flexible black covers. You can carry each volume with you until you have mastered its contents. 3,500 pages of actual information and 4,700 illustrations. Once you see these books and put them into actual use you will never again want to be without them. Try it at our expense.

## SEND NO MONEY

It will cost you nothing to receive these books—to look them over—ask them all the questions you can think of—use them in your work—study them—pick up some information that will increase your earning ability. We will ship you the entire set of 10 volumes entirely FREE.

This is a sign of our confidence in the guides. Pure gold does not object to being tested. Keep them for seven days and if you do not decide that you can't get along without them, return them to us and owe us nothing.

When you decide to keep them you only have to pay \$1.00 down and remit the balance of \$9.00 on the easy payment of \$1.00 a month till paid for. Use this coupon to get the books. It will pay you many times over.

**THEO. AUDEL & CO.**  
72 Fifth Ave. New York, N. Y.

SEND NO MONEY - USE THE COUPON

### READ THIS PARTIAL LIST OF CONTENTS

- No. 1** Contains 348 pages, 388 illustrations. Electrical signs and symbols—static and current electricity—primary cells—conductors and insulators—resistance and conductivity—magnetism—induction coils—dynamo principles—classes of dynamos—armatures—windings—commutation—brushes, etc.
- No. 2** Contains 348 pages, 394 illustrations. Motor principles—armature reaction—motor starting—calculations—brake horsepower—selection and installation of dynamo and motors—galvanometers—standard cells—current measurement—resistance measurement—voltmeters—wattmeters—watt hour meters—operation of dynamos—operation of motors, etc.
- No. 3** Contains 300 pages, 423 illustrations. Distribution systems—wires and wire calculations—inside, outside and underground wiring—sign flashers—lightning protection—rectifiers—storage battery systems, etc.
- No. 4** Contains 270 pages, 379 illustrations. Alternating current principles—alternating current diagrams—the power factor—alternator principles—alternator construction—windings, etc.
- No. 5** Contains 320 pages, 614 illustrations. A. C. Motors—synchronous and induction motor principles—A. C. commutator motors—induction motors, transformers, losses, construction, connections, tests—converters—rectifiers, etc.
- No. 6** Contains 298 pages, 472 illustrations. Alternating current systems—switching devices—circuit breakers—relays—lightning protector apparatus—regulating devices—synchronous condensers—indicating devices—meters—power factor indicators—wave form measurement—switch boards, etc.
- No. 7** Contains 316 pages, 379 illustrations. Alternating current, wiring power stations—turbines; management, selection, location, erection, testing, running, care and repair—telephones, etc.
- No. 8** Contains 332 pages, 436 illustrations. Telegraph—simultaneous telegraphy and telephony—wireless—electric bells—electric lighting—photometry, etc.
- No. 9** Contains 322 pages, 627 illustrations. Electric railways—electric locomotives—car lighting—trolley car operation—miscellaneous applications—motion pictures—gas engine ignition—automobile self-starters and lighting systems, electric vehicles, etc.
- No. 10** Contains 613 pages, 599 illustrations. Elevators—cranes—pumps—air compressors—electric heating—electric welding—soldering and brazing—industrial electro-lysis—electro plating—electro-therapeutic—X-rays, etc.

Also a complete 126-page ready reference index of the complete library. This index has been planned to render easily accessible all the vast information contained in the 10 electrical guides. There are over 13,500 cross references. You find what you want to know instantly.

**THEO. AUDEL & CO.**  
72 Fifth Ave.  
New York, N. Y.

Please submit me for examination Hawkins Electrical Guides (price \$1 each). Ship at once, prepaid, the 10 numbers. If satisfactory I agree to send you \$1 within seven days and to further mail you \$1 each month until paid.

Signature.....

Occupation.....

Employed by.....

Residence.....

Reference..... R. N. May

### What Electrical Men Say

#### Helped Him Make Good

"It is only right for me to recommend highly the Hawkins Guides, for they have been of the greatest assistance to me in placing me in my present position as Superintendent of Construction Department of one of Ohio's largest Electrical Companies. I would like to see every man have a set of Hawkins Guides."  
Geo. Knecht, Columbus, Ohio.

#### In the Naval Electrical Dept.

"The Hawkins Guides are great help to me in the Naval Electrical Department, which they cover very thoroughly."  
C. J. Cornell, U. S. Receiving Ship, Brooklyn, N. Y.

#### Superintendent

"I am now superintendent of the Dunnville Hydro-Electric Systems, and Hawkins Guides were a great help to me in holding down a responsible position."  
W. E. Swartz, Dunnville, Ontario.

#### Wireless Operators

"I have worked wireless for ten years—but I wish I had these books years ago, as they have saved a great deal of trouble."  
H. Marshall, Steamer M & B No. 2, Walkerville, Ont.



# LEARN WIRELESS At Home By Mail

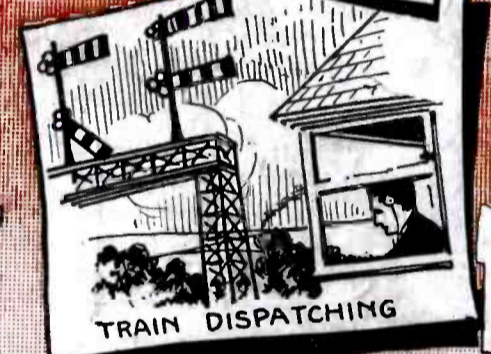
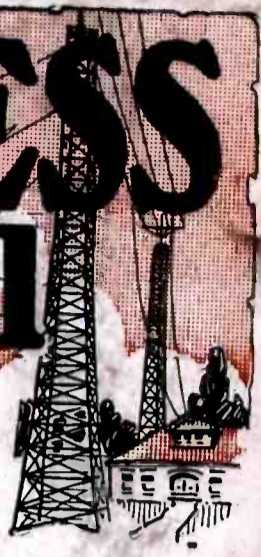

## Big Opportunities Open On Land and On Sea

### Good Pay—Fascinating Work

Calls are steadily coming in for National Radio Institute Graduates. Many attractive positions are now open in Merchant Marine, Commercial Land Radio Service, Radio Supply Factories, U. S. Navy, Aerial Mail, and large Business Corporations.

#### Big Money Waiting For You

Now you can quickly and easily build upon your own knowledge of telegraphy and receive your license as a Senior Wireless Operator. Wireless salaries run as high as \$6,000 a year. It's only a short step for you to these splendid positions—with good pay, travel if you want it, fascinating work and big future opportunities. And now as never before is your big lifetime opportunity to get in on the wonderful future this fascinating field holds for you.

You can learn wireless the National Radio Institute way, quickly and easily, by mail right in your own home, in your spare time. No previous experience or training is necessary. With our help you can quickly qualify for first grade government license and a fine position. Read the letters of some of our students on this page.

#### U. S. Department of Commerce Recognizes N. R. I.

and allows its graduates 5 to 10 points credit when taking the examination for First Grade Government License. This school heads the printed list of reputable Wireless Schools recommended by the U. S. Shipping Board. If you are eager to travel, anxious to visit foreign countries, and increase your knowledge of world affairs, Wireless offers the chance of a life time. On shipboard you are rated as an officer. But you need not travel unless you wish. You may secure a position at one of the many ever increasing land radio offices.

#### New Automatic Wireless Instrument Free

In addition to all necessary text books and other equipment with which we supply you, we furnish FREE to every student our marvelous new automatic Natrometer, which transmits Wireless messages in 600 different combinations, and can be regulated to operate at any speed from 1 to 30 words a minute.

You receive the instrument after your enrollment; it becomes your personal property upon completion of our course.

FREE—In addition to our complete course in Wireless Telegraphy, every student is given our complete course in modern Wireless Telephony. These combined courses enable our students to fill positions requiring a knowledge of both Radio Telegraphy and Telephony.

Read what we have done for our graduates. Then send the following coupon today for our FREE BOOK containing all particulars and special Short Time Offer.

### NATIONAL RADIO INSTITUTE

Dept. 569 WASHINGTON, D. C.

#### What Others Say—

This N. R. I. Graduate Says—

"There is no other profession today offering the opportunity to travel and see the world at the same time paying a good salary, as radio telegraphy. My board, of course, costs me nothing. The work is not hard; in fact it is the most interesting work I have ever been in. We are sailing for Verdo, Norway, and will come back by way of England and France. I will get a chance to see the Land of the Midnight Sun.

Lawrence Waring, Jr.,  
Norfolk, Va.

#### Finishes Course in 8 Weeks

John Hasselberger was graduated from the N. R. I. in 8 weeks. He is now Wireless Operator on the S.S. Paysandu. Just before sailing he wrote, "Just a few words of appreciation for what you did for me. I requested a boat leaving New York for South America. The U. S. Shipping Board immediately placed me. I sail shortly as Radio Operator on the S.S. Paysandu"

#### Two Rewards

"Thanks for your diploma which I received this morning. Today I also received the result of my examination—a First-Grade Commercial License.

P. Gilleece,  
Philadelphia, Pa."

#### Another Student Says—

"I write this to let you know that I passed my examination for a Commercial First-Grade License and have obtained a position on the S.S. Bulfoil.

C. H. McDough,  
Port Arthur, Tex."

These are just a few of the hundreds of letters in our files telling the same story—good positions, interesting work and a bright future.

#### MAIL THIS COUPON TODAY

NATIONAL RADIO INSTITUTE Dept. 569, Washington, D. C.  
Send me your FREE book "Wireless The Opportunity of Today." Tell me about your Home Study Course in Wireless Telegraphy and Telephony—the free post-graduate course—and your Special Instrument offer.

Name .....

Address .....

City..... State.....