

# RADIO NEWS

REG. U.S. PAT. OFF.

20 Cents  
October  
1920

Over 100 Illustrations  
Edited by H. GERNSBACK

## "REPORTING NEWS BY RADIO"

SEE PAGE 202

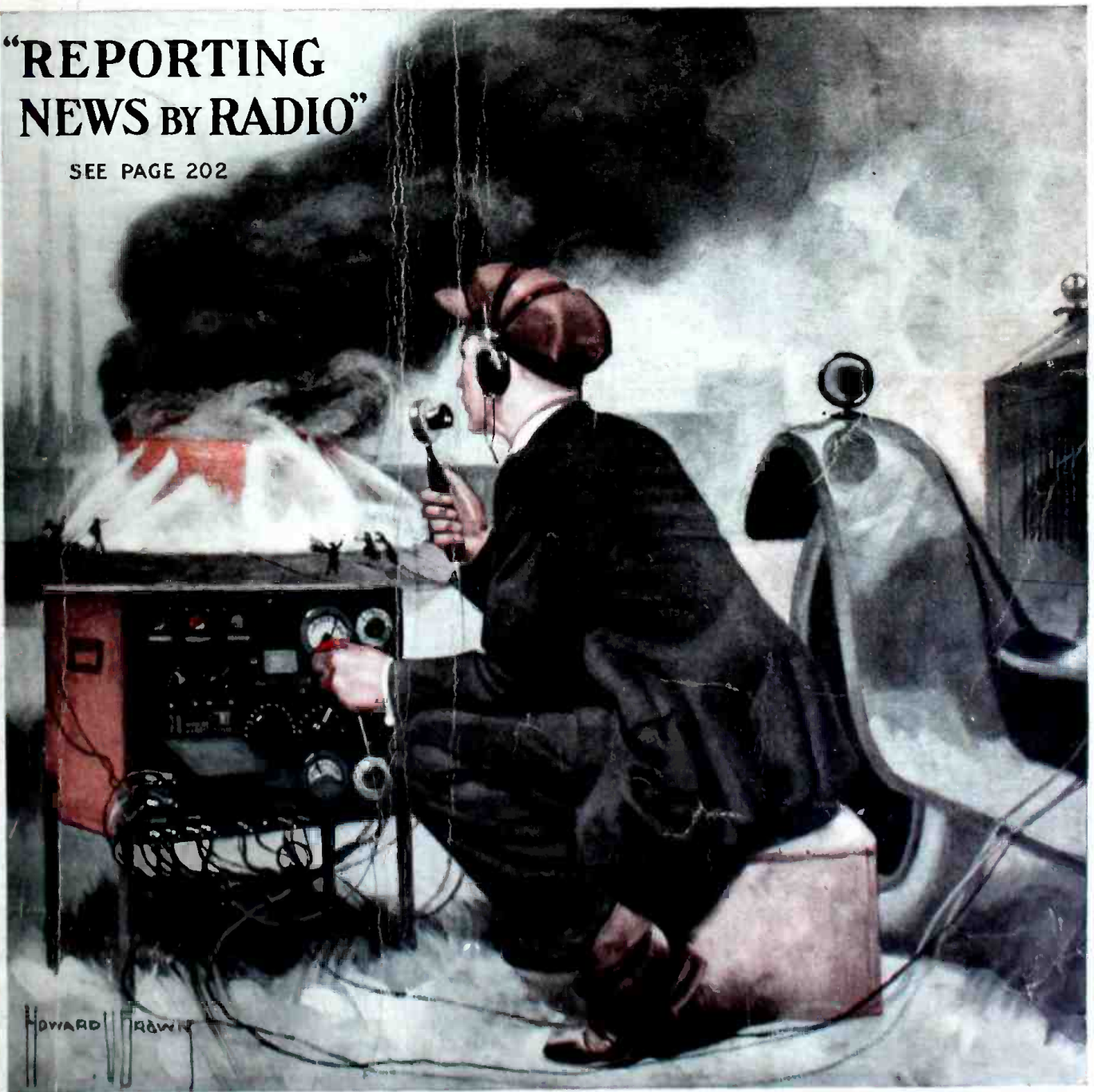

"THE 100% WIRELESS MAGAZINE"

# From Nothing to Something

You will do it—

with this new Paragon RA-10

Signals which on actual tests are inaudible with any other type of receiver, become easily readable. "Coming from Nothing and amplifying to something."



Licensed under Armstrong Patent 1,113,149

**AND  
HERE IT IS**  
The Paragon  
**RA-10**

## Greatest Improvement in Modern Radio

Do you remember the super service of the old original Paragon RA-6 amplifying short wave receiver? This new set surpasses it in every respect

*and the original RA-6 was the only one of its kind*

150% improvement over the old original Paragon, away ahead of all other receivers and excels the most serviceable set on the market today.

### Here are the 150% Pointers

A Wave Length range of 150 to 1,000 meters.

25% more sensitive and selective than the RA-6.

All amplification obtained without change of spark tone.

Objectionable effect of change in note entirely eliminated.

Coupling has scale of 180° instead of 90°, giving wider range of coupling.

Controls on all adjustments fitted with vernier attachments permitting of very fine tuning and control.

No dead end losses.

Cabinet of quartered oak; overall size 20 $\frac{5}{8}$  x 8 x 7 $\frac{1}{2}$ "; white filled engraving, bakelite panel, knobs and dials.

Every set sealed before leaving factory, which is a guarantee for two years.

A super product of Adams Morgan Co.'s unapproachable engineers.

**And the price \$85.00.**

Startling surprises in store for you if you will send for special bulletin describing this set.

Remember the old Paragon—this one beats it and all others by miles—our special bulletin tells you how. Send for it—it's free.

Our word of honor to you is our guarantee. Let us prove it.

## CONTINENTAL RADIO AND ELECTRIC CORP.

J. DI BLASI, Secretary  
DEPT. C.3.

*Sole Distributors of the Paragon RA-10*  
6 WARREN STREET

J. STANTLEY, Treasurer  
NEW YORK



# CONNECTICUT RADIO

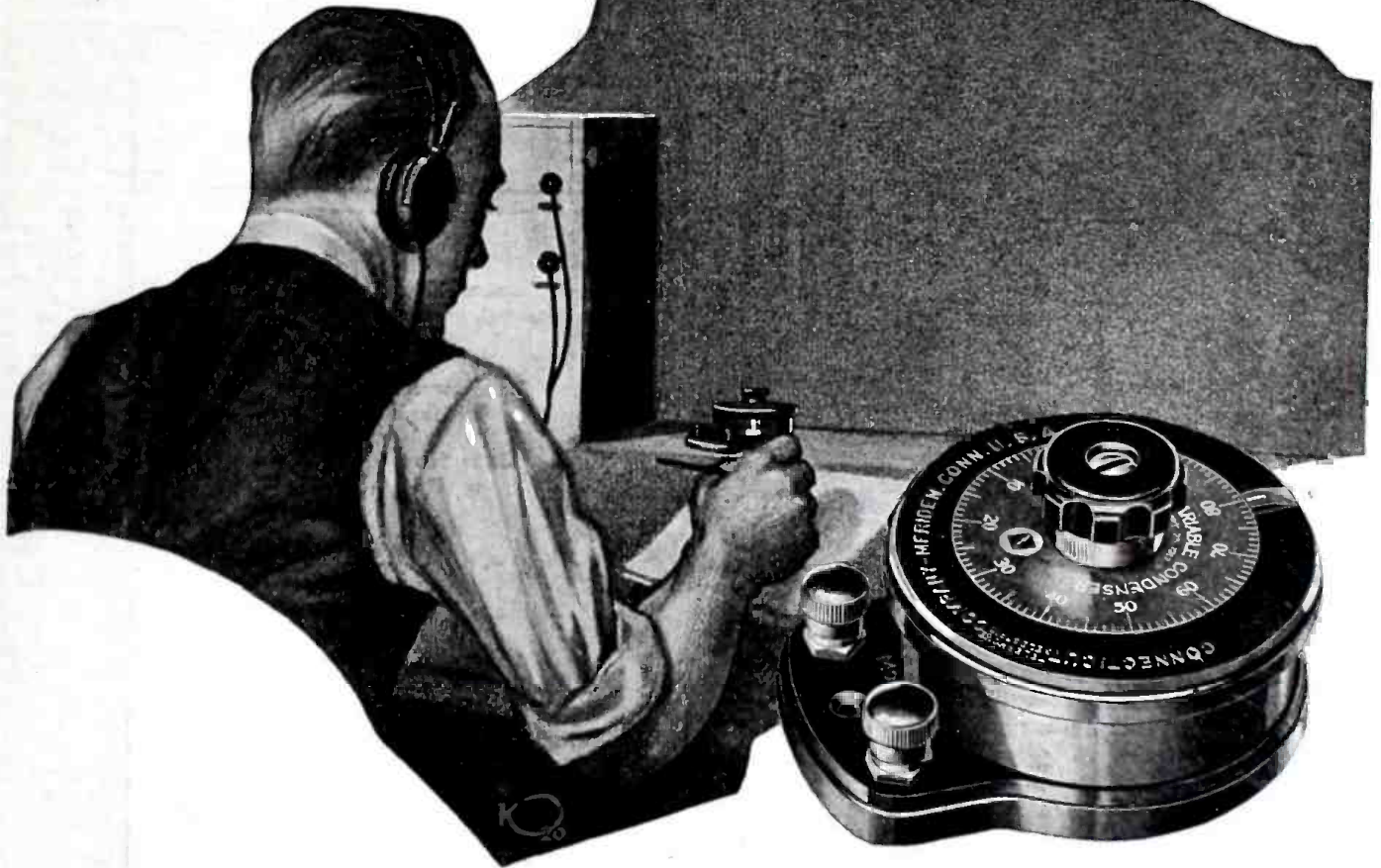

## Increase Your Range with this Variable Condenser

The almost complete absence of "effective resistance" in the Connecticut Variable Condenser enables you to receive a signal often ten times the strength of that picked up with a rotary condenser.

Combined with the finer adjustments given by this Condenser, this stronger signal capacity remarkably increases the efficiency of any set—which means an increased range.

Compact, stable, simple, operating smoothly throughout a scale of 360 degrees (twice the scale of the rotary condenser) the Connecticut Variable Condenser is one you should know all about.

We have a brief booklet which tells the whole story. Your name on a postal brings it.

**CONNECTICUT TELEPHONE & ELECTRIC COMPANY**  
Meriden Connecticut

# RADIO NEWS

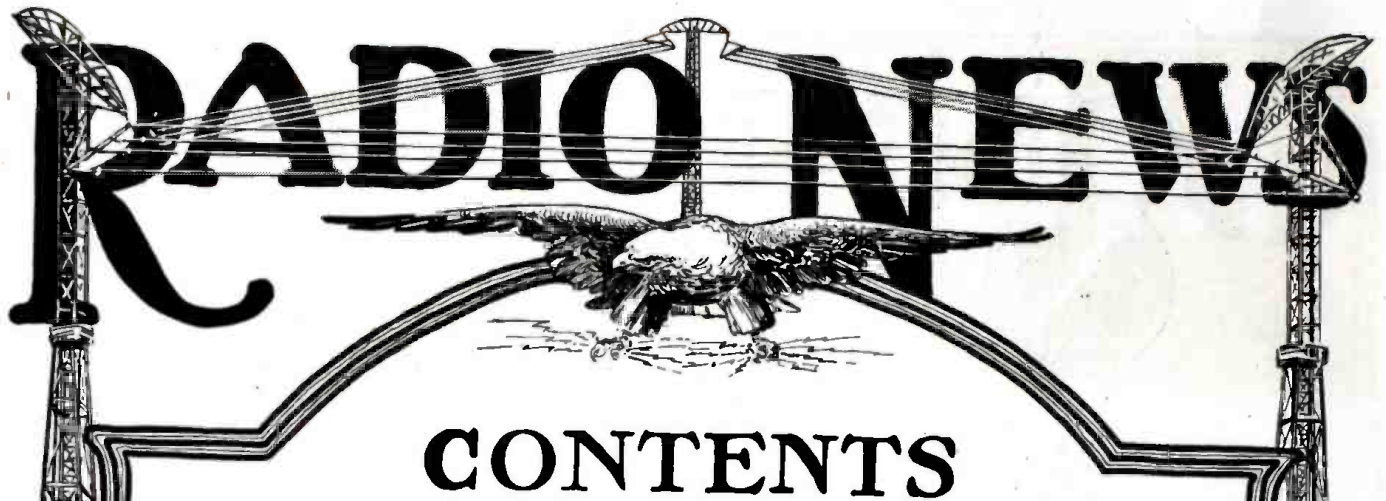

## CONTENTS

VOL. 2

FOR OCTOBER

NO. 4

	PAGE		PAGE
The Backward Amateur, By H. Gernsback	199	Improved Vacuum Tube Circuits for Short Wave Communication, By Thomas Brown	212
Radio Telephone Progress in Europe....	200	Important—The Ground Switch, By Edwin D. Strickland	214
The Vision of Radio.....	201	Switches for Radio Sets, By Thomas W. Benson	215
A British Vacuum Tube Control Unit....	201	Wireless Fakes and Fakers, By Austin C. Lescarboursa	216
Reporting News by Radiophone.....	202	The Radio Man's Code, By Erald A. Schivo	217
Developing Radio in the Hills, By Pierre H. Boucheron	203	New Radio Patents.....	218
Electron Power Tubes and Some of Their Applications, By William C. White	204	Radio Digest .....	219
Crewless Battleship Controlled by Radio	206	The "Casey" Station at Savannah, By James F. Maher	220
A New Amplifying Transformer.....	206	With the Amateurs.....	221
A Portable Combination Receiver, By Russell H. Robinson	207	Junior Radio Course .....	222
The Audion—Its Action and Some of its Applications.....By Lee De Ferest	208	Radio Dictionary .....	223
Loud Talking Reproducer for Radio and Telephone Signals, By H. Winfield Secor	211	Junior Constructor .....	224
		I-Want-To-Know .....	225
		Correspondence from Readers.....	227

RADIO NEWS is published on the 25th of each month at 233 Fulton Street, New York. There are 12 numbers per year. Subscription price is \$2.00 a year in U. S. and possessions. Canada and foreign countries, \$2.50 a year. U. S. coin as well as U. S. Stamps accepted (no foreign coins or stamps). Single copies, 20 cents each. A sample copy will be sent gratis on request. Checks and money orders should be drawn to order of EXPERIMENTER PUBLISHING CO., INC. If you should change your address notify us promptly, in order that copies be not miscarried or lost. No copies sent after expiration.

All communications and contributions to this journal should be addressed to: Editor, RADIO NEWS, 233 Fulton Street, New York. Unaccepted contributions cannot be returned unless full postage has been

included. ALL accepted contributions are paid for on publication. A special rate is paid for novel experiments; good photographs accompanying them are highly desirable.

RADIO NEWS, Monthly. Entered as second-class matter June 6th, 1919, at the Post Office at New York, N. Y., under the Act of March 3, 1897. Title registered U. S. Patent Office. Copyright, 1920, by E. P. Co., Inc., New York. The Experimenter Publishing Co., 333 Fulton Street, N. Y., N. Y. The Contents of this magazine are copyrighted and must not be reproduced without giving full credit to the publication. RADIO NEWS is for sale at all newsstands in the United States and Canada; also at Brentano's, 37 Avenue de l'Opera, Paris. For Great Britain: Geoffrey Parker & Gress, 62 & 64, The Mall, Ealing, London.

Published by EXPERIMENTER PUBLISHING CO., INC.  
H. GERNSBACH, President

S. GERNSBACH, Treasurer

233 Fulton Street, New York City  
R. W. DE MOTT, Secretary



# MURDOCK No. 55

**2000  
OHM  
DOUBLE SET  
\$4.50**



**3000  
OHM  
DOUBLE SET  
\$5.50**

## RIGHT IN PRICE AND IN PERFORMANCE

The substantial success earned by these receivers can be attributed to the instant recognition and acknowledgment of their remarkable value, by thousands of users. If, by chance, you are not acquainted with their merits, or are dubious regarding the possibility of securing really good 'phones at such prices, we suggest a trial, with the customary assurance of "satisfaction or money back."

SOLD BY REPUTABLE DEALERS EVERYWHERE

*Bulletin No. 20 will be ready for distribution about September 15*

### WM. J. MURDOCK CO.

50 CARTER ST.

CHELSEA

(50)

MASS.

509 MISSION STREET

SAN FRANCISCO, CALIF.

# SPECIAL PREMIUM OFFER

With a Year's Subscription to Radio News or Science and Invention (Electrical Experimenter)

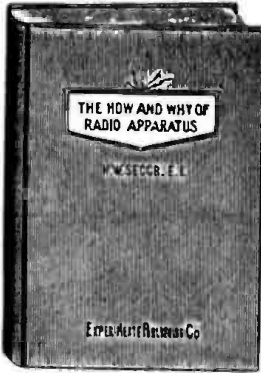

**Offer A**  
 Science and Invention  
 (Electrical Experimenter)  
 for one (1) year with  
 The How and Why  
 of Radio Apparatus  
 REG. PRICE \$3.00  
 \$1.75  
**\$4.75**

**Offer C**  
 Science and Invention  
 (Electrical Experimenter)  
 for one (1) year with  
 A Thousand and  
 One Formulas

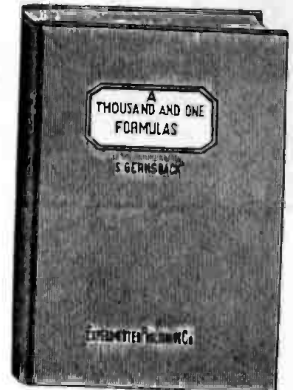

**SPECIAL PRICE OFFER, A or C, \$3.75**

**Offer B**  
 Radio News  
 for one (1) year with  
 The How and Why  
 of Radio Apparatus  
 REG. PRICE \$2.00  
 \$1.75  
**\$3.75**

**Offer D**  
 Radio News  
 for one (1) year with  
 A Thousand and  
 One Formulas

**SPECIAL PRICE OFFER, B or D, \$2.75**

This newest of Radio works, bound in flexible velum and hand sewed, has 160 pages. Size of book 6 x 9 inches.

A Laboratory Handbook for the Experimenter. Bound in flexible velum. 160 pages. Size 6 x 9 inches.

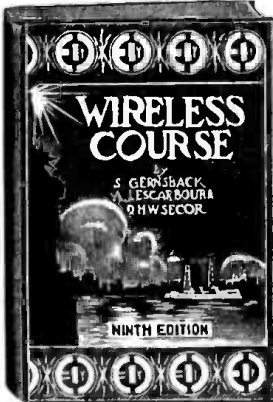

**Offer E**  
 Science and Invention  
 (Electrical Experimenter)  
 for one (1) year with  
 Wireless Course in 20  
 Lessons  
 REG. PRICE \$3.00  
 \$1.25  
**\$4.25**

**Offer G**  
 Science and Invention  
 (Electrical Experimenter)  
 for one (1) year with  
 Experimental  
 Electricity Course

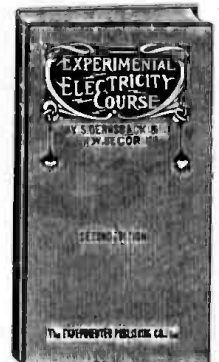

**SPECIAL PRICE OFFER, E or G, \$3.50**

**Offer F**  
 Radio News  
 for one (1) year with  
 Wireless Course in 20  
 Lessons  
 REG. PRICE \$2.00  
 \$1.25  
**\$3.25**

**Offer H**  
 Radio News  
 for one (1) year with  
 Experimental  
 Electricity Course

**SPECIAL PRICE OFFER, F or H, \$2.50**

Book is bound in flexible Velum; has 160 pp. Size 7x12 inches.

Book is bound in flexible Velum; has 160 pp. Size 5x9 in.

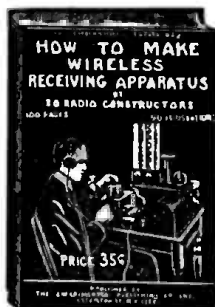
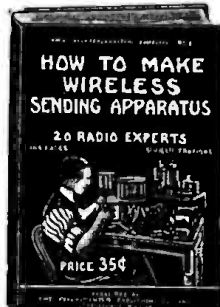
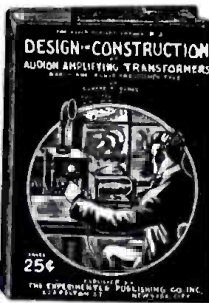

**Offer K**  
 Science and Invention  
 (Electrical Experimenter)  
 for one (1) year with  
 Design and Construction of  
 Audion Amplifying - Trans-  
 formers.  
 How to Make Wireless Send-  
 ing Apparatus.  
 How to Make Wireless Re-  
 ceiving Apparatus.

Reg. Price	Special Price to you
\$3.00	\$3.25
.95	
<b>\$3.95</b>	

Printed on heavy paper, paper bound. Size 5 x 7 inches. Fully illustrated. The latest book out.

Book has 100 pages. Size 5 x 7 inches. 88 illustrations. Paper cover printed in two colors.

Book has 100 pages. Size 5 x 7 inches. 90 illustrations. Paper bound, in two colors.

**Offer L**  
 Radio News  
 for one (1) year with  
 Same Books as Offer (K)

\$2.00	\$2.25
.95	
<b>\$2.95</b>	

**EXPERIMENTER PUBLISHING COMPANY, Inc.,**  
 236-A Fulton Street,  
 New York City, N. Y.

Dear Sir:

I accept your offer ..... Enclosed find \$.....  
 in payment of premium and one year subscription.

Name .....

Address ..... Town ..... State .....



# RADIO APPARATUS

*Distributors of Reliable Radio Apparatus  
for Schools, Colleges and Experimenters  
in Every Branch of the Radio Field*



**"PITTS CO"**  
The sign of service and  
immediate delivery!  
All we ask is a trial!

**REMEMBER!**  
We carry an immense stock  
and can make immediate de-  
livery on every item listed!

## AMPLIFYING TRANSFORMERS

No. A-2 Acme mounted.....	\$7.00
No. A-1 Acme semi-mounted.....	5.00
No. A-3 Acme unmounted.....	4.50
No. 166A General Radio, mounted.....	7.00
No. 166A General Radio, semi-mounted.....	5.25
No. 166A General Radio, unmounted.....	4.50
No. Z-73 Clapp Eastham, mounted.....	7.50
No. Z-73A Clapp Eastham, unmounted.....	5.00
No. 238-W Federal.....	7.10
No. P Wireless Specialty.....	7.95

F. D. PITTS CO., BOSTON, MASS.

## AMPLIFIERS

No. RORE Grebe one step.....	\$25.00
No. RORG Grebe det. and one step.....	47.00
No. RORK Grebe two step.....	55.00
No. RORD Grebe det. and two step.....	75.00
No. P-808 DeForest det. and one step.....	75.00
No. P-200 DeForest two step.....	70.50

F. D. PITTS CO., BOSTON, MASS.

## CHANGE-OVER SWITCHES

No. Y-858 Clapp Eastham, large.....	\$12.50
No. 463 Murdock, up to 1 K.W.....	4.80
No. P-2 Porcelain D. P. D. T.....	.80

F. D. PITTS CO., BOSTON, MASS.

## "B" BATTERIES

No. 768 Ever-ready 22.5 V., large.....	\$3.50
No. 768 Ever-ready 22.5 V., small.....	2.25
No. 7636 Standard 22.5 V., large.....	2.40
No. 7659 Standard 22.5 V., variable.....	3.25
No. P-8 Ever-ready flashlight batteries 45 volts, set of 10.....	3.50

F. D. PITTS CO., BOSTON, MASS.

## BUZZERS

No. 178A General Radio Hi-pitch.....	\$2.00
No. Y-744 Clapp Eastham, Hi-pitch.....	1.75
No. P-6 Century, Hi-pitch.....	2.00
No. 77 Meaco High frequency, Hi-pitch.....	2.05
No. 8010 Watch-case brass.....	.75
No. 8011 Watch-case nickel-plated.....	.75

F. D. PITTS CO., BOSTON, MASS.

## COILS (De Forest Honeycomb)

L-25.....	\$1.40
L-35.....	1.46
L-50.....	1.52
L-75.....	1.60
L-100.....	1.70
L-150.....	1.80
L-200.....	1.90

## COILS (De Forest Honeycomb) Continued

L-250.....	\$2.00
L-300.....	2.10
L-400.....	2.25
L-500.....	2.40
L-600.....	2.65
L-750.....	2.88
L-1000.....	3.00
L-1250.....	3.35
L-1500.....	3.80

F. D. PITTS CO., BOSTON, MASS.

## CONDENSERS (Receiving)

No. 366 Murdock, solid case, .001 Mf.....	\$4.75
No. 367 Murdock, .001 Mf.....	4.75
No. 368 Murdock, .0005 Mf.....	3.75
No. Y-800 C. E. Balanced, .0005 Mf.....	7.50
No. Y-800B C. E. Balanced, .001 Mf.....	9.50
No. Y-800C C. E. Balanced, .0015 Mf.....	11.50
No. P-7 Tresco Knock-down 11 plate.....	1.50
No. P-8 Tresco Knock-down 21 plate.....	2.25
No. P-9 Tresco Knock-down 41 plate.....	3.20
No. Cv-500 DeForest un-mtd, .005 Mf.....	6.25
No. Cv-500A same as above without knob and scale.....	4.95

F. D. PITTS CO., BOSTON, MASS.

## CONDENSERS (Transmitting) Dubilier

Type	Watts	Voltage	Cap.	Price
D-100	250	10000	.007	\$19.00
D-101	500	14000	.007	30.00
D-102	1000	21000	.007	45.00
D-103	1000	25000	.007	50.00

F. D. PITTS CO., BOSTON, MASS.

## ANTENNA WIRE

No. F-1 7 strand No. 23 tinned copper per foot.....	\$0.01 1/4
500 feet or over, per foot.....	.01
No. F-2 No. 14 hard drawn copper, per lb. (80 ft per lb.).....	.60
No. F-3 7 strand No. 20 Phosphor-bronze, per foot.....	.02 1/4
500 feet or over, per foot.....	.02

F. D. PITTS CO., BOSTON, MASS.

## INSULATORS (Antenna)

No. 02 4" strain type.....	\$0.50
No. 03 10" strain type.....	1.00
No. 04 16" strain type.....	1.50
No. 06 Porcelain 3" very strong.....	.15

F. D. PITTS CO., BOSTON, MASS.

## GROUND EQUIPMENT

No. G-100 100 ampere 600 volt ground switch.....	\$4.50
No. G-2 Weather-proof No. 4 ground wire, per foot.....	.10
No. G-3 Heavy porcelain knob with screw for wire, complete, each.....	.12

F. D. PITTS CO., BOSTON, MASS.

## RHEOSTATS

No. R-1 Porcelain base.....	\$1.00
No. R-2 Remier back mounting.....	1.75
No. R-3 Paragon back mounting.....	1.75
No. R-4 General Radio B. M.....	2.50

F. D. PITTS CO., BOSTON, MASS.

## JACKS

No. 1423-W Federal 2 circuit.....	\$0.90
No. 1422-W Federal closed circuit.....	.55
No. 1421-W Federal open circuit.....	.55
No. W E-1 Western Elec. 3 circuit.....	.90
No. W E-3 Western Elec. open circuit.....	.55

F. D. PITTS CO., BOSTON, MASS.

## PLUGS

No. 1428-W Federal brass.....	\$2.00
No. 1428-W Federal silver-plated.....	2.50
No. J-100 DeForest brass.....	1.10

F. D. PITTS CO., BOSTON, MASS.

## TUBE SOCKETS

No. GB-1 General Radio.....	\$1.75
No. R-300 DeForest.....	1.50
No. W8A-1 Wireless Specialty.....	1.50
No. 550 Murdock.....	1.00

F. D. PITTS CO., BOSTON, MASS.

## GRID LEAKS

No. MW-2 Marconi 1/2, 1, 2, 3 or 5 megohms, each.....	\$1.00
No. G-100 DeForest variable.....	.75
No. ROCA Grebe grid cond. and 1/2 megohm leak.....	1.40
No. ROCB Grebe grid cond. and 3 megohm leak.....	1.70

F. D. PITTS CO., BOSTON, MASS.

## TELEPHONES (Pair)

No. B-100 Brown 4000 Ohm imported British phones, super-sensitive.....	\$20.00
No. 1 Type C Baldwins, Standard Navy type.....	16.50
No. 2 Type E Baldwins, New type, ultra- sensitive.....	18.50
Brandes Superiors 2000 ohms.....	7.00
Brandes Trans-Atlantic 2500 ohms.....	10.00
Brandes Navy Type 3200 ohms.....	14.00
No. 55 Murdock 2000 ohms.....	4.50
No. 55 Murdock 3000 ohms.....	5.50

F. D. PITTS CO., BOSTON, MASS.

**Important!** Every article listed sent to any part of the United States postage prepaid or express prepaid. We want your business!

Series No. 7 (Keep this page and watch for next month's)

**SEND 6 CENTS IN STAMPS FOR NEW CATALOG!**

**F. D. PITTS CO., Inc.**

12 Park Square

Dept. C

Boston, 11, Mass., U.S.A.



*The Recognized Symbol of Superior Performance*

### Amrad Knob and Dial

In essential features the Amrad indicator leads all others. Clockwise rotation. Metal alloy dial shields circuits from capacity effects of the hand. Universal hard rubber knob takes standard 1/4" shaft or 8/32 thread machine screw. Standard Navy practice followed in the entire design.

- Type A, 0-180. . . . \$0.80
- Type B, 0- 90. . . . .80
- Type A, 0-180, Dial only, 3" . . . . \$0.40
- Type B, 0- 90, Dial only, 3" . . . . .35

*Send for Descriptive Bulletin R*



### Amrad Rheostat

Intended for use with standard 180 dial indicators. Can be mounted on back or face of panel. Circuit closes with maximum 6 ohms resistance in series with filament. Black composition base not susceptible to chipping or fracture. Heavy current carrying capacity of 2 1/2 amperes makes possible the control of two vacuum tubes with single rheostat.

- Type A, as illustrated . . . . . \$1.75
- Type A-1, with Knob and Dial . . . . . 2.55

*Send for Descriptive Bulletin S*

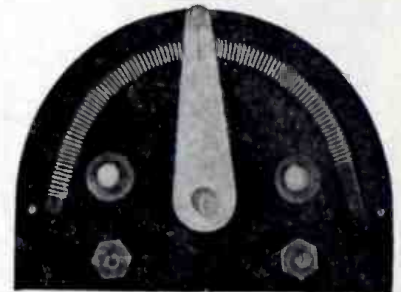

### Amrad Tube Base

Designed especially for discriminating operators who place efficient operation paramount. Intended particularly for panel mounting. Long, genuine Navy springs which hold their tension used. Bakelite base, perfect insulation, wide separation between terminals. These features and soldered connections insure noiseless and efficient circuits.

- Type B, as illustrated . . . . . \$0.90

*Send for Descriptive Bulletin S*

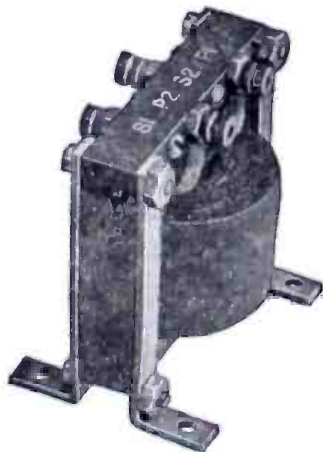

### Amrad Ampliformer

A highly efficient type of amplifying transformer adopted after careful development for use in the standard Amrad VT Amplifier Units soon to appear. Noticeable increase of signal strength made possible by use of core laminations punched out of sheet. The low reductance thus obtained makes the Amrad Ampliformer suitable for use with a wide variety of vacuum tubes.

- Type A-1, as illustrated . . . . . \$7.00
- Type A, unmounted . . . . . 5.00

*Send for Descriptive Bulletin S*

Radio Operators: Amrad Bulletins are sent free upon request. See our announcement on page 253 of this magazine for complete list. The complete Amrad Catalog sent free, and your name put on our mailing list upon receipt of your dealer's name and address. Visit your nearest Amrad dealer, as advertised in August Radio News, and inspect the latest Amrad products.

# AMERICAN RADIO AND RESEARCH CORPORATION

15 Park Row  
New York

Address all Communications  
to New York Office

Factory and Laboratory  
Medford Hillside, Mass.





# RADIO NEWS

H. GERNSBACK — EDITOR  
PIERRE H. BOUCHERON — ASSOCIATE EDITOR

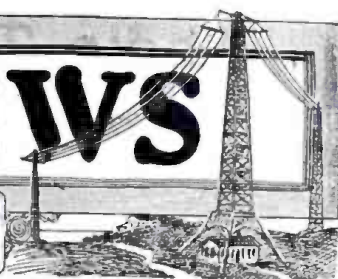

Vol. 2

OCTOBER, 1920

No. 4

## The Backward Amateur

**T**HE other day, a young chap walked into my office and after a preliminary introduction and general hand-shake, started to "pan me out."

"Mr. Gernsback," said he, "you have some mighty fine things in RADIO NEWS, but also some mighty poor ones. Your last \$100 Prize Radio contest was a fizzle and the mere fact that you are running it again proves it. What on earth is the idea of giving a prize for some freak outfits that will never work, and will be of no practical use to anyone? Why not go after something that is useful, and that will advance the art, instead of freakish ideas that retard it?"

The argument seemed good and sound until I took from my desk a small box about the size of a pocket kodak and showed it to my visitor. I asked him if he had seen any thing like it, and he wanted to know what it was. I informed him that it was a complete radio receiving apparatus, including a two-stage amplifier, batteries, antenna and everything combined, and still the whole outfit was not any too bulky, so that it could readily have been carried in one's pocket. It took but a few minutes to get it to work, and actual messages were received in the office in short order.

My friend was very much crestfallen and apologized profusely for his criticism, and I then proceeded to show him the workings of the outfit. The thing that was more or less new was the tiny "baby" audions, not much larger in diameter than a fountain pen, the exact size of them as a matter of fact being  $1\frac{1}{2} \times \frac{3}{8}$ ". Two such audions were used, which we understand are of Western Electric make, and do not have to glow at a bright red heat, but are used best at a low glow. Hence the very small "A" batteries can be incorporated readily in the outfit. This outfit weighs less than three pounds including batteries (without phones); it will shortly be placed on the market by a British concern and will prove a distinct novelty—useful as well as practical.

Why are we looking for small outfits of the type above described? The following extract taken from a recent cable despatch best explains the reason:

"Two reporters of the London *Daily Mail* were sent off for the day with a portable radio telephone. They were told that they might be wanted during the day and that meanwhile no restrictions need be placed upon their movements except that they should keep in touch by means of their portable radio receiving set. No pre-arrangement as to time, place or the nature of the message to be sent was given. One reporter was summoned to duty while rambling at Hampstead Heath. The other, who had no knowledge at all of radio, was summoned while in a moving train, to the astonishment of his fellow travelers. He was suddenly called by name in a clear voice proceeding

apparently from a little suit-case, but in reality from a Marconi six-valve amplifying set contained in the suit-case. The surprise of the other passengers was not lessened by a sudden burst of music that issued from the same enchanted suit-case. It came from the station band at Chelmsford, and was listened to not only by the reporter, but also by Marconi himself on shipboard, many thousand miles away."

The London paper remarks: "Is this to be a feature of our lives in the near future? Shall we go about our daily pursuits accompanied by a small pocket radio set which has the power to put us in touch at any moment with any corner of the globe? If so, the dawn of universal brotherhood should indeed be near, for surely mutual intercourse whatever passing friction might arise, can only in the end meet with mutual sympathy and mutual understanding."

Just so! Evidently most of our amateurs as yet have not seen the light. They really do not believe in the wonders of their own art. They balk at anything that is new, and decry it as impractical and visionary—until someone comes along and proves it very much otherwise. The trouble with 90 per cent of you amateurs today is that you are fast asleep at the switch. Most of you are like sheep following blindly some well-meaning but misguided leader. Someone gets up a certain type of an outfit and immediately the majority of the amateurs follow suit and copy it down to the last screw. Someone starts making a two-stage amplifier outfit as big as a house, and within two weeks it is all the rage thruout the length and breadth of the country; and so it goes.

If Marconi, Branly, De Forest, Pickard, Fessenden, Rogers and Armstrong had all followed blindly in the footsteps of everyone else, radio would today be very much as it was during the days of Hertz. The trouble is that amateurs do not wish to exercise their inherent ingenuity. Wake up, amateurs! Get off the beaten track! Do something new, even if it does not bring you immediate fame. Sometimes a new idea, even if it does prove hopeless for the time being, may be a stepping stone for something really wonderful.

When Edison experimented with an electric light bulb containing two filaments in a vacuum he discovered the "Edison Effect." For a generation the idea was not turned to any practical account, until De Forest and Fleming took it up and gave us the audion. So from the innocent Edison effect one of the most astounding scientific wonders was obtained. Does this not teach us a good lesson? The crying need in America today is for originators in the radio field—and we cannot have too many.

Again I say, *Amateurs of America, wake up! Get off the beaten track!*

H. GERNSBACK.



# Radio Telephone Progress in Europe

Details of the Apparatus Used in a British 15 K.W. Installation

Illustrations Courtesy of "The Electrician," London

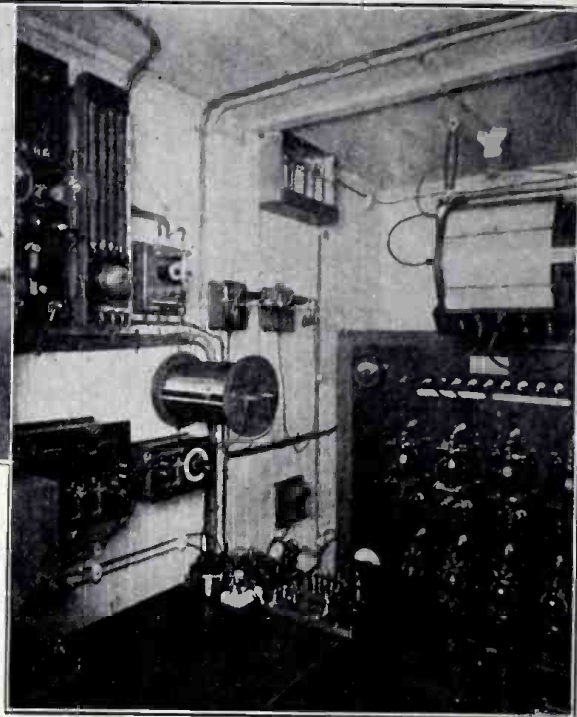
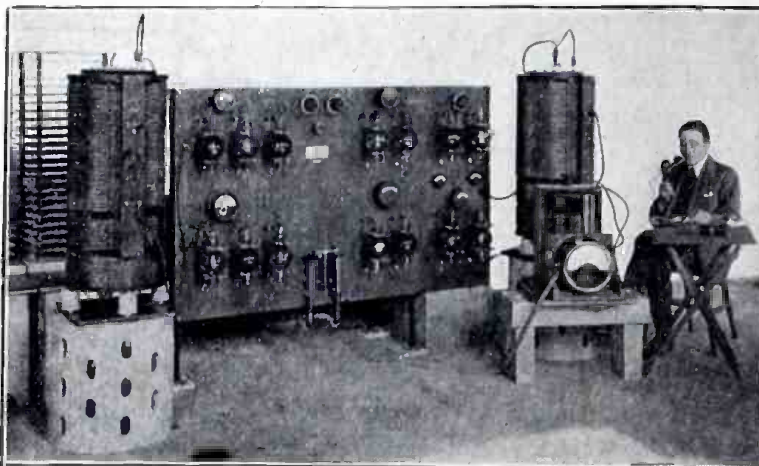

Fig. 1 and Fig. 5, Respectively. How Does a 15 K.W. Bulb Transmitter Appeal to Your Sense of Power? Above Is Shown a General View of the 6 K.W. Marconi Radio Telegraph and Telephone Set Which Performed Such Excellent Work During the Initial Experiments at Chelmsford, England. Recently This Was Replaced by a Unit Capable of 15 K.W. and a Working Wavelength of 2,800 meters. To the Extreme Right We Have a Close-up of a 3 K.W. Vacuum Tube Transmitter of the Type Installed on Large Trans-Atlantic Liners. We have it from the Knowing Ones That V. T. Transmision Will Shortly Replace Spark and Arc Systems. Watch for Developments.

**T**HE development of radio telephony in the very early days was so slow that it seemed almost at one time as if the results obtainable would hardly warrant any great attention being paid to this system of communication. A decided fillip to the development was, however, given by the invention of the Fleming valve, while experiments carried out in 1913 by the Marconi Wireless Telegraph Company brought the question into quite a practical category. When war broke out, sets with a range of about 50 km. were actually being manufactured.

In these pre-war sets a three electrode valve and a 500-volt battery were used. Continuous oscillations were generated in a closed circuit, which was coupled to the

aerial. The microphone was connected in series with, and at the lower part of the aerial. Since the armistice a large amount of attention has been devoted to new designs and ideas, with the result that corresponding satisfactory progress has been registered.

Among the latest developments we may mention the Marconi 6 kw. telegraph and telephone transmitter, which we illustrate in Fig. 1. This is the set with which the first series of recent interesting experiments in radio telephony which were duly chronicled in the daily press were carried out. Subsequently this set was replaced by one with a capacity of 15 kw. working on a wave length of 2,800 meters, of which we give some details below.

## THE 15 KW. SET.

The generator used in these experiments was a 15 kw. alternator generating current at 500 volts at a frequency of 200. Current from this machine was supplied to the primary side of a 20,000-volt transformer, whose secondary winding was tapped at its middle point as shown diagrammatically in Fig. 2. The two rectifying valves connected to the secondary of the transformer as shown cause the condenser  $K_1$  to be charged to half the total secondary voltage unidirectionally once every half-cycle. This maintains the condenser charge at about 10,000 volts, and thus forms a source of high-tension direct current for supplying the transmitting and low frequency magnifying valves. The arrangement generally comprises two high frequency circuits,  $A L_1 E$ , which is the aerial circuit, and  $L_2 C K_2$ , which is the closed circuit. By means of the transmitting valve shown in the diagram, and the reaction coil  $R$ , the continuous oscillating current maintained in this latter circuit is transmitted to the aerial through the coupling coil  $C$ .

## SPEECH PHENOMENA.

As mentioned above, a wave length of 2,800 meters is used, the frequency of the continuous oscillations in the aerial being about 100,000 per second. It is obvious that for speech to be heard at the receiving end the wave forms produced at the transmitting end must be superimposed on the ordinary high frequency wireless transmission current. The elementary diagrams which we produce herewith indicate this graphically. Fig. 3a diagram shows for clearness the ordinary continuous wireless wave, and Fig. 3b, the composite wave formed by the combination of this and the waves of varying amplitude caused by the voice. The lower half of the lower curve, which is shown dotted, is of course rectified by the valve apparatus. To eliminate the distortion of the harmonics in the speech waves, and so obtain the best quality speech, it has been found that the best method is to

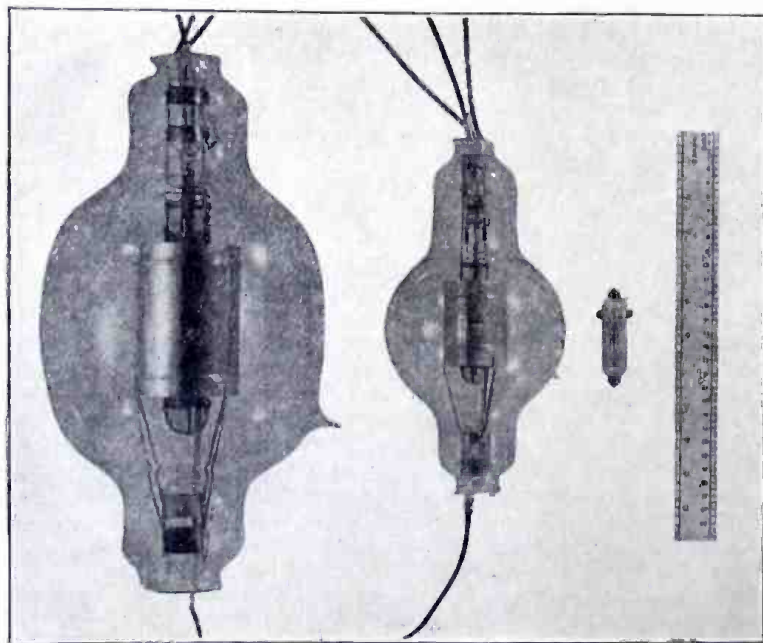

Fig. 4. Here are the Vacuum Tubes which Make These High-Power Experiments Possible. These Two Types Are Known as the MT2 and MT4, Respectively. Note Their Size When Compared to a Foot Rule. Also Note the Smaller Bulb of the Kind Used by Amateurs and Others in This Country. Nothing Mean About the Construction of These "Lamps!"



absorb the energy in the aerial in accordance with the speech wave formed.

This is effective by stepping up the microphone current to produce a voltage curve similar in shape to that produced by the varying current caused by speech by means of a two-stage low-frequency amplifier. The voltage variations are thus magnified and are impressed on the grids of the absorption valves. As is well known the resistance of a three-electrode valve varies with the voltage impressed on the grid, so that in this case the conducting power of the absorption valves varies with the voltage curve produced by speech.

In the present instance, therefore, these valves absorb energy from the aerial in amounts depending upon the degree to

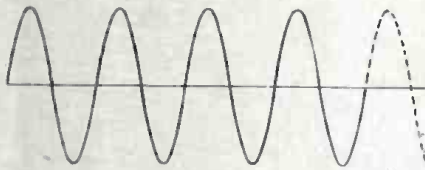

CONTINUOUS OR UNDAMPED WAVE  
Fig. 3a

which they are made conductive by the voltage generated by the impressed speech, owing to the fact that they are connected across the aerial tuning inductance. This energy is dissipated in heat in the valves themselves, so that they must be large enough to prevent any ill effects from overheating.

**DETAILS OF APPARATUS.**

Their resistances are also higher, as they have to withstand higher voltages. The vacuum is also raised to as high a degree as possible by means of the most modern exhaust pumps. The valve filaments are made of tungsten, and the anode and grid

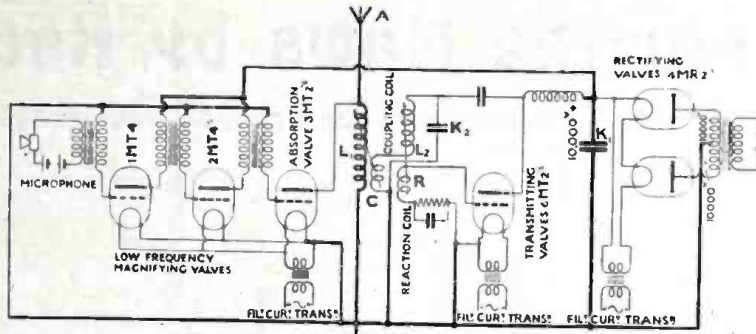
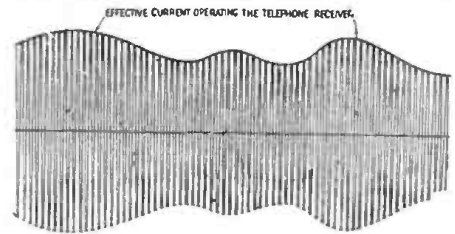

Diagram of Connections  
15 KW VALVE SET  
Fig 2

are of nickel. Fig. 1 shows the arrangement of the valves during operation. Six transmitting valves of type MT4 are mounted on the left side of the panel; the four middle valves are the rectifying valves type MR4, while of the MT4 valves on the extreme right side of the panel three are absorption valves and one is low-frequency magnifying valve. In this case the low-frequency amplifier employed has one stage only.

In the middle of the lower half of the panel is fixed an electromagnetically operated signalling switch which is employed for keying when the

set is used for continuous wave telegraphy. Fig. 5 shows a 3 K.W.V.T. transmitter.



EFFECTIVE CURRENT OPERATING THE TELEPHONE RECEIVER.  
CONTINUOUS OSCILLATIONS WITH VARYING AMPLITUDE CAUSED BY VOICE.  
Fig. 3b

# The Vision of Radio

WHEN such a huge machine as the old battleship *Ohio*, without a man on board, can be made to perform all of the evolutions required of a vessel, with the directing impulses furnished entirely by the mystic medium of the radio apparatus, the predictions of radio enthusiasts must be taken with more seriousness than we have been giving them. It is their vision that the day is not far distant when earth, air and water shall fall under the sway of ether wave and when men many miles distant shall control machinery and direct commercial enterprises of vast importance.

When young John Hays Hammond made his first experiment with a radio-controlled motorboat in the waters of Long Island

Sound only a few years ago his work was regarded with patient tolerance by people who had no intimate knowledge of the forces with which he was working and the possibilities which his success might open up. But the grizzled old hulk of the *Ohio* is now a mute warning to all of us that we must be prepared to believe almost anything that the scientific visionaries of today are dreaming.

Suppose, for a moment, that we had had efficient radio direction of ships and aircraft during the war. What would the result have been? Fleets of bombing planes would have sailed over the enemy lines, scattering destruction and death, at no risk

of loss of precious lives to us. The German U-boat menace would have been a simple problem to solve, for ships could have been sent into every submarine harbor—ship following ship as the preceding one was sunk, until an impassable barrier had been piled up across the entrance to every port, with no danger to human life in the undertaking.

It is a vision that all of us have not the sight to see; it is one, however, which we all can appreciate when we know that the keen eyes of the elect, peering out over the horizon of the future, make it out in the mists coming toward us and very soon to be alongside.—Philadelphia *Public Ledger*.

## A British Vacuum Tube Control Unit\*

IN the accompanying illustration, we have the British equivalent to our many types of control panels. As will be noted this set makes use of the British type of valve detector which has its elements set in a horizontal as compared with the American upright method. Incidentally this valve detector was the first piece of British apparatus to be marketed after the Armistice.

The hook-up is practically the same as those employed in this country except that a .002 condenser is placed between the filament-battery side of the telephone and led directly to the plate instead of being bridged across the telephones. The grid condenser has a capacity of .0002 mfd., in this case.



To the Left of This Illustration is Shown the Instrument With Vacuum Tube Ready for Use While to the Right We Have the Base turned In Such Manner as to Show Internal Set-Up.

The manufacturers designed this unit to enable experimenters to quickly convert their crystal receivers to a valve amplifier and rectifier. With a slight modification of internal wiring the instruments can be changed for C.W. reception. Altho this set is designed to receive British valves, the manufacturers will alter the base so as to receive American V.T.'s.

In the accompanying illustration two views are shown. One showing the instrument ready for use and the other one with the base turned so as to show internal wiring.

One notable feature of British vacuum tube instruments is that they are made to set on a flat surface in comparison to our panel type method of mounting.

\* Photograph by courtesy of Mitchell's, London.



# Reporting News by Radio

The Latest Achievement of the Versatile Radiophone

**W**E knew it. The radiophone has at last entered commercial life with a vim which promises many future conquests. In this case the radiophone recently stepped into newspaperdom via the offices of the Los Angeles *Examiner*.

In order to prove that the experiment is not a fallacy nor the product of journalistic imagination, two excellent photographs are reproduced on this page showing the two essential sides of the story. The lower illustration is none other than Mr. Ray T. Van Ettisch, city editor of the Los Angeles *Examiner* making use of a portable radiophone set. He is instructing reporter Chaudler Sprague who is in the country, miles away from the newspaper offices.

In the upper photograph we see Mr. Sprague in the very act of receiving instructions from his chief at the home office. To the right is shown Lieut. J. T. Morris, army radio officer of Marsh Field, Cal. As may be noted by scrutinizing the apparatus, the United States Signal Corps installed the system. Major B. K. Yount, commanding officer of the Field, cooperated with the newspaper in order to demonstrate to the public the possibilities of radio telephony.

A complete radiophone installation was first erected at the *Examiner* Building, Los Angeles, Cal., and an extension brought down to the editor's desk. After this the reporter and the radio officer left by automobile to "cover" various happenings. The first stop was Exposition Park where the set was tested out at short range after having taken ten minutes to set it up. This particular set having a working range of twenty miles, the next stop was Long Beach, where a newspaper story was corraled and shortly thereafter the set was hastily installed in a vacant lot. Ten minutes later the reporter was again in communication with his chief and the story accordingly reported.

A short time afterwards the party set out for the amateur fisherman section of Santa Monica Bay, Cal. An interesting story was gleaned here owing to the fact that a fleet of professional fishing boats had come into the Bay and was seining for fish much to the dismay and indignation of those who were there for sport.

Again the installation was quickly set up and headquarters was given the "human interest" fish story. No, curious reader, up to now we have not been informed as to who won priority fishing rights.

The *Examiner* naively informs us that altho the 'phone in this instance worked to perfection, the apparatus is a trifle cumbersome for use except possibly in an emergency where the reporter expects to be miles away from a telephone. Incidentally we are also informed that many experiments are being conducted whereby it is

Photos by Los Angeles "Examiner."



Reporter Sprague Receiving Radiophonic Instructions from the City Editor of Los Angeles Examiner Miles Away. The Army Officer is Lieut. Morris, Radio Officer of Marsh Field, California, Who is Supervising Technical Details of Operation.

predicted that within a short time the apparatus will be so simplified and condensed that a reporter can carry a portable radio-



City Editor Van Ettisch of Los Angeles Examiner, Instructing his Star Reporter by Means of the Portable Radiophone Set Mentioned Here.

phone set on any "story" and use it to good advantage even in the heart of the city.

We may thus conjure a newspaperman reporting a big fire, or a big flood, or a railroad wreck or any other dire calamities, by pressing a button in his pocket and talking thru a small mouth-piece with his city editor downtown. These things are possible but probably will not take place for many days to come.

We must disappoint you. America is not the first to make use of the radiophone for reportorial work. The feat was recently accomplished by the London *Daily Mail* and was reported as a complete success. In this case the reporter toured the provinces of the big city in a motor car and phoned in his stories to the editor in the heart of London by means of radio telephony. In this event a Marconi six-step amplifier was used at the receiving end.

Incidentally the first radiophone message spoken at sea on board a vessel destined for publication in a daily newspaper was received in the London *Daily Mail* office several weeks ago. The vessel happened to be the British S.S. *Victorian* aboard which were delegates on their way to the Imperial Conference in Canada. The event occurred while the steamer was a considerable distance off the north coast of Ireland. Sir Campbell Stuart, managing editor, dictated a message from the deck of the liner to a reporter stationed at the Poldhu radio station in Cornwall. Here is what the reporter had to say concerning the important happening.

"I spoke thru an ordinary telephone transmitter just as if I were calling a correspondent in the next town using the regular land line telephone. I said 'Hello Victorian,' and it was like calling a spirit from the deep to hear him reply on the instant, 'Hello Poldhu.' We were just getting to conversation when a dramatic intervention took place. The whole atmosphere was charged with shrill pipings spelling out in the Morse Code the seafarers' dreaded SOS. On the moment the Government station at the Lizard sent out a command to all operators to cease talking in order that there should be no hindrance to the transmission of the distressed vessel's message.

"Then, just as a moment before there had been nothing but shrill pipings from all quarters, there came a dead silence, thru which there rose loud and clear the call of the distressed ship. She said she was the American vessel *Coquitt* and was in trouble off the Bishop Rock, Scilly Islands, and requiring immediate assistance. The Lizard took the matter in hand in a motherly fashion, arranged for the needed aid to be sent, and, this settled, the wireless world started talking again as if nothing unusual had occurred."

(Continued on page 248)



# Developing Radio in the Hills\*

How a Radio Man with an Idea Broke Away from Precedent and Surprised Even Himself at Its Novelty

By PIERRE H. BOUCHERON

**T**HINGS were getting dull of late. Nothing new had been said, written, or worked up in the line of radio. As a matter of fact, this summer has been a terribly dull one in our field. At least in-so-far as anything radically new is concerned, so last week the man who controls the destinies of RADIO NEWS and

facturing and testing machinery. The nearest available source was a considerable distance from the adjacent site. This entailed the erection of seventeen poles for the running of a 2,300-volt power line with its potential stepped down to 220 and 110 volts. Besides this, a roadway had to be built covering over half a mile. Finally, came

*Spider Web Coil*, so called because of its similarity to the web woven by the common house spider. Not only is this coil unique in its appearance, but has proven very effective for radio receiving and transmission work. Incidentally, a patent has been allowed by Washington for this device and will probably be issued within a short time.



Three Photographs Taken at Radio Hill. To the Left We Have a Practical Working Model Devised by the Inventor for the Purpose of Rapidly Winding "Spider Web" Coils. In the Center Is Shown Mr. Eugene T. Turney, a Practical Idealist, Surrounded by Some of His "Pets" While to the Right Is a Long-Wave Three-Coil Receiving Unit Consisting of Primary, Secondary and Tickler, the Primary and Tickler Being Variable in Respect to the Secondary in the Center.

*Science and Invention* said, "Why don't you go up and see what is doing on Radio Hill. The radio fraternity has never heard of it, and perhaps there is something new up there that would interest it." So hillward I went.

Radio Hill! What more suitable name could be given to this most ideal of spots devoted to the research and long-distance exploiting of radio instruments? Such is the name which this inventor, formerly of New York City and well known to many radio amateurs by his development of the *Crystaloi* detector, has christened his laboratory—surroundings which would make any real amateur green with envy should he contemplate the excellent receiving site and reception qualities of this neighborhood.

## THE IDEA

For years this man, who has been a confirmed city dweller, had been told right and left that a business, and particularly one having to do with radio research work, could not be carried on effectively at any great distance from a large metropolis, where parts, renewals, and other necessary instruments can always be obtained at a moment's notice. He thought different, however, and waited for the opportune time when he could cast aside conventional commercial ideas and install himself in his "lab" in some far-away place in the hills. When he spoke to friends and explained his project, they advised him against it; it simply could not be done. In order to conduct a radio proposition, it had to be done near or in the heart of a big city with its attendant commercial advantages. His plan was to choose a spot most ideal for radio research and there go to it to his heart's content. The result is that today a most effective layout has been installed at Holmes, Dutchess County, not far from the Berkshire Hills, New York State.

There were, of course, many difficulties to be surmounted. For instance, when the matter of power was considered—electrical power, which is necessary to operate all manner of manu-

the large building suitable for work shop and laboratory. In addition to this, of course, are residences, out-buildings, garage, etc. No mean task, let me tell you.

Life at Radio Hill for those engaged in assisting its owner would appear almost Utopian. When workmen are thru their day's work and when testers and helpers have tested to their heart's content, they may turn to relaxation in the form of fishing, game shooting, swimming, as well as winter sports. At the base of Radio Hill is a large lake, which has been stocked with fish and which is provided with an abundant number of small row boats. The matter of relaxation has been given considerable attention and is really closely allied to the big idea. A well-satisfied workman will naturally do his best in his day's work and will have very little time, if any, to think about strikes, increased wages, etc.

## THE SPIDER WEB INDUCTANCE

We can hardly proceed without giving some attention to this addition to practical radio of today developed at Radio Hill. Pancake coils have always been very desirable in many conditions met with in radio on account of their good appearance and small space factor. They were, however, rather hard to wind, at least the old types were. In the present instance we introduce the

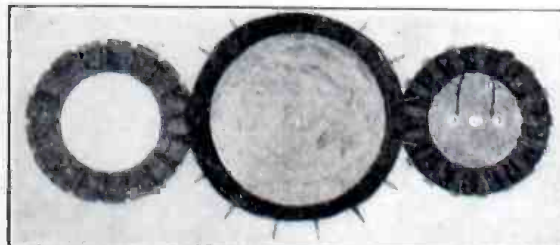

Evolution of Three Stagger-Wound Coils. The First Is in the Center and Is Wound Around Pins Inserted Upon a Wooden Disk. The Second Is to the Right, Having the Improvement of Being Wound Upon a Slotted Insulating Disk. The Third and Present "Spider Web" Is Seen at the Extreme Left.

The principle underlying this coil and other similar coils, among which is the "stagger-wound," is perhaps not so strikingly new as may be imagined by some of the newcomers in the radio game. In fact, our friend Zenneck briefly mentions them on page 51 of his excellent volume and refers to them as "flat spiral" inductances. These early coils, however, were not effective and had no evident merit on account of their large distributed capacity.

In speaking of this development, it may be said that it has done for the above otherwise useless coil what Weston did for the D'Arsonval galvanometer. In this case Weston placed the coils within the meters in such a manner as to make practical measuring instruments. The great success of the Weston meters needs no recounting here.

## THE PROBLEM

The effective inductance of today must have the following desirable qualities.

1. As small a distributed capacity as possible.

2. The space factor is next in importance. Coils must take up little room in modern radio sets.

3. High frequency resistance must be reduced to a minimum.

4. Magnetic leakage must also be reduced.

Unfortunately the magnetic leakage in many coils of today is seldom considered, but nevertheless plays an important part in ultimate efficiency.

The "spider web" coil is evidently extremely well adapted to fit the above requirements. This was done in the following wise. Several years ago this radio man built one of the coils shown in the above illustrations and upon test, as we have previously said, found that they possess no merit over other forms of winding; in fact, it was rather the opposite condition. It was apparent that by the proper choosing of the insulation core, as well as the proper spacing of the wire, the coil could be made to be a most desirable inductance.

(Continued on page 226)

\* Illustrations by courtesy of Laboratories of Eugene T. Turney.



# Electron Power Tubes and Some of Their Applications

Part I  
By WILLIAM C. WHITE

Research Laboratory, General Electric Company

[Editor's Note:—There seems little doubt that C. W. vacuum tube transmission is slowly but surely rising to the point where we may expect to find this system of radio superseding spark and arc systems. In the present article the three-element electrode tube, otherwise known as the pilotron, as well as many divert names, is given a very thoro exposition of factors concerning design and construction which determine the output in these power bulbs. The article is then followed by a description of a typical pilotron power tube, after which are discuss the properties of oscillating circuits. Some excellent photographs and descriptions of present-day vacuum tube transmitters will be included by way of summary. We expect our readers to gain considerable knowledge of electron power tubes as presented by Mr. White in this excellent paper.]

**T**HERE is a considerable field of application for three-element electron tubes as oscillators or amplifiers to give outputs of several hundred to several thousand watts.

For this purpose it is possible to utilize a very large number of small tubes operating in parallel, but for reasons of expense, complexity, liability to breakdown of units and space required, such a solution of the problem is impracticable and becomes increasingly so the greater the power output required.

In radio transmitting apparatus particularly, there is a field for continuous wave high-frequency outputs of about one kilowatt.

Excluding amateur installations, the greater proportion of radio transmitting sets are of the so-called medium power type giving outputs of high-frequency energy of 250 to 2,500 watts into the antenna. With the usual size of antenna employed and the logical organization of wave lengths, operation in the wave length range of 300 to 2,000 meters (1,000,000 to 150,000 cycles) is usually desired.

At the present time spark sets, mostly of the quench-gap type, are used for this class of transmitting equipment.

The adoption of continuous wave trans-

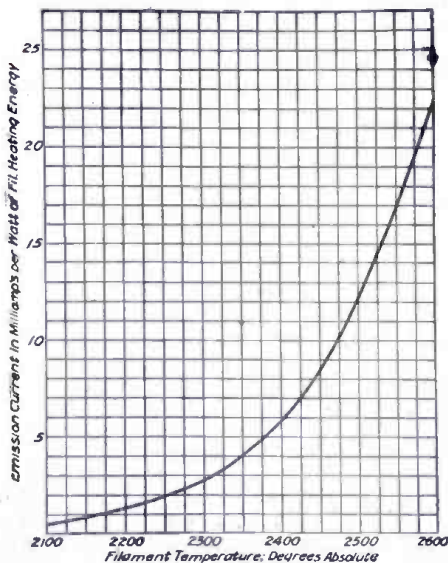

Fig. 1. Variation of the "Efficiency" of Electron Emission with Temperature for Tungsten Filament Cathode.

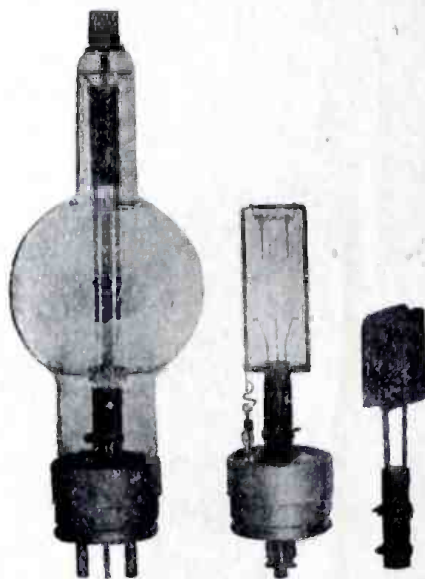

Fig. 2. Large Type of Pilotron Tube, Assembled and Disassembled.

mission to supersede damp wave transmission has brought about wonderful improvements in the case of very low power and very high power installations.

Spark sets of the medium power class mentioned above cannot be replaced by the type of apparatus used on the high power continuous wave sets.

Neither the high-frequency alternator, the Poulsen arc nor the so-called timed spark systems are practical for this particular class of stations, principally because of their inability to operate at the short wave lengths required and also due to lack of flexibility of wave length in the case of the alternator and poorer characteristics of the arc at low power.

Also in the case of radio telephony, voice control is a comparatively simple matter with three-element electron tubes.

Therefore it is logical to believe that this class of medium power transmitting equipment is a particularly promising field for the three-element vacuum tube.

There are also several other fields of application, some of which will be described later.

Since the three-element power tube itself is the basis of such equipments, its characteristics and the features required for power output will be first considered.

## The Three-Element Power Tube

There are a number of factors in the design and construction of a three-element vacuum tube which may limit its output.

(1) Dissipation of energy in the form of heat at the anode so great that deterioration of the vacuum results, or certain of the parts lose their mechanical strength, or even melt.

(2) Insufficient electron emission, resulting in a definite limitation of plate current and therefore limiting the input energy to the tube.

(3) Insufficient exhaust treatment.

(4) Insufficient dielectric strength in the materials holding the electrodes in place and in the lead-in wires or terminals.

(5) Insufficient mechanical strength of the electrodes or their parts, so that the

high anode voltage causes a displacement and probable short-circuiting, due to the mechanical force of the electrical field.

(6) Improper geometrical design or construction so that the electrical constants of the tube are incorrectly proportioned to the conditions of operation. This allows the factors which cause the first five limitations to be at values above the possible minimum.

These factors will now be taken up more in detail, together with comments relating thereto.

## (1) Dissipation of Energy from the Anode

Of the input to the plate circuit of the tube a portion appears as output and practically the entire remainder is lost as heat at the plate.

In the types of oscillating circuits used at the present time the output approximates 50 per cent of the input, actual values ranging from 25 per cent up. Therefore, in the design of the anode and bulb provision must be made to dissipate more energy than is produced.

The heat energy leaves the anode or plate mostly by radiation, but a certain proportion is carried away by conduction thru the plate supports. The necessary plate area acting as anode is more or less determined by the desired electrical characteristics, but its actual area, to facilitate radiation of heat, may be increased by vanes or other forms of attached surfaces. It is good practice to make the plate out of the same piece of metal as the vanes, as it is surprising how poor the heat conductivity between two pieces of metal may be that are in intimate contact by a process such as riveting. This effect is often plainly apparent in plates that are running at a red heat by the difference in color of parts supposedly in intimate contact.

In the choice of material for the plates of power tubes the use of tungsten or molybdenum is very desirable, as it gives the following advantages of energy dissipation for a given area:

(1) These metals, in the form of vacuum tube plates, can be freed from gas to a greater extent than any other metal.

(2) They retain good mechanical strength at a bright red heat.

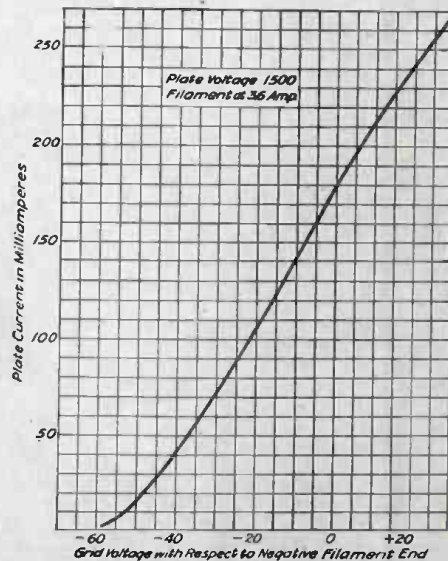

Fig. 3. Typical Characteristic Curve for the Type of Pilotron of Fig. 2.



(3) The rate of evaporation of the metal which would cause blackening of the bulb is very small, even at a bright red heat.

(4) On account of their very high melting points they can stand up under very high inputs of energy over a short period of time. This is important in safeguarding the tube from excessive inputs with no output when, from some accidental cause, a high voltage power tube stops oscillating and the plate current is only limited by the electron emission.

The writer has noted this latter defect in many foreign power tubes. Their rated operating condition is so near the absolute limit which the tube will stand that any change in conditions is liable to spoil the vacuum, or a mishap stopping oscillations almost instantly causes destruction of the tube by excess dissipation of energy. It certainly is not good engineering practice to so rate vacuum tubes. This defect in tubes of foreign design is usually accentuated by the fact that the design is of rather low impedance for the voltage employed, thus making the plate current at full rated plate voltage greatly in excess of the normal load current in the oscillating condition.

When a tube fails to function properly and the characteristic blue glow of excessive ionization appears, this gas usually comes from the metal of the plates, the glass or from other metal portions of the tube, such as plate supports, grid frame or supporting sleeves.

Extravagant claims are often made as to the output of a vacuum tube. If the tube is used in the usual types of circuits, so that the efficiency is of the order of 50 per cent, an examination of the size and material of the anode gives very good evidence as to the power capabilities of a tube, assuming it is satisfactory in all other respects.

A little experience with tubes of various designs gives a person a very good idea of the approximate amount of energy which can be liberated from any form of anode of particular material without either rendering it too weak mechanically, or too hot so that excessive evaporation takes place.

(2) *Insufficient Electron Emission*

When a tube is delivering alternating current energy, either as an amplifier or oscillator, a certain average direct current is supplied to the plate from the direct current source.

Electrons, of course, cannot be "stored up" and used even a short period of time after their emission. Therefore, there must be a constant emission of them sufficient to meet the maximum demand portion of the plate current cycle.

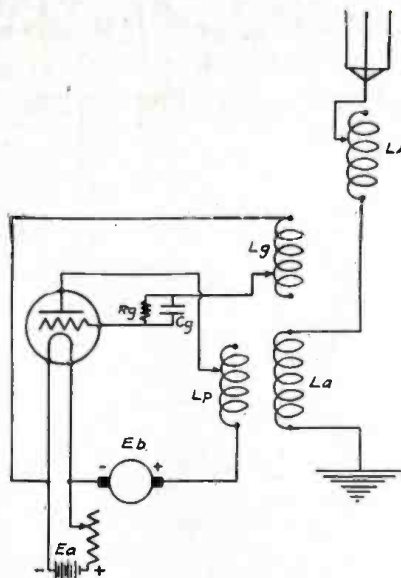

Fig. 4. Typical Oscillating Circuit for Energizing a Radio Transmitting Antenna.

With a pure sine wave form of plate current an emission corresponding to double the average plate current is required to give the peak value. Also during the period of the cycle when the plate current is maximum the grid voltage and therefore the grid current is at a positive maximum. A direct-current meter placed in the grid circuit of an oscillating tube supplying energy under proper adjustments shows a current of roughly 10 per cent of the average plate current. Therefore the peak value of electron current to the grid is several times this value, running up as high in certain cases as the average plate current itself.

It is desirable to have a certain excess electron emission so that the tube will deliver practically full energy over the range in variation of filament current that is liable to occur in actual supply circuits or through the limits of variation of a filament current regulating device.

Also slight differences in the dimension of filaments for different tubes of the same type necessitates usually a further allowance of excess emission.

These factors taken together usually require that the emission at rated filament current be three to five times the average current while oscillating, as measured on a direct current instrument.

There is also an effect which is negligible on receiving and other low power tubes, but which is an important factor on high voltage power tubes. This is the effect on filament temperature, and therefore upon the electron emission, of the electron current of the plate circuit, adding to or subtracting from the filament current.

If the filament is operated from a direct-current source thru a series resistance in the circuit the electron current will add to the filament current if the negative of the plate voltage source is connected to the negative filament terminal and it will subtract from it if connected to the positive filament terminal. This effect will not be uniform over the entire length of the filament but will be variable, being a maximum or minimum at the end of the filament to which the negative terminal of the plate source is connected.

When it is remembered that the average plate current of a tube usually have a value between 2 and 7 per cent of the filament current and that a 3 per cent increase or decrease in the heating current of a

tungsten filament respectively halves or doubles the filament life, the importance of allowing for this is apparent.

This filament heating effect of the plate current also has another important aspect. If for any reason a high voltage power tube stops oscillating, the plate current will usually rise to a value limited only by the filament emission. If the return or negative of the plate source is connected to the negative end of the filament this abnormal current flow will increase the temperature and therefore the emission which in turn increases the plate current, this effect being accumulative, often destroying the filament in a few seconds.

Therefore, on a high-voltage power tube with direct-current filament excitation it is advisable to connect the negative terminal of the plate voltage source to the positive end of the filament.

If possible, alternating current should be used for filament excitation with the regulating rheostat in the power side of the transformer circuit and the return of the grid and plate circuit made to a center tap on the winding supplying the filament.

This connection assures minimum disturbance in the plate and grid circuits from the frequency of the filament source.

The plate circuit current in this case divides evenly between the two filament legs. Also the direct electron current and the alternating filament current add at a 90-degree displacement to give the combined heating current so that the additive effect is much smaller. For instance, a one-ampere electron current added to a four-ampere filament current would give a five-ampere heating current at the hottest part of the filament if it were d. c., and only 4.13 ampere if a. c.

For a tungsten filament there is a definite relation between the electron emission current, filament heating watts and temperature.

A curve is shown (Fig. 1) giving the plot between milliamperes emission current per watt of filament heating energy and absolute temperature of the filament. This relation holds for any diameter or length of filament, but its values are subject to some modification for particular cases owing to the cooling effect of lead wires and filament

(Continued on page 245)

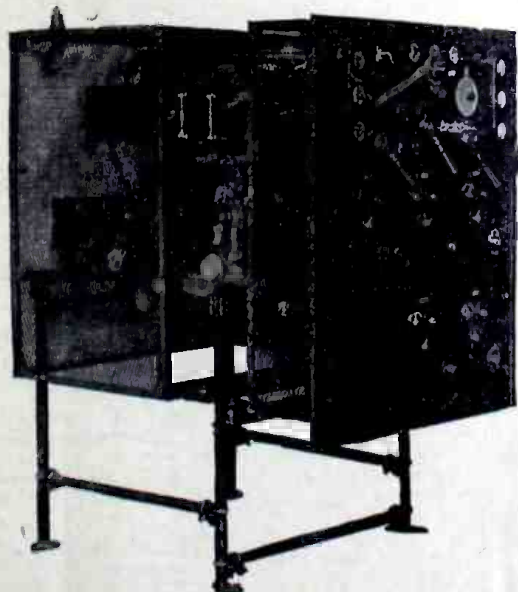

Fig. 5. Pilotron Radio Transmitting Set. In the Open Position Shown All Circuits Are Disconnected.

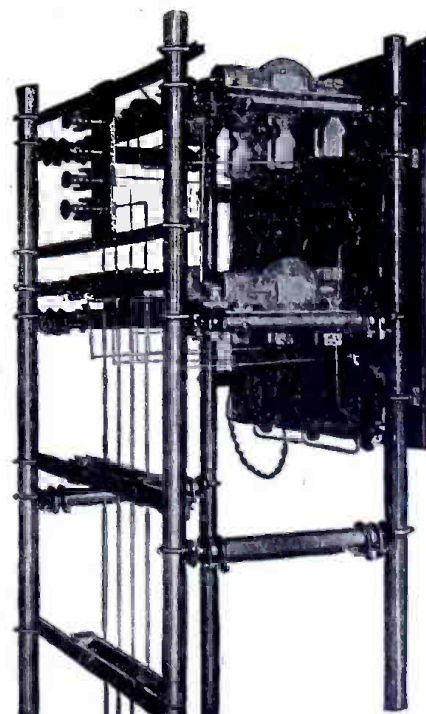

Fig. 6. Another Multiple Pilotron Set Arranged for Only Three Wavelengths.



# Crewless Battleship Controlled by Radio

Some Interesting Experiments Now Being Carried on by the United States Navy.  
Designed to Revolutionize Present Naval Warfare

WE are advised that the long forecasted experiments employing radio control of battleships are now being conducted by the United States Navy. If the experiments are successful some interesting changes will probably be made in the future building program of our battleships. In this instance, radio once more takes its place as the prime factor of operation.

Recently two battleships left the Philadelphia Navy Yard bound for the Delaware Capes, where the secret experiments took place. One of these vessels, Coast Battleship No. 4, which was formerly the U. S. S. *Iowa*, of Spanish-American War fame, is shown in the accompanying photograph on this page. The other vessel is the U. S. S. *Ohio*. The latter will be the one doing the controlling from her radio cabin and the movements of the *Iowa* will be effectively directed at certain distances. That is to say, the starting, stopping, and slowing down of the engines as well as the steering apparatus is to be entirely controlled by means of a secret radio system devised by John Hays Hammon, Jr., who, by the way, will supervise

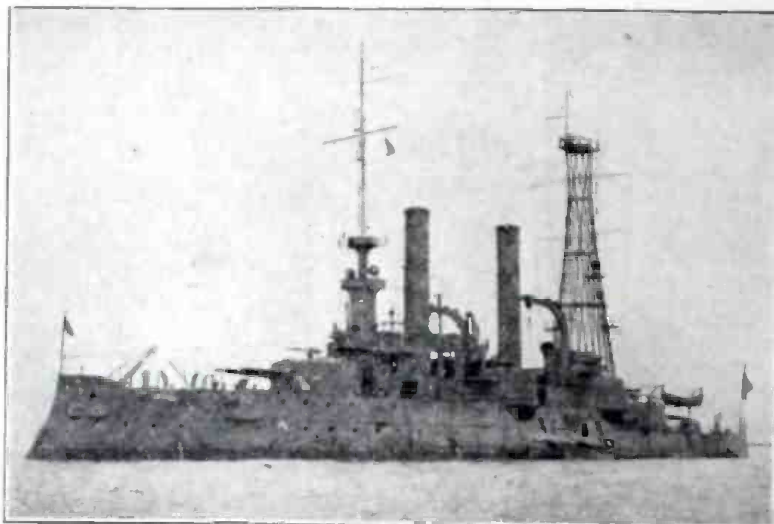

Photo by International Film Service

Carrying Out a Secret Experiment, the Control of One Large Battleship with No Person Aboard, by Another Warship, Thru Radio, Two U. S. Navy Battleships Recently Left the Philadelphia Navy Yard for the Delaware Capes Where the Radio Control Experiment Was Made. Coast Battleship 4, Once the U. S. S. *Iowa* (photograph), of Spanish-American War Fame, Plowed Thru the Sea with Her Engines and Helm Controlled from the Radio Room Especially fitted on the Warship *Ohio*.

the technical details of the experiment. Not only will the speed and direction be controlled by radio, but also the smoke barrage as well.

During the last few months both of these vessels have been fitted out with the radio

which up to now has not been entirely successful.

It is also understood that similar experiments are now being conducted by the British Navy. Details of the two systems, however, will not be made public for some time.

control system which is at present entirely secret. Commanded by a skeleton crew, the *Iowa* proceeded to the Capes under her own steam, where the crew abandoned the ship and radio control took charge, not a single person remaining on board.

Meanwhile the U. S. S. *Indiana*, sister ship of the *Iowa*, and also a hero ship of the Spanish-American War, is being fitted with a similar equipment at the Philadelphia Navy Yard, and if the above experiment proves successful, the surrendered German warships which have been on exhibition in New York Harbor will probably be equipped with the same system, thus affording the American Navy an ideal opportunity for target practice under war conditions.

In addition to the above possibilities, statements have been made that the present system will make possible the satisfactory operation of directing torpedoes by radio,

## A New Amplifying Transformer\*

ONE of the most important items in the successful operation of an audio frequency amplifier is the coupling or intervalve transformer.

In order to produce a satisfactory amplifying unit, it is essential that the input and intervalve transformer characteristics be such as to "blend" with some of the tube characteristics. The D. C. resistance of the primary winding should be comparatively low, in order that a low plate potential battery may be used and that the ratio between the primary reactance and resistance be a maximum value.

Furthermore, the question of primary impedance must carefully be considered and that of the ratio of primary and secondary number of turns. The latter is determined both from the desired value of amplification and the tube characteristics in order not to exceed the grid voltage where distortion of the output begins to become effective.

Other items enter in the design of the transformer, such as core design, where it is necessary to carefully apportion the dimensions in order to obtain the minimum core loss for the frequency under which the transformer is operated. The magnetic reluctance must be so adjusted as to give least distortion of the output, at the same time deriving maximum coupling and the careful design of magnetic joints in order to avoid noises due to poor magnetic joints.

The problem of leakage flux from the core and windings is also of extreme importance, as this is the main controlling factor of coupling between amplifying stage,

as this is usually the prime cause of "howling" and "squealing." These noises are due to coupling giving rise to the generation of e. m. f.'s at audio frequencies.

The coils must be so designed as to minimize their distributed capacity or increase it to such a value and with this high resistance produce a broad resonant condition with the existing inductance of the windings. This is sometimes advisable when using the amplifier as a signal amplifier when the natural frequency of the transformer is

shown in the photograph. This new "Saco-clad" transformer is of the totally enclosed shielded type. The leakage reactance is practically zero and the coupling is a maximum.

Primary and secondary windings are wound in sections, and both of these windings are assembled alternately. With this arrangement the coupling is increased and the leakage reactance reduced.

The ratio of primary and secondary is 1 to 4.5, giving a far greater voltage transformation than found with existing types of transformer.

The core being a shell and composed of silicon steel laminations, these give a very low core loss. With this type of core, and with a minimum leakage coefficient, it becomes possible to mount these transformers in any position without fear of coupling due to the leakage flux, for this flux is practically zero.

Incidentally, this coupling or intervalve transformer is the smallest transformer of its kind, measuring 1 15/16" in diameter and two inches high and weighs 9 oz.



Top and Side View of the Smallest Efficient Amplifying Transformer. This Illustration is Slightly Less Than Actual Size. Nifty, Eh?

equal to that of the incoming signal, hence further amplifying of the incoming signal due to resonance phenomena.

It is obvious, therefore, that in order to produce a satisfactory amplifying coupling transformer that all of the above items must be considered.

The above items have been fully met in the newly designed coupling transformer

### NEXT MEETING OF THE INSTITUTE OF RADIO ENGINEERS

The next meeting of the Institute of Radio Engineers will be held on Wednesday, October 6th, 1920, at 8.15 P. M., at the Engineering Societies Building, 29 West 39th Street, New York.

A paper on "Radio Taste Reception" by Alfred N. Goldsmith and Edward T. Dickey will be presented. Members and their friends are cordially invited to attend.

\* Illustration by courtesy of Mr. S. Cohen.



# A Portable Combination Receiver

By RUSSELL H. ROBINSON

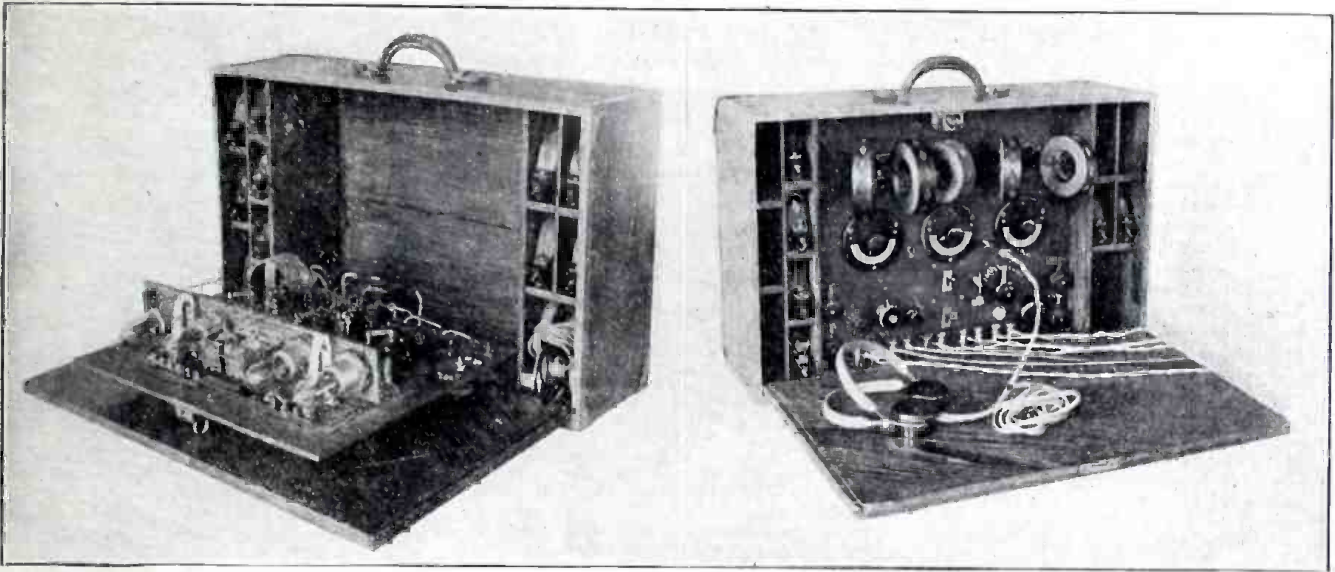

Rear and Front Views of This Well-Arranged Portable Receiver Unit. Everything Necessary is Contained Within the Case Except Antenna and Batteries. Note Well Manner of Housing Extra Coils. Also Note That in the Right-Hand Photograph the Lid of the Case Takes the Place of Receiving Desk.

*Editors' Note: Mr. Robinson evidently made good use of his time while in the Signal Corps branch of the U. S. Army. Judging from the excellent photographs shown on this page we are confronted with striking evidence of his handiwork and skill. Our readers will agree with us, when we say that this portable V.T. receiver is indeed a well planned and excellently designed set. While it is rather too large a unit to be entered in our Portable Radio Contest, it is nevertheless a most effective way to employ four vacuum tubes in a portable receiver.*

*Do we understand rightly that this example of workmanship is only one of the many which have been constructed by ex-army and navy radio men? If so let us hear from you former "doughboys" and "gobs". Be like Mr. Robinson and do not hesitate to show off your skill to the radio public.*

**T**HE receiving set illustrated herewith was constructed at the Signal Corps School at Camp Alfred Vail, N. J., by the writer who was formerly a student at that school.

The parts were obtained from supply houses in New York City, Toledo, Ohio, and Boston, Mass.

This set has the following advantages: It is portable, everything being enclosed in the carrying case except the antenna, ground, storage battery and plate batteries.

It can be made to receive short and long waves either damp or undamp with either the crystal or audion detector. The crystal and buzzer tester is used when storage batteries and high voltage plate cells are not available or are exhausted. As shown in the illustra-



tions four bulbs are used. The first to the left is the detector, the second and third bulbs are amplifiers. The fourth bulb is used with the heterodyne reception.

The operator may quickly change from short to long wave reception or vice versa by use of the upper De Forest switch

shown. The lower switch governs the particular detector being used.

For receiving on short wave lengths from 300 to 800 meters the De Forest coupler is used. Honeycomb coils are used in receiving long waves ranging from 800 meters to 25,000 meters. The mounting for these coils is in the upper left-hand corner of the panel. The third plug of this mounting is for the tickler coil.

The mounting in the upper right-hand corner holds two coils either L or LL 1000 for the heterodyne reception.

The left-hand telephone jack can be used when the signals come in so loud that the detector bulb is sufficient for reception. This of course is designed to save both

A and B current, for the insertion of the receiving plug cuts off the filament current from the two amplifiers.

Separate switches control the filament current to the receiving bulbs and to the heterodyne bulb. The rheostat is in the circuit to the receiving bulbs. The tickler coil may be cut in or out by the lower left-hand switch.

In tests made with this set at the school, Western Electric's VT 1's were used. Ship stations came in very loud and clear on the short wave coupler. Arlington came in clear on the honeycomb coil mounting using two LL 500 De Forest coils. Coils LL 1500 and LL 1250 were used respectively in receiving the long waves.

In receiving signals from stations transmitting long undamp waves such as Sayville and Annapolis the heterodyne was far superior to the tickler method. In fact, the signals in this case came in so loud that the operator had to remove the receivers for comfort.

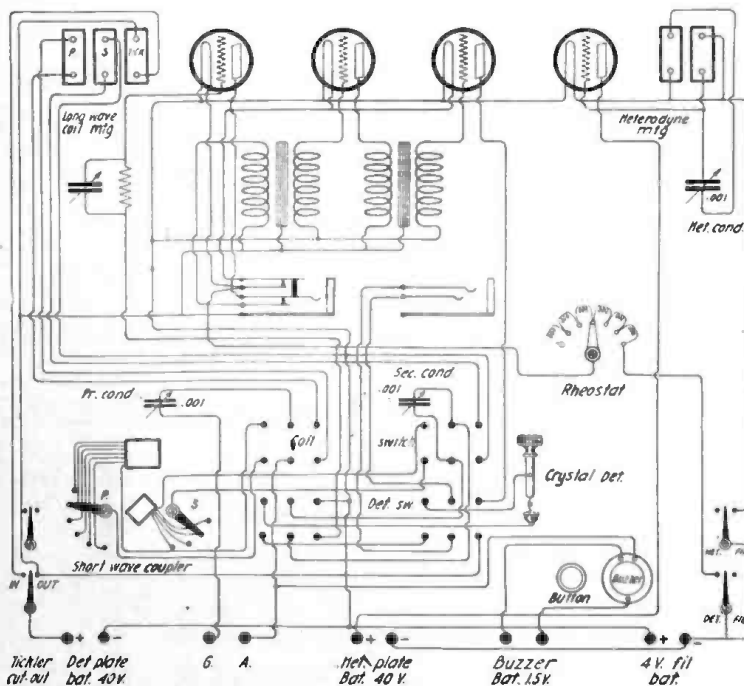

Complete Wiring Diagram of the Portable Set Which Employs Four Vacuum Tubes. Mr. Robinson is To Be Complimented Upon His Excellent Craftsmanship.



# The Audion—Its Action and Some Recent Applications

By LEE De FOREST, Ph.D., Sc. D.

## Part I

A historical paper of unusual interest to the Radio fraternity

**A**NALOGIES are apt to be interesting, and in scientific matters frequently instructive and clarifying. The title of this paper, "The Audion," suggestive of *Sound*, prompts the consideration of an analogy in the realm of *Sight*—the microscope. The audion, in a measure, is to the sense of sound what the microscope is to that of sight. But it is more than a magnifier of minute sounds, electrically translated; the audion magnifies and translates into sensation electric energies whose very existence as well as form and frequency, would but for it remain utterly unknown. As the microscope has opened to man new worlds of revelation, studies of structure and life manifestations of natural processes and chemical reactions whose knowledge has proven of inestimable value thru the past three generations, so the audion, like the lens exploring a region of electro-magnetic vibrations but of a very different order of wavelength, has during the scant thirteen years of its history opened fields of research, wrought lines of useful achievement, which may not unfairly be compared with the benefits from that old prototype and magnifier of light

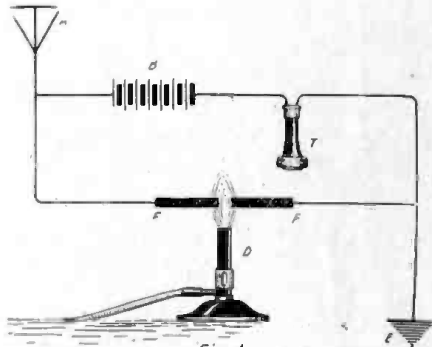

"I Next Explored a Bunsen Burner Flame, Using Two Platinum Electrodes Held Close Together, Connected with an Outside Circuit."

in the telephone receiver the signals from a distant wireless telegraph transmitter. The resistance of this new "flame detector" was decreased when the flame was enriched by a salt. Next the incandescent gases of an electric arc were considered; and likewise the action in the more attenuated gases of an ordinary lamp bulb, surrounding an incandescent filament or filaments.

But during these early years I was afforded little time to concentrate on this laboratory problem, and it was not until 1905 that I had opportunity and facilities for putting to actual proof my conviction that the same detector action which had been found in the neighborhood of an incandescent platinum wire, or carbon filament, in a gas flame existed also in the more attenuated gas surrounding the filament of an incandescent lamp. In one case the burning gases heated the electrodes; in the other the electrodes heated the remanent gases. But in both it was *first* the electrons from the hot electrodes, and *second* ionization of the gases which these electrons produced, which established an electrically conducting state, extraordinarily sensitive to any sudden change in electrical potential produced on the electrodes from some outside source.

Considering therefore this actual genesis of the audion it will be seen that it was never, strictly speaking, a *rectifying* device. True, both electrodes were seldom alike and a "polarization" was always had from the outside battery, but any rectification of the alternating currents impressed on the detector was merely incidental and played no vital part in the action of the audion. From the beginning I was obsessed with the idea of finding a *relay* detector in which local

electric energy should be controlled by the incoming waves—and not a mere manifestation of the electrical energy of the waves itself. Hence it was that the external battery as a source of local energy was always employed when the incandescent filament was utilized as source of the electric carriers through the gas. The battery for lighting the filament *Q* styled the "A" battery and, as distinguished from this, the other battery was named the "B" battery. This nomenclature has been retained, and is today commonly accepted, even by the many who for various reasons refuse to recognize the name "audion."

At the period now under consideration, 1903-05, I was familiar with the Edison effect and with many of the investigations thereof carried on by scientists, Professor Fleming among others. In 1904 I had outlined a plan of using a gas heated by an incandescent carbon filament in a partially exhausted gas vessel as a wireless detector, in place of the open flame. But here the rectification effect between hot filament and a cold electrode was not considered. Two filaments, heated from separate batteries, would give the desired detector effect equally well. What I had already found in the flame detector and now sought in a more stable and

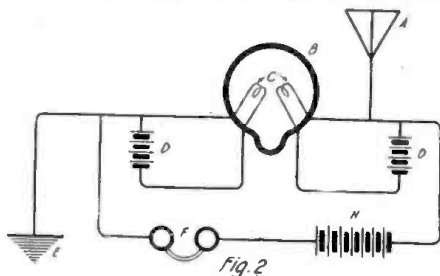

"What I Had Already Found in the Flame Detector I Now Saw It in a More Stable and Practical Form."

waves. But when the first steps were taken in the work, which eventually resulted in the audion of today, I no more foresaw the future possibilities than did the ancient who first observed magnification thru a drop of water realize the present application of the high-power microscope to bacteriology.

In 1900, while experimenting with an electrolytic detector for wireless signals, it was my luck to be working by the light of a Wellach burner. That light dimmed and brightened again as my little spark transmitter was operated. The elation over this startling discovery outlasted my disappointment when I proved that the unusual effect observed was merely acoustic and not electric. The illusion had served its purpose. I had become convinced that in gases enveloping an incandescent electrode resided latent forces, or unrealized phenomena, which could be utilized in a detector of Hertzian oscillations far more delicate and sensitive than any known form of detecting device.

The first "commercial" audion, as it originally appeared in 1906, was therefore no accident, or sudden inspiration. For failing to find in an incandescent mantle the genuine effect of response to electrical vibrations I next explored the Bunsen burner flame, using two platinum electrodes held close together in the flame, with an outside circuit containing a battery of some 18 volts and a telephone receiver. See Fig. 1—the form used in 1903. Now, when one electrode was connected to the upright antenna and the other to the earth, I was able to clearly hear

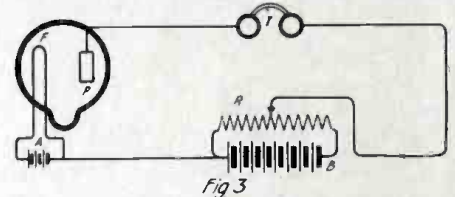

"Then Obviously, Too, I must so Connect My Telephone 'B' Battery so as to Make the Cold Electrode Positive."

practical form, was a constant passage of electric carriers in a medium of extraordinary sensitivity, or tenuity, which carriers could be in any conceivable manner affected to a marked degree by exceedingly weak electrical impulses, delivered to the medium, indirectly or thru the hot electrodes. Fig. 2.

The ordinary small incandescent lamp of that epoch supplied admirably the conditions I required merely by the introduction of a second electrode. That added electrode could be either hot or cold. Obviously, therefore, use it cold, avoiding thus the unnecessary battery. Then obviously, too, I must so connect my telephone "B" battery as to make this cold electrode positive, for otherwise no local current could flow through the gaseous space in the lamp between the unlike electrodes. Fig. 3.

The high frequency impulses to be detected were, as in the earlier flame type, originally applied directly to these same two electrodes. That these alternating electric currents were thereby rectified was merely incidental. A glance at the plate-current, plate-voltage curve (Fig. 4) shows why, even were both anode and cathode hot, the receipt of a train of high-frequency current waves would produce a resultant change in the normal telephone current and result in a signal. This typical curve, taken from a "gasey" lamp, such as I first employed, is curvilinear over two portions. If now the "B" battery potential was so adjusted that the detector was operating on either knee of this curve the increase to this locally applied voltage, resulting from the positive halves of the wave-train, would produce a greater

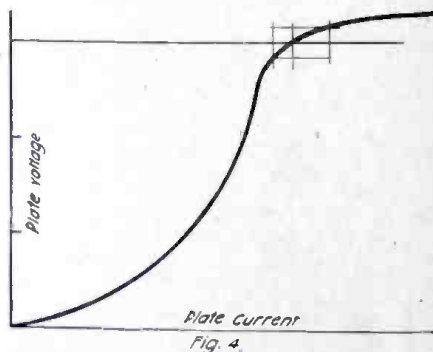

"This Curve Shows Why, Were Even Both Anode and Cathode Hot, the Reception of Waves Would Produce a Change in the Normal Phone Current."



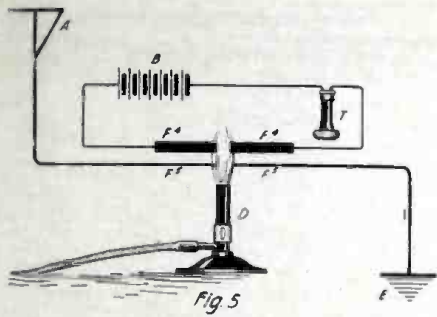

This Shows the Original Idea of Keeping the High-Frequency Current Path Distinct from the Local Telephone Current.

(or less) increase in the local current flowing across the gap than would the negative halves of the wave-train produce a decrease (or increase, as the case might be).

In other words, the responsive action of this two-electrode audion was due to the asymmetry of its characteristic curve rather than to its rectifying property. This latter property could be made to aid, to increase the intensity of the signal produced originally and mainly by the so-called "trigger" or genuine relay action of the device, which was always controlling the local energy by means of a much smaller income energy.

In other words, then, the two-electrode audion, with "A" and "B" batteries, was not primarily a "valve." And I have always objected to this misapplication of the name *valve* to the audion; a name which our British friends have from the first persisted, with a stubbornness worthy of a better cause, in misapplying!

Long before the two-electrode relay audion of 1905 had a chance to prove its worth in commercial wireless service I had found that the influence of the high-frequency impulses could be impressed to better advantage on the conducting medium from a third electrode. In its first inception the third electrode also dates back to the flame detector of 1903. Fig. 5, taken from the earliest patent of the audion group, shows the original idea of keeping the high-frequency current path distinct from that of the local telephone current. Consequently when in 1906, having secured the maximum efficiency from the two-electrode vacuum type, I cast about for further means of improvement, it was but natural to revert to this plan of separating the two circuits. The new electrode connected to the high-frequency secondary circuit was at first applied to the outside of the cylindrical lamp vessel; the other terminal of the secondary circuit was led to one terminal of the lamp filament. Fig. 6, of a 1906 patent, shows this progenitor of the third electrode. This simple arrangement proving a step in advance, I concluded that if this auxiliary electrode were placed within the lamp the weak charges thereto applied would be yet more effective in controlling the electron-ionic current passing between the filament and plate.

Fig. 7, taken from a patent filed two months after the preceding one, illustrates the next arrangement tried. Here I used two plates, one either side of the filament—one in the telephone circuit, the other in the high-frequency circuit associated with the

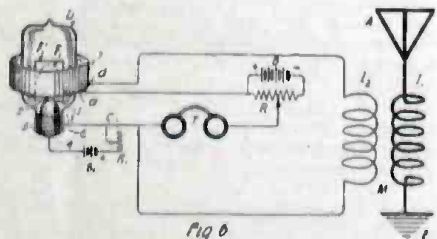

This Illustration, Taken from a 1906 Patent, Shows the Progenitor of the Third Electrode.

antenna. It will be noted also that here for the first time was shown the third, or "C" battery, in the input circuit, so much employed of late, notably when the audion is used as amplifier of telephonic currents. This two-plate device proved another decided step forward, and I realized then that if this third electrode were placed directly in the path of the carriers between the filament and plate anode I would obtain the maximum effect of the incoming impulses upon the local current flow. But obviously another electrode thus placed directly in the stream must not be a plate—it must be perforated to permit the carriers to reach the anode. A wire bent back and forth in form of a grid should answer admirably. Fig. 8, taken from the patent filed in January, 1907, the so-called "Grid Audion" patent, illustrates the preferred form which the idea promptly assumed.

In surveying the wide field of electric communication today one cannot look back at that little figure, of the first grid electrode, without a sense of wonder at the enormous changes which it has wrought. It has made possible commercial trans-oceanic radio telegraphy. It has realized trans-continental telephony: it has made reception of wireless signals half-way around the globe an everyday occurrence. The uncanny

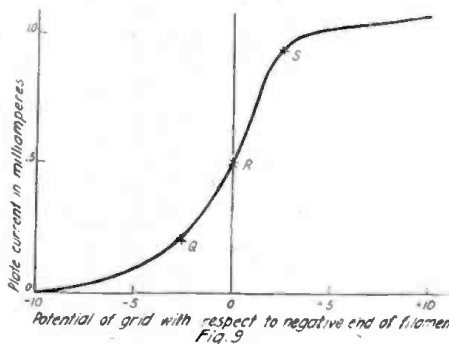

Curve Showing the Expression of the Current Going from Filament to Plate.

accuracy of millions of shells from the Allies' guns, the clock-like precision of advancing barrages, would have been impossible save for the effectiveness of their trench and airplane radio service, in which the grid audion was the essential heart. Today this little grid controls and modulates an ever-increasing kilowattage of radio telephone energy, which as early as 1915 conveyed the spoken voice from Arlington to Honolulu, and more recently from New Brunswick to the transport *George Washington*, in the harbor of Brest. It has already placed twenty simultaneous telephone messages upon a single pair of wires. A few ounces of grid wire make possible the saving of hundreds of tons of copper in long-distance telephone conductors. It has given to the physicist a tool for the exploration of unprobed fields of research; and to the electrical engineer a generator, without moving parts, of alternating currents of any desired frequency, from one to ten million period per second—a machine absolutely constant and reliable in its silent work.

Let us consider briefly the explanation of all this radical advance, the theory of the invisible mechanism whereby this astonishing control of powerful energies by minute impulses is effected. Lacking a very concrete conception of just what electrons are and just how electric charges residing on a grid can so effectively dam back the flood of electrons expelled at enormous velocities from a hot cathode at the urge of high potentials—our minds must be content with pictures of characteristic curves and mathematical formulæ, at best but crudely inter-

The fundamental operating characteristic

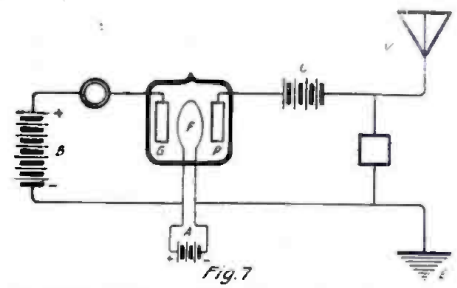

In This Instance We Have the Next Arrangement Tried Following That of Fig. 6.

of the audion is that expressing the current flowing from filament to plate in terms of the potentials supplied to the grid. Fig. 9 expresses this relation graphically. Here we see that a moderate negative potential (10 volts) applied to the grid completely cuts off the current between filament and plate. As this negative grid charge is reduced to 0 the plate current rapidly increases. As the grid potential becomes positive this plate current continues to increase up to a point S, after which it rapidly approaches a saturation value, above which the plate current will not rise, regardless of how high is the positive potential applied to the grid. This curve was taken with a given fixed potential difference applied between filament and plate, and for a given filament temperature. This sample characteristic was taken from a "hard" audion, from which the gas has been sufficiently well exhausted to show no irregularity in its curve, due to ionization. It will be observed that over the straight-line portion of this curve, between points Q and S, when the grid potential varies a small but equal amount on right and left of zero, the amplitude of variation in the plate current is directly dependent on the variation of the applied grid potential. In other words, there will be over this range no distortion between the wave form of the incoming alternating potential impressed on the grid and that of the current fluctuations produced in the plate, or output, circuit. Obviously, therefore, the straight-line characteristic of the audion characteristic is the one to utilize in an audion amplifier, or repeater, whether for amplifying radio or voice-frequency currents. Consequently we find telephone engineers going to extreme lengths to so design their audions and circuits, and to so regulate the potentials applied to the grid, as to operate entirely within this straight-line characteristic. The result is a perfect reproduction of voice currents, but magnified to any extent desired by the use of two or more such amplifiers connected in cascade—from ten to twenty thousand times or more.

But when the audion is used as a simple detector of damped radio signals, where it is desired to obtain the maximum possible integrated effect from a train of incoming high-frequency waves upon the direct current in the plate circuit, it is desirable to operate at the lower, or upper, knee of this characteristic curve, for the reason already explained. Here we have taken advantage of the asymmetry of the curve, so that the sum of the decreases in the plate current as

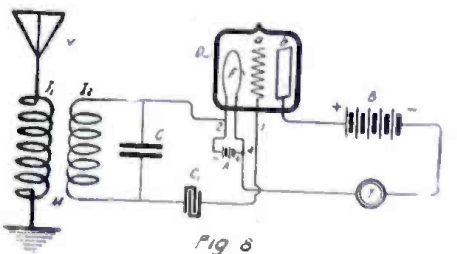

This Arrangement, Taken from a Patent File of January, 1907, Illustrates the Preferred Form of Element Arrangement.



the grid potential decrease, greatly out-values the sum of the increases in the plate current, when the grid potentials increase. This results in an integrated decrease in the current through the telephone receiver, which may represent much greater energy than that of the incoming wave-train.<sup>1</sup> It is thus that the audion can operate as a true relay device, possessing a sensitiveness far greater than that of the most perfect crystal rectifier, or of any valve. Consideration of the advantage of thus working on the asymmetric portion of the audion curve would lead us to expect an increase in sensitiveness as a detector of spark signals if this asymmetry be further emphasized by the introduction of a small amount of gas into the bulb, thus producing a very appreciable amount of ionization. Such has long been known to be a fact—no high vacuum audion today equals, as a radio detector, the "soft" bulbs which were in very general use a few years ago. The presence of such an amount of gas is usually evidenced by a blue haze seen around the anode when high potentials (say from 60 to 100 volts) are applied across plate and filament. Ionization phenomena always introduce certain irregularities in the operation of the audion and kinks or cusps in its characteristic curves—even where the gas pressure does not greatly exceed one-ten-thousandth of a millimeter of mercury.

Our knowledge of electrons is of comparatively recent date. In 1899 J. J. Thomson showed that negative electricity is given off from a heated carbon filament in the form of electrons having a mass of 1/1800 that of a hydrogen atom. These electrons may be considered as atoms of electricity. Richardson, in 1903, first applied the electron theory of metallic conduction to emission from heated conductors. He assumed that electrons are ordinarily held bound within the metal by an electric force at the surface, by a tension similar to the surface tension of liquids. But if the velocity of an electron be made sufficiently high, as by applied heat, it is able to overcome this surface force and escape. The number of electrons, therefore, which attain the necessary critical velocity to escape will increase very rapidly with the temperature. The laws are similar to those governing the increase in vapor tension of a liquid with increasing temperature. Richardson thus concluded that the electronic emission from an incandescent metal should increase according to a similar equation:

$$i = a \sqrt{T} e^{-\frac{k}{T}}$$

where  $i$  is the current per square centimetre at temperature  $T$ , and  $k$  is a constant dependent on the latent heat of evaporation of the electrons. But actual investigations of the Richardson law, notably by Dr. Langmuir, showed that as the heat of a cathode filament was increased the thermionic current increased first in accord with Richardson's equation, but that beyond a certain point further increase in temperature produced no further increase in thermionic current.

A family of saturation curves, each one corresponding to a certain applied fixed potential between cathode and anode, results, as shown in Fig. 10, where the first parts of the several curves combine to form a single curve following Richardson's law. These curves<sup>2</sup> show that the thermionic current does not continue to increase as expected, because the space surrounding the hot filament is capable of carrying only a certain current for a given potential difference. The explanation offered is that the electrons surrounding the filament soon set up a "space charge" which repels new elec-

trons escaping from the filament, causing some to return to the filament.

From a study of the curve family of Fig. 10, Langmuir has evolved a formula introducing the factor of plate potential, in the case of a filament coaxial with a cylindrical anode. Here the current in amperes

$$i = 14.65 \times 10^{-6} \frac{V^{\frac{3}{2}}}{r}$$

where  $r$  is the radius of the cylinder in centimetres. But extremely minute amounts of gas vitiate the correctness of this formula by neutralizing more or less the space charge.

Therefore for a power oscillator a certain definite amount of gas in the tube may prove a distinct advantage. The filament, if of tungsten, has a tendency to absorb gas, so that if a small amount only is left in the tube on exhaustion the audion shows a tendency to grow "harder" with use. A perfect vacuum is never attained; spectrum analysis shows traces of residual gases always present, even in the "hardest" of tubes.

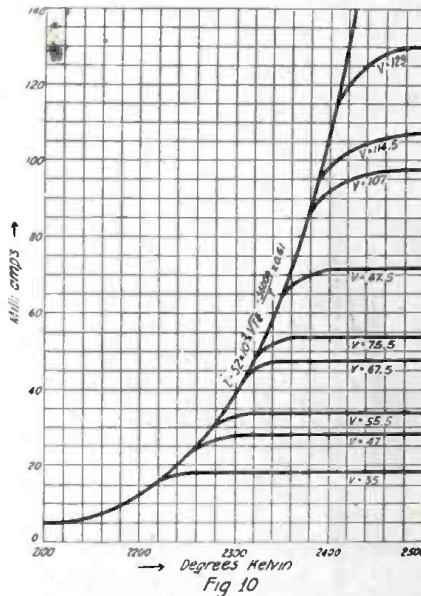

In This Case We Have a Family of Saturation Curves Each One Corresponding to a Certain Applied Fixed Potential Between Cathode and Anode.

If powerful bombardment of anode plates is long continued, gases will be thereby driven out from the metal and the tube rapidly become too soft to be of use—unless the gases have first been thoroly exhausted from all metal parts within the oscillion, by methods well known to the X-ray tube art. Moreover, too much positive ionization tends to disintegrate the cathode filament. With negligible ionization there appears to be no disintegration of the filament by the electronic discharge, and its life is as great as tho no electronic current flowed.

We have just seen, then, how the space charge surrounding a hot cathode can, in the absence of sufficient ionization, produce a saturated condition of the plate current. This current, or number of electrons emitted, is fixed by the cathode temperature for a given applied voltage, while the velocity of the electrons is dependent on this applied voltage. These electrons, escaping from the cathode and producing the choking space charge, can equally well charge up a third electrode located in this space to a considerable negative potential with respect to the cathode. It will be seen, therefore, how readily one can expect to control the plate current by means of relatively small potentials, positive or negative, applied to this control electrode, the grid. But the presence of the grid between cathode and anode so complicates the electric field distribution that a theoretical analysis of the relation between the plate current and the

plate voltage and the grid voltage (with respect to the filament) is too complicated to be of any practical use. Empirical formula for predetermining the characteristics of various types of audion have been evolved. These, unlike the greater mass of mathematical writings already flooding this new art, are actually proving of some real help to the tube engineer.

In a highly exhausted bulb the so-called "space charge" ordinarily acts to very quickly limit the thermionic current flowing from the hot cathode to the cold anode, but the present of positive ions partly neutralizes this space charge. Now if a small positive charge be applied to the grid the velocity of the electrons passing thru it is increased, and consequently they produce more ions by bombardment. Moreover, the number of electrons passing the grid is increased, which in turn again increases the ionization. If too much gas is present, permitting too large a plate current to flow, the relaying action of the audion disappears, because the grid charges are then unable to control the large ionic currents. This condition is usually evidenced by the visible blue glow. In the region between these two limits the audion may possess an extraordinary sensitiveness, as is usual with any condition of instability.

In the early days when audions were exhausted, like the ordinary incandescent lamp, by oil pumps merely, it was ordinarily impracticable to exhaust to such high vacua as to permit the use of more than 40 to 80 volts of B potential, without producing this excessive ionization. However, in 1912, when I first began to construct larger bulbs for large amplification of telephonic currents, it became apparent that the higher voltage necessary for producing the loud amplifications desired required higher and higher potentials, which obviously necessitated higher vacua, and better methods of exhaustion. It was then for the first time that I caused audion bulbs to be exhausted by X-ray tube methods, enabling me to apply several hundred volts of plate potential. So the perfecting of means for exhausting the bulb kept pace with the growing requirements for larger power to be handled. There was at no time in the evolution of the audion, from the original incandescent lamp vacuum to those high exhausts now necessary in the largest "power-tube," or oscillion, any definite demarkation in the degree of vacuum needed or obtained. The lamp-makers' and glassblowers' skill kept pace with the radio engineers' requirements of larger bulbs and greater amounts of energy handled.

In the earlier types of audion detector a stopping condenser in the grid lead was usually, but not always, employed. There were then sufficient ions in the bulb to ordinarily prevent the gradual accumulation on the thus insulated grid of a large negative charge, which would very rapidly completely cut off the plate-filament current. However, when heavy static discharges struck the receiving antenna it was frequently observed that the audion would be "paralyzed" for several seconds thereafter. We early learned how to discharge this residual negative accumulation on the grid, at first merely by putting the wetted fingers across the grid and filament terminals. This primitive "grid leak" was soon made in permanent form—for example, a wet string, and later a high-resistance graphite pencil mark. As the degree of vacuum of the bulb was increased the necessity for this grid leak became more urgent, and since 1913 it has been generally applied to all high vacuum tubes, when stopping condensers are used; whether the bulb be a detector, amplifier, or generator of alternating currents.

Part 1 of a paper read before the Section of Physics and Chemistry and the Philadelphia Section, American Institute of Electrical Engineers, January 15, 1920.

Part 2 of this interesting historical paper will be published in the November number of RADIO NEWS.

<sup>1</sup> Where a "C" battery is employed for keeping the grid always negative, the audion is operated on the lower knee of its characteristic curve.

<sup>2</sup> Due to Dr. Langmuir.



# Loud-Talking Reproducer for Radio and Telephone Signals

Full Working Details Are Given Herewith So That the Experimenter Can Build One of the Latest Type Loud Talking Reproducers for Radio or Telephone Reproducers

By H. WINFIELD SECOR

**T**HE instrument described herewith, when used in connection with a two or three step audio amplifier, will reproduce radio signals or regular telephone speech so that it can be heard all over the room and, in fact, over a distance of several hundred feet, providing it is carefully built and properly operated.

The mechanical details of this ultra-powerful loud-talker are quite simple and the parts required in building it are relatively few in number. Therefore, the clever radio and electrical experimenter should find little difficulty in building one of these instruments. For one thing, after the powerful electro-magnet has been built, or else obtained from the usual junk pile, as it would not have to be exactly like the one here shown, either in size or magnetic power, the builder may save himself a lot of trouble by using a good sized phonograph reproducer, or perhaps a watch case telephone receiver, or again, the diafram end of a large sized Bell telephone receiver which holds the diafram, and serves as a mounting and opening for the sound amplifying horn.

For general experimental work, any size diafram, of course, can be used; but in the commercial type instrument working on this principle the diafram has a free or vibrating diameter of 3½ inches, and it is recommended that it be made to have a free diameter between the supports of at least 3 inches for model shown here.

## BUILDING THE ELECTRO-MAGNET

The direct current electro-magnet shown in Fig. 1 has been designed especially to operate on storage battery current; but it can be wound with proportionately smaller wire, so as to be operated on 110 volt direct current where desired. The dimensions of the winding bobbins or spools are given in the drawing Fig. 1. The spool measures six inches between the bobbin cheeks, and the winding when finished measures approximately 2½ inches in diameter.

The core, as well as the pole-pieces and the yoke, are made of the best grade pro-

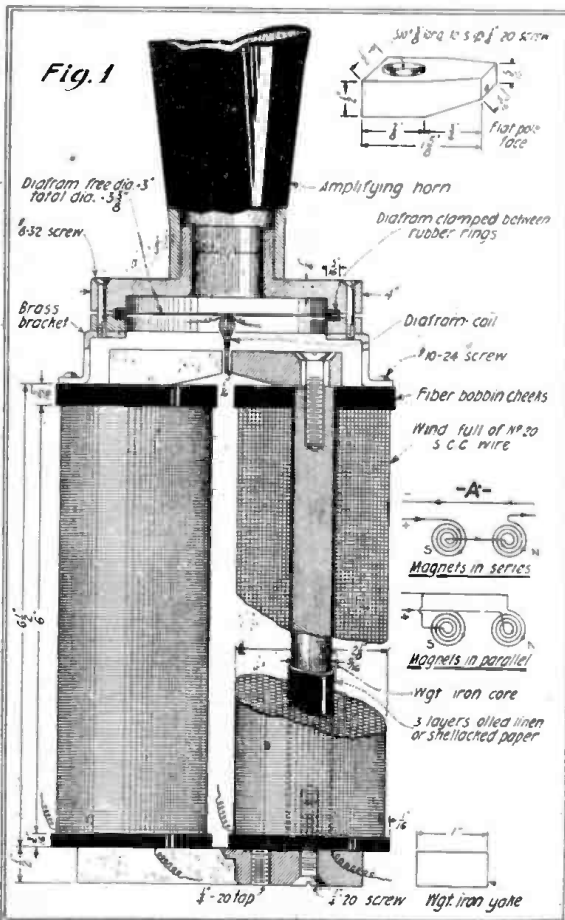

Complete Description of the Constructional Details of the Electro Magnets and Manner of Winding Them. Pole Pieces Are Also Described.

curable of soft wrought iron. It should be as soft as possible, so as not to retain any appreciable degree of residual magnetism. The wrought iron magnet cores can be cut from a piece of 9/16 inch diameter round bar stock and should have their ends faced off in the lathe, or else filed perfectly flat and true. The length of the core is 6½ inches; the lower ends of the bobbins are provided with 3/16 inch fibre cheeks, measuring 2¼ inches in diameter and tightly fitted on the core; while the two upper ends are to be provided with fibre cheeks 5/16 inches thick, about 2¼ inches in diameter.

Suitable holes should be drilled in the two lower bobbin ends thru which to pass the lead wires from the magnet windings. Before winding the spools the iron core should be carefully covered with about three layers of thin oiled linen or shellacked paper. Paraffined paper is also good. It is always the best policy in winding any type of electro-magnet never to rely on an inside lead comprised solely of a length of the fine wire of which the magnet is wound, and you will invariably find it the best policy to employ a piece of small stranded cable in every case, such as thin lamp cord.

The starting end of the winding can then be soldered to this stranded lead inside the spool end, and the joint covered with a piece of tape or silk. Each of these spools will require approximately three pounds of No. 20 single cotton covered copper magnet

wire. The two spools should be wound evenly in layers on a lathe if possible, or else a small winding rig can be fixed up for the purpose. When the spools have been wound full the outside layer should be covered with a piece of heavy cloth or string, shellacked and glued in place to protect them.

The wrought iron yoke connecting the bases of the magnetizing coils and core is made of 1 inch by ½ inch stock, about 4 inches long; the yoke is preferably drilled to accommodate the two ¼ inch No. 20 thread machine screws, for which the cores have been tapt at both ends, and also the yoke is drilled and tapt for the same sized thread to accommodate two similar size screws for the purpose of mounting it rigidly on base.

The method of connecting up the two electro-magnet spools is shown at Fig. 1A, both for series and also for parallel connections, more about which will be said later.

The wrought iron pole-pieces are to be made according to the dimensions given at Fig. 1, and should have slots drilled and filed in them with a rat-tail file, so that when the complete electro-magnet is assembled the two pole-faces can be approached to within 1/16 inch of each other, or, in fact, a little closer.

## CURRENT CONSUMED BY ELECTRO-MAGNET

The electro-magnet as described was especially calculated for operating on battery potential such as storage battery current. The resistance of each spool or coil will be about 12½ ohms or 25 ohms for the two coils when connected in series. If you have 24 volts available, say from dry or storage batteries, or else from a dynamo, then the current will be E divided by R, or 24 volts divided by 25 ohms, which gives .94 ampere. The watts here consumed will be about 22½.

If only 12 volts D. C. is available, then the two coils may be connected in parallel and the current will then be twice that at 24 volts potential, or 1.88 amperes. The joint resistance of the two coils connected (Continued on page 253)

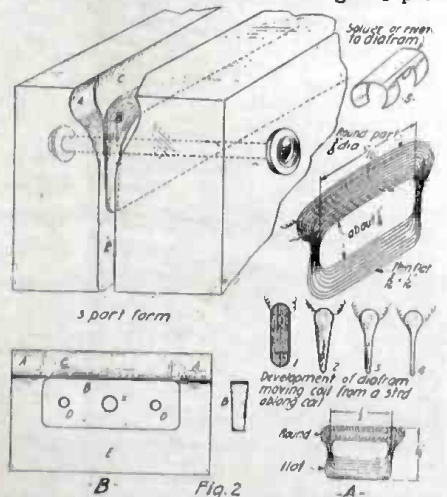

Construction of the Moving Diafram and Method of Winding It.

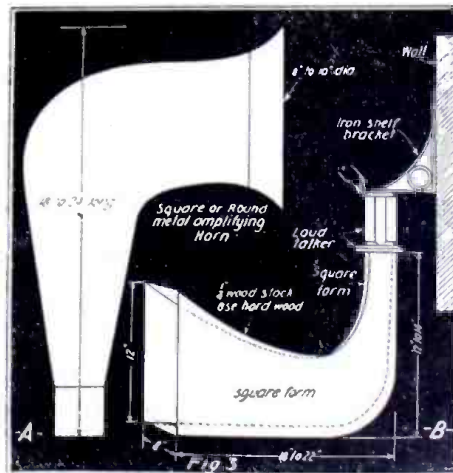

Two Forms of Sound Amplifying Horns Which May Be of Metal or Wood.



# Improved Vacuum Tube Circuits for Short Wave Communication

A V. T. Transmitting and Receiving Circuit Suitably Adapted for Amateur Work

By THOMAS BROWN

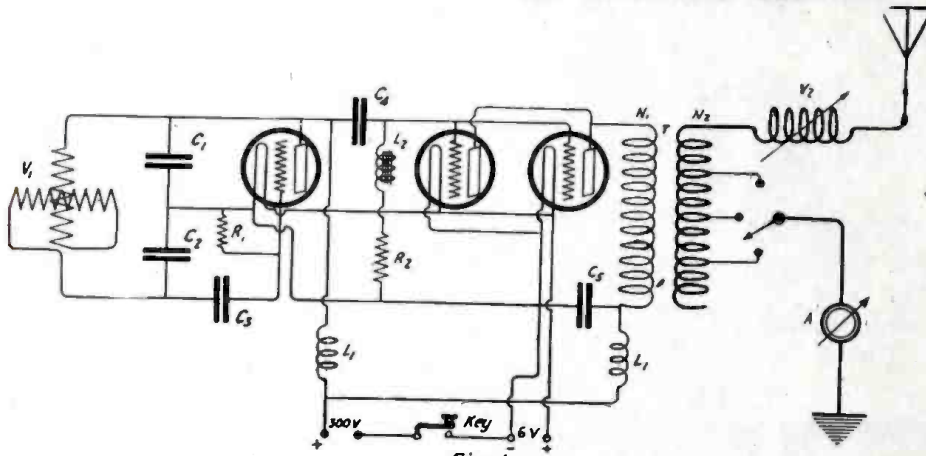

Diagram of the Improved Vacuum Tube Transmitting Circuits Described Here. There Are Two Distinct Sets of Tubes. The First, Which Consists of One Tube, is That Shown to the Extreme Left, While the Second, Which Consists of Two Tubes, is That Shown to the Extreme Right. The First is Used as an Oscillator and the Second as an Amplifier.

**EDITOR'S NOTE:** Here indeed are two unique vacuum circuits, one of which is designed for amateur C. W. transmission, while the other is suitable for reception. Mr. Brown is to be complimented upon his excellent contribution to amateur radio. Incidentally it is suggested that our readers carefully read and analyze what he has to say concerning this most important of radio subjects—that of continuous wave radio telegraphy. Judging from present indications, this method of transmission is destined to shortly take the place of both spark and arc. Amateurs would do well to confine part of their attention to experimentation along these lines.

**N**O doubt most experimenters who have attempted to carry on continuous wave telegraphy with vacuum tube transmitters and the heterodyne receiver at short wavelengths have found that it is extremely difficult to obtain really satisfactory communication owing to variations in the tone of the beat note. Movements of the operator's body near the apparatus and swaying of the antenna or lead-in in the wind cause slight changes in the capacity of the different circuits which are nevertheless sufficient, at wavelengths less than 200 meters, to often cause the beat note to change beyond the limit of audibility. Part of the message is thus lost.

It is the purpose of the present article to describe circuits which overcome the above difficulty. Both the transmitting and receiving circuits are involved. At the transmitter it is desirable to so arrange the circuits that the antenna in no way affects the frequency of the system. The writer has not seen any circuits published for amateur use where this is done. All of the usual circuits show the antenna as part of the oscillatory system and any change in capacity of the antenna therefore causes a change in the radiated frequency with loss of beat note at the distant receiver. In addition to entirely removing the antenna from the oscillatory circuits it is also important to properly shield those circuits so that the effective values of their elements determining the frequency shall not be altered by changing the location of the set or by movements of the operator or other persons in its neighborhood. At the receiver the swaying of the antenna or lead-in

does not usually affect the beat note because of the extremely loose coupling commonly and properly employed for sustained wave reception and the ensuing independence of antenna from the tuned oscillating secondary circuit. The latter must, however, be properly arranged and adequately shielded to immunize it from stray capacity effects which will cause changes in tuning.

## TRANSMITTER.

The transmitter to be described is shown in Fig. 1. It will be seen that there are two distinct sets of tubes, (1) used as an oscillator, and (2) used as an amplifier. In the figure the oscillator is shown as comprising a single tube while two tubes in parallel are used in the amplifier. This disposition and number of tubes is by no means necessary, however. The arrangement in any given case will depend upon the power it is desired to develop. One tube may be used as an oscillator and one as amplifier or several may be used in parallel as amplifiers and will multiply the output accordingly. It will be evident from the diagram that the functions of the oscillating tube (1) are first, to generate oscillations whose frequency to all intents and purposes is fixed by the values of inductance  $V_1$  and capacities  $C_1$  and  $C_2$ , and second, to excite the grid or input circuit of the amplifier tubes (2) with radio oscillations of this fixed frequency. A certain amount of oscillatory power is absorbed in the grid circuit of the amplifier and this of course increases with the number of amplifier tubes. With the type of transmitting tube usually supplied to the amateur it will be found that not more than four amplifier tubes can be effectively driven by one oscillator tube.

No attempt will here be made to give exact data for the construction of the various circuit elements because these will depend upon the number of tubes used and upon the antenna and range of wavelengths to be covered. It is, however, desired to present such theory regarding the operation of the several circuits as to enable anyone at all familiar with vacuum tube apparatus to design the various constituent elements.

Referring to Fig. 1, the oscillator circuit (1) is of the usual capacity coupled type.  $C_1$  should be about twice as large as  $C_2$  and for wavelengths in the neighborhood

of 150 meters these condensers may conveniently have capacities of 1500 and 700 micro-microfarads respectively. The grid leak resistance  $R_1$  may be of the order of 10,000 ohms and blocking condenser  $C_3$  2000 m.m.f. as usual. The input or grid-filament circuit of the amplifier is connected across the plate condenser  $C_4$  of the oscillating circuit, the oscillating voltage developed across this condenser serving to drive the amplifier. Condenser  $C_5$  prevents the high (d.c.) positive voltage supply to the plate of the oscillator tube from getting to the grid of the amplifier, and with the leak resistance  $R_2$  gives the amplifier the proper negative grid bias. One of the functions of  $C_4$  is obviously to act as a coupling medium between the oscillator and amplifier. If it is made very small its impedance will be high and the oscillating voltage impressed on the amplifier will be small. More powerful excitation is obtained as  $C_4$  is increased. For two amplifier tubes of the usual amateur type and wavelengths of the order of 150 meters  $C_4$  may conveniently have a capacity of 2000 m.m.f.  $R_2$  may be in the neighborhood of 5,000 ohms. The choke  $L_2$  may be conveniently used to prevent the passage of radio frequency currents through  $R_2$ .

## THE RADIO FREQUENCY OUTPUT TRANSFORMER.

The output of the amplifier is passed to the antenna through transformer T. The design of this transformer is very important and differs materially from that of the usual radio oscillation transformer. This transformer is closely coupled, that is, its primary and secondary windings are so disposed relative to one another as to reduce magnetic leakage to a minimum. It has even been found desirable under certain conditions in circuits of this type to make this transformer of the closed iron core type.

When this transformer is properly designed the operation of the circuits is as follows. The wavelength which it is desired to radiate is set by means of variometer  $V_1$ , the oscillating circuit  $V_1$ ,  $C_1$ ,  $C_2$ , having been previously calibrated. The antenna variometer  $V_2$  is then adjusted until the antenna current is maximum. Before tuning the antenna, the plate current supply to the amplifier tubes will be very small if transformer T has been properly built. If the transformer has not been correctly designed the plate current with the antenna detuned may be very large and endanger the tubes. When the antenna is tuned to the frequency of the master oscillator (1) the tube plate current should increase to its maximum value.

The load on the amplifier tubes is the antenna, introduced into the output or plate circuit of these tubes thru the trans-

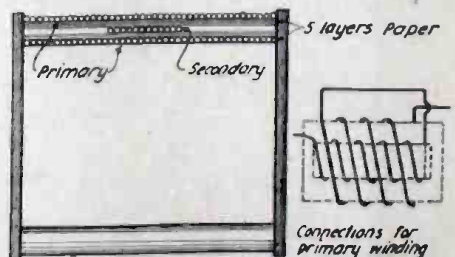

Fig. 2

Approved Construction Layout for the Radio Frequency Output Transformer



former T. When the antenna is tuned it acts like a resistance and the load on the tubes is therefore resistive only. When the antenna is detuned it acts virtually as though opened and the load on the tubes is only the inductance of the transformer primary. This primary inductance disappears when the antenna is tuned and current flows therein, for then the antenna current at every instant flows in such a direction and with such amplitude that the magnetic field produced by it in the transformer exactly opposes the magnetic field produced by the primary current.

In order to protect the tubes from excessive plate current when the antenna is detuned, it is necessary to design the primary winding of the transformer with sufficient inductance to choke down the current. As explained, this inductance is neutralized when the antenna is brought in tune and the load then becomes practically pure resistance. When two or three amplifier tubes are used at 150 meters or thereabouts an inductance of the order of a millihenry will be found sufficient to hold the plate current to safe values provided care is exercised in the winding so as to reduce its self capacity to a minimum.

As is well known, maximum output is obtained from any electrical generator when the impedance of the load it supplies is made equal to its own internal impedance. In the present case our generator is the vacuum tube amplifier with internal impedance equal to the resistance between plate and filament. This may be of the order of 5,000 ohms for a single tube and therefore one-half of this value for two tubes in parallel, one-third for three tubes, etc. For maximum output the load must be made equal to this. Obviously a transformer having a one to one turn ratio would not be suitable because an antenna never has a resistance of the order of thousands of ohms. A more likely value for the antenna resistance would be 20 ohms and a one to one ratio transformer for such an antenna would only introduce a load of 20 ohms into the plate circuit of the vacuum tubes. By changing the ratio of primary to secondary turns, however, the effective resistance on the primary side can be made anything desired. It can easily be shown that if  $R_a$  is the load resistance on the secondary of a closely coupled transformer and  $N_1$  and  $N_2$  the number of primary and secondary turns respectively, the effective resistance on the primary side is

$$R_a = \left(\frac{N_1}{N_2}\right)^2 R_a$$

Thus, if our antenna resistance is 20 ohms and the combined internal tube resistance 2,000 ohms, we choose the ratio of primary to secondary turns in accordance with the above formula so that the 20-ohm antenna load shall be introduced into the trans-

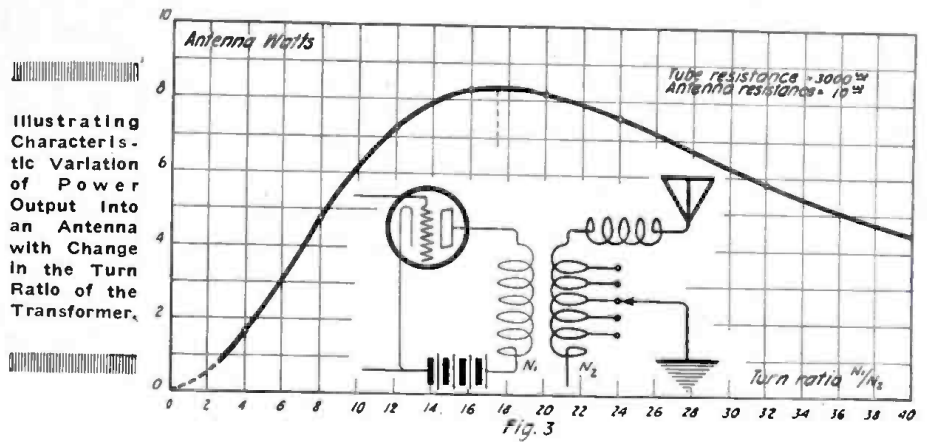

former primary circuit as 2,000 ohms.

$$2,000 = \left(\frac{N_1}{N_2}\right)^2 20$$

$$\left(\frac{N_1}{N_2}\right)^2 = 100$$

$$\frac{N_1}{N_2} = 10$$

In other words, the primary winding should have ten times as many turns as the secondary in this case in order to get maximum output.

If the set is apt to be used on any one of several antennas where the resistances will be different in each case or over a very wide range of wavelengths, in which case the antenna resistance may vary considerably, the secondary winding of T should be provided with taps brought out to a switch. By means of this switch the turn ratio  $N_1/N_2$  of the transformer can then be changed so as to match up the antenna and tube resistances for any given set of conditions and thus always get maximum output.

An approved construction for the transformer T is shown in Fig. 2.

In Fig. 1 it will be seen that the high voltage d. c. is supplied to the plates of oscillator and amplifier tubes thru choke coils  $L_1, L_2$ . These coils prevent the radio frequency currents passing into the battery circuits. Condenser  $C_3$  is a radio frequency by-pass for the high voltage supply.

Fig. 3 shows the characteristic variation of power output into an antenna with change in the turn ratio of the transformer. This curve was taken for an internal tube resistance of 3,000 ohms and an antenna resistance of 10 ohms. It will be seen that maximum antenna power is obtained when

$$\frac{N_1}{N_2} = 17.3, \text{ making the introduced load resistance equal to the tube resistance.}$$

$$\left(\frac{N_1}{N_2}\right)^2 R_a = (17.3)^2 \times 10 = 3,000 \text{ ohms.}$$

RECEIVER.

Fig. 4 shows improvements in receiving circuits for short wave working. The arrangement shown is for self-heterodyne reception with an audio frequency amplifier. If the amplifier is not used the telephone receivers are of course to be connected in the circuit in place of transformer T. The primary and secondary tuning condensers are covered with metal cases which should be grounded to the movable plates of the condensers. This effectually shields the condensers from the effects of the operator's hands and body.

The unit  $C_1, L_1, L_2, C_2, L_3, L_4$ , is a filter circuit. This circuit entirely isolates the radio frequency system from effects impressed at binding posts 1 and 2. In ordinary circuits this filter is not used and as a result it is a common experience to have a change in heat note caused by touching the metal part of the head telephones, or by removing these from the head, or rearranging the plate battery, or connecting in an amplifier, etc., etc. The use of this filter prevents all such effects, and to those who have never employed the arrangement the enormously increased steadiness of note in beat receiving will be a welcome surprise. For wavelengths from 75 to 200 meters the proper values for the capacities and inductances in this filter are as follows:

$$C_1 = 1,000 \text{ m.m.f.}$$

$$L_1 = 0.05 \text{ m.h.}$$

The dotted line in Fig. 2 shows the outline of the set box containing the radio circuits.

SUMMARY AND DISCUSSION.

Improvements in transmitting and receiving circuits for amateur use at short wavelengths have been described. The chief advantages of the use of these circuits are ease of operation and stability of beat note. This is secured in the transmitter chiefly by means of a new type circuit in which the antenna is entirely removed from the oscillating circuit, the oscillation frequency therefore being independent of changes in the antenna constants. At the receiving end improved beat note stability is obtained by the proper use of shielded condensers and of a special shielding filter circuit.

In the usual types of vacuum tube transmitting circuits the antenna system is made part of the oscillating circuit. The capacity of the antenna determines the frequency of oscillation or wavelength of the set. The performance of the circuits is also very materially affected by the resistance of the antenna, since this is directly in the oscillating

(Continued on page 251)

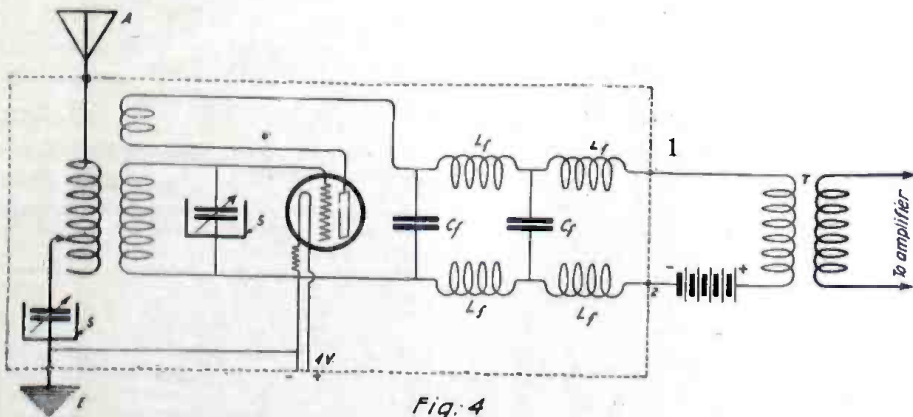

Fig. 4

Improved Hook-Up in Receiving Circuits Suitable for Short Wave Work. This Arrangement is Meant for Self-Heterodyne Reception in Connection with an Audio Frequency Amplifier.





# Important!—The Ground Switch

By EDWIN D. STRICKLAND

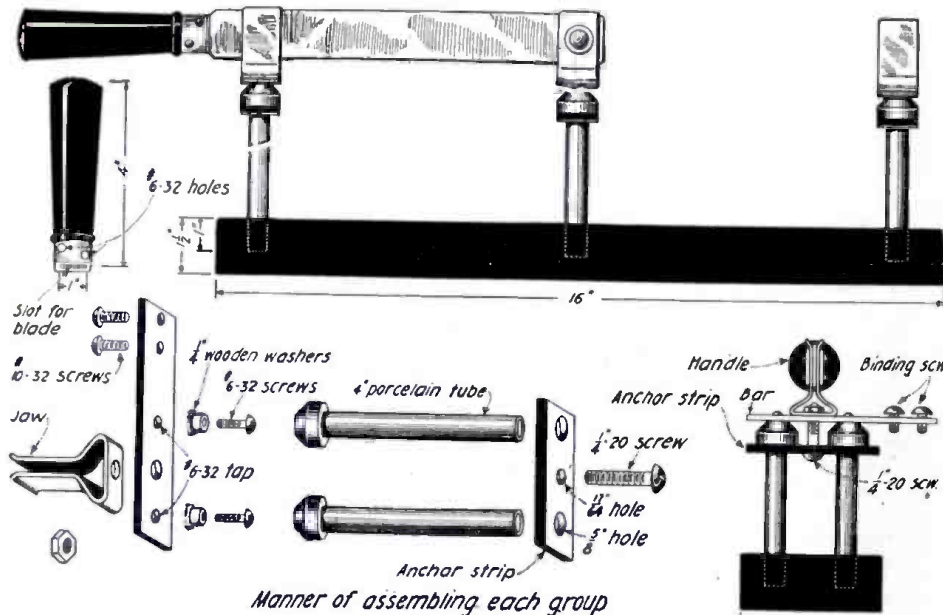

Complete Layout with Proper Dimensions of Metal and Wood Parts and Size of Screws of a Good Ground Switch.

**D**URING the hot summer months attention should be called to the Ground or Lightning switch of a radio installation. In order properly to protect the instruments and building on which the switch is placed from the enormously high voltage and current present when dealing with lightning, its construction must be heavy enough to safely carry said lightning; and its insulating qualities must be sufficient to hold the high voltage. Furthermore, if the insulation is poor, the efficiency is reduced; for a certain amount of energy, which would otherwise actuate the receiver, is dissipated thru the faulty insulation, before reaching the instruments.

The Ground switch described here was

constructed for approximately one dollar and a half. Its construction combines superior insulation, mechanical strength and ruggedness, heavy current carrying capacity, neat appearance, and comparatively low cost. A short description should enable the average amateur to readily construct this switch.

The base is 16"x3"x1½" in dimensions. Two 5/8" holes are bored 1" deep in the middle and near each end to admit the 4" porcelain tubes. The porcelain tubes should fit quite snugly into these holes. The anchor strips near the top of the porcelain tubes are 3"x1"x¼". The copper bars that carry the switch jaws and binding screws are 4"x1"x¼".

Assemble the three groups of tubes, anchor strips, bars, and jaws by inserting two porcelain tubes thru 5/8" holes in the anchor strips; the jaws are held in place by ¼" screws that pass thru the anchor strips and binding screw bars with a nut screwed on the upper end in the bottom of the jaws.

Note that two 10/32 screws are used for each connection. This greatly simplifies connecting, as, when stranded wire is used, half the strands may be secured by one screw, while the other half is fastened to the screw remaining.

In order to keep the bars from turning, ¼"x¼" washers, wooden or otherwise, are secured to the underside by 6/32 screws, threaded in holes that should be in alignment with those of the tubes.

The switch lever is copper, 9/16"x1"x3/8". The handle is made from a round stick, 4" long by 1" in diameter, flattened on one end and slotted for 1" to admit the lever. It is secured by two 6/32 screws and nuts and reinforced with wire. The tubes are glued in the holes in the base, which should fit quite tightly with strong glue after the assembling of each group.

100 ampere switch jaws, porcelain tubes, copper strips, and 18 screws are all that it is necessary to purchase. The base handle and anchor strips are of pine wood and are enameled black.

The assembly of the various items may be gleaned from the drawing. Of course, the positions of the connection screws and other constructional details may be altered to suit individual conditions; but if the general points of construction are followed, the amateur will have an addition to his station that should adequately protect him from lightning as well as maintain the efficiency of the station to the maximum. Every up-to-date amateur should be satisfied with nothing less.

*Editor's Note:* Mr. Strickland sent us a photograph of the switch described above but unfortunately it was too small to reproduce here. It was however, clear enough for us to see that the finished instrument presented a good appearance and was well made.

## A Finish for Your Cabinet

By J. B. LONDON

If the following instructions are followed closely when you finish your cabinet set it will look like a manufactured cabinet, just as would a fine piece of furniture. It will give you a hand-rubbed piano finish.

After you have constructed your cabinet, whether it be out of oak wood for an oak finish or out of birch or mahogany for a mahogany finish, scrape the surfaces with a steel scraper, or a piece of glass. Then sandpaper with a No. 1 or No. 2 sandpaper and finally sandpaper with a No. 0 or No. 00 sandpaper.

When you get your cabinet perfectly smooth give it one coat of any good pene-

trating wood stain (do not use varnish stain), employing the color you desire. Do not put the second coat on until the first coat is perfectly dry. Rub over cabinet very lightly with steel wool between coats. Put as many coats as is needed to give a light or dark color as desired. After the final coat of stain has dried thoroly give the cabinet a VERY THIN coat of orange or white shellac. When the shellac is dry again take a piece of steel wool and rub over the cabinet VERY LIGHTLY (being careful not to press too hard—thus cutting into the stain), just hard enough to take off part of gloss.

Now procure a good furniture varnish

and give the cabinet one coat, being careful not to let the varnish accumulate too thickly in any one place, which can be accomplished by brushing lengthwise first, then crosswise and back to lengthwise. You should use a camel's hair brush for varnishing but any other soft brush will do. After varnishing the cabinet put it in a closet or any other dust-proof place. Each coat of varnish should set in twenty-four to thirty-six hours if it is not disturbed. After the first coat is set rub very lightly with steel wool and apply the second and third coats, following the same directions given for the first coat.

(Continued on page 250)



# Switches for Radio Sets

By THOMAS W. BENSON

HAVING noted a number of radio sets employing various forms of switches mounted on the outside of the cabinet the following paragraphs were prepared to describe several forms of switches, easy of construc-

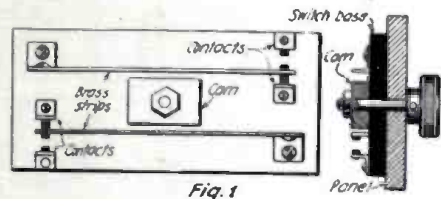

Fig. 1  
Simple Form of a Double-Pole, Double-Throw Switch Controlled by Rotary Knob.

tion, that can be mounted inside the cabinet.

In Fig. 1 is shown an exceedingly simple form of a double-pole, double-throw, switch control by a rotary knob. This switch has but two positions, having no off point. No dimensions are given for the reason that the design permits of wide variation without affecting the result. The switch consists of two brass strips arranged to move between stationary contacts. The fixt contacts are mounted on "L" shaped strips of brass fastened to the block by wood screws or bolts as desired. A rectangular block of insulating material mounted on a shaft serves to spread the strips when turned thru an angle of 90° thus moving the brass strips to the other pair of contacts.

The action is smooth, the switch retaining either position, despite excessive vibration. The use of silver or platinum points as illustrated will decrease the resistance of the contacts. The mode of connecting this switch is very evident but in adapting for any purpose it should be noted that one or the other set of contacts are always closed and hence it is unsuitable for certain purposes. This form of construction is limited to the two pole type.

Where a double-pole, double-throw switch having an off point is required the form of construction shown in Fig. 2 can be employed. Here we have two brass strips that play between fixt contacts. The

strips rest in the slot in the cam when in the off position but can be thrown to one side or the other by rotating the cam.

The side view shows how the switch is attached to the panel, it requiring but two holes, one to pass the knob spindle and the other to take a short bolt passing thru the metal strip attached to the insulating block. It will be evident that this switch can be extended to four, six or even eight poles without difficulty. When a greater number of circuits are controlled it is advisable to

throw switch in which all contacts are closed in the off position is necessary. A form of switch that will accomplish this is shown in Fig. 3. In this case the center stud is stationary, two sets of brass strips, the contacts on which are normally in con-

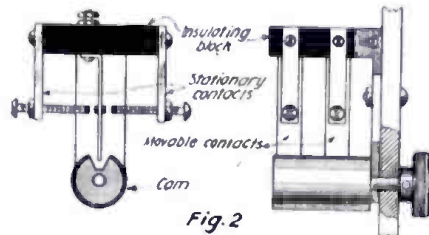

Fig. 2  
In This Case Two Brass Strips Play Between Fixt Contacts.

tact with the studs, are raised by rotating the cam. The construction is similar to that shown in Fig. 2, and more contacts may be added if desired; an end support for the cam will also be required with this switch.

By a slight change in construction the last switch described can also be made with an off point where all contacts are open. This modification is shown in Fig. 4, where it will be seen that the contacts are open when the ends of the brass strips rest on the rounded sides of the cam. However, when the cam is rotated the strips will fall into the low spot and allow contact to be made.

The capacitive effect of these switches can be reduced somewhat by employing spring wire in place of strips. Certain changes in design will be necessary under this condition, chiefly the use of grooves in the cams to prevent side motion of the wires and the use of "V" shaped stationary contacts to receive the wires. It is well to bear in mind that the dielectric losses in bakelite are rather high. For this reason parts carrying radio frequency currents of opposite polarity or of appreciable phase displacement, should be mounted as far apart as possible in this material.

The arrangement of stops on the front of the panel is left to the constructor. The use of these switches will result in a panel that can easily be wiped clean, a necessity where high efficiency is desired.

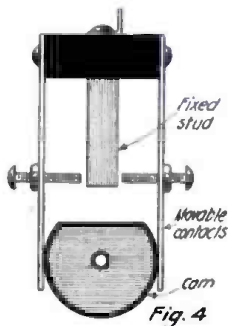

Fig. 4  
This Switch is a Modification of That Shown in Fig. 3.

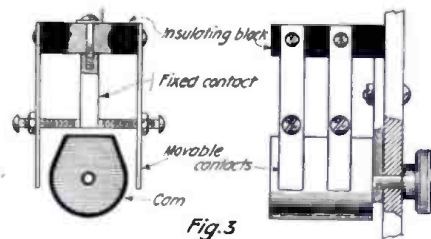

Fig. 3  
This Illustrates a Double-Pole, Double-Throw Switch Where It Is Necessary to Close All Contacts in the "Off" Position.

add another strip to support the free end of the cam shaft. In the two-pole type this extra strip is not required. Platinum points can also be used to improve the contact.

For some purposes a double-pole, double-

## Change-Over Switch for Receiving Cabinets

This change-over switch is very simple in design, easy to make and looks very neat when mounted upon a receiving cabinet.

No dimensions are given as the space in the cabinet will govern the size of the switch in most cases.

When the switch is on primary position the detector circuit is connected directly to the primary thus making the primary a single slide tuning coil, which is often a very effective and useful method of tuning. When on secondary position, the circuit is loose coupled as most receiving circuits are.

Amateurs will find that this switch is very useful for tuning in stations of unknown wavelengths as the primary switch can be set to its correct wavelength without having to explore with both primary and secondary on every wavelength before the desired station comes in loudest.

A rod of brass R constitutes the axle by which the switch is manipulated. A piece of hard rubber or fiber H is drilled to take

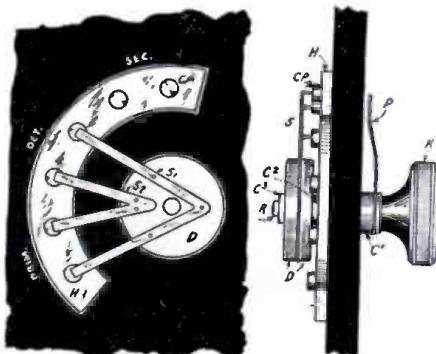

Here is a Well-Designed Change-Over Switch Suitable for the Panel of a Receiving Cabinet. The Sketch to the Left Shows the Manner in Which the Switch Will Look When Arranged in Back of the Panel, While the Sketch to the Right Shows a Side View of Both Front and Back Parts.

the contact points (CP) as shown. Two discs of fiber (DD) are drilled to fit over the rod R. On these discs are fixt the contact springs which are made from thin sheet brass. The free ends of the springs should be bent over so that they bear upon the contact points with slight pressure to insure a perfect connection.

Collars with set screws (C1 C2 C3) should be set on the rod to keep everything in place.

The front of the cabinet can be marked off as shown and a pointer should be attached to the knob K as shown.

From the present position of the switch blades it is easy to see that the detector and telephone circuit is connected for single coil tuning, while if the switch is moved to the secondary position, the circuit becomes a regular loose coupled one. The device is indeed a simple and effective one.

Contributed by RAYMOND LISTER.



# The Radio Man's Code

A Story of the Sea

By ERALD A. SCHIVO

**T**HE steamship Orion strove to make hadway toward Panama, thro the furious storm, raging continuously since nightfall. The enormous freighter, encumbered as she was, pitched and groaned heavily. The wind whistled and raced with inexorable violence thru the taut, stranded wires of the vessel's antenna.

The utter blackness which enveloped the ship portended the imminent peril of the turbulent sea. The massive bulk upon the ocean's infuriated waters, was as a child clutched in the jaws of a huge animal bent on destruction.

The distant droning of the engines served as a sedative to Ralph Goodwin, radio operator aboard the Orion. He was quite serene and listened intently to the detonations of the storm.

Although it was his period of off-watch, sleep was impossible in such weather and besides Goodwin had the receivers clamped to his ears. The intermittent signals from afar were generally feeble: "San Diego" he declared resentfully, "what's the matter with a few ships?"

Charles Goodwin, his brother, smiled complacently.

"My dear boy," he grinned, "would you value my position as purser?"

"Purser!" ejaculated the wireless man, "I wouldn't trade you for a fortune. No my sweet brother I'd as soon be a sailor."

At the mention of the word "sailor" Charles Goodwin expressed animosity.

"Sailor! the exasperated man cried. "Do you know, Ralph, what one of those contemptible scoundrels accomplished?"

Surprised, the brother answered: "No, you mean to tell me one of those insignificant individuals can anger you?"

The ringing of the ship's bell sounded the hour.

Charles Goodwin quickly arose. "There goes the hell for me—tell you about it some other time, a purser has duties that must be attended to, you know."

Goodwin gave little attention to his brother departing. The insistent transmitting of the powerful San Diego station was monotonous. Goodwin copied, but soon observed that it was government code, and desisted muttering in an incoherent manner.

A heavy and abrupt step sounded outside of the radio shack. Goodwin turned and recognized the habit and figure of the captain in the doorway.

"Are you in communication with San Diego?" asked the skipper, his voice tremulous, yet austere.

"Certainly," answered Goodwin expectantly, "we are only two hundred miles south."

"Take this message and send it immediately: 'To Mrs. Mary Smith, 18 State St., San Diego, Cal. Son washed overboard during storm. Will send letter explaining manner of death. Lobb, Commander.'"

After repeating the message the captain hurried from the radio room.

With the closing of the door, the dynamo began to purr, its volume rising to a windy

roar. Then there was a clicking of switches and the abrupt crackle and detonation of the spark penetrated to the commander, somehow thrilling him with its monotonous and insistent sharp piercing tone.

Three times Goodwin called the station at San Diego. Then the Orion's call followed, endlessly repeating its cry thru night-bound leagues of violent atmospherics and loneliness.

Fifteen minutes past: Goodwin successfully transmitted the message, thankful for the brief intermission of action.

The tumult raged relentlessly: it was not extraordinary that a man had been washed overboard into a whirling sea. He sympathized with the mother who would receive the disastrous news. "Washed overboard" he had transmitted. What did

"Go ahead," he instructed the *Hartford* operator.

He then stopt the whirling machine and turned to the receiving instruments. His trained fingers first adjusted the sensitive apparatus for any flaw in wavelength.

Goodwin copied the *Hartford* message with flushed face: *To Commander, Orion, Harry Smith picked up by this vessel while clinging to drift log. Requests arrest of Charles Goodwin for attempted murder. Declares shoved overboard. Johnson, Commander, S.S. Hartford.*"

Goodwin transmitted his O.K. and communication between the two steamers ceased.

Charles, his brother, attempted murder! Absurd! What possible motive could he have?

The written radiogram literally burned the fingers of the young operator. He must take the message to the captain. His brother would be arrested, perhaps subjected to irons; certainly imprisonment for the remainder of the voyage if not the former.

It was incredulous: his brother was incapable of committing such an act. There was positively no motive.

Perspiration began to cover Goodwin's entire body. He remembered the conversation with his brother prior to the captain's appearance. He admitted being quite angry with one of the sailors. Was attempted murder the result?

He stared at the message in his hand. It was inconceivable. His duty told him to deliver the radio-

gram; immediately brotherly affection told him to withhold the message and warn his brother.

What was he to do? An alternative presented itself that of warning his brother and thus give him a chance to skip at the next port and say he never received the message. But before a notary public he had sworn the oath of secrecy. Revealing to his brother the portending danger necessitated the breaking of the vow. . . .

Goodwin remained motionless, his hand retaining its grasp on the inevitable message. Conflicting emotions carried his convictions first one way and then the other. The matter was incontestable. He was a radio operator. *It was the code of the radio man to remain faithful to his position no matter what the circumstances.*

Despite the storm, he prepared to take the message to the captain. The opening of the door brought him face to face with the wrathful and sonorous storm. He was certain to find the skipper on the bridge. Gradually he struggled toward it. He could now faintly hear the stentorian voice of the second officer. It was not the commander who was then on the bridge.

Thru the turbulent night, clamorous with the agitation of the tumult, Goodwin labored, striving to reach the captain's cabin. After winding thru narrow passages he eventually arrived.

His dull knocking was almost immediate.

(Continued on page 240)



During the Fury of the Storm a Sailor Had Been Shoved Overboard.

the captain mean by that short sentence? Indubitably there must be something more; the commander, he was convinced had withheld something.

Goodwin extracted a cigarette from a fresh package. Abstractedly he lighted it and soon discharged a whirl of smoke toward the ceiling. He then contemplated over the message of the skipper. . . .

Synchronous with a buzzing in his receivers, a thunderous blast of wind caused the vessel to tremble from bow to stern, the trembling continuing for some moments. The operator was annoyed because of his inability to decipher the incoming signals. The low tone, he was certain, belonged to a ship station.

An unexpected calm awakened him from a short reverie. He tuned frantically to a three hundred meter wave length. Immediately the incoming signals were much louder.

"They are calling the *Orion!*" he murmured; waiting impatiently for the unknown call. Then after a moment: "The *Hartford!* What can he wish?"

Goodwin slammed the dynamo switch shut: he faced the apparatus eagerly. Soon the rotary gap settled into a resounding roar as he threw another switch and pressed the key. A little later his deft manipulation of the key was filling the little room with a deafening clamour. He called the *Hartford* signing the call of the *Orion*.



# Wireless Fakes and Fakers

Some Experiments Demonstrating the Credulity of Laymen and Radio Men Alike in the Old Days of Induction Coils, Spark Gaps and Electrolytic Detectors

By AUSTIN C. LESCARBOURA\*



"The Manager Arrived, Listened and Became Convinced."

Hong Kong, China, and the buzzer in the house next door may sound exactly alike in the telephones of a receiving set. To the layman there is absolutely no difference in the buzzes; and to the professional radio man there is only a difference in that one can be translated into words and sentences and messages, while the other is meaningless. But supposing that buzzer is connected in circuit with a telegraph key, and said key is manipulated by a skilled operator bent upon deception. Then, in nine cases out of ten, the average professional radio man may be deceived if the joke is handled with the requisite skill and good judgment.

And so we must admit that radio is a fertile field for the practical joker and faker alike. Looking back thru the relatively brief span of radio communication, we can recall many an amusing case of radio faking innocent enough in some cases, to be sure, but bent on raising large sums of money from unsuspecting investors on the other. At any rate, these incidents may make good reading for the newcomer as well as the old hand in amateur radio, so here goes with a choice collection gathered during my career of several years in radio manufacturing and operating:

It was back in the days of open-core transformers. In the stockroom of the company for which the writer worked were a large number of these transformers made after the pattern of the Rhumkorff coil. At that time the Marconi magnetic detector appeared to be about the one best bet in the line of detectors, and one could not resist the temptation of striving to emulate or even surpass Marconi's simple apparatus. So one day found the writer busily engaged in trying to make a magnetic detector from a 1½-kilowatt open-core transformer; a pair of telephones was connected with the secondary, while the primary winding was placed in an aerial circuit. The aerial consisted of four wires about fifty feet long, with a long lead-in some 75 feet long passing down thru a chimney all the way from the roof to the ground floor of the six-story building.

This experiment proved successful from the start. No sooner were the connections made when signals were plainly heard in the telephone receivers. These signals proved to have a preponderance of dashes, and were sent out, so it seemed, by a skilled and methodical operator. In those days the Morse code was in general use, and these slow and somewhat awkward signals were certainly out of the ordinary. But try as we would, neither my co-worker nor myself could read these signals. They were certainly not

in Morse or in Continental code. What could they be?

Mars! That came into our minds; for then, as now, someone was always hearing mysterious signals that must surely originate in our neighboring planet. The signals continued hour after hour, with occasionally a brief let-up of only a few minutes. Not wishing to lose this great opportunity of being the first to receive Martian signals, we phoned to the manager to come over immediately and verify our "startling" discovery.

The manager arrived, listened and be-

came convinced. Here we were with an open-core transformer, a pair of telephone receivers and a small antenna receiving signals from some unknown source, most likely Mars! Fame appeared to be just around the corner. We were about ready to announce the matter to the public, when we were rudely brought to our senses in the following wise:

A day later a lineman in the employ of a stock quotation ticker agency

happened to be working on the roof. We asked him what he was doing, and he informed us that he was running an additional pair of wires down the chimney. There were already several wires down that chimney, being used for stock ticker service in our building. In fact, he suggested that we might possibly be troubled with induction from these wires, and that our lead-in would perhaps be better if it ran along the outside of the building.

Troubled with induction! In truth, that was the very thing which we had mistaken for Martian signals. Here, at last, was the explanation of those mysterious dashes sent with such mathematical precision.

Well, that same lead-in served on many an occasion for a little practical joke. Those were the days of crude detectors and receiving sets, and a receiving range of one hundred miles was something not to be scoffed at. So one day we were listening to a visitor who told us he had invented about everything worth inventing in the radio line. He had invented a wonderfully sensitive detector; an interference preventer; a buzzer transmitter that worked like a charm for miles, and what not.

Not to be outdone by this would-be radio wizard, whose achievements were mostly of a nebulous character, we decided to do a little wizardry of our own. We invited this second Marconi to call on the following day, when we would take great pleasure in showing him our super-sensitive, extra-long range receiving set—something which was to be kept absolutely secret for fear some foreign government or company might learn its details and appropriate the fundamental ideas involved.

A plain box, containing a simple galena detector and connected with a pair of tele-

(Continued on page 234)



"Our Wizard Friend Was Amazed. He Had Never Heard of Anything Like This Set Before."

\* Managing Editor Scientific American.





# NEW RADIO PATENTS

## Electrical Oscillation Generator.

(No. 1,294,326, issued to Joseph Bethenod.)  
 This invention relates to a new arrangement enabling the power and the stability of generators of the preceding type to be increased. The diagram gives by way of example an arrangement enabling the invention to be put into practise.

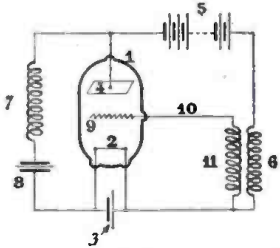

The generator is represented by the vacuumized bulb or receptacle containing a filament heated by a source of current and an anode which may consist either of a plate (coated, if desired with alkaline oxides) or of a mass of mercury or of amalgam.

Between the anode and the cathode is applied the potential difference of a suitable source branched in series with an inductance.

Finally, across the terminals of the electrodes the oscillating circuit is shunted.

Up to this point we find the ordinary connection of the singing arc. A supplementary electrode is added to the generator, which may consist of a metallic grid, and this electrode is connected to the filament by means of a circuit comprising an inductance coupled with the inductance of the feed circuit.

In the diagram it has been assumed that this coupling is due to a mutual induction between the windings, but of course this coupling could be effected in any other known manner.

Experience proves that by virtue of the presence of the electrode and of the circuit coupled inductively with the feed circuit a substantial reinforcement of the oscillations produced in the oscillating circuits is obtained.

## Wireless Transmission of Speech.

(No. 1,341,232. Issued to Carl C. Hanson.)

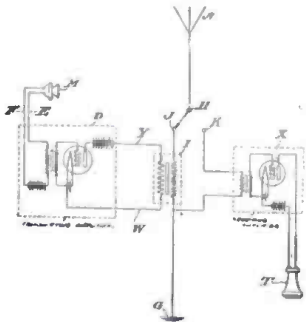

This invention relates to the transmission of articulate speech thru natural media, without connecting wires or other conducting members between the transmitting and receiving stations. It differs radically from the well known radio systems in that it employs only waves at audio, or voice-frequency, rather than waves of radio frequency. This distinction between audio or voice-frequency and radio frequency is now well recognized

by radio engineers, and others skilled in the electric arts and is clearly pointed out in the specification forming part of my prior United States Patent No. 1,315,197, dated September 2d, 1919.

Said prior patent describes and claims certain improvements in a wireless audio frequency receiving station, in which the essential element is a vacuum tube relay for amplifying the audio frequency energy. This invention has made practical the Edison and Dolbear systems of wireless communication in that it rendered possible, for the first time, the maintenance of reliable communication over distances heretofore known to be impossible by use of said systems.

The present invention relates, primarily, to certain improvements in the transmitting circuits employed in systems of the character above referred to, and is based upon the discovery that if a vacuum tube relay, of sufficiently high power, is inserted in the transmitting circuit it will deliver to the antenna circuit voice-frequency energy of such augmented strength as to materially increase the distance over which reliable telephonic communication may be maintained.

At the transmitting station I employ a transformer, having in its primary circuit an amplifier the input of which is voice controlled thru the instrumentality of a telephone transmitter. The secondary terminals of the transformer are connected to an antenna circuit.

At the receiving station there may be an amplifier and telephone receiver connected to said amplifier, the input terminals of this amplifier being connected to the antenna and antenna circuit.

The annexed drawing illustrates my invention diagrammatically. In said drawing telephone transmitter M is shown as connected to the input terminals E and F of the transmitting amplifier D. The feeble voice currents controlled by the telephone transmitter M are amplified many hundreds of times by the amplifier D. This amplified current is conducted to the primary of the transformer I from the terminals Y and W of the transmitting amplifier D. The secondary terminals of the transformer I are connected to an antenna circuit A-G. The switch H is used to connect either the transmitting or receiving apparatus to the antenna circuit. The receiving apparatus consists of an amplifier X and telephone receiver T. The input of the amplifier is connected to the antenna circuit. The telephone receiver T is actuated by varying currents received and amplified by X. The amplifier X may consist of, for example, the well known De Forest audion amplifier. The transmitting amplifier D may be of the high power type, using the Plotron tube as developed in the research laboratory of the General Electric Company at Schenectady, New York.

When switch H is placed on point J the transmitting apparatus is connected to the antenna circuit A. When switch H is placed on K the receiving apparatus is connected to the antenna circuit.

The use of an amplifier at the receiving station where oscillations of only low frequency are employed at the transmitting station is, I believe, a new and useful improvement in such a system of speech transmission.

The use at a transmitting station, of a voice controlled amplifier, of the type employing Plotron tubes, controlling the current flow in the primary circuit of a transformer, the secondary terminals being connected to the earth and antenna and thereby producing only low frequency electro-static fields, is a very important feature of my invention.

## System of Teledynamic Control.

No. 1,319,678, issued to John Hays Hammond, Jr.)

This invention relates to systems for controlling and operating mechanisms from a distance, and relates more particularly to systems in which pneumatic or hydraulic machinery for operating the steering gear and engines of torpedoes and other vessels and the like, is controlled by radiant energy transmitted from a distant station.

The accompanying drawing shows, in diagrammatic form, a receiving station on my system, which may be located on a torpedo or other vessel. It is to be understood that there is a corresponding transmitting station, capable of sending out electric waves of several predetermined lengths, said waves having several predetermined frequencies of amplitude variation or several predetermined group frequencies.

In the drawing, A is a receiving antenna, connected to earth at E through the inductance coils L<sup>1</sup> and L<sup>2</sup>.

Oscillation circuit L<sup>3</sup> C, comprising the inductance coil L<sup>3</sup> and the variable condenser C, is inductively coupled to the antenna circuit by means of the coils L<sup>1</sup> and L<sup>2</sup>, and is tuned to one of the wave lengths of the transmitting station. Oscillation circuit L<sup>3</sup> C, by means of the stopping condenser D and the rectifier R, transmits unidirectional current impulses to the coil L<sup>4</sup>, said current impulses having a frequency corresponding to one of the wave amplitude variation frequencies or to one of the wave-group frequencies of the transmitting station. Oscillation circuit L<sup>4</sup> C<sup>1</sup> comprising the inductance coil L<sup>4</sup> and the variable condenser C<sup>1</sup>, is tuned to this same frequency of wave amplitude variation or wave group, and is inductively coupled to coil L<sup>4</sup> by means of coil L<sup>3</sup>. By means of stopping condenser D<sup>1</sup> and rectifier R<sup>1</sup>, the oscillation circuit L<sup>4</sup> C<sup>1</sup> supplies unidirectional current impulses to relay F. When relay F is actuated, it causes electromagnet M to be energized by means of the battery B, and the core or plunger N is attracted.

Under the control of plunger N are the ports K and J, which open and close pipes T and V, respectively. Pipe T leads from the tank or reservoir C to the cylinder O, and pipe V is an exhaust pipe from cylinder O. Tank G contains compressed air or other suitable fluid under pressure. Piston P, in cylinder O, is connected, by means of piston rod Q, with the helm S, which is attached to the rudder of the torpedo or other vessel.

Oscillation circuit L<sup>4</sup> C<sup>1</sup>, comprising the inductance coil L<sup>4</sup> and the variable condenser C<sup>1</sup>, is inductively coupled to the antenna circuit by means of the coils L<sup>2</sup> and L<sup>4</sup>, and is tuned to a second wave length of the transmitting station different from the wave length of oscillation circuit L<sup>3</sup> C.

When a signal or impulse from the transmitting station ceases, the oscillation circuits, relay and electromagnet which have been active will be deenergized, the corresponding plunger and ports will return to their original positions and the pipes leading into and out of the cylinder O will be closed. In this way the movement of the helm and the course of the torpedo or other vessel can be controlled from the distant transmitting station. The arrangement of the apparatus here shown may be altered as found suitable in any given case, and I do not limit myself to the use of air as a working fluid, but may use any other suitable gas or any suitable liquid, nor do I limit myself to a steering device for torpedoes or other vessels, but may put my in-

vention to any use desired; and in general I do not confine myself to the particular apparatus and mechanisms here shown, but various changes and modifications, within

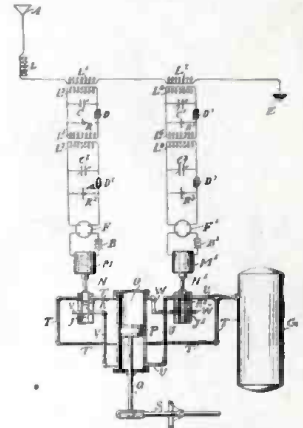

the capacity of those skilled in the art, may be made in the particular apparatus shown and described herein, without departing from the spirit of my invention provided the means set forth in the following claims be employed.

## Signaling Instrument

(No. 1,324,525, issued to Frederick Geogg Smith)

This invention relates to electrical apparatus for teaching the signaling systems commonly used commercially or in warfare, and my object is to devise apparatus which will give either visual signals, the tap signals of the Morse system, or the buzzing signals of the wireless apparatus. A further object is to arrange the apparatus so that it may be used for the actual transmission of signals by Hertzian waves over limited distances, and also so that the tapper or buzzer signals may be listened to telephonically.

My invention consists in the novel arrangement of the apparatus as illustrated in the accompanying drawing, which is a diagrammatical view of the apparatus.

In this drawing I is an electric circuit provided with a key 2, by means of which it may be closed or opened. Connected with this circuit is the circuit 3 of the lamp or visual signal device 4. 5 is the circuit of the buzzer, of which 6 is the winding. The circuits 3 and 5 are each connected with the cir-

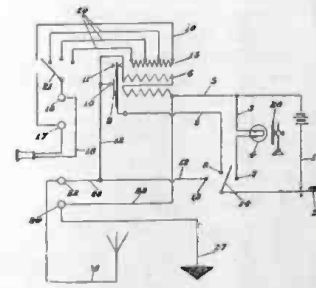

cuit 1 and with switch contacts 7 and 8. The buzzer is of ordinary construction, the circuit being ordinarily made or broken between the vibrator 9 and the vibrator post 10. The vibrator will vibrate between the stops 11.



# RADIO DIGEST

## STATIC PERFORMANCE TEST BY THE BUREAU OF STANDARDS AND THE A. R. R. L.

Some excellent data concerning static conditions during June and July, 1920, has been prepared by Mr. S. Kruse, Assistant Electrical Engineer of the Bureau of Standards. Among these interesting performance records is gleaned the following:

The transmitting and recording stations of the recent fading test system were chosen by the Operating Department of the A.R.R.L. with regard to their geographical location and also their known past performance. All of the calls appearing in the system are those of well known stations. In addition to the fading data obtained, which will be discussed in a later paper, there has been obtained considerable information as to the performance of this group of stations, admittedly of our best.

A caution is in order; much of the reception here discussed is not commercial communication, nor even relay communication. Many very good curves were obtained through atmospheric conditions which made it all but impossible to distinguish the letters which were being sent. Under such conditions the exchange of messages would have been impossible; in fact it is very likely that if the test had not been sent at a fairly exact time the station could not have been identified.

It is not well, then, to conclude that the same group of stations could have handled traffic through the very adverse weather in which the tests were run.

They did, however, obtain fading test curves consistently during a season of the year that has been regarded as making all short-wave work impossible, and did this over an average distance of 400 miles at 250 meters wave length with the existing transmitters and receivers. There was also a fairly large amount of conversation between the sending stations in the intervals between tests.

During the winter the Mississippi Valley presents ideal transmission conditions, great ranges being covered by low-powered stations—not occasionally, late at night, but consistently, day after day from September to April. Five hundred mile communication between  $\frac{1}{2}$  KW. sets is regarded as a matter of course and attracts little attention. That is about the distance from Boston to Richmond.

In the summer, conditions are violently different. Ranges decrease tremendously; often it is not possible for good one kilowatt stations 70 miles apart to communicate in daylight. And with nightfall comes QRN of a kind unknown on this coast.

It is impossible to keep a crystal in adjustment during the particularly bad evenings, while the uproar in the receivers is such that receiving becomes impossible unless signals are very loud.

I have been much surprised to find that at both Washington and New York, local lighting generally fails to produce disturbances of a violence equal to that of these regular summer evenings statics which are quite apart from storms. Q. S. T. for September.

## "POZ" OR THE NAUEN RADIO STATION

Herr W. Dornig gives some rather detailed information in the *Elektrotechnische Zeitschrift* of Dec. 25, 1919, concerning the apparatus in use at Nauen Radio. We are informed that there are two aeriels the larger a T aerial over 2 km. long with a capacity of 30,000 cm. and the smaller a triangular aerial of 15,000 cm. The former is supplied from the 400-KW. high-frequency machine and the latter from the 100-KW. quenched spark set. The 7-ton cast steel inductor of 1.65 metre diameter

runs at 1,500 r.p.m. and having 240 teeth carries a frequency of 6,000. The rotor carries two ventilators and water-cooling tubes run through the armature stampings behind the winding tunnels. The output is 1,200 amperes at 450 volts. This passes through a step-up transformer and then through two or three frequency-doubling transformers in cascade. The Morse key causes a relay to short-circuit a resistance inserted between the step-up transformer and the first doubler. A somewhat detailed description is given of the 400-KW. frequency-doubler for  $f = 12,000/24,000$ . The stampings are 0.07 mm. thick but only weigh 26 kg., whilst the weight of copper is only 20 kg. Two such transformers constitute the doubler. They are oil immersed and also have forced oil circulation with external oil cooling. The motor input is 620 KW. on a long dash and 325 KW. when sending. The power supplied to the antenna is 410 KW.

## DESIGN AND USE OF LOOP ANTENNAE.

M. B. Sleeper in the current issue of *Every-day Engineering* discusses the problems in-

### Radio Articles in the October Issue of Science and Invention

(Formerly Electrical Experimenter.)

*Radio Transmission of Power*, By Samuel Cohen.

*Reporting the Yacht Race via Radio*, By Donald McNicol.

*Radio Telephony Across the Ocean*,—A Marconi Experiment.

*Simplest Long Wave Receiver—*

*Full Details for Building a Simple Oscillating Audion Set with Single Tube, Suitable for Receiving of Wave Lengths up to 25,000 meters.* By Elliott A. White, Formerly Instructor in Radio, Air Service School for Radio Mechanics, Carnegie Institute of Technology, Pittsburg.

*How to Become a Professional Radio Man. Part Two.* By Pierre H. Boucheron.

*Amateur Radio Laboratory "Prize Contest."*

involved in the design and operation at maximum efficiency of these very useful antennae. In this instructive article we find the following timely remarks:

A loop, or coil antenna, or, as the British call it, a frame aerial, is not merely a solenoid or pancake arrangement of wire. The loop has very definite characteristics, controlled by the mechanical dimensions, the frequency at which it is used, and the circuits connected to it. Experimenters may know that these things are true, but few understand the process of actually designing a loop, or how to use it.

In the first place, let us see for what purposes a loop can be used. Below are the most common ones:

1. Short-distance reception.
2. Long distance reception.
3. Direction finding.
4. Directional transmission.

1. A properly designed loop is good for short-distance reception, particularly on 200 meters, for, as will be shown later, the efficiency is higher at short wavelengths. This type of work calls for a small loop, 2 or 3 feet square, which can be mounted over the operating table. An audion detector will permit reception over several miles from a spark coil.

In cities and harbors a great deal of receiving can be done on a small loop from ships and 200-meter stations. The directional effect helps to reduce interference.

2. Long-distance reception requires a multi-stage amplifier or a very large loop, 10 to 15 feet square. If possible, a loop should be set up indoors, as moisture and dust tend to reduce the insulation between the turns. In general, a straight antenna of the single-wire type is much better because it is easier to erect and is more efficient. On the other hand, local interference, if not in the line of direction of the loop, is reduced.

3. Loops used as direction finders, like those for other purposes, must be designed for the wavelength range over which they are to operated.

4. For transmitting, the loop is not as good as a straight antenna because of its low resistance. However, it is well adapted to vacuum tube transmitters, and extremely interesting experiments, either in telegraphy or telephony, can be conducted with it. Spark coils have also been used in the loops, and quite successfully.

In the following paragraphs we shall consider the design factors which influence the inductance, natural period and resistance of a loop.

In actual practice it is found that a loop should not be operated at less than 1.5 to 2.0 times its natural wavelength.

### THE RECEPTION FACTOR

In experimenting with loops some measure of efficiency is necessary. This is called the reception factor, given by the expression

$$\text{Reception Factor} = \frac{NaL}{\lambda^2 R}$$

N = Number of turns on the loop,

a = Area enclosed by a turn,

L = Inductance of the loop,

$\lambda$  = Wavelength of the incoming signals.

and R = Effective resistance of the loop at  $\lambda$ .

To determine the efficiency of a loop over a range of wavelengths the reception factor is determined at a number of wavelengths and plotted against those wavelengths.

### THE WIRE TELEPHONE AND RADIO.

Announcement has been made that an agreement has gone into effect between the American Telephone and Telegraph Company and the General Electric Company, for the purpose of advancing the art of radio transmission and communication. The Telephone Company has purchased a minority interest in the Radio Corporation of America, and Mr. W. S. Gifford, vice-president of the former company has been made a director of the Radio Corporation.

This new development in the Communication world is of large significance. It may come as a surprise to some that the American Telephone and Telegraph Company discerns practical possibilities in radio telephony. The fact of the matter is, as early as the year 1915 the president of the company at that time—the late Theodore N. Vail—issued a formal statement outlining the company's relations with and obligations toward wireless communication, in which it was stated that: "As fast as conditions make it possible, or potential business makes present extensions of prospective value to the system and to the public, either directly or indirectly, the American Telephone and Telegraph Company will extend, enlarge and amplify its system in every way that scientific research and development make possible and social or business de-

(Continued on page 244)



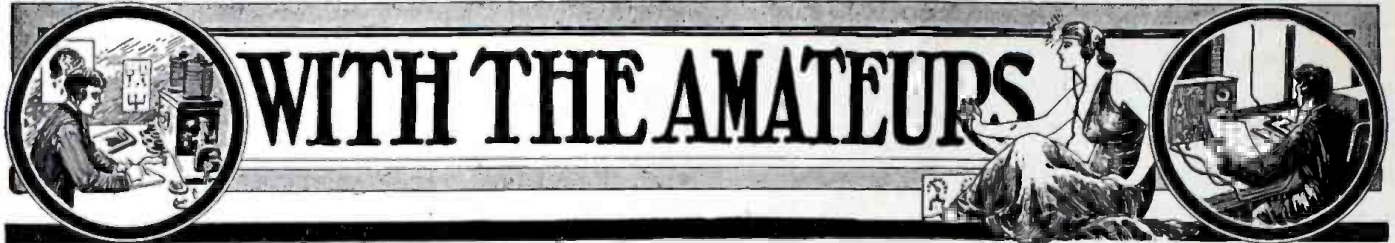

**T**HIS Department is open to all readers. It matters not whether subscribers or not. All photos are judged for best arrangement and efficiency of the apparatus, neatness of connections and general appearance. In order to increase the interest in this department, we make it a rule not to publish photographs of stations unaccompanied by a picture of the owner. We prefer dark photos to light ones. The prize winning pictures must be on prints not smaller than 5 x 7". We cannot reproduce pictures smaller than 3½ x 3¼". All pictures must bear name and address written in ink on the back. A letter of not less than 100 words giving full description of the station, aerial equipment, etc., must accompany the pictures.

**PRIZES:** One first monthly prize of \$5.00. All other pictures published will be paid for at the rate of \$2.00.

## The "Casey" Station at Savannah

By JAMES F. MAHER

**T**HIS station, as well as others in various parts of the U. S., has been established for the purpose of giving free training to all men who have seen service in the various military and naval establishments of the United States. It is not the purpose to confine this educational work to ex-service men, for others are also admitted to the class.

ute is regarded as necessary to qualify, as it is generally conceded that it takes a thirty-word man to handle twenty consistently and accurately. Great stress is laid on sending ability, for we say "anyone can learn to receive, but only a good operator can send," a truism that all old-timers will recognize. In short, when our men finish we want them to thoroly understand that

trols, wave changers, etc. It is the usual compact sending unit, and is very efficient both for actual working and demonstration. Then there is the usual assortment of leyden jars, transformers, spark gaps, oscillation transformers, and things for experiments aside. We have 110-220 D. C. and 110 A. C. at 60 cycles.

The undamp wave transmitter is the

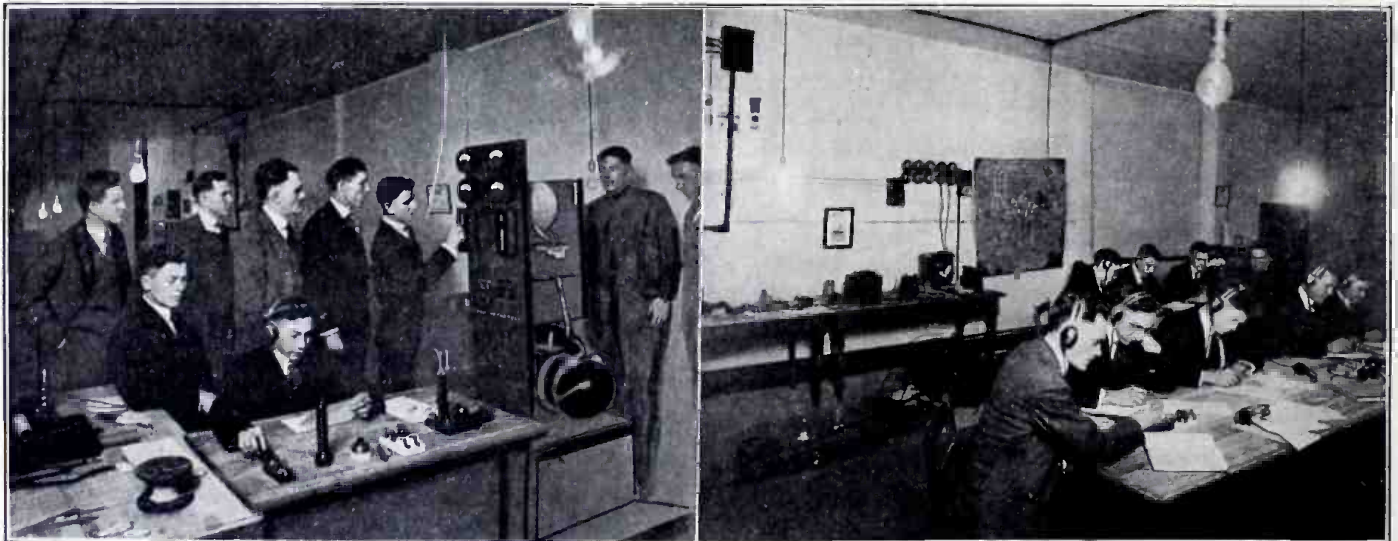

While the Student Seated in the Foreground is Sending a Message Others Are Observing the Behavior of the Panel Type Transmitter and Making Various Adjustments While Under Load. To the Right is Shown Instructor Maher Sending Code to Embryo Marconis.

The course for radio electricians goes over a period of six months, the first half of which is devoted entirely to purely electrical subjects, without any reference to radio whatsoever. Instruction is carried on with a complete electrical laboratory and apparatus actually used in commercial practice. Motors, dynamos, storage batteries, transformers, meters, starting devices, etc., for practical work; with theoretical work on magnets and magnetism, electromagnets, ohm's law, power measurement, measurement of resistance, magnetic field due to a current, the generator, the motor, inductance, capacity, electrochemistry, measuring instruments, alternating currents, reference being made to standard books on the subject.

While we do not have any radio during this period, we do have code practice for half the session of two hours. This code work is very thoro, the men being drilled in mixed number and letter groups, rarely any straight, connected matter, except toward the finish, when they may rush off for speed honors. Thirty words per min-

some poor chap at the other end is trying to copy everything they send, a matter surprisingly hard to make some realize.

Now comes the radio, and everyone now understands the phenomenon of induced current, or at any rate thinks he does, so that when everyone comes up for air in the early part of the second half of the course, all they can see are lines of force from Carnarvon, Lyons, Rome, Nauen, and nearer home, Annapolis, Tuckerton and old reliable, NAA, with the usual entertainment nightly from the Shipping Board "orchestras."

Audibility in Savannah, Ga., is really very good during all but the midsummer months, and static is not what one would expect, so that reception here is unusually fine for students. We rather discourage the use of amplification because of the bad effect of getting used to loud signals; however, there is a three-step available whenever necessary.

The spark transmitter is a one-kilowatt panel type, 500 cycle, rotary synchronous and quenched gaps, automatic starter, con-

usual CW with the small power tubes, and also the larger 250-watt size. The students have devoted probably the greatest part of their time to these instruments, for they seem to be most fascinating. We have up to 750 volts direct current available for vacuum tube work, with a maximum of 1¼ kilowatt. For filament lighting we use a set of those "country lighting plant" type accumulators, immense cells in high glass containers, excellent to demonstrate the chemical effects in charging. In connection with CW work, we carry on considerable experiment with the radiophone, which is now so common down here as to excite very little comment. The last Fourth of July we gave a radiophone concert to the naval destroyers in the Savannah River.

The receiving apparatus comprises every conceivable form for detecting the elusive wave; crystals, and their contemporary brothers, with the whole run of electron relays, audions and V. T.s, and the further infinite variety of regenerative, tuned

(Continued on page 250)



## Station of Charles N. Bloom

IT was a few months before our country entered the "World War" that I first became interested in radio. It is hard to say what prompted me at the time, but I do remember that I was very much interested—and still am. During the war I did not have much time to devote to my new hobby, for I was kept busy selling Liberty Bonds and working for different War Relief committees.

After the close of the war I erected my first aerial, having previously used a bed-spring antennae. At that time I used a small crystal detector cabinet. Then, little by little, buying here, constructing there, I finally made my station an object of pride, which was frequently visited by my friends.

"Listening in," I'll admit, is very interesting, but I would much rather experiment, — — —, with the result that I have already applied for two patents in the radio operati line.

Like other radiophone enthusiasts, I would



This Young Enthusiast Confines His Attention to Radio Telephony. He Has Secured Good Results Using One Vacuum Tube With a Plate Voltage of Only 40 Volts.

say, my phone set is the thing I pride most. With it I have successfully transmitted speech to a friend of mine a considerable

will hear from us in the near future. CHARLES N. BLOOM. 571 East 140th Street, New York City.

## Robert M. Sincock Station

THE following is a description of Radio Station 8-MT. The aerial is of four wires on a sixteen (16) ft. spreader and is on the top of a three-story building. The ground is made on a water-pipe and an iron fence, which is directly under the aerial.

The transmitter is not shown in the photograph, as it is rather hard to get at with a camera. Oscillation transformer and gap are swung from the table-top, thus eliminating a lot of noise and also cutting down the secondary leads. The secondary leads are not over six inches over all and the closed circuit makes use of all the ribbon in the secondary of the O. T. The high voltage transformer is an old-style Thor-darson. Condenser is glass plate oil immersed and was designed by C. M. Charpeming of Connellsville, Pa. In designing this condenser, he was very particular about cooling, and the result is a very efficient condenser, which is almost impossible to "blow" with a 1 kw. The transmitter is all home-made with the exception of the transformer.

For receiving, we have three different sets. One for short waves, one for 600 meters and one for long waves. Starting at the right of the picture is a two-step amplifying short wave regenerative set which we use for amateur work exclusively. I could fill a whole column with stations logged with this set. "Ones," "twos," "threes," "fours," "fives," "eights" and "nines" by the dozen. Next is a Mignon R. C. L. 5 for six-hundred meter "stuff," and I guess we've heard almost every ship on the ocean. Next is a honeycomb set employing a one-step amplifier, which can also be used for the amateurs in an emergency. With this set we have "listened-in" on practically all of the European high-powered stations.

Aside from the apparatus shown, I have just added a variometer regeneration set, a motor generator set for storage battery charging, and a new pair of Baldwin mica diaphragm phones.

Radio 8-MT has been heard in practically all the eastern states and actual work has been done with 1-YB, Dartmouth College, Hanover, N. H.; 4-YB, Savannah Radio School, Savannah, Ga., and 9-ZL at Mani-

towoc, Wis., with an antenna current of 9 to 12 amperes. I should be glad to hear from anyone who has ahead 8-MT.

Radio 8-MT.  
ROBERT M. SINCOCK,  
Box 1135, Uniontown, Penna.

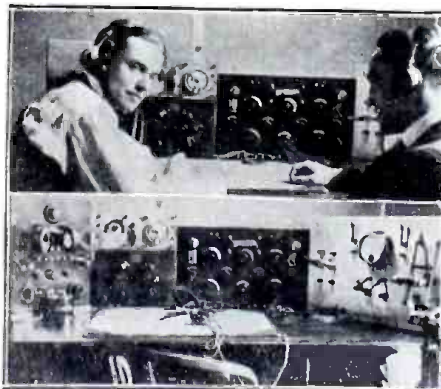

The Upper Photograph Show Mr. Sincock Entertaining a Radio Friend by "Listening-in." Below is Shown a More General View of the Complete Sending and Receiving Installation.

### A HAWAIIAN RECORD.

Not many weeks ago, when it was announced in the morning and evening papers of Honolulu that signals from the powerful Lafayette station at Bordeaux, France, were picked up by the Yerba Buena naval station at San Francisco, Lieut. Com. F. C. Raguet, of the Wailupe station at Oahu, and his operators, began to "listen in" for the Bordeaux station. As a result of their efforts signals were heard very clearly last night. The approximate distance was 9,500 miles in a direct line to Bordeaux in an easterly direction and 15,500 miles in a westerly direction.

Star Bulletin, Honolulu, Hawaii.  
WAH SOON SHIN.

### FELLOW MEMBERS, AND ALL RADIO AMATEURS EVERYWHERE.

You will notice that our meeting place will hereafter be at the address given below. There is a hall at that place which has accommodations for our association, and due to the courtesy of the librarian, arrangements have been made for our meetings to take place there instead of at the former quarters. Later in the season we may have the opportunity of securing the larger hall in the same building.

You remember the success of last season and the crowning event at Mosebach's. It made us the real live radio association of this part of the country. Ferris and Ballantine leave us for other fields of labor. The good work they did for us will not go astray because they leave us. We will have them with us now and then and their interest in us will always be with us. The old crowd are anxious to get down to "brass tacks" and have the association started. Then come the newer things in radio and the various developments which have taken place while some of you were sporting at the shore or up country. But, say, did you ever hear so much stuff in the air as was the case this summer? Why, because Radio has gotten a big jump in the minds of the amateurs. Wonderful things to talk about, to hear about and to do—this season.

Get your friends and bring them in for a membership card. No fuss about becoming a member. Hand the money to the secretary and he gives you the card. So easy. And then the treats you will get in the winter at our meetings.

Meetings of the Philadelphia Amateur Radio Association, first and third Monday nights of each month at 8 P. M.

Building of the Free Library of Philadelphia, H. Josephine Widener Branch, 1200 North Broad Street.

GORDON M. CHRISTINE, M.D.,  
President, 2043 N. 12th Street.  
H. PAUL HOLZ,  
Secretary, 1902 N. 11th Street.





# JUNIOR SECTION

## Junior Radio Course

### Additional Detectors

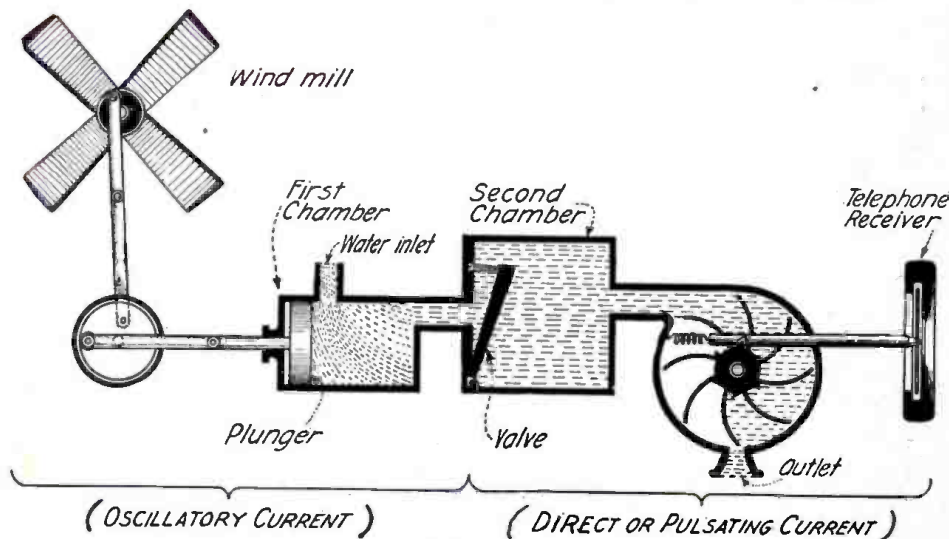

Fig. 5

In This Analogy, the Backward and Forward Motion of the Plunger Within the Cylinder Can Be Compared to the Oscillations Produced in the Antenna. This Causes a Backward and Forward Displacement of Water in the First Chamber. At Each Forward Movement, However, a Certain Amount of Water Is Forced Out of the Valve Opening, but When the Plunger Starts Back the Second Chamber Is Immediately Closed by Means of the Valve Shutter. Thus, Altho Water and Plunger May Move Back and Forth in the First Chamber, the Water in the Second Chamber Moves Only in One Direction at Each Spurt. Each One of These Spurts Cause the Turbine Wheel to Move Each Time Accordingly, and by Means of the Clutch Mechanism Shown, Causes the Diafram of the Receiver to Move Up and Down. The Speed of This Movement Depends Entirely Upon the Speed of the Plunger. In the Case of a Complete Radio Receiver Set the Same Action May Be Said to Take Place, Except, of Course, That in This Case the Windmill is Replaced by the Aerial, the Plunger by the Tuner and Condenser, the Valve by the Detector, and Finally, the Turbine Wheel and Other Mechanism Shown by the Telephone Receivers. Likewise in Radio, the Speed of the Receiver Diafram (and Consequently the Pitch of the Note) Depends Entirely Upon the Speed or Frequency of the Received Oscillations.

#### THE MARCONI MAGNETIC DETECTOR.

**F**OLLOWING up our study of various forms of pioneer detectors, the Magnetic Detector is one which all students of radio should be familiar with on account of its strikingly different form and manner of operation over others. It is at present almost obsolete; that is to say it is being very little used in the practical radio we know of today. It was, however, in use for many years on vessels equip with the Marconi system, particularly the British, as the American operators were never very much in favor of it, preferring various forms of crystal rectifiers. Its great advantage, however, was its sturdiness and reliability altho not as sensitive to weak signals as some forms of crystals. In Fig. 1 we see the general scheme employed in the Marconi magnetic detectors, which may be said to function as follows:

A band made up of a number of very fine insulated iron wires is made to revolve upon two grooved wooden or ebony disc which are in turn operated at a rather slow speed by means of a clockwork motor. The band of wire passes thru the air core of the primary coil, which is wound with a few turns of small silk covered copper wire and thru which pass the received oscillations from the antenna.

The secondary coil which, as will be seen,

fits directly over the primary consists of a bobbin of insulated copper wire having the same ohmic resistance as that of the telephone receivers employed. This is usually 75 ohms. Permanent horseshoe magnets with their poles arranged as shown in our illustration are placed directly above and quite near to the two coils.

#### ACTION OF THE MAGNETIC DETECTOR.

As soon as the aerial picks up a signal sent out by a distant transmitter station, the electro magnetic oscillations pass thru the primary coil on their way to ground and by so doing cause a slight change in the flux of the moving iron band. (This flux of course is caused by the two permanent magnets, but, since the band is constantly moving along, it is acted upon but momentarily). The presence of this flux causes a very small amount of electricity to be induced in the telephone receivers and this very small current is slightly increased every time a signal is received. This slight increase causes the diaframs of the receivers to respond with a click each time and is a true reproduction of the tone and other characteristics of the distant transmitter spark; in other words, twice as many clicks are heard per second as there are cycles in the supply current of the transmitter. These clicks take the sound of a buzz.

#### ADVANTAGES AND DISADVANTAGES OF THE MAGNETIC DETECTOR.

As previously mentioned, the magnetic detector is seldom used today. Its great advantage was its reliability and constant adjustment. All an operator had to do was to wind the clockwork motor occasionally and it was always ready and adjusted for maximum sensitiveness. It was not very effective, however, to weak signals around the wavelengths of 200 and 600 meters altho for high waves, such as 2,000 and 3,000 meters, it was quite as sensitive as any of the crystal detectors.

#### CRYSTAL DETECTORS.

The crystal detecting and rectifying devices are indeed the "grand old playthings" of radio. Despite the rapid advance of the vacuum tubes within recent years, the economy, ease of operation and effectiveness of the crystal detector will always cause it to remain close to the heart of the real amateur and particularly so to the beginner. Just think! What could be simpler and at the same time more wonderful than to be able to receive radio telegraph and telephone messages many hundreds and often thousands of miles away—all this by the mere use of a piece of mineral crystal placed lightly between two metal springs or other similar arrangement. The crystal detector is certainly a useful as well as interesting part of modern radio.

#### VARIOUS CRYSTALS USED.

Here is a list of some of the many mineral crystals which can be and have been used with excellent results for detectors or rectifiers of radio oscillations. They are given in the order of their importance and worth:

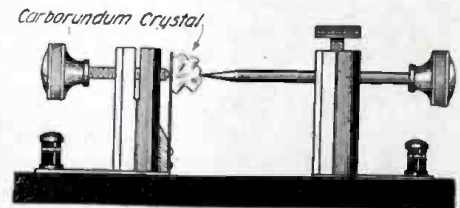

Fig. 2

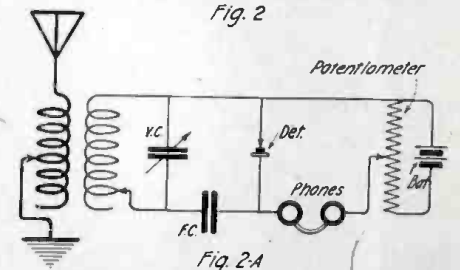

Fig. 2-A

Fig. 2 Shows a Type of Commercial Carborundum Crystal Detector, While Fig. 2-A Shows a Suitable Method of Connection.



- 1—Carborundum
- 2—Galena
- 3—Silicon
- 4—Bornite
- 5—Zincite
- 6—Copper pyrites
- 7—Iron pyrites
- 8—Chalcocite
- 9—Molybdenite
- 10—Titanium Dioxide

In fact many other crystals of all descriptions have been proposed and used with varying degrees of success. For instance, small pieces of common coal have detected and rectified signals for small distances.

**PRACTICAL FORMS OF CRYSTAL DETECTORS.**

Now carefully study the details of Figs. 2, 3 and 4 which illustrate three styles of practical crystal detectors which have been widely used by both commercial and amateur operators.

Fig. 2 is that of the Carborundum Detector. In this a specially selected piece of high grade carborundum\* is placed between a metal contact point and a very strong brass or phosphor bronze spring and the instrument is connected up in the same manner as other crystal detectors. In this case, however, a weak battery is connected in the circuit as shown in Fig. 2A, as it has been found that a small battery potential adds remarkably to its sensitiveness. There is no rule for knowing just where the most

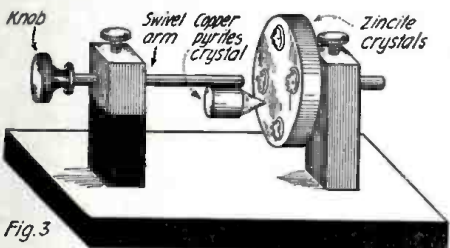

Fig. 3

The "Perikon" Detector, Which Makes Use of a Combination of Two Crystals, Zinc Oxide and Copper Pyrites.

sensitive spot of any crystal lies and this must be found by actual experiment, altho, ordinarily, it does not take very long to find the best point of contact.

Fig. 3 is that of the "Perikon" detector, so-called by G. J. Pickard, its inventor. This type proved much more sensitive than the carborundum altho not quite as sturdy and reliable. It consists of a combination of two crystals; zinc oxide (also called zincite) and copper pyrites. As may be seen the copper pyrites crystals are several in number and are placed in a cup by means of soft lead. This cup may be revolved so as to present its various crystal surfaces to

\* Carborundum is produced by coke, sand, salt and sawdust heated to an intense heat in an electric furnace.

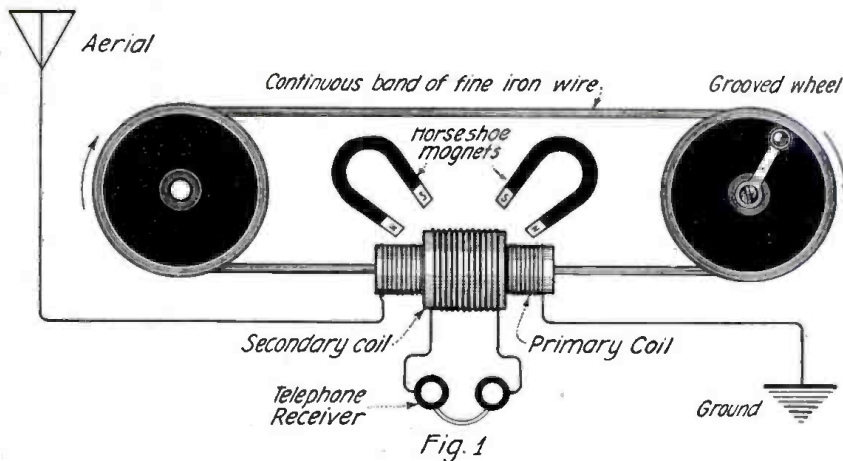

General Scheme Employed in the Marconi-Magnetic Detector. In This Case the Aerial and Ground Are Connected in an Elementary Manner for the Sake of Simplicity.

the opposite crystal which is the zincite. The zincite, on the other hand is placed in a small cup or holder at the end of a revolving arm having a swivel or universal joint so that by means of the knob the operator may secure the best adjustment for sensitive reception. This detector does not require a battery in its circuit but in some cases it has been used to advantage. The "Perikon" is seldom used today.

Fig. 4 is that of a detector stand adaptable for any form of crystal requiring a very delicate spring adjustment and is suitable for galena, silicon or iron pyrites. Galena, however, is preferable to others as it is probably the most sensitive and reliable; in fact it is extensively used by practically all amateurs. It does not require an external battery and contains many sensitive spots.

In Fig. 4 the crystal is placed permanently in the cup by means of soft lead and its most sensitive surface (to be found by preliminary test) presented to the catswhisker hair spring as shown. The contact point is made by means of a lever arm set in a central swivel joint between two spring brass holders. This form of detector stand is probably the most effective for use with the sensitive galena crystal. However, any arrangement will do which insures an easily changed point of contact. Look on the Junior Constructor page for various schemes employed by other amateurs, in this as well as previous issues of RADIO NEWS.

**ACTION OF CRYSTAL DETECTORS.**

All forms of crystal detectors operate on the rectifier principle. That is to say, they rectify the alternating nature of the received oscillations to a pulsating direct cur-

rent capable of making the telephone receivers respond. This was fully explained in our August Lesson. In order that the action be fully understood by newcomers to our course, the analogy shown in Fig. 5 will help to make matters clear. Carefully and slowly read the caption beneath this analogy.

**QUESTIONS FOR THIS LESSON.**

1. What do you know about the Marconi Magnetic Detector?
2. Name as many mineral crystals suitable for radio detectors as you may recall without glancing at the given list.
3. What are the advantages of the carborundum detector?
4. What combination distinguishes the "Perikon" Detector from other mineral crystal detectors.
5. Describe fully the Galena Crystal detector and its advantages. (a) Sketch two crystal detector stands which will be suitable for either Galena or Silicon.

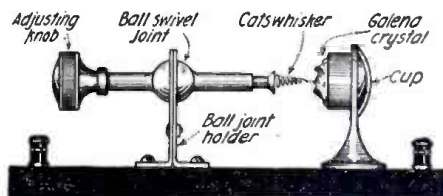

Fig. 4

A Well-Known Detector Stand, Suitable for Several Kinds of Crystals Requiring Light Contact.

# Dictionary of Technical Terms Used in Radio Telegraphy and Telephony\*

- Reluctance**—Magnetic equivalent of Electrical Resistance. Also see Hysteresis.
- R.P.M.**—Rotations per minute.
- R.P.S.**—Rotations per second.
- Refraction**—The bending of a ray of electromagnetic radiation of any kind which takes place when that radiation passes from a medium having one electric constant to another medium having a different dielectric constant
- Rectifier Electron**—A device for rectifying an alternating current by utilizing the approximately unilateral conductivity between a hot cathode and a relatively cold anode in so high a vacuum that a pure

- electron current flows between the electrodes.
- Rectifier, Gas**—An electron rectifier containing gas which modifies the internal action by the retardation of the electrons or the ionization of the gas atoms.
- Relay, Electron**—A device provided with means for modifying the pure electron current flowing between a hot cathode and a relatively cold anode placed in as nearly as possible a perfect vacuum. These means may be, for example, an electric control of the pure electron current by variation of the potential of a grid interposed between the cathode and the anode.

- Relay, Gas**—An electron relay containing gas, which modifies the internal action by the retardation of the electrons or the ionization of the gas atoms.
- Relay Key**—An electrically operated key.
- Resistance, Critical, of a Circuit**—That resistance which determines the limiting conditions at which the oscillatory discharge of a circuit passes into an aperiodic discharge.
- Resistance, Effective, of a Spark**—The ratio of the power dissipated by the spark to the mean square current.

(Continued on page 238)

\* This Dictionary was started in our March issue.



# Junior Constructor

## "BALL-BEARING" SLIDER.

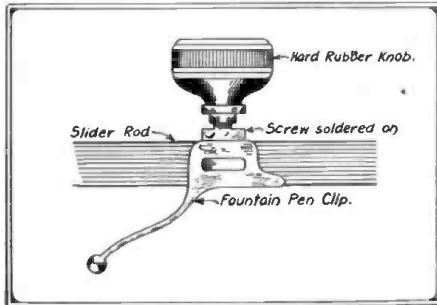

An Ordinary Fountain Pen or Pencil Clip Will Make a Pretty Good Slider.

A "ball-bearing" slider for rheostats, tuning coils, etc., is easily made by slipping an ordinary fountain pen clip on the square brass rod to be used on the instrument, and hammering the clip square. A small brass machine screw is soldered head downward to the clip and a hard rubber knob fitted to it.

Contributed by JOSEPH LIEBOWITZ.

## DUSTPROOF CRYSTAL DETECTOR.

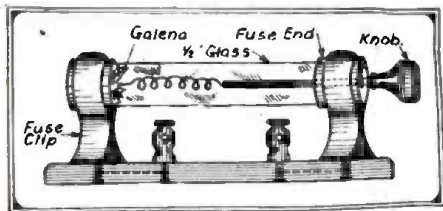

Here Is Something Useful—a Dustproof Detector. Easily Made, Too.

This little crystal detector can be made from an old burnt-out cartridge fuse, any size, using a glass tube in place of fiber and you have a neat as well as a compact instrument. It cost me 10 cents for the glass tube. Or, if you wish, you may cut the neck and bottom of a 1/4-inch vial and use it as I have. This makes it dustproof, weatherproof and not easily jarred out; as the catwhisker is coiled silver wire and light tension, it cost me 25 cents to have it nickel-plated and it now looks like a \$5.00 instrument. It has stayed in adjustment one to two weeks at a time.

Contributed by C. H. SHIPTON.

## POTENTIOMETER SWITCH ARM.

Many amateurs buy high-resistance sectors and make their own potentiometers for audions or other detectors, using a brass switch lever to vary the resistance. The brass wears away on the resistance sector, thus lowering the resistance and often making the potentiometer useless. Potentiometer switch levers may be bought, but here is a way to make one that is just as good as the store-bought variety:

First, procure a battery carbon from a small, wornout flashlight cell. It has a

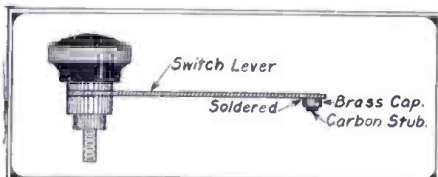

Use a Small Piece of Battery Carbon for the Contact Point of Your Potentiometer Switch Arm.

brass cap on one end. About 1/8 inch from the brass cap saw the carbon rod in two. Now solder the brass cap with the stub of carbon in it to the end of any brass rotary switch lever and a first-class potentiometer switch results. The above diagram illustrates the procedure and appearance of the appliance.

Contributed by MAXEY JARMAN.

## WIRE WINDING HINT.

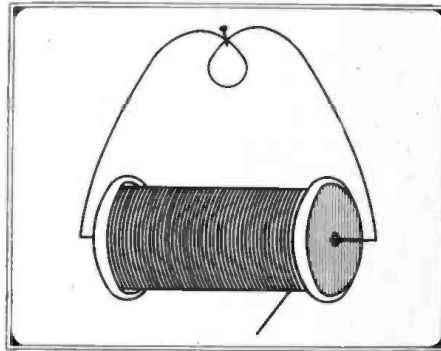

Don't Have Your Grandmother Hold Your Wire Spool; Let a Small Piece of Stiff Wire Do the Job.

When winding coils, the disposition of the spool from which the wire is feeding is usually a bothersome detail.

Attention is therefore called to the following, very simple device, which can be quickly made, and which meets the emergency admirably.

The drawing makes description practically unnecessary. A piece of wire is used of any desired length. It should be fairly heavy gage. Bend into shape shown, insert prongs into hole in spool, and hang up on a nail by the loop.

Contributed by CHARLES S. WOLFE.

## PANEL MOUNTING FOR OSCILLATION TRANSFORMER.

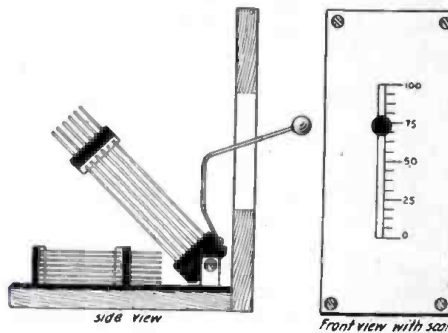

Here's a Transmitting Panel Idea Which Will Improve the Looks of Your Set.

This is a very easy way to construct a Murdock oscillation transformer into an inside mounting for panel use. All that is needed in order to do this is a 1/4-inch brass rod bent to the form that is shown in the drawing and pounded flat at one end. After doing this drill two holes in the flattened end and screw it onto the block that holds the coil. When this is done get a composition knob and thread it onto the end of the rod. The scale can be scratched on in the manner described in one of the late RADIO AMATEUR NEWS issues. My own panel was made up of 1/4-inch Bakelite.

Contributed by DON C. BROCKWAY.

## AN AERIAL IDEA THAT WORKS.

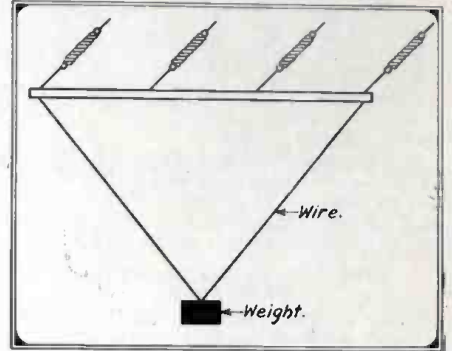

Even Tho You Have a Small Aerial, Prepare for the Wintry Winds Like Mercer Did.

Many amateurs are troubled by the wind twisting their aerials up. Others buy long ropes and guy the ends of the spreaders. Here's an idea that the writer uses. Take two pieces of stiff wire, each the length of the spreader, and a weight and, as shown in the accompanying diagram, arrange these.

Contributed by R. H. MERCER.

## PANEL ROTARY SWITCH.

Here is a rotary switch which can be mounted on the panel of a receiving set.

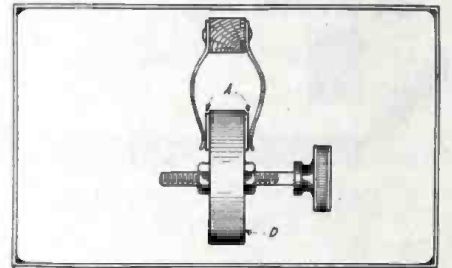

This Panel Rotary Switch Might Prove Just the Thing for Certain Hook-Ups.

In the December, 1919, RADIO AMATEUR NEWS there was a hook up for changing an audion from a detector to an amplifier by means of a four pole double throw switch. This rotary switch can do this much easier than the old type. By putting more contacts A, A on block of wood or fiber D you can have any number of poles.

Contributed by JOHN BOWERS.

## POTENTIOMETER FROM CARPENTER'S PENCIL.

A very good potentiometer can be made by carefully splitting a carpenter's pencil and taking out the lead. The lead is mounted on a suitable base by brass strips. A slider is made to bear on the lead. A ball bearing slider such as the "Electro" is very good for the purpose. The other details are shown in the drawing.

Contributed by J. BONANNO.

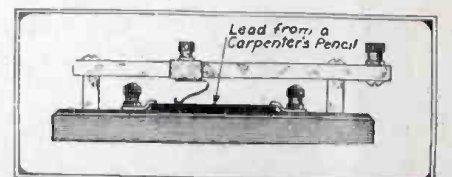

One of Those Square Carpenter's Pencils Will Do the Trick Very Nicely. Keep Away From Father's Tool Box, Tho.



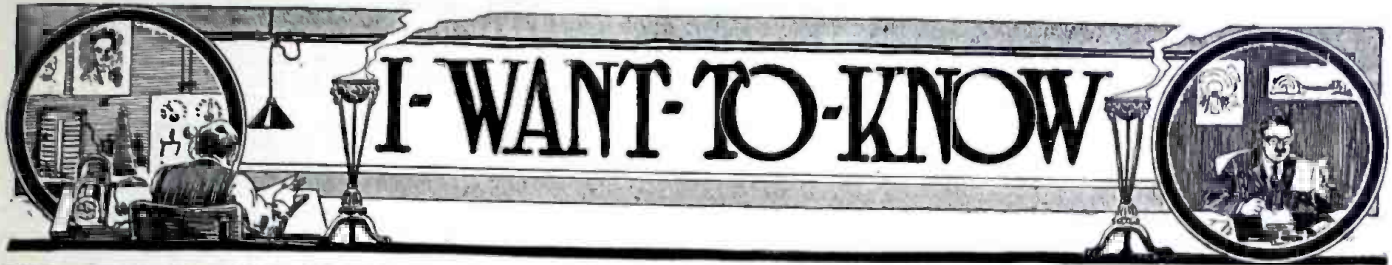

**T**HIS Department is conducted for the benefit of our Radio Experimenters. We shall be glad to answer here questions for the benefit of all, but we can only publish such matter of sufficient interest to all.

1. This Department cannot answer more than three questions for each correspondent.
  2. Only one side of the sheet should be written upon; all matter should be typewritten or else written in ink. No attention paid to penciled matter.
  3. Sketches, diagrams, etc., must be on separate sheets. This Department does not answer questions by mail free of charge.
  4. Our Editors will be glad to answer any letter at the rate of 25c for each question. If, however, questions entail considerable research work, intricate calculations, patent research, etc., a special charge will be made. Before we answer such questions, correspondents will be informed as to the price charge.
- You will do the Editor a personal favor if you make your letter as brief as possible.

### NO LICENSE REQUIRED FOR RECEIVING

(208) Russell D. Rich, Albany, N. Y., inquires:

Q. 1. I have been thinking of setting up a radio receiving station. However, it is not quite clear to me whether a license is required and, if so, what kind; also what is meant by "special amateur license"?

A. 1. There is no license required for the operation of a receiving station. Licenses are required solely when amateurs employ transmitters as well as receivers. The special amateur license is issued to experimenters only in special cases, the Government officials deciding what is and what is not a "special case".

### EMPLOYING RECEIVING BULBS INSTEAD OF A GENERATOR

(209) C. Holmes, Washington, D. C., writes:

Q. 1. I would like to know if 110 v. A. C., which has been stepped up thru a transformer and rectified by means of rectifier bulbs, could be substituted for the high voltage generator described in the Radiophone Set of Mr. Dannalls in RADIO AMATEUR NEWS for June.

A. 1. Yes. This method of securing the necessary high plate potential may be employed instead of the generator. It has the advantage of being less expensive; in fact, the experimenter may construct his own transformer and purchase the necessary rectifier tubes.

### GROUNDING OF LINE PROTECTORS.

(210) L. G. Windom, Columbus, Ohio, writes:

Q. 1. How should a so-called "line protector" be grounded?

A. 1. Line protecting devices are grounded to the nearest effective earth ground. If this is not available a good ground may be secured by burying a large metal pipe or plate in about 6 feet of preferably moist ground. A line protector is for the purpose of protecting the apparatus from lightning or accidental high tension fouts.

Q. 2. I have a 1/4 kw. transformer but cannot secure a spark from the gap when the aerial is connected in the circuit. What can be the trouble?

A. 2. Your question is rather vague. If you are employing this transformer in connection with a regular amateur transmitting circuit, it is possible that your spark gap is too wide. It is also possible that your aerial is poorly insulated or is grounded.

### SERIES-SHUNT CONDENSER SWITCH.

(211) John Franklin, Kansas City, Mo., asks:

Q. 1. Will you publish a diagram showing method of quickly changing an aerial tuning condenser from a series to a shunt connection?

A. 1. You will find manner of connection explained in the diagram illustrated on this page.

Q. 2. I have a considerable amount of copper tape having the dimensions of .025 by 1/4 inch. Will this be suitable for a receiving aerial?

A. 2. If you have a sufficient quantity of this tape on hand and do not wish to go to the expense of purchasing antenna wire, there is no reason why you cannot use the tape for an aerial. It should prove quite suitable as it offers a fairly large surface to electro magnetic waves.

### CAGE TYPE ANTENNA.

(212) Clarence Smith, Shamokin, Pa., writes:

Q. 1. Please publish complete dimensions for building a cage type antenna in order to keep its natural wavelength at about 200 meters.

A. 1. We can serve your interest in no better way than by referring you to page

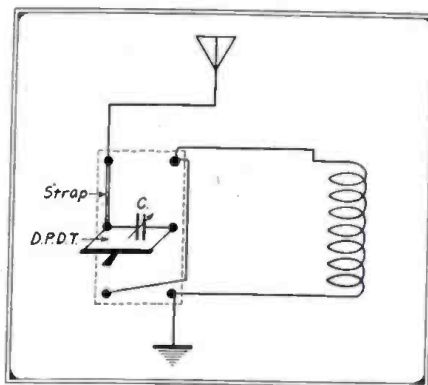

Q. 211. Connection for Quickly Changing from a Series to a Shunt Condenser Hook-up.

81 of August RADIO NEWS, where we publish "The Construction of a Cage Type Antenna" by Lloyd C. Greene. In this case the complete information for a cage type antenna having a natural period of about 180 meters was given.

### CARDBOARD TUBES OF ALL SIZES.

(213) John Showalter, Wabash, Ind., inquires:

Q. 1. Will you publish the name of a firm which sells cardboard tubes 2 feet long and 6 inches in diameter as well as other sizes?

A. 1. We refer you to The Baehm Paper Co., 219 Fulton St., N. Y. C.

Q. 2. What is the approximate natural period of a four-wire aerial 100 feet long and 40 feet high?

A. 2. The approximate wavelength of the aerial you mention is slightly over 200 meters.

### FEDERAL VERSUS ACME TRANSFORMERS.

(214) William Baker, Brooklyn, N. Y., wishes to know:

Q. 1. Concerning the Federal and Acme amplifying transformers, which do you think is best suited to be used with audiotron vacuum tubes?

A. 1. These two transformers are manufactured by two most reliable firms and you cannot go wrong in either case, either one being suitable for the purpose you mention.

### TWO METHODS OF BUZZER TRANSMISSION.

(215) F. M. Libby, New Brighton, N. Y., asks:

Q. 1. What is the approximate transmitting distance of a high frequency buzzer when used with a coil shunt?

A. 1. This depends upon individual conditions. Some amateurs have only been able to secure a range of one mile while others have secured distances of five miles or more with buzzer transmission.

Q. 2. How is vacuum tube radio telegraphy transmission accomplished?

A. 2. A Vacuum Tube power circuit and modulated wave is secured by means of a so-called "chopper" placed in the antenna circuit. That is to say, the oscillator tubes generate and cause to be radiated an undamped wave. This in turn is broken up or "chopped" so as to be readable in spark receiving circuits by means of a high frequency buzzer placed in the aerial circuit. Sending is accomplished by means of a key and battery in series with buzzer.

### PREFIXES OF METRIC SYSTEM.

(216) C. K. Brown, Chicago, Ill., writes:

Q. 1. Please publish the prefixes of some of the electrical units mentioned in radio work. I feel sure this is not very clear to many amateurs.

A. 1. The following list of prefixes is herewith given:

Prefix	Abbreviation	Meaning
micro		one millionth
milli	m	one thousandth
centi	c	one hundredth
deci	d	one tenth
deka	dk	ten
hekto	h	one hundred
kilo	k	one thousand
mega	M	one million

Q. 2. What are the English equivalents to one meter, and to one kilometer?

A. 2. A meter is equal to 3.281 feet, while the kilometer is equal to 0.6214 mile.



## \$100 "PORTABLE RADIO" PRIZE CONTEST

**WE** again make the announcement of the third \$100 prize contest entitled "Smallest Portable Radio Outfit".

A great many amateurs,—if not the majority,—are intensely interested in a small portable outfit that can be taken about when visiting friends, when going away for week-end parties, for camping and a great many other purposes. Particularly during the summer and fall a good portable receiving outfit is greatly desired and highly prized, as we have been able to satisfy ourselves from experience.

With modern radio apparatus, properly put together, it is possible to receive messages over surprising distances, even with small, but compactly built, apparatus, and there is no reason why our amateurs should not be able to turn out something really worth while. In awarding prizes the judges will take into consideration not only the smallness of the outfit, but its efficiency as well. In other words, the first prize will not necessarily go to the amateur who builds the smallest outfit, but rather to the one who builds a small one that is efficient as well. Of course the word "small" as used here is rather elastic. In other words, the outfit which can be slipped into the pocket might be a smaller one, no larger than an ordinary watch! But, bear in mind, what we are after is not a freak outfit. A microscopic radio receiving outfit could no doubt be built, but we dare say, it would not be very efficient. We have recently seen a European outfit that was quite complete and could be carried around in a walking cane, and this was not a bad idea at all; besides it worked well. This may be a hint for some of our radio enthusiasts.

### Requirements of the Outfit

**THE** outfit must have means for tuning. It may have one or more detectors. It should have means for receiving messages by sound, which may be the usual set of telephone receivers or something better.

There must, of course, be also an aerial of some sort as well as a "ground" or ground connection. Due to the very nature of the contest, it is of course necessary that the aerial be such that it will not take up too much

room nominally. Concentrated aerials of the loop type can be used, or any other contrivance that takes up a minimum space, but gives quite a good capacity when unfolded or extended.

Remember that the editors are not looking for freaks. *The outfit must work* and in order to prove it, the contestant must build it, for no entry will be considered, unless it is accompanied by a photograph of the actual outfit.

In publishing the various ideas, all the rights revert to the publishers. The latter also reserve themselves the right to publish manuscripts which were sent in to this contest, altho they are not prize winning articles.

**PRIZES OF \$100 IN GOLD**

First Prize . . . . . \$50.00  
 Second Prize . . . . . 25.00  
 Third Prize . . . . . 15.00  
 Fourth Prize . . . . . 10.00

In that case full space rates will be paid for any manuscript published that did not win a prize.

As will be noted, the publishers offer prizes totaling \$100.00 in gold for the best article on the smallest practical and efficient radio telegraph or telephone receiving outfits.

Several radio experts will act as judges in this contest. Every one of the judges will pass upon the manuscripts submitted, and there can be little doubt that all contestants will be treated fairly and impartially. From the very nature of the contest, we are certain that it will not only bring out the very best there is in the American amateur, but that it will advance the art for portable radio receiving outfits considerably.

### Rules for the Prize Contest

**THE** set to be described may be of the usual receiving type. Vacuum tube type, or crystal detectors may be used at option of builder.

There should be some new features embodied in the outfit that are not known now, or have not been published heretofore. It is quite important, and as a matter of fact necessary that the set must have been actually built, that it is either in use, or has been in use. Wild "ideas" or patent descriptions are strictly excluded from this contest. It is also obvious that insofar as this contest is conducted chiefly to bring out NEW ideas, commercial radio outfits are excluded from this contest. It is necessary to state what instruments are used, and if some of the instruments have been bought, the make must be stated.

A good diagram of the connections neatly executed in ink is to be furnished. A good photograph, not smaller than 5x7 inches giving at least two views of the set is necessary. A photograph of the builder is also required.

All photographs, diagrams and other data sent in by contestants which are not used will be returned at our cost.

In cases where there seems to be some doubt as to the practicability of the instrument we reserve the right to ask to inspect and test the set; insured parcel post charges at our own expense both ways. Of course, we shall return the instrument promptly. This, however, will not be requested if the photographs and descriptions are convincing.

More than one outfit may be entered by contestants. The contest is open to everyone, radio clubs included, except manufacturers.

The manuscripts should not be longer than 1,500 words; 1,000 words preferred. All prizes will be paid upon publication.

**The Contest closes in New York November 15th, and the first prize winning article will appear in the December, 1920, issue. Address all manuscripts, photos, etc., to "Editor Portable Radio Prize Contest," care of this publication.**

## Developing Radio in the Hills

(Continued from page 203)

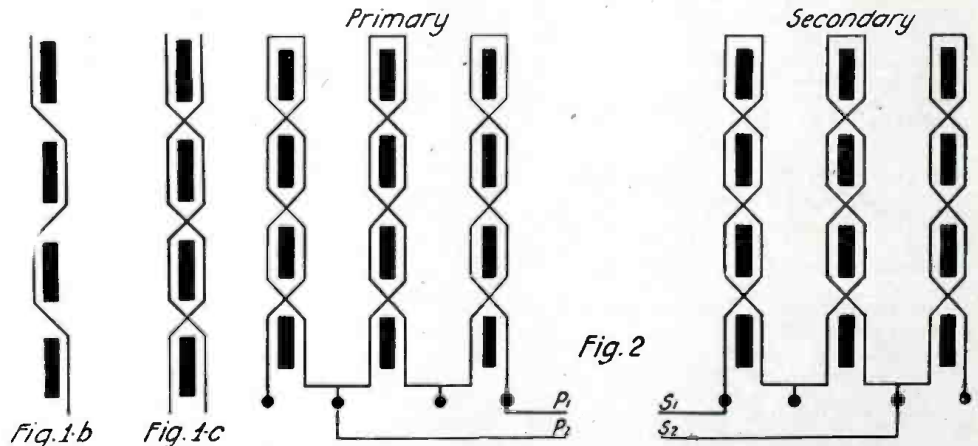

**Figs. 1a, 1b and 1c** Show the Core Form and Manner in Which Wire is Wound Upon It. **Fig. 2** Illustrates a Schematic Arrangement of a Primary and a Secondary "Spider Web" Coil.

In the illustrated samples shown here a core made of formica having excellent insulating qualities combined with great strength, was cut in the shape shown in Fig. 1, which in the present case has seventeen slots. Next was wound a suitable sized wire in the manner shown at Fig. 1b, that is to say, the core was revolved upon a suitable mechanism and the wire was placed first on one side of the slot and then across to the other side of the slot and then back again until a complete revolution of the core had been made. Upon the second revolution the winding upon the coil assumed the form shown in Fig. 1c. The process was then kept up until the coil was wound to a predetermined inductance.

The evolution of the three coils is shown above where one coil was wound upon a small wooden disk to which had been previously inserted metal prongs. The second step is where the coil was wound upon an insulated slotted core, but in this instance distributed capacity was found to be still too great to make the coil very useful. The next step was therefore the designing of a core having slots wide enough to permit the crossing of each layer as near to a right angle as possible. This is effectively shown at Fig. 1c and therein lies the success of the coil. It will be noted in such a coil that the distributed capacity is bound to be less owing to the fact that the wires cross at less frequent intervals than

does any other multi-layer coils. Of course different sized coils necessitate different styles of core and wire. In the case of a 200 meter unit comprising a primary, secondary and tickler coil, a sample of which is shown in our illustrations, the wire is composed of No. 24 B & S gage single silk covered and in the larger one No. 26 wire is used.

### ADVANTAGES OF THE "SPIDER WEB" COIL

1. It has more inductances in the same given space than others. This is due primarily to the fact that there is no magnetic leakage in the coupling of adjacent coils and the

(Continued on page 230)



# CORRESPONDENCE FROM READERS

## CONCERNING HONEYCOMB COILS

Editor of RADIO NEWS:

I have just encountered a peculiarity of Honeycomb Coils, the correction of which trouble I believe will be of interest to all Amateurs using this type of inductance.

I am the proud possessor of a very elaborate receiver with three stages of amplification, and a good antenna, being on the roof of a four-story apartment building, with all four wires brought to the lightning switch at the bottom, but in spite of all this, I could do no long distance receiving on short wave lengths during damp or rainy weather.

It is not necessary to dwell on the usual trouble-hunting procedure through which I went each time, we have all done it, suffice it to say that I found none.

One night when this condition was exceptionally bad, I noticed that the fibre bands which go around the coils were a little soft! At the time I was trying to pick up some 600 meter stuff but could get nothing.

You can readily see what had happened! I immediately removed the bands with a screw driver and there they were! All the 600 meter boys pounding away oblivious of my joy! The plugs had absorbed moisture and were fastened to the plug at one end, and the socket at the other, with screws through the coil mounting!

To fasten the coils to the mounting without the bands, is a very simple job. Clamp the two together and drop hot sealing wax on one side and then on the other, first removing the small piece of band which is put between the plug mounting and the coil, then trim it all down with a knife.

If the job is done carefully and the sealing wax run well into the centre, it will take more hard usage than the insulation will stand to break the bond made by the wax. To protect the coils from hard usage, I have mounted them in an upright position using a suggestion published recently in RADIO NEWS, wherein a strip of wood is drilled with holes in which the plug is inserted.

For Amateurs constructing their own coils however, I would suggest that the coil mounting be made with a lug or stud of the mounting material and be made to come thru the coil and the coil held in place with a fibre nut, or a brass one well insulated from the coil itself. If the coils are wound on heavy enough paper the insulating feature can be disregarded.

HAMLIN R. FORDYCE, 8A1J,  
Cincinnati, Ohio.

## WHY ARE V.T.'S SO COSTLY?

Editor of RADIO NEWS:

Judging from your past articles I infer that you are deeply interested in amateur welfare and particularly that part concerning the H.C. of radio apparatus. For that reason permit me to make the following remarks.

It is agreed that the vacuum tube is indeed a most necessary appliance of modern radio. It is, however, a very costly one at present. Is this absolutely necessary? Why do we have to pay \$7.00 or more to our manufacturers for a bulb which the Woolworth stores can give us for \$.10, lacking, of course, only two pieces of metal—the grid and the plate?

I am acquainted with several amateurs who with crude tools have been able to construct a fairly practical vacuum tube for \$.30. It would seem that our manufacturers could sell one from somewhere in the neighborhood of \$.20; so why \$7.00? Is it a case of profiteering?

It is understood, of course, that the patent situation is not quite clear and that there are many conditions attending the manu-

facture of modern vacuum tubes which are very costly to meet but again I repeat, why \$7.00 a throw?

What do other amateurs think of this matter?

CARL MASSON,  
Jamaica Plain, Boston, Mass.

## INFINITE WAVE RECEPTION.

Editor of RADIO NEWS:

Perhaps some of your many readers will be able to give me a little light on the following subject. In any case, I would like to learn their views.

Smith has a IKW station. Jones has only a ¼-inch spark coil. Smith, of course, will hardly speak to Jones now because he claims he can transmit two thousand miles. He means to imply, I suppose, that, with the average present-day equipment at the receiving end, his set will transmit signals that are audible two thousand miles away. For, the distance to which any station can actually transmit is, to my way of thinking, infinite! And I mean all this regardless of the size or location of the transmitting station or the amplitude of the transmitted wave.

Given, an infinitely sensitive receiver, what is to prevent the reception, in China (or Mars for that matter), of waves emitted from a buzzer that is located in Alaska?

To me, the development of a really efficient receiver contains unbounded possibilities. It is a strange fact but nevertheless true that to-day, with all our modern radio improvements and "super-sensitive" receivers, with all our "efficient" bank wound and "honey comb" inductance in conjunction with our multi-stage radio- and audio-frequency amplifiers and with all due respect to the wonders that have been accomplished and the geniuses who have made them possible; there is not one single bit more energy abstracted from the aerial now than there was in the days of the coherer!

Because man takes that same amount of feeble current from the aerial that he obtained 15 years ago and by its trigger action thru a bank of his modern vacuum tubes causes energy to be released from his "B" batteries all out of proportion to the receiving current, he foolishly and vainly boasts of being able to transmit power by wireless! Better, by far, bend his energies toward perfecting a device or a method that will enable him to do away with his multi-steps of amplification by making use of a little more of the energy that is already in his aerial!

Wishing RADIO NEWS and its Editor much success, I am,

GEORGE N. GARRISON,  
East Orange, N. J.

(Mr. Garrison is correct. He voices our ideas as printed in our January, 1920, editorial, where we said:

The question before us is: How far can you detect an electrical wave? Theoretically there is no limit. In other words, as time passes and our detectors become more sensitive we find that we can reach further and further. We will all live to see the day when the waves emitted from a buzzer will be picked up after having traveled around the globe a distance of 12,000 miles. Undoubtedly they reach much further but unfortunately our earth will then have become too small, for the emitted waves certainly travel infinitely further.

## FADING SIGNALS

Editor of RADIO NEWS:

I take exception to the views of Mr. Fitch as set forth in the article "A Possible Explanation of Fading," which appeared in the May issue of R. A. N.

Aboard a steamer I have listened to many stations while steadily approaching them, and also while receding from them. As a rule there was no fading. I have listened to

NPG continuously for some time while receding at full speed, and observed no fading. In such cases, I should have passed thru Mr. Fitch's "stationary nodes" had they been present.

This much is demonstrable: Each wave is characterized by a magnetic force and an electric force which are directed at right angles to each other and to the line of their travel. Velocity is three hundred thousand kilometers per second. We are concerned with the magnetic force rather than the other, because it is the magnetic force that cuts our receiving aeriels and induces therein the currents the effects of which we hear in the phones.

I think that Mr. Fitch's article is misleading. There are such things as stationary waves, but such waves occur in special cases, such as that of reflection, where the reflected waves meet the original ones.

Fading may possibly be due to moving masses of electrically charged water vapor which pass between stations.

S. W. SUTTON,  
Leavenworth, Washn.

## AN ANSWER TO THE ABOVE.

Editor of RADIO NEWS:

In reply to Mr. Sutton's letter I must say that his experience surely proves that ordinary wireless waves are not standing waves, but this does not prove that standing wireless waves do not exist. He states that there are such things as stationary waves, but such waves occur in special cases, such as that of reflection, where the reflected waves meet the original ones. Why shouldn't these special cases apply to wireless waves as well as say, sound waves, light waves, mechanical waves, etc? Hertz experimented with stationary radio waves on a small scale.

It is well known that only a small amount of the energy picked up by a receiving antenna is absorbed in the detector circuit; most of this energy being re-radiated from the receiving antenna. These re-radiated waves meet the original waves, and, if the distance between the two stations is correct, interference waves will be set up between the two stations. If a receiving station happens to be located on a potential node between these two stations, it cannot respond to the sending station; but if either of the two stations de-tune the system, the middle station can respond to the sending station. We may be copying signals of a certain station loud and clear, but just as soon as some one behind us tunes in these signals, they fade away. I think that the only possible way to prove this theory is to notify the operator at the sending station when his signals fade, and have him gradually shift his wavelength. If the signals come back to audibility, we would know that the fading phenomenon was due to standing waves.

I do not agree with Mr. Sutton that we are concerned with only the magnetic force of wireless waves. In the December, 1919, issue of the Proceedings of the I.R.E., there is an article "An Oscillation Source for Radio Receiver Investigations," describing how the electric field and then the magnetic field of a vacuum valve oscillator was shielded from a small receiving set, and it was found that the electric field is by far the stronger for exciting the receiver circuit.

I do believe that the energy from a sending station is propagated by conduction over the surface of the earth, because radio frequency currents travel over the surface of conductors; and the depth of penetration is a function of the frequency, decreasing with increase of frequency. Since energy is radiated from a conductor carry-

(Continued on page 242)



## Play the Hawaiian Guitar Just Like the Hawaiians!

Our method of teaching is so simple, plain and easy that you begin on a piece with your first lesson. In half an hour you can play it! We have reduced the necessary notions you learn to only four—and you acquire these in a few minutes. Then it is only a matter of practice to acquire the weird, fascinating tremolos, staccatos, sturs, and other effects that make this instrument so delightful.



The Hawaiian Guitar plays any kind of music, both the melody and the accompaniment. Your tuition fee includes a beautiful Hawaiian Guitar, all the necessary picks and steel bar and 52 complete lessons and pieces of music.

**Send Coupon NOW  
Get Full Particulars FREE**

**First Hawaiian Conservatory of Music, Inc.**  
233 Broadway NEW YORK

I am interested in the HAWAIIAN GUITAR. Please send complete information, special price offer, etc., etc.

NAME ..... R.N.  
ADDRESS .....  
TOWN .....  
STATE ..... Please write name and address clearly.

**\$5.00 SUIT**  
MADE TO ORDER  
**SAVE**

To prove our unbeatable values and get your steady trade, will make two piece suit to your measure for only \$15.00. Style shown in the picture or any one of 185 style combinations to select from. One year's satisfaction guaranteed or every penny back—quick.

**NO EXTRA CHARGES**  
You pay just what we say, not one penny of extras for anything. We even pay all postage and express. You save one-half—like before the war.

**EARN \$60.00 CASH WEEKLY**  
You can take orders easy for these clothes in spare time and make \$3000 a year and up at home. Friends and neighbors buy an **SEND NO CASH** mail \$17.50 in seven days.

**FREE—BIG SAMPLES**  
New samples show latest styles and 80 real cloth samples. Buy at inside Wholesale prices. Write now for Big Free Outfit.  
**SPENCER MEAD COMPANY**  
Wholesale Tailors Dept. 929 Chicago

### What a Dime Will Bring You From the Nation's Capital

The little matter of 10 cts. will bring you the Pathfinder eight weeks on trial. The Pathfinder is an illustrated weekly, published at the Nation's center, for all the Nation; an independent home paper that prints all the news of the world and tells the truth; now in its 28th year. This paper fills the bill without emptying the purse; it costs but \$1 a year. If you want to keep posted on what is going on in the world, at the least expense of time or money, this is your means. If you want a paper in your home which is sincere, reliable, entertaining, wholesome, the Pathfinder is yours. If you would appreciate a paper which puts everything clearly, strongly, briefly—here it is. Send 10c to show that you might like such a paper, and we will send the Pathfinder on probation eight weeks. The 10c does not repay us, but we are glad to invest in new friends. Address: The Pathfinder, 492 Landon Sta., Washington, D. C.

*Pathfinder Election Guide settles all election disputes; check full of facts and figures. 32 page vest-pocket pamphlet free with every trial subscription.*

### RAISE RABBITS

Make \$60 a year profit from one pair. Thousands are doing it right now. It's easy, pleasant, profitable work and we help you get started.  
Write today for circular.  
**PIGEON SUPPLY HOUSE, Box 251, Hanover, Pa.**  
"Pigeons-Poultry-Pet Stock"

### STAMMER

Send 10 cents coin or stamps for 70-page book on Stammering and Stuttering, "Its Cause and Cure." It tells how I cured myself after stammering for 20 years.  
Benjamin M. Boguo, 663 Boguo Bldg., Indianapolis

## Developing Radio in the Hills

(Continued from page 226)

coils being perfectly flat the entire magnetic area is always available in the coupling of circuits.

2. Distributed capacity is reduced to a minimum. This desirable condition is brought about by the fact that the wire runs parallel for a greater distance and crosses itself less frequently than any other type of coils.

3. There is very little high frequency resistance, because there being no interior magnetic field, or air core, H.F. resistance is considerably reduced.

4. The coils occupy very little space, in fact they are so thin that three of them can be arranged in a space taking up less than 1/4 of an inch.

### WINDING MACHINE.

The early samples of the "spider web" coil were of necessity wound by hand. This involves considerable time and expense as may be imagined. In order to produce these coils on a commercial scale the inventor has built a machine which will wind the coils at a very rapid rate. An excellent reproduction is shown in one of our illustrations. This device is indeed a unique little arrangement and would delight some of our mechanically bent amateurs. By its use the automatic winding of each coil is accomplished in about one minute. As may possibly be noted by referring to the above model, the core of each coil is placed in a keyed slot and after the beginning of the inside wire has been started the core is revolved at a high rate of speed, whereupon the winding is automatically accomplished by means of a side to side or lateral motion so that the wire is wound first on one side and then passes the open space between each slot to the other side. After each complete turn, an automatic arrangement moves the lay of the wire to a point slightly above that of the preceding layer. In this manner the windings are effectively built up until they have reached the top of the core when the coil is then fully wound. The mechanical details of this interesting little machine are extremely simple and efficient in their manner of operation.

### A "SPIDER WEB" RECEIVING UNIT.

In another one of our illustrations may be seen a complete receiving unit consisting of primary, secondary and tickler coils, two of which are movable and one stationary. There are six binding posts permitting any circuit to be used. The doors containing primary and tickler inductances are capable of very fine adjustment and are so set and installed that they will stay in proper adjustment on any good place without moving from side to side. With two condenser .0005 and .001 mfd. this set which has been built primarily for amateur work will easily respond to wavelengths of from 175 to 400 meters and gives excellent results.

For long wave work an arrangement similar to that shown in Fig 2 can easily be installed whereby two or more inductance units mounted side by side are made to take care of increased wavelength ranges. In this instance, however, a jack and plug arrangement may be installed or a dead-end switch employed.

### AS A TRANSMITTING INSTANCE.

There is one use for the spider web coil which up until recently could not be said  
(Continued on page 232)



## THE "ILLINOIS" VARIABLE CONDENSER

The Condenser with "Star Spring" Tension MADE RIGHT—STAYS RIGHT  
Hard Rolled Aluminum Plates

These condensers are made by a watch mechanic schooled in accurate workmanship. Personally we will need no introduction to Amateurs who have "listened in" for "time" and "weather" from 9. ZS.

Three Styles: No. 1. Panel; No. 2. Open Type as shown; No. 3. Fully Encased. Anti Prosteer. Less than pre-war prices. Fully assembled and tested.

Style No. 1	No. 2	No. 3	Money back if not satisfied. Just return condenser within 10 days by insured P.P.
43 Plates, \$3.50	\$4.60	\$4.75	
23 Plates, 2.75	3.75	4.00	
13 Plates, 2.25	3.25	3.50	

Sent Prepaid on Receipt of Price.

Except: Pacific States, Alaska, Hawaii, Philippines and Canal Zone, add 10c. Canada add 25c. Foreign Orders other than Canada not solicited. NOTE: Above Prices Effective November 1st, 1920.

The "ILLINOIS" is rapidly adding to the number of its friends. The buquets they fling only spur us to still more careful work, and more rigid inspection. It is a matter of pride that among the thousands of instruments sent out, not a single complaint has been received of bad condition. This may possibly be because every instrument is subjected to the scrutiny of the "old man's" eyeglass.

Now we will take you into our confidence, and tell you the reason for the above slight change in price. We know more about manufacturing costs than we did when we started. Then, there have been sharp advances in the cost of materials; in some cases nearly 100 per cent.

Again the difference in the price of the various sizes and styles were originally based almost entirely on the difference in material. Experience has shown that as the number of plates increases, the labor of assembling and adjusting increases in a much greater ratio. For this reason the slight advance we make in the new list is in the larger units; the smallest remaining unchanged.

Patent is pending on the "Star Spring" feature, which has been very valuable. The action of this spring produces an unvarying friction that holds the "rotor" in any position to which it may be set, and at the same time automatically centers the plates in relation to each other, and prevents any possibility of "endshake."

The plates are in proper relation by construction, and will remain so, obviating any necessity of readjustment. Once right, always right. Once mounted on your panel, there is one thing that you can depend upon to never give you trouble.

We again thank our friends for their letters of generous appreciation.

Kindly note: We issue no Catalog, and make no "trade discounts". We set our prices at the lowest limit, and leave the "middle man" out for the sole benefit of the "consumer".

G. F. Johnson, 625 Black Ave., Springfield, Ill.

## The Livest Catalogue IN AMERICA

Our big, new electrical cyclopedia No. 22 is waiting for you. Positively the most complete Wireless and electrical catalogue in print today. 80 Big Pages, 300 Illustrations, 200 Instruments and apparatus, etc. Big "Treatise on Wireless Telegraphy." 20 FREE coupons for our 160-page FREE Wireless Course in 20 lessons. FREE Cyclopedia No. 22 measures 6 in. x 9 in. Weight 1/2 lb. Beautiful stiff covers.



Send 10 cents in stamps or coin for which we will send our latest Cyclopedia Catalogue No. 22 as described.

**ELECTRO IMPORTING COMPANY**  
236a Fulton St., New York City





## To the Discriminating

Radio-Craft caters to those who demand the best in Radio Apparatus.

Detector Unit  
Price \$15.00

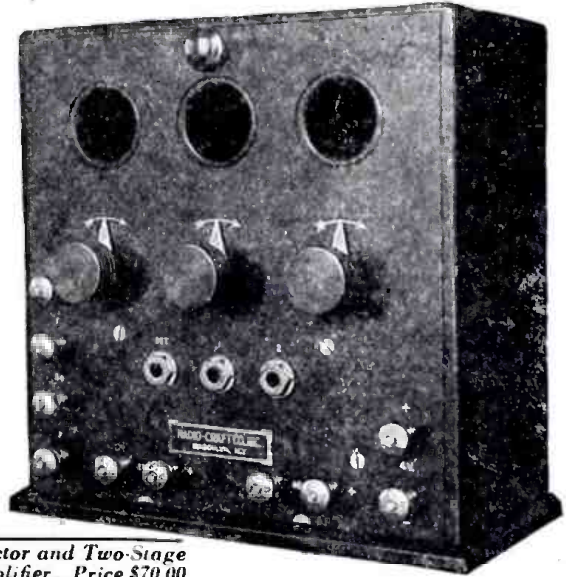

Insist on Radio-Craft products. Even with their outstanding superiority in design, materials and workmanship, Radio-Craft products cost no more than ordinary instruments.

Radio-Craft apparatus is sold by  
Continental Radio & Electric Corp., N. Y. C.  
Manhattan Electrical Supply Co., N. Y. C.  
Radio Distributing Co., Newark, N. J.  
Philadelphia School of Wireless Telegraphy, Philadelphia, Pa.  
Kelly & Phillips, Brooklyn, N. Y.  
McCarthy Bros. & Ford, Buffalo, N. Y.  
Rudolph Schmidt & Co., Rochester, N. Y.  
Atlantic Radio Co., Boston, Mass.  
American Electro Technical Appliance Co., New York City.  
And Other Responsible Dealers

**RADIO-CRAFT CO., INC.**

Brooklyn, New York  
Perfection in Radio Instruments

Detector and Two-Stage  
Amplifier. Price \$70.00

JOBBER'S INQUIRIES INVITED

# Don't Take Our Word for It

## Read What Others Say—Then Prove It for Yourself



"Superior" Set, 2,000 ohms \$7.00

We don't ask you to take our word for the superiority of Brandes Matched-Tone Receivers. Thousands of operators have written to us unsolicited letters and all are enthusiastic over the results they got with Brandes Receivers. Read what some of them say, then act on our trial offer below.

"They are all and more than you claim them to be."—W. M., Columbus, Ohio.

"They are the best phones anyone can buy. They bring in the stations you don't hear with other phones and cut out half the static."—M. B., Richfield, Utah.

"I have tested very many receivers at various prices and none of them are in the same class with yours. Honest goods, good inspection and testing (previous to shipment) ought to be known."—J. B., Fall River, Mass.

"I own a pair of your 2,000 Ohm Superior Headsets and have used them for the last two years.

They are better than ever, picking up messages when many others have failed."—E. H., Lowden, Ia.

"I can receive N.A.A. much sharper and clearer with your Superiors than with my \_\_\_\_\_, 2,000 Ohms, and they were good phones."—C. D., Bellefonte, Pa.

"With average antenna of only 40 feet height, crystal detector, and my 'Superior' phones I have been able to hear ships 1200 to 1400 miles at sea and land stations up to 1200 miles distant—before 9 P. M."—C. S. M., Concord, Calif.

### Here's Our Offer:

Send 5c for catalog "G." Order any pair of our receivers you want. Try them 10 days in comparison with the phones you have now. If they aren't better phones for clearness, sensitiveness and distance than what you are now using, return them to us and back comes your money immediately and without question. Brandes phones are used by U. S. Government experts, colleges and technical schools, and by professionals and amateur operators all over the world.

**BRANDES**  
Matched-Tone  
**Wireless**  
**Receivers**

**C. BRANDES, Inc.**  
Wireless Receiver Specialists

32 Union Square, New York, N. Y., Room 823



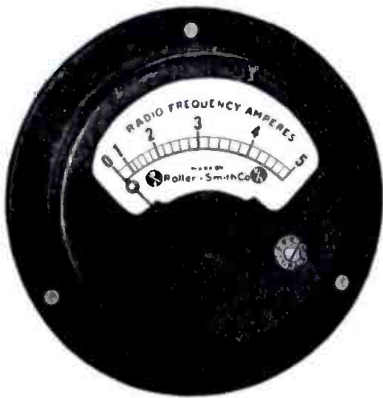

## Quality Instruments

For measuring your transmitter output use Roller-Smith Type TAW Radio Ammeters.

*Because*

They are especially designed for short wave sets, both spark and C. W.

They are accurate on both direct current and on alternating current up to 2,000,000 cycles.

They represent the highest quality instruments obtainable.

Ask your dealer for Type TAW. If he hasn't it, write us and we will put you in touch with one that has.

**POLLER-SMITH COMPANY**  
Electrical Instruments Meters and Circuit Breakers

MAIN OFFICE:

15 Barclay Street, New York

WORKS:

Bethlehem, Pennsylvania

CHICAGO—Monadnock Block

CLEVELAND—6523 Euclid Avenue

DETROIT—Majestic Building

Other Offices in Principal Cities

## STORAGE BATTERIES FOR WIRELESS

We can furnish storage batteries in units of ten cells, sealed in hard rubber case, suitable for "B" battery, for \$9.75, delivered, charged ready for use.

Money back if desired within ten days.  
Maximum discharge rate one ampere.  
Weight 2½ lbs.

LEE STORAGE BATTERY CO.

504 E. State St. Rockford, Ill.

## XX Bakelite Panels

1/8" thick, 12" wide, any length, at 25c per linear inch.  
Shipping weight, 3 lb. per square foot.

## Heavy Gray Cardboard Tubing

¾" and 1" diameters, at 25c per foot, postpaid.  
Order shipped on next mail, guaranteed.

A. K. Lalg. Radio Supplies

Pelham Manor New York

## Developing Radio in the Hills

(Continued from page 230)

of any other concentrated inductance of the present day, and that is for transmission work. There is no reason why this form cannot eventually become a standard and practical inductance for transmission and particularly in power vacuum tube work, where the potentials employed are much easier to handle than either spark or arc sets. This possibility opens up a field of endeavor well worth being seriously considered by our manufacturers of radio apparatus especially those who are today building radiophone and radio telegraph vacuum tube transmitters as well as regular small power sets. Of course this applies to long wave transmission as well as to low wave work such as used by amateurs and which involves very little oscillatory circuit inductance.

### CONCLUSION.

Enough has been said concerning the advisability of individuals so inclined repairing to the distant hills or even in the backwoods where one can give full sway to the development of ideas without fear of being molested by the constant grinding activities of a large city. Cheer up you amateurs who live in the backwoods and thank your lucky stars for your lot. It is often mid such ideal surroundings as are present at Radio Hill that the hopes and ideas of a lifetime may be carried out. Radio development is fortunately one of the things which may be carried out in this manner. Figure it out for yourself whether you be novice, professional, amateur, or top notch engineer. This inventor has secured over 100 patents of various kinds covering not only radio but many mechanical, musical and photographic devices. Under his present ideal surroundings he hopes to double that number within a comparatively short time. What is to stop you or anyone else from doing the same? Peace of mind and plenty of breathing space—that's the secret.

### THE FIRST "AROUND THE WORLD" RADIO MESSAGE.

The following is a copy of the first message to be heard around the world. It was received by Secretary of the Navy Josephus Daniels recently from the Lafayette radio station at Bordeaux, France; the world's most powerful transmitter.

"NSS de Lafayette  
Secretary of the Navy  
Washington, D. C.

This is the first wireless message to be heard around the world and marks the milestone on the road of scientific achievement.

Lafayette Radio Station,  
Aug. 21, 1920, 4:00 A.M."

### NEW RADIO COMPANY FORMED.

Trade Commissioner Brady at Buenos Aires cabled Department of Commerce that organization of a company had been completed which will establish direct radio service between Germany and southern countries of South America.

The company has been capitalized at \$4,300,000, of which about half is held in Germany. Radio service is expected to be established in 1922 and commercial messages will be sent at rates equal to approximately one-third of present cable rates.

## October's Special Value!

DeForest CV 500 Variable Condenser. . . . \$6.05  
Max. capacity, .0005; minimum, lowest possible. Above type has no knob or pointer.

We supply a

Large 3/8" Corwin Knob and Dial. . . . . 1.70

Special Sale Price **\$6.25** Regular Value **\$7.75**

### AERIAL WIRE 1c PER FOOT

7 strands No. 22 solid copper—tin plated to prevent oxidation. Maximum radiation and strength. Maximum strength and radiation. Include postage on 15 lbs. per 100 feet.

### GROUND WIRE 8c PER FOOT

\$7.00 Per 100 Feet  
No. 4 solid copper—triple braid—rubber covered. Include postage on 20 lbs. per 100 feet.



Lightning Switch, \$4.00  
600 volts, 100 amps., S.P.D.T.

### Audiotron Adaptor

Consists of standard 4 prong base with brass supporting connectors. Permits mounting tube in vertical position, no filament will not sag and touch grid.

\$1.75 Postpaid

NEW! — NEW! — NEW!

10,000 OHM GRID LEAK, \$2.50

Designed for VT Transmitters

### HONEYCOMB COIL ADAPTOR

Attach to binding posts of a Murdock or similar variable condenser, insert H-C coil, making a tuning unit. \$1.50 per pair.

See Our Ad on Page 234

**Radio Equipment Co.**

630 Washington St., Boston, II, Mass

## NEW VIBRATONE Jr. RADIO TRANSMITTING SET



This Set Illustrated Above Operates on 110 VOLTS, D. C. or A. C.

It is absolutely complete as shown. Needs no helix, spark gap, condensers, etc., etc. Simply connect to aerial, ground and electric circuit, and send.

### NO BATTERY EXPENSE

Runs all day for 2 cents.

Sends three to five miles.

PRICE \$18.00 COMPLETE

With Key, Plus and 8-foot Cord

Send for descriptive circular 150D—To-day

WIRELESS EQUIPMENT CO., Inc.

188-190 GREENWICH STREET, NEW YORK

## THOSE NAVY TYPE DAILS

—The only ones for sale for amateur use  
90 cents each

THE C and S RADIO CO.

Dept. US1 Omaha, U. S. A.

"Superlative Radio Engineering Productions"

## Arnold Loose Couplers

Combination Loose Coupler Parts and accessories.

Send 3c stamp for literature which is sure to interest you.

J. F. ARNOLD

2082 Lexington Av. N.Y.  
Established 1910

READ THE CLASSIFIED ADVERTISEMENTS ON PAGES 260-262



# SENSITIVE? *The Navy Thinks So*

Improved Type "E".....\$20.00  
 Original Type "C".....\$16.50

Your dealer handles Baldy Phones. If he cannot supply you, send direct.



THE U. S. Navy, the British, French and several other European Governments, in addition to most professional operators, have adopted Baldwin Phones as their standard of electromagnetic receiver excellence.

The reason for this preference is apparent. Exceptional sensitiveness combined with ruggedness gives Baldy Phones their popularity. The diaphragm is made of the finest quality selected mica with the force concentrated at the exact center as in the high-grade phonograph reproducers.

The small armature is pivoted and designed to act as a fulcrum when connected to the diaphragm by a small link. There is no tension or springing of metal as in ordinary receivers. Four pole pieces of a single solenoid act upon both sides of a lightly balanced armature.

## John Firth & Co. Inc.

MAKERS OF  
 U.S. Bureau of Standards *Wavemeter* == *Kolster Decimeter*  
 18 Broadway New York

# Baldwin Phones

*The International Standard for Super Service*

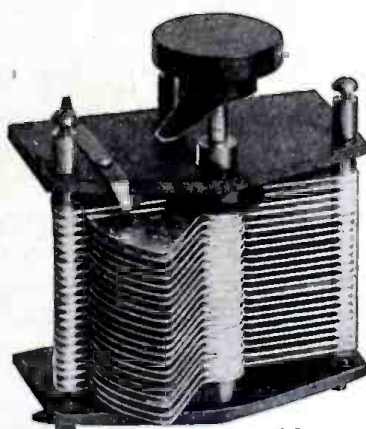

43

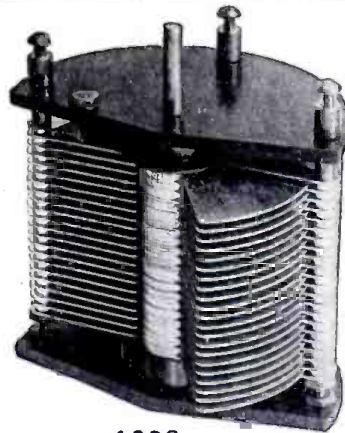

4300

## Entire Satisfaction

is what our customers say.

## ARE YOU

GETTING ENTIRE SATISFACTION from condensers you have purchased elsewhere?

IF NOT, we are sure you will be pleased with what we are offering, *because*, we manufacture *only* the BEST.

*All we ask is GIVE US A TRIAL.*

This month we wish to announce a NEW MODEL of VARIABLE CONDENSER, which will be known as SERIES "T". It is of the same general construction as our SERIES "S" condenser, but is built of heavier material, the aluminum plates being die stamped from 1/32" hard rolled stock. The spacers are also of heavier stock, and the general assembly insures a very rigid instrument. At the present time we are unable to fill orders for the SERIES "S" condenser, as we cannot obtain materials, but can ship the NEW SERIES "T" or the SERIES "L" condenser from stock.

### SERIES "T".

No. 20	2 plate Vernier.	.....	\$2.00
No. 70	7 plate, approx.	.0001 m.f. ....	\$2.35
No. 130	13 " "	.0002 m.f. ....	\$2.75
No. 170	17 " "	.0003 m.f. ....	\$3.15
No. 230	23 " "	.0005 m.f. ....	\$3.60
No. 310	31 " "	.0007 m.f. ....	\$4.30
No. 430	43 " "	.001 m.f. ....	\$5.25
No. 630	63 " "	.0015 m.f. ....	\$7.50

Include postage for one pound to your city.

### PRICES

### SERIES "L".

No. 2300	23 plate, .00075	.....	\$6.00
No. 4300	43 plate, .0013	.....	\$8.00
No. 6300	63 plate, .002	.....	\$10.00

Include postage for two pounds.

Prices include knob and pointer and mounting screws. Specify whether brass or nickel pointer and screws, and thickness of your panel.

Either style of condenser, fitted with indicating dial at additional cost of 75c.

## THE WIRELESS SHOP

511 West Washington St.

A. J. EDGCOMB

Los Angeles, Cal.



## Indicating QUALITY

The Corwin Indicating Dial, by its superior performance of accurate indication is recognized by radio men as a popular and needy addition to any set. It has been further improved and now comes in two sizes, three and three and seven-eighth inches in diameter.



This larger dial (3 7/8") fills the general demand for an indicator to fit the standard one-quarter inch shaft; quality and workmanship better than ever.

3" dial only, 75c; with knob, \$1.30. 3 7/8" dial only, \$1.00; with knob, \$1.70. Sent postpaid anywhere.

We are distributors of the better class of radio apparatus and offer a superior service on products manufactured by A. R. Co. Acme, Radisco, Murdock, Radio Craft, Clapp-Eastham, Moorehead, etc.

Ten cents brings our latest catalog to you, describing the above dial and all standard radio apparatus.

**A. H. CORWIN & CO.**  
Dept. B2, 4 West Park Street  
NEWARK, N. J.

## Wireless Fakes and Fakers

(Continued from page 217)

phone receivers, comprised the epoch-making receiving set. A collection of coils, condensers and switches lent "atmosphere" and confusion to the test, to be sure, and threw our wizard friend off his guard. Meanwhile I connected an ordinary buzzer and two cells of dry battery across the aerial and ground, and placed the sending key on the roof. When the time came for the demonstration of the super-sensitive, extra-long range receiving set, "I was unfortunately called out of the room by some urgent call or other," and two minutes later found me on the roof, key in hand.

For the next half hour that receiving set picked up the most marvellous messages—Peking, Cape Town, Manila, Melbourne, San Francisco, London, Paris, Moscow, Vienna—all call letters from points far and near were heard with equal clearness and volume—and all in English, strange to say. Obviously, I did not possess the means of sending in other languages, and I quite forgot in my excitement that other countries used other languages. Meanwhile our wizard friend was amazed. He had never heard of anything like this set before. And he kept our "secret" by circulating reports of the set far and wide, much to our satisfaction and his subsequent discomfiture when we made the cruel hoax known.

When an art is new the possibilities are tremendous. So little wonder that the early stages of radio found many of us working on the simplest ideas with fondest hopes that we might accidentally stumble on some simple principle that might spell fame and fortune. In those days we trusted to luck, in sharp contrast to the present efficient method of working step by step along definite mathematical lines which are thoroly known to the profession but which, so it seems, hold promise of something more if pushed far enough.

One of our hobbies in those early days was some simple form of transmitter in place of the crashing open spark gap. Somehow or other, a commutator arrangement appealed to us as a discharger. A small battery motor with an extra contact on the commutator, make-and-break, a spark coil and a small condenser were arranged so as to produce a fat high-pitched spark at the commutator break. Listening-in with a crystal detector, the musical spark could be plainly heard above incoming signals; and even in our office three blocks away the signals from the little motor came in quite strong.

Now again I say, in those days everyone was credulous—credulous because the art was new and full of mystery. Physicists and mathematicians had not yet boiled it down to cut and dried equations and rules, and speculation was consequently rife. Our manager became greatly exercised over the battery-motor transmitter. He insisted on a "long-distance" test—between our shop and his home some twelve miles away. Naturally, he never heard us over that distance, but it was a long time before he would admit that the scheme was impracticable. Like all buzzer arrangements, the signals were loud when nearby, but had no carrying qualities.

Interference prevention! This was the rallying cry of most radio inventors of the time of which we write. Practically everyone had solved the interference problem, and it was said that hundreds of stations might operate in close proximity without interfering with each other.

Yet came a day when the writer, left alone with little or nothing to do in a large radio station intended for testing purposes, decided to test out some of the interference

(Continued on page 236)



## Our Paragon Rheostat

has become the standard filament resistance. For back of panel or table mounting 2 1/2" diameter. 8 ohms, 1 1/2 amps. \$1.75 Postpaid Immediate shipment.

Standard VT Socket, \$1.00. Why Pay More?

A-P or Moorhead Electron Relays, \$6.00.

A-P Type SE 1444 Amplifier VT's, \$7.00.

44 Volt Variable "B" Battery, \$3.80.

Complete in handy wooden case and adjustable phosphor-bronze "Jiffy" connectors. Better than block batteries! If one 4.4 v. unit weakens prematurely, it can be removed and replaced, thereby not impairing the total voltage—making this the best battery value on the market.

Fresh 4.4 v. renewal units always in stock.

40c each—or \$3.10 per 10, plus 4 lbs. postage.

Young & McCombs Rotary Spark Gap, \$18.

"Cootie" Key, Double Action, Stands 2 K.W. Plain Brass Finish, \$4.50; Nicked, \$5.00.

Don't Forget!

We carry a complete line of all worthwhile Radio Equipment, such as Acme, General Radio, Murdock, Chelsea, DeForest, etc.

See Our Ad. on Page 232.

## Radio Equipment Co.

630 Washington St.,

Boston, 11, Mass.



## UTTMARK'S NAUTICAL ACADEMY RADIO SCHOOL

NEW YORK

BOSTON

THIS school offers a thorough course in all branches of Radio Telegraphy. Prepares you thoroughly for Government examinations, Merchant Marine, Commercial Land Radio, Radio for Railroads, Radio for Aerial Mail Service, Etc. Elementary and Advanced Classes, day and evening sessions.

Nautical Academy established 1804;  
Radio School, 1920

CAPTAIN F. E. UTTMARK, Principal

Write, call or phone for illustrated booklet.

8 STATE ST., NEW YORK, N. Y.

Facing Battery Park, N. Y.

Telephone, Bowling Green 8079

For Radio — UTTMARK'S — For Navigation

## STANDARD RADIO EQUIPMENT

MURDOCK BRANDS BURGESS GREBE BENWOOD SPEC. DE-FOREST  
AGENTS FOR FEDERAL TEL. AMERICAN RADIO AUDIO TRON CHICAGO RADIO LAB. DUBILIER TRESCO AND OTHERS  
U. of I. SUPPLY STORE, Inc.  
627-29-31 SOUTH WRIGHT STREET  
CHAMPAIGN, ILLINOIS

## WIRELESS TELEGRAPHY

Make your own "Wireless," also Dynamos, Batteries, Motors, Telegraph, Telephone, Lights, Bells, Alarms, Coils, Current Reverser, Electric Engines, etc. Book with 75 Illustrations; by experts so anyone can understand it. With Catalog. All 10c, 3 for 25c pp

J. C. Dorn, 705 S. Dearborn St., Dept. 21, Chicago, Ill.

## YOU NEED LOCOMA

an interesting, inspiring, instructive MAGAZINE, dealing with the serious side of Personal Subjects — LOVE, MARRIAGE, DIVORCE, BIRTH CONTROL, EUGENICS, SEX HYGIENE, etc. 15c. a copy, \$1.50 a year, 8 months, trial 50c 100 E. E. & M. Bldg., Farmington, Michigan.

NEW LAMPS FOR OLD ONES!!!  
A recent agreement with the  
EASTERN VACUUM TUBE LABORATORIES  
Permits us to extend  
RELIABLE AND PROMPT SERVICE  
in the repair of vacuum tubes  
Audiotrons, Electron Relays,  
Moorhead VT'S, Marconi VT'S } \$3.50  
W.E. and other makes quoted on request.  
"Satisfaction in Ten Days"  
Cash must accompany all orders. Tubes must be  
carefully packed to avoid breakage.  
SOMERVILLE RADIO LABORATORY  
See Our Ad. on Page 217.  
102 Heath St. Somerville, 45, Mass.

## RADIO APPARATUS

built to your specifications. Raw material and parts. Machine work done for experimenters. Get my prices before buying elsewhere.



A. C. PENFIELD  
CONNEAUTVILLE, PA.



# A New Radio Production

## TURNNEY SPIDER-WEB INDUCTANCE

### EMBODIED IN A SMALL UNIT

Statement:	Reason
<p>More Inductance</p> 	<p><i>There is no magnetic leakage in coupling. The coils being flat, the entire magnetic area of the coil is available.</i></p>
<p>Less Distributed Capacity</p> 	<p><i>The wire runs parallel for a greater distance and crosses itself less frequently than any coil known.</i></p>
<p>Lower High Frequency Resistance</p> 	<p><i>There being no interior magnetic field or air core, high frequency resistance is reduced to a minimum.</i></p>
<p>Occupies Less Space</p>	<p><i>The coils are so thin that three of them occupy less than 1/4 inch.</i></p>

THE WINDING  
Note Angle at Crossing.  
Formica Core.

*The Turnney Spider-Web Unit*

This unit contains three Turnney spider-web inductance coils. Two movable and one stationary. There are six binding posts permitting most any type of circuit to be used. The doors, as shown in cut, are capable of very fine adjustment and stay where they are placed. With two condensers, .0005 and .001 m.f., it will respond to wavelengths of 75 to 100 meters, and to give results such as you have not had before.

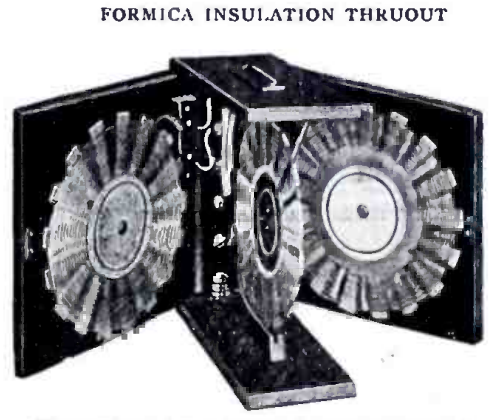

Illustration shows front of cabinet removed

Patent Pending  
Dimensions, 4 1/2 x 5 x 1 1/4  
PRICE, \$6.00

EUGENE T. TURNNEY LABORATORIES  
Holmes, New York

*Further information on request*

## APPARATUS WHICH EXCELS

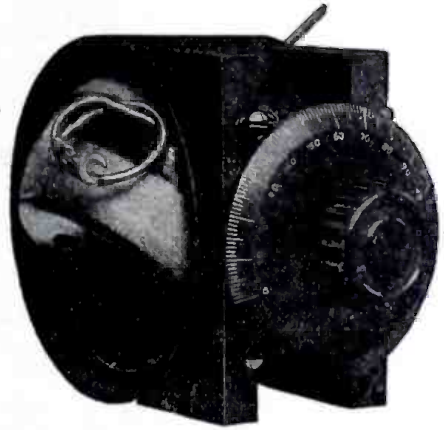

in those qualities which for 13 years have maintained its enviable reputation for reliability will be found pre-eminent in the display rooms of discriminating dealers and is manufactured by

**CLAPP-EASTHAM COMPANY**  
120 Main Street CAMBRIDGE, MASS.

*Catalog sent for 6c stamps.*

TYPE Z.R.V. Variometer has unit construction with bakelite shell and hard wood ball. Has low dielectric losses and a range of inductance of 1.25 mil henry maximum to .1 mil henry minimum. It is readily used on a table or mounted on panels.

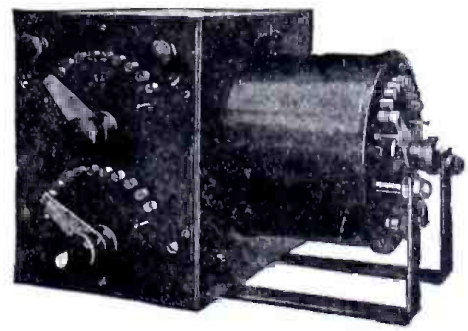

Complete with 3-inch dial and knob.....\$6.50  
Without dial or knob..... 5.75

Radion Receiving Transformer  
200-3000 Meters. Price \$14.00



# Boys! Learn the Hidden Secrets of the Air ★

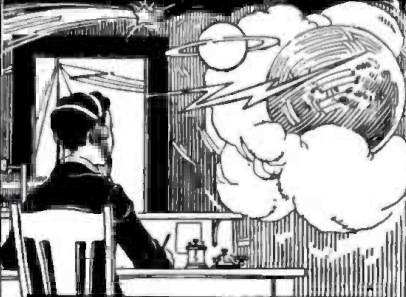

Listen in! Startling news flashed from far corners of the earth—or boy operators chatting with each other by wireless. No wonder large numbers of boys have taken up wonderful wireless. Be one of them Yourself. Catch messages.

## Send Messages! Our New Wireless Manual Tells You How

Tells all you want to know about wireless. Describes how messages travel. How to put up equipment, "aerials", "wave lengths", receiving, sending and all other points. Gives the codes, too. A handy text book and catalog on wireless. The finest ever published.

Send 25 cents. Ask for Wireless Manual M 12. We credit the 25 cents on first order. Thus you can get this **FREE** splendid book

Write at once—address nearest office

Manhattan Electrical Supply Co., Inc.  
New York, Chicago  
St. Louis, San Francisco



(Continued from page 234)

prevention systems about which so much had been said. Throwing the automatic starter of the two-kilowatt motor-generator set, he was soon ready to send. A station about 25 miles away happened to be calling up another station some 150 miles farther. The writer broke right in on the conversation and insisted on receiving a report on how his signals came in. At first the station called refused to pay any attention, but after ten minutes, during which it must have been impossible for the operator to hear the distant station, he changed his mind. And the same experiment was tried with other stations the same afternoon, with about the same results. And yet we heard no end to the marvellous accounts of interference preventers!

Speaking of interference, there was a doctor in New York City who had a personal grievance against one of the large radio companies then in full bloom of its short-lived glory. Of course, the reader will appreciate that we are writing about a time when there were no radio laws or regulations of any kind. The ether was simply a huge aerial battlefield, with the law of the survival of the fittest applying in full measure. The fellow with the most powerful spark did much as he wanted.

The doctor in question, wishing to interfere with the traffic of the company in every way possible, installed a 10-kilowatt transformer in his uptown apartment. Day in and day out found him, or some of his many amateur friends, operating that 10-kilowatt transformer and making an awful splash in the ether for miles around. Indeed, he could just about drown out everything around New York City, but his signals soon died down a few miles out of the city. His station had no carrying power, to be sure; but, after all, his main endeavor was to interfere with a certain group of stations in the city so as to make life unbearable if not impossible for them. And he certainly did. The commercial stations had to suspend operations, more or less, while the doctor amused himself with his transmitter.

However all that may have been, the radio telephone, then in its infancy, presented the best field of all for the radio faker. We cannot help recalling the case of a German radio company which gave a demonstration of its radiophone before the German authorities. The demonstration was a complete success: the set transmitted over a surprisingly great distance, farther, in fact, than had ever been attempted up till that time. Then someone let the cat out of the bag. It was proved that the great distance spanned was due to the telegraph lines running parallel with the transmitting aerial at one end and with the receiving aerial at the other. The radiophone messages were merely induced in the telegraph lines which served as the conducting medium between the stations.

Then there is the case of an American company which radiophoned over a surprisingly great distance also. Everything went fine. The conversation was clear and lost little by the fact that it was spanning a hundred miles of air. Later on, some cruel person let it be known that this radio company, long since defunct, had hired a telegraph line for the occasion and that the tests were really undertaken over the usual circuits. Of course, the tests should be convincing; and what could be more certain than to use the tried and proved methods of telephony? The laymen would not know any better, so why not? But the truth will out every time, eventually.

A decade or more has passed since the experiences of which we write here. In that time radio has undergone a great change for the better. The questionable gentlemen who played so conspicuous a part in the early history of the art and

(Concluded on page 238)

# KLAUS RADIO CO.

Radio and Electrical Apparatus Manufacturers of

EUREKA, ILLINOIS

Distributors for

- Grebe
- De Forest
- Murdock
- Moorhead
- Radisco
- Thordarson
- Clapp-Eastham
- Amrad
- Amco
- Acme, etc.

Catalog 6c

**SPECIAL PROPOSITION for Responsible Dealers.**

Bulletins Issued Monthly

## Canadian Amateurs

TREMENDOUS saving in COST by dealing with a Canadian Firm specializing in Supplying your requirements.

Have that last year's set completed. We carry a full line of parts.

Our Apparatus is backed up by **GUARANTEE. QUALITY of WORKMANSHIP and LOW PRICE.**

## Radisco Agents

Also TRESKO knock down Condensers and Tuners carried in stock.

**THE VIMY SUPPLY CO.**  
567 College Street  
TORONTO, ONT.

## What's in a Name?

An open statement to all Radio men, by C. H. Rauschenberg, proprietor of the Penn Radio Apparatus Co., of Greenville, Pa.

**THE Penn Radio Apparatus Co.**, of Greenville, Pa., is the original company of that name. Through two years of fair dealing we have secured the confidence and good-will of hundreds of radio men.

Recently several new companies have been started with names similar to our own. This causes confusion and as we stand on our own merits and wish to avoid any misunderstanding, we have decided to adopt a new name which will distinguish us clearly from all other concerns. Hereafter we will be known as the

## 20th Century Radio Co.

This new name involves no change of policy whatsoever, and you can still rely on us as in the past for

Complete stocks,—prompt service,—fair prices.

**WHY** not get in touch with us when you want some new radio equipment of any kind?

Cordially yours,  
C. H. Rauschenberg.

New catalogue just out mailed for five cents in stamps

## Electrical Manufacturers!!

(Attention)

Our Service at your disposal

## Siegert Pattern Works

Wood and Metal Patterns and Models

813-15 W. 35th St. Chicago, Ill.

**G. A. Grid Condenser**



Price 35c Postpaid in U.S.A. 40c.  
A Condenser at 35c that Replaces \$1.00  
**THE GENERAL APPARATUS CO.**  
570-N West 184th St. New York City

It will pay you to read the Classified Ads. Turn to pages 260-262



**"USE THE TUBE THE NAVY USES"—**

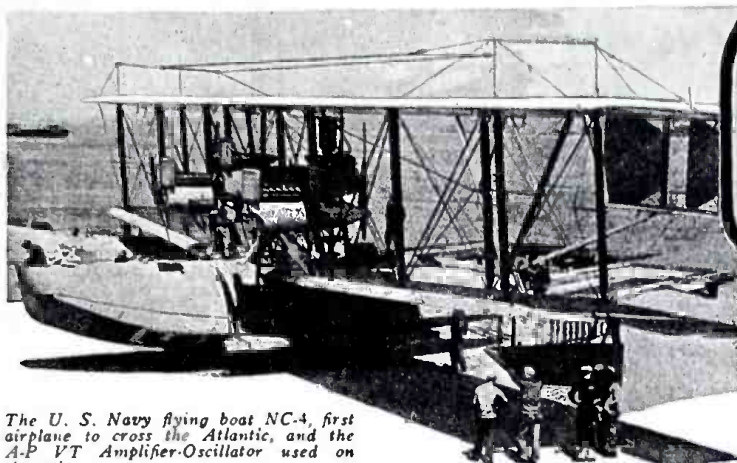

*The U. S. Navy flying boat NC-4, first airplane to cross the Atlantic, and the A-P VT Amplifier-Oscillator used on the trip.*



**THE A-P VT  
AMPLIFIER-  
OSCILLATOR**

Equipped with the SHAW standard four-pronged base.

**A-P TUBES CROSS WITH NC-4**

**W**ITH such remarkable efficiency did the A-P tubes serve on this trip, so much did they contribute to the success of this great achievement that the Bureau of Engineering of the U. S. Navy voluntarily wrote our Laboratories a letter of appreciation.

**Amateurs—"Use the Tube the Navy Uses"—the A-P VT Amplifier-Oscillator—price \$7.00. Order from your dealer. Descriptive pamphlet free upon request.**

*A-P Tubes manufactured under the De Forest Audion and Fleming patents. Other patents applied for and pending.*

Used in conjunction with the A-P Amplifier Oscillator is our A-P Electron Relay, price \$6. A combination of two or more A-P VT tubes as amplifiers with an A-P Electron Relay as the initial detector or oscillator is the ideal receiving combination for long distance amateur or long wave reception.

**ATLANTIC RADIO SUPPLIES COMPANY**  
8 Kirk Place Newark, New Jersey

**PACIFIC RADIO SUPPLIES COMPANY**  
638 Mission Street, San Francisco, California  
*Distributors for Moorhead Laboratories*

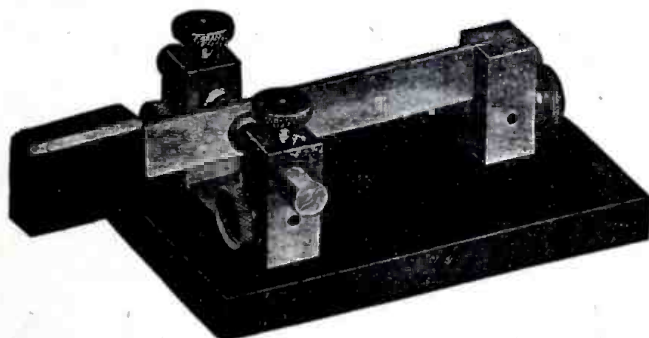

**THE  
"COOTIE"  
WIRELESS KEY**

**A "KNOCK-EM-DEAD" BEAUTY,**  
(as one of our customers named it)  
Thousands in use in every radio district.  
Will handle 1 K.W. satisfactorily

The "Cootie" key is the snappiest sending device offered on the market for reliable spacing of characters. Listen to 9NV, 9LU, 9MS, 9UG, 9BY, and judge for yourself. Large standards, formica knob, substantial silver contacts suitable for use up to 2KW. The double action of the "Cootie" key lends an individuality to your sending.

**PRICE \$5.00**  
AT  
YOUR DEALER

**EXCLUSIVE REPRESENTATIVES**  
9th Radio District

**MANHATTAN ELECTRIC SUPPLY CO.**  
114 So. 5th Ave. Chicago, Ill.

6th Radio District  
**L. MEYBERG COMPANY**  
428 Market St. San Francisco, Cal.

3rd Radio District  
**RADIO ENGINEERING COMPANY**  
827 Madison Ave. Baltimore, Md.

7th Radio District  
**L. MEYBERG COMPANY**  
428 Market St. San Francisco, Cal.

5th Radio District  
**ROSE RADIO SUPPLY CO.**  
121 Camp St. New Orleans, La.

Immediate  
Deliveries  
Money-Back  
Guarantee



Manufacturers  
Jobbers  
Distributors of  
Radio Supplies

Send 4c in Stamps for Our 50 Page Catalog of Radio Supplies



## We Take Pleasure

in announcing the opening of a branch store of the ATLANTIC RADIO CO., at 15 Temple Street, Portland, Me., facilitating quick deliveries to Northern New England amateurs. A complete stock of Radio Equipment is available at all times.

**This Month** we call your attention to the two new instruments are designed to incorporate the standard Vacuum Tube, Engraved Bakelite Panel in Oak Base.

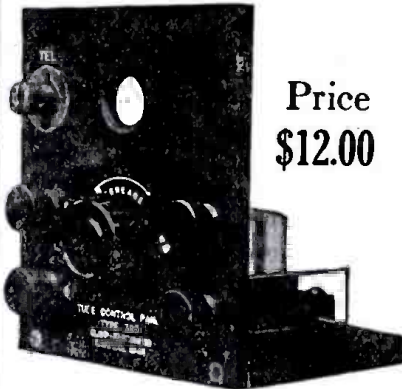

Price  
\$12.00



Price  
\$18.00

### Read This Letter

Rochester, N. Y.  
June 30, 1920.

Atlantic Radio Co.

Gentlemen:—I wish to thank you for your very prompt service which you gave me on my last order and for your ability to deliver at once just what was wanted. Such service as I received is so unusual that I cannot refrain from thanking you. The goods you sent were all perfect and the best of the kind I have yet seen.

Very truly yours,  
(Name on request.)

**"Bulletin 14"** 108 pages—  
over 100 illustrations—sent upon receipt of ten cents. A Rebate Certificate good for 10 cents on first dollar order is inclosed.

## ATLANTIC RADIO CO.

Incorporated

MAIN OFFICE:  
88 Broad St., Boston 9, Mass.  
PORTLAND BRANCH:  
15 Temple St., Portland, Maine



## DO YOU KNOW ?

**Type 101 Panel Switch**  
A beautiful and efficient rotary switch for general use. Furnished in two sizes.  
1" radius brass finish 40c. Nickel finish 50c.  
1½" radius brass finish 50c. Nickel finish 60c.

**Type 102 Panel Switch**  
A compound switch consisting of two electrically independent switches mounted with concentric knobs.  
1½" radius brass finish \$1.10. Nickel finish \$1.25.

**Type 103 Panel Switch**  
A rotary panel switch which is double pole and double throw. Will change variable condenser from series to parallel, etc.  
1½" radius brass finish 75c. Nickel finish 85c.

**Type 104 Panel Switch**  
A complete unit for back of panel mounting. The latest and best in rotary panel switches. Better looking, more efficient and easier to mount.  
Complete with Type 116 Dial and 6 contacts \$2.25.  
Complete with Type 116 Dial and 11 contacts \$2.50.

**Switch Contacts**  
Threaded shank contacts with heads 3/16" x ¼"—14 other styles in our catalog.  
No. 112E Brass 2½c. No. 112F Nickel 4c.

**Type 116 Indicating Dials**  
Of polished hard rubber accurately engraved, filled with brilliant white, furnished complete with knob and bushing to fit 3/16" shaft. 90° scale 0-50 or 180° scale 0-100.  
3" diameter \$1.25. 3" diameter \$1.50.

**Type 5A Variometer Parts**  
Set No. 1 contains carefully turned wooden parts including winding form. Price \$2.50.  
Set No. 2 contains all parts including 3" Type 116 Indicating Dial. Price \$5.00.

**Type 14A Rotary Gap**  
The best gap on the market. Belt driven well quenched, clear tone and high efficiency. Price \$10.00.

THAT the designs used in WILCOX products are "THE BEST" because they are the result of scientific research and careful engineering.  
WILCOX DESIGNS don't "JUST HAPPEN."

THAT the materials used in WILCOX products are "THE BEST" because no others are considered by our engineers or purchasing department.  
WILCOX MATERIALS are "THE MARKET'S BEST."

THAT the workmanship on WILCOX products is "THE BEST" because it is performed by skilled craftsmen working with modern tools.  
WILCOX WORKMANSHIP is "EXACTLY RIGHT."

THAT "WILCOX" means "THE BEST" IT'S THE TRUTH.

### THE WILCOX LABORATORIES

Engineers and Manufacturers

LANSING Dept. G MICHIGAN

Order from this ad or send five cents for catalog. All prices Postpaid.

We are prepared to make apparatus to order or do any kind of experimental work.

(Continued from page 236)

who were to blame for the unsavory reputation which radio once had in the financial world, have been exposed, one by one, and expelled from the field. Men of integrity, real skill and knowledge have taken their place. The art today is built on a substantial foundation and no longer can practical jokes be played except on the veriest beginner. We live in the age of cold facts.

### RADIO TELEPHONY SIMPLIFIED —A CORRECTION

Concerning "Radio Telephony Simplified," which appeared in Radio News for September, on pages 146-147, an error was made in drafting the circuit diagram of Fig. 9, on page 147. By referring to this page it will be seen that the "B" batteries are directly shorted. The correction should be as follows:

The horizontal line extending between the lower part of grid leak R to the upright battery—inductance lines should be cut out. If this is not quite clear the editors will send diagram upon request.

### Radio Dictionary

(Continued from page 223)

**Resistance (Radiation)**—This is the ratio of the total energy radiated (per second) by the antenna to the square of the R.M.S. current at a potential node (generally the ground connection).

**Resistance, Radio Frequency**—This is the ratio of the heat produced per second in watts to the square of the R.M.S. current (r.f.) in amperes in a conductor.

**Resonance**—Resonance of a circuit to a given exciting alternating E.M.F. is that condition due to variation of the inductance or capacity in which the resulting effective current (or voltage) in that circuit is a maximum.

**Note 1.**—Instead of varying the inductance and capacity of a circuit the frequency of the exciting field may be varied. The condition of resonance is determined by the frequency at which the current (or voltage) is a maximum.

**Note 2.**—The resonance frequency corresponds the more accurately to the frequency of the free oscillations of a circuit, the lower the damping of the exciting alternating field and of the excited circuit.

**Residual Charge**—Charge left in a condenser after the first momentary discharge. It is due to Electric Absorption.

**Residual Magnetism**—Magnetism retained by a piece of iron after magnetizing force is withdrawn.

**Resinous Electricity**—Early name for negative charges. Adopted because it was produced by rubbing resinous substances with fur. See Vitreous.

**Resistance**—Opposition to flow of current.

In a wire is directly proportional to length, directly proportional to specific resistance, and inversely proportional to its cross-section. Shape of material does not affect resistance; but see Reactance, etc. Unit is Ohm, which see.

**Resistance Box**—A box containing a number of wire coils of known resistance, which may be connected up in various ways, by means of switches or plugs, to produce any desired total resistance.

**Resistivity**—See Specific Resistance.

**Resonance**—Exists where the natural frequency of a circuit has the same value as the frequency of the alternating or periodic E.M.F. set up in it. The E.M.F. is then in Tune or Sympathy with the Natural Frequency of the circuit.

**Resonator**—Device for detecting by resonance oscillations produced by an oscillator. See Hertzian Resonator. Term is also used in United States when referring to sound box employed with telegraph sounder.





# The Newest Radio Development— The DeForest Portable Buzzer “Radiophone”\*

Type O. T.—5



DeForest Portable “Radiophone”  
Transmitter Buzzer Type O. T.—5  
\*“Radiophone” Name Copyrighted.

THE latest development of the famous DeForest Oscillation Transmitter (Wireless Telephone). For Automobiles, Motor and Sail Boats, Camps, Surveying and Exploring Parties, Forest Patrol, Farms, and all isolated places, this new “Radiophone” Set offers sure, quick, practical word-of-mouth communication. Operates on two 6-volt storage batteries; no “B” battery or other outside source of high potential is required. Can be easily transported; entire Transmitter, including batteries, weighs less than 60 pounds. Range on ordinary Amateur aerial is 5 to 10 miles, and can be materially exceeded under proper conditions. Operates with any suitable type of Receiver and Audion Detector; with or without an Audion Amplifier, depending on the range to be covered and loudness of reception desired.

**Price** Without Storage Batteries **\$135.00**  
Including Vacuum Tubes

F. O. B. New York

Investigate this new DeForest production now. Order at once to insure early delivery; either thru your regular dealer or direct from us.

**DE FOREST RADIO TELEPHONE AND TELEGRAPH COMPANY**

Inventors and Manufacturers of High Grade Radio Apparatus

1415 Sedgwick Avenue

New York, N. Y.

Lee DeForest, Inc., 451 Third St., San Francisco, Western Distributors



## Gassy or Soft Vacuum Tubes Are The Best Detectors

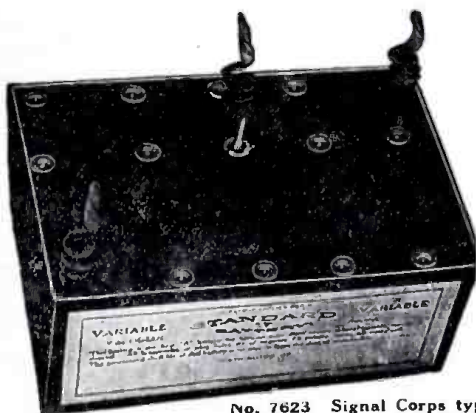

No. 7650 Standard Vacuum Tube Plate  
Battery. (Patent Applied For) Price \$3.25

IT is a fact that gassy or soft vacuum tubes are still the best detectors, but in order to obtain the maximum efficiency from such tubes it is absolutely essential that a variable plate battery be used. The No. 7650 VARIABLE STANDARD VT BATTERY is constructed in such a manner that the voltage may be adjusted by steps of 1½ volts for any plate potential from 1½ to 22½ volts. This is accomplished by having permanently soldered “Arranbee” jacks at each cell and using an “Arranbee” plug with flexible lead, which combination ensured perfect connection wherever employed.

Not only do we supply the battery herein described, but we also handle a battery of the Signal Corps type and the Navy type, as follows:

- No. 7623 Signal Corps type 2 x 2½ inches x 3¾ inches, 250 hours service, \$1.35
- No. 7625 Navy type 6½ x 4 x 3 inches, 1200 hours service, \$2.40

Dealers, Jobbers, and Distributors, write for our discounts

The STANDARD VT BATTERY will be found on sale at all live dealers. The guarantee protects you.

Insist on the Standard V.T.—Do Not Accept Substitutes

**PACENT ELECTRIC COMPANY, Inc.** REPRESENTING:

A. H. Grabs & Co., Inc. Builders of Regenerative Receivers and other radio apparatus of distinction. Complete new catalog will be sent on receipt of 10 cents in stamps.  
Dubilier Condenser Company, Inc. Builders of Mica Condensers for transmitting, receiving and laboratory work. Catalog will be sent on receipt of 10 cents in stamps.

Richter-Schottler Co. Manufacturers of dry batteries for vacuum tube work. Bulletin R1 is yours for the asking.

The Magnavox Company. Manufacturers of loud speakers, power amplifiers, voice and music amplifying equipment. Bulletin on request.

Rawson Electrical Instrument Company. Manufacturers of ultra-sensitive instruments for precision and research work.  
Electrical Products Mfg. Co. Manufacturers of Duo-Lateral Coils and other machine wound coils for radio and electrical equipment. Bulletin P1 is yours for the asking. Inquiries on special coils will be given our attention.

150 Nassau Street

Telephone Beekman 5810

New York City



Knock 'Em Dead  
This Winter

# Get A Benwood Disc.

Here is a real disc.

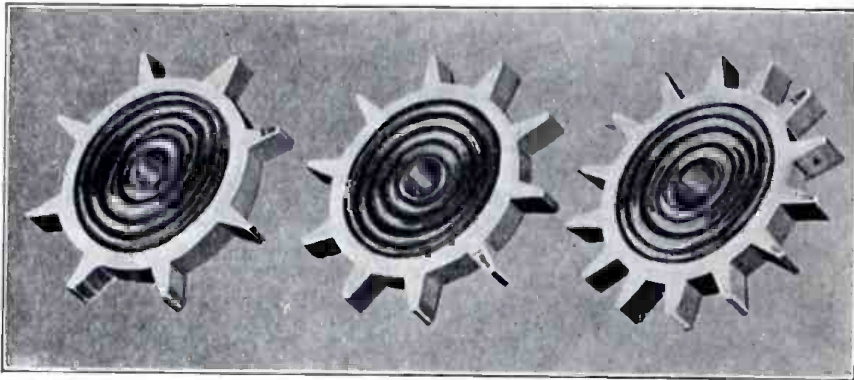

Give the old spark a chance. It will do the rest. Make your call famous thruout the country. Gives a clear musical note. The disc is a solid aluminum casting, true to the hundredth part of an inch.

Made with 4, 8, 10 and 14 points. Drilled for any size motor shaft. Has WIDE sparking points that are tapered, thus giving the quick break that is so much desired by those who know.

Designed for 1 K. W. installations

Order from your dealer. He has them in stock. If not we can ship direct and make IMMEDIATE shipment.

Specify size of motor shaft when ordering.

9 L C

THE BENWOOD CO., Inc.  
Cor. 13th and Olive Sts., St. Louis, Mo.

9 K U

## LOUD SPEAKING HORN

TYPES HD2, HW2, HD5 EACH

\$15.00

NEW TYPE HBH HORN which contains the world-famous mica diaphragm amplifying receiver. Complete with jack, either desk or wall type—

\$25.00

FOR THE PAST FIVE YEARS WE have made a specialty of designing and building loud speakers for all purposes.

### There is a "MODERN" for Every Need

Due to the rapid success of "Modern" Loud Speakers there are many imitations of little or no value on the market to-day. Insist on the genuine, bearing the "Modern" trademark, which is your guarantee.

Intended to be used directly in the 2nd or other stages of your amplifier.

Our experiments and research prove that this type horn is by far superior than other larger and cheaply made horns which are, to say the least, unsightly.

The specially constructed receiver does all the work and gives the wonderful results that "Modern" Loud Speaking Horns are noted for.

WRITE FOR BULLETIN A2 WHICH DESCRIBES OUR LOUD SPEAKERS AND OTHER APPARATUS.



WRITE FOR BULLETINS



FOR SALE AT ALL "MODERN" AGENCIES

ELIZABETH NEW JERSEY

"The Rail and Harbor City"

## The Radio Man's Code

(Continued from page 216)

ately answered by:

"Come in."

The commander was seated comfortably in a large armchair and quite placidly lowered a book he had been reading, when Goodwin entered the room.

"Well?" questioned the captain, "something for me?"

Goodwin answered weakly: "A message from the *Hartford*."

"Hand it over, why the delay?" the commander demanded.

Goodwin hastened to comply, for when a captain orders, there is no hesitation.

"Um," mused the man in the armchair, after reading the radiogram. He looked the wireless man over and noted the ashen face and trembling hands.

"Your brother?"

"Yes sir," the young man's voice was pitiable, "I am sorry but it's part of my job," he whispered. Grief, misery and unhappiness made the face of the young man haggard.

"Um," spoke the captain in a reassuring tone. "You're mistaken, Goodwin; your brother is not guilty. He is not the only Charles Goodwin on this vessel. I shipped a sailor by that name. He is now in irons. Sorry you suffered so, my boy, it shows the making of a man. Send another message to Mrs. Smith telling her about the rescue. . . ."

Goodwin retired from the captain's cabin as one awakening from a dream. His eyes were brilliant with happiness. His brother was no criminal.

The storm roared on; the wind shrieked like a human being in hysterical rage. Nothing resisted its blinding, uproarious fury. An unfastened life boat banged disconsolately at almost regular intervals, as though a part of the irresistible detonations.

Through it all the invincible freighter plodded on as if knowing stern men controlled its perilous movements; and the radio man, ever ready with his mysterious apparatus, would remain at his key no matter what the disaster.

### ENGLISH AS THE UNIVERSAL RADIO LANGUAGE.

From Germany comes the suggestion that English be favored as the international language for use when wireless telegraphy and radio telephony have been made thoroly practical. Most of the troubles incident to the transaction of business and the transmission of news will, it is asserted, come from the use of many different languages, this being only one of several difficulties in the way at the present stage of radio development.

The head of Germany's wireless system, Count Arco, is quoted as saying that while he is an enthusiastic Esperantist, he believes that a popular vote (he is presumably speaking only of Germany) would elect the English tongue for general wireless international use. While it is possible that this opinion is colored to some extent by dislike of France, for whose language as a medium for international communication supremacy has always been claimed, and by the certainty that German would not be used, the idea is a good one.

It is plain that a common speech for radio is desirable, if not absolutely essential. English is undoubtedly understood by more people who are likely to send and receive such messages than any other language. The German suggestion that it be made the official radio speech is practical and worth considering.





**MAGNAVOX**

**RADIO TELEMEGAFONE**

*Type R-1 with small horn \$75*  
*Type R-2 with large horn \$93*

**DEALERS**

Atlantic Radio Co., Boston, Mass.  
Doubleday-Hill Electric Co., Pittsburg, Pa.  
Pacent Electric Co., New York, N. Y.  
Intermountain Electric Co., Salt Lake City, Utah.  
Southern Electrical Co., San Diego, Calif.  
Magnavox Representative, 606 Mutual Life Bldg., Seattle.

*Ask for Bulletin 21020*

**THE MAGNAVOX COMPANY**

2701-2765 EAST 14<sup>TH</sup> STREET  
OAKLAND, CALIFORNIA

*CONNECT "AA" to your detector or amplifier, and "BB" to a 6-volt battery*

## Better Apparatus at Lower Prices

is making our business grow by leaps and bounds. We have the most complete stock in the country ready for the big fall rush and are in a position to make

**PROMPT DELIVERY ON ALL ORDERS**



**COPPER AERIAL WIRE**

**50c per 100 Feet**

Another large shipment of this excellent solid copper wire has just been received by us. The gauge is No. 14 and the wire runs 80 feet to the pound. We also sell No. 12 gauge at 80c per 100 feet. This size approximates 50 feet to the pound.

*A few of the items you can save on*

Esco tested Galena, per sack .....	25c
Esco tested Silicon, per sack .....	30c
Panel type rheostat, shipping weight one pound.....	\$1.00
4-prong V.T. socket on base, shipping weight one pound.....	\$1.50
Slightly used telephone plug and jack, shipping weight 4 ounces, complete .....	85c
AudioTrons, Mooreheads and Marconi Bulbs, immediate delivery.	

*Cash in registered letter, check or money-order must accompany all orders. If shipment by parcel post is desired include postage, otherwise material will be shipped by express collect.*

Our illustrated catalogue of 48 pages is now ready. 15c in stamps will secure a copy. This amount will be credited on your first order for \$1.50 or over.

**Electrical Specialty Company**

Dept. R-48-50 South Front St., Columbus, Ohio  
Dept. R-20 North 9th St., Philadelphia, Pa.

**TWO STORES FOR YOUR CONVENIENCE**

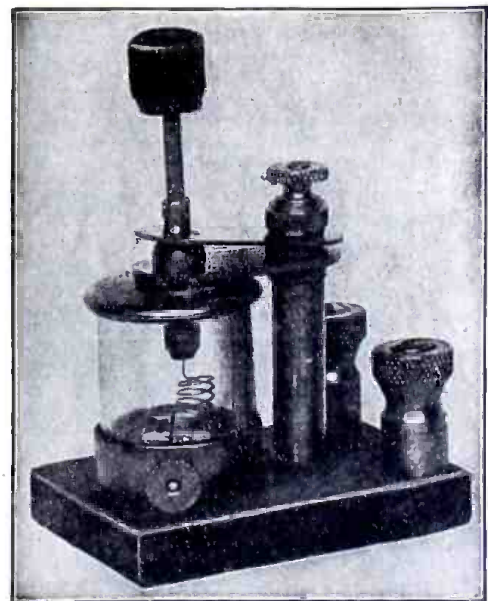

**Weather Proof Crystal Detector**

The type of the detector illustrated is being sold at prices ranging as high as \$4.50. Our price is \$2.80. This instrument is absolutely dust and moisture proof. The crystal, which is one of galena mounted in a block of Woods metal, is encased within a glass cylinder rendering it impervious to atmospheric conditions. Has ball and socket joint. Shipping weight 1 lb Price \$2.80.



**Correspondence from Readers**

(Continued from page 227)

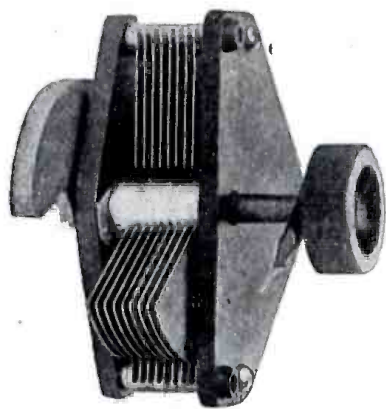

Condenser No. 4

**CHELSEA**  
Variable Condensers  
(Die-Cast Type)

- No. 1.—.0011 m.f. mounted. \$5.00
- No. 2.—.0006 m.f. mounted. \$4.50
- No. 3.—.0011 m.f. unmounted \$4.50
- No. 4.—.0006 m.f. unmounted \$4.00

Top, bottom and knob are genuine bakelite, shaft of steel running in bronze bearings, adjustable tension on movable plates, large scale reading in hundredths, high

amply separated and accurately spaced plates.

Unmounted types will fit any panel and are equipped with counter-weight.

**VARIABLE GRID LEAK**

Permits the selection of the proper leak resistance regardless of the type of tube, or its use as detector, amplifier or oscillator. Ten steps give a range from 1/2 to 5 meg-ohms. Genuine bakelite base and knob.

All our apparatus embodies the highest degree of mechanical construction, electrical efficiency, and good appearance.

Immediate Delivery—Catalog sent upon request

Purchase Chelsea Apparatus from your dealer

**CHELSEA RADIO CO.**

Manufacturers of Radio Apparatus and Moulders of Bakelite



PRICE \$3.00

15 FIFTH STREET  
CHELSEA, MASS.

ing high frequency currents, energy is radiated from the surface of the earth as well as from the sending station, and this energy is entirely lost. For this reason, with the same power, greater distances can be covered with the longer waves than with the shorter; that is, less energy is lost by radiation from the longer waves. Of course this energy is accompanied by a magnetic force and an electric force at right angles to each other and to the line of their travel, the same as the electric energy flowing thru any conductor. In other words, the wave is polarized.

Mr. Sutton states that fading may be due to masses of electrically charged water vapor which pass between stations. How can this account for the so-called "dead spots," when stations seem to talk right over our heads to other stations farther on? If the charged cloud cast an "electric shadow" on our station, I should think that all other stations within the shadow would be unable to hear the signals.

CLYDE J. FITCH,  
Pittsfield, Mass.

**THE FAME OF THE RADIOPHONE SPEEDS.**

Editor of RADIO NEWS:

For about four weeks past I have occasionally heard voices and bits of radio telephone conversation in my receivers when listening in. However, I had never been able to tune in so I could hear them clear, and was puzzled to know where it was coming from.

On the night of Aug. 26th., just after returning from my vacation, I was listening in and heard the voices again. This time I hit a peculiar combination on my set that brought them in almost as clear as talking across town on a wire. The conversation seemed to be in code, but I clearly got the statement that it was Wrigley talking, at Chicago, Ill. The word "Wrigley" being pronounced and spelled out, and Chicago, Ill., pronounced very clearly.

The following day I sat down after dinner to read my August RADIO NEWS, which came while I was away. In this I found an article regarding William Wrigley, Jr., of Chicago, and his Radiophone.

Pursuing my way further I came upon an article on "The Radiophone in California." The next night San Catalina came in as if in the next room instead of 975 miles away. I have listened to them many nights since, depending on the static, and I can say that Southern California amateurs are not the only ones who are enjoying a real treat.

The receiving set I am using consists of a receiving transformer similar to "Duck's 5BB Navy Type," a Marconi "VT" detector, Aud.-Ult. Aud. switch, 2 Murdock variable condensers, Brandes 2000 ohm receivers, grid leak, batteries, etc. I have no amplifier at the present time, but have placed orders for instruments for a one-step audion.

The thing about this performance that seem marvelous, is that this Radiophone, destined for use over a distance of approximately 37 miles, is as audible here, at a distance of 975 miles on a simple receiving set, as it apparently is at the limit of its supposed range.

CHAS. E. BECKWITH,  
Sprague, Washn.



**DUCK'S** New Big 200-Page No. 14  
Wireless Catalog and 100  
Page Electrical Catalog

The wireless catalog mailed for 12c and the electrical catalog for 6c, either in stamps or coin, which amount you are privileged to deduct on your first order of \$1.00. Catalog positively not sent otherwise.

This edition of our wireless catalog is the most complete and elaborate we have ever put out. It embraces everything in wireless worth while. As an encyclopedia of information it is invaluable. It is printed on excellent paper and with a beautiful cover. Your amateur friend will tell you that there never has been any wireless catalog to take the place of Duck's, can absolutely rely on the quality of every instrument listed in this catalog. In a word it is all worth while catalogs in one.

**Audio Tron bulbs prepaid \$6.00**

We discontinued selling Audio Tron bulbs and accessories for a short time but we have again resumed their sale and can guarantee immediate delivery.

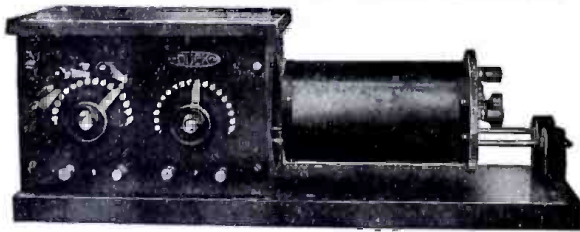

NEW MODEL 5BB. NAVY TYPE RECEIVING TRANSFORMER

A big improvement over our former model. Primary divided into four sections, with three dead end switches, greatly improving selectivity. Secondary divided into three sections, with two dead end switches, eliminating harmonics. The change in the construction of the guide rod support makes it possible to obtain a looser coupling. It is a wonderful improvement over our old model both in performance and appearance. Only \$27.50.

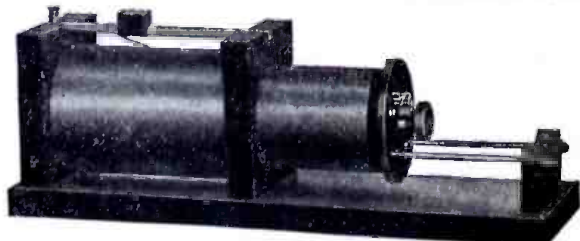

OUR IMPROVED ARLINGTON RECEIVING TRANSFORMER

The secondary on our new type Arlington is divided into three sections with two dead end switches, eliminating dead end effect and harmonics and giving greater selectivity. The end support is similar to that on our Navy type permitting a looser coupling. It is a beautifully finished instrument.

Price Only \$15.00

THE WILLIAM B. DUCK CO., 231-233 Superior St., Toledo, Ohio



**LICENSED RADIO STATION**

CALL  CALL

OWNER \_\_\_\_\_ OPERATOR \_\_\_\_\_

RADIATION \_\_\_\_\_ HOURS OF \_\_\_\_\_  
WAVELENGTHS \_\_\_\_\_ OPERATION \_\_\_\_\_

No. R-400—Should be in every Radio Station. Back-ground white cardboard 8 x 10; words "Licensed Radio Station" in bright red; "Call" in black; "Owner," "Operator" and balance in red. Price each, postpaid, 15c.



No. R-403

A Few Distinctive Items from the  
**FRANKLIN**

Line of Radio Apparatus  
of Quality—Priced Right

**ZONE OF QUIET**

**RADIO RECEIVING STATION**

No. R-401—The most effective card ever produced. Back-ground white cardboard 8 x 10; "Zone of Quiet" bright red; "Radio Receiving Station" and design in black. At least two should be in every station. Price each, postpaid, 15c.

**RADIO STATION WALL CARDS—ORIGINAL AND ATTRACTIVE**

CATALOGUE READY SOON—  
SEND US YOUR NAME NOW

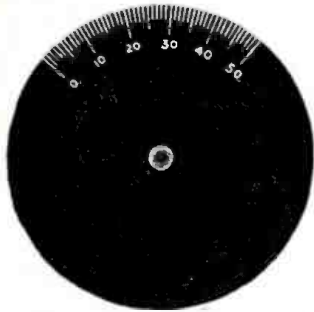

No. R-301—Engraved Bakelite Dial, same quality and finish as No. R-300, suitable for all forms of 90 degree coupling, 2 1/4" in diameter. May be had with two style knobs. Price each, postpaid, 50c.

**HANDS OFF**

**DANGER!**

**HIGH VOLTAGE WIRELESS APPARATUS**

No. R-402—Protect your visitors by hanging one of these cards on your condenser, transformer, spark coil, etc. Back-ground white cardboard 8 x 10; Skull and Crossbones design and word "Danger" in bright red; "Hands Off" and "High Voltage Wireless Apparatus" in black. Price each, postpaid, 15c.

No. R-403—Arrow points the way to your station, and should be used frequently along the route. Back-ground is bright red cardboard 10 x 6. Indicating arrow and "Radio Station" in white. Price each, postpaid, 15c.

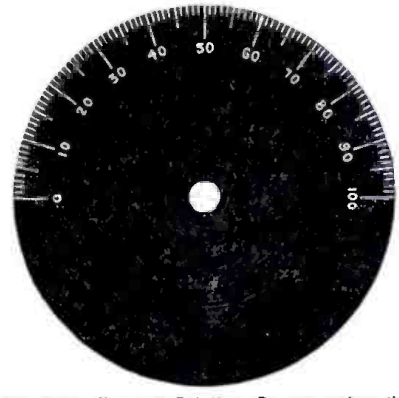

No. R-300—Engraved Bakelite. Do not confuse this item with any other dial on the market, as it is not to be compared with molded, stamped, or pressed dials offered the experimenter. Lathe turned from XX grade sheet Bakelite, 3 inches in diameter, circular grained satin finish, accurately engraved on Gorton machine, and filled with everlasting brilliant white. Also furnished with knobs. Price each, postpaid, 75c.

**THE FRANKLIN POLICY — YOUR SATISFACTION IS NOT DEBATABLE — YOUR MONEY WILL BE PROMPTLY REFUNDED IF YOU ARE NOT PERFECTLY SATISFIED.**

**FRANKLIN SALES COMPANY**      *Manufacturers—Factory Representatives*

**160 N. Wells Street, Chicago**

**Look at these Prices for AUDIOTRONS**

*This advertisement is published by the Kehler Radio Laboratories in an effort to cut down the high cost of radio. We have on hand a considerable stock of genuine new AUDIO TRONS. To gain the confidence and good will of all progressive amateurs, we are offering them for a short time only at these special prices. Nowhere else can you duplicate these prices for*

**AUDIOTRON**

*The original tubular vacuum detector, amplifier, oscillator*

**Your Last Chance**

to get a genuine hand-made, super-sensitive, double-filament, double-life AudioTron detective, amplifier, oscillator. Manufacturing reasons make it impossible to continue the present type of AudioTron. Here's your chance to get some of the last ones at reduced prices.

Now that all restrictions have been lifted and AudioTrons can be used as detectors, amplifiers and oscillators, they are doubly valuable and every amateur should take advantage of this wonderful opportunity.

ONE FOR	<b>\$5.50</b>
TWO FOR	<b>\$5.25</b> each.
THREE FOR	<b>\$5.00</b> each.
FOUR FOR	<b>\$4.75</b> each.
REGULAR PRICE	<b>\$6.00</b>

**Fully Guaranteed**

by us and the AudioTron Manufacturing Company. This type has a double filament of special thorium tungsten and the operating life is over 2,000 hours. No special socket is required. The electrical and mechanical dimensions result in a heavy plate current and corresponding signal strength. Plate voltage over 40.

These tubes are guaranteed to arrive in good condition and to prove fully satisfactory. Replacement of all unsatisfactory tubes will be made free of charge.

**Don't Lose a Minute—Send your order to-day to**

**KEHLER RADIO LABORATORIES**

*901 West First Street, Abilene, Kansas*



### Radio Apparatus

The Mutual Purchasers Association offers radio amateurs membership that will bring them co-operative saving on all purchases of radio and electrical apparatus.

3000 amateurs are now buying everything they need through this association, getting fast service and co-operative buying on the goods of all the radio houses of standing, advertised in this publication.

You can order any popular radio part advertised in this magazine from the association and secure fast service and saving.

Send stamp to Dept. 3 for details and have your name enrolled as a member of this co-operative association without cost.

**MUTUAL PURCHASERS ASSOCIATION**  
2 & 4 Stone St., New York City

### COMBINATION No. 3

Complete set of parts for Audio-Tron Control Panel.

- 1 Filament Rheostat.....\$1.50
- 1 11 plate K.D. Condenser..... 1.80
- 3 laminated blade Switches..... 2.10
- 18 Nickeled Switch Points, 1/4"x1/4"..... .45
- 11 Nickeled Binding Posts..... 1.40

Regular price.....\$7.25

Combination Price **\$5.75**  
Good Until Nov. 15

Optional additional equipment.

- 8"x8"x3/16" Bakelite XX Panels.....\$1.90
- 8 3/4"x8 3/4"x6 1/2" Mahogany Cabinets..... 6.00
- Double Filament AudioTrons..... 6.00



**PENN RADIO APPARATUS CO.**  
1157 Green Street,  
Dept. 3. Reading, Pa.



### KEY AND BUZZER SETS

with high tone adjustable buzzer, and lever type key.  
PRICE \$1.75

WITH FLAT SPRING KEY \$1.25

- Buzzers unmounted.....\$0.50
- Lever keys unmounted..... .75
- 20 amp. batt. switches, bakelite base—
- S. P. S. T..... .40
- S. P. D. T..... .50
- HIGH GRADE LEVER TYPE SENDING KEY,  
BAKELITE BASE AND KNOB..... 1.25

(All postpaid)

**AJAX ELECTRIC CO.**

Palmer St. Cambridge, Mass.

### VACUUM-TUBES REPAIRED

Marconi—Moorhead—Audiotrons  
Four Dollars Each, Postage Paid  
Standard Grid Leaks, \$1.25; Bases, 60c;  
and Sockets, \$1.00.

**THE DALTON LABORATORY**  
Dalton and Belvidere Sts., Boston, 17, Mass.

### Radio Digest

(Continued from page 219)

mands make desirable. To this end the American Telephone and Telegraph Company will, so soon as the necessary construction and equipment can be assembled, extend the universality of its system by wireless stations at selected points on the coast so located as to enable persons and places not able to be connected in any other way to maintain communication with the world through the Bell system."

The Executives now directing the affairs of the American Telephone and Telegraph Company are to be congratulated upon bringing to fruition at this early date the coordination of effort and of interest which will insure extension and progress of modern methods of long distance communication.

The ably managed Radio Corporation of America gains outstanding advantages in this pooling of resources: much wasteful litigation is, very likely avoided; duplication of research and engineering effort is minimized, and it would seem that much may be expected in the way of promptly furthering the hook-up of wire and wireless methods of communication, where this is desirable.—*Telegraph and Telephone Age.*

### WIRELESS TRANSMISSION OF PHOTOGRAPHS.

By MARCUS J. MARTIN

This volume is the second edition of the subject which has just been published by the Wireless Press, Ltd., of London.

The author introduces the present volume by mention of some early experiments in the direction of radiophotography and the conditions involved. The Bernochi, Knudsen and Korn systems are briefly mentioned.

The preparation of the photographs, transmitting and receiving apparatus is described and a comparison made of various systems. Practical application of the art is also considered.

The author describes his own system of radio photography which he has termed the "Telephotograph." In this instance he describes the necessary transmitting and receiving instruments and how they are made to operate. Some excellent data is given in Appendixes, A, B, and C concerning the selenium cell; the preparation of the metal prints, and some timely information on lenses, respectively. These items are very useful due to the fact that these subjects play an important part in the practical radio photography of today.

The author does not claim that he has solved the problems involved in this practically unknown branch of the radio science and does not hesitate to add that present methods are open to improvement. He has, however, treated the subject in an unusually practical point of view and the volume should prove not only interesting but instructive to Americans who are interested in radio photography.

The volume contains 140 pages of text and 77 illustrations, several of which are actual photographs taken of the author's various experimental models.

### RAPID RADIO TRANSMISSION

It is reported that experiments in radio telegraphy by officers employed at the experimental signal station at Woolwich, England, have succeeded in transmitting messages over considerable distance at the speed of 100 words a minute and that very much greater speeds have been proved to be attainable.

### INDICATING DIALS

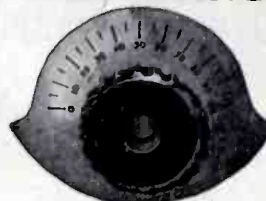

Lacquered brass, 2 1/2" in diameter, genuine bakelite knob 1 1/4" in diameter. Offset shoulders act as stops. Same dial used by

U. S. Signal Corps. Your money refunded if not satisfied. Price, three for one dollar, postpaid.

**The Factory Distributing Co.**  
130 N. Wells Street Chicago, Ill.

### PACIFIC COAST AMATEURS

- Amrad Gaps.....\$18.75
- Magnavox..... 75.00
- Electron Relays..... 6.00
- Moorhead Vt's..... 7.00
- Transmitting Tubes..... 7.50
- Amplifying Transformers..... 5.00
- 2-Stage Amplifiers..... 40.00
- Audion Panels..... 15.00

We stock Radisco-Bunnell-De Forest-Murdoch apparatus—and others.

**NORTHWEST RADIO SERVICE CO.**  
609 Fourth Avenue, Seattle, Wash.

### NEW ORLEANS RADIO

APPARATUS and SUPPLIES

**ROSE RADIO SUPPLY**

604 Gravier St., New Orleans, La.

Send 10c for Latest Catalog

### ABOUT VACUUM TUBES and "B" BATTERIES

We have just received a shipment of Moorehead VT's and Electron Relay tubes

These two classes of tubes used together make a perfect detector and amplifier system as they were designed to operate in conjunction with each other. A fresh supply of Burgess B Batteries for your plate circuit have just arrived and you had better order yours now.

Orders placed now will assure you of prompt delivery.

### PRICES

- Moorehead VT Tubes.....\$7.00
- Moorehead ER Tubes..... 6.00
- Burgess Batteries at regular list prices.

"The House of Service"

**Northern Radio Laboratory**

Specialists in Radio Apparatus

111 Main St., CLYDE, OHIO

The Second Edition of the

### Consolidated Radio Call Book

has met with instantaneous approval. The issue is already nearly exhausted. For a short time only, there will be a few copies at \$1.25 each.

**CONSOLIDATED RADIO CALL BOOK CO.**  
41 Park Row, N. Y. C.

### \* PRICES SLASHED \*

Regardless of Conditions on Condensers, Audions, Phones, Raw Material, Switch Points and etc.

SEND STAMP AT ONCE FOR CIRCULAR  
**RADIO TESTING STATION**  
25 Sturges St., Binghamton, N. Y.



## Electron Power Tubes and Some of Their Application

(Continued from page 205)

supports and also variations in emissivity factor for different samples of tungsten. This curve is plotted from Dr. Langmuir's published data.\*

In types of high power tubes in which the plates are of tungsten or molybdenum and are located close to the plate and operated at a bright red heat, the filament temperature will be higher than when the plates are cold. Therefore, in the operation of such a tube the filament current may be reduced after the plates have come up to their normal operating temperature.

Altho in vacuum tube circuits it is advisable to include a voltmeter or ammeter in the circuit of the filament or filaments, such an instrument should not be wholly relied upon for filament adjustment.

The best practise is to operate tubes at the lowest filament temperature consistent with satisfactory operation. In this way maximum tube life will be obtained.

### (3) Insufficient Exhaust Treatment

As is now well known, it is not only necessary to reduce the gas pressure in the bulb to a minimum, but it is even more important to free the internal parts from gas so that the pressure of gas in the bulb remains low thruout the life of the tube.

The exhausting process for a vacuum tube increases in difficulty the higher the power of the tube and the higher the voltage at which it is to operate.

This condition arises at higher powers and voltages, owing to the fact that the positive ionization effects are greater and the temperature of the parts higher.

Keeping the glass walls of the tube cool by artificial means will help to better the vacuum, because it not only prevents the glass from liberating gas, but may actually enable it to absorb some gas that might be liberated from other parts of the tube.

### (4) Insufficient Dielectric Strength in the Materials Holding the Electrodes and in the Lead-in Wires or Terminals.

In a three-element oscillating tube the maximum voltage occurs between the grid and plate and may easily reach a value three times the normal operating plate voltage. This is due to the fact that with a pure inductance in the plate circuit the current may vary between zero and twice normal value each cycle, and therefore the voltage between filament and grid may vary between zero and twice normal. At the same time there is a 180-degree relation between grid and plate voltage; therefore, with a tube of low amplification constant the grid voltage may easily reach the value of average plate voltage.

It will therefore be seen that with a tube operating at a plate voltage of several thousands, the dielectric strain may be considerable. Owing to the temperature at which power tubes operate this factor is made more serious.

A high vacuum is the best insulator under these conditions and air at atmospheric pressure also is a good insulator.

Glass, however, is necessarily used for supports. The dielectric strength of glass decreases rapidly with increase of temperature. This is true of all grades of glass but the effect is much more marked in some grades than in others.

Hot glass is conductive and acts like an electrolytic solution. Bubbles of gas form at the negative electrode and if this electrode is one of the seal-in wires leakage of air soon results.

(Continued on next page)

\* "The Characteristics of Tungsten Filaments as Functions of Temperature," by Irving Langmuir, G. E. REVIEW, Vol. 19, No. 3, March '16.

# LEARN WIRELESS AT HOME

## The Demand for Good Wireless Operators Far Exceeds the Supply

The New York Wireless Institute will make you an operator—AT HOME—in your spare time—quickly, easily and thoroughly. No previous training or experience required. Our Home Study Course has been prepared by Mr. L. R. Krumm, Chief Radio Inspector, Bureau of Navigation, N. Y. Radio experts able to impart their practical and technical knowledge to YOU in an easy to understand way, will direct your entire Course. The graded lessons mailed you will prove so fascinating that you will be eager for the next one. The instruments furnished free, will make it as easy to learn the Code as it was to learn to talk. All you will have to do, is to listen.

### Big Salaries

Wireless operators receive excellent salaries ranging from \$125 to \$200 a month and it is only a stepping stone to better positions. There is practically no limit to your earning power. Men who but yesterday were Wireless Operators are now holding positions as Radio Engineers, Radio Inspectors, Radio Salesmen at salaries up to \$5000 a year.

### Travel the World Over

A Wireless Operator can visit all parts of the world and receive fine pay and maintenance at the same time. Do you prefer a steady position without travel? There are many opportunities at the numerous land stations or with the Commercial Wireless or with the Steamship Companies.

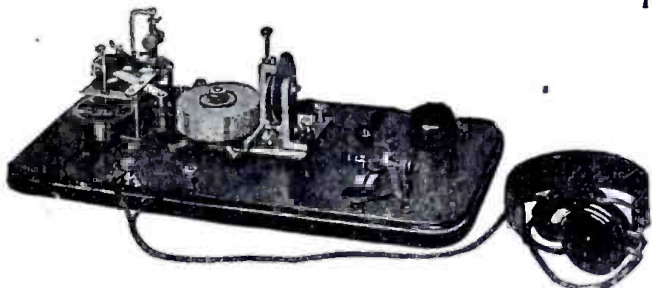

This wonderful Set for learning the Code furnished free with our Course

The Transmitter shown is the celebrated *Omnigraph* used by several Departments of the U. S. Government and by the leading Universities, Colleges, Technical and Telegraph Schools throughout the U. S. and Canada. Start the *Omnigraph*, place the phone to your ear and this remarkable invention will send you Wireless Messages, the same as though you were receiving them, through the air, from a Wireless Station hundreds of miles away. When you apply for your license, the U. S. Government will test you with the *Omnigraph*—the same model *Omnigraph* as we furnish to our students. Ask any U. S. Radio Inspector to verify this.

### FREE Post-Graduate Course

A one month's Post-Graduate Course, if you so desire, at one of the largest Wireless Schools in N. Y. City. New York—the Wonder City—the largest port in the World and the Headquarters of every leading Wireless and Steamship Company.

### FREE Instruments and Text Books

We furnish free to all students, during the course, the wonderful receiving and sending set exactly as produced in the illustration. This set is not loaned, but given to all students completing the Course.

### Easy Payments

A small payment down will enroll you. We will make the payments so easy that anyone ambitious to enter the fastest growing profession—Wireless—may do so.

### Send for FREE Booklet

Without obligating you in any way, send for our booklet "How to Become an Expert Wireless Operator"—it is free. Mail the coupon below, or postal or letter—but do it today.

**NEW YORK WIRELESS INSTITUTE**  
Dept. 22, 258 Broadway  
New York City

New York Wireless Institute  
Dept. 22, 258 B'way, N. Y. City

Send me free of charge, your booklet "How to Become an Expert Wireless Operator," containing full particulars of your Course, including your Free Instrument Offer.

Name .....

Address .....

City or Town.....State.....



# Try This Sensitive Radio Head Set

It is equipped with non-conducting spool heads and slotted pole tips which eliminate eddy current losses. Furthermore all operating parts of these

## STROMBERG-CARLSON Radio Head Sets

are housed in dust and moisture-proof aluminum cases. Have adjustments for temperature variations. Strongly constructed; very sensitive for use on shore or aboard ship.



This sample set will be sent upon receipt of \$12. 6-foot moisture-proof cord attached. For commercial or private radio service. Money refunded if not satisfied.

Bulletin 1206R gives full particulars. Write Today.

Stromberg-Carlson Tel. Mfg. Co.  
ROCHESTER, N. Y.



# NEW MOTORS

FACTORY GUARANTEED ALL SIZES PROMPT DELIVERY

### Polyphase Motors

9 and 3 phase. A. C., 440 v. 60c., 1750 R. P. M. Complete with base and pulley

- 1/2 H. P. - \$46.50
- 1 H. P. - \$66.50
- 2 H. P. - \$86.50
- 3 H. P. - \$98.50
- 5 H. P. - \$116.50

### Direct Current Motors

110 or 220 volts, D. C. shunt wound, 1750 R. P. M. With base pulley and starting box.

- 1/4 H. P. Washing Machine Motor - \$28.50
- 1/4 H. P., 32 v. Washing Machine Motor - \$28.50
- 1/2 H. P. - \$58.50
- 1 H. P. - \$82.50
- 2 H. P. - \$124.50
- 3 H. P. - \$142.50
- 5 H. P. - \$218.50

### Single Phase Motors

110-220 volts, A. C., 60 cycle, 1750 R. P. M. with pulley

- 1/4 H. P., 220 v. induction Washing Machine Motor - \$28.50
- 1/4 H. P., 110 v. grinding buffing motor - \$28.50
- 1/2 H. P. induction, full load start - \$46.50
- 1/2 H. P. repulsion induction For compressor motor - \$54.50
- 1 H. P. repulsion induction, Special Garage Motor - \$74.50
- 2 H. P. repulsion induction with sliding base - \$126.50
- 3 H. P. repulsion induction with sliding base - \$146.50
- 5 H. P. repulsion induction with sliding base - \$188.50

### Charging Generators

Suitable for all lighting, Battery Charging and Power Requirements.

- 8 v., 10 amp. - \$19.50
- 15 v., 10 amp. - \$26.50
- 40 v., 6 amp. - \$31.50
- 110 v., 2 1/2 amp. - \$31.50
- 110 v., 5 amp. - \$52.50
- 40 v., 12 amp. - \$52.50
- 110 v., 9 1/2 amp. - \$67.50
- 40 v., 25 amp. - \$67.50
- 110 v., 18 amp. - \$116.50
- 40 v., 50 amp. - \$116.50
- 110 v., 26 amp. - \$156.50
- 110 v., 50 amp. - \$238.50
- Moving Picture Air Generator 60 c., 35 a. - \$116.50

WRITE FOR CATALOG. BARGAINS IN MOTORS AND GENERATORS

**1/4 SPECIAL**  
110 volts  
A. C., 60 c.  
S. P., 1750 R. P. M.  
Complete, cord, plug and pulley

**WASHING MACHINE MOTORS**  
Specially designed for operating Small Commercial Grinders, Bottle Washers, Etc. Reg. Val. \$24.50

**\$26.50**  
Each

MONEY BACK

GUARANTEE

SHIPPING TERMS: 25% deposit required on all orders. Balance C. O. D. by Express. Sight draft with Bill of Lading attached by freight.

MANUFACTURERS' DISTRIBUTOR

CHAS. H. JOHNSTON, Box 16, West End, Pittsburgh, Pa.



VIEW IN RADIO LABORATORY

# Become a Commercial Operator on the Pacific Coast

Positions constantly open on vessels plying to South America, the Orient, Alaska, Hawaii and Atlantic Coast. Salaries, \$125 and expenses. Best equipped Radio School on Pacific Coast. For further information address

**Y. M. C. A. School of Radio Telegraphy**  
Seattle, Washington



It is interesting to note that in a tube in which the leads are brought thru a pinch seal the electrolysis is much more serious with the tube oscillating than with the tube operating non-oscillating with the same plate voltage and energy loss in the tube.

With the best grades of glass at a temperature of about 400 degrees C, the dielectric strength at high frequency is less than a layer of air of equal thickness.

Therefore, in the design of a high-power tube it is necessary to have the electrical path between electrodes thru the glass as long as possible and located in one of the cooler parts of the bulb.

Under certain conditions of improper adjustment of the oscillating circuit the voltage between grid and filament may rise very high. This necessitates careful insulation between these leads both in the tube and in the base.

Related to this question of dielectric strength between electrodes is the question of high frequency dielectric losses in the material employed, such as the glass of the tube and the insulating materials of the bases. This factor becomes very important because often these dielectric are subjected to an intense electric field of high frequency.

If the materials used have a high dielectric loss heat will be generated at the points of loss, adding to the liability of breakdown and also decreasing the efficiency of oscillation.

(5) *Insufficient Mechanical Strength to Withstand the Mechanical Force Due to the Electric Fields.*

The filament and grid mesh are most subject to this strain, because of their comparatively small size. The most usual effect of this strain is a contact between filament and grid or grid and plate.

On several occasions the writer has seen double helix spiral filaments pulled into almost two parallel strands by this force. Also, if the plates are operated by alternating current of a commercial frequency, some of the grid strands may have mechanical resonance to this frequency and vibrate to destruction.

When operating an audible frequency oscillator it is not uncommon to have the tube emit a distinctly audible tone of the frequency generated.

(6) *Improper Geometrical Design or Construction*

If the value of the amplification constant is too low, an excessive grid excitation voltage is required for power oscillation. This makes more difficult the problems of mechanical and dielectric strengths

If the value of plate impedance is too high for the voltage used or for the output desired, the grid current will be excessive while oscillating because the grid must be carried to a high positive value to obtain the necessary maximum of plate current.

In this case also greater emission will be required to supply the added grid current.

This question of proper proportioning of the electrodes to obtain the best electrical constants is not within the scope of this paper. These two examples were stated to give an idea of some of the factors involved.

As in most cases of design, the final choice of constants is a compromise which, it is believed, will give the best results under the conditions of service.

In the case of a power vacuum tube, certain practical considerations usually decide the electrical design rather than the choice of the electrical constants for absolute maximum output.

In the case of a tungsten filament type of tube the plate voltage is chosen as high as possible consistent with the operating conditions and procurability of the voltage source.



The desired power output being decided upon, and knowing the probable efficiency, the input direct current is then determined. It is then best to design the elements of the tube so that at full plate voltage, with the filament at a maximum temperature, the plate current will not exceed two or three times normal oscillating value when the grid is at zero potential.

Although a design made in this way will show a higher impedance and therefore a somewhat lower output than the use of a lower impedance, the ease of handling and safety to the tube during telegraphic operation and particularly while making adjustments more than compensate, it is believed, for the loss in maximum output.

For efficient operation and use of the tube as a modulator, as large a value of amplification constant as possible is advisable; this choice, of course, assuming a value of impedance as chosen above.

In the foregoing it is understood that by impedance is meant the value obtained from the slope of the plate-voltage plate-current curve. This, of course, is not the apparent resistance of the tube found by dividing the plate voltage by plate current for a given value of grid voltage.

It is possible that future developments in the vacuum tube art might make maximum output a better criterion than ease and safety of operation, the latter being gained by auxiliary and protective devices.

The question of the possible efficiency of the vacuum tube as a generator of oscillations is dependent to some extent on the proper tube design, but much more largely on the circuit employed. This question has been quite thoroly investigated and reported upon in a very interesting paper recently presented.\*

**DESCRIPTION OF PLIOTRON POWER TUBE**

As an example of a three-element power tube, the Type P pliotron will be described.

This tube is rated at 250 watts output with 1500 volts on the plate. The filament consumes about 80 watts. The plate current at full load is approximately 300 milliamperes. This tube is shown in Fig. 2, a view of the grid filament and plate elements being also included.

The bulb and glass parts are constructed of Pyrex, a special strong heat-resisting glass. The globular part is five inches in diameter and there are two arms extending from opposite sides making, when based, a total overall length of approximately 14 1/4 inches.

The cathode arm is 2 1/2 inches and the anode arm 1 1/2 inches in diameter. The net weight is approximately 25 ounces. For shipment the tubes are crated individually.

There are three terminals in the base at the cathode end. The center blade is the grid terminal, the two pins being the filament terminals. The anode terminal is the cap at the anode end.

The filament is of ductile tungsten wire W-shaped in form. The range of filament current used is 3.5 to 4.0 amperes.

The U-shaped grid frame and the wire forming the grid mesh are of tungsten and are freed from gas by the exhaust treatment.

The anode or plate are of tungsten supported by molybdenum rods. The plates and these rods are, of course, thoroly freed from gas during the exhaust treatment.

Under normal operating conditions the plates run at a dull red heat. During exhaust treatment they are brought up to a brilliant red heat by electron bombardment dissipating nearly 2 kw. of energy. An average characteristic curve plotted between grid voltage and plate current for this type of tube is given in Fig. 3.

(Continued on next page)

\*"The Vacuum Tube as a Generator of Alternating Current Power," by J. H. Morecroft and H. T. Fritz. Presented before the Philadelphia meeting of the A.I.E.E., October 10, 1919.

# Announcing The New 1921 Model RED HEAD RADIO RECEIVERS A Triumph in Radio 'Phone Building

The Famous  
**ARLINGTON**  
TESTED CRYSTALS  
The Acknowledged  
Standard in Radio  
Detector Minerals.



It has been said by advanced radio physicists that vacuum tubes are no more sensitive than "very good" spots on galena. Hundreds of testimonials now in our files testify to the probability of such a statement. These letters come from users of Arlington Tested Crystals. Arlington Tested Minerals have been on the market seven years and are sold by reputable dealers everywhere. Each crystal is individually tested and boxed in a lithographed metal container. Imitations are available but you can be assured of the original genuine crystals by looking for the signature "J. S. Newman" on each box.

- N A A Tested Galena, post-paid .....35c
- N A A Tested Silicon, post-paid .....35c

**Mail Order Service**  
Our mail order department is prepared to make practically immediate shipment on all radio apparatus of the following standard makes:

- |          |            |
|----------|------------|
| DeForest | Thordarson |
| Murdock  | Acme       |
| Signal   | Mignon     |
| Grebe    | Amrad      |
| Amrad    | And Many   |
| Bunnell  | Others     |

Mail your orders to us and be assured of real radio service.

3000  
ohms



\$12.50  
set

The new "Red Heads" are ready. Rugged and sturdy as ever—but even more exquisitely sensitive. The same handsome appearance—but wound to a higher resistance.

The same guarantee—we, not you, assume the risk.

For five years Red Head Receivers have held an enviable position in the radio field.

The new model will maintain their popularity.

*Detail:* 1,500 ohms each receiver (3,000 ohms per pair); cast aluminum backs; genuine Bakelite ear caps, re-enforced cords with strain loops and posts; phosphor bronze head bands. Money refunded if Red Heads don't please you.

Price, prepaid anywhere, \$12.50 complete set.

Catalogues Free on Request

## The Newman-Stern Co.

1874-76 East Sixth Street Cleveland, Ohio

These Distributors can supply "Red Heads" and N A A Minerals to Dealers and Experimenters:  
DeForest Radio Telephone and Telegraph Co., New York. J. H. Bunnell Co., New York.  
Signal Electric Co., Menominee, Mich. Lee DeForest Co., San Francisco, Cal.



Our TYPE J METERS while low in price, are rugged, accurate and of refined appearance, widely used on Gov't apparatus. Max. Dia. 3 1/4 inches. Prompt shipment on 0-3 & 0-5 Ammeters and 0-100; 0-300; & 0-500 Milli-Ammeters.

For a few months, to introduce, **\$6.00** POST PAID

Our bulletins—sent for 4c—on Radiophone & CW Accessories List everything you need.  
Place your order now for the new DeForest Buzzer Radiophone, \$135. PROMPT DELIVERY  
**Somerville Radio Laboratory**  
102 Heath St., Somerville 45, Mass.

### ANNOUNCEMENT

Our Improved type Honeycomb Coil Adaptor can be used in many New ways—as in back-of-panel coupling mountings, attachment plugs for unmounted lattice coils, etc.—because it has

**ADJUSTABLE ARMS** permitting it to fit any pair of binding posts, etc. Try one!

**No Increase 75c** In Price  
Separate N. P. Brass Jacks and Plugs to fasten direct on panel, for single H-C coil mounting, 35c per set.



# TUNGSTEN AND MOLYBDENUM

FANSTEEL PRODUCTS CO. INC.  
MFRS. OF

## TUNGSTEN

CONTACTS  
SPARK GAPS  
BUTTONS  
ROD  $\frac{1}{2}$  INCH DIAM. TO .050 INCH. DIAM.  
SHEET

## MOLYBDENUM

SHEET  
ROD  $\frac{1}{2}$  INCH DIAM. TO .050 INCH. DIAM.  
WIRE TO .020 INCH. DIAM.  
SPECIAL SHAPES

OUR LABORATORY WILL ANSWER YOUR QUESTIONS

TRADE **FANSTEEL** MARK

CHICAGO, ILLINOIS  
FACTORY & LABORATORY-NORTH CHICAGO, ILL.

## INTRODUCING RAY-DI-CO (NOT INC.)

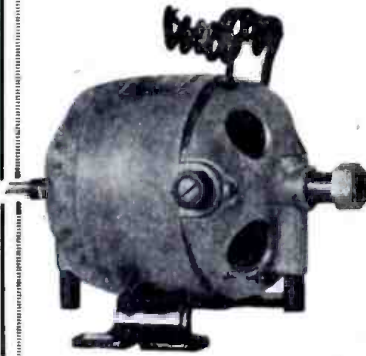

### 50-ONLY, SPECIAL RAY-DI-CO

Spark Gap Motors Type C-2. 110 Volts  
Specify A. C. or D. C.

THESE MOTORS  
EQUIPPED WITH  
SPECIAL THRUST  
BEARING.

Special introductory price  
This lot only

**\$ 8.15**  
EACH

ELIMINATING  
VIBRATION.  
SATISFACTION  
GUARANTEED.

Postpaid in U. S. A.  
REG. PRICE \$13.85

### RAY-DI-CO. (NOT INC.)

Radio Supplies

CHICAGO, ILL.

2653 N. CLARK ST.

Specializing in the designing and construction of Radio Phones to your specifications.

Come to our  
**RADIO EXHIBIT**  
at the **ELECTRICAL SHOW**  
OCTOBER 6th to 16th, inclusive  
You will find us on the second floor

BOTH 207

Grand Central Palace  
44th Street & Lexington Ave.

We will show everything imaginable that would interest an amateur, from the smallest radio part to the complete station.

### NEW PRICE LIST

A new complete price list of all Radio Apparatus and parts ready October 1st.

**AMERICAN ELECTRO TECHNICAL APPLIANCE CO.**  
Dept. E, 235 Fulton Street New York

It is interesting to estimate the future development in size and output of the three-element power tube.

In the opinion of the writer, the physical dimensions of the glass bulb pliotron are somewhere near their limits. This is because large glass constructions are expensive to build, difficult to safely ship, and a very slight mishap, such as a small crack or leak, practically destroys the total value of the tube.

It is believed that the much-to-be-desired increase in power output per tube unit will be obtained in one or more of the following ways:

(1) Increase of plate voltage for the glass tubes up to the neighborhood of 100,000 volts, or whatever limit is set by the feasibility of the production and use of such a high voltage. By the use of these high voltages, in special circuits, which seem possible of development, a very high efficiency is probable, so that possibly 100 kw. may be generated by a pair of tubes each not much larger except for terminal arms than the Type P tube described.

(2) By the use of a hermetically sealed metal tube.

(3) By the use of a metal or glass tube or combination in which the vacuum is maintained by a continual or intermittent method of exhaustion.

In any case the use of as high a voltage as practical is desirable.

The advantages of increased voltage are due to the fact that for a given output the currents are smaller, thus simplifying the problems of emission and space charge. The outputs and efficiencies can be made higher because more voltage is available for the output circuit and a smaller proportion is lost in the tube.

Part II of this important paper will be concluded in our November issue.

Preserve the present issue as some of the illustrations will be referred to in the final installment.

## Reporting News by Radio

(Continued from page 202)

These important events bring home to us the realization of the great importance of radio telephony. While these two experiments were conducted more as test cases than with the intention of continuing them permanently, there is no doubt that within a short time not only newspapers, but hospitals ambulance service, police and fire departments, train and ship service and countless other important organizations will recognize the value of the radiophone and make use of it practically and permanently. To this end, let us all work together, we who are in the radio field, towards the simplification of present systems. This will be a step in the right direction as prospective users of the radiophone cannot be expected to spend months in learning the systems which are rather complicated when compared with the familiar and ever ready land wire telephony.

### THESE DAMP CELLARS.

Ma: Joe gets undamp signals now.  
Pa: Yes, I know; he moved his radio station from the cellar to the main floor.—  
Mario Ottino.

### JUNIORS!

Are you carefully preserving each installment of our Radio Dictionary and pasting same in a blank note book for reference?



## Navy Broadcasts for Amateurs

### Code Translations for Month of August

*(Editor's Note: Each month an abstract of the amateur code messages sent out by the New York Radio Station NAH will be published in RADIO AMATEUR NEWS. The purpose of this is so that amateurs who copy this code may have a means of checking up what they have received and thus know how they are progressing in receiving ability.)*

The following messages were broadcasted in the Amateur Radio Code by Navy Radio Station, New York, N. Y., on 1,500 meter wavelength, during August, 1920:

Aug. 1—English—The Navy Officials at Forty four Whitehall Street New York have been authorized to offer special inducements to ex Navy men who wish to enlist for two years to make cruise on USS St Louis scheduled to depart for Turkey in near future.

Aug. 2—Code Two—New Radio Station at Marion, Massachusetts call "WSO" transmits on eleven thousand five hundred meters to POZ Nauen Germany.

Aug. 3—Code Two—Boy Scouts of America announce free trip to Eastern States Exposition lasting seven days early in September will be given to forty Boy Scouts stop Applications stating qualifications should be addressed to Boy Scouts of America Headquarters Fifth Avenue Building New York City

Aug. 4—None sent due to urgent Government business.

Aug. 5—Plain English—Following received from London quote Do a good turn daily seems to mean break a world record daily to the Boy Scouts of America delegates to the Scout contests of the World in London period Latest sensational feat that of the famous Pine Tree Patrol of Miami Florida who established worlds record in trek cart competition period Our eight scouts covered five hundred yards over obstacles with two wheeled trek cart loaded with sand bags weighing four hundred pounds in two minutes comma fiftythree and three fifths seconds comma unloading cart to go over wall comma loading again comma running through pool of water and so on period Took competing Welsh team over four minutes unquote.

Aug. 6—Code Four—Steamer Coronia call letters MRA will conduct high power arc test off the United States coast on twenty four hundred meters at one AM and nine AM seventy fifth meridian time August eighth comma ninth comma and tenth.

Aug. 6—Code Six—Navy eight oared crew comma by winning national championship July twenty fourth comma become American representatives at Olympic Games.

Aug. 7—Code Six—Press bulletins from the Olympic Games will be forwarded by NAH.

Aug. 8—Code Two—Ex German warships Ostfriesland and Frankfurt scheduled to anchor in North River New York August ninth.

Aug. 9—Code Ten—It is understood that Sayville Radio Station call letters NDD will transmit on eighteen hundred meters wave length for new schedule beginning August ninth.

Aug. 10—Code Six—Acknowledge letter from operator Reynolds Camp Meade Maryland period Book containing call letters of all United States radio stations may be obtained from Government Printing Office Washington DC for ten cents per copy.

Aug. 11—Code Four—Five service balloons are entered for National Balloon Race scheduled to start from Indianapolis September eleventh.

Aug. 12—Code Two—Four seaplanes are being tested at Moorehead City North Carolina to be used for rescue work by the Coast Guard Service during September and October.

Aug. 13—Code Two—The War Department has authorized an official air flight from Panama to Washington DC early in September.

Aug. 14—Code Two—Quote Boy Scouts of America Delegation at International Scout Jamboree comma London comma was awarded by vote of all present comma first place in the chief event of the Jamboree period This included a demonstration of all Scout activities period Denver Scout Band won second place in World Championship contest period Delegation left for Paris on August ninth period Signed Boy Scouts of America in quote.

Aug. 15—No broadcast sent due to urgent Government work.

Aug. 16—Code Four—Acknowledge correspondence dated tenth from Operator Patch Dubuque Iowa too late to make arrangements suggested period Letter follows.

Aug. 18—Code Eight—Associated Press dispatch states Italian destroyer Alberto Carlo Racchia comma struck a mine in the Black Sea near entrance to Bosphorus July twenty fourth comma nineteen of the crew perished.

Aug. 19—Code Two—Press dispatch states Germany's war losses were nearly two million dead and missing.

Aug. 20—Code Four—Chief Bender once star pitcher of Philadelphia Americans and now manager of New Haven club pitched no hit no run game against Bridgeport club of Eastern League Nineteenth August.

Aug. 21—Plain English—Quote Antwerp August Nineteenth period The Boy Scouts of America Jamboree delegation called for home from Antwerp on the Army Transport Princess Matoka Wednesday morning period All well period On Tuesday the delegation was the guard of honor to King Albert at the Olympic Games and on the same day visited Cardinal Mercier.

## "SIGNAL" RADIO APPARATUS



"Signal" Wireless Practice Set  
No. R68.....\$2.50

This was one of the most popular sets in use by army and navy men during the war. This set is a necessity to those who wish to learn the Continental Code.

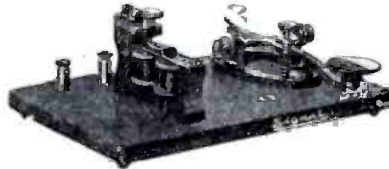

"Signal" Adjustable Practice Set  
No. R69.....\$2.90

The demand for adjustable practice buzzers has grown so great that we have developed this new type, whose note can be adjusted from the lowest pitch to a shrill scream.



"Signal" Standard Wireless Key  
No. R62—6 contacts.....\$3.70  
No. R63— $\frac{1}{4}$ " contacts..... 4.50  
No. R64— $\frac{3}{8}$ " contacts..... 5.50

Our "Signal" standard key is made entirely of brass, finished satin and lacquered. Perfect adjustment is obtained by heavy screws and locknuts. Insulation is of special mica bushings. Contacts are of pure coin silver.



"Signal" Overland Wireless Key  
No. R65—6 contacts.....\$5.25  
No. R66— $\frac{1}{4}$ " contacts..... 6.00  
No. R67— $\frac{3}{8}$ " contacts..... 7.00

This fine key is made in accordance with commercial standards. The base is of polished marble; the frame is heavy brass, carefully machined. The lever is of solid brass and very long, which allows a smooth, resilient action. The contacts are coin silver, and firmly set.

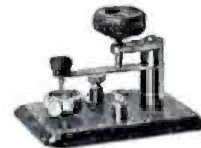

"Signal" Silicon Detector  
No. R40.....\$2.00

Our Silicon Detector is so constructed as to permit of very fine, yet rigid, adjustment. Being universal in adjustment, it may be adjusted to any degree of pressure and will hold its setting indefinitely. Metal parts are highly nickel plated. The base is of black insulating material.



"Signal" Junior Loose Coupler  
No. R24.....\$6.00

To satisfy the demand of the beginner for a small, loose coupler capable of receiving amateur and 600 M. wave length, we have brought out this very efficient instrument. Its extreme range is about 800 M. and will tune well under 200 M. It is well constructed of birch, mahogany finished. Brass parts are polished and lacquered.

Secure "Signal" Apparatus from your dealer, or if he cannot supply you write our nearest distributor giving your dealers name.

### SIGNAL ELECTRIC MFG. CO. MENOMINEE, MICH.

DEALERS—For prices and discount write any of the following distributors:

- |   |  |
|---|--|
| P. M. Dreyfuss Co., 150 Chambers St., New York, N. Y.         | Signal Electric Mfg. Co., 33 S. Clinton St., Chicago, Ill. |
| Newman Stern Co., 1874 6th St., Cleveland, Ohio               | G. C. Kowfeldt & Co., Minneapolis, Minn.                   |
| A. W. Marshall Co., 141 Jefferson Ave., Detroit, Mich.        | Globe Commercial Co., 618 Mission St., San Francisco, Cal. |
| C. H. Walls & Co., 1433 Syndicate Trust Bldg., St. Louis, Mo. | Irlan & Powers, Canal Bank Bldg., New Orleans, La.         |
|   | R. E. T. Pringle Co., 95 King St. E., Toronto, Ont.        |
|   | R. E. T. Pringle Co., New Blinks Bldg., Montreal, Que.     |

## YOU HAVE A BEAUTIFUL FACE BUT YOUR NOSE?





**BEFORE                      AFTER**

**I**N THIS DAY AND AGE attention to your appearance is an absolute necessity if you expect to make the most out of life. Not only should you wish to appear as attractive as possible, for your own self-satisfaction, which is alone well worth your efforts, but you will find the world in general judging you greatly, if not wholly, by your "looks," therefore it pays to "look your best" at all times. Permit no one to see you looking otherwise; it will injure your welfare! Upon the impression you constantly make rests the failure or success of your life. Which is to be your ultimate destiny? My new *Nose-Shaper*, "TRILETY" (Model 24) corrects new ill-shaped noses without operation, quickly, safely and permanently. It is pleasant and does not interfere with one's daily occupation, being worn at night.

Write today for free booklet, which tells you how to correct ill-shaped noses without cost if not satisfactory.

**M. TRILETY, Face Specialist      1432 Ackerman Bldg., Binghamton, N. Y.**



## FALL TERM NOW STARTING

Registration now open for complete standardized course preparing you for first grade commercial license and best paying positions. Individual instruction in classes of limited size.

Not merely a school, but a real home for the out-of-town student. Comfortable dormitory rooms, modern gymnasium and swimming pool.

Write for descriptive booklet F

## Y.M.C.A. RADIO SCHOOL

MARCY AVE., NEAR BROADWAY

Brooklyn, N. Y.

Telephone, Williamsburg 3800

## When Signals Are Weak

They can be brought in one hundred times stronger if you connect into circuit a



### Vacuum-Tube Detector and Two-Stage Audio-Frequency Amplifier



TYPE RORD

This instrument embodies the latest development in Amplifier construction—The Grebe Automatic Control. A telephone jack and plug system controls both the filament and telephone circuits automatically. With the plug in the first jack the Detector only is in use; in the second jack one stage of amplification is added and the output transferred to the telephones. In the third jack the second stage is connected into circuit and the complete unit is in operation.

There are three posts for the B battery; the outer posts are connected to the end terminals of the B battery; the intermediate post to a tap on the B battery. Thus, the full voltage of the battery is applied to the AMPLIFIER tubes while any desired part of the same battery is applied to the DETECTOR tube.

Ask your Dealer to show you this and other Grebe Models—if he doesn't carry our line, write us for Catalog—mentioning his name.

A. H. GREBE & CO., Inc., 72 Van Wyck Boulevard, Richmond Hill, N. Y.

## REAL RADIO APPARATUS

Distributors—De Forest, Murdock, Grebe, Clapp Eastham Apparatus. Perfection Tuners and Condensers. Benwood Rotary Quenched, Honey Comb Coils, Better "B" Batteries.

Phila., "Radisco Agency"  
The First Wireless School in America.

Established 1911  
Day and Evening Classes.  
Correspondence Course.

### PHILADELPHIA SCHOOL OF WIRELESS TELEGRAPHY

Parkway Bldg., Broad and Cherry Streets

Headquarters for Grebe Apparatus in  
Philadelphia Territory.



IMMEDIATE DELIVERIES

LEADING MANUFACTURERS' PRODUCTS

## WESTERN RADIO ELECTRIC COMPANY

ESTABLISHED

"FOR BETTER SERVICE TO THE WESTERNER"

550 South Flower Street

Los Angeles, Cal.

A \$2.00 bill will bring you interesting reading and worth while ideas for many months to come. Bound volume No. 1 of Radio Amateur News, \$2.00 plus postage. Experimenter Publishing Company, 236a Fulton Street, New York City.

## A Finish for Your Cabinet

(Continued from page 214)

When the third and last coat has set hard the rubbing begins. Get a piece of burlap or a piece of Brussels' carpet and fasten it around a flat wooden block. Dip the block into oil (machine or cylinder oil) so as to get oil on the burlap, then dip into some powdered pumicestone (procured at any drug store) and rub the cabinet lengthwise on all sides until it is perfectly smooth and glossy. To get a good finish it is necessary to rub a great deal, using plenty of pumicestone. When you have finished rubbing wipe the whole cabinet off with a rag saturated with gasoline. This is to take off all the oil left in the process of rubbing. If you prefer a dull finish to the glossy one after rubbing with the pumicestone wax it with Johnson's floor wax.

Contributed by J. B. LONDON.

## The "Casey" Station at Savannah

(Continued from page 220)

wing and amplification, audio and radio frequency. Loop transmitting and receiving has come in for a little investigation also; this is a most acceptable form for demonstration, as it is absolutely "wireless," and even the skeptical are quickly convinced, rather a difficulty when using a water pipe.

The main antenna is flat top, between two telegraph poles, directional north; flat top 90 feet, seven phosphor bronze wires; lead in, four wires bunched, 60 feet long to lightning switch. Lead in insulator to take care of 5 kilowatts. All leads of copper tubing.

We have done a little long-distance work, as follows: University of Michigan, 8XA; Ashland, Ohio; Salem, Ohio; Norfolk, Va.; Washington, 3XF, and many others. Perhaps the most noteworthy is Georgia Institute of Technology, 4YA, in Atlanta, which station, although not very far in miles, has an intervening geological condition that has hitherto made communication impossible.

In this communication work we acquaint the student with the conditions of interference and atmospherics encountered, and the methods used in each particular case in getting through the QRM and QRN. This method is invaluable.

At the close of the session in the Savannah school, July 15, we issued certificates of proficiency to nine men, three of whom have left Savannah as radio operators for Europe, Cuba and South America, respectively. The school will reopen again in the fall. Our assigned radio call is 4YB. Call us up sometime.

JAMES F. MAHER,  
Radio Instructor.

## EXTRA! CHICKEN DETECTOR!

This is a new Italian invention and works as follows: Take an ordinary detector and then embed a piece of chicken into the soft metal, the same as you would do with any other mineral. Be sure that the chicken is very sensitive, otherwise the detector will not work well. It matters not what part of the chicken you use. Most any piece is sensitive.

P. S.—Forgot to state that galena means chicken in Italian.

Contributed by MARIO OTTINO.



**Improved Vacuum Tube Circuits for Short Wave Communication**

(Continued from page 213)

circuit. A high resistance antenna may cause the set to stop oscillating altogether and in any case the antenna, being directly in the oscillating circuit, contains harmonics. The higher the antenna resistance the more pronounced will be the harmonics. Thus, with the usual type of transmitting circuit, it is quite customary when sending on say 600 meters, to find that harmonic frequencies corresponding to 300 meters and 200 meters and sometimes even higher harmonics are also being radiated. With these circuits the design must be carried out for an antenna of a certain given capacity and resistance. If, after the set is built, it is desired to use it on an antenna having a different capacity and different resistance, it is always found that the output is not only reduced but the wavelength adjustments are different, the plate current to the tubes may be excessive, and the set generally behaves poorly. A wavemeter is always required to make adjustments for the radiation of a given wavelength. It is also found, as previously noted, that swaying of the antenna or lead-in in the wind causes a change in radiated wavelength, since it changes the effective capacity of the oscillating system. This is very serious in short wavelength beat working. A further characteristic of these circuits is that the output is not uniform over the entire range of wavelengths covered by the set. More radiation current is obtained at some wavelengths than others and in nearly all cases the antenna current is less at the long wavelengths than at the short ones, a disadvantage because the effective radiation is less at long waves and the antenna current should therefore be large instead of small.

The new circuit described herewith has advantages over others in which the antenna is part of the oscillation circuit in all of the features just mentioned. In the first place the operation is entirely independent of the antenna used or of variations in its capacity such as may be caused by swaying in the wind, etc. The frequency is definitely fixed by the master oscillator circuit and this may be calibrated directly in wavelength once and for all on a scale associated with the variometer V<sub>1</sub>. Nothing in the antenna system can affect the oscillations in this circuit. The oscillations in the master oscillator circuit are amplified and then past to the antenna through the transformer T. The antenna may be twenty feet high or one hundred feet or of any shape, kind or capacity whatsoever. All that is necessary is to tune it by means of antenna inductance V<sub>2</sub> to the frequency impressed from the master oscillator and amplifier and adjust the number of turns in the secondary of the transformer T until the resistance introduced by the antenna into the tube circuit matches the tube resistance so that maximum output is obtained. After building and calibrating the set a wavemeter is not needed for the master oscillator circuit itself serves as a wavemeter. If the antenna sways in the wind the change in its capacity simply throws it slightly out of tune with the impressed oscillations and the only effect is a slight falling off in antenna current. The radiated frequency does not change but remains that of the master oscillator. There is therefore no change in the tone of the received beat note. It is found that this circuit gives practically uniform output over the entire range of wavelengths. Furthermore, there can never be but a single frequency present on the antenna. No harmonics can possibly appear because the antenna is not part of the oscillating circuit and is tuned to only one frequency. In this circuit

(Continued on page 252)

**General Radio Apparatus**

**Variable Air Condenser No. 182**

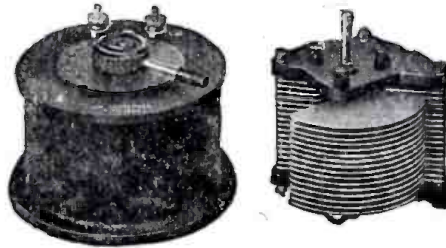

This condenser fulfills the demand for a moderately priced high grade laboratory condenser. Of compact size and excellent construction throughout, it has proved the favorite condenser for all types of oscillating circuits. The shape of the movable plates is such that the capacity varies as the square of the angle of rotation. This results in a straight line variation of wavelength with condenser scale rotation. Price, fully mounted, .0007, \$12.00.

**Variable Step Inductor No. 111D**

This instrument has proved itself to be an absolute necessity in the radio laboratory or radio station. It may be obtained in practically any range, and the use of the ten point switch with the "dead end" attachment makes its use possible over the entire range of the coil inductor. Maximum inductance, 10 m.h. \$18.00.



**Decade Resistance Unit No. 102F**

Of excellent material, workmanship, and possessing a high degree of accuracy, this three dial resistance box is recommended for all radio measurements. Resistance Units are non-inductively wound; this renders the use of the box possible on direct and alternating currents of any frequency. Type 102F, current 0-100 Ohms in .1 Ohm steps, \$32.00.

**Rheostat No. 214A**

The careful design and smooth working characteristics of this rheostat have rendered it the most popular of its kind on the market. It is supplied for both front or back of board mounting. It is normally supplied in a resistance of 7 ohms with a current carrying capacity of approximately 1.75 amperes. Price \$2.50.



We carry a very complete line of radio materials at all our stores with competent experts to explain the working of the various instruments Your patronage solicited.

**Manhattan Electrical Supply Co., Inc.**

New York—17 Park Place 110 West 42nd Street 127 West 125th Street  
 CHICAGO 114 S. Wells St ST. LOUIS 1106 Pine St. SAN FRANCISCO 604 Mission St.



No. 44 B. & S. Enamelled Wire

**Wind Your Own High-Ohmage Receivers**

This wire, which is so fine that over 45,000 feet go in one pound, is used for all high grade Wireless Receivers. We have only the following few spools left over. Order at once. First come, first served.

Weight	40	36	14	39	38	28	49	34	29	30	36	16	46	22	43	hundredths of lbs.
Amount	\$9.20	\$8.26	\$3.22	\$8.97	\$8.74	\$6.44	\$11.27	\$7.82	\$6.87	\$6.90	\$6.88	\$3.68	\$10.56	\$5.06	\$9.06	

Don't send any Money! Simply select the spool wanted and we will send it, or the next in size, C. O. D.

**ELECTRO IMPORTING COMPANY**

231A Fulton Street New York, N. Y.

**Dependable Radio Apparatus**

A new Tuner and a new Short Wave Set have joined the **DEPENDABLE FAMILY**

Catalogue Mailed for 10 Cents in Stamps

**DORON BROTHERS ELECTRICAL COMPANY**  
 Hamilton, Ohio.



## Radiophone Music from ALASKA With the C. R. L. Paragon!

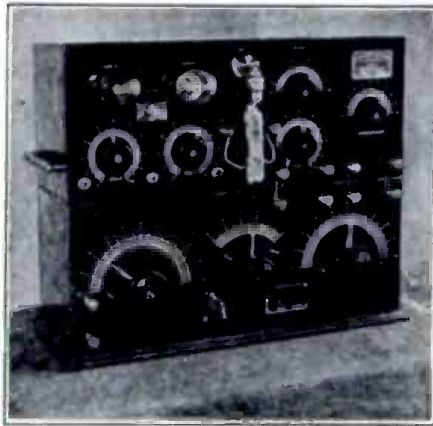

C. R. L. Paragon  
Short Wave Reg. Receiver

During the week of July 26th, L. J. Simms of Station KBC, Billings, Montana, copied radio telephone conversation from Alaska, using our famous C. R. L. Paragon and Amplifgon combination! And this in summer!

Think of what the C. R. L. Paragon can do for your relay work this winter!

The C. R. L. Paragon can now be used to receive long wave time signals. Watch for our announcement of the Paragon Time Adapter next month.

C. R. L. Paragon Short Wave Regenerative Receiver, F.O.B. Chicago—\$55.00.

Licensed under original Armstrong U. S. Patent No. 1,113,149 and U. S. Application Serial No. 807,388.

## CHICAGO RADIO LABORATORY

5525 Sheridan Road (Testing Station 9ZN)

11316 Carmen Avenue

Chicago, Ill., U. S. A.

## NOSTAT

"Conquerer of Static"

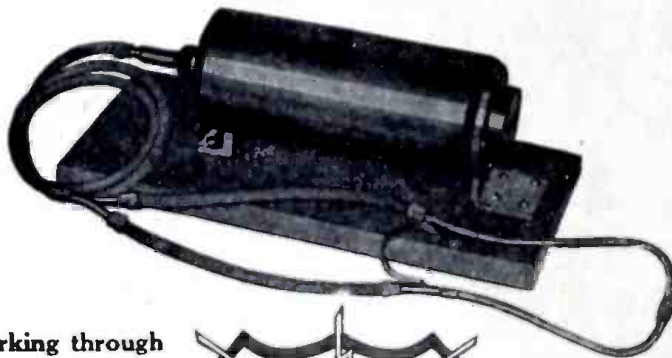

For working through  
(QRN) or (QRM)



For sale by Dealers  
or direct

The one piece of  
Radio equipment  
you can not afford to  
be without.

NOSTAT COMPANY  
118 St. James Place  
Brooklyn, N. Y.



## New Long Wave Tuner

This new Tuner is a big step forward in receiving undamped stations because it tunes from 2,000 to 20,000 meters and dispenses with all loading coils. It is very selective and efficient. Just what you have been longing for. Price with polished hard rubber panel, \$50.00.

Send 2-cent stamp for new bulletin.

Colby's Telegraph School  
AUBURN, N. Y.

## Fisherman Find Undersea Radio Plant

A recent dispatch from Malta, informs us that a complete wireless apparatus which was anchored in twenty fathoms of water off Melleha Bay, with the mast and working parts below the surface to a depth of about eight fathoms, has been discovered by a party of Maltese fishermen. The apparatus, which was subsequently removed by the dockyard authorities for an examination, is of German construction and is complete in every detail.

Undoubtedly signalling went on regularly during the war with submarines lying in wait for British vessels, it being quite possible to sink the mast before the operations were detected.

## LARGE JAPANESE STATION TO OPEN SOON

Word has reached this country that the transmitter of Japan's new high power radio station is expected to be opened in October. It is believed radio transmission half way round the world will be made possible by the apparatus. The receiving portion of the set has been successfully operating since March and receives press messages direct from Germany and picks up messages sent from Nauen to Buenos Aires.

It has been announced that radio telephony will be installed in connection with the plant, which will enable American ships to keep in communication with the land station.

## ANOTHER SPARK PLUG INSULATOR

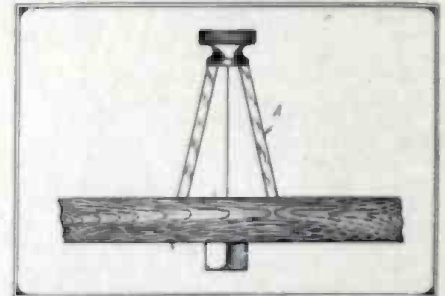

Use a Spark Plug Post for Your C. W. Panel.

For those who wish to make power binding posts for their sending sets here is a good idea for a neat, simple and cheap insulator for it. A is the porcelain from a Splitdorf spark plug. It has an extra large hole thru the center, on account of the mica insulation, and a flat bottom. By passing a brass rod, threaded at both ends, thru it and fixing it to a base you have an excellent power binding post.

Contributed by JOHN BOWERS.

## THREE CHEERS FOR THE NAVY

Commenting on the rapid advance of the radio art, a humorous writer cracks the following: "The Navy used to use buzzers to test their detectors, and motor generators to transmit with. Now they transmit with the buzzers and use the M. G.'s for exhibits."

(Continued from page 251)

there is no danger of blowing up tubes due to excessive plate current such as always results in other types of circuits if the antenna is opened. An open antenna in the new circuit simply brings into play the inductance of the primary of transformer T (Fig. 1), which effectually limits the plate current and protects the tubes.



### Loud Talking Reproducer for Radio and Telephone Signals

(Continued from page 211)

in parallel will now be  $6\frac{1}{4}$  ohms. By Ohm's Law, we have 12 divided by  $6\frac{1}{4}$  equals 1.9 amperes.

For those interested in the design of the electro-magnet it may be said that it is the usual rule to allow 1,000 circular mils per ampere of current for stationary windings, not cooled in any special manner. As No. 20 B. & S. gage wire has a cross-sectional area of 1,021 circular mils, the current of .94 ampere will be seen to be proper for the constant and cool operation of these magnet coils.

Where the electro-magnet is to be operated on 110 volts direct current, such as from a lighting circuit, the size of wire is made proportionately smaller and, in fact, inversely to the ratio between the voltage here designed for, and the higher voltage, in this case, 110 volts. In other words, the inverse ratio between 24 volts and 110 volts is about  $\frac{1}{4}$ , and the size of wire chosen for the higher potential should have about  $\frac{1}{4}$  the cross-sectional area in circular mils.

The current taken at 110 volts D. C. will, of course, now be about  $\frac{1}{4}$  or less than that consumed at 24 volts, or about  $\frac{1}{4}$  ampere. The two magnet coils would be connected in series under these considerations, for 110 volt service, when wound with the finer wire.

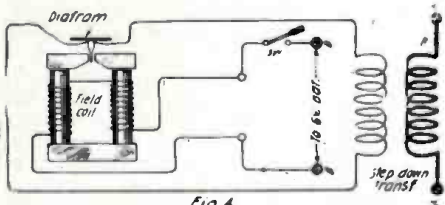

Wiring Diagram of the Various Instruments When Connected in Circuit.

#### BUILDING THE MOVING DIAFRAM COIL.

One of the most delicate parts of the entire apparatus must now be constructed. This is the small moving coil mounted on the lower side of the diafram. This coil manifests an up and down or vertical movement when carrying a current, and when placed between the pole-pieces of the powerful electro-magnet. This moving coil has been tried with a resistance valve of differing magnitude and the resistance to be used will depend upon the purpose to which the amplifier or loud-talker is to be adapted.

However, if the moving coil is wound to have 75 ohms resistance, then it can be used for radio or other work where the current is of relatively high potential, or low current (amperage) value by interposing in the circuit a step-down transformer (a small spark coil of the right proportion will do, the secondary being connected to the audion amplifier circuit and the primary terminals to the loud-talker moving coil).

Data on this transformer was given in an article appearing in the Radio Department of *Science and Invention* for August on page 408. Where this loud-talker is to be used for amplifying or reproducing the spoken voice, an ordinary microphone is connected in series with a battery of several cells and the moving coil.

At Fig. 2-A is shown the simplest method of building the moving diafram coil. This consists in winding the necessary length of wire, 31.1 feet of No. 36 copper magnet wire, giving 75 ohms resistance, and this may be wound of even thickness or about  $\frac{1}{8}$  inch thick, on a standard wooden form, the same as any ordinary form-wound magnet coil.

# AMRAD

The Recognized Symbol of Superior Performance

A revision of prices September 15, 1920, was required in order to maintain the Amrad standard of quality. Former prices of Amrad Radio Products published in catalogs or bulletins now in circulation should be disregarded and this list consulted when planning purchases:

ARTICLE	Descriptive Bulletin	List Price
Induction Coil, 6 volt, Type C.....	P-2	\$35.75
Induction Coil, 32 volt, Type C-1.....	P-2	38.50
Quenched Gap, 1 K.W., Type G-1.....	G	41.50
Quenched Gap, $\frac{1}{2}$ K.W., Type G-2.....	Q	24.50
Quenched Gap, $\frac{1}{4}$ K.W., Type G-3.....	Q	16.00
Quenched Gap Gaskets (each).....	Q	.05
Resistance, 1 K.W., Type A-1.....	Q	10.00
Resistance, $\frac{1}{2}$ K.W., Type A-2.....	Q	7.50
Resistance, $\frac{1}{4}$ K.W., Type A-3.....	Q	5.35
Cabinet and Panel, 5 x 5 x $6\frac{1}{4}$ ", Type A.....	R	3.00
Cabinet and Panel, 10 x 5 x $6\frac{1}{4}$ ", Type B.....	R	5.00
Cabinet and Panel, 10 x 10 x 10", Type C.....	R	10.75
Cabinet only, $4\frac{7}{8}$ x $4\frac{7}{8}$ x $6\frac{1}{8}$ ", Type A.....	R	2.00
Cabinet only, $9\frac{7}{8}$ x $4\frac{7}{8}$ x $6\frac{1}{8}$ ", Type B.....	R	3.25
Cabinet only, 10 x 10 x 10", Type C.....	R	5.65
Bakelite Panel, 5 x 5 x $\frac{1}{8}$ ", Type A-1.....	R	.75
Bakelite Panel, 10 x 5 x $\frac{1}{8}$ ", Type B-1.....	R	1.50
Bakelite Panel, 10 x 10 x $3/16$ ", Type C-1.....	R	4.50
Cabinet connector, with screws, Type A.....	R	.15
Panel Brackets, Type A.....	R	.15
Knob with dial, 180°, Type A.....	R	.80
Knob with dial, 90°, Type B.....	R	.80
Rubber Knob, with screws, Type A.....	R	.45
Dial only, 180°, Type A.....	R	.40
Dial only, 90°, Type B.....	R	.35
Bushing for $3/16$ " shaft, Type A.....	R	.12
Panel Switch, Type B.....	R	.35
Switch Points, each, Type B.....	R	.03
Binding Post, large, Type H-16.....	R	.31
Binding Post, medium, Type J12.....	R	.17
Detector Stand, duplex, Type C.....	T	7.00
Detector Stand, single, Type C-1.....	T	4.00
Detector Contactor and Cup, Type C-2.....	T	2.25
Wavemeter, 130-230 meters, Type D.....	W-1	8.50

**Operators:** Any bulletin desired sent upon request. If you wish our complete catalog and your name entered on our mailing list, send us your dealer's name.

**Canadians:** Send for Canadian edition of our catalog giving Canadian prices and complete list of Canadian dealers carrying Amrad products.

## AMERICAN RADIO AND RESEARCH CORPORATION

15 Park Row  
New York

Address all Communications  
to New York Office.

Factory and Laboratory  
Medford Hills, Mass.

### Audion Control Unit only \$13.75



The K. & G. Wireless Supply Co., in its efforts to place technically correct and reliable wireless apparatus well within the price reach of critical amateurs, announces its new Audion Control Unit, Type A1. This new unit is absolutely reliable and can be used with every known circuit. It is designed and built for exacting service. It combines the very latest ideas in design with the best of material and workmanship. The cabinet,  $8\frac{3}{8}$ " x 6", has a highly polished mahogany finish and with its well mounted bakelite panel will add much to the attractiveness of your station. The unit contains these instruments: vacuum tube socket (for standard 4-prong tube), filament rheostat (30 ohms), grid condenser, grid leak, and filament switch. Panel has binding posts, suitably engraved in white, for secondary, detector, phones, and filament battery. Whole back of cabinet swings open on hinges and thus permits easy insertion of tube and batteries and complete inspection of the interior. Efficiency guaranteed, or money refunded.

Price \$13.75, without tube or batteries. If your dealer can't supply you, order direct. Dealers: Write for proposition.

**K. & G. WIRELESS SUPPLY CO.**

Dept. 16B, 152 Chambers Street

New York City

Just off the press—bound volume No. 1 of Radio Amateur News, July 1919 to June 1920. Send for your copy today! \$2.00 plus postage. Experimenter Publishing Company, 236a Fulton Street, New York City



# "SHRAMCO SPECIALTIES"

## BRASS SWITCH POINTS

	Doz.	50	100
No. 626— $\frac{1}{4}$ " x $\frac{3}{8}$ ", with screw	\$ .30	\$1.10	\$2.00
No. 627— $\frac{1}{4}$ " x $\frac{1}{4}$ " head, $\frac{5}{8}$ " shank, with nut and washer	.36	1.25	2.25
No. 628— $\frac{1}{4}$ " x $\frac{1}{4}$ ", with screw	.30	1.00	1.75

## KNOBS

	Each	Doz.
No. 601— $\frac{1}{2}$ " dia., 8-32 bushing	\$ .04	\$ .45
No. 602—1" dia., 8-32 bushing	.08	.85
No. 606— $1\frac{1}{4}$ " dia., $\frac{13}{16}$ " high	.15	1.70
No. 800—Panel Binding Post, brass finish, black knob	.10	1.10
No. 751—Brass finish Panel Switch, single blade, $1\frac{3}{8}$ " radius	.35	3.75
No. 850—3" Dial Indicator only	.70	each
No. 851—3" Dial Indicator with knob	1.25	..
No. 801—22.5 Volt "B" Battery, small	1.40	..
No. 802—22.5 Volt "B" Battery, large	2.40	..

Postage extra on above.

Send 5c in stamps for our Catalog J showing complete line

SHOTTON RADIO MFG. CO., P. O. Box 3, SCRANTON, PA.



# MIGNON UNDAMPED AND REGENERATIVE RADIO APPARATUS

(MIGNON AND ARMSTRONG PATENTS)

Endorsed by Radio Department of D. L. & W. R. R. Co.

Write for Literature

## MIGNON MFG. EXPORT CORP., NEWARK, N. J.

AUTHORIZED AGENTS The Northern Radio Laboratory, Clyde, Ohio  
Canadian Radio Mfg. Co., Beinville, Quebec, Canada

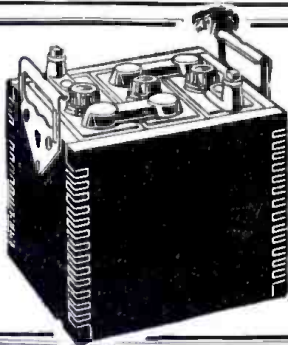

### Canadian Radio Amateurs

We have on hand, ready for prompt shipment, a number of first-class Storage Batteries.

Price \$26.25  
F.O.B. Montreal  
Batteries will be shipped by Express Collect unless otherwise specified.

8 Volt—35 Ampere Hour Width 7 7/16"  
Capacity Length 6 9/16"  
Plates 5 1/2" Wide Weight 27 Lbs.  
Height 8 1/8"

These storage batteries are Canadian Made, from Canadian material and Canadian labour.

They are ideal batteries for Valve Filament lighting, Induction coil operation, Motor Car and Motor Boat Ignition, etc.

SCIENTIFIC EXPERIMENTER, LIMITED  
11 St. Sacramento Street Montreal, Que.

## MEMORIZE CONTINENTAL CODE ALMOST INSTANTLY

This method THE short cut to success

Get Wise. Ask for latest reports from Successful, Satisfied, Gratiified, Grateful Users, Maine to California—Texas to Canada. Free on request or

### COMPLETE CHART

and full instructions 50 CENTS

C. K. DODGE

Box 300 Mamaroneck, N. Y.

# NEW TYPES



Inquiries for literature and orders for MIGNON SYSTEM new type regenerative radio apparatus should be made at once to us. This will insure immediate delivery\* to you.

"The house of service"

NORTHERN RADIO LABORATORY

Specialists in Radio Apparatus

111 Main St. Clyde, Ohio

Authorized Mignon Representatives

A single-silk covered copper wire, or in fact double-silk covered wire is preferable. The coil should have several strings tied around it, the strings having been placed in the form before the winding was started, and tying the strings around the coil before removing it from the three-part collapsible form.

After the coil has been removed, it can then, with a little care and ingenuity, be worked, slowly and gradually, into the desired shape, as shown in the stages showing from 1 to 4 at Fig. 2-A. The coil should be shellacked while this forming operation is in progress, so that by the time it has been finally worked to the shape shown at the fourth stage, i. e., having a flat thin base like a knife, a little under 1/16 inch thick, the shellac will begin to harden and the coil caused to hold its shape. It may be necessary to place a weight upon the flattened portion of the coil, in order to cause it to maintain an even flat shape, and the top can be tied with several strings so as to preserve its rounded-out form.

The round-shaped portion at the top of the coil is to be gript by the spring clip made of bronze or brass, shown at 5 in Fig. 2-A. This clip may be riveted to the center of the under surface of the diafram.

To those desiring to work out the coil more exactly and also to provide a standard form on which further coils can be wound to exact shape at the start, the scheme at Fig. 2-B will, perhaps, appeal more strongly. With a little patience this three-part wooden, fibre or metal form can easily be made, the dimensions being checked up from those given in connection with the coil drawing in Fig. 2-A. One or two machine screws and nuts past thru holes drilled thru the three-part form, will hold it tightly together while the coil is being wound.

The edges of the winding block B should be carefully rounded so as to avoid sharp corners, and the curvature at the top edges may be more pronounced than that at the bottom edges.

It will be seen that the flat part of the coil is thus automatically wound at the first operation in the space E, which should be about 1/16 inch wide only. By carefully curving the ends of the two outside form blocks at AA, more room for the winding operation will be obtained, and the gradually tapering form of the coil easily obtained while the form is revolving on a central axis or shaft X.

Depending upon how tight the coil is wound, there should be about 160 to 180 turns, but by measuring off the number of feet of wire as previously specified or else by measuring the resistance on a Wheatstone bridge, this can be readily checked up.

Small lengths of thread should be placed in the form shown at Fig. 2-B before the coil is started, so that after the turns are all wound on, the threads may be pulled over and tied so as to bind the coil in a compact manner. The screws holding the form together can then be removed, the two sides separated and the center block gently pushed out of the coil. The coil should be carefully examined and dipped in insulating varnish or thin shellac, then allowed to dry thoroly.

Several strings may have to be tied along the flat lower portion or else a piece of paper wrapt around it and a weighted block placed on the flat portion while it is drying, to render it perfectly flat and even in thickness. The paper may be left on if it is quite thin, after the coil is dry and ready for use. Placing the weighted coil on a slightly hot plate will dry and bake it quickly.

The experimenter should build several of these coils of different resistances, for he will find that various coils work best under certain conditions and for certain purposes. Instead of stepping down the current from the audion amplifier circuit, the coil could be wound with very fine wire such as No.



40 or 43, so as to have a resistance of from 500 to 1,000 ohms. The fine wire leads from the coil should be wound around a nail or other small object so as to give sufficient flexibility to them, and they can be later secured to suitable terminals on the instrument.

A piece of thin silk or paper should be placed around the circular top of the coil, so that the clip which is to hold it will not damage it.

The diafram may be of mica about .006 to .008 inch thick or else of fosfor bronze or German silver. Iron or ferro-type diaframs should not be used for this instrument, as they will be effected by the magnetic flux in proximity to the pole-pieces and thus interfere with the proper action of the instrument. Various thicknesses and diameters of diaframs can be experimented with until the most effective result with a certain strength of magnet and amplifying circuit is obtained.

If you have a phonograph sound box or reproducer having a diafram about 2½ inches to 3 inches on its free or vibrating diameter, you could use this very well instead of building one. If you have to build the diafram rings and support, the idea for making this part will be readily obtained from the drawing Fig. 1. This comprises simply two rings of brass or other non-magnetic metal, with a tubular part extending at the top to make firm connection with the amplifying horn or chamber.

The rings should be clamped together by six to eight No. 8/32 machine screws, which can be threaded into the lower ring, except at the two diametrically opposite points, where the screws should thread into the two brass brackets supporting the diafram ring. The diafram itself should be held evenly and tightly all around its outer edge between two rubber rings. If these rings are not available in just the size or form you wish, a suitable length of small rubber tubing can be used, this being prest flat when the clamping rings are screwed together. About ¼ inch air space should be left between the diafram and the inner face of the top clamping ring as shown.

#### SOUND AMPLIFYING CHAMBER

Quite possibly you have or can easily procure a large size metal horn or amplifying chamber to fit onto the opening in front of the diafram of the loud-talker you have built. If not, designs for two different forms of sound-amplifying chambers are suggested in Fig. 3. A metal horn is widely used for such apparatus as this, but it is very simple to build one of wood as shown at 3-B, and the writer prefers the wooden horn. One built like that shown at Fig. 3-B corresponds to those extensively used in phonographs and will give very fine results, as the writer has found. It can be built of ¼ inch or thicker stock if desired and the general form there shown can be followed without much trouble.

If the horn is of quite large size it will probably require a little more bracing or guying by means of cords or wires than that afforded by the iron shelf bracket shown at B, Fig. 3. In this case the magnet structure is placed on top and the diafram below. A wooden sound chamber of the general size shown at Fig. 3-B may be made in a straight horn shape without any right angle bend if desired, but usually the form illustrated conserves space and is more desirable.

#### PRECAUTIONARY REMARKS.

In the final assembly the points to be watched are the following: That the polarity of the two upper pole-pieces of the electro-magnet are N. and S. respectively, and this can be tested by means of a small compass, or else by checking the windings and connections by means of the diagram, Fig. 1-A. The flat lower part of the diafram coil should move freely up and down for a distance of about 1/16 inch



**EASTERN  
RADIO**

**INSTITUTE**

899 BOYLSTON ST.  
BOSTON, MASS.



TEL.  
BACK BAY  
5 9 6 4

## FALL CLASSES!!!

In addition to the splendid radio equipment now in use at the EASTERN RADIO INSTITUTE we wish to announce that we have just added—

**A COMPLETE NEW 2 K.W. FEDERAL ARC TRANSMITTER. THIS IS AN EXACT DUPLICATE OF THE HUNDREDS THAT WILL SOON BE IN USE ON VESSELS OF THE U. S. SHIPPING BOARD.**

Now is the time to take instruction at an Institute where the very latest spark and arc receivers and transmitters which you will actually use on the ships are at your disposal.

When you take into consideration that the Institute was founded in 1913 and has specialized in the training of Wireless operators for over seven years we feel that we know how to give the student proper training. Our graduates may now be found all over the world as Chief operators, Chief radio inspectors, Engineers, Superintendents, Directors of corporations, etc. The number of students to whom we have given instruction at this date numbers over four thousand (4000). Remember—We have actually enrolled, graduated and placed more Commercial operators than ALL the Radio schools in New England combined!!

If you are considering taking up Commercial radio why not let us train you? Our rates of tuition are reasonable and it costs you no more to avail yourself of our YEARS of RESULTS and SUCCESS. Just remember—We have trained thousands of satisfied students before YOU and have placed ALL our graduates in good positions. What we have done for them we can do for YOU.

**OUR FALL CLASSES, DAY AND EVENING, START MONDAY, SEPTEMBER 13TH. WE EARNESTLY URGE YOU TO MAKE EVERY EFFORT TO JOIN THIS CLASS AS RADIO TODAY OFFERS A VAST FIELD FOR ACHIEVEMENT AND SUCCESS.**

Our latest, illustrated prospectus giving you complete information is yours for the asking. If there is any further information I can give you just drop me a line or come in and see me.

Co-operatively yours,

F. D. PITTS, Director.

Series No. 1.

## ATTENTION ★ YOU DX MEN

Do you know that thru the use of the "RVA" SERVICE which places ANY piece of ANY make of apparatus, parts, and supplies, at your disposal on the

### INSTALLMENT PLAN

you can equip your station for real participation in the DX work this Fall and be one of those to establish the expected records, talked about at all the radio gatherings during this past summer. Send 20c (stamps or coin) for a year's subscription to the latest "all-radio" circular there is published; the "RVA" BULLETIN. Eight to sixteen pages an issue, three to five supplements, a page of bargains, each month and with the first issue a Loose-Leaf Binder. Prompt action will assure your getting back copies also. 20c credited on your first installment plan order. Watch the October issue for the announcement of the new "RVA" Transmitting Condenser, a "real" instrument at a most reasonable price.

**J. DONALD VANDERCOOK & CO.**

Suite 4—First National Bank Building

ELMHURST

ILLINOIS

Ready for delivery, first edition of bound volume No. 1 of Radio Amateur News. \$2.00 plus postage. Experimenter Publishing Company, 236a Fulton Street, New York City



**NOTICE OUR NEW ADDRESS? BIGGER BUSINESS. LARGER QUARTERS.**

**THERE IS A CONGENIAL ATMOSPHERE OF FRIENDLINESS AT THE G. A. HOUSE. COME UP AND VISIT US.**

# BAKELITE

The Standard Insulating Material for all Radio Work

## G. A. Standardized Panels

Hundreds of pounds now in stock, ready to ship to you the day your order is received.

For several months we have been held up in obtaining Standardized Bakelite Panels. Now they have come—hundreds of pounds of them, smoothly and squarely cut, guaranteed accurate to 1/32 in. The sizes are arranged for Standardized Panel Construction, altho they can be used for everything from detector bases to complete receiving or transmitting sets.

Thick	2 1/2 x 5 ins.	5 x 5 ins.	5 x 10 ins.	10 x 10 ins.	10 x 15 ins.
1/8 in.	\$0.30	\$0.60	\$1.18	\$2.35	\$3.50
	2 oz.	4 oz.	8 oz.	1 lb.	2 lbs.
3/16 in.	\$0.44	\$0.88	\$1.76	\$3.50	\$5.25
	3 oz.	6 oz.	12 oz.	1 1/2 lbs.	3 lbs.
1/4 in.	\$0.58	\$1.16	\$2.30	\$4.60	\$6.85
	4 oz.	8 oz.	1 lb.	2 lbs.	4 lbs.

**SEND US YOUR ORDERS—WE ARE AS NEAR TO YOU AS THE NEAREST MAILBOX—MAIL IT**

You Can Depend Upon the G. A.



G. A. Bulletin Send 3c.

**THE GENERAL APPARATUS COMPANY, Inc.**  
570-N West 184th Street, at St. Nicholas Ave. New York City

# ATTENTION AMATEURS

The only practical adapter

Price \$1.50

## RADISCO AGENCY

We make up sets to specifications



Made by the  
**AMATEUR WIRELESS EQUIPMENT CO.**

1390 Prospect Ave., Bronx, N. Y.

Catalogue sent on receipt of 10c, which may be deducted from first order.



Dealers write for proposition

# DOUBLE ANNOUNCEMENT

## Central Radio Company

CENTRAL RADIO COMPANY is the largest radio supply house in the central states. A complete stock of all leading makes assures prompt shipments. Exclusive central states agent for A. H. Grebe & Co. Every radio man in the Mississippi Valley should write at once for a copy of our latest bulletin and special information, which will be mailed free upon request.

## Central Radio School

CENTRAL RADIO SCHOOL is the best radio school in the central west. Modern, complete equipment. Special licensed radio station. Experienced instructors trained to teach. Low rates and expenses. Both radio-telegraph and radiophone courses. Day and evening classes. Our school only nine miles from Kansas City. Enroll any time. New classes formed first Monday of each month. Catalogue free.

NOTE:—We are successors to Independence Radio Institute, advertised in August and September Issues.

**CENTRAL RADIO BUILDING, INDEPENDENCE, MO.**

The material contained cost thousands of dollars to assemble. You can get a copy of bound volume No. 1 of Radio Amateur News for only \$2.00 plus postage. Experimenter Publishing Company, 263a Fulton Street, New York City.

between the pole-pieces, and these should not be separated much over 1/16 inch. Thinner coils with smaller air gaps between the pole-pieces may advantageously be experimented upon, as this is one of the most important factors in the efficiency of this type of apparatus.

In connecting the moving coil element with a microphone and battery current, for the purpose of using it as a regular telephonic loud-talker, care should be taken to see that not too high a potential is applied; usually about 10 to 15 volts will be found sufficient. For those desirous of obtaining louder reproduction of signals a somewhat more powerful electro-magnet may be built and the calculations for the windings of such can be made without much trouble.

Fig. 4 which appears on page 253 shows the circuit arrangement of the completed instrument.

The general arrangement described in this experimental instrument is patented and it must not be built to sell.

### PHOTOS BY RADIO AGAIN.

It is interesting to learn that a Dane has, by a timely invention, succeeded in transmitting pictures by means of a system of radio telegraphy. Just how it is done is not explained, but there seems to be reason enough for believing that an actual invention of some degree of efficiency has been made. It is thus no longer improbable that in the course of a few years the newspapers will be able to publish sketches of events on either side of the Atlantic as rapidly as they receive the news.

### MEXICO INSISTS HER RADIO STATIONS PLAYED NEUTRAL

Denial of published charges that the national radio station at Chapultepec was used to communicate with Germany during the World War and that its personnel is German in its most important components, is made in a statement printed by *El Heraldo de Mexico* over the signature of F. Frias, the new director-general of the national telegraph lines.

According to Senor Frias, the Chapultepec plant was in process of construction from the middle of 1917 to the middle of 1919 and, because it could not function at full efficiency during that time, communication with Nauen was an impossibility.

Senor Frias asserts that the only Germans connected with the station are employed in the shop annexes and are engaged exclusively in making new equipment for substations, while Mexicans direct and operate the station.

The Mexican radio system, Senor Frias states, consists of 23 stations, 14 on the coasts and 9 in the interior. The coastal stations are mainly for maritime service, while the interior stations, with Chapultepec, are for the service of the government, especially when other lines of communication are cut, a contingency he declares which has been, unfortunately, common during the last ten years.

### 872 AMATEUR RADIO STATIONS SET UP NEAR CHICAGO.

Since the government ban on amateur radio was raised last October, 872 amateur stations have been opened in the Chicago district, comprising Illinois and eleven neighboring states, according to a report sent to Washington by Charles C. Kolster, United States radio inspector for the district.

Of this number 262 are in Chicago. "The real radio fan would do anything to get money enough to buy radio equipment," Kolster said. "The cheapest equipment costs around \$25 and some of the radio enthusiasts paid as high as \$3,500 for their apparatus."



## Work Out Three Plans for Professional Radio Men

Three independent plans for a system of graded licenses for radio operators are being worked out, it is understood. The leaders of the wireless operators, in accepting the proposal made by Admiral William S. Benson, chairman of the Shipping Board, for the extension of the life of the present agreement ninety days, have communicated with the various locals of the association. They have asked what the various locals think is advisable in view of conditions. In the meantime they are endeavoring to work out a system whereby years of experience will be rewarded with better pay and the amount of work done will have some relation to the wage received.

The Shipping Board has referred the matter to Eugene Chamberlain, Commissioner of Navigation. The American Steamship Owners' Association was not consulted by the Shipping Board prior to the suggestion of an extension of ninety days in the life of the agreement. It is known that the shipowners are opposed to the granting of increases in wages to the operators, although they are not unsympathetic to the desire of the men to better their condition.

The radio operators are working out a plan which will be submitted to Commissioner Chamberlain for due consideration.

It is reported that the three radio companies, which are under contract to the shipowners and the Shipping Board for furnishing sets and operators, are laboring on a plan which they think will solve the problem now facing the shipping interests.

The Shipping Board, in conjunction with the Commissioner of Navigation, is understood to be active in regard to the scheme. It is said that the governmental board feels that the radio service should be encouraged and that there ought to be some stimulus for an operator to remain in the service after he obtains the position of a chief operator. At the present time he could not make more than \$125 a month if he confined himself to radio work.

The shipowners do not feel disposed to grant the demands made by the operators recently. The wireless men wanted an eight-hour day, with provision for overtime pay, increases of \$75 monthly for chief operators and \$50 for assistants, assurance that the operators would not be required to perform additional services on board ships and that they would be permitted to leave the vessels when they were in port. By figuring overtime on a rather liberal scale the shipowners figured that a chief operator, who did not have to be more than twenty-one years old, might draw as much salary as a first mate on a large freighter. They were not consulted by the Shipping Board, but it is understood that they have been asked to write to Washington and inform the Commissioner of Navigation what their views of the situation are.

At the present time there are only two classes of operators, chief and assistant. It is thought that the salaries of the operators should be increased with the performance of certain years of service. For instance, it is believed that the Commissioner of Navigation will recommend a certain percentage of increase every few years. It is suggested that a 10 per cent increase be put into force for the chief operator every three or five years.

No statement has been made by the president of the United Radio Operators' Association since he returned from Washington, where the conference was held. It is thought that it will be several days before the system will be worked out to such a point that there can be an intelligent discussion of its merits and defects.



## Learn Telegraphy

(Wireless or Morse)

The EASIEST, QUICKEST, CHEAPEST WAY

# AT HOME

In Half the Usual Time

# WITH THE OMNIGRAPH

"Just Listen—The Omnigraph will do the teaching"

The Omnigraph is an Automatic Transmitter that teaches you both the Wireless and Morse Codes, at home, without any expense except the cost of the machine itself. Merely connect to battery and your Buzzer, or Buzzer and Head Phones, or to your Sounder and the Omnigraph will send unlimited messages by the hour, at any speed you desire.

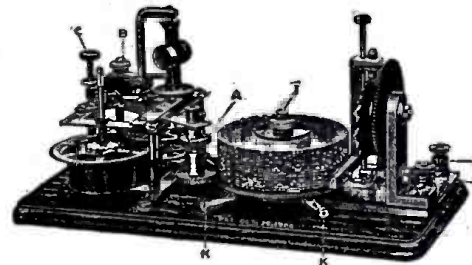

USED BY THE U. S. GOVERNMENT

The Omnigraph is used by the Government in testing all applicants applying for a Radio License. It is also used extensively by the large Universities, Colleges and Telegraph Schools throughout the Country for teaching Wireless and Morse.

Hundreds of the Army's skilled operators who served during the war learned with the Omnigraph.

## Let The OMNIGRAPH Teach You Wireless

For a few dollars you can have a complete outfit that will make you an experienced operator in the shortest possible time. No hard, laborious work—just learn by listening. The Omnigraph is adjustable so you can start receiving messages slowly, gradually increasing the speed as you become proficient.

You'll be surprised how quickly you will attain speed. Even if you are already an operator the Omnigraph will help you. It will make you more proficient, more accurate and more confident. Thousands of Omnigraphs are in use today and thousands of operators owe their success to them.

### Write for Free Catalog

Send for a catalog today, showing the 3 different models, \$12.00 to \$28.00. Every Omnigraph is sold with the absolute guarantee that you must be satisfied or your money back for the asking. Mail the coupon today—the catalog will come to you by return mail.

**The Omnigraph Mfg. Co.**  
26 F Cortlandt St., New York City

**The Omnigraph Mfg. Co.**  
26 F Cortlandt St.,  
New York City.

Gentlemen:—

As per your ad in Radio News please mail me your free catalog of Omnigraphs.

Name .....

Address .....

City..... State.....

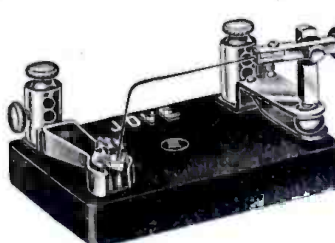

**Bunnell** INSTRUMENTS  
Always Reliable

**JOVE DETECTOR**  
Handiest, Handsomest, Best  
Sample by Mail, \$2.00  
Tested Galena Crystal, 25c

(MORGAN PATENT)

**J. H. BUNNELL & CO., 32 Park Place, New York**

We are distributors of the Standard Electric Novelty Co.'s Type B "Cyclone" Audion Batteries. Also of De Forest and all the leading manufacturers of High Class Wireless Apparatus. Send stamp for new edition 42RN Catalog.

A welcome addition to your library! Send \$2.00 plus postage today and your copy of bound volume No. 1 of Radio Amateur News will come forward by return mail.  
Experimenter Publishing Company 236a Fulton Street, New York City



# RADIO SERVICE



apparatus is designed and built to give you complete satisfaction.

Each piece of apparatus is thoroughly inspected and tested before it leaves our factory, thereby insuring you of a product that will work perfectly.

The AUDION CONTROL PANEL as illustrated sells for only \$6.50 and operates as well as the more expensive kind, while the material used in its construction is the best obtainable.

The Radio Service V. T. Sockets are acknowledged as the best obtainable. The triple tube type is illustrated.

**SPECIAL**  
A Radio Service 3" etched aluminum dial graduated from 0° to 180° for 30 cents post-paid. A limited quantity only on hand.

- Type S1—Single Tube (for inside mounting) \$1.20
- Type S2—Single Tube (for bench and experimental use) 1.50
- Type S3—Double Tube (for amplifier use) 2.75
- Type S4—Triple Tube (for detector and two-stage amplifier or three-stage amplifier use) 3.75

*These receptacles are all made in two styles, for either receiving or transmitting tubes. This should be specified when ordering.*



Grid or Telephone Condensers 35 cents each

Type S4—Price \$3.75

If your dealer cannot supply you, order direct from

**RADIO SERVICE & MFG. CO. Lynbrook, L. I., New York**

## STUDY WIRELESS or LEARN TELEGRAPHY

**18** Boylston St. } STUDENTS  
Cor. Washington } Enter  
**BOSTON** } **ANY TIME**

*Results and Positions Guaranteed*

Best equipped Radio School in New England. There has been a Telegraph School at 18 Boylston St. for over 18 years.

Send for free literature.

**MASSACHUSETTS RADIO AND TELEGRAPH SCHOOL**

R. E. Trip

Tel. Beach 7168

G. R. Entwistle

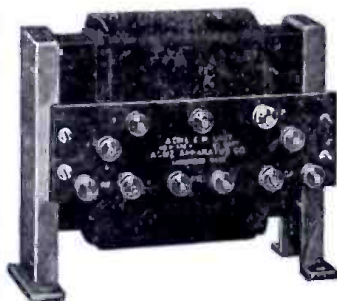

## ACME

is now synonymous with TRANSFORMERS and is coming to be synonymous with

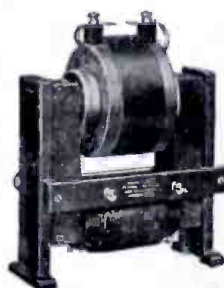

## C W

The increased sales of ACME APPARATUS is proof of its efficiency, attractiveness and service.

Our growth has been on the merits of our apparatus.

**ACME APPARATUS COMPANY**

25 WINDSOR STREET  
CAMBRIDGE 39, MASS.

## Bright Outlook for Amateur Radio

Since the war interest in radio telegraphy and telephony has increased to the extent that there is hardly a square mile in the populated sections of this country that does not boast of at least one antennae system.

This interest is partially due to the great number of men who received radio training in the Signal Corps of Naval Radio branches of the service, but possibly due in a greater degree to the very material increase in the range and efficiency of present-day wireless equipment.

As the number of radio devotees increases an added incentive is given to the pleasure of owning and operating one's own station. The American Radio Relay League, an organization composed solely of amateur operators, has undertaken to provide the opportunity of sending a message to anyone in this country without charge. And now, on any evening, hundreds of these "feeless" messages can be heard hurrying to their respective destinations via the obliging amateur.

The radio telephone, once an instrument of conjecture, can now be found in almost every progressive station. The amateur station, unlike the commercial station, is unmolested by the patent situation, and for this reason amateur equipment rivals that of the most advanced commercial installation.

Dancing by radio is the latest fad; by the use of a radiophone and a phonograph at the transmitting end and a sensitive radio receiver equipped with an amplifier, and a loud-speaking horn at the receiving end music can be heard all over the hall. The station transmitting may be hundreds of miles away, but the notes are as clear and as well modulated as if the orchestra were in the same room!

Wireless concerts also give added pleasure to the owner of radio-receiving apparatus. The Western Electric Company experimental station at Deal Beach, N. J., has provided entertainment of this nature for the past few months. The program includes selections by famous artists, band music, humorous pieces and lectures. This concert is given every Tuesday evening, starting at 10 o'clock and continuing until midnight, and can be heard for hundreds of miles in every direction.

The radio art is ever new. Although its development has been phenomenal, the next five years will see many radical changes, all affording greater efficiency and creating greater interest. *Boston Post.*

### AMATEUR STATION SIGNALS CORRECT TIME

In the suburbs of an eastern city an efficient and unusual method of giving his neighbors the correct time has been developed by a public-spirited young radio enthusiast. As the local telephone company has abolished its former custom to inform subscribers of the correct time through its "centrals," and the town clock is usually on (or rather off) strike, the signals are most welcome.

A wooden rack has been constructed to hold an old single-barrel shotgun, pointing toward the ground, in the yard near by the window of the wireless station. When it is nearly time for the Arlington, Va., wireless time signals, which are broadcast at noon and at 10:00 p. m., eastern standard time, the gun is loaded with a blank shell and a string attached to the trigger and led to the operator's desk. This enables the operator to fire the gun on the hour and thus inform all within a large radius of the exact time.

Of course this method would be impossible in a thickly populated community with ordinances against firearms.—*Popular Mechanics.*



## Marconi's Surprise for our next President

We are informed from a correspondent in Naples, Italy, that providing the great inventor is successful in some of his present experiments, it may be possible for him to greet our next President in November by transmitting the strains of the "Star Spangled Banner" by means of the radio telephone from the cabin of the yacht "Electra" which as many of our readers know is the experimental vessel of Mr. Marconi and which is now located somewhere in the Mediterranean Sea.

Senor Marconi's guests recently danced on board his yacht to the music of an orchestra played in London, so distinct was the transmission by wireless telephone.

Senor Marconi is now engaged in perfecting a "direction finder" with which to locate ships at sea.

### THE BORDEAUX RADIO STATION.

Monuments in France of American constructive achievement will long endure. Our Expeditionary Forces have been withdrawn for many months, but the material things created by our constructive genius to insure success to the fighting men—docks, warehouses, railroad trackage and equipment—will constitute for many years reminders of the A. E. F.'s stay in France. A further contribution to France of American enterprise was recently announced. The largest and most powerful radio plant in the world has just been completed at Bordeaux and will soon be turned over to the French government. Begun early in the war by the Americans and constructed on American plans, it was but half finished when the armistice was signed. Since the armistice, the Bordeaux radio plant has been pressed to completion, and France now stands in possession of the world's most powerful radio station.

The Bordeaux radio plant is an example of a work which, while originally intended for purposes of war, will nevertheless prove a useful and valuable instrumentality of peace. The Bordeaux wireless station will constitute a lasting reminder of the ability of America to perform veritable miracles of construction to do the thing which has never been done before. It should serve no less as a potent inspiration to the French to push forward the rebuilding of their martyred towns and villages.

### NEEDED RADIO INVENTION.

However well equipped with wireless a ship may be, an accident that results in its sinking puts an end to its distress signals and may not even allow time to begin them, leaving its hurriedly manned lifeboats without any means of communication with each other or with a rescue ship. An eastern inventor has designed a simple and compact radio system intended as permanent equipment for one or more lifeboats on each vessel. The wireless apparatus, used for both telegraphing and telephoning, is enclosed in a water-tight box at the stern and grounded through a metal plate on the bottom of the boat. To shut out extraneous sounds and add to the sensitiveness of the set the operator is equipped with a helmet containing the telephone receiver.

### ANOTHER NEW RADIO STATION ON LONG ISLAND

The commercial plant which is being erected on a six-acre tract by the Cutting & Washington Company at East Hampton, L. I., is nearing completion, and officials of the company hope to begin transmitting messages through it by Oct. 1. The cost of the plant, including the radio instruments, will be approximately \$150,000, it is said. It will have a radius of from 3,000 to 4,000 miles.

# Hook'er to Yer Bulb

THE MOST WONDERFUL TUNER IN THE WORLD FOR \$15.00



It weighs but two pounds—size about 4½ x 4½ x 3". It has a primary and secondary coil only and receives all arc signals from 5,000 M. to 20,000 M. It will not work with a crystal detector. The wiring diagram is on the bottom of each tuner. Do not remove top of tuner or you will destroy it—the coils are waxed in and leads are short. Tests all over the world show this tuner will receive efficiently arc signals on the smallest aerial. We recommend a single wire 25' high by 40' long. Three variable condensers and an audion are needed for the circuit.

Don't take our word for it—write us for name of nearest Amateur using one. Add Parcel Post.

## N A A—ARLINGTON TUNER—5,000 M

This tuner is same size as above tuner, only it has a tickler coil and uses the straight audion hook up with tickler in series with phones. It is the only spark tuner that gets NAA on a small aerial without any variable manual coupling. This tuner also gets the arc signals at 5,000 meters and records easily wireless phone talk from 600 to 5,000 meters. Priced at \$15.00 plus Parcel Post.

## KNOCKED DOWN OR ASSEMBLED CONDENSERS

Which kind do you want? Made for panel mounting and are complete with scale, pointer and knob. Used all over the world. No C. O. D. orders, add Parcel Post. Buy from your local dealer or send us his name if he can't supply you. Formica tops and bases. Movable plates are now held by nuts and not clamped with washer as formerly.

11 Plate K.D. ....	\$1.80	11 Plate assembled. ....	\$2.75
21 Plate K.D. ....	2.25	21 Plate assembled. ....	3.25
41 Plate K.D. ....	3.20	41 Plate assembled. ....	4.25

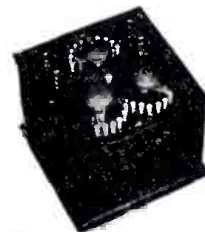

## UNIVERSAL CONDENSER

The only fool proof, complete assembled condenser in the world that will fit any cabinet, and take the place of any and all the condensers that you may be using. IT HAS A CONTINUOUSLY VARIABLE CAPACITY FROM .00025 MF. TO .001 MF. Studs are so mounted as to prevent any leakage and to fit any holes you may have already drilled in your panels. Size 3 x 3 x 1" and shipping weight one pound. Priced at \$2.50 and add Parcel Post.

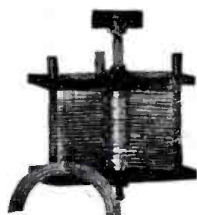

**SOLD BY TRESKO, Davenport, Iowa**  
OR YOUR DEALER

Be a sport and send 5c for our Catalog. Foreign orders solicited. Canadian Amateurs buy from Canadian Dealers. All products licensed under Marconi and Armstrong Patents.

# ACE

## Oh! By Gosh!

You want our new ACE Unicoil set. Any wave range from 150 to 20,000 Meters, uses unmounted Honeycomb or Duo-Lateral Coils, brings the sigs. and the price without coil is only \$40.00.

Order coils for wave length 1,200 Meter coil \$1.45. Amateur wanted, we have them. 10,000 to wave length coil \$1.30. We have 20,000 Meter coil,—\$3.35. 1,000 the best C-W sets going. to 3,500 Meters,—\$2.25. 400-

REMEMBER "You may pay more, but you can't buy better"

## THE PRECISION EQUIPMENT CO

Dept. A. 2437 Gilbert Avenue, Cincinnati, Ohio.



# OPPORTUNITY AD-LETS

Follow these advertisements every month. Reliable advertisers from all over the country offer you their most attractive specials in these columns.

Classified advertising rate four cents a word for each insertion. Ten per cent discount for 6 issues, 20 per cent discount for 12 issues. Name and address must be included at the above rate. Cash should accompany all classified advertisements unless placed by an accredited advertising agency.

Objectionable or misleading advertisements not accepted. Advertisements for the December issue must reach us not later than November 10.

## THE CIRCULATION OF RADIO NEWS IS OVER 40,000

EXPERIMENTER PUBLISHING CO., INC., 233 and 236 Fulton Street, New York, N. Y.

### American Made Toys.

**An Opportunity for Home Workers** on small scale and manufacturers on large scale to make American Metal Toys. Army, Navy, Machine Guns, Cannons, Warships, Indians, Cowboys, Wild Animals, Whistles, Bird-Whistles, Religious designs and other toys and novelties. Greatest chance for industrious people to have an independent business. Enormous demand for cheap toys offers unlimited field and great future all over United States and foreign countries. Experience or tools not necessary. Hundreds and more made complete per hour. Casting forms, complete outfit from \$3.00 up. We buy these goods paying fixed prices. Attractive prices offered for painted goods. A strictly business proposition. No one need apply unless he means business. Booklet and information furnished free. We have no sales agents and we warn against worthless and cheap imitations. Toy Soldier Manufacturing Co., 32 Union Square, New York.

### Agents Wanted.

**Big Money Varnishing Floors, woodwork, etc.** \$1.00 brings you directions for making brilliant oil varnish at \$.75 per gallon. C. Parker, Box 1234, Seattle, Wash.

### Automobiles.

**Build Your Own Speedster** or racing body; write today for money-saving pamphlet showing different styles. Floege's System of Body-building, North Chicago, Ill.

### Aeronautics.

**Propellers for Aeroplane Propulsion**, small propellers for motorcycle-driven snow and ice sleds, road speedsters and hydroplanes. 5-foot diameters, \$12; others in proportion. Hub mountings, bearings, sprockets and counter-shafts complete. Crawford Motor and Aeroplane Mfg., 142 South Rampart St., New Orleans, La.

### Motors, Engines and Dynamos.

**8-Inch, 110-v. Electric Fan**; new; guaranteed 1 year; \$7.00. 110-v. Universal Electric Iron, \$7.50; regular price \$8.50. Above prices for limited period only. Postage extra. Special prices on all house wiring material. Stranded No. 18 R.G. Copper Wire, 20 ft. 55c. Just the thing for connections. Reuben E. Shumaker, Galion, O.

### Help Wanted.

**Stop Daily Grind.** Start silvering mirrors, auto headlights, tableware, etc. Plans free. Clarence Sprinkle, Dept. 48, Marion, Indiana.

**Earn \$25 Weekly**, spare time, writing for newspapers, magazines. Experience unnecessary; details free. Press Syndicate, 5665, St. Louis, Mo.

**Instrument and Meter Experts** wanted everywhere. Our graduates earn big money. We train you to be meter engineer and hold responsible position. Write for our Special Offer. Fort Wayne Correspondence School, Dept. 405, Fort Wayne, Ind.

**Be a Mirror Expert.** \$3-\$10 a day; spare time home at first; no capital; we train, start you making and silvering mirrors, French method. Free prospectus. W. R. Derr, Pres., 579 Decatur Street, Brooklyn, N. Y.

**Detectives Earn Big Money, Travel.** Great demand. Experience unnecessary. We train you. Write for free particulars. American Detective System, 1068 Broadway, New York.

### Patent Attorneys.

**Millions Spent Annually for Ideas!** Hundreds now wanted. Patent yours and profit. Write today for free books—tell how to protect yourself, how to invent, ideas wanted, how we help you sell, etc. 301 Patent Dept., American Industries, Inc., Washington, D. C.

### For Advertisers.

**Don't Experiment.** White space is too costly. Let Jacobus write your advertising. Letters, \$3.50. Jacobus Advertising Service, 41 Bruen Ave., Irvington, N. J.

### Formulas.

**Any Formula You Want** only 50 cents. John R. Kerr, P. O. Box 201, Brooklyn, N. Y.

**Invisible Inks (Double Writing).** Write your message with it, over that write with a visible ink, erase it and the invisible appears. Complete formula, 25c. Edward Gille, 714 S. 12th, Quincy, Ill.

### Business Opportunities.

**For \$7.20** and a little time you can make \$4.80 selling 12 bottles of our auto body polish, different from any other, sells with every demonstration. Send \$1.00 for full size bottle and particulars, to see for yourself. Blue Seal Mfg. Co., Blue Bell, Montgomery County, Pa.

**Patents For Sale.** To sell, buy, or obtain patents write Patent News, 309, Washington, D. C.

**Turn Your Spare Time** into money for that apparatus you want. Start a profitable, permanent home business. Steady weekly income. No investment but your brains and spare time. Positively no soliciting, agency proposition. Write today. Address Opportunity, Box 175, Fredonia, N. Y.

**Substantial Manufacturing Corporation** wants capable men to establish branch and manage salesmen; \$300 to \$2,000 necessary. Will allow expenses to Baltimore as explained. Address Mr. Clemmer, 603 N. Eutaw St., Baltimore, Md.

**If You Want To Sell** or exchange your farm, unimproved land, city property or patent, write me. John J. Black, 194th St., Chippewa Falls, Wis.

### Books.

**Wanted—Back issues** of Radio Amateur News and Electrical Experimenter. Boston Magazine Exchange, 109 Mountfort Street, Boston, Mass.

**Subscription Agents—Best** magazine proposition. Make big money. Write for particulars. Concordia Magazine, 9-A Water St., York, Pa.

**How I Acquired My Millions—a** book of ideas. Price postpaid only 10 cents. J. R. Kerr, Box 291, Brooklyn, N. Y.

**The Amateur Electrician.** Pocket size, 20c. (coin). Joe Tillberg, Proctor, Vermont.

**Latin Students—Word** for word English translations of "Caesar," "Cicero," or "Virgil." Postpaid, \$2.00 each. Monongahela Novelty Co., Monongahela, Pa.

**Special Service Magazine.** A magazine of mail order selling; every mail order dealer needs it. Stamp brings free descriptive circular. J. R. Kerr, Publisher, P. O. Box 291, Brooklyn, N. Y.

**Nature Facts** married and engaged people should know, concisely given, 25c. Central Sales, 601 Ninth Ave., New York.

**Wireless Course in 20 Lessons.** By S. Gernsbach, A. Lescarbourea and H. W. Secor, E. E. Tells you everything you want to know about "Wireless"—theory, practise and history. A clear, concise course on every phase of this subject; 166 pages—350 illustrations, 30 tables. Flexible cloth cover, 75c. postpaid. Stiff cloth cover, \$1.25 postpaid. Experimenter Publishing Co., Book Dept., 236-A Fulton St., New York.

**Just Off the Press.** Design and Construction of Audion Amplifying Transformers (Radio and Audio-Frequency Types). By Edward T. Jones, late Associate Editor Radio & Amateur News. The transformers shown in this book have never been described in print before and have usually been considered a manufacturer's secret. The designs are very rugged and simple. A book that every radio "bug" should have. Written so you will understand every word. Price 25c postpaid. Experimenter Publishing Co., Book Dept., 236-A Fulton St., New York City.

**How to Make Wireless Receiving Apparatus.** 100 pages—90 illustrations. Only strictly modern radio apparatus are described in this book and the illustrations and descriptions are so clear and simple that no trouble will be experienced in making the instruments. Paper covered, 35c postpaid. Experimenter Publishing Co., Book Dept., 236-A Fulton St., New York City.

### Correspondence Courses.

**Dollars Saved.** All kinds of used correspondence courses sold. (Courses bought). Lee Mountain, Pisgah, Alabama.

### Health.

**Pyorrhea (Rigg's Disease—Bleeding or Swollen Gums)—**Hundreds have been helped by our successful home treatment. Purifying, healing, preventative. Full month's treatment, consisting of a very beneficial massage paste and an antiseptic tooth-cleansing paste to be used in place of your ordinary dentifrice together with full directions for treatment, \$1 postpaid. Or write for free Booklet "R." Pyorem Mfg. Co., 439 Seventh Street, Brooklyn, New York.

**Tobacco or Snuff Habit Cured** or no pay; \$1 if cured. Remedy sent on trial. Superba Co., SB, Baltimore, Md.

### Electrical Supplies and Appliances.

**Mechanical Drawing Instrument Sets;** bargain. Send for catalog. National Instrument Co., 4517 N. Lawndale Ave., Chicago, Ill.

**Water Locating** by Mansfield's water finder is interesting and profitable. Particulars from Edwin Mansfield & Co., 94 Victoria Road, New Brighton, England.

**Five 110-volt D.C. Ceiling Fans;** good condition. Make offer; one or all. Penn Radio Co., Greenville, Pa.

### Photo Developing.

**Print Your Photos on Silk,** very beautiful and attractive pictures. Send only \$1 for package of silk, prepared; postage prepaid. F. Irsa, Elizabeth, N. J.

**For Prompt Service** and best results, mail all your films to L. E. Peterson, Box 439, Galesburg, Ill., for correct printing. Send for price list.

### Postcards.

**Everything in Postcards.** Live-wire list free. Worth-while samples, 25c. Mention subjects preferred. Mutual Supply Co., Bradford, Pa.

### Rubber Stamps.

**Rubber Stamps Made to Order.** McCaddon Company, Zanesville, Ohio.

### Stamps and Coins.

**100 Old and Current American** and Foreign Stamps, including revenue, stock transfer, documentary, etc.; 25c. Chas. Durso, Dept. 50, 25 Mulberry St., New York City.

**Coins, Medals, Paper Money, Antique Firearms, Indian Relics, Curios, Stamps.** Catalog free. Antique Shop, 33a South 18th, Philadelphia.

**500 Different Stamps, \$1.40;** 200, 30c.; 100, 13c.; approvals. Michaels, 5600 Prairie, Chicago.

**800 Stamps, only 25c.** John Hammond, Elliott City, Maryland.

### Song Poems.

**Have You Song Poems?** I have best proposition. Ray Hibbeler, D115, 4040 Dickens Ave., Chicago.

**Song-Writers' Manual & Guide Sent Free.** Contains valuable instructions and advice. Submit song-poems for examination. We will furnish music, copyright and facilitate publication or sale. Knickerbocker Studios, 311 Gaiety Bldg., New York.

### Stammering.

**St-Stu-t-tering and Stammering** cured at home. Instructive booklet free. Walter McDonnell, 121 Potomac Bank Bldg., Washington, D. C.

### Scenery for Hire.

**Collapsible Scenery** for all plays. Amelia Grain, Philadelphia, Pa.

### Telegraphy.

**Telegraphy (both Morse and Wireless)** and Railway Accounting taught quickly. Tremendous demand. Big salaries. Great opportunities. Oldest and largest school; established 46 years. All expenses low—can earn large part. Catalog free. Dodge's Institute, M. St., Valparaiso, Ind.

### Miscellaneous.

**Big Mail Free!** Just send your name. W. E. Fitzpatrick, Box 722, Chicago, Illinois.

**Build Your Own Motorboat.** Interesting work for boys. Send 50c. for a complete set of clearly drawn plans of a 21-ft. motorboat or cruiser including list of material required. A. Rank, 193 Grand Ave., North Bergen, N. J.

**Electrical Tattooing Machine,** \$3, \$5 and \$7. Catalogue for stamps. J. H. Tempe, 1019 Vine Exp., Cincinnati, Ohio.

**Carbon Papers and Ribbons.** Get our prices first. Any amounts. Reuter Trochelman, 34 E. 6th St., Cincinnati, Ohio.

**Tattoos Removed.** Simple process. Satisfaction guaranteed. Pharmaceuticals and instructions for \$1. No stamps. Alfred Hogue, 45 Gale Ave., Pittsfield, Mass.

**"Arnold."** The Ball with Psychic Power. Priceless as an amusement device; more entertaining than the Ouija Board. Science is baffled; doctors dumfounded. Price \$1.00; \$8.00 per doz. J. Harvey Arnold, Princeton, N. J.



News Correspondents.

Earn \$25 Weekly, spare time, writing for newspapers, magazines. Experience unnecessary; details free. Press Syndicate, 506 St. Louis, Mo.

Novelties.

The Reliable Weather Prophet—Send 10 cents for me, hang me up. I will tell you when it will rain or shine. Particulars for stamp. National Specialties, 32 Union Sq., New York City.

Office Devices.

We Buy for Cash, Rebuild and Sell for about half new price, Multigraphs, Addressing Machines, Duplicators, etc. Don't be misled by firms infringing on our name. We are the original Office Device Company, 154-C West Randolph, Chicago.

Printing.

3,000 Two Color Labels, \$1.25. Irvin J. Wolf, Station E, Philadelphia.

Radio League Members—50 name cards with emblem of League printed, 45 cents; 100 letter-heads and envelopes with emblem, \$1.75. Printing Arts Press, 83 East 24th St., Paterson, N. J.

Phonographs.

Build Your Own Phonograph. Big saving. Blue prints, parts price list, instructions free. Associated Phonograph Co., Dept. R-N, Cincinnati.

Wireless.

Sets and Apparatus for sale cheap. Write your wants. A. B. S. Lab., 1315 E. High St., Davenport, Iowa.

Q. S. T.—Amateurs. We have a few Western Electric VT-1, \$10.00; two filament audiotrons, \$6.10; Marconi and Moorhead VT-1 and VT-2, \$7.10; Murdock 43-plate variables at old price, \$5.50; audiotron adapters, \$1.50; and other bargains. Write quick. The Coastal Radio Co., 301 Second Ave., Asbury Park, N. J.

Complete Radio Outfit for receiving station, range 300 miles. Complete set of parts, including coil forms, switch knobs, wire, head phones, aerial equipment, etc. Complete in every detail. Packed in wooden cabinet with Wireless Manual and instructions. Only a few of these splendid outfits left. Price \$25. Blair Coursen, 55 Hitchcock Hall, Chicago, Ill.

Special; No. 24 Double Cotton Covered Wire, \$1 per pound; postage extra. Frank Peterson, Muscoda, Wis.

All Amateur Apparatus bought or made in accordance with The Radio Buyers' and Builders' Handbook invariably re-sells very profitably. Study my June and July display advertisements in Q. S. T., see why, and get your copy now, R. Clark, Barnes Rd., Newton, Mass.

Amateurs, Attention! Couplers, tuners, detectors, cheap. Write for particulars. National Radio Specialty Co., 5613 Cedar Avenue, Phila.

Amateurs, Attention: Transmitting condensers built especially for spark coils up to 2", \$2.00 each. Radio apparatus built and tubes wound to specifications. Cabinets and other wood-work a specialty. Lee Brothers Co., 605 N. Walnut St., Champaign, Ill.

Audion Control Unit—Bakelite panel on which is mounted a V. T. socket, grid condenser, rheostat, grid leak, B bat., and six binding posts. Price \$8.00. Telephone cords, 4 and 5 conductor, 6 ft. long, at 45c. each. High potential mica condensers, .002 and .005 approx. capacity at \$1.25 and \$1.50 each. Postage extra. Haupt Elec. Supply Co., 2442 Ogden Ave., Chicago, Ill.

Wireless Instruments for Sale. Send stamp for list. Bernard Davis, 1130 Mellon St., Pittsburgh, Pa.

Radio Phonists Attention. High voltage generators. We supply these motor generator sets in various capacities, especially designed for radio phone work, also low powered rotary converters, dynamotors, fractional H. P. motors and storage batteries. We are in a position to solve your generator problems and supply machines to fill your requirements. We also have the standard RAY-DI-CO phone sets complete, or furnish any part thereof. In fact, if it is radio equipment of any kind, or a set of your own design, write us stating your wants and become acquainted with our service. RAY-DI-CO (not Inc.), 2653 A, N. Clark St., Chicago, Ill.

Good Radio Receiving Sets, \$8.50 and Up. Panel transmitting sets, \$30.95 and up. Radiophone apparatus, wire, supplies of all kinds. Catalog 6R for two-cent stamp. Pocket code card free. Jenkins, 929 Purchase St., New Bedford, Mass.

Double Pole Western Electric Single Head Set, with nicked head band and cord, \$1.75; steel lever legless sending key, \$1.00. Silk wound 200-meter coupler, \$5.50. Prepaid in U. S. A. E. Hancock Co., Austin, Texas.

Dead? Your "A" battery we mean. Always ready if you use our B-B Battery Booster. Charges your battery overnight for 10c. Soon pays for itself. Every amateur needs one. \$1.00. It's ready to ship you. Hi Co., Marion, Ill.

600-Volt, 100-Amp. S. P. S. T. Copper Switch, \$2.00. Amplifiers, Acme transformers, detectors, Moorhead tubes, Bakelite-Dilecto panels. Anything in radio. Send stamp for price list. Jerome Haas, 2011 Atlantic Ave., Atlantic City, N. J.

Wireless—(Continued.)

Radio Telephone. Simple description of the Radio Telephone with complete circuits of a transmitter, receiver and amplifier. With this data anyone can construct a radio telephone capable of transmitting fifty miles. The amplifier used with a loud speaker intensifies the voice very clearly. 25 cents, postpaid. Forest Publishing Co., 114 State Street, Boston, Mass.

Doktoro Pierre Corret, 19 Boulevard de la Republique, Versailles (France), deziras kore-sondi kun Amerikaj amatoroj de radiotelegrafo en franca lingvo au en lingvo internacia ESPERANTO.

Custom Built Receiving Set. Absolutely new and the last word in construction and design. Lavishly complete. Range 150-20,000 meters. Cost \$400.00 to construct. Will sacrifice \$250.00. Layton Wolfe, 1706 North 50th St., Seattle, Washington.

This Month Only Grid Condensers, polished mahogany case, nickel plated binding posts, 60c. R. T. S. tested Galena. Large piece, per box, 24c. Look for our ad on page 244. Radio Testing Station, Binghamton, N. Y.

Sale—Helix, 1/4-K.W. transformer and quenched gap, Murdock 1,500-meter loose coupler. Full information on request. Alan MacCracken, Towle School, Port Deposit, Md.

Switches and Switch Points 3/16-inch dia. by 5/16-inch high, tapped with 4-36 screw. Brass and N. P., 48c. and 60c. dozen. Send stamp for circular. Liberty Radio Supply Co., 6808 Aberdeen St., Chicago, Ill.

Amateurs. Mica-Copper Foil Grid Condensers, 40c. In lots of 6 or more, 35c. Sure-Lock VT Receptacles, \$1.00; 6 or more, 95c. Send for literature. A. F. Krause & Company, 689 McDougall Ave., Detroit, Mich.

Portable Sets of all kinds made to order. Inexpensive, Light and Efficient. A. & S. Laboratories, 727 East 2nd St., Paterson, N. J.

Exchange.

DeForest P-401 Audion Control, new, \$10.00. Baldwin amplifying phones practically new, \$10.00. Bargains. Come quick. A. L. Byler, 2051 Bellevue Ave., Phila., Pa.

For Sale—Complete amateur radio station. Richard Bohannon, Boonville, Indiana.

Bargain—E. I. Co. Vario Selective Coupler, \$6. Never used. Write Harold Bettinger, 606 West High Street, Mt. Vernon, Ohio.

For Sale—1-I.W. Thordorson R. Type Transformer, \$30; Navy Type Coupler, 3,500 meters, \$12.00; Murdock Receiver, 2,000 ohms, \$3.00; 3 pr. W. E. Phones, \$8.00 each; 1-inch Spark Coil, \$3.00; 2 pr. Brandes Navy Type Receivers, \$10.00; Superior, \$5.00; Sayville Rotor and Standards, \$4.50; 1 Honeycomb Coil mounted (panel) with 3 coils, \$7.00; 1 Navy Type Vario Coupler mounted in cabinet, \$6.00; 1 Knockdown Variable Condenser, 43-plate, \$1.50; 1 Locking Inductance No. 510 Murdock, \$2.50; 1 Crystal Det., large size, \$4.50. Wanted—Variable Condensers, W. E. Bulbs. George Kostka, 2347 So. Ridgeway Ave., Chicago, Ill.

For Sale—DeForest LC 100, three LC 25 coils. Eight dollars. Harry Jones, 2605 Fourteenth St., Washington, D. C.

For Exchange for Wireless Goods the following: 1,350-ohm Tel. relay; one 20-ohm sounder; two keys for wireless; one 16-H.P. motorcycle engine; twin has mag. also. All goods in first-class condition. Would like sending transformer for part exchange. All letters answered. Harold Hurley, Lake Como, New Jersey.

Forced to Sell Immediately—New DeForest Audion Ultra-Audion Panel, Number P-500. In perfect condition. New 40-volt Burgess "B" Batteries; without bulb, \$20.00. Alfred Hubbard, R. D. No. 6, Pontiac, Mich.

Coit Automatic Special, 22 L.R., and Audley Holster. Perfect condition; \$40. Wallace Huston, Woodland, California.

For Sale: A complete wireless set, including audions, "A & B" batteries and aerial. Sell for a \$75 money order. Write for a list. Thos. J. Henninger, 48 S. Second Street, Shamokin, Pa.

Amateurs Attention: We as a progressive radio supply company are going to be the first to lower the cost of radio apparatus. Every month we are going to run special offers on the different makes of apparatus. As a starter this month we are making our special offer—Acme apparatus—for one month only—5 per cent less than list price. All goods shipped prepaid east of the Mississippi and all goods guaranteed. The early orders get our stock and when exhausted other orders will have to wait a week or ten days, therefore come early. Mail orders only. Radio M. O. Supply Co., 533 West End Ave., New York City.

For Sale—Complete DeForest Unit Set—mounted firm polished panel—perfect working order—make offer—includes bulbs and verniers. Prescott Smith, 35 N. Maple Ave., Ridgewood, N. J.

Bargains—Two Grebe Variometers with large dials, \$15; 2 Murdock sections, \$5.00; Mescoe 3-inch coil, \$8.00; DeForest Coupler, \$2.50. All letters answered. Morris Press, 839 Thrall Ave., Woodhaven, N. Y.

For Sale—No. 23 cotton covered wire, \$1.10 per pound. Also No. 28, No. 30, No. 32 Green Silk covered wire. Ralph Winters, 404 Pearl Street, Camden, N. J.

Exchange—(Continued.)

Going To College. Must sell large damped-undamped Formica receiving cabinet. Includes Honeycombs covering wave-lengths 200 to 20,000; three 43-plate variables; new double filament Electron Relay; Brandes phones; two new Burgess "B" batteries; rheostat; variometer; anti-capacity switch; fifteen control switches. Six circuits possible by switching arrangement. Includes circuit for use as Radio-phon transmitter. Cost me over \$85 to assemble. Will sell for \$48 cash. Also sell 1-inch coil with gap for \$4. P. H. Craig, 3397 Glenmore Ave., Cincinnati, Ohio.

Wanted—1/2 K.W. Transformer. R. W. Curtis, 6316 Delaware St., Chevy Chase, Md.

For Sale—One short wave regenerative set, and loading coil 12,000 meters. Both for \$17.00. Also 500-ohm wire-wound potentiometer, \$3.75. First money order takes them. Wm. Davis, 231 Stanley Ave., Canon City, Colo.

Don't Read This. Selling out. Duck's Audiotron Panel, and other apparatus too numerous to mention here. Send for list. G. W. Calvert, Chalfont, Bucks Co., Pa.

For Sale—2-20,000 meter loading coils for \$10.00; new Atwater-Kent uni-spark coil, \$3.50; 1/2 spark coil, \$2.25; 6-speed, worm-gear speed reducer, new, \$4.50; L-shaped transformer core-iron \$1.25 for enough for each transformer. New audiotron, \$4.50; 5 ball insulators, \$1.00. Send money order. Howard English, 221 Pine St., Shamokin, Pa.

For Sale—Stromberg Carlson phones, three new audions, three variable condensers, Blitzen quarter-kilowatt transformer, Electrical Encyclopedia, telegraph instruments, Bakelite panels, meters, plate camera, insulators, aerial wire, etc. Red stamp brings price list. Arthur Egan, 6 Whiting Ave., Holyoke, Mass.

Will Sell new Gilbert loose coupler for \$16; also two Blitzen condensers, 43-plate, at \$4.00 each. H. E. Edgerton, Aurora, Neb.

For Sale to highest bidder, Key West cabinet, worth \$22; E. I. Tuning coil, worth \$3.50. Murdock loading coil worth \$4.50. Write James Obrig, 106 Washington Place, Ridgewood, N. J.

For Sale—Inch-and-half spark coil, \$7.00; Marconi V. T., \$6.00; socket, \$1.00; 2,500-meter loose coupler, \$8.00; 43-plate variable, unmounted, \$3.00; 10,000-meter leading coil, \$5.00. None of this apparatus used more than two hours. All new. Address Mr. Leonard Gore, 212 S. Rosewood St., Phila., Pa.

Sell—3,500-meter receiving transformer, \$8.00; 1,500-meter receiving transformer, \$3.50; 1,500-meter tuning coil, \$3.00; 1,000-meter tuning coil, \$2.50; 15,000-meter loading coil, \$5.00; audiotron control panel with cabinet, \$8.00; audiotron one week old, used twice, with grid condenser, \$4.00; 1-K.W. wireless key, \$1.50; 1-K.W. spark gap, \$1.00; 1-K.W. helix with clips, \$3.00; 3-sending glass plate condensers, each, \$7.75; rotary spark gap motor, speed 4,000 r.p.m., \$5.00; line telephone two-station outfit, \$3.00; No. 5 erector, \$3.00; Jove detector with crystal, \$1.25. Raymond Fiedler, 70 Sargent St., Lawrence, Mass.

For Sale—DeForest V.T.-21, \$10.00; Acme Amplifying Transformer with binding posts, \$4.00. E. Nething, 32 Hemlock Street, Brooklyn, N. Y.

Amateurs. Join our wireless exchange and get a regular discount on all makes of radio apparatus. Membership fee 50c. Don't delay; join now. Send 10c. for new catalog just off the press. Newark Wireless Exchange, 98 Eaton Place, East Orange, N. J.

Sale—Radio receiving set, damped or undamped, Formica Front Audion and Ultraudion control panel, Transatlantic Receivers, 12-volt storage battery. First money order for \$50. Gordon Mallory, 1224 Leighton, Anniston, Ala.

Bargain—Duck's new Navy Coupler. Hardly used. Worth \$27.50—Sell \$20.00. Louis Lakatos, 4720 N. 11th St., Philadelphia.

For Sale—Stamp collection of about 3,000 stamps in Modern Album. Appraised at \$38.50. First money order for \$28 gets it. Laurel Kettler, Piqua, Ohio. Box 809.

Special! D. C. aeroplane generator, 12-volt, 250-watt; make fine charging plant, \$12; 3-ft. loader, \$6; Brandes fones, hardly used, \$5.50; King Type B toy transformer, 2-20-v., \$3.50; fifty-five 5x7-in. photo plates, tinfoil coated, \$35. \$5; over 1 lb.; new No. 33 S.S.C. wire, \$3.50; Murdock O. T., \$3.50; Arlington coupler, \$5. Postage extra. G. Kosteletzky, 11802 Union Ave., Cleveland, Ohio.

Sell: 1/2-K.W. Transmitting Set, \$32.50; 1,500-meter Receiving Set with Audion Detector \$40.00. No junk. Used two months. 40% off list price of apparatus. Miscellaneous material, etc. Write for particulars. Wm. S. Knapp, 2634 Wabash Ave., Kansas City, Mo.

Sell or Trade—for receiving apparatus. 110 A. C. motor, Murdock loading coil, step-down transformer, rifle, polishing head. Write F. Kryszewski, 1310 North St., Rochester, N. Y.

Wanted—Transmitting, Receiving Set. Also parts. Omnigraph reasonable. A. Koepfle, 601 21st St. N. W., Washington, D. C.

New 7-Panel DeForest Bakelite set receiving. Baldwin Phones, twelve Honeycomb coils. Write for particulars. Cooper, 58 Jiroch, Muskegon, Mich.

(Continued on page 262)



## Mail Us Your Radio Wants

We will surprise you with the fastest service in filling your orders that you ever knew. In delivery of radio apparatus by mail, SPEED is our motto. We make prompt shipment to any part of the U. S. — and postpaid too.

	Each
22½ V. "B" Battery	\$1.25
RORH Detector	17.00
Grid Condenser	.35
Stopping Condenser	.35
RORE Amplifier	25.00
CRC Amplifier	65.00
Corwin Dials	1.30

### Radisco Agents

Radisco Coils—	
LRD 40	\$0.70
LRD 100	\$0.95
LRD 325	1.40
LRD 1200	2.65
LRD 750	\$2.00

Tap Coils—	
LRD 325 3.	\$1.70
LRD 1200 3.	\$2.90

Coil centers plain... Pair \$0.25  
Coil mounting for Radisco Coils... 6.00

For a more complete list of Radio apparatus send 10c for catalog, cost of which will be deducted from first \$1.00 order.

Open Evenings Until 9:30 P. M.

**KELLY & PHILLIPS**

312 Flatbush Avenue, Brooklyn, N. Y.  
Telephone Sterling 2380

## TELEGRAPHY

(Both Morse and Wireless) and RAILWAY ACCOUNTING taught thoroughly and quickly. Big salaries now paid. Great opportunities for advancement. Oldest and largest school; established 46 years. Endorsed by Telegraph, Railway, Radio, and Government officials. Expenses low—opportunities to earn large portion. Catalog free.

DODGE'S INSTITUTE

8 Street, Valparaiso, Ind.

## "LITZ" WIRE

For Loop Aerials, Variometers, Coils and Connections requiring wire of low high-frequency resistance. We can supply "Litz" Wire consisting of 20 strands No. 38 wire, individually enameled, twisted and covered with a double service of silk. Any quantity. 1c per foot



**A-P ELECTRON RELAYS \$6.00**

**A-P TRANSMITTING TUBES 7.50**

Immediate Deliveries

**FREE—D. H. E. Radio Catalog No. 2—FREE**

**DOUBLEDAY - HILL ELECTRIC CO.**

Radio Department—Desk B

715 Twelfth Street, Washington, D. C. 719-21 Liberty Avenue, Pittsburgh, Pa.

## Wanted—Superintendent for Radio Factory

Brooklyn, N. Y. factory just starting in to manufacture amateur radio apparatus wants superintendent for radio plant. We want a man who has had similar experience, knows how to handle men, is familiar with tools and dies, and must also be a good machinist. One with executive ability preferred. State salary, experience, how soon services will be available. Box No. 6, care of this publication.

## OPPORTUNITY AD-LETS

(Continued from page 261)

### Exchange—(Continued.)

Wanted—Chicago Radio Laboratory Paragon or Grebe C.R. 3 Short Wave Regenerative Receiver, also Audion Detector and two-stage Amplifier to go with same. State lowest cash price. Address Alfred Gienow, River Edge, N. J.

For Sale—1,000 feet No. 12 rubber covered wire, \$20.00. Milton Ackerman, St. Johnsville, N. Y.

For Sale—18,000 R.P.M. motors. 1/5 H. P. A. C. or D. C. One of each voltage 32 and 110. New, unused and in perfect condition. Best offer takes one or both. E. R. Gowdy, 42 Freeland St., Worcester, Mass.

For Sale: Wireless Receiving Apparatus. Send two-cent stamp for list. Goebel, 372 West 127th St., New York.

For Sale. Omnigraph transmitting and receiving set. Also different parts. Excellent condition. Box 3051, You St., Post Office, Washington, D. C.

Receiving Cabinet For Sale. Good value. For full information write Harold Woodman, 63 School St., Auburn, Maine.

For Sale—¼-K.W. Transformer; A-1 condition; \$8.00. J. F. Wilhelm, 119 W. 4th St., Williamsport, Pa.

Sale—Short wave regenerative set, \$25; 5-A navy coupler, \$14; 3-slide tuner, \$3; amplifying transformer, \$5; oscillating coil, \$5; Cambridge semi-quenched rotating spark gap, \$25; four sections Clapp-Eastham transmitting condenser, \$3.50 per section; commercial type oscillation transformer, \$8; antenna switch, \$3.25; hot wire ammeter, \$4.50. Wanted: Amrad quenched gap and resistance. John E. Wynkoop, 4054 Chestnut Street, Phila., Pa.

For Sale—Two Federal Amplifying Transformers, \$9.00. H. Van Dohla, 348 W. 36th St., New York City.

Short Wave Regenerative—Penn Radio make, new. Tunes 150-600 meters. First \$12.00 takes it. Underwood, Box 565, Monongahela, Pa.

For Sale—Complete Receiving Outfit, Audion Detector with bulb and numerous instruments. Cheap, \$35.00. Carl Schroeder, 154 E. 50th St., New York City.

For Sale—6-inch Spark Coil. Write Maurice H. Simmers, Macomb, Ill.

### Exchange—(Continued.)

Sell new Duck 3-slide tuning coil. Jove Detector, \$6.50. Orlo Stevens, Donna, Texas. Box 143.

For Sale—Audion Detector Set; 2,500 meters. Further information apply to Carl Staugaard, 4531 N. Rockwell St., Chicago, Ill.

Trade—2-inch Bulldog and 2 Leyden Jars for No. 2 Omnigraph. Send to V. Sandors, Box 374, Sharon, Pa., and get coil and Leyden jars by return mail.

Sacrifices! Long wave regenerative receiver, 4,000-20,000 meters. Gets domestic and foreign arcs; one tube; \$40. Short wave regenerative receiver, 150-750 meters, \$20. Crystal cabinet receiver, 200-2,500 meters, \$7.50. "Radio," 110 Park Row, New Orleans, La.

Radio Steel Mast for sale; 60 ft., with guys, insulators, turnbuckle and directions to erect. First \$22.00 gets it. R. Robida, Tilton, N. H.

For Sale or Exchange. Have Weston Ammeter and Voltmeter, Model 280. Brand new. Send for particulars and list of other apparatus. Edward Kichter, 107 Conselyea St., Brooklyn.

Amateurs—Radio apparatus bought. Extraordinary prices given. Send postal. Rogers, Pitt St., Redfern, Sydney, Australia.

Swap. \$80 worth of wireless material for motorcycle or \$60 cash. For particulars write M. Arnold Richter, Rutgers Prep. School, New Brunswick, N. J.

Moving, Must Sell 1,500-meter loose coupler, \$3.00; 3,000-ohm phones, \$4.00; Gelana detector, \$1.50; etc. Write for list to Wm. F. Ackerman, 737 E. 23rd St., Paterson, N. J.

For Sale. Complete panel receiver with phone, \$10.00. Tuning coil, \$2.50. Particulars on request. Herman W. Seikel, Dover, Ohio.

Hark Ye Amateurs! Two 10,000-meter loading coils, \$5 each (pair, \$9); 2,500-meter navy coupler, \$9; 15,000-meter coupler, \$18 (both for \$25). Also spark coils, crystal detectors, etc., etc. Everything in excellent condition. Edmund Smith, Creek Road, La Salle, New York.

Let's Swap! Buy! Sell! What'd'ye got? What'd'ye want? Dime quarterly. National Exchange Medium, Detroit.

Sell—Complete receiving station, all new. Call or write. Emanuel Nyman, 525 W. 160th St., New York City.

For Sale or for Rifle or Shotgun—DeForest \$21.80 Vernier in aluminum case, \$16; DeForest \$35 pre-war variable, make offer; Century buzzer, \$1.35; audion bracket, 75c; general radio key, \$5.00; rheostat, 75c; Bunnell rotor and standards, never used, \$6.50; Bunnell \$4.50 gap, \$3.00; four Murdock \$5.00; section condenser, \$3.00 each, all \$10.00; Murdock \$13.85 ammeter, \$8.00; audion panel, \$8.00; Mescro arm transmitter like new, \$2.50; 2 M.F. fixed condenser, 75c. Small Runnkoff coil and key, \$3.50. Natalish, 68 West 56th Street, New York City.

For Sale: Liberty vacuum cabinet, with audion; 43-plate Murdock and Clapp-Eastham condensers; Holtzer-Cabot phones; Murdock series condenser; and Chambers ¼-K.W. condenser. Arthur Haake, West Norwood, New Jersey.

New DeForest Oscillation. New General Radio Wavemeter; other wireless apparatus. Want large storage battery, battery charger A. C. 6-cylinder high tension magneto. 120 Christie St., Ridgefield Park, N. J.

Wanted: Automatic Pistols. Natalish, Stockbridge, Mass.

Trade or Sell Cheap—Stamp affixer, one-minute sleeve camera, kerosene-gas burner, stereoscope, adding machine, stenotype shorthand typewriter, other things. List free. Chas. Durso, Dept. 50, 25 Mulberry Street, New York City.

Genuine "Jupiter" Aerial Wire. Seven strands No. 22 solid copper. 100% conductivity. 1½c. per foot, \$12.00 per thousand. No C. O. D.'s. 15 pounds per 1,000 feet. Send postage. Lee A. Bates, 8 Moen Street, Worcester, Mass.

The How and Why of Radio Apparatus, by H. W. Secor, E. E. This newest book on radio matters fulfills a distinct gap in wireless literature in that, while the treatment is made as understandable and as free from mathematics as possible, it at the same time, incorporates a wealth of technique and instruction for the Radio Amateur—the Radio Operator—the Installation and Designing Expert—as well as teachers and students of the subject in general. A very broad field has been covered by the author, at the same time giving a great deal of information not found in other text-books. If you are engaged in any branch of the Radio or allied arts at all you will surely need this latest contribution to radio literature, which is destined to be found on every radio man's book shelf before long. This newest of Radio Works, cloth bound in Vellum de Luxe, Gold stamped and Hand Sewed, has 160 pages. Size of Book 6 x 9 inches. The How and Why of Radio Apparatus, Postpaid \$1.75. Experimenter Publishing Co., Book Dept., 230-A Fulton St., New York City.



# PATENTS TRADE-MARKS AND COPYRIGHTS

## SPECIAL OFFER FREE OPINION AS TO PATENTABLE NATURE

Before disclosing an invention, the inventor should write for our blank form "Evidence of Conception." This should be signed and witnessed and if returned to us together with model or sketch and description of the invention, we will give our opinion as to its patentable nature.



## OUR THREE BOOKS MAILED FREE TO INVENTORS

Our Illustrated Guide BOOK

### HOW TO OBTAIN A PATENT

Sent FREE on Request

Contains full instructions regarding Patents, Trade-Marks, Foreign Patents. Our Methods, Terms, and 100 Mechanical Movements illustrated and described, Articles on Patent Practice and Procedure, and Law Points for inventors.

### OUR TRADE MARK BOOK

Shows the value and necessity of Trade-Mark Protection and gives information regarding unfair competition.

### OUR FOREIGN BOOK

We have Direct Agencies in all Foreign Countries. Write for our illustrated Guide Book on Foreign Patents.

#### SPECIALIZATION OUR STAFF

The field of invention is so fast that it is impossible for any one man to become an expert in all the different classes of invention. Only those practically skilled in the class to which the invention relates are capable of rendering efficient service. For this reason Victor J. Evans & Co. employ a number of patent lawyers and mechanical experts who have been selected for their special knowledge and ability in certain lines of invention. Each case is placed in charge of experts in the classes in which the invention relates.

#### THE VALUE OF YOUR PATENT

Will depend much upon the skill and care with which your case is prosecuted in the United States Patent Office. This work will receive the benefit of skill and experience acquired by a long and successful practice. We spare neither time nor pains to secure the broadest possible patents that the inventions will warrant. That every case entrusted to us receives our best efforts,

and that our work is done consistently, skillfully and thoroughly is evidenced by the many unsolicited letters of commendation that we receive constantly from our clients. We will furnish upon request lists of clients from any State in the Union for whom we have secured patents.

**Our New York, Philadelphia, Pittsburgh, Chicago, and San Francisco Offices**

Owing to the growth of our business we have established for the benefit of our clients Branch Offices in New York City, Philadelphia, Pa., Pittsburgh, Pa., Chicago, Ill., and San Francisco, Cal. These branch offices being located in these large commercial cities, together with our Main Office located near the U. S. Patent office, in Washington, enables us to more promptly handle the business of our clients, particularly as the branch offices are in constant touch with the Main Office and fully equipped to handle patent business in all its branches.

*Highest References—Prompt Attention—Reasonable Terms*

FREE COUPON



## VICTOR J. EVANS & CO. PATENT ATTORNEYS

New York Offices 1007 Woolworth Bldg. Philadelphia Offices 135 S. Broad Street Pittsburgh Offices 514 Empire Bldg.  
 Chicago Offices, 1114 Tacoma Bldg. San Francisco Offices, Hobart Bldg.  
 Main Offices, 867 9th Street Washington, D. C.

Gentlemen: Please send me FREE OF CHARGE your books as described above.

Name .....

Address .....



# AUDIOTRON

*The Original Tubular Vacuum Detector, Amplifier, Oscillator*

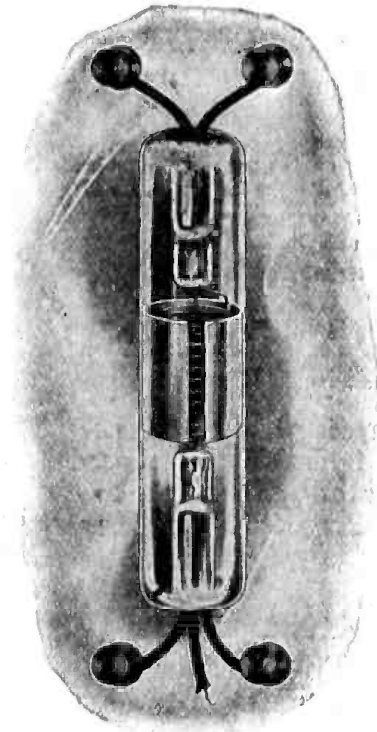

## NOW FREE FROM ALL RESTRICTIONS

### Dealers and Amateurs!

AUDIOTRONS, recognized as the most sensitive detectors ever produced, are now licensed under Fleming Patent No. 803684 to be used only for amateur and experimental uses in radio communication. They are no longer limited to audio frequency and can now be used as detectors and oscillators as well as amplifiers.

All patent questions also have been definitely settled. Vacuum tube patents are basic and have been sustained by the Federal Courts.

Be sure to get genuine AUDIOTRONS. They outclass any other form of detector and are absolutely free from all legal restrictions or difficulties. These new uses make it even more necessary to insist on the genuine. You can always tell a real AUDIOTRON by the name stamped plainly on the glass.

Insist on the name AUDIOTRON on every tube you purchase. Fully guaranteed by the AUDIOTRON Mfg. Co. (Read the guaranty below).

AUDIOTRON the only tube satisfactory enough to stand a guarantee!

## Your last chance for an AUDIOTRON double filament DETECTOR

Manufacturing reasons make it impossible to continue the present hand-made AUDIOTRON.

This type has a double filament of special thorium tungsten and the operating life is over 2,000 hours. No special socket is required. The electrical and mechanical dimensions result in a heavy plate current and corresponding signal strength. Plate voltage under 40.

The few thousand that will still be produced, however, will be of the same standard of excellence that has characterized every AUDIOTRON. Already recognized as the most sensitive detector on the market, these few that still remain, with all restrictions on amateur use lifted,

are undoubtedly the greatest opportunity ever offered to amateur radio operators.

See your dealer at once or order direct. Be sure to benefit by this last opportunity to secure a hand-made super-sensitive, double filament AUDIOTRON Detector, Amplifier, Oscillator.

**\$6.00 each**

**(No increase in price)**

*The AUDIOTRON Exclusive Guaranty:* Each and every AUDIOTRON is guaranteed to arrive in good condition and to prove fully satisfactory. Replacement of unsatisfactory tubes will be made free of charge.

**AUDIOTRON MFG. COMPANY**

*(Successors to the AUDIOTRON Sales Co.)*

Dept. A      Lick Bldg.      San Francisco, California

### Dealers—

Get in touch with the AudioTron Mfg. Co. at once. We will give you full information about settlement of all patent difficulties. You will also be interested in our new proposition for wide awake dealers.

After the present supply is exhausted, new types of AudioTron, manufactured entirely by machinery, will be offered for sale. Our extensive advertising during the Fall will establish definitely the superiority of the AudioTron and will create new sales for you. Be sure to take advantage of our full co-operation at once. Prepare to cash in on the AudioTron reputation, established since 1915. Write us today for full details.



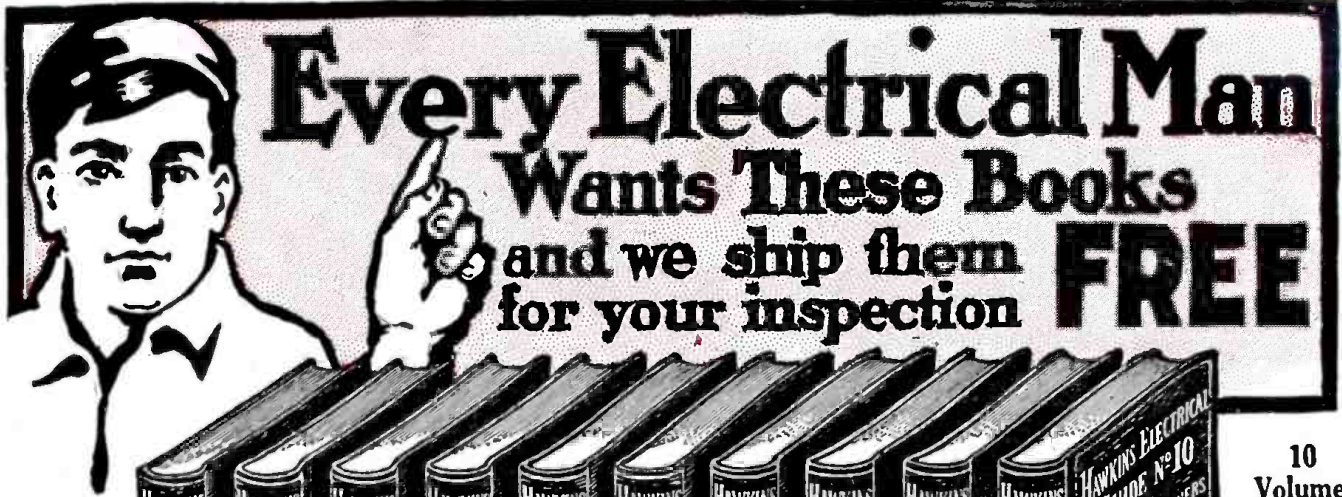

Flexible Covers  
—  
Handy Pocket-Size Volumes

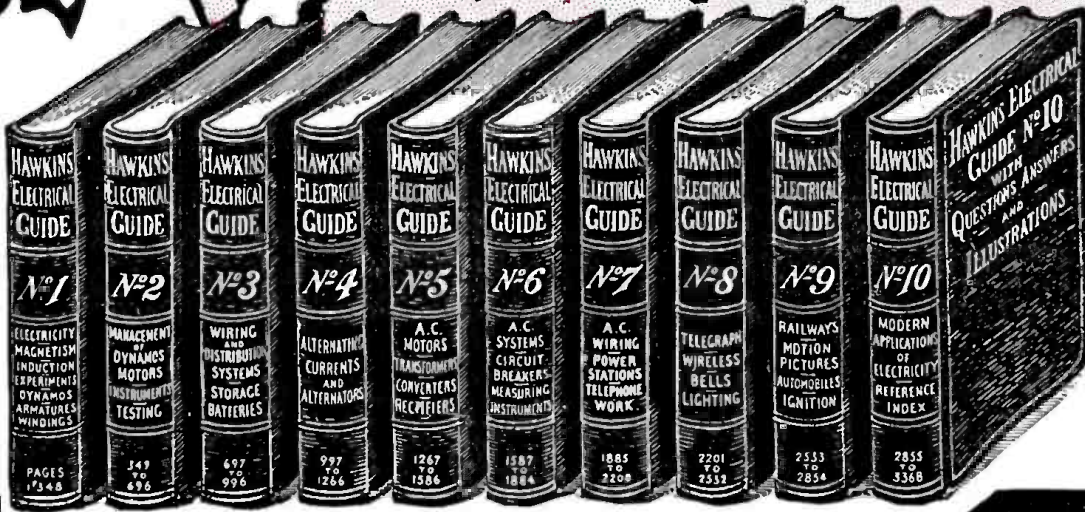

10  
Volumes  
3500  
Pages  
4700  
Pictures  
\$1 Per  
Volume  
\$1 Per  
Month

## Just what you need to know to succeed in ELECTRICITY

EVERY electrician, every engineer, every mechanic should know about these wonderfully helpful instructive books, which give in plain words a complete working knowledge of electrical engineering in all its phases.

You run into some new electrical problem almost every day. The information you need to help you in your every day work is in

# HAWKINS ELECTRICAL GUIDES

These books place electricity at your finger ends. They cover every imaginable subject, principle, theory, problem, trouble, and way of doing things electrically. Every subject is indexed so that you can turn right to it. They are a study course and a reference guide in one, written in plain every day language—no wasted words—only what you need to know—chock full of up-to-the-minute electrical knowledge. The guides are a complete course in electrical engineering. They will help you in every detail of the day's electrical work. You can't ask an electrical question that Hawkins Guides can't answer.

### Pocket-Size Flexible Covers

The books are small enough to slip into your coat pocket—handsomely bound in flexible black covers. You can carry each volume with you until you have mastered its contents. 3,500 pages of actual information and 4,700 illustrations. Once you see these books and put them into actual use you will never again want to be without them. Try it at our expense.

## SEND NO MONEY

It will cost you nothing to receive these books—to look them over—ask them all the questions you can think of—use them in your work—study them—pick up some information that will increase your earning ability. We will ship you the entire set of 10 volumes entirely FREE. This is a sign of our confidence in the guides. Pure gold does not object to being tested. Keep them for seven days and if you do not decide that you can't get along without them, return them to us and owe us nothing.

When you decide to keep them you only have to pay \$1.00 down and remit the balance of \$9.00 on the easy payment of \$1.00 a month till paid for. Use this coupon to get the books. It will pay you many times over

**THEO. AUDEL & CO.**  
72 Fifth Ave. New York, N. Y.

**SEND NO MONEY - USE THE COUPON**

### READ THIS PARTIAL LIST OF CONTENTS

- No. 1** Contains 348 pages, 388 illustrations. Electrical signs and symbols—static and current electricity—primary cells—conductors and insulators—resistance and conductivity—magnetism—induction coils—dynamo principles—classes of dynamos—armatures—windings—commutation—brushes, etc.
- No. 2** Contains 348 pages, 394 illustrations. Motor principles—armature reaction—motor starting—calculations—brake horsepower—selection and installation of dynamo and motors—galvanometers—standard cells—current measurement—resistance measurement—voltmeters—wattmeters—watt hour meters—operation of dynamos—operation of motors, etc.
- No. 3** Contains 300 pages, 423 illustrations. Distribution systems—wires and wire calculations—inside, outside and underground wiring—sign flashers—lightning protection—rectifiers—storage battery systems, etc.
- No. 4** Contains 270 pages, 379 illustrations. Alternating current principles—alternating current diagrams—the power factor—alternator principles—alternator construction—windings, etc.
- No. 5** Contains 320 pages, 614 illustrations. A. C. Motors—synchronous and induction motor principles—A. C. commutator motors—induction motors, transformers, losses, construction, connections, tests—converters—rectifiers, etc.
- No. 6** Contains 298 pages, 472 illustrations. Alternating current systems—switching devices—circuit breakers—relays—lightning protector apparatus—regulating devices—synchronous condensers—indicating devices—meters—power factor indicators—wave form measurement—switch boards, etc.
- No. 7** Contains 316 pages, 379 illustrations. Alternating current—wiring power stations—turbines; management, selection, location erection, testing, running, care and repair—telephones, etc.
- No. 8** Contains 332 pages, 436 illustrations. Telegraph lines—simultaneous telegraphy and telephony—wireless—electric bells—electric lighting—photometry, etc.
- No. 9** Contains 322 pages, 627 illustrations. Electric railways—electric locomotives—car lighting—trolley car operation—miscellaneous applications—motion pictures—gas engine ignition—automobile self-starters and lighting systems, electric vehicles, etc.
- No. 10** Contains 613 pages, 609 illustrations. Elevators—cranes—pumps—air compressors—electric heating—electric welding—soldering and brazing—industrial electrolysals—electro plating—electro-therapeutic—X-rays, etc.

Also a complete 126-page ready reference index of the complete library. This index has been planned to render easily accessible all the vast information contained in the 10 electrical guides. There are over 13,500 cross references. You find what you want to know instantly.

**THEO. AUDEL & CO.**  
72 Fifth Ave.  
New York, N. Y.

Please submit me for examination Hawkins Electrical Guides (price \$1 each). Ship at once, prepaid, the 10 numbers. If satisfactory I agree to send you \$1 within seven days and to further mail you \$1 each month until paid.

Signature.....  
Occupation.....  
Employed by.....  
Residence.....  
Reference.....

### What Electrical Men Say Helped Him Make Good

"It is only right for me to recommend highly the Hawkins Guides, for they have been of the greatest assistance to me in placing me in my present position as Superintendent of Construction Department of one of Ohio's largest Electrical Companies. I would like to see every man have a set of Hawkins Guides."  
Geo. Knecht, Columbus, Ohio.

**In the Naval Electrical Dept.**  
"The Hawkins Guides are great help to me in the Naval Electrical Department, which they cover very thoroughly."  
C. J. Cornell,  
U. S. Receiving Ship, Brooklyn, N. Y.

**Superintendent**  
"I am now superintendent of the Dunnville Hydro-Electric Systems, and Hawkins Guides were a great help to me in holding down a responsible position."  
W. B. Swartz, Dunnville, Ontario.

**Wireless Operators**  
"I have worked wireless for ten years—but I wish I had these books years ago, as they have saved me a great deal of trouble."  
H. Marshall,  
Steamer M & H No. 2,  
Walkerville, Ont.





# LEARN WIRELESS

**At Home Quickly and Easily**

**W**IRELESS is the hinge upon which swing the doors to success. It is the very foundation of the road which leads to many professions, vast in scope, big in responsibility, satisfying in progress and salary.

A trained Wireless Operator with initiative and ambition can easily fulfill his ideals for a successful future; one including a position filled with vital enterprise, adventure, and financial success.

## Attractive Work—Alluring Salaries

Radio offers interesting work in pleasant environment, besides substantial salaries. Radio Operators' salaries start at \$125 a month with all living expenses—board, lodging, laundry, etc.—paid. When totalled and added to salary, it means \$200 or more a month, at the very start. Advancement to higher positions with bigger pay is readily accomplished.

## Travel Without Expense

If you are eager to travel, anxious to visit foreign countries and increase your knowledge of world affairs, wireless offers unequalled opportunities. On shipboard you are rated as an officer, living and eating with the officers, and mingling with the passengers. All without one cent's expense to you! Land Wireless positions are just as attractive if you prefer them.

## Instruments Furnished Every Student

We furnish all necessary books and equipment *with our course*. Our famous Natrometer—automatic transmitting and receiving set—is among this outfit. This instrument sends you messages at varying speeds just as you would receive them from distant wireless stations—and is operated entirely without the use of "aerials".

**BOOKLET FREE**—It explains how we helped hundreds of ambitious men and women, and how we can give you a thorough Wireless training in your spare time, at home, by mail, and help you secure a worth-while position.

**NATIONAL RADIO INSTITUTE**  
Dept. 336 14th & U Sts., N. W., WASHINGTON, D. C.

*Send This Coupon Today*

**NATIONAL RADIO INSTITUTE,**  
Dept. 336 14th & U Sts., N. W., WASHINGTON, D. C.

Send me your **FREE** book "Wireless The Opportunity of Today". Tell me about your Home Study Course in Wireless Telegraphy and Telephony—the free post-graduate course—and your Special Instrument offer.

Name .....

Age ..... Address .....

City ..... State .....

THE GAREY PRINTING CO., INC.  
NEW YORK