

# RADIO AMATEUR NEWS

15 Cents  
**JULY**  
 1919  
 Edited by  
*H. Gernsback*



**IN THIS  
 ISSUE:**

**THE AUDION AND THE AMATEUR**  
 By Dr. Lee de Forest  
**EXPERIMENTS ON GROUND ANTENNA**  
 By Chas. D. Herrford

**HOW I BECAME A RADIO BUG**  
 By Thomas Reed  
**DESIGN OF ROGERS GROUND ANTENNA**  
 By J. Stanley Brown

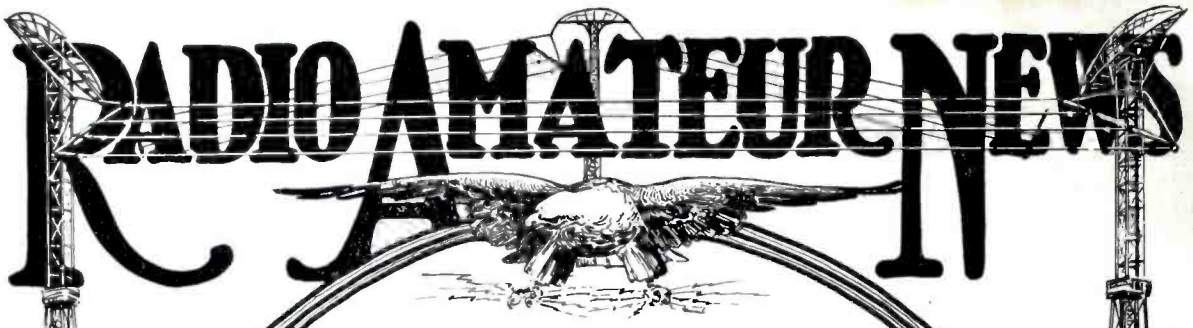

# CONTENTS

	PAGE		PAGE
"Why Radio Amateur News Is Here" By H. Gernsback, Editor	5	"Audio Frequency and Radio Frequency"	27
"The Audion and the Radio Amateur" By Dr. Lee De Forest	6	"Some Experimental Radio Suggestions" By Thos. W. Benson	28
"Transatlantic Radio Reception" By Major Chas. A. Culver	7	"A Buzzer Practice Outfit De Luxe" By Oscar Schwendt	29
"Design of Rogers Ground Antennae" By J. Stanley Brown	10	"A Simple Hot-Wire Meter" By Francis H. Ransford	30
"Experiments on Ground Antennae with Their Relation to Atmospherics" By Chas. D. Herrold, E.E., R.E.	11	"A Radio Amplifier" By Fred Whitehouse	30
"New Type of Electron Tube" By H. P. Donle	14	"Loose Coupling of Amateur Transmitter" By Geo. M. Baker	31
"Radio Translator" By Major Chas. A. Culver	16	"Ideas".....By Thos. W. Benson	32
"Modern Amateur Radio Apparatus" By A. H. Grebe	17	"High Voltage Audion Battery" By L. M. Lafave	32
Club Doings .....	18	What They Think of It.....	33
"A New High-Note Shunt Radio Buzzer" By Louis Gerard Pacem, I.R.E.	19	"How I Became a Radiobug" By Thomas Reed	34
"U. S. Navy Airplane Sets" By L. F. Ryan	20	With the Amateurs.....	36
\$100.00 Radio Prize Contest.....	22	"Open Once More".....	36
"The Future of the American Radio Amateur" By H. Gernsback	23	"Dusting 'Em Off".....	37
"Sustained Wave Radio Telephone and Telegraph Transmitter" By Samuel D. Cohen	24	"Vacuum Tube Amplifier With Crystal Detector" .....	38
		"Banked Windings" .....	38
		Radio Digest .....	38
		Junior Section .....	39
		"I Want to Know" .....	40

RADIO AMATEUR NEWS is published on the 25th of each month at 233 Fulton Street, New York. There are 12 numbers per year. Subscription price is \$1.50 a year in U. S. and possessions, Canada and foreign countries, \$2.00 a year. 1" 8. cent as well as U. S. stamps accepted (no foreign coins or stamps). Single copies, 15 cents each. A sample copy will be sent gratis on request. Checks and money orders should be drawn to order of EXPERIMENTAL PUBLISHING CO., INC. If you change your address notify us promptly, in order that copies be not misdirected or lost. A red wrapper indicates expiration. No copies sent after expiration.

All communications and contributions to this journal should be addressed to Editor, RADIO AMATEUR NEWS, 233 Fulton Street, New York.

H. GERNSBACK, President.

Unaccepted contributions cannot be returned unless full postage has been included. All accepted contributions are paid for on publication. A special rate is paid for novel experiments; good photographs accompanying them are highly desirable.

RADIO AMATEUR NEWS, Monthly. Application for entry at the Post Office, New York City, as second class matter. Title registered U. S. Patent Office. Copyright, 1919, by R. F. Co., Inc., New York. The Contents of this magazine are copyrighted and must not be reproduced without giving full credit to the publication.

RADIO AMATEUR NEWS is for sale at all newsstands in the United States and Canada; also at Brentano's, 37 Avenue de l'Opéra, Paris.

S. GERNSBACK, Treasurer.



# FOR EXPERIMENTERS ONLY!!

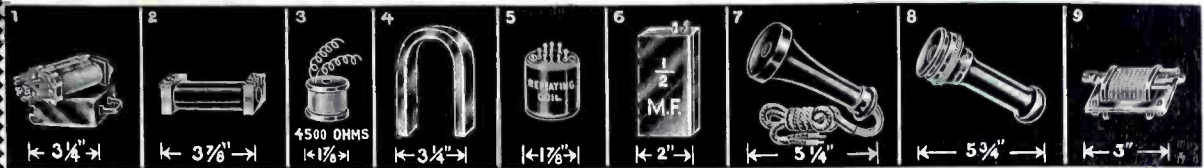

WE have in the past held many extraordinary sales, but we believe that the present one eclipses all by the wonderful values we are offering. The goods which we offer on this page are all standard telephone apparatus. Every piece we are offering is equipment that for one reason or another was discontinued by the telephone companies. If you wanted to buy any of the pieces which we offer herefrom, from the manufacturers, the price would at least be ten times what we are asking for it. You can readily ascertain this for yourself by looking over our wonderful prices.

**RUSH**  
Cut out and attach to your order. It will leave us within 24 Hours.

We have bought a large block of these goods and have a large quantity of every item on hand. Immediate shipment can be made on all of the goods in practically any quantity within reason. Shipment within twenty-four hours will be made if you use the adjoining coupon. This coupon saves you several days and your order will then be considered a rush order. We guarantee every piece to be as represented, and will refund the money if goods are not exactly as claimed by us.

**NO. 1 TELEPHONE RELAY, 1500 ohms**—has two silver-contact springs and is very sensitive. Can be used wherever a sensitive relay is needed. It is adjustable and can be used for a variety of purposes. No. 1 Relay—shipping weight, 2 lbs. Price..... **\$1.50**

**NO. 2 STANDARD TELEPHONE Induction Coil, primary 1 ohm, secondary 55 ohms.** Used wherever you need a good induction coil. Has primary and secondary and iron wire core, three leads. No. 2 Induction Coil as described—shipping weight, 2 lbs. Price..... **\$0.50**

**NO. 3 STANDARD RESISTANCE** wound with German silver wire—500 ohms, can be used as a choke or plain resistance, and has many other uses that readily suggest themselves to the experimenter. No. 3 Standard Resistance as described—shipping weight, 4 oz. Price..... **\$0.40**

**NO. 4 HORSESHOE MAGNET, size 3 3/4 inches wide x 5 inches high.** Will lift about 1 lb. Quality such as used on magnets, which means the best. No. 4 Horseshoe Magnet—shipping weight, 2 lbs. Price..... **\$0.30**

**NO. 5 REPEATING COIL (Transformer).** This is a standard small repeating coil and is used by all telephone companies. It has different windings and eight contacts. Entirely enclosed in iron. The resistance being respectively 72 and 120 ohms, and 90 and 100 ohms. Diagram is furnished. Can be used for wireless, for boosting signals, etc. No. 5 Repeating Coil—shipping weight, 2 lbs. Price..... **\$0.50**

**NO. 6 1/2 M.F. CONDENSER.** This is a standard telephone condenser and has 1/2 microfarads. Condenser comes in neat metal case. This condenser is used in connection with spark coils to absorb the vibrator spark. Invaluable for buzz buzzers to absorb spark and make the sound of tetter more steady. Is also used by some experimenters in connection with wireless where a fixed capacity is needed. Several of these condensers should be in every experimenter's laboratory. No. 6 Condenser, 1/2 M.F.—shipping weight, 1 lb. Price..... **\$0.50**

**NO. 7 DOUBLE POLE BELL TELEPHONE RECEIVER**—hard rubber casing with a 71 coil and the Standard 75 ohm powerful magnets. This receiver can be used in connection with any ordinary

telephone work, and you will even find it sensitive enough for short distance wireless work.

**NO. 8 STANDARD TELEPHONE RECEIVER** with Metal Head. This receiver is made by Stromberg Carlson Co., with genuine hard rubber casing and our cup. A very good foot-proof as well as sensitive receiver that cannot be put out of order if you try. Used for the same purpose as No. 7 Telephone Receiver. No. 8 Standard Telephone Receiver—shipping weight, 3 lbs. Price..... **\$0.75**

**NO. 9 IMPEDANCE COIL (Close Core Transformer).** This is a very fine little transformer and is used extensively in connection with telephone work. It is in reality an A.C. transformer for which you would pay \$5.00 if you had it made to order. The primary has 0.15 ohms, secondary 2000 ohms. It can be used for a variety of purposes that will suggest themselves to every experimenter. Can be used successfully to boost wireless signals, also in connection with audions, etc. An A-1 instrument. Size 3 x 3 inches. No. 9 Impedance Coil—shipping weight, 2 lbs. Price..... **\$0.65**



**NO. 10 MICROPHONE AND BRACKET.** An A-1 sensitive microphone of the carbon grain type. Has hard rubber multipieces and enamel steel bracket. The instrument being 10 inches long. This microphone, in connection with our No. 7 or 8 Receiver, will constitute a complete telephone outfit, good to speak 50 miles or more, at a remarkably low price. No. 10 Microphone and Bracket—shipping weight, 5 lbs. Price..... **\$1.00**

**NO. 11 REPEATING COIL (Transformer).** A standard repeating coil used for telephonic work. The coil windings are encased in an iron tube 2 1/2 inches in diameter. There are eight terminals for the four windings to connect to and the instrument is invaluable in connection with radio work to boost up signals, audion work, etc. Many interesting uses will be found for this coil. Resistances are: 100, 120, 145, 175 ohms. No. 11 Repeating Coil—shipping weight, 8 lbs. Price..... **\$2.00**

**NO. 12 POLARIZED RINGER with Bells.** The resistance of the two coils is 1250 ohms each. The armature is perfectly adjustable. Bell will work on any magneto. We also furnish blue print with ringer showing how a first class polarized relay can be made by anyone using only a few pieces of metal and screws. No. 12 Polarized Ringer with Bells—shipping weight, 2 lbs. Price..... **\$1.50**

**NO. 13 POLARIZED RINGER with Bells.** This is the same kind of ringer as the No. 12, except that it is not adjustable and that the resistance is less. First class in all respects. Blue print furnished with this to make polarized relay same as with No. 12. Solenoids on this ringer are worth more than the price we ask for the entire ringer, and do not forget a powerful magnet that goes with it. No. 13 Polarized Ringer with Bells—shipping weight, 2 lbs. Price..... **\$1.00**

**NO. 14 HARMONIC RINGER.** This ringer is a

polarized and has a powerful magnet. It works on 65 cc. cycles and any magnet will operate it if run at a certain speed. A very finely built instrument. Resistance of each coil being 200 ohms. Can be converted into a polarized relay by substituting a very fine leaf spring from the heavy one furnished. A most interesting instrument with which to experiment. No. 14 Harmonic Ringer—shipping weight, 4 lbs. Price..... **\$1.60**

**NO. 15 RINGER** without Bells—600 ohms. This also is a polarized ringer and has an adjustable armature. The adjustment is done by means of the screw. A beautiful little instrument. With this instrument we furnish a blue print showing how a polarized relay can be built. You should have several of these beautiful little instruments. They are worth their weight in gold; the powerful magnet alone being worth more than the price we ask for the entire instrument. No. 15 Ringer—shipping weight, 2 lbs. Price..... **\$0.80**

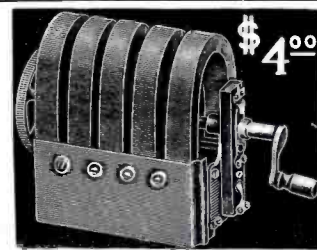

## No. 55 5-bar magneto, 110 Volt A. C. Generator

This is one of the most powerful magnetos ever built, when manufactured in order to put good stuff into them; equip with transmission, make and break, etc. Transmission wheels are all brass, crank handle furnished. This magneto, as well as the other ones listed below, will light a 110-volt lamp merely by turning the crank handle slowly. While this magneto is alternating current only, it can be rewound so it will light up a number of four, six and 10-volt lamps, all depending upon the thickness of the wire you wind on the armature. As we furnish these magnetos, they will give a powerful alternating current and you will not be able to stand the current when grasping hold of the terminals. This makes an ideal shocking machine. All our generators can be transformed into a direct current machine by equipping it with a low-voltage commutator. Every experimenter should have one of them in his shop. Many other experiments which can be performed with this machine will readily suggest themselves to any experimenter. The magnetos furnished with these generators are very powerful, each one being able to lift one pound easily.

**NO. 55 5-BAR MAGNETO GENERATOR** as described—shipping weight, 25 lbs. Price..... **\$4.00**

**NO. 33 3-BAR GENERATOR,** same as described above except that it has only 3 bars, and is somewhat smaller. No. 33 3-bar Generator—shipping weight, 10 lbs. Price..... **\$2.00**

**NO. 44 4-BAR GENERATOR,** same as No. 55 except that it has 4 bars, and is somewhat smaller. No. 44 4-bar Generator—shipping weight, 15 lbs. Price..... **\$3.00**

**NO. 66 6-BAR GENERATOR,** same as No. 55 except that it has one more magnet and the armature is somewhat larger and more powerful. This is the biggest type made and is the most powerful. No. 66 6-bar Generator—shipping weight, 30 lbs. Price..... **\$4.50**

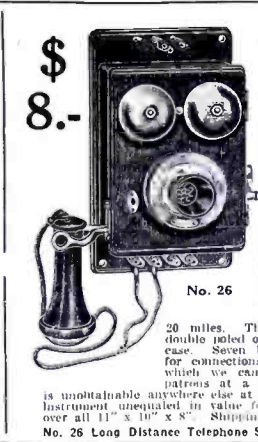

## Complete Wall Set

This is a complete commercial telephone station. The cabinet is of polished oak, piano finish, within which is contained the powerful magnet, the 500 Ohm polarized ringer and induction coil. The magnet is exceptionally efficient, being of the two piece type with brass gear transmission. The extra sensitive microphone, mouthpiece and two zones are mounted on the front of the cabinet giving the entire instrument that desirable appearance of compactness and efficiency. Guaranteed to work over 20 miles. The telephone receiver is a double bell one, and has a hard rubber case. Seven binding posts are provided for connections. The instrument is one which we can offer with pride to our patrons at a ridiculously low price. It is unobtainable elsewhere at less than \$18.00 and is an instrument unequalled in value for the price we ask. Size over all 11" x 10" x 8". Shipping weight, 15 lbs. Price..... **\$8.00**

**CARBON GRAIN TRANSMITTER**  
A special design of transmitter for long distance work. It is used on wireless telephony sets where a steady current of 50 to 1 ampere is constantly required. Sizes over all 3 1/2 x 2 1/2 inches. Shipping weight, 3 lbs. No. 6080 Carbon Grain Transmitter as described..... **\$1.00**

**ELECTRO IMPORTING COMPANY**  
231A Fulton St., New York City

I enclose herewith 6 cents in stamps or coin, to cover postage for which please send me your latest Cyclopedic Catalog No. 20 as described.

NAME \_\_\_\_\_  
ADDRESS \_\_\_\_\_  
STATE \_\_\_\_\_ R. A. N. 7-19

## ELECTRO IMPORTING CO., 231A Fulton Street, NEW YORK

"The Livest Catalog in America"  
Our big, new electrical cyclopedic No. 20 is waiting for you. Instantly the most complete wireless and electrical catalog in print today. 176 Big Pages, 400 Illustrations. 300 Instruments and apparatus, etc. Big "Treatise on Wireless Telegraphy." 20 FREE coupons for our 100-page FREE Wireless Course in 20 lessons. FREE Cyclopedic No. 20 measure 7x5 1/2". Weight 1/2 lb. Beautiful stiff covers.

You benefit by mentioning the "Radio Amateur News" when writing to advertisers.

# AMPLIFY YOUR RADIO SIGNALS

ONE of the greatest drawbacks since the invention of wireless telegraphy is the receiving of weak signals at the receiving station. Many devices were proposed to improve this condition, but without success, on account of the mechanical difficulties encountered in these amplifying devices.

However, this was recently solved by the introduction of an exceedingly sensitive microphone transmitter, which is known to detect sound waves with great accuracy and magnify them through an intermediate telephone circuit.

By the employment of the new DETECTAGRAPH-TRANSMITTER, the amateur can amplify the radio signals to such an intensity that he can hear the signals about his station without the need of the telephone head set.

By the addition of a loud talking telephone he is able to hear the messages many feet away from the instrument. He is also able to demonstrate the operation of his wireless apparatus to his friends.

The super-sensitive DETECTAGRAPH-

TRANSMITTER herewith shown is two and three-eighths inches in diameter, five-eighths of an inch thick and weighs less than three ounces. It is the most sensitive sound detecting device ever brought before the public.

The manner in which the amplifying process is attained is by attaching with tape the DETECTAGRAPH - TRANSMITTER to the regular wireless receiver as indicated in the diagram.



### Practical Instruments for Commercial and Scientific Purposes.

### Other Uses

Not only is this instrument applicable for amplifying radio signals, but it can be used with equal satisfaction for magnifying other sounds. Phonograph music can be transmitted from one place to another by means of this instrument, and those who are afflicted with deafness will find enormous benefit by using this transmitter.

It is the greatest device for building your own loud talking telephone, detectagraph and other de-

vices. Can be used for any purpose where a sensitive detecting instrument is required.



Our Super-Sensitive Detectagraph Transmitter. Price, \$7.00 Complete



Model "B" Horn, with Loud Talking Receiver, Cord Plugs and Desk Stand Base. Price, \$10.00 Complete

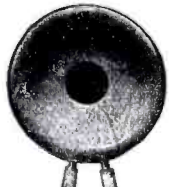

Our Special No. 25 Loud Talking Receiver. Price, \$4.00 Complete

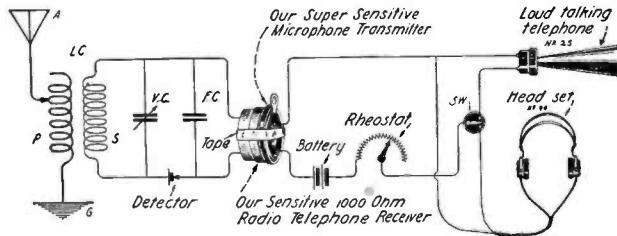

Model "C" Horn, with Loud Talking Wall Receiver. Price, \$10.00 Complete

## DETECTAGRAPHS

### FOR THE EXPERIMENTER

### FOR DETECTIVES

### FOR THE DEAF

**DETECTAGRAPH.** This detecting instrument of marvelous sensitivity can be used for detecting secret conversations. Outfit consists of Sensitive Transmitter, 25-ft. Black Cord, Receiver, Headband, Case and Battery. **\$15.00** Complete



Detectagraph Rheostat, especially made for amplifying circuits. Complete **\$2.00**



Super Sensitive No. 40 Receivers to be used in connection with Detectagraph Transmitters.

**\$10.00**

### DETECTAGRAPH JUNIOR DEAF-PHONE

The outfit consists of a Super-Sensitive Transmitter, with a cord connector; Super-Sensitive Ear Piece with small black cord; Black Single Headband; Black Case and two small Batteries. Transmitter 2 3/8 inches in diameter, 5/8 of an inch thick, and weighs less than three ounces.



**\$15.00** Complete

G. Boissonnault Co., 25 Church St., N. Y. C.

As per your ad in Radio Amateur News, please send me free circulars and full particulars about your Detectagraph Devices.

NAME.....  
ADDRESS.....  
CITY.....  
STATE.....

Order direct from ad. Or write for free descriptive circular. For your convenience use the coupon.

## G. BOISSONNAULT COMPANY

25 CHURCH STREET NEW YORK CITY

Makers of Super-Sensitive Microphone Devices





# RADIO AMATEUR NEWS

H. GERNSBACK EDITOR

Vol. 1.

JULY, 1919

No. 1

## WHY "RADIO AMATEUR NEWS" IS HERE

**R**ADIO AMATEUR NEWS with this issue makes its debut to the radio fraternity. At this occasion it may not be amiss to state the pertinent reasons for its existence, and why as a matter of fact it just *had* to come.

This magazine is the logical outcome of many attempts to publish a purely Radio periodical, independent thruout and devoted to American Radio Amateurism.

In 1908 I started the first magazine in America in which were published many radio articles—MODERN ELECTRICS. Radio Amateurism being in its infancy then, could not support a purely radio magazine,—so MODERN ELECTRICS devoted only about one-quarter of its contents to radio. In 1913 I came out with the ELECTRICAL EXPERIMENTER. This magazine has been more prominent than any other on account of its very important radio section. Even during the war—with radio amateurism dead, and nearly every radio magazine discontinued—the ELECTRICAL EXPERIMENTER, at a great financial loss, continued publishing radio articles uninterruptedly, month after month, to keep alive the radio spark in the hearts of our amateurs.

But now that the war is won,—now that the amateurs have won *their* war, by defeating a proposed new law which would have destroyed American Radio Amateurism—we will witness the most wonderful expansion of the radio arts ever dreamt of. The amateur is here to stay and so is radio in general. I predict an astounding growth of the art during the next ten years. Every other house will have its radiophone, to converse with friends and relatives, for business and for pleasure. Marvelous inventions will be made in Radio during the next decade—unbelievable now.

Because I am a staunch believer in the glorious future of Radio in America, I have launched RADIO AMATEUR NEWS. Its first issue will mark the time when amateur radio in America has come into its own again, when it has been re-born greater than ever—a Phenix rising, more beautiful than before, from his ashes.

I felt that the time was ripe for a purely radio magazine,—a 100% radio magazine,—by and for the amateur. I felt that a magazine for the entire radio fraternity, be he scientist, advanced, or junior amateur, was badly needed, and that is why you are now reading this, the first issue of the newcomer.

And here is the platform upon which RADIO AMATEUR News stands. I pledge myself to a strict adherence to every plank:

- 1st. Only Radio—100% of it—*nothing else*.
- 2nd. An Organ for and by the amateur. The amateur's likes and wants will always come first in this magazine.
- 3rd. Absolute Independence. RADIO AMATEUR NEWS has only one Boss—its readers. This magazine is not, nor will it ever be, affiliated with any stifling, commercial radio interests whatsoever.
- 4th. Truth—first, last and always. When you see it in RADIO AMATEUR NEWS you may be sure that it is so. Not being affiliated with commercial radio interests, this magazine will have no reason to suppress important articles, discoveries, etc.
- 5th. RADIO AMATEUR NEWS is and will be the sworn enemy of all adverse and unfair radio legislation. Our Washington representative will inform us immediately of any new radio legislative measures. No unfair bill will become a law before all amateurs have had their say.

6th. The uplift of American Radio Amateurism out of the "kid" class, into the serious status to which the art is entitled. Amateur Radio is not a plaything or a sport—it is a useful, mind-ennobling art—it vanquishes distances, it saves lives and it will be as necessary as the telephone ten years hence.

7th. Instructive first and last. Up-to-date scientific articles for your instruction will always have first place in RADIO AMATEUR NEWS. We shall publish purely scientific articles every month, articles that on account of their length are often crowded out of other publications.

8th. First in print with the News. You will find all important Radio News in this magazine from one to three months ahead of all other publications—always.

Now, my friends, it's up to you how great and how big RADIO AMATEUR NEWS shall be. Its future is in your hands. We're off . . . . .

Three cheers for American Radio Amateurism—  
*Long live the Radio Amateur.*

H. GERNSBACK,  
Your Editor.

# "The Audion and the Radio Amateur"

By DR. LEE DE FOREST

Written especially for "Radio Amateur News"

THE writer can lay claim to the honor of having been one of the original wireless amateurs in America. When he started experimenting in 1898 and '99 the Art itself was very amateurish, from the Rhumkorff coil transmitter to the coherer and trembler of the receiver; while the ranges that were then covered were small enough to have satisfied the most jealous guardian of governmental radio-regulations, had such a functionary then existed.

It was not until 1902 and by the introduction of the self-restoring detector and telephone receiver, the alternating current generator and transformer, and the tuned circuits at transmitter and receiver, that the infant art can be considered as placed on an engineering foundation.

The first two of these radical advances originated in America, and for some time distinguished the American designed apparatus from that of the British or the Boche.

The story of the original conception of the Audion idea, using heated electrodes and ionic or thermionic conduction thru gases (atmospheric or rarefied) is, I believe, so well known as to require no repetition here. Certain it is that had I not been thoroly imbued with the spirit of the radio amateur, forever on the lookout for brand new principles and devices, I would not have hit upon the germ idea, which the subsequent years have developed to such astonishing utility in fields so widely divergent.

And right here let me say that the surfaces only of those early researches were scratched. To-day if a radio amateur wishes to begin where I began, with a small quiet gas burner, burning illuminating gas enriched by salts, (such as of potassium, sodium, etc.), with various shaped electrodes, variously spaced and located in the flame, with the necessary range of *B*, and *C* (grid) voltages, he will find himself for a trifling expense in the midst of phenomena of delightful novelty and attractiveness, with the ever-present lure of discovery urging him on and on. It will not be difficult for him to soon discover genuine utility in some of his arrangements, with a countless number of practical applications suggesting themselves to his ingenious and investigating mind. But most lads will prefer to start with the most perfected and up-to-date type of three-electrode audion bulb, equipped with a good assortment of tuning coils, "ticklers," variable condensers, grid resistance "leaks," and batteries for the *A*, *B*, and *C* circuits.

Given such an equipment as the above, I can imagine no keener zest, no livelier interest in any toy or device than the young man will experience during the flying hours, up in his "Radio Lab.," locked away from the family, the movies, and "the gang."

Here then are mysteries to be investigated which would have baffled old Sir Isaac;

forces of which Faraday himself never dreamed; etheric voices infinitely more delicate than the faintest sounds from Aeolian harps of the fairies. Invisible messengers, speeding like light, through the darkness come whispering to him directly from the antenna of some gigantic station

First, there are the plain detector arrangements, with and without a grid condenser, with or without a grid or *C* battery. In the old days when the lamps were exhausted with simple oil-pumps, we had the fascinating "blue glow" or halo around the plate or filling the bulb, when a too-high *B* voltage was applied. Gradually the pumping processes have been improved until now the ordinary well built audion contains too little gas to show this visible and beautiful evidence of ionization. With the blue glow, however, a host of fascinating experiments can be made, such as the effect of a magnetic field on the glow and on the sensitiveness and general behavior of the audion—the "squealing" condition, the unstable condition when a blue ball plays around a corner of the plate and comes and goes with each strong received Morse signal—like a veritable little blue imp dodging back and forth in instantaneous response to his master's voice uttered



A Picture to Make the Heart of Any Radio Man Swell. The Inventor of the Most Wonderful Thing Ever Thought of by Man, in His New York Laboratory. Look, Ye Radiobugs! The Instruments on the Tables About Dr. DeForest.

on the bottom side of the world, or he hears the call of a tiny ship a thousand leagues at sea.

Then, too, and frequently too often, he can hear the surly growl of distant sky-farces; the mutterings of mysterious storms coming from over a hundred horizons; or the strange cracklings and shuddering sounds from the uppermost ceiling of the atmosphere, originating in or reflected from that intangible "Heavyside Layer". Static, in fact, may be profanely

perhaps a hundred miles away!

Then there is the multitude of heterodyning, or regenerative and "ultraudion" circuits—connecting the receiver circuit across the grid and plate, instead of, as usual, across grid and filament. One can go on trying one arrangement after the other, making comparisons for relative sensitiveness and sharpness of tuning.

Numerous as are these types of audion "hook-ups" now illustrated in the text magazines, the industrious investigator can still conceive new ones, and the study of these and the search for a published duplicate, to see whether or not you have hit upon a new audion circuit (and if so to classify it and analyze its operation), is perhaps a more fascinating problem than anything which other branches of electrical research can offer.

Then there is the audion amplifier—an amplifier of almost anything, from high-frequency currents transmitted from Russia or Japan to the slow pulse of heartbeats. One can try audions in cascades, coupled together by inductance, by capacity, or high resistance; single audions amplifying others connected in parallel, or small ones controlling larger, "pyramided" until the faintest signal multiplied in strength a million times can be heard for blocks, or so that a party of merry-makers can dance to music played perhaps one hundred miles away!

Can anyone wonder then at the keen and ever-growing enthusiasm among youngsters of all ages for the audion, the little lamp which seems at times to radiate thought waves as well as light, so marvelous and versatile are its functions, so infinitely sensitive and delicate, so mysterious and yet so certain in its operation!

(Continued on page 43)



Dr. DeForest, as a Radiobug in 1902. With His Own "Electrolytic Responder."

explained as the "cackling of the Heavyside Layer!"

No amateur has owned an audion for a month without trying at least thirty different styles of "hook-up"—one for each day—and if he is worth his salt, he will by that time have thought of at least thirty other and additional circuits in which he wants to try the bulb.



# Transatlantic Radio Reception

By Major Charles A. Culver, Signal Corps, U. S. A.

WITH the opening of hostilities between the United States and the Central Powers, there arose the physical possibility that the enemy would interrupt the Transatlantic cables. In order to provide for such a contingency, it therefore became necessary to take steps to improve the then existing Transatlantic radio service.

Some time before the United States entered the war the United States Government, through the Navy Department, in the interests of neutrality assumed control of the Transatlantic radio transmitting stations at Sayville, Long Island, and Tucker-ton, N. J., these stations having been owned and controlled by German interests.

On October 4, 1917, a conference between representatives of the Navy and War Departments was held at New London, Conn., "relative to the substitution of radio for cable service in the Atlantic." At this conference a plan was formulated to initiate a system of Transatlantic radio communication "to serve in event of failure of cables between the United States and Europe as brought to attention by the Interallied Protocol, 22, August." The diagrams shown as exhibit A1, A2 and A3 indicate the general plan of operation decided upon. The transmitting stations at Annapolis, Md., and Marion, Mass., were not at that time completed. Later, New London was abandoned by the Navy Department as a control receiving center in favor of Belmar, N. J. Receiving stations were also established by the Navy at Chatham, Mass., and Bar Harbor, Me. Washington was not used to any extent for receiving Transatlantic traffic.

It was believed that it would be possible to find several sites so located that, at any given hour of the day, at least one of the stations would be able to make perfect copy, and that by combining the results secured at several stations, an uninterrupted receiving service could be secured. It was appreciated that the British Association Committee for Radiotelegraphic Investigation had collected and analyzed a large amount of data bearing on X's,<sup>1</sup> and also that De Groot had conducted an extensive investigation in the Dutch East Indies bearing on this matter, but it was felt that the problem confronting American radio engineers and scientists was, from the nature of the case, more or less local in character and peculiar to Transatlantic reception on this continent.

On October 15, 1917, the writer was detailed by the Officer-in-Charge of the Radio Development Section to organize the work of securing the necessary data upon which a decision might be based with reference to such optimum receiving centers. First Lieut. Eugene Sibley was detailed to

assist the writer in the organization of the work.

### CONDITIONS AND EQUIPMENT.

It was decided to begin the investigation by establishing six experimental Transatlantic receiving stations at suitably located Army posts, with headquarters at Washington, D. C., and steps were immediately taken to secure the necessary personnel and equipment.

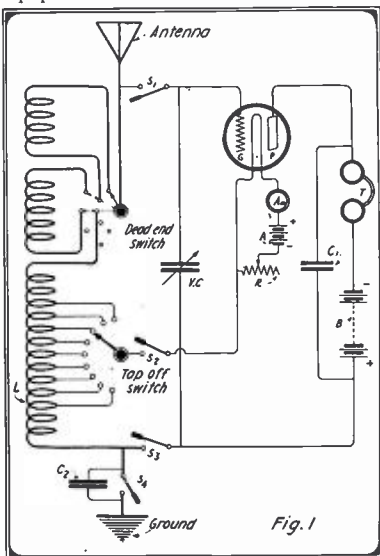

The Receiving Set Used in Trans-Atlantic Work by the War Department.

The general plan of procedure included not only the taking of audibility measurements on static X intensity and received signal strength during twenty-four hours daily, but, in addition, arrangements were made to secure at all stations simultaneous meteorological records, the purpose being not only to locate optimum receiving centers but, if possible, to determine the factors which govern extraneous electrical disturbances.

Owing to the personal equation of the operators, it was obviously essential that a receiving set should be employed having a minimum number of adjustments. Such a set was accordingly designed having only one critical adjustment, and so arranged as

to be directly connected to the antenna. A diagrammatic sketch of this receiving set as used is shown in Fig. 1, the variable condenser (0.003 M.F.) being the adjustable element just referred to. The total inductance in the antenna circuit had a value of approximately 14.4 M.H. Standard Signal Corps V.T-1 detector tubes, 20-volt "B" batteries, and telephone receivers were employed. Standard amplifiers, SCR-72, were used in connection with these receiving sets. The shunted telephone method of measuring the audibility of signal strength and X intensity was used. For this purpose audibility meters made by the General Radio Company, and reading from unity to 8000, were employed. The complete scheme of connections is shown diagrammatically in Fig. 2.

The antenna system employed in the tests consisted of two horizontal wires, each 1000 feet long (304.8 meters), arranged in the form of a "V," the two wires being separated by an angle of 10° and supported on suitable insulators 15 feet (4.6 meters) above the ground. This particular height was used for physical reasons, as in certain cases it was necessary to extend the antenna across roadways, this being the lowest practical height under such circumstances. The median line between the two wires of the antenna coincided with the great circle joining Lyons, France, and a given receiving station. The antenna wires were placed at an angle with respect to one another in order to partially compensate for any slight error in the determination of the true direction of the great circle. As an example of the functioning of an antenna of the general type used in these tests, there is shown in Fig. 4 the relation between the length of a low horizontal one-wire antenna and the energy intercepted, in terms of signal audibility.

The mean values of antenna constants are as follows: Fundamental wave length, 1609 meters; capacity at fundamental wave length, 0.00355 M.F.; inductance at fundamental wave length, 0.2026 M.H.

Through the cooperation of the Meteorological Section of the Science and Research Division, a meteorological observer and suitable meteorological equipment were secured for use at the several stations. The following meteorological observations were made, continuous automatic records being secured of the first four factors listed below.

- Air pressure
- Air temperature
- Relative humidity
- Soil temperature
- Wind velocity
- Wind direction
- Condition of sky

Hourly observations were made on the last three variables mentioned above.

The personnel at each station consisted of a non-commissioned officer in charge, four radio operators and a meteorological observer. A commissioned officer was detailed to supervise the operation of every two stations. Several months were required to properly train the operators in making the necessary observations. As a result the data undoubtedly increased in reliability as the investigation progressed.

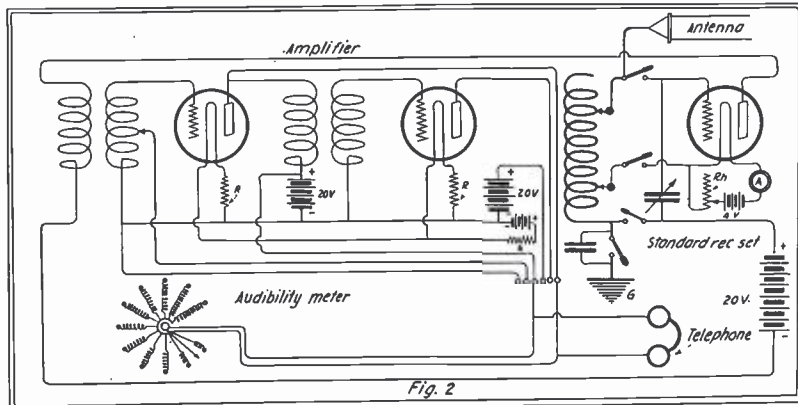

Showing How Efficient Comparative Tests Were Made by Means of the Audibility Meter. The Amplifiers in Circuit.

<sup>1</sup>The symbol X will be used throughout this report to indicate any extraneous electrical disturbances, except interference from other radio stations and inductive effects from power lines, and which tend to interfere with radio communication. The terminology will thus be made to conform with the practice of the British Association.

As indicated above, the shunted telephone method of measuring audibilities was employed. While it is realized that this method of making observations is comparatively crude and that a large personnel equation necessarily enters into the records, every effort was made to reduce these factors to a minimum. To this end the watches or "tricks" of the operators were rotated and their readings checked; operators were transferred at times from one station to another; receiving sets were also changed. In addition to these measures First Lieut. John A. Riner acted as inspector and visited the various stations from time to time for the express purpose of standardizing the observations, particularly the audibility readings. It is believed that the number of observations made and the length of time during which the investigation was in progress, in part at least, compensates for the inherent inaccuracy of the individual observations.

In determining the relative merits of the various receiving centers, the values of the X-signal ratios are of some value. However, in the last analysis the utility of a given station site was determined by the character of the results in the form of actual copy taken. The Transatlantic traffic from the European stations at Lyons, France (YN); Rome, Italy (IDO); Nantes, France (UA); Carnarvon, Wales (CV), and to some extent Nauen, Germany (POZ), was copied daily and the copy forwarded to the Washington office. Beginning April 1st this copy was carefully compared by an office force trained for the purpose and a daily rating given to each station. By comparison of these results it was possible to determine the net results of the varying receiving conditions on actual traffic. This method disclosed facts which would not have been apparent from an examination of the numerical readings on signals and X's alone.

In securing the data, hourly readings on X audibility and half hourly readings on signal audibility were made. Each station was equipped with a high grade timepiece which was carefully regulated and set to keep standard time. The X intensity readings were made with the receiving apparatus set to respond to an 8000-meter wave and also to a 14,000-meter wave. The lower value was taken for the reason that it was of the order of the shortest wave used in long distance work and the higher value was of the order of the longest waves in use. X audibility readings were made when using the detector, one step, and two steps amplification. Signal audibilities were read on one step amplification only. In making the audibility measurements on X's the practice was followed of adjusting the audibility meter until near the point of extinction of sound due to the individual crashes, and if no sound was heard for a period of approximately three seconds the setting of the meter was taken as the reading. After some experience the operators were able to make fairly comparable readings. Owing to the high value of the X intensity during the summer months, and because the audibility meters did indicate values above 8000, the X intensity readings on the detector only were plotted subsequently to July 1st. All data considered in this report were collected in the year 1918.

The daily numerical radio and meteorological data were forwarded to the Washington office and reduced to the form of curves and charts. The curves were so arranged that at any given hour of the day simultaneous conditions at all of the stations could be noted. The data in this form were subjected to careful analysis with the results hereinafter outlined. In passing, it may be of interest to note that more than 1500 separate observations were plotted for each day's record, ten distinct lines of evidence being recorded for each station. The curve sheets were 30 inches wide and totaled 270 feet in length. The reduced

photostat copies are more or less unsatisfactory, as the original curves were plotted on a larger scale and in colors, therefore it has been considered inadvisable to include them in this article. The original curves

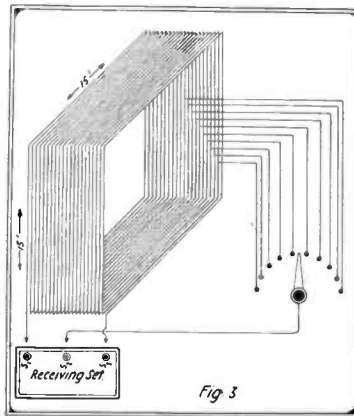

COIL ANTENNA

37 Turns Insulated No. 12 Stranded Copper Wire Spaced  $\frac{1}{4}$ " Between Centres. Ten Taps to Switch Beginning On Second Turn.

and data are on file in the office of the Chief Signal Officer, the curves and charts being packed in a box marked STARS and being packed in a box marked STARS (meaning Special Transatlantic Receiving Stations), Case No. 1, and the data and copy sheets in a box labeled STARS, Case No. 2.

#### SIGNAL STRENGTH.

Turning now to the question of the other variable in radio work, namely, changes in signal strength (audibility), it may be said that this phase of the general problem was given careful attention. In studying the variations in signal strength the traffic from the station at Lyons, France (YN), was taken as a basis.

An examination of the records showing the mean daily signal audibility of Lyons (LN) as noted at three of the receiving stations, indicates that the signals from a given station may show a comparatively high audibility value at one or more of the

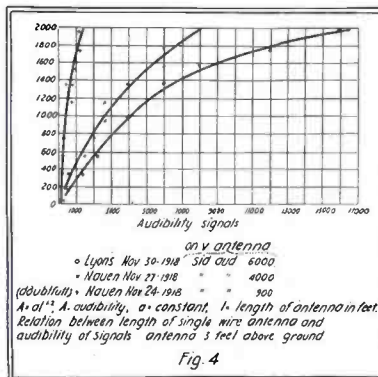

The Curve Which Was Plotted to Determine Relation Between Length of Antenna and Audibility.

stations on a certain date and at the same time a low value at another station, and vice versa. It is also evident that the signals from a given transmitting station may have a high audibility value at a given receiving station on a certain date, while signals from some other station are com-

paratively weak at that particular time, and vice versa. It was also found that a given station might show a comparatively satisfactory signal audibility for a period of time of the order of a month or several months, while during some other period the signal audibility would be found to be low.

An effort was made to determine whether barometric conditions over the North Atlantic Ocean bore any possible relation to the variations in signals from the station at Lyons. Charts covering the month of March, 1918, were prepared for use in this investigation by the Weather Bureau and showed barometric areas across the North Atlantic, especially in the region of the great circle passing through New York and Rome, and near Lyons. The data available for the compilation of the charts above referred to were limited, owing to military conditions. The data showed that when a low barometric area in Midatlantic existed on the great circle referred to the signals at Devens had decidedly low values in seven cases and decidedly high values in two cases. At the Fort Monroe Station, under the above conditions, the signal audibility showed a decidedly low value in ten cases and high values in seven cases.

In the above connection it should be noted that during the period considered lows obtained across or above the particular great circle and highs below. At no time during the month was there a high off the North Atlantic coast or in the middle of the ocean over the circle. The only locality where high areas occurred was on the European coast. From an examination of the limited data available it would appear that a low pressure area on the great circle in Midatlantic tends to result in low signal audibility on the American Continent. There is also some evidence for the tentative conclusion that cloudiness over the Atlantic on the great circle results in low signal values at the receiving stations. Owing, however, to the limited amount of data available for this particular phase of the investigation, it would obviously be profitable to extend the study over a longer period under conditions favorable to the securing of more complete data.

Charts were prepared setting forth the hours at which the signals from a given station (Lyons) have maximum and minimum values, respectively. These charts clearly indicated that the maximum and minimum values do not necessarily occur simultaneously at the several receiving stations. These charts also show that the maximum and minimum values at a given receiving station on a given day may obtain for a period of several hours; further, these maximum and minimum values do not occur at the same hour each day and appear to bear no definite relation to the time of sunrise, except possibly that the maxima are more apt to occur in the forenoon, prior to 10 A. M. This latter observation is evident from the data recorded subsequently to approximately August 1, at which time Lyons began to work a daily schedule which extended practically thruout 24 hours.

It is also desired to direct attention to a period of unusually high signal audibility during the latter part of March. The audibility values just referred to were more or less common to all the receiving stations, and applied to the signals from the stations at Rome, Carnarvon and Lyons. This phenomenon was also noted by the Navy Department. The writer is informed that the records of the Department of Research in Terrestrial Magnetism of the Carnegie Institution show that an abnormally high value of the electrical conductivity of the air occurred on March 21. This date falls within the period of abnormally high audibility values above referred to. This, of course, may be only a coincidence, and yet the occurrence naturally suggests the advisability of investigating the possible relation of the con-



ductivity of the atmosphere to radio signal strength. In order to accomplish this satisfactorily it would be necessary to establish a chain of observatories between the transmitting and receiving stations in order to secure reasonably comprehensive data with reference to the conductivity of the air.

The experience gained during the Transatlantic investigation shows that a given receiving station does not necessarily functionate equally well in receiving from all transmitting stations. For example, the station at Fort Screven, Ga., was never able to secure satisfactory signals from Rome; the station at Oberlin, Ohio, was more or less unsuccessful in receiving the station at Nauen, Germany; and the station at Madison could not successfully secure copy from the station at Lyons.

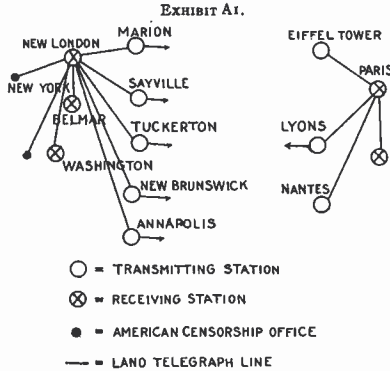

EXHIBIT A1  
America Transmitting, France Receiving, Paris Designated As Chief Receiving Center and Lyons Designated to Send Acknowledgments.

Experience also leads to the conclusion that comparatively little energy from the European stations, particularly from the station at Lyons, passes beyond the Great Lakes. The station was installed at Sault Ste. Marie, Mich., to further investigate this point, but the termination of the Transatlantic investigation prevented the carrying out of this part of the program. However, the results of a preliminary radio survey made in the region of Sault Ste. Marie tend to show the latter site would prove to be a fairly satisfactory inland receiving center.

Since the signal strength of all European stations as received at the Signal Corps station at Ithaca, N. Y., was always comparatively high, and since the storm map shows fewer electrical storms in the northern part of New York State in the region of the St. Lawrence River than at Ithaca, it was planned to investigate the region of the St. Lawrence River. The closing of the experimental work also prevented the carrying out of this survey. In view of the facts just stated, and also because of the fact that the great circle from Lyons passes approximately down the St. Lawrence River Valley, it is believed that a radio survey of that region in New York should be made.

In general it may be said that the stations at Rockport, Mass., and Princeton, N. J., experienced the strongest signals, with the Ithaca station ranking next. The Virginia and Maine stations showed signal values of the same order of magnitude, but of decidedly lower value than the stations above mentioned. The signal strength at Oberlin was of the same order as that which obtained at the Maine and Virginia stations. As previously stated various steps were taken to check the above indicated result. Certain additional checks were about to be made just as the work was terminated. If the data extending over nearly a year are at all indicative of actual conditions, it would appear that the geographical distance

of the receiving station from the transmitting station is not by any means the only important factor in predetermining received signal strength.

**INVESTIGATION OF ANTI-X DEVICES AND AGENCIES.**

At the same time that data bearing on X's and signal strength were being collected and studied, an effort was also made to investigate various suggested and original anti-X devices and agencies. In order to carry out this feature of the work most effectively a field laboratory was installed in Maryland just outside of the District, west of Washington. The equipment was sheltered in a portable house similar to those used at several of the receiving stations. The site of the laboratory was in an open field, the temporary use of which was donated by patriotic citizens of Washington, thus affording excellent opportunity for thoroughly testing various antenna systems and other anti-X devices.

Starting with the well-known fact that a low horizontal antenna is less subject to extraneous electrical disturbances than one of the vertical type, a number of antenna arrangements and other devices were investigated with respect to their anti-X properties. While X's and signal audibility measurements were made in each case, the final tests as to the effectiveness of any given device or agency was whether an operator could actually make better copy with the apparatus under test than with the standard low horizontal antenna.

Previously to the experiments at the Field Laboratory above referred to, helices, 15 feet square (see Fig. 3), were constructed at Camp Devens, Ft. Brown, Ft. Screven, and Ft. Monroe stations, and a 12-foot helix at the Oberlin station. The winding of the 15-foot helices consisted of 40 turns of stranded copper wire, spaced 1/4 inch between centers. The 12-foot helix had 45 turns. The helices at Camp Devens, Ft. Brown, and Oberlin were housed. Tests were carried out to determine the relative effectiveness of these helices when compared with the horizontal antennas used at the stations. The evidence showed conclusively that the helices did not possess any advantage over the horizontal antennas. The ratio was not improved and at times the signals on the helices were prohibitively weak.

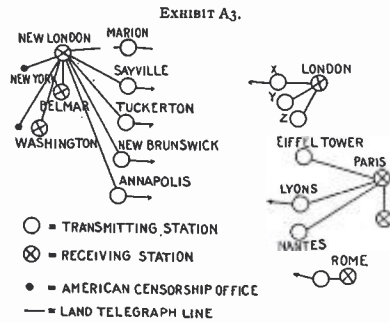

EXHIBIT A3  
America Transmitting, England, France and Italy Receiving, Chief Receiving Centers: England, London; France, Paris; Italy, Rome. Stations Sending Acknowledgments: England, Lyons; France, Lyons; Italy, Rome.

Both audio and radio balancing between two helices at right angles were tried in an effort to neutralize the X effects, but without success. Simultaneous photographic records of X impulses received on two helices placed at right angles to one another and in a vertical plane appear to show that the extraneous disturbances do not occur simultaneously at two mutually perpendicular planes. The amplitude of the impulses recorded is not significant. In making these records the receiving and recording appa-

ratus were interchanged from time to time in order, as far as possible, to eliminate experimental errors. In making these records the helices had a common vertical axis and it is possible that electrostatic coupling between the two helices existed. In view of this possibility, these tests should be repeated with the helices placed far enough apart to reduce the coupling to a negligible quantity.

The screening of a horizontal antenna was also investigated. A horizontal thousand-foot (305 meters) single-wire antenna was placed at a mean distance of approximately 3 feet (0.9 meters) above the ground and enclosed in a screening system composed of closed loops of copper wire 18 inches (45.8 cm.) in diameter, the plane of the loops being vertical and spaced at a distance of 20 inches (50.8 cm.). These loops

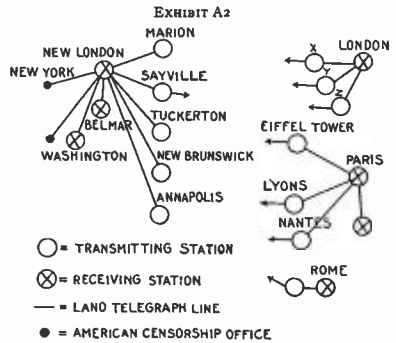

EXHIBIT A2  
England, France and Italy Transmitting, America Receiving, New London Designated As Chief Receiving Centre and Sayville Designated to Send Acknowledgments.

were connected by high resistance wire and the screening system was grounded at several points thruout its length thru 2500 ohm resistance units. Repeated tests showed that such a screening system possessed no advantages over an unscreened system.

It has been suggested that a mechanical covering for the antenna system might prevent the deposition of local electrical charges on the wire of the antenna, with the attendant electrical disturbance. In this connection, it may be noted that the large helices, referred to above, were constructed of insulated wire, and several of the helices were used within a building. No noticeable difference was observed, so far as X's are concerned, between the behavior of the helices operated in the open or enclosed. Further tests along this line were carried out at the Field Laboratory. Careful measurements were made on two horizontal antennas, the wire of one of which was covered with a light insulating material having a comparatively low specific inductive capacity, and an antenna constructed of bare wire, but otherwise identical. No difference in the functioning of these two antennas could be detected.

It was thought that possibly an antenna having concentrated capacity might be less subject to extraneous electrical impulses than one composed of long wire. An antenna consisting of 600 square feet (55.74 square meters) of copper window screen, and supported at various heights above the earth's surface up to 12 feet (3.7 meters), was compared with a 1000-foot (305 meters) horizontal antenna consisting of two wires. The signal strength on the copper screen antenna was prohibitively low, and the ratio showed no improvement over the usual horizontal antenna.

Another anti-X possibility investigated consisted of a vertical subterranean antenna. At Dumfries, Va., about thirty miles (48.3 Km.) south of the City of Washington, is located the Cabin Branch Mine, which produces iron and copper  
(Continued on page 43)

# Design of Rogers "Ground" Antennæ\*

By J. STANLEY BROWN

Late Radio Expert, U. S. Naval Service

NOW that the silence in regard to *Underground Wireless* has been broken, the Radio Amateur will undoubtedly be very glad to know a few of the facts in regard to its operation and installation. The writer has had the privilege of working on the Rogers Underground System while at the

are necessitated by the marked directional tendencies of Mr. Rogers' invention. Leads from the antennæ are brought into the receiving station, which should be near the ground—or even under it—and connected to a selector switch. (Detailed information for the construction of a suitable selector switch will be given in a later issue.) The

able shunt across the phones. Take two or three audibility readings and compute an average. Disconnect the last twenty foot section and repeat the process. Keep this process up until it is determined which of the bare splices the "peak" lies between. Small values of capacity and relatively large values of inductance give the best results; so adhere to them during the testing. Next bare splices are made every 3 or 4 feet in the 20 foot section *decided upon*, and the tests are repeated. The critical wire length will thus be found. The unnecessary sections of wire are salvaged.

## TREATING THE SPLICES

The splices are now soldered, rubber taped, vulcanized, friction taped and served with marlin. The outboard end of the wire is split for about an inch, the conductor cut away, wrapt with rubber tape, vulcanized and thrust in a pothead filled with melted "Okonite" or similar insulating substance. The pothead and wire are served with marlin.

The pothead mentioned is made of a six inch length of  $\frac{3}{8}$ " pipe with a cap on one end.

## TESTING FOR GROUNDS

The wires are tested for "leaks" to the ground with the audion "B" battery and a D. C. voltmeter. The experimenter should not be deceived by the 2 or 3 volt capacity "kick." Leaks of but one or two volts are not serious but those more marked must be located and repaired.

## LONG WAVE RECEPTION

When installing this system for the reception of very long waves, it is not necessary to make optimum tests. The transmitted waves of the big arc and generator stations vary so much that any attempt towards optimums would be absurd. However, the U. S. Navy calling wave for arc work is 4,000 M. A suitable length and size of wire is 1,000 feet of No. 12 D. R. C. copper wire. This wire when used in connection with a standard Navy receiving set or any good long wave receiver will tune to 15,000 M. For the longer waves, however, a 1,500 to 2,000 foot length is superior. For long wave work the underground antenna is far superior in every way to the raised antenna.

## IN REGARD TO STATIC INTENSITY

Several statements have been made as to the lack of interference from static. Let us be frank. On clear days the ground wire is very little better than a good elevated aerial, in my experience. At no time is it absolutely free from electrical disturbances, but it is a good receiver when the severest electrical storms are raging—the operator is never endangered and ordinary commercial work goes serenely on. (It is thus easy to see what the Amateur radio "relays" of the future will be like.)

It is a generally accepted fact that the largest per cent of the small amount of the disturbances present in this system are those picked up by the coils of the receiving set. As proof of this the writer has often disconnected the primary leads and attempted to copy the Atlantic arc stations 800 miles away. It would often be impossible to do so, due to local electrical dis-

(Continued on page 46)

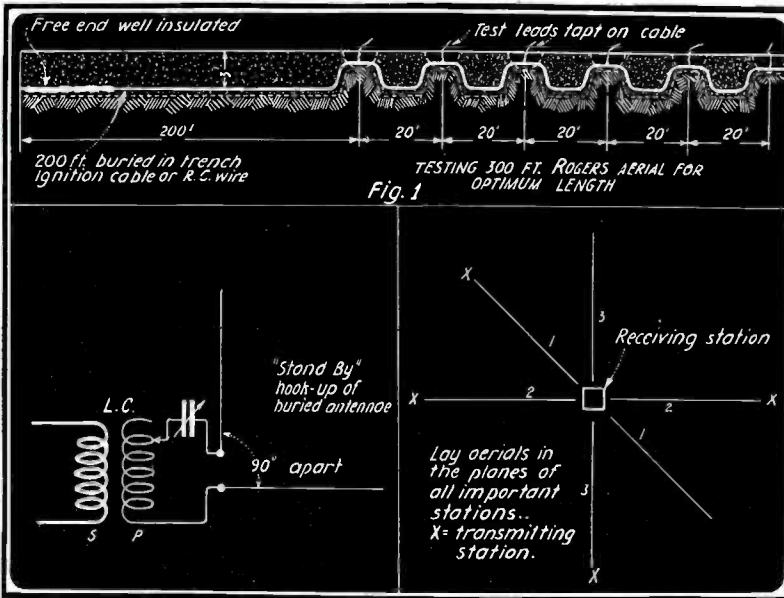

Great Lakes radio station; in the U. S. N. Radio Laboratory, Norfolk, Va., and also at New London, Conn.

One of the most favorable features of the ground antenna is its *extreme sharpness of tuning*. Even on the very long waves of from 10,000 to 15,000 meters, signals of but few meters difference from others of equal intensity, can be easily copied *without interference*. This feature makes the subterranean system very adaptable to distant control installations. In fact, so adaptable is it that the control station need not be more than a few hundred feet from the transmitter.

## CONTROL STATIONS

If the station under construction is to receive wave lengths of from 425 to 952 meters wave length, then a length of wire known as the "600 M. (M. = meter) Optimum" (= best) is used. With the standard 20,000 volt high tension cable so much used by the Amateur at hand, it is safe to say that in damp ground or fresh water a 240 to 250 ft. length will be correct. If No. 12 D. R. C. copper wire is used, a length of 140 to 150 ft. will be sufficient.

In laying out the underground aerial system, wires to at least 6 points of the compass should be installed. Take note of the direction from which the greatest number of signals have always been received. Run one wire in this direction and one in the opposite direction. If a large number of signals have always been received from two or three directions, make sure that each origin is in the plane of one set of wires. The large number of wires

switch has a ground lead connected to it, also.

Any of the wires may be used in connection with each other or a ground or with an elevated antenna. A curious fact noted here is that upon changing the terminals of the receptor from a ground lead to a second ground wire, no change is noted in the wave length of the primary circuit. Louder signals, however, result from the use of two wires in preference to one and a ground.

## STANDING-BY

The approved method of "stand-by" connection is that of connecting two wires of different directional tendencies to the set. For example: an east and north, southeast and southwest or some equivalent set spaced 90 degrees apart.

## SECURING AN OPTIMUM

The method used in securing an optimum is crude but simple. After a few trials it was made plain that with the standard 20,000 volt high-tension cable a 600 M. optimum would lie between 200 and 300 feet. Therefore, a 300 foot length of cable was buried for 200 feet of its length to a depth of about three feet. From there on to the end, a bare splice was made every 20 feet. The splices were kept off the ground by small squares of fiber. The remaining wire is then buried except at the splices, around which a hole large enough to work in was left. See Fig. 1.

Arrangements, with some transmitting station to send out ...'s for 5 minutes, should be made.

Shunt an audibility meter or an adjust-

\* This article was past by the Bureau of Naval Intelligence.



# Experiments on Ground Antenna with Their Relation to Atmospherics

By CHAS. D. HERROLD, E. E., R. E.

**E**ARLY in February of 1908 in a lecture to students I stated that not only should it be possible to transmit radio signals thru the conducting layer of the earth's crust, but express it as my firm conviction that it was impossible to send long-distance signals in any other way than by the aid of that terrestrial conducting layers.

I believed that a proof of this would eventually be found, and determined to devote myself to this problem. It was a difficult problem to separate the free Herzian wave from the gliding earth wave and show the existence of a true earth impulse or component. I commenced preliminary experiments with oscillators of various types, raising both the transmitter and receptor as far as practicable above the earth and carefully avoiding all ground effects. I then gradually lowered both the receptor and emitter and found that as they neared the earth there was a tendency for the waves to drop down and ground themselves, thus increasing the distance of response.

In these experiments I used a polarized relay and detector of tungsten wires laid across sharp steel blades, 20 wires being used, 5 in multiple and 4 sets in series. This made 40 contact coherers in multiple series, and was very sensitive and reliable. I used a combination of wing and dumbbell as oscillator which emitted a "Whip Crack" of wavelength .55 meter, and later replaced the large ball with a cylinder to obtain a train of oscillations.

Then I grounded one side and, as was to be expected, the distance of response still further increased. All this was very interesting but did not prove the existence of a true impulse thru the ground. Altho there was strong corroborative evidence I had to accept the Scotchman's verdict of "not proven."

I found that it was out of the question to use any of the highly damped oscillators and cohering devices even of the self-righting types; however, I used these for detonating small explosive charges, in one set of tests firing 83 charges with 3 misses or prematures.

I read Tesla's account of his Colorado Springs experiments in which he observed stationary waves due to a distant storm, and conceived the idea that it would be possible with two synchronized oscillators to produce stationary waves in the conducting layer of the earth and utilize them for exploding submarine mines.

This conception proved to be somewhat in advance of any instruments at my disposal, and it was towards the close of the following summer before I obtained any results. I chartered a small sloop and a power boat for towing. My system consisted in installing two grounded oscillators, one on the shore and the other on the sloop, and a receptor on the launch and searching for the nodes and loops using fairly long wavelengths. I succeeded in producing stationary waves without reflection by the interference of two gliding grounded waves. The general inferiority of existing methods of transmission and reception, and the tremendous difficulty experienced in getting any two oscillators to remain constant long enough to get tests and to maintain the detecting system of constant sensibility caused me temporarily to abandon this work.

I had a good shop and a mechanic, and having put in about 8 years as instru-

**S**INCE the publication of the Rogers Underground Wireless System a few months ago, the Editor has received many letters from would-be radio investigators, claiming priority to this important invention. None of them, however, produced documentary proof of their priority.

There is no question at all that to Dr. Nikola Tesla go the honors of being the pioneer inventor of Underground Radio. His early published reports prove this abundantly. Unfortunately, Tesla at the time of his invention did not have our modern instruments at hand, so the world was cold and skeptical to his announcement, mainly because the radio art at that time was still an unknown quantity.

Very recently we had submitted to us the accompanying article by Mr. Chas. D. Herrold, a painstaking and able radio investigator of high genius. From the documents in our hands, sworn to before Notary, in November, 1912, and February, 1913, it appears that Mr. Herrold no doubt shares with Mr. Rogers the honors of being the first on the ground as far as experimental proof of Tesla's theory is concerned. It appears further that unknown to each other the two investigators followed the same paths in a truly remarkable manner.

Mr. Herrold, however, during his experiments came across many highly important phenomena never published before. Only to mention a few we cite:

Transmitting signals using Static only; the relation of earth currents to sun-spots; transmission of signals, using earth currents only; proof of TRUE ground radiation, completely demonstrating Tesla's "ground Radio."

We take this occasion to congratulate Mr. Herrold on his far-reaching accomplishment; we consider ourselves fortunate in being permitted to publish his important contribution to the radio art.

—EDITOR.

ment maker I built and tried out practically every form of detector and oscillator with perhaps the exception of high-frequency alternators.

The result of eight months' work served to strengthen my belief in two general propositions. First, oscillations do take place in the earth itself whenever radio energy is transmitted, and second, the oscillator must "attack" the earth at two points at the same time which is different from that of Tesla, who proposed to "pump" the energy into and out of the earth at one point only. In other words, the earth must be periodically charged to a positive and negative potential simultaneously at two more or less sharply defined points one-half wavelength apart. I concluded that unless some more positive and reliable method of production of undamped waves were developed and unless there should be discovered more sensitive and reliable method of detection, ground wireless could not succeed.

About this time the technical magazines published reports of the improved system of Valdemar Poulsen, and shortly afterwards the American Company took over the patent rights and commenced development work after the truly American fashion of overlooking no details. I became interested in arc systems and saw in them the successful solution of the problem of Earth Potential Signaling. The greatest secrecy was maintained over the improvements being made on the laboratory sets furnished from Copenhagen, so those of us who would profit intellectually were obliged to content ourselves with the comparatively meager reports of the original experiments. The American Company at first made the mistake of trying to develop the rapid, automatic Einthoven Galvanometer Photographic Recorder as well as the Radio-Telephone before they had either their oscillating or detecting system perfected. At last they abandoned these, perfected their active arc and its cooling system, producing oscillations of the third

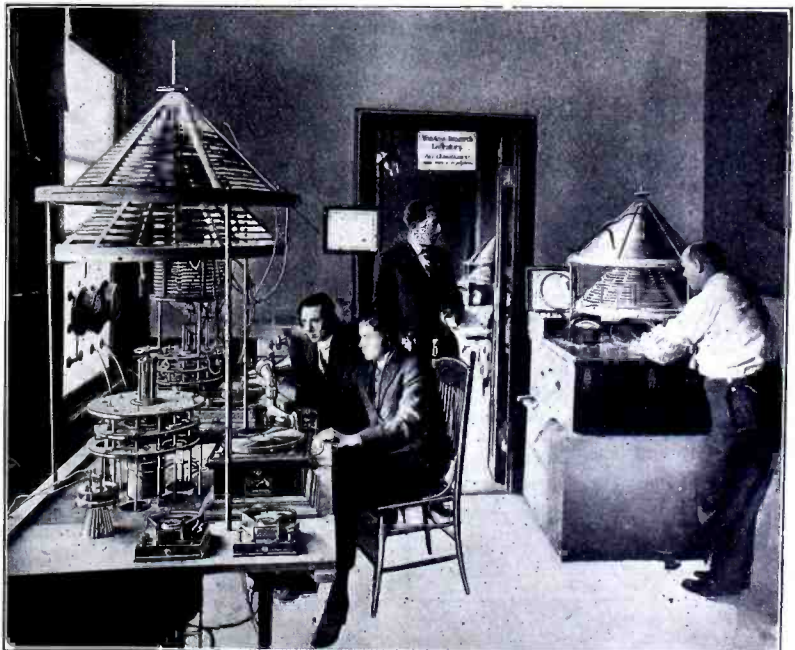

One of the Laboratories in Which Mr. Herrold's Startling and Revolutionary Discoveries Were Made. Note the Unusual Apparata.

order (Unidirectional), and then made their greatest single improvement by cutting the arc into the ground circuit.

Early in 1910 I again commenced experimenting on Ground Radio. On the south

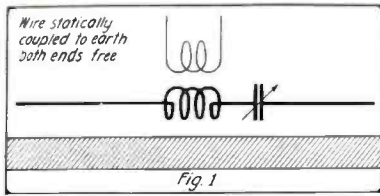

and west of the high steel building of the Garden City Bank in San Jose, California, I constructed different forms of antenna containing in all over 11,000 feet of wire. For purposes of comparison one of these was a flat top bent L and the others were dipped down almost to the metal roofs, being grounded at their highest point thru the instruments. This was particularly adapted to the damped spark we were using and served admirably to charge up the earth and carry on earth potential signaling. Its large distributed capacity made it impractical when we tried to use it with undamped oscillations. Using 7000 feet of this antenna system, my students made preliminary tests and then Mr. Newby transmitted a distance of 90 miles with an expenditure of only 15 watts of input energy. Mrs. Glass and Mr. Newby, my two operators and the students were anxious to publish this, so the material was prepared and placed in the hands of Mr. Gernsback, then Editor of "Modern Electrics." It will be found on page 296 of "Modern Electrics" for August, 1910. If you will carefully read line 5 you will find this statement: "Further tests were carried on the following day, the Farallon Islands registering interference showing that the EARTH'S POTENTIAL HAD BEEN DISTURBED AT THIS DISTANCE (about 90 miles). In this expression you find the humble opinion of an obscure radio experimenter buried, but put there for a purpose."

In October, 1910, an opportunity arose to prove the ground-potential theory in a positive and absolute manner. The new 9-story steel building of the First National Bank was about completed, and thru the courtesy of the President, Mr. Willis Clayton, and the constructor, Mr. Ambrose, I was given permission to carry on researches. I connected my instruments in the basement to the main feeders of the wiring system which were completely surrounded by steel conduit, and signals were sent and received. I was assisted by Mr. Allen Stauffer and my students.

To still further carry on these researches under conditions carefully selected, I built a cabin in a pocket gulch off of Linden Canyon in the Santa Cruz Mountains. Every board of this cabin had to be carried in by hand over a steep trail and down a long slide. A galvanized steel wire over 2000 feet long, Fig. 20, was suspended over this gulch with means provided for direct or static grounding at each end

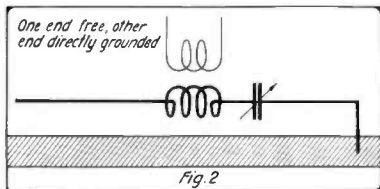

or both ends and means for cutting in the instruments.

It might be thought that the use of a steel wire was objectionable, but since the skin

penetration for the frequencies (oscillation) of the stations which I was using as checks, were less than the thickness of the galvanizing and the magnetic retardation due to the action of the steel on the internal field was only a small percentage of the total, I found the steel wire answered my purpose quite as well as a stranded, hard-drawn phosphor bronze or copper cable. However, I suspended from this wire at right angles at its middle point 3000 feet of copper wire so as to get 90 degree directional working. This wire was insulated from the steel wire, and was also arranged so that I could directly or statically ground each end or both ends.

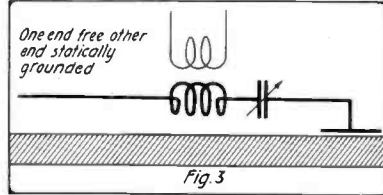

Storms destroyed the copper antenna after my first tests, but the steel wire remained by permission of the Navy Department until finally removed by order of the Department of Justice a short time before the signing of the armistice.

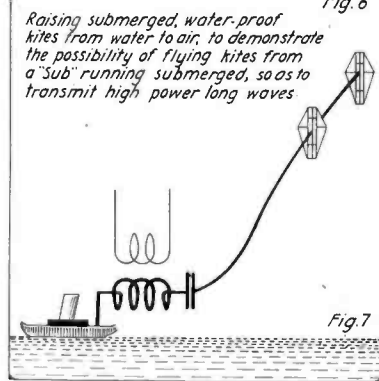
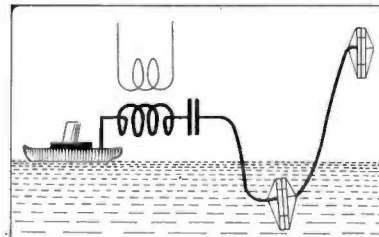

I strung wires thru the almost impassable brush in various directions, and in one case grounded the wire at both ends in two springs of fresh mountain water, Fig 20 (lower). I also tried star and delta connections, using three and four grounds, tried radiogoniometers on two right angle ground antennas, Figs. 16 and 18. In one case, Fig. 17, a T was used parallel to the earth and rounded at three points with provisions for cutting out each or all grounds in some tests. This T was not sharply directional, and a greater number of stations were audible without critical adjustments of inductance and capacity. In fact my plan was to try every possible arrangement that might throw a little light on this fascinating riddle.

Although these tests were performed in a completely land-locked pocket gulch surrounded by high mountain walls, we were able to receive readable signals from great distances under ideal conditions of inter-

ference and static, in fact on a background of absolute silence. So remarkably free were all signals from strays that I have repeatedly heard my operator at my San Jose Station breathe into the modulator of

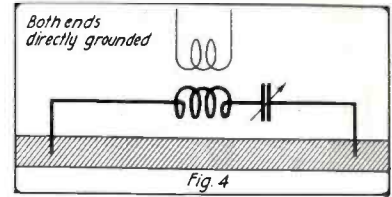

my arc Radiophone or drop a phonograph needle, or brush his sleeve against the mouthpiece. (I had in the meantime developed my own multiple arc radio-system based on the Jahnke principle, and was in fine shape for experimental work. I had a four and a six arc set of carbon and copper tubes immersed in liquid alcohol, both of which had been used in Radio-Telephone tests up to nearly 1000 miles.) My students used to sit in the little cabin and copy press and commercial messages. It was by a study of thousands of words copied on these wires that I obtained much valuable data as to selectivity and directivity.

I also went across the Santa Clara Valley into Alum Rock Park, a public reserve completely surrounded by mountains, and there performed experiments with wires laid on the ground, wires grounded at both ends or one end either statically or directly, Figs. 1, 2, 3, 4 and 5. In one case we received signals on a wire grounded at one end to a rail buried in the old Central Tunnel and the other free, and in one test grounded in the Penetentia Creek. In one case the wire was laid in the bed of the stream. I was assisted in these tests by Mr. Camp, of the Marconi Company, and Mr. Newby, a very able Marconi operator.

A great measure of the success of this mass of experiments was due to Mr. E. A. Portal, who was with me for over 5 years, and since the war was Chief Radio Electrician at Goat Island. He was a remarkable operator, who could copy off a Wheatstone Automatic at unusual speeds. In comparative tests with audion amplifiers and Malay Kites and ground antenna he showed wonderful ability in picking out some particular station from a mass of interference and static. A report of these kite tests and tests of the Radio-Telephone is to be found in a thesis of the University of California, 1916, by Messrs. Partsch, Reid and Stull. Stull, a graduate student with me for four years, also assisted in my tests in San Francisco Bay, in which we combined Malay Kites with submerged rubber-covered wires and dragged submerged rubber-covered wires after a fast launch (Figs. 6, 7, 8 and 9). We used three step vacuum amplifiers and oscillating audions of great sensibility.

Still further tests were conducted in Alum Rock Canyon. Thru the extreme courtesy of Mr. W. H. Davison, Chief Electrician for the San Jose R. R., and Mr. Brown, in charge of the Sub-Station, I

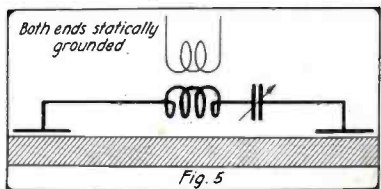

was allowed to hook a long portable cable to the 600 V.D.C. line directly at the Sub-Station, and operate my 4 and 6 arc Radio Telephone sets. This was an ideal ar-



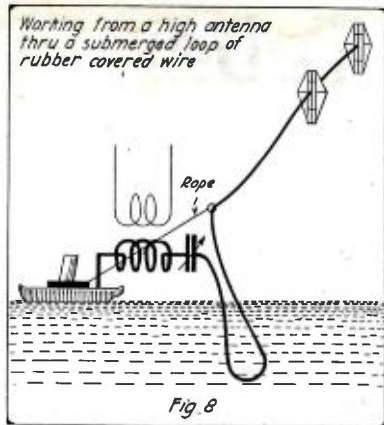

rangement, as it gave me great flexibility and enabled me to make quick changes in the field. Furthermore, my sets were portable and quick acting, being magnetically controlled so that from 4 to 6 series arcs could be stopped and started instantly without a hitch. In fact my operator could break in the middle of a two-syllable word and make the arcs "come back" instantly without any loss of annunciation. Our boys could unload the entire equipment from the auto and balance up ready to operate in a few minutes.

Results showed that transmitting ground antennæ must be raised from the earth in their middle portions to avoid too close static coupling and the effect of close-bound charges and yet be closely coupled with the earth at their ends. The arrangement

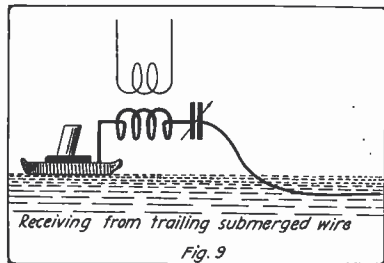

shown in Fig. 5 when the wire is slightly raised, Fig. 19, and the upper wire of Fig 20 are adapted for transmission. Long ground antennæ should be of Litzendraht or preferably of thin copper strips built up into a cable with empire cloth strip separators, the strips being turned up edgewise to the earth to avoid internal surgings and breakdowns within the cable. I built up "Litz" cables, in fact I have on hand now over 5000 feet of this (100 strand) and some 500 strand "Litz" which we stranded ourselves from No. 34 and No. 36 insulated wire. Ground antennæ must be laid in the direction of the station to which or from which signals are being sent or received, and when their ends are localized have a length  $\frac{1}{2}$  W. With shorter wires inductance added give them an electrical length of  $\frac{1}{2}$  W. With wires like Figs. 1, 2 and

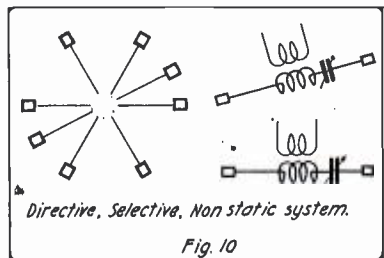

3 adjustments are not so critical, and the length of the wire bears no simple mathematical relation to that of the received wave. To get results with submerged wires long undamped waves were necessary which probably account for Kiebitz's negative results with dirt-covered trenches and damped short waves. "Whip Crack" waves would not penetrate at all which partly accounts for the absence of static on ground antennæ.

I became deeply interested in investigations into the nature of static and its relation to ground effects. I found that "Grinders" or "Whip Crack atmospheric X's" act as *Stosserregung*, or shork exciters, setting up persistent oscillations in any antenna of any period. Hence the utter futility of any attempts to get rid of static directly by weeding or sifting in the receiving set. The ground antennæ are static eliminators naturally because the earth is not a free vibrator (at least for the range of vibration in use in Radio), and as stated before the penetration of the ground

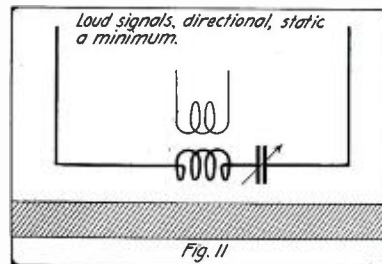

component for highly damped impulses is practically zero, which is proven by the use of subterranean and sub-aqueous antennæ.

Observations conducted by me in September, 1910, indicated that "Grinders" and "Whip Crack" atmospherics originated above the antenna. This was shown by the use of a statically (artificially) charged carpet aerial placed directly above a small receiving antenna and also by actually maintaining an artificial static charge on the antenna itself with means provided for changing the sign of the charge as the polarity of the air changed. I have an affidavit on this conception bearing the date September 28, 1910, but no patent was taken out. I believed then and still think that this form of static originates very high up in the earth's atmosphere and is caused by impact of visible and invisible

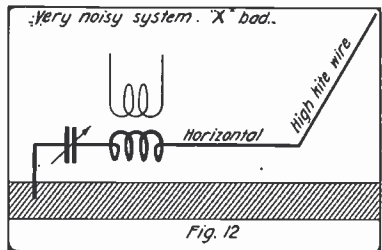

meteoric bodies entering the earth's atmosphere and setting up electronic disturbances whose intensity varied with the amount of electrification of the air. When this matter is finely divided and of considerable volume these disturbances are so numerous as to be inaudible, but set up continuous oscillations of small amplitude in the antenna sufficient to keep the detection partly broken down. It would manifest itself by a lower audibility of incoming weak signals. The existence of this "inaudible" static is shown by placing a galvanometer and valve in a raised antenna circuit and noting the weak current. At the time the tail of Halley's comet

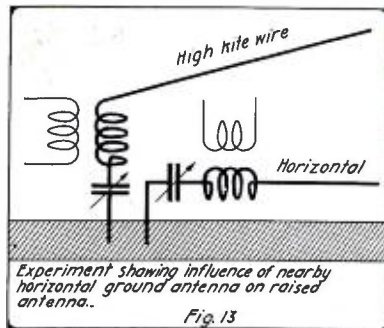

was to contact the earth astronomers requested radio men to note the effect, if any. I conducted tests for several days before and after to determine if there was any noticeable change in the atmospherics or signal audibilities. A curve was sent by me to Dr. W. W. Campbell, Director of Lick Observatory. My results were perfectly negative as far as any effect I was able to note.

It is with deepest interest that I have read of the Anti-Static Antenna of Mr. Weagant of the Marconi Company. The masterly manner in which he has handled the verticle-propagation principle in his epoch-making discovery of a static eliminator should be an inspiration to all research workers.

To show how close a man may be to a great fundamental invention without perceiving it, I call attention of readers to

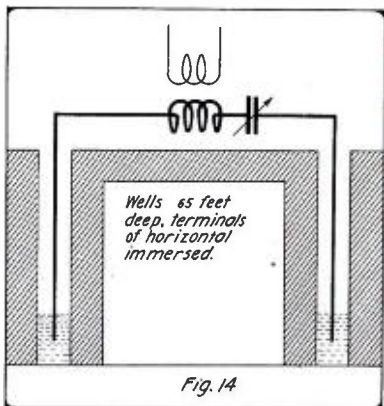

my experiment in Fig 11. This combination antenna was designed primarily by me for the purpose of showing the difference between the pure ground component and the gliding wave by comparing it with that of Fig. 1. Had I taken the precaution to carefully balance each one of the vertical wires and equalize their oscillating constants (Fig. 11) I would possibly have stumbled onto a static "Stopper." As a curious biproduct of my researches I succeeded in transmitting signals by means of static, using a "Chopper" and key in the ground circuit of an ordinary bent L antenna and no other power.

In experiments with ground effects I (Continued on page 44)

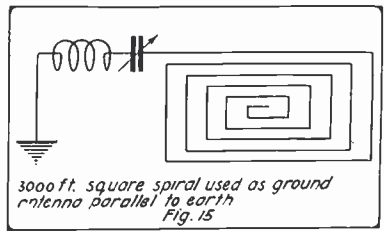

# A New Electron Tube

By H. P. DONLE\*

**T**HE present forms of electron tube amplifier, detector, or oscillator, although remarkable for their adaptability and efficiency, have developed along more or less well defined paths and deviated very little in principle from the original forms.

A vacuum tube has been developed, however, by the author which not only departs entirely from previous usage, but operates by means of what is believed to be a new effect, viz., electrolytic conduction in a hot dielectric.

Before considering the operational characteristics of this device a description of the tube structure will probably aid in understanding more fully its functions. In Fig. 1 the structure is shown diagrammatically where F is a filament; C is the controlling electrode surrounding (F) both, contained within a glass tube T, the electrode A on the outer wall being a metallic coating applied directly to the glass surface. In operation this electrode (A) is connected to the positive terminal of a battery, the negative terminating at one end of the filament and when used as a detector of radio frequency oscillations the receivers are included in this circuit.

In practice this tube is exhausted to the highest obtainable vacuum, and therefore the filament, when heated by its battery, is the source of a pure electronic emission which forms the connecting link for the "B" battery between the filament and the anode electrode, the resistance of this connecting link varying with the potential of the control.

The point of immediate interest is the passage of current through the glass. Glass has up to the present time been looked upon as at least a fair insulator although it has been known that at or near the melting

such elements as copper, tin, iron, nickel, platinum, etc., an apparent polarization took place which very greatly increased the resistance of the combination. This is without doubt due to an electrolytic action at the anode surface which renders it almost non-conductive. While the glass is in this condition, if the source of potential be short circuited, the energy held on the electrode surfaces will be returned through the circuit. All of these phenomena, although, of course, perfectly commonplace in a liquid conductor, have, it is believed, up to the present been unknown in a solid.

With silver electrodes this last action is almost entirely absent; so much so that glass with one electrode of silver and one of nickel will, at the proper temperature, become a fair conductor when the silver is the anode terminal of the applied E.M.F., but will be very high resistance with silver the cathode.

Fig. 3 is the current-temperature curves for the glass samples prepared, one with both electrodes of silver and the other having two platinum electrodes, the applied potential in each case being 20 volts.

It might be supposed that the electrolytic disassociation of the glass walls would make it impracticable to construct a tube in this manner. This was found not to be the case, for it is entirely feasible to so distribute the current density and magnitude that disassociation will take place at a very slow rate, and glass life will be one of the smallest factors in the tube life.

Several types of tubes which are illustrated, operating by the conductive properties of heated glass, have been designed, the glass being heated to the required degree by the filament and maintained at its proper temperature by enclosing the tube within an outer shell of glass. This is provided with vents at its lower end in order

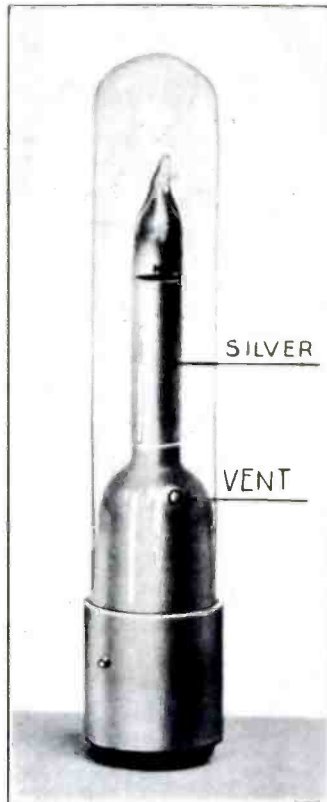
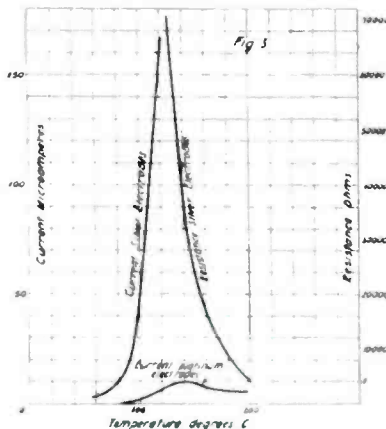

Fig. 8. Type "C" New Donle Electron Tube. It Operates On a New Principle i.e., Electrolytic Conduction of HOT Glass.



Curve Showing Conductivity of Glass at Various Temperatures.

point it becomes a good conductor. This property of becoming strongly conductive when heated to a semi-fluid state is probably shared by all other so-called dielectrics; but it is obvious that it would be absolutely impossible to operate a vacuum tube at such a temperature. Glass begins to soften at approximately 425° C. and does not attain red heat until heated to about 600° C.

Glass, however, when in contact with certain elements, becomes a good conductor at far lower temperatures than these; but

the conduction through it when in this condition is purely electrolytic, and all the phenomena accompanying conduction through a liquid electrolyte are present in hot glass, such as decomposition, polarization, etc.

Conductivity tests of glass in contact with various elements were made by preparing short lengths of glass tubing (Fig. 2) with a band of the metal surrounding the outer circumference near the middle of the tube and a second band of the same metal inside the tube immediately under the outer band, this tube being heated to the required temperature in an electric oven.

It was found that using electrodes of

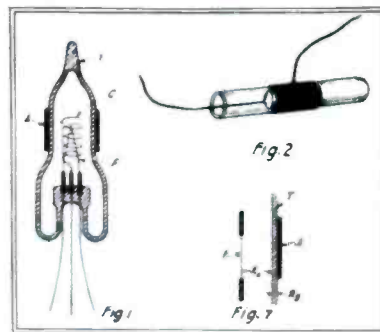

1: Structural Details of the New Electron Tubes. 2: How the Glass Conductivity Tests Were Made.

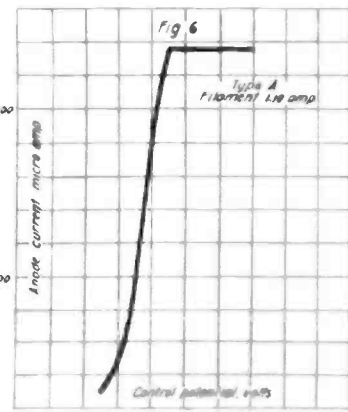

Curve Showing Characteristic Anode Current Control Potential.

that the temperature will not exceed its proper value.

The evacuation of a tube of this type is extremely simple, for, owing to the very small metallic areas exposed and their close proximity, it is possible to "clean" the tube of gas by simply lighting the filament and applying a low potential between one leg of the filament and the external anode. This potential is, however, usually twice its normal operating value. With the first application of this potential there is an emission of gas from the glass tube which is drawn off by the pump, but after a few minutes

\*Radio Engineer, Connecticut Telephone & Electric Co., Inc.



this comes and there is apparently no further emission from this source during the tube life.

There is, however, a strong "cleaning up" action in the tube, which is without doubt due to electrolytic action of the glass. During the process of glass disassociation there is a continuous liberation of metallic sodium from the heated portions of the tube. This deposits in the form of a bright silvery coating in the cooler portions of the glass. The presence of this within the tube would partly account for the cleaning up of any occluded gases.

A frequent source of gas in a vacuum tube is the melting of that connected portion which connects the tube with the pump when the tube is sealed. With these tubes the presence of gas is very noticeable after sealing, but after a few minutes of normal operation it is to all indications no longer present.

The type A tube is shown in Fig. 4, its component parts in Fig. 5, and its characteristic anode current control potential in Fig. 6.

The construction of this tube needs very little description, the entire inner structure with the exception of the supporting wires being tungsten and molybdenum. The glass tube is drawn to a smaller diameter immediately over the filament and coated on the outside in that portion with silver.

The characteristic of this and succeeding tubes show one peculiar feature, namely, the flattening of the curve at or near zero control potential. The cause of this is readily explained.

In this tube we have, in effect, two resistances (Fig. 7) that from filament to inner wall of the tube ( $R_a$ ) and that of the glass walls ( $R_g$ ). This latter is nearly a fixed value determined largely by glass temperature and somewhat by current passing through it, but  $R_a$  depends entirely upon the charge residing on the control. It is obvious, therefore, that as we make the control more positive we decrease this resistance until we reach a point where it is unappreciable compared to  $R_g$ , and therefore in this condition ( $R_g$ ) is the controlling factor in current flow between filament and anode.

With this particular type of tube this

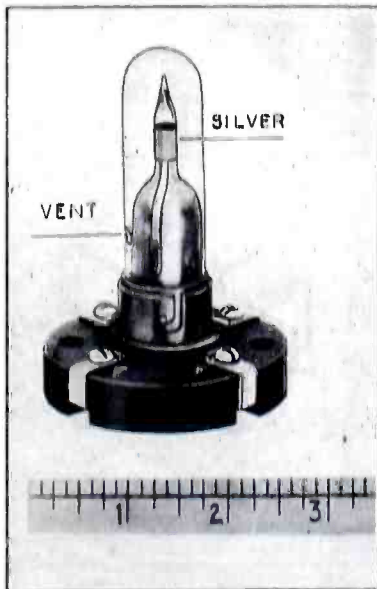

Fig. 4. The Dopic Electron Tube Mounted and Ready for Use. Note Venthole of Outer Jacket.

taken place at zero control potential, but if it was possible to increase the glass temperature without increasing the electronic

emission, the position of this bend would be at a more positive control potential.

It is obvious, therefore, that the position of this bend may be placed anywhere on the control potential by merely altering the ratio of electronic emission to glass temperature.

An example of this is demonstrated in the type C tube (Fig. 8). In this tube the mass of the filament has been increased and its temperature decreased. We therefore are able to retain the proper temperature of glass, but with a decreased emission.

Aside from their electrical characteristics these tubes possess structural advantages even more obvious. These advantages need no description, for they are illustrated very clearly in the various figures. The construction and assembly of these parts is so simple that manufacture on a quantity production basis is considerably more feasible than the conventional type of the electron tube.

In practical operation these tubes prove eminently adequate from every standpoint. Their exceptional oscillating properties make them particularly adapted for use as regenerative or oscillating detectors. In all

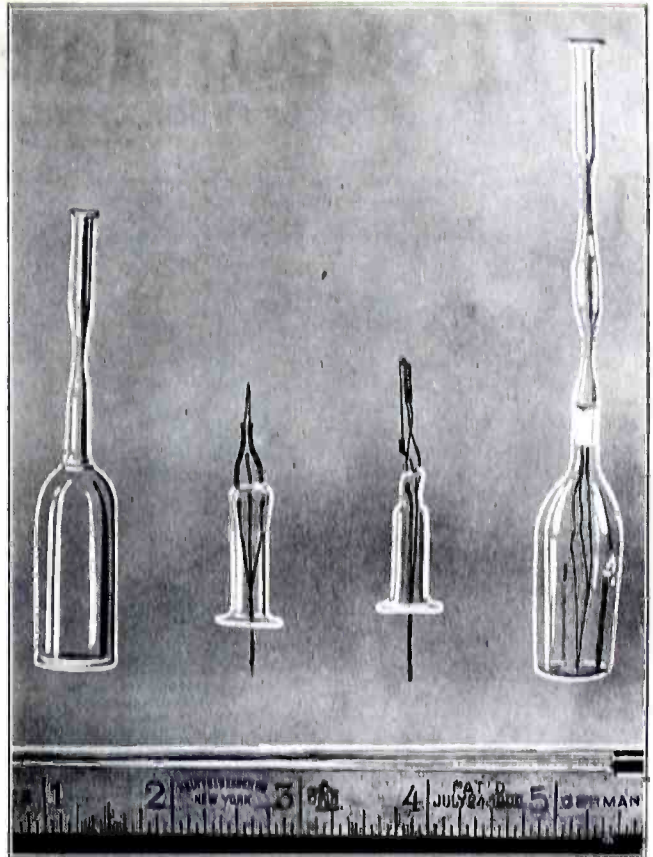

Fig. 5. The Component Parts of the Dopic Tube Shown in Fig. 4. This Tube is Simply itself and is Very Rugged at the Same Time.

cases their operation seems to be better when a stoppage condenser is placed in the control circuit, although it is entirely practical to operate them with a polarized grid in the usual manner.

We have been very fortunate in having the characteristics of these tubes checked by Dr. Chaffee of Craft Laboratory, and wish to take this opportunity of expressing our appreciation of his most valuable assistance.

## Future of Amateur Very Bright

DEPARTMENT OF COMMERCE  
Radio Service

Office of Inspector,  
Mr. H. Gernsbach,  
Radio Amateur News,  
233 Fulton St., New York, N. Y.

Sir:  
The future of the amateur as well as the commercial operator is very bright. Amateurs are now being examined and those who qualify will be given their license when we receive instructions from Washington to do so—after peace has been declared.

Applications for station licenses will not be issued until that time, and all persons are cautioned not to operate an unlicensed transmitting station. All present amateur licenses, whether station or operator's, are void, and no renewals will be issued. To pass the examination for amateur first grade radio operator's license applicant must be able to receive and transmit ten (10) words per minute and an average of 70% or over in theory is required.

The demand for commercial first grade radio operators is increasing every day, and

experienced men holding licenses need not remain out of employment. The salaries are \$110 per month for senior operators, and \$85 for junior operators. This includes meals and quarters on board ship, so that a man has a chance to travel to various parts of the world, which should appeal to many, and save money at the same time. Men able to handle a typewriter and do clerical work on our own ships are able to make more money, depending on the circumstances.

It is therefore advisable for those interested to go to a reliable radio school and learn modern methods of commercial work; as the U. S. Merchant Marine is growing every day operators will always be required.

Examinations for all grades of radio operator's license are held at this office, Room 631, Custom House, Bowling Green, New York City, every day except Saturdays, Sundays or holidays at 9.30 A. M.

Respectfully,  
Charles P. Guthrie,  
U. S. Radio Inspector.

New York, N. Y., May 21, 1919.

# Radio Translator

By MAJOR CHARLES A. CULVER.

SIGNAL CORPS, U. S. A.

THE most promising device for the elimination of extraneous disturbances, including interference from other stations which we have investigated, is a device designed by this branch, a working model having been constructed in the Signal Corps Field Laboratory. Briefly, this device consists of a tuned reed associated with an electromagnetic system, and an external acoustic resonating chamber. Drawings showing several different ways of assembling the parts are shown in our illustration.

The telephone receiver commonly employed in connection with radio reception is incorrectly designed for use in radio work. The telephone receiver was originally constructed to reproduce the voice with its many overtones, hence the diaphragm is highly damped and has a comparatively flat resonance curve. The result of such a construction is that X (static) and other extraneous impulses excite the diaphragm, as well as the signals themselves. The signal impulses from a radio receiving set closely approximate a monotone; that is, the signal tone is comparatively free from overtones or upper partials. Quality or timbre therefore need not be considered in arranging to translate these electrical impulses into audible sounds. It therefore becomes possible to design a translating device for use in radio work which will be highly selective with respect to signal tones and which will respond but feebly to impulses out of resonance with the vibrating member.

Proceeding along the lines just indicated, the device referred to in the second paragraph above has been developed. By the use of a comparatively stiff reed, R, of the proper coefficient of elasticity, and fastened at one end only, the so-called "musical effect" of the X's, commonly present in other similar devices, is very much reduced. The proper mechanical relation of the resonant chamber, C, to the reed is important. Energy from the resonant chamber is conveyed to the ears of the operator by means of short rubber tubes similar to those of a stethoscope. The device is exceedingly simple and robust. It is preferable to enclose the resonant chamber and the electro-

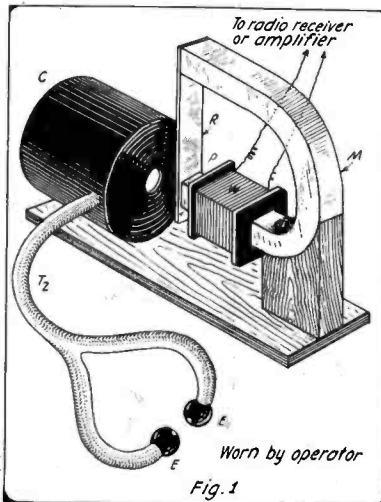

The Radio Translator Spells the Doom of the Telephone Receiver. The New Instrument Is Highly Efficient and Greatly Eliminates Static.

poses, but repeated tests show that the ratio of the X's to signals is materially improved by the use of this apparatus, and high when using the radio translator, in connection with two steps amplification, for comfortable reading. The use of the new device makes it possible to reduce the ratio in practically all cases at least to unity.

Aside, however, from the possible utility of this device in connection with the reduction of the effects of vagrant extraneous disturbances, the apparatus should prove to be of considerable utility in preventing interference from nearby high power continuous wave or spark stations. Its performance in this respect has been very satisfactory. Owing to the fact that the device consists essentially of a double filter, it has been found by actual tests that wave lengths differing by at least 1 per cent. can be completely shut out. It has also been found that this receiver when used for the reception of spark signals smoothes out the spark tone into a clear musical note.

Owing to the fact that the final design of the radio translator was not completed until about November 1, it was not possible to give the device a trial at the several receiving stations, but practical tests made at the Field Laboratory extending over a period of a number of weeks have shown that the invention of this apparatus marks a distinct advance in the means designed to overcome the interference in radio communication. Steps are being taken by the Chief Signal Officer to secure legal protection for the use of the radio translator by the Government.

### Radio Audiometer.

Another piece of apparatus developed at the Field Laboratory, which, though not an anti-X device, is so closely related to this and similar future investigations that it will be described here.

All who have attempted to deal with the measurement of radio signal strength appreciate the desirability of an improved method of making such measurements. An effort has accordingly been made to devise some device or combination of apparatus which might give results that are more

nearly quantitative than those obtainable by the shunted telephone method.

Reference has just been made to a piece of apparatus designed by the Transatlantic Branch to be utilized for the purpose of eliminating extraneous disturbances of various types. Using the electromagnetic system of the radio translator basis, a device was designed which gives promise of being a satisfactory quantitative method of measuring the intensity of radio signals and X intensity.

The drawing listed as Exhibit O shows the construction of the device. The electromagnetic system W actually used was that taken from a P-11 W E telephone receiver. The steel reed R was a portion of an artist's spatula, and should, in practice, be just stiff enough to prevent it being drawn to the pole pieces of the electromagnets when adjusted a distance from the same giving maximum sensitiveness. The length of the reed used depends upon the pitch of the beat tone desired.

If a tiny mirror, C, of the order of a square millimetre in area, be fastened to the free end of the metal reed, R, by means of an exceedingly light and short piece of very flexible material, D, such as celluloid or colodion, and the reed is caused to vibrate the mirror will tend to rotate about the axis located in the thin strip to which the mirror is fastened.<sup>2</sup> By making the strip which supports the mirror very short a beam of light reflected from the mirror to a scale 70 centimetres away will be moved through a distance equal to 2500 times the amplitude of the metal reed itself. Referring to the drawing, L is a suitable source of light, A and B lenses arranged to give a well-defined image of the source L at the conjugate focal point L', this image being received on a suitable scale or sensitive photographic paper. Signals having audibility of 15 will give a deflection of 2 millimetres on the scale. A deflection of this magnitude is ample for photographic recording purposes and may readily be increased by amplifying the signals or using a greater scale distance. For quantitative measurements the deflection may be read directly on the scale or by means of a sec-

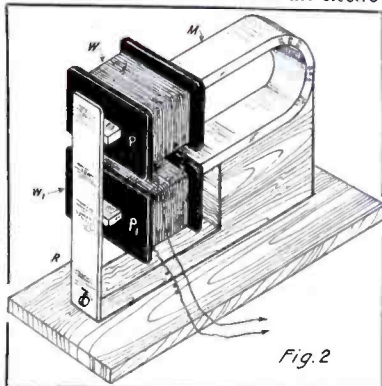

A Modification of the Radio Translator. Here the Reed Is Influenced By Two Electro-Magnets.

magnetic parts in such a manner as to prevent extraneous noises and air-currents from acting upon the resonant chamber. The efficiency of this device, which might be called a radio translator, is not as high as the best receivers used for radio pur-

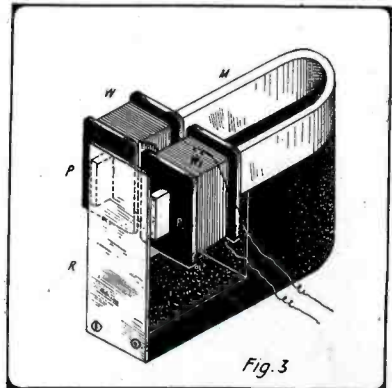

Still Another Modification. Any Amateur Can Construct This New Device. In Time It Will Supplant Head-Phones.

ond optical system. The essential parts of the apparatus are exceedingly simple and the device is very sensitive, having a higher sensibility and being decidedly more rugged than the similar apparatus made by the

(Continued on page 46)



# Modern Amateur Radio Apparatus

By A. H. GREBE

Expert Radio Constructor

**T**HE closing of amateur radio stations two years ago was no doubt regarded as a great hardship by most of the radio enthusiasts at the time. Yet, now that we can look back on what has taken place, it was

.....  
 This Is the Kind of Apparatus All You Radiobugs Have Always Wished for.  
 .....

for the good of the radio art. The immediate demand for trained operators and constructors provided a great opportunity for the amateur wireless men to prove their ability while helping out the Government in the great emergency; and the whole-hearted and spontaneous manner in which these men adapted themselves to the new order of things need hardly be repeated here; indeed, the long list of former radio operators who achieved great success in the various branches of the Government departments thoroly demonstrates the part they played and how they played it.

The intensely interesting features of the new types of apparatus used by the radio amateurs in Government service temporarily diverted their thoughts from the amateur wireless art. However, no sooner was the armistice signed when the old-time wireless hobby came back into existence—and came back strong. The intensity of this hobby was soon demonstrated by the tremendous and successful effort to defeat the anti-amateur radio bill which was under consideration some months ago.

With war at an end and with things once more swinging back into their normal course, all attention is now concentrated on the rebuilding of amateur radio stations. Radio communication is one of the arts that has benefited greatly through the war; and amateur radio is benefiting by the return of its followers from more or less protracted service in the Army or Navy. Most of the boys have had experience with the highest type of radio apparatus which were developed during the war,

.....  
 A Cabinet to Hold the Vacuum Tubes Without Any Risk to Their Delicate Lives.  
 .....

when the United States was confronted by the ever-threatening danger of severed cables and the consequent isolation of the United States from the Allies in Europe.

The ablest radio men in the United States combined efforts in developing war-time radio instruments, and it is this wealth of ability and experience that is now finding

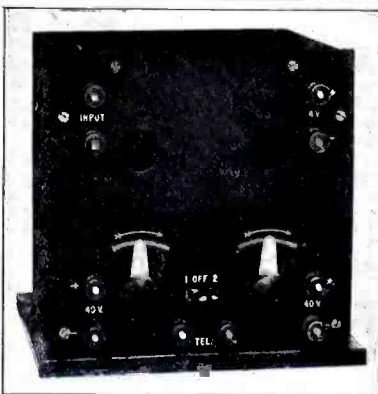
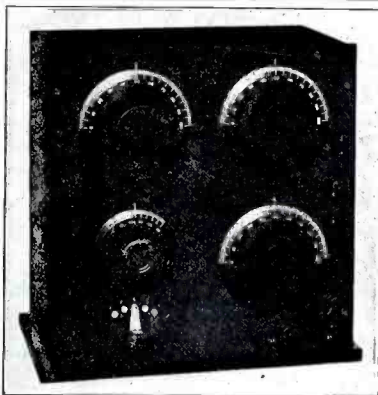
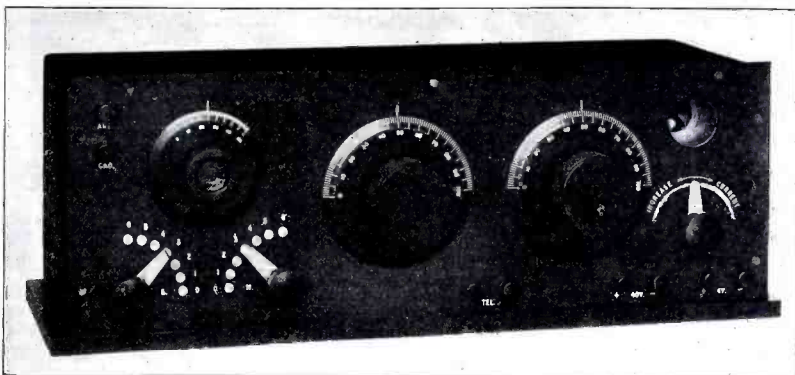

its way into the amateur radio art. Former instruments, which were recently regarded as the last word in wireless by the enthusiastic radio amateur, will have to be remodeled or replaced in accordance with the high standards of the Government stations of today. For it is certain that the

.....  
 Here Is Another Set That Would Look and Work Great on Your Table.  
 .....

radio amateur will not be satisfied to operate antiquated apparatus after being in such close contact with the highest development of the day.

There are many advanced engineering developments which may be immediately applied to the amateur stations. Among these are the vacuum tube transmitter, the radio and audio-frequency amplifier, and the loop system for communication and direction finding.

During the writer's activities in connection with the design and manufacture of apparatus for the Government, several instruments were developed which suggested their applicability to amateur purposes. First of all, there is the receiver shown in figure 1, which was designed for use by the Signal Corps and represents a high-grade type of short wave regenerative receiver, employing continuously variable inductances of the variometer type as tuning elements. Figure 2 shows a direct adaptation of this type of receiver for amateur use. It will be noted that the general mechanical features have been preserved, although the operating control has been modified to meet the particular requirements of the individual.

A compact and efficient two-stage amplifier is shown in figure 3. This type of amplifier has been developed to such a high degree that it may be placed in combination with various types of receivers and operated for an indefinitely long period after the initial adjustment.

.....  
 Apparatus Like This Makes for the Highest Efficiency in Reception of Big Distance Work.  
 .....

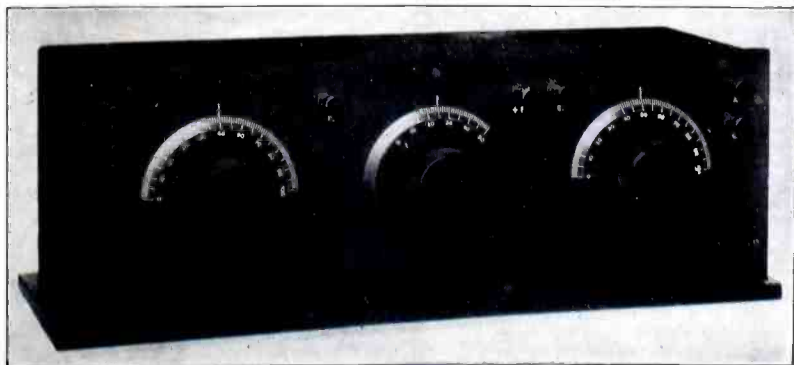

The present stage of vacuum tube transmitter development offers an unlimited field and promises to replace the usual form of spark transmitter altogether. It seems likely that the 500 cycle quenched spark transmitter will be the only survivor of the spark system after a short space of

time, and for this reason amateur experimental work will largely be along the lines indicated by the vacuum tube.

A type of vacuum tube transmitter control and a convenient mounting for a bank of tubes suitable for experimental purposes

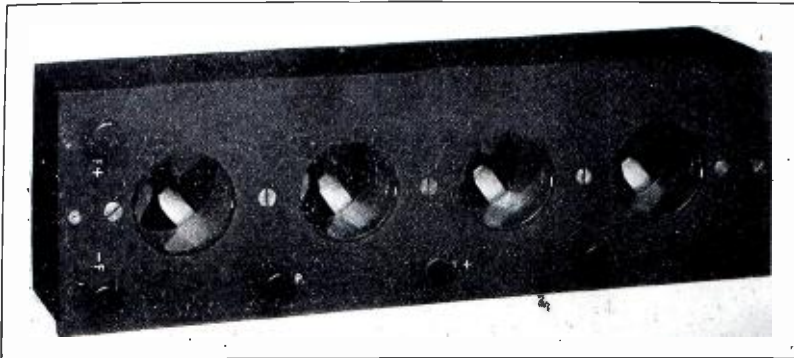

is shown in figures 4 and 5. The controlling elements are arranged in a manner which permits a multiplicity of circuits to be tested by altering the connections leading to the panel.

One of the most interesting fields for research and experimental work is found in the loop systems which have recently been developed to a remarkable extent. Even now it is possible to receive from European and Pacific Coast stations with a loop consisting of some forty or fifty turns of wire spaced one-quarter of an inch apart and suspended on a frame fifteen feet square. For short wave lengths, loops having four or five turns of wire suspended on a five-foot square frame have been used with great success.

The Modern Way of Mounting Audion or Other Vacuum Tubes.

## CLUB DOINGS

### MEETING OF N. E. AMATEUR WIRELESS ASSOCIATION

The first post-bellum meeting of the New England Amateur Wireless Association was held at the Everett High School recently with an attendance of about seventy-five, Mr. G. R. Entwistle presiding.

A very interesting talk was given by Mr. Arthur Batcheller, the New England Radio Inspector.

All amateur sending licenses, both "operator" and "station," have been automatically cancelled, and when stations are licensed again, new call letters will be assigned. This step is necessary to avoid confusion.

In order to secure a first grade amateur license one must be able to both send and receive not less than ten words a minute, and must also pass a technical examination.

An amendment to the radio laws has been proposed whereby second grade licenses will be issued only after the applicant has filed a sworn statement in regard to the details and physical dimensions of his apparatus (i.e. the length in feet of aerial, ground leads, etc., and input of transformer or coil, whether a short wave condenser is used, etc.).

The radio inspectors will visit the principal cities at certain periods notifying holders of these licenses two or three weeks beforehand. These men will be expected to appear and take an examination for a first grade license. Those who do not appear nor advise the inspector of their inability to do so, will be regarded as no longer interested and their licenses will be cancelled.

The law regarding interference will be as strictly enforced among amateur stations as it now is among commercial stations.

All in all the future of amateur radio looks bright indeed. Mr. Batcheller expects to have five thousand licensed amateurs in New England before long.

The fact that out of twenty-five hundred licensed amateurs in New England the majority enlisted, speaks strongly in favor of continuing amateur radio, for these men were enabled to take up their duties without special training, thereby saving the Government a vast amount of time, which was at such a premium in those strenuous days when every second counted, and the whole war depended upon our ability to safeguard our merchant fleet to send supplies and men to France, to smash the Prussian machine and save ourselves from the fate of Belgium.

A committee was appointed to secure permanent quarters for the club.

Until further notice a meeting will be held once every two weeks.

In order to complete the records the club

### ONE CENT A WORD FOR YOU.

*If you have a good true story to tell us about yourself and your station or any unusual radio occurrence or matter connected with radio, we want that story. We will pay one cent a word upon publication for all accepted stories. We desire you to feel that this new magazine is your magazine, and we will do all in our power to make it so. We want to make it as human as it is possible. Will you help?*

would like to hear from former members now in the service.

Address all communications to the secretary, Mr. P. W. Pratt, 100 Harvard Street, Everett, Mass.

### BIRD ISLAND SCIENTIFIC EXPERIMENTAL CLUB.

Some of the boys in our town, as well as myself, were interested in the art of radio and wanted to get together in order to learn something about it. We started a club, each contributing \$1. Thereupon we invested in some simple and understandingly written books on wireless telegraphy and electricity, appointing one member as instructor. His duty was to read from these books and explain the details clearly, thus helping each of us to get a firm knowledge of the subject.

If all radio amateurs would get together, that is, those in each town, and do likewise, it would help each one to learn more about their favorite hobby, and in that way keep them together, thus making friends of one another instead of enemies, always arguing as to "who has the best set."

There is a gentleman who is coming to this town shortly, who has served in the

The next issue of this magazine will be out on July 25th. This will be the monthly publishing date hereafter

U. S. Navy for six years as radio operator, and we have decided to ask him to be our instructor hereafter. This, we believe, will help us all on the road to more knowledge about the radio art.

We have also decided to do all kinds of scientific experimenting, and have therefore called the association "The Bird Island Scientific Experimental Club," which we think applies very well to our organization.

All of the members expect to join the N. A. W. A. or the Radio League of America soon, so as to be thoroughly acquainted with the big league affairs, such as "Radio Relays," et cetera.

We would like to hear from other clubs in order to improve our own laboratory and other affairs.

Address the Bird Island Scientific Experimental Club, Bird Island, Minn., care of Harold Smith, secretary.

### ELECTRICAL FEATS AT H. S. RADIO CLUB SHOW.

At the meeting of the Radio club of the Schenectady, N. Y., high school the program for the electrical show, which will be given soon in the high school was planned. Toward its preparation many difficult electrical feats were performed at the meeting. Marcus Graubart, club lecturer, gave a short demonstrated lecture on static electricity and with the assistance of LeRoy Mix gave a demonstrated lecture of eddy currents.

The program of this show tends to instruct, as well as to amuse those who attend, by the spectacular feats which will be performed by the student members. Exhibitions with static electricity, eddy currents, electromagnetism, spark coils, revolving disks, synchronic motors, high frequency and other electrical apparatus will be given. A short chemical exhibition will also be included.

The show committee consists of Demitri Trone, chairman, Marcus Graubart, LeRoy Mix, Phineas Washer and Edward Munsell.

### ATTENTION RADIO CLUBS

You, Mr. Secretary, make a monthly report of the activity of your club. Lots of new things come up, new resolutions are adopted, new apparatus are installed, and all sorts of important work is transacted in your club. Your fellow-amateurs would like to know what is going on in your club. Won't you tell them about it by giving us a monthly report? It will give your club standing, and will bring you new members. No charge for this. Address Editor, Club Gossip.



# A New High-Note Shunt Radio Buzzer

By LOUIS GERARD PACENT, I. R. E.\*

**T**HE BUZZER, unlike other radio instruments, was used in the early days of the art and still persists today as a very necessary piece of equipment for various radio purposes. Every wavemeter must have a buzzer, for it is the buzzer that generates the oscillations of a prescribed wavelength. Every receiving set requires a buzzer, for it is not complete without a buzzer so connected as to test the sensitiveness of the detector, as well as aid in wavelength adjustments. Buzzers are used for modulating the high-frequency waves in radio telephone transmitting equipment, in order to transmit undamped waves more readily with a persistent wave generator. Every beginner in the art of radio communication learns his Morse or Continental code by means of a high-note buzzer and other associated apparatus. Besides, there are many other cases which might be cited here, bearing on the extensive use of buzzers for radio work, but in view of the limited space at the disposal of the writer the foregoing examples must suffice.

Despite the wide application of the buzzer, its development has been slow, very slow; in fact, until quite recently none of the buzzers obtainable in the open market had functioned properly for the purpose mentioned above, for the following broad reasons:

- 1.—The energy output was too small to be detected by the usual laboratory instruments, especially when used on long wavelengths.
- 2.—The tone emitted was not constant enough to permit of accurate measurements.
- 3.—Exposed connecting wires were easily broken, and this rendered the instrument inoperative.
- 4.—The change of adjustment could not be readily made.
- 5.—No precautions were taken to eliminate the sparking that took place at the break and that caused uneven wear of the contacts, causing the note and the output to change.
- 6.—The usual design does not permit an even pull on the armature.

During the war the need for a good buzzer for radio purposes was felt by the radio departments of the United States Navy and Army, and for this reason the

problem of designing a suitable instrument was undertaken by the writer. The result of this work was the buzzer shown in

similar screw. The magnet coils are connected in series with a total direct current resistance of 3.9 ohms. Shunted across

The New Buzzer Designed by Mr. Pacent. 1. Screw Adjusting Armature Tension. 2. Screw Adjusting Stationary Contact. A. A Novel Feature—a 3 Ohm Shunt Across the Magnet Coils.

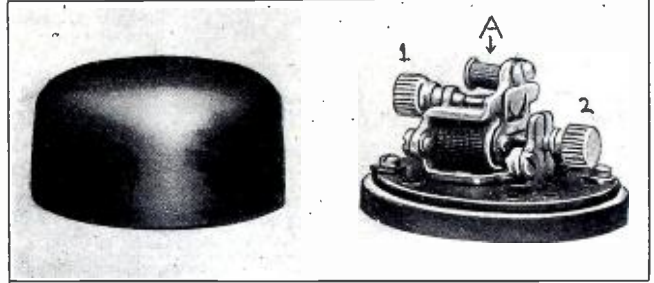
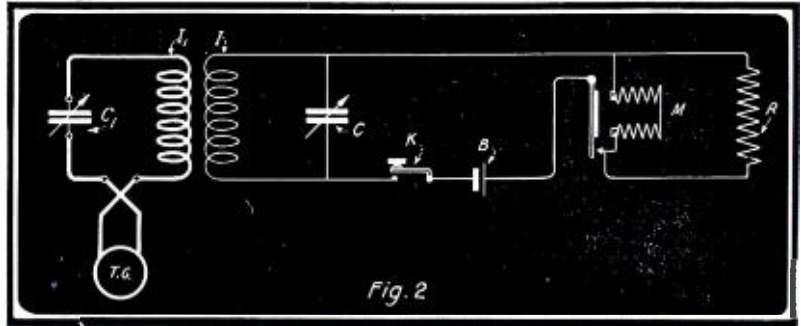

figure 1, which has been formally approved by the Navy and Army for all radio purposes.

The present buzzer maintains a constant note and is especially desirable as an exciter for checking wavemeters, wherein a pure note and ample energy are prime requisites. It consists of practically a closed circuit magnetic field of low reluctance, having a steel armature to which is riv-

eted a strap supporting a movable contact. The contacts are of genuine platinum, which is essential to good results. The parts are mounted on a condensie base to insure constancy in operation. The writer believes that the exact action of the buzzer with and without resistance shunt is as follows:



Showing the Exact Action of the New Buzzer As an Exciter.

eted a strap supporting a movable contact. The armature tension is adjustable by means of a screw with a milled head that is large enough to be easily and permanently adjusted with the fingers. The stationary contact is adjusted by means of a

nated. The contacts are of genuine platinum, which is essential to good results. The parts are mounted on a condensie base to insure constancy in operation.

The writer believes that the exact action of the buzzer with and without resistance shunt is as follows:

Considering the arrangement in figure 2, the inductance  $I$  and the capacity  $C$  are tuned to the radio frequency desired. The buzzer is shunted to the resistance  $R$  connected across the magnets  $M$ .  $K$  represents the key for making and breaking the circuit, and  $B$  is one dry cell for supplying the current. This circuit is coupled to another circuit tuned to the same frequency or wavelength composed of the inductance  $I'$  and the capacity  $C'$ .  $T.G.$  is a thermo-galvanometer for indicating the energy induced in the circuit.

Action of buzzer without shunted resistance as the case with the usual instrument.

When the key is closed, the battery causes a current to flow around the circuit, a magnetic field is produced in the buzzer magnets and in the inductance  $I$ . If we assume, for the moment, that the resistance  $R$  is not present in the circuit, then after a short interval of time the armature of the buzzer is attracted by the magnets and the circuit is broken.

As the inductance of the buzzer is quite large in comparison with  $I'$ , the field of the former will be the main source of energy as the circuit is broken. This causes a spark to appear at the contacts of the (Continued on p. 16)

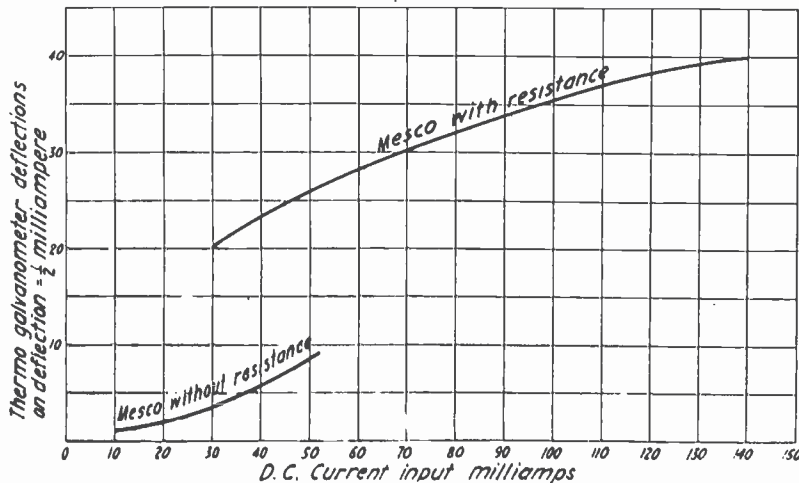

Curve Showing Exceptional Efficiency of the Buzzer.

\* Munneger Wireless Departments, Manhattan Electrical Supply Company.

# U. S. Navy Airplane Sets

By L. F. RYAN

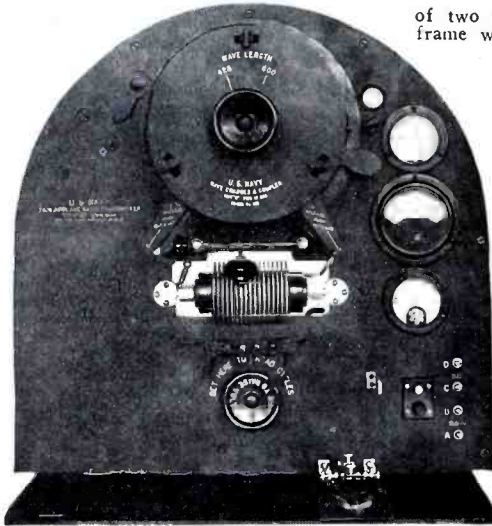

This Transmitter for Aeroplanes is a "Beauty." Its Efficiency is Wonderful Under All Conditions.

One of the great achievements in the past year in radio is the  $\frac{1}{2}$ -kw. Airplane Radio Transmitter used by the United States on their dirigibles and airplanes during the great war. It was designed for the purpose of compactness and durability as well as efficiency.

The panel of the transmitter, Fig. 1, is constructed of a sheet of black bakelite dilecto, reinforced by a bent wood frame extending around the curved section and metal angles on the sides and bottoms. Upon the front of the panel is mounted the wave changing device, the quenched spark gap, control switch and rheostat, also the meters. All wiring connections are made on the back of the panel. The panel complete (as shown in Fig. 1) weighs exactly 44.5 lbs.

The transmitter consists of several parts, the most essential being the propeller-driven generator, Fig. 2, right, and the panel, which is supported within the fuselage. The set is of the 500-cycle quenched spark type with a specially designed wave changer adjustable for two wave lengths—425 and 600 meters.

The generator is air-driven. It consists

of two generators enclosed in the same frame with both armatures on the same shaft—one a direct current generator supplying excitation current, and an alternator which develops the primary power used in the transmitter. The weight of the generator complete is 28.5 lbs.

The alternator is a 500-cycle machine and runs at 5000 R.P.M. It may safely be operated at an output of 500 watts. It is of the rotating armature type and has twelve poles and develops an open circuit voltage of 75-220 volts; it is controlled by a brake-control lever mounted in the fuselage. The brake consists of a steel brake drum integral with the propeller hub. To start generator it is only necessary to release brake. The D. C. generator supplying excitation current for the alternator is shunt-wound and develops an open circuit E.M.F. of 150 volts. The exciting current furnished to the alternator field varies from about 0.2 to 0.7 amperes.

The exciting current flows in addition to field coils thru a switch, the field rheostat and frequency meter. The

meter is a D. C. ammeter of 1 ampere scale capacity, calibrated in

The Receiver is Quite as "Dandy" as the Transmitter.

cycles.

The propeller is of birchwood and is 2 feet in diameter.

It drives the generator at a speed of 5000 R.P.M. when flying at 65 miles an hour. It is connected to the generator shaft and is partly self-regulating, in that the generator

speed is maintained fairly constant over a wide range of airplane speed and in that the speed drops under load only to 4500 R.P.M. The generator is bolted securely to a convenient part of the wings or the frame.

The condenser used is a United States Navy Standard of the mica dielectric type and has a capacity of .004 microfarads and will also operate at 100% overload.

The protective condensers used are of the mica dielectric type, two being connected in series across the transformer primary, the resonance reactance, and the alternator armature. The condensers are .01 microfarad each.

The most important and principal part of the set is the wave changer. It consists of two concentric coils, the primary and secondary. The inner coil is the primary and consists of sixteen turns of edgewise copper strip. The coil is enclosed in a dilecto barrel with top and bottom guides, operating on runners inside the secondary. The cover is secured by three wing knobs, which permits its quick removal.

On the primary rear plate is mounted a wave changer switch consisting of a rotating contact arm operating on ball contacts. By this switch the wave length can be changed from 425 to 600 meters by the hand wheel which is mounted on the cover as shown in Fig. 1. To vary the coupling the primary is slowly pushed in and out of

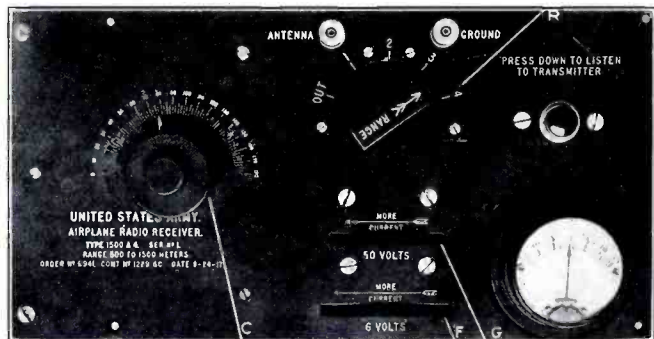

the outer concentric coil—the primary.

The secondary consists of forty turns of copper ribbon wound edgewise on a dilecto frame. The frame is removably attached to the dilecto panel and locked in place by the lever at the extreme left of the coupler unit.

The antenna connection to the oscillation transformer is made with a "Rajah" terminal at the rear end. The ground connection is made thru the adjustable ground clip terminal between the coupler and ammeter. This provides a turn by turn adjustment.

The "Works" of the Receiver. Note the Vacuum Tube in the Lower Left-Hand Corner, Inside the Cabinet. It's Ideal if You Are Not Too Curious to See the Filament Glow.

The key is a modified flame-proof Morse type and is mounted on a bakelite base hinged on the base of the panel so it can be clipped in a vertical position when out of use. The reactance is an open laminated iron core in series with the 500-cycle transformer. The resistance is 0.3 ohms. The field rheostat has 300 steps and a resistance of 200 ohms.

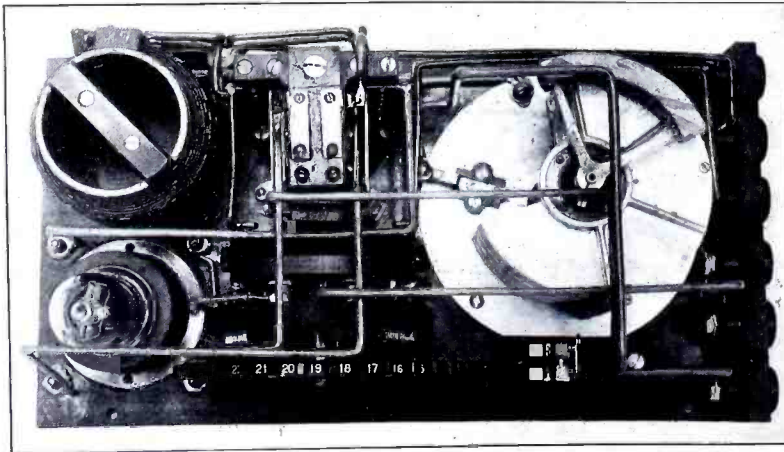



The spark gap is of the quenched type, having sixteen cast aluminum plates, the sparking surfaces being of pure silver. The plates are separated by fish paper gaskets. The gap is mounted on the front of the panel as seen in Fig. 1. It is made airtight by lock nuts on each end. For full power, eight to ten gaps are used.

The transformer is of the closed core type rated at 500 watts, 500 cycles and 110 volts. At 80% power factor it will develop full power.

The service switch (shown in Fig. 1) is used to close and open both exciter and alternator circuits at the panel. The watt meter is of a special design with a scale reading from 0 to 750 watts.

The antenna is wound on the antenna reel as shown in Fig. 2 (upper left corner), the reel being mounted outside the fuselage of the plane. The length of the antenna is 300 feet, the number of turns in use being shown on a scale on the front of the antenna reel.

The receiver used on airplanes is shown in Fig. 3. It is of the panel type. The panel is a piece of bakelite dielecto and mounted in a leather carrying case. On the front of the panel are mounted the wave changing switch, the ammeter and condenser knobs.

The receiver is direct coupled, the primary and secondary being mounted on a micaite tube; the coils are wound with Litzendraht wire, in banks. One of the features of this set are the rheostats; they consist of an ordinary rheostat which is securely fastened to a rotating shaft, which in turn is fastened to a large and small wheel. These wheels are so calibrated that the exact amount of current being used is shown in the opening on the front of the panel (see *F*, Fig. 3). This rheostat is the "A" battery. The smaller wheel *G*, which is shown directly above this, is the "B" battery. These rheostats are used to control the voltages of the audion tube.

The knob *R* is the wave changing switch. The set is designed to work on four waves—300, 452, 600, 952 respectively. The rotary condenser *C* is made up of aluminum

mitting, the only difference being when receiving on various waves the antenna must be reeled up or let out, according to the wave length used. The receiving distance

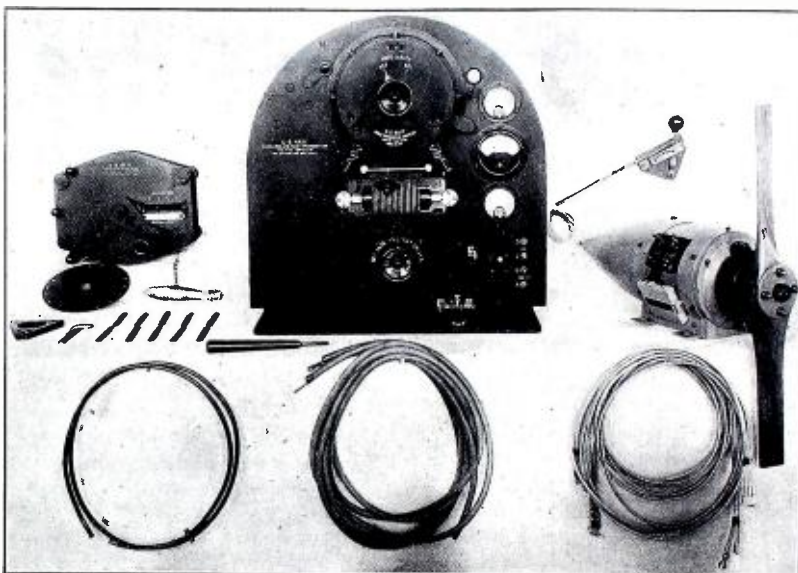

The Air-Driven Generator at the Right is the Contrivance That Supplies the 500 Cycle "Juice" for the Transmitter. The Airplane Therefore Literally Uses Wind to Send With Great Stuff!

plates and has a 180 degree swing. All connections in this set are made of copper tubing. The connections to the antenna, ground, and phones are made at the side of the leather carrying case, which can be distinctly seen in Fig. 4.

The aerial used is the same as for trans-

at 1000 feet actual test was 50 miles in daylight. These sets are built to stand an enormous amount of wear and abuse. They are the most efficient sets ever produced for the reception of radio signals from an airplane.

(Photos courtesy Emil J. Simon)

## Stranded Wire (Litzendraht) in Radio Instruments

THE use of conductors consisting of a number of fine wires to reduce the skin effect is common. The resistance ratio for a stranded conductor is, however, always considerably larger than the value for a single one of the strands. Only when the strands are at impracticably large distances from one another is this condition even approximately realized.

Formulas have been proposed for calculating the resistance ratio of stranded conductors, but although they enable qualitatively correct conclusions to be drawn as to the effect of changing the frequency and some of the other variables, they do not give numerical values which agree at all closely with experiment. The cause for this lies, probably, to a large extent in the importance of small changes in the arrangement of the strands. The following general statements will serve as a rough guide as to what may be expected for the order of magnitude of the resistance ratio as an aid in design, but when a precise knowledge of the resistance ratio is required in any given case it should be measured.

**Bare Strands in Contact.**—The resistance ratio of  $n$  strands of bare wire placed parallel and making contact with one another is found by experiment to be the same as for a round solid wire which has the same area of cross section as the sum of the cross-sectional areas of the strands; that is,  $n$  times the cross section of a single strand. This will be essentially the case in conductors that are in contact and are poorly insulated, except that at high frequencies the additional loss of energy due to heating of the imperfect contacts by the

passage of the current from one strand to another may raise the resistance still higher.

**Insulated Strands.**—As the distance between the strands is increased, the resistance ratio falls, rapidly at first, and then more slowly toward the limit which holds for a single isolated strand. A very moderate thickness of insulation between the strands will quite materially reduce the resistance ratio, provided conduction in the dielectric is negligible.

Spiraling or twisting the strands has the effect of increasing the resistance ratio slightly, the distance between the strands being unchanged.

Transposition of the strands so that each takes up successively all possible positions in the cross section—as for example, by thorough braiding—reduces the resistance ratio but not as low as the value for a single strand.

Twisting together conductors, each of which is made up of a number of strands twisted together, the resulting composite conductors being twisted together with other similar composite conductors, etc., is a common method for transposing the strands in the cross section. Such conductors do not have a resistance ratio very much different from a simple bundle of well-insulated strands.

The most efficient method of transposition is to combine the strands in a hollow tube of basket weave. Such a conductor is naturally more costly than other forms of stranded conductor.

**Effect of Number of Strands.**—Experiments show that the absolute rise of the resistance in ohms depends on the diameter

of a single strand, but is independent of the number of strands. Since, however, the direct-current resistance of the conductor is smaller the greater the number of strands, the resistance ratio is greater the greater the number of strands. Reducing the diameter of the strands reduces the resistance ratio, the number of strands remaining unchanged, but to obtain a given current-carrying capacity, or a small enough total resistance, the total cross section must not be lowered below a certain limit, so that, in general, reducing the diameter of the strands means an increase in the number of strands.

**Coils of Stranded Wire.**—In the case of solenoids wound with stranded conductor, the resistance ratio is always larger than for the straight conductor, and at high frequencies may be two to three times as great. It is appreciably greater for a very short coil than for a long solenoid.

For moderate frequencies the resistance ratio is less than for a similar coil of solid wire of the same cross section as just stated, but for every stranded-conductor coil there is a critical frequency above which the stranded conductor has the larger resistance ratio. This critical frequency lies higher the finer the strands and the smaller their number. For 100 strands of say 0.07 mm. diameter this limit lies above the more usual radio frequencies.

This supposes that losses in the dielectric are not important, which is the case for single-layer coils with strands well insulated. In multiple-layer coils of stranded wire, dielectric losses are not negligible at high frequencies.

# \$100 Radio Prize Contest

The most important Radio Amateur event in years

THE period of reconstruction is upon us. Now that the Government has taken off the ban for receiving radio messages, and that probably at the time when this issue appears in print the ban on sending will be off as well, it behooves us to look into the future.

In the past we grew accustomed to radio instruments which were utterly unscientific, and which were merely the outcome of a whim of the individual constructor. The whole world being under reconstruction, there is no reason why radio itself should not be reconstructed as well along modern lines.

The Publishers always having been in the lead as far as the amateur radio art is concerned, wish to go on record here with the suggestion as well as the recommendation that hereafter amateurs should operate only efficient sets. There is today no excuse for inefficient, crude, home-made apparatus that never can operate at the highest efficiency.

With this point in mind, RADIO AMATEUR NEWS will, for several months to come, conduct a series of prize contests to bring out the best that is possible for radio amateurism in the United States.

The first topic we have chosen will be entitled, "*An Ideal Receiving Set.*"

America's foremost radio experts have graciously volunteered to act as judges of this contest. As every one of the judges will pass upon the manuscripts submitted, there can be little doubt that all contestants will be treated fair and impartial. Furthermore,

we feel certain that this contest will not only bring out the best there is in the American amateur, but that it will lift the art to a new and greatly advanced level, unknown and undreamt of before the war.

Here are the men who will act as the judges of the contest. A distinguished array of the best radio talent in America:

**Dr. Lee de Forest, Inventor of the Audion**

**Dr. Greenleaf W. Pickard, Inventor of the Crystal Detector**

**Dr. Louis Cohen, Ph.D., Radio expert and inventor**

**Fritz Lowenstein, Radio expert**

**Samuel D. Cohen, Amateur Radio expert**

**H. W. Secor, Assoc. I. R. E., Associate Editor, Electrical Experimenter.**

**H. Cernsback, Editor, Electrical Experimenter & Radio Amateur News**

Accordingly, we offer this month:

PRIZES OF \$100 IN GOLD	
First Prize . . .	\$50.00
Second Prize . . .	25.00
Third Prize . . .	15.00
Fourth Prize . . .	10.00

## RULES OF THE PRIZE CONTEST

The receiving set to be described may be of the cabinet form, or it may be of individual instruments assembled on a table or board. The outfit must have

been in operation or must be in operation now.

It is necessary to state what instruments are used, and if certain instruments have been bought, the make must be stated. A complete diagram, neatly executed in ink, is to be furnished. A good photograph (not smaller than 5 x 7") giving at least two views of the set is necessary. A photograph of the builder is desired.

It is necessary that the outfit must have some new feature which has not been described before, and the set must be strictly up-to-date in all respects. The sizes and the kind of wire used in the construction must be given, as well as the dimensions of the principal parts. More than one outfit may be entered by a contestant. The contest is open to every one except manufacturers of wireless apparatus. The manuscript should not be longer than 1,500 words. 1,000 words preferred. A further condition is that in addition not more than 100 words giving the utility of the outfit and its practical purpose are to be stated.

All prizes will be paid upon publication.

The contest closes in New York on August 12th, and the first prize-winning article will appear in the September issue.

Address all manuscripts, photos, etc., to "Editor Radio Prize Contest," care of this publication.

In the August issue we will announce a second radio prize entitled, "*An Ideal Sending Set.*"

THE PUBLISHERS.





# The RADIO LEAGUE of AMERICA

HONORARY MEMBERS  
CAPT. W.H.G. BULLARD, U.S.N. NIKOLA TESLA.  
PROF. REGINALD FESSENDEN. DR. LEE DE FOREST.



Manager, H. Gernsback

Note: Readers of this magazine will welcome the monthly department of the *Radio League of America* which for four years has run in the *Electrical Experimenter*. It will be found only in the RADIO AMATEUR NEWS hereafter.

## The Future of the American Radio Amateur

By H. GERNSBACK

WHEN the writer founded the *Radio League of America* in 1916 he had only one object in view and that was the furtherance and the welfare of the American radio amateur. As is well known, the *Radio League of America* is a scientific body and exacts no dues or fees whatsoever; every amateur, even the most humble, can and should be a member.

The League proved its worth last winter when hostile legislation was proposed, and when for a time it looked as if the radio amateur would be wiped off the map. Mainly due to the fact that the *Radio League of America* had thousands of members, and that the publishers immediately sent letters to the members apprising them of the coming danger, was the threatened bill killed. Had it not been for these thousands of names, it is quite likely that the bill would have passed in a rush, as there was no national body with a sufficiently large amount of amateurs in existence. Radio League members sent protesting letters by the thousands to Washington, and our legislators woke up to find that the radio amateur could not be wiped off the map so easily. The immediate result was that the Act of 1912 is in force today. On April 15th of this year all receiving radio stations opened up, and soon sending will also be restored. All this would not have been possible except for the universal solidarity of the radio amateurs.

When on April 15th the amateur stations were again permitted to open, universal rejoicing of radio amateurs took place all over the country. That the radio amateur in the United States has come to stay and that he is considered seriously in many quarters is best attested by the widespread attention he has aroused in all quarters. Not only are lay individuals interested, who never cared much about radio before, but the press of the country is giving very wide publicity to the radio amateurs. The daily papers are teeming with their work, while the Sunday newspaper magazines are printing stories and pictures of prominent amateurs right along.

There is nothing in the United States that has taken hold of the public imagination as much as amateur radio in all its phases. It is the cleanest and the most serious pastime that could be thought of. It ennobles and instructs, and it does more than anything else we know of to lift the young man from his humdrum existence to lofty heights. The knowledge that the young man gains while an amateur can never be lost. It will be of paramount importance to him when he grows up, and it matters not what his future will be and in what business he engages in. Once an amateur—always an amateur! The one important outstanding fact about amateur radio is that it unquestionably sharpens the senses as few things do. The new art gives patience; it makes our eye and ear keener than they were before; it makes our hands

more subtle, more nimble, and the long spells of waiting between messages make for alertness. No wonder the radio amateur is looked upon with envious eyes by his friends less fortunate who have not embraced the wonderful art.

Of course, it should be always remembered that radio amateurism is still in its infancy. Let us therefore look into the future and let us see what it holds for us.

Eight years ago the writer in the preface of his book, "The Wireless Telephone," predicted that within ten years every farmhouse would be equipped with a wireless telephone that could be put in a box two feet square. In those days the wireless telephone was a seven-day wonder, while the audion as a source of generating waves and sending radiophone messages had as yet not arrived. The writer's statement, therefore, was smiled at by the then wiseacres, who in their superior way thought that the thing could not be done. But during the war we have seen tremendous advances of the radiophone art, and the writer predicts now, that before the end of next year, every amateur will have his radiophone.

It is the writer's opinion that as far as the radio amateur is concerned, the wireless telegraph is on its decline. More and more amateurs are becoming obsessed with the idea to own a radio telephone, as they realize that the radio telegraph system is antiquated and that there is not as much fun and instruction in tapping the key as in actually talking to your friends. While of course we will always have the radio telegraph, and while no doubt for many years the amateurs will wish to punch the key in order to do up-to-date experimenting, such as for instance recording messages on tape, etc., etc., still there can be no doubt at all that the radio telephone is THE thing, and who would not rather listen to the actual voice than to the humdrum *rah da, da, dah?*

The writer predicts that the radio telephone will solve all our Q. R. M. troubles, for as soon as we begin to use it in great numbers it will become an absolute necessity that the amateur must find a means of tuning his instruments so sharply that interference will practically be unknown. The writer thinks it is perfectly possible to tune within 1/10 of 1% of a one meter's wave length.

While already, today it is possible to tune very sharply, the next few years will bring great advances along this line. It will be possible for instance, for one amateur to tune for 175.88 meters wave length, while the fellow next door to him is talking away loudly at 175.89 meters without the two interfering with each other. This may sound like a wild dream at the present time, but nevertheless it is coming about, and we think soon at that.

We believe that in time to come, the radio inspectors will have little work to do, as the amateurs will solve their problem of interference themselves, and it will be an unheard of occurrence in the near future

to have any one amateur over-step the boundary of his 200 meters.

The researches of Mr. Rogers have opened an entirely new field to the amateur, and while at present it is only possible for the amateur living in the country to use the Rogers antenna, we will in the forthcoming issue describe a new system showing how the Rogers' Underground System can also be made available for the city chap who cannot dig long trenches.

During the next few years, Nikola Tesla's earth wireless will also come into its own in an undreamt of manner today. When Tesla speaks of underground wireless, he does not mean transmission by Hertzian waves as we know it today. Nikola Tesla in his experiments years ago demonstrated that it is possible to send energy, using nothing but the earth, not by using Hertzian waves, but by galvanic (high frequency) currents. Just as our trolley car systems today use the earth as a return wire, sending thousands and thousands of horsepower thru the earth, so will we in future use the earth as a source of transmitting energy, with the difference that there will not be an overhead wire. All the transmission will be thru the earth. Will it not be a wonderful day for the amateurs when it will be possible for one to operate an electric motor in a friend's house without any intervening wires? And this day is not far off.

But in order to bring all these things about, it is absolutely necessary that the amateur be allowed his freedom of the ether, without it he can accomplish nothing. Always remember that the *Radio League of America* is the amateurs' "watch-dog" and that it looks out for his interests. It costs nothing to be a member, but it is an honor to be one.

At the present time, the sky is clear, just the same as it was last December. Clouds may roll up any time at Washington, and the thousands of amateurs cannot afford to let some busy-body, for reasons only known to himself, blue-pencil us amateurs into oblivion.

The *Radio League of America* is the clearing house for all radio amateurism in the United States, and today has more members than any other league, i. e., 21,609, but it needs more of them. It wishes to have every amateur as an enrolled member. The membership of the *Radio League of America*, established in 1915, is gratuitous. There are no dues or fees to be paid. All the League wants is the name of every amateur and his address, so that first of all, if a national emergency arises, the Government can rely on the amateurs for quick communication. Also in case adverse legislation should be attempted, the League wishes to notify every member immediately, as it did last December.

Send at once for 8-page free booklet describing purpose of the League.



# Sustained Wave Radio Telephone and Telegraph Transmitter

By SAMUEL D. COHEN

**T**HE time has arrived when the amateur's heart's desire is about to be fulfilled. He now has at his command the means and apparatus for obtaining a satisfactory radio telephone for moderate range transmitting. The success of this new art is due to the rapid development of the vacuum tube which is used as a radio frequency generator, also newly developed arcs suitable for sustained wave generation and means for operating the same on short wavelengths. In addition

to these developments, the improvement of modulating means for this sustained wave generator, has made its application comparatively simple and readily applicable to amateur radio telephone and telegraph transmitters.

It is the purpose of this article to introduce to the amateur field a suitable and satisfactory sustained wave telephone and telegraph transmitter, which can be constructed by the average amateur, and which will be suitable for transmitting both radio

telegraphic and telephonic messages for a distance of 25 to 35 miles. The type of instrument herewith described is a modification and improvement of the radio telephone transmitter which the writer built some time ago, the apparatus having given highly satisfactory results. With the aid of the description and data herewith, the reader should have no trouble in obtaining the desired results. The apparatus is designed to operate on wavelengths of 150 to 210 meters with a normal size amateur antenna.

The generation of high frequency or sustained wave oscillations for this set comprises three vacuum tubes of standard make, such as the Moorehead type, all of which are connected in parallel. The writer has found by test that from a single receiving vacuum tube with high vacuum and high plate potential, it is possible to obtain about 5 to 8 watts of high frequency energy on wavelengths ranging from 150 to 600 meters, with a normal filament current. It is then possible by the use of three vacuum tubes, as used in this proposed set, that about 20 watts of high frequency energy can be obtained, when operating the plate potential of the three tubes on 900 to 1,000 volts and a filament current of  $\frac{3}{4}$  of an ampere, which is the normal current necessary to operate the tungsten filament vacuum tubes, such as the Moorehead type.

In Fig. 1 the front view of the transmitter is shown, while Fig. 2 illustrates the inside of the transmitter with the side-covering of the box removed. The panel of this transmitter is made of  $\frac{3}{4}$  inch thick "Bakelite-Dilecto" 14 x 18 inches. The three vacuum tubes are mounted on the extreme upper part of the panel as shown, and three large holes are bored,  $2\frac{1}{2}$  inches in diameter, in the panel, so that the vacuum tubes may be secured in their respective receptacles, which are held within the case, as can readily be seen from Fig. 2. The holders for these tubes are of standard construction, and can be obtained from any reputable radio concern. It is therefore not advisable for the amateur to make them himself. The three sockets, 1, are mounted on a piece of Bakelite, 2, 1 inch wide and  $\frac{3}{4}$  inch thick by 13 inches long. This separating piece is held by means of brass brackets, 3, indicated in Fig. 2. The brackets are then secured to the panel. The filament current control is obtained by the use of a rheostat, 4, of 10 ohms resistance. The rheostat proper is mounted on the back of the panel, as indicated in Fig. 2, and is controlled by means of a handle placed on the fore surface of the panel, as indicated in Fig. 1. The dial is secured to the filament rheostat handle, illustrated in Fig. 1. This dial should be made preferably of Bakelite, 3 inches in diameter,  $\frac{3}{16}$  inch thick and a  $\frac{3}{4}$  inch bevel made on its edge, engraved if possible, to indicate the position of the controlling arm on the rheostat. It is very desirable and essential to note the exact

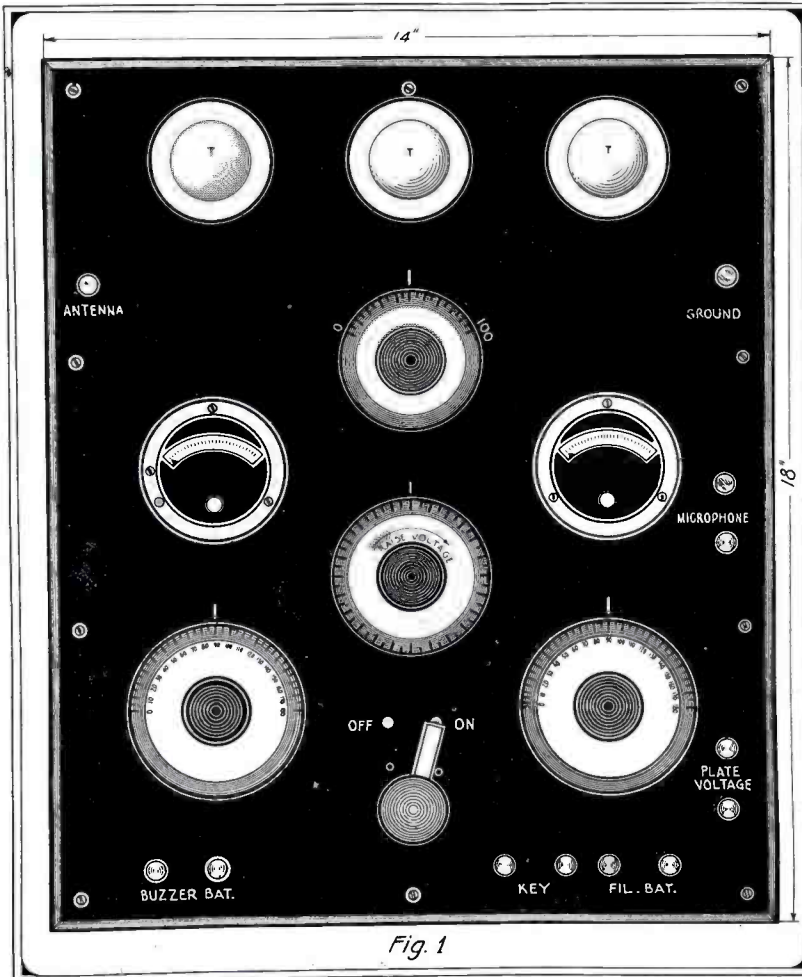

Fig. 1

An Exceptionally Efficient Undamped Wave Transmitter, the Cost of which Lies Within Reasonable Limits. The Ideal Transmitter for Amateur Radio Telephone and Telegraph Work.



filament current flowing thru the filaments of the three vacuum tubes, and therefore a low reading direct current ammeter is placed in the filament circuit. The ammeter should be of the standard 3 inch type, having a scale from 0 to 3 amperes, which should be preferably of the moving coil type, and is placed at the center left hand side of the panel, as indicated in Fig. 1.

The filament control switch can be of any construction, and is mounted at the center extreme lower part of the panel. Two studs are used, for the on and off positions, as illustrated.

The high frequency division of this set comprises a primary inductance coil, as shown in Fig. 3, and consists of a Bakelite tube  $4\frac{1}{8}$  inches outside diameter, 4 inches inside diameter and is  $4\frac{1}{4}$  inches long. The tube is wound with 80 turns of No. 20 double cotton covered magnet wire. A tap is taken off at the 41st turn. The winding begins  $\frac{5}{8}$  inch from the top as indicated.

The coupling or secondary coil, shown in Fig. 4, is turned out from hard wood, preferably mahogany, as per dimensions given. Wind on each section of this form fully, using No. 20 double cotton covered wire. The leads of each section are led thru the two small holes which are drilled with a No. 30 drill as indicated, and the leads soldered underneath. Care should be taken that the two leads which are to be soldered are the end of one, and the beginning of the winding of the other, also that both windings are wound in the same direction. The other two leads are soldered to the two  $\frac{1}{4}$  inch brass rods, which protrude thru the  $\frac{1}{4}$  inch hole and serve both as supporters of this coil, and connections to the winding. The coupling coil is held in place in the primary coil, as indicated in Fig. 3. The primary and coupling coils are mounted on the upper center of the panel, as is clearly shown in Fig. 2. The turning of the coupling coil is accomplished by means of the coupling coil rod passing thru the panel and on which a knob is attached. A Bakelite dial is also secured to this rod and engraved from 0 to 90 degrees. This dial is clearly shown below the center vacuum tube. A variable condenser of the standard 43-plate type, which has a maximum capacity of 0.00095 microfarads, is shunted across the primary coil, and this is mounted on the lower right-hand side of the panel, a suitable handle and dial being secured to the rotating member shaft. The dial is engraved from 0 to 180 degrees. An additional condenser of the same capacity is used in the ground side of the transmitter,

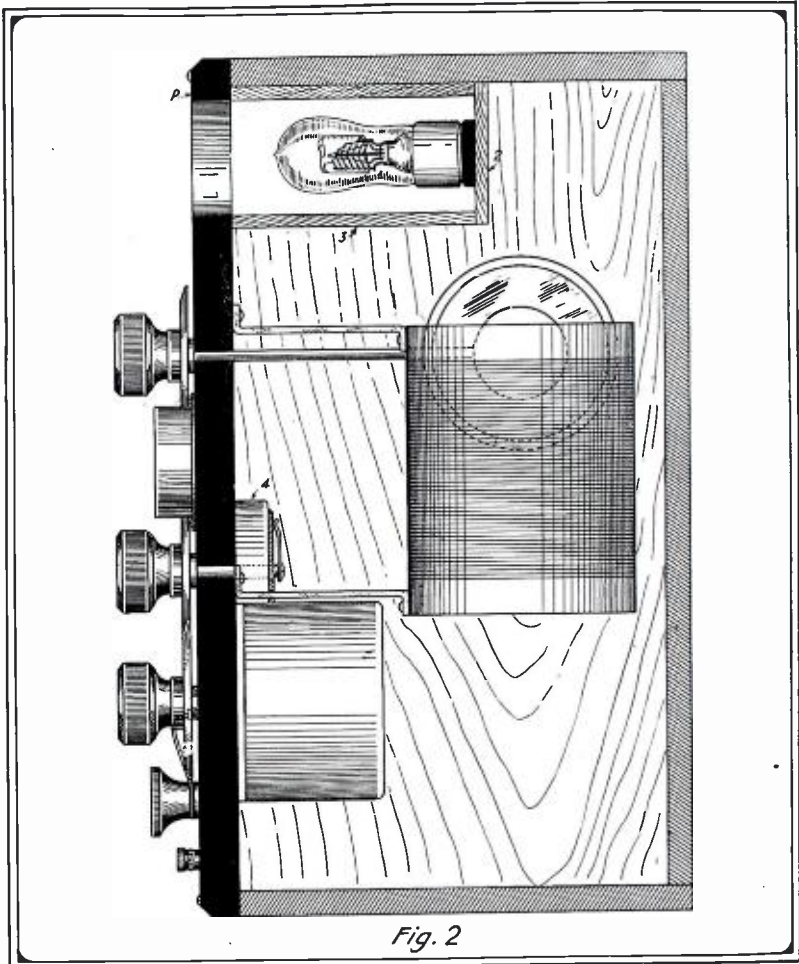

Side View of the Undamped Wave Transmitter with Side of Cabinet Removed to Show Mountings.

so as to enable to operate at low wavelengths. This is mounted in the same line but at the left-hand side of the panel, and equipt with the same type dial indicator.

A radio frequency meter is utilized in the ground side, and its range is from 0 to 1 ampere, being of the standard 3 inch diameter type. The meter is mounted in direct line with the vacuum tube filament ammeter, but on the right-hand side of the panel. The binding posts for the filament battery, plate battery, microphone, ground, antenna, key and buzzer batteries are all mounted on the panel in the order indicated in Fig. 1.

The wiring diagram of the transmitter is indicated in Fig. 5. You will note that the central tap of the primary coil is connected to one side of the filament, while the whole coil in itself is shunted with a variable condenser, used to obtain the desired oscillations in that particular circuit. The coupling coil is connected to the antenna thru the variable capacity microphone and the radio frequency ammeter,  $A_1$  to the ground, G.

The high potential for the plates of the vacuum tubes is obtained from a high voltage generator, G. This generator can be obtained for a moderate sum from several reliable concerns. The price ranges from \$50 to \$150 for a 1,500 volt direct current machine. In series with the generator, an inductance,  $L_2$ , of the iron core type is connected. This consists of an iron core 1 inch in diameter, 12 inches long, wound with 80 turns of No. 12 double cotton covered wire. Both the generator and the inductance,  $L_2$ , are shunted with a 2 micro-

farad condenser. The purpose of the inductance  $L_2$  is to eliminate as much as possible the commutator "ripple" of the generator, thereby producing a more constant potential applied to the plates; as it was found that the ripple of the generator causes undesirable sounds at the distant receiving station. The grids of the vacuum tubes are linked to the positive side of the filament by means of a high resistance leak of 500,000 ohms. This is used to prevent

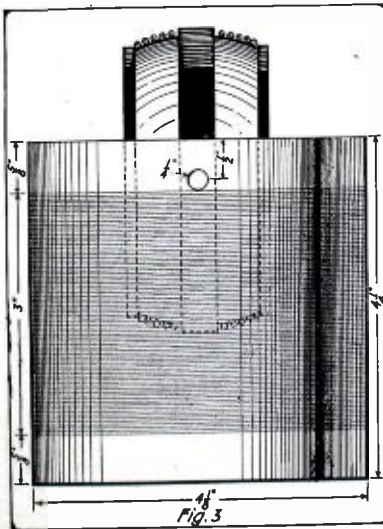

Details of the Variometer.

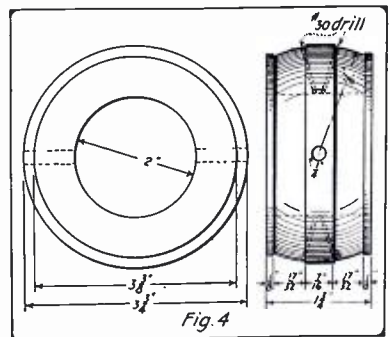

Detail of Variometer Secondary.

the grids from becoming too negative with respect to the filament, which prevents the tubes from oscillating.

It is of course expected by the majority of amateurs that considerable difficulty will

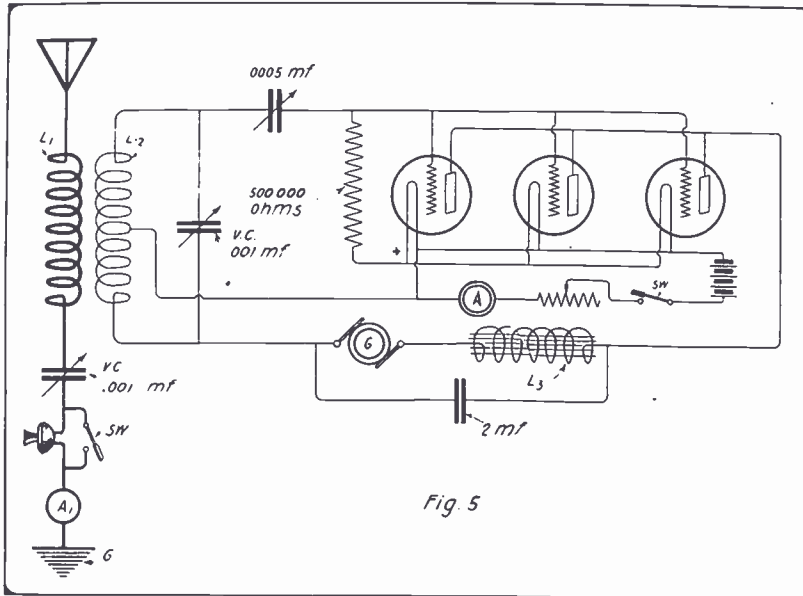
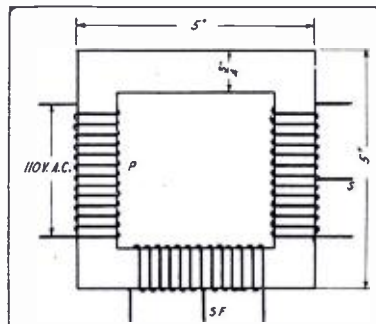

Diagram of Connections for the Undamped Wave Transmitter.

be encountered in purchasing the high voltage machine, due perhaps to cost or other reasons, and the writer who has been working with the same handicap as most of the amateurs, found a suitable means of obtaining the high voltage for application to the plates of the oscillating tubes, i.e., by rectifying the alternating current which the majority of amateurs have installed in their homes, and to step up the 110 volt supply to high enough potential suitable for the work. For these amateurs, the diagram in Fig. 6 shows the method utilized by the writer in securing the high voltage direct current. This is accomplished by boosting the impressed alternating current voltage, which is in the order of 110 volts in most cases, to the voltage required by the plate in the tube, by means of a special transformer, and rectifying the high voltage alternating current into a high voltage direct current by means of two vacuum tubes of the same construction as utilized in the oscillator, except that the grid of each tube is not used—in other words, making the tubes act as pure rectifiers of alternating current by means of the uni-directional principle, accompanied by the hot-filament, cold-plate phenomena. It will be noted in Fig. 6 at the right that the transformer has three windings. One of these is used to light the filaments of both tubes, as indicated. The exact construction of the transformer used for this work is shown in Fig. 7. The core consists of No. 27 gage laminated steel sheetings, cut to make a core 5 x 5 inches and 3/4 inch high. Each lamination is 3/4 inch wide. Three of the legs of the core should be covered with six layers of empire cloth and well shellacked. The primary into which the impressed 110 volt current is applied consists of 50 turns of No. 14 double cotton covered wire. On the other leg the filament secondary should be wound and should consist of 10 turns of No. 16 double cotton covered magnet wire. An additional tap is taken off the fifth turn. The secondary, or the high tension winding, consists of 500 turns of No. 28 double cotton covered magnet wire, and each layer is insulated with two layers of empire cloth. An additional tap is taken on the 250th turn. It is advisable to have each leg wound separately and then completely assembled and properly secured by means of clamping bolts. Fig. 8 illustrates a cabinet arrangement of the high voltage vacuum tube rectifier, which will be ex-

tremely valuable both for giving high voltage uni-directional currents, for vacuum tube work or any place where high potential uni-directional currents are desired. The



This Shows How the A. C. Transformer to be Used on Audion, is Made.

two switches are shown on the lower panel. One is used for the high tension side, while the other for the filament current. The filament rheostat is mounted directly in the center of the panel as indicated. The vacuum tube holders are held in the same manner as those used in the main trans-

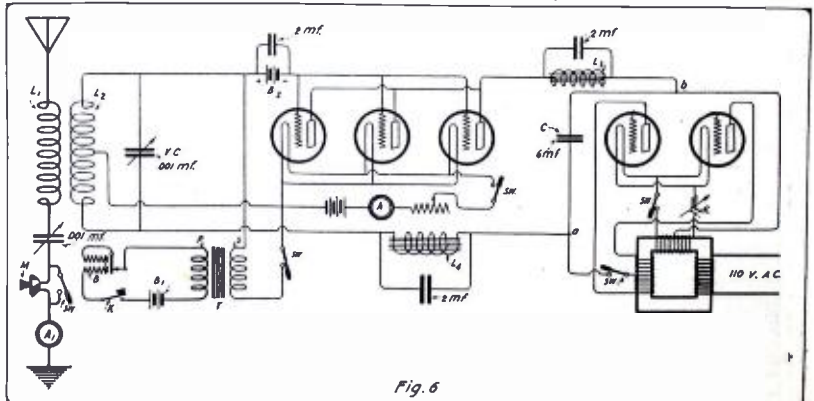

Showing How Alternating Current May Be Employed As High Voltage for the Plate Circuits of the Vacuum Tubes

mitting panel. Four binding posts are used, one pair for the impressed 110 volt alternating current supply, while the other at the left-hand side for the high tension delivery.

Referring back to Fig. 6, it will be noted that the delivery side of the high-tension rectifier A, B, is shunted with a high capacity, C, of the order of 6 microfarads, and this condenser is used to make the uni-pulsating currents of the delivery side of the rectifier as much as possible a continuous current. Therefore, to help this process and straight out the alternating current into a constant current, additional inductances L3 and L4 are used, both of which are shunted with 2 microfarad capacities. The inductances L3 and L4 consist of a laminated iron core 8 inches long, 1 inch in diameter and wound with 4 layers of No. 14 double cotton covered wire. The high-capacity condenser, C, should be constructed of mica, suitable to withstand a maximum potential of 3000 volts, and the condenser section should be properly clamped and insulated and finally immersed in beeswax compound, to eliminate losses as much as possible. In this particular diagram, the biasing grid battery B<sub>e</sub> is used, and the potential is of the order of 10 volts. It is shunted with a 2 microfarad condenser. The negative side of the battery is connected to the grid side of the tubes, as shown. It will be found by the use of the biasing grid battery that it is more readily possible to make the tubes oscillate, especially for power work. The subject of adding a biasing battery to the grid bears entirely upon the characteristics of the tube, and at times it will be found to better advantage to use the grid condenser and grid leak than where the biasing battery is utilized.

In converting the sustained wave transmitter into a telegraph transmitter, it was found by the writer that this can be accomplished with best success by applying a modulated frequency upon the grid and filament of the oscillating tubes, and to do this he has found that by shunting a secondary of a small telephone induction coil T, Fig. 6, across the grid and filament side of the oscillator, and by exciting this telephone secondary thru the telephone transformer primary, by means of a buzzer B, current of said buzzer is interrupted by means of a key, K, thru the battery, B. With this method a modulated wave of the frequency nearly corresponding to the frequency of the buzzer, is impressed upon the grid potential. The grid now affects the plate output current, and hence a modulated wave is superimposed upon the carrying wave. This method of radio telegraphic transmission with sustained waves is found to give very satisfactory results, insofar as transmitting distance is concerned. However, it was found at the receiving station that the signal received was not of the exact



frequency corresponding to the frequency of the buzzer, and at times the signals were very ragged in tone. This is due to the asymmetry of the potential applied on the grid, and to the potential obtained from the buzzer, which is superimposed upon the normal operating voltage on the grid. In order to eliminate this ragged sound reception at the receiving station, the writer suggested to couple a coil consisting of several turns of wire to the antenna system, the coil being excited by means of a buzzer. The current in the buzzer is interrupted by means of a key. Still another method has been utilized by the writer to accomplish the desired results of transmitting radio telegraphic messages with the use of a sustained-wave transmitter, namely, to introduce a coil of 5 turns in the ground side, and short circuiting this coil by means of the key giving rise to a change in frequency between the frequency emitted by the transmitter when the coil is in circuit, and the frequency obtained when the coil is short circuited. This naturally gives rise to a beat frequency, and the method was found to give quite satisfactory results.

It should be remembered whenever operating the sustained wave transmitter as a telegraph transmitter, that the microphone, M, should be short circuited by means of a switch. It is also advisable to short circuit the microphone whenever the transmitter is not being used for speaking purposes, thereby preventing the carbon

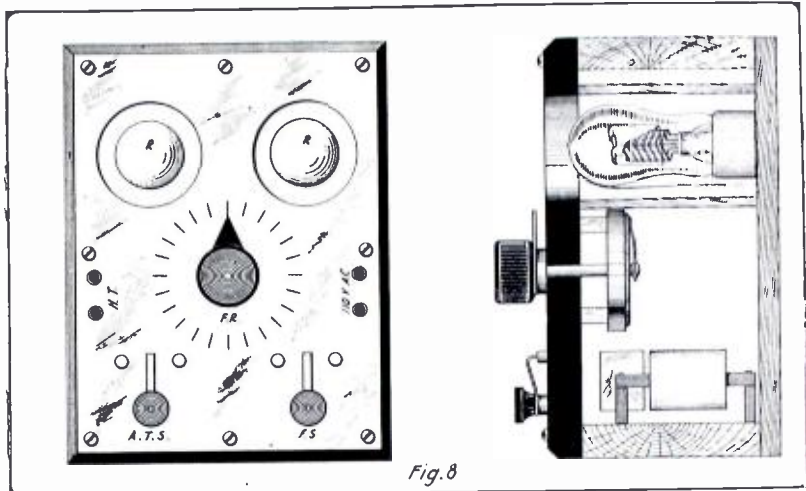

Fig. 8  
A Control Cabinet for the Vacuum Valve Rectifiers for Furnishing High D. C. to the Plate Circuit of the Transmitting Bulbs.

granules in the microphone button from becoming too hot, thus causing packing.

A similar transmitter of the above description has given considerable satisfaction to the writer, who hopes that the readers

will obtain even better results with the one above described. The success of the above apparatus is entirely dependent on the attention to details which the amateur pays in constructing it.

## Audio Frequency and Radio Frequency

Alternating currents are generated at various frequencies, covering a remarkably wide range. Depending on their application, the frequencies in practical use fall into three well defined classes:

(a) Commercial frequencies, which nowadays generally mean 25 or 60 cycles per second.

(b) Audio frequencies, around 500 to 1,000 cycles per second.

(c) Radio frequencies, usually between 100,000 and 1,000,000, but extending in extreme cases down to perhaps 10,000 and up to several million cycles per second.

Commercial frequencies are used for lighting and power. The great machines in the central stations which supply our cities with current operate at these frequencies.

Audio frequencies are those conveniently heard in the telephone. When alternating currents are sent through a telephone, the diaphragm of the latter vibrates. The vibrations are heard as sound. The more rapid the vibrations, the shriller the tone. Vibrations at the rate of 4,000 or 5,000 per second give a shrill whistle, while the lowest notes of a bass voice have somewhat under 100. If a 500-cycle generator supplies cur-

rent to a spark gap and the spark jumps once on the positive and once on the negative half-wave, then at the receiving station, the signal is heard in the telephone as a musical tone of 1,000 vibrations per second.

Radio frequencies occur in the circuits of radio apparatus, for instance in an antenna. They are too rapid to cause a sound, in a telephone, which can be heard by the human ear. They may be generated by dynamoelectric machines of highly specialized construction, but are usually produced by other means.

## How Do You Like "Radio Amateur News"?

When it was first decided to publish this magazine, we contemplated a great many different names. It is no easy matter to pick out a name for a new magazine, and inasmuch as we could not ask our readers before we started the magazine, we take this occasion to put the name to a popular vote. We feel that you, the reader, have just as much to say about it as ourselves.

The question was, should we name your magazine "Radio News" or "Radio Amateur News." Some of our friends thought it wise to use the former name, and we think perhaps the advice is good, as after a year or so, when the magazines becomes big enough to carry all kinds of radio news, the word "amateur" will then be superfluous. Of course, we will always have the amateur at heart the same as now,—you have our pledged word for that. But someone was of the opinion that the amateur does not like to be called an amateur. Now, what is your idea of this? We have prepared a blank below, which we ask you to be good enough to fill out. Place an X in the square showing your preference. Please cut out, paste it on the back of a postal card and mail to us. In the next issue we will tell you whether it is going to be "Radio

Amateur News" or just plain "Radio News." Understand that this is your maga-

zine. You are the boss, and you must decide it for us.

I, A READER of your new magazine, have carefully considered the matter of the title for the magazine, and I have checked below the name which I like best.

- RADIO AMATEUR NEWS.
- RADIO NEWS.

Name .....

Address .....

City .....

It being the policy of this publication not to publish the names of manufacturers of apparatus and devices described in these pages, our "Technical Service Bureau" will be glad to forward the required names upon receipt of a stamped envelop or stamped postal card.

# Some Experimental Radio Suggestions

By THOS. W. BENSON

AS the word goes forth for the re-opening of the thousands of amateur stations throuout the country the experimenter is once more permitted to test the thousand and one ideas that are constantly flitting thru his brain. Within the past two years gigantic strides have been made in the perfection of radio apparatus, but it remains for the amateur to adopt most of these to his special needs and to develop the apparatus necessary for maximum efficiency under the conditions imposed by the Government.

The use of regenerative short-wave receptors has brought the amateur receiving station to a high degree of efficiency, but the transmitting apparatus and aerial remains substantially the same as it was five years ago. There are several points at which these can be improved, and the purpose of these paragraphs is to point out means for improving the weak points in the average radio installation.

The announcement of the Rogers underground aerial at first would seem to solve the difficulties of interference from static and induction. That it eliminates these faults found in the long overhead aerials used for long-distance reception is a proven fact, but to the fellow in the big city the underground aerial is as yet impossible. We can easily string wires over the rooftops, but when it comes to digging under the neighbors' houses then—well, it isn't done.

In pre-war times unbelievable distances were covered with the overhead aerial that demonstrated they were correct in design, but atmospheric disturbances caused much annoyance. It is evident, then, were it possible to eliminate these disturbances, the overhead aerial would be entirely satisfactory and for amateur purposes cheaper and easier to erect.

But why not let us eliminate the static and strays? It can be done despite the fact that it has foiled every attempt in the past. By co-operation it is easily conceivable that a solution will be found even as other problems have been solved by the united efforts of many minds on the same subject. The writer would suggest that the editor of this magazine donate a page or a half page in each issue to the subject of static elimination, publishing therein the condensed results of experiments conducted by the readers. Such a method of tackling the problem is bound to bring results.

It may not be out of place to register our disapproval against the arm-chair experimenters who scoff and ridicule a suggestion because it sounds impractical. Men such as these have held up progress in many fields of endeavor. Try everything, no matter how foolish it may seem. Who, for instance, would have thought that messages could be received on a wire buried in the ground? Apparently it can't be done, but it has. And so with many things; none of us know so much about the subject that we can ridicule another.

Turning now to the transmitting end of the station. The perfection of heavy current electronic relays promises a ready source of sustained wave oscillations, and hence radio-telephony. It will, however, be some time before they become cheap enough to compete with the transformer and gap discharger. Therefore, any effort to improve the conventional type of transmitter will not be entirely useless or wasted effort.

The quenched gap is highly efficient but has not found application with 60-cycle transmitters, due to the mushy note emit-

ted that makes it highly unsuitable when working thru QRM, but efficient when few sets are working. The use of a non-synchronous gap in series with the quenched gap improves the note, but the efficiency falls off rapidly. The combination of the rotary and quenched gaps in one instrument gives an easily readable note, but a form of quenched arc would give very satisfactory results, as it would have few moving parts.

That some form of Chaffee or Lepel Arc has not been adopted by the amateur is still a mystery. Although descriptions of this type of apparatus appeared years ago in various magazines the writer has yet to hear of an amateur set incorporating this design.

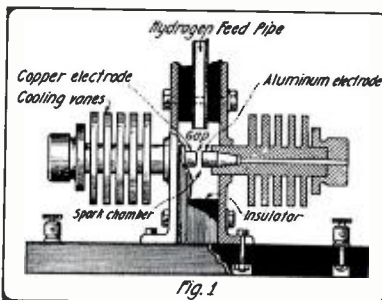

Fig. 1  
A Form of Chaffee Arc that is Easily Constructed and Possesses a High Rate of Efficiency.

A short description of the important features of this type of apparatus will show the advantages in a clever manner. The transformer used has a secondary voltage of 500 to 600 volts. The condenser

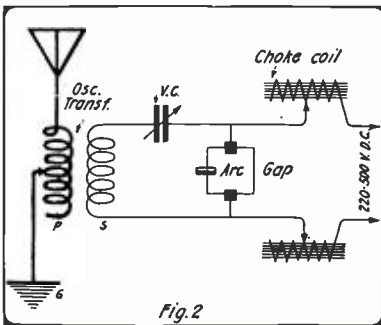

Fig. 2  
Diagram Showing Connections to Be Used in Order to Obtain Best Results with the Arc.

of about .01 Mfd capacity can be made of mica or paraffined paper and tinfoil. The gap consists of two plates of polished copper spaced .001 inch apart by a perforated disk of paper. When in operation the paper burns away and has to be renewed from time to time. The oscillation transformer has a primary of fixed value closely coupled to the secondary, which is variable either by clips or taps.

The operation of the apparatus depends upon the aerial being shocked into oscillation, then being allowed to oscillate freely at its own period. When the key is closed the surge of current starts the aerial circuit oscillating; the return swing then induces currents in the primary circuit, which added to the transformer voltage, is sufficient to break down the gap. The surge of current across the gap gives a second im-

pulse to the aerial circuit which is allowed to oscillate freely due to the arc being quenched instantly. This action continues as long as the key is closed.

It will be seen that the tuning is done entirely by the aerial circuit and resonance between the open and closed circuits is of little importance. The pitch of the note emitted is extremely high and damping is practically eliminated from the emitted wave. The over-all efficiency of such a set is high, in the neighborhood of 80% against a 40 or 50% in the high tension sets. Brushing and corona losses are done away with and leakage reduced to a minimum.

The arcs heretofore described for such work were without exception water cooled, which is troublesome and unhandy. It remains for the amateur to develop an air-cooled arc that can readily be taken apart for renewal of the paper separator.

These are but two of the subjects requiring immediate attention from the serious experimenter, but they are of great importance. The solution of the former will result in longer receiving range, while the latter will give maximum transmitting distance with limited power and wave lengths.

## Answer Of NC-4 By Radio Spread Over World in 3 Minutes

A record in radio was established by the Navy Department on May 14, when a message was sent from Secretary Roosevelt to the NC-4 flying to Newfoundland, a reply received and relayed to Paris, London, Panama, San Diego and ships at sea, all within three minutes.

Naval officials said no such speed had ever before been attained in wireless communications.

At 11.18 Acting Secretary of the Navy Roosevelt sent a message to the NC-4 as follows:

"What is your position? All keenly interested your progress.—ROOSEVELT.

Two minutes later the radio operator took the following reply from Commander Read of the NC-4 on the desk at the Navy Department:

"ROOSEVELT, Washington.—Thank you for good wishes. NC-4 is 20 miles southwest Seal Island, making 85 miles per hour.—READ."

One minute later this message was being relayed to all ships and the big wireless station in Europe and Central America. The operation was completed within three minutes, and six minutes later messages were received from Panama and San Diego confirming receipt of the message from the NC-4.

Radio officials explained that the original message to the NC-4 was sent from Washington to the radio station at Otter Cliffs, Maine, and relayed there to the plane in the air, which replied by the same route. On receipt of the message from the NC-4 in Washington a radio operator flashed it to Annapolis and New Brunswick, both stations being connected on one key, and these in turn flashed it broadcast. The whole operation which began at 11.18 A. M. was concluded at 11.21. Lieutenant T. A. M. Craven directed the feat, which radio officials said would go down as one of the most remarkable instances of radio telegraphy.



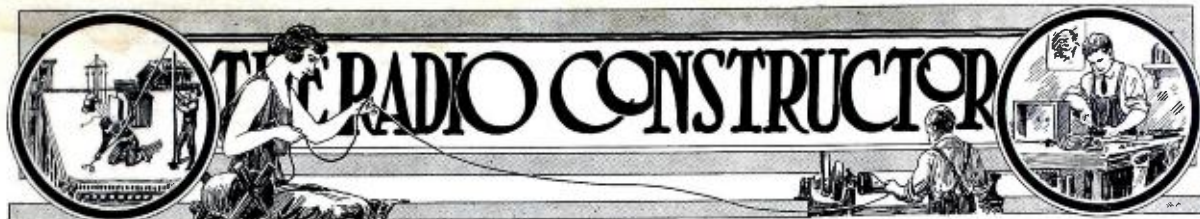

# A Buzzer Practise Outfit DeLuxe

By OSCAR SCHWENDT

THE average code practise set, as most readers realize, comes very far from producing ideal signals for practise work. By ideal signals the writer means signals which are identical to, or approach very nearly, the characteristics of signals received on a regular wireless outfit. The main faults of the practise outfits now in use are lack of flexibility in readily changing strength of signals in the 'phones and annoyance from the buzzer used to produce the signals.

The writer has succeeded in producing a practise outfit in which the ideal signals are almost fully realized and in which faults of other similar sets are overcome. Referring to the accompanying drawings the reader will note that the instrument consists essentially of a small case wherein a buzzer is muffled, a means for controlling the audibility or strength of signals, and necessary binding posts for connections.

The case can readily be constructed by reference to drawings 1 and 2, and should be made of Spanish cedar, obtainable from cigar boxes. The case should be fastened together with glue. Blocks  $\frac{1}{4}$ " square and  $2\frac{1}{4}$ " long should be glued in each corner. The top is fastened with screws and the bottom with small brads. The wood should be well sanded, stained a dark mahogany and given several coats of varnish and

pins by means of which the panel is held in place. The knob *K* should have a brass pointer *J* fastened on its shaft by means of a nut. The pointer should be bent, as shown in drawing 2, to bring it close to

The induction coil should be fastened, as shown in figure 2, by a small brass strap *H* to the partition which extends across the inside of the case and is glued in place.

A good buzzer, such as a "Radiotone," is placed in the rear part of the case. Connections are made as in figure 4. Wires between induction coil, buzzer and binding posts are past thru small holes in the partition. Binding post *T*<sub>3</sub> can be omitted if desired, but the writer recommends that it be used. It is connected to the contact post of the buzzer and can be used in energizing wavemeters, testing crystals and countless other ways.

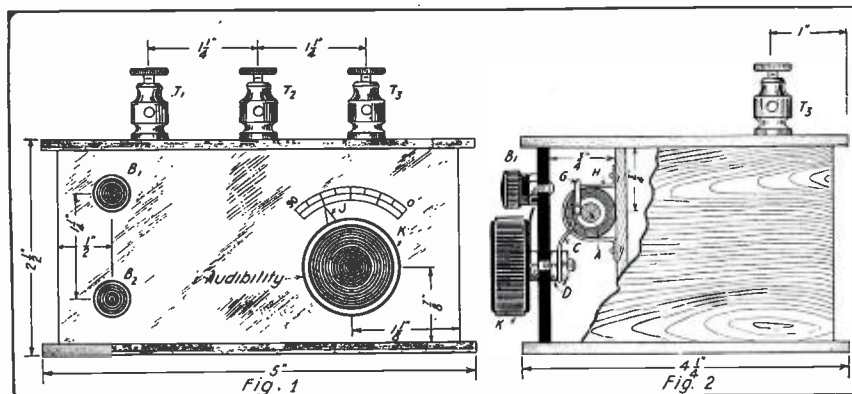

The Kind of Buzzer Outfit That Should Find a Place in Any Amateur's Scheme of Things. Fig. 1 Shows the Front of the Cabinet and Fig. 2 a Side-View, Showing the Workings.

the scale which is scratched in the hard rubber, the scratches being filled with a chalk and water paste, thus making white lines against dark ground.

The audibility control, which is the outstanding feature of this instrument, is next in order of construction. Drawing 3 gives details of the construction, white cut-away of drawing 2 reveals its position in the finished instrument. The small induction coil is wound on a fiber tube about  $\frac{3}{8}$  inch in diameter and  $1\frac{1}{4}$  inches long. The primary consists of two layers of number 26 S.C.C. wire, while the secondary is wound with three or four layers of number 32 S.C.C. wire. Three layers will usually be enough. The rod *A* is made of a piece of a large nail and should be of the size designated in figure 3. A hole is drilled in one end large enough to pass a piece of number 14 copper or aluminum wire, *G*. An arm *C* is made from a piece of brass about  $1\frac{1}{4}$  inches long, other dimensions as shown, and should be bent as indicated in figure 2. It should have a hole drilled near one end the same size as was drilled in rod *A*, while at the other end it should be drilled so that the arm can slip on shaft of knob *K*. It is fastened on the shaft with two nuts, *D* figure 2, which should be soldered after making sure that arm *C* is in the same position as pointer *J*. The wire link *G* is made of number 14 copper or aluminum wire, as stated before, and is past thru the holes in rod *A* and arm *C* and bent over at right angles. The correct amount of upward bend will have to be found by experiment. It should be just enough to allow rod *A* to slide in and out of the fiber core of the induction coil freely and gradually when knob *K* is rotated thru 90 degrees.

Binding posts *B*<sub>1</sub> and *B*<sub>2</sub> are connected in series with an omnigraph and battery, or key and battery. 'Phones are connected across posts *T*<sub>1</sub> and *T*<sub>2</sub> for ordinary signals. By rotating knob *K* the signals are made to correspond to far distant or very close stations, as the operator desires. If very loud signals are desired, connect 'phones across either *T*<sub>1</sub> or *T*<sub>2</sub> or *T*<sub>3</sub>. The audibility control, however, has no effect when the 'phones are connected in this manner and the tone of the signals is somewhat distorted and scratchy, so the first connection is usually preferable.

The tone effect is exactly as if receiving from a commercial station.

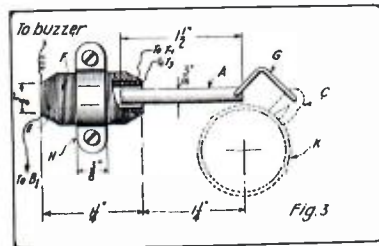

Something New for Buzzers: an Audibility Control. It Consists of a Miniature Induction Coil With Variable Windings.

finally rubbed down with pumice stone and oil.

The panel is made of hard rubber taken from an old storage battery jar. Holes should be drilled for the shaft of knob *K*, the hard rubber composition binding posts *B*<sub>1</sub> and *B*<sub>2</sub> and for the four brass escutcheon

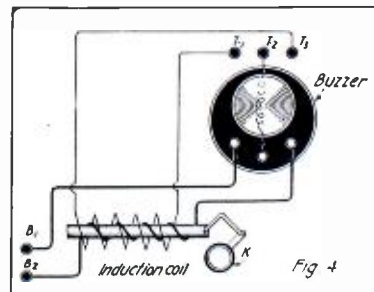

The Results You Get With the Buzzer Described and This Hook-Up Warrant Its Construction.

### MONEY FOR YOUR ARTICLES.

We want good, live radio articles. For these the highest prices will be paid by us. Articles with snappy illustrations are particularly desirable. One cent a word for all accepted articles.

# A Simple Hot-Wire Ammeter

By FRANCIS H. RANSFORD

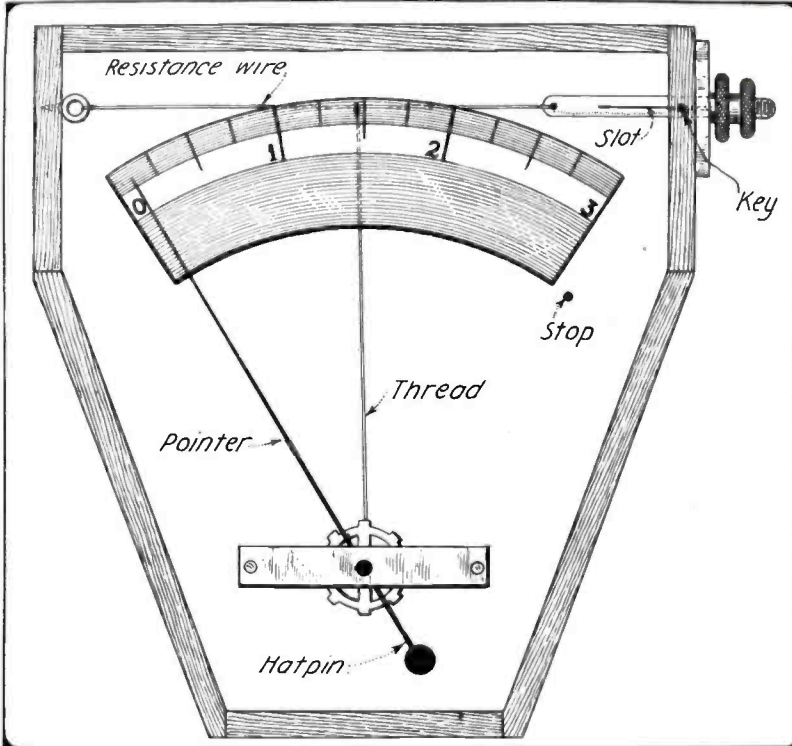

A Hat Pin, an Old Clock, a Bit of This and a Bit of That—Presto! An Honest-to-goodness Hot Wire Ammeter.

How many times have you wanted a hot-wire ammeter, but sighed and tried to forget it when you felt of your wallet, with

its thin old sides? The author experienced this desire many times, and finally constructed the instrument here described. The

material used was an old box (to make the case), balance wheel from an old alarm clock, regulating screw from old-style telegraph sounder, a piece of No. 30 Climax resistance wire, and a hatpin.

The balance-wheel framework is mounted on the base in the position shown in such a way that the spring tends to rotate the wheel toward the right. The hatpin is balanced across a pencil, or other fulcrum, and soldered to the balance-wheel shaft at the center of gravity. The resistance wire may be any small size of German silver wire. The German silver is used because of the rather large heating effect, due to the high resistance, and because it has a high coefficient of expansion. The longer the wire, the more accurate the meter, but eight or ten inches should suffice. It is mounted between the screw-eye and regulating screw, as shown.

A thread, preferably silk, is wrapped once or twice about the balance-wheel shaft, toward the left, so that when the thread is pulled, the wheel will rotate toward the left. The other end of the thread is tied to a small piece of wire, which, in turn, is tied to the middle of the resistance wire. If the thread were tied directly to the resistance wire it might burn off, as the center of the wire is its hottest point.

The zero mark is put on the scale at the left. The resistance-wire slack is taken up by tightening the regulating screw. This deflects the needle toward the left. The needle is placed over the zero mark in this way, and the other points of the scale are obtained by comparison with a standard ammeter, using a battery and rheostat. Before using the meter each time, the needle should be set at zero for accuracy. The meter should be compared frequently with a standard ammeter.

The thinner and longer the resistance wire, the more accurate will be the meter.

(Continued on page 46)

# New Radio Amplifier

By FRED WHITEHOUSE

Now is the time to build your instruments, and every amateur needs an amplifier.

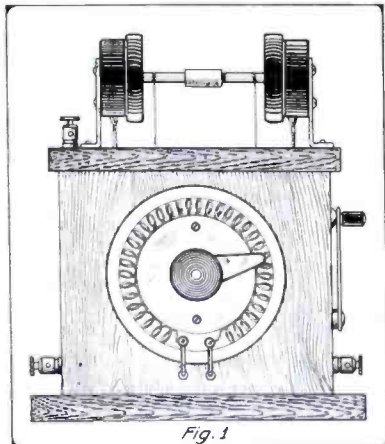

An Amplifier for Radio Reception That Any Clever Amateur Can Build.

In the accompanying drawing, Fig. 1, is shown the amplifier complete. It consists of two 1000 ohm receivers mounted on a base in a vertical position.

The receiver shells are dripped and tapt to admit two small machine screws which fasten them to the brass angles.

Both supports are plain L's with a hole in the bottom part to clamp to the base.

In the center of each of the diaframs is mounted a carbon rod  $\frac{1}{4}$ " in diameter and 2" long. A slot is cut near one end of each with a fine saw. A very thin, flexible wire is wound over this slot and solder poured in to hold it there. By twisting the saw while cutting the slot, the slot will be made wider at the bottom, and the solder will hold the wire in place.

The carbon rods are fastened to the diaframs with shellac. They should be placed in a hot oven to insure the complete evaporation of the alcohol in the shellac, and thus hold the carbon firmly.

The receivers are mounted so their faces will be  $4\frac{1}{2}$ " apart and connected in series to two binding posts at the left of the base.

A paper tube is made to fit not too snugly around the rods. This is put in place as shown in Fig. 2, and filled with polished carbon (microphone) grains. This completes the amplifier.

A good arrangement for controlling the

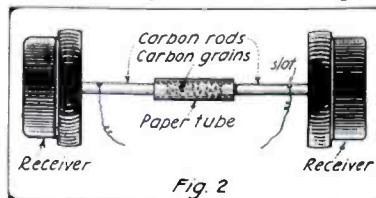

The "Main Thing" in This Amplifier is the "Microphone"—simplicity itself.

apparatus is shown in Fig. 3. A wooden box is constructed large enough to contain three standard dry cells. On one side of the box is mounted a four-point switch (Fig. 1) and a small, finely adjustable

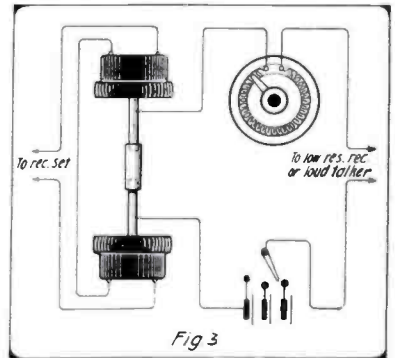

Showing How the Amplifier is Hooked-up for the Highly Desirable Results.

rheostat is mounted on the front.

The batteries and switches are wired as shown in Fig. 3.

An extra 1,000 ohm receiver should be connected in series with the telephones actuating the amplifier, to test the adjustment of the detector. A switch may be arranged to short circuit this receiver when it is not required. When made properly this amplifier will do remarkable work.



**A NOVEL PANEL DETECTOR**  
Herewith is a description of a crystal

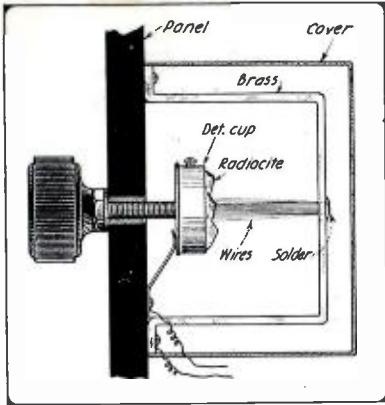

A Panel Detector with Possibilities.

detector for a panel receiving set. The catwhisker, instead of being adjustable is stationary, and is composed of a number of stiff brass wires, bunched. I have received best with the crystal "Radiocite." As this instrument is covered, it is dust proof, and therefore very efficient. I have had better results with this detector than I have with one using a single adjustable catwhisker. Contributed by G. DANKER.

**SENDING 3 MILES WITH BUZZER.**  
By E. T. Jones.

The following description of a new buzzer circuit is quite a departure from the regular buzzer transmitting circuits and not only has the distance possible by a certain type of buzzer been increased, but it is practically possible to play music with such a circuit, providing the buzzer is adjusted to its highest pitch before being installed in the circuit.

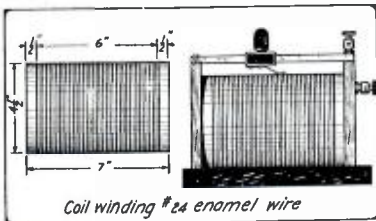

It was discovered that by using an inductance coil of the following dimensions: 4 1/2" in diameter by 6" (of actual winding), triple the response was had at the receiv-

ing end and the frequency of the note was easily changed by varying the inductance shunted across the vibrator. It sounded somewhat similar to the audion's musical notes, and each and every change was easily noticed at the receiving end approximately three and one-half miles distant. The signals were increased from faint to strong, which is quite an increase.

As seen in the drawings any variable

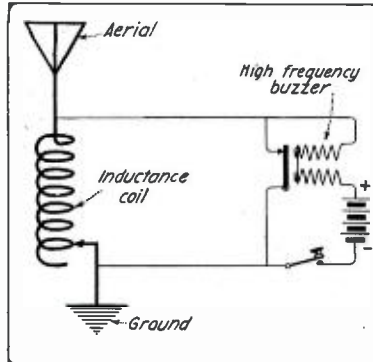
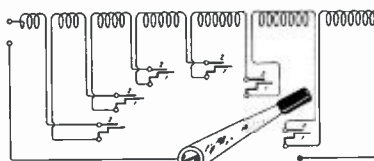

Diagram Showing How to Send Three Miles with a Buzzer.

single slide tuner or inductance coil can be employed, but the coil shown gave the best results for this particular buzzer.

**NO DEAD-END SWITCHING ARRANGEMENT.**  
By E. T. Jones.



How the Sections of a Coil Are Varied by the Simple Switch.

We have seen many no-dead end arrangements in print, but most of them are too expensive and involve too much precision in adjustment for correct operation. Taking advantage of these facts I have succeeded in providing the following arrangement which has proven its value in both simplicity and operation.

In this arrangement the remaining coils in the circuit are cut out or disconnected by the insulated stud A depressing the contact arm 1 which makes contact with the contact point strip 2. A simpler arrangement could not be had, and the beauty is its successful operation; besides the cheapness

of the complete outlay makes it worth while. When the arm of the switch is resting

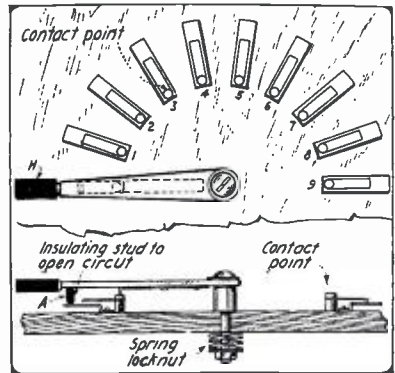

Details of the "Dead-end" Switch.

on contact point No. 3 then in this position the remaining coils 4, 5, 6, 7, 8 and 9 are disconnected by means of the insulated stud A pressing on the brass contact arm 1 which is thereby disconnected from the brass arm 2.

**"LAP" WINDING.**

I have seen many articles published describing inductances for radio receivers but have never seen anything about "lap winding" of the kind I here describe.

I have used this kind of loading coil in commercial practice and found it to work fine as it cuts the length of the coil in half for a given amount of wire wound in the old single layer way. It is very desirable for use with a ships set; that is, not built for long enough waves to get arc signals. I will do the best I can to describe what I mean, however, by taking a pencil and a

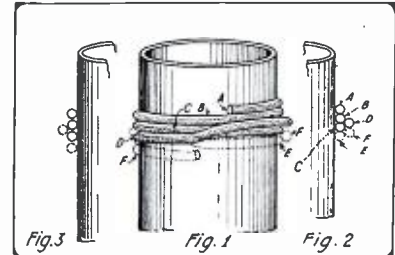

How "Lap" Winding is Done.

piece of cord, the reader will soon see how it is wound.

Beginning at A wind three turns, B, C and D, then lap the next turn over between (Continued on page 46)

**Loose Coupling of Amateur Transmitter**

By GEO. M. BAKER

Air Service School for Radio Operators, Austin, Tex.

Now that the time for "scolding" approaches I would like to register an appeal for loose coupling between the two oscillating circuits of the transmitting set.

In the past the average amateur held the view that whenever he loosened the coupling of his oscillation transformer, he was sacrificing radiation and distance for the sake of reducing interference with his neighbor's work.

This is far from the case. I will bet a good hat that I can take any good transmitting set and get better radiation on medium coupling than on maximum coupling. This is due no doubt to mutual inductance. That is to say the open oscillating circuit retransfers energy to the primary oscillating circuit that it would otherwise use up. But it must be remembered that the above condition will not

take place unless the two oscillating circuits are in perfect resonance.

I have been in a government laboratory for a long period during the war and in my spare time I have carried out a number of experiments which have a bearing upon amateur work. Among other sets I used a 1/2 k.w. non-synchronous spark transmitter. A lumped oscillation transformer similar to the Murdock or Blitzen Radio-Coupler was used. I found that there was no excuse for using a closer coupling than 45%. In fact the antenna current increased up to this point. With the two circuits in perfect resonance I found it was possible to get a surprising amount of current flow in the secondary circuit with a coupling of 90%. The decrement with this arrangement proved to be .00 per complete cycle.

The advantages of sharp tuning are too evident to be repeated. The point I want to emphasize is that the transmitting set will actually cover a greater distance with moderately loose coupling than with close coupling. Any of the amateurs who had a pre-war range of 1,500 miles know this.

All of us will have to see that some plan be carried out to get sharp tuning after we open again. There will be a larger number of experimental stations than ever before. Think of the men who have received training in the army and navy who will go home with a lively interest in radio work. I have been in touch with several thousand such men and while many of them who declared they were going to open an amateur station as soon as they reached home, will never do so, a large number of them certainly will.

# Ideas

By THOS. W. BENSON

**U**NDERSTAND first of all that I am a great believer in ideas, good ideas. An idea is worth a lifetime of labor, and then some, but just what constitutes a good idea, especially in radio work? I have heard a few good ones, and here pass them on to you, perhaps you can do something with them without getting a headache.

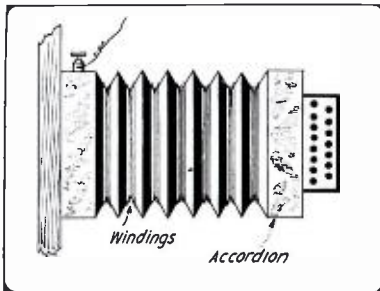

A Wonderful Ideal Tune In Hawaii and Practice Accordion Lessons Simultaneously.

For instance, there is the *Accordion Tuner*. There is a certain law, or rule or theorem or whatever it is called, that states the inductance of a coil will vary with the proximity of the turns. Let us then arrange a coil that can be stretched, as it were, and we have a loading coil that will make old Mr. Deadend a has-been. Take that old accordion and wind ten turns of wire in each depression, put two heavy nickle posts on one end and fasten to the wall. To tune, grasp the nearest handle, gently depress C natural and pull. There you are!

Just think of the possibilities of the device not only as an instrument of use, but of abuse—I mean amusement. On a real busy night the folks would be highly entertained with your performance while "sitting in"!!

Or, again. We also have the truth before us that a current will tend to contract a loose spiral when flowing thru it. Eureka! plug the G sharp open and extend the instrument. When a stray wave ambles down the lead in—Whee-e-e, the instrument wheezes, as you, with perfect sang-froid, step over and tune 'em in!!

Or your radiophone experts may find an inspiration in a hot-wire transmitter. It is very simple. Take a large funnel, fit the small end with a perforated cork in which is inserted a short length of glass tubing drawn to a small hole in a bunsen flame. The opening is to be placed opposite the filament of a miniature incandescent lamp from which the globe has been removed. Of course it will require several trials before the proper size lamp is obtained, but it only requires a little patience and a lot of credit, financially speaking.

Connect the lamp filament in series with the ground lead and start the arc. When the proper size lamp is used the filament will be just red. At this temperature it will offer a certain amount of resistance. However, when words are spoken into the funnel the air will cool the filament, lower its resistance and in this manner modulate the radio waves to conform with the undulations of the voice.

Simple, clever and doubtless efficient. And to think fussy old carbon transmitters are still being used for the purpose. What fools these radios be.

Funny how few amateurs realize the importance of having several lamps glowing on different parts of their apparatus. They give that mysterious appearance that all scientific instruments should have to pro-

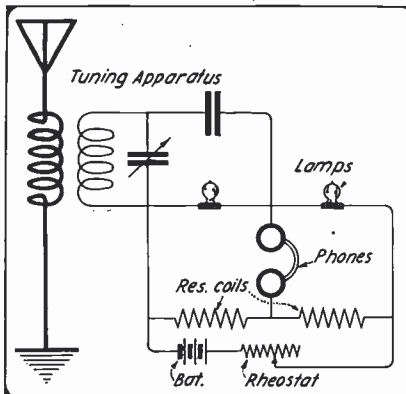

An Exceptionally Clever Method of Receiving That Will Displace Crystals and Even Audions.

tect the art from the influx of common beings. If you know what I mean.

Therefore, use them as detectors. It surely can be done. Lend an ear and be convinced. As above stated, the resistance of a tungsten lamp varies with the temperature of the filament. Then why not

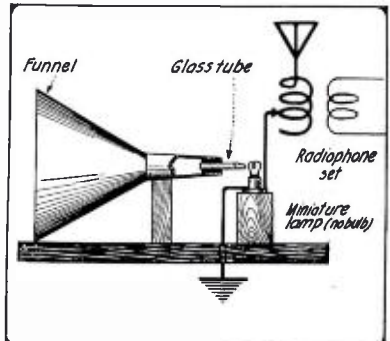

All the Troubles of Radiophone Engineers Dispelled By This Marvelous Invention.

put them in a bridge circuit and have the incoming wave unbalance the bridge?

The whole secret is given away in the attached illustration. Balance the bridge with the lamps just red, switch in the tuning apparatus and listen. The operation is simplicity itself and very reliable. A wave leaps down the lead in, a current shoots thru the secondary circuit of the coupler and one of the lamps. Blooie, the resistance drops and puts the balance of the bridge on the kibosh, the telephone clicks and success has been achieved. Let us bid the mineral detector a fond goodbye, they were great in their day, but now—

There may not be a grain of inspiration in the whole article, and there may be a ton of inspiration in a sentence. It all depends on you, dear reader. Read this all carefully, there surely must be some little acorn that with proper nurturing will grow into the mighty oak of Fame; Fame for you and for me. (Watson, the needle, and pleasant dreams!)

[No, Mr. Benson promised NOT to patent the above!—Editor.]

## High Voltage Audion Battery

By L. M. LAFAVE

I wish to describe a primary battery which I think should appeal to the experimenter who wants a high-voltage battery for general laboratory use of low amperage. It was found ideal for my audion set. The 30 cells shown give about 40 volts.

The cells are made of carbons from old dry cells, drilled to receive the zinc electrode. The carbons are dipped into boiling paraffin to make them leak proof. They should be heated before dipping in the wax so that it will penetrate into the carbon a little before it gets hard. No paraffin must enter the hole. You will notice that the carbon acts as container for the active elements, and is the negative electrode (positive pole) at the same time. It presents the largest possible surface to the electrolytic, which is an advantage. The carbons should be forced into holes in the base board as shown in the sketch and photo. The base should be treated with hot wax after the holes are made, to prevent the liquids from going into the wood and causing trouble if any should be dropped, in filling the carbons.

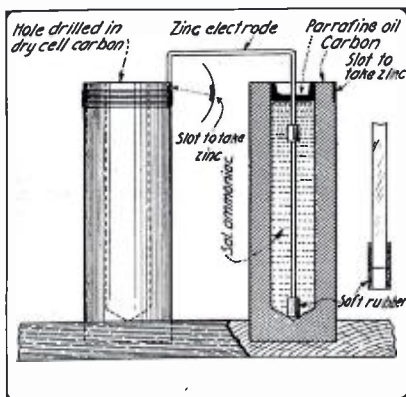

A Very Good Home-made Battery Which May Be Used In the Audion Plate Circuit. Note Mounting of Carbon Containers in Base-board.

The zinc electrodes are cut from 1/16" zinc sheeting or even 1/32", which may be obtained at a tinsmith's shop. The lower end of the zinc is forced into a piece of soft rubber tubing shown in illustration. Near the top another piece of tubing is placed to prevent the zinc from touching the carbon.

When the zinc strips are placed in the carbons there is no fear that they will touch the carbon, although there is most of the zinc surface exposed to the electrolytic. After the battery is assembled all the exposed metal should be coated with the wax, which may be applied while hot with a small brush.

Paraffin oil should be put on the surface of the electrolyte to keep the water from evaporating.

The electrolyte consists of one pint of water in which is dissolved 3 ounces of sal ammoniac and 1 ounce of chlorid of zinc.

The picture shows an experimental battery made by the writer which proved very satisfactory.



# WHAT THEY THINK OF IT

## FROM THE INVENTOR OF THE AUDION.

Dear Mr. Gernsback:—

I am much interested in your announcement of the forthcoming magazine RADIO AMATEUR NEWS.

There can be no question that a large field of usefulness awaits the new magazine. The magnificent service which Radio has rendered to the Allied Cause during the war, especially in the multiplicity of its new applications there, and the intense interest which these developments have aroused in the minds of every patriotic young American, convinces me that RADIO AMATEUR NEWS will enjoy a unique opportunity for usefulness.

Wishing it and its editors every success, I remain,

Very sincerely yours,

LEE DE FOREST.

New York, May 9, 1919.

## FROM THE INVENTOR OF THE CRYSTAL DETECTOR.

My Dear Mr. Gernsback:—

I heartily approve of your idea of starting a new magazine, RADIO AMATEUR NEWS. There is certainly room for an unbiased publication devoted entirely to matters of radio interest, which is not filled by the present periodicals issued by radio companies, or by the various electrical trade journals.

Sincerely yours,

GREENLEAF WHITTIER PICKARD.

Newton Centre, Mass., April 12, 1919.

## FROM THE INVENTOR OF UNDERGROUND RADIO

Dear Mr. Gernsback:

I take great pleasure in sending you my subscription for the RADIO AMATEUR NEWS. Your magnificent work in scientific journalism cannot be too highly praised, inspired as you have a nation-wide interest in all scientific subjects, particularly in the radio art. I will look forward with genuine pleasure to the birth of RADIO AMATEUR NEWS and take this occasion to congratulate students and scientific men for the aid that will be furnished them in this your latest achievement.

With cordial good wishes I remain,

Very sincerely yours,

J. HARRIS ROGERS.

Hyattsville, Maryland, May 17, 1919.

## TOM REED, TOO, IS ON DECK!

Dear Mr. Gernsback:

I've got to hand it to you again; you've always been "Johnny on the Spot," but in this new Radio Magazine you're "Johnny picking Out the Spot to be On before there is a Spot."

While you're printing this magazine, the Huns are "refusing" to "sign," and Amateur Radio is still fast asleep, tucked in under the Wartime Restriction blanket. But you know that they WILL sign soon, and then—pop!—in an instant Radio will be wide awake again, and scrabbling like a kid on Christmas morning for the new rink-tions that War has stuck in its sock. That awakening will be the "Spot," and RADIO AMATEUR NEWS will be found occupying it.

From a Radio standpoint, the War never did cause us any worry. The real black day for us was in last December, when that astounding Government monopoly of wireless was proposed. Think of it! To tie up a whole rising young Giant Science as a mere instrument for "ruling" a free people! Just as well commandeer all of Luther Burbank's wonderful hybrid trees for the exclusive growing of schoolmaster-switches! We won't name any names, old top, but the idea was typically Hunnish.

It might have been rushed through for all that if you hadn't marshalled the "Radiobugs" against it. I'll say that scene is going down in history as a companion piece to "The Boston Boys and General Gage." Remember it? The group of urchins, each towing his sled, lifting exasperated chubby faces to Junker Geo. III's minion—the Von Bissing of his time and place—with their "Now your soldiers have destroyed our slide, and we will bear it no longer!"

Congress dropped the radio law the way Gage did the coasting prohibition—as tho it were unexpectedly hot; and I'll bet a kilowatt to a cat-whisker that a Congressman or two—and maybe a Cabinet officer—grumbled much the same unwilling tribute that the Third Assistant Tyrant did in 1775—"These boys draw in the spirit of Liberty with the very air they breathe!"

Well, good luck to the New Mag! "Smash" goes the bottle—"She starts, she moves, she seems to feel the thrill of life along her"—transformer.

Yours very truly,

THOMAS REED.

Boston, May 16, 1919.

## WE'RE WITH YOU, BEN.

Dear Mr. Gernsback:

I have just received your letter regarding RADIO AMATEUR NEWS. All I have to say is, "Go to it." I have no doubt that it will not fail, and am sure it will succeed. What is needed in amateur wireless publications is a strictly wireless magazine—one that will not tell us of what other men did in radio but teach us how to do it. Make it a "How-to-Make-It" magazine. I have stopped buying . . . and similar magazines because they speak too much of other inventions, things done already, and not things that will be done. What is needed is a magazine that gives all new ideas—not instruments in radio—and then tells us how to apply these ideas to our own instruments.

I am a student at Columbia University.

Here's to RADIO AMATEUR NEWS.

Sincerely yours,

BENJAMIN SOLARZ.

Brooklyn, N. Y., May 16, 1919.

## "R. A. N."

Dear Mr. Gernsback:

Have just received your letter stating your new enterprise. Enclosed find a check to help it along. I am a college student and altho my time is limited I always manage to read the "E. E." I am having the "R. A. N." (apologize for the new nickname) sent to my home, as I will be there in time to receive the first issue. If the "R. A. N." will be as interesting as the "E. E.," don't worry as to its success.

C. KOCOUR.

Champaign, Ill., May 17, 1919.

## THANKS. "FATHER" AND "CHILD" ARE DOING NICELY!

Dear Mr. Gernsback:

Enclosed find my subscription for five years to RADIO AMATEUR NEWS, your new "child." May it grow up worthy of its "father," as I have every confidence it will. Wishing you success in the new venture, I remain,

Sincerely yours,

C. A. HELLMANN.

Washington, D. C., May 15, 1919.

# TO OUR READERS

The publishers of RADIO AMATEUR NEWS are also the publishers of the *Electrical Experimenter*. The latter magazine for seven years has published the highest-grade radio articles in America—and will continue to do so. Its radio section comprises from eight to twelve pages of the choicest radio articles published anywhere—and is famous on this account alone among radio bugs.

Now you have looked thru this issue of RADIO AMATEUR NEWS. You have noted that it is "different" from the *Electrical Experimenter*, as it is "different" from any other radio publication. And it will continue to be "different." This issue is but a poor sample of what we intend to give you after a few months—with your help.

But the point we wish to bring out is this: There will be absolutely no duplication of articles in our two magazines. Both will be entirely different as to their radio articles.

One will supplement the other. If you are reading RADIO AMATEUR NEWS, you will want to read the *Electrical Experimenter*, and vice versa. One is not complete without the other. Together, the two magazines will give you ALL the radio articles, ALL the radio news, you crave for.

The radio art has become so big that one magazine could not hold all of it. And that's ONE reason for this new magazine.

THE PUBLISHERS.

## DOLLARS FOR IDEAS

Amateurs, we want your ideas! Tell us about that new stunt you have meant to write up right along, but never got to. Perhaps you have a new idea. Perhaps you have a new hook-up or perhaps you made your old clock-works do something new. If so, we want that idea, and want it bad. For

every contribution which we accept, for every idea, we will pay \$2.00. This refers only to simple ideas and does not by any means refer to long articles, for which we pay much higher rates. Why not get busy at once? Address Editor, this publication.

## CLUBS, PLEASE NOTE

We want the latest gossip from all clubs and associations. We will be only too glad to give them the widest publicity. We ask the secretary of each club or association to send us a monthly report of the doings of his club. Such notices will be published free of charge. All amateurs, no matter where they live, should know what our clubs are doing, and what is being done to further their members' welfare and interest. RADIO AMATEUR NEWS will be an exchange place for ideas of this kind.

# How I Became a Radiobug

By THOMAS REED

**A**N electrical experimenter is now pretty generally known as a "Bug." They accuse me of wishing this name on the long-suffering fraternity, but I disclaim the blame or credit, whichever it calls for. Me, I never denied I was crazy over natural science. No bughouse, "be it ever so humble," that was lined with scientific apparatus, but would be "home, sweet home" to me. So you see it took only common frankness on my part to call myself a Bug. It was the later company acknowledging the same eccentricity who made it a badge of distinction.

If you accept the definition, then obviously a wireless enthusiast is a "Radio-

Every morning as I rode to work I saw that little plant. I felt the bite of the Radio microbe. I longed to mess around in this new application of electricity. But my school and leisure days were over; I was bogged in business, as were my former companions in experimentation; and it being hard to "start anything" alone, I only looked on enviously and did nothing.

In those early days the wireless art was carefully guarded, as patents were being sought which appeared to promise high value. No one was ever admitted to Prof. Stone's shack, and at night an armed watchman was always on duty. However, a few of the general principles of Radio filtered into the community, and I gathered them in.

brim of it a platinum wire dipping a quarter of an inch below the surface. The wire being specified as "fine," I used one of 36 gage, which seemed to me very fine indeed!! In series with this I connected one of my trusty "wet cells" and a long-handled 75-ohm receiver. My aerial was an "inside" one, of bell-wire draped around the moulding of my room, conducting through the "apparatus" to a gaspipe ground.

All being ready, I held the heavy receiver to my ear and prepared to be delighted with the pretty buzzing sounds which were bound to ensue. The "ensuing," however, was distinctly bad; it was more than "practically" nil. I held that receiver up till it weighed in the neighborhood of 150 lbs.; my arm had creeping paralysis, and my ear was registering a temperature of 212 degrees Fahrenheit in the shade; but not a sound occurred beyond the excusable ringing of a faithful auricular organ that was being abused and knew it.

It would seem as if pitying Heaven might have sent me at least a "static"—something you can capture with a screen-door spring and a hairpin. Even a small, cheap "X" would have meant joy to me, but I was denied even that.

Strange how near you can come to success without attaining it, isn't it? In this case, the main obstacles appear to have been the following:

1st, there were no signals to be received, Prof. Stone's stations being the only ones in New England, so far as I know, and he only operating for short periods, as I afterward learned.

2nd, my "fine" No. 36 platinum wire should have been a Wollaston-process wire of about .0003 or .0001 inch diameter—it was only 50 times too large!—and arranged with a screw adjustment to barely touch the surface of the electrolyte.

3rd, my receiver, instead of being 75-ohm, should have been a high-resistance one of 500 to 1,000 ohms.

Outside of these "small" defects and the lack of a potentiometer and a tuning-coil, there was scarcely anything the matter, you see!! That's it, laugh, you Vicious Personalities, laugh! Why didn't I get a few books on the subject—something practical like Phil Edelman, for instance—go to a lecture or two, send for a catalogue, or at least look in a supply-store window, and inform myself? Oh, sure. Phil was still in short pants, and the supply stores were vacant lots. Why didn't I snoop around Prof. Stone's tar-paper palace of mystery and get shot by the watchman, you mean? That's all there was of the facilities you mention.

The negative result of my experiment was discouraging, and business taking my time increasingly, I made no more. The art developed without my assistance—except as it may have got along a little better for my leaving it alone. The Government took it up, Navy Yards were equipped, commercial stations established, and finally the amateurs began to appear. One amateur in my neighborhood had a really lofty aerial for those times, and as I passed his house I could hear his sparks snapping, and even see their flash from the street. I always felt the bite of the microbe, but the game seemed too expensive and complicated, and I lacked associates and thought I lacked time.

It was a bright young schoolboy "Bug" who eventually opened the door to me. This kid talked like a veteran about the

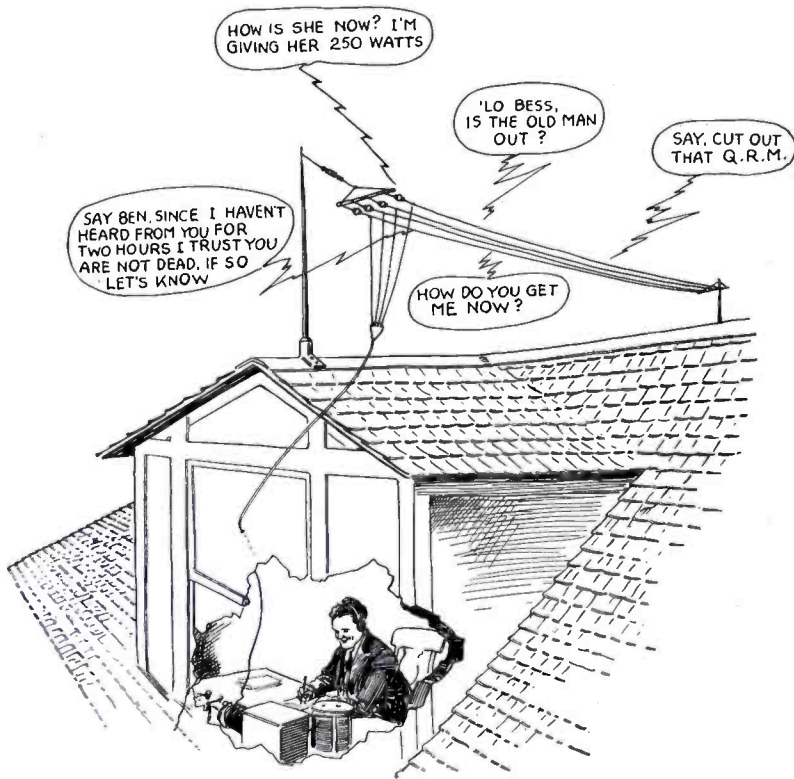

A Twist of the Switch Into the 200-meter Fields, and the Working, Worrying World Changes to That of the Eager, Fearless, Advancing New Generations, As Quickly and Completely As One Scene Gives Place to Another on the Movie-screen.

bug"; and I scented a movement to make the title official, since the Editor of this new journal invites me to tell in the first issue (which I take as the great honor it is) how I became one of "them there things."

As near as I can place it, it was back in the early 1900's when I first saw a wireless aerial. In a dreary stretch of vacant "filled land" between Cambridge and Boston, where the buildings of the Massachusetts Institute of Technology now stand, Professor Stone had erected a shack and mast for his researches; and it was rumored among the villagers that without wire or any sort of physical connection, he could exchange messages with a similar outfit of his, way down on the Lynn marshes, perhaps ten miles away! Almost incredible.

Telephonic reception had come, and the coherer had been abandoned for the receiver. I learned that signals could be received by the device of three needles stuck in a cork, the points of which made imperfect contact between two brass-plates in circuit with the aerial. This was the thermic detector. Then came news of the electrolytic, a platinum wire dipping into acidulated water.

The latter development succeeded in enthusing me to the point of my first experiment, which was a failure of the degree called in astronomy "complete totality." I always enjoy recalling a first experiment, and noting the one to a dozen reasons why it couldn't have succeeded in a thousand years. I half-filled an old cold-cream pot with acidulated water, and hung over the



fundamental simplicity of wireless. He had the nerve to tell me that with a bit of silicon, a simple helix with sliders, a two-cigarette size condenser, and a bedspring for an aerial, one could pick up signals from the commercial station at Wellfleet, some 70 miles distant in an air-line! I pooh-poohed him brutally, but he stuck to his fable. He knew it was so because he'd done it himself, so that for me, pish! and likewise tush! Finally he convinced me. Believe me, that was when that microbe bit! He bit and brought his family to bite, and settled down and stayed. I could hardly wait to return home before beginning construction of the simple receiving instruments. As usual, my first experiments failed, but now I knew what I was after, and soon I was in full-fledged communication with the busy Radio-world that had been around me all the while without my knowing it. I've never left it since, except during the war-deprivation; and during that dark period I've known how Robinson Crusoe felt on his desert island, cut off from his kind!

I don't wonder at all at the thousands and thousands who have become Radio-bugs; what puzzles me is the other thousands who haven't; it must be only inertia on their part, as it was on mine. I like to cry up the pleasures of wireless to the Outer Barbarians and hear 'em murmur, "Gosh, that is fun, but isn't it hard to learn?"

The chance generally comes when I'm riding with a party along country roads, and find in a lonely spot the humble wireless outfit of some struggling Bug—you know the type, a couple of spindling, bow-legged masts, guyed at every spavined joint, with a few kinky wires straggling into an attic window. Some one remarks, "You seem to see more and more of these things; wonder what there is in it, anyhow?" And another volunteers, "Why, Tom, here is one of these wireless fiends, ask him." Then it's "What is the attraction, Tom?" and I try to tell as much as I can about the fascination of Radio, in words of one syllable, before the subject is ousted by the next intellectual appeal—such as a hen scuttling under the wheels and saving her sily neck by a feather's-breadth for later decapitation in due course of commerce.

The opportunity being brief, I tell 'em principally of the spectacular side of Radio—the real thrills that have come to me through the little round receiver. The revenue-cutter Acushnet muttering to herself out in Pollock Rip Slue, or around the Handkerchief Shoal, as she scours the fog in search of a disabled craft. The great pause in the chattering wireless world while the Carpathia, bearing the survivors of the Titanic and the desired, yet dreaded, news of the disaster, was creeping toward New York. How unused we were to horrors then!

I describe the first stammering communication from Sayville, L. I., to Nauen, Germany. The unconscious irony of it—"President to Kaiser, congratulations, trust in increase of amity!" In how short a time afterward I heard that same Sayville brazenly snarling its wicked orders to the Hun cruisers lurking off our coast, and hush-hushing its spy-reports to the home of spies in Berlin! I tell 'em how it sounded at an isolated fishing-camp, deprived of news all day, when the Wellfleet service steadily spelled out that crushing message: "The Steamship — Lusitania — TORPEDOED — twelve hundred lives — men, women and children —"

Or, if the hen still delays to run, I tell 'em of the big jolt my system got when I first heard, among the dots and dashes, a real humm voice, the first crude wireless telephone: "Hello, hello Hawkins, can you hear me?" That was all, but it seemed like being present at the struggle of a new

science for mastery over an old. And as a whirlwind finish, I describe the Audion amplifier, magnifying ether-waves a million-fold, unhampered by earthly disturbances, such as set a limit to the power of the telescope; and rave that some fine day a fellow listening on a wire like this may catch a word in a language never heard before. And when he does, human knowledge will expand like a bomb-burst to include the experiences of planet-dwellers,

Why, Radio is like sitting at an open window on that street in Paris where they say everybody you know will pass if you wait long enough. Why isn't it taught to invalids and shut-ins to cheer their lives? Especially the blind—the blind would make good operators, too.

And here I am at the end of my string, without having touched on the best part of Radio—the warm comradeship of amateurism that pervades it. A twist of the



I Describe the First Stammering Communication from Sayville, L. I., to Nauen, Germany. The Unconscious Irony of It—"President to Kaiser, Congratulations, Trust in Increase of Amity!"

communications starting our way a million years ago, concerning a culture still a million years ahead of ours!

You have to feed "strong stuff" like that to impress an auto party with "what there is in it"; but planets or no planets, what you and I enjoy is the everyday whispering of the Radio world. The telegrams to the liners out in mid-ocean, grave and gay, just as they come. From a convivial dinner-party somewhere in the west, "Greetings, old chap, wish you were here, feed the fishes for us!" Or this, from a saddened, shrouded house in Baltimore, "Mother passed away this morning without regaining consciousness; she never knew." Or this from the stony lair of callousness and greed, Manhattan, "Dearest, I wish you safety. I miss you so!"

Or the call from the lonely station far out on the Cape sands, "Twelve noon—southeast gale—sea rough, weather thick, observation one-fourth mile." Or watchful Arlington droning, "Capt. Smith, S. S. Sarmiento, reports derelict, latitude and longitude this and that, decks awash, stump of foremast standing." Or at night, the careful news-service, a whole daily paper in a nutshell, with baseball-scores and stock-fluctuations to relieve both kinds of "fears and sorrows that infest the soul."

switch into the 200-meter field, and the working, worrying world changes to that of the eager, fearless, advancing New Generation, as quickly and completely as one scene gives place to another on the movie-screen. They try out their new instruments—"How is she now? I'm giving her 250 watts." "I've got some 24-wire you can have." "Come on over, old man, I'd like to show you my dump." The Radio Inspector cuts in, "1PXX, you must have sharper tuning; wave too broad." "Sure, 1AC, I'll measure your wave-length, go ahead." "Say, there's a new Opr, on at WDL—he's sore because he can't get NPZ." A "relay message" drifts along, just starting from an Eastern college to be passed from hand to hand, a few miles at a time, clear across the continent to an old home in Oregon: "Passed exams, Mater; love; tell Florrie!"

Does it seem petty? Old One, these generous boys are what stood between you and me and the Fate of Belgium, and this prattle of theirs is going to ripen as tomorrow's wisdom. They're catching up with us, and when they bump us by the stern, he who is a wise old guy will let the bump accelerate his pace, not balk it and fall on his nose. A boost and a knock are very much alike, except in their effects!



Or This from the Stony Lair of Callousness and Greed, Manhattan. "Dearest, I Wish You Safety. I Miss You So!"

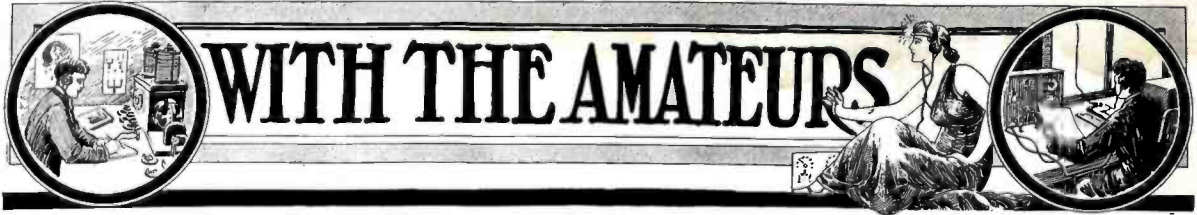

**T**HIS Department is open to all readers. It matters not whether subscribers or not. All photos are judged for best arrangement and efficiency of the apparatus, neatness of connections and general appearance. In order to increase the interest in this department, we make it a rule not to publish photographs of stations unaccompanied by a picture of the owner. We prefer dark photos to light ones. The prize winning pictures must be on prints not smaller than 5 x 7". We cannot reproduce pictures smaller than 3½ x 3½". All pictures must bear name and address written in ink on the back. A letter of not less than 100 words giving full description of the station, aerial equipment, etc., must accompany the pictures.

**PRIZES:** One first monthly prize of \$5.00. All other pictures published will be paid for at the rate of \$2.00.

## Open Once More!

**W**HAT is the use of having a nice station all dolled up with the most wonderful "rinksuns" imaginable, —quoting Thomas Reed,—and then let the world not know about it? Rank injustice we call it! Why hide behind your own light? You know what your den looks like inside, but what about us? Why not let us have a peck into your sanctum so we too can say "Ah! Now that's some station!" RADIO AMATEUR NEWS will pay you hard cash for a GOOD picture of your station as well as a picture of yourself, but, for heaven's sake, don't send us prints the size of a postage stamp. These we cannot publish. Look at the pictures on this page. Most of them are pictures, honest-to-goodness ones. That is what we want! If you wish to win that \$5.00 prize your picture must be at least 5" x 7". Send no prints smaller than 3½" x 3½", for we cannot use them. This holds true of both pictures, the one of the station as well as the one of yourself. And when you have your own picture taken, don't hide behind your spark gap, or use your phones as eyeglasses! Your fellow workers aren't all beauties themselves!! Now go to it. Attaboy!

P.S. We might as well add that we would much prefer to have the picture of the station as well as yourself taken by a regular photographer. Amateur prints, nine times out of ten, do not do the station or apparatus justice. Won't you therefore in your own interest have a professional make the picture? It will repay you in the end. It costs but very little.



This is the sort of well arranged and well equlpt station which we would like to see adopted by all amateurs. This particular one and the one below blooms at one of the New York Y. M. C. A. branches.

### FAKE PICTURE CONTEST

While your Editor was editing *Modern Electrics* years ago, some one slipt a hot one over on him. Some wise gink from out West who had been watching the pictures which were being printed of radio amateurs and their stations, took it into his wise head to fake up a wireless station and submit it. He went about it very cleverly, and, sure enough, it was published! He simply camouflaged a lot of old junk, arranged it on a table and made it look like a real wireless outfit. It looked so good, it fooled us completely! His tuning coil, for instance, consisted of a sawed-off rolling pin with the wires painted on them. He also had a large helix made of cardboard with a lot of junk put on it. After we

had published the picture, he, of course, gave us the due Ha! Ha! but we thought it too good to keep it quiet, so the readers were told about it. So they all had the merry Ha! Ha! on Ye Editor. This put something into our head, so here goes:

We will pay \$5.00 for the best fake wireless station picture sent in to us, and we will begin publishing them in the next issue. At least 100 words describing how you pulled it off, are required. Now please, Boys, don't make our lives miserable. Don't, for heaven's sake, send us real ones and tell us they are camouflaged! AND, on the other hand, don't send fake ones to *With the Amateurs* Department and expect to get prizes and then have the Ha! Ha! on us, after we publish them as real ones!! We admit that we have carved out a beautiful job for ourselves, and the Editor can see where his summer vacation will be spent inside a large and healthy helix with padded wires.

Address all fake pictures to Editor, *Fake Station Contest*.



This shows the Editor's Idea as to what we are coming to. We insist that the radiophone is THE THING. Our prediction is that within three years or less amateurs will only have radiophone outfits.

### 15,000 COPIES

Of this issue 15,000 copies have been printed and circulated. It contains 48 pages and over 100 illustrations. From point of circulation, size and contents, it represents by far the greatest radio magazine today.



### H. A. Mackley's Station

The photo of my set is self explanatory, so I won't go into details very deep. The Audions are arranged so that any one may be used as the detector and the others as amplifiers. Set is hooked up for spark and undamped signals. The loading inductance mounted under the operating table out of sight. The loose coupler is good for 4500 meters itself and arranged so that the dead-end effect is lost on the short waves. The transmitting apparatus are all mounted behind the operating table, thus doing away with all unsightly wiring. The transmitting set has a 1 KW closed-core transformer plate glass and oil condenser oscillation transformer and high-speed rotary gap. The leads are either copper ribbon or No. 4 B. & S. copper wire, and are made as short as possible. The transmitting aerial has 4 wires 45 feet long and fifty feet high, made of five strands of No. 16 B. & S. copper, thus giving a large surface and having great tensile strength. The ground is a counterpoise in addition to a water pipe, bonded at the far end. The receiving aerial is 80 feet long and 80 feet high, six-wire, No. 16 single B. & S. copper. Receiving range from the Gulf and Atlantic

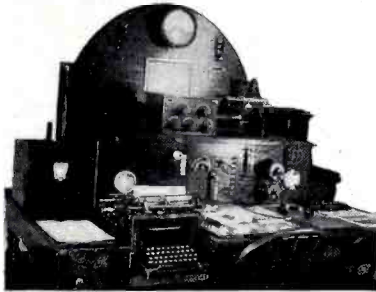

This Looks Like an Up-to-date Outfit, and We Sure Do Like It. Note the Typewriter, Coast, and have copied KWT Teller, Alaska, with two Audions.  
H. A. MACKLEY.

### Leo Hirsch's Station SENDING SET

Thordarson 3/4 K. W. transformer rotary gap, commercial key, Murdock condensers, oscillation transformer, hot wire ammeter, and kick-back preventer.

#### RECEIVING SET

One audion detector, Navy type loose coupler, one amplifying coupler, variometer, two variables undamped coils and two pairs of Brandes phones.

With this station I have been heard in every district except the 3rd, 6th and 7th, having a sending range of about 900 miles.

With the receiving set I hear a beehive of commercials, and have heard long distant amateurs every night; also, with the amplifying coil in I hear N. A. A. about 30 feet from the phones.

LEO HIRSCH, Columbus, Ohio.



Mr. Leo Hirsch Has Certainly One Fine Old Station. Unfortunately, He Sent Us One of Those "Post-Office Stamp" Photos, so You Need a Microscope to See All the Nice Things He Has!

### Dusting 'Em Off

April the 15th, 1919!  
A memorable date. The date that made the dust-rag famous. One wholesale dust-rag house in Chicago ordered 9 carloads of 'em—but the demand was much greater. Our staff statistician doped it out that on April 15th 129,796 1/2 square yards of dust-rags were used to dust off all the radio sets in America. Placed end to end these rags would reach from New York to Podunk, Miss. Cut up into strips one inch wide they would reach from Horta (Azores) to Lisbon, Portugal. Our statistician also figured it out that no less than 29,159 lbs. of miscellaneous dust was dusted off these long-sleeping sets. It took 46,971 1/4 horse power to pull out from their hiding places all the American radio sets that were buried (but not forgotten) for two long and heartbreaking years. 196,759 horse power were expended in putting up again radio amateur aerials all over the continent.

During the months of April and May, 427 flea-power worth of energy was sent into the ether by amateur transmitting sets!

11,125 radio amateurs are in hospitals down with the itch. They itched that bad to get their fingers again on their sending sets!!



You Guess It! He WAS in the Army. Otherwise Where'd He Get That "Professional" Dusting Pose—AND the Wrist Watch.

### HEARS WIRELESS TALK IN UNDERGROUND VAULT.

A wireless telephone message from the radio station at New Brunswick, N. J., was received recently at Asbury Park inside a steel and concrete vault underground by W. Harold Warren of New Brunswick. He had a portable receiving set, carried in one hand, and neither aerial nor ground connection.

The main dining room of the Hotel Klein, New Brunswick, was connected with the local radio station by regular telephone and a relay connection made by wireless telephone. The music of the hotel's orchestra was clearly heard by Mr. Warren inside the vault at Asbury Park.

The commandant of the radio station said that on the last trip of the steamer George Washington to France with President Wilson the orchestra of the hotel was connected by wireless telephone with the vessel and the music was clearly heard when the ship was 600 miles at sea.

### TRY OUT AIRPLANE SIGNAL.

Experts of the Army Signal Corps have begun experiments with a recent invention which they believe will prove valuable in making the airplane a commercial utility. Described as an "audible beacon," the new contrivance is designed as a signal which will advise the aviator not only of his own position regardless of weather conditions, but will serve as accurate marks for suitable landing places.

"The beacon" is said to be a combination of the radio telephone and the ordinary phonograph. Its operation will be more or less automatic and will repeat a word or signal designating its position. For instance, one at Langley Field, the interdepartmental aviation base, might send out the call "Langley" at stated intervals.

Officials working on the invention believe that the next step will be the adoption of the sound-ranging device, now used by armies in connection with artillery fire, to enable aviators to determine without delay the distance and direction of the call of any one of these sending stations.

### MONTHLY PRIZES.

This department pays the highest prizes for illustrations of amateur radio stations.

We give a monthly prize of \$5.00 for the best picture. All others published are paid for at the rate of \$2.00. When do we get YOURS?

### DESCRIPTION OF 6NO

I am enclosing a photo of my set with description.

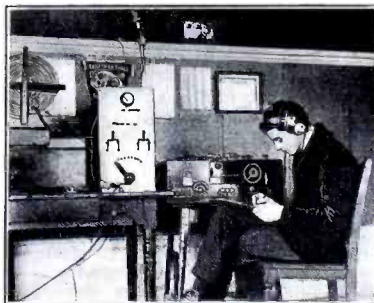

A Neat Station and a Fine Switch-Board, Even if the Switch-Knob Is Big!

Sending set.—One-half KW closed-core transformer, oil immersed condenser, pancake oscillation transformer and Murdock rotary. The switchboard mounted beside the set furnishes the control for the various instruments, a hot-wire meter is used to measure the output, and on high power registers three amps.

Receiving set.—The receiving instruments are mounted in a mahogany cabinet and consist of loose coupler, load coils, four variables, three crystal detectors and one audion with batteries. Have been able on galena to hear KIKK in Honolulu, Several Alaskan stations, and NAA and NAR.

LELAND J. SPALDING,  
San Francisco, Cal.

# Radio Digest

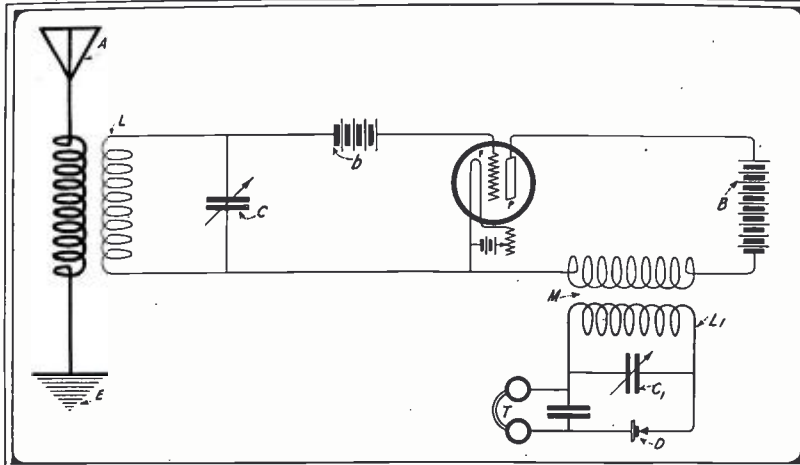

The Vacuum Valve used in a circuit as shown above possesses many distinctively efficient qualities. It amplifies the sigs. BEFORE they reach the audibility circuit.

## VACUUM TUBE AMPLIFIER WITH CRYSTAL DETECTOR.

The characteristic curves of a vacuum tube show that the best value of grid voltage for amplification is not the same as for best detecting action, which is an argument for using separate tubes for these two purposes. This adds somewhat to the complexity of the apparatus, and leads some operators to prefer the combination of a vacuum tube for amplifying and a crystal detector for receiving. Such a circuit is shown here.

The oscillating circuit  $L C$  is coupled to the antenna and is tuned to the frequency of the latter, which is that of the incoming waves. The alternations of voltage between the terminals of the coil  $L$  are applied between the filament  $F$  and grid  $G$  through the battery  $b$ , which has been previously adjusted in voltage so that the plate current has a value corresponding to a point on the straight part of its characteristic.

The amplified oscillations in the plate circuit are communicated to the oscillating circuit  $L_1 C_1$ , which is coupled to the plate circuit through the coil  $M$ . The circuit  $L_1 C_1$  is tuned to the frequency of the received waves like the other two circuits. The alternations of voltage between the terminals of the coil  $L_1$  are rectified in the crystal detector  $D$  in the usual way, and cause an audio frequency current to flow in the telephone receivers.—*Radio Pamphlet No. 40, U. S. Signal Corps.*

## ELECTRICAL OSCILLATIONS IN ANTENNAS AND INDUCTANCE COILS.

JOHN M. MILLER.

The theory of circuits having uniformly distributed electrical characteristics, such as cables, telephone lines and transmission lines, has been applied to antennas. It is said that the results of this theory do not seem to have been clearly brought out, and it is hoped that in this paper some misunderstandings may be cleared up. No attempt has been made to show how accurately the theory applies to actual antennas. The transmission-line theory can also be applied to the treatment of the effects of distributed capacity in inductance coils.—*Scientific Paper No. 326, Bureau of Standards.*

## CANADA, TOO, OPENS UP.

OTTAWA, May 5.—The war-time regulation cancelling licenses for the operation of amateur wireless stations throughout the Dominion, has been rescinded. The amateur wireless operator may resume his experiments, subject to the pre-war regulations. At the outbreak of hostilities there were 110 licensed amateur stations in Canada.

## BANKED WINDING.

In certain coils the capacity may be reduced by using the so-called "banked" winding. Instead of winding one layer

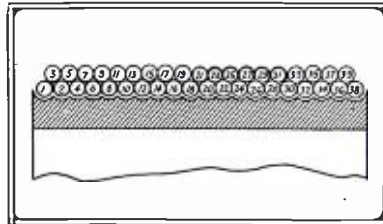

Method of Banking the winding of a Coil in Order to Reduce its Distributed Capacity.

complete and then winding the next layer back over the first, one turn is wound successively in each of the layers, the winding proceeding from one end of the coil to the other. The best results are obtained in a coil of a few layers. The method is illustrated in illustration for a coil of two layers, the succession of the turns being indicated in the numbers. The turns in the lower layer are prevented from slipping during the winding by grooving the coil form or covering it with rubber tape. The maximum voltage between adjacent wires in this two-layer coil is the voltage corresponding to three turns.—*Circular of Bureau of Standards.*

## GROUND TELEGRAPHY IN THE WORLD WAR.

LIEUT. WILLIS L. WINTER.

The development of ground telegraphy in the war zone is described in this article, with the suggestion that this system of communication may be of interest as applied to civil life.—*Journal of Electricity, March 1, 1919.*

## "SOUND WAVES" OF THE RADIO.

It is almost inconceivable that in these days of wireless communication, when every large steamship that plies the oceans is furnished with wireless apparatus, and the vast spaces between the continents are criss-crossed by the sound waves of the radio, so long a time should have elapsed between the rescue of Hawker and Grieve by the little Danish seafarer Mary and the receipt of the news by the world.—Editorial from the New York *Evening Mail*. (Possibly the sound waves of the radio didn't yell loud enuf!!—EDITOR.)

## MODIFIES RESTRICTIONS ON SHIPS' USE OF WIRELESS.

The State Department has been advised that the British Admiralty has announced that from noon May 1 all restrictions on wireless telegraphy on ships will be removed except in the North Sea, the English Channel, east of the line joining Dungeness and Boulogne, in Baltic Northern Russia, in the waters of the Mediterranean, the Black Sea and the Sea of Marmora.

## HARVARD NAVAL RADIO SCHOOL.

The naval radio school established at Harvard University during the war has been closed and the personnel and equipment transferred to the school at the Great Lakes naval training station.

Commander David A. Weaver has been detached from duty at the Harvard school and assigned to the Great Lakes station.

## AIR-THERMOMETER AMMETER.

This instrument, which is really a calorimeter, was formerly used in wave meters and in measurements of high-frequency resistance, for currents of a few hundredths to a few tenths ampere. Current passing through the fine wire heats the air in the glass bulb and causes the alcohol in the right side of the U-tube to rise. In order to eliminate the effect of other heat than that produced in the hot wire it is desirable to inclose the bulb in a vacuum jacket. A null instrument is easily made on the air-thermometer principle, by connecting a bulb to the right side of the U-tube, entirely similar to the one shown on the left side. If the two sides are exactly alike, the liquid column will not move when the  $RI^2$  in one one wire equals the  $RI^2$  in the other.—*Circular of Bureau of Standards.*

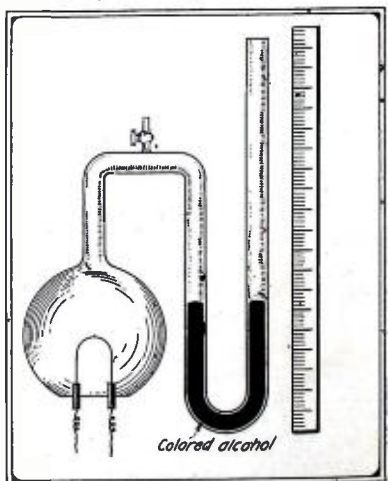

Air-Thermometer Ammeter.





# A Boy's Experience With Wireless Telegraph

By EMANUEL NYMAN

I never knew how fascinating an art wireless telegraphy was until I visited a friend one day who owned a new and up-to-date set of instruments. When I put his wireless phones over my ears and listened to calls that he said came from stations over one hundred miles away, I determined to have a station of my own, but the one objection

in such a manner that one end of the wire came into contact with the galena. I placed two binding posts on the base, one connected to the brass upright and the other to the piece of brass holding the galena. My detector was now finished and I turned my attention to the tuning coil.

First I bought a rolling pin and sawed the ends off. Then I nailed a square board to each end of the wooden core. Next I wound the core with No. 24 B. & S. cotton covered copper wire to the end, taking care to wind the wire evenly. I then scraped off the insulation in a straight line across the top and side of the coil. Each line was  $\frac{1}{4}$ " wide. Directly over the uninsulated part of the wire I arranged brass rods fitted with small brass cubes for sliders. The sliders had small springs that came into contact with the uninsulated wire. The wire and rods were connected to binding posts on each end of the coil. This completed my tuning coil.

The phones I bought from a firm of high standing. I got an excellent 75 ohm head-set for \$2. My receiving set was now complete except for a condenser which I decided to make later on.

My friend helped me to erect the aerial which consisted of two "Antenium" wires 50 feet long and 75 feet high. The wires were kept apart by spreaders which were attached to two chimneys. The lead in came to a lightning switch on the outside of the building. I connected up the instruments properly, using a No. 4 copper wire in wiring from instruments to the gas pipe.

Erecting the aerial and wiring the instruments took the better part of the afternoon and I decided to test the set in the evening. My friend brought his buzzer in the evening and he showed me how to test my detector with it. After the detector was adjusted I threw in the switch that connected the aerial with the instruments. I heard nothing but a low humming in the phones. I looked to the wiring and found everything properly connected. I then moved

one of the sliders on the tuner a short distance and then, clear and distinct, I heard the high pitched spark of a sending station. I passed the receivers to my friend who could read the signals. He said it was some navy yard station calling and he copied the message which was in a secret code, but I have always kept that message as a souvenir of the first message received with my instruments. I stayed up late into the night

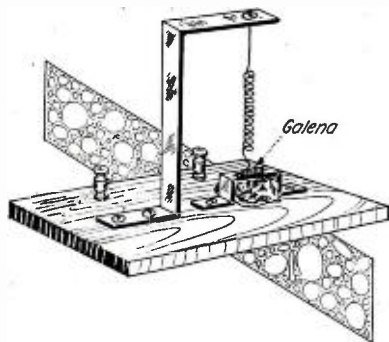

A Clever and Reliable Galena Detector Without a Detector "Cup".

was the cost of the instruments. My friend had new, highly finished apparatus that cost quite a lot of money, while I had only a few dollars at my command.

The only way out of it, as far as I could see, was to make my own apparatus. I had my friend explain to me the fundamental principles of his apparatus, and after eliminating some, I decided to make a tuning coil, detector, and to buy the phones.

The detector seemed the easiest, so I started that first. I mounted a brass upright with the top bent over, on a base. A hole was made in the middle of the bent part. Directly under the hole, on the base, I screwed a piece of brass that had a hole  $\frac{1}{2}$ " in diameter in the middle. In this hole I inserted a piece of galena. Then I suspended a fine brass wire from the top hole

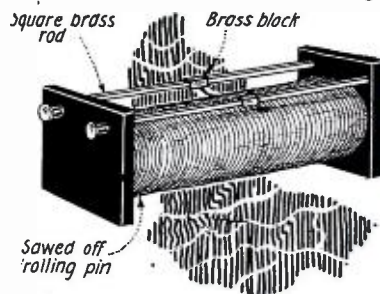

An Old Rolling Pin, a Few Brass Blocks and Rods, Some Wire—Presto, a Tuner.

listening to the different stations when just at 10 o'clock I heard the great station at Fire Island ticking off the time signals.

My station was a huge success and I soon received an invitation to join a radio club which was being organized in my neighborhood. The club took all the leading electrical and wireless magazines. One day as I was looking through the *Electrical Experimenter* I saw an application blank to the *Radio League of America* on the page in front of me. I cut it out and mailed it to the manager of the league and I soon became a member. I was furnished with a certificate printed in green and gold which I proudly displayed in my station. I urged every member of the club to become a member of the league and soon we were 100 per cent. members of the *Radio League of America*.

## A GOOD GALENA DETECTOR

The parts of this instrument are found around the "haunts" of any "bug." The cat-whisker is held by an old nut and lock-nut (F and E), off some ancient door-

bell screwed on a brass bolt (I) after the head has been cut off. This bolt is put through the wire hole in a brass binding-post (C) and has a black knob on the other end (B). The binding post (C) may be elevated if not high enough. The mineral cup is the butt of an old powder-shell and is threaded for a lock-screw (G and H). The parts are assembled on a hard rubber base with two binding posts (A), and connections made.

### An Amateur's Key.

A piece of brass (C) is cut about  $\frac{1}{2} \times 4$ " and has two holes in one end and a threaded hole in the other to receive the bolt of the knob (E). The contact (A', Fig. A) is taken from an old dry cell (A<sup>2</sup>, Fig. B) and is easily screwed into the wooden base, if a hole of proper size is drilled. Then the key is fastened down with screws (D) and two binding posts (B) added and connections made. This

results in a very good contact key, if properly made.

Contributed by John E. Crawford.

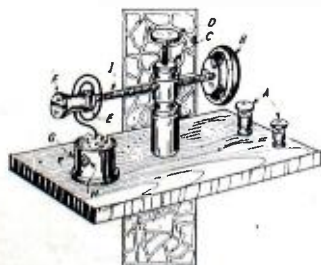

An Excellent Example of the "Polygot" Radio Instrument.

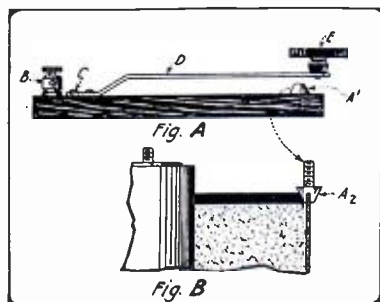

A Simplified Key from Odd Bits of Junk, Found in Every Boy's Junk Box.



THIS Department is conducted for the benefit of our Radio Experimenter. We shall be glad to answer here questions for the benefit of all, but we can only publish such matter of sufficient interest to all.

1. This Department cannot answer more than three questions for each correspondent.
2. Only one side of the sheet should be written upon; all matter should be typewritten or else written in ink. No attention paid to pencilled matter.
3. Sketches, diagrams, etc., must be on separate sheets. This Department does not answer questions by mail free of charge.
4. Our Editors will be glad to answer any letter at the rate of 25c for each question. If, however, questions entail considerable research work, intricate calculations, patent research, etc., a special charge will be made. Before we answer such questions, correspondents will be informed as to the price charge.

You will do the Editors a personal favor if you make your letter as brief as possible.

### INDOOR AERIAL.

(1) D. C. Bold, Chicago, Ill., asks us about using galena detectors for radio receptors.

A. 1. You can, of course, bend the "cat-whisker" wire contact on the detector so that the point of the wire will rest on the smooth top surface of the crystal. No battery is required with galena.

With indoor aerials you should always use as much wire as possible and in some cases a form of umbrella style aerial is very good indoors, to get the greatest spread possible in a small space.

The iron pipes running through the house for gas and water have some effect on the aerial but no great amount usually, especially if the pipes run at approximately right angles to your aerial construction.

### WIRELESS QUESTIONS.

(2) A. Albert Smith, Hoboken, N. J., asks several questions on radio matters.

A. 1. We cannot understand why the mere adjustment of a detector should necessitate such a great change in the inductance used in tuning.

You must have made some change in the capacity of your aerial to cause this marked effect, as detectors have little or no effect on the wave length.

Your suggestion for a new loose coupler is not exactly new and possesses no advantage over modern types. In winding the two coils so close you practically destroy all selectivity, which is the secret of the operation of the loose coupler. The plan will work, we admit, and the coupler will produce louder signals under certain circumstances, but for all around work use your present loose coupler.

The adopted method of shortening the wave length of an aerial is to connect a variable condenser in series. This is done on shipboard when the "distress signals" are sent out and all stations with the long wave require a series condenser to pick up short waves. We know of no instruments which will eliminate excessive static without also weakening to a certain extent the wireless signals. The only way this static may be done away with to an appreciable extent is to shunt a variable condenser across the coupler secondary, which dissipates considerable static. The Rogers Underground Aerial is perhaps the best present method to eliminate static, but it does not reduce it 100%.

### LONG DISTANCE RADIO RECEIVING.

(3) D. W. Fisher, Portland, Me., asks several radio queries:

A. 1. In order to operate simultaneously 2 spark coils, the windings (primaries) should be connected in series and one vibrator is then used for interrupting the primary current of both coils, and of course more battery voltage is to be used as the 2 primary windings have a greater resistance than one coil only. Their output under the

proper conditions as just outlined will be equal to that of both coils, when operating independently. The secondaries are connected in series, too.

In regard to your radio receiving range, this will be probably 1,200 to 1,500 miles or more under good conditions, especially at night. It might be possible that you could hear the Clifden, Ireland, station of the Marconi Company, but you will have to use for this purpose the very best receiving apparatus possible and some form of amplifier would be necessary, we believe from our experience in the matter.

All of the European wireless stations, including that at Hanover, Germany, are heard at the Columbia University Radio Station, and their aerial is about 550 feet long of 4 strands of Phosphor bronze cable, spaced about 5 feet apart and elevated about 130 feet above the ground. Needless to say, they are using a form of highly perfected amplifier developed in their research laboratory and data on same is not available at present.

### Radio Articles in the July Number of Electrical Experimenter

*Hello Europe—Via Radio*, by Charles M. Ripley.

*Photographing European Radio Signals Over Here.*

*The Pumping and Testing of Audions*, by C. Murray.

*The Pilotron Oscillator.*

*New Koster Direct Reading Wave-meter and Decremeter.*

*Operate Your Audions on Alternating Current*, by Elliot A. White, Former Instructor in Radio, Air Service School, Carnegie Institute of Technology.

*Tree Wireless—How Live Trees Received Radio Messages Across the Ocean*, by Major General George Owen Squier, Chief Signal Officer, U. S. Army.

*New 1 K.W. Standard Navy Panel Type Transmitter*, by Lester Ryan.

*Besides all the latest improvements in radio, and items of general interest to all radiomen, both amateur and professional.*

### RADIO RECEIVING SET WON'T RESPOND.

(4) D. M. Goff, Albany, N. Y., writes us at length enclosing photos, complaining about his radio receiving set not operating at all, even tho particularly well built and wired up.

A. 1. We must confess that it is not very pleasant to have such poor results as you mention from a large wireless receiving set constructed as shown in your photographs, etc., but we believe that you can get this outfit working right by the aid

of the suggestions contained in the following.

Your wiring diagram appears to be all right, and if you are not using the *buzzer test*, you should of course do so, in order to properly adjust the detectors to their greatest sensitivity. It sometimes occurs that the fixed or the variable condensers may become short-circuited, and they should be tested for this trouble by means of a buzzer and battery.

Regarding your aerial, which of course is quite important, you appear to have this arranged quite efficiently in that, as you state, it is situated at approximately right angles to the nearby high tension transmission lines. Secondly, in regard to your aerial, we would suggest that you employ 2 to 4 strands, spaced 4 to 5 feet apart or more with a considerable length in the flat-top section, giving this main section between spreaders a length of, say, 200 to 300 feet, and we are sure that this will bring you results; and also of course the higher you can get the aerial, the better. We do not advise extra long lead-ins, but do not believe that this will become necessary in your case.

You might also try a looped aerial. We know from experience as well as from that of a great many of our readers, that a long aerial will give good results for receiving; and some of our amateur friends have used a 2 to 4 strand aerial as long as 300 to 400 feet with great success, and some of them have even used a single strand with a length, as just mentioned, very successfully.

Direct current lighting service in houses does not ordinarily have any effect on radio instruments.

### RADIO ANTENNA-WAVE LENGTHS.

(5) O. J. Keeler, Boston, Mass., writes: Q. 1. What has the factor four to do with the wave length of a certain antenna?

A. 1. We cannot here go into theoretical discussion of just why or rather what the factor four has to do with the wave length of a radio aerial and its exact length proper; but suffice it to say, this factor is generally nearer 4.5 than it is 4, as far as it is our actual experience in measuring aerial wave lengths with a wave meter in the laboratory. We may also say that the wave length of a certain aerial is equal to about 4.5 times its actual length and height in meters; one meter being equivalent to 3.28 feet; and also the wave length of a simple tuning coil is equivalent to, roughly, four times the actual length of the wire on the coil.

Q. 2. Why can I not receive radio signals from a distant station when my set is first class in every respect?

A. 2. We have looked over your diagrams and believe you are not using a fixed or blocking condenser, and this of course should always be used, preferably across the telephone receivers, for the longest distance work.



**AERIAL LEAD-IN ARRANGEMENT.**

(6) O. T. Shonts, Cleveland, O., sends us sketches of lead-in wires brought down from the far and near end of his aerial flat-top. He wishes to know which is best.

A. 1. Perhaps the best method is to connect the lead-in wire to the end of the flat-top section nearest the instruments. Some have used the aerial arrangements you show with the lead-in joined to the far end of the flat-top, however, to increase their natural wave length period.

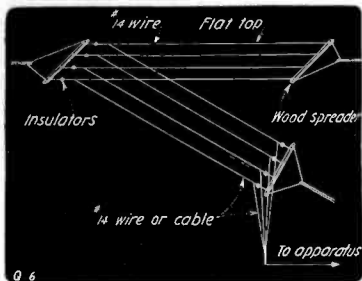

A Lead-In Arrangement That Is Effective In Giving Small Aerials a Greater Wave-length.

In this case, however, the lead-in strands should be brought down at a straight angle with the flat-top, as our sketch shows.

**USE OF TWO LOOSE COUPLERS.**

(7) Alfred B. Smith, Braintree, Ky., asks for hook-up for two loose couplers in a radio receiving station.

A. 1. Diagram is given herewith for connection of two loose couplers, with the other usual instruments. In this way the second loose coupler serves as a duplex loading coil in both primary and secondary

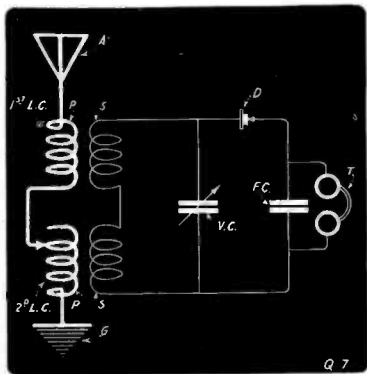

Two Loose Couplers in Series Will Push a Lot of Inaudible Sigs Into Your Phones.

of the second coupler with a wide range of coupling.

**VARIOMETER.**

(8) L. O. Master, Portland, Ore., inquires:

Q. 1. Can an ordinary loose coupler be used as a variometer?

A. 1. Yes, providing the windings of both the primary and secondary coils are wound with the same size wire and of a large size. The primary coil is connected in series with the secondary in such a manner that their magnetic fields oppose each other. Results obtained with such an arrangement will not be as efficient as if the coupling is varied at right angles to each other. In this case a large space is necessary in order to obtain the same amount of coupling as if the coils were turned at an angle to each other, as in the standard type variometer.

Q. 2. Would the sensitiveness of crystal detectors be increased if they were heated?

A. 2. Some rectifying crystals increase

their sensitiveness when they are slightly heated, such as molybdenum and silicon. This is done by placing the whole detector on a sand bath, which is heated either by an alcohol torch or a bunsen burner. It should not be heated more than about 5 to 8 degrees above the surrounding atmosphere.

**WAVE LENGTHS.**

(9) B. J. Walters, New Orleans, Louisiana, wishes to know:

Q. 1. What is the wave length in meters of an "L" type aerial 90 feet long, 50 feet high?

A. 1. Two hundred and fifty meters, if made with four strands.

Q. 2. How is the above figured?

A. 2. The wave length of an aerial is determined by knowing two factors; namely its inductance and capacity. These are determined either by calculation or actual measurement. In the former case, the dimensions of the antenna must be known and substituted in the following equation:

$$W = 59.6 \sqrt{L \times C}$$

Where:—W=wave lengths in meters  
L=inductance in henries  
C=capacity in microfarads.

The answer to Question 1 was obtained from a curve which shows the wave length of a four-wire antenna, having different altitudes and lengths. The curve was plotted from Dr. Austin's formulæ and is quite exact.

**AUDION CURRENT.**

(10) N. C. Paull, Los Angeles, Cal. inquires:

Q. 1. Can the direct current of 80 volts, 4 amperes, developed by an alternating current rectifier be used in place of the flashlight cells of the "B" battery and the storage battery of the "A" battery of an Audion when used in series with proper resistance?

A. 1. We are very doubtful if you can use the direct current obtained from a rectifier for the high potential current, as the current obtained from such a device is somewhat pulsating and not truly direct.

Q. 2. Is the exhaustion of an Audion bulb necessary for it to rectify or simply to prevent the oxidation of the filament?

A. 2. The exhaustion of an Audion bulb is necessary in order to obtain rectification, and also to prevent the oxidation of the filament when lighted.

**CARBORUNDUM.**

(11) P. Fletcher, Richmond, Va., inquires:

Q. 1. How is ordinary carborundum made, and give the chemical reaction?

A. 1. The material is made in an electric furnace from a mixture of sand, coke, sawdust and salt. The real action is in the sand, which is an oxide of silicon SiO<sub>2</sub>, often called silica. The mixture facilitates the escape of gases. The salt seems to act as a sort of flux. At the high temperature the silica is dissociated, the silicon melting with carbon (from the burned sawdust) to form carbide of silicon SiC, and its oxygen uniting with other carbon to form carbon monoxide CO, which then unites with more oxygen from the air, and burns into carbonic acid gas CO<sub>2</sub>. The chemical reaction as follows: SiO<sub>2</sub>+3C=SiC+2CO. The carbide of silicon SiC or carborundum forms a small mass of thin crystals having beautiful colors. These are crushed and made into various shapes for abrasives.

Q. 2. What is a "bug" cut-out?  
A. 2. Bug cut-outs are small single pole cut-outs for placing in cramped and awkward places, such as in electric lighting fixtures where a regular fuse block cannot be used. Their use is practically prohibited to-day.

**TUNING COIL.**

(12) U. N. B., Houston, Texas, desires:

Q. 1. The wavelength of a tuning coil 4 1/2 inches in diameter and wound eleven inches with No. 24 enameled copper wire.

A. 1. The wavelength of this coil is approximately 795 meters.

Q. 2. If an amateur has some electrical instruments that he made himself, would he have to take out any kind of a license before he could sell them?

A. 2. No.

**STEP-DOWN TRANSFORMER DATA.**

(13) Geo. Chester, East Cleveland, Ohio, asks:

Q. 1. Is there any way of hooking up two or three single or double slide tuning coils so as to make them as efficient as a loose coupler?

A. 1. The diagram herewith shows how to connect a three slide tuner so as to give results equal to that of a loose coupler as far as tuning is concerned.

Q. 2. If so, would the wave length of the above be the combined wave length of the included coils?

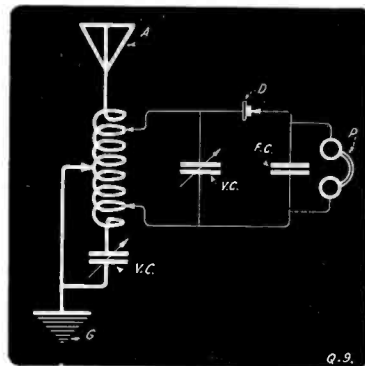

How to Squeeze Most "Juice" Out of a Three-slide Tuning Coil.

A. 2. Yes. The wave length would depend also upon the size of the coils and upon the shunt capacities therein.

**ULTRA-AUDION.**

(14) A. Medford, London, England, wants:

Q. 1. A connection for an Ultra-Audion?

A. 1. The diagram herewith shows the connections.

Q. 2. What crystal detector do you consider the best in connection with a single step Audion amplifier?

A. 2. Practically any of the well-known crystal detectors can be used.

Q. 3. Should the illumination intensities of filaments of a two-step amplifier be similar?

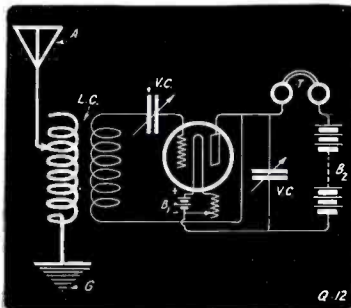

The Ultra-Audion Hook-up Shown is Fine for Receiving from Undamped Stations.

A. 3. The intensity of the first filament should be lower than the second. This can be determined by experiment as different Audions have different characteristics.

## HALCUN BAKELITE AUDION PANEL

A die molded panel. 5" by 9"  $\frac{3}{8}$ " thick. A beautiful permanent glossy black. Wires and all connections molded right into the panel, entirely concealed, impossible to corrode or become loosened. Switches all of the bearing type large shafts to prevent wear.

All metal parts nickelled. Connections arranged for damped spark, undamped arc, regenerative and ultra connections. There is nothing like this panel on the market. It is a quality article thruout. Other manufacturers ask more for wood and thin sheet panels.

The Halcun panel in  $\frac{3}{8}$ " thick with a beveled edge provided with supporting brackets. Price, less bulb, prepaid. \$12.50

Our big full line catalogue 6c

**HALCUN RADIO CO.** 437 Market St. San Francisco, Cal.

## Western Experimenters

Buy your apparatus and parts in the West and save money. We have the largest stock on the Pacific Coast and sell at Eastern prices. A full stock of HALCUN and MURDOCK apparatus always on hand. BRANDES wireless receivers, etc. In addition to our own line of highgrade, long and short wave tuners, Regenerative receivers, and Wireless Telephone apparatus for amateur use. Our part list contains everything for the man who desires to build his own equipment. Complete sets of any type or size built to your own design. Just send us a rough sketch and let us quote you prices. We can save you money.

**SPECIAL INTRODUCTORY OFFER.**—Complete parts for our \$15.50 Audion Panel ready to assemble consisting of genuine Bakelite panel cut to size and all holes drilled, switches, contacts, stops, binding posts, back-mounted rheostat, wire, and line-print of instructions. Arranged for reception of damped and undamped signals.

Complete parts ..... \$5.85

Send stamp for our complete catalog.

**WESTERN RADIO LABORATORIES**  
New Call Building,  
74 New Montgomery St.,  
SAN FRANCISCO, CALIF.

## BOYS Build and Fly Your Own Training Plane

Train yourself in Aviation. Be an Amateur Aviator with an Aeroplane of your own. Learn how Aeroplanes are built; learn the principles of construction, operation and control. We sell IDEAL Accurate Scale Drawings, and Building and Flying Instructions which show you how to build a perfect Model Aeroplane, 3 ft. size, that will rise from the ground by its own power and fly like a big one. Send now for the Drawings and Instructions for the one you want to build.

**Drawings and Instruction for**

Curtiss Military Tractor	Taube Monoplane	<b>25c</b> EACH Set of 7 \$1.50 postpaid
Bleriot Monoplane	Curtiss Flying Boat	
Nieuport Monoplane	Wright Biplane	
Curtiss Peeli Racer		

Ideal Model Aeroplane Catalog R 5c—None Free

**IDEAL AIRPLANE & SUPPLY COMPANY**  
154-161 Wooster St., New York City

## TELEGRAPHY

Both wire and wireless, and Station Agency taught thoroughly and quickly. **BIG WAGES NOW PAID**, some of our recent graduates procuring \$138.00 per month to start. Great opportunities for advancement. Our school the oldest and largest—annual enrollment 600 students. Endorsed by railway, telegraph, wireless and government officials. Expenses low—chance to earn part. Catalog free. Write.

**DODGE INSTITUTE, 26th St. Valparaiso, Ind.**

**WIRELESS TELEGRAPHY SET**  
Just as the cat shows it. Fine for learning telegraphy or for a private line. With code and full instructions. \$8.00

**WIRELESS PRACTICE SET**  
The first need of every wireless amateur. High pitch buzzer and key for learning wireless code. Also for test buzzer. \$1.00

**BLINKER PRACTICE SET**  
For learning the visual code. \$1.00

Any two of above sets may be used for a short line between nearby houses, etc. Send postage for 1 lb. Ask for catalog R.

**READ THE CLASSIFIED ADS. ON PAGE 48**

**AUDION AMPLIFIER.**  
(15.) H. Schonwald, Blackwell, Oklahoma, writes:  
Q. 1. I hear that you will give information to Radio "bugs." If that is so, would

A. 1. It does make a difference. Opposing the windings on a receiving transformer generally chokes signals. On high waves the choking effect is the more deadly.  
Q. 2. Would better results be obtained if

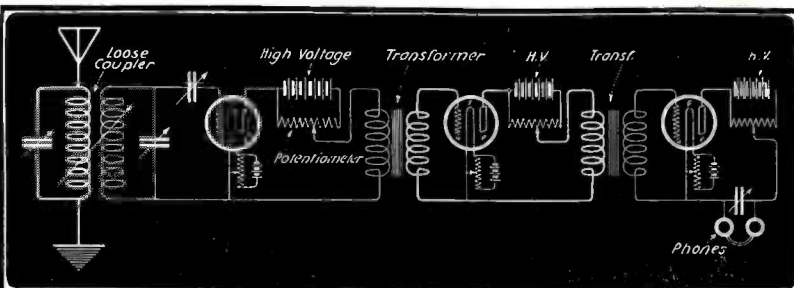

A "Cascade" Arrangement of Three Audions That Will Make a New Yorker with a Sixty-Foot Aerial Hear China and the South Pole.

you please give me the diagram for the "two-step amplifier?"

A. 1. Diagram for two-step amplifier herewith:

Q. 2. Is the Audion bulb with the two wings any better than the single-winged one? If so, how are the two-winged audions connected so as to form a two-step amplifier?

A. 2. Subjected to the hard usage and strain imposed upon radio receptors during the Great War, it was proven that the doubled element vacuum tubes were the most satisfactory. In the types in common use, there is but one conductor to both grids or both plates. The diagram for amplifications is therefore the same as for the other type of tube.

**WAVE LENGTH QUERIES.**

(16.) P. Langman, Seattle, Wash., writes:  
Q. 1. What is the natural wave length of my aerial, composed of four wires 175 feet long, elevation 100 feet from the ground? The wires are separated from each other by a distance of 2 feet.

A. 1. The natural wave length of your antenna is 530 meters.

Q. 2. What is the advantage of a loose coupler over a tuning coil?

A. 2. Sharper tuning is obtained with the use of an inductively coupled tuner.

Q. 3. What is the formula for obtaining the frequency generated by a Poulsen arc?

A. 3. The formula is—  
$$F = \frac{5.033 \times 10^6}{\sqrt{\text{Cap. M.F.} \times \text{Ind. Cms.}}}$$
  
where: F is frequency of oscillations in cycles per second.

**TESLA COIL.**

(17.) Bruce Hinds, Barberton, Ohio, requests information as to whether:

Q. 1. A 3-inch spark coil will be large enough to operate a Tesla coil whose primary is ten inches in diameter wound with  $\frac{1}{2}$ -inch copper ribbon, the secondary of which is twelve inches in length, wound with 300 turns of No. 30 wire; if it is not, what size closed core transformer is necessary?

A. 1. The spark coil will be sufficient to operate the Tesla coil.

Q. 2. What is the approximately secondary voltage of a 10-inch Tesla coil?

A. 2. Close to one million volts.

Q. 3. Where can I procure German silver wire?

A. 3. Driver Harris Electrical Co., Harrison, N. J.

**LOOSE COUPLERS.**

(18.) J. E. Bousquet, New Orleans, La., inquires:

Q. 1. Does it make any difference if the primary and secondary windings of a loose-coupler do not run in the same direction, that is, they oppose each other?

the primary of a loose-coupler were wound with ordinary bell wire, which is about No. 18 or 16, and the secondary with No. 24.

A. 2. No hard and fast rule can be laid down for the winding of loose-couplers. The size of the wire to be used depends upon the length of the coil, the covering of the wire, the coil's diameter, the wave-lengths it is desired to receive and the other instruments used in conjunction with the coupler. Your combination will work, but try No. 20 or 22 for the primary.

**RECEIVING HOOK-UP.**

(19.) F. Start, Toronto, Canada, requests:  
Q. 1. A method of connecting the following instruments: One small tuning coil, one loading coil, one loose-coupler, a galena detector, fixed condenser and a pair of phones.

A. 1. The diagram given herewith shows a method of connection which makes use of the tuner as a loading inductance for the secondary circuit of the set. If this is not desired, the coil may be hooked-up in series with the loading coil and the antenna to further increase the wave length range of the set. Placing the loading coils in both the primary and secondary circuits and in inductive relation to each other gives excellent results.

Q. 2. What instruments would increase the efficiency of the above apparatus?

A. 2. The only suggestion for increased efficiency that can be made is the inclusion

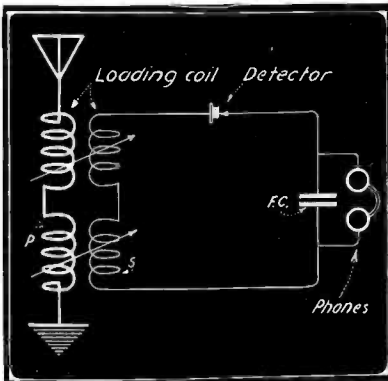

Putting "Pep" into a Receiving Set by Coupling Primary and Secondary Leaders.

of a variable condenser shunted across the terminals of the secondary of the loose-coupler. This makes for finer tuning.

Q. 3. Where can I procure instructions for making the instruments required and described in Question 2?

A. 3. We would not advise that you make your own variable condenser unless you own very fine tools.



## Transatlantic Radio Reception

(Continued from page 9)

pyrites. There is in this mine a vertical shaft 1000 feet (305 meters) deep. A series of preliminary comparative tests was made at this mine in April, and a more complete series of experiments was carried out in the latter part of July. A vertical insulated wire, approximately 1000 feet long, was suspended in this shaft, and a receiving set connected to the upper end, various earth connections being tried, such as steam and water pipes in contact with moist earth.

For a basis of comparison, an antenna consisting of a single horizontal wire, 1000 feet long, was extended over the ground to the southwest from the mine entrance, and supported on trees high enough above the earth to clear the surface vegetation; the maximum height of this wire did not exceed 4 feet (1.2 meters).

The receiving set was also connected to the lower end of the pendant wire, earth connection being made to piping at the bottom of the mine. Under the above conditions signals from Lyons (YN), France, were heard loud enough to be identified. Signals from several high power American stations were heard with comparatively high audibilities when the receiving apparatus was connected to either the upper or lower end of the pendant wire.

(Communicated by Major General George O. Squire, Chief Signal Officer, U. S. Army, to the Franklin Institute.) (Excerpted)

## THE AUDION AND THE RADIO AMATEUR

(Continued from page 6)

Edgar Allen Poe, in his "Thousandth and First Tale," once showed how far more wonderful and incredible were the "modern miracles" of his day than the wildest imaginings of the old Arabian story-tellers. Yet Poe lived in a primitive and prosaic day compared to ours. What would he have said had one told him that a whisper spoken in Washington could be heard throughout a large room in Paris, and that without so much as a wire between the cities; or that a man flying above the clouds could address in stentorian tones a vast throng on the earth, far beyond his vision, while euhemerides of silence intervened.

And all of this is made possible by a little lamp and some zinc cans containing damp powder. Compared to these actual wonders, does not the simple old story of Aladdin's lamp and its obedient genii seem like a very tame reality? Yet this little lamp is to-day everybody's servant. Every amateur can become Aladdin. Rub the audion lamp in the proper fashion, bombard it's *trades* with electrons and a million tiny genii will fly with the wings of light to the ends of the earth to convey your message.

Of course, this is figuratively speaking. As a matter of fact, the earth has no ends, neither has any amateur as yet an oscillation or collection of such sufficiently powerful to transmit his voice to the well known Antipodes. However, the wonders which you, every one of you, can actually make the audion perform, either as a detector, a heterodyner, an amplifier of high or low frequency currents, (wire or wireless) an oscillation generator of low or high frequency currents, for radio or for music, or as a voice-controlled "modulator," to mediate, in accordance with speech, the radiated energy from another bulb—all these wonderful and useful things every one of you can experiment upon and achieve, with one or two audion bulbs.

When I consider what toys and play things the studios had of to-day has at his disposal, what unlimited possibilities for investigation and instruction fraught with boyish delight, the delight of discovery mingled with the joy of construction and achievement, I almost regret that my own boyhood did not fall in this present era

# Wireless Receiving Ban Raised

## MESCO WIRELESS PRACTICE SET



The Practice Set comprises a regular telegraph key, without circuit breaker, a special high pitch buzzer, one coil Red Seal Dry Battery, and four feet of green silk covered flexible cord.

The key and buzzer are mounted on a highly finished wood base, and three nickel plated binding posts are so connected that the set may be used for five different purposes.

List No. 42  
42 Telegraph Practice Set, with Battery and Cord ..... \$3.24  
Weights 4 lbs. packed.  
Price does not include postage.

## MESCO Combination Practice Set for Learning the Morse and Continental Visual and Audible Codes

This outfit is the only reliable instrument which will enable students to become proficient operators in the U. S. Naval Service, because it is equipped with a buzzer and miniature lamp enabling the user to master both the visual and audible signals quickly.

List No. 52—Practice Set with Red Seal Battery and Cord ..... \$4.05

Weights 4 lbs. packed. Price does not include postage.



## MESCO RADIO BUZZER



This buzzer maintains a constant note and is recommended as an exciter for checking wave meters where pure note and ample energy are required.

It consists of practically a closed circuit field of low reluctance, having a steel armature to which is riveted a strap supporting a movable contact. The armature tension is adjustable by means of a screw with a milled head large enough to be easily and permanently adjusted with the fingers. The stationary contact is adjusted by means of a similar screw. The magnet coils are connected in series with a total D. C. resistance of 3.9 ohms. Shunted across these coils is a resistance having a D. C. value of 3 ohms. This shunt eliminates all sparking such as occurs at the break on ordinary radio buzzers, and the energy saved thereby is transferred into an oscillating circuit connected to it, the result being that this buzzer as constructed radiates five times more energy than any other existing type. All connecting wires liable to be broken are eliminated. Contacts are of genuine platinum, which is essential in order to maintain a constant note. The parts are mounted on a bakelite base to insure consistency in operation.

Diameter 2 in., height 1 1/4 in. The cap is attached to the base by a bayonet joint.  
List No. 35  
35 Mesco Radio Buzzer ..... \$2.05

We carry a Large and Complete Line of Standard Wireless Material Recognized by Experts as such with Competent Experienced Wireless Attendants in Charge

## Send for the New Edition of Our Catalog M28

It is pocket size, contains 264 pages, with over 1,000 illustrations, and describes in plain, clear language all about Bells, Push Buttons, Batteries, Telephone and Wireless Telegraph Material, Electric Toys, Burglar and Fire Alarm Contrivances, Electric Call Bells, Electric Alarm Clocks, Medical Batteries, Motor Boat Horns, Electrically Heated Apparatus, Battery Connectors, Switches, Battery Gauges, Wireless Telegraph Instruments, Ignition Supplies, etc.

## Manhattan Electrical Supply Co., Inc.

17 Park Place, New York, N. Y.

CHICAGO  
114 S. Welle St.

ST. LOUIS  
1106 Pine St.

SAN FRANCISCO OFFICE: 604 Mission St.

## TWO EXCEPTIONAL BOOKS

### Experimental Wireless Construction

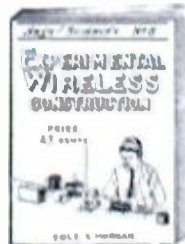

tells you in plain language and in detail with working drawings how to make your own wireless apparatus. Loose couplers, fixed and variable condensers, spark coils, helices, etc., also the aerial. 86 pages—93 illustrations.

Lessons in wireless telegraphy. Third edition explains each instrument and principle used in wireless so that you can understand it. Everything from aereals to vacuum tubes. Don't buy apparatus until you understand what you are buying. 72 Pages—66 illustrations.

THESE BOOKS WILL SAVE YOU MANY TIMES THEIR COST!  
Price 25 cents each. Postpaid Anywhere

COLE & MORGAN, Inc., Publishers P. O. Box 1471, New York, N. Y.

Send stamp for list of up to date books



## COMMERCIAL WIRELESS

Splendid opportunities now in the MERCHANT MARINE for Wireless Operators. Salaries now being paid—Junior Operators, \$85 per month; Chief Operators, \$110; food and quarters included. Equivalent ashore from \$35 to \$40 per week. Interesting and fascinating work. Our graduates in all parts of the world as operators, instructors, inspectors, etc., etc. Students from all over the country. If you are interested in Commercial Radio let the EASTERN RADIO INSTITUTE train you. Endorsed by Marconi and Government officials. SUMMER COURSES. Day or evening start June 30th. Enroll for this date if possible or any Monday thereafter. Send for prospectus.

**EASTERN RADIO INSTITUTE**  
899B Boylston St. Boston, Mass.



## U. S. NAVY FLYING BOATS HAVE CROSSED THE OCEAN

Build your own flying boat from our superior working blue prints and materials. The ONLY Hydair Flying Boat on the market that will actually rise from the water and fly under its own power. 2 sheet working blue print 1/2 actual size with full building and flying instructions. \$1.00 postpaid in U. S. Complete materials to build this wonderful flying boat with full building and flying instructions including two special hand carved propellers. \$5.00 postpaid in U. S. Canada 25c extra.

Blue prints of the following flying models, 1/2 actual size, with full building and flying instructions, 50c per copy postpaid in U. S.

BLERIOT RACER—600 Foot Flyer  
MANHATTAN RACER—2000 Foot Flyer  
MONTAUK FLYER—Files 500 Feet  
Complete set of 4 working blue prints \$2

**HEC AEROPLANE CO.**  
Flying Boat Dept. 6 W. 48th St., New York, N. Y.

**ADVERTISING PAYS**  
It pays the man who advertises and it pays the man who answers ads. For advertising rates in the Radio News, address Advertising Dept., 233 Fulton St., N. Y.

### Experiments on Ground Antenna With Their Relation to Atmospherics

(Continued from page 13)

encountered strong earth currents when not using stopping condensers. It was difficult for me to separate the "sneak" currents from the car lines, from the true earth currents, however frequent opportunities arose when the power was off. I have a

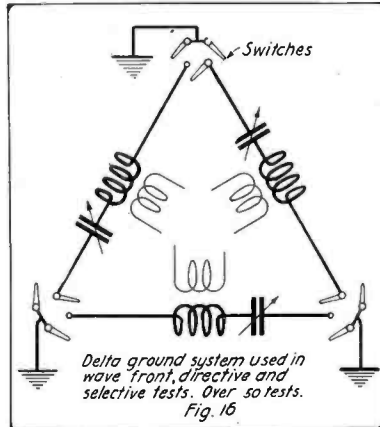

small astronomical telescope and have established to my own satisfaction the connection between earth currents and solar disturbances, especially when facule and spots are near the central meridian of the sun. I wanted to find out if these earth currents affected the audibility of weak signals. Results seemed to indicate that they did. I found also that when signals were weak on a bent L they were likewise weak on a ground antenna, which seemed to indicate that a bent L antenna under all conditions is a form of ground antenna statically coupled with the earth. I succeeded in transmitting signals a short distance using these earth currents with a key and "Chopper" cut in.

My system of observing these earth currents consisted in cutting a millimeter reading to a ground antenna of form Fig. 4 without condenser or inductance. I replaced this millimeter by a hot wire ammeter, or even a common 8

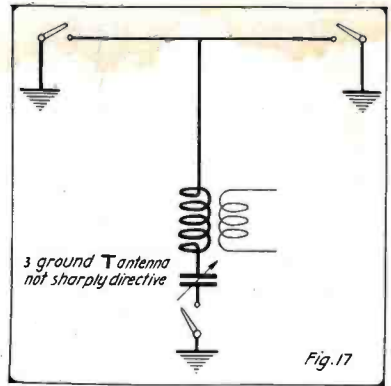

C.P. lamp. It made a fine radiation meter for radio-telephone as it showed the true ground radiation. I used this pilot system for years in connection with Radio Phone researches. An 8 C.P. 110 V. lamp was cut into a wire near the end grounded in my station on the roof of the 7-story steel building, thence running down the face of the building and along the roofs of low metal-roofed buildings to the Imperial

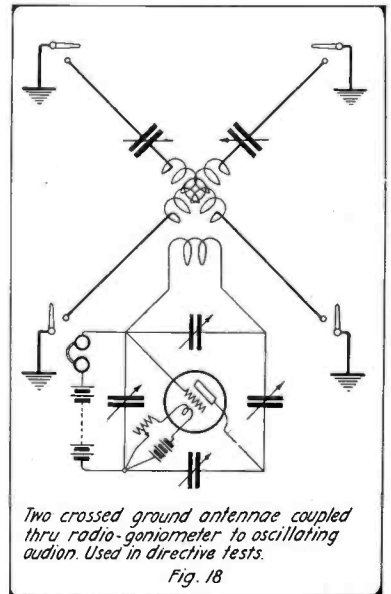

# THE NEW YORK ELECTRICAL SCHOOL



THE N. Y. ELECTRICAL SCHOOL is the pioneer and premier school of the "Learn by Doing" method. When you have completed this Course you shall be fully qualified to handle ALL branches of Electrical Industry. The equipment of this School is unequalled and up-to-the-minute. No preparation needed to become a "learner" in this school. You can start to learn on any day of any week throughout the whole year. Send for catalogue.

**OPEN ALL SUMMER**  
**NEW YORK ELECTRICAL SCHOOL**  
29-31 West 17th St. New York City

You benefit by mentioning the "Radio Amateur News" when writing to advertisers.



Hotel, where it was soldered to an iron pipe. The steady glow of this lamp when my arc transmitter was on showed the true ground radiation. When a phonograph

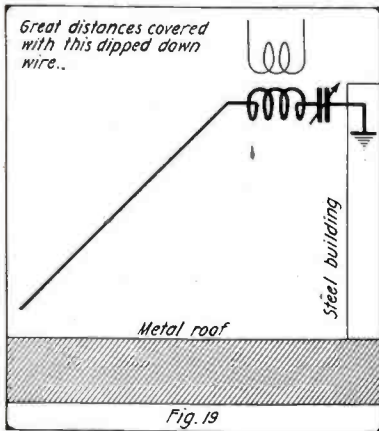

was placed in front of the voice modulator of the Radio-Phone this grounded lamp danced constantly to the music, showing in a striking manner the true "voice currents" passing thru the earth. I used this as an indicator of the true voice modulation. The use of the lamp instead of the meter was suggested by Alfred H. Cohen, Esq., of

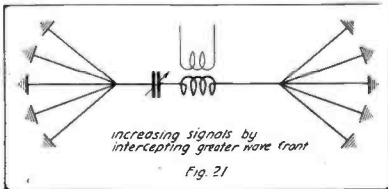

Fruitvale, California, a clever and paint-taking research worker in the field of Radio

In this review of my work I have endeavored to give such facts as may be of use to radio enthusiasts who care to enter this fascinating field of research. The world is very large and there is room for us all, even those of us who are the lesser lights. Let us not forget that great honor is due to the great Tesla, who with true prophetic insight first turned our attention to the possibilities of the whole earth as a conductor of radio-energy, and to Kietz, Zehnder, Count Arco and others with their contributions to this great subject, and to Mr. Rogers and his co-workers, congratulations on the honor of first publicly disclosing a practical working system of ground radio reception.

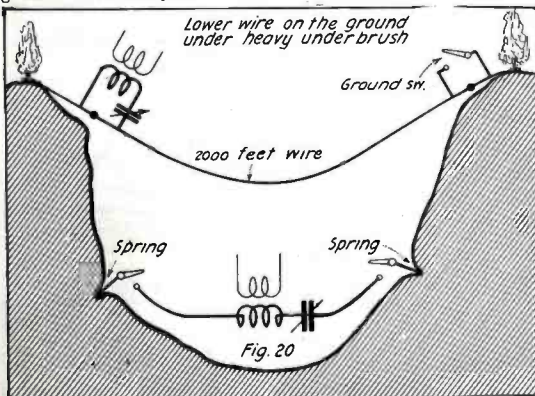

You benefit by mentioning the "Radio Amateur News" when writing to advertisers.

## 4 Famous Books!

EACH ONE  
A BIG  
SUCCESS!

THE  
BOOKS  
YOU  
MUST  
HAVE

### Wireless Course in 20 Lessons

By S. Gernsback, A. Lescarboura and H. W. Secor. E. E.

A course that tells you everything you can possibly want to know about "Wireless" starting off in lesson No. 1 by explaining the Principles of Electricity. The second and third lessons are devoted to magnetism, motors, generators and wiring. And then, by simple, easy stages, this wonderful Course takes you into "Wireless". The mysteries of "Wireless" are unfolded to you by the use of such simple-language so skillfully used that of necessity you must understand every word. The subject is not treated superficially, however, for there is a whole lesson devoted to the Theory and Mathematics of this epoch making subject. To lend charm to the Course, the last lesson (No. 20) is devoted to a history of Wireless and the men who developed it.

Size of book is 7 x 10 1/4 in., 160 pages, 350 Illustrations, 30 tables.  
Flexible cloth cover...per copy \$5.00  
Stiff cloth cover...per copy 1.00  
Postpaid

### Experimental Electricity Course in 20 Lessons

By S. Gernsback and H. W. Secor. E. E.

A Course of the theory and practice of Electricity for the Experimenters. This is undoubtedly one of the most complete and comprehensive treatises of this special subject ever published. The book is written by the same authors as the famous "Wireless Course in 20 Lessons".

Every phase of experimental electricity is treated comprehensively in plain English. It is a book not only for the beginner but for every experimenter and student of Electricity. New Experiments are described and explained and nearly every application of Electricity in modern life is given in simple language.

The book contains 128 pages and more than 400 illustrations.

Flexible cloth cover...per copy \$5.00  
Stiff cloth cover...per copy 1.00  
Postpaid

### No. 1. How to Make Wireless Sending Apparatus

No. 2. How to Make Wireless Receiving Apparatus  
By 20 Radio Experts.

#### Two Remarkable Books

Book No. 1 contains 100 pages, size 7 x 5 in. and 88 illustrations, paper bound.  
Book No. 2 contains 100 pages, size 7 x 5 in. and 90 illustrations, paper bound.

These two books have been written and published entirely for the wireless enthusiast who wants to make his own radio apparatus. They contain more information on how to make it than any other books we know of. Only strictly modern radio apparatus are described in these books and the illustrations and descriptions are so clear and simple that no trouble will be experienced in making the instruments.

Book No. 1—How to make Wireless Sending Apparatus .....25c  
Book No. 2—How to make Wireless Receiving Apparatus .....25c  
Postpaid

THE EXPERIMENTER PUBL. CO. Book Dept. 233 Fulton St., New York

### WEST INDIES WIRELESS TO U. S.

Commercial wireless service between St. Thomas, St. Croix, San Juan, Santo Domingo and Port-au-Prince and the United States has been opened through the naval radio station at Guantanamo and cable from that city to the United States. Twenty cents a word will be charged, plus cable charges from Guantanamo to the United States.

### SIX CENTS IN STAMPS

will bring you the new HALCUN catalogue, and place your name on our permanent mailing list for one year insuring you of every new bulletin that we issue.

HALCUN RADIO CO. 437 Market St. San Francisco, Cal.

### Subscribe to the Livest Radio Magazine The RADIO AMATEUR NEWS

Offers you up-to-the-minute wireless articles exclusively. Published for amateurs, about amateurs.

\$1.50 a year

Send all subscriptions to  
EXPERIMENTER PUBLISHING COMPANY  
231 Fulton St., New York City

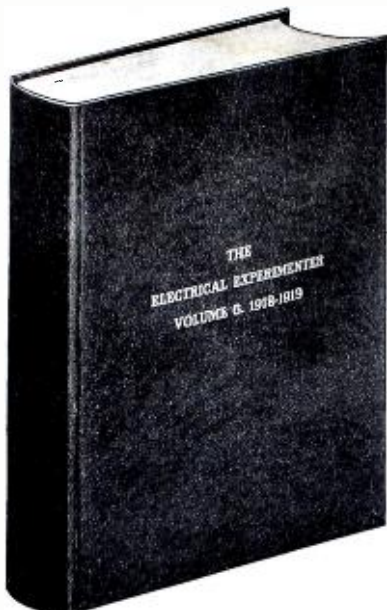

# This Book Cost \$34,000

1200 Authors Contributed

Our Bound Volume No. 6 contains a goldmine of electrical and scientific information. No such value has ever been offered before for so low a price. A marvelous cyclopedia of electricity. A reference book of authentic information not found in any other book in print.

Volume contains twelve numbers of the "Electrical Experimenter" magazine—May, 1918 to April, 1919, inclusive. There are 984 pages, 2,110 complete articles, 1,908 illustrations, 369 questions and answers. Sizes, 12" high; 9" wide; 2" thick.

A world of electrical information; the entire electrical progress for one year; the greatest reference book on current "Wireless"—all at a price within reach of everybody. Mind you, the book is durably bound in attractive green linen with heavy covers. Letters stamped in gold. You will be proud to have it in your library. We have only 600 copies, therefore be sure and order to-day. Shipping weight 8 lbs. Add a sufficient amount for postage, otherwise we must ship by express.

**\$3<sup>00</sup>**

add postage for 8 lbs.

Positively the Greatest Electrical book bargain in the World. We ship AT ONCE. Order today to avoid delay.

EXPERIMENTER PUBLISHING COMPANY, Inc.  
Book Department

233 Fulton Street - New York, N. Y.  
R. A. N. 7-19

Fill in—Tear out—and Mail  
Gentlemen:  
Please send at once your Volume No. 6 as advertised, for which I enclose herewith \$.....  
I also enclose \$..... extra for postage.  
Name .....  
Address .....

## Design of Rogers Ground Antennae

(Continued from page 10)

turbances and static. Upon reconnecting the ground wires, the signals would "come in" with ear-splitting loudness, and the audibility meter would show practically no increase in static. It is safe to say that this will never be said for an elevated aerial.

No trouble was experienced in receiving from the giant long wave spark stations Canarvon (BZZ) and Bolinas (KET) if loose tickler coupling was employed.

Directional tests have been made on POZ (Nauen, Germany) with a 2,000 foot length of insulated wire laid on the ground in a northeasterly direction, without the trouble of covering it over. Very good signals were obtained.

There seems to be no advantage in increasing the number of conductors.

For the proper tuning of the primary the variable series condenser is a necessity. The best all around hook-up is the regular audion with inductive coupling between the plate and grid. The tickler coil should be wound with about  $\frac{3}{4}$  as many turns as the secondary. It is not out of place here to advise the present day Amateur to adopt the calibrated secondary condenser and to do away with the large clumsy loading coils so evident in many earlier stations. He will see before long that the latest Amateur instruments will come forth with banked inductances and condensers with wave-length calibrations. No longer will his set sing a merry tune every time he brings his hand near it.

Experimenting with the ground wire system is not all "milk and honey." At times the absence of signals is disheartening.

At the best all attempts at transmission will be very unsatisfactory due to the many insulation troubles which have held up all work along these lines for some time. One thing the Radio Amateur can be thankful for, however, is that the invention of Mr. John Harris Rogers opens to him a vast new field of experimentation and may, as a recent article points out, lead us nearer to the wireless transmission of power so much talked about by Nikola Tesla.

## A New High-Tone Radio Buzzer

(Continued from page 19)

buzzer, which lasts a short time and forms a conducting path to keep the circuit closed. The majority of the energy of the field is thus dissipated in the form of light and heat. The buzzer thus forms a shunt for the condenser and prevents all the energy of the magnetic field  $I$  from being transferred to the electrostatic field of  $C$ . Therefore, depending on how quickly the break occurs, more or less of the energy of  $I$  flows to  $C$  and back again, setting up high frequency oscillations damped out by the resistance in the circuit.

Now if we suppose that the resistance  $R$  is across the magnets  $M$ , its value being sufficiently high so that enough current flows in the magnets to pull over the armature, then when the break occurs the energy of the buzzer's magnetic field is used up in this resistance and the circuit is opened suddenly and without sparking. This allows the energy of  $I$  to flow to  $C$  and back, thus permitting a larger current to be produced and to last a longer time, since the only loss of energy is in the resistance of this circuit, which is kept small. This assumes that the dielectric of the condenser is air, which is usually the case. The sudden break is also of value in producing a high

voltage in oscillation circuit, as it depends upon the time rate of change of the flux. It is obvious that there would be a best resistance for  $R$  for a given buzzer, because if the value is too small, not enough current can flow through the buzzer magnets, while if the resistance is too high, the contacts carry part of the energy and sparking results at the contacts.

Hence it follows that the shunting of the buzzer magnets causes an increase in the output or efficiency of a buzzer, as is clearly indicated in figure 3; and at the same time, this practice enables the buzzer to operate without the contacts burning and eventually sticking. Since the present buzzer is freer from sparking at the contacts, it is all the more suitable for wavemeter work wherein excitation from contact sparking is to be avoided for accurate work. In view of the fact that this instrument is now available to amateurs, it will be used extensively for all radio purposes and in particular for varying the grid potential on a valve transmitting set.

## Radio Translator

(Continued from page 16)

General Electric Company. X impulses affect the system, giving sufficiently marked deflections for quantitative measurements.

Owing to the fact that the device was not developed until about December 1, samples could not be constructed and used for

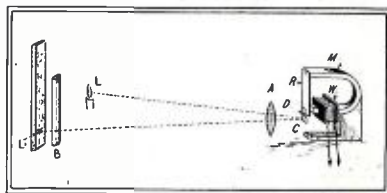

The New Radio Audiometer of Marvellous Sensitiveness.

making quantitative measurements at the special receiving stations. However, the results secured in tests made at the Field Laboratory on Transatlantic signals indicate that the device gives promise of being a more satisfactory means of measuring signal and X audibility than the shunted telephone method. Steps are also being taken to protect the Government in use of this apparatus as a recording device.

(Communicated by Major General George O. Sauter, Chief Signal Officer, U. S. Army, to the Franklin Institute.)

## A HOT-WIRE AMMETER.

(Continued from page 30)

Also, a light needle should be used, and the scale placed as near as possible to the needle for accurate work.

The action of the meter is as follows: The current heats the resistance wire, which stretches, allowing the spring to wind up thread and turn the needle to the right. The greater the current, the greater the slack, and the greater the deflection. On cooling the wire contracts, thus pulling the needle back to zero.

## "LAP" WINDING.

(Continued from page 31)

B and C as shown at Fig. 2, following around and crossing as shown by the dotted turn E. F makes a turn coming out at F; the process is then repeated as was done with D. Figs. 2 and 3 show how this forms two layers, taking only half the length of tube required for the old single layer winding. I wish to state that we have read P. O. Z. in a certain port on the Atlantic coast in the day time with aeriols on other ships (grounded) in the vicinity.

Contributed by C. D. Short,  
Elec. R. U. S. N.

You benefit by mentioning the "Radio Amateur News" when writing to advertisers.



# FREE TO YOU!

## Read this Remarkable Offer!



**OFFER No. 1**

### Wireless Course

The most comprehensive Wireless Course ever printed. Contains 160 pages, 350 illustrations. Size of book 6 3/4" x 10". Very fine flexible cloth cover.

FREE with a year's subscription.

Add 5c for postage

**OFFER No. 2**

### Experimental Electricity Course

This masterpiece contains 160 pages, 400 illustrations. Size of book 5" x 9". Printed on extra thin paper, so book can be slipped into pocket. Handsome flexible cloth cover.

FREE with a year's subscription. Add 5c postage

**OFFER No. 3**

**How to Make Wireless Sending Apparatus**  
By 20 Radio Experts  
**How to Make Wireless Receiving Apparatus**  
By 20 Radio Constructors

These books are by far the most successful wireless books on the market. Size of each book 5" x 7", well bound on good book paper. Covers in two colors. We really cannot praise these books too highly. Each book contains 100 pages and from 88 to 90 illustrations. **BOTH** books FREE with a year's subscription. Add 5c for postage

This is a very limited offer. It may be withdrawn at any time, due to the tremendous cost of paper, which IS JUST DOUBLE WHAT IT WAS ONE YEAR AGO. We have only a limited supply of these fine books on hand; after they are gone we cannot reprint the books until conditions become normal again. **Now is your chance.**

The publishers of this journal have earned an enviable reputation of giving more than 100 cents' worth for each dollar spent with them. Profit by this liberal opportunity NOW; it may never be made again.

## HERE'S THE OFFER

Subscribe to RADIO AMATEUR NEWS for one year, at the regular subscription price of \$1.50 per year (Canada, foreign and New York City \$2.00) and we will send you either books shown in one of the above offers. If you subscribe for two years, two offers will be given, etc.

If you are a subscriber at present take advantage of this wonderful opportunity anyway. If you do, we will extend your present subscription.

*This Offer Limited.*

*Act Now.*

**EXPERIMENTER PUBLISHING COMPANY**  
223 FULTON STREET  
NEW YORK CITY

7-19

**FILL IN — TEAR OUT — AND MAIL**

Gentlemen: Please enter my subscription to the RADIO AMATEUR NEWS for the term of \_\_\_\_\_ year, for which I enclose herewith \$\_\_\_\_\_ You will also send me at once FREE your book, as per offer No. \_\_\_\_\_

Name \_\_\_\_\_

Address \_\_\_\_\_

*You benefit by mentioning the "Radio Amateur News" when writing to advertisers.*



## Opportunity Ad-lets

YOU will find many remarkable opportunities and real bargains in these columns. It will pay you to read and investigate the offerings made every month by reliable firms, dealers and amateurs from all over the country. No matter what you may be seeking, whether radio apparatus and supplies, the opportunity to make money, or anything else, you will find listed here the best and most attractive specials of the month.

Advertisements in this section two cents a word for each insertion. No advertisement for less than 20c accepted. Name and address must be included at the above rate. Cash should accompany all classified advertisements unless placed by an accredited advertising agency. Ten per cent discount for 6 issues, 20 per cent discount for 12 issues. Objectionable or misleading advertisements not accepted. Advertisements for the August issue must reach us not later than July 10.

EXPERIMENTER PUBLISHING CO., INC., 233 Fulton Street, New York, N. Y.

### Business Opportunities

\$30.00 a week evenings. I made it with a small mail-order business; continued my regular job daytime. Free Booklet tells how; 2 cents postage. Albert W. Scott, Cohoes, N. Y.

**Read Advertisers' Companion** if you want more money. Sample copy 10c. Jacobus, 1073 Sanford Ave., Irvington, N. J.

**Stamp names on key checks** spare time make as high as \$19 a hundred. Send 25c for sample and instructions; returned if required. Elct Keytag Co., Cohoes, N. Y.

**Patents for sale.** To buy or sell patents address Patent News R. Washington, D. C.; only inventors' newspaper published.

**Chiropractic—the new Profession.** You can learn and earn your way. Practitioners earning \$3,000.00 a year and upwards. Proficiency quickly acquired. Send card for information. Howard College, 515-25 S. Ashland Blvd., Chicago.

**\$10.00 a Day for Amateur Photographers.** Ten cents brings the plan which has been successfully operated. J. W. Bilodeau, Lyndonville, Vt. Dept. 199.

### Stamps & Coins

**Fortunes in Postage Stamps—Start stamp business of your own.** Send 50c for sample stock, worth \$1.50. M. Shedel, 29 Collahie St., Toronto, Canada.

**100 Different Stamps, 12c; 200, 27c.** Michaels, 5600 Prairie, Chicago.

**25 Old Siamese Stamps, 20c; 50 China-Japanese, 12c.** Philatelic Star, Madison, New York.

**Free Stamps to Approval Applicants.** Harland Burgett, 419 Spring St., Lima, O.

### Books

**What Every Draftsman Should Know.** Very useful booklet. Price 12c postpaid. Wack Booklet Co., 1043 Patten St., Philadelphia, Pa.

**Dear Reader—If Occult, New-Thought and Scientific books appeal to you, send for my catalog, it's free.** I have books on Personal Magnetism, Concentration, Spiritualism, Clairvoyance, Seership, Will, Mind, Hypnotism, Mesmerism, Character Reading, Healing, Mysticism, Success, Salesmanship, Mechanics, Entertainment, etc. A. W. Martens, R79, Burlington, Iowa.

**Nature Laws—Every married and engaged person should know.** Two volumes complete, 50c. Central Company, 599 Ninth Ave., New York.

**"Sincere Words,"** 1919 wonder booklet. Be healthy—know the surest way to success; 20c postpaid. "Success," 1943 Patten St., Philadelphia, Pa.

### Exchange

**Sell—1/2 K.W. Packard Transformer \$8, new Crystaloi detector, oscillation transformer, Murdock phones, 600 v. lighting and antenna switches, oil condenser, antenna wire (copper) and insulators, vibrating rectifier, accordion.** List free. Lowell P. Hoyt, Presque Isle, Maine.

**Wanted—Typewriter.** Have 2 1/2 feet plain and 20 feet plated 1/2 inch copper ribbon, condenser, three sectioned condenser, detector. Harold Miller, 4916 Austin Ave., Chicago, Ill.

**For Sale.** New guaranteed Audion, \$5.25; will be sold to first inquirer. C. Gillespie, 72 Woodward Ave., Buffalo, N. Y.

**Trade.** Electrical apparatus for 4000 coupler; Navy preferred, also variables. Edward Brown, East Marion, L. I., N. Y.

**For Sale.** Hawkin's Electrical Guides, Hike meter, 110-volt portable heater, two-cell medical battery, back copies of Electrical Experimenter, Wireless Age, Wireless World, Everyday Engineering. Earl C. Brown, 514 Virginia Avenue, Martinsburg, W. Va.

**For Sale.** Grebe, De Forest, General Radio and other apparatus. Please enclose stamp. Natalish, 68 West 50th Street, New York City.

### For Advertisers

Dollars will come your way when we prepare your advertising copy. Sales letters, \$2. Jacobus Advertising Service, 1073 Sanford Ave., Irvington, N. J.

### Formulas

**Invisible Inks.** 30 formulas, 15c. Horton P. Jones, Perry, Ia.

**20,000 Recipes and Formulas worth \$100.00 to anyone.** Price only \$1 postpaid. Clifford Camp Co., Clarendon, N. H.

**Formulas.** Resilvering mirrors, fish bait, how to make a hectograph, 10c. Each list 2c. W. Clifford, 634 W. Spruce St., Shamokin, Penn.

### Wireless

**We Fully Qualify You by Mail for the Government first-grade commercial license as a wireless operator, fitting you for positions in merchant marine or land stations.** Positions pay \$10 and living expenses, up to \$3,500 yearly. Our profit-sharing plan guarantees a saving of 10 per cent. on tuition to successful students and estimated saving of 50 per cent. Free post graduate course in our Washington school, the largest in America, where we have daily attendance averaging 200 students, expert Government instructors, and full equipment. Most thorough course. Illustrated catalogue and details of profit-sharing plan on request. Service Radio School, Dept. E, 902 Pa. Ave., Washington, D. C.

**Amateurs! Special seamless cardboard tubing for Receiving Transformers.** 5 in. and 3/8 in. outside diameter, 25c per foot; 6 in. diameter, 30c. Any length. Maier & Co., 335 East 93rd St., New York.

**Complete Receiving Sets, \$8.50, \$9.50 and up.** Instruments, parts, minerals. Circular for stamp. Inquiries invited. Jenkins, 943 Purchase St., Room 2, New Bedford, Mass.

**Radio Amateurs.** Now is the time to get your stations in readiness. Everything for the amateur. Send purple stamp for circular describing Standard apparatus only, at prices that will save you money. Crescent Wireless Supply Co., 1500 Lafayette Ave., Mattoon, Ill.

**Radio Apparatus of Quality—Manufactured to your own specifications.** Radio Engineering Company, Baltimore, Md.

**Now That We're Alive Again, Keep Alive by reading the "Aire News."** The "Aire News" is a monthly amateur radio magazine containing many novel departments and sure to please either the novice or expert as it contains live, peppy, simply written articles interesting to both. Yearly subscription \$1.50 or three months trial subscription 25c. Be progressive. Send your subscription, regular or trial, immediately and receive the "Reopening Issue" which will be a rip-roaring success. Delay means your missing much so act now and subscribe today. American Institute of Radio Engineering, Omaha, Neb.

**For Sale—Clapp-Eastham type E, 5 K. W. transformer, slightly damaged, \$100.00.** K. M. Briggs, 26 Albemarle St., Rochester, N. Y.

**Wanted—Five sections** Murdock moulded condenser in good condition. State price. Burle R. Jones, Muskogee, Okla.

### Help Wanted

**Wanted: Men, Women and Children** to take part in a Moving Picture Play. Honorably discharged soldiers of good figure, and good moral character are wanted, and many others, including artists, mechanics, and musicians, singers, etc. Those wishing to take part in this play should write for a special folder giving an outline of the play and characters needed with instructions how to apply for such position. Some may show such adaptability, and develop such good talent that they may become regular movie stars, and secure good paying positions by starting in this way. Send stamp for 8-page circular. Address John M. Biggs Co., Box 324, Chaitanooga, Tenn.

### Telegraphy

**Telegraphy (both Morse and Wireless) and Railway Accounting** taught thoroughly and quickly. Big salaries now paid. Great opportunities. Oldest and largest school; Est. 45 years; catalog free. Dodges Institute, 25th St., Valparaiso, Ind.

### Cameras

**Slightly Used Cameras—Bargains.** Send for list. Cameras exchanged and paired. L. Huber, 1146 Stebbins Ave., Bronx, New York.

### Health

**Tobacco or Snuff Habit cured** or no pay. \$1.00 if cured. Remedy sent on trial. Superba Co., S. B. Baltimore, Md

### Music

**Music? Buy direct and save money; 2 copies postpaid and pricelist, 15c (coin).** Hazeldine Music Co., 7115 34th Ave., Brooklyn, N. Y.

### For Men

**Dredge's Necktie Valet** removes wrinkles (without ironing) from neckties. Sample, 25c. 190-D Pilgrim, Highland Park, Mich.

### Tricks, Puzzles & Games

**Send dime for two tricks and Lists.** W. Woolley, Peoria, Ill., Dept. R.

**Magic—Entertain at home.** Tricks, puzzles, novelties. Big catalogue "B," 25c. Martinka & Co., Inc., Harry Houdini, President, 493 Sixth Ave., New York City.

**1000 Stage Tricks** with 500 illustrations. Catalogue, 15c; small catalogue free. Hornmann Magic Co., Sta. 6, 304 West 34th St., New York.

**Boys—Send 10c for the greatest magic trick book ever published—free trick.** Lindhorst Magic Shop, St. Louis, Mo.

### Scenery for Hire

**Collapsible Scenery for All Plays.** Amelia Grain, Philadelphia, Penn.

### Patent Attorneys

**Patents—My fee payable in monthly installments.** Send sketch for advice. Booklet free. Frank Fuller, Washington, D. C.

**Save Money—I will work out your complete patent application, including drawings, for \$25.** Ready for filing. H. E. Sener, Consulting Engineer, Patent Expert, 143 Broadway, New York.

### For Inventors

**Sell or Finance Inventions—Send dime for sample copy of Money-Talks Magazine.** 70-B Park Place, Newark, N. J.

**Inventors! Protect yourselves.** Record your idea before exposing it to anyone, even to me. Paul Klein, M.E., Consulting Engineer, Registered Patent Attorney, 21 Park Row, New York City.

### Electrical Supplies & Appliances

**Send 75c for guaranteed penlite flashlight; exact representation of a fountain pen.** Worth \$1.50. McLardie, Box 465, Dayton, Ohio.

**Electrical Photographic and chemical apparatus, motors, fans, switches, spark plugs.** Advise what you want or have for sale. H. C. Hancock, Bogota, N. J.

**Old Dry Batteries Renewed.** Guaranteed directions, 10c. McLardie, Box 465, Dayton, Ohio.

### Chemicals

**Chemicals in sets, \$13.50 to \$54.25.** Apparatus in sets, \$11.75 to \$55. Write for particulars. Ziegler Experimental Laboratory, Rochester, N. Y.

**June list and 10 formulas, 5c.** Erlenmeyer flask free with each \$2.50 order. Everything you need. Write us. Frane, Eureka, Ill., Dept. A.

### Postcards

**Five Prettiest Women Cards—Hand colored, 25c; camera bargain list free.** Chas. Durso, Dept. 50, 25 Mulberry St., New York City.

### Miscellaneous

**Marvelous! Our tabulated multiplication card dispenses with the mental process of multiplying.** Everything is down in figures, making accuracy always possible. Card is handy pocket size designed for instant use. Price only 10 cents (coin). Payment required with orders. Tabulated Information Card Co., 2040 Chestnut St., Philadelphia, Pa.

You benefit by mentioning the "Radio Amateur News" when writing to advertisers.





# BE A CERTIFICATED ELECTRICIAN

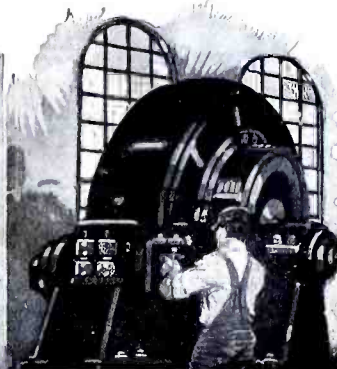
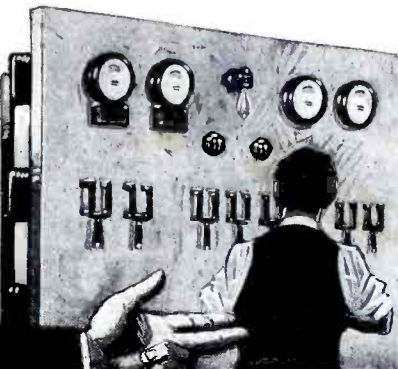

## I WILL TRAIN YOU AT HOME

### A REAL POSITION LIKE THIS—FOR YOU

The country needs thousands of trained, Certificated Electricians to fill good positions—and at big pay. It's all a matter of knowing how, and I will teach you by up-to-date, modern instruction. You can learn at home, without interfering with your regular work, by my highly successful method of *Home Instruction in Practical Electricity*.

**Prepare NOW and be ready in a few months to earn your \$46 to \$100 A WEEK**

*Send for this Book*

My book, "HOW TO BECOME AN EXPERT ELECTRICIAN," has started thousands of young men on the way to splendid success. A new edition of this has just been printed. I want every young man interested in Electricity to have a copy, and will send you one, ABSOLUTELY FREE AND PREPAID. Write me today.

### How I Train My Students

As Chief Engineer of the Chicago Engineering Works I know exactly the kind of training a man needs to enable him to get and hold good positions, and to earn big pay. I have trained hundreds of men who are holding splendid electrical jobs.

I give each of my students personal attention and a complete and thorough training. I give him a SPLENDID ELECTRICAL OUTFIT FREE, and much of the training is done by actual work. When my students graduate and receive their Certificate, they are ready for a real position. But *still more*, at any time you wish you can come to our splendidly equipped Electrical Shops for special training. No other school can give you this.

### A Real Opportunity for YOU

Wishing is never going to make your dreams come true. You've got to *study—to learn*. A man is worth possibly \$2 or \$3 a day from his neck down—and no more; but there is *no limit* to what he can be worth from his neck up.

A *trained mind* is what gets the big pay. It is this training that you need, and I can train you in a few months. Are you ambitious to make a real success—then send me the coupon—today.

### Electrical Outfit FREE

To every student who answers this ad I am giving a Splendid Electrical Outfit of standard size Electrical Tools, Instruments, Materials, etc., *absolutely free*. Furthermore, to every Electrical Student I give a truly *valuable* surprise that I cannot explain here.

### Free Employment Service

I am continually receiving requests from employers to send them trained Electrical men. I assist my students to secure good positions. I keep in touch with them for years, helping and advising them in every possible way.

### Write Now—Don't Delay

Delay never got you anything. Action is what counts. Get started—and get started now. Write me, or send me the coupon, right NOW.

### L. L. COOKE

CHIEF ENGINEER  
Chicago Engineering Works  
Dept. 417  
441 Cass St.  
CHICAGO

**USE THIS "FREE OUTFIT" COUPON**  
CHIEF ENG. COOKE, Chicago, Ill.  
Dept. 417, 441 Cass St.  
Send me the coupon, fully prepaid and entirely free—complete outfit at your own risk over for this month.

## YOU CAN DO IT

*You benefit by mentioning the "Radio Amateur News" when writing to advertisers.*





# Every Electrical Man Wants These Books and we ship them for your inspection **FREE**

Flexible  
Covers  
—  
Handy  
Pocket-  
Size  
Volumes

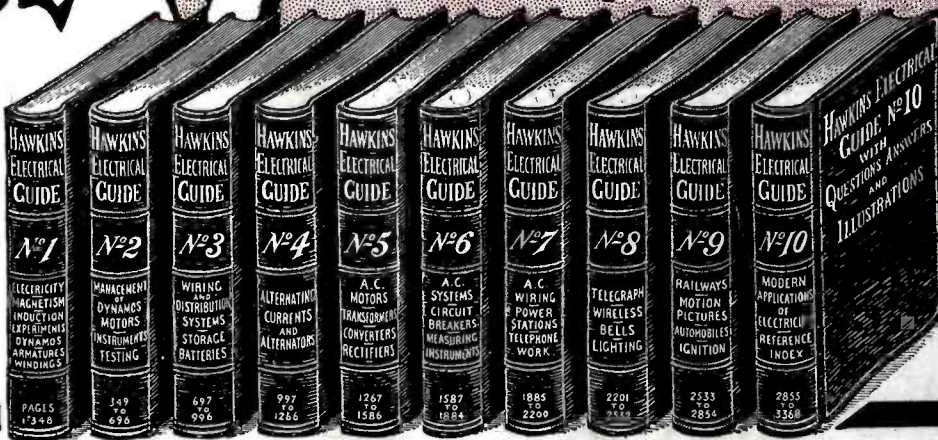

10  
Volumes  
3500  
Pages  
4700  
Pictures  
\$1 Per  
Volume  
\$1 Per  
Month

## Just what you need to know to succeed in ELECTRICITY

### READ THIS PARTIAL LIST OF CONTENTS

- No. 1** Contains 348 pages, 388 illustrations. Electrical signs and symbols—static and current electricity—primary cells—conductors and insulators—resistance and conductivity—magnetism—induction coils—dynamo principles—classes of dynamos—armatures—windings—commutation—brushes, etc.
- No. 2** Contains 348 pages, 394 illustrations. Motor principles—armature reaction—motor starting—calculations—brake horsepower—selection and installation of dynamo and motor—galvanometers—standard cells—current measurement—resistance measurement—voltmeters—wattmeters—hour meters—operation of dynamos—operation of motors, etc.
- No. 3** Contains 300 pages, 423 illustrations. Distribution systems—wires and wire calculations—inside, outside and underground wiring—sign flashers—lighting protection—rectifiers—storage battery systems, etc.
- No. 4** Contains 270 pages, 379 illustrations. Alternating current principles—alternating current diagrams—the power factor—alternator principles—alternator construction—windings, etc.
- No. 5** Contains 320 pages, 614 illustrations. A.C. Motors—synchronous and induction motor principles—A.C. commutator motors—induction motors, transformers, losses, construction, connections, tests—converters—rectifiers, etc.
- No. 6** Contains 298 pages, 472 illustrations. Alternating current systems—switching devices—circuit breakers—relays—lighting protector apparatus—regulating devices—synchronous condensers—indicating devices—meters—power factor indicators—wave form measurement—switch boards, etc.
- No. 7** Contains 316 pages, 379 illustrations. Alternating current, wiring power stations—turbines, management, selection, location, erection, testing, running, care and repair—telephones, etc.
- No. 8** Contains 332 pages, 436 illustrations. Telegraph—simultaneous telegraphy and telephony—wireless—electric bells—electric lighting—photometry, etc.
- No. 9** Contains 322 pages, 627 illustrations. Electric railways—electric locomotives—car lighting—trolley car operation—miscellaneous applications—motion pictures—gas engine ignition—automobile self-starters and lighting systems—electric vehicles, etc.
- No. 10** Contains 612 pages, 612 illustrations. Elevators—cranes—pumps—air compressors—electric heating—electric welding—soldering and brazing—industrial uses of electricity—electro plating—electro-therapeutic rays—X-rays, etc.

THEO.  
AUDEL & CO.  
72 Fifth Ave.  
New York, N. Y.

Please submit me for examination **Hawkins Electrical Guides** (price \$1 each). Ship at once, pre-paid, the 10 numbers, if satisfied, I agree to send you \$1 within seven days and to further mail you \$1 each month until paid.

Signature.....  
Occupation.....  
Employed by.....  
Residence.....  
Reference..... R. A. N. July

EVERY electrician, every engineer, every mechanic should know about these wonderfully helpful instructive books, which give in plain words a complete working knowledge of electrical engineering in all its phases.

You run into some new electrical problem almost every day. The information you need to help you in your every day work is in

## HAWKINS ELECTRICAL GUIDES

These books place electricity at your finger ends. They cover every imaginable subject, principle, theory, problem, trouble, and way of doing things electrically. Every subject is indexed so that you can turn right to it. They are a study course and a reference guide in one, written in plain every day language—no wasted words—only what you need to know—check full of up-to-the-minute electrical knowledge. The guides are a complete course in electrical engineering. They will help you in every detail of the day's electrical work. You can't ask an electrical question that Hawkins Guides can't answer.

### Pocket-Size Flexible Covers

The books are small enough to slip into your coat pocket—handily bound in flexible black covers. You can carry each volume with you until you have mastered its contents. 3,500 pages of actual information and 4,700 illustrations. Once you see these books and put them into actual use you will never again want to be without them. Try it at our expense.

## SEND NO MONEY

It will cost you nothing to receive these books—to look them over—ask them all the questions you can think of—use them in your work—study them—pick up some information that will increase your earning ability. We will ship you the entire set of 10 volumes entirely FREE. This is a sign of our confidence in the guides. Pure gold does not object to being tested, keep them for seven days and if you do not decide that you can't get along without them, return them to us and owe us nothing.

When you decide to keep them you only have to pay \$1.00 down and remit the balance of \$9.00 on the easy payment of \$1.00 a month till paid for. Use this coupon to get the books. It will pay you many times over.

THEO. AUDEL & CO.  
72 Fifth Ave. New York, N. Y.

SEND NO MONEY—USE THE COUPON

### What Electrical Men Say

#### Helped Him Make Good

"It is only right for me to recommend highly the Hawkins Guides, for they have been of the greatest assistance to me in placing me in my present position as Superintendent of Construction Department of one of Ohio's largest Electrical Companies. I would like to see every man have a set of Hawkins Guides."

Geo. Knecht, Columbus, Ohio.

#### In the Naval Electrical Dept.

"The Hawkins Guides are great help to me in the Naval Electrical Department," which they cover very thoroughly," C. J. Cornell, U. S. Receiving Ship, Brooklyn, N. Y.

#### Superintendent

"I am now superintendent of the Dunaville Hydro-Electric Systems, and Hawkins Guides were a great help to me in holding down a responsible position."

W. E. Swartz, Dunnville, Ontario.

#### Wireless Operators

"I have worked wireless for ten years—but I wish I had these books years ago, as they saved me a great deal of trouble." H. Marshall, Steamer M & B No. 2, Walkerville, Ont.

Get benefit by mentioning the "Radio Amateur News" when writing to advertisers.