

# RADIO

# MAINTENANCE

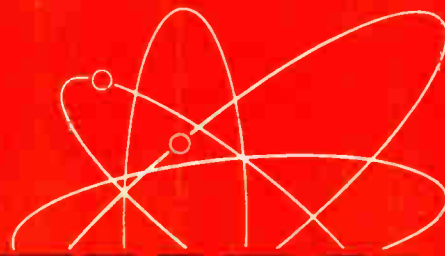

AM·FM·TV

JANUARY 1949 40c



the battery that's made for the **Radio Trade...**

● The *selective distribution* of RCA Batteries primarily through radio dealers and servicemen adds up to more repeat business for you.

Remember, too, that RCA Batteries are *radio engineered* for extra listening hours... that this completely rounded line *covers virtually all renewal requirements.*

ALWAYS KEEP IN TOUCH WITH YOUR RCA DISTRIBUTOR



**RADIO CORPORATION of AMERICA**

HARRISON, N. J.

## AUTO RADIO and HYTRON go together

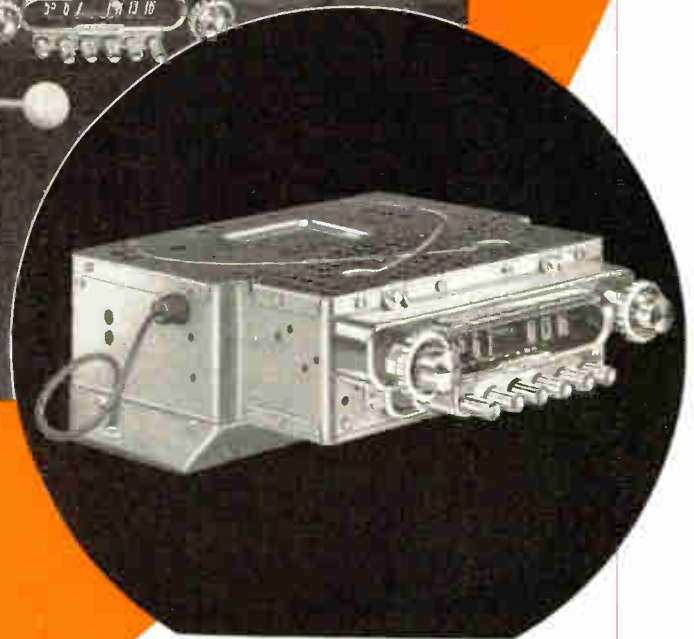
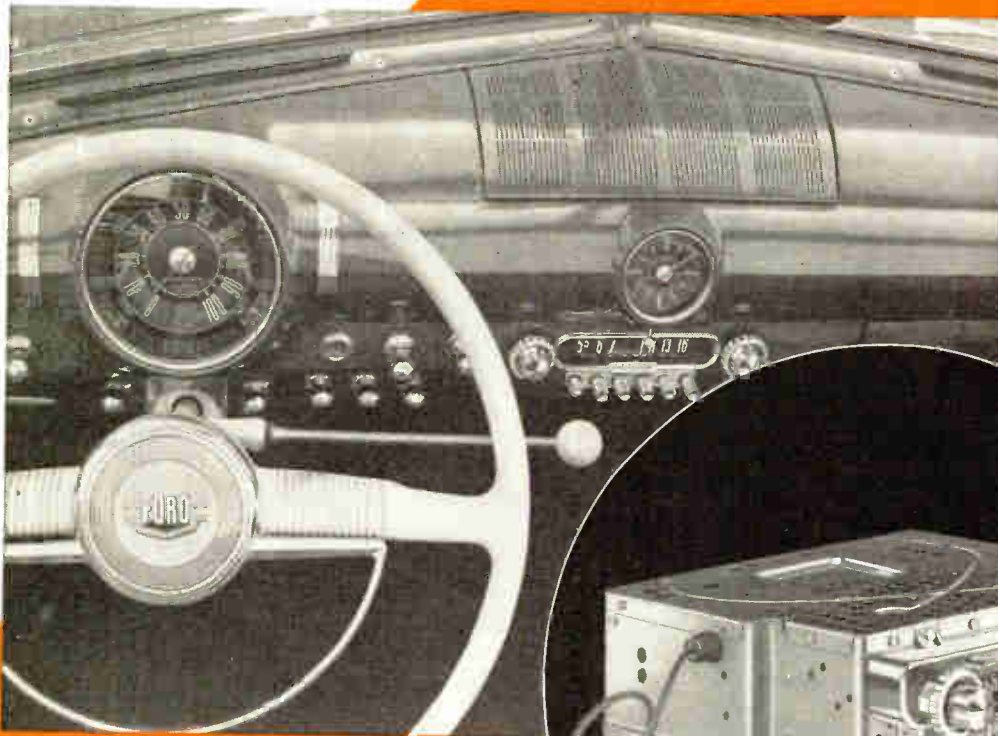

"A Ford in your future?" There will probably be a fine new Ford radio receiver on the dash. Chances are good this receiver will be equipped with tubes by Hytron. For Hytron is a major supplier of Ford auto radio tubes. That is only natural. Hytron *specializes* in auto radio tubes — both GT and miniature. Close engineering co-operation with leaders like Ford help make Hytron auto radio tubes leaders, too. 'Nuff said. Hytron and auto radio go together.

SPECIALISTS IN RADIO RECEIVING TUBES SINCE 1921.

# HYTRON

RADIO AND ELECTRONICS CORP.

MAIN OFFICE: SALEM, MASSACHUSETTS





**MR. SERVICEMAN:  
This is for YOU**

**CREI Presents Just the  
Course You Need and  
Want to Safeguard Your  
Future—Earn More Money**

# "Television and FM Servicing"

**Practical On-the-Job Training Program for the  
Better Serviceman Who Wants Greater Earn-  
ings and Security In This Expanding Field**

**T**HIS basic CREI Servicing Course paves the way to greater earnings for you. Since 1927 thousands of professional radiomen have enrolled for our home study courses in Practical Radio Engineering. Now, CREI supplies the answer to the need for a Practical Servicing Course. You do not have to be, or want to be, an engineer to benefit from this course. It is written for you—the average good serviceman! It's not too elementary for the experienced. It's not "over the head" of those who have limited experience—if they have real ambition and natural ability.

CREI developed this course at the request of several large industrial organizations. The urgent need of capable, trained servicemen is one of the big problems of the industry. Hundreds of thousands of Television

Receivers will be marketed in 1949. By 1951 two million TV units are expected to be flowing into American homes. With Television comes FM receivers and circuits. This new field demands a tremendous increase in the number of properly trained television and FM technicians to install and service this equipment.

**CREI EQUIPS YOU TO INSTALL AND SERVICE  
ALL TYPES OF TELEVISION AND FM RECEIVERS**

Now . . . with the help of this new CREI streamlined Service course you can move ahead to unlimited opportunities in your chosen field. CREI has again taken the lead by offering a course so entirely new that for the first time in our twenty-one year history we can offer a down-to-earth course of training for servicemen. In offering this course at a popular price, CREI is enabling thousands

of the "top third" now engaged in service work to enter the ultimate profitable field of television and FM installation and service.

This can be your big year! Don't waste another day. CREI has the answer to your future security in this new servicing course. Write today for complete information. The cost is popular. The terms are easy. The information is free. Write today.

**Radio Service Division of  
CAPITOL RADIO  
ENGINEERING INSTITUTE**

*An Accredited Technical Institute*

**Dept. 221A, 16th & Park Rd., N. W., Wash. 10, D. C.**  
Branch Offices: New York (7) 170 Broadway • San Francisco (2) 760 Market St.

**MAIL  
TODAY**

**CAPITOL RADIO ENGINEERING INSTITUTE**  
16th E. Park Road N.W. Dept. 221A, Washington 10, D.C.

Gentlemen:

Please send me complete details of your new home study course in Television and FM Servicing. I am attaching a brief resume of my experience, education and present position.

NAME \_\_\_\_\_

STREET \_\_\_\_\_

CITY \_\_\_\_\_ ZONE \_\_\_\_\_ STATE \_\_\_\_\_

I AM ENTITLED TO TRAINING UNDER G. I. BILL

# Test Pointers

## ON INTERMITTENTS

One of the greatest single problems encountered by the radio technician in his daily work is the intermittent radio set.

However, when suitable instruments are used to monitor intermittent receivers, the regular shop schedule can be maintained. Other service jobs can be completed while monitor instruments stand watch for any change in the functioning of an intermittent receiver.

Less effective methods are also used to shoot intermittent trouble. In an attempt to save man-hours, some technicians habitually replace a majority of the capacitors in an intermittent receiver at the outset. This remedy is frequently unsuccessful because many intermittents are caused by defective resistors, coils, switches, tubes, etc. Even after all of the suspected items are replaced, an appreciable percentage of receivers remain intermittent. In such cases, man-hour costs are pyramided on top of component costs; if these costs are passed on to the customer, good will suffers.

Artificial acceleration of the intermittent cycle is helpful in some cases. High line voltage will hasten the breakdown of certain marginal components. Low line voltage frequently causes a defective oscillator to cease operation. Some intermittents can be speeded up by increasing the operating temperature of the chassis by placing it in a carton with an incandescent lamp.

Although all of these methods work at times, signal-monitoring techniques have been found to be the best answer to the intermittent problem. Occasional checks of the monitor indicators show whether gradual operating changes are taking place. After the intermittent occurs, it can be localized to a particular section of the receiver by analysis of the monitor instruments.

Monitoring instruments have the advantage of providing a *continuous* check of the oscillator frequency and voltage, of the intermediate signal frequency and amplitude, of the audio input and output, of the receiver power consumption, and of the avc supply voltage.

Oscillator frequency shift is one of the most elusive causes of intermittent operation. Other obscure intermittents are caused by defective power-supply components, which show up on the monitor chiefly as a change in power consumption.

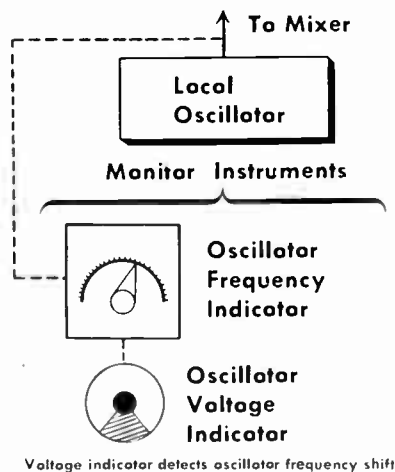

This brief discussion illustrates the important fact that many hours of time can be saved if the receiver is divided into five main sections, or channels, which can be monitored continuously. These are the hf oscillator, the rf or if channel, the audio system, the power supply, and the avc channel. After the intermittent has been localized to one of these sections, the instrument probes can be used to "close in" on the defective component.

Continuous monitoring places intermittent trouble-shooting on a firm technical basis.



## The RCA-162-C Chanalyst Electronic Analyzer

# makes the difference between profit and loss

THE RCA-162-C Chanalyst Electronic Analyzer solves once and for all the problem of time-consuming intermittents. It works for you unattended—and spots the fault in any receiver whenever it shows—leaving you free for other work. That's why the RCA Chanalyst more than pays for itself in the time it saves.

The RCA-162-C will give you a *positive* check of any fault which takes place in the receiver under test. Its four electron-ray tubes plus an electronic voltmeter give an immediate indication of any change when it occurs. Once the trouble is localized it is a simple matter to determine the cause.

Find out today how the RCA-162-C Chanalyst Analyzer can make more

money for you. Ask your RCA Test and Measuring Equipment Distributor for the new bulletin on the 162-C, or write RCA, Commercial Engineering, Section 51AX, Harrison, New Jersey.

### SPECIFICATIONS

**RF-IF Indicator Channel:**  
Frequency Range . . . . . 96 kc. to 1700 kc.  
Frequency Calibration . . . . .  $\pm 2\%$

**Oscillator Indicator Channel:**  
Frequency Range . . . . . 600 kc. to 15,000 kc.  
Frequency Calibration . . . . .  $\pm 2\%$

**AF Indicator Channel:**  
Frequency Response 150 to 50,000 cycles

**VT Voltmeter Indicator Channel:**  
Voltage Ranges 0-5, 25, 125, 500 DC Volts  
Scale . . . zero center with positive and negative deflection

**Input Impedance . . . . . 11 Megohms**

**Wattage Indicator Channel:**  
Input Range . . . . . 30 to 250 watts

Always keep in touch with your RCA Distributor



**RADIO CORPORATION of AMERICA**  
TEST AND MEASURING EQUIPMENT HARRISON, N. J.

# RADIO

# MAINTENANCE

INCLUDING  
ELECTRONIC  
MAINTENANCE

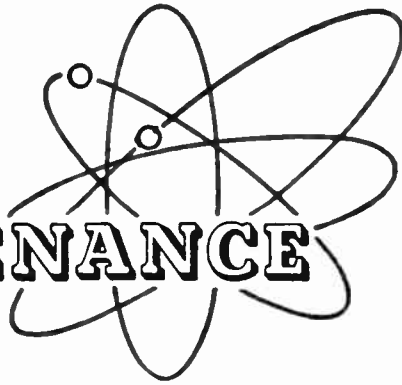

Volume 5

JANUARY 1949

Number 1

## CONTENTS

Editorial .....	4
Audio Systems in FM .....	J. Richard Johnson 12
The nature of high fidelity performance	
TV Tuning Systems .....	John B. Ledbetter 14
Analyzing some television front ends	
Advertise, Win Customers and Prosper .....	Victor M. Turner 18
An introduction to business promotion	
Roof-to-Receiver, Over .....	C. T. Josephs 21
2-way communication during TV installation	
Over the Bench .....	John T. Frye 22
Electronically Speaking .....	31

**WILLIAM F. BOYCE**  
Publisher

**JOSEPH J. ROCHE**  
Editor

**VICTOR M. TURNER**  
Art Director

**MORTON SCHERAGA**  
Contributing Editor

**THOMAS A. BYRNES**  
Director of Field Services

**AL JOHNSTON**  
Circulation Manager

### ADVERTISING REPRESENTATIVES

**Eastern**  
Herbert J. Olsov  
480 Lexington Ave.  
New York 17, N. Y.  
Plaza 9-0861

**Midwestern**  
Stuart J. Osten  
333 No. Michigan Ave.  
Chicago 1, Ill.  
Dearborn 2-3507

Copyright 1948, Boland & Boyce, Inc.

Radio Maintenance is published monthly by Boland & Boyce, Inc., at 34 No. Crystal St., East Stroudsburg, Pa., U.S.A.; Executive and Editorial Office, 460 Bloomfield Ave., Montclair, N. J. Subscription Rates: In U. S., Mexico, South and Central America, and U. S. possessions, \$3.00 for 1 year, \$5.00 for two years, single copies 40 cents; in Canada, \$3.50 for 1 year, \$6.00 for 2 years, single copies 45 cents; in British Empire, \$4.00 for 1 year, \$7.00 for 2 years, single copies 60 cents; all other foreign countries, \$5.00 for 1 year.

Entered as second class matter July 13, 1946, at Post Office, East Stroudsburg, Pa., under the Act of March 3, 1879.

Change of address: Four weeks' notice required for change of address. When ordering a change, please furnish an address stencil impression from a recent issue if you can. Address changes cannot be made without the old stencil as well as the new one.

RADIO MAINTENANCE • JANUARY 1949

## New Book makes AUTO RADIO REPAIR twice as easy!

Covers all auto  
Radio types from  
mid-1930's to  
present, includ-  
ing mobile FM.



Just Out!

## SERVICING THE MODERN CAR RADIO, by A. L. Hurlbut

Second edition, 702 pages, 8 1/2 x 11, 222  
illus., over 500 circuit diagrams... \$7.50

Here—written by a practical auto radio expert of 20 years' standing—is everything to help the beginner or experienced serviceman gain profitable skill in the fast-growing field of car radio servicing. A complete guide to the work. Book not only describes installation, testing, and repair methods fully, but also gives needed special facts of car radio circuits, differences between car and home radio servicing problems, shop set-up and business-getting ideas, etc. And invaluable for all jobs is the big gallery of circuit diagrams on hundreds of models, old and new.

### Practical facts and methods on:

- getting into the car radio business
- differences between mobile and home radios
- antennas and input circuits
- power supplies
- circuit features
- auto electrical systems
- setting up shop
- car set installations
- antenna installation
- loudspeaker installation
- remedying interference
- servicing procedure
- vibrator maintenance
- loudspeaker servicing
- car-radio alignment
- push-button tuning, etc.

### "OPPORTUNITY OF A LIFETIME FOR ALERT SERVICEMEN"

Says A. A. Ghirardi author of famous radio servicing books and articles

"SERVICING THE MODERN CAR RADIO represents an opportunity no wide awake serviceman can afford to miss. There are over 9,000,000 car radios—approximately 16 out of every 100 radio receivers in use—a wonderful field for increasing business; stepping ahead of competition! Good auto radio men are scarce, and this book gives you a gold mine of information you need to cash in on this profitable, fast-growing business."



ALFRED A. GHIRARDI

### 10 DAYS' FREE EXAMINATION

Murray Hill Books, Inc.  
(Division of Rinehart & Co.)  
Dept. RM-19, 232 Madison Ave.,  
New York 16, N. Y.

Send me Hurlbut's Servicing the Modern Car Radio for 10 days' examination on approval. In 10 days I will send \$7.50, plus few cents postage, or return book postpaid. Postage paid on cash orders; same return privilege. (Books sent on approval in U. S. only. Price outside U. S., \$8.00, postpaid.)

Name .....

Address .....

City (Zone) & State .....

Occupation .....

# TRANSVISION

## NEW Television Kits, and Equipment Important Advances in TV Reception and Servicing!

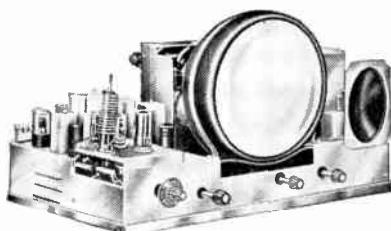

MODEL 10A TV KIT

### NEW 10" TV KIT at amazingly LOW PRICE!

The new Transvision Model 10A electromagnetic TV Kit gives a bright, stable 52 sq. in. picture. Has 10" picture tube, and **CONTINUOUS TUNING** on all 12 channels. Its high sensitivity makes for improved long distance reception; especially good on high channels. Complete with all-channel double-folded dipole antenna and 60 ft. of lead-in wire.  
**MODEL 10A TV KIT, less cabinet**..... Net \$199.00  
**MODEL 12A TV KIT, same as above, but has a 12" picture tube**..... Net \$263.00

### NEW STREAMLINED CABINETS

for Transvision Model 10A or 12A TV Kit. Made of select grain walnut with beautiful rubbed finish. Fully drilled, ready for installation of assembled receiver. Walnut Cabinet for 10A or 12A (Specify)..... Net \$44.95 Mahogany and Blonde slightly higher.



ALL-CHANNEL BOOSTER

### TRANSVISION ALL-CHANNEL TELEVISION BOOSTER

To assure television reception in weak signal areas, or areas which are out of range of certain broadcast stations, Transvision engineers have designed this new booster. It increases signal strength on all television channels. **Tunes all television channels continuously.** Can be used with any type of television receiver. Unusually high gain in upper television channels.  
**Model B-1**..... LIST \$44.95

### TRANSVISION REMOTE CONTROL UNIT KIT

Will operate any TV receiver from a distance. Turns set on, tunes in stations, controls contrast and brightness, turns set off. Ideal for installations where the television receiver is inaccessible. Tuner unit is a high gain, all-channel unit with about 50 micro-volt sensitivity. Easy to assemble in about an hour.  
**Model TRCU, with 25 feet of cable**..... Net \$69.00  
 Without cabinet..... Net \$65.00

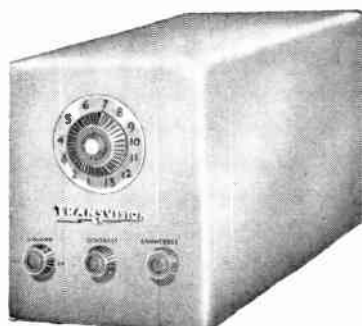

REMOTE CONTROL UNIT KIT

### NEW... TRANSVISION SWEEP SIGNAL GENERATOR FOR TELEVISION AND F.M.

Complete frequency coverage from 0.227 MC with no band switching... Sweep width from 0.12 MC completely variable... Accurately calibrated built-in marker generator.

**OUTSTANDING FEATURES:** (1) Frequency range from: 0.227 MC... (2) Dial calibrated in frequency... (3) Sweep width from 0.12 MC completely variable... (4) Self-contained markers readable directly on the dial to .5% or better. (No external generator required to provide the marker signals)... (5) Crystal controlled output makes possible any crystal controlled frequency from 5-230 MC... (6) Plenty of voltage output—permits stage-by-stage alignment... (7) Output impedance 5-125 ohms... (8) Directly calibrated markers 20-30 MC for trap, sound and video IF alignment... (9) RF for alignment of traps for IF channels when a 10" volt meter is used as the indicating medium... (10) Unmodulated RF signal to provide marker tips simultaneously with the main variable oscillator... (11) Markers can be controlled as to output strength in the pip oscillator... (12) Power supply completely shielded and filtered to prevent leakage... (13) All ac tubes are the new modern miniature type... (14) Phasing control incorporated in the generator.  
**MODEL NO. SG**..... Net \$99.50

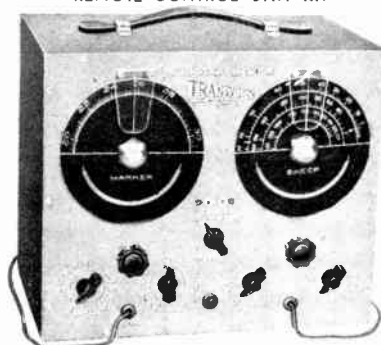

SWEEP SIGNAL GENERATOR

**Radiomen... You Can Get Into The TELEVISION BUSINESS**  
 In a **BIG WAY** with the **TRANSVISION DEALER PLAN**  
 WRITE FOR FOLDER D-1

NEW 8-PAGE CATALOG showing complete Transvision line now available at your distributor, or write to:  
**TRANSVISION, Inc.** Dept. RM **New Rochelle, N. Y.**

In Calif.: Transvision of California, 8572 Santa Monica Blvd., Hollywood 46  
 All prices 5% higher west of Mississippi; all prices fair traded. All prices subject to change without notice.

## LOOKING AHEAD

THE future of the service technician has never looked as bright as it does today. It has always been apparent that the need for radio servicing would increase as the years went on, but just how much opportunity for expansion the next few years would bring was an unknown factor. Television and FM have provided the answer to the service industry's prayers. They are golden opportunities with which the service technician can build himself a better future.

Television, which two years ago faced a difficult and, in the minds of many, uncertain future, has had the opportunity to prove itself. Its success to date has been beyond the expectations of its most optimistic prophets. FM has made steady progress; and although it has not expanded as rapidly as it might, it is moving forward toward universal acceptance.

One of the factors which has caused some to doubt the importance of television, has been the difficulties blocking the path to national coverage. These problems are sure to be overcome since the means have already been developed and demonstrated. You can be sure that in the not too distant future, television coverage will equal that of present radio broadcasting.

Television cannot succeed without many thousands of trained service technicians. This fact has already been demonstrated in those areas where television receivers are being sold in large numbers. Without expert technicians to install receivers and keep them working, this new industry would be destined to complete failure. A television receiver cannot be delivered to the customer's door and forgotten. If a fault develops, the television receiver cannot be disregarded as was the \$9.95 midget. It represents a very substantial investment, and its owner is willing to pay a reasonable price to have it repaired.

Exactly what does this mean to the service technician and the owner of a service establishment? It means that the opportunity to expand and earn more money is literally being forced upon you. This opportunity brings with it the necessity for increasing your ability both as a *technician* and as a *business man*. It will also bring greater competition, as is inevitable in an industry which offers the newcomer so much.

To help you make the most of your opportunities, the editors of *Radio Maintenance* are preparing to present an increasing number of articles on the business aspects of radio servicing. Subjects such as advertising, salesmanship, business management, and bookkeeping will be covered.

In this issue you will find an article on advertising by Vic Turner. Read it. It won't solve all your advertising problems or answer all your questions. No magazine article can. It will give you, however, some idea of what advertising can do for you. If each article you read gives you one new idea, the time and effort it took to read it will have been well spent.

Incidentally, Vic Turner has agreed to answer as many letters regarding advertising problems as he can. Here is a valuable opportunity. Mr. Turner knows his stuff. So don't miss the chance to get some expert advice. People usually have to pay for it.

Television will receive more editorial attention than it has in the past, because it is the biggest technical hurdle the industry must cross to assure success.

Read these articles, they are important to you. Make them part of your plan for the future and remember this—Progress is inevitable, those who grasp the opportunity will assume a more important place in their community, they will render a greater service to their fellows and they will reap greater rewards. Those who do not rise to the occasion will fall by the wayside. There is no third course.

JJR

*The Capacitors that Lick*

**MOISTURE**

**VIBRATION**

**HEAT**

**... yet cost you not one cent extra!**

## SPRAGUE PHENOLIC MOLDED TUBULAR CAPACITORS

Types **TM** and **MB**

(600 Volts)

(1600 Volts)

Take a look at Sprague Type TM and MB Phenolic Molded Tubular Capacitors! See how their sturdy phenolic jackets offer *complete* protection against moisture, vibration and heat—the three factors that cause 9 out of 10 failures in ordinary wax tubulars. Then try Sprague TM's and MB's on your toughest jobs—and you'll quickly understand why these little units represent the greatest capacitor development in modern radio servicing history! Sprague TM's and MB's are a "must" for auto radio, aircraft radio and television applications. And because they cost exactly the same as ordinary wax cardboard tubulars, wise servicemen use them exclusively for all service replacements. There are no service complaints, no dissatisfied customers when you use Sprague TM's and MB's.

Get the genuine article! Be sure and ask for Sprague TM's and MB's by name!



**SPRAGUE PRODUCTS COMPANY**  
North Adams • Massachusetts

JOBGING DISTRIBUTING ORGANIZATION FOR PRODUCTS OF THE SPRAGUE ELECTRIC COMPANY

# 50 YEARS OF PROGRESS WITH KESTER SOLDER

The present type of cored solder used by industry was first made by J. F. Kester in 1899. From the simple beginning of its first application . . . a few soldered connections in the old hand-crank telephone . . . it has continued to grow by keeping pace with new techniques as demanded by industry. Today's modern production would not be possible without cored solder.



## Standard for Industry and Home Since 1899



*Over 100,000 Types and Sizes*

**of KESTER Flux-Cored SOLDER**

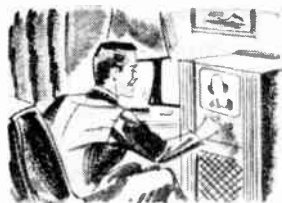

**RADIO-TELEVISION**—The early commercial amateur, and professional builders of radios accepted Kester Rosin-Core Solder as standard. Then as now, Kester still leads in this field.

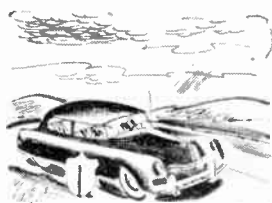

**AUTOMOTIVE**—Ever since its inception Kester Acid-Core Solder has been and still is the standard in the automotive field and for the trade. Mechanics and repairmen insist upon it.

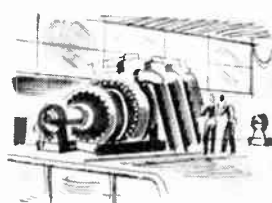

**ELECTRICAL-ELECTRONIC**—Kester makes a great variety of "specialized" core solders and solder preforms—even those suitable for the fine touch required in electronic work.

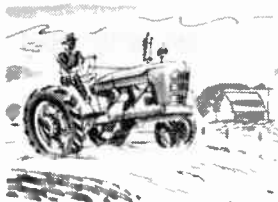

**AGRICULTURAL**—For a half century Kester Cored Solder has been the farmer's standard for maintenance and repair. He uses Kester because his soldering must be fast and reliable.



**HOMECRAFT**—In hobbycraft as well as home repair, good solder bonds are essential. Kester Metal Mender and Radio Solder are the standards for all home-craft workers.

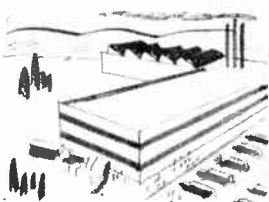

**INDUSTRIAL**—Kester Cored Solders have met every requirement for the past half century. They have earned the reputation for and are recognized as standard for industry.



**KESTER SOLDER**

**KESTER SOLDER COMPANY**

4201 Wrightwood Avenue, Chicago 39, Illinois

FACTORIES ALSO AT NEWARK, NEW JERSEY • BRANTFORD, CANADA



# Cash in - on the **PHILCO** LP RECORD PLAYER



## **TREMENDOUS NEW PROFIT OPPORTUNITY FOR RADIO SERVICEMEN**

Here's a brand new avenue to big profits for radio servicemen everywhere! Yes, every service customer is a prospect for the revolutionary new Philco M-15 record player that equips any radio or phonograph, old or new, to play the amazing 45 minute non-breakable Vinylite records.

Now . . . start at once making these big, extra profits on service calls . . .

1. Profits on sales of the Philco M-15.
2. Profits on installing jacks in customers' radios and phonographs. A simple, easily installed jack is all they need to plug in and play the Philco M-15.

**Get the facts about this red hot, nationally advertised Philco product.  
Millions want it! See your Philco Distributor today!**

# Build YOUR OWN TEST EQUIPMENT

## Heathkit ELECTRONIC SWITCH KIT DOUBLES THE UTILITY OF ANY SCOPE



**\$34.50**

Two separately controllable traces on individual inputs on any scope. See both the input and output traces, locate distortion, phase shift, etc., immediately. Individual gain controls and positioning control. Coarse and fine sweeping rate controls. Complete Heathkit matches others, with 5 tubes. All metal parts are punched, formed and cadmium plated. Complete with tubes, all parts, detailed blueprints and instructions. Shipping Wt. 13 lbs.  
**Nothing ELSE TO BUY**

## HEATHKIT CONDENSER CHECKER KIT

**\$19.50**

*Nothing ELSE TO BUY*

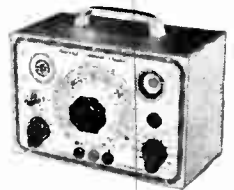

A condenser checker anyone can afford to own. Measures capacity and leakage from .00001 to 1000 MFD on calibrated scales with test voltage up to 500 volts. No need for tables or multipliers. Reads resistance 500 ohms to 2 megohms. 110V 60 cycle transformer operated complete with rectifier and magic eye indicator tubes. Easy quick assembly with clear detailed blueprints and instructions. Small convenient size 9" x 6" x 4 3/4". Wt. 4 lbs.

## HEATHKIT SIGNAL GENERATOR KIT

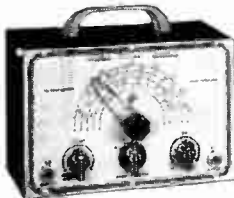

**\$19.50**

*NOTHING ELSE TO BUY*

Every shop needs a good signal generator. The Heathkit fulfills every servicing need, fundamentals from 150 Kc. to 30 megacycles with strong harmonics over 100 megacycles covering the new television and FM bands. 110V 60 cycle transformer operated power supply. 400 cycle audio available for 30% modulation or audio testing. Uses 6SN7 as RF oscillator and audio amplifier. Complete kit has every part necessary and detailed blueprints and instructions enable the builder to assemble it in a few hours. Large easy to read calibration. Convenient size 9" x 6" x 4 1/2". Wt. 4 1/2 lbs.

## HEATHKIT SIGNAL TRACER KIT

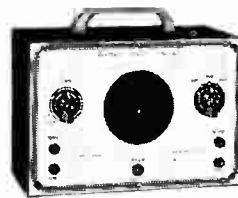

**\$19.50**

*Nothing ELSE TO BUY*

Reduces service time and greatly increases profits of any service shop. Uses crystal diode to follow signal from antenna to speaker. Locates faults immediately. Internal amplifier available for speaker testing and internal speaker available for amplifier testing. Connection for VTVM on panel allows visual tracing and gain measurements. Also tests phonograph pickups, microphones, PA systems, etc. Frequency range to 200 Mc. Complete ready to assemble. 110V 60 cycle transformer operated. Supplied with 3 tubes, diode probe, 2 color panel, all other parts. Easy to assemble, detailed blueprints and instructions. Small portable 9" x 6" x 4 3/4". Wt. 6 pounds. Ideal for taking on service calls. Complete your service shop with this instrument.

## HEATHKIT SINE AND SQUARE WAVE AUDIO GENERATOR KIT

The ideal instrument for checking audio amplifiers, television response, distortion, etc. Supplies excellent sine wave 20 cycles to 20,000 cycles and in addition supplies square wave over same range. Extremely low distortion, less than 1%, large calibrated dial, beautiful 2 color panel, 1% precision calibrating resistors, 110 V 60 cycle power transformer, 5 tubes, detailed blueprints and instructions. R.C. type circuit with excellent stability. Shipping weight 15 pounds.

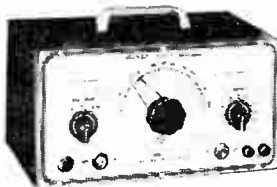

**\$34.50**

*Nothing ELSE TO BUY*

## THE NEW HEATHKIT VACUUM TUBE VOLTMETER KIT

The most essential tool a radio man can have, now within the reach of his pocketbook. The Heathkit VTVM is equal in quality to instruments selling for \$75.00 or more. Features 500 microamp meter, transformer power supply, 1% glass enclosed divider resistors, ceramic selector switches, 11 megohms input resistance, linear AC and DC scale, electronic AC reading RMS. Circuit uses 6SN7 in balanced bridge circuit, a 6H6 as AC rectifier and 6 x 5 as transformer power supply rectifier. Included is means of calibrating without standards. Average assembly time less than four pleasant hours and you have the most useful test instrument you will ever own. Ranges 0-3, 30, 100, 300, 1000 volts AC and DC. Ohmmeter has ranges of scale times 1, 100, 1000, 10M and 1 megohm, giving range .1 ohm to 1000 megohms. Complete with detailed instructions. Add postage for 8 lbs.



**\$24.50**

*Nothing ELSE TO BUY*

## HEATHKIT FM AND TELEVISION SWEEP GENERATOR KIT



**\$24.50**

*NOTHING ELSE TO BUY*

### THE BASIC FM AND TELEVISION SERVICE INSTRUMENT

At the lowest cost possible, anyone can now service FM and television receivers. The Heathkit sweep generator kit operates with oscilloscope and covers all necessary frequencies. A few pleasant hours assembling this kit puts any organization in position to share the profits of the FM and TV boom.

Every part supplied — grey crackle cabinet, two color calibrated panel, all metal parts punched, formed and plated. 5 tubes, complete detailed instructions for assembly and use. Shipping weight 6 lbs.

## The NEW 1948 HEATHKIT 5 INCH OSCILLOSCOPE KIT

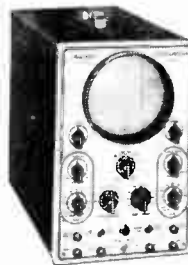

**\$39.50**

*NOTHING ELSE TO BUY*

New improved model of the famous Heathkit Oscilloscope. Building an oscilloscope is the finest training for television and newer servicing technique and you save two-thirds the cost. All the features and quality of instruments selling for \$100.00 or more. Supplied complete with cabinet, two color panel, 5B1 tube, 2 5Y3 tubes, 2 6SJ7 tubes and 8B4 sweep generator tube. Power transformer supplies 1000V negative and 350 volt positive. Sweep generator 15 cycles to 30 M. cycles. Has vertical and horizontal amplifiers. Oil filled filter condensers for long life. Complete blueprints and instructions included.



The **HEATH COMPANY**

... BENTON HARBOR 10, MICHIGAN

# SYLVANIA ADVERTISING HELPS SERVICE DEALERS INCREASE THEIR SERVICE BUSINESS!

Read what these 3 dealers say about Sylvania's Dealer Campaign for Summer and Fall

## ELECTRONICS Service Company

F. H. Radio Recording Equipment  
Public Address Phone 3-2342  
Tulsa, Oklahoma  
October 23, 1949

Advertising Department  
Sylvania Electric Products Inc.  
Emporium, Pa.

Gentlemen:

We would like to express our appreciation to Sylvania for its co-ordinated advertising campaign. It has, so far, resulted in a steady increase in our service business. During September our business increased 30 per cent and to date in October it has shown a 28 per cent increase. We feel that this increase is due to this campaign since we have used it exclusively during this time.

We have used the radio spot announcements over our local station and mailed the direct mail postal cards to our customers. We have also used the newspaper ad mats in our local paper upon occasion.

It is a great help to the radio service business to have this service provided so inexpensively. Thanks to you of Sylvania.

Very truly yours,  
*Vernor P. Rodgers, Jr.*  
Vernor P. Rodgers, Jr.  
Manager and Prop.

VPR:ML

"September business increased 30%"

DAMON'S RADIO SERVICE  
1006 E. 14th St. SAN LEANDRO

## RAPID Radio Service

R. H. DAMON

Advertising Department  
Sylvania Electric Products  
Emporium, Pa.

Gentlemen:

Enclosed is my order for the second kit to the Sylvania co-ordinated advertising program.

I took over this business on July 1 and have been using the advertising material from your first kit. I have found that it really pays to advertise. The previous business was bankrupt and had no volume of service business.

With help from Mr. W. A. Hall, the local Sylvania salesman, and the advertising material furnished by him, my business now shows great promise. Mr. Hall works for C. C. Brown Co. of San Francisco, one of your distributors. Mr. Hall filled my rush order for a Sylvania Tube Tester which has already increased my sale of tubes.

I am enclosing a few copies of my ads using Sylvania ad mats which appear in the local paper, the San Leandro News Observer and the San Leandro Shopping News. These papers have a circulation of 18,000. This type of advertising brought in over 100 radio sets for repair during the month of July. I hope business grows like this every month from now on.

Sincerely yours,

R. H. (Bob) Damon  
Damon's Radio Service  
1006 E. 14th Street  
San Leandro, Calif.

"Newspaper ads brought in over 100 radio sets for repair during July!"

MYERS RADIO SERVICE CO.  
216 FOURTH AVE. WEST PHONE 1564 ASHLAND, WISC.

Advertising Department  
Sylvania Electric Products  
Emporium, Pa.

Dear Sir:

I am writing to tell you how much your co-ordinated advertising has helped my business.

I have used the postal cards, the window displays and the radio spot announcements to promote my business. The radio station. They are used at various hours so I have contacted a large range of people.

I make my living entirely through service and the sale of used records, so anything which helps to increase my business is very valuable to me. Since I have been using your campaign my business has increased from an average of \$90.00 per week to about \$135.00 per week gross. My use of the campaign has cost me about \$12.00. Before I used the campaign I was spending an average of \$7.00 per week. For the extra expense I have certainly received a fair return.

I am very much pleased with the radio spots in your booklet.

*Robert Myers*  
Myers Radio Service Co.

"Gross business increased from \$90.00 to \$135.00 per week!"

## SYLVANIA'S FEBRUARY, MARCH AND APRIL CAMPAIGN IS NOW READY.

### Here's what it contains:

- 3 Postal Card Mailings—one for each month.
- 3 Window Displays—one for each month.
- 3 Window Streamers—one for each month.
- 6 Newspaper Ad Mats—two sizes for each month.
- Radio Spot Announcements—several for each month.

### SEND FOR FULL INFORMATION NOW!

Remember, this campaign designed for your use ties up directly with Sylvania's ad campaigns on a national scale. You pay only the postage on the government postal cards you mail. Sylvania supplies everything else free! Mail coupon today!

# SYLVANIA ELECTRIC

RADIO TUBES; CATHODE RAY TUBES; ELECTRONIC DEVICES; FLUORESCENT LAMPS, FIXTURES, WIRING DEVICES; LIGHT BULBS; PHOTOLAMPS

Sylvania Electric Products Inc.  
Advertising Department  
Room R-2001  
Emporium, Pa.

Gentlemen: Please send me full details on your February, March and April Service Dealer Campaigns.

Name \_\_\_\_\_  
Company \_\_\_\_\_  
Address \_\_\_\_\_  
City \_\_\_\_\_ Zone \_\_\_\_\_  
State \_\_\_\_\_



**The Most Complete  
REPLACEMENT  
VIBRATOR LINE IN THE WORLD**

Reputation is not built overnight! Radiart's reputation has grown over the years because of its many points of superiority! Beyond the fact that the quality and design of every one of the 82 types of Radiart Vibrators . . . is beyond compare . . . the solid completeness of the line makes them the favorite wherever good vibrators are sold FOR MOST EVERY NEED TO ORIGINAL SPECIFICATIONS . . . there is a CORRECT Radiart replacement vibrator! NO OTHER VIBRATOR MANUFACTURER CAN MAKE THAT STATEMENT! Guess work is eliminated . . . all good jobbers carry most all numbers in stock . . . if your jobber does not have the number you want . . . he can get it, FAST . . . as special orders are given speedy attention . . . with immediate shipment of his order! Insist on Radiart for the EXACT REPLACEMENT Vibrator . . .

**IT'S RIGHT WHEN IT'S RADIART**

LEADING THE FIELD SINCE 1935

**THE RADIART CORPORATION**

CLEVELAND 2, OHIO

EXPORT . . . SCHEEL INTERNATIONAL . . . CHICAGO 18, ILLINOIS

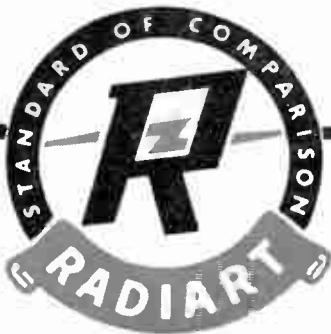

# TV Test Equipment that covers all present and future bands.

## IN GOOD COMPANY

The Mega-Sweep, a high quality instrument, is now being used by these and other leading manufacturers.



Federal Telecommunication Laboratories, Inc.



BELL TELEPHONE LABORATORIES

E. I. DU PONT DE NEMOURS & COMPANY



GENERAL ELECTRIC COMPANY BELMONT RADIO CORPORATION

# THE MEGA-SWEEP



**THE MEGA-PIPPER**

Precise crystal positioned marker generator. Used with the Mega-Sweep, the Mega-Pipper generates four sharp marker pips which are displayed on the response curve on the oscilloscope. These pips appear simultaneously at sound and picture i.f. carrier and adjacent sound and picture i.f. carrier frequencies. Pips are applied directly to oscilloscope and do not disappear when tuned into traps. Fast, precise tuning of traps and positioning of i.f. characteristics possible. Plug in crystals make it possible to change Mega-Pipper to any i.f. frequency in the RMA bands.

Price \$150.00 f.o.b. factory

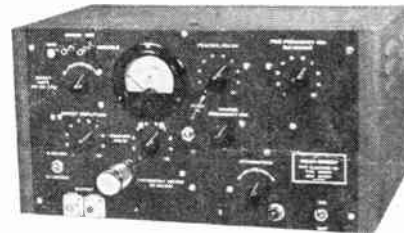

**THE MEGA-SWEEP**

Expert opinion says, "Yes, you must have a Sweeping oscillator to do TV service work." Why not buy the best and assure the best quality work. The Mega-Sweep is the only sweep capable of operation in the UHF-TV bands now being discussed. Wide Sweep (up to 30 mc) continuously variable attenuator with flat frequency response, low amplitude modulation while sweeping. The sawtooth type sweep is entirely electronic. Only one r.f. sweeping voltage in output. No spurious signals, no phasing or synchronizing problems.

Price \$395.00 f.o.b. factory

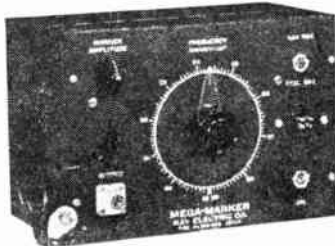

**THE MEGA-MARKER**

Experts say, "A marker is essential for use with your sweeping oscillator." The Mega-Marker is a precision variable oscillator (accuracy 0.25%) which operates with the Mega-Sweep. Crystal oscillator (4.5 mc) included for calibrating instrument's variable oscillator and supplying accurate marker for lining up video sound trap and intercarrier i.f. and discriminator. Includes output amplitude control, provision for mixing Mega-Sweep and Mega-Marker outputs for application to the receiver under test.

Price \$60.00 f.o.b. factory

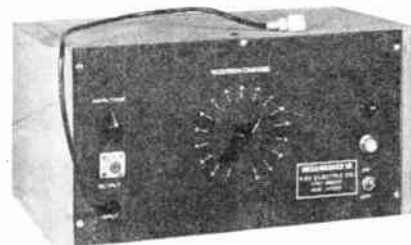

**THE MEGA-MARKER SR.**

This unit provides a crystal controlled high accuracy (0.01%) sound r.f. carrier for each of the twelve television channels. The carriers can be used tone modulated or unmodulated by setting a panel switch. Includes amplitude control and switched channel tuning. Contains independent power supply and can be used either with Mega-Sweep or as an independent test instrument for tuning TV receiver local oscillator on all twelve channels.

Price \$195.00 f.o.b. factory

WRITE FOR FULL SPECIFICATIONS

**KAY ELECTRIC CO., 24 Maple Ave., Pine Brook, N. J.**

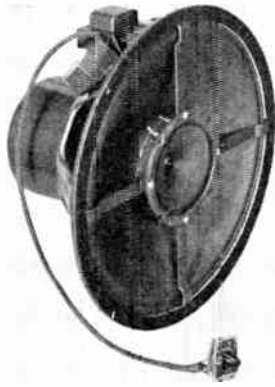

# Audio Systems in FM

by J. Richard Johnson

Continuing our series on f-m servicing with a discussion of high fidelity performance in the acoustic output of the f-m receiver

**I**N the servicing of modern f-m receivers, the radio service technician has found a new opportunity for profit. At the same time, however, he is dealing with a new kind of customer. Many of the owners of f-m receivers are severe critics of the quality of reproduction available from these receivers. They have been taught that f-m reception should be nearly perfect and, since they have been induced to buy their receivers on that premise, certainly no one can blame them for expecting the best.

We know that f-m reception *can* be so good that it will delight even the most fastidious ear. At the same time, we know that much of the f-m receiving equipment commercially available does not even pretend to provide any more than *part* of the advantages of the f-m system of communication. However, confusion between claims for the performance of very elaborate expensive receivers and the small compact types often leads to a misconception of the quality to be expected from the latter.

Although maladjustments of the r-f and i-f sections of the f-m receiver can cause distortion, with reasonable care almost any standard tuning section (in a receiver or as a separate unit) can produce an audio output signal with a high degree of fidelity. The quality of the acoustic output (sound waves) from the loudspeaker is largely determined in practice by the characteristics of the audio frequency section, including amplifier stages, tone and compensation controls, and the loudspeaker unit or system.

It is by a proper knowledge of this portion of the receiver that the servicemen can judge what should be expected in the way of high quality reproduction. He is then in a position to advise the customer as to whether his receiver is performing properly and to check the condition of service jobs as they leave the shop.

Accordingly, before we continue with our detailed circuit analysis of the a-f amplifier sections of f-m receivers, we will consider in this article what we really mean by "good quality" and "high fidelity" so that the circuit features we will discuss in later articles will take on their full meaning.

## What is High Fidelity?

F-M has brought the fidelity of reproduction possible to such a point that people's personal, biological, and psychological reactions play an important part in the determination of whether their reaction is favorable. The scientific factors involved affect different people differently. However, it has been found that *people are rapidly becoming educated to high fidelity*. At one time it was felt that

the average listener would not appreciate good fidelity; the very favorable response to high fidelity f-m receivers has proven, however, that this idea is wrong and that all that is needed is a certain amount of contact with good quality for full appreciation.

Let's consider the technical features of high fidelity. With the great amount of emphasis that has been placed on frequency response, one might be led to believe that if a system has a wide frequency response, high fidelity is assured. Nothing is further from the truth. In fact, attempts to increase the range of frequencies fed through an amplifier often result in much *poorer* quality, because high frequencies are more subject to distortion effects than low frequencies. Actually, there are several factors, all of which determine fidelity.

The measure of fidelity, of course, is the degree to which the sound waves reaching the listener's ears are identical to those produced in the studio of the broadcasting station. As we will see later, *parts* of a system may actually be designed to introduce distortion (modification of response) to compensate for other parts, but the ultimate objective is the same.

The basic electrical factors involved in high fidelity are as follows:

## Harmonic Distortion

1. *A minimum of harmonic distortion.* Harmonic distortion manifests itself as a change of the wave form of the audio frequency voltage being amplified, the wave form change be-

ing due to its passage through the system. Harmonic distortion is, of course, a factor to be considered in both a-m and f-m receivers, but the added frequency response range desired makes it more important in f-m receivers.

All distorted or undistorted wave forms can be considered as composed of pure sine wave components, even though (as in ordinary practice) the distortion has not come about by actual addition of any signals to the desired one.

Fig. 1 illustrates one way in which harmonic distortion can be introduced in the audio amplifier section of a receiver. In this example, the bias resistor has dropped to too low a value and the input signal is too strong, producing distortion of the wave form as shown at the right (output circuit). Of course, in practice a *complex* wave form is handled because of the many components contained in voice and music waves, but the effect can be more clearly seen by using the sine wave signal of Fig. 1 for testing.

That the distorted wave form of Fig. 1 is the same as an undistorted wave with harmonics added is illustrated in Fig. 2. This graph shows that the fundamental sine wave A combined with a certain quantity of third harmonic (signal having a frequency exactly three times that of wave A) wave B, produces a distorted wave similar to that of the output signal in Fig. 1.

Thus, even though in the example of Fig. 1 no additional signals are added, harmonic signals are actually created because of the non-linear nature of the amplifier response. This non-linear response is due in turn to the improper bias (in this particular case).

*Harmonic signals are signals having a frequency which is any whole multiple of the frequency of the fundamental, or main signal.* When harmonic components which were not in the original desired signal are added by its passage through an amplifier, that amplifier is said to introduce *harmonic distortion*.

Harmonics are rated by the percentage of their voltage compared to the voltage of the main, or fundamental signal. Until recently, it was felt that harmonic distortion could not be detected by the listener until

→ To page 24

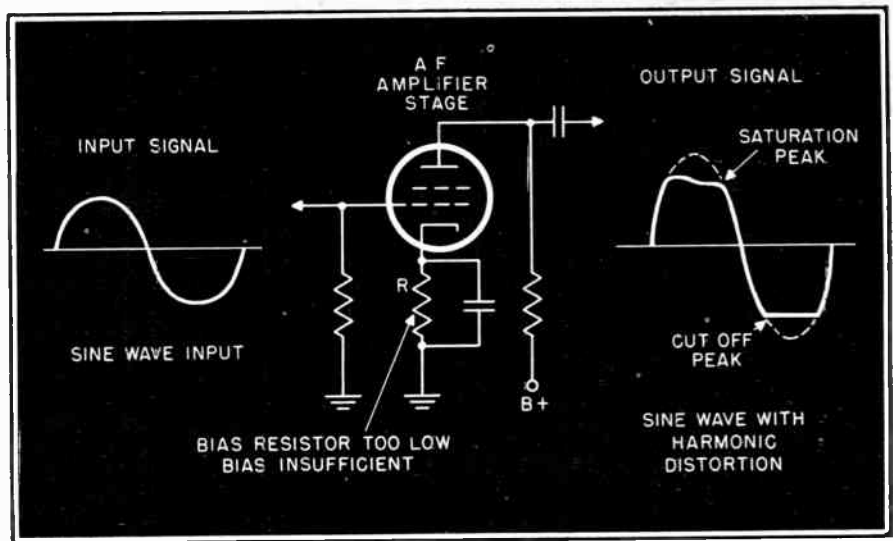

Fig. 1 How harmonic distortion is produced in an amplifier tube by maladjustment of circuit voltages, as shown in the waveform (right). Here, distortion is produced by an input signal which is too strong and a bias resistor which has too low a value

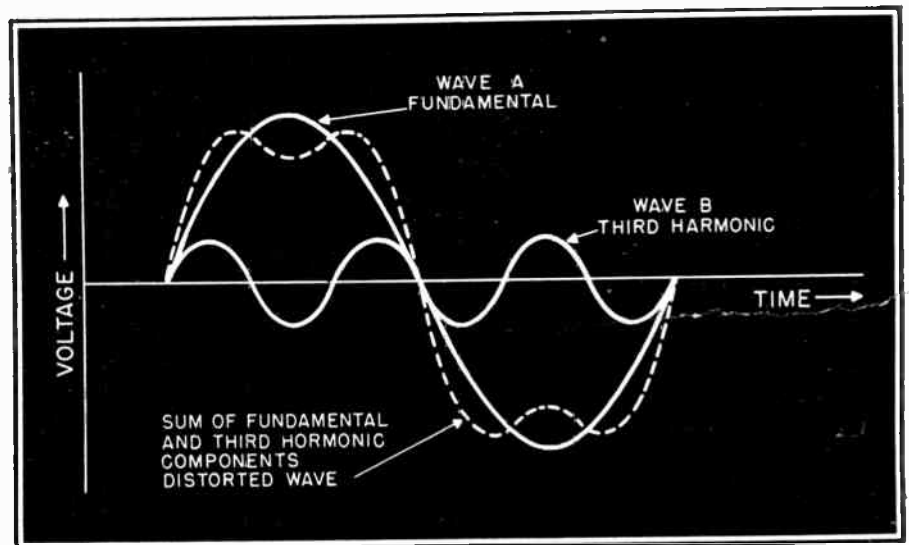

Fig. 2 The above graph shows that the addition of a third harmonic frequency (Wave B) to a fundamental sine wave (Wave A), can produce distorted signals. Note that the distorted wave form shown here is very similar in shape to that produced in Fig. 1

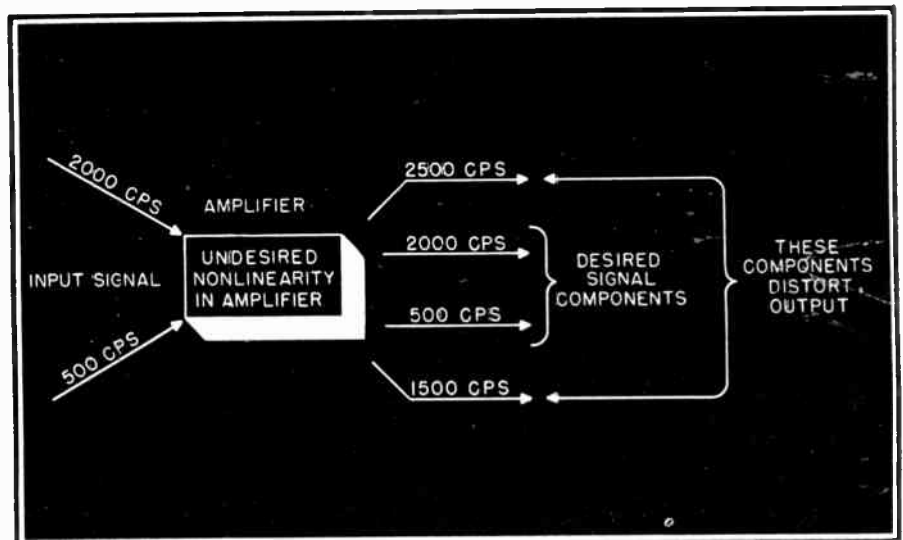
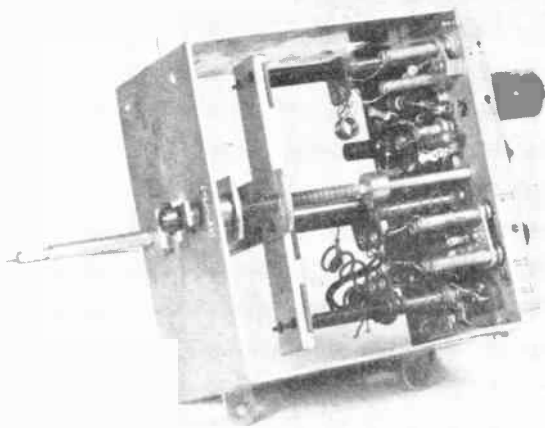

Fig. 3 Illustration of production of intermodulation distortion when two or more waves of different frequencies pass through an amplifier with a non-linear input-output voltage amplitude characteristic. Only two of the input signal components are shown



# TV TUNING SYSTEMS

by John B. Ledbetter

You have to understand them in order to work on them efficiently

**I**N ANY receiver, efficiency in the tuning system or "front end" is extremely important. This is especially true in television receivers, which must have a practically uniform response over a very wide range of frequencies (44 Mc to 216 Mc), while maintaining a 4.5 Mc band width for each of the 13 television channels. In this article we will discuss the various types of tuning systems which have been developed to meet

these requirements and some of the problems involved in their development.

## Fundamental Circuit Requirements

Briefly, here are some of the requirements a good television tuning unit must meet in order to give satisfactory service: (1) a high signal-to-noise ratio, (2) an i-f bandwidth of 4.5 Mc, (3) high gain in the r-f

and i-f stages, (4) good oscillator stability, (5) lack of microphonics in the tubes and tuning controls, (6) suppression of images, re-radiation from the oscillator, etc. There are a number of other considerations which must also be satisfied in a good television tuner, but these become rather involved technically, and are beyond the scope of this article. We are more concerned with the way in which the requirements listed

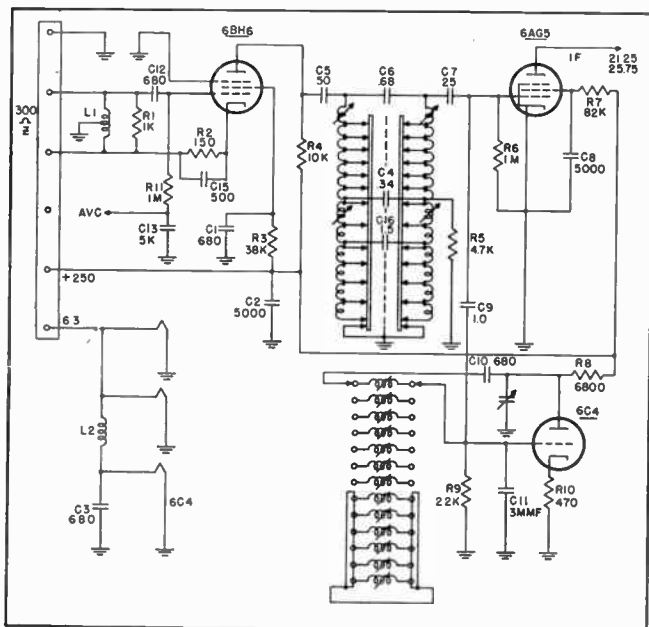

Fig. 1 Schematic diagram of Sarkes Tarzian TT 2 tuner, using a 300-ohm input feeding into 6BH6 pentode r-f stage

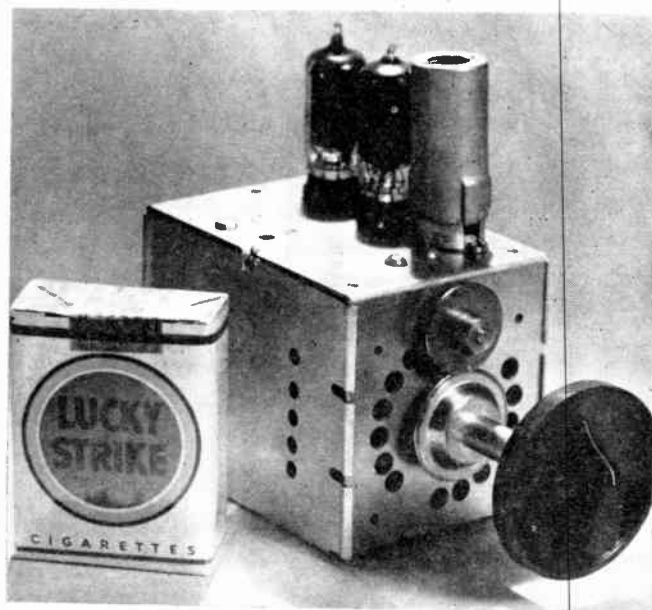

Fig. 2 This Sarkes Tarzian television tuner, a typical low cost unit, uses a simulated transmission as the tuning element



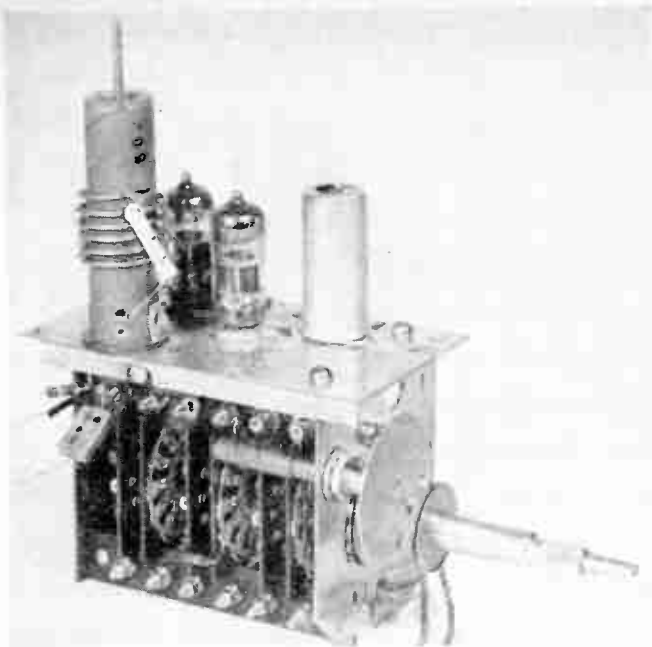

Fig. 3 Above is RCA tuner, using variable-inductance tuning. In such systems, highest frequency coil must be aligned first



Fig. 4 Philco tuner shown features removable interchangeable coils and provides 8 channel coverage. Coils snap in place

above are met, since the majority are problems which affect the operation of every receiver, television or otherwise.

There are a number of ways in which these requirements can be satisfied. Actually, a good receiver engineer can produce a television tuning system which would outperform anything now being mass-produced, as far as operation is concerned. Such a unit, however, generally would be prohibitive in cost and would necessarily have to be custom built. In practice, such factors as price range, ease of assembly, adaptability to mass production, etc., must be taken into consideration and the tuning system worked out accordingly. Since there is always more than one solution to every problem, different receiver engineers have come up with their own pet systems.

Simply, here is how some of the front-end problems are solved: The

signal-to-noise ratio can be made high by using a good r-f circuit and employing a high-frequency pentode such as the 6AU6 connected as a grounded-grid triode. Grounding the grid prevents oscillation in the r-f stage by isolating the output circuit from the input. This not only makes the tuning circuit more stable, but at the same time prevents oscillator re-radiation into the antenna system via the r-f stage. Operating a high-gain pentode as a triode, also cuts tube noise in half without reducing the gain of the stage. Oscillator harmonics, images, etc., as well as oscillator radiation, can be eliminated or kept very low by building the tuner around a good r-f stage and employing a sufficient number of i-f stages. Gain, band width, and microphonics, too, can be controlled by careful selection of tuned circuits and the types of tubes to be used in each stage. In most tuners, oscillator

drift is compensated by using an oscillator series condenser having a negative coefficient.

#### Methods of Tuning

Basically, tuning in all receivers must be accomplished by varying either the capacity or inductance, or both, in the r-f detector and oscillator circuits. Various combinations may include permeability tuning, switch-type inductive tuning, continuously-variable inductive tuning, and either switch-type or continuously-variable capacity tuning.

Ordinarily, losses in a switch-type inductance-tuned circuit would be excessive, due to contact resistance of the switch blades and distributed capacity in the selector switch and coil leads. In practice, however, this advantage is offset by placing all coils in each respective circuit in series and making each section operate as a quarter-wavelength trans-

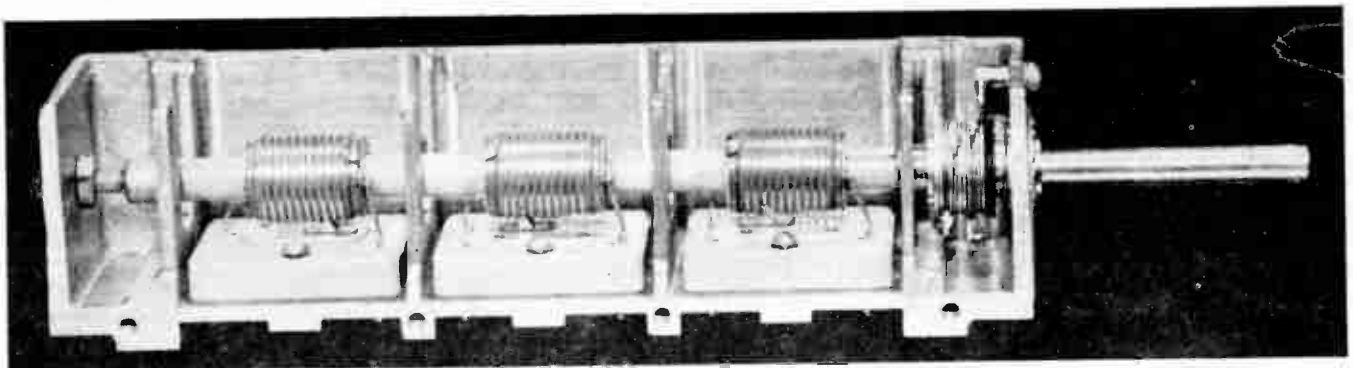

The "Inductuner" shown above makes possible a continuous tuning r-f front end. It is used in Allen B. DuMont receivers

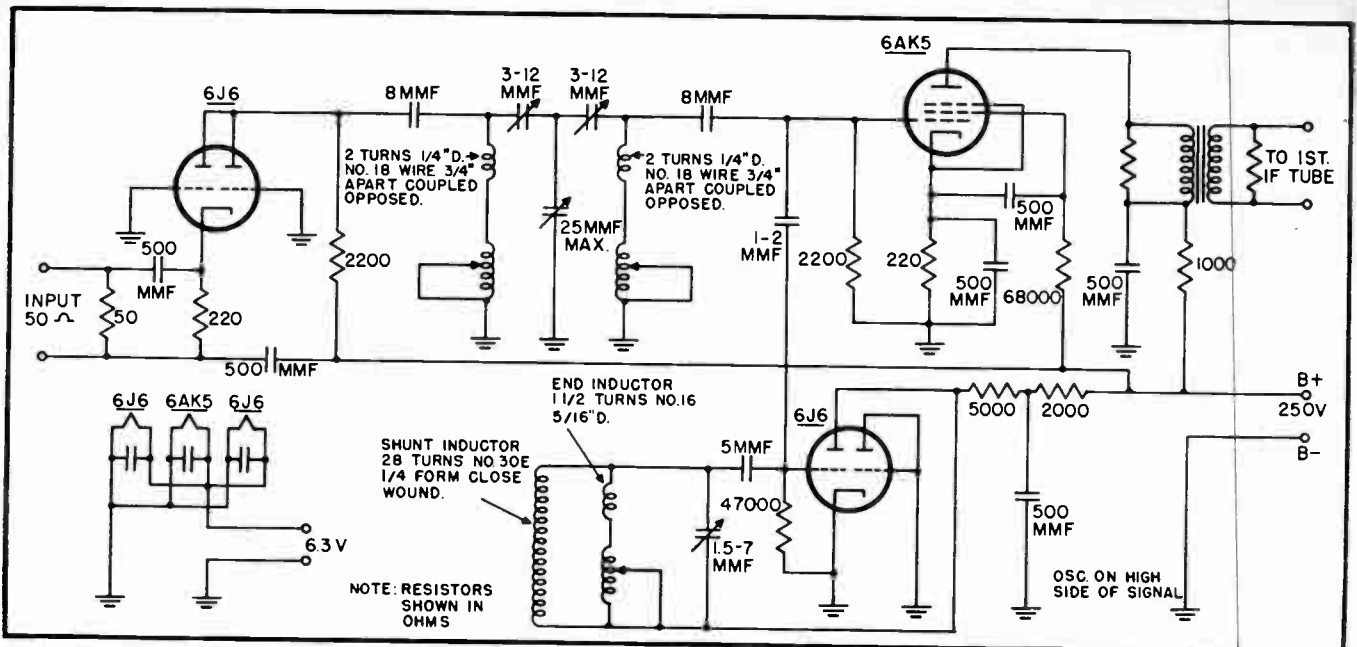

Fig. 5 A typical circuit for use with the "Inductuner". It provides continuous coverage for the 44-216 megacycle band

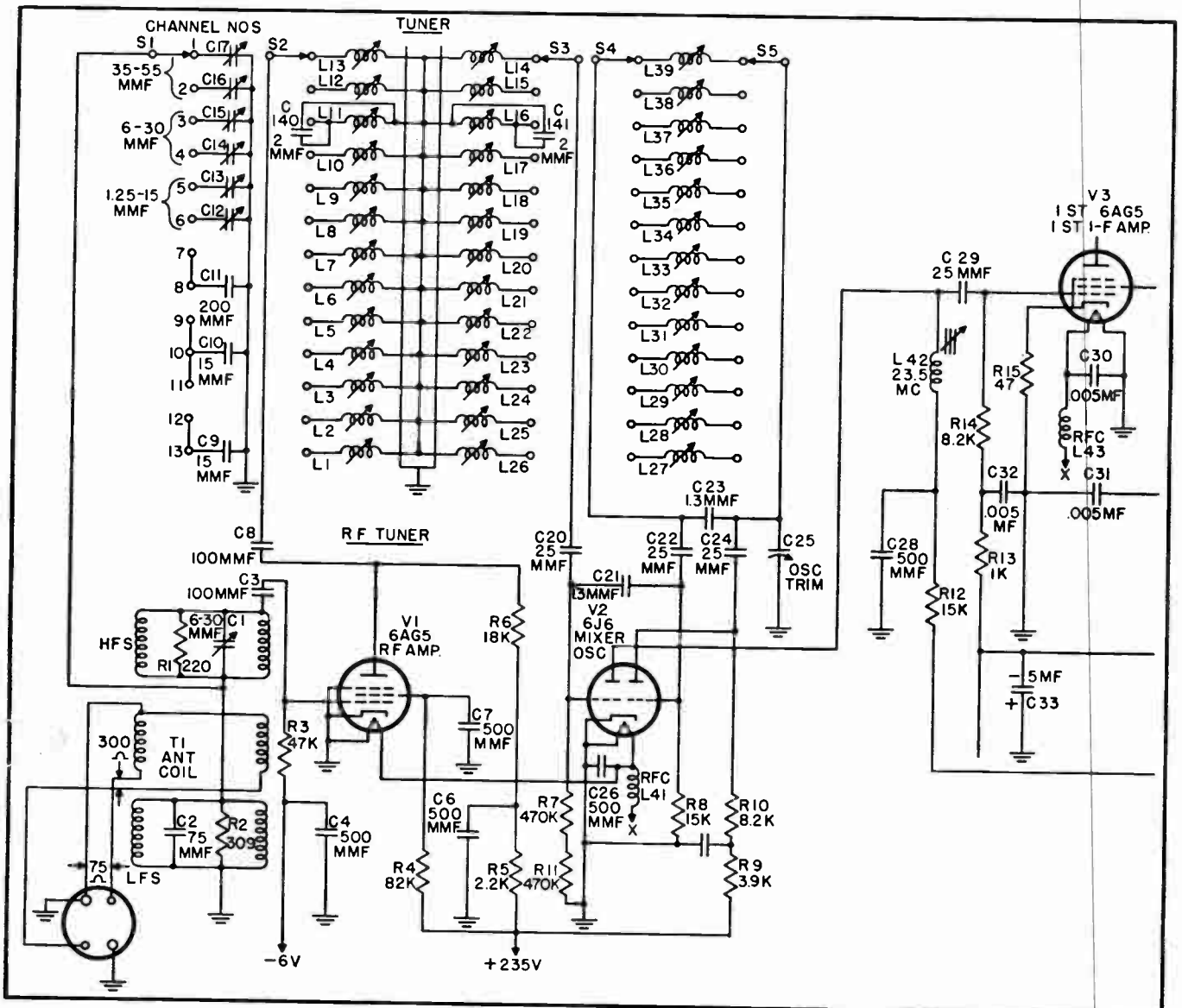

Fig. 6 The Motorola tuner circuit, shown above, utilizes pre-tuned trimmer condensers to cover Channels 1 through 6. Channels 7 through 13 are tuned by using fixed capacitors and factory-set slug-tuned coils

mission line at its proper channel frequency. All unused sections of the line are shorted.

### Capacity Tuning

Some of the advantages of capacity-tuned systems are: simplicity, low cost, long life, trouble-free service, and easy to produce. Disadvantages include: common coupling between gang sections, excessive stray capacities, rotor contact resistance, large size, and a tendency to be microphonic in operation. These problems have been overcome in several low-cost tuners, however, and operation seems to justify the use of capacity tuning. General Instrument Corporation, for instance, uses two separate condensers, each with three push-pull sections, ganged to a common shaft. One condenser tunes the 54-88 Mc band (disregarding Channel 1), and the other covers the 174-216 Mc range. Fine oscillator adjustment is accomplished by a vernier condenser operated from a concentric shaft on the regular bandswitching shaft. Link-coupling for each band simplifies r-f adjustments. Only two adjustments are required.

This tuner uses an untuned input feeding into a 6J6 twin triode operated as a double-tuned push-pull r-f stage. A 6J6 converter, with push-pull grids and parallel-connected plates allows working into either a single or double tuned i-f coil. Link coupling is also used in the oscillator stage.

### Inductance Tuning

Advantages of variable-inductance tuning are: improved "Q," low distributed capacity, increased tuning range, minimum of coupling between stages, freedom from microphonics, increased efficiency, and better stability.

Many receiver manufacturers use some form of switch-type inductance tuning, employing a simulated transmission line as the tuning element. The Sarkes Tarzian TT-2 tuner (Fig. 1 and 2) is typical of a low-cost tuner of this type. Individually-tuned series inductances are arranged to form a parallel-wire transmission line, whereby a quarter-wave section is switched into the circuit for each channel. Switching is accomplished by a shorting-bar type rotary selector switch. This tuner uses a 300-ohm input feeding into a 6BH6 pen-

tode r-f stage. The plate of the 6BH6 and the grid of the 6AG5 mixer are inductance-tuned successively from Channel 13 to Channel 1. The 6C4 oscillator has adjustable inductances for each channel and a small variable capacity for fine tuning.

A similar system is employed by RCA (Fig. 3). In both the above tuners, the highest-frequency coil must be aligned *first*, progressing in order to the lowest-frequency coil. The RCA tuner uses 6J6 double triodes in the r-f, converter, and oscillator stages.

### Switch-Type Inductance Tuning

This method of tuning differs from the above only in that *separate* coils are used for each channel. Philco, for instance, employs an 8-position turret-tuner into which coils for any 8 channels can be snapped. Use of the turret (Fig. 4) allows extremely short leads and low distributed capacity. In Philco's system, the mixer and oscillator coils are located in the front section of the turret drum. R-F and antenna coils are in the back section. Oscillator a.f.c. and a.v.c. for picture and sound circuits is also included.

### Continuous Inductance Tuning

A continuously-variable inductance system has these advantages: minimum distributed capacity, since no switch contacts are present; mini-

imum of mechanical operation and microphonic tendencies; and longer life. DuMont and Transvision, Inc., employ the "Inductuner" (Fig. 5) as their basic tuning system. The "Inductuner," which consists of three separate variable inductance units ganged on a common shaft, covers a continuous range of 44 Mc to 216 Mc. The "Inductuner" is highly accurate and capable of good mechanical and electrical stability.

### Switch-Type L/C Tuning

Motorola (Fig. 6) uses a combination L/C arrangement to cover both television bands. Pretuned trimmer condensers are used to tune the low-frequency winding for Channels 1 through 6. High-frequency Channels 7 through 13 are tuned by effectively shorting the low-frequency winding (LFS) out of the resonant circuit by connecting C11, C10, and C9, respectively, across it. By using these condensers in a series-resonant circuit, a more effective short of LFS can be obtained than by grounding various turns through a band switch. C2 is permanently connected across LFS to aid in shorting it above Channel 6. Damping resistors R1 and R2 are used to obtain a constant input impedance. The double-tuned 6AG5 r-f stage is inductance slug-tuned by L1 through L26. C18 and C19 help maintain a constant 4.5 Mc bandwidth and are made an integral

→ To page 29

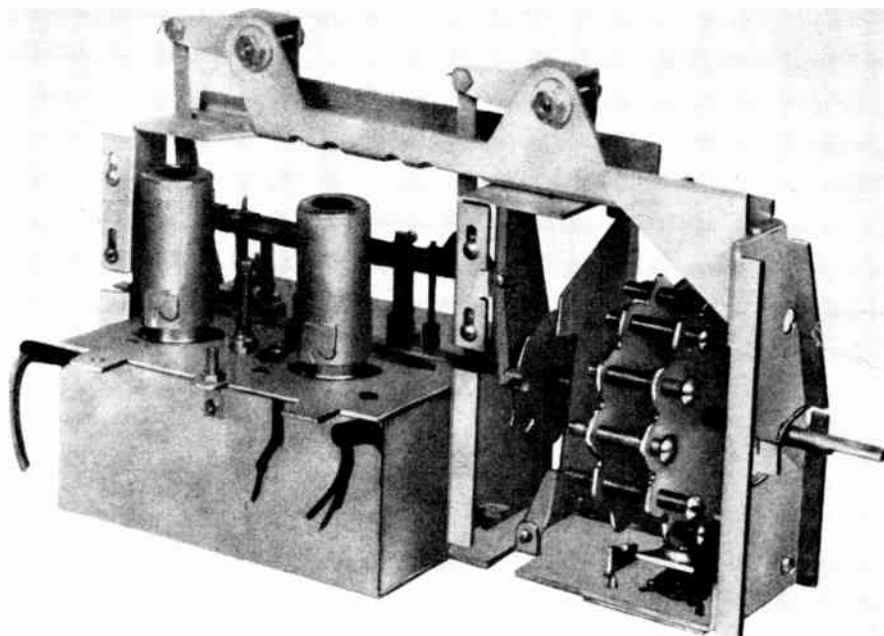
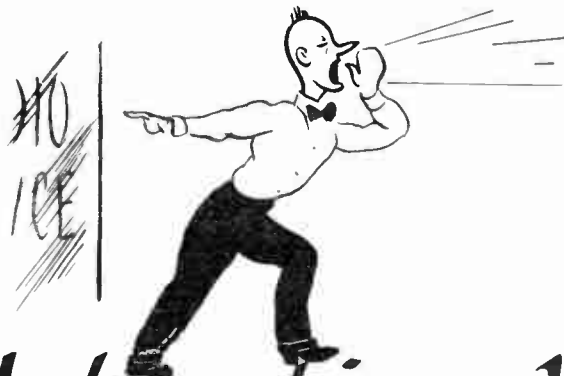

Fig. 7 The Belmont tuner shown above utilizes continuous permeability tuning. A mechanical system automatically stops at each station



# Advertise, Win Customers and Prosper!

**A**DVERTISING plays an important part in our national economy. It is a vital factor in the welfare of any business, and the more we know about it, the more successful our business enterprises will be.

In order to help radio servicemen with their business promotion, Radio Maintenance is presenting a series of articles on the subject, of which this is the first. In this series we will endeavor to give radio servicemen a complete outline of advertising principles and practice. We will try to answer all your questions on the subject, and present a clear picture of the benefits of advertising. In the course of the series you will find detailed plans for tested and proven advertising campaigns.

Our aim is to help you make more money—which you certainly will by advertising, if you are not already doing so. If you do advertise, you will find in this series many helpful pointers on how to improve your program.

## Importance of Advertising

First of all, we want to stress the necessity of advertising in some form. No matter how small your shop or how small a community you're located in, advertising is a must.

Despite the fact that America is the most advertising-conscious country in the world, thousands of businessmen in all trade do *not* advertise, and do not reap the benefits of ad-

by Victor M. Turner

Advertising Manager, Radio Maintenance

vertising. Among these non-advertisers, we're sorry to say, are quite a few radio servicemen.

If you fail to advertise, you're throwing away dollars—dollars in profits that should be yours.

"O. K.," says Joe Doe who makes only twenty-five bucks a week in a hamlet in the hinterlands, "where do I get the money to spend on advertising?"

The answer is that advertising is not necessarily expensive to inaugurate. There are two highly effective means of advertising which cost next to nothing—one: your classified telephone directory. If you're not in it with the minimum line or more, you're just plain batty. For only a few dollars extra, the phone company will list your name and services in bold-face type.—Two: penny post-cards. A hundred cost only a dollar and if you haven't the cash to pay for printing *write* your message on each one yourself. Personalized messages are powerful. Direct-mail or-

**"It pays to advertise."**

**Yes—you've heard that time-worn slogan before and you'll hear it again. It's always quoted because it's always true**

ganizations have gone to painstaking lengths to develop reproduction processes which make it possible to turn out mass letters that appear to be individually typed and signed.

In addition, many of the manufacturers whose lines you carry provide free advertising and selling aids in all forms. You should take advantage of the opportunities they offer.

There are many other low-cost ways of advertising. We will present them in detail later.

## Your Market is not Saturated

Along about there our struggling friend (and others who are in a better-than-struggling position) may ask: "But where should I mail these things? I'm in a district where everyone knows me—I'm the only radio serviceman in these parts. They *have* to come to me!"

To that we can smugly say, "Not so, brother, not so!"

You must advertise not only to bring in new customers, but to prod the old ones into action. For example: Do you know of someone who owns an extra radio receiver which is not working and which will remain that way until the receiver they are now using fails. The proper kind of advertising can induce them to get the extra set fixed now. Why do you suppose the old family dentist keeps sending out those little "reminder" cards?

These two examples are the extreme cases, but they serve to defeat two inevitable arguments against ad-

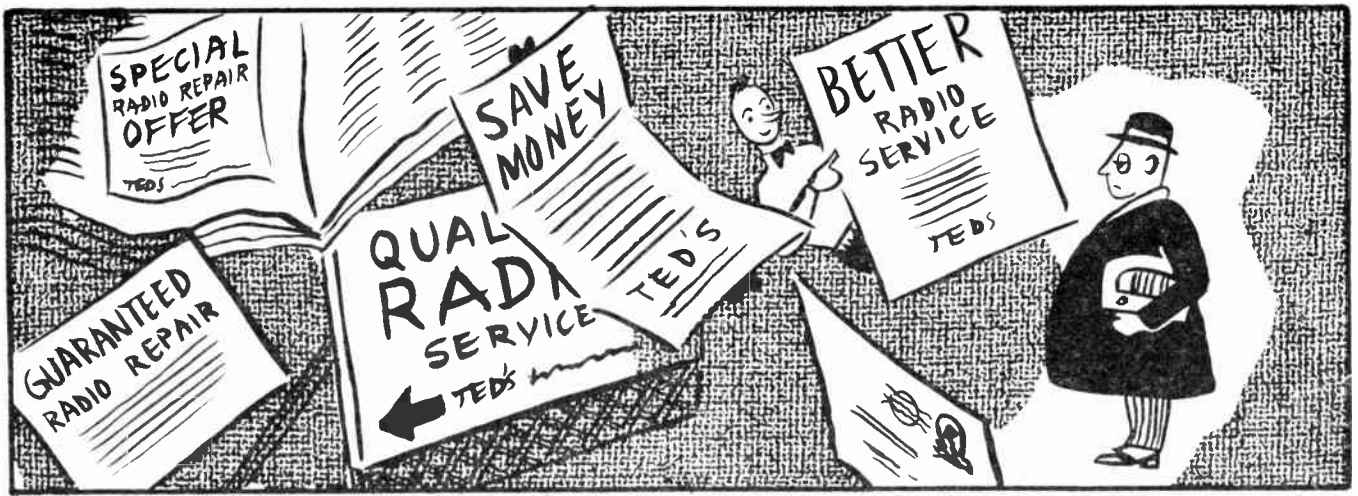

The first principle of successful advertising is to get your customer's attention

vertising used by small business men. Fortunately, most servicemen are above the \$25 a week Joe Doe class, but far too many will still say they "can't afford" to advertise when actually they can't afford *not* to! While the majority of servicemen is up against competition of varying degrees in their neighborhoods, here again too many feel they've built up as much business as the area can provide. Oh, how wrong they are!

### The Strongest Weapon in Competition

When it comes to real competition in the bigger towns and cities, advertising can very well mean the difference between staying in business and being forced out. When there are three or four other independent servicemen on the same street, plus multiple-product retailers and department stores who send out their own radio servicemen, the guy with the good ad in the newspaper and/or the

smart mailing piece will be the one making the most money. It isn't enough to give better service, because people won't know you're better unless you get them to try you out.

So much for those who are not advertising. Now let's meet another radio serviceman who has this to say:

"I have tried advertising, but it doesn't seem to do any good!"

This is a typical state of mind with many men who have small business establishments. It brings up the problem of effectiveness in advertising and how to *check* the results of this advertising.

### Don't Form Hasty Conclusions

Our serviceman is probably wrong in saying the advertising doesn't do him any good. His ad, whether it was in the daily paper or in the form of a mailing piece, probably carried a message that said (in general): "I do reliable, high-quality repair work. Try me when your radio needs fix-

ing." This advertising is low-pressure and will not induce immediate action on the part of the recipient. The serviceman does not know whether his ad is bringing in customers or not, and he is making a mistake if he swears off advertising. An immediate check on your advertising's effectiveness can be made by inserting a "hook" of some kind, such as a limited time special offer. Later on in this series of articles, we will explain in detail the various ways to check the returns on your promotion.

Perhaps our disillusioned friend is right when he says his ad didn't do him any good. It may have been a very poorly planned promotion piece that had no effect on anyone. But if it was, he should find out just what was bad about it and then make up another ad that *is* effective. There *never* is any case where advertising, properly done, is wasted effort. We intend to show you specific examples

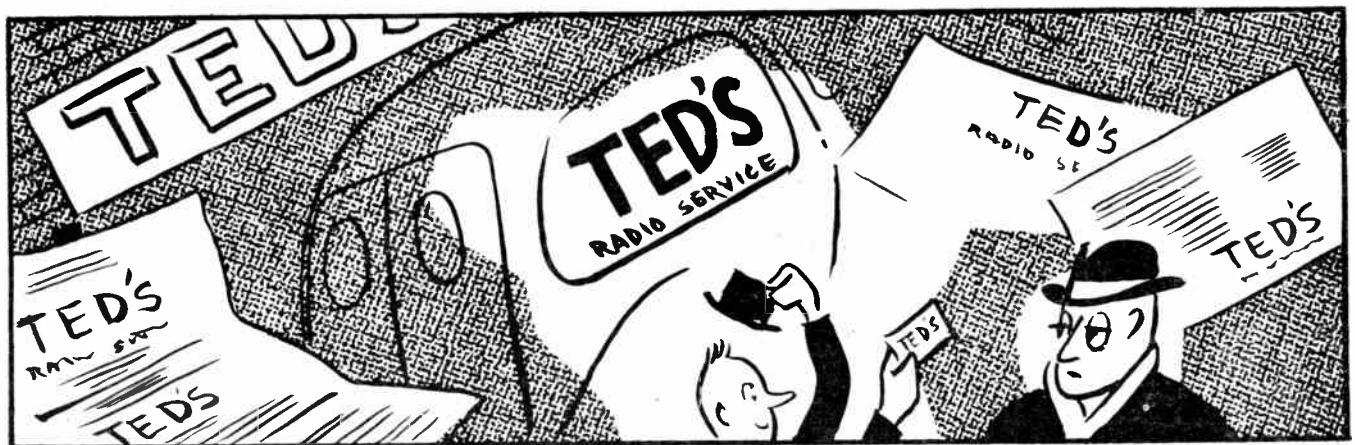

Then impress your name upon him, as often and in as many ways as possible

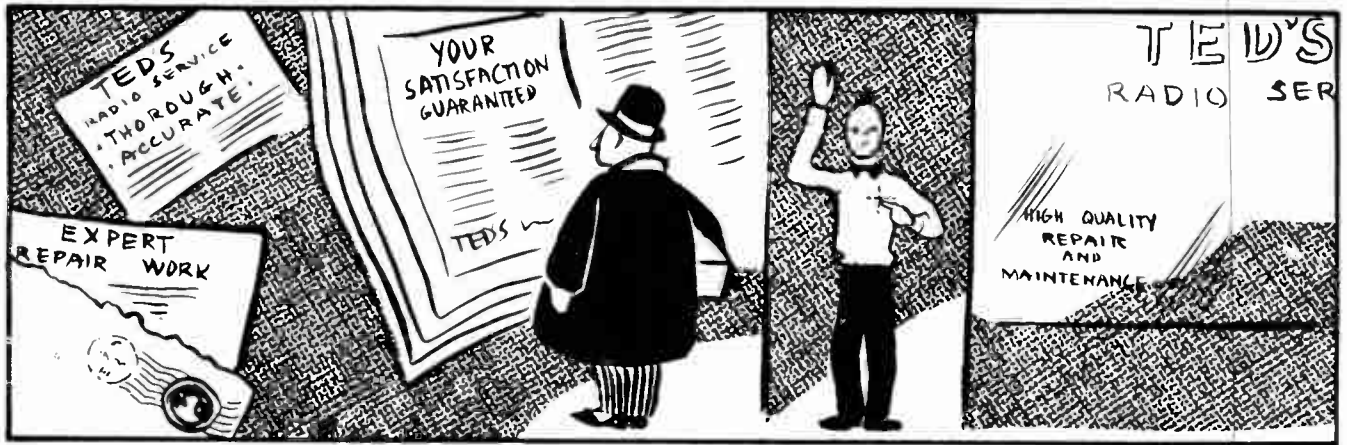

Tell a convincing story to get the confidence and trust of your customer

of good and bad advertising, for we realize that proper advertising make-up is a tough job. There's no disgrace in having put out an ad or even a complete campaign that was a flop. Failing to learn from your mistake is, however, a cardinal sin. A lot of money can go down the drain on poor advertising, but there seldom is an ad that didn't benefit the advertiser in some way. One thing, though, is sure—NO advertising brings in NO business.

**Rare Cases—  
But There are Some**

Since we are now living in a prosperous time, there may be some servicemen who are working to their present capacity. Hence they may feel that they cannot handle more work and therefore should not advertise for more.

As this article is not one on business management, we won't attempt to tell you how and when to expand, but we do want to say this: Allow-

ing business to be turned away for lack of help or operating space is a poor policy. Make a careful estimate of how you can branch out without taking much of a risk—then advertise for the new customers. When the lean times comes, the individual customer will let his minor repairs go, so there will be fewer calls from him. He'll wait longer before buying that new set, so you won't make as many sales to him. That's when a longer list of clients will mean that you can take up some of the slack. Don't let any opportunity for establishing yourself securely go by!

We've focused our attention on some of the more obvious reasons for advertising. Now let's look into some of the longer-range advantages derived from it.

**Look at Your  
Neighboring Businessmen**

There's a lot of concrete evidence available to show the radio servicing trade as a whole why it should do

much more advertising than it does. This evidence can be found right in your own neighborhood. Just take a look around.

See that big super-market? Food is something people have to buy whether it was promoted or not. True! But some of the food retailers were not content to sit around and wait for the customers to arrive. They took to full-page advertising in the local press, and now these retailers have expanded from little holes-in-the-wall grocery stores to the huge, modern markets with customers and money rolling in.

And take a look at the auto-parts stores. Through smart merchandising and consistent advertising in the daily papers these tradesmen have built up big volume businesses.

There are lots of others—clothing stores, furniture dealers, department stores — all of which advertise heavily. In 1947 almost four billion dollars was spent for advertising in

→ To page 27

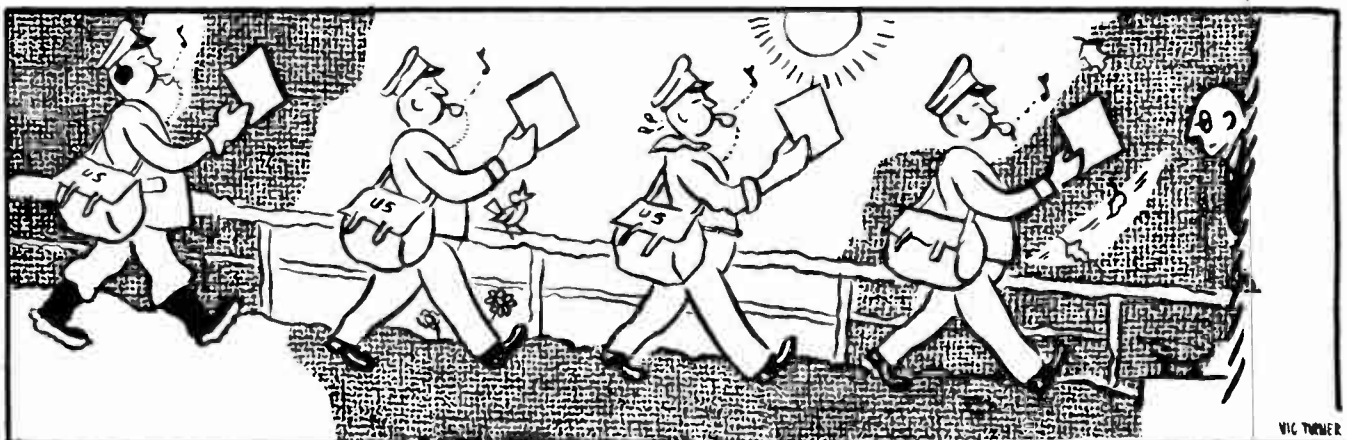

And keep reminding him, day after day, week after week, season after season

# ROOF TO RECEIVER, OVER

by C. T. Josephs

With installation of television receivers, a means of roof-receiver communication is needed. The author tells us how he solved this problem.

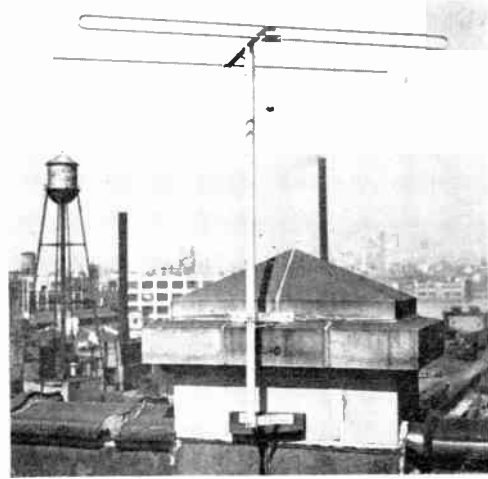

**W**ITH the event of television, there arose a great need for a communication system between the roof and receiver for the many installations required. Hence, servicemen have tried and are using many schemes. Some use Walkie-Talkies, battery or electric inter-coms, battery powered phones, etc. One of the simplest methods is the use of the sound-powered phone set used by the Navy in the last war. These phone sets do not require any battery power and can be purchased in most surplus stores. This system, however, has a disadvantage in that sufficient two-conductor cable or line must be carried by the serviceman in addition to all the other equipment necessary on an installation job. Often, the cable gets tangled and brings forth some incoherent language because, as a rule, the serviceman does not wind the cable into a neat coil or on a small reel after each job.

Having a couple of ordinary

phones on hand, the author developed a scheme to use these and eliminate the inter-connecting leads usually required. This method proved quite satisfactory by using two ordinary phones, 2 blocking condensers, 4 blocking coils, and two 1.5 volt flashlight cells. The transmission line from the antenna to the receiver is used as the inter-connecting cable or leads. The connection of these units is shown in Figure 1. The blocking coils are hand wound on a  $\frac{1}{2}$  watt, 1 megohm insulated type resistor. Seven turns of #18 enamel covered wire are equally spaced on the body of the resistor and the ends are soldered to the pigtails of the resistor. Two of these coils are soldered permanently in series with each lead from the phone to be used on the roof and the loose ends of the leads are provided with alligator clips. The parts at the receiver end (shown in the dotted lines) are combined into a small box with proper clips to hold the flashlight cells. The box is pro-

vided with the four terminals required, that is, two terminals for the line to the roof and two terminals for a short line to the receiver.

If a set of sound powered phones can be purchased, the system will become simpler. The flashlight cells and the blocking condensers which blocked the 3 volts d.c. from the receiver, are no longer required. Therefore, the box to house these parts is also not required. The coils may be soldered into the phone leads as previously performed on the other phone and the leads similarly provided with alligator clips. In this case, all the serviceman has to carry for his inter-communication system is a set of sound-powered phones provided with the blocking coils.

The author has found that the system described here is very simple to operate. It has proven of great value in the actual installation of TV antennas by considerably simplifying the problem of Roof-to-Receiver communication. ✓ ✓ ✓

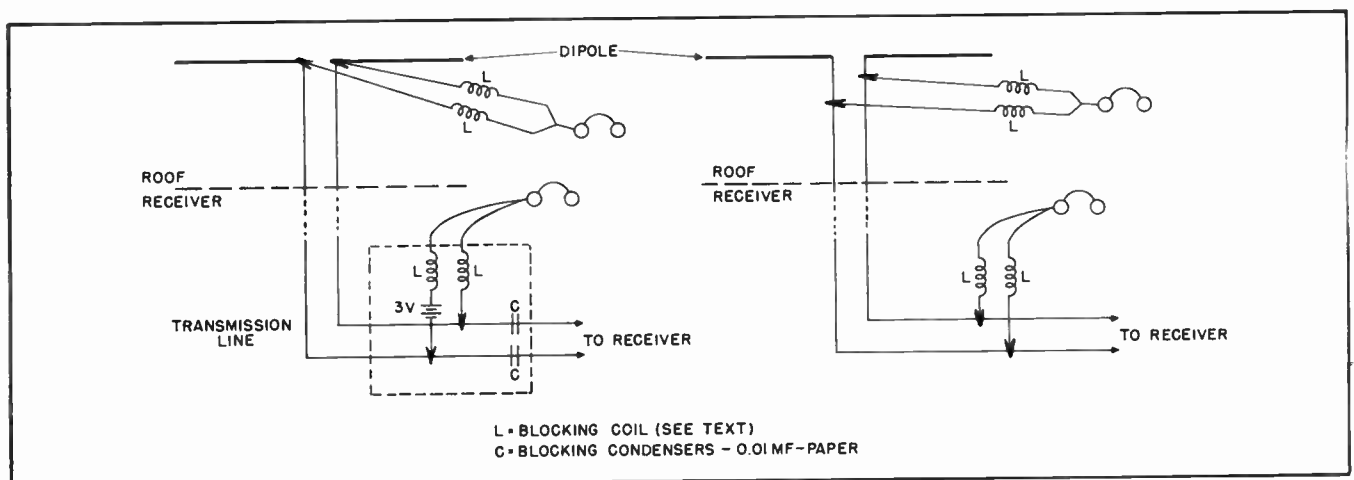

Fig. 1. Circuit of roof-to-receiver communication systems.

# American Beauty

## ELECTRIC SOLDERING IRONS

are sturdily built for the hard usage of industrial service. Have plug type tips and are constructed on the unit system with each vital part, such as heating element, easily removable and replaceable. In 5 sizes, from 50 watts to 550 watts.

### TEMPERATURE REGULATING STAND

This is a thermostatically controlled device for the regulation of the temperature of an electric soldering iron. When placed on and connected to this stand, iron may be maintained at working temperature or through adjustment on bottom of stand at low or warm temperatures.



For descriptive literature write

110-1

**AMERICAN ELECTRICAL  
HEATER COMPANY**  
DETROIT 2, MICH., U. S. A.

# OVER THE BENCH

by John T. Frye

**J**UST how much electric current do you think is necessary to cause death? It really does not matter what you think, except that the wrong idea may be leading you to be careless with voltages that are potentially deadly. What does matter is this *fact* agreed upon by the medical fraternity: Any current from seventy to ninety milliamperes or above may cause death.

That is not very much, is it? It is less than the current requirements of a  $\approx 47$  pilot lamp. Any receiver you put on your bench, be it an ac-de midget, a three-way portable, or a chassis from a standard console can supply this much lethal current without straining itself.

The amount of current that passes through your body is a function of the applied voltage and the skin resistance. Dr. George J. Nichols, the cardiologist, says that skin resistance varies from as low as 300 ohms when drenched with sweat, to as high as a megohm. The average resistance is around 5,000 ohms.

Using that 300 ohm value, Ohm's law will tell you that twenty-one volts could drive the deadly seventy mils through your body. You do not service many receivers that do not have at least twenty-one volts running around loose in them, do you? Even the smallest hearing aid battery can provide this much voltage.

The serviceman should let these facts sink into his mind, for they should make him realize that every set he places on his bench could kill him. Working, as he does, with electricity every day, he is likely to become careless. It is the old story of "familiarity breeds contempt." He laughs about being bitten, not realizing, apparently, that one of those

bites could be as deadly as that of a cobra.

Let me earnestly urge you right now to make yours a "safe" service bench. First, do not work on a cement floor. If the floor of your shop is cement, see to it that the place where you stand when working at the bench is covered with a good insulating material, such as rubber. Remember that one side of the 110 volt line is grounded; so if you are standing on a cement floor, all you have to do is touch the hot wire of the ac input and your body will be bridged right across the line.

Use an isolation transformer between the line and the set upon which you work. This will give you added protection against one of those hot-wire-to-ground electrocutions, and it will also have other advantages when working with ac-de sets. Make sure that none of your service tools, such as electric drills, service lamps, soldering irons, etc., have their frames grounded to one side of the line cord. A few minutes of checking with the ohmmeter can set your mind at rest on this score.

See to it that all of the power to the bench is cut off by a single, easily-accessible switch. Recently I saw a setup that I particularly liked. The power switch was mounted on the wall at one end of the bench, and a strong cord ran from the handle of this switch through screweyes along the whole front edge of the bench. When the switch was closed, all of the slack was taken out of the cord; so in case of an emergency, a single tug at this cord from any position along the bench would cut off the power. Since two men normally worked at this bench, if either were frozen by the grip of an electric cur-



rent, the other could release him without any loss of precious time. Furthermore, if a set were dragged from the bench, in falling it would cut the current.

With the advent of television, the serviceman is encountering dangers even greater than those to which he has been exposed. Many TV receivers have potentials well above those used on an electric chair. In fact, the potentials are so high that insulation which ordinarily provides a good margin of safety against shock can no longer be depended upon to do this. Special probes are necessary, and the use of a good pair of line-man's gloves when working on such a set is no affectation.

In addition to looking out for his own safety, the serviceman has a very definite responsibility to protect his customers against accidental shock. They are admittedly ignorant about things electrical, and they depend upon him to see to it that their receiver not only plays well, but that it is also safe to use.

In general, line cords that are frayed or on which the rubber insulation has deteriorated should *always* be replaced. When replacing parts, no unprotected high-voltage point should be allowed to appear above the chassis or at any other place where it can be reached with the chassis in position in the cabinet. Women *will* dust the back of receivers with the power turned on. (One told me she could see better when the pilot lamp was burning!)

AC-DC sets are particularly dangerous because of the fact that the B-minus point—often the chassis—is tied to one side of the line. This means that the full line voltage may appear between the chassis and the ground. Under such conditions, any exposed bit of metal that is connected to the chassis is a source of danger. This includes protruding set-screws of dial knobs and chassis mounting bolts that are not covered with insulation.

Whenever possible, I see to it that every ac-de set that leaves my shop has push-on knobs; and if set-screws knobs have to be used, they are of the type in which the set-screw is well down in a hole in the knob. High-voltage tape is used to cover exposed chassis-mounting boltheads. A cardboard rear cover is *always* in

-- To page 29



## Dynamic Mutual Conductance TUBE TESTER

# HICKOK

Tests all the latest tubes, including television, with the famous HICKOK Dynamic Mutual Conductance circuits. Tests tube-life, an exclusive HICKOK feature. Scale readings are directly in Micromhos—a test originated and developed by HICKOK and used by most expert AM, FM and Television servicemen as the highest standard of accuracy.

Mail this ad for literature and free copy of our regular 50c Service Instruction Manual.

THE HICKOK ELECTRICAL INSTRUMENT CO.  
10934 Oupent Avenue • Cleveland 8, Ohio

## Notice to Service Organizations!

### RADIO MAINTENANCE Magazine Special Group Plan

Radio Servicemen enrolled in service trade organizations may subscribe to RADIO MAINTENANCE at a special Group Plan price. WRITE US FOR PRICES. Here's how it's done:

1. Offer open to members of Radio Servicemen's Associations, societies or organizations.
2. Applies to all orders from these organizations containing *five or more* names.
3. Orders must be on the *organization* letterhead and must give the name and address of each subscriber. State subscriber's service status (is he a shop owner, employee of service department, service manager, etc?) Magazines will be delivered to subscriber's address.
4. Payment must accompany each order.
5. If a serviceman already has a subscription he may renew it through this group plan, but be sure to mark plainly "RENEWAL" in these cases.
6. Address all orders to:

RADIO MAINTENANCE Magazine,  
460 Bloomfield Ave., Montclair, N. J.



## Permoflux

# SPEAKERS

POWER! FIDELITY! RUGGEDNESS!

Famous name manufacturers rely on their unvarying high quality. Satisfy your customers with Permoflux PM and EM replacements.

TWO COMPLETE FACTORIES TO SERVE YOU

PERMOFLUX

PIONEER MANUFACTURERS OF PERMANENT MAGNET DYNAMIC TRANSDUCERS

PERMOFLUX CORPORATION

4900 W. Grand Ave., Chicago 39, Ill. • 236 S. Verdugo Rd., Glendale 5, Calif.

See Your Jobber

WRITE FOR CATALOG

→ From page 13

it had reached a value of 5% or more. However, since the advent of f-m and modern high fidelity system, experience implies that the public is educated to recognize somewhat lower values, perhaps even as low as 2%.

**Intermodulation Distortion**

2. Another way in which the wave from a signal may be distorted by the presence of unwanted signal components of other frequencies is by *intermodulation*.

Intermodulation is the result of the heterodyning of two or more of the components of the desired signal which have different frequencies. These two signal components mix in any portion of an amplifier which has non-linear impedance characteristics, to produce "sum" and "difference" signals in the output wave. This action is exactly the same as that which takes place in the mixer section of the superheterodyne receiver. In the superheterodyne, the mixing action is desirable and purposeful, to obtain the i-f signal. In audio frequency amplifiers, however, the intermodulation creates unwanted distortion of the wave and is naturally to be avoided as much as possible.

Fig. 3 gives an example of the production of intermodulation distortion. The input signal to the a-f amplifier, ordinarily made up of a large number of different frequency components, is represented here with only two components for the sake of simplicity. In a perfect amplifier, these two components, one having a frequency of 2000 cps and the other a frequency of 500 cps, would pass through the amplifier without distortion. But if the relation between voltage input and voltage output for different amplitudes is not linear, these signals *modulate* each other and produce the beat notes shown. One beat signal has a frequency equal to the sum of the frequencies (2500 cps) and the other has a frequency equal to their difference (1500 cps). These additional components are not supposed to be in the signal and their presence causes them to combine with the desired signal components, distorting the wave form.

**Did You Know...**



**THAT IN 10 HOURS  
AN AVERAGE RADIO  
SPEAKER EXERTS  
ENOUGH ENERGY TO  
MOVE A LOADED  
BOX CAR 50 FEET?**

Of course, you'd never attempt to use a loudspeaker for this purpose... but, it is true that in just 10 hours an average loudspeaker does exert an amount of energy that will move a loaded box car 50 feet! This means that although OPERADIO builds speakers with the skill and care of a watchmaker... these speakers are sturdily constructed to stand up under heavy continuous use. OPERADIO speakers are delicately balanced to authentically reproduce the sweetest high notes of a piccolo, yet, carry the tremendous power of a full orchestra crescendo!

**ASK FOR OPERADIO SPEAKERS —  
A FULL LINE OF OUTSTANDING  
SPEAKERS FOR EVERY PURPOSE!**

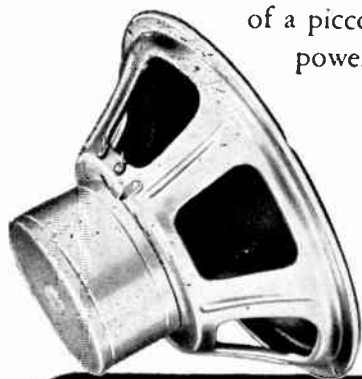

**OPERADIO**

**RADIO REPLACEMENT and  
PUBLIC ADDRESS SPEAKERS**

**OPERADIO MFG. COMPANY • St. Charles, Illinois**

Thus harmonic distortion and intermodulation distortion both affect the wave form of the signal by the addition of undesired signal components. They are distinguished by the fact that harmonic distorting components all have frequencies equal to a whole multiple (2, 3, 4, etc.) of the desired signal frequencies, whereas intermodulation distorting components have frequencies equal to the sum and difference of the frequencies of the desired components producing them. Secondary intermodulation, that is, interaction between the products of intermodulation, also occurs, but unless the amplifier is exceptionally poor, the distortion will be negligible from this source.

The causes of intermodulation distortion are generally the same as the causes of harmonic distortion. These causes are any factors which lead to a non-linear condition. Examples would be improper bias, such as illustrated in Fig. 1, or wrong component or voltage values in the plate or grid circuits of the amplifier tubes.

One of the most common causes of both harmonic and intermodulation distortion is the use of an output transformer of inadequate ratings. Also, improper loading and adjustment of power amplifiers, especially those using pentodes, can have the same effect.

### Frequency Response

3. The third factor in the production of a high fidelity signal is that the system, including the tuner, the a-f amplifier, and the loudspeaker must reproduce equally well the signal components of all frequencies in the audible range or, at least, all the frequencies produced in the program in the station studio.

F-M stations are required by law to radiate a signal whose modulation is equally strong and undistorted (after allowing for de-emphasis) for all modulation signal components between the frequencies of 50 cps and 15,000 cps.

*A flat response (meaning equal output) over the range 50—15,000 cps does not necessarily produce high fidelity!* Since harmonic distortion components are higher in frequency than the fundamentals, addition of more high frequency response to a  
→ to page 26

# Be an FCC Licensed Radio Technician and DOUBLE YOUR PAY!

## Which Do You Want?



Better Pay



A Nice Home



A New Car



Greater Security



Happy Vacations and Travel

Get Your FCC Ticket  
Jobs worth  
**\$3,000 to \$7,500**  
are opening up  
right now for  
FCC Licensed  
Radiomen.

Add Technical Training to your Practical Experience and

# Get Your FCC COMMERCIAL RADIO OPERATOR LICENSE in a Few Short Weeks



It's EASY if you use CIRE Simplified Training and Coaching AT HOME in SPARE TIME

Get This Amazing New Booklet

Get your license easily and quickly and be ready for the \$3000 to \$7500 jobs that are open to ticket holders. CIRE training is the only planned course of coaching and training that leads directly to an FCC license.

Your FCC Ticket is always recognized in all radio fields as proof of your technical ability.

1. TELLS OF THOUSANDS OF BRAND-NEW, BETTER-PAYING RADIO JOBS NOW OPEN TO FCC LICENSE HOLDERS.
2. TELLS HOW YOU WILL BENEFIT BY HOLDING AN FCC COMMERCIAL LICENSE.
3. TELLS HOW YOU CAN GET YOUR FCC COMMERCIAL RADIO OPERATOR LICENSE IN A FEW SHORT WEEKS—EASILY AND QUICKLY, BY USING CIRE SIMPLIFIED TRAINING AND COACHING AT HOME IN YOUR SPARE TIME.
4. TELLS OF HUNDREDS OF OUR SUCCESSFUL STUDENTS WHO NOW HAVE LICENSES AND NEW, BETTER-PAYING JOBS.
5. TELLS HOW WE PREPARE YOU TO PASS THE NEW FCC COMMERCIAL LICENSE EXAMINATIONS, WHICH NOW INCLUDE FM AND TELEVISION.
6. TELLS HOW WE GUARANTEE TO TRAIN AND COACH YOU UNTIL YOU GET YOUR LICENSE.
7. TELLS HOW WE HELP YOU TO GET A BETTER-PAYING, LICENSED JOB, WITH OUR FREE AND EXCLUSIVE SERVICE, WHICH PREPARES YOUR EMPLOYMENT APPLICATION FOR MAILING TO HUNDREDS OF EMPLOYERS, INCLUDING FM, AM AND TELEVISION BROADCAST STATIONS, RADIO MANUFACTURERS, POLICE RADIO STATIONS, AND RADIO-EQUIPPED TAXI, BUS AND PUBLIC UTILITY COMPANIES.



## Get All 3 FREE!

**CIRE Graduates Find FCC License Pays Off**  
"I now hold ticket P-10-3787, and holding the license has helped me to obtain the type of job I've always dreamed of having. Yes, thanks to CIRE, I am now working for CAA as Radio Maintenance Technician, at a far better salary than I've ever had before. I am deeply grateful."  
Student No. 3319N12  
"I was issued License P-2-11188 on November 4. The next day I was signed on board a tanker as Radio Operator-Purser. Besides radio operating, I handle the payrolls, etc., which is all over-time and brings my monthly pay up to between \$500 and \$450."  
Student No. 2355N12

**CLEVELAND INSTITUTE OF RADIO ELECTRONICS**  
Desk RM-1, 4900 Euclid Bldg., Cleveland 3, Ohio  
(Address to Desk No. to avoid delay)

I want to know how I can get my FCC ticket in a few short weeks by training at home in spare time. Send me your FREE booklet "Money Making FCC License Information," as well as a sample FCC-type exam and free booklet, "How to Pass FCC License Examination" (does not cover exams for Amateur License). Approved for Veteran Training under "G.I. Bill of Rights."

Name .....

Address .....

City ..... Zone ..... State .....

Veterans check for enrollment information under "G.I. Bill"

NO OBLIGATION — NO SALESMEN

# UTAH OVAL SPEAKERS FOR Television



## Replacements FOR ALL SETS!

Television creates new opportunities of profit for servicemen and a new need for replacement speakers. Now Utah announces two new ovals especially designed for TV. Both are 4x6's, the SE46T6 with a 60 ohm field and the SE46T10 with 100 ohms resistance. Other ovals in the Utah line qualify for use in television sets. Many permanent magnet weights and various field coil resistances are available in 4x6's, 5x7's and 6x9's. TV is big business — see your jobber today.

**UTAH RADIO PRODUCTS**  
HUNTINGTON, INDIANA  
DIVISION OF INTERNATIONAL DETROLA CORPORATION  
EXPORT DIVISION: MORHAN EXPORTING CORP. N. Y., N. Y.

utah

**UTAH FOR AM, FM, VIDEO**

### PROGRESSIVE MARKETERS

Dave Kubrick — Irv Brown

### RADIO-TELEVISION SALES SPECIALISTS

Eastern Factory Sales Representatives for:

Transvision Television  
American Condenser Co.

Harrison Wire Recorder

Precision Transformer Co.  
Boland & Boyce, Inc.

41 Union Square, N. Y. 3, N. Y.

ALgonquin 4-7486

### Audio Systems in FM

slightly distorted (say 5%) amplifier, will make the distortion much worse, since many of the harmonics which were previously inaudible are now heard.

Thus we find that frequency response and harmonic and intermodulation distortion are intimately related. *If the harmonic and intermodulation distortion effects are not kept to a very low level, a wider frequency response only makes an amplifier worse rather than better.*

### Phase Response and Transients

4. Phase shift distortion, which has a bad effect on video amplifiers in television receivers, is never bad enough in a-f amplifiers in f-m receivers to cause servicing or maintenance troubles. In the more elaborate high fidelity systems, however, some consideration is paid to keeping *transient response* to a minimum. Transients results from the tendency of certain combination of components (say, a resistor and a condenser) to be shocked into oscillation for a few cycles at their natural frequency. This effect is noticeable in some amplifiers when a cymbal or bass drum causes a sudden electrical impact on the system; the sound is not sharp and definite. Investigation and remedy of such trouble may at present be outside the scope of the service engineer, but it is important that he notice and recognize such symptoms.

### Practical Applications

The foregoing information about the definition and nature of high fidelity is important to the *practical service man* for the following reasons:

1. The public is becoming educated to the benefits and enjoyment possible from high fidelity reproduction. The service engineer must keep his customers well-informed on the subject.

2. In advising the prospective purchaser of a receiver, the serviceman must be prepared to discuss in detail and *explain in simple language* the advantages and the limitations of various f-m receiver models.

3. In making replacements, alignment jobs and other operations, the serviceman must be aware of the various factors necessary to assure that proper fidelity is maintained after the job is complete and the receiver returned to the customer. ✓ ✓ ✓

## Advertise

→ From page 20

the U. S., of which nearly one and a half million was for *local* advertising.

A radio service shop may never reach the stage where it has as many daily customers as does a super food market, but we want to get across the incontestable fact that promotion *can* build up a trade *and the demand* for the products or services of that trade.

Some of the above mentioned local businesses built up their volume and increased the demand for their goods by a laborious and costly re-organization based on existing conditions.

### You Have the Opportunity

The radio service field does not have to do this, because two new developments—FM and Television—have come along. These new additions are revitalizing shots in the arm that make a new era for servicemen a certainty. Home receivers, as a result of these developments, are much more complex and will require more expert maintenance. From here on, the radio and television service technician assumes an increasingly important position in his community. His services will be more essential and vastly more respected. What an opportunity this is!

In advertising campaign planning there's a never-ending search for "new angles" from which to present a story. You—the service technician—have had FM and Television handed to you on a solid silver platter. These are new opportunities, the like of which any industry would give millions to have.

It is inevitable that the sudden appearance of a golden opportunity will cause a stampede in the direction of the bright light. Some of the participants will be trampled to death and others will be left behind on the barren ground. You can bet that the men who come out on top will be those who not only gave their customers better service, but who knew how to *advertise* that service.

(Article number two in this series will cover the planning of an advertising program for your radio service shop, based on small and large income. In the meantime, why not write in your questions on advertising? We'll try to print and answer as many letters as we can. You will help yourself and others by doing this—let's hear from you!) ✓✓✓

# Flexibility makes

## "the Service Man's Line"

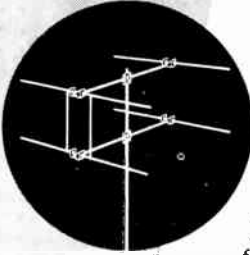

Brach antennas . . . long known for dependability . . . maximum reception . . . trouble-free operation . . . durability and ease of installation . . . now feature an added extra . . . Flexibility. Unique construction features aid the service man in making a more rapid installation to which future additions or modifications can be easily made.



**1. FLEXIBILITY** A complete line designed with basic antenna parts which are convertible to more complex arrays as required by location and reception problems.



**2. COMPLETE KITS** Each antenna model is independently designed and furnished in a completely packaged kit containing all necessary hardware, download (when desired) and the Universal Base Mount . . . ready for installation.

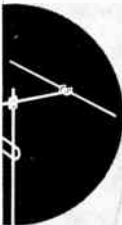

**3. PRE-ASSEMBLY** Each antenna is factory pre-assembled as far as possible, ready to erect. Complete and simple installation instructions. Saves valuable man-hours on the roof.

**4. MECHANICAL STRENGTH** Weather - tested for durability, Brach Antennas feature a husky steel mast, rigid connections, sturdy base mount, neat appearance. All parts corrosion resistant.

**5. SUPERIOR RECEPTION** Designed with engineering "know-how". All Brach antennas are factory pre-tuned, matched for 300 ohm transmission line with large diameter aluminum elements for better signal pick-up. Directivity patterns and standing wave ratios available upon request.

## New! Tops in TV! HI-LO ROTATABLE Antenna

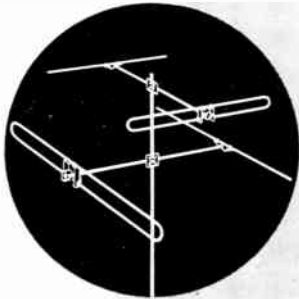

Here it is! A rotatable antenna to provide peak performance with any station at any time. Brach introduces the new "Superview" Rotatable, covering both high (174 MC to 216 MC) and low (88 MC to 108 MC) TV bands. High band extension available for easy addition to standard dipole array for separate orientation. No more multiple images. No more "weak" stations. Brach's Superview HI-LO assures television reception that's tops. Make sure and investigate the new Superview line today.

Write for Free Brach catalog showing complete line of TV and FM antennas and accessories.

WRITE FOR CATALOG NO. RM 304



# L. S. BRACH MFG. CORP.

200 CENTRAL AVENUE, NEWARK, N. J.

WORLD'S OLDEST AND LARGEST MANUFACTURERS OF RADIO ANTENNAS AND ACCESSORIES

# Astatic FL SERIES Pickups

Play BOTH 33 $\frac{1}{3}$  and 78 RPM Records WITHOUT changing Needle Pressure or similar adjustments

NOT HAVING to change needle pressure or make similar adjustments—in switching from 33-1/3 to 78 RPM Records with Astatic FL Series Pickups—has done much to put these revolutionary phonograph playing arms in a leading position in the new long-playing equipment field. All that the user need do is change cartridges. Takes only a second, because they are designed to fix themselves in playing position on the same slip-in principle which firmly joins barrel and cap of many modern fountain pens. New engineering, mechanically and electrically, assures perfect tracking, unparallelled reproduction, at the featherlight needle pressure of five grams. Comparable reproduction quality at lower cost is available in other Astatic units, which round out the complete Astatic Long-Playing Line. Write for new brochure, giving full details, illustrations.



FL-33 CRYSTAL PICKUP



FLC-33 CRYSTAL PICKUP



FLT-33 CRYSTAL TRANSCRIPTION PICKUP



400-QT-33 CRYSTAL TRANSCRIPTION PICKUP



Astatic Crystal Devices manufactured under Brush Development Co. patents

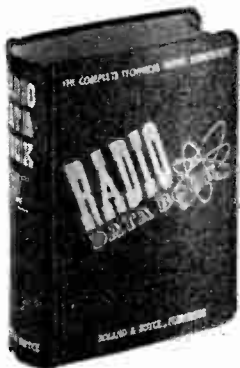

TWO GREAT BOOKS . . .  
COVERING EVERYTHING IN  
RADIO & TELEVISION

EVERYTHING IN RADIO AND  
ELECTRONICS IN ONE BOOK!  
THE MOST COMPLETE  
TELEVISION MANUAL

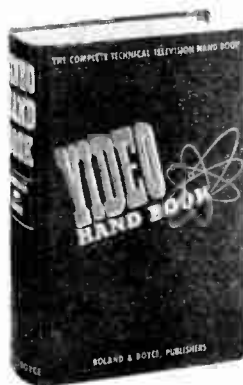

## THE RADIO DATA BOOK

the only radio handbook of its kind . . . 1148 pages . . . 12 sections, each covering a radio subject more completely than any other book!  
12 complete books in one only  
Less than 42c per book!

**\$5.00**

## THE VIDEO HANDBOOK

768 pages . . . 14 sections, covering every phase in television . . . over 800 illustrations . . . handsomely bound in Du Pont Fabrikoid with red and silver letters.

ADVANCE SALE  
ORDER NOW!  
**\$5.00**

Mail This Coupon to Your Jobber Today — or direct to: RM-1  
BOLAND & BOYCE, 460 Bloomfield Ave., Montclair, N. J.

Send me 1 RADIO DATA BOOK  
 I enclose \$5.00 (\$5.50 Foreign)  
 I enclose \$1.00 and will pay postman \$4.00 on delivery (in U. S. only)

Send me 1 VIDEO HANDBOOK  
 I enclose \$5.00 (\$5.50 Foreign)  
 I enclose \$1.00 and will pay postman \$4.00 on delivery (in U. S. only)

NAME .....  
 ADDRESS .....  
 CITY ..... ZONE .....  
 STATE .....

## BACK NUMBERS . . . . . . get them while they last

February 1948

LET'S WORK TOGETHER  
HOW TO USE SWEEP GENERATORS  
VOLTAGE REGULATORS

March 1948

HOW TO ELIMINATE HUM  
TELEVISION INTERCARRIER SYSTEM  
SWEEP GENERATORS OR FM ALIGNMENT  
PART II

April 1948

NEW FM SIGNAL GENERATOR  
DB CALCULATORS MADE EASY  
GET THE MOST FROM YOUR VTVM  
AFC IN FM

May 1948

TROUBLESHOOTING RECEIVER  
DISTORTION  
INTERFERENCE  
A POCKET FM SIGNAL GENERATOR  
A SWEEP GENERATOR FOR F.M. & T.V.

June 1948

INTERFERENCE PART II  
HEATER-CATHODE HUM  
SUPER SERVICE  
F. M. AND YOU

July 1948

OHM'S LAW IN RADIO SERVICING  
INTERFERENCE PART III  
HOME SERVICE CALLS . . .  
DO THEY PAY?  
SERVICING RC FILTERS

August 1948

ADVERTISING WILL BUILD YOUR BUSINESS  
INSTALLATION OF F.M. ANTENNAS  
CUSTOM BUILDING  
YGS-3 SIGNAL GENERATOR

September 1948

SERVICING WITH VTVM  
TRANSMISSION LINE PROBLEMS  
RADIO PHOTOGRAPHS  
RECEPTION UNLIMITED

November 1948

RECORD CHANGER REPAIRS  
SIGNAL TRACING TV  
NEW TV INSTRUMENTS  
F.M. DETECTORS

RADIO MAINTENANCE MAGAZINE  
460 BLOOMFIELD AVE.,  
MONTCLAIR, N. J.

Please send me the back numbers  
checked here . . .  
I am enclosing 35c for each copy, or  
\$2 for any 8 copies.

February 1948       June 1948  
 March 1948       July 1948  
 April 1948       August 1948  
 May 1948       September 1948  
                       November 1948

NAME .....  
 ADDRESS .....  
 CITY .....  
 ZONE ..... STATE .....

## TV Tuning Systems

→ From page 17

part of the waveband switch in order to keep lead inductance at a minimum. A twin 6J6 is used as a triode mixer and Colpitts oscillator. Fine tuning adjustments are made with a small condenser (C25). The major frequency changes are made by switching the oscillator coils, which also are slug-tuned and pre-set at the factory.

### Permeability Tuning

Advantages of permeability-tuned systems are the same as with other variable inductances. The main disadvantage is the problem involved in mass production. It is extremely difficult to turn out permeability-tuned units which have uniform tracking and calibration, due to the small number of turns involved, the large wire size required, and the extremely wide frequency range to be covered in such a short motion of the tuning slugs. One manufacturer uses braided tinsel to overcome this difficulty. Zenith, in its f-m tuners, uses four parallel wires for each coil winding as the solution. Other disadvantages of permeability systems are mounting and wiring arrangements, the necessity for thin-walled forms, termination, etc. Belmont, however, employs a continuously-tuned, mechanically-ganged permeability tuner in their model 21A21 receiver (Fig. 7) with excellent results.

Many variations of the above systems are being used and developed. Basically, the principles and operation will remain the same, but it will be interesting to note the circuit arrangements and tuning systems to be employed in future television receivers. ✓ ✓ ✓

## Over the Bench

→ From page 23

place. If the original one has been lost or thrown away, a new one is made.

Quite often a little casual conversation with a customer will reveal a condition that is highly dangerous. For example, as a customer of mine was leaving the shop recently with his little ac-dc set under his arm, he mentioned that he always liked this

# ORIENT

**AMPHENOL**  
*adapt STACKING to the conditions of the area...*

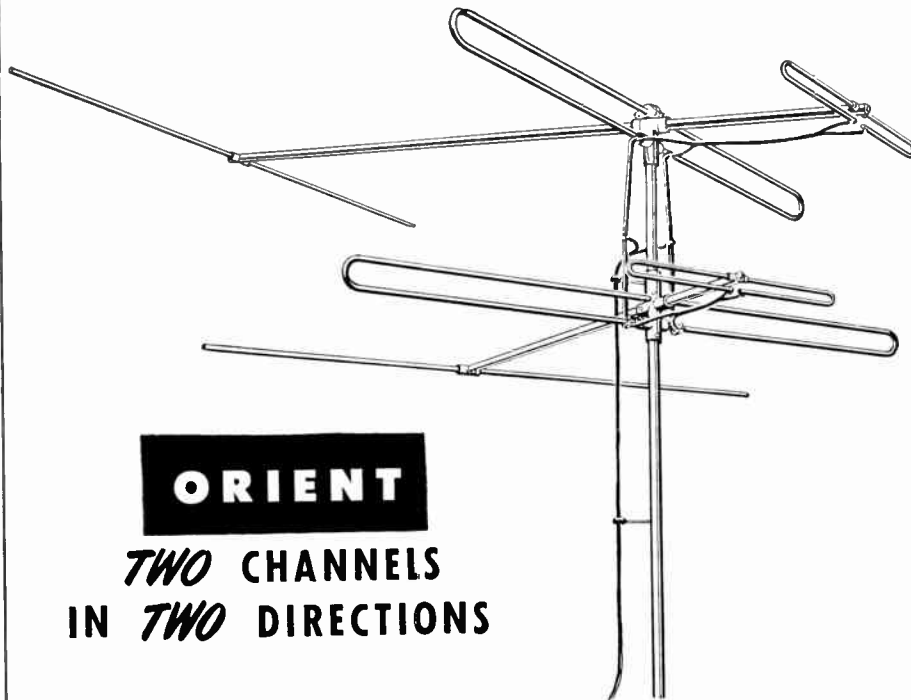

**ORIENT**  
**TWO CHANNELS**  
**IN TWO DIRECTIONS**

The usual objective of Antenna Stacking is for the purpose of acquiring db gain—with Amphenol's 114-302 Stacked Array there is a plus value, another adaptation, one which is very important in congested TV areas. Both the upper and lower bays provide all-channel reception and each bay may be individually oriented. Overlapping signals or station interference on same channels within receiving areas may now be separated—if and when the bays are stacked for orientation. In the smaller illustration lower right, observe the same array stacked for db gain on all channels. Amphenol Antennas offer many plus values in being perfected electrically and mechanically in every detail.

*To keep posted on all that's new in TV and FM Antennas, be sure your name is on the Amphenol list to receive the monthly issue of ENGINEERING NEWS. Current issue contains timely information on these subjects—yours for the asking.*

**AMPHENOL**

**AMERICAN PHENOLIC CORPORATION**  
1830 SO. 54TH AVENUE • CHICAGO 50, ILLINOIS

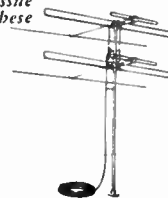

particular little set because it would sit on a narrow shelf just above the bathtub and enable him to listen to a favorite morning program while he was bathing.

I picked up a magazine I had been reading that morning and showed him a story about a woman who had been doing exactly the same thing and who had been electrocuted when

the radio toppled into the tub. When he finished reading the story, he was in a receptive mood to hear this cardinal safety rule: *Never have any electrical appliance where you can reach it while in a bathtub.*

Remember, having a healthy respect for electricity is a good way to stay healthy. ✓ ✓ ✓

**DANGER  
HIGH  
VOLTAGE**

# SAFE..SIMPLE

HIGH VOLTAGE TV Tests to 60,000 VOLTS

WITH THE NEW

## PRECISION SERIES TV

Super High Voltage Safety Test Probes

NOW . . . Test high voltages with safety and confidence. Series TV super high voltage test probe is custom designed for YOUR safety FIRST and provides the accuracy and dependability you expect from products bearing the "Precision" name.

- ★ Extended high dielectric anti-leakage paths.
- ★ Multi-channelled guard barrier.
- ★ Full handle length internal arc-back shield directly grounded.
- ★ External arc-back barrier directly grounded.
- ★ Fully shielded instrument connecting cable.
- ★ All critical high potential and ground connections within the probe are positively accomplished via high compression contact springs.
- ★ Special helical film-type cartridge multiplier, developed specifically for very high potentials.
- ★ Custom molded polystyrene probe head, bakelite handle and barrier. Specially machined and toolled Lucite internal components.
- ★ "Application Engineered" to meet the exacting requirements demanded by its intended field of usage.

- ★ Series TVP. Probe less cartridge. Net Price \$12.35
- ★ Series TV-1 . . . Probe with cartridge for Precision EV-10VTVM. Net Price \$15.45
- ★ Series TV-2 . . . Probe with cartridge for Precision (or any) 20,000 ohms per volt test set with a 6000 volt range. Net Price \$15.45

**NEW** Wide Range Sweep Generator Series E-400 \$124.70  
5" Cathode Ray Oscillograph Series ES-500 \$149.50

**YOUR ANSWER TO TV & FM COMING NEXT MONTH See your Precision Distributor NOW!**



- ★ Multiplier cartridges are available to match most popular 20,000 ohms/volt test sets and vacuum tube voltmeters.

Series TV High Voltage Test Probes provide direct kilovoltmeter facilities with your present high sensitivity test set, and vacuum tube voltmeter such as the "Precision" instruments illustrated below.

See them on display at all leading radio equipment distributors along with the complete Precision line of modern electronic test instruments for all phases of AM-FM-TV service and maintenance.



Model 85—20,000 ohms per volt AC-DC test set. Rotary range and function selection. 34 ranges to 6000 volts, 60 megs., 12 amps., 70 DB. 4 1/2" meter. Net Price \$38.75



Model 858-L—20,000 ohms per volt Multi-Master High Speed, push button operated. 54 ranges to 6000 volts, 600 megs., 12 amps., 70 DB 4 1/2" meter. Net Price \$54.10

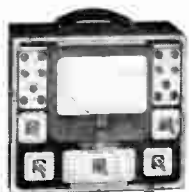

Model EV-10 MCP—High sensitivity, zero-center VTVM plus complete AC-DC V-O-M facilities to 6000 volts, 2000 megs., 12 amps., 70 DB with 7" meter. Net Price \$89.95



Model 10-54-P—Combination Electronic Tube Tester, and 20,000 ohms per volt V-O-M Ranges to 6000 volts, 12 amps., 60 megs., 70 DB 4 1/2" meter. Net Price \$134.40

### PRECISION APPARATUS COMPANY, INC.

92-27 Horace Harding Boulevard • Elmhurst, New York  
Export Division: 458 Broadway, New York, U. S. A. Cables—Morhanex

## SPEAKER SPECIALIST

Build yourself a reputation for improved tone of every speaker job you handle. A.G. will back you with the finest reconing service.

- Cones and fields in stock for any speaker
- Full range frequency test
- Audio test at full power rating
- Professional workmanship

Send a trial speaker, parcel post, for quick reconing and return in perfect condition . . . 5"—\$1.50 . . . 12"—\$3.00 . . . others low too!

## A. G. RADIO PARTS CO.

3515 N. 17th St.

Philadelphia 40, Pa.

### CORRECTION

The formula appearing on page 42 of the December 1948 issue of Radio Maintenance has been printed in error. The correct formula should read as follows:

$$E_1 = \frac{E_1 \times (F - 1)}{F - \left( \frac{E_1}{E_2} \right)}$$

## BINDERS!

PRESERVE YOUR RADIO MAINTENANCE MAGAZINES IN THEM

RADIO MAINTENANCE  
160 Bloomfield Avenue  
Montclair, N. J.

Please send me . . . binders at \$2.00 each.

Total amount enclosed . . . . .

Name . . . . .

Address . . . . .

City . . . . . Zone . . . . .

State . . . . .

# 30,000

SERVICE TECHNICIANS

Read  
RADIO MAINTENANCE  
Every Month  
Every day is  
RADIO MAINTENANCE  
day in your shop!

RADIO MAINTENANCE RM-1  
460 Bloomfield Ave.,  
Montclair 1, N. J.

Please send me RADIO MAINTENANCE for:

2 years at \$5.00

1 year at \$3.00

Check enclosed

Bill me later

Name . . . . .

Occupation . . . . .

Address . . . . .

City . . . . . Zone . . . . .

State . . . . .



# ELECTRONICALLY SPEAKING

\*\*\*\*\*

Sales of radio receiving tubes continue to climb. September sales totalled over 18 million, representing an increase of 1.7 million over August and more than 2 million over September 1947, it was reported by the Radio Manufacturers Association. Of the total, 13 million tubes sold for new sets, 5 million went for replacements. The remainder was taken up by export and government agencies. Total sales of receiving tubes for the first nine months of 1947 exceeded 144 million.

Television in the operating room. Actual operations were televised for purposes of demonstrating new surgical techniques at the recent meeting of the American College of Surgeons in Los Angeles. Instead of having to depend on verbal descriptions, surgeons were able to watch operations actually being performed over ten receivers provided by G.E. According to the President of the College, TV contributed a major share to the success of the meeting.

Television has gone Navy. Early this year, weekly schedules of lectures will be telecast four miles to large screen receivers at the Merchant Marine Academy at Kings Point, N. Y. This experimental program will be compared in results with the standard method of instruction. The experiments are being conducted by the Special Devices center at Sands Point and are under the direction of the Office of Naval Research. General Electric Co. is supplying complete studio equipment and monitoring receivers for the project. ✓✓✓



# NEW TORQUE DRIVE KIT

*Makes Sales and Service Easy!*

**3 TYPES  
REPLACE OVER  
150 STANDARD  
MODELS**

*Lightest, Most Efficient,  
Crystal Pickup Cartridge  
Ever Produced!*



## SELL MORE CARTRIDGES

It's a colorful display . . . creates interest . . . and action . . . helps you sell *more* replacements to old and new customers.

## SATISFY MORE CUSTOMERS

You give *faster* replacement service. Your customers get *more* pleasure and *more* good plays . . . even from old, worn records!

## SIMPLIFY YOUR SERVICE JOB

It's a complete *service* Kit, too. Contains everything for time-saving, labor-saving replacement. Gives you 3 basic models that replace over 150 standard types.

## MAKE MORE MONEY

Saves ordering time and service time. Cuts overhead. You make a good profit on every cartridge sale . . . and every service job. Builds needle sales, too! *Put the Kit on display . . . take one with you on your service calls.* Available in Kit "A" (Osmium) and Kit "B" (Sapphire). Each Kit contains 6 cartridges, 4 extra needles, mounting plates, replacement chart.

Order from your E-V Distributor or write for Bulletin No. 142

**ELECTRO-VOICE, INC., BUCHANAN, MICH.**

Export: 13 East 40th St., New York 16, N. Y., U. S. A. Cables: Arlab

E-V Pat. Pend. Licensed under Brush Patents.

NEW MODEL 114 MICROGROOVE CRYSTAL CARTRIDGE AND NEW MODELS 20 AND 22 MAGNETIC CARTRIDGE FOR REGULAR AND MICROGROOVE ALSO AVAILABLE

IT PAYS TO REPLACE WITH

**Electro-Voice**

**"TV+FM+AM... We're making sure that we get all of this business..."**

"We don't propose to let even one customer walk out of our place. If it's a TV, AM or FM set that needs servicing, we're making sure that we can handle the job satisfactorily. And one way of making sure is by constantly using our reference library of Rider Manuals."

—Says Mr. I. Zwickel  
Signal Radio Hospital  
Brooklyn, New York

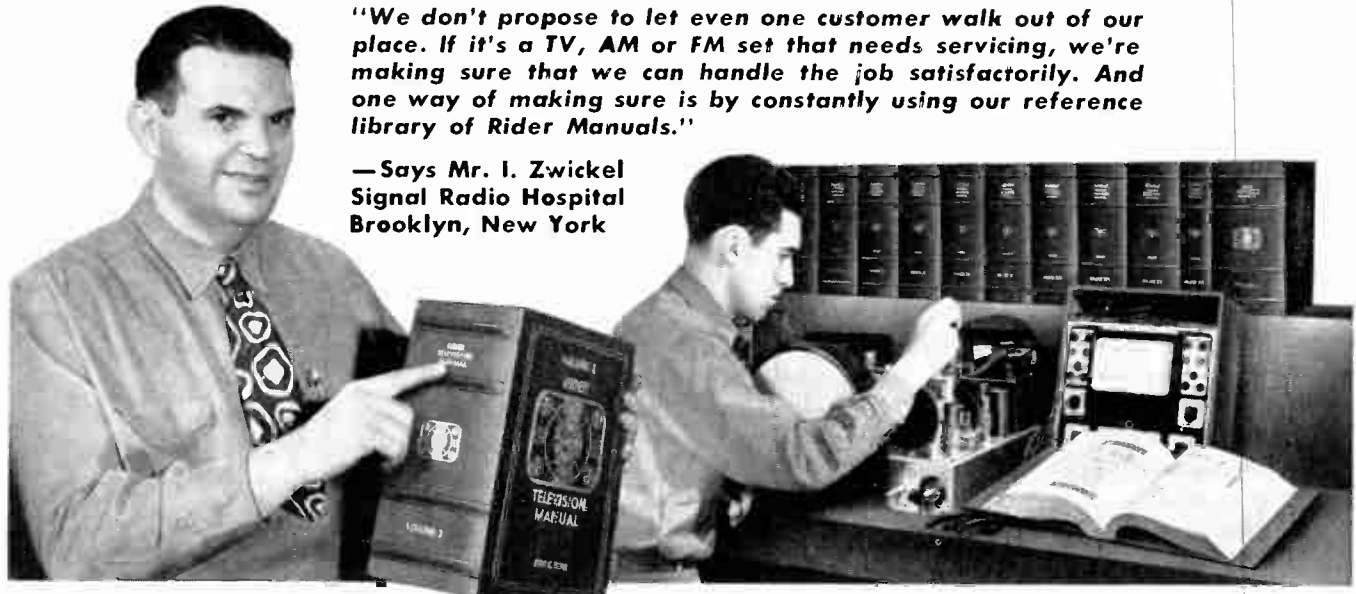

**All Leading Servicemen Use RIDER MANUALS**

A ready reference for all sets from 1930 to 1948 — Volumes 1 to 17 are at your Jobber's Now. He also has Volume 1 of the Rider Television Manual.

**At Your Jobber's Soon!**

VOLUME **2**

**RIDER TELEVISION MANUAL**  
PLUS 2 Separate Books, "HOW IT WORKS" and INDEX

Even though most of your business is now done on servicing AM and FM, it doesn't take a genius to figure that within the very near future a heavy portion of revenue will come from TV. John F. Rider looks into the future for you, prepares now with a new series of Rider Television Manuals. In these Manuals, too, will be found the OFFICIAL, AUTHENTIC DATA from the set manufacturers themselves. In these Manuals, too, will be found the material necessary, including GIANT SIZE schematics, to guide you and your men to quick and easy methods of servicing TV

**Available Now!**

**RIDER PA MANUAL**

The first industry-wide public address equipment Manual incorporating the amplifier production of 147 manufacturers from 1938 to 1948.

2024 pages; plus "How It Works" book which explains theory of various PA circuits and method of rapidly locating faults; plus Index.

All complete for..... **\$18.00**

**At Your Jobber's Soon!**

VOLUME **18**

**2000 Pages PLUS Separate "How It Works" Book and cumulative Volumes XVI, XVII and XVIII INDEX**

Rider Manuals are absolutely dependable because they contain the OFFICIAL, AUTHENTIC DATA of the set manufacturers themselves. Only in Rider Manuals will you find this information—set down in an easy-to-follow form to save you time; to save you money; and to help you do a real, factory-type servicing job. And you can tell your customers, too, that you are giving them factory-authorized service. All leading servicemen use Rider Manuals because they know that the Rider-Exclusive "Clarified Schematics" provide time-saving breakdowns of multi-band jobs. In Volume XVIII even wire recorders are covered, along with FM and AM sets and record changers.

Both Books, Complete..... **\$19.80**

**RIDER MANUALS**

- Television Manual, Volume 1, (plus HOW IT WORKS and INDEX) \$18.00
- Volume XVII .....\$16.50
- Volume XVI .....\$ 8.40
- Volume XV .....\$19.80
- Volume XIV to VII (each volume) .....\$16.50
- Volume VI .....\$12.50
- Abridged Manuals I to V (one volume) .....\$19.80
- Record Changers and Recorders .....\$ 9.00
- Master Index, covering Manuals, Vols. I to XV..\$1.50

JOHN F. RIDER, PUBLISHER, Inc., 480 Canal Street, New York 13, N. Y.  
Export Agent Rocke International Corp., 13 E 40th St., N.Y.C., Cable ARLAB.

**RIDER MANUALS mean SUCCESSFUL SERVICING**

NOTE: The Mollo Radio Service Encyclopedia, 6th edition, makes reference to only one source of radio receiver schematics—Rider Manuals.  
ANOTHER NOTE: The C-D Copacitor Manual for Radio Servicing, 1948 edition No. 4, makes reference to only one source of receiver schematics—Rider Manuals.

**MAKES FRIENDS...AND KEEPS THEM!**



**GENERAL**  **ELECTRIC**

181-HA2-0000

FIRST AND GREATEST NAME IN ELECTRONICS

**Designed to Save You Time and Money**

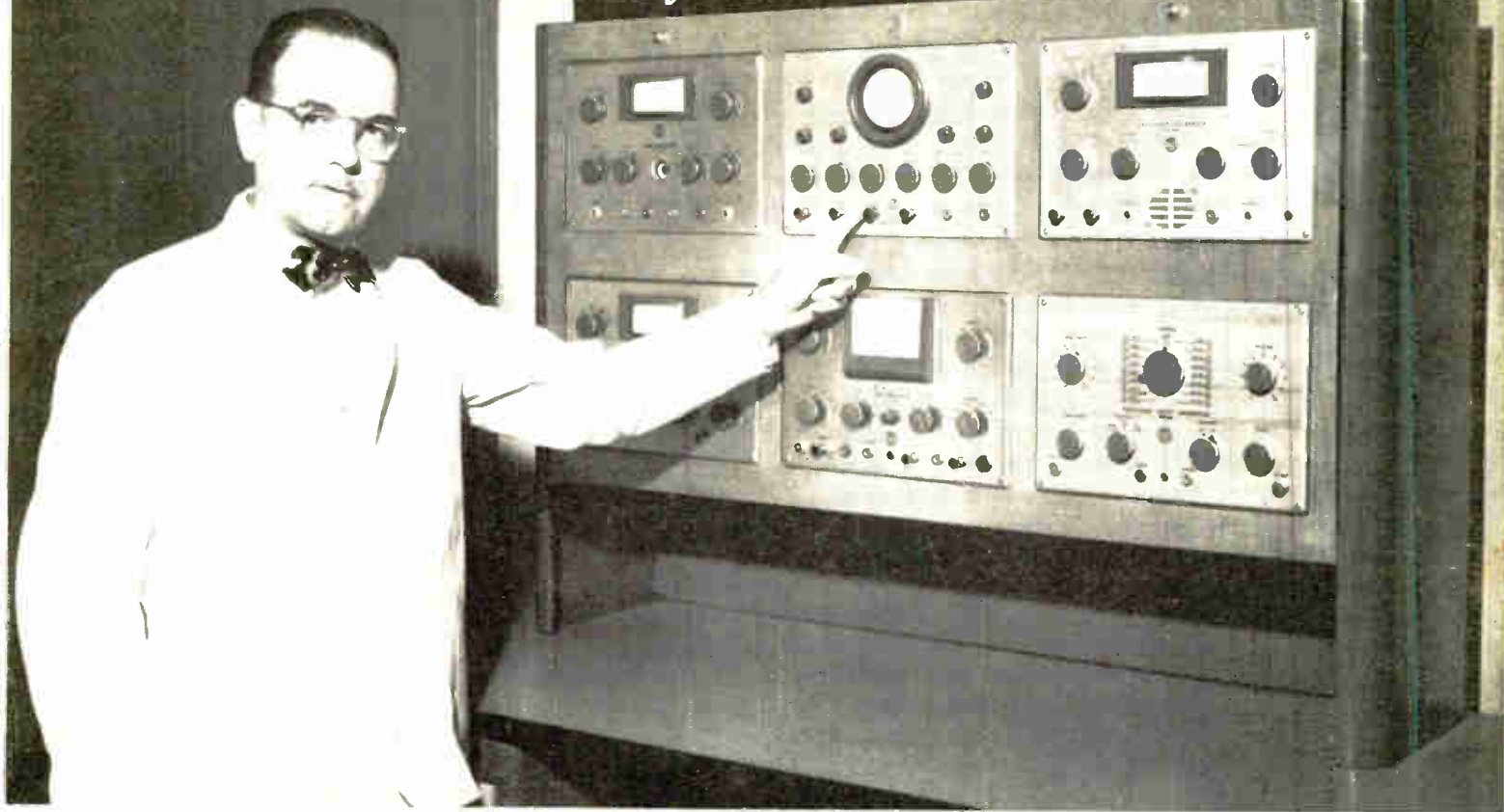

**How to make  
more money  
in the servicing  
business!**

Your local jobber believes in helping you—his best customer—to make more money, because then you will become a bigger customer and everyone will be happy!

In line with this policy, he pledges his high standard of service and better buys for radio servicemen . . . *AND* he will present ideas to help you expand your business. In the months to come he will feature a different subject each month on this back cover of **RADIO MAINTENANCE**. This may be in the nature of new moneymaking ideas, or announcements of special sales in his store, or suggestions on the proper equipment for your work. In all cases, the idea will be to help you—the radio serviceman—make more profit.

Of course his staff of experienced clerks are ready to serve you every day. Drop in his store today—browse around. He has all kinds of good buys you may want to look over. Just mention **RADIO MAINTENANCE**—and watch this back cover for extra profit for you!

**RADIO MAINTENANCE**

460 Bloomfield Ave.

Montclair, N. J.