

AUGUST 1948

35 CENTS

**EVERYTHING IN TELEVISION · RADIO · ELECTRONICS
FOR THE RADIO SERVICE - TECHNICIAN**

RADIO

MAINTENANCE

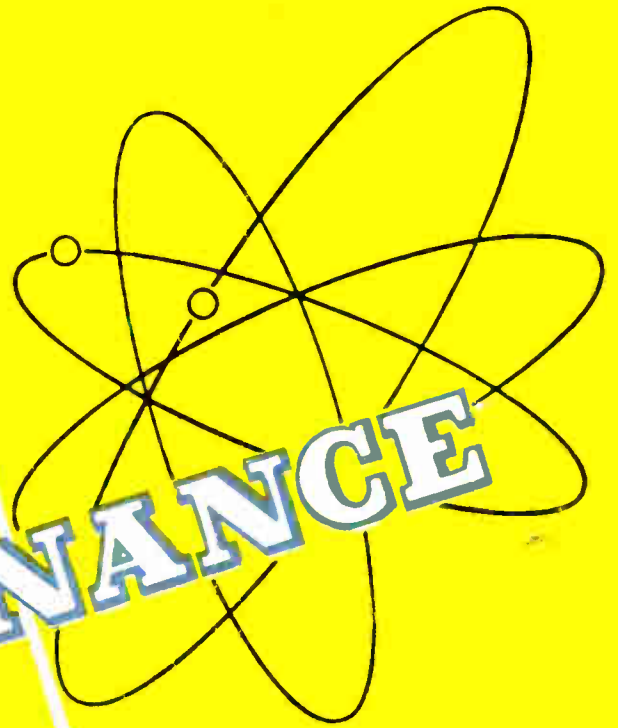

**ADVERTISING WILL BUILD
YOUR BUSINESS**

**INSTALLATION OF F-M
ANTENNAS**

CUSTOM BUILDING

**YGS-3 SIGNAL
GENERATOR**

YEARLY SUBSCRIPTION \$3.00

BOLAND & BOYCE INC., PUBLISHERS MONTCLAIR, N. J.

World Radio History

DESIGNED FOR THE BETTER SERVICE SHOP . . .



RCA WR-39A
Television Calibrator

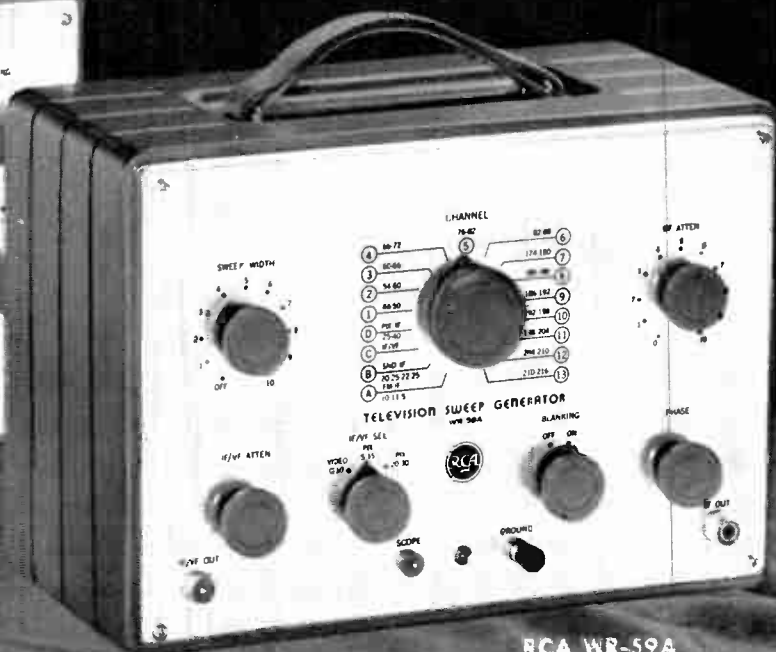

RCA WR-59A
Television Sweep Generator

The RCA TV DUO . . . your answer to precision television servicing

• The RCA WR-39A Television Calibrator and WR-59A Television Sweep Generator are brand-new additions to RCA's comprehensive line of matched test units for modern AM, FM and TV servicing. They incorporate advanced design features reflecting the wide experience of RCA engineers in the field of television.

These companion units furnish *all basic signals* necessary for the rapid, precision servicing of television receivers. Flexibility, versatility, and accuracy are outstanding characteristics of each instrument individually and in combination. For alignment, the TV Duo can be used with any good oscilloscope.

The WR-39A Television Calibrator has two crystal oscillators for establishing the calibrator frequency. The marker oscillator operates on fundamental frequencies

in all bands, and provides markers at all TV frequencies. An easy-reading scale enables quick, crystal-harmonic identification, and a built-in speaker is provided for zero-beat indication.

The WR-59A Television Sweep Generator covers all broadcast television channels, TV- and FM-if bands. All ranges employ fundamental signals, are pre-set, and can be quickly selected by means of a band switch. Sweeps are provided for both 10.7-Mc. and 25.75-Mc. if bands, and for video channels to 10 Mc. Amplitude variation is less than 1 db. The piston attenuator has a maximum ratio of 20000/1.

See your RCA Test Equipment Distributor today for the full technical details or write RCA, Commercial Engineering, Section HX59, Harrison, New Jersey.

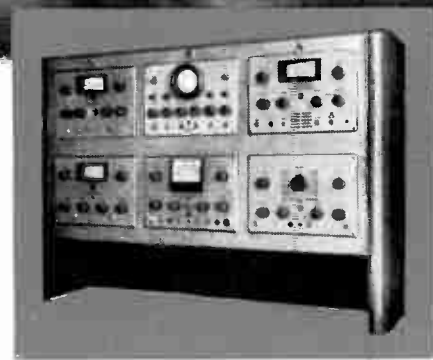

Now — a complete service set-up . . . with RCA matched test units of your choice!

This beautifully finished all-steel laboratory-type rack is designed to accommodate any combination of six RCA matched test units you choose . . . to meet your various service requirements. Plenty of chassis room below for closeup work . . . or any unit can be readily removed for outside jobs. Six units in rack illustrated provide *complete* AM, FM and TV servicing set-up.

Available from your RCA Test Equipment Distributor



RADIO CORPORATION of AMERICA
TEST AND MEASURING EQUIPMENT
HARRISON, N. J.

"YOU CAN'T BEAT KEN-RAD TUBES!"



"You can't beat Ken-Rad tubes—I found that out long ago!

"Ever since 1935, when I started in business, I've been using Ken-Rad tubes.

"And believe me, they hold up—never let me down!

"I found Ken-Rad tubes dependable. So I sold them to my customers. They like them, too. I never receive a complaint.

"In fact, I think a good part of the big repeat business I do is the result of Ken-Rad tubes.

"Quality pays off!"

JOHN F. BERANICH, 4439 West Madison St., Chicago, Ill., does a big business servicing radios, and like thousands of other servicemen he uses Ken-Rad tubes. He likes their dependable quality!



"HERE'S WHY YOU CAN'T BEAT KEN-RAD TUBES!"

"From start to finish, Ken-Rad tubes undergo strictest inspections and tests.

"I know, because I help test them!

"They're made to stand up, satisfy customers, increase your business.

"You can depend on Ken-Rad tubes because they're tested for noise, microphonics, static, life, shorts, appearance, gas, air and hum.

"Your customers can depend on Ken-Rad tubes because they're built, throughout, to the highest standards of quality, stamina, and endurance."



WALTER DOWNING, Foreman, Raw Materials Inspection Department, is in charge of comprehensive testing of all materials used in making Ken-Rad tubes. Here cathode sleeves are being tested for breaking strength.

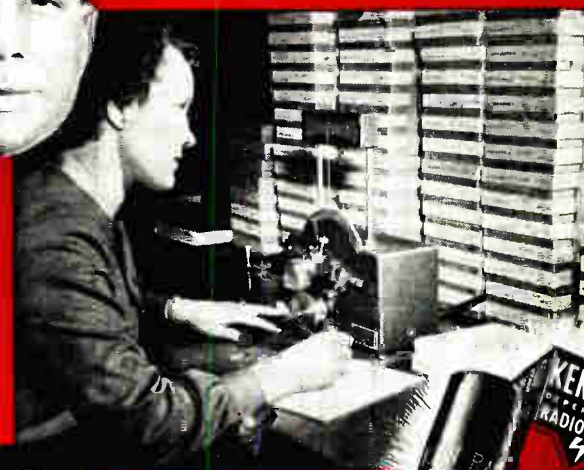

KEN-RAD *Radio Tubes*

PRODUCT OF GENERAL ELECTRIC COMPANY

Schenectady 5, New York

**The
Serviceman's
Tube**



WEATHER:
FAIR
and PROFITABLE

GOOD NEWS

RAYTHEON
Radio Receiving Tubes*
Special Purpose Tubes
Transmitting Tubes
Hearing Aid Tubes

FOR RADIO SERVICE DEALERS EVERYWHERE

RAYTHEON BONDED DEALER PROGRAM BUILDS STEADY, PROFITABLE SALES



"BOND" OF LOYALTY CEMENTS RAYTHEON DEALER AND DISTRIBUTOR

The Raytheon Bonded Dealer Program links you with the best parts distributor in your town — the Raytheon Tube Distributor. Ask us to put him in touch with you so he can tell you all about the Program and how you can make the most of it.

Newton, Mass., August '48—Everybody talks about the need for building public confidence in radio repair work. Raytheon has done something about it! The makers of Raytheon Receiving Tubes working with the Raytheon Distributor in your locality have swept away this one big barrier to profitable volume. How? *By making available to qualified Service-Dealers' Shops an iron-clad 90-day BONDED guarantee on labor and parts backed by the hundred million dollar assets of the Western National Indemnity Company.*

FREE INSURANCE!

Raytheon pays for this Surety Bond. It doesn't cost you a cent! But, my! what a magnet for attracting and holding customers. The Raytheon BONDED SERVICE GUARANTEE spells *confidence* to all who see it displayed, and confidence is the essence of successful radio service today. Your Raytheon Distributor has a bond for you. See him, *today*.

TUBE BUYERS HAIL CODE OF ETHICS IDENTIFYING RAYTHEON BONDED DEALERS

Here it is — the famous Code that means business to your customers and builds business for you:



The RAYTHEON Code of Ethics for Bonded Electronic Technicians

1. GUARANTEE ALL RADIO REPAIR WORK FOR 90 DAYS.
2. Use only parts of recognized quality.
3. Charge no more than list price for parts installed.
4. Perform only such work as is necessary.
5. Test customers' tubes as accurately as possible.
6. Keep labor charges at a reasonable level.
7. Maintain the highest quality service.
8. Maintain proper equipment for good repair work.



*Including the new Raytheon Bantall Tubes for simplifying your tube stock problem with no loss of sales. Write for full information.

RAYTHEON MANUFACTURING COMPANY
RADIO RECEIVING TUBE DIVISION

NEWTON, MASSACHUSETTS • CHICAGO, ILLINOIS • LOS ANGELES, CALIFORNIA

RADIO

MAINTENANCE

INCLUDING
ELECTRONIC
MAINTENANCE

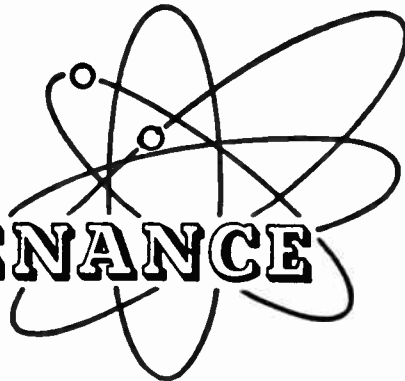

Volume 4

AUGUST 1948

Number 8

CONTENTS

Custom Building for Increased Profits	Walter I. Fischman	12
Here is another profitable field for the radio service mechanic		
A New AM-FM Signal Generator	John B. Ledbetter	15
The General Electric YGS-3 signal generator		
Installation of FM Antennas	J. Richard Johnson	18
How to relate installation fundamentals to the actual situation.		
How to Check High Voltage Supplies of TV Receivers	M. Mandl	20
Points to watch for when trouble-shooting TV		
Advertising Will Increase Your Business	Dan Valentine	22
Some methods of promoting your radio service outfit		
Time Savers	H. Leeper	26
The Industry Presents		28
New products		
Electronically Speaking		30
Review of Trade Literature		32
Over The Bench	John T. Frye	34

WILLIAM F. BOYCE
Publisher

JOSEPH J. ROCHE
Editor

VICTOR M. TURNER
Art Director

FRANK SCHMITT
Advertising Sales Manager,
Eastern Division

MARVIN H. ALBERT
Associate Editor

THOMAS A. BYRNES
Director of Field Services
and Quality Control

STUART J. OSTEN
Midwestern Advertising
Manager

MORTON SCHERAGA
Contributing Editor

AL JOHNSTON
Circulation Manager

Midwestern Office
228 No. La Salle St.
Chicago 1, Ill.
Dearborn 3507

Eastern Office
460 Bloomfield Avenue
Montclair, N. J.
Montclair 2-7101

West Coast
Swain Associates
639 So. Wilton Place
Los Angeles 5, Calif.
Dunkirk 8-2248

Copyright 1948, Boland & Boyce, Inc.

Radio Maintenance is published monthly by Boland & Boyce, Inc., at 34 No. Crystal St., East Stroudsburg, Pa., U.S.A.; Executive and Editorial Office, 460 Bloomfield Ave., Montclair, N. J. Subscription Rates: In U. S., Mexico, South and Central America, and U. S. possessions, \$3.00 for 1 year, \$5.00 for two years, single copies 35 cents; in Canada, \$3.50 for 1 year, \$6.00 for 2 years, single copies 40 cents; in British Empire, \$4.00 for 1 year, \$7.00 for 2 years, single copies 50 cents; all other foreign countries, \$5.00 for 1 year.

Entered as Second Class matter July 13, 1946, at Post Office, East Stroudsburg, Pa., under the Act of March 3, 1879.

Change of address: Four weeks' notice required for change of address. When ordering a change, please furnish an address stencil impression from a recent issue if you can. Address changes cannot be made without the old stencil as well as the new one.

*Features
You Can
Talk About*

Presenting the most Complete Line of Nylon Needles with Knee Action

The Swing is towards Nylon—because Nylon Needles by Webster-Chicago eliminate surface noise . . . groove hopping . . . filter but not dampen surface noise and preserve records. Show . . . suggest . . . and sell these 4 profit building needles!



Red Nylon with Knee Action. New! Genuine sapphire tip. Plays longer—reproduces highs and lows perfectly. None finer! \$500



Ivory Nylon with Knee Action. Precious jewel tip, reproduces the full diatonic scale. \$350



Black Nylon with Knee Action. An old standby for sales and profits with precious metal, osmium alloy tip. \$250



The NEW Tear drop all Nylon with highly polished rose jewel tip. Softens scratch without losing reproduction brilliance. \$175



WEBSTER-CHICAGO
5610 Bloomingdale, Chicago 39, Ill.



Safety

The cop on the beat that protects your home . . . guides children across the street — he offers an important factor of safety in community life! And so it is with the patented construction feature of the RADIART VIBRATOR — the mica stacks! Because of this mica detail, sudden shifts in load peaks to high voltages are taken in stride, because they are designed to carry an overload! The resulting longer life and more dependable, longer performance means more satisfied customers for you . . . and yet this expensive feature costs no more! Just another factor that has helped build RADIART VIBRATOR superiority, and made them the fastest selling in the field.

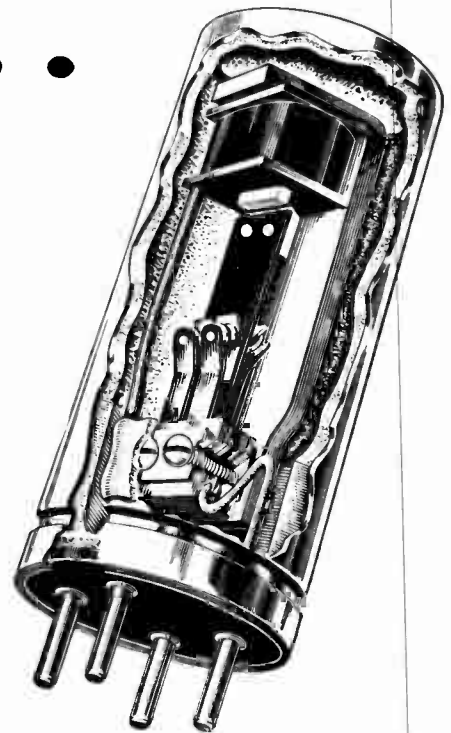

The Radiart Corp.

CLEVELAND 2, OHIO

EXPORT-SCHEEL INTERNATIONAL, 4237 N. LINCOLN AVE., CHICAGO 18, ILL

NOW... SYLVANIA OFFERS THE RADIO SERVICEMAN ANOTHER PROFIT-BUILDING PLAN FOR THE FALL!

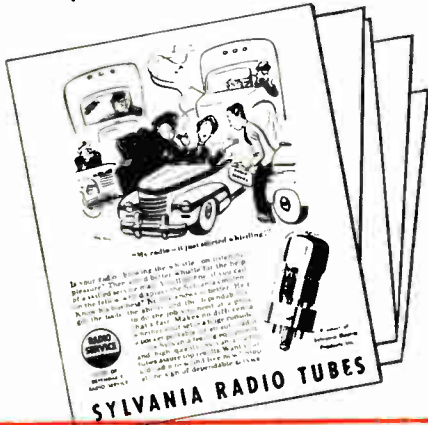

Shown at the left is one of Sylvania's national ads to appear in Life, The Saturday Evening Post, Collier's, Radio Best... during September, October, November and December. This series of ads is designed to sell you and your dependable radio repair service to your prospects.

HERE'S HOW YOU TIE UP WITH AND CASH IN ON THESE ADS...

...in 5 different ways!



1.

4 POSTAL CARD MAILINGS—ONE FOR EACH MONTH

Sylvania supplies these cards in 3 colors, imprinted with your name and address. You pay only the postage on each card. You send them to your customers and prospects!



2.

4 WINDOW DISPLAYS—ONE FOR EACH MONTH

Sylvania supplies you FREE 4 big, colorful displays. Each one is tied in with the national advertising using the same illustrations and copy. You put them in your window to attract customers!



3.

4 WINDOW STREAMERS—ONE FOR EACH MONTH

Sylvania gives you FREE these four 2-color streamers. They are also tied in with Sylvania's national advertising. You attach these to your window as another means of attracting new customers!



4.

8 NEWSPAPER AD MATS—TWO SIZES FOR EACH MONTH

Sylvania sends you FREE 2 ad mats for each month—one and two-column by seven inches. Use them in your local or neighborhood papers and classified telephone directory.

5.

RADIO SPOT ANNOUNCEMENTS—SEVERAL FOR EACH MONTH

Sylvania also provides FREE several radio commercials for each month for the radio serviceman who uses radio advertising. Call or see your local radio station for rates.

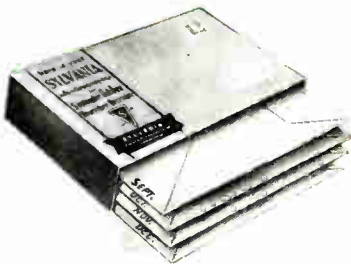

THIS 4-MONTH ADVERTISING PROGRAM PACKED IN ONE HANDY KIT

Covering the months of September, October, November and December, this hard-hitting sales promotion program is packed in one big kit. You pay only the postage on the government postal cards you mail. Sylvania supplies everything else without charge.

YOU CAN IDENTIFY YOURSELF WITH THIS DECAL Put this decal on your door, windows and truck. It is reproduced in Sylvania's national ads and identifies you as the radio serviceman described in Sylvania's national advertising.

Learn how you can participate in this Fall advertising program. Write Sylvania Electric Products Inc., Advertising Department, Emporium, Pa., or see your Sylvania Distributor.



SYLVANIA ELECTRIC

RADIO TUBES, CATHODE RAY TUBES, ELECTRONIC DEVICES, FLUORESCENT LAMPS, FIXTURES, WIRING DEVICES, PHOTOLAMPS, ELECTRIC LIGHT BULBS

**Here Is a
Rich New
Market!**

**Thousands of existing radios
may be transformed *easily* into**

**WIRE RECORDER
COMBINATIONS!**

**with the
Webster-Chicago Model 78**

Many prospects would like wire recorders as part of their radio—but it may not be practical for them to buy new radios with the wire recorder built in.

These are potential customers for a Webster-Chicago Model 78 wire recorder and your service installation.

Tell them about the Model 78 and you can open up a vast, new, profitable field for both your sales and service departments.

Demonstrate the Webster-Chicago Model 78—show him how neatly it can be installed in the record album storage space of their present radios.

Suggest the fun and the valuable uses for wire recordings—preserving the first words and voices of growing children, fine music for full hour uninterrupted listening, favorite radio programs, party entertainment and home movie commentaries.

Install the wire recorder designed for the purpose—the Webster-Chicago Model 78.



Build Sales

**Put Profit in your service department
with the Webster-Chicago Model 78**



WEBSTER-CHICAGO

Model 78

**Was designed
for the job!**

\$99⁵⁰

West of the Rockies
\$99.95

Use Stock Hardware

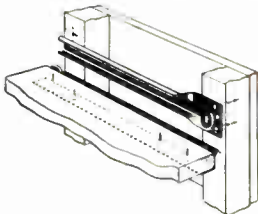

The Model 78 can be easily installed using stock slide-drawer hardware, readily obtainable in your community. Or, write to Webster-Chicago Sales Engineering Department for sources of supply and installation information.

Ask about Installation Parts Kit SD-30.

- The famous simple-to-operate Webster-Chicago wire transport mechanism!
- Contained in an attractive metal case—complete, one unit, ready to install!
- Records $\frac{1}{4}$, $\frac{1}{2}$ or one hour spools from microphone, radio or recorder changer!
- Push-button control for "record" or "listen" on microphone, radio, record changer.
- Meter type recording level indicator!
- "Record", "rewind" or "erase" operations are easily controlled—positive action!
- Complete with microphone and one spool of wire!
- All necessary cables and plugs included!
- Self-contained power supply, 115 volts, 60 cycles!

*Call your Webster-Chicago Wire Recorder Distributor
or write for full information.*



WEBSTER-CHICAGO

5610 West Bloomingdale Avenue · Chicago 39, Illinois

When the Heat is On . . .



Mallory Capacitors Maintain Capacity Even at Temperatures of 185° F.

You will probably never intentionally install a capacitor to operate continuously at a temperature of 185° F. Still it's reassuring to know that Mallory capacitors have, among other plus values, the quality to take over 2,000* hours of operation at that heat with no loss of capacity.

It's also reassuring to know that Mallory capacitors are ahead of your expectations on most of the points you look for in a capacitor. The carefully guarded purity of materials and protection against contamination during manufacture assure you long shelf-life without reaging, longer life in an inactive set,

low RF impedance, and the ability to withstand high ripple current.

Service men as well as set manufacturers appreciate the year-in-year-out quality of Mallory capacitors—and realize it's due to the same care in manufacturing that justifies the name "Mallory Precision Products."

THE MALLORY "GOOD SERVICE FOR GOOD BUSINESS" PLAN

will increase business and profits in your shop.

A unique follow-up file makes it easy to keep customers.

You tie in with Mallory acceptance to develop new business—ask your distributor about it.

*2,000 HOURS OF OPERATION

An actual test of Mallory capacitors operated in an oven at 185° F. and 150 volts DC, plus 10 volts of 120 cycle ripple, showed them still going strong and with increased capacity at the end of 2,000 hours. Typical results:

At Start of Test		After 2,000 Hours	
Capacity	Resistance	Capacity	Resistance
20.9 mfd	6.16 ohms	23.5 mfd	6.5 ohms
20.1 mfd	6.5 ohms	23.4 mfd	6.55 ohms

BUY MALLORY ASSURED QUALITY AT REGULAR PRICE LEVELS

P. R. MALLORY & CO. Inc.
MALLORY

CAPACITORS . . . CONTROLS . . . VIBRATORS . . .
SWITCHES . . . RESISTORS . . . RECTIFIERS . . .
VIBRAPACK® POWER SUPPLIES . . . FILTERS

® Reg. U. S. Pat. Off.

APPROVED PRECISION PRODUCTS

P. R. MALLORY & CO., Inc., INDIANAPOLIS 6, INDIANA

**NEW UNITS!
NEW MARKETS!
NEW SALES!**
for the

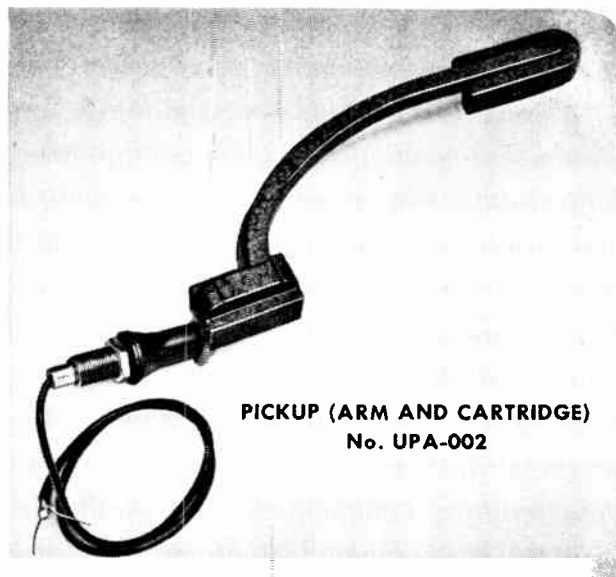

**PICKUP (ARM AND CARTRIDGE)
No. UPA-002**

VARIABLE RELUCTANCE CARTRIDGE

THESE three new General Electric units open up greater and greater sales possibilities for the Variable Reluctance Cartridge.

Tailored for this fast-moving unit, they fit a ready-made market. Installation problems are simplified, labor is reduced to a minimum, and performance is improved.

Order today—get sales rolling.

PICKUP (ARM AND CARTRIDGE) . . . No. UPA-002

For 10 and 12 inch records

This inexpensive Pickup has an immediate appeal for the serviceman, high fidelity enthusiast and experimenters—in fact, everyone who owns a record player.

This arm can be used with any record player without automatic changer and provides excellent response with absence of undesirable resonance.

A mounting template is supplied with each Tone Arm.

TRANSCRIPTION ARM . . . TYPE FA-21-A

For Professional Use

Broadcasters, sound laboratories, recording studios and wired music services will welcome this unit to simplify turntable problems.

It's easy on the operators—easy to spot in correct groove—no instability worries.

PHONO PREAMPLIFIER . . . No. UPX-003—with RECTIFIER

(For 117 volts, 60 cycle)

This self-contained preamplifier solves a tricky, laborious, installation problem for the busy serviceman. Installations can be made quickly, easily, profitably. The unit is ready to operate when attached to the set—just plug it into the nearest available outlet.

For complete information on these three units write: *General Electric Company, Electronics Park, Syracuse, New York.*

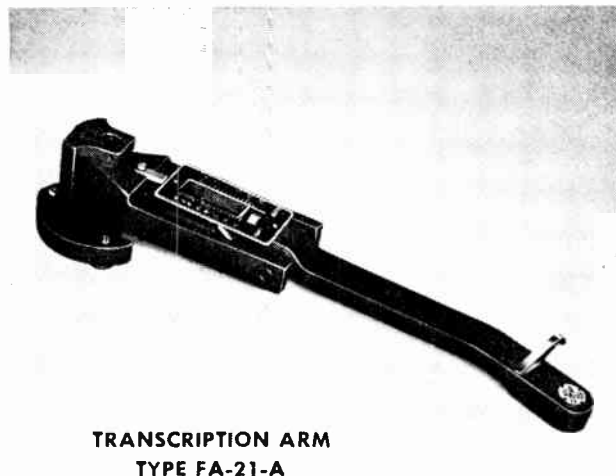

**TRANSCRIPTION ARM
TYPE FA-21-A**

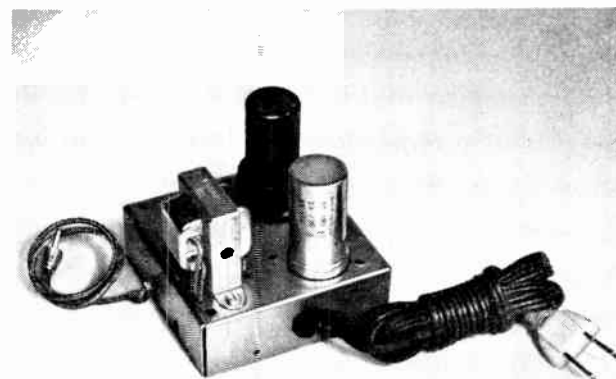

**PHONO PREAMPLIFIER
No. UPX-003**

169-G7

GENERAL  ELECTRIC

An Entirely New Product

New Alnico 5 driver unit entirely enclosed within the one piece rigid horn, yet may be removed without special tools.

Strong trunions lock projector in any position but never freeze—trunion parts are stainless steel and rust-proof metal.

Internally and externally completely corrosion-proof and rust-proof.

Weatherproof and anti-corrosion terminal box with removable cover.

Heavy, rugged U bracket with three holes making centering and "aiming" easy.

Exclusive Jensen Hypex formula (Patent 2,338,262) gives improved acoustical performance and wider sound distribution.

Four Reflex models from 24-inch to 9-inch. Two Reflex Radial models from 24-inch to 10-inch. Representing new highs in performance . . . new lows in price.



Jensen

6637 So. Laramie Ave., Chicago 38
Designers and Manufacturers of Fine Acoustic Equipment

**SAVE TIME
do a BETTER job**



SANGAMO Type 30 Plastic Molded Tubular Paper Capacitors

Thousands of radio service men are enthusiastic about this easier-to-handle, easier-to-install tubular capacitor! Molded in a thermo-setting plastic—with capacity values permanently *sealed* in, and with no wax ends to melt out at high temperatures—they assure better characteristics, longer life, and more dependable performance.

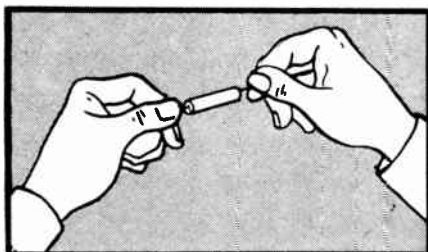

Easier to Handle

The plastic molded case gives improved mechanical stability . . . does away with the necessity for delicate handling . . . leads are

so firmly fixed that it's almost impossible to *pull* them out!

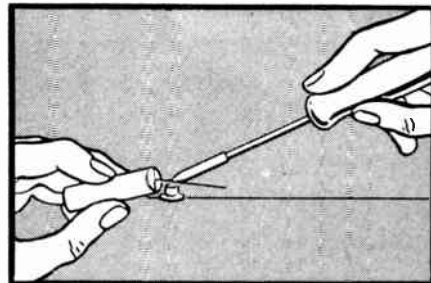

Easier to Install

Sangamo Type 30 Capacitors can be used wherever ordinary wax-filled paper capacitors are now used. No more mess of running wax—heat from a soldering iron will not melt out ends—nothing can burn. This means easier installation, fewer damaged assemblies, and more jobs finished in less time.



Sangamo manufactures a complete line of paper, mica and silver capacitors. Write for Catalog No. 23B for full information.

PAPER • MICA • SILVER • CAPACITORS

SANGAMO
ELECTRIC COMPANY
SPRINGFIELD • ILLINOIS

SC484A

CUSTOM BUILDING FOR INCREASED PROFITS

by Walter I. Fischman

The radio service technician will find a profitable field open to him if he is prepared to handle custom building of radio-phonographs and rebuilding of old AM sets to include FM and television.

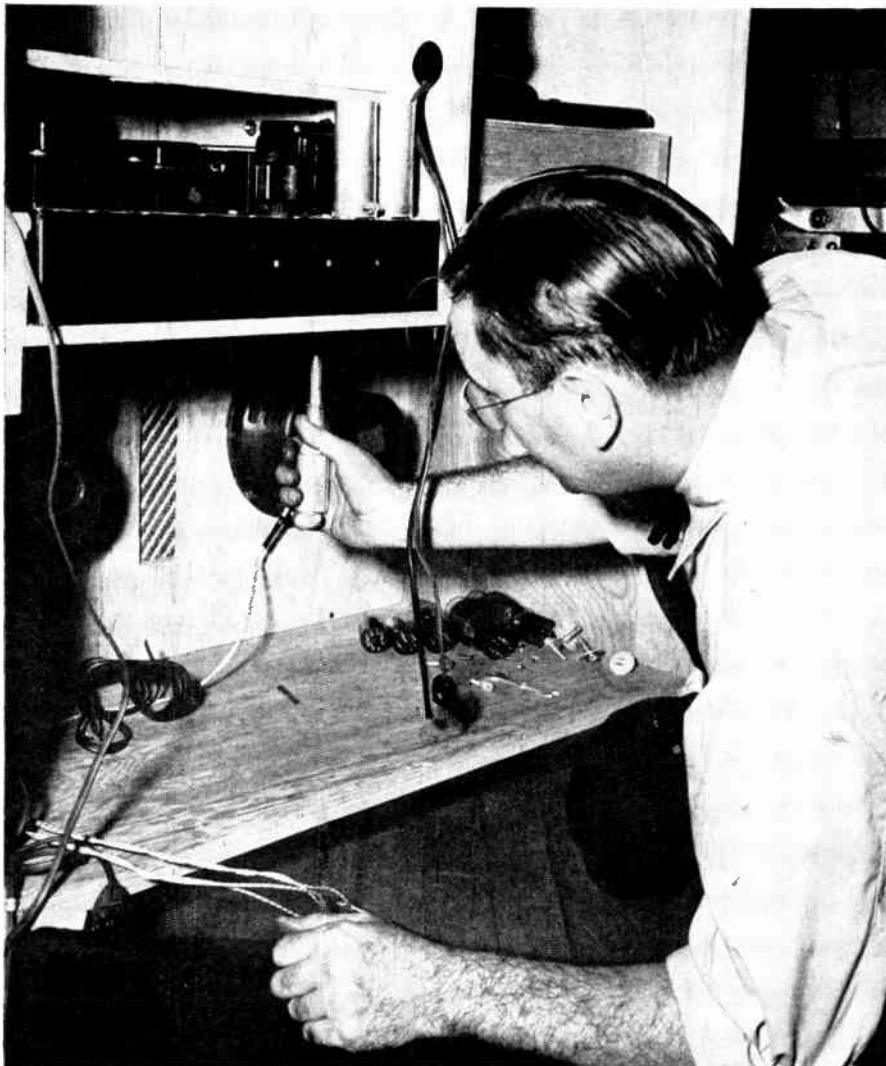

Steve Nawalany is one radio service technician who has made a profitable sideline out of his work in custom building.

THE growing interest in specially built radio-phonographs has provided a profitable market for radio firms equipped to handle the trade. The growth of television and FM has provided another opening for those service shops ready to alter customers' AM sets to include these new services. Vertech Radio and the Danby Radio Corporation of Philadelphia are two outlets for whom these custom building and rebuilding opportunities have spelled profit.

When Vertech Radio first opened its doors, it wasn't a chance gamble by inexperienced men. Both partners in the business, Charles Niwinski and Robert Isackman, were well acquainted with the radio service business. Both former RCA employees, they had an excellent background for the custom market as well as a thorough grounding in radio servicing.

Their original plan was to first concentrate on the servicing to establish their business in this field and then from there, go on to tackle the various phases of custom construction.

Because they would depend at first to a large degree on business off the street, an accessible location was essential. A store with basement storage facilities located adjacent to the University of Pennsylvania answered the problem.

Originally stock and fixtures were simple. A counter, service bench and racks for sets were all the furniture the store had upon opening. Gradually, as the business warranted expansion, another bench, other counters and considerably more storage and display space was added. Finally even this was insufficient to keep the equipment in order and the concern was forced to move to larger quarters.

When the two partners of Vertech Radio decided to go into business together, they gave considerable thought to how they were going to break into a competitive field. Granted they could turn out top radio service work at a reasonable price. Granted too that they had the know-how and skill to construct special sets, they still felt they should give themselves every possible boost before opening.

On a limited budget, this posed a problem. Their first step was to put a sign in the window. Besides the store name and the fact that they

did radio service, the sign also carried the following message, "For the fullest enjoyment of your record library, let us build a custom radio-phonograph exclusively for you." Other signs inserted at later intervals all stressed this same theme.

The partners gave considerable thought to newspaper advertising, but decided that it was too costly for their limited promotional budget. One shot advertising is ineffective and small ads are of little value unless carried over an extended period, and that runs into money.

Direct Mail

They decided direct mail was cheaper and could be pointed at just the target desired. A small shop specializing in mimeographing and little advertising jobs designed a card for them. A little eye-catching drawing attracted attention and the brief but pithy text brought home the point. A little space was left blank so that a few lines could be added by hand for the personal touch when some of the cards were sent out as a follow-up. Quite a few cards were run off on ordinary penny post cards.

Niwinski and Isackman both had handled outside service work in addition to their jobs at RCA and so they checked back through their books and picked out likely customers for the mailing list. They thought back through their service calls and tried to remember the people who had large record libraries. Arrangements were made to use the mailing list of a concert managing society.

When answers were received, they were followed up carefully with personal letters. A good system was set up in the shop and people invited in to hear it. Although not requiring a large investment in dollars, all this promotion took considerable time.

Record Shop Tie-In

For the future, they plan a tie-in with a large record shop who will refer customers to them for a prearranged cut. It will work out to their mutual advantage, for a person with a fine radio-phonograph will be inclined to purchase more records.

From the experience of Vertech Radio, specially built radio-phonographs seem to fall into three general categories.

First is the simplest . . . a set assembled from stock components. This usually utilizes the more in-

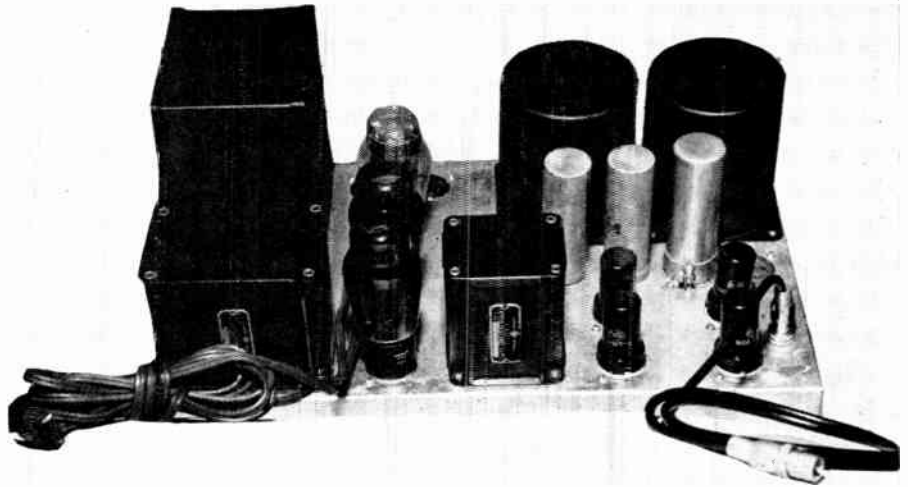

Top view of the basic audio amplifier and power supply used by Danby Radio Corporation. The chassis contains 3 stages of push-pull class A triodes together with filament plate supply for a separate AM-FM tuner.

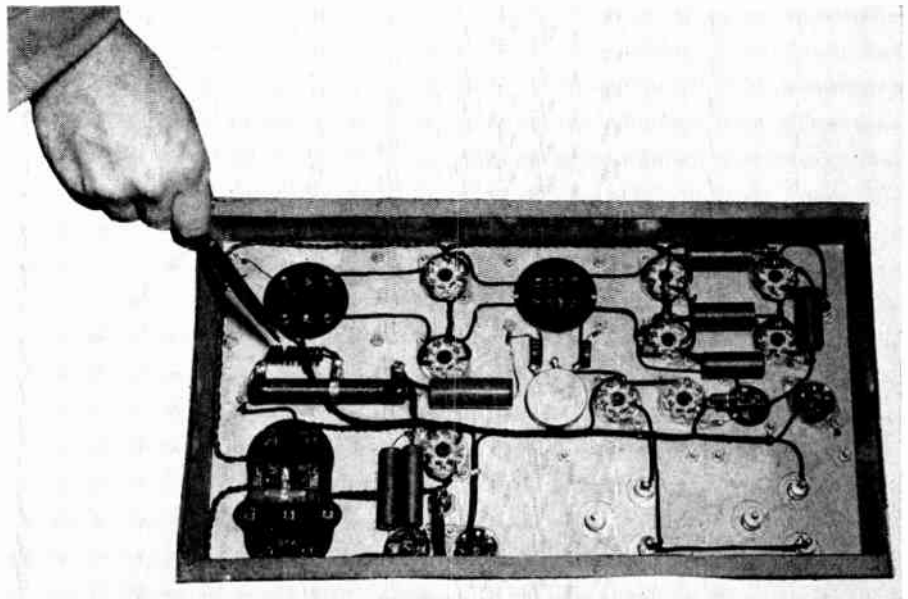

Here is the underside view of the audio amplifier. Careful engineering design and planning results in the elimination of many parts.

expensive amplifiers, speakers, etc., but if care is given to the matching of the equipment, and if frills are cut permitting more to be spent on the parts, surprisingly good results can be had.

Secondly is the set built from parts, but in this case the components are altered by the serviceman to give even better response and tonal value. This set costs more and takes more time to build, but also sells for more.

Last is the phonograph completely engineered and built by the radio-man, himself. This type of installation goes up into the very high priced brackets, but there are customers with discerning enough ears to demand the top in custom performance.

There are also variations of these three types, such as a new set in an old set with some new components, an old set modernized, etc.

Before they took the plunge, the Vertech partners asked themselves, "How are we going to make out financially from this special order angle of radio?" Then it was almost impossible to figure accurately, but according to their calculations, three factors were in their favor. First they would use better parts. The customer, of course, would pay for that. Secondly more time would be put into construction and assembly. Again it would be John Customer who would dig into his wallet for this. Lastly, the tools and equipment

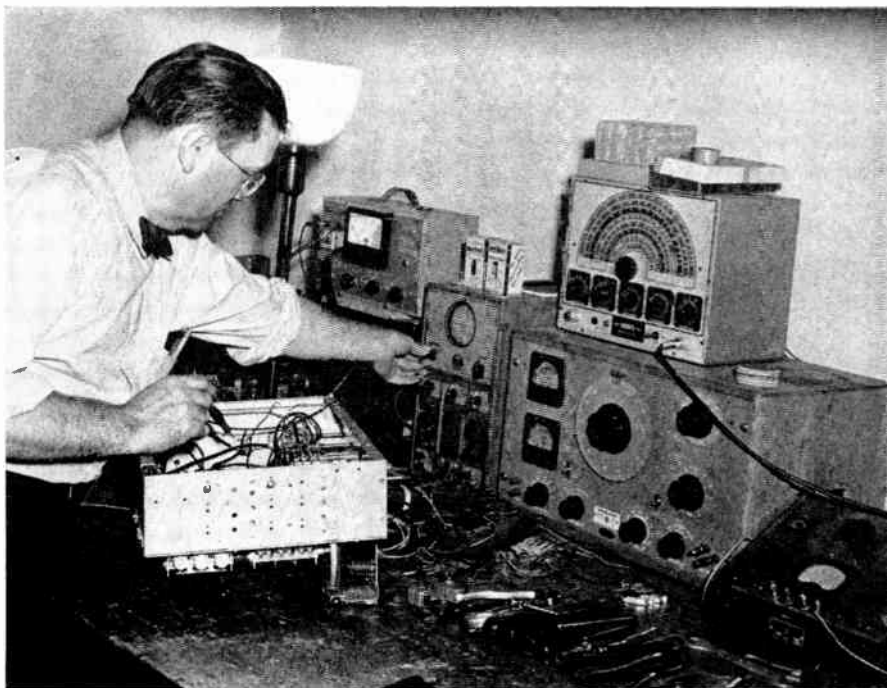

Steve Nawalany uses a scope to check for possible audio distortion. This is part of the routine check on each set that goes out of the shop of Danby Radio Corporation.

would already be there and they might just as well get additional money using them for another phase of the work.

One factor that Vertech found in their favor was that a large amount of work for special sets came in through the recommendations of satisfied customers. In regular service work a certain amount of business can be counted on through such recommendations but the serviceman who depends on this alone without any other promotion will be in unhappy state when the bills come due.

That's where custom building differs. Vertech Radio found that once they had a few sets out, a large portion of their business came from satisfied customers telling others about them. It seemed to work this way: People who have serious interests in music and the accompanying collecting of records, are usually the ones who are sufficiently interested to want high fidelity. These same people almost always have friends with similar tastes. It's the same with almost any hobby, Golfers go with golfers, model railroad fans with railroaders and so on in that vein.

As Charles Niwinski explains it, there's a sense of pride involved when a man buys a special set. The man closely identifies his set with the radioman who built and sold it to him. The net effect is to make the

owner brag about his equipment and talk it up to the advantage of the radio shop.

The two partners found that their shop, without any renovations, served for their custom radio-phonograph trade. It had to be kept more orderly than usual, for a man who is having a set built will not just leave an order and then return to pick it up on the appointed day. He's around the shop quite a bit and it pays to have him impressed. That meant shelves were straightened, the workbench kept clean and some of the junk tossed down the basement. It made the shop more imposing and helped keep a customer from accidentally sticking his foot through a perfectly good speaker.

Customer Satisfaction

Tools weren't much of a problem. Outside of the regular kit and instruments, a scope and a good audio oscillator were sufficient for most work. All test equipment was checked over thoroughly as adjustments are much finer in high fidelity work.

One factor that Vertech has found is that the customer plays a vital role in the building of his set. He is necessary, for instance when the tone controls are adjusted, to say, "There, that's how I like it to sound." The firm tries to build up

an alliance in the customer's mind between the set and the company. The customer must be sold on the set and Vertech.

Vertech tries to keep one point in mind. They build high fidelity sets . . . that's true, but they build them to the *customer's* concept of fidelity. He is the man who is paying and he is the one who must go away feeling he has the best set in the world. Few customers want gross distortions, but for every one who understands high fidelity, there are those who want no needle scratch and consequently no highs and a bass response like a battery of French 75's.

More and more people are learning to recognize and appreciate high fidelity and some of them are quite avid on the subject. It stands to reason that a person who has devoted enough time and interest to the reproduction of recorded music to want a specially built set, is somewhat of a bug on the subject.

Some customers look with disdain on a record changer and insist on nothing less than a heavy duty turntable and a professional arm. Some want extra sets of switches and perhaps unnecessary adjustments. Some insist on special speakers or even specify certain transformers. In these cases Vertech Radio has found that the old adage holds true and the customer is always right. The extra work is remembered in making out the bill, however.

The company feels that it is good practice to guarantee sets for at least 90 days. For the higher priced sets, the guarantee is extended to a year. For this reason only the best quality parts are used. Defective parts (faulty due to manufacture) usually break down within a few days so that sets are usually played steadily for several days before being sent out. As a result, very few service calls are needed. Beyond the period of the guarantee, Vertech is almost certain of getting all service work on their sets.

Concerning actual hi-fi reproduction itself, the two partners have found that several factors should be kept in mind. The audible range of the human ear is somewhere between 20 and 15,000 cycles. It varies with individuals and tends to become more limited in later years. While it

→ To page 35

a new AM-FM signal generator



Another test equipment article designed to keep you informed on what's new for the serviceman.

by John B. Ledbetter

THE exacting requirements of frequency modulation have brought about a radical change in receiver servicing, not only in actual service procedure but also in the type of instruments required in alignment and circuit analysis. The following discussion will be devoted to description of a new service instrument whose versatility and many applications make it one of the most important test instruments on the modern

service bench. The serviceman who fully understands its operation and practical applications will be in a position to efficiently service any type of AM-FM receiver with a minimum of operating time and instrument adjustment.

The General Electric YGS-3 Signal Generator is a compact, well-designed unit which represents a combination of four basic units. These are: (1) an RF oscillator with a fundamental frequency range of 100 Kc. to 150 Mc.; (2) an FM

oscillator with center frequencies of 1, 20, and 50 Mc., and frequency deviations of ± 20 , ± 30 and ± 750 Kc.; (3) a 1-Mc. crystal oscillator; and (4) a variable-frequency audio oscillator. These units may be used separately or in any logical combination. Incorporation of two oscillators results in higher circuit efficiency and provides an improved L/C ratio on all ranges. The lower oscillator covers Bands "A" (100 to 320 Kc.), "B" (320 to 1000 Kc.), "C" (1 to 3.2 Mc.), "D" (3.2 to 10 Mc.), "E"

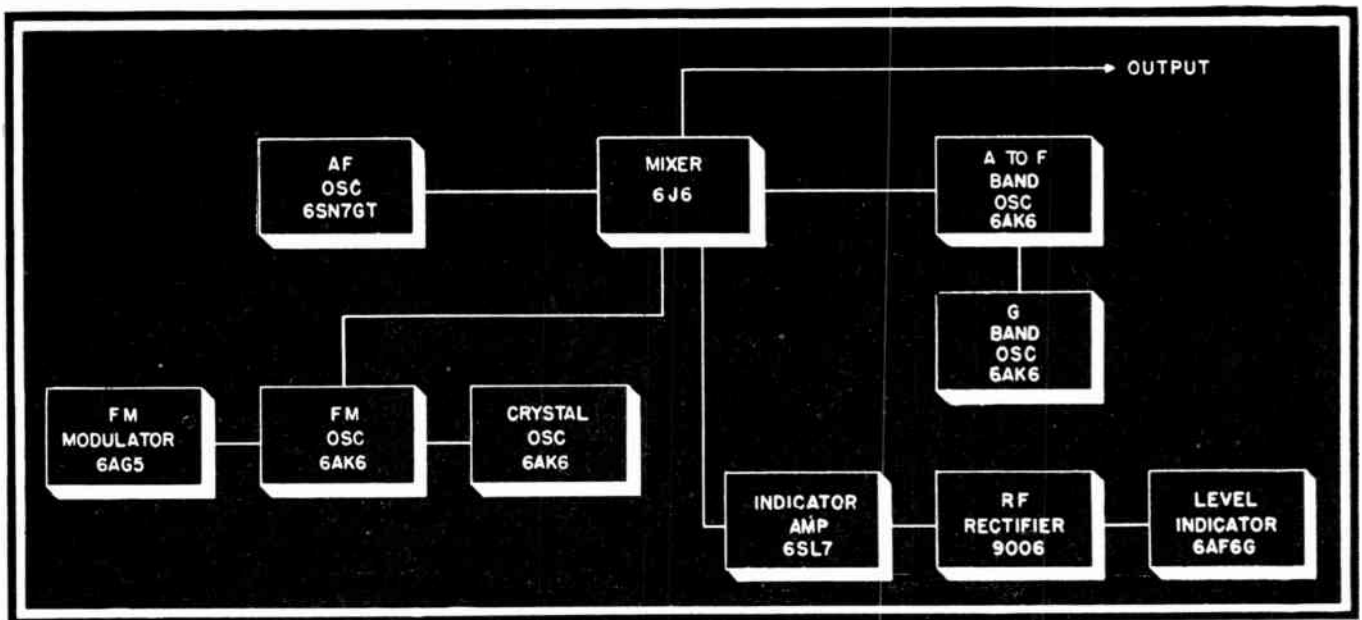

Fig. 1—Block diagram of the YGS-3 unit.

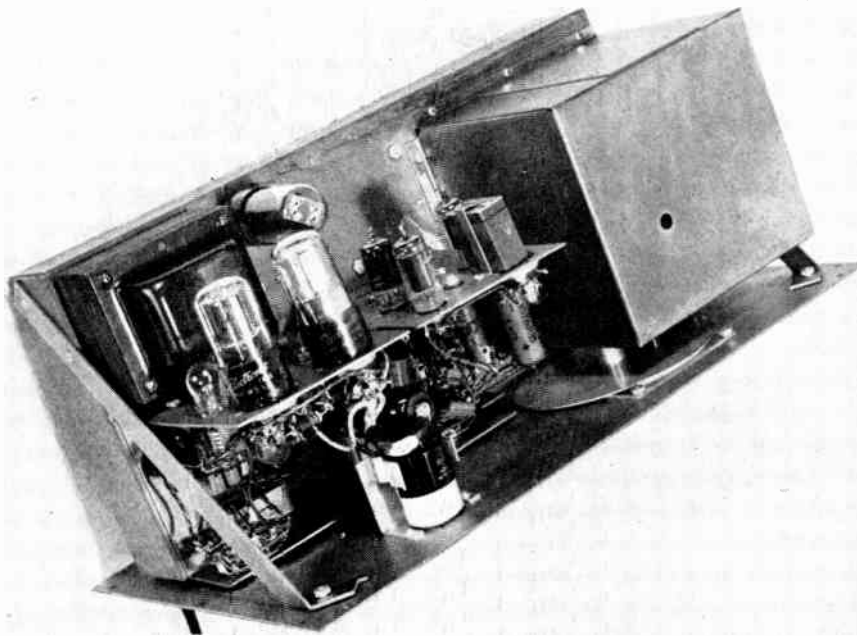

Fig. 2—View of the inside of the YGS-3 signal generator.

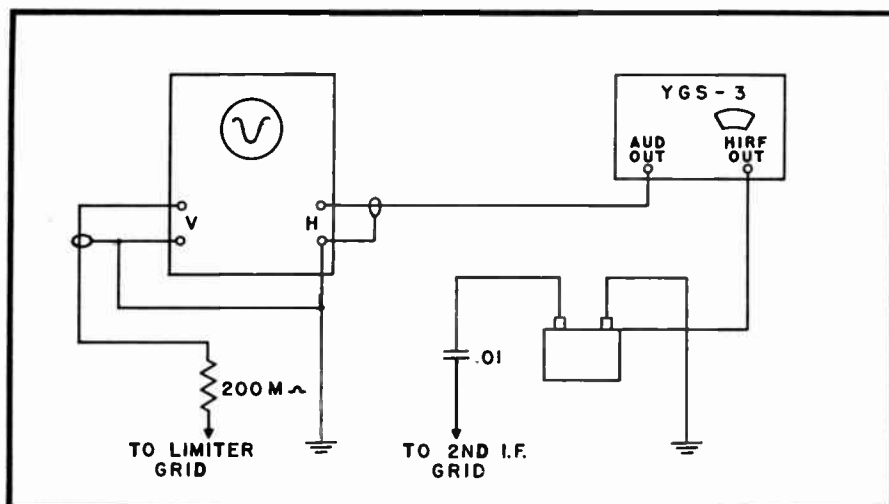

Fig. 3—A typical setup for visual alignment.

(10 to 32 Mc.), and "F" (32 to 70 Mc.). Band "G" (70 to 150 Mc.) is covered by the high-frequency oscillator. An internal mixer makes it possible to obtain any desired FM frequency within the beat-frequency range of the RF and FM oscillators.

Both oscillators may be modulated at any frequency within the 100 to 12,000-cycle range of the internal audio oscillator or from an external source. Percentage modulation is continuously variable from 0 to 100%. The dual section eye tube is calibrated to indicate 30% modulation on AM with the RF Level and Audio Attenuator controls advanced until a zero shadow angle is obtained on the respective sections of the tube. Frequency deviation of FM output signals is also regulated by the Audio

Attenuator. With the Output Selector switch in the RF+FM position, the frequency deviations indicated on the FM Switch will be obtained when the Audio Attenuator is advanced until a zero shadow angle is obtained on the AF section of the eye tube.

Complete control of output level on all ranges is made possible by an RF control in conjunction with the step and fine attenuators. A 1-Mc. low-drift crystal in the crystal calibrator unit provides strong harmonic output, modulated or unmodulated, up to 50 Mc. Crystal calibration output is obtained with the Output Selector switch in either the RF+Xtal or Mod. Xtal positions. Amplitude modulation of the crystal oscillator at any frequency from 100 to 12,000 cycles may be obtained by setting the

Output Selector switch in the Mod. Xtal position. Percentage of modulation is continuously variable from 0 to 100% by the Audio Attenuator control. Unmodulated crystal output is obtained with the Output Selector switch in the RF+Xtal. position and the RF level control in the counter-clockwise position.

The Audio Switch allows selection of four audio voltages: (1) 60 cycles, (2) 400 cycles, (3) 100 to 12,000 cycles, variable, and (4) external. An R-C type audio oscillator provides good stability, low distortion, and essentially flat output from 100 to 12,000 cycles. An especially important feature of this circuit is the simultaneous provision of modulating voltage for the FM oscillator and the horizontal amplifier voltage for an external oscilloscope for FM discriminator and IF alignment.

With the YGS-3, the following outputs can be obtained: (1) unmodulated RF, (2) amplitude-modulated RF, (3) unmodulated crystal, (4) RF plus crystal, (5) amplitude-modulated crystal, (6) FM, (7) FM plus RF (internally mixed), (8) fixed audio, and (9) variable audio. Spurious radiation and leakages are kept to a minimum by employing double RF and attenuator shielding, RF trap circuits and line filters.

The YGS-3 employs 11 tubes, including 4—6AK6 RF oscillators, 1—6AG5 reactance modulator, 1—6SL7 electron-ray tube amplifier, 1—6AF6 electron-ray tube, 1—6SN7 audio oscillator, 1—6J6 mixer, 1—9006 RF rectifier, and 1—5Y3 rectifier.

In spite of its versatility and complex circuit functions, the number of controls and selector switches in the YGS-3 are kept to a minimum. Appearing on the front panel are, at the top, the electron-ray tube and range dial scale. Controls in the center row are, left to right: Audio Switch (for selecting 60 cycles, 400 cycles, variable audio oscillator, or external); FM Switch; Tuning Control; and Range Selector. At the bottom are: Audio Attenuator (with On-Off switch); Variable Audio Frequency; RF Level; Multiply By selector (for increasing or decreasing RF output level by factors of ten); and the RF Attenuator. At the bottom of the panel are: line cord; Audio Output jack; Audio Input Connector; fuse; High RF Output; and normal RF Output jacks. The Audio Input jack

is provided so that an external audio source may be used. This input is connected to the calibrated Audio Attenuator so that external audio voltages may be read directly in DB. RF output voltage at the RF Output jack is regulated by the Multiply By and RF Attenuator controls. The RF Attenuator varies the input at the RF Output jack from 0 to 50 ohms. A 100-ohm resistor housed in the shielded compartment at the end of the RF cable acts as part of the attenuator network and reduces cable resonance effects at high frequencies.

Operation

The RF Level control should always be set at the lowest possible level in order to prevent possibility of spurious radiation. The maximum setting usually is required only on the higher frequency bands where compensation for increased circuit losses is necessary. With the Output Selector switch in the RF+Xtal position for calibration purposes, the RF Level control should be reduced to prevent the RF signal from blanketing out the weaker crystal oscillator harmonics.

With the Output Selector switch in the Mod. RF position, the RF section of the electron-ray tube will indicate 30% amplitude modulation. In the Mod. RF and Unmod. RF positions, the indicator tube is calibrated to indicate 25 millivolts output with attenuator controls set for maximum output. Although the tube is not calibrated to any specific RF output level in the remaining Output Selector positions, it does provide a useful check on the relative output of the RF oscillator, and can also be used to determine the optimum RF Level setting required when mixing RF+FM and RF+Xtal.

If slightly more than the specified band width is required on FM output, the Audio Attenuator control may be increased beyond the setting necessary to just close the AF section of the electron-ray tube. Care should be exercised in increasing this setting, however, since excessive audio input to the reactance modulator tube will result in a non-linear sweep and may partially cut off the reactance tube.

Several combinations of RF and FM oscillator frequencies may be mixed in order to obtain the desired FM output frequency. An IF frequency of 10.7 Mc., for example,

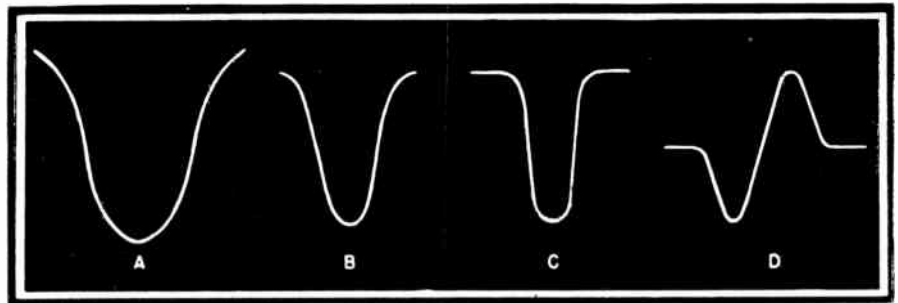

Fig. 4—Normal curves that should be obtained in visual alignment.

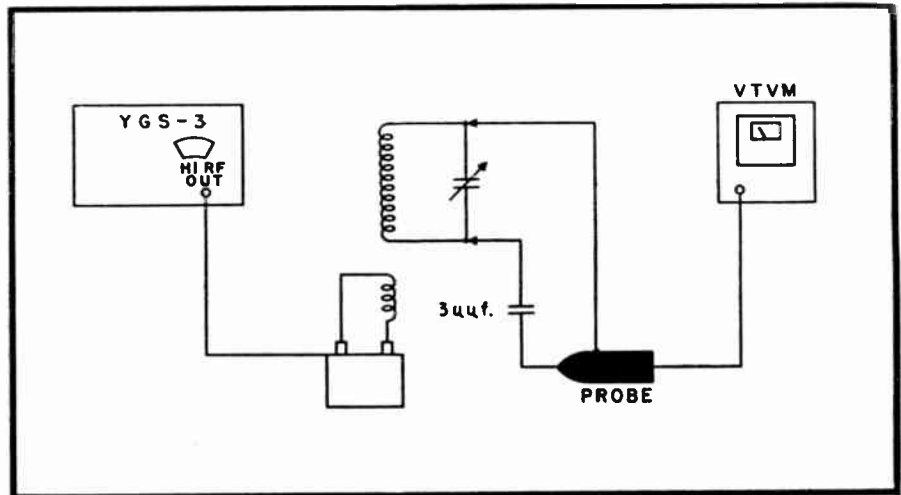

Fig. 5—Setup of YGS-3 and VTVM for determining the figure of merit of inductance.

can be obtained by setting the FM oscillator at 50 Mc. and the RF oscillator at either 60.7 Mc. or 39.3 Mc. In actual practice the RF frequency should always be set *higher* than the FM frequency in order to reduce the possibility of inadvertently mixing the RF oscillator signal with a lower-frequency harmonic of the FM frequency.

Alignment Notes

Alignment of a specific receiver should be carried out, whenever possible, exactly as recommended in the manufacturer's service notes. Generally, alignment of an AM-FM receiver should be performed in the following order: (1) FM intermediate-frequency stages, (2) AM intermediate-frequency stages, (3) FM oscillator (high band), (4) FM Converter and RF amplifier (high band), (5) FM oscillator (low band), (6) FM Converter and RF amplifier (low band), (7) SW oscillator, (8) SW Converter and RF amplifier, (9) BC oscillator (trimmer), (10) BC Converter and RF amplifier, (11) BC oscillator (padder). Both oscillator adjustments should be repeated as necessary for proper tracking. (In aligning *any* receiver, all IF

stages should be peaked or "flat-topped" as required *first*. Then, in order, all bands should be aligned, starting at the highest frequency and working down to the broadcast band.

The extreme flexibility offered in the two-oscillator and mixer combination incorporated in the YGS-3 can readily be seen. Suppose, for example, that it is desired to employ a frequency-modulated signal to visually "flat-top" an AM receiver having an IF frequency of 455 Kc. with the RF oscillator adjusted to 1455 Kc., the FM oscillator set to 1 Mc. ± 20 Kc., and the Output Selector in the RF+FM position, the following frequencies will be present at the RF Output jacks: 455, 1000, 1455, and 2455 Kc.

The 455 Kc. frequency may be used to align the IF stages, and the 1000 and 1455 Kc. frequencies employed to check alignment of the RF stages, all without moving the dial of the signal generator. The 2455 Kc. frequency is useful for aligning a portion of the short-wave band if one is included. Since the unused frequencies are greatly attenuated by the tuned circuit under test, only the desired frequency will be obtained at

→ To page 45

INSTALLATION OF FM ANTENNAS

by J. Richard Johnson

Here are the practical points to be considered when installing FM Antennas.

IN OUR last FM article (RADIO MAINTENANCE, July 1948) we discussed the basic fundamentals of FM receiver antenna installation. This article will show how to relate these fundamentals to actual installation.

Experience makes it clear that the receiving antenna can "make or break" an otherwise fine FM installation. Giving your customer the best kind of performance of which his receiver is capable will bring your outfit valuable good will.

Surveying The Installation

A careful survey of the installation before actual work begins may save time and expense for you and the customer. The preliminary survey should include the following important operations.

1. *General nature of the location.* The serviceman will probably be quite familiar with the general location factors without special investigation. This part of the survey includes answering such questions as "Is the

neighborhood close enough to FM stations to provide good reception with ordinary equipment?" and "Are other, nearby FM receivers functioning well?"

From this standpoint, the well established serviceman knows his neighborhood well. In a town located 75 miles from the nearest FM station he will realize that a highly efficient antenna and an advantageous position for its mounting is necessary. On the other hand, the FM listener in or near a large city having several FM stations will probably get good reception with loops, under-rug and other indoor antennas. Even in the latter case, however, a good outside antenna installation may be desirable to bring in one or two out-of-town stations.

The emphasis on line-of-sight travel in connection with FM waves may have led to the impression that reception suddenly drops off to almost nothing at the line-of-sight distance. This is definitely *not* the case! *FM reception under average conditions of terrain is excellent at locations many miles beyond the horizon.*

On the other hand, distance and terrain are both important factors. They should be carefully considered in the estimate of the antenna requirements. So our general location survey should tell us what stations are within range, the probable strength of these signals, and whether the stations are all located in the same direction.

2. *Specific nature of the location.* Let's suppose we have made the estimate necessary in item 1, either from past experience or in connection with the particular installation. We then proceed to the details of the location itself.

Local obstructions are often important. For instance, although the general community may enjoy good FM reception, a hill or tall building may throw a "signal shadow" over the location in question. Such fac-

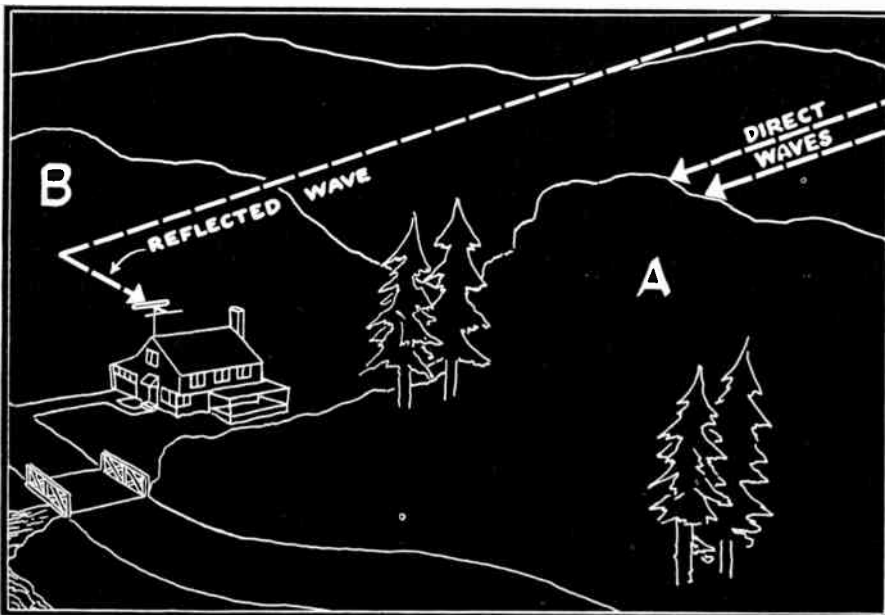

Fig. 1. A difficult FM installation problem and one way to solve it. The stations from which reception is desired, are located in the direction from where the arrows come. Hill "A" is an obstruction, preventing direct reception. So the reflection from hill "B" is utilized.

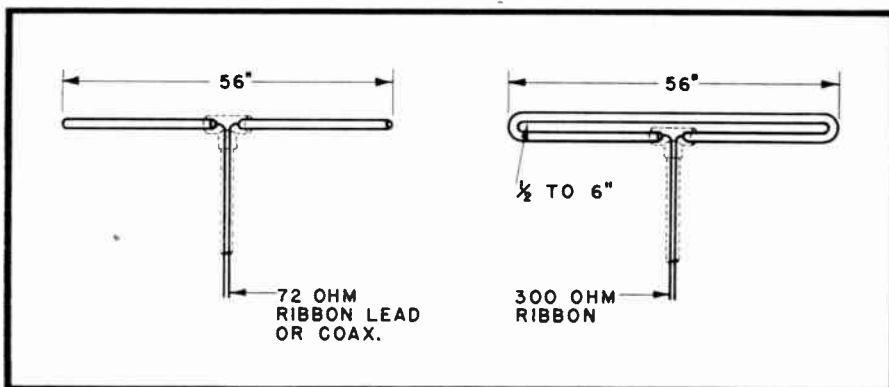

Fig. 2. Left: A Simple dipole. Right: A folded dipole.

tors will influence two things: the gain necessary in the antenna and the choice of the location of the antenna mounting.

Another important factor is the location of the nearest road and the amount of traffic. Although sufficient signal will limit most noises in the receiver, *ignition noises are very strong at FM frequencies.* It is always desirable to keep the antenna as far as possible from heavy automobile traffic.

A directional antenna is useful in combatting ignition noise interference if the stations to be received are in a different direction from that of the automobiles causing the noise. Of course, the serviceman doesn't have much control over the relative directions involved. But he can save himself the trouble of trying to eliminate, by means of directional antennas, noises which originate in the same direction as the stations.

3. *The receiver itself.* The receiver design has an important effect on the performance, regardless of the nature of the antenna and how it is erected. Unfortunately many FM receiver models now on the market are incapable of doing complete justice to the benefits of FM. These designs have sacrificed certain features in order to lower the price for a greater distribution. *Many owners of "FM" receivers have never heard good FM reception.*

Consider, for instance, the matter of sensitivity and limiting. The noise suppressing qualities of an FM receiver depend greatly upon the degree of limiting possible on any station whose signals are to be received. Some receiver models will provide good limiting with very strong stations at a distance of a few miles but a negligible amount with more distant stations. Perfectly quiet operation requires not only a very efficient limiter, but also sufficient sensitivity in the RF and IF sections to "swamp" or "saturate" the limiter.

An example of a receiver suitable for realization of full benefits of the FM system would include one or more r-f amplifier stages, three or more i-f amplifier stages, a cascade limiter (2 tubes) and a Foster-Seeley discriminator. Several tuners of this type of design are on the market and give full limiting on a signal in the order of 1 microvolt. Of course this is the ideal arrangement, and one should not expect to find such an

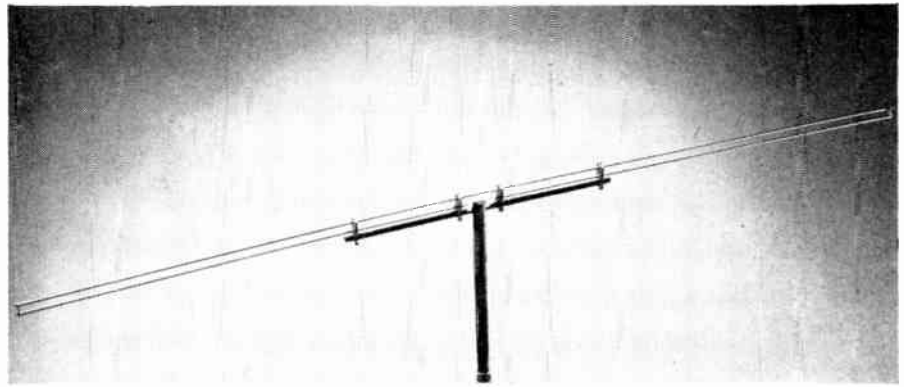

Fig. 3. A typical folded dipole

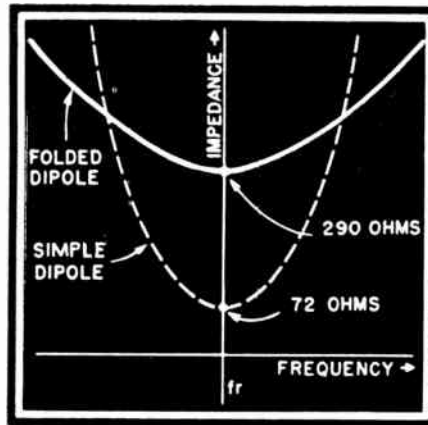

Fig. 4. Relative impedance variation of simple and folded dipole antennas. The actual variation with frequency in each case depends on the cross sectional area of the antenna elements. (see text)

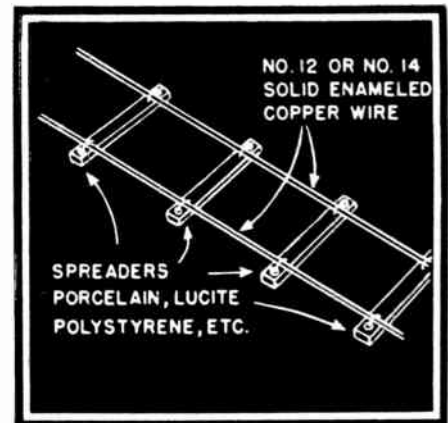

Fig. 5. How a line of approximately 300 ohms may be constructed for cases in which 300 ohm ribbon line is not available, or other cases in which the feed line is to be very long.

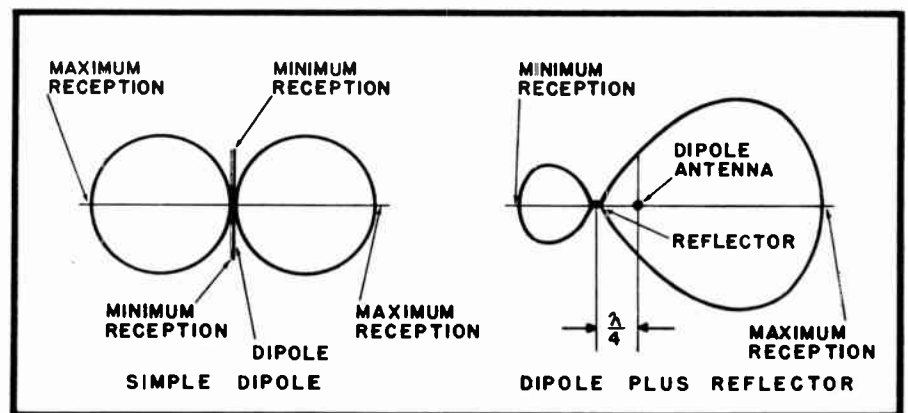

Fig. 6. Patterns showing the relative characteristics of a simple dipole and the same dipole with a reflector added.

elaborate lineup in the general plan of home receivers. But it should be remembered that each time we sacrifice important functional features, we sacrifice performance.

The three important parts into which we have divided our survey are interrelated. The type of location partially governs the type of receiver necessary for good results. Local obstructions may make reception different from that usually experienced in the neighborhood. Fig.

1 shows a typical installation terrain problem. In this case a road with heavy traffic is located in a direction opposite to that of the FM station, but a high hill is located close by and between the house and the station. The solution to this problem was the use of a dipole and reflector directional antenna which was pointed toward hill B for reception of the reflection from this hill.

An outside antenna is always desirable. Although local stations with-

HOW TO CHECK HIGH VOLTAGE SUPPLIES OF VIDEO RECEIVERS

Points to be considered when undertaking High Voltage measurements in television receivers.

by M. Mandl

A DECREASE in the picture brilliancy of a television receiver, or the total blanking out of the screen, may be due to the loss or reduction of the high voltage which feeds the 2nd anode of the pix tube. This refers particularly to cases where the picture failure occurs suddenly after a period of normal operation, and cannot be brought back by the usual control adjustments.

When high voltage measurements are undertaken, however, much greater care must be taken than is customarily the case when servicing low voltage supplies. Voltages in-

involved in television work may range from a few thousand volts to as much as 30,000 volts, depending on whether we have a small direct view set or a projection job. For this reason precautions are essential to prevent equipment damage and reduce the hazard of shocks to the serviceman.

Second anode voltages in television receivers using tubes up to 10" in diameter can be read directly on a few of the vacuum tube voltmeters on the market today having a full scale range of 10,000 volts. However, a lower range vacuum tube voltmeter (or even a 20,000 ohm per volt meter) can be utilized to good advantage if it is capable of reading a few thousand volts DC. By em-

ploying a bank of resistors, such meters can be used for measurements of 2nd anode voltages far in excess of the meter scale.

Ten resistors, each 10 megohms, are mounted on a piece of high resistance material, such as Lucite or Plexiglas. This type of mounting prevents corona effects which might occur when humidity is high.

Resistor Rating

The resistors should have a rating of 1 watt each, and must be wired in series, with two flexible leads attached to each end of the bank. The closer the tolerance rating of the resistors the better, since we would like the voltage drops across them to be

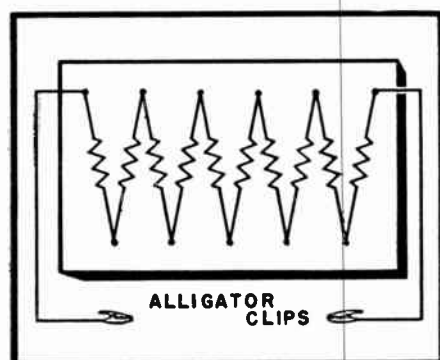
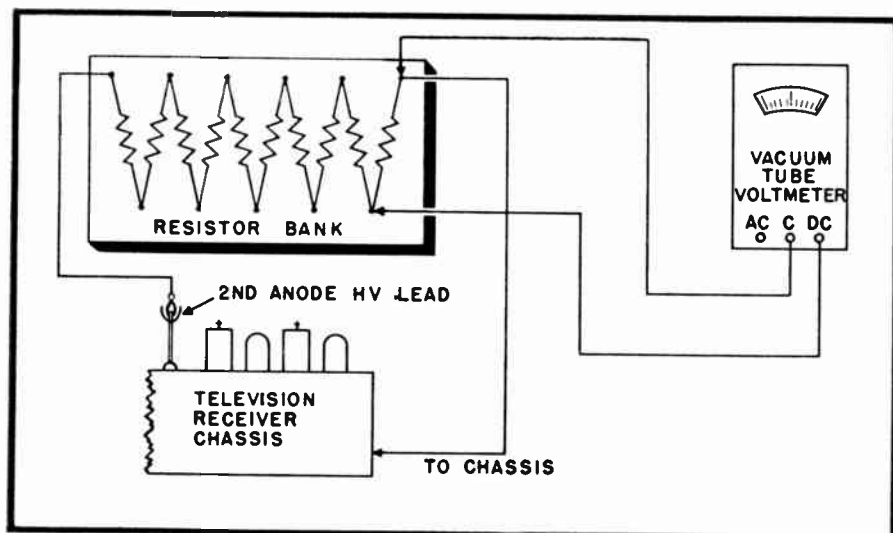
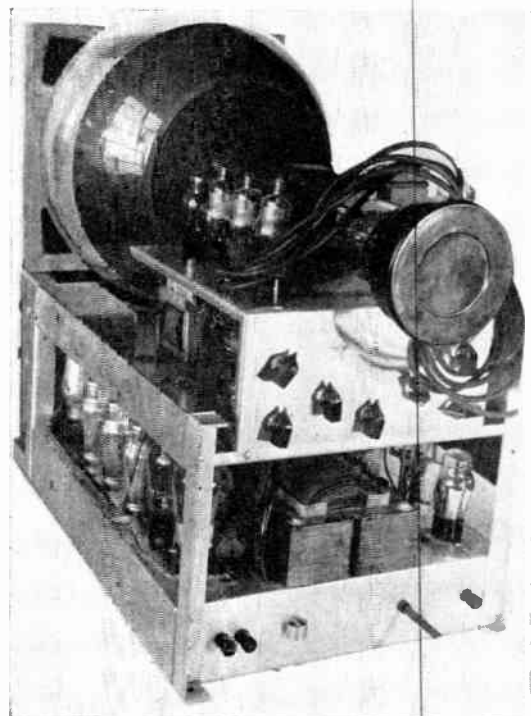

Fig. 1. Above: Bank of 10 resistors, 10 megohms each, for testing second anode voltage with low reading meter. Set-up is as shown, left, in Figure 2.

the same. Alligator clips at the tips of the leads facilitate attaching. See Figure 1.

The television set is turned off, and the bank of resistors attached to ground and 2nd anode terminal, as shown in Figure 2. After attaching the meter, the TV set is turned on, and the voltage across the resistor nearest ground side is read directly on the meter. This reading, when multiplied by 10, gives the 2nd anode voltage. Thus, if the VTVM reads 1000 volts across the lower resistor, and if all resistors have the same value, the total voltage will be approximately 1000×10 . Obviously there will be an error factor, due to the shunting effect of the meter, but it will be found that results are highly satisfactory and 2nd anode voltages clearly indicated.

Make sure high voltage is sufficiently separated from any part of the chassis to prevent arcing. It is best to keep the television set turned off until all connections have been made. If your VTVM reads up to 5000 volts DC, measurement can be taken across two resistors for greater meter deflection. On power supplies below 10,000 volts, such a meter could read one-half the voltage by being placed across five of the resistors.

A low resistance voltmeter of the 1000 ohm per volt variety is not recommended, because of the increased loading effect. A 20,000 ohm per volt meter works out very nicely, since a full scale reading of 6,000 volts on such a meter would give 120 megohms as the input impedance, and in consequence would have a negligible loading effect when placed across one or more of the resistors in the bank.

Second anode voltages on the projection sets could be measured by the same method, using a bank of 30 resistors of the 10 megohm rating. While this involves a fairly large number of resistors, it is preferable to the method so often employed which consists of drawing a spark by bringing the 2nd anode lead near the chassis. The latter method is not always reliable, and puts a heavy load on the high voltage supply.

Continuity Check

Once we have established the fact that our high voltage supply is at fault, we can proceed with continuity

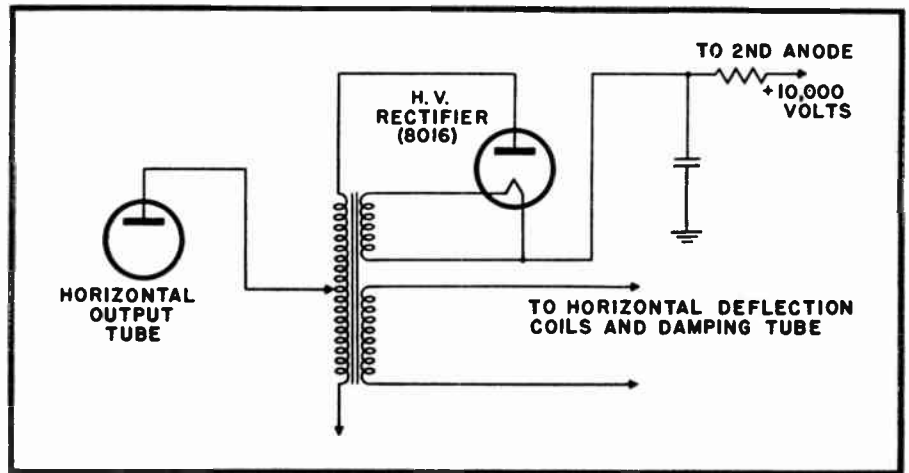

Fig. 3. Inductive "kick-back" type of high voltage television power supply. Failure of any horizontal deflection circuit would cause high voltage loss.

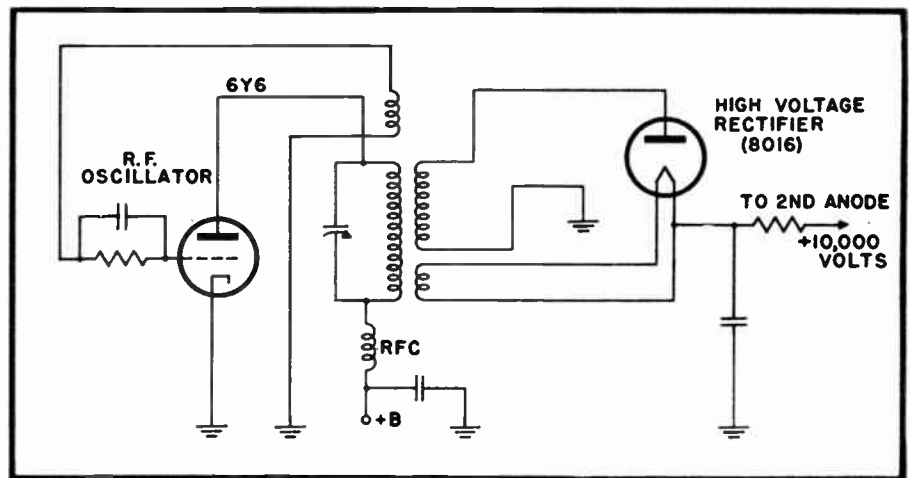

Fig. 4. R.F. type power supply. High voltage failure may be due to defective oscillator tube or associated components, including oscillator B voltage supply.

checking of the entire circuit in order to localize the defective component.

Every test involving an ohmmeter should be made with all power off. The safest way is to remove the AC plug from the power mains, and not depend on the panel switch alone, since a hot AC line may still be present in the set. Another precaution before applying continuity prods to any part of the set, is to momentarily short the 2nd anode terminal to chassis, thus making sure the high voltage filter condensers are discharged. Only then is it safe to apply the test prods of the ohmmeter to the various sections of the high voltage power supply.

The continuity check should embrace all components which might contribute to failure of the high voltage system. In most TV sets this involves removal of the high voltage compartment cover, which often con-

tains damping tube and horizontal sweep circuits as well as the high voltage rectifier and associated transformers.

If the supply consists of the inductive "kick-back" type utilizing the energy developed by the collapsing field of the horizontal deflection coils, check all circuits from the horizontal oscillator to the deflection coils.

This is necessary because such a power supply depends on the horizontal sweep circuit's function, and a defective tube or circuit component in the horizontal sweep circuit would lower the 2nd anode voltage, or cause complete voltage failure. See Figure 3.

If, on the other hand, the high voltage is derived from an RF type power supply, then it will be necessary to check the RF oscillator tube and associated circuits, including the low voltage supply feeding the RF

→ To page 37

ADVERTISING WILL INCREASE

YOUR BUSINESS

by Dan Valentine

THE time is now here when radio service men have to start thinking of ways to entice customers into their establishments.

In other words, the holiday is over in the radio service business. From now on, the competition will be getting rougher and tougher—and the big percentage of the business will go to the radio servicemen who go out of their way to publicize their business and advertise properly.

In the radio repair business, more than any other, eventual success depends upon that intangible something called goodwill. And this all-important goodwill can be built over a short period of time by any enterprising radio serviceman, with just a little extra thought and effort.

First, you must realize that you, as an independent business man in a community, are an important part of that community. You have all the privileges of a respected member of the community—and you also have all the responsibilities of any community leader.

If you want to be regarded as a

leading business man (and you will have to be so regarded if you want to prosper) it's up to you to take an interest in your town. Take part in the activities, join clubs, take out a membership in the chamber of commerce and be a volunteer worker in charity drives like the Red Cross, Community Chest and the March of Dimes.

In the coming competitive business world, a man is going to have to learn to get around. Personal contact and friendship still plays a big part in business success. In other words, a fellow would rather send his broken radio set down to "his friend, Joe" than to the cold, impersonal Jones Radio Service Shop. That's the first point—get out and make friends.

Next comes advertising. The old saying about the people battering their way to your door if you make a better mouse trap still goes. But you have to let people know where you are, and you have to let them know that you are making "mouse traps."

Radio service shops are rather at a disadvantage when it comes to advertising. Large department stores and groceries can take an entire page, splatter a flock of cut-price specials around the ad, and the people will flock to the store. Obviously, a radio repair establishment can't do this. In the radio service field there is little opportunity for cut prices or loss leaders.

But you can sell your reputation, your experience—and the experience and knowledge of your employees. And there's an idea for a unique advertising campaign. Why not feature a picture and short biography of your employees in a series of weekly ads. These advertisements should be of the small display type. The advertising men of your local newspapers will be glad to help you with the copy.

There's something about a slogan when it comes to advertising. Think of a short, catchy phrase that will be a slogan for your shop. Include something along this line: "We guarantee our work," "You must be sat-

Count pay scales at the proper levels in all employes, including members of the Cabinet and the heads of independent agencies." (Continued on page 18, col. 2)

**"MEET..
BILL WILLIS!"**
(HE'S OUR FM EXPERT)



FOR TOP RADIO WORK, IT'S:
**MACPHERSON'S
RADIO SERVICE SHOP**
SO. MAIN & TWELFTH ST.



Above are two types of effective advertising you can use. On the left is a typical newspaper ad. In such ads, keep your name and address prominent. On the right is a clever idea used by one service technician. This is one side of a postcard. He has hundreds of cards printed like this and gives them away, free. They prove to be excellent advertising.

VOL. XVII (17)

Should be over your bench NOW!

Factory-facts on FM as well as AM radio receivers and allied equipment of 115 manufacturers. Record changers and wire recorders.

Rider-Exclusive "clarified-schematics", break-down every multiband job into individual diagrams of circuits as they exist with each turn of wave band or equipment switch.

The separate "How It Works" book and the Index comes with the Manual at no extra cost. Explains the theory of new radio circuits and elaborates on the mechanical innovations of the sets covered by the Manual.

1648 PAGES, PLUS "HOW IT WORKS" BOOK AND INDEX . . . \$15.00

VOL. 1 JUST OUT

RIDER

Television
MANUAL



OVER 1400 PAGES
(but the equivalent of 2000 pages)

PLUS, 2 Separate Books, "HOW IT WORKS" and INDEX . . . Complete \$15.00

Circuit descriptions, adjustment of various trimmers, traps, transformers, etc., voltage and resistance readings, alignment instructions, parts lists, schematics, patterns, chassis views, wave forms. Everything needed on 1946-1947 television receivers (complete and kit) of 34 leading manufacturers.

208 page "How It Works" book covers underlying theory of television. Transmission and reception, frequency standards, antennas, various portions of television receivers.

Television
"HOW IT WORKS"
Available Separately

If television is not yet in your area, it will be soon. Here is theory you want. **\$2.70**

VOL. 1 RIDER PA MANUAL

Out in September

The first industry-wide service manual covering products of all leading manufacturers of PA amplifying systems, manufactured since 1938 to date. Schematics, voltage data, resistance values, capacity values, parts lists, etc. "HOW IT WORKS" explains theory of various designs employed in different types of amplifier systems, the servicing of PA systems, using sine wave and square wave means of checking, methods of rapidly locating faults. Everything you need. **Approx. 2000 Pages. . . \$18.00**

"We have never seen anything to take their place"

Says **N. W. SCOTT, JR.**
Manager of the Service Dept.
BRITTS RADIO SERVICE, Orlando, Fla.

"We have depended upon the authoritative data in Rider Manuals for years. We have never seen anything to take their place, for the efficient, profitable, successful operation of a radio servicing business."

THAT'S WHY WE ALWAYS HAVE A COMPLETE SET."

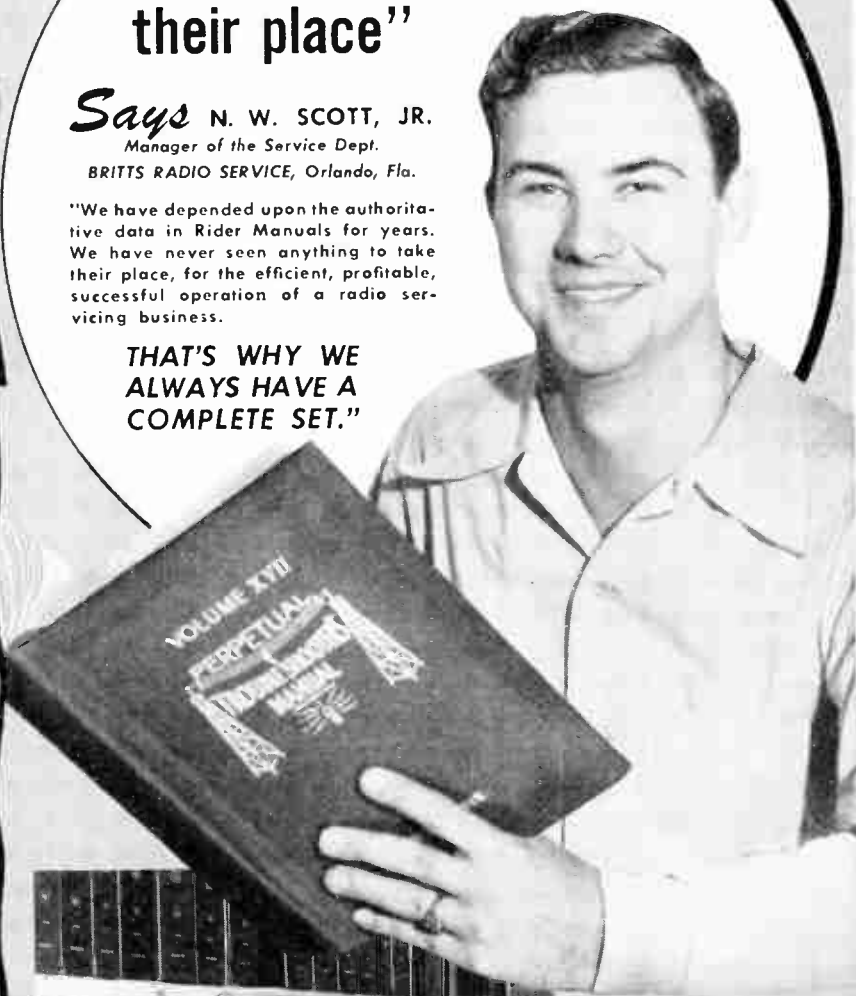

You, TOO—
NEED ALL 17 RIDER MANUALS

- Volume XVII . . . \$15.00
- Volume XVI . . . 8.40
- Volume XV . . . 18.00
- Volume XIV to VII (ea. vol.) . . . 15.00
- Volume VI . . . 11.00
- Abridged Manuals I to V (one vol.) . . . \$17.50
- Record Changers and Recorders 9.00
- Master Index, covering Manuals, Vols. I to XV 1.50

RIDER MANUALS *Mean* **SUCCESSFUL SERVICING**

JOHN F. RIDER PUBLISHER, Inc., 404 Fourth Avenue, New York 16 Export Agent: Rockefeller International Corp., 13 E 40th St., N.Y.C. Cable ARLAB

NOTE: The Mallory Radio Service Encyclopedia, 6th Edition, makes reference to only one source of Radio Receiver Schematics—Rider Manuals.

"Centralab parts

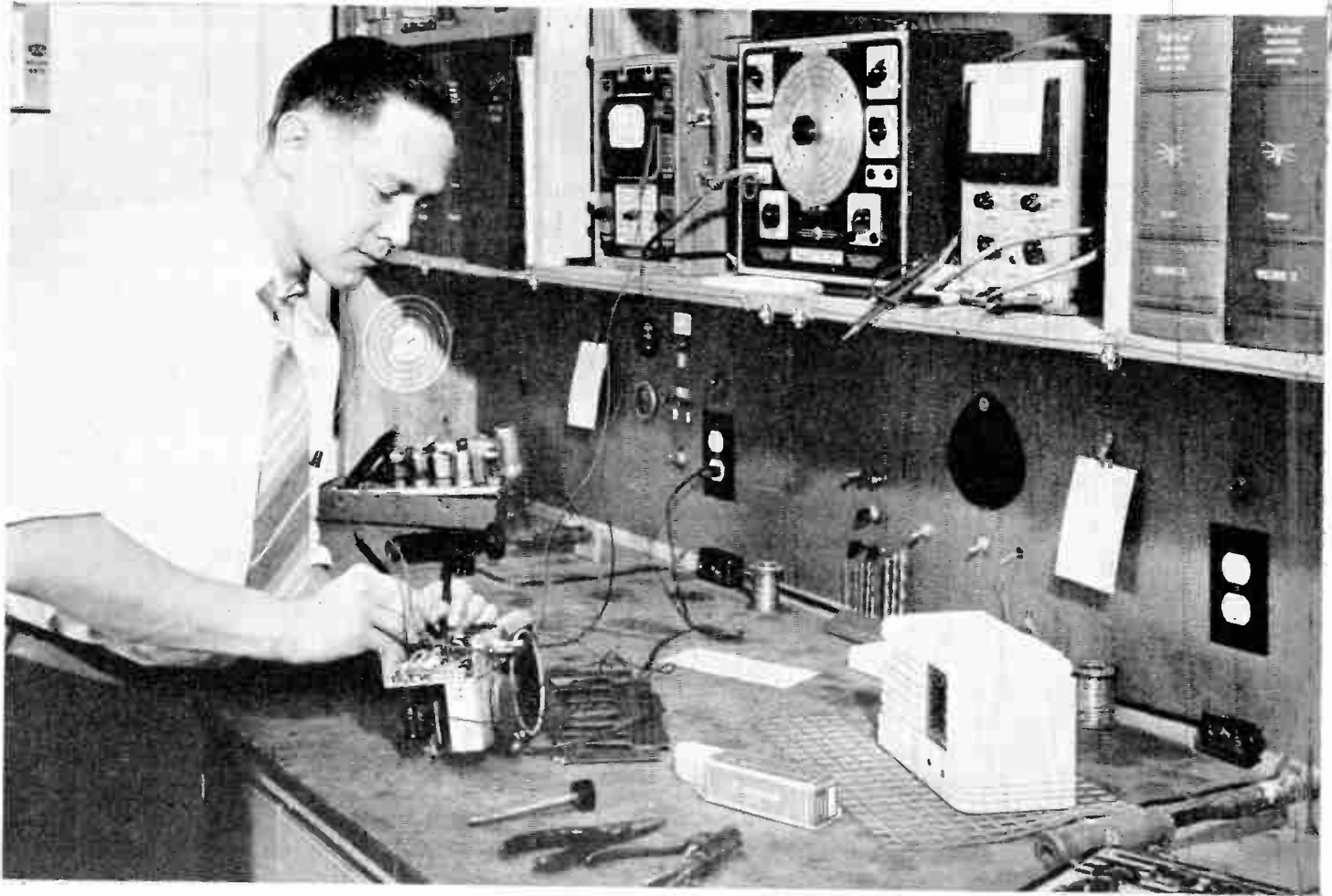

Capacitors: CRL line of ceramic By-pass and Coupling Capacitors gives you ceramic dependability and permanence at a new low price! Packaged in a convenient envelope, *Hi-Kaps* are clean, easy to stock and handle. Wide range from .000050 to .010000 mfd. Rating — 600 WVDC, 1000 V. flash tested. Just out! New ceramic *Hi-V'o-Kaps* for television and high voltage use!

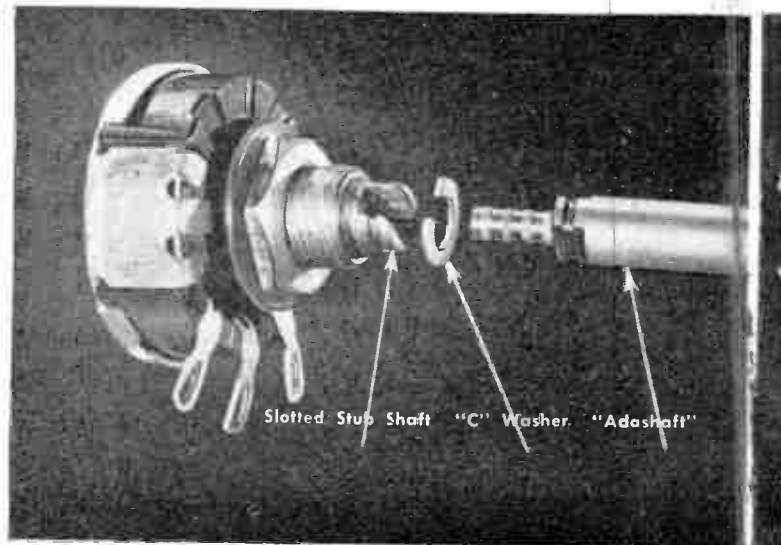

Controls: With CRL's improved *Adashaft* Radioshms you can carry a small stock of controls, yet be ready to handle almost any kind of control replacement problem. No wiggle, no wobble, no slip. Just insert shaft pilot in hole provided in control stub shaft, and slip "C" washer into place. Available in all sizes for all Model "M" volume control applications. Six types of shafts.

never let me down!"

— says **Vernon Gosnell, Milwaukee, Wisconsin**

Good replacement parts go hand in hand with good workmanship when you're running a successful service shop! That's why Vernon Gosnell — like thousands of other service repairmen — stocks a complete line of Centralab service components. Compare quality . . . compare performance . . . compare price, and you'll see why radio servicemen everywhere use CRL parts to increase the efficiency of their shops and give their customers fast, dependable service. Build up your service business with quality parts! For the complete story on the Centralab line, get in touch with your Centralab Distributor!

← "Gosnell Radio & Service Shop, Milwaukee, Wisconsin, matches good workmanship with Centralab quality parts," says Vernon Gosnell, owner. That means easier, faster service and repair . . . improved customer satisfaction!

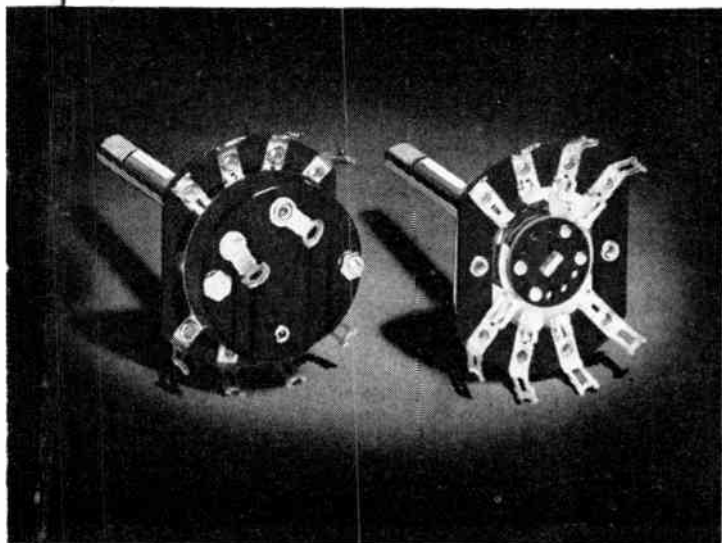

Switches: Centralab offers you a complete line of Tone, Rotary Selector, Lever Action and Medium Duty Power Switches, which features a wide variety in both laminated phenolic and steatite insulation. Available with shorting or non-shorting contacts. See your Centralab Distributor for further information, or write direct for Catalog 722.

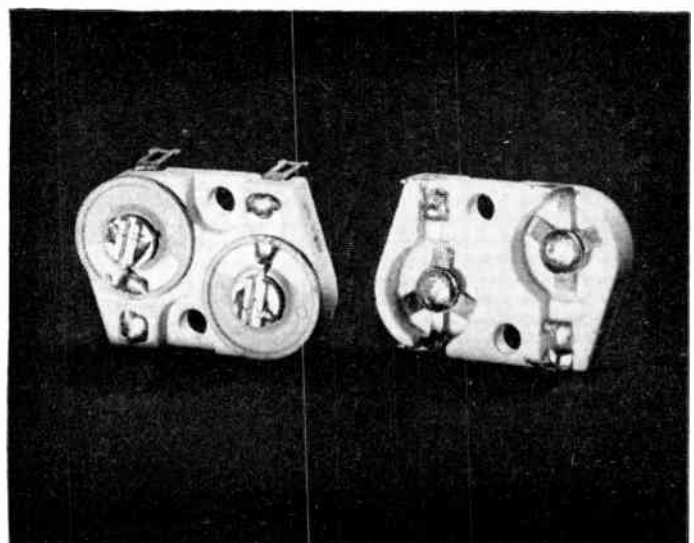

Trimmers: CRL's Ceramic Trimmers are made in four basic types with full capacity change within 120° rotation. Working voltages, 500 DC. Flash test, 1100 volts DC. Type 820—3 ranges from 2.6 to 35 mmf. Type 822—7 ranges from 2 to 50 mmf. Type 823 — 8 ranges from 5 to 125 mmf. Type 824 — 5 ranges from 1½ to 35 mmf. Spring pressure maintains constant rotor balance.

TIME SAVERS

by H. Leeper

THREE WAY PLUG

When it is necessary to solder a customer's radio in the home it is often difficult to connect the soldering iron, radio and lamp to the ordinary house outlet.

One or two three-way plugs as illustrated, carried in the service kit, will be useful for this purpose. This does away with the need for stringing wires over the floor from another outlet.

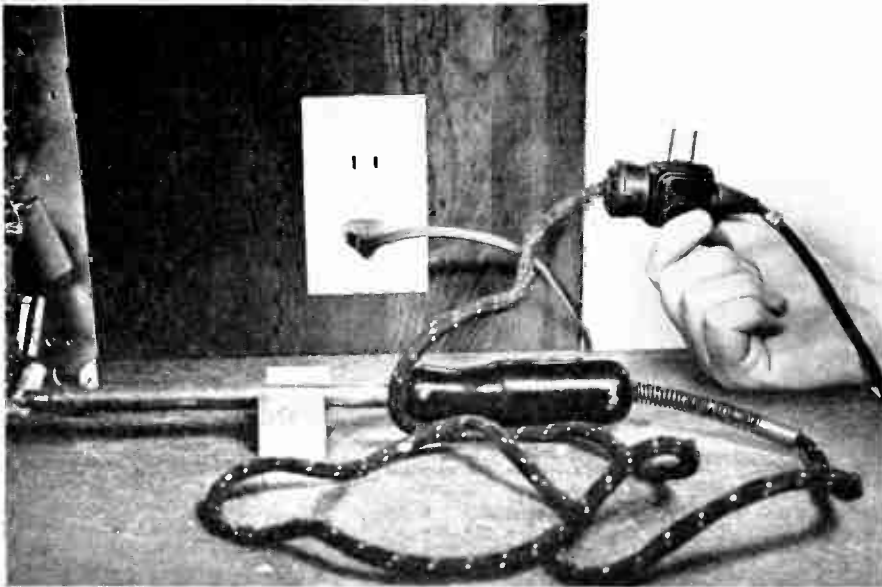

NEEDLE POINT TEST PROD

A discarded phonograph pickup cartridge may be used as a test prod with a needle point for piercing wire insulation.

The needle holding assembly is soldered to the cartridge so that when the needle is inserted it makes contact with the case of the assembly. A wire is soldered to the opposite end of the cartridge for the test lead and the rubber insulator from an ordinary test clip may be used over the cartridge to protect the operator from shock.

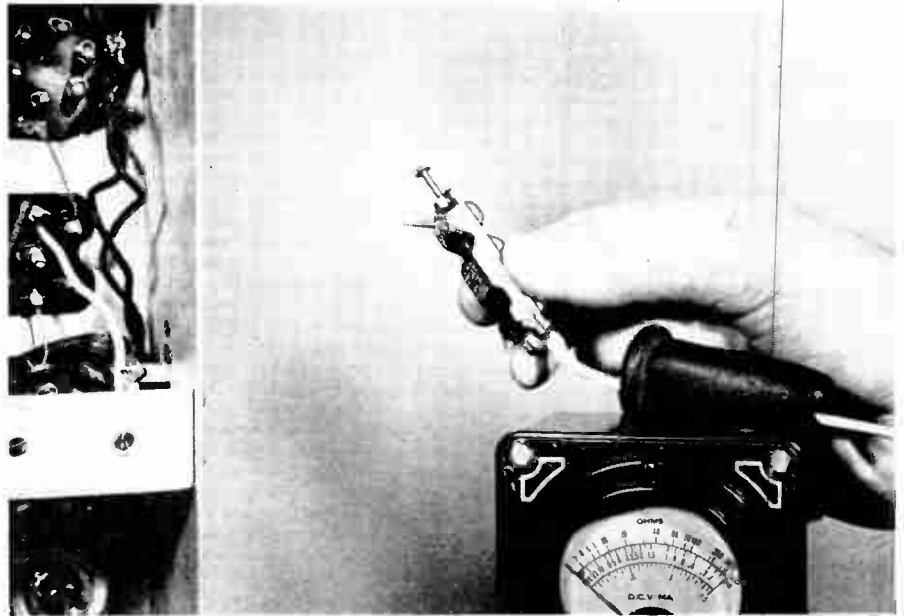

DIAL CORD HOLDERS

It is often desirable to carry two or more grades or sizes of dial cord in the service kit for replacement purposes. This may be done with a minimum of space in the kit by winding the cord on empty film spools as illustrated.

A hole is drilled in one end of the spool flange—through which the loose end of the cord is pulled. The spool ends may be marked as "F" for fine cord, "M" for medium cord etc., with white enamel paint.

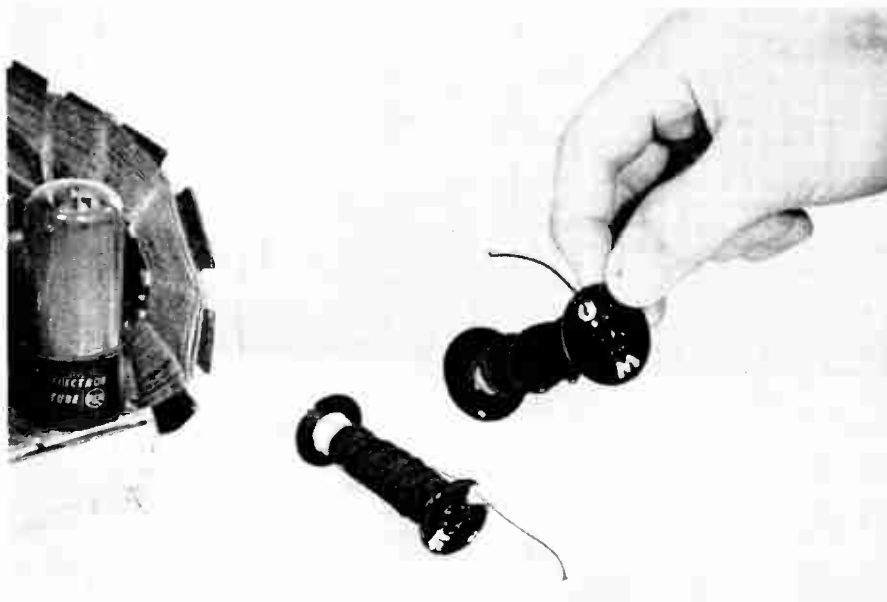



SPRAGUE Molded Tubulars

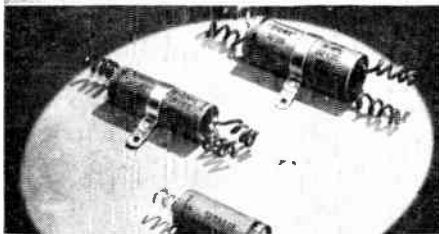

SPRAGUE Koolohm Resistors



SPRAGUE EL Midget Capacitor Types

YOUR REPUTATION...

and your customers deserve the best!

SPRAGUE

These are but a few of the many capacitor and resistor types in the complete SPRAGUE Line. "Specify SPRAGUE" in all your repair work. Build a reputation for a quality job while you are building a more profitable business!

WRITE FOR THE COMPLETE CATALOG

SPRAGUE PRODUCTS COMPANY, North Adams, Mass.

JOBGING AND DISTRIBUTING ORGANIZATION FOR THE PRODUCTS OF THE SPRAGUE ELECTRIC COMPANY

LAMP CLAMP

A clamp on type of lamp as illustrated may be assembled by attaching the spring clamp arrangement to an ordinary lamp socket.

Such a lamp is particularly useful when inspecting the customer's radio in the home or in removing the chassis from the cabinet.

It may be c'amped to the cabinet as shown, the swivel permitting the light to be placed at various angles.

The clamp attachment may be purchased at auto supply or photographic supply stores.

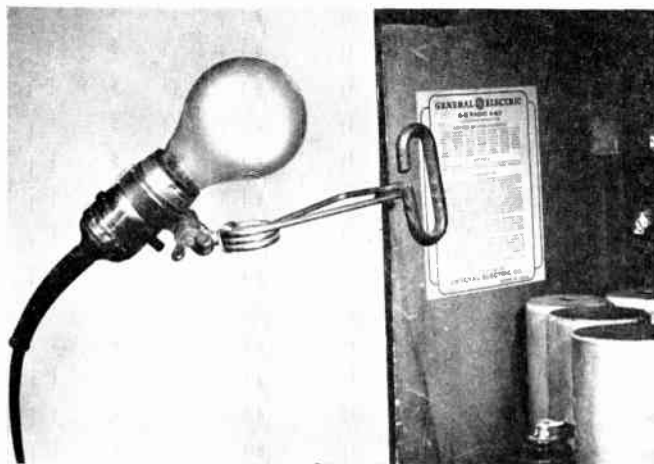

TEST LEAD HOLDERS

Clips salvaged from worn out dry batteries may be used to advantage as holders for test leads and other wires.

The base of each clip is drilled and fastened to wall or bench with a screw.

With the pointed section of the clip bent inward and the top section bent outward—each clip will accommodate several wires or test leads.

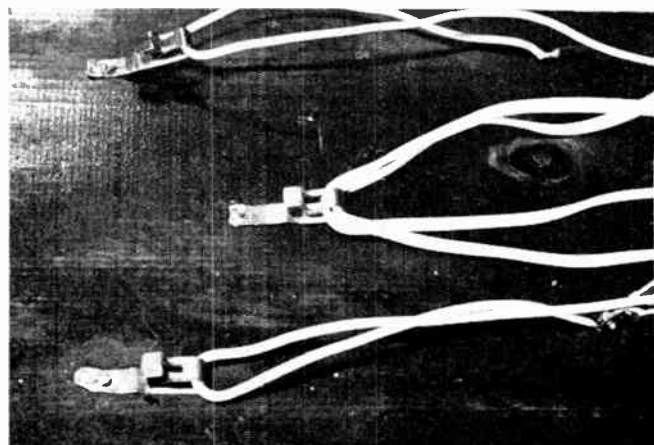

THE INDUSTRY PRESENTS



VOLT-OHM-MIL-AMMETER

A New Volt-Ohm-Mil-Ammeter of advanced modernistic design is announced by the Triplett Electrical Instrument Co., Bluffton, Ohio. A new type enclosed molded switch permanently retains contact alignment, wide range scales and features completely insulating the large sensitive meter, precision resistors, etc.

Six D.C. Volt ranges from 0 to 6,000, at 20,000 Ohms/Volt assure greater accuracy for testing Television and other high resistance D.C. and A.C. circuits. Six A.C. ranges to 6,000, at 5,000 Ohms/Volt provide greater accuracy in audio and other high impedance

A.C. circuits. Five Direct Current ranges from 0-60 Microamperes to 0-12 Amps.; Resistance ranges to 100 Megohms; Decibels from -30 to +70 DB and Output ranges afford complete Volt-Ohm-Mil-Ampere analysis.

Precision resistors—each rigidly mounted in its own molded compartment—are directly connected to the switch.

A large 5 1/2" meter provides easy-to-read multi-color scales, and is separately housed in a molded case. The stream-lined black, molded case, 3-7/32" x 5 1/2" x 7 1/2", is completely insulated and has removable, black leather strap handle.



TRANSFORMERS

Peerless Electrical Products Division of Altec Lansing Corporation, 6920 McKinley Ave., Los Angeles 1, Calif., announces a new "20-20 Line" of audio transformers, flat within 1 db from 20 cycles to 20,000 cycles. Makers claim "superior Altec Lansing design principles at prices attractive to present-day manufacturing and replacement markets". Maker prepays transportation anywhere in U.S. on orders totalling 100 lbs. or more.

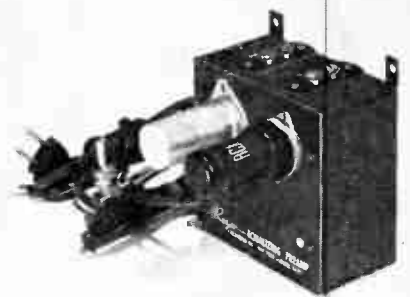

EQUALIZING PREAMPLIFIER

A new equalizing preamplifier for variable reluctance and magnetic phonograph pickups, which requires no soldering iron or technical training, and which can be installed by the average set-owner in less than a minute, has been announced by Roger Television, Inc., 366 Madison Ave., New York 17, N. Y. Measuring about 4" x 4" x 4" overall, the unit is heatless, humless, shockless and light in weight. Incorporating a completely self-contained transformer-type 117V AC power supply which draws only 3 watts power, the unit may be plugged directly into the wall socket. By cutting the phonograph's shielded output lead with a knife or scissors,

ASTATIC PIONEERED THE FIRST CRYSTAL DEVICES
Again Astatic takes the lead

**with MICROPHONES
and PHONOGRAPH PICKUPS**
**Employing the AMAZING PIEZOELECTRIC
CERAMIC ELEMENTS**

Astatic again assumes a pioneer role . . . in making available, for the first time, the unique physical advantages of the amazing, piezoelectric ceramic element, in a microphone and phonograph pickup cartridge of advanced quality and fidelity. Unaffected by heat, moisture or dryness, they can go virtually anywhere . . . provide transcription quality reproduction, troublefree service, in tropical climates, under exposure to direct sunlight, heat from klieg lights or automotive interiors, when subjected to the many other conditions that threaten damage or impaired performance to other type instruments. These, plus other important advantages, combine to assure an immediate, enthusiastic reception for Astatic ceramic devices.

NOW AVAILABLE Astatic has incorporated ceramic elements in two of its most popular product designs—the convertible "Velvet Voice" Microphone and the "Quiet Talk" series pickup cartridges. Now moving through Astatic production lines, they are immediately available.

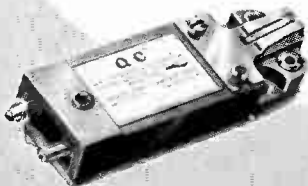

Write for prices,
specifications



barring the two resulting lead endings, and catching them under the screw terminals provided, the complete installation is made in a matter of seconds. Full instructions are provided.

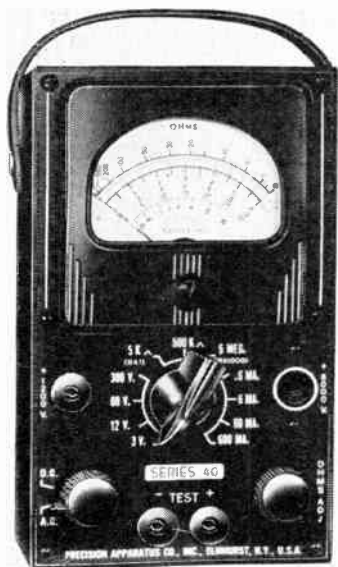

CIRCUIT TESTER

A new pocket-size wide-range circuit tester, Series 40, for use by service technicians, maintenance engineers, production inspectors, trouble shooters and radio amateurs has been announced by Precision Apparatus Co., Inc., 92-27 Horace Harding Blvd., Elmhurst, L. I., N. Y. This instrument, built into a custom-molded bakelite carrying case, has dimensions of only 3 3/4" x 6 1/4" x 2 1/2", yet offers every design feature and full-bodied components as are regularly incorporated in "Precision's" larger multi-range test sets. The unit affords 31 AC-DC ranges to 6,000 volts, 600 MA, 70 DB and 5 megohms. It is entirely self-contained and ready to operate. No external batteries or multipliers are required. The meter is a full-sized 3" rectangular cased instrument of 400 microampers sensitivity. Rotary range selection permits only two pin jacks to serve all standard functions and a special recessed safety jack provides for hte 6,000 volt circuit. All multiplier and shunt resistors are accurate to 1%. The unit is supplied complete with ohmmeter batteries and test leads.

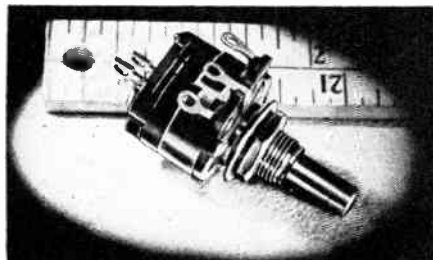

SMALLER VOLUME CONTROL

A smaller, handier, 15/16" diameter carbon volume control is announced by Clarostat Mfg. Co., Inc., 130 Clinton St., Brooklyn, N. Y. Despite its compactness, nothing has been sacrificed in electrical and mechanical sturdiness. This control is of entirely new design, having been developed from scratch to meet the demand for more compact components.

The new control is available with or with-

out switch. However, the switch is factory-equipped or built integral with the control proper. Dimensions are 15/16" diameter by 29/64" deep without switch, or 49/64" deep with switch. Standard units have a 1/4" long 3/8-32 threading bushing, together with a 1" long knurled shaft, and are available in 250,000, 500,000, 1,000,000 and 2,000,000 ohm values, with the Z audio taper. For manufacturers' requirements, other resistance values are available, as well as other shafts.

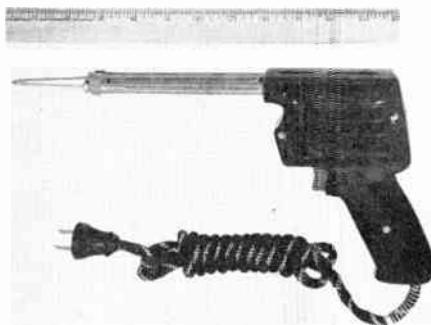

SOLDERING GUNS

Two "longer reach" soldering guns—8" and 12" units have been announced by Weller Mfg. Co., Easton, Pa. These two new models offer many advantages by providing easy access to spots otherwise difficult to reach. The eight inch soldering gun is scientifically balanced and well suited for all normal soldering, plus the advantage of longer reach. The twelve inch model is designed for particularly "long reach" requirements, such as telephone multiple maintenance.

Dual heat at 100 and 135 watts is provided on both new models. They operate on 115 volts at 60 cycles. With these additional models, the Weller line now offers six different soldering guns. Although each has certain distinctive features, all Weller Soldering Guns include fast five second heating, built-in transformer, long life Flexitip, pre-focused spotlight and trigger switch.



VOLTMETER

A "Master VoltOhmyst", latest and most advanced in the popular series of RCA electronic voltmeters, which features circuit innovations providing for capacitance and current measurements over an extremely wide range, has been announced by the Test and Measuring Equipment Activity of the RCA Tube Department.

With the large number of capacitance measurements encountered in the servicing of high-frequency equipment — comparable to resistance measurements in standard AM equipment—the versatile, wide-range capacitance-measuring ability of RCA's new Master VoltOhmyst, Type WV95A, makes it a tool

→ To page 45



Servicemen's choice!
in . . .



● Old-timers in Arizona learned long ago that there's a healthy air about Cunninghams. That's because Cunningham tubes are built to the highest quality standards for long life and top performance. When renewal tubes are needed, customers vote for Cunninghams. For a healthy reception, use Cunningham tubes in *your* work.

See your
CUNNINGHAM DISTRIBUTOR

Electrical Equipment Co. of Ariz. . . Phoenix
Standard Radio Parts Tucson



CHECK!

**ALWAYS the
RIGHT shaft!**

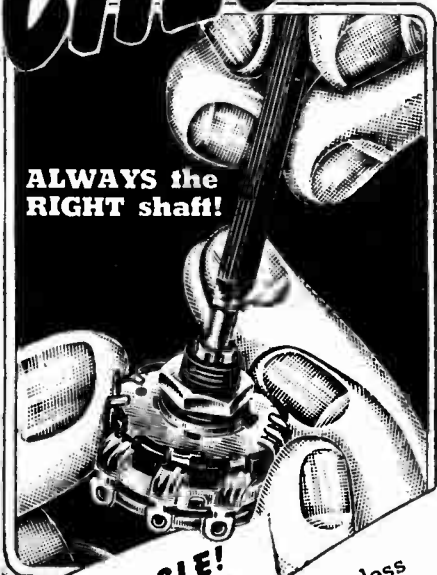

**NO WIGGLE!
NO WOBBLE!**

Clarostat shafts are centerless ground. Fit snugly in bushing. Yet turn so **SMOOTHLY!**

**EASY TO
CUT!**

Clarostat shafts are of aluminum. That means easy and quick cutting to correct length.

YOU PICK IT!

Select the right control — ohmage, taper, tap. Then select the right shaft. All for \$1.25. No extra charge for special shaft!

CLAROSTAT



Ask your
Clarostat
jobber for
latest catalog. Or
write us.

Controls and Resistors

CLAROSTAT MFG. CO., Inc. · 285-7 N. 6th St., Brooklyn, N. Y.

In Canada: CANADIAN MARCONI CO., Ltd.
Montreal, P.Q., and branches

ELECTRONICALLY SPEAKING



The radio industry has just completed a record-breaking production year which also saw both FM and television receiver manufacturing reach volume proportions. Paul V. Galvin, chairman of the RMA Set Division, reported at the 24th annual convention of the Radio Manufacturers Association.

"The last year has been one of record-breaking production, even of over-production in some types of receivers," Mr. Galvin, who is president of Motorola, Inc., of Chicago, said. And this record was established, he added, amid "our highest competitive and production cost conditions."

"One of the new problems facing the industry, particularly set manufacturers, is the new military production program resulting from world tension and the preparedness program of the administration and Congress. During the next few months the industry will feel its impact and RMA already has taken steps to meet the new responsibilities. The large military production presages definite results on our civilian output and also possibly future Government restrictions and controls. Our job ahead is to program the dual responsibilities, continuing civilian activities and at the same time meeting the needs of our Government."

Among the RMA promotion projects cited by Mr. Galvin are the continuing "Radio-in-Every-Room . . . Radio-for-Everyone" campaign and National Radio Week, both of which are under the direction of the advertising Committee. Radio Week, which this year will be observed the week of Nov. 14-20, is jointly sponsored by RMA and the National Association of Broadcasters.

A total of 118,027 television re-

ceivers were manufactured by RMA member-companies during the first quarter of 1948, according to the Radio Manufacturers Association. This output is almost three times the production rate of the corresponding quarter of last year and 66 percent of the total TV set output during 1947.

Radio set production remained at a high level, and FM-AM sets were high for the first quarter as compared with the corresponding period of 1947. Fewer AM radios, especially table models, were reported for the 1948 quarter, however. The first 1948 quarter production of TV sets brought the total output of RMA companies since the war to more than 300,000 and FM-AM receivers to 1,794,418.

Production of auto radios and portables continued at a high rate during the first quarter. More than 935,000 auto sets and about 518,000 portables were reported.

Rapidly expanding television set production presages continuing good business for the radio industry's component manufacturers. Chairman J. J. Kahn of the RMA Parts Division told the 24th annual convention of the Radio Manufacturers Association.

"Home radio set production figures—approximately 200,000 sets a week at present—coupled with forecasts of almost the same rate of television set production within four years, indicates a bright future for the component parts industry," said Mr. Kahn, who is president of the Standard Transformer Corp., of Chicago.

With television and FM receiver production rising rapidly, the radio industry's sales volume should continue at the record-breaking level attained in 1947 despite a reduction in

the manufacture of AM or standard radio, Max F. Balcom, president of the Radio Manufacturers Association, told RMA members.

The radio industry moved into the billion dollar category last year when almost 20 million radio and television sets, two million receiving tubes, and \$212 million worth of transmitting equipment were produced and sold. Mr. Balcom predicted that television receiver production in 1948 will reach between 600,000 and 750,000 as compared with about 175,000 TV sets in 1947 and may double the 1948 output in 1949.

"The industry is facing the fact that the manufacture of high priced radio sets is now on a reduced quantity basis due to the greater impetus of television," he said. "Also, the greater interest in FM will without doubt replace part of the previous AM production. However, with the growing output of television and FM there is no reason why total sales volume in the radio industry cannot continue at the same high level attained during the year 1947. The past year saw a return to "normal" competitive production with an output of radio receivers that "surpassed normal," Mr. Balcom said, and was the first year of "volume production" for television and FM.

"We now have an over-production of table model AM receiving sets," he added. "FM set production was below its early expectations, while television receiver production was in excess of industry expectations early in the year."

During 1947 the industry turned out 1,200,000 FM sets, about 175,000 television receivers, 3,000,000 auto sets, and more than 2,500,000 portables, he reported.

Production of television receivers continued to climb during May, while radio set production in a seasonal decline fell below both the previous month's output and the May 1947 total, the Radio Manufacturers Association has reported.

May's TV set production by RMA member-companies totalled 50,177 for an average of more than 12,500 receivers produced weekly. The average weekly production of television receivers in May represented an increase of more than 38 percent over the average weekly pro-

duction for the first quarter of 1948. May's output brought TV set production by RMA member-companies to 214,543 for the first five months of 1948 and the total manufactured since the war to more than 400,000.

Radio set production, including FM-AM and TV receivers, totalled 1,096,780 in May compared with 1,182,473 in April. FM-AM set production totalled 76,435 as against 90,635 receivers of this type manufactured by RMA member-companies in April.

Nescorp Electronics division of National Equipment and Supply Company has just moved to new spacious quarters at 806-810 West Jackson Boulevard, Chicago, Illinois. They occupy a three-store front with a good deal of warehouse space.

In the past, Nescorp Electronics has dealt with surplus radio-electrical-electronic equipment. Their future plans include, in addition to this surplus equipment, a full jobber line of standard merchandise made by national manufacturers. In this way, they will be able to serve the dealer, serviceman, ham, and anyone else interested in electronic equipment.

A new line of television components, for use with 10-inch picture tubes requiring 50 degree magnetic deflection at an accelerating voltage of 9000 volts, has been announced by the Receiver Division of the General Electric Company's Electronics Department. The components consist of a horizontal output transformer, horizontal size control, horizontal linearity control, deflection yoke, focus control, centering device, mounting bracket and ion trap.

The permanent magnet centering device is the only one on the market today, according to R. S. Fenton, sales manager for the division's component parts section. "✓✓✓"

send for **FREE**
folder on the **new**

**RADIO DATA
BOOK**

•
BOLAND & BOYCE, INC.
MONTCLAIR, N. J.



Servicemen's choice!

in . . .



© Servicemen in Delaware are casting their votes for Cunningham—the tube that's "built for service." For top quality and performance, you can't beat Cunninghams. They've been satisfying particular customers since 1915. They'll bring more customers *your way* if you "make it Cunningham" when renewal tubes are needed.

See your
CUNNINGHAM DISTRIBUTOR

Radio Elec. Service Co. of Pa., Inc.,
Wilmington

Cunningham Tubes

A product of
RADIO CORPORATION OF AMERICA
Harrison, N. J.

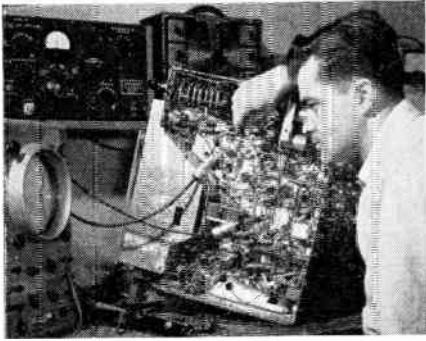

BIG NEWS OF THE YEAR!

Introducing—

The 1st All Service Course
in CREI History

"Television and FM Servicing"

This basic CREI Servicing Course paves the way to greater earnings for you. Since 1927 thousands of professional radiomen have enrolled for our home study courses in Practical Radio Engineering. Now, for the first time, we introduce a Practical Servicing Course. You do not have to be, or want to be, an engineer to benefit from this course. It is written for you—the average good servicemen! It's not too elementary for the experienced. It's not "over the head" of those who have limited experience—if they have real ambition and natural ability.

CREI developed this course at the request of several large industrial organizations. The urgent need of capable, trained servicemen is one of the big problems of the industry. Hundreds of thousands of Television Receivers will be marketed in 1948. In years to come millions more will flow into American homes. With Television comes FM receivers and circuits. This new field demands a tremendous increase in the number of properly trained television and FM technicians to install and service this equipment.

This can be your big year! Don't waste another day. CREI has the answer to your future security in this new servicing course. Write today for complete information. The cost is popular. The terms are easy, the information is free. Write today.

MAIL COUPON TODAY

CAPITOL RADIO ENGINEERING INSTITUTE
16th & Park Road, N. W., Dept. 488
Washington 10, D. C.

Gentlemen:

Please send me complete details of your new home study course in Television and FM Servicing. I am attaching a brief resume of my experience, education and present position.

NAME

STREET

CITY ZONE.....STATE.....

I am entitled to training under G.I. Bill.

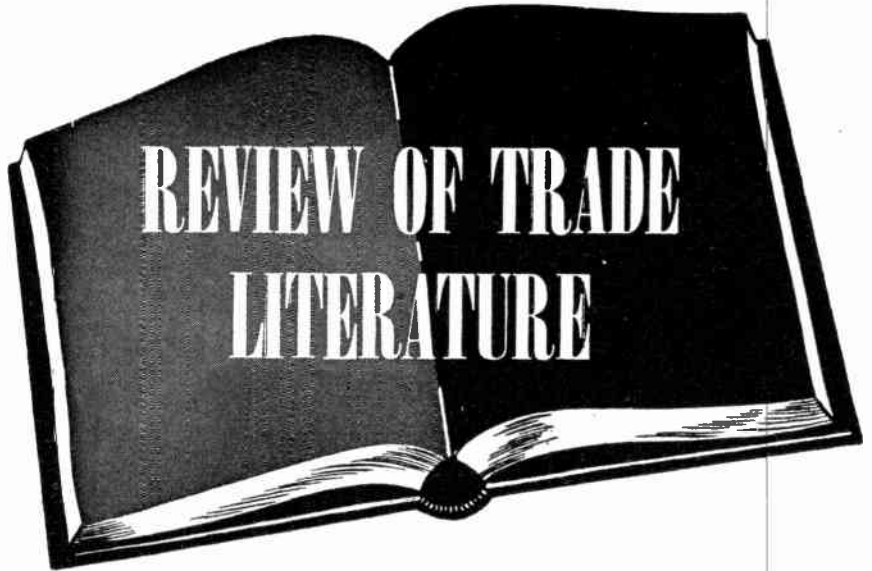

To avoid delay when writing to the manufacturer give issue and page number

Television and FM Receiver Servicing—This 212-page book, written by Milton S. Kiver, gives practical information on the servicing of television and FM receivers. It examines the problems of operation and installation of the antenna system, and of the television receiver itself. There are chapters on television test equipment and servicing, and on the alignment and trouble shooting of the receiver.

FM fundamentals are discussed at length in a separate chapter. There is information of commercial FM receiver circuits, FM receiver alignment, and FM servicing. An appendix is devoted to the allocation of television channels — Metropolitan Districts of the U. S. This book is illustrated throughout with graphs, schematics, and photographs of equipment.

D. Van Nostrand Company, Inc., 250 Fourth Ave., New York, published this book, which sells for \$2.95.

Television—How it Works—This 203-page book gives explanations of the operation of television receivers such as are on the market today. In a preface to the book, John F. Rider states: "This book will develop a familiarity with television — practice will develop more—other texts will add still more knowledge—attendance at a school will be of great benefit—past experience on regular broadcast receivers is a cornerstone on which to build—in short, it is a combination

of many things that will make a competent television technician."

Separate chapters deal with the television system, frequency characteristics of the television signal, antennas, the RF amplifier, oscillator, and mixer circuits, the FM sound channel, the IF and detector section, video amplifiers and DC restorers, synchronizing circuits, sweep circuits, the picture tube, power supplier, and alignment and servicing. There is an eight page trouble-shooting chart at the back of the book.

This book is sold by John F. Rider, Publisher, Inc., 404 Fourth Ave., New York 16, for \$2.70.

Replacement Speaker Catalog—Utah Radio Products, Huntington, Indiana, announces its new 1948 Radio Replacement Speaker Catalog, Number 100, is now available for distribution. This new 11-page catalog has been especially designed to make it easier for the serviceman to select the proper speaker for any particular sound application.

Complete electrical specifications for each speaker are listed in easy-to-read tables. Physical dimensions listed are within close tolerances so that the serviceman knows if the speaker will fit the job simply by referring to the catalog. A new, simpler parts numbering system is fully explained to help make ordering easier. Many new models, in various sizes and types, are listed. Over 90 speakers are available for immediate delivery. Utah describes the function

of its country-wide distributing organization on the final page of the catalog.

To obtain this new book write to the company, Utah Radio Products, Division of International Detrola, Huntington, Indiana, or ask an authorized Utah jobber.

Lightning Protection—A new 15-page catalog, Number 48-A, has just been issued by L. S. Brach Manufacturing Corporation of Newark, N. J., manufacturers of radio and electrical equipment.

Important considerations relative to the role played by lightning arresters in radio, police alarm, fire alarm, railroad signal, telephone and telegraph circuits are discussed—particular reference being made to the advantages of Rare Gas Arresters over other mediums, in affording protection against the effects of lightning induction sustained by exposed wires during storms, and high voltage induction sustained by wires in close proximity to high voltage circuits.

Outstanding among the many examples of such arresters, whose specifications are clearly cataloged in the booklet, are Type 272 Arrester, designed particularly for telephone and telegraph circuits where a Rare Gas Arrester is desired in combination with a line fuse; the popular Type 36, which effects economy in first cost as well as space occupied in the housings where installed; Type 390, a "Triplepath" unit, for signal and telephone hook-ups, which maintains a balanced system of protection from lightning and electrostatic charges—draining the line of abnormal electric charges whatever the source; and Types 1205 and 1206 Triplepath Arresters which, in addition to line-to-ground, provide a shunt across the circuit—particularly desirable where space is limited, as in Fire or Police boxes.

Described also are the widely-used Brach Switchboard Lightning Arresters—with which nearly all modern central office switchboards are provided; and Brach's Portable Rare Gas Arrester Testing Set—capable of testing all types and makes of vacuum and rare gas lightning arresters.

Special sections are devoted to discussing Entrance Panels, House Arresters and Terminals, Terminal Strips, and Potheads, and enumer-

ating specifications for these items. Short descriptions are also given of the Vincent Rare Gas Relay, Type RTC-2; the very useful, easily-handled Brach Test - O - Lite, which has found universal acceptance as a means for checking electrical circuits within the very high voltage range of 100 to 500 volts; the Safe-T-Glow High Tension Detector; and Brach Fixed Neon High Voltage Indicators.

Text matter throughout is generously illustrated with photographs and drawings. All items are tagged with reference numbers, making ordering a simple procedure.

Stancor Transformers—The publication of a new 24-page catalog (140-II) has been announced by Standard Transformer Corporation. Listed are over 400 STANCOR stock items, including audio and power transformers and reactors, power packs, volt adjusters, radio transmitter kits and television components. Also included are charts on transmitting tubes, driver-modulator combinations, and matched power supplies. Catalog 140-H is available at no cost from Standard Transformer Corporation, Dept. E, Elston Kedzie and Addison Streets, Chicago 18, Illinois.

Television Course—The Howard W. Sams television course is a welcome addition to the Sams Photofact Folders. Installment #1 of the Photofact Folder Set #38 establishes a very high quality of both text and illustration. This first booklet in the series is 12 pages long, easy to understand and full of useful, practical information for the radio service technician interested in understanding the latest television developments. The Photofact Folders are published by H. W. Sams & Co., Inc., 2924 East Washington Street, Indianapolis 6, Indiana.

send for **FREE**
folder on the **new**

**RADIO DATA
HANDBOOK**

•
BOLAND & BOYCE, INC.
MONTCLAIR, N. J.



Servicemen's choice!
in . . .



• Georgians cast their votes for Cunningham—the tube built for long life and trouble-free service. When renewal tubes are called for, you'll favor *more* customers by making Cunningham tubes *your* first line.

See your
CUNNINGHAM DISTRIBUTOR

Southeastern Radio Parts Co. . . Atlanta
Southeastern Radio Parts Co., Savannah



American Beauty

ELECTRIC SOLDERING IRONS

are sturdily built for the hard usage of industrial service. Have plug type tips and are constructed on the unit system with each vital part, such as heating element, easily removable and replaceable. In 5 sizes, from 50 watts to 550 watts.

TEMPERATURE REGULATING STAND

This is a thermostatically controlled device for the regulation of the temperature of an electric soldering iron. When placed on and connected to this stand, iron may be maintained at working temperature or through adjustment on bottom of stand at low or warm temperatures.

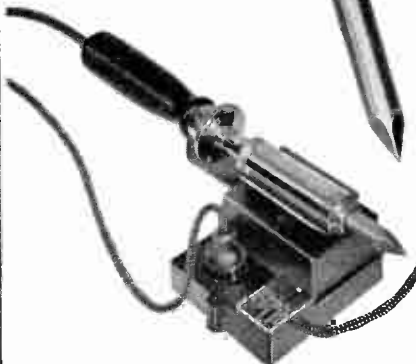

For descriptive literature write

110-1

**AMERICAN ELECTRICAL
HEATER COMPANY
DETROIT 2, MICH., U. S. A.**



by John T. Frye

THE advent of FM and TV is not an unmixed blessing to the radio serviceman, and his trouble starts even before he is required to do any service on these receivers. It begins when one of his customers asks for his advice in connection with the purchase of a new receiver. The nasty situation is considerably aggravated if his service area lies at some distance from FM and TV transmitters.

The questions go like this: Would you advise me to buy an FM or TV set now or to wait a while? Will the prices come down soon? Do you think important improvements will be made in the near future? Just what kind of reception can I expect to get with a new FM set or with a new TV receiver? What kind of an antenna will I have to have? What's this business about line-of-sight reception?

It would take a seventh son of a seventh son to answer all of those questions correctly and confidently. They are but a small sampling of the queries dinned into the serviceman's ears each day. The worst part is that he does not know where to look for the answers. Quite often theory and practice seem to be poles apart.

He has read, for example, that good television reception requires a "healthy" signal at the antenna input terminals. He knows that it has been the practice of some manufacturers to refuse to sell a TV receiver to a person living beyond the normal receiving range of a television transmitter. He has read the books about the propagation of high-frequency waves, and he has the formula for figuring out line-of-sight distances between transmitter and receiver antenna all down pat. He boils all of this down into simple one-syllable words and passes it along to his customer together with a "go-easy" word of caution.

What happens? A fly-by-night dealer comes into town with the sole idea of exploiting the television boom. He high-pressures this customer into shelling out around a thousand dollars for a complete television installation, including a special antenna, a hundred-foot tower, a pre-amplifier, etc. What is more, the combination quite often works fairly well. Reception is spotty at times, but there are other nights when TV signals from a hundred miles away are clear and sharp.

Permoflux SPEAKERS

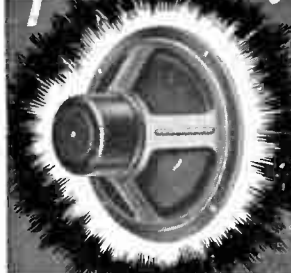

YOUR JOBBER CAN SUPPLY YOU!

Permoflux quality and dependability—the same as supplied to the major set manufacturers—is your assurance of complete customer satisfaction. You'll find Permoflux Speakers easy to install and readily available in both PM and Electrodynamic types. You'll find too, that it pays to give your customers "tops in tone" with a Permoflux Replacement Speaker.

TWO COMPLETE
FACTORIES TO SERVE YOU

PERMOFLUX

WRITE FOR
FREE BULLETIN

PIONEER MANUFACTURERS OF PERMANENT MAGNET DYNAMIC TRANSDUCERS

PERMOFLUX CORPORATION

4900 WEST GRAND AVE., CHICAGO 39, ILLINOIS
236 SOUTH VERDUGO ROAD, GLENDALE 5, CALIFORNIA

What is the result? The serviceman loses considerable face in his community. He is branded a false prophet or an old fogey who does not keep abreast of modern developments in his field. Since he was proved wrong about TV reception, people begin to wonder if he really knows much about radio at all!

There are several contributing factors to this confusing situation. In the first place, the manufacturers are trying to be ultra-conservative in their claims as far as television is concerned. They want the "first impression" of this new art to be a good one, and that is why they are reluctant to sell a receiver to anyone who may not be able to get satisfactory results. Neither do they expect many of their customers will be willing to buy outboard amplifiers or erect hundred-foot towers; so their claims as to satisfactory reception distances are quite conservative.

At the same time, any amateur who has spent much time on the high frequency bands knows that receiving conditions here—both on a point-to-point and a time-to-time basis—are extremely unpredictable. To help things along, the portion of the sunspot cycle through which we are passing makes the highly-variable conditions on these frequencies even more spotty than usual.

At any rate, it seems that Nature is trying to make a liar out of conservative theory, and the serviceman is left strictly in the middle.

What can he do about it? Well, in the first place, he can see to it that he quotes an authority when he is asked for advice. Various magazine articles have appeared on TV and FM reception distances, and he should refer the customer to one of these. If he has such magazines on file, well and good; if not, a little time spent with the *Reader's Guide* at the local library will give him a wealth of material to which to refer.

In the second place, he should obtain some first-hand information on the subject. A good beginning would be to visit the various TV installations in his vicinity and see the receivers in action. Careful notes should be made as to the make of receiver used, the type and height of the antenna, whether or not a pre-amplifier is employed, etc. An effort should be made to obtain an unbiased report on the reliability of reception.

Both the location of the receiving station and the terrain surrounding it should be taken into consideration. If instruments are available, a measurement should be made of the actual voltage delivered by the antenna system.

When all of this information has been gathered and evaluated, it should be used to set up a TV receiving station by the serviceman himself. He can, if he wishes, buy a commercial receiver; or he can build a set of his own, possibly employing one of the "kits" on the market. Each method has advantages: the commercial receiver will probably have a higher resale value when the serviceman is through experimenting with it; but this is more than offset by the experience gained from constructing a set; moreover, the prestige of having it known that he built his own TV receiver will not hurt his reputation with his customers—if it works, of course!

Working with this receiver, experimenting with antennas, trying out various pre-amplifiers, the serviceman will soon build up a wealth of concrete and practical experience about what can be expected in the way of reception in his own community; and then when his advice is sought, he can speak with confidence and authority. He will have established a standard of what constitutes "normal" reception in his area, and he will be thoroughly prepared to tackle the problems of servicing FM and TV equipment. ✓ ✓ ✓

Custom Building

→ From page 14

is valuable for a set to reproduce as much of the scale as possible, there is a far more important factor.

Under perfect conditions, music should be played at the same level at which it was recorded. In actual practice, however, a compromise must be made between the musical enjoyment of the listener and the right of his neighbor to a little peace and quiet. The set should be adjusted to the room in which it will be played. Besides the afore mentioned volume balance, there is the consideration of the size and dimensions of the room and the type of furniture and draperies in it. Adjustment is necessary in the actual room so that the acoustic qualities don't swallow up highs or muffle bass. ✓ ✓ ✓



Servicemen's choice!
in...



● Since 1915, people in Indiana have come to know that every crop of Cunninghams is a fine crop. That's because Cunningham tubes are built to exacting standards for long service life and top performance. You can cultivate a larger crop of customers by using high-quality Cunninghams when renewal tubes are called for.

See your
CUNNINGHAM DISTRIBUTOR

F. J. MEUNIER CO.,
Indianapolis



EVERYTHING IN RADIO AND ELECTRONICS IN ONE BOOK!

THE RADIO DATA BOOK

the only radio handbook of its kind . . . 1148 pages . . . 12 sections, each covering a radio subject more completely than any other book!

Used by Engineers, Servicemen, Designers, Laboratory Technicians, Draftsmen, Operators, Inspectors, Amateurs, Experimenters, Research Development, Consultants, Broadcast Technicians, Planners, Installation Men, Military, Marine, Police, Fire, Forestry and Railroad Communications. ANYONE and everyone in radio and electronics can use this book!

Plan every operation in radio and electronics with the Radio Data Book. This new radio bible will be your lifelong tool . . . you will use it every day, on the board, at the bench, in the field! Use it for engineering, construction, troubleshooting and testing. The RADIO DATA BOOK will be your invaluable aid in design, experiment and in layout. It will help make your production better, faster and easier. In any and every operation in radio and electronics, you will use the RADIO DATA BOOK!

SECTION 1. 150 BASIC CIRCUITS

For the first time all the basic circuits used in radio and electronics are compiled in one book. Everyone working at or using radio or electronics needs these circuits for reference and increased knowledge. Designers need no longer wade through scores of books to find the right circuit—they're all here! Servicemen uncertain as to type or function of any stage in a radio set can find it easily and quickly in this section. Each circuit shown in a clear-cut diagram. Each circuit described completely as to construction, function and operation. Each circuit properly classified and clearly labeled for instant reference! Every basic operating unit in the entire field of electronics for the convenience of everyone in radio—150 circuits—completely illustrated—ALL in this one section!

SECTION 2. TEST EQUIPMENT

Instruments for testing are the eyes and ears of anyone concerned with electronics. Complete knowledge of these instruments is essential for efficient operation—and this section contains the knowledge needed. Here you become acquainted with the designs and functions of all test equipment. All types of volt, current and ohmmeters, tube checkers, condenser meters, inductance meters, bridge measuring devices, RF signal generators, AF signal generators, signal tracers, distortion analyzers, test speakers, oscilloscopes, square-wave generators, frequency meters, field strength and tuning meters are explained and illustrated. From this section anyone working in electronics can determine the proper equipment for any particular job. Completely illustrated—all text in easy to read and understand style.

SECTION 3. TESTING AND MEASURING

How to use test equipment and make every kind of measurement in radio. Everyone working at or using radio or electronics must make some type of test or measurement at some time or other. In this section you will find complete, illustrated instructions on all types of measuring operations—Direct Current; D.C. Voltage; D.C. Power; A.C. Voltage . . . using AF, IF and RF Voltmeters; A.C. Power . . . IF, AF, and RF; Alternating Current . . . AF, IF and RF current; Frequency measurements . . . oscilloscopes as frequency meters; Resistance; Inductance and Inductive Reactance . . . bridge measuring . . . RF; Capacitance and Capacitive Reactance . . . bridge measuring . . . RF; Q Measurements; Resonant Frequency; Audio Equipment . . . output . . . gain . . . phase shift . . . distortion; Transmitting Equipment . . . carrier frequency . . . output power . . . plate efficiency . . . noise or hum; Antenna . . . impedance, power directivity and gain, and Transmission line measurements; Receiving Equipment; Signal Tracing; Aligning AM & FM Superhets, and Television Rec. step by step, every detail covered;—all included in this thorough coverage, plus many others. This section alone is worth the price of the entire book!

SECTION 4. ANTENNAS

This section presents complete information on all antennas, transmitting and receiving. Completely illustrated, showing various types of antennas, their construction and wave patterns. The

twenty or so different types of television antennas now on the market are illustrated and discussed. Loading, impedance, polarization, directivity, etc., are explained and diagrammatically illustrated. The entire function of antennas is explained in detail—from the theory of wave propagation, radiation and reception—through the design of various types of antennas and their selection and installation for various requirements—to the tuning and feeding of antennas. All this information is presented in non-mathematical style for all to understand and for quick reference.

SECTION 5. SOUND SYSTEMS

The planning, selection of equipment and the assembling and combining of various components in complete PA installations. Every type of unit used is described and analyzed in detail. There are tables and charts giving proper power output needed for any given area—rooms, halls, ball parks, etc. There are charts on power outputs of the various units used, and patterns of microphones and speakers. Complete installations are illustrated and described. Complete instructions for wiring and placements of components and controls. And in addition, the proper maintenance of P.A. systems is thoroughly explained.

SECTION 6. RECORDING

This section is the only complete description of disc recording found in any radio manual on the market. Here all phases of recording are covered—both home and commercial. All types of recording equipment are described and complete instructions for making recordings are presented . . . directions of feed . . . grooves per inch . . . depth of cut . . . lateral and vertical engraving . . . amplitude . . . velocity . . . pre emphasis . . . recording standards . . . every detail is covered. Amplifiers, needles, cutting heads, motor drives, discs are all individually discussed in detail. Completely illustrated with line drawings, diagrams, charts, etc.

SECTION 7. TUBE MANUAL

The only uncommercial tube manual giving complete listing of all transmitting and receiving tubes with each tube base illustrated alongside the description. No thumbing through pages to find the base after reading the data—no skipping from one manual to another for different tube types. They're all here—easy to find—a quick—invaluable reference!

SECTIONS 8 & 9. CHARTS, FORMULAS, CODES, GRAPHS, SYMBOLS

Here in these two sections are found all data and information useful to anyone in radio and electronics. For the first time in radio history this information has been presented in its entirety. All the nomographs. All the numerical tables needed for formulas. All the conversion factors. All the color codes, resistor condenser speaker, transformer, plug, battery codes! Yes—All the factual data for everyone in electronics plus complete descriptions as to function and use of all

Eighteen months were spent digesting this material into the most concise, the clearest, and the most readable form. The result is this invaluable manual . . . The RADIO DATA BOOK. Whether you use this book for general reference, for scientific instruction, or for education, one thing is certain—the practical help, the daily usefulness you will derive from it will prove to be worth many, many times its astonishingly low price. Get your copy today!

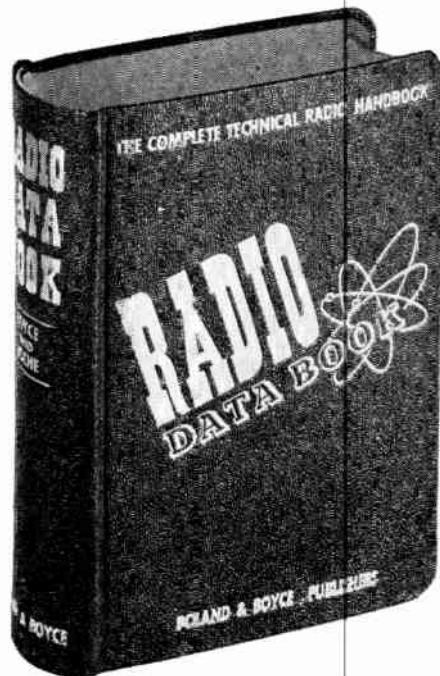

charts! The only other book containing like information has only 1/3 of all the data presented here! An invaluable reference, a gold mine of time-saving short cuts!

SECTION 10. 50 TESTED CIRCUITS

98% of all equipment built in radio & electronics is covered here in a section presenting the typical circuit with parts list and descriptions of each type. Here you will find receivers from the smallest to the largest—Crystal, Crystal Detector with Amplifier, One tube regenerative, A.C. One tube regenerative, two tube TRF, AC-DC Superhet, four tube TRF, AC-DC TRF, AC operated Short wave regenerative, Battery operated short wave regenerative, Short wave regenerative with plug-in coils, A.C. operated superhet, Battery operated portable, Three-way portable, automobile, and superregenerative VHF. An FM Tuner, regenerative preselector. Ten meter converter, short-wave converter and a 17-tube television receiver. A one-tube practice and a two tube code practice oscillator. Amplifiers: AC-DC, Microphone and phonograph, high-powered A.F. class B for mobile use, 14 watt AF. Push-pull Class C. RF, push-pull pentode, Class C power and a Class B linear RF amplifier. Also a wireless record player, 14 watt AF amplifier, low power modulator, intercom set and many other complete operating circuits. This is by far the most useful collections of circuits ever presented.

SECTION 11: DICTIONARY OF ELECTRONIC TERMS

This dictionary will explain every radio term—any word used in radio. It is so complete and so clear in its explanations that the student and professional alike can read and understand the RADIO DATA BOOK by referring to this dictionary.

SECTION 12. BIBLIOGRAPHY

Here is a unique and valuable list of books for anyone desiring further details on any subject in Radio. Here books of the highest rating are listed and a description of their contents is included. You can instantly determine which is the book you want.

COMING SOON!

THE VIDEO HANDBOOK

Everything in Television in one Book! 768 pages completely illustrated.

This new handbook will be invaluable to everyone concerned with the technical aspect of Television. Everything from the basic theory of television through the design and characteristics of receivers to final installation, operation, and maintenance is covered. This is a completely new book that includes all of the latest developments in the field—the components discussed are of the newest design—the practical maintenance described is a result of intensive study of the equipment placed in operation during the past few months.

The VIDEO HANDBOOK will be out in December, but we have received a flood of orders already. To insure your getting a copy in the first printing—mail your order now. \$5.00 in U.S.A.

12 complete books in one only \$5.00!
Less than 42c per book!

MAIL THIS COUPON TO YOUR JOBBER TODAY, OR DIRECT TO:
BOLAND & BOYCE INC., PUBLISHERS
460 BLOOMFIELD AVE., MONTCLAIR, N. J.

Enclosed is full amount.

Enclosed is \$1.00. I will pay postman balance on delivery (in U.S.A. only).

Please send me the RADIO DATA BOOK at \$5.00. (\$5.50 foreign). RM-8

Send me the VIDEO HANDBOOK at \$5.00. (\$5.50 foreign).

NAME

ADDRESS

CITYZONE

STATE

BOLAND & BOYCE INC., PUBLISHERS

Checking TV

→ From page 21

oscillator. See Figure 4.

All modern, popularly priced sets, and nearly all higher priced projection jobs use either the kickback type of power supply for high voltage, or some form of rf supply. As a final word of caution, however, the serviceman should be particularly watchful when servicing older sets using rectified 60 cycle current for the high voltage supply. Low frequency currents are much more dangerous than high frequency currents and can prove fatal.

High frequency currents derived from an rf oscillator are less dangerous because the loading effect of bodily contact will detune the circuit and decrease the voltage. A point to remember, however, is that any high voltage is dangerous, depending on your physical condition. Even low voltage can be highly dangerous to someone with a weak heart. ✓ ✓ ✓

Advertising

→ From page 22

ified—or your money back!" "A battery of trained radio men to insure complete radio service."

Anything of this type will do. A short catch-phrase incorporating your name or the name of your shop will do wonders. Feature the slogan in each of your ads, on your business stationery, and on the front of your shop. It will pay. People remember slogans.

But newspaper advertising is just one medium. Don't forget radio. Radio advertising has been coming to the front in the past few years, and it is particularly adaptable to radio service shops.

How's this for a spot announcement on the radio?: "Are you hearing this message sharply and clearly? (pause) You should. All modern radios are built to give top performance at all times. However, all finely-built machines develop flaws once in a while. And when they do—when your radio fails to give you top performance—bring it to the Jones radio repair center—where trained radio experts work on your fine precision instrument. Remember—a radio is a mechanical work

of art—it takes trained men to care for it. The next time your radio fails—bring it to the Jones radio repair center."

The above 100 words will cost you very little over your radio station. And they will produce results. Try it. And experiment with the copy. There are many angles that can be used to make the patter bright, ear-catching, and compelling.

Many radio service shops are reporting better than average results from the use of direct mail campaigns.

A clean, up to date mailing list, when it is coupled with hard-hitting direct mail copy, is one of the most potent advertising mediums that can be found anywhere. It's inexpensive, informal, exclusive—and it gets right into the home of the potential customer.

Although a direct mail campaign is suited to almost every type of business, it is particularly adaptable to the radio repair field. Practically everyone has a radio these days, and some of these radios are getting plenty old and in need of repair after seven years of war.

A good mailing list should be divided into two parts: the names of your present customers and the names of potential customers. It is better to vary the copy on the direct mail pieces for the two groups.

Of course, the actual mail copy is important, but it is not the most important. A good, clean, carefully-selected *mailing list* is of primary importance in the success of any direct mail campaign.

However, the task of compiling a mailing list is not a difficult one. It just takes a little extra thought and effort. The place to start in compiling a list is right at home, with your customers. Make your list of customers form the nucleus for the list. Then, get hold of your local telephone and city directories. They are a continual source of names.

And the newspapers will furnish you daily with all the names you will ever need for a top-flight mailing list. If your state or city keeps a record of personal property, and that means radios, try to get hold of the names on the list. Also, if there is a city record on new radio sales, get that list, too.

The newspapers will be your best source for names. Clip the mar-

→ To page 38

use... OHMITE Replacements

BROWN DEVIL RESISTORS... Wire-wound, vitreous-enameled type. Now in compact 5-watt size. Also 10 and 20-watt units.



LITTLE DEVIL RESISTORS... Now 1/2 and 1-watt sizes in ±5% tolerances. Also 1/2, 1, and 2-watt sizes in ±10% tolerances.

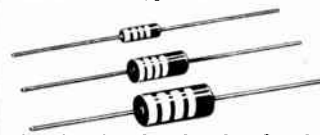

TYPE AB POTENTIOMETER... A new extremely high quality molded composition unit—rated 2 watts with a good margin of safety.

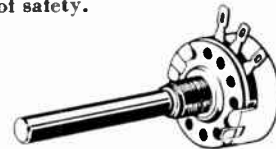

DIVIDOHM ADJUSTABLE RESISTORS... Wire-wound vitreous-enameled type—10 to 200 watts. Sturdy... dependable.

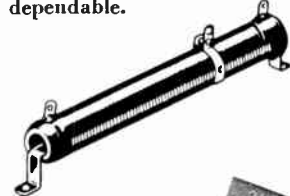

See Your Nearest
Ohmite
Distributor

Send for
Catalog 19



OHMITE MANUFACTURING CO.
4913 Flournoy St., Chicago



Be Right with...

OHMITE

RHEOSTATS • RESISTORS
TAP SWITCHES

30,000

SUCCESSFUL

RADIO

SERVICE-TECHNICIANS

READ

RADIO

MAINTENANCE

EVERY MONTH!

RADIO MAINTENANCE today fills a breach that has existed in the radio field for a long time. Already 30,000 technicians read **RADIO MAINTENANCE** every month because it is devoted entirely to the radio servicemen.

The **RADIO MAINTENANCE** staff specializes in the preparation of articles on every phase of Radio Maintenance in series form which may be filed and used for reference. The leading articles cover everything for the radio servicemen on Television, FM and AM; Test Equipment; Electronic Appliances; Tools; Antennas; Alignment; Troubleshooting; Repair; Construction; Pick-Ups and Sound Amplification and Reproduction Equipment. Also, in **RADIO MAINTENANCE** each month there are departments on hints and kinks, the latest news of the trade, review of trade literature, radiomen's opinions, new products and news from the organizations. All articles are presented in a step-by-step precision style, clearly illustrated with schematics, accurate photographs, specially prepared drawings, white on black charts, color diagrams, isometric projection and exploded views.

Binders in beautiful green simulated leather are now available for your **RADIO MAINTENANCE** magazine.

RADIO MAINTENANCE is not sold on newsstands.

RADIO MAINTENANCE MAGAZINE RM-8
460 Bloomfield Avenue,
Montclair, N. J.

Please send me
RADIO MAINTENANCE for
() 2 years, \$5
() Payment enclosed
() 1 year, \$3
() Bill me later

Name

Address

City—State

Occupation*

Title

Employed by

* Independent Serviceman—Dealer
Serviceman — Service Manager — Dealer —
Distributor — Jabber.

Advertising

→ From page 37

riages, new residents in the community, births, and so on.

Send each newly-married couple in your trade area a card of congratulations. It's a sure bet that they either own a radio or will soon. And where there is a radio, there will always be a need for repair.

Try to bring out in your advertising the idea that radios should be inspected and checked at least twice a year. Remember the old dental saying—see your dentist twice a year? Why not make that the theme of your entire advertising campaign? Have your radio checked at least twice a year. Emphasize the preventive part of radio repair. Stress the fact that it is much more economical to catch the defects in a radio before they happen than after. It would be rather effective to outline your advertising campaign around the idea of a radio clinic. Some rather clever ads can be worked around that idea. It would be eye-catching to use a smattering of medical terms in the ads to attract attention.

One radio service establishment in the west has conducted a rather unique mailing campaign right in its own neighborhood. The operators have prepared a mailing list of all persons living within a one-mile radius of the shop. The direct mail literature plugs the fact that the shop is within "easy walking" distance. The owners of the shop report better than average results.

There is practically no limit to what can be accomplished with a good mailing campaign. But remember, the list is the thing. You can have the best copy in the world, but

if it doesn't get to the right people, it won't produce results.

And when you think of advertising don't forget the rural weekly newspapers in your trade areas. Times have changed in the past 25 years. Today, the farmers and the small town residents are only a few motoring minutes from the large trade centers. So, why not allot a part of your advertising budget to the weekly newspapers in small rural communities withing a 50-mile radius of your service shop. The rates are low and the reader interest in the rural papers is high.

The classified pages also promise a cheap method of advertising. For a few pennies a word it is possible to get your sales message across to thousands of potential customers.

And, amazing as it might seem, the daily and weekly newspapers give away a large amount of advertising for nothing. This advertising is called publicity. In other words, let your local newspapers know that you are in business. When you receive a new type of modern radio repair equipment that is unique, call your local newspapers and tell them about it. It is very possible that they'll make a news story out of the information. The fact remains that everyone is interested in radio these days. And any little piece of odd information regarding radio is of news value.

By combining all aspects of sales promotion: personal contact, newspaper advertising, direct mail advertising and publicity, you can gain a jump on competitors in your area, and have a firm place in the community when the lush era is over, and business becomes something you have to fight for. ✓ ✓ ✓

RECONE — FOR FINER TONE

Send your speakers to A. G. for the original 48 hour
WALDOM RECONING SERVICE

- Parts in stock for *any* speaker
- Audio test at full power rating
- Reasonable prices
- Guaranteed workmanship

Write for price schedule—see how you can profit
by tying-in with this new, fast reconing service.

A. G. RADIO PARTS CO.

3515 N. 17th St.

Philadelphia 40, Pa.

FM Antennas

→ From page 19

in a few miles may be receivable with a loop or inside antenna, the listener will often wish to receive more distant stations in addition to the locals.

It is difficult to obtain an antenna with reasonably equal response over the wide range represented by the FM band (88-108 MC). Practical antenna design represents a compromise. The response of the antenna is made as broad as possible; then the resonant frequency is chosen so as to favor the weakest stations if length adjustment on the spot is possible. In commercial designs, resonance is usually chosen at the geometric mean between the high and low edges of the range, which turns out to be 98 MC.

Fig. 2 shows the design of a simple dipole and a folded dipole for this mean frequency. The simple dipole has a sharp frequency response and will show serious loss of signal at the edges of the band. The folded dipole has a broader frequency response, and is quite satisfactory in most locations of medium signal strength.

The simple dipole is matched by a coaxial cable feed line and the folded dipole by a 300 ohm twin lead at their resonant frequency. However, as shown in Fig. 4, the simple dipole's impedance varies tremendously over the FM band and any line matching would only apply in a small range of frequencies near resonance. The variation from resonant impedance of the folded dipole is much more gradual. There is therefore less additional loss in this type due to mismatch at the extreme frequencies of the range. Fig. 4 is based on the use of an average size rod or tubing in the construction of the antenna; the spacing of the elements of the folded dipole is also assumed aver-

send for FREE
folder on the new

**RADIO HAND
AND
DATA BOOK**

**BOLAND & BOYCE, INC.
MONTCLAIR, N. J.**

The ONLY POWER SUPPLY

that gives these ratings*
without overheating

Electro
ELECTRICAL AND RADIO EQUIPMENT

MODEL "A"

* 6V at 15 amps. in parallel
* 12V at 7 1/2 amps. in series
* 6V at 7 1/2 amps. separately
115 volts 60 cycles input



Operates auto radios with solenoid tuning and tone controls — also 12 volt marine and aircraft radios.

Height: 7 3/4" Length: 11 3/4"
Width: 7 3/4" Ship. wt. 31 lbs.

DC OUTPUT

Oversize transformers, chokes and rectifiers insure against overheating. Large capacity condensers for wide-range voltage regulation. Instantaneous power for solenoid operation. Two separately filtered DC output sources.

Compact. Sturdy. 18-gauge steel construction. Handsome blue Hammerloid finish. Comes completely equipped including 6' rubber cord and plug. Vastly superior and costs no more than batteries for equal service.

Send for complete description of this up-to-the-minute power supply.

ELECTRO PRODUCTS LABORATORIES

Pioneer Manufacturers of Battery Eliminators

549 West Randolph Street

Chicago 6, Illinois

age. At best, only a relative indication of the impedance variation of each can be given because the resonance curve depends a good deal on the cross sectional area of the elements. In general, antennas of large cross sectional area have the broadest frequency response and the least impedance variation.

Choice Of The Line

Matching the feed line to the antenna is desirable, but in receiving it is not as important as matching the line to the receiver's input circuit. In choosing the line, therefore, first match its characteristic impedance to the value called for by the design of the receiver. This is ordinarily specified on the receiver itself or in the manufacturer's service manual, which will also often make valuable suggestions about recommended antenna systems.

FM receivers generally have the standard input impedance value of 300 ohms. 300 ohm ribbon line as shown in Fig. 5 is therefore suitable. This line matches a folded dipole antenna properly. With a simple dipole, some sort of matching arrangement is desirable. If ribbon line is

not available, 300 ohm open wire line may be made up from antenna wire and suitable spreaders as shown in Fig. 6. This open wire line has very low losses if the spreaders are made of polystyrene or other types of low loss material and the spacing of the wires is kept reasonably constant. Lengths of this kind of line up to 1000 feet will not show serious attenuation.

Antenna Arrays

Antenna arrays have two main objectives: gain and directivity. The gain of an antenna is the ratio of power (or, sometimes, voltage) presented to the feed line compared to that presented by a simple dipole in the same location under the same conditions. The gain is ordinarily a power ratio, expressed as db. For instance, an antenna which feeds

→ To next page

TUBULAR ELECTROLYTICS

Fresh stock Fully guaranteed

20 mfd. 150 V. 10 for \$1.79
20-20 mfd. 150 V. 10 for 2.49
8 mfd. 450 V. 10 for 1.85

Postage extra, 25% deposit on C.O.D.
Write for our free bargain lists featuring
"AMERICA'S BEST BUYS"

POTTER RADIO CO.

1314-M McGee Street Kansas City 6, Mo.

twice as much power to a receiver as a simple dipole is said to have a gain of 3 db.

The directivity of an antenna is closely related to the gain. Ordinarily an array has a gain because it reduces the pickup sensitivity in some undesired directions in order to concentrate it in the desired directions. Some arrays concentrate the pickup in the vertical plane, some in the horizontal plane and still others in both.

The simplest type of array is the dipole and reflector combination shown in Fig. 7. The reflector is an extra element, longer than the dipole and placed in back of the dipole with respect to the direction of best signal reception. Fig. 8 shows the pattern of a simple dipole compared to the pattern when a reflector is added. Notice how the sensitivity is increased in one direction (from the reflector through the dipole) and decreased in others (sides and back). The dipole may be either the simple type or the folded dipole shown in the array of Fig. 7. A variation of this type of array uses an extra element in *front* (same direction as the received station) of the dipole. In

this case the extra element is called a "director." Some arrays have both directors and reflectors.

These extra elements are not connected to the feed line and are referred to as *parasitic elements* and the array which uses them is called a *parasitic array*.

Parasitic arrays give a good amount of gain and are simple and easy to feed. They have, however, two important limitations.

1. The parasitic elements couple to the dipole element (this produces the gain) and add more load across the resistance of the dipole. The impedance of a parasitic array (at the feed point) is therefore much lower than the impedance of the dipole element alone. Accordingly, the same type of line which matches the dipole by itself is not suitable when the dipole becomes part of a parasitic array. One ingenious method for overcoming this difficulty involves the use of a folded dipole. When the parasitic element or elements are added, the original 300 ohms has dropped to about 70 to 100 ohms which can be matched by a coaxial line.

2. The frequency response of a parasitic array is sharpened by the

fact that the parasitic elements have resonance curves which add to the selectivity curve of the dipole element. Because the sharpness of the response curve gets worse as parasitic elements are added, practical FM antennas seldom use more than one of these elements (Fig. 7).

Special Antennas

Certain special types of antennas for FM concentrate on obtaining a broad band characteristic so that reception can be nearly equally good on all channels of the FM frequency band. Such an antenna is shown in Fig. 9. This antenna adds to the band width by being designed to have a large effective cross sectional area. This is the same factor which makes the folded dipole response broader than that of a simple dipole. The horizontal cross pieces all act as a unit (if closely spaced) and in this case (Fig. 8) are equivalent to a number of folded dipoles in parallel. The total impedance of an antenna is not affected by increasing the cross section in this manner, so this antenna is fed with 300 ohm line, as in the case of the ordinary folded dipole. ✓ ✓ ✓

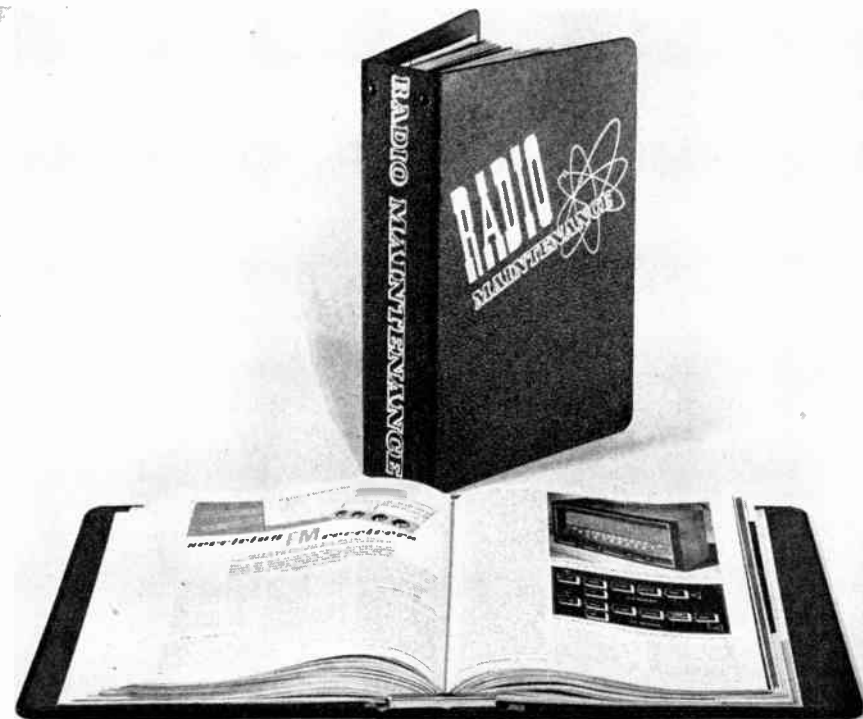

BINDERS

TO PRESERVE YOUR
RADIO MAINTENANCE
MAGAZINES

Keep your back numbers of
RADIO MAINTENANCE in
these handsome green and
gold binders. Each binder will
hold up to 18 copies of the
magazines without puncturing
holes or mutilating them in
any way. They are held se-
curely but are easily removed
if desired. With the index
printed at the end of each
year, your magazines will be
a constant reference for . . .
a valuable service library.
Send for your binders now!

RADIO MAINTENANCE
460 Bloomfield Avenue
Montclair, N. J.

Please send me binders at \$3.00
each. (2 for \$5.00)
Total amount enclosed

Name
Address
City Zone
State

WARD sets the stage

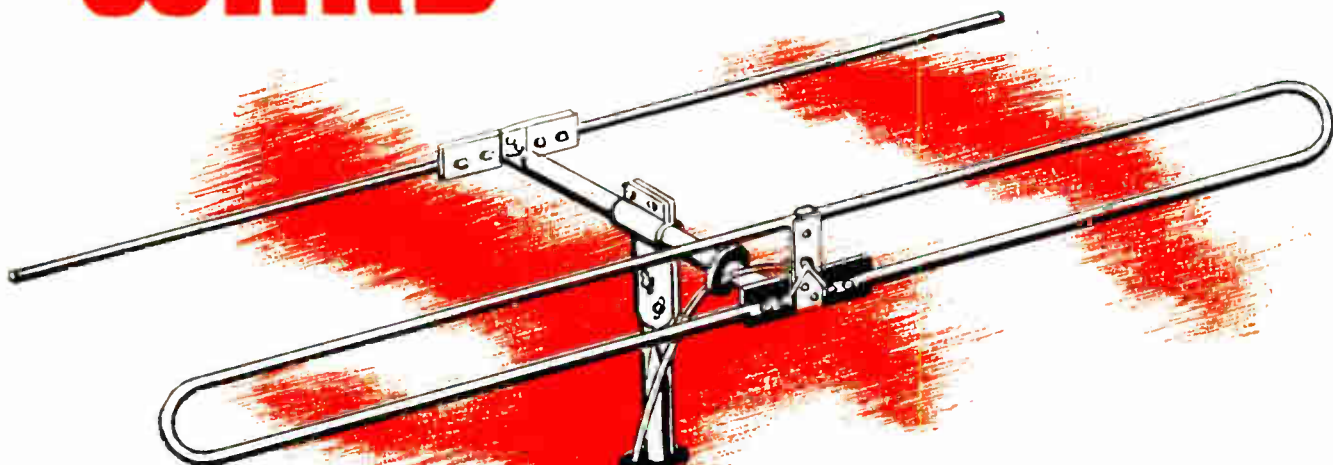

-for a "boom"
in FM and
Television
aerial sales

An intensive consumer advertising campaign in the Saturday Evening Post and leading newspapers is convincing millions of present and prospective FM and Television set owners that:

- (1) *Quality reception is difficult, if not impossible, without a good outside dipole antenna.*
- (2) *Ward "Magic Wand" FM and Television Aerials offer the finest FM and Television reception at modest cost.*

Alert radio dealers are finding this campaign exceedingly helpful in creating extra sales and profitable installation jobs. In addition these dealers are winning satisfied customers who can now enjoy the true beauty of FM or television reception.

Available in straight or folded dipoles for both FM and television bands (reflector kits available), Ward "Magic Wand" Aerials are products of the world's largest makers of aerials for car and home.

Listing at only \$9.00 to \$12.00 (reflector kit \$5.25) they are priced to encourage volume sales and an adequate profit margin.

Phone or see your nearest Ward distributor today for full details on how to capitalize on this hard-hitting consumer advertising for Ward "Magic Wand" FM and Television Aerials; or write direct to:

THE WARD PRODUCTS CORPORATION

1529 E. 45th St.

DIVISION OF THE GABRIEL COMPANY

EXPORT DEPT., C. W. Brandes, Mgr., 4900 Euclid Ave., Cleveland 3, Ohio.
IN CANADA Atlas Radio Corp., 560 King St., W., Toronto, Ont., Canada.



WORLD'S
LARGEST MAKER
OF AERIALS
FOR CAR AND HOME

WARD
Magic Wand
FM AND
TELEVISION
AERIALS

FM-TELEVISION AERIAL OPPORTUNITY!

WARD PRODUCTS CORP.
1529 E. 45th St., Cleveland 3, Ohio

Please advise how I can profit from your national advertising for "Magic Wand" FM and Television Aerials.

NAME _____
COMPANY NAME _____
ADDRESS _____
STATE _____ CITY AND ZONE _____
MY JOBBER IS _____

IT'S HERE! WEBSTER-CHICAGO AUTOMATIC MICROGROOVE RECORD CHANGER

**"MICROGROOVE" IS HEADLINE NEWS—
MODEL 133 IS "CASH REGISTER" NEWS!**

Model 133 • the famous Webster-Chicago *foolproof* record-changer mechanism • New balanced tone arm and nylon knee action needle • magnificent reproduction from microgroove records • 33 RPM turntable speed — plays 10 twelve inch or 12 ten inch microgroove records *automatically* at one loading • 4 hours of continuous record play with fast change cycle.

THE *Matinee*

First of the Webster-Chicago line of automatic record changers for microgroove recordings • Phone your Webster-Chicago distributor for details. Don't delay! Be ready for the microgroove records. **\$38⁷⁵** Retail
\$39.95 West of the Rockies

WEBSTER - CHICAGO

5610 West Bloomingdale Ave.
Chicago 39, Ill.



TUBES ARE KNOWN BY

THE COMPANY THEY KEEP

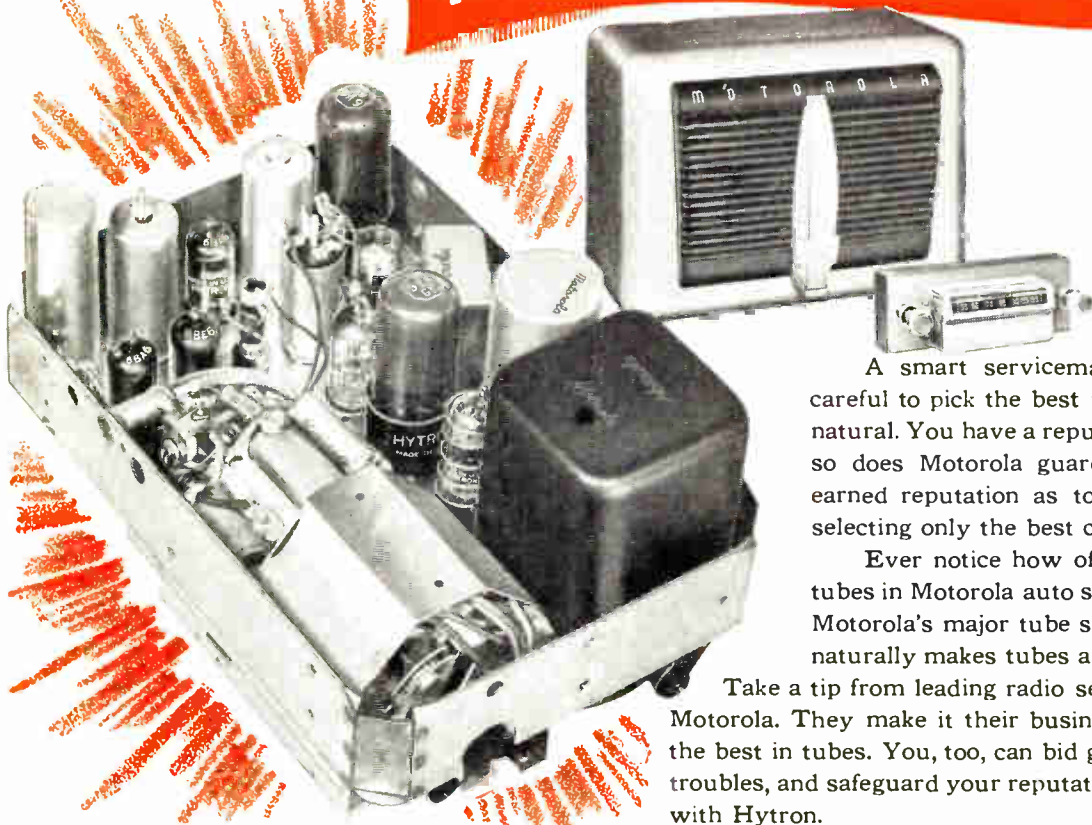

A smart serviceman, you are mighty careful to pick the best in tubes. That's only natural. You have a reputation to protect. Just so does Motorola guard jealously its well-earned reputation as tops in auto radio by selecting only the best components.

Ever notice how often you find Hytron tubes in Motorola auto sets? To rate as one of Motorola's major tube suppliers, Hytron just naturally makes tubes a lot better than good.

Take a tip from leading radio set manufacturers like Motorola. They make it their business to know and use the best in tubes. You, too, can bid goodbye to your tube troubles, and safeguard your reputation by "going steady" with Hytron.

SERVICEMEN—Win These Monthly Prizes!



FIRST PRIZE, JULY
Hickok 156A Indicating Traceometer.

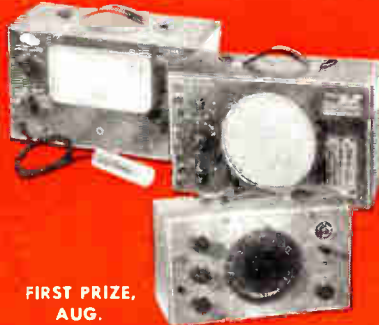

FIRST PRIZE, AUG.
McMurdo Silver 900A "Vomax," 904 C/R Tester, and 905A "Sparx."



FIRST PRIZE, SEPT.
Jackson 641 Universal Signal Generator.



FIRST PRIZE, OCT.
Weston 769 H-F Electronic Analyzer.



Want one of these deluxe first prizes? Perhaps a \$200 U. S. Savings Bond grand prize? Or one of four \$50 and four \$25 U. S. Savings Bond second and third prizes? Try your hand at any or all of Hytron's monthly contests exclusively for radio servicemen. It's easy. Here's how. Get entry blank

with complete details from your Hytron jobber, or write us. Describe your proposal for a simple, economical shop tool like the Hytron Tube Tapper or Miniature Pin Straighteners. Mail entry to Hytron Contest Editor. Then hold your breath. The finger of the judges may point at you.

SPECIALISTS IN RADIO RECEIVING TUBES SINCE 1921



HYTRON
RADIO AND ELECTRONICS CORP.

MAIN OFFICE: SALEM, MASSACHUSETTS

NEW 9-PIN
Miniature Pin Straightener



Only 49¢ at Hytron jobbers

Signal Generator

→ From page 17

the correct dial setting on the receiver. Any number of sum and difference frequencies may be produced by heterodyning the oscillators to produce any desired output frequency.

Visual alignment of broad-band IF circuits can be greatly simplified, especially if the circuits are considerably out of alignment, by first using an unmodulated signal of the correct IF frequency and roughly peaking the IF trimmers for maximum amplitude at the grid of the first limiter stage in FM receivers or across the diode load in AM receivers. A frequency-modulated signal can then be fed into the input of the IF amplifier and the proper response curves brought into *exact* alignment on the scope.

For receiver alignment, the YGS-3 is connected in the usual manner and all adjustments made for proper indication on a VTVM or output meter, or on a scope. It is recommended that an oscilloscope be employed whenever possible, especially in FM discriminator and IF alignment. In Figure 3 is shown a typical set-up for visual alignment.

Normal curves obtained at the grid of the limiter tube with the signal generator output applied successively to the grids of the last IF stage, the first IF stage, and the converter should resemble those shown in Figures 4A, 4B, and 4C respectively. The discriminator curve (with the YGS-3 connected to the converter grid and the vertical plates of the scope connected to the discriminator output) should resemble Figure 4D.

Miscellaneous Applications

By virtue of such features as a low-impedance RF output and calibrated Audio Attenuator, the YGS-3 is readily adaptable to a number of uses which ordinarily cannot be performed by high-impedance signal generators. For example, it may be used to determine (1) the resonant frequency of tuned circuits, (2) "Q" of inductances, (3) DB gain in amplifiers, and (4) output of phono preamplifiers. In addition, the FM oscillator section, in conjunction with a phone pickup, may be used as a wireless record-player for demonstrating FM receivers.

The relative "Q" or figure of merit of inductances may be determined by connecting the YGS-3 and a VTVM as shown in Figure 5. The RF Output cable is loosely coupled to the inductance under test with a small 1 or 2-turn loop. The VTVM coupling condenser may be very small to minimize capacity loading of the circuit; if desired, the VTVM probe may simply be connected to the insulation of the coil wire and the 3 mmf. coupling condenser eliminated. High "Q" coils will exhibit sharp meter peaks as the YGS-3 is tuned through resonance. Coils having lower "Q" will give broader, less pronounced readings. The parallel resonant frequency of a tuned circuit may be determined by tuning the YGS-3 to obtain a peak reading on the VTVM and reading the frequency on the signal generator dial.

To measure DB gain of an amplifier, connect a suitable output meter across the output of the amplifier, feed an audio signal from the YGS-3 (through a .1 mfd. condenser) into the grid of the last audio stage and adjusting the Audio Attenuator for a pre-determined output level. Then apply the audio signal to the grid of the second stage and reduce the Audio Attenuator setting until the same output level is indicated on the output meter. The difference between the two readings on the Audio Attenuator is the gain in DB of the second stage. Gain of preceding stages may be made in the same manner.

The gain of a phono preamplifier may be checked by feeding a 400-cycle audio signal into the phono input jack and measuring the output with a VTVM. Since the output of a pickup is normally about 10 millivolts, a voltage divider network must be inserted in the output lead of the signal generator in order to drop the calibrated 1-volt output of the YGS-3 to this level. In most cases an ex-



Free illustrated booklet tells the "Inside Story" of an amazing new servicing method. It also contains valuable "hints and kinks" for every radio man. Just send your name, address, and the words—"Inside Story"—on a post card and we will mail your copy at once, without cost or obligation. Do it now before you forget!

FEILER

FEILER ENGINEERING CO.
Dept. 8M8 945 George St.
Chicago 14, Ill.

ternal series resistor of about 330,000 ohms will drop the output level to approximately 10 millivolts. For measurement, the Audio Attenuator is adjusted to just close the AF section of the indicator tube. Under these conditions, a reading of approximately 1.25 volts should be obtained on the VTVM. (For this reading the input resistance of the VTVM should be 2 megohms or higher).

These simple applications are in themselves only a few examples of what can be done with an instrument such as the YGS-3. Many more time-saving applications will suggest themselves to the serviceman as he becomes better acquainted with its features. ✓ ✓ ✓

Industry Presents

→ From page 29

of outstanding usefulness to industrial laboratories and the service shops engaged in the servicing of FM and television equipment. Capacitance measurements from 5 micro-microfarads to 1,000 microfarads may be made with the new instrument which also reads currents from 1 microampere to 10 amperes. ✓ ✓ ✓

send for **FREE**
folder on the **new**
RADIO & ELECTRONIC
HANDBOOK

●
BOLAND & BOYCE, INC.
MONTCLAIR, N. J.

... A **NATURAL** Combination for SERVICING by SIGNAL SUBSTITUTION

The Modern, DYNAMIC, Speed Approach to radio receiver alignment and adjustment problems.

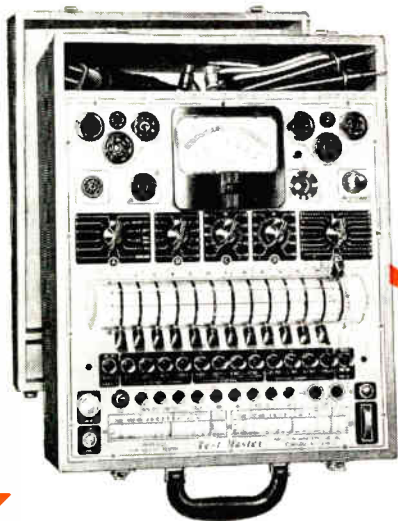

S-S-S

Requires nothing complex to learn
Is Universal—non-obsolete
Does not require costly, extraneous apparatus
Employs only BASIC TEST EQUIPMENT—as is absolutely necessary for the conduct of up-to-date radio service technique.

PLUS



Net Price
\$134.40

Net Price
\$67.25

A Reliable Tube Tester . . . A High Sensitivity Circuit Tester such as the NEW Precision Series 10-54 Electronamic Test Master*

Combination Master Electronamic Tube Performance Tester, Battery Tester and 35 Range, Push-Button Operated, Supersensitive Set Tester.

TUBE TESTING HIGHLIGHTS

- ★ Features the Precision "Electronamic" circuit—the all-inclusive, single-operation, positive, vacuum-tube Performance Test.
- ★ 12 Element Central Lever Selector System affords highest practical order of obsolescence insurance.
- ★ Absolute Free-Point element short-check and performance test selection regardless of varying or multiple pin and cap terminations.
- ★ Employs standard tube basing numbering system on all element selectors, permitting most simplified operation and comprehension of test results.

CIRCUIT AND BATTERY TESTING HIGHLIGHTS

- ★ 35 A.C. and D.C. ranges to 6000 volts, 60 microamperes, 12 amperes, 70 DB, 60 megohms.
- ★ 20,000 ohms per volt D.C., 1,000 ohms per volt A.C.
- ★ High speed, positive, double-wiping contact, push-button selection of ranges.
- ★ All standard ranges at Only Two polarized tip jacks.
- ★ Tests all standard radio A, B and C batteries under dynamic load conditions, simulating actual performance.

NEW 9th edition of "Servicing by Signal Substitution" NOW OFF THE PRESS!

Furnished FREE with the Series E-200-C Signal Generator. Also available from Precision distributors or factory at nominal cost of 40¢ per copy. The signal generator is more than merely an alignment tool. S-S-S tells how—in simple, direct terms.

A Stable, Accurate Source of R.F. Signals such as the NEW Precision Series E-200-C Wide Range Signal Generator

- ★ Direct Reading Frequency coverage 88 KC to 120 MC for A.M., F.M. and T.V. alignment (absolute fundamentals to 30 MC).
- ★ 1% Accuracy on all bands. Precision "Unit-Oscillator" construction.
- ★ 6½" etched aluminum, no-glare dial. Approximately 8 ft. of scale length.
- ★ Built-in, direct reading A.V.C. Substitution network—overcomes A.V.C. incurred tuned circuit resonance shift.
- ★ Specifically designed for Servicing by Signal Substitution.

* Instead of Series 10-54 Combination Tester, similar application is obtainable via use of Series 10-12 or 612 Tube Testers and the Series 858 or 85 high-sensitivity test sets.

SEE the "Precision" Master Electronamic Test Instruments on display at all leading radio parts and equipment distributors, or write for the Precision 1948 catalog fully describing the Precision Electronamic tube performance testing circuits. Watch for additional Precision Test Instruments for specialized television applications. Coming soon . . . High Voltage Test Probe, Sweep Generator and Oscillographs.

PRECISION APPARATUS CO., INC.
92-27 HORACE HARDING BOULEVARD, ELMHURST 8, N. Y.
Export Division: 458 BROADWAY, NEW YORK CITY, U. S. A. • Cables: MORHANEX

Howard W. Sams

presents the amazing
RADIO INDUSTRY

RED BOOK

**REPLACEMENT PARTS
BUYER'S GUIDE**

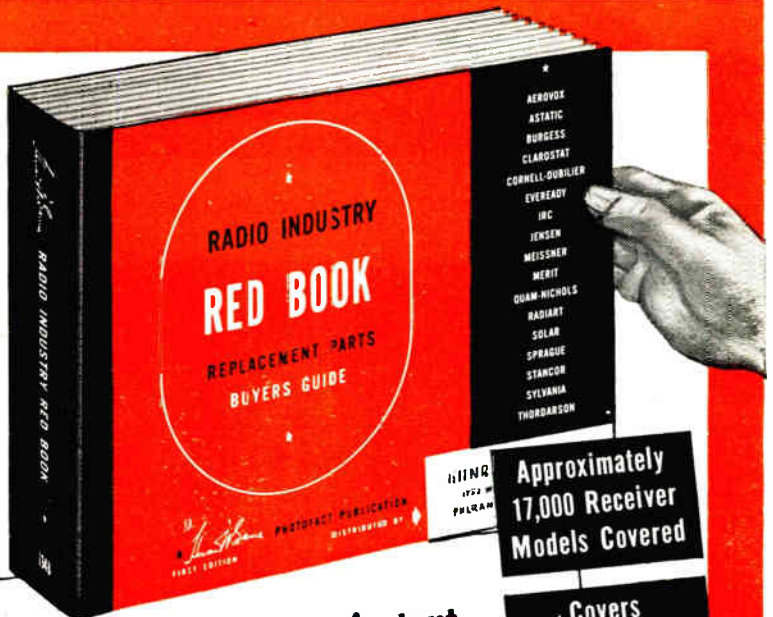

Approximately
**17,000 Receiver
Models Covered**

Covers
Ten Years:
1938 to 1948

Easy to Use:
All Data
Quick to Find

440 Pages
Smythe-bound
Opens Flat

NOW — a SINGLE authoritative volume that gives you instant reliable data on ALL replacement parts for thousands of popular radio receivers . . . more useful data than in all other replacement parts guides and manuals **COMBINED** . . .

COMPLETE!

The First Cooperative Industry Effort in Behalf of the Radio Service Technician

FOR THE FIRST TIME IN RADIO HISTORY!

All 9 Major Replacement Components Listed

(not just 1 or 2 components)

17 Leading Parts Manufacturers Represented

(not just 1 manufacturer)

COMPLETE DATA ON ALL RECEIVER REPLACEMENT PARTS — ALL IN THIS ONE GREAT BOOK!

Save time! Stop wasteful hunting! Get ALL the parts data you need—quickly—from this single book. NOW—for the first time—have all the replacement parts data you need—ALL in one single, authoritative volume. No more waste of valuable time searching through dozens of incomplete manuals and catalogs. The RED BOOK, first and only complete parts guide ever produced, covers approximately 17,000 radio models made from 1938 through 1947—10 full years. Lists parts made by 17 leading manufacturers—not just one! Gives you complete, accurate data on all 9 major replacement components—not just one or two! Clear, concise, easy-to-use—over 440 pages (8½" x 11") bound in a sturdy sewed cover, arranged alphabetically by manufacturer and model number for quick reference. Does away with confused collections of separate books and manuals—gives you complete information—PLUS data that cannot be found in any other source—at a fraction of the price you'd pay for the books it replaces. There's never been anything like it—absolutely indispensable for every service shop!

Only the RED BOOK gives you ALL this invaluable data. Here's everything you need to know about the replacement parts for the receivers you service daily. The RED BOOK gives you original manufacturers' parts numbers, proper replacement parts numbers and valuable installation notes on *Capacitors, Transformers, Controls, IF Coils* (including Peak Frequencies), *Speakers, Vibrators* and *Phono Cartridges*. *Tube and Dial Light* data includes number of tubes in each chassis, with type number for each tube, plus dial light numbers. *Battery* data includes replacement numbers on A, B, and AB packs. The following leading replacement parts manufacturers are represented in the RED BOOK:

- | | |
|------------------|------------|
| AERVOX | ASTATIC |
| BURGESS | CLAROSTAT |
| CORNELL-DUBILIER | IRC |
| EVEREADY | JENSEN |
| MEISSNER | MERIT |
| QUAM-NICHOLS | RADIART |
| SOLAR | SPRAGUE |
| STANCOR | SYLVANIA |
| | THORDARSON |

18 months in preparation—over \$90,000 to produce. The RED BOOK is the product of thousands of man-hours spent in laboratory research and in cooperation with 17 participating manufacturers to produce the most complete, accurate, authoritative parts replacement guide ever published. Every bit of information in this amazing book has been painstakingly checked to insure maximum accuracy and usefulness. Over \$90,000 was spent to prepare the RED BOOK—the only book that brings you everything you need to know—every bit of replacement parts data you want to make your work easier and more profitable. You can't afford to be without the RED BOOK. It's the indispensable guide you'll use profitably every single day. Stop hunting for the right answers now—order your copy today.

THE INDISPENSABLE RED BOOK... ONLY... \$3.95

Mail This Order Form to Your Parts Jobber Today or send directly to HOWARD W. SAMS & CO., INC., 2924 E. Washington St., Indianapolis 7, Ind.

My (check) (money order) for \$..... enclosed.
 Send.....RED BOOK(S) at \$3.95 per copy.
 (I understand that delivery will be made to me in September.)

Name.....
 Address.....
 City.....State.....

BE SURE TO ORDER YOUR RED BOOK TODAY

HOWARD W. SAMS & CO., INC.
INDIANAPOLIS 7, INDIANA

ADVERTISERS

A. G. Radio Parts Co.	38
<i>Agency: Arthur Liebscher</i>	
American Electrical Heater Co.	34
<i>Agency: Dudgeon, Taylor & Bruske, Inc.</i>	
Astatic Corporation	28
<i>Agency: Wearshtler Adv. Co.</i>	
Capitol Radio Engineering Institute	32
<i>Agency: Henry J. Kaufman & Assoc.</i>	
Centralab	24, 25
<i>Agency: Kalu-Van Piefersom-Dunlap Assoc., Inc.</i>	
Clarostat Manufacturing Co., Inc.	30
<i>Agency: Austin C. Lescarboursa & Staff</i>	
Electro Products Laboratories	39
<i>Agency: Merrill Symonds Advertising Agency</i>	
Feiler Engineering Company	45
<i>Agency: Turner Advertising Agency</i>	
General Electric Co.	I, 9
<i>Agency: Maxon, Inc.</i>	
Hytron Radio & Electronics Corporation	44
<i>Agency: Henry A. Loudon, Advertising, Inc.</i>	
Jensen Manufacturing Co.	10
<i>Agency: Burton Browne Advertising</i>	
P. R. Mallory & Co., Inc.	8
<i>Agency: The Aitkin-Kynett Co.</i>	
Ohmite Manufacturing Co.	37
<i>The Fenshelt Company</i>	
Permoflux Corporation	34
<i>Agency: Turner Advertising Agency</i>	
Philco Radio Corporation	3rd Cover
<i>Agency: Hutchins Advertising Co., Inc.</i>	
Potter Radio Company	39
<i>Agency: Potter Radio Company</i>	
Precision Apparatus Company	46
<i>Agency: Shappe-Wilkes, Inc.</i>	
Radio Corporation of America	2nd Cover, 29, 31, 33, 35
<i>Agency: J. Walter Thompson Co.</i>	
Radiart Corporation	4
<i>Agency: Ohio Advertising Agency</i>	
Raytheon Manufacturing Co.	2
<i>Agency: Walter B. Snow & Staff, Inc.</i>	
John F. Rider, Publisher, Inc.	23
<i>Agency: Lansford F. King, Adv.</i>	
Howard W. Sams & Co.	47
<i>Agency: George Brodsky, Advertising</i>	
Sangamo Electrical Co.	11
<i>Agency: Arthur R. Mogge, Inc.</i>	
Sprague Products Co.	27
<i>Agency: The Harry P. Bridge Co.</i>	
Sylvania Electrical Products, Inc.	5
<i>Agency: Newell-Emmett Co.</i>	
Ward Products Corporation	41
<i>Agency: Burton Browne Advertising</i>	
Webster-Chicago Corporation	3, 6, 7, 42, 43
<i>Agency: Fuller, Smith & Ross, Inc.</i>	

BACK NUMBERS

Get Them While They Last

JANUARY 1946

THE PROBLEMS OF ORGANIZATION
TELEVISION RECEIVER INSTALLATION
RADIO MAINTENANCE IN AVIATION
USING THE OSCILLOGRAPH FOR
DISTORTION MEASUREMENTS

APRIL 1946

A MIDGET AUDIO FREQUENCY
OSCILLATOR
IF I WERE A SERVICEMAN
AN EQUALIZED AMPLIFIER FOR
MAGNETIC PICKUPS

MAY 1946

PA SYSTEMS
TEST PANEL FOR THE MODERN BENCH
RINGING THE BELL

JUNE-JULY 1946

FUNDAMENTALS OF TELEVISION
VOLUME CONTROL TAPERS
THE ELECTRONIC OHMMETER
VECTOR ANALYSIS

AUGUST 1946

AVC CIRCUITS
FM TROUBLESHOOTING
TELEVISION RECEIVER FUNDAMENTALS
RECORD CHANGERS

DECEMBER 1946

TELEVISION RECEIVERS ...
THE RF SECTION
TUNING THE INDICATORS
PART II—THE OSCILLOGRAPH ...
HOW TO USE IT
REPLACING AUTO CABLES

JANUARY 1947

SERVICING BY EAR
TELEVISION RECEIVERS ... VIDEO
CHANNEL
PART III—THE OSCILLOGRAPH ...
HOW TO USE IT
MINIATURE TUBE CHART

FEBRUARY 1947

THE OSCILLOGRAPH ... HOW TO USE
IT PART IV
TELEVISION RECEIVERS ... THE SOUND
CHANNEL
THE AUDIO OSCILLATOR
SELENIUM RECTIFIERS

MARCH 1947

ANTENNAS ... FM AND TELEVISION
PART I
SERVICING AUTOMATIC RECORD
CHANGERS
OSCILLATORS AND CONVERTERS
TELEVISION RECEIVERS ... THE VERTICAL
SWEEP

APRIL 1947

ANTENNAS ... FM AND TELEVISION,
PART II
PHASE INVERTER CIRCUITS
A UNIVERSAL SPEAKER
TELEVISION RECEIVERS ...
THE HORIZONTAL SWEEP

MAY 1947

THE OPEN AND CLOSE CASES
VOLTAGE DOUBLERS
SIGNAL TRACER
TELEVISION RECEIVERS ... THE
CATHODE RAY TUBE

JUNE 1947

WHEN THE CUSTOMER ISN'T RIGHT
TEST EQUIPMENT MAINTENANCE
CRYSTAL CONTROLLED SIGNAL
GENERATOR
TELEVISION RECEIVERS ... THE
POWER SUPPLY

JULY 1947

SERVICING FM RECEIVERS
TEST EQUIPMENT MAINTENANCE, PART II
TELEVISION RECEIVERS ...
FLYWHEEL SYNC

AUGUST 1947

SPEAKER MATCHING
TEST EQUIPMENT MAINTENANCE, PART III
SERVICING FM RECEIVERS
TELEVISION ... HF POWER SUPPLIES

RADIO MAINTENANCE MAGAZINE

460 BLOOMFIELD AVE., MONTCLAIR, N. J.

Please send me the back numbers checked here ...
I am enclosing 35c for each copy, or \$2 for any 8 copies, or \$3.25 for all 14.

- | | |
|---|--------------------------------------|
| <input type="checkbox"/> January 1946 | <input type="checkbox"/> May 1947 |
| <input type="checkbox"/> April 1946 | <input type="checkbox"/> June 1947 |
| <input type="checkbox"/> May 1946 | <input type="checkbox"/> July 1947 |
| <input type="checkbox"/> June-July 1946 | <input type="checkbox"/> August 1947 |
| <input type="checkbox"/> August 1946 | <input type="checkbox"/> April 1947 |
- Have selected 8 copies ... enclosing \$2.00 Send me all 14 ... enclosing \$3.25

NAME

ADDRESS

CITY

ZONE STATE

30,000

SERVICE TECHNICIANS

Read
RADIO MAINTENANCE
Every Month
Every day is
RADIO MAINTENANCE
day in your shop!

RADIO MAINTENANCE
460 Bloomfield Ave.,
Montclair 1, N. J.

Please send me RADIO MAINTENANCE for:

- 2 years at \$5.00
 1 year at \$3.00
 Check enclosed
 Bill me later

Name

Occupation

Address

City Zone

State

22 MILLION PHILCO RADIOS!

... Yes, by far, here is your greatest market for
Tubes, Batteries, Parts and Accessory Products!



BATTERIES



TUBES

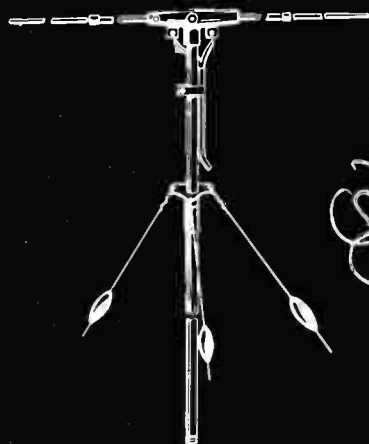
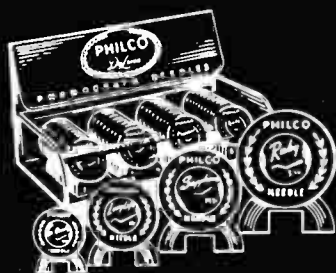

ACCESSORIES



Cash in on America's preference for Philco. Sell genuine Philco accessories and replacement parts. They are preferred by Philco owners... are known and accepted by all radio owners for dependable quality and long life.

The complete Philco line of tubes, batteries, parts and accessories—engineered for all radio makes and models—enables you to concentrate on this ONE PREFERRED BRAND, avoid duplicate stocks and overlapping lines, speed turnover, make more money. Get complete facts from your Philco Distributor.

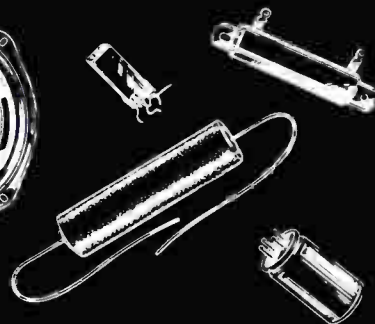
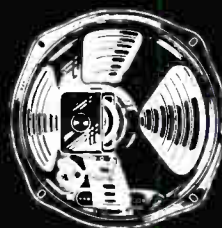

RADIO PARTS

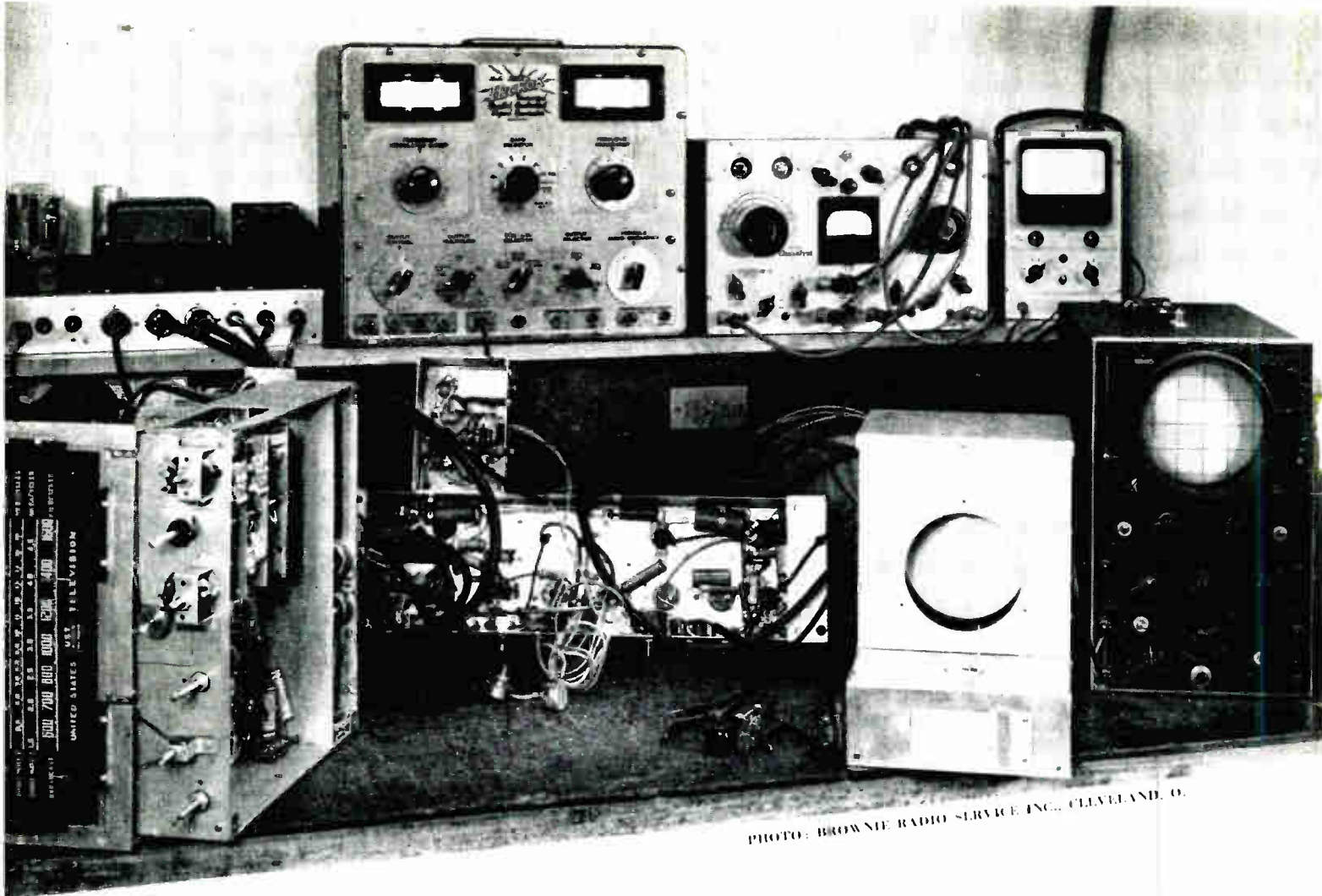

PHOTO: BROWNIE RADIO SERVICE, INC., CLEVELAND, O.

30,000
Successful
Servicemen
use
RADIO
MAINTENANCE
every day

RADIO MAINTENANCE is one of the most valuable items among radio servicing tools. Using the proper tools speeds up work—increases profits. In every issue, **RADIO MAINTENANCE** presents articles and departments full of money-making ideas. Add it to your previous issues and form a complete service library. All your **RADIO MAINTENANCE** magazines are designed to form a reference library in themselves. Binders holding up to 18 copies each are now available for preserving your **RADIO MAINTENANCE** library — don't miss a single issue!

RADIO MAINTENANCE MAGAZINE

460 BLOOMFIELD AVE.

MONTCLAIR 1, N. J.