

MAY 1948

35 CENTS

EVERYTHING IN TELEVISION • RADIO • ELECTRONICS  
FOR THE RADIO SERVICE • TECHNICIAN

# RADIO MAINTENANCE

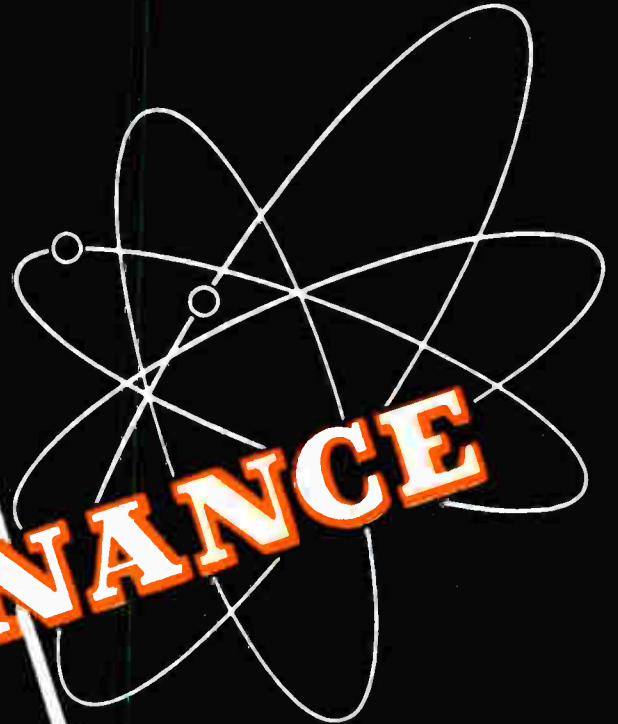

TRUBLESHOOTING  
RECEIVER DISTORTION

INTERFERENCE

A POCKET F.M.  
SIGNAL GENERATOR

A SWEEP GENERATOR  
FOR F.M.  
AND T.V.

YEARLY SUBSCRIPTION \$3.00

BOLAND & BOYCE INC., PUBLISHERS MONTCLAIR, N. J.

*Welcome*

**IN EVERY HOME IN AMERICA**



GENERAL  ELECTRIC  
*Electronic TUBE*  
MADE IN U.S.A.

**GENERAL  ELECTRIC**

FIRST AND GREATEST NAME IN ELECTRONICS

178-GA-8950



# Modern HAS ALL 17 VOLUMES

**"We would never try to operate . . . without a complete set of RIDER MANUALS . . ."**

"We would never try to operate a radio servicing business without a complete set of Rider Manuals, for we service sets of all makes and ages, must have all the data at hand to locate quickly troubles in all receivers. That's why we always order the latest volume as soon as it's published"

*Says* **JACK E. KENNEY**

of Modern Radio and Television Sales and Service, Spokane, Washington

Operators of successful servicing shops know that the shortest path to profit lies through speedy diagnosis. That's why complete sets of Rider Manuals, well-worn from much use, are found over their benches.

Nowhere . . . nowhere else but through Rider Manuals can you build a library of circuit data containing so many models of so many single-band receivers, so many multi-band receivers (beginning with Vol. XV all broken down into "clarified-schematics"), so many manufacturers, wire recorders and record players . . .

so much vital information. From no other single source can you get such complete coverage of U. S. receivers and allied equipment.

Give Your shop The Sign of Successful Servicing... a complete set of Rider Manuals.

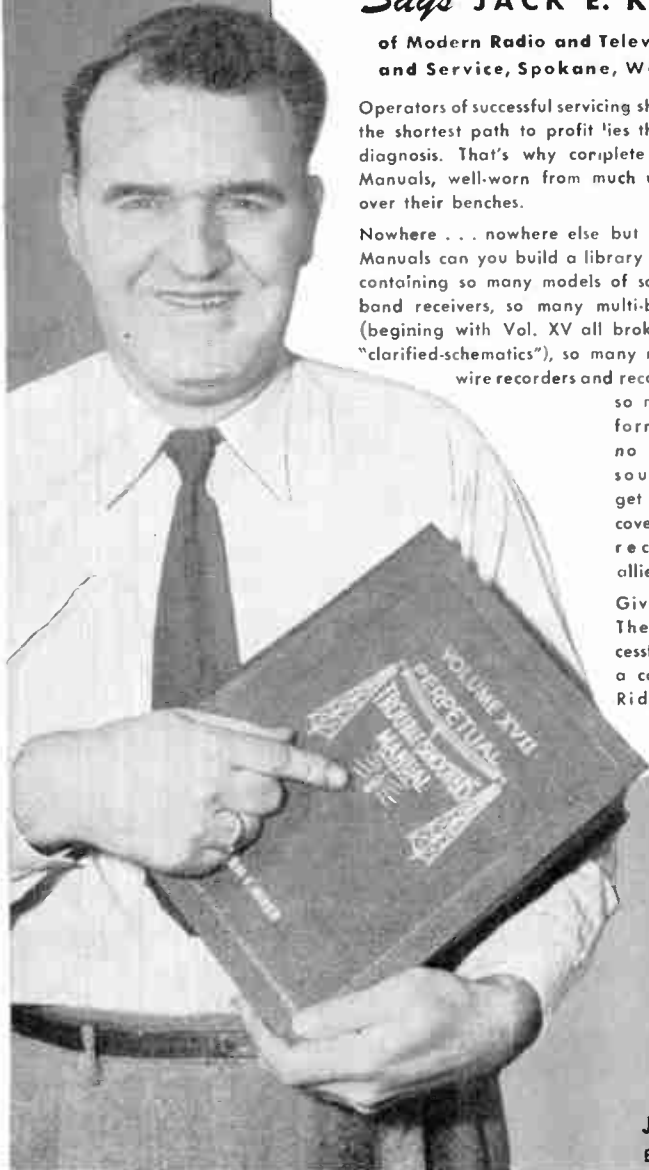

**COMING IN JUNE!**  
**Vol. 1 . . . RIDER TELEVISION MANUAL**



*Approximately*  
**1000 PAGES**  
PLUS—Separate

"HOW IT WORKS" Book.  
Also index . . \$15.00.

Provides the servicing information you need on the products of major manufacturers; complete sets and kit sets. "How it Works" book explains theory of operation on TV sets.

**RESERVE YOURS AT YOUR JOBBERS**

*Complete* **ORIGINAL MANUFACTURERS DATA**

*You* **NEED ALL 17**

|   |         |
|---|---------|
| Volume XVII . . . . .                                   | \$15.00 |
| Volume XVI . . . . .                                    | 8.40    |
| Volume XV . . . . .                                     | 18.00   |
| Volumes XIV to VII (ea. vol.) . . . . .                 | 15.00   |
| Volume VI . . . . .                                     | 11.00   |
| Abridged Manuals: I to V (one vol.) . . . . .           | 17.50   |
| Record Changers and Recorders . . . . .                 | 9.00    |
| Master Index, covering Manuals, Vols. I to XV . . . . . | 1.50    |

**VOL. XVII NOW AT YOUR JOBBERS'**

# RIDER MANUALS

*Mean Successful Servicing*

**JOHN F. RIDER, PUBLISHER, Inc., 404 Fourth Avenue, N. Y. 16**  
Export Agent: Rocke International Corp., 13 E. 40th St., N.Y.C. Cable ARLAB

NOTE: The Mallory Radio Service Encyclopedia, 6th Edition, makes reference to only one source of Radio Receiver Schematics—Rider Manuals.

**PROFITS for YOU and  
LEASURE for your CUSTOMERS**

**SHURE**

when you install a **SHURE**

*"Muted Stylus"*

**CRYSTAL CARTRIDGE**

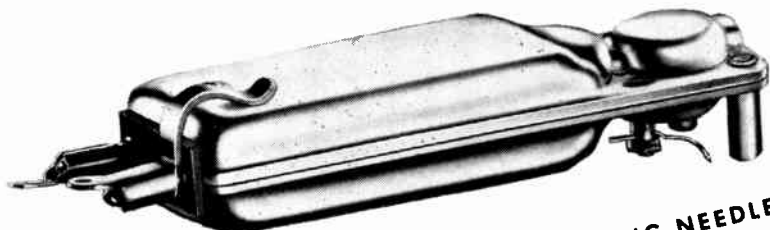

AMAZING NEEDLE  
QUIETNESS

**THOUSANDS OF SET OWNERS ARE  
USING AND PRAISING THE "Muted Stylus"**

The "Muted Stylus" crystal cartridge can be used to replace most other crystal cartridges being used today. Its amazing needle quietness will charm and please all the set-owners who are dissatisfied with ordinary reproduction. The "Muted Stylus" banishes needle talk and scratch and hiss. It also features high output (around 2 volts) . . . record-matched frequency response . . . low tracking force . . . and "finger-tip" needle replacement. For all applications—give them "something better"—install a "Muted Stylus".

**"MUTED STYLUS" CARTRIDGES**

|            |            |             |                    |
|------------|------------|-------------|--------------------|
| Model W60B | (Osmium)   | Code: RUSID | List Price: \$7.50 |
| Model W60A | (Sapphire) | Code: RUSIS | List Price: \$8.50 |

**"MUTED STYLUS" NEEDLES**

|            |            |             |                    |
|------------|------------|-------------|--------------------|
| Model A62A | (Osmium)   | Code: RUZAP | List Price: \$1.50 |
| Model A61A | (Sapphire) | Code: RUZAN | List Price: \$2.50 |



*Shure Patents Issued and Pending. Licensed under  
patents of the Brush Development Co.*

**SHURE BROTHERS, INC.**

**Microphones & Acoustic Devices**

225 W. HURON ST., CHICAGO 10, ILL. • CABLE ADDRESS: SHUREMICRO

**OFF  
OUR CHEST**

This morning's mail brought a copy of the Pittsburgh Press, whose front page carries the headline "On the Spot Investigation Reveals — Radio Repair Racketeers Dupe Public."

This is not the first such investigation which has come to our attention. Several others have been made, but the Pittsburgh case is particularly important because of the manner in which it was conducted. According to the newspaper, the investigation was made by the Pittsburgh Better Business Bureau at a cost of almost \$2,000.

The Better Business Bureau is a reputable and respected organization. Sixty-eight radio repair shops were checked. New receivers were used. The receivers were "rigged," that is, faults were purposely created. The investigation concluded that the majority of the radio repair shops were overcharging and otherwise performing repairs with "larceny in their hearts."

It is not our purpose to defend the results obtained or the methods used in this investigation. We would like to point out, however, that the details of the investigation and the organization which performed it are sufficient to convince the general public that they are being mistreated by the average radio serviceman.

Incalculable damage has been done to all of the radio service shops in the Pittsburgh area. In other parts of the country action taken now can avoid the reenactment of what has already taken place in Pittsburgh. Such action can only be effective if it represents the organized efforts of all the radio service technicians in an area. Proof of this effectiveness has been provided in areas where well organized groups are already in existence.

The newspaper account states that a Pittsburgh servicemen's organization is being formed. If a strong organization had been in existence, it could have done an effective job of protecting the interests of the honest radio repair shops in the Pittsburgh area.

Strong local, and perhaps a national, servicemen's organizations are absolutely necessary if the confidence of the public is to be maintained.

# RADIO

# MAINTENANCE

INCLUDING  
ELECTRONIC  
MAINTENANCE



Volume 4

MAY 1948

Number 5

## CONTENTS

|  |                |         |
|--|----------------|---------|
| Trouble Shooting Receiver Distortion ..... | K. E. Stewart  | 16      |
| How to remedy receiver distortion, Part I  |                |         |
| Interference .....                         | Paul M. Miller | 20      |
| A simplified approach to the problem       |                |         |
| A Pocket F.M. Signal Generator .....       |                | 23      |
| A practical miniature instrument           |                |         |
| A Sweep Generator for F.M. and T.V. ....   | McMurdo Silver | 24      |
| The solution to the T.V. alignment problem |                |         |
| The Notebook .....                         |                | 30      |
| Practical suggestions from readers         |                |         |
| Time Savers .....                          | H. Leeper      | 32 & 44 |
| Over the Bench .....                       | John T. Frye   | 34      |
| A serviceman's opinion                     |                |         |
| The Industry Presents .....                |                | 36      |
| New products                               |                |         |
| Review of Trade Literature .....           |                | 43      |
| Catalogs, books, etc.                      |                |         |
| Electronically Speaking .....              |                | 45      |
| Case Histories .....                       |                | 50      |
| Letters .....                              |                | 52      |

**WILLIAM F. BOYCE**  
Publisher

**FRANK SCHMITT**  
Eastern Advertising

**STUART J. OSTEN**  
Midwestern Advertising  
Eastern Office  
460 Bloomfield Avenue  
Montclair, N. J.  
Montclair 2-7101

**JOSEPH J. ROCHE**  
Editor

**MORTON SCHERAGA**  
Contributing Editor  
Midwestern Office  
228 No. La Salle St.  
Chicago 1, Ill.  
Dearborn 3507

**VICTOR M. TURNER**  
Art Director

**THOMAS A. BYRNES**  
Director of Field Services  
and Quality Control

**AL JOHNSTON**  
Circulation Manager  
West Coast  
Swain Associates  
639 So. Wilton Place  
Los Angeles 5, Calif.  
Dunkirk 8-2248

Copyright 1948, Boland & Boyce, Inc.

Radio Maintenance is published monthly by Boland & Boyce, Inc., at 34 No. Crystal St., East Stroudsburg, Pa., U.S.A.; Executive and Editorial Office, 460 Bloomfield Ave., Montclair, N. J. Subscription Rates: In U. S., Mexico, South and Central America, and U. S. possessions, \$3.00 for 1 year, \$5.00 for two years, single copies 35 cents; in Canada, \$3.50 for 1 year, \$6.00 for 2 years, single copies 40 cents; in British Empire, \$4.00 for 1 year, \$7.00 for 2 years, single copies 50 cents; all other foreign countries, \$5.00 for 1 year.

Change of address: Four weeks' notice required for change of address. When ordering a change, please furnish an address stencil impression from a recent issue if you can. Address changes cannot be made without the old stencil as well as the new one.

# CHECK!



**HOT OFF THE PRESS!**  
Clarostat Service Manual — over 32,000 control replacements, most complete job, yet!

**TAKES IN ALL SETS!**  
Lists all standard radios from 1938 up to most of 1947 models.

**IT'S A "MUST"!**  
You can't afford to work without it. Only 50c list. Don't wait! Get it NOW!

**CLAROSTAT**  
Ask your Clarostat jobber for your copy. Or order from us.

*Controls and Resistors*

CLAROSTAT MFG. CO., Inc. • 285-7 N. 6th St., Brooklyn, N. Y.

In Canada: CANADIAN MARCONI CO., Ltd.  
Montreal, P.Q., and branches



# The true test of performance— ***DEMAND***

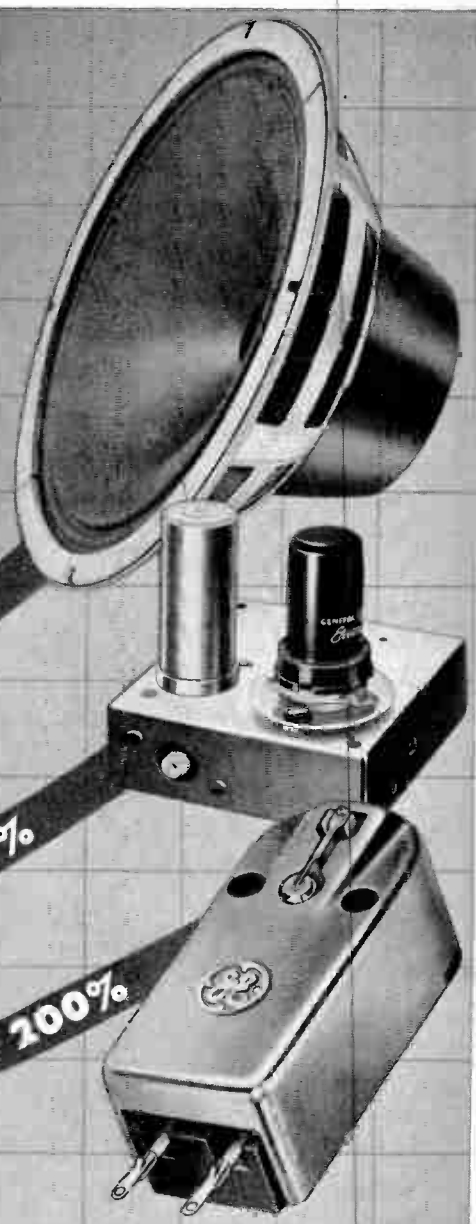

**G-E Speaker Sales** **UP—NEARLY 100%**  
 "The Speaker with the Aluminum Foil Base Voice Coil"

**G-E Pre-Amplifier Sales** **UP—OVER 100%**  
 "The Important Link for Adapting the Pickup"

**G-E Variable Reluctance Pickup Sales** **UP—OVER 200%**  
 "The Pickup They're All Talking About"

**Up—Up—Up**—go sales on these fast-moving G-E products that every service man needs—day in and day out.

The figures shown here represent the past three months as compared with the previous three months. The reason for these spectacular increases is no secret

—it's simply G-E quality. That, plus proper design and the right price means consumer acceptance—consumer demand—consumer action.

Make that action mean dollars for you. Order your stock of these fast sellers now—start your sales curve rising.

For additional information on these three units write:  
 General Electric Company, Electronics Park, Syracuse, N. Y.



# GENERAL ELECTRIC

100-03

**TEST**

**TELL**

**SELL**

**New 3-step aerial replacement deal by WARD makes you extra sales, extra profits, extra fast!**

Ward's new national advertising makes selling auto replacement aerials *easier* than falling off a log. The new 1-2-3 strategy gives you everything you need to . . .

- 1 TELL the customer the likely cause of his radio trouble.
- 2 TEST to see if the aerial is at fault.
- 3 SELL a handsome replacement aerial to make the radio play like new.

Nothing complicated about it; it works like a charm. You make \$2, or more, on every aerial you sell, plus an installation charge.

Ward's Auto Aerial Tester Package includes free sign and display. You pay only for the aerials. Write today for details. Also . . . please send name of your parts jobber.

**THE WARD PRODUCTS CORPORATION**  
 1529 EAST 45TH STREET, CLEVELAND 3, OHIO  
 DIVISION OF THE GABRIEL COMPANY  
 IN CANADA: Airos Radio Corp., 560 West King Street, Toronto, Ontario  
 EXPORT DEPT.: C. O. Brondes, Mgr., 4900 Euclid Avenue, Cleveland 3, Ohio

**WARD** *Aerials*

WORLD'S LARGEST PRODUCER OF AERIALS FOR CAR AND HOME

**FAULTY AERIALS CAUSE 2 OUT OF 3 CAR RADIO TROUBLES**



Watch for these ads in The Saturday Evening Post, Collier's and The American Weekly



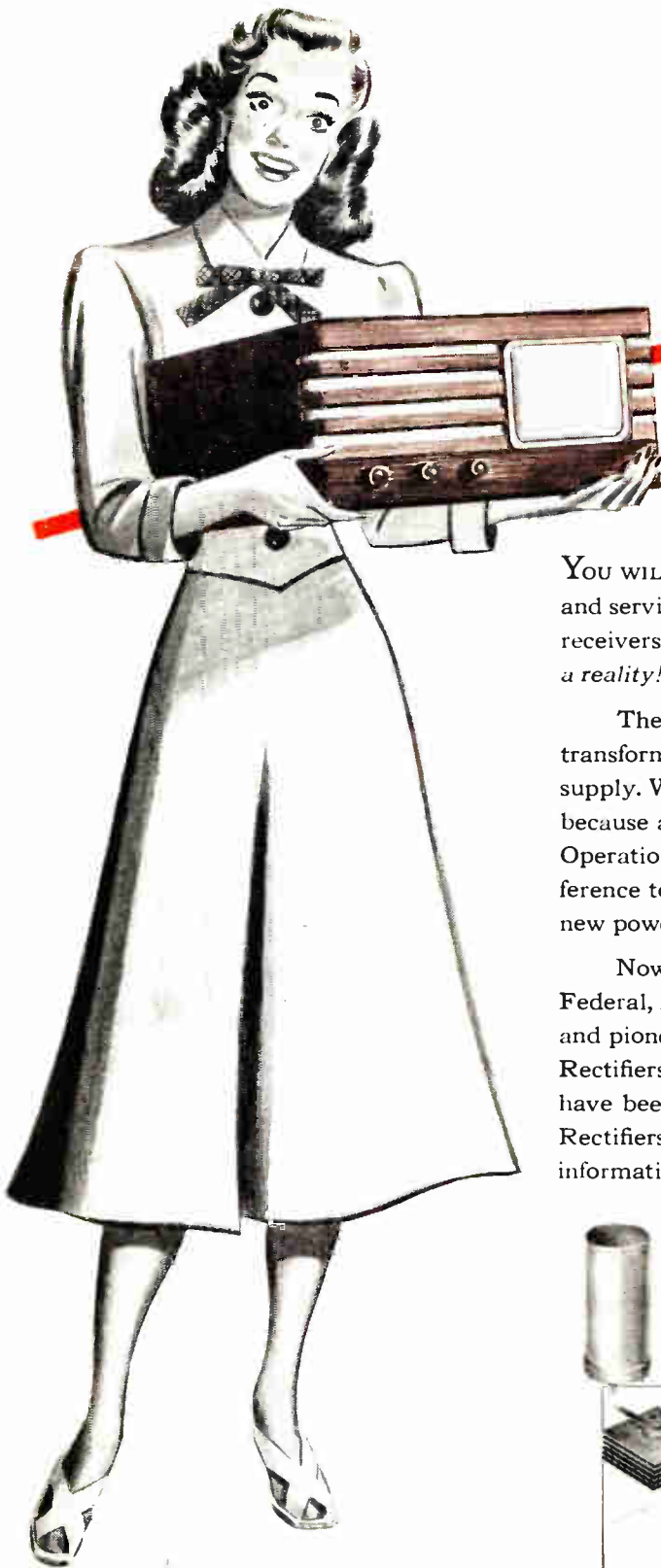

# Get ready for better television for more people

You WILL make more money from television, in both installation and service, when thousands instead of hundreds can afford to buy receivers. *Lighter and more compact television receivers are now a reality!*

The answer is simple. Selenium Rectifiers eliminate power transformers, rectifier tubes and filter chokes in the multiple power supply. Weight is cut as much as 90 per cent in the power supply, because a complete Selenium unit weighs less than half a pound. Operation is cooler. There is the electronic advantage of no interference to the cathode ray tube due to stray magnetic fields. This new power supply can be located almost anywhere in the set.

Now is the time to know more about this new development. Federal, *first* manufacturer of Selenium Rectifiers in this country and pioneer of their many developments, is also *first* in Selenium Rectifiers to power television receivers. Equipment and circuits have been tested in our laboratories. Write today for "Selenium Rectifiers for Television Receivers"—a paper that gives you full information. Address Dept. F958.

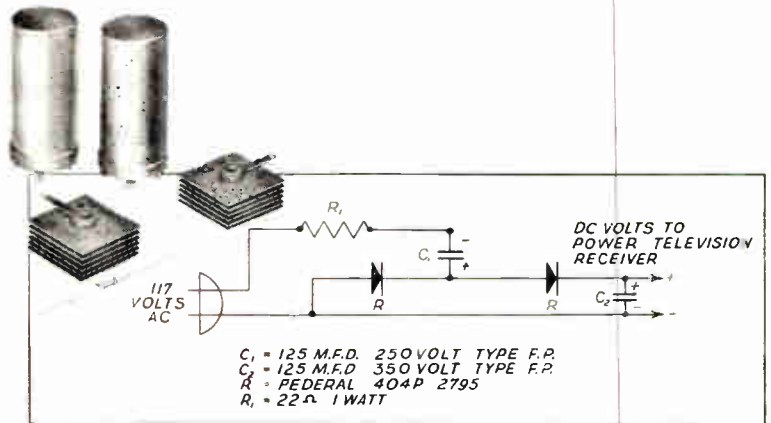

## Federal Telephone and Radio Corporation

SELENIUM and INTELIN DIVISION, 900 Passaic Ave., East Newark, New Jersey

In Canada:—Federal Electric Manufacturing Company, Ltd., Montreal, P. Q.  
Export Distributors:—International Standard Electric Corp., 47 Broad St., N.Y.

KEEPING FEDERAL YEARS AHEAD... is IT&T's world-wide research and engineering organization, of which the Federal Telecommunication Laboratories, Nutley, N. J., is a unit.



# ONE Button —

... clears every switch setting  
 ... ready for the next tube test

## Model 335 Plate Conductance Tube Tester

The Simpson Automatic Reset is just another of the practical refinements that make Simpson tube testers serve you better than other testers. When you finish a test, just press the Automatic Reset button and instantly all switches, both push button and rotary, return to normal. This not only saves time but prevents error due to previous settings being left in position at the beginning of the new test. The Reset mechanism, in whose design and tooling many thousands of dollars have been invested, is Simpson patented. No other switch control mechanism is so completely automatic.

Simpson Model 335 adds the Automatic Reset to its many other features. It tests tubes in percentages of rated plate conductance, also indicating that tube is good, fair, doubtful, or definitely bad. Only a few settings are necessary for the most complicated tube. Sockets for all types of tubes are provided, including the new 9-pin miniature; also the sub-miniature as used in hearing aids, etc.

For 105-130 volts, 50-60 cycle. Size: 15 1/2" x 9 1/2" x 6 1/4"  
 Dealer's Net Price, complete with 12-page Operator's Manual ..... \$85.00



## Model 340 SIGNAL GENERATOR — 75 Kilocycles to 120 Megacycles Fundamentals to 30 MC.

Electron coupled circuit assures extreme stability and output uniformity throughout the band. Standard 30% modulation at 400 cycles. Coils, amplifier and signal selector individually shielded. Effective shielding throughout. Each coil individually calibrated to close tolerances against standard by means of variable inductance and variable minimum capacitance. For 105-130 volts, 50-60 cycle. Size: 16" x 10" x 6".

Dealer's Net Price, complete with 44 page Operator's Manual ..... \$69.85

# Simpson

INSTRUMENTS THAT STAY ACCURATE

**SIMPSON ELECTRIC COMPANY**  
 5200-5218 W. Kinzie St., Chicago 44, Ill.



McMurdo  
**SILVER**

# Announces the NEW 900A VOMAX



Net Price  
**\$68.50**

**C**ONTINUOUS RESEARCH, study of thousands of cases of actual field experience now enable us to offer you the new 900A "VOMAX". Revolutionary as was the original, the new 900A forges far ahead in simplicity, dependability all-around *usability*.

Just 34 months ago McMURDO Silver Co. announced "VOMAX"—the first truly stable, ultra-high input resistance v.t.v.m. Lifting the v.t.v.m. out of the limited laboratory-application class. Silver engineering and use-experience made "VOMAX" the first *universal* v.t.v.m. Its acceptance was instant and overwhelming — for "VOMAX" will measure, at input resistance so astronomically high as not to "load down" any circuit to which it may be connected — d.c. volts, a.c., a.f., i.f. and r.f. volts, d.c. milliamperes and amperes, resistance and db. — all over tremendous range and with laboratory accuracy. Used in scores and hundreds by such competent organizations as the National Bureau of Standards, the Navy, Army, F.C.C., C.A.A., Veterans Administration, G. E., Western Electric Co. Recommended by Bendix, "VOMAX" is consistently copied, never equalled — stands today as "standard of comparison" for the entire industry.

In announcing the new "VOMAX" we think you'll agree that we can feel just a bit proud of having again done the impossible to give you the world's finest *universal* Laboratory Caliber Electronic Test meter at only Net \$68.50.

## FEATURES

- Non-breakable glass 7" meter completely protected behind panel.
- Single hand-convenient probe gets into tight places, banishes usual snarl of easily lost and broken test leads.
- Newer — and fewer — miniature u.h.f. tubes.
- 51 ranges at highest available a.c. and d.c. input resistance.
- Absolutely stable—one adjustment sets meter zero for all ranges.
- No grid current error. Exclusive to "VOMAX", this vital feature is carried to new heights in new 900A.
- 24 d.c. ranges at 51 and 126 megohms, constant input resistance. 0 thru 3, 7.5, 12, 30, 75, 120, 300, 750, 1200 and 3000 volts. Polarity reversing switch.
- 6 a.c./r.f. ranges, 20  $\Omega$  thru 300 mc., 20 megohms input resistance shunted by 7 mmfd. 0 thru 3, 12, 30, 120, 300 and 1200 volts.
- 3 db. ranges.—10/+10, +10/+20 and +20/+50 db.
- 6 resistance ranges. 0 thru 2000, 20,000 and 200,000 ohms. 0 thru 2, 20 and 2000 megohms.
- 6 direct current ranges. 0 thru 1.2, 30, 120, 300, 1200 ma, and 12 amperes.
- True vacuum tube meter in all but current functions. No low-resistance, frequency-erroneous copper oxide rectifiers.

Every good jobber features the new "VOMAX", new *super-sensitive* 905A "SPARK" Signal Tracer, 910 Universal Test Speaker & 18 Watt Universal Output Transformer, 906 FM/AM Signal Generator, new 909 and 911 TV and FM Sweep Signal Generators, 904 Resistance/Capacitance Tester. All, Laboratory Caliber Electronic Test Instruments at a price you can afford.

OVER 37 YEARS OF RADIO ENGINEERING ACHIEVEMENT

*McMurdo Silver Co., Inc.*

EXECUTIVE OFFICES: 1240 MAIN ST., HARTFORD 3, CONN.  
FACTORY OFFICE: 1249 MAIN ST., HARTFORD 3, CONN.



# RADIO SERVICEMEN!

## 19 PRIZES FOR 18 IDEAS

### HERE'S HOW EASY IT IS TO WIN

Right now, you may have a winning idea at work in your shop. An idea for a simple service tool which makes your work easier, faster, more profitable. Hytron wants to help make such needed tools available to all servicemen — at cost. You can cash in on your idea easily — and also help the other fellow.

Simply obtain an official entry blank from your Hytron jobber — or write us. Answer a few simple questions on the blank. Then include a sketch with constructional details — or a photograph — or a model of your proposed tool. Mail

to Hytron Contest Editor. The tool should be simple, practicable, durable, compact, easy and economical to manufacture. Examples: Hytron Tube Tapper and Miniature Pin Straightener.

That's all there is to it. Nothing to buy. Nothing difficult. No fancy writing. And could you use one of those beautiful deluxe test equipments — or one of those crisp new Savings Bonds! Check the easy rules. Get an official entry blank today for full details on how to win. Send in as many entries as you wish — in any or all six contests. Everyone wins a Tube Tapper. Your idea may hit the jackpot. Let's go!



### HERE ARE THE EASY RULES

**WHO . . .** Any bona fide radio serviceman who repairs radios for the general public and who lives in continental United States is eligible for these contests, except employees of Hytron, their advertising agencies, and their families.

**HOW . . .** Get official entry blank from your Hytron jobber, or write us. Describe on blank your idea for a shop tool for radio servicemen. Include sketch and constructional details — a photo — or model. Make your proposed tool simple, practicable, durable, compact, easy and economical to manufacture (preferably to sell without profit at 50¢ or less) — like the Tube Tapper or Miniature Pin Straightener.

**WHERE . . .** Mail to CONTEST EDITOR, HYTRON RADIO & ELECTRONICS CORP., SALEM, MASS.

**WHEN . . .** There are six monthly contests. Opening and closing dates for each contest are the first and last days of each of the months from May through October, 1948, inclusive. The postmark date determines month of entry. Entries for final month's contest must be postmarked before midnight, October 31, 1948, and received by November 15th. At judges' discretion, unsuccessful entries in any month's contest may be re-considered among following months' entries. You may submit as many different ideas as you wish in any or all six monthly contests. Use separate blank for each entry.

**PRIZES . . .** See special listing of prizes.

**JUDGES . . .** Entries will be judged on originality, simplicity, practicability, durability, compactness, and ease and economy of manufacture. Judges will be: Sanford Cowan, Editor & Publisher of *Radio Service Dealer*; W. W. MacDonald, Managing Editor of *Electronics*; Oliver Roche, Chief Editor of *Radio News*; Joseph Roche, Editor of *Radio Maintenance*; J. L. Stoutenburgh, Executive Editor of *Radio & Television Retailing*; Lewis Winner, Chief Editor of *Service*.

Judges' decisions final. Duplicate prizes in case of ties. No entries returned. Entries become property of Hytron, who may, at its option and by special arrangement with the entrant, pay the cost of a patent application (if the tool is patentable) with the understanding that Hytron is to have a non-exclusive license to manufacture, distribute, and sell the tool without royalties. Contests subject to all Federal and State regulations. Winners will be notified by mail. Grand prize winner will be announced in radio service trade papers shortly after close of final contest. Prize winner list available approximately one month after close of last contest.

### HERE ARE SOME EXAMPLES



Hytron's Tube Tapper and Miniature Pin Straightener show you the kind of tool wanted. Check off the qualities. Simple? Yes. Practicable? Usable time-savers. Durable? Built to last. Compact? Carry them in your pocket. Easy and economical to manufacture? Adapted to mass production. Tube Tapper a nickel; Pin Straightener 49¢ — both under 50¢. Tools associated with tubes preferred, but other original service tools also acceptable.

### HERE ARE THE PRIZES

#### First Prizes

- MAY DuMont Type 274 Five-Inch Oscillograph.
- JUNE Radio City Products Model 665-A, the "Billionaire", V-T Volt-Ohm-Capacity Meter, Insulation Tester; and Model 705-A Signal Generator.
- JULY Hickok Model 156A Indicating Traceometer.
- AUG. McMurdo Silver Model 900A "Vomax" Electronic Volt-Ohm-Milliammeter; Model 904 Condenser/Resistor Tester; and Model 905A "Sparx" Dynamic Signal Tracer/Test Speaker.
- SEPT. Jackson Model 641 Universal Signal Generator.
- OCT. Weston Model 769 High Frequency Electronic Analyzer.

Second Prize — Each Month \$50 U. S. Savings Bond

Third Prize — Each Month \$25 U. S. Savings Bond

#### Grand Prize.

\$200 U. S. Savings Bond — to contestant whose idea is judged to be best of the 6 winning monthly first prizes.

SPECIALISTS IN RADIO RECEIVING TUBES SINCE 1921

# HYTRON

RADIO AND ELECTRONICS CORP.

MAIN OFFICE: SALEM, MASSACHUSETTS





... a Pocketful of  
**PRECISION**  
*Series 40*  
 Compact Wide-Range Circuit Tester

Self-Contained to 6000 Volts AC & DC  
 5 Megohms, 600 MA, + 70 DB,  
 with full size 3" Rectangular Meter

In a custom molded bakelite carrying case, the series 40 is an unparalleled instrument of its type and size. Ideally dimensioned and engineered to meet the need for a portable, compact, yet rugged, accurate test set to withstand hard, long term usage as is imposed by the service technician, maintenance engineer, production inspector, trouble-shooter, radio amateur, etc.

The Series 40 offers every advanced design feature and full-bodied components as are regularly incorporated in "Precision's" larger multi-range test sets, including: Rotary Range Selection—1% shunts and multipliers—heavy duty insulated pin jacks—Large numeralled, easy reading meter.

**ALL RANGES**, including 6000 volts and 5 Megohms, are **SELF-CONTAINED** and ready to operate. **NO EXTERNAL BATTERIES OR MULTIPLIERS ARE REQUIRED.**

**RANGE SPECIFICATIONS**

- ★ 6 A.C.-D.C. & Output Voltage Ranges: all at 1000 ohms per volt. C-3-12-60-300-1200-6000 volts.
- ★ 4 D.C. Current Ranges: 0-6-6-60-600 MA.
- ★ 3 Resistance Ranges: with self-contained batteries. 0-5000-50,000 and 0-5 megohms.
- ★ 6 Decibel Ranges from -22 to +70 DB.
- ★ Full Size 3" Rectangular Meter: 400 microamperes ± 2% accuracy.
- ★ 1% Wirewound & Metallized Resistors.
- ★ Only 2 Pin Jacks serve all standard functions.
- ★ Recessed 6000 volt safety jack.
- ★ Anodized, etched aluminum panel: resistant to moisture and wear.



See this new "Precision" Test Set now on display at all leading radio parts and equipment distributors, or write directly for the Precision 1948 catalog describing the complete Precision line of quality Electronic Test Instruments for all phases of modern radio-electronics—A.M., F.M. and TV.

Series 40 (illustrated) In custom molded bakelite case with plastic handle. 3 3/4" x 6 1/4" x 2 1/2". Complete with ohmmeter batteries and test leads.

**NET PRICE \$24.75**

**PRECISION**  
 TEST EQUIPMENT  
*Standard of Accuracy*

**PRECISION**  
 APPARATUS COMPANY INC.  
 92-27 HORACE HARDING BOULEVARD  
 ELMHURST 5, NEW YORK



# Somewhat More Silent Than a TOMB!

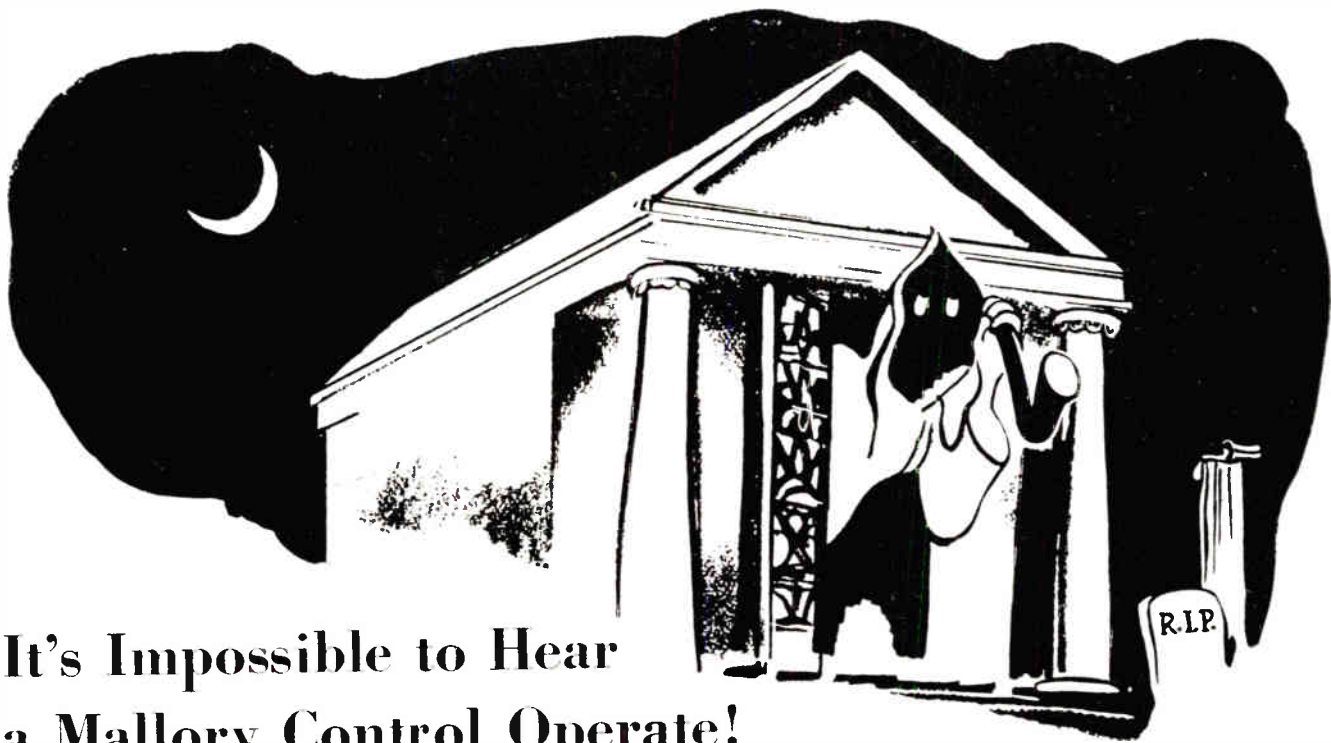

## It's Impossible to Hear a Mallory Control Operate!

Even super-sensitive meters, built for the U. S. Navy to inspect delicate electronic communication equipment, do not show an audible sound level when Mallory carbon controls are tested.

Mallory carbon controls give you totally silent operation—the tapers are smooth and accurate to assure maximum adjustment in the

proper ranges—the overall resistance values are uniform and the life of the control is the longest ever provided. This kind of quality keeps customers satisfied.

Mallory has given you so many "firsts" in the

field of radio-electronic replacement parts that you know Mallory products are the finest that can be produced! Sell them with confidence, install them with ease. The Mallory line of Volume Controls, Capacitors and Vibrators has been standardized; they are a profitable line to stock.

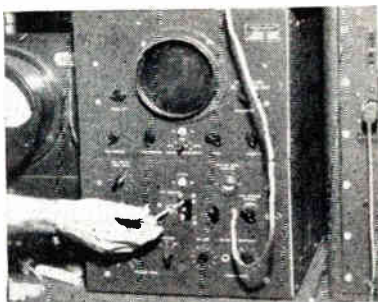

*Meter used in the noise level test. Readings were taken on volume controls of all leading manufacturers. Mallory controls gave no audible sound, registered 22% below all others in inaudible sound vibrations.*

### "Good Service for Good Business"

A business plan that will raise the earnings of radio-electronic servicemen. One important item in the plan is a unique system for following up your customers for repeat orders.



And there are ways of linking your name with the Mallory trade mark, to get the benefit of Mallory advertising. Better ask your distributor about it!

WHAT WILL  
MALLORY  
DO NEXT?

See Us at  
the Radio  
Parts Show

**P. R. MALLORY & CO. Inc.**  
**MALLORY**

CAPACITORS . . . CONTROLS . . . VIBRATORS . . .  
SWITCHES . . . RESISTORS . . . RECTIFIERS . . .  
VIBRAPACK® POWER SUPPLIES . . . FILTERS

\*Reg. U. S. Pat. Off.

**APPROVED PRECISION PRODUCTS**

**P. R. MALLORY & CO., Inc., INDIANAPOLIS 6, INDIANA**

# YOU'LL WANT THIS ON YOUR DOOR!

This five-color decal identifies you as the man Sylvania is talking about—in the big new national campaign now under full steam in *Life*, *The Saturday Evening Post*, *Collier's*, *Radio Best*.

Display this decal on your door, your windows, your truck—to hook your store up with Sylvania's nationwide advertising.

The decal is yours for the asking . . . in 8-inch or 12-inch size . . . in any quantity you want!



GET THIS DECAL IN 8-INCH OR 12-INCH SIZE

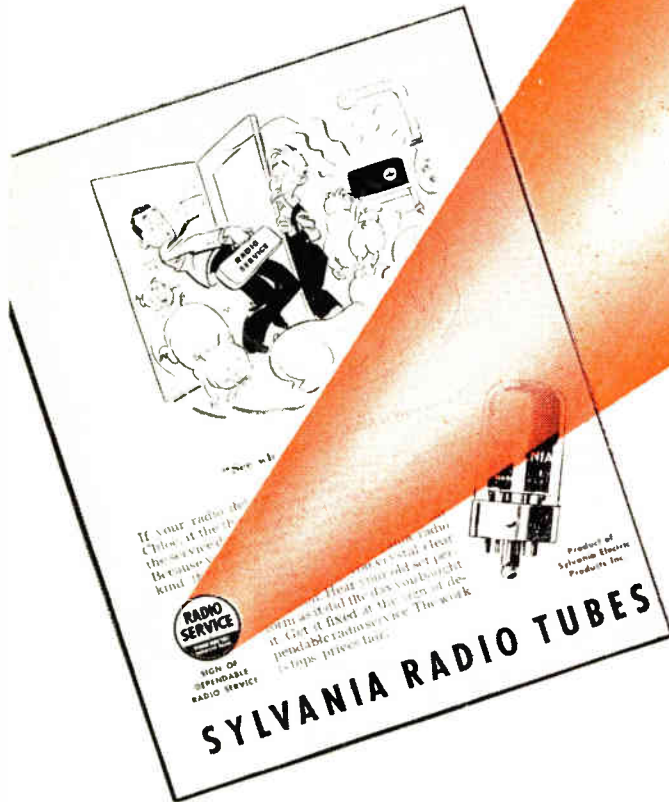

See for yourself how quickly this cartoon ad catches the eye. See how strongly it features the Radio Serviceman's decal—*your decal!*

In every Sylvania ad throughout 1948 . . . in four great, nationally-read magazines . . . your customers—and the people you want for customers—will see this decal over and over again. They'll look for it when their sets need servicing—be sure they see it on your store.

## LOOK FOR THE JOBBER WHO DISPLAYS THIS COMPANION DECAL

He's the authorized Sylvania Distributor in your locality. He's ready to supply you with top-quality Sylvania Radio Tubes and Test Equipment, for the kind of servicing jobs that will keep your customers coming back to you.



SEND THIS COUPON

**NOW** FOR THIS **FREE**

SYLVANIA SERVICEMAN'S DECAL

# SYLVANIA ELECTRIC

Radio Tube Division, Emporium, Pa.

MAKERS OF RADIO TUBES; CATHODE RAY TUBES; ELECTRONIC DEVICES; FLUORESCENT LAMPS, FIXTURES, WIRING DEVICES; ELECTRIC LIGHT BULBS

Sylvania Electric Products Inc.  
Radio Tube Division  
Advertising Dept., Room R-1605  
Emporium, Pa.

Gentlemen:

Please send, free, the following quantities of the Sylvania Serviceman's decals:

..... 8-inch decals ..... 12-inch decals

Name.....

Company.....

Address.....

City..... Zone #.....

State.....



**UP  
and  
DOWN**

# Lever Switching Connects Each Tube Pin to Proper Circuit

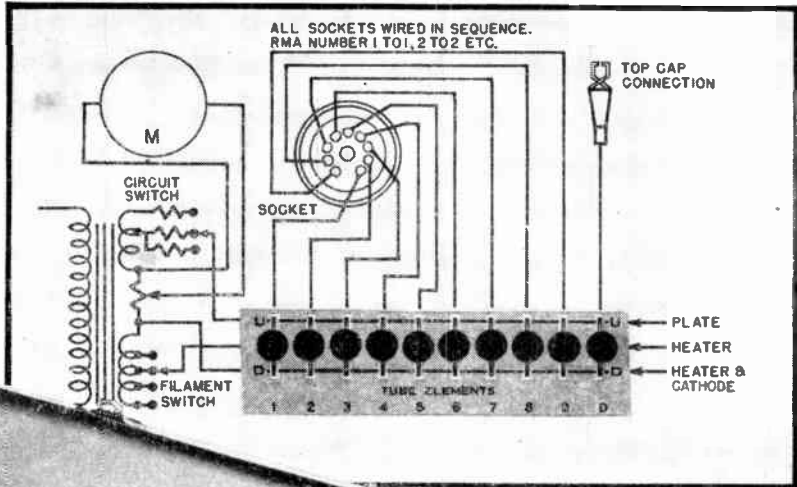

## TUBE TESTER

Triplet lever switching circuit arrangement has 7 distinct advantages contributing to maximum flexibility, simplicity of operation and anti-obsolescence.

**MODEL  
3413 \$60<sup>75</sup>**  
DEALER NET

NEW TRIPLET TELEVISION TESTERS COMING  
WATCH

**1. ALL ELEMENT CHECK**—Thorough conclusive test of tube elements, shields and taps. The only commercial tester to get at each tube pin and make an open and short check.

**2. NO HUNTING FOR SOCKETS**—No plugging into wrong socket—Circuit flexibility requires only one socket for each type of tube base.

**3. CIRCUIT CLARITY**—Lever switch numbering corresponds to RMA tube pin numbers, connected to bring out each active tube element. A simple up or down motion of the lever instantly makes the connection.

**4. OPERATION SIMPLICITY**—Minimum of control settings plus straightforward arrangement of this outstanding emission circuit. Generally

not more than five of the 10 lever switches need be set.

**5. PICTURE YOUR CIRCUIT**—Assures confidence in tests and enables special tube checks for balanced circuits, special loads, etc. "Trick" switching circuits make it more difficult for the serviceman to "picture" his test circuit.

**6. SET UP YOUR OWN TEST FOR NEW TUBES**—The "pictured" circuit and straightforward test procedures enable the user to set up for new tubes. A feature rarely found in commercial type tube testers.

**7. INDIVIDUAL CONTROL FOR EACH TUBE ELEMENT**—Takes care of roaming elements, dual cathode structures, multi-purpose tubes etc., in addition to standard value tests.

*Precision first... to Last*



**TRIPLET ELECTRICAL INSTRUMENT CO. • BLUFFTON, OHIO, U.S.A.**

*In Canada: Triplet Instruments of Canada, Georgetown, Ontario.*



# Power Unveiled

Here it is! The answer to a thousand problems . . . possible because of the skillful design and engineering that has made Radiart the leader. We are proud to unveil this POWERFUL VIBRATOR in conjunction with the annual Chicago showing, an event of great moment. The old rotary inverter is replaced with this rugged vibrator where high voltage changes from D. C. to A. C. are required. This advanced design incorporates vast improvements on anything the field has previously known, and has a wide variety of industrial and domestic applications.

See this, and other Radiart products at our display booth.

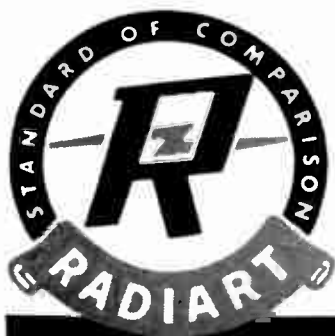
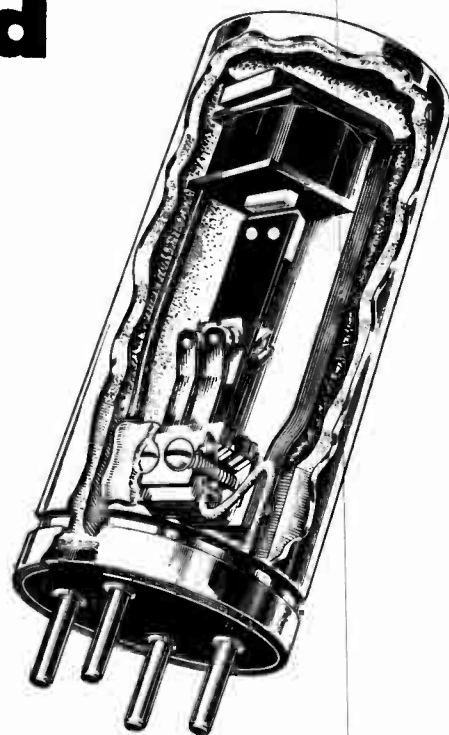

## The Radiart Corp.

CLEVELAND 2, OHIO  
Export-Scheel International Inc.



# Buy Quality - Buy SANGAMO

Since 1923 Sangamo Capacitors have had a reputation for high inherent quality. Discriminating users have learned to rely on Sangamo for excellent design and construction, honest characteristics and conservative ratings. There is a Sangamo Mica or Paper Capacitor to fill your every need.

Type 71

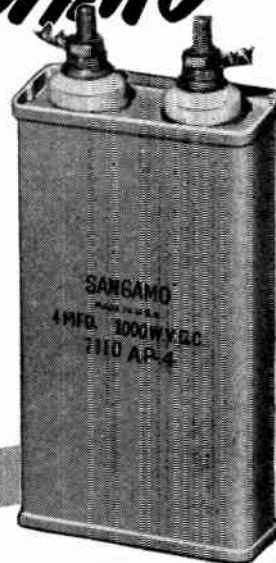

## DIACLOR IMPREGNATED CAPACITORS

Designed for use on broadcast and aircraft transmitters, and in many varied high voltage circuits. These small-sized, light-weight, long-lived capacitors have high insulation resistance, high dielectric strength, and low power factor. Available within a range of 600 to 6000 V. D. C. W. or higher.

Type 20-21



## METAL-CASED MINERAL OIL PAPER CAPACITORS

Extremely popular because of their excellent bypass and coupling qualities. They offer unusually stable performance from 55° C below zero to 85° C above zero. These "Jack-of-all-Trades" Capacitors are available within a range of 200 to 2000 V. D. C. W.

Type 40



## DIACLOR FILLED FILTER CAPACITORS

Particularly suitable for use in communications equipment, industrial electronic, and other high voltage filter applications. They are enclosed in aluminum containers designed to facilitate mounting, and have an insulating washer and spade lug for insulating from the chassis.

Type 50



## MINERAL OIL BYPASS CAPACITORS

Primarily intended for bypass applications. Their characteristics are excellent for R. F. and A. F. bypass, audio frequency coupling, and A. C. circuits, under all humidity conditions and at temperatures up to 85° C, subject to RMA standard temperature/voltage adjustment.



PAPER • MICA • SILVER • CAPACITORS

**SANGAMO**  
ELECTRIC COMPANY  
SPRINGFIELD • ILLINOIS

Sangamo manufactures a complete line of paper, mica and silver capacitors. Write for Catalog No. 76B for full information.

# TROUBLESHOOTING RECEIVER DISTORTION

## PART 1

by K. E. Stewart

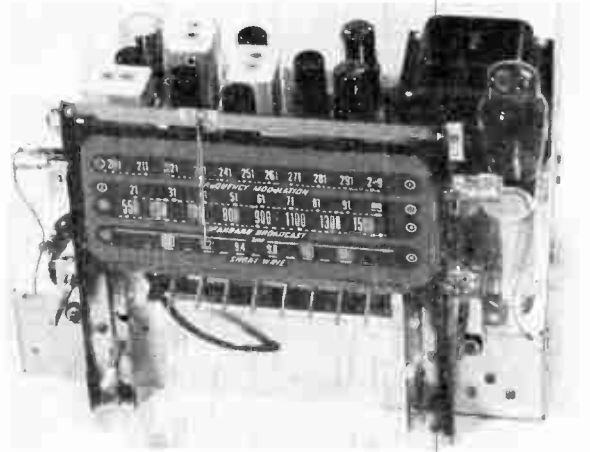

**THE CAUSE OF DISTORTION IN THE OUTPUT OF A RECEIVER CAN BE VERY ELUSIVE. THE AUTHOR OUTLINES THE VARIOUS TYPES OF DISTORTION, THE CAUSES OF DISTORTION, AND HOW IT MAY BE ELIMINATED. THE ARTICLE WILL ASSIST THE READER IN DEVELOPING A SYSTEMATIC METHOD OF DISTORTION TROUBLE-SHOOTING.**

**T**HE prime requisite of a radio receiver is that it be able to deliver from its loudspeaker an intelligence which is as nearly identical to the intelligence which is superimposed upon the carrier wave of the broadcasting station as is possible. To achieve this, the output voltage fed to the speaker must be identical in every respect, other than amplitude, to the voltage wave comprising the modulation envelope of the carrier. Any condition which brings about a deviation from the original waveform will introduce distortion into the intelligence received.

There are essentially three (3)

types of distortion i. e.:

(1) Harmonic Distortion—also referred to as amplitude, or non-linear distortion

(2) Frequency Distortion, and

(3) Phase Distortion.

Since the ear is very insensitive to phase distortion, it is of little importance in receivers of sound only. Therefore, in this article we will be concerned only with the first two.

### Harmonic Distortion

This type of distortion is caused by generation in the receiver of frequencies not present in the signal. These frequencies are harmonics of

the frequencies present in the signal, and also frequencies equal to the sums and differences of those frequencies. These sums and difference frequencies are known as intermodulation frequencies.

Harmonic distortion is brought about primarily by improper operating conditions of the tubes, resulting in curvature of the dynamic characteristics, and will generally be held to a minimum if the grid bias, plate voltage, and load impedances are correct, and the signal voltage is not so strong as to cause overloading.

Overloading of any particular

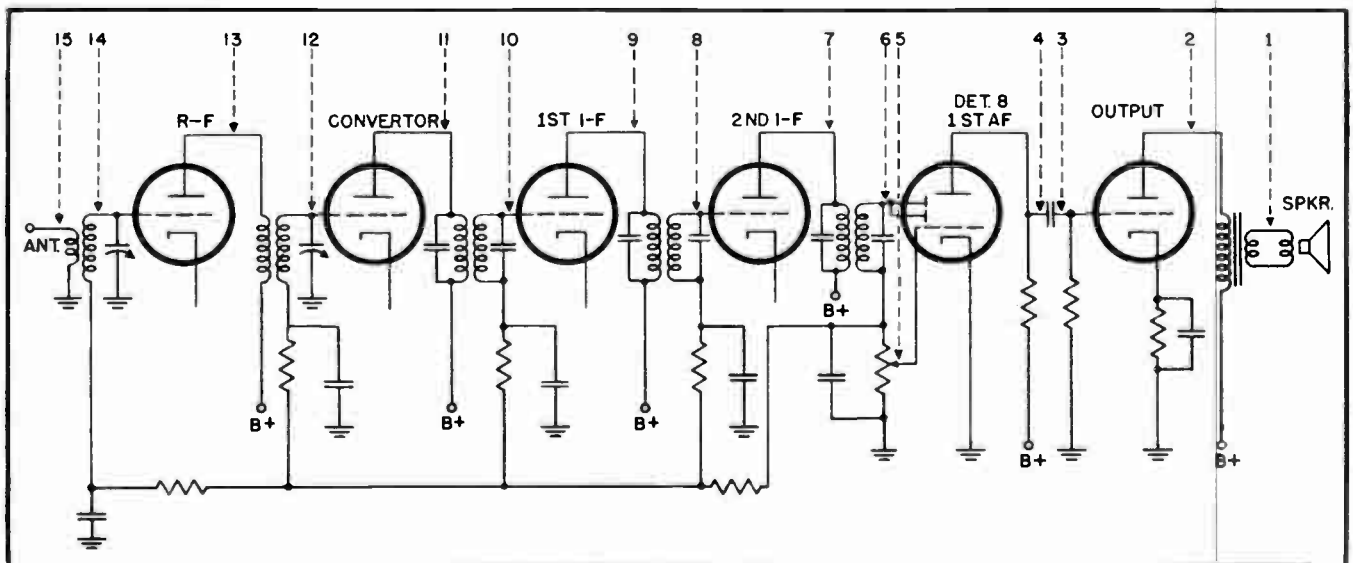

**Fig. 1** A simplified schematic diagram of a receiver showing recommended check points in the order in which tests are made. The tests are made with a signal tracer while a signal is being fed into the input of the receiver.



stage occurs when the signal voltage is so high as to cause the normal range of operation on the dynamic transfer characteristic of the tube to be exceeded. If the signal becomes sufficiently strong, the plate current may cease to flow entirely during a portion of the cycle.

### Frequency Distortion

Frequency distortion is the result of unequal amplification of the different frequency components of a signal and results from the dependence of circuit impedances upon frequency, causing attenuation of some frequencies and accentuation of others, and is generally held at a minimum in circuits not containing transformers or other inductors. There need not be frequency distortion in reactance or transformer coupled stages, however, if the reactors or transformers are properly designed. Impedance mismatches in audio stages are also a source of frequency distortion. If a signal rich in harmonics is fed into a stage with mismatched impedances, some frequencies will be reinforced and others will be attenuated. The load impedance of an audio stage should be high for maximum voltage output, but where current is involved, distortion will be introduced by any mismatch of impedance. Consequently, the load impedance is designed to effect a compromise between power output and distortion.

Distortion can originate in any stage of a receiver, including the speaker itself. The experienced serviceman can often recognize the peculiar kinds of distortion associated with certain troubles, and can go directly to the source without the aid of any instrument other than his ear. In most cases, however, much valuable time will be saved by the use of test equipment. In a great many cases it is impossible to locate and properly remedy such troubles without the aid of proper test equipment. An oscilloscope is a very desirable instrument to have access to for such work, although a signal tracer with a detector probe will often lead the serviceman to the trouble and requires less time to use than the oscilloscope. A modulated signal generator is, of course, a *must*. The writer also considers a vacuum tube voltmeter to be an essential instrument for servicing modern receivers, and especially so in shooting

distortion troubles. If one does not have access to either a vacuum tube voltmeter or an oscilloscope, he will waste many hours of valuable time at best, and in many cases probably will not be able to effect the proper cures at all.

Harmonic distortion is responsible for the majority of the distortion troubles in a receiver, and since tube operating conditions are the chief cause of this type of distortion, it is important to be able to determine the exact voltages which are applied to the various tube elements. A vacuum tube voltmeter is absolutely necessary to make these measurements. Many distortion troubles can be located without any instrument other than the VTVM.

Since distortion can originate in any part of the receiver, time will be saved by first localizing the distortion to a stage through the use of a signal tracer (see Fig. 1). For instance, if a signal taken from the voice coil of a receiver is distorted and the signal appearing on the control grid terminal of the output stage is undistorted, then it is logical to assume that the trouble is in the last stage. If distortion exists at the grid of the output stage, then the output of the preceding stage should be checked, then its input, etc., working back toward the first stage in this manner until the distortion is localized. When the offending stage has been located, it is necessary to test voltages, etc., in the stage where the distortion exists rather than to make haphazard tests throughout the receiver.

The tubes should always be tested first. A defective tube is often the source of distortion trouble and although a tube tester will not point out a defective tube in 100% of the cases, it will do so in the majority

of cases. If there is any reason to doubt the merits of a tube, it is better to check it by substituting a tube known to be good.

### Coupling Condensers

No one method can be claimed to be the universal solution to tracking down the source of distortion in a radio receiver. Each case is an individual one and poses its individual problems. It is of paramount importance to utilize one's knowledge of theory together with logic and reasoning in analyzing distortion troubles. For instance, one of the most common offenders in audio stages is the leaky coupling condenser, which is connected between the plate of one stage and the control grid of the following stage.

In most cases, this condenser is not "dead shorted" but has a high resistance leak, sometimes of the order of several megohms. It would be a comparatively simple matter to apply the test leads of any voltmeter between the grid end of the condenser and B— in order to determine a "dead short" as the grid potential would be the same as the plate potential of the preceding stage and therefore a high positive reading would be obtained on the meter. Logic points out, however, that where the leak is in the order of megohms, there would be little use to expect a reading on an ordinary low resistance voltmeter as the I-R drop across the condenser would be equal to approximately the plate voltage of the preceding stage the instant that the meter became a part of the circuit.

If a vacuum tube voltmeter is used, (Fig. 2) the presence of any positive voltage at the grid can be readily determined, as this type of meter does not draw current from

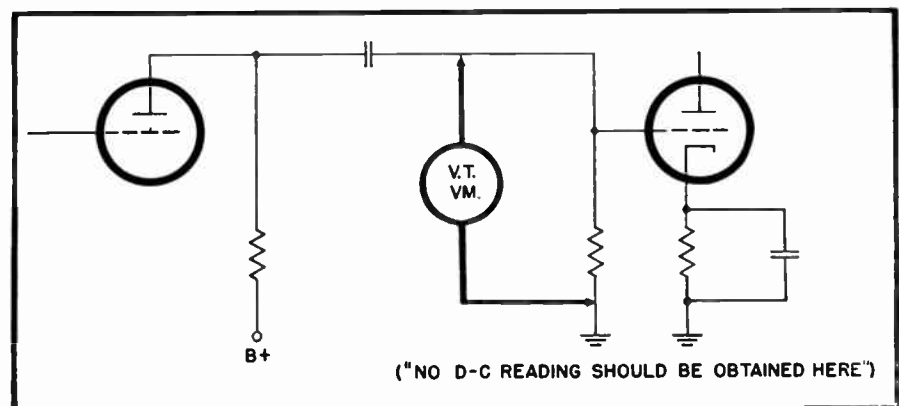

Fig. 2. If the vacuum tube voltmeter indicates the presence of a voltage drop across the grid resistor, the coupling condenser is probably leaking.

the circuit. It will not be necessary to disconnect the condenser from the circuit. Where a leak is suspected, the tube, which has its grid connected to the condenser in question should be removed from its socket before dismissing the possibility of leakage. flow of grid current may sometimes reduce the voltage at the grid to a minimum, or the bias which is developed across the cathode resistor may be sufficient to cancel out the positive voltage which would otherwise be present. It must also be remembered that if a fixed bias is being applied to the grid, that this bias may be greater than the positive potential. The bias voltage would be less negative than normally, if the coupling condenser is leaking because of the I-R drop which will consequently take place across the grid load resistor. A comparison should be made between the bias supply voltage and the voltage at the grid. A leaky coupling condenser will be indicated if a considerable difference exists between the two readings (see Fig. 3).

### Overloading

As previously stated, overloading may take place in one or more stages when the amplitude of the input signal is excessive. In some cases, the signal may swing the grid-voltage beyond the plate-current saturation point. The grid may swing positive and draw current, or the grid voltage may swing past the plate current cut-off point. An oscilloscope is an ideal instrument for detecting such conditions. A sinusoidal voltage from the signal generator may be fed into the input of a circuit and a comparison between the input and output waveforms will detect the presence of overloading. If the serviceman does not have access to an oscilloscope, there are other methods of approaching the problem.

We know that the grid of a class A amplifier should never become positively charged. A positive potential can be readily detected with the VTVM and indicates overloading (see Fig. 3). It should be remembered that the grids of a class B output stage may normally swing positive during the cycle of operation.

A D-C milliammeter can also be used. We know that the average plate current flow should remain constant in a push-pull class A amplifier. Therefore, the reading on a

D-C milliammeter placed in the common B+ lead to such a stage (Fig. 4) should remain the same and overloading will be indicated by any fluctuation of the meter reading.

A VTVM connected to the plate will also detect any current fluctuation, since any change in current flow will produce a corresponding change in plate voltage, although the voltage change may be very slight if the voltage regulation is good. In a stage containing only a single tube, overloading will not necessarily cause any change in the average plate current, because both the negative and positive halves of the cycles are affected. An upward fluctuation of class A amplifier plate current will indicate excessive negative bias, whereas a downward fluctuation of plate current will indicate insufficient negative bias. Grid current flow in a class A amplifier will indicate either excessive signal voltage or insufficient

negative bias, or a combination of both.

### A. V. C.

Improper A. V. C. action may be the cause of incorrect operation of the R-F or I-F stages.

The great majority of present day receivers utilize the diode detector A. V. C. system. A trouble often encountered in this circuit is that of too strong an A-V-C action. Such a condition will not only reduce the sensitivity of the receiver but serious distortion may result, especially if the A-V-C voltage becomes strong enough to bias one or more tubes beyond their cut-off. If one or more R-F stages should have its grid driven negative to the extent that plate current flow ceases entirely during the negative half of the applied signal, the tube will tend to act as a grid bias detector, and a form of distortion known as "cross modu-

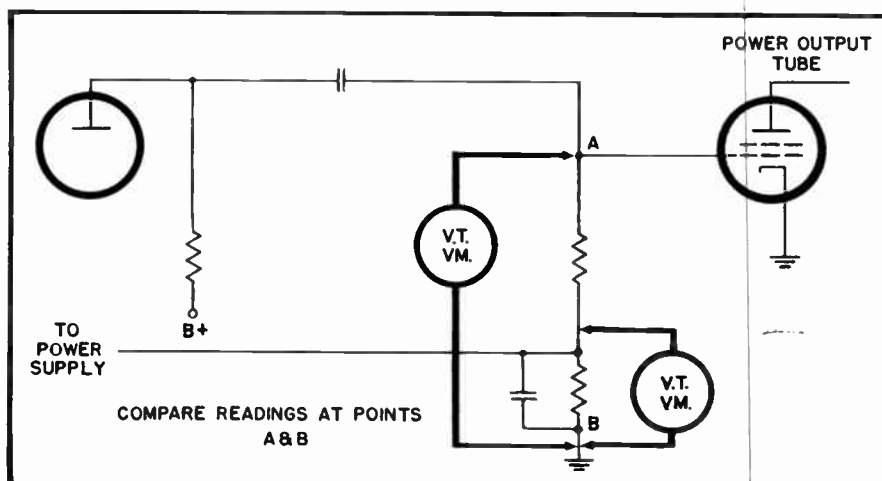

Fig. 3 Taking two successive readings as shown above, the coupling condenser may be checked. If there is a considerable difference between readings the condenser is probably bad.

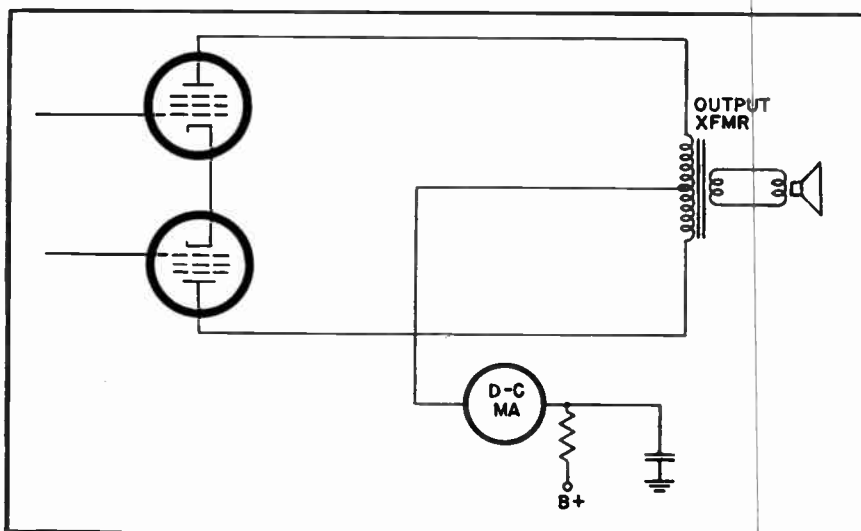

Fig. 4 A d.c. milliammeter connected as shown may be used to check the operation of a push-pull class A amplifier.



lation" results. Two stations will appear to come in together. Such a condition is not always the fault of the A-V-C action, however. The D-C bias supplied to the tube may be too great or the fault may lie in the tube itself. The cut-off point of remote cut-off, or variable Mu tubes, which are used in A-V-C controlled stages, tends to approach zero grid bias as these tubes age. New tubes should be substituted before concluding that some other trouble exists. In a receiver operating normally, the A-V-C voltage developed may run as high as 40 volts, depending upon the amplitude of the signal and the number of tubes under control. Generally, the fewer the number of tubes controlled, the greater will be the A-V-C voltage developed for a given signal strength. If it becomes apparent that the A-V-C voltage is too great, the A-V-C diode tube should first be checked by substituting a tube known to be good. A gassy diode will cause excessive A-V-C voltage to be developed. This diode is often incorporated in the same envelope as the 1st A-F amplifier triode such as in the 6SQ7, 7C6, etc. The A-V-C and, or the detector diode may also be incorporated in a separate envelope such as the 6H6 or 7A6. If the tube is not faulty, the diode load resistor has probably increased in value. If this load resistor becomes lower in value, the A-V-C action will not be great enough, that is, the voltage developed will not be sufficient and a strong signal may overdrive one or more of the stages under control. The absence of A-V-C voltage is usually accompanied by fading as well as poor tone quality. In many cases, the volume control potentiometer itself serves as the A-V-C load resistor as well as the audio load resistor as shown in Fig. 5. It is important that the potentiometer be of the correct value, not only to assure the correct A-V-C voltage being applied to the stages under control, but also in order to preserve the time constant. If the value of the load resistor or any of the associated filter condensers or resistors in the A-V-C line should change in value, or if they are replaced with the wrong values, the time constant will be upset. The effective time constant, in seconds, in an R-C circuit is equal to the product of the resistance in megohms and the capacity in microfarads. The

optimum value of time constant is a compromise value which is sufficiently great to provide adequate filtering and yet small enough to prevent too long a time lag from being introduced, which in turn would prevent the A-V-C action from keeping pace with rapid fading and tuning operations.

Generally the time constant of an A-V-C circuit should not exceed 0.1 of a second. Many receivers are so designed as not to allow an excess of about 0.06 of a second. Should the time constant be too great, it will become difficult to tune in stations accurately to the point of resonance and the signal will be received with a "popping" sound. On the other hand, if the value of time constant is too small the gain of the stages under control may become a function of the modulation, due to insufficient filtering action. This condition will result in distortion due to the audio frequency modulating the R-F signal, and may also result in howling due to feedback. A leaky by-pass condenser in the A-V-C line will reduce the A-V-C voltage and also lower the time constant. The slight-

est leakage in one of the by-pass condensers will seriously affect the voltage because of the high values of resistors used in these circuits. An absence of A-V-C action will usually be indicated by blasting as the receiver is tuned and the output will usually be accompanied by excessive static-like noise.

If the small R-F filtering condenser across the audio load resistor ( $C_1$  in Fig. 5) should become open, or be too low in value, a high pitched whistle or howl will be introduced into the output. The value of this condenser is in the order of micro-microfarads. On the other hand, if the value of this condenser is too large, the high frequency response will be affected and a loss of volume will result.

Small filter capacitors are often ( $C_2$  in Fig. 5) connected between the plates of one or more of the audio stages and ground. The same symptoms generally apply to corresponding defects associated with these condensers as with the detector R-F filtering condenser.

Howling will sometimes originate

→ To Page 53

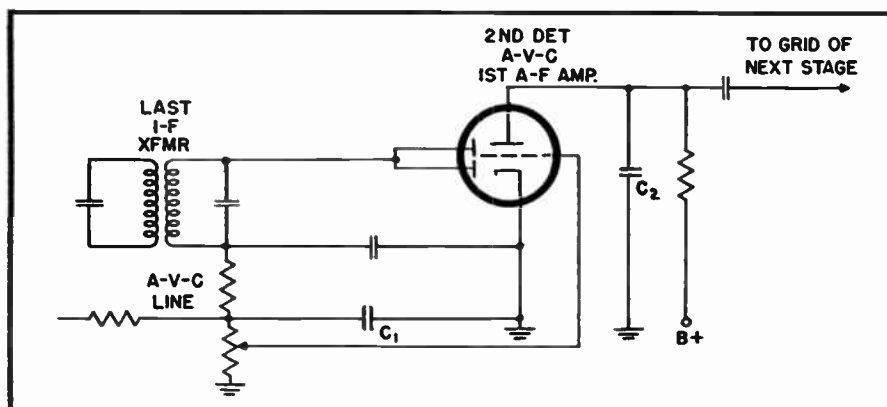

Fig. 5 A simplified circuit showing a combined second detector, a.v.c., first audio amplifier.

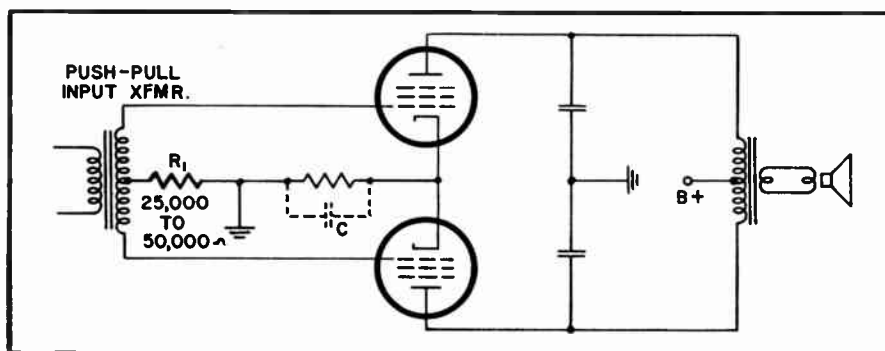

Fig. 6 As explained in the text, the insertion of  $R_1$  will often eliminate parasitic oscillations.

# interference



## A SIMPLIFIED APPROACH TO THE PROBLEM OF ELIMINATING MAN-MADE INTERFERENCE.

by Paul M. Miller

ONE of the biggest headaches in the radio service business is that old complaint "It's noisy" or "It has too much static."

Most servicemen shy away from such "nuisance" jobs, often recalling former disappointing attempts—disappointing because of lack of knowledge of the fundamentals in this specialized field of noise, lack of proper equipment, and probably a large portion of lack of confidence. A common attitude of Mr. Average Serviceman, when confronted with noise problems, is that of apathy. The customer feels this, and gets the impression that little or nothing can be done for him. The serviceman briefly explains to him that there is nothing wrong with his radio, but that he has "interference" in the vicinity of his home, causing the disturbances in his receiver.

It is much better and far more profitable to explain to the customer that although his radio is not defective, interference is appearing in the set at its location and can probably be removed, or at least minimized, with filters, wave traps, a new antenna, a new location for the old antenna, (lead-in's too), shielding certain wires inside the set, or locating and repairing the interfering device itself.

Since Television has arrived and this same interference can be seen on the screen, as well as heard in the speaker, the customer will no longer accept interference as he has in the past.

He knows that a television program is not satisfactory when the screen is cluttered up with "noise

pattern," and he also knows that the modern serviceman goes to great lengths to eliminate this noise and static. And following this line of logic he reasons that if noise can be removed from television receivers with a little effort, it can also be removed from his own radio—and he is correct. *Most* interference can be removed or reduced to an acceptable level.

This article is intended to simplify the subject and create a more favorable attitude by the serviceman toward coping with these jobs. After the serviceman gains a little experience servicing interference, the work should prove to be no more time consuming than an ordinary service call to the home.

Of course we are all familiar with the various types of receivers, but let's run through them again, looking at them as they are affected by interference. Most numerous, of course, are the AC-DC types (including Portables). Most of these sets have no RF stage. Lack of amplification before the mixer causes a decrease in the signal to noise ratio.

The signal from the antenna comes directly into the mixer tube, through a broadly tuned circuit. AC-DC sets are thus more sensitive to power line interference.

The straight AC type receivers usually have much better selectivity and sensitivity, more tuned circuits, better filtering, power line isolation, higher operating voltages, and the *important* advantage of having a *ground* connection. A good ground connection cannot be over-emphasized for its noise reducing qualities,

especially in high-noise districts and locations that are some distance from a broadcasting station. *Many times a ground connection will be all that is needed to reduce the interference to an acceptable level.*

Then there are the Multi-band radios. These receivers operate on the short wave bands as well as the broadcast band. The owner of such a receiver, when switching from the broadcast band to a short wave band immediately notices an increase in the noise level. The signals are not as strong, his antenna is usually a gross mismatch for the band he is tuning, and at the higher frequencies, receiver noise begins to appear in objectionable quantities.

FM sets are not subject to the same types of interference as AM sets. Interference is primarily amplitude modulated and the FM limiting circuits clip the noise to the signal level and it is not nearly as noticeable. The FM discriminator circuit does not respond to amplitude modulated noise when a reasonably strong carrier is being received. FM sets have problems all their own, one of which is hiss and receiver noise between stations. This is due mainly to the high-gain tubes and circuits used. Some of the later model FM sets are being manufactured with squelch circuits incorporated in the chassis which remove this noise during tuning between stations.

### Types of Interference

Atmospheric noise in most cases is caused by lightning (not necessarily in the vicinity). This is a difficult



type of interference to conquer because the noise level is dependent upon many varying factors such as frequency, weather conditions, the season of the year, etc. Because of atmospheric noise, radio communication service on the lower frequencies is limited.

Starting at about 30 megacycles, the atmospheric noise is usually lower than the receiver noise (noise generated by the thermal agitation of resistance parts of radio and the flow of current in the tubes).

A large percentage of interference from amateur signals can be removed quite easily. In most cases it merely depends upon the point of entry of the interfering signal. Methods and equipment for removing "Ham" interference will be discussed in Part 3. Probably the most familiar source of interference is small appliances such as electric razors, fans, fluorescent lights, refrigerators, elevators, arc welders, diathermy machines, X-ray machines, oil burners, ignition systems, street cars, defective antennas and lead in's, etc. In small appliances, noise is caused by the operation of the device itself, creating a high-frequency oscillation. Many types of appliances such as toasters, irons, etc., cause small sparks (arcs) as a result of change in the electrical conditions of the device, which are essential to its operation. These appliances actually act as small transmitters setting up a disturbance which may effect reception at a considerable distance.

The greatest intensity of radio frequency interference falls in the frequency band between 150 and 300 kilocycles, and continues up into the high frequency and very high frequency bands at reduced levels.

### Points of Entry

Interference may enter the receiver at any of numerous points. The most common points of entry are the Power Line and the Antenna.

The less common points of entry are the Intermediate Frequency stage, the Audio stage, the Detector stage and the Oscillator stage. A little experience diagnosing interference problems will often enable the serviceman to classify the *type* of interference upon hearing it.

Every serviceman recognizes the 60 cycle hum in a speaker as coming in through the power lines and rectifier circuit, and he knows that a

filter condenser to ground will stop it. He has *filtered* this interference out. He also recognizes the code signals of a local radio amateur's station, so he installs a wave trap of the correct size, tunes it, and the code disappears. He has *tuned* this interference out. So it is with most other types of interference. They can usually be filtered, tuned, and often grounded out. Interference can be radiated from the device itself, or can be radiated by the power lines carrying the noise. Power lines can pick up noise as they pass a device radiating noise, and carry it to a receiver connected somewhere along the line. The chassis of a radio can pick up radiated noise, and can introduce power line noise into various parts of the circuit. So it is ex-

tremely important to have a good solid ground collection at the receiver. (Remember AC-DC chassis are sometimes exceptions!)

If the source of interference is close to the receiver, the noise may be picked up and amplified by the grid and plate leads under the chassis, especially if they are long, or unshielded. The antenna can pick up interference that is radiated from the interfering device or from the power lines carrying the noise.

It is most desirable to eliminate the interference at the *source* instead of at the receiver. Again, if the source of the noise is close enough, and strong enough, it may saturate the set with its effects. It can enter through the power line, the antenna, the individual wires of the set, or the

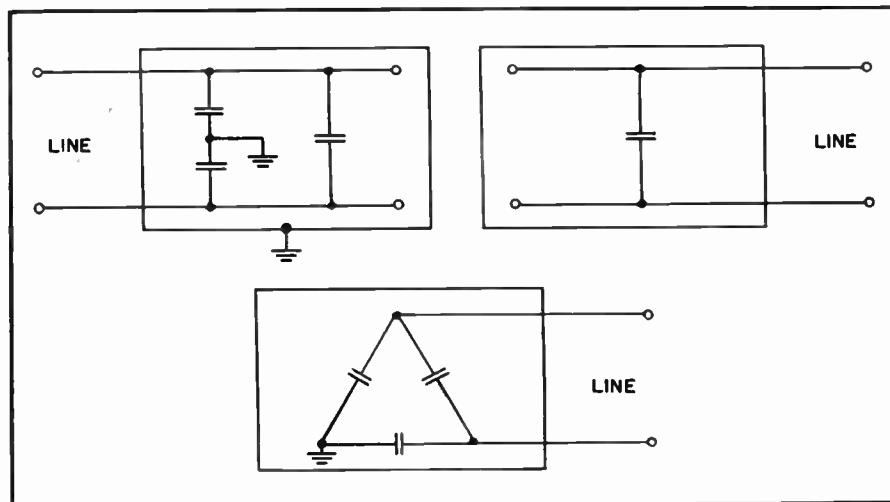

Fig. 1—Circuit diagrams of three capacity-type filters.

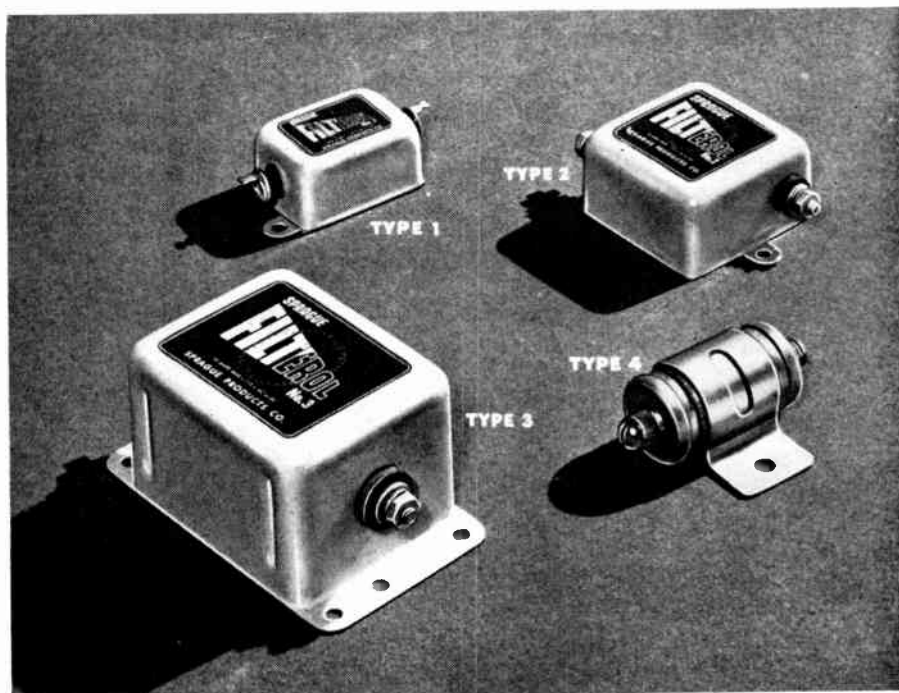

Fig. 2—Sprague Filterols. These units are effective high frequency filters.

chassis. Attacking it at one entry point at the receiver often does little good, while one little filter at the source will clear it up.

### Theory of Filters

An interference filter is a small container, enclosing one or more condensers and often choke coils, in various arrangements. Most filters can be attached either to the power line or to the device causing the disturbance, but of course it is best to install the unit at the source, wherever possible. Some filters are installed in series with the line, some are installed across the line. Most capacity type filters are installed in parallel with the line, or from line to ground. There are no current limitations on filters of the capacity type, however those filters containing coils or chokes or a combination of chokes and condensers should be selected with a view of the current requirements of the receiver or the device to which the filter is attached.

Interference filters act in three ways: 1—Suppression. 2—Rejection. 3 — Diversion. Suppression of the noise at the source, rejection of the noise at the receiver, diversion of the noise to ground along the lines.

Every serviceman knows that a small condenser between the plate of an output tube of a receiver and ground will attenuate the higher frequencies, a larger condenser will attenuate the lower frequencies, and a still larger condenser will just about attenuate everything—signal and all. The frequency of interference is a major factor in filter design.

Most of the interference jobs that the serviceman will run into will be caused by home appliances, whose frequency range is not too broad. Simple capacitor filters will usually suffice in these cases where the noise is not too severe. In other cases the frequency is so high that an ordinary capacitor filter is useless. The effectiveness of a high-frequency filter depends to a large extent upon the correct values of inductance or capacity, or both, their placement in the container, length and type of leads. The Sprague company recently informed the author that they found the mechanical design and construction had a very great effect on the attenuation characteristics of their filters. A certain combination of capacity and inductance may figure out mathematically to resonate at a cer-

tain frequency, but placing the components close together to save space, pouring pitch or insulating compound all over them, and enclosing the whole business in a metal container, can change things considerably.

### Capacity Types

The simplest form of noise filter is merely a condenser of suitable capacity shunted across the line, or from the line to ground. It works well in many cases, but simple condenser arrangements are not satisfactory where it is necessary to attenuate high noise levels over a broad band of frequencies.

Schematic diagrams of capacity type filters are shown in Fig. 1. Simple capacity filters that are effective at comparatively low frequencies become inductive at the higher frequencies and their attenuation suffers. During the war an urgent need arose for a filter that was effective at the high-frequencies of military communications and radar. The Sprague Filterol No. 4 is just such a filter. (See Fig. 2) They call it a "Hypass" filter. It is a capacity type but has a fundamentally different design from conventional type capacitor filters, in reality are three terminal networks which are non-resonant at frequencies up to 150 megacycles or more. Whereas the conventional type of capacitor used as a filter to bypass is a two terminal device connected across a circuit, or from circuit to ground. Hypass capacitors, being three terminal networks, are applied by connecting the main terminals in series with the circuit to be filtered, and the metal case of the filter is connected to ground.

The circuit applications of Hypass capacitors include those where it is desired to eliminate the conduction of high frequency currents, such as filament and power supply leads, high frequency filtering of rotary machines, elimination of conduction between units operated from common power supplies, etc. A particularly valuable feature of these Hypass capacitors is the grounded case which can be mounted through chassis or bulkheads to permit both filtering and shielding for "feed through" applications.

### Capacitive-Inductive Types

These are filters that are a combination of condensers and chokes in various arrangements, some of which are shown in Fig. 3. Some arrangements are known technically as Pi filters, or twin Pi filters. The attenuation of a Pi filter is constant over a broad frequency range, at least its attenuation characteristics are far greater than a capacity type filter. Attenuation in order of 80 db is possible with a good design of Pi filter. That is a ratio of 10,000 to 1. In ordinary small motors, household appliances and other cases where the interference is not too severe, attenuation in the order of about 20 db will be sufficient, in the more severe cases about 40 db is satisfactory.

Capacity-Inductive filters also have their limitations. A Pi filter that is designed to be effective up to a few megacycles becomes practically useless at 30 megacycles. It is the design that counts. Thus the serviceman who is accustomed to installing "a couple of condensers" in the AC line to "eliminate noise" will find it less work to let the filter design en-

→ To Page 49

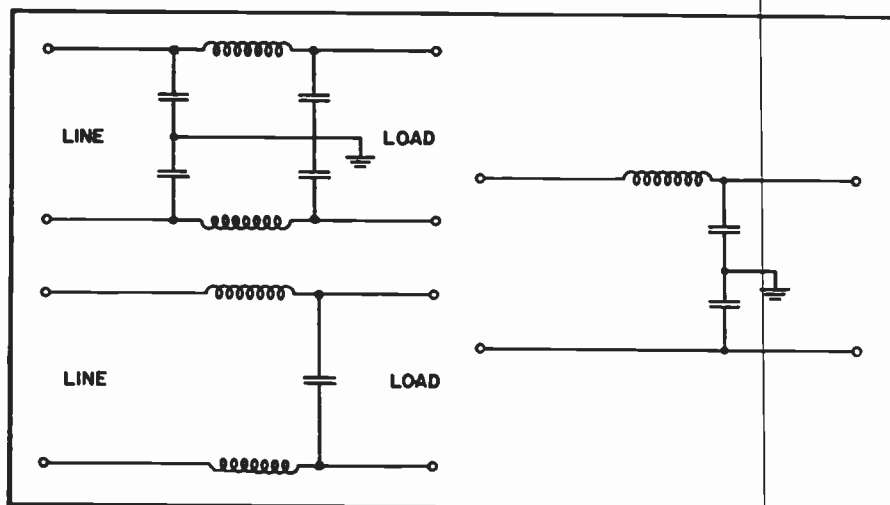

Fig. 3 Three types of capacitance-inductance filters.



# A POCKET FM SIGNAL GENERATOR

**HERE'S A SWEEP GENERATOR THAT'S  
REALLY PORTABLE!**



Something new in the way of FM signal generators is exemplified by the RCP Model 720. The instrument is very small and light and may be conveniently carried in the service kit. Although not as elaborate and complete as the larger FM generators, this unit includes all the features necessary to do signal tracing and alignment of FM receivers.

This little signal generator will be very useful in the service shop which is not yet encountering a great number of frequency modulation receivers.

The 10.7 mc. standard intermediate frequency signal and output at 88, 98, and 108 mc are selected by means of a "slide rule" type switch. These frequencies are preset and one position on the switch corresponds to each one. Power output is comparable to the output of larger models, and is controlled by the knob on the panel.

The internal view of Fig. 1 shows the main components and how they are mounted. In the center near the top is the selenium rectifier and to the right on the other side of the metal partition are the filter condensers. Just below the rectifier and near the panel are the output potentiometer and the neon bulb which is used as an audio oscillator. Below these are the miniature tube (12BA6), the coil and the trimmer condensers.

The circuit is shown in the diagram of Fig. 2. The oscillator tube will be recognized as one which is now being used in many AC-DC FM tuners, namely the 12BA6. The tube is connected as an electron coupled

Hartley oscillator. The coil is divided into two main parts, L1 and L2. The switch selects different combinations of these sections to adjust the oscillator to the desired output frequencies.

The neon bulb is used as a relaxation oscillator to produce the audio modulation frequency. This bulb is connected between B plus and ground, in series with a 2 megohm resistor. A 1000 mmf condenser connected in parallel with the neon bulb provides the capacity needed for

oscillation. This audio oscillator is coupled to the screen of the RF oscillator so as to phase modulate the RF signal. With a single audio modulating frequency phase modulation and frequency modulation produce identical signals. Thus in this generator we produce an FM signal.

Plate voltage is obtained from an AC-DC supply in which a selenium rectifier is used. The output of the rectifier is passed through an RC filter composed of a 5000 ohm resistor

→ To Page 48

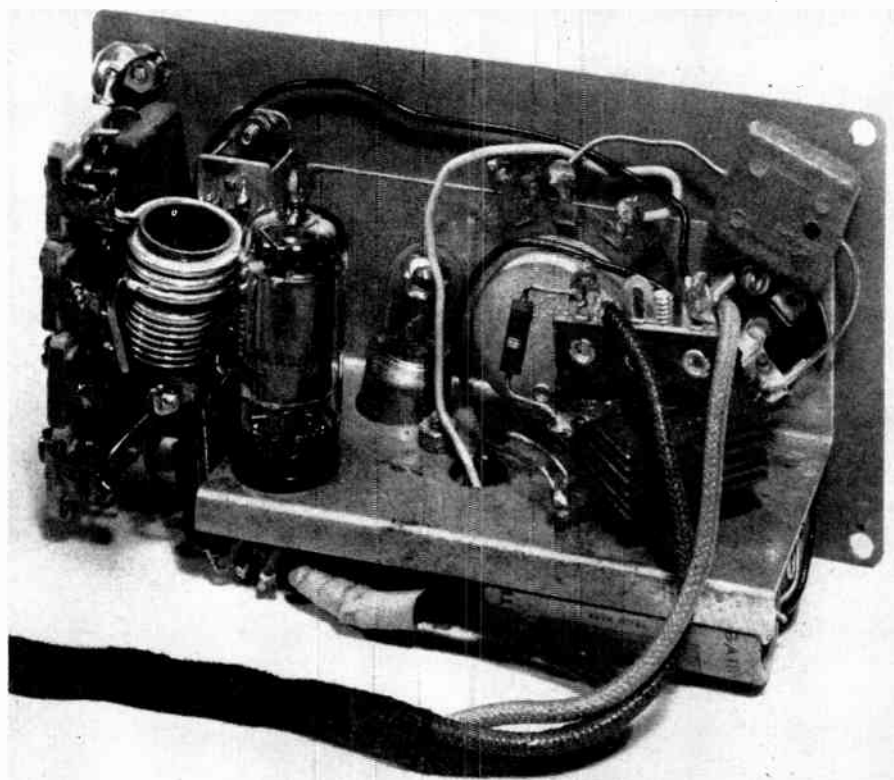

**Fig. 1** Photographic view of the inside of the Radio City Products Model 720 pocket FM signal generator.

**A NEW SIGNAL GENERATOR COVERING ALL F.M. AND TELEVISION FREQUENCIES. EQUIPPED WITH INTERNAL SWEEP, AVAILABLE FOR 40 KC. TO 10 MC., IT FILLS THE NEED FOR A TELEVISION ALIGNMENT INSTRUMENT.**

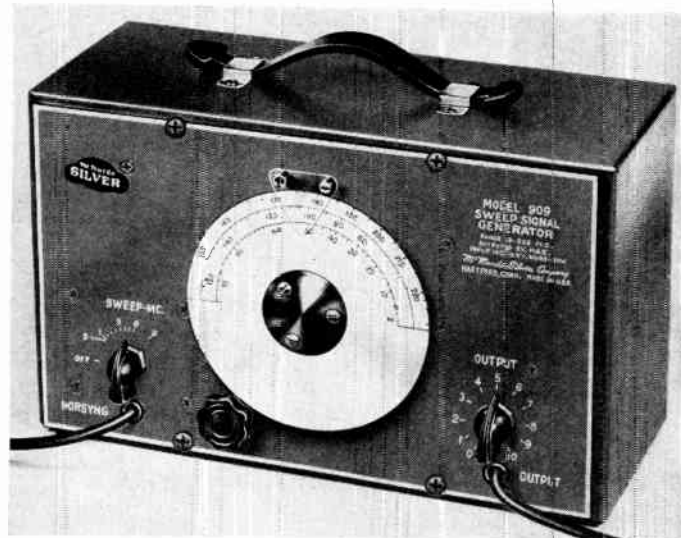

# A SWEEP GENERATOR FOR FM AND TELEVISION

by **McMurdo Silver**

**U**NTIL the advent of the broad-band i.f. amplifier circuits, found in FM and TV receivers, visual alignment has deserved little attention from the service technician. In the servicing of conventional AM receivers, the pass-band width of the usual 455 kc. i.f. amplifier has been so narrow, so sharp, that alignment by signal generator test signal and output meter has been quite satisfactory. An occasional exception to this rule has been the infrequently encountered "high fidelity" AM receiver having variable i.f. selectivity. Even in these seldom encountered cases, however, good alignment could be effected by output meter indications. This has been true because the means of broadening the i.f. circuits for high fidelity reception has been by adjustable overcoupling of i.f. transformer primaries and secondaries—which could be properly aligned for both sharp and broad conditions by simply loosening coupling (increasing selectivity) and then aligning by fixed-r.f.-signal and output meter method at sharpest selectivity setting.

Such technique cannot be applied to either FM or TV i.f. amplifiers, for they are not made with variable selectivity. Instead i.f. transformer primaries and secondaries are overcoupled at the start, or mighty close to it for all practical service purposes. This means that some method of

alignment must be employed which will insure proper centering of the i.f. pass-bands at the specified i.f. center frequency, together with symmetry of the selectivity curves upon either side of center. This can be accomplished by making a multiplicity of single frequency measurements of the amplifier being aligned, at, above and below i.f. center frequency, plotting same into a curve, examining the curve—and then starting all over again in a long, tiresome and exasperating attempt to accomplish by AM signal generator and output meter what could have been accomplished in five to ten minutes using a sweep (frequency modulated) signal generator and oscilloscope. It is, therefore, safe to say that in practical service work neither success may be assured nor profit earned by the technician not equipped with a sweep generator and 'scope.

These facts are so well recognized by factory engineers, and by experienced service technicians, as to be substantially impossible of question. The only question has been as to where to obtain a suitable sweep generator at much less than a king's ransom, since every worthwhile service shop already has a good cathode-ray oscilloscope. The author feels that the answer to this "\$64 question" is the instrument described in this article. The instrument is illustrated and described, together with

operating suggestions applicable to all FM and TV receivers.

## Requirements

For the alignment of pre-war as well as currently produced FM and TV i.f. amplifiers, r.f. signals variable in amplitude from substantially zero to about  $\frac{1}{2}$  volt are required throughout the entire range of 4 to 216 mc. Pre-war FM receivers coming in for service will often be found to have intermediate frequencies of 4.3 mc. and occasionally lower. The newest TV receivers go up to 216 mc. To provide conservative "overlap" at each end of this range, the new Silver Model 909 Sweep Generator was designed to cover the continuous range of 2 through 226 mc.—with no gaps to cause inadequacy either today or at some later date when frequencies lying within any gap left in the generator frequency range might come into use. Frequency modulation, or periodic and rapid sweeping of the generator's r.f. output frequency must be panel-knob controllable from as little as 40 kc. to as much as 10 mc. Frequency stability must be of the highest, construction and circuit design of the simplest to insure dependable service over long periods of time without attention or failure.

So stated, the requirements of the ideal sweep generator do not sound very imposing. That they are far



more difficult to attain than to state is proved by the complexity and high cost of instruments heretofore offered in attempts to satisfy these requirements. It is believed that the instrument herein described is a long-needed relief from both of these drawbacks. But let the design features of the instrument prove the point.

Fig. 1 illustrates a pleasing simplicity of controls and arrangement. Fig. 2 illustrates a simplicity of construction surprising in terms of past efforts toward such an instrument. Fig. 3 illustrates its circuit diagram—again a presumed welcome relief from complexity. Let us examine the design in terms of Fig. 3.

### The Circuit

Only three "tubes" are required, though this is a deceptive statement, since each of the three envelopes seen in Fig. 2 is a dual-tube. (See Fig. 3). One triode section of one of the new 12AT7 u.h.f. dual triodes functions as a fixed-frequency oscillator operating at 114 mc. This tube is diagrammed as 12AT7b at upper right of Fig. 3, together with its inductance-tuned coil L1, grid condenser C4a, grid leak R4a and output load resistor R2 in its cathode return circuit. At upper left is the second half of this 12AT7. This tube, 12AT7a, functions as a reactance modulator and is used to periodically sweep the frequency of 12AT7b over a range of frequencies above and below 114 mc. determined by the setting of SWEEP control P1. P1 is fed with 60 cycle a.c. from one side of the secondary of power transformer T1 through voltage-dropping resistor R5. Different settings of P1 yield frequency sweeps of from 40 kc to over 10 mc. The sweep is at a 120 cycle rate when the instrument is fed from a 60 cycle power line. If the mains frequency is 50 cycles, the sweep rate will be double this frequency, or 100 cycles. This doubling of rate of frequency sweep of the reactance modulated oscillator in terms of the local a.c. mains frequency occurs because, as mains frequency starts from a negative and moves to a positive voltage peak the r.f. oscillator frequency is swept from, for example, 5 mc. below to 5 mc. above 114 mc. As the mains voltage then reverses direction and changes from positive to negative, the oscillator frequency is similarly

swept from 119 to 109 kc. (in this example), but in reverse direction.

So far, we have variable frequency-modulated r.f. output at one frequency only — and not a much used one at that. But, most important, we have a panel knob which when set to a given position on its scale, will always produce the same magnitude and linearity of frequency sweep — something impossible were any attempt made to sweep a variable frequency, rather than this fixed frequency oscillator.

12AT7c in Fig. 3 is a variable frequency oscillator tuning over the frequency range of 112 to 77 mc. It consists of the tube, trimmer capacitor C2, main dial controlled tuning capacitor C1, inductance-trimmed coil L2, grid leak R6 and grid condenser C4. Its output is fed to mixer-detector 12AT7d through coupling capacitor C5, exactly as the fixed frequency oscillator 12AT7b output is fed to the mixer grid through coupling capacitor C8. R.f. output is taken through a co-axial cable in series with d.c. insulating capacitor C6 across a selectable portion of mixer OUTPUT load potentiometer P2.

At the bottom of Fig. 3 is diagrammed an essentially conventional full-wave rectifier power supply comprised of S1, T1, X4 rectifier tube and filter C7, C7a and R7. It will be noted that the customary filter choke has been replaced with re-

sistor R7. This is permissible since some voltage drop in the filter is desired, current drawn by the 12AT7's is quite low, and space and cost is saved by this logical substitution.

### Obtaining the Frequency Coverage

It is probable that the reader is by now wondering how a range of 2 through 226 mc. is obtained from this generator employing one oscillator fixed at 114 mc. supplemented by a second oscillator tuning from 112 to 37 mc.—and having no band-switching: The answer, although new and believed original, is simple once the new principle involved is grasped. Band 1 of this instrument covers 2 through 37 mc. A little quick figuring will reveal that this is the difference-frequency range between the two oscillators. Thus when the variable oscillator is tuned to 112 mc., the fixed oscillator operates at 114 mc., and the difference frequency is 2 mc. Similarly tuning the v.f.o. to 37 mc., subtracting 37 from 114 mc. yields output at 77 mc. This is conventional beat-frequency oscillator technique.

What about the second and third frequency ranges? The second range is calibrated upon the center dial-scale as 60 through 151 mc. It is provided by the second harmonic of the first range. Output throughout this second range is closely compar-



Fig. 1 This illustration shows one of the many factory tests—checking the pass-band of the Television Receiver (right) upon a scope (center) with the new Sweep Generator (front).

able to that throughout the first due to the short excitation-cycle of the oscillator at high frequencies. This is simple enough, but what of the third range of the band-switchless oscillator? Every radio man knows that when two oscillators beat together both sum and difference frequencies result in a suitable mixer. If we mentally add the 144 mc. of fixed frequency oscillator to the 37 mc. output of the variable frequency oscillator, we get 151 mc. If we add 112 to 144 mc., we get 226 mc. These are the limits of the third band exactly as calibrated upon the dial of Fig. 1.

Thus the use of the difference frequency range, the 2nd harmonic thereof, and the sum frequency range of two beating oscillators—for the first time in radio's history to the writer's knowledge, gives three ranges without band-switching—and band-switching of u.h.f. oscillators operating above 10 megacycles is not a nice thing to contemplate in terms of stability, contact resistances, etc.

All of these output frequencies are simultaneously present in the output of the instrument. At first this might seem undesirable. Actually it is of no consequence, since they will be so far separated in frequency that even the most badly misaligned FM or TV i.f. amplifier which can be imagined could respond only to the particular frequency set up on the dial. This is not strictly true, but at the one point where it is not true, far from being a disadvantage, it turns out to be a distinct advantage! The only cross-over point which significantly occurs in the range of the two oscillators is at 57 mc.—the exact center of one TV channel. When output is set at this frequency, with sweep applied as for visual alignment, the pleasing result of this cross-over is a helpful marked "pip" appearing on the 'scope i.f. pass-band picture at the exact center of its proper curve.

### Other Considerations

A sweep frequency signal generator is not intended for receiver sensitivity measurement. Sensitivity is always measured with an unmodulated r.f. signal with no frequency sweep applied. Sensitivity of an FM receiver, for example, would be measured with an AM signal generator in terms of microvolts input needed to saturate the receiver's lim-

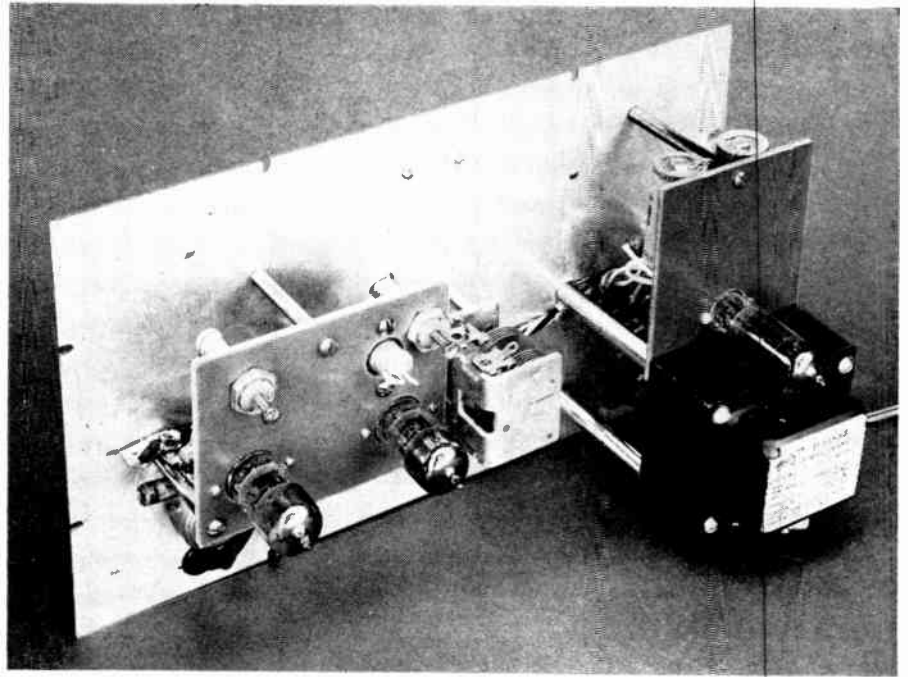

Fig. 2 The simplicity of this wide range FM/TV Sweep Generator is extraordinary, as its interior view shows.

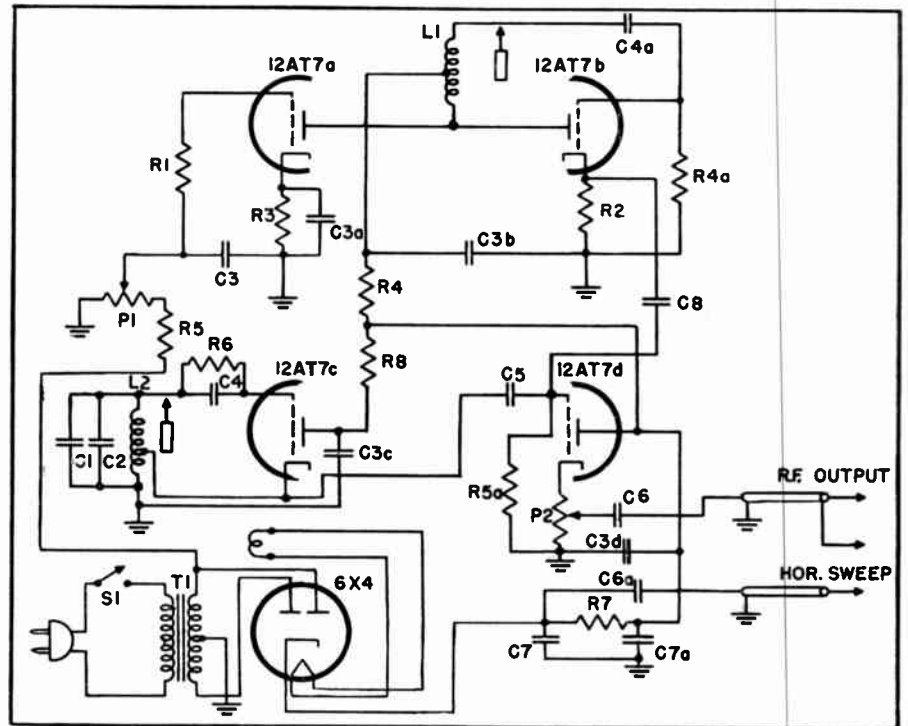

Fig. 3 A schematic diagram of the new frequency sweep signal generator,

iter tube. Thus, the problem of strays which so seriously besets the usual AM signal generator used in making sensitivity measurements does not apply to a sweep generator. Instead the problem becomes not how low the sweep generator's output may be cut down, but how high it may be made. This is because oscilloscopes are rather insensitive "volts-meters," and require that plenty of

signal be fed into the average i.f. amplifier to give a usefully high vertical trace of the selectivity curve being scrutinized. At least one set maker has insisted that at least 2/10 volt is necessary from any acceptable sweep generator. The instrument illustrated more than satisfies this, or any reasonably imaginable, output requirement with its 1/2 volt output.

→ To Page 46



# NOW! FAMOUS \$500 TELEVISION COURSE YOURS WITH PHOTOFAC FOLDERS!

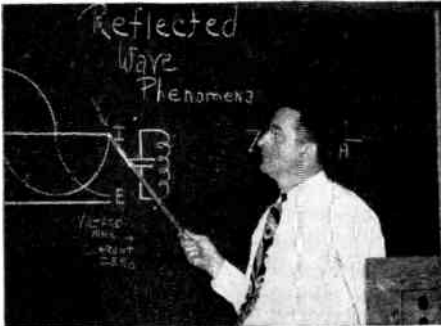

Mr. Albert C. W. Saunders' background includes association with the Marconi Company, teaching experience at Harvard and M.I.T.; founder Radio Technician's Guild; full member I.R.E.; Graduate, Portsmouth College, England. Mr. Saunders gave the first actual television demonstration in New England in 1935.

## Famous Saunders' Course **EXCLUSIVE** in Howard W. Sams' PHOTOFAC

We have been able to prevail upon Mr. Saunders to transcribe his famous course on Television for PHOTOFAC *exclusively*. The only other way you can get this course is by paying \$500 and attending the Saunders School. *Now*—with PHOTOFAC at no extra cost to you—you can have this wonderful instruction that fits you for Television servicing!

## Get Ready to Make Big Money in Television Servicing with This Practical, Successfully Proved Instruction!

**NOW! AT NO EXTRA COST TO YOU**—you can have the nationally-famous \$500 Saunders' Television Course! It's the world's finest training—*practical* down-to-earth training that actually prepares you for Television and keeps you 'way out ahead of the game. Here's the *first real help* in Television for Servicemen—brought to you *exclusively* by PHOTOFAC and PHOTOFAC alone! If you want to stay in Radio Servicing, you can't afford to miss a single installment of this amazing Television Course! Read every word of this announcement and then ACT!

### Not Just a Book — A Complete Training Course in Television!

You get the actual \$500 Television Course, exactly as taught in the nationally-famous Saunders Radio & Electronics School at Newton, Mass. We literally bring this course to you in print—transcribed word for word from the original lectures, supplemented by graphic training aids, exclusive PHOTOFAC "exploded" views and hundreds of visual illustrations, prepared under Mr. Saunders' personal supervision. This is the same course attended by hundreds of established service technicians and by service personnel of leading set manufacturers—the same \$500 course!

### First Installment Appears in PHOTOFAC Set No. 38!

The Television Course will appear in regular installments in each PHOTOFAC Folder Set, beginning with Set No. 38. Each installment will include the *right* amount of material so that you will be able to digest it easily and completely between issues. Instruction will be kept up-to-date and will include the latest information promptly as it is available on the subject. There's no need to wait now for books that will never cover the ground adequately, or to buy books that are obsolete already. Be sure to order PHOTOFAC Set No. 38 *now*—and begin to qualify yourself for Television!

### PRACTICAL, CLEAR, EASY-TO-FOLLOW TELEVISION TRAINING

Experts in the field of Television and Radio training acclaim the famous Saunders Course. It is remarkable in its ability to simplify and explain the most complicated theory and practice. It describes the action of an electronic circuit so originally and simply that it can be visualized in an unforgettable manner. The Saunders Course avoids higher mathematics and engineering terminology beyond the experience of the practical man. You know where you are every step of the

way, and you bridge the gap between Radio and Television with quick, simple understanding that makes unfamiliar subjects easy to master. As you progress in the course, Television circuits will unfold and become as clear and understandable to you as the Super-heterodyne circuit. You will be able to follow and use effectively the practical servicing data on specific Television receivers prepared for you by PHOTOFAC. Get started in the Course today with PHOTOFAC Set No. 38.

### Get Television Training Worth \$500—Plus Incomparable Photo- fact Service Data at the Cost of PHOTOFAC Alone!

Here's the chance of a lifetime that really fits you for a profitable, successful career in Television servicing. Just think of it—you get the world's finest radio service data in PHOTOFAC—at only \$1.50 per set—and at the same time you train practically and successfully for Television with the finest course available in the country—a course worth \$500.00 that *costs you nothing extra!*

**DON'T MISS A SINGLE INSTALLMENT OF  
THIS TELEVISION COURSE! MAKE SURE  
YOU OWN IT ALL! GET STARTED WITH  
PHOTOFAC SET No. 38 TODAY . . .!**

***Yours! AT NO  
EXTRA COST***

**\$500 TELEVISION COURSE BEGINS  
IN SET No. 38. ORDER TODAY!**

**HOWARD W. SAMS & CO., INC.**  
INDIANAPOLIS 6, INDIANA

Export—Ad. Auriema—89 Broad St., New York 4, N. Y.—U. S. of America  
Canada—A. C. Simmonds & Sons, 301 King St., East—Toronto, Ontario

**PHOTOFAC SERVICE**

"The Service that pays for itself over and over again"

Mail This Order Form  
to your local Parts Distributor,  
or to HOWARD W. SAMS & Co., Inc.  
2924 E. Washington St., Indianapolis 7, Ind.  
My (check) (money order) for \$1.50 enclosed.

Send PHOTOFAC Folder Set No. 38, including the first installment of the famous \$500 Saunders Television Course.

Name.....

Address.....

City.....State.....

# Announcing New Addition



## THREE TYPES OF TERMINALS FOR FLEXIBILITY, CONVENIENCE

**TV1-501 AND TV1-502 ROD TYPES:** .160" diameter rod type terminals. For use with fuse or clip-type connections. Terminals are solid brass, silverplated and soldered directly to electrodes.

**TV2-501 SLOT-AND-THREAD TYPE:** .160" diameter with  $\frac{1}{16}$ " x  $\frac{3}{16}$ " slot in one terminal. Other terminal tapped 6-32,  $\frac{3}{16}$ " deep for "twinning" or convenient chassis mounting.

**TV3-501 DUO-THREAD TYPE:** One terminal tapped 6-32,  $\frac{3}{16}$ " deep full threads. Other terminal, 6-32, male thread  $\frac{1}{4}$ " length. Designed for convenient series or tapped series connections.

| Centralab Unit               | User                | Mfg. Part Number |
|------------------------------|---------------------|------------------|
| TV1-501<br>List Price \$1.75 | Andrea Radio Corp.  | HCH2701          |
|                              | Allen B. DuMont     | 3-14-41          |
|                              | Industrial Telev.   | 30-1299          |
|                              | Philco              | M-940173-1       |
| TV2-501<br>List Price \$1.75 | RCA-Victor          | 110504           |
|                              | Stromberg-Carlson   | W137477-1        |
|                              | Crosley             | 65A11-1          |
|                              | Admiral             | 17.41            |
| TV3-501<br>List Price \$1.75 | Fada                | N6917            |
|                              | Garod               | 21A90013         |
|                              | Sonora              | BB106            |
|                              | Telequip Radio      |                  |
| TV1-502<br>List Price \$2.25 | Motorola            |                  |
|                              | Cleervue Telev.     |                  |
|                              | Consolidated Telev. |                  |
|                              | Lectrovision Inc.   |                  |
|                              | Allen B. DuMont     | 3-1488           |

## LOOK FOR "HI-VO-KAPS" ON CURRENT TV SETS!

Already in use on television equipment of leading manufacturers (see table), *Hi-Vo-Kaps* were designed and developed by Centralab to meet the stated requirements of television project engineers. Save this handy table to check users, prices and parts numbers.

### Cutaway view shows integral ceramic construction

Solid brass terminals, soldered directly to electrodes.

Metallic silver electrodes fired directly to high dielectric constant Ceramic-X.

Low loss, mineral filled phenolic resin.

Three terminal types for strong, fast connections.

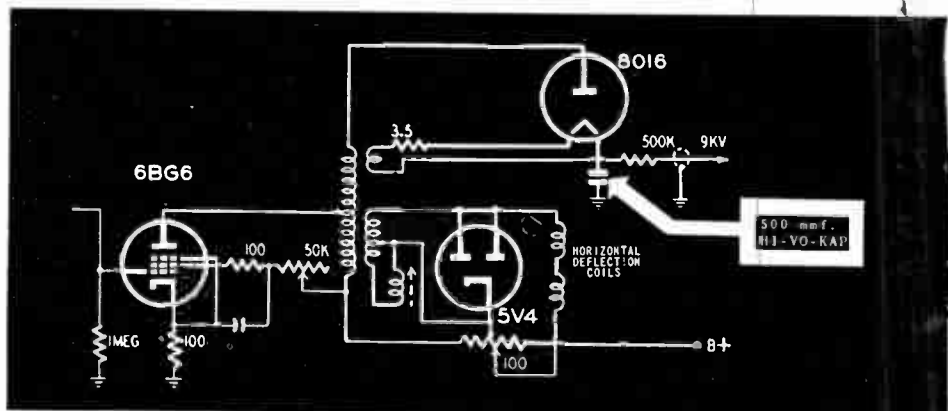
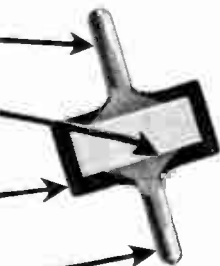

New Centralab *Hi-Vo-Kaps* made with Ceramic-X, combine high voltage and small size for television and high voltage applications. Diameter 1.000", Length .510".

Circuit diagram of simplified typical television power supply shows where and how *Hi-Vo-Kaps* fit into this high voltage by-pass application. Ceramic construction of *Hi-Vo-Kaps* assures long life, dependable performance under all types of operating conditions. The word *Hi-Vo-Kaps* is a registered trade mark.





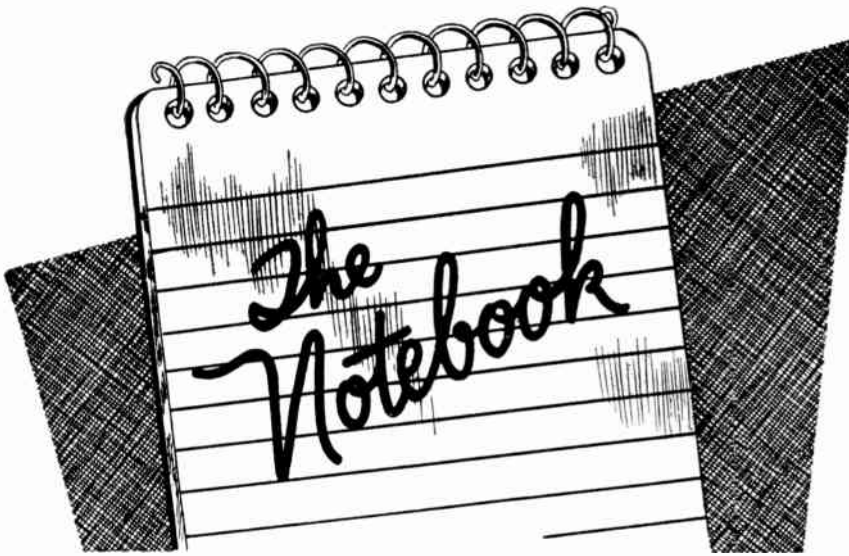

### MINIATURE VISE

When soldering leads and small parts, it is often difficult to hold them in position. A handy vise which will solve the problem can be made by stretching a strong rubber band across the handles of a pair of pliers as shown in the diagram. The pliers may be laid on the bench, the leads being soldered should be placed in their jaws. They will be held there by pressure caused by the rubber band. The larger the pliers and the stronger the rubber band, the better.

E. Donald Cox  
Mercury Radio Service

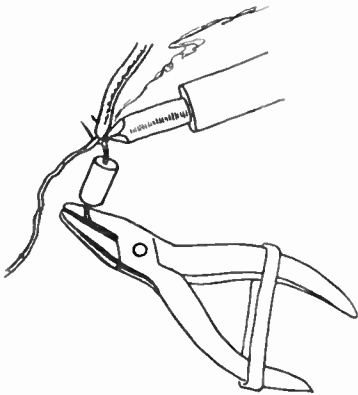

### NUT-BREAKER

Often it is desirable to use long machine screws in out-of-the-way places, then break them off. The length of the bolt allows you to get into difficult locations.

An efficient nut-breaker for cramped locations is illustrated. Just take an iron or steel rod and drill a hole lengthwise from one end. Make it big enough just to clear the largest bolt to be used and it will be useful for several sizes smaller. Place this gadget on the rod down to the point where

you want to break it off. Then rock back and forth until a clean break is made.

HOLE TO FIT  $\frac{9}{32}$ ,  
 $\frac{7}{32}$  OR  $\frac{1}{8}$   
MACHINE SCREW

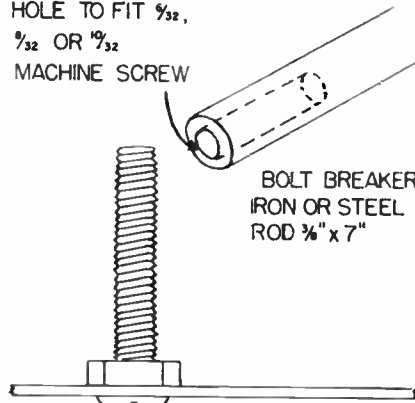

BOLT BREAKER  
IRON OR STEEL  
ROD  $\frac{1}{2}$ " x 7"

### WAVE TRAP

A good wave trap can be made from an old i-f transformer by cutting it in two so as to separate the primary and secondary windings. A 5-50 mfd. condenser should be connected in series with the good coil as shown in the diagram.

O. J. McDaniel  
Sumatra, Florida

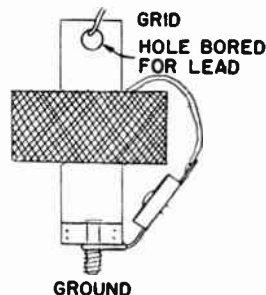

### WIRE STRIPPER

A wire stripper always comes in handy. An effective one which will always be at hand can be made by filing or grinding a notch in a pocket-knife blade. The notch should be

about 1" from the end of the blade and about  $\frac{1}{8}$ " deep as shown in the diagram.

Marion L. Rhodes  
Knightstown, Indiana

NOTCH IN  
BLADE

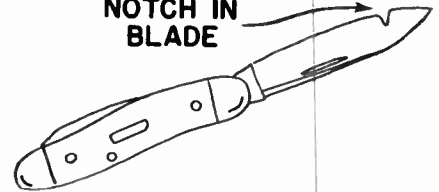

### IGNITION NOISE

Stubborn cases of ignition noise in automobile receivers can often be cured by the following procedure. Wind a coil consisting of 3 or 4 turns of unshielded wire on a 3" diameter form. Connect the coil in series with the receiver antenna lead. With the automobile engine running and the set operating, move the coil around under the dash until a location is found where the noise drops out. The coil may then be fastened in position.

L. Buscombe  
Mimico, Ontario

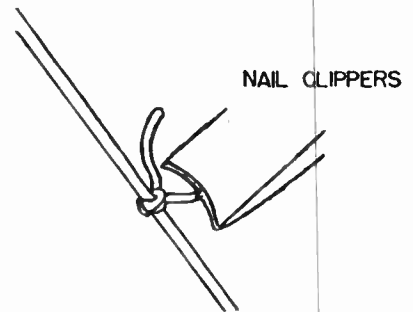

### Cutting Recorder Wire

Very fine wire is used on wire recorders. When a break is repaired by tying a knot, the ends must be clipped off. You may find that your "diagonals" don't cut this wire so well. Fingernail clippers have proved to be very useful for this purpose.

Raymond Bates  
Meridian, Miss.

### Tar Remover

Pitch or tar from burned out transformers and other overloaded units can produce a very unsightly appearance. This material can be removed by application of some *spirits of camphor*. First, remove as much as possible by scraping with a knife. Then apply a small amount of the liquid to a cloth and rub the tar spot briskly. This removes the black color completely and gives the chassis a new appearance.



# Why play "PENNY-ANTE"... when your business is at stake?

A good reputation, like good-will, is built by many deeds, but may be destroyed by a single dissatisfied customer. Your reputation is too valuable to risk for the few pennies "saved"

by buying inferior or unknown "bargains." That's why we keep repeating "Your Reputation and your customers deserve the best!" And the best means Sprague.

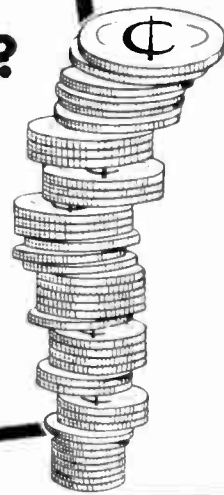

SPRAGUE TM TUBULARS—The first truly practical MOLDED Paper Tubular Capacitors!

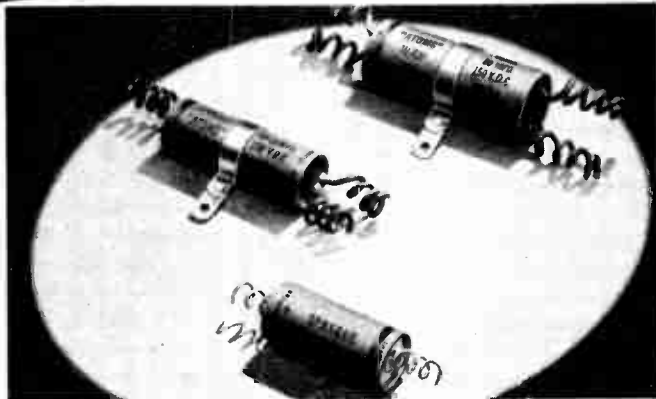

SPRAGUE ATOM5—Universal Midget Dry Electrolytics!



SPRAGUE LM—Universal Mounting Replacements!



SPRAGUE EL—Self-Mounting Midget Can Type!

Reach for a **SPRAGUE**  
and Know You're Right!



**THESE SPRAGUE PRODUCTS ARE UNCONDITIONALLY GUARANTEED!**

When used at their capacitance and voltage ratings, these Sprague Products are unconditionally guaranteed to render satisfactory performance.

CAPACITORS

\*KOLOHM

RESISTORS

# SPRAGUE

\*T.M. Reg.  
U.S. Pat. Off.

SPRAGUE PRODUCTS COMPANY, North Adams, Mass.

{JOBGING AND DISTRIBUTING ORGANIZATION FOR THE PRODUCTS OF THE SPRAGUE ELECTRIC COMPANY}

*Another  
Webster-Chicago  
First*

Presenting the most  
Complete Line of  
**Nylon Needles**  
with  
**Knee Action**

The Swing is towards Nylon—because Nylon Needles by Webster-Chicago eliminate surface noise . . . groove hopping . . . filter but not dampen surface noise and preserve records. Show . . . suggest . . . and sell these 4 profit building needles!



**Red Nylon with Knee Action. New! Genuine sapphire tip. Plays longer—reproduces highs and lows perfectly. None finer! \$500**



**Ivory Nylon with Knee Action. Precious jewel tip, reproduces the full diatonic scale. \$350**



**Black Nylon with Knee Action. An old standby for sales and profits with precious metal, osmium alloy tip. \$250**



**The NEW Tear drop all Nylon with highly polished rose jewel tip. Softens scratch without losing reproduction brilliance. \$175**



**WEBSTER-CHICAGO**  
5610 Bloomingdale, Chicago 39, Ill.

# TIME SAVERS

by H. Leeper

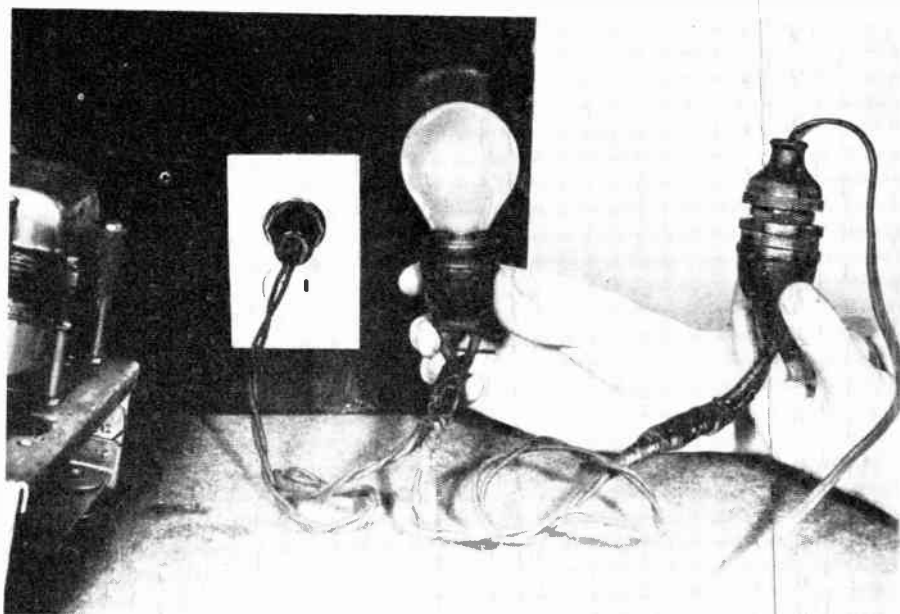

## CHECKING POWER TRANSFORMERS

Two weather proof sockets as illustrated, wired in series with the line cord plug, are worth keeping in the service kit for checking suspected defective power transformers.

With the radio tubes removed, the radio is plugged into one of the series sockets and a 40 or 60 watt lamp bulb is placed in the other.

With the radio switch turned on and the series outfit connected to a wall outlet, the lamp should light very dim if at all, unless the windings of the transformer are shorted or grounded, in which case a fairly bright light will show.

The series sockets may be used for other test purposes, such as replacing the lamp with a fuse of lower rating than the house fuses, when it is desired to connect to the other socket some appliance which may be defective.



## TRANSPORTING TABLE MODELS

Surplus gun covers made of heavy canvas of the type shown are being sold at stores handling such goods.

The cover illustrated is around 20 inches at the bottom where the draw strings are located, about 27 inches to the point where held and has some 18 inches of a narrow strip extending beyond—which is folded over and does not show in the photo.



# 12 BOOKS IN 1

IN THE

## RADIO DATA BOOK

THE ONLY RADIO HANDBOOK OF ITS KIND! . . . 1148 PAGES . . . 12 SECTIONS, EACH A COMPLETE COVERAGE OF ONE RADIO SUBJECT.

TOGETHER, THE 12 SECTIONS FORM THE MOST COMPLETE, EASY TO READ HANDBOOK MONEY CAN BUY!

Plan every operation in radio and electronics with the *Radio Data Book*. This new radio bible will be your life-long tool . . . you will use it every day, on the board, at the bench, in the field! Use it for engineering, construction, troubleshooting and testing. The *RADIO DATA BOOK* will be your invaluable aid in design, experiment and in layout. It will help make your production better, faster and easier. In any and every operation in radio and electronics, you will use the *RADIO DATA BOOK*!

The *RADIO DATA BOOK* is a work of complete authority, prepared by engineers with many years of practical experience. They have been assisted by the Boland & Boyce staff of editors skilled in preparing electronics manuals for the U. S. Signal Corps for many years. These men have worked for several years gathering material for this book . . . all the knowledge of radio principles and operation . . . all the statistics . . . all the newest developments in electronics . . . every possible angle and detail. Eighteen months were spent digesting this material into the most concise, the clearest, and the most readable form. The result is this invaluable manual . . . The *RADIO DATA BOOK*. Whether you use this book for general reference, for scientific instruction, or for education, one thing is certain—the practical help, the daily usefulness you will derive from it will prove to be worth many, many times its astonishingly low price.

Here's a description of just ONE section — Section 5, Sound Systems:

This section covers the planning, selection of components, and assembly of complete P.A. installations. Every type of unit and material used in a sound system is described and analyzed. Components are classed as to size and type of P.A. installations in which they should be used. Tables and charts are given from which to determine power and ratings. Microphone and speaker construction are described and illustrated in detail . . . placement in auditoriums, etc., for proper acoustical results is explained and illustrated. Patterns of the different types of microphones are illustrated as are the proper methods of wiring up the various units, etc.

The above is just one of the twelve big sections in the *RADIO DATA BOOK*. We wish we had room here to describe all twelve in detail, but just look over the list of sections, and you will see why this is the best radio handbook money can buy. Send in your order for the *RADIO DATA BOOK* today!

**COMING SOON!**  
**THE VIDEO HANDBOOK**  
 Everything in Television in one Complete Textbook

Over 500 pages completely illustrated.

This new handbook will be invaluable to everyone concerned with the technical aspect of Television. Everything from the basic theory of television through the design and characteristics of receivers to final installation, operation, and maintenance is covered. This is a completely new book that includes all of the latest developments in the field—the components discussed are of the newest design—the practical maintenance described is a result of intensive study of the equipment placed in operation during the past few months.

There are five completely illustrated sections in the *VIDEO HANDBOOK*, each over a hundred pages long.

The *VIDEO HANDBOOK* will be out October 15th, but we have received a flood of orders already. To insure your getting a copy in the first printing—mail your order now.

The *VIDEO HANDBOOK* is \$5.00 alone, or you can order it with the *RADIO DATA BOOK* and get both books at the special price of \$9.00. Send in the coupon today.

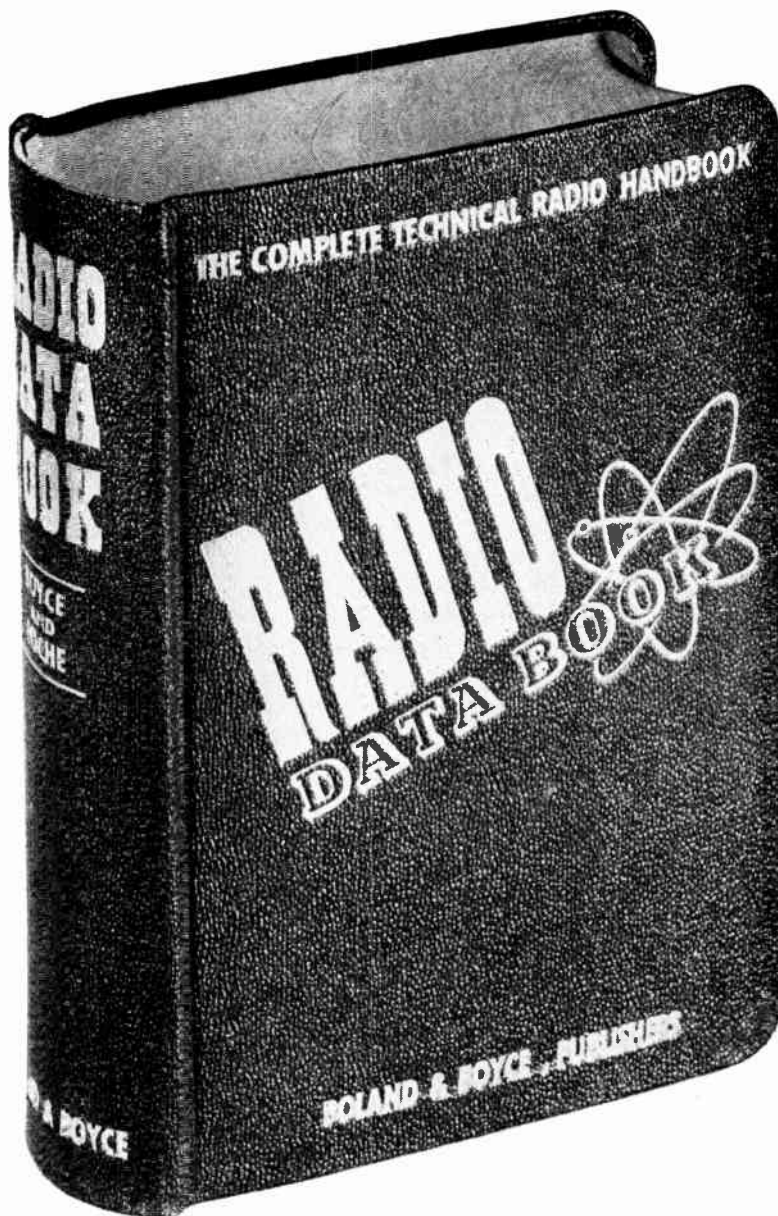

- 12 sections . . . 1000 pages . . . Completely illustrated
- Section 1. THE 150 BASIC CIRCUITS IN RADIO
  - Section 2. COMPLETE TEST EQUIPMENT DATA
  - Section 3. TESTING, MEASURING AND ALIGNMENT
  - Section 4. ALL ABOUT ANTENNAS
  - Section 5. SOUND SYSTEMS
  - Section 6. RECORDING
  - Section 7. COMPLETE TUBE MANUAL
  - Section 8. CHARTS, GRAPHS AND CURVES
  - Section 9. CODES, SYMBOLS AND STANDARDS
  - Section 10. 50 TESTED CIRCUITS DESIGNED FOR OPTIMUM PERFORMANCE
  - Section 11. DICTIONARY OF RADIO AND ELECTRONIC TERMS

**12 complete books in one only \$5.00!**  
 Less than 42c per book!

MAIL THIS COUPON TO YOUR JOBBER TODAY, OR DIRECT TO:  
 BOLAND & BOYCE INC., PUBLISHERS  
 460 BLOOMFIELD AVE., MONTCLAIR, N. J. RM-5

- Enclosed is full amount.
- Please send me the *RADIO DATA BOOK* at \$5.00.
- Enclosed is \$1.00, I will pay postman balance
- Send me the *VIDEO HANDBOOK* at \$5.00.
- Send me BOTH books at the special price of \$9.00.

NAME .....

ADDRESS .....

STATE ..... ZONE ..... CITY .....

**BOLAND & BOYCE INC., PUBLISHERS**

# American Beauty

## ELECTRIC SOLDERING IRONS

are sturdily built for the hard usage of industrial service. Have plug type tips and are constructed on the unit system with each vital part, such as heating element, easily removable and replaceable. In 5 sizes, from 50 watts to 550 watts.

### TEMPERATURE REGULATING STAND

This is a thermostatically controlled device for the regulation of the temperature of an electric soldering iron. When placed on and connected to this stand, iron may be maintained at working temperature or through adjustment on bottom of stand at low or warm temperatures.

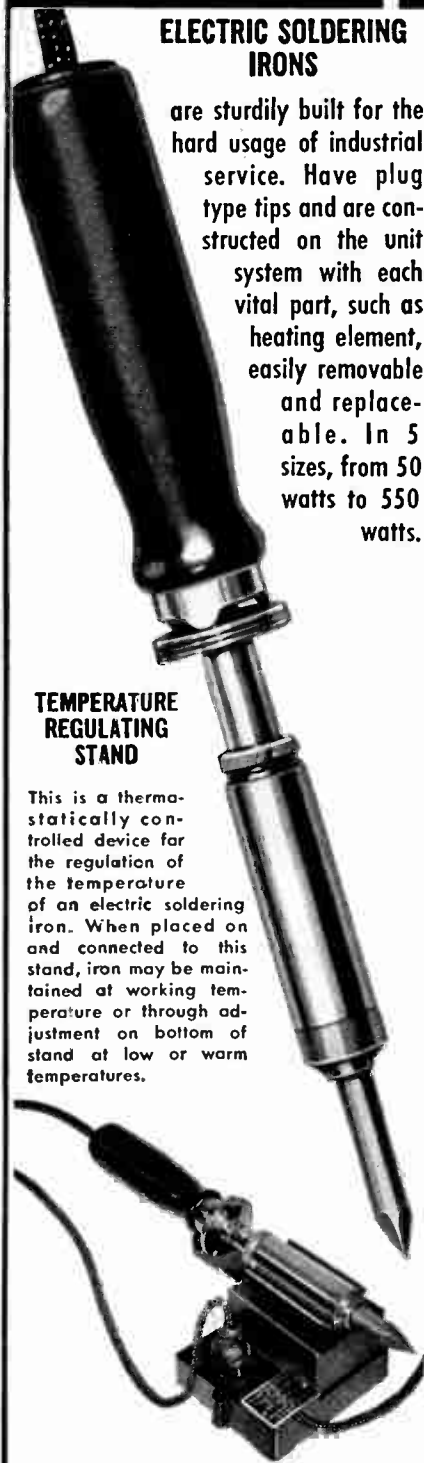

For descriptive literature write

110-1

**AMERICAN ELECTRICAL  
HEATER COMPANY**  
DETROIT 2, MICH., U. S. A.



by John T. Frye

**A** GOOD serviceman is somewhat of a ladies' man.

Hold it now, my friend! Before you rush off to thrust that statement under the little woman's eyes, you had better read on. What I mean is that the radio serviceman should have a sympathetic understanding of what a woman expects and appreciates in the way of radio service.

A little reflection will reveal the necessity of this. All surveys show that women do far more radio-listening than do men. The radio, as a piece of furniture, is properly in her domain; and keeping that set going is a responsibility in which she takes a keen personal interest. Try to recall the radios you took in yesterday. Did mostly men or women telephone for you to pick up the sets? See what I mean? Whether you realize it or not, you are working chiefly to please women.

As a single man, I can have the foolhardy courage to say flatly that women are not as easy to please as are men—or perhaps it might be more accurate to say that they are not so timid about showing their displeasure. Being inexperienced in mechanical matters, they are likely to be unreasonable in their expectations and demands—such as insisting that you take the summer static out of their reception, or make their punch-board midget sound like the neighbor's three-hundred-dollar console! Details loom just as importantly in their eyes as do major factors in the operation of their set. A dial knob that is not tight is just as heinous an oversight as leaving out the filter condensers.

This state of affairs must be accepted philosophically. Nothing worth the trying can be accomplished in the way of educating your feminine customers. The only course

open is to arrange your service procedure so as to include as many as possible of the services that women like, expect, and demand.

In the first place, see that every set that leaves your shop has been thoroughly cleaned. That means taking out *all* of the dust and grime and not just that part that may impair the operation of the set, such as between the plates of the tuning condenser. Make sure that the chassis, the speaker, and every nook and corner of the cabinet are thoroughly and painstakingly cleaned. By all means wash and polish both sides of the dial glass, even though this means considerable work in removing it. Your woman customer has undoubtedly been itching for months to get at that smoked appearance these glasses take on; so she is certain to be pleased when she finds that you have done what she could not.

Do not forget that the radio may be an electronic mechanism to you but to your woman customer it is a piece of furniture. Do everything you can to make it look as gleaming and as new as possible. A good scratch-remover kit can win you as many steady customers as a full-page advertisement. A can of furniture polish, judiciously mixed with elbow-grease, is worth reams of sales talk.

Never forget that the woman's interest centers in externals of the radio. The volume control, the tone control, and the tuning knob *are* the radio as far as she is concerned; so be certain that these three are functioning perfectly. The volume control should work smoothly both from the electrical and mechanical points of view. The control of the volume should be silent, gradual, and complete. Occasionally a volume control or tone control shaft will turn quite hard in its bearing, either through



galling of the metal or through an accumulation of grime. If you cannot correct this with the use of carbon tetrachloride and a fine grade of oil, replace the control. Long-nailed feminine fingers cannot exert much torque.

A slipping tuning control seems to be particularly exasperating to the ladies. No time is wasted that is spent in rendering the tuning action smooth and positive. Be sure, too, that the pointer is exactly where it belongs. A pointer that is of ten kilocycles is as disturbing as a picture hanging crookedly on the living-room wall.

The replacement of frayed line cords and soiled or faded speaker grille cloths will place you right up alongside Clark Gable or Van Johnson in popularity; but if you *really* want to make a hit with the ladies, show them how you can get rid of unsightly ground and antenna wires by installing a built-in antenna that will permit them to shift the receiver around the living-room to their heart's content. (Be careful on this one though; for there are some sets in which such a change is not practical, especially if much listening is done to out-of-town stations.)

It is hardly necessary to point out that woman's practice of judging by externals is not confined to her radio. She is very likely to rate your ability by your personal appearance and that of your shop. If you are untidy in your dress, and if your shop looks as though it never saw a broom, it is going to take a great deal of persuasion to convince her that you know your business.

In talking with her, try to avoid using that superior, this-is-all-over-your-head tone. She is ignorant about mechanical matters, but she does not enjoy being slapped in the face with the fact. She gets enough of that from her husband. Try using simple, non-technical language and clear little analogies to explain what repairs her radio needs.

Finally, I am forced to admit that if you train yourself to please your women customers, you will be a better radio repairman for it. Women long ago learned the secret that Somerset Maugham set down on paper:

"It is a funny thing about life—if you refuse to accept anything but the best, you very often get it." ✓ ✓ ✓

*Show... Suggest... Install*  
**The NEW, PROFIT-MAKING Model 78**  
**WEBSTER-CHICAGO**  
**WIRE RECORDER**



★ **New Push Button Controls**  
**Give Greater Flexibility**  
**and Simplify Operation**

Here's how to make fast profits! Show . . . suggest . . . install the new, simplified Model 78 Webster-Chicago wire recording unit. It is built around the famous Model 79 wire transporting mechanism and has a built-in pre-amplifier, inter-stage amplifier and oscillator. The push button control means easy operation, better recording and flexibility in handling. The recording level meter provides easy, accurate recording volume control. Comes complete with microphone, 15 minute spool of wire and necessary cords for radio connection with easy to follow instructions. Size 11" x 11 $\frac{3}{8}$ " x 5 $\frac{3}{8}$ ".



See Your Webster-Chicago Distributor

**WEBSTER-CHICAGO**

FAMOUS FOR RECORD CHANGERS AND NYLON PHONOGRAPH NEEDLES

5610 BLOOMINGDALE AVENUE • CHICAGO 39, ILLINOIS

**Capitol Radio Engineering Institute**  
Pioneer in Radio Engineering Instruction—Since 1927

- |   |   |
|---|---|
| <input type="checkbox"/> ELEVATOR CONTROLS  | <input type="checkbox"/> X-RAY                |
| <input type="checkbox"/> ELECTRIC FENCES  | <input type="checkbox"/> SAFETY DEVICES       |
| <input type="checkbox"/> FURNACE CONTROL  | <input type="checkbox"/> SELECTING MACHINERY  |
| <input type="checkbox"/> FURNACES, INDUCTION  | <input type="checkbox"/> SIGNALLING           |
| <input type="checkbox"/> GAS DETECTION  | <input type="checkbox"/> SIGN CONTROLS        |
| <input type="checkbox"/> GRINDING   | <input type="checkbox"/> SMOKE CONTROLS       |
| <input type="checkbox"/> HEATING CONTROLS   | <input type="checkbox"/> SORTING              |
| <input type="checkbox"/> HOIST CONTROLS   | <input type="checkbox"/> STROBOSCOPES         |
| <input type="checkbox"/> HYDRAULIC CONTROLS   | <input type="checkbox"/> SURFACE EXAMINATORS  |
| <input type="checkbox"/> METAL FINISHING  | <input type="checkbox"/> THERMISTORS          |
| <input type="checkbox"/> MICROSCOPES  | <input type="checkbox"/> THERMISTOR CONTROLS  |
| <input type="checkbox"/> MOTOR CONTROLS   | <input type="checkbox"/> THERMISTOR EQUIPMENT |
| <input type="checkbox"/> PACKAGING  | <input type="checkbox"/> THERMISTOR GAUGES    |
| <input type="checkbox"/> MOBILE COMMUNICATIONS EQUIPMENT FOR:   | <input type="checkbox"/> TELEVISION SYSTEMS   |
| <input type="checkbox"/> POLICE, FIRE, FOREST SERVICE, AIRCRAFT, MARINE, EXPLORATIONS, RAILROADS, TAXICABS, STREETCARS, BUSES, TRUCKS, AMBULANCES, EMERGENCY VEHICLES, ETC. | <input type="checkbox"/> HEARING AID          |
| <input type="checkbox"/> SYNCHRONIZERS  | <input type="checkbox"/> TELEPHOTOGRAPHY      |
| <input type="checkbox"/> THERAPY EQUIPMENT  | <input type="checkbox"/> HOME FACILITIES      |
| <input type="checkbox"/> THERMISTOR GAUGES  | <input type="checkbox"/> RADIO WEAR           |
|   | <input type="checkbox"/> HOME SOLAR           |
|   | <input type="checkbox"/> RADIO TELEVISION     |
|   | <input type="checkbox"/> ALARM SYSTEMS        |
|   | <input type="checkbox"/> RADIOLOGICAL         |
|   | <input type="checkbox"/> CHEMICAL             |

**How do you stack up in the modern radio servicing field?**

## CREI Technical Training Can Prepare You Now to Meet These New Demands That Mean More Money and Security for You!

Have you taken a really good look recently at the expanding service field? Do you have a feeling of helplessness when you think of some of the intricate, new-model equipment that you may be called upon to service? Or of the many jobs you may be missing in these related fields because you feel you don't know anything about them?

There is no need to tell these things you already know. But it is important for you to realize that, no matter whether you are a "beginner" or an "old timer" CREI home study training can help you. You will find that CREI courses in Radio-Electronics and Television are pitched to your own level. They take you *all the way* from introductory basic principles to advanced training, on to specialized subjects. CREI training can help you *right now*, in your daily work in the installation and servicing of radio-electronic equipment.

Find out for yourself how CREI can help you to greater security and prosperity. See and read an actual lesson. Get the feel of how easy and interesting it is to improve your ability with CREI. Send in the coupon now!

MAIL COUPON  
FOR FREE  
BOOKLET &  
COMPLETE DETAILS



**Capitol Radio Engineering Institute**  
16th and PARK RD., N.W., DEPT. RT-5  
WASHINGTON 10, D. C.

Mail me FREE 24-page booklet, "CREI Training for Your Better Job in Radio Electronics." I am attaching a brief resume of my radio experience, education and present position.

Check one  PRACTICAL RADIO-ELECTRONICS Course  PRACTICAL TELEVISION

Name .....

Street .....

City ..... Zone ..... State .....

I am entitled to training under the G.I. Bill

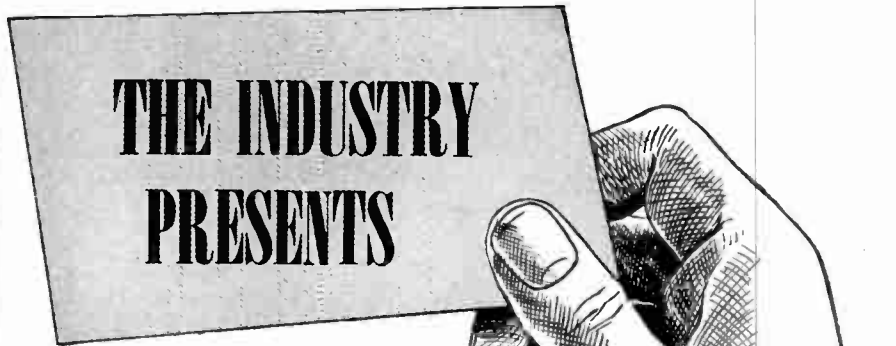

### PORTABLE PA AMPLIFIER

Altec Lansing Corporation announces a new portable public address amplifier. Conservatively rated at 15 watts, the model A-324 has a rating of full power output within 1 db from 35 to 12,000 cycles. Four input channels are provided, two of which allow 95 db gain for low impedance microphones. Each channel has its individual volume control for mixing purposes. The other two high impedance inputs give a gain of 72 db for radio or phonograph pickup or high impedance microphones. Continuously variable base control and treble attenuator are also provided. For further information, write to Altec Lansing Corporation, 250 West 57th St., New York 19, N. Y.

four ranges for ohms. The highest resistance scale is 50 megohms. The tube tester includes miniature socket types and comes complete with roll type chart. For further information, write to the Triplet Electrical Instrument Company, Bluffton, Ohio.

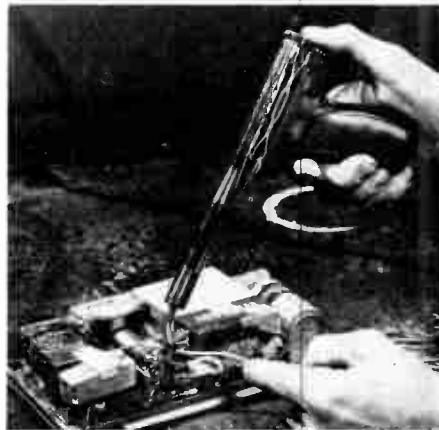

### GUN GRIP IRON

The new Lenk gun type soldering iron features ease of handling and accuracy of placement. The unit is light and the plastic handle protects the user from the heat developed while soldering. For further information write to Lenk Manufacturing Co., Newton Lower Falls, Massachusetts.



### VOLT-OHM-MILLIAMMETER-TUBE TESTER

The Triplet Model 3480 Combination Volt-Ohm-Milliammeter-Tube Tester measures AC volts, DC volts, DC milliamperes and ohms as well as including a complete tube checker. There are five ranges each for AC and DC volts, three ranges for milliamperes, and



### FM TUNER

Special features of the new Meissner 8C FM receptor include audio output, flat within plus or minus 2db from 50 to 15,000 CPS; audio voltage, 3 volts rms at minimum useable signal input, and AF output as high as



15 volts rms obtained without distortion. For further information write to Meissner Manufacturing Division of Maguire Industries, Mt. Carmel, Ill.

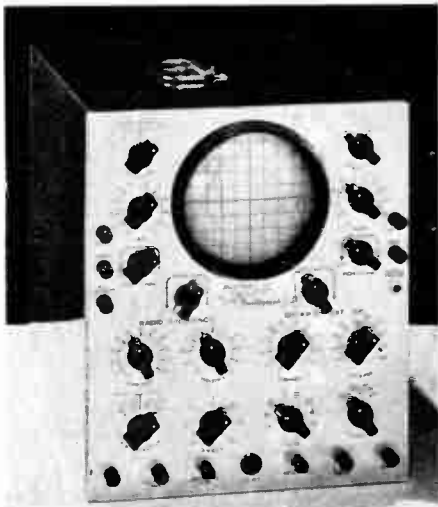

### OSCILLOGRAPH

The Hickok Model 505 Cathode Ray Oscilloscope features a wide and a narrow band FM oscillator which can be used for alignment. This oscillator and a mixer for converting an AM signal generator to FM, are self contained in the Oscilloscope Unit. In addition there is a modulation circuit which permits the FM oscillator to be either internally or externally modulated. Also included is a detector permitting the wave form of any modulated RF signal to be viewed directly. Other features include a signal tracer jack and a sinusoidal sweep with a phasing control useful in visual alignment. For further information write to The Hickok Electrical Instrument Co., 10634 Dupont Avenue, Cleveland 8, Ohio.

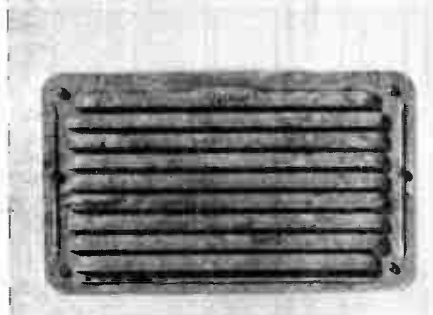

### AUTO EXTENSION SPEAKER

The Musicola Extension Speaker attaches to any automobile radio to provide additional volume in the back seat of a car. The speaker mounts on the shelf behind the rear seat. It is protected by a metal case and a three way switch is provided to select the regular, or the extension unit. Further information can be obtained by writing to The Musicola Sales Company, Chicago, Ill.

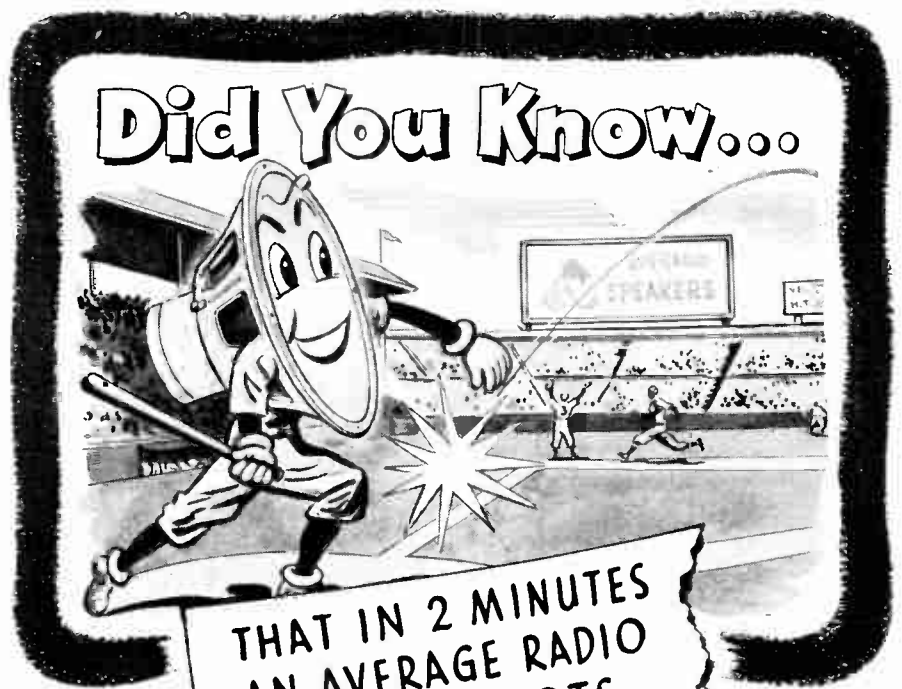

**THAT IN 2 MINUTES  
AN AVERAGE RADIO  
SPEAKER EXERTS  
ENOUGH ENERGY TO  
HIT A BASEBALL  
OVER 850 FEET?**

That's a homerun in any ball game but of course you can't put a loudspeaker in as a pinch-hitter. However, it is true that the amount of energy exerted by an average radio speaker in just 2 minutes could hit a baseball 850 feet! This means that although OPERADIO builds speakers with the skill and care of a watchmaker... these speakers are sturdily constructed to stand up under heavy, continuous use. OPERADIO speakers are delicately balanced to authentically reproduce the sweetest high notes of a piccolo, yet, carry the tremendous power of a full orchestra crescendo.



**ASK FOR OPERADIO SPEAKERS —  
A FULL LINE OF OUTSTANDING  
SPEAKERS FOR EVERY PURPOSE!**

**OPERADIO**

**RADIO REPLACEMENT and  
PUBLIC ADDRESS SPEAKERS**

**OPERADIO MFG. COMPANY • St. Charles, Illinois**



# LEADERS IN THE DEVELOPMENT OF ELECTRONIC INSTRUMENTS

## Announcing THE EDL WIDE RANGE OSCILLOSCOPE

PERMITS DIRECT OBSERVATION OF COMPOSITE VIDEO SIGNAL

Embodying many recent developments is the new EDL, Model 75, wide range oscilloscope. Vertical amplifier response is  $\pm 2$  DB from 10 cycles to 5 MC — permitting study of television signals and all waveforms with high harmonic contents.

An extremely desirable feature of this versatile instrument is a self contained voltage calibrator with an accuracy of  $\pm 5\%$ . Test probe has shielded cable to eliminate stray pickup.

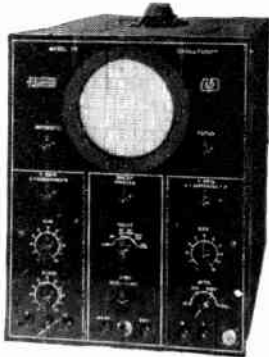

Model 75

### FEATURES

#### Vertical Amplifier:

Response —  $\pm 2$  DB 10 cycles to 5 MC  
Sensitivity — Direct — .1 volt RMS per inch  
Sensitivity With Probe — 1.0 volts RMS per inch

#### Horizontal Amplifier:

Response —  $\pm 2$  DB 10 cycles to 200 kc  
Sensitivity — .5 volts RMS per inch

Sweep Frequency — 10 cycles to 60 kc.

WRITE FOR FURTHER DETAILS

# EDL Instruments

ELECTRONIC DEVELOPMENT LABORATORY

2655 W. 19th ST.  
CHICAGO 8, ILL.

MFR'D. BY



## PIN-STRAIGHTENER

The Hytron Radio & Electronics Corporation recently announced a miniature tube pin-straightener. The tool has been made available to radio servicemen at less than the cost of manufacture. It has been carefully designed and constructed for long life and trouble-free performance. The miniature pin-straightener is available from your Hytron jobber.



## VACUUM TUBE VOLTMETER

Electronic Instrument Company Model 221 vacuum tube voltmeter features greater linearity of AC ranges and automatic overload safety protection. An accuracy of 2% on all ranges is claimed and each instrument is individually calibrated. Input impedance is 26 megohms. Further information may be obtained by writing to Electronic Instrument Company, Inc., 926 Clarkson Avenue, Brooklyn 3, N. Y.



## MEGA-PIPPER

The Kay Mega-Pipper supplies four crystal controlled signals which are independent of

MAY 1948 • RADIO MAINTENANCE



# Free

NEW COMPLETE *Concord*

# RADIO CATALOG

160 VALUE-PACKED PAGES

Mail coupon for FREE copy of this great, new Concord Catalog—a vast, complete selection of everything in Radio, Television, and Test Equipment. Thousands of items... latest 1948 prices. LOWER prices on finest-quality RADIO SETS, PHONO-RADIOS, RECORD CHANGERS, RECORD PLAYERS, RECORDERS—wire and disc, PORTABLES, AMPLIFIERS, COMPLETE SOUND SYSTEMS, TESTERS. Latest listings of all well-known, standard, dependable lines of radio parts and equipment. 4,212,014 SATISFIED CUSTOMERS CANNOT BE WRONG! Concord's quarter-century reputation for Customer Satisfaction is the reason Radio Men (the Experts who Know) keep coming back to CONCORD. At CONCORD, YOU MUST BE COMPLETELY SATISFIED or your money will be refunded.

23 pgs. Radio and Television Sets • 62 pgs. Radio Parts  
18 pgs. Sound Amplifiers and Accessories • 23 pgs. Ham Gear  
9 pgs. Electronic Test Equipment

Mail COUPON TODAY!

CONCORD RADIO CORPORATION, Dept. RM-185  
901 W. Jackson Blvd., Chicago, 7, Ill.  
Yes, rush FREE COPY of the comprehensive new Concord Radio Catalog. (Please Print)

Name.....  
Address.....  
City & Zone..... State.....

# CONCORD

RADIO CORPORATION

CHICAGO 7 ATLANTA 3  
501 W. Jackson Blvd. 265 Peachtree St.  
Downtown Chicago Branch: 225 W. Madison  
Lafayette Radio Corp.



the circuit under test. Useful for television alignment, these pips establish the picture, sound carrier, and also the adjacent channel points. No switching or adjustment is necessary for frequency control. Unit has a self-contained power supply, weighs 15 pounds and measures 8 x 16 x 8 inches. Further information may be obtained by writing to Kay Electric Company, Pine Brook, New Jersey.

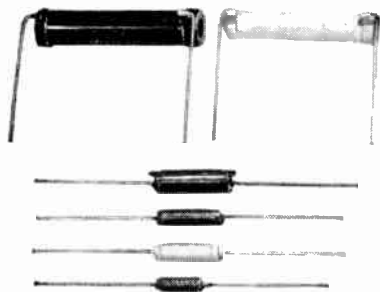

### RF CHOKES

The Ohmite Manufacturing Company, has developed six new radio frequency chokes. The recommended operating ranges are as follows: Stock No. Z-14, 7 to 35 megacycles; Z-28, 20 to 60 mc; Z-50, 35 to 110 mc; Z-144, 75 to 190 mc; Z-235, 160 to 350 mc; and Z-460, 320 to 520 mc. The first two units are rated at 600 milliamperes. The other four are rated at 1000 ma. Ohmite's lowest frequency model, formerly designated as Z-3, will now be designated Z-7. It covers frequencies from 3 to 20 mc. These new chokes are single-layer wound on low power factor steatite or molded plastic cores and are covered with a moisture-proof coating which protects the wire and holds each turn firmly in place. The units are mounted by means of their 1 1/2" tinned copper wire leads. These new chokes are described in Bulletin 133, obtained by writing to Ohmite Manufacturing Co., 4954 Flournoy Street, Chicago, Ill.

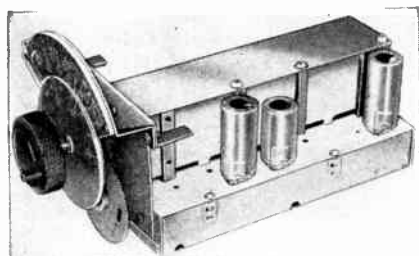

### NEW INPUTUNER

A new model of the Dumont Inputuner has been announced. This unit is an RF tuning section for television receivers. Similar to the Inputuners now being used in Dumont receivers, the new model provides 30% more gain and an improved band width characteristic. The assembly is compact, well suited to custom built installations. Continuous coverage is provided from 44 to 216 mc covering FM, amateur and telephone stations as well as television stations. The Mallory-Ware Inductuner is used and the design is such that stability is better than 1 kc per degree C. For further information about this unit write to Allen B. Dumont Labs., Inc., 2 Main Avenue, Passaic, N. J.

### WIRE STRIPPER

The new improved Speedex wire strippers are designed to strip wire sizes from #8 to

# Very HIGH OUTPUT VOLTAGE



for stage  
by stage  
alignment...

The HICKOK Model 288X Universal Crystal Controlled Signal Generator enables the serviceman to use advanced servicing techniques for easier and more accurate set testing.

This is particularly important when checking FM and Television units. The extremely high voltage output of the 288X makes possible visual, stage by stage, alignment of IF stages, limiter and discriminator. Fundamentals are used throughout its wide range and crystal controlled outputs assure an accurate signal. For bulletin giving full details and all technical characteristics, write for 288X.

# HICKOK

THE HICKOK ELECTRICAL INSTRUMENT COMPANY  
10634 DUPONT AVENUE • CLEVELAND 8, OHIO

# TINY... but MIGHTY OIL TUBULAR CAPACITORS



● For superlative performance and longest life in tight spots or mighty compact assemblies. Oil-impregnated, oil-filled. Fully sealed against oil leakage or moisture penetration. Metal case insulated — not connected to capacitor section. Outer insulating tube. Center mounting strap.

Previously in 400, 600, 1000 and 2000 v. D.C.W. ratings, but now extended to 2500, 3000, 3500 and 4000 v. for television and other higher-voltage applications.

### See Our Jobber . . .

● Order Aerovox Type 89 oil tubulars for your severe-service needs. Ask for latest catalog. Or write us.



**FOR RADIO-ELECTRONIC AND  
INDUSTRIAL APPLICATIONS**

**AEROVOX CORP., NEW BEDFORD, MASS., U.S.A.**  
Export: 13 E. 40th St., New York 16, N.Y. • Cable: 'ARLAB'  
Canada: AEROVOX CANADA LTD., Hamilton, Ont.

#30 and feature hardened steel precision ground cutting blades. Emphasis is placed on ease of operation, and 750 to 1,000 wires can be stripped per hour. For further information, write to General Cement Manufacturing Co., 919 Taylor Avenue, Rockford, Illinois.

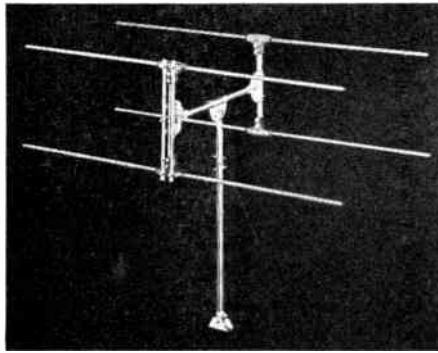

### TELEVISION ANTENNA

The Camco Television Antenna Model T35 features two stacked dipoles with reflectors. Maximum reception is unidirectional and at right angles to the plane of the antennas. The gain is 5DB with a 15DB rejection of unwanted signals. The antenna is rotatable and can be tilted for best polarization. Further information can be obtained by writing to Camburn Inc., 32-40 57th Street, Woodside, New York.

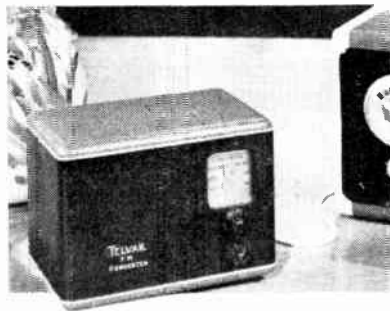

### FM TUNER

The Model FMC-12 Telvar FM Tuner can be attached to any ordinary radio by a local radio serviceman. It is housed in a leatherette cabinet measuring 9 1/2 inches by 7 inches overall and uses the audio section of the AM broadcast receiver. The new superregenerative FM detector is used. For further information, write to Audar, Inc., Argos, Indiana.



### ANTENNA DISPLAY

The Ward Products Corporation has released a new FM antenna display. This display

is compact and suitable for use on tables, counters, etc. It is part of a new merchandising campaign for the Ward line of FM and Television antennas. For full information on this display and the campaign write to Ward Products Corporation, 1523 East 45th Street, Cleveland 3, Ohio.

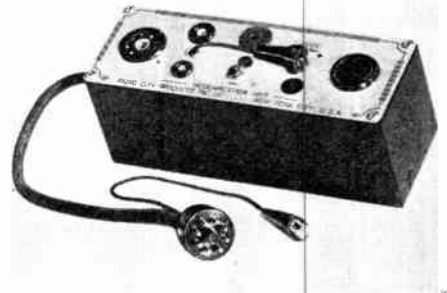

### MODERNIZATION UNIT

Radio City Product's Model 120 modernization unit will bring old tube testers up-to-date. Its steel case is in hammertone gray and 3 x 8 x 2 3/4 inches in size. The unit weighs one and a half pounds.

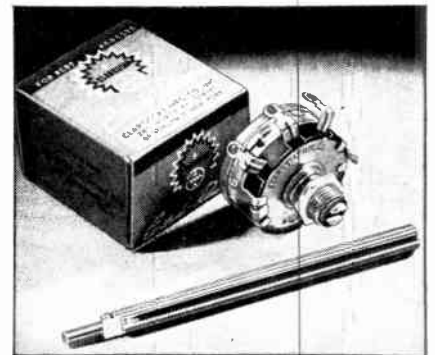

### SLIP-DRIVE VOLUME CONTROLS

Slip-Drive (Clutch type) volume controls are now made by Clarostat Manufacturing Company for use in auto radios and in home radios with motor driven operation. They provide slippage if the control shaft is turned beyond end limits, thus avoiding damage to the control. This series is available in "Z" taper values from 250,000 ohms to 2 megohms, also in tapped models. A number of attachable shafts are available. For further information, write to Clarostat Manufacturing Company, Inc. of 130 Clinton Street, Brooklyn, N. Y.

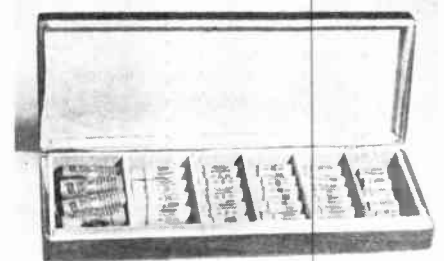

### ELECTROLYTIC CONDENSERS KIT

A combination kit of "Akrad" Electrolytic Condensers has been made available by the



Olson Radio Warehouse, Inc. The chest contains an assortment of 27 of the most popular sizes of 25 volt, 150 volt and 450 volt condensers. For further information, write to Olson Radio Warehouse, Inc., 73 East Mill Street, Akron 8, Ohio.



### WIRE RECORDER

The Wire Recording Corporation of America has released a lightweight portable magnetic wire recorder called the Wireway. This unit features a built-in oscillator which permits broadcasting to any radio within 150 feet as well as a turntable for playback. Containing its own amplifier, the unit may be used as a portable public address system. Size is 18 x 11½ x 8 inches and weighs 23 pounds. Unit comes complete with crystal microphone and two ½ hour spools of wire. For further information, write to Wire Recording Corporation of America, 1331 Halsey Street, Brooklyn 27, N. Y.

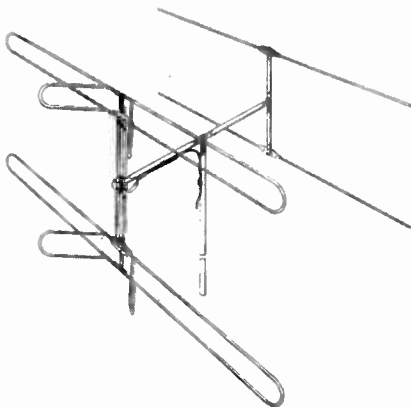

### ANTENNAS

A new line of JFD antennas are designed to be quickly converted to other larger arrays. A single element antenna can be converted to a more elaborate type on the job by use of suitable kits provided for the purpose. Types cover a complete range from 44 to 216 megacycles. Elements are made of ½ inch heavy gauge aluminum tubing and masts of 1 inch aluminum tubing. The antennas are also designed to facilitate quick assembly. For further information, write for an illustrated eight page catalog. Address your request to JFD Manufacturing Company, Inc., 4117 Fort Hamilton Parkway, Brooklyn 19, New York.

# ESPEY

*The Custom Built Chassis*



There are  
*Chassis*  
and  
there are  
*Chassis*

How many times have you wished you could replace that worn out AM set now housed in a beautiful, highly thought-of cabinet? At last it's possible—and at a price within the reach of everyone! The ESPEY line of custom-built chassis is designed for such installations, as well as for custom-built and other special applications. Take the ESPEY MODEL 7-B, for instance. It's a top quality AM-FM receiver, featuring high fidelity reception, illuminated slide rule dial, full tone control, and is wired for phonograph operation.

Its superheterodyne circuit contains 10 tubes plus a rectifier tube, and operates on 105/125 volts AC, 50/60 cycle. Furthermore, it's supplied ready to operate, with 10" speaker containing an Alnico #5 magnet, both AM and FM antennas, and all hardware needed to make the installation easy and complete.

For Further Information, Write Dept. F

**ESPEY** MANUFACTURING COMPANY, INC.  
526 EAST 72<sup>ND</sup> STREET-NEW YORK 21, N.Y.

## Permoflux SPEAKERS

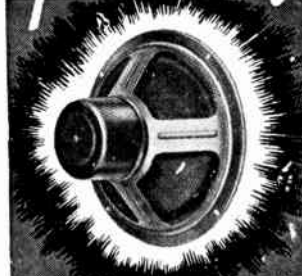

### YOUR JOBBER CAN SUPPLY YOU!

Permoflux quality and dependability—the same as supplied to the major set manufacturers—is your assurance of complete customer satisfaction. You'll find Permoflux Speakers easy to install and readily available in both PM and Electrodynamic types. You'll find too, that it pays to give your customers "tops in tone" with a Permoflux Replacement Speaker.

TWO COMPLETE  
FACTORIES TO SERVE YOU

**PERMOFLUX**

WRITE FOR  
FREE BULLETIN

PIONEER MANUFACTURERS OF PERMANENT MAGNET DYNAMIC TRANSDUCERS

## PERMOFLUX CORPORATION

4900 WEST GRAND AVE., CHICAGO 39, ILLINOIS  
236 SOUTH VERDUGO ROAD, GLENDALE 5, CALIFORNIA

# 30,000

## SUCCESSFUL

### RADIO SERVICE - TECHNICIANS

#### READ

# RADIO MAINTENANCE

## EVERY MONTH!

**RADIO MAINTENANCE** today fills a breach that has existed in the radio field for a long time. Already 30,000 technicians read **RADIO MAINTENANCE** every month because it is devoted entirely to the radio servicemen.

The **RADIO MAINTENANCE** staff specializes in the preparation of articles on every phase of Radio Maintenance in series form which may be filed and used for reference. The leading articles cover everything for the radio servicemen on Television, FM and AM; Test Equipment; Electronic Appliances; Tools; Antennas; Alignment; Troubleshooting; Repair; Construction; Pick-Ups and Sound Amplification and Reproduction Equipment. Also, in **RADIO MAINTENANCE** each month there are departments on hints and kinks, the latest news of the trade, review of trade literature, radiomen's opinions, new products and news from the organizations. All articles are presented in a step-by-step precision style, clearly illustrated with schematics, accurate photographs, specially prepared drawings, white on black charts, color diagrams, isometric projection and exploded views.

Binders in beautiful green simulated leather are now available for your **RADIO MAINTENANCE** magazine.

**RADIO MAINTENANCE** is not sold on newsstands.

**RADIO MAINTENANCE MAGAZINE**  
460 Bloomfield Avenue,  
Montclair, N. J.

RN-5

Please send me **RADIO MAINTENANCE** for

2 years, \$5

1 year, \$3

Payment enclosed

Bill me later

Name .....

Address .....

City—State .....

Occupation\* .....

Title .....

Employed by .....

\* Independent Serviceman—Dealer Serviceman—Service Manager—Dealer—Distributor—Jobber.



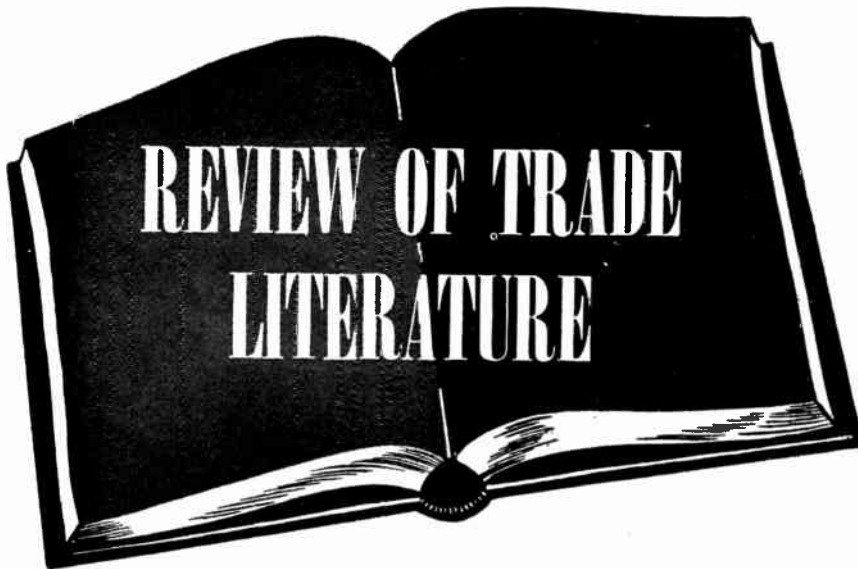

To avoid delay when writing to the manufacturer give issue and page number.

**O**S-TRONIC Publications has announced the availability of "Practical Amplifier Diagrams," by J. Robin and C. Lipman, a collection of 45 amplifier circuit diagrams. Complete parts lists and descriptions of each amplifier are given. The book also includes a section on construction notes. Over a hundred pages, plastic spiral binding. List price, \$2.00.

Harrison, N. J.—A newly revised and greatly expanded edition of "RCA Receiving Tables for Television, FM, and Standard Broadcast," (Form 1275-D) a quick-reference booklet for radio dealers, servicemen, and other tube users, has been announced by the RCA Tube Department.

The new edition, priced at 10 cents, is available from RCA Tube Distributors or the Commercial Engineering Section, RCA Tube Department, Harrison, N. J.

*Television Encyclopedia*—Stanley Kempner—451 pages—\$60—Fairchild Publishing Co.

This book contains a great deal of valuable and generally unavailable information about television.

It is divided into three parts. Parts One and Two, "Milestones to Present Day Television," and "Pioneers and Contemporaries in Television," constitute an excellent history of the subject arranged for easy reference. Part Three, "Television's Technical Vocabulary" does an excellent job of living up to its title.

The book will prove useful to everyone in the television field.

Howard W. Sams & Co. have recently announced the first edition of the Radio Receiver Tube Placement Guide. This publication will prove useful to all servicemen. Covering receivers manufactured from 1938-1947, it is the answer to the often encountered problem of tube placement.

The book consists of 1880 sketches of receiver chassis, representing 5400 receivers. Indexed for quick reference and laid out in a clear, easy to read style, this new publication will save many hours at the bench. It contains 192 pages and is available at \$1.25 from your jobber or direct from Howard W. Sams & Co., Inc., 2924 E. Washington St., Indianapolis, 7, Ind.

An up-to-the-minute compilation of all receivers in current use, based on a survey by leading compilers of service data, is offered in the 7th Edition Clarostat Service Manual just off the press. The 127 pages of this handy manual are packed with solid listings including such vital information as the set manufacturer and model number, the original part number, the Clarostat type designation, shaft, total resistance value, how used, and special notes.

Priced at 50 cents per copy, the manual is obtainable at your Clarostat distributor or direct from the Clarostat Mfg. Co., 130 Clinton St., Brooklyn 2, N. Y.



**"YOU DON'T HAVE TO BE CRAZY TO BE IN THE RADIO BUSINESS... BUT IT SURE HELPS A LOT"**

**YEP! WE'RE SO CRAZY WE'RE GIVING STUFF AWAY FREE!!**



Free with every order of \$10.00 or more—this handy, sturdy steel parts box ideal for storing those small easily lost parts. Box measures 7 1/4" L. x 6 1/4" W. x 4 3/4" D. Remember—your order for \$10.00 or more brings you this dandy box absolutely free.

**2 TUBE WIRELESS PHONO OSCILLATOR**  
This fine piece of equipment is being sold at almost the price of the tubes alone. A real bargain. While quantity lasts . . . ea. \$3.25

**"ULTRA MIKE" WIRELESS MICROPHONE**  
Light—Economic operation. Completely self contained. No connections to power lines. Complete with batteries, tubes, etc. Retail at \$18.00  
Your price . . . . ea. \$6.63

**STEVENS CO-SPIRAL SPEAKER**  
15" high fidelity speaker with a reproducing range of 40 to 16,000 cps. Power handling capacity 15 watts. Input impedance 16 ohms. Alnico V magnet. Weight 2 1/2 lbs. Brings new listening pleasure to all types of high fidelity equipment. List \$80.00  
Net . . . . . ea. \$47.04

**G.E. VARIABLE RELUCTANCE CARTRIDGE**  
A wonderful new magnetic cartridge that provides excellent high fidelity reproduction. Practically eliminates needle noise. Fits almost any pickup. Requires pre-amplifier. List \$7.95 ea.  
Ea. . . . . \$4.67

**PREAMPLIFIER FOR G.E. VARIABLE RELUCTANCE CARTRIDGE**  
3 3/4 x 3 3/8 x 4 1/2". Increases output and equalizes cartridge for flat response. Attaches easily. Complete with tubes and diagram. List \$9.00  
Net . . . . . ea. \$4.82

**MEISSNER FM RECEPTOR**  
Covers complete FM band from 88-108 MC. Easily installed for quick conversion of any AM receiver, PA system, or phono-amplifier. Has 8 tubes—latest miniature design. 3V output. Comb. volume control and line switch. Comes in a handsome walnut cabinet. Shpg. wt. 8 lbs.  
List \$57.50  
Net . . . . . ea. \$38.33

**6 TUBE DETROLA PHONO COMBINATION AC CHASSIS**  
Complete with tubes, speaker, and aerial. Completely wired. Ea. \$14.95

**ALL NEW FULLY GUARANTEED STANDARD BRAND TUBES**

|       |     |       |     |
|-------|-----|-------|-----|
| 35Z5  | 50c | 50L6  | 59c |
| 12A6  | 29c | 1L6G  | 97c |
| 50B5  | 39c | 1LN5  | 97c |
| 25L6  | 39c | 1H5   | 39c |
| 6X7   | 59c | 1A7   | 39c |
| 117Z6 | 75c | 50A5  | 59c |
| 117L6 | 98c | 12SQ7 | 59c |
| 1N5   | 59c | 35L6  | 45c |
| 12K7  | 49c | 35W4  | 79c |
| VT32  | 30c | 6N7   | 85c |
| 7N7   | 45c | 12BE6 | 59c |
| 826   |     |       |     |

Write for our new, FREE 1948 Catalog.  
Terms: 25% Deposit with order . . .  
Balance C.O.D.

**MORT'S RADIO SHACK**  
630 W. Randolph St. Chicago, Ill.

# TIME SAVERS

by H. Leeper

## A TEMPORARY VISE

A third hand or some means of holding small parts is often needed when working with small equipment. Two battery clips which are bolted together will be of assistance in such emergencies.

The one clip is attached to a firm support—such as the radio chassis—leaving the other clip to hold the desired part.

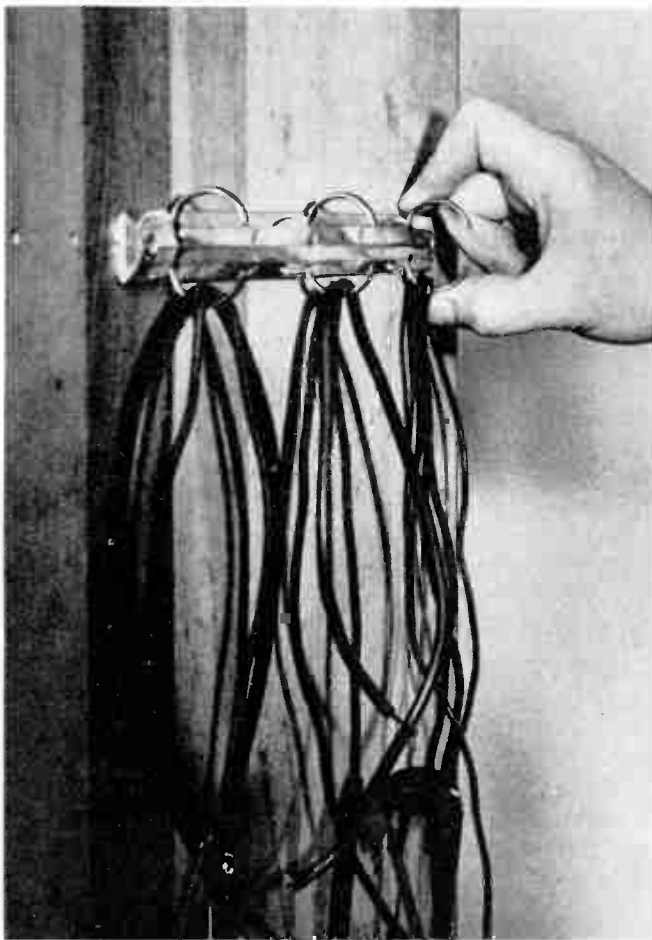
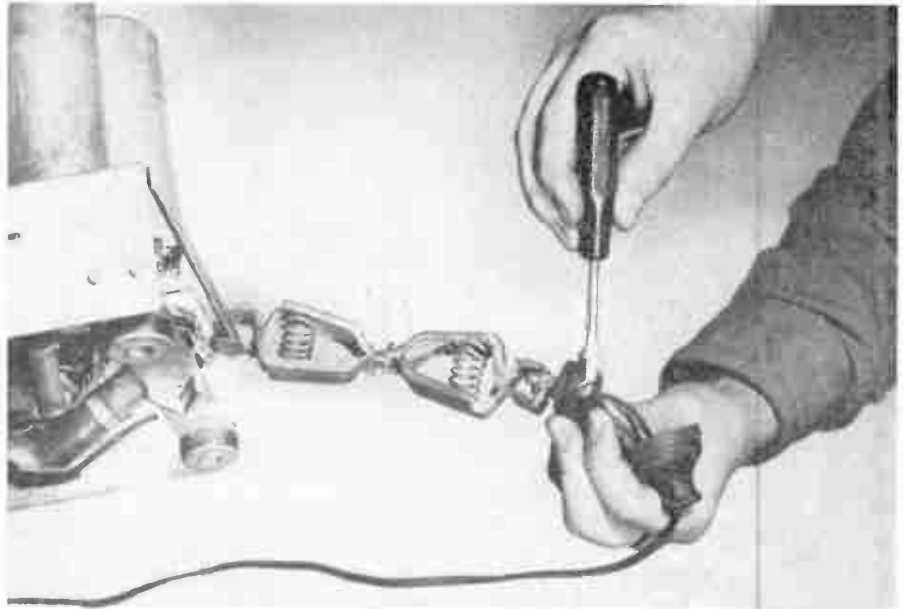

## TEST LEAD HOLDER

The metal clip binder from a worn-out notebook may be used to advantage for test leads as shown.

The ends of the binder are drilled so that it may be mounted with screws in a convenient place.

Clips are sprung open to insert or remove wires. When in the closed position leads are prevented from slipping over other wires and falling to floor as often happens with ordinary open type hooks.

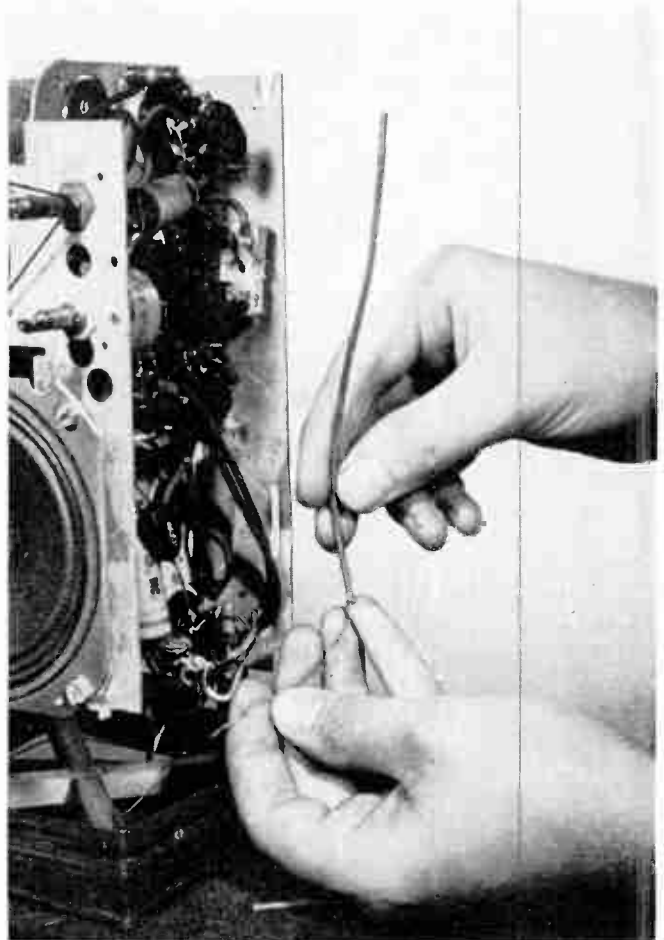

## LOOP ANTENNA LEADS

The lead wire from the loop aerial of some portable radios has only a thin layer of cotton insulation which in time often becomes frayed and unravels from the wire. This results in the bare wire striking other parts when the set is moved and is noticeable as noise or loss of signal. Well insulated sleeving of the proper size is obtainable at the radio store and a short piece of this sleeving may be slipped over the wire as illustrated, to improve reception in such cases.



# ELECTRONICALLY SPEAKING

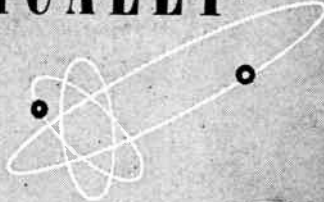

This month the first of an interesting monthly contest series will be held. The Hytron Radio & Electronics Corporation is offering three prizes monthly for a period of six months to the servicemen who submit the best ideas for radio service shop tools. The complete details of the contest will be found in an advertisement elsewhere in this issue.

We think that this contest offers the serviceman a unique opportunity to pass on to the trade his ideas for small useful service tools. Just about every serviceman we know has one or more of his own gimmicks or gadgets which he devised to solve often unencountered problems. We think that the field for radio service tools is comparatively undeveloped and that there is a real need for new ideas.

There are a couple of other features of this contest which we particularly like; among them the fact that Hytron plans to manufacture the winning tools on a nonprofit basis, and that if the company feels the tools are particularly worthwhile, they will pay the cost of a patent application in the contestant's name, retaining only the right to nonexclusive manufacture, distribution, and sale without royalties.

Read over the rules. We think you will like the idea. If you send in an entry, you automatically receive a tube tapper pencil which makes the whole thing just about foolproof. The next time you are at your jobber's get an entry blank and submit your favorite brain child.

Television will become a billion dollar business according to J. H. Stieckler, Advertising and Sales Production Manager of Westinghouse Home Radio Division.

He predicted that while television will become a big business in itself, it will not replace radio as we know it

today but in fact will bring about an upward swing in radio sales. He sighted the history of the phonograph business as an example of a business which was originally thought doomed by the rapid growth of radio in the '20's. He pointed out that the phonograph business not only continued, but reached a peak of \$300 million in record sales alone—\$100 million more than any other time in its history. He also pointed to the fact that the advent of f.m. and television is accelerating improvements in a.m. broadcasting and in the quality of the phonograph records being manufactured.

A new program entitled the "Good Service for Good Business" plan has been launched by the P. R. Mallory Company. Mallory distributors are holding meetings of servicemen to introduce this plan which includes offering a number of practical selling tools designed to aid the serviceman in building his business and increasing his profits.

One feature of the plan is a new Mallory sound slide film entitled "Good For You." The plan includes also a three-way agreement among the company, distributor, and the serviceman. As part of the agreement, the serviceman receives a customer follow-up file box complete with alphabetical and monthly index cards and a set of 250 special triple post cards which Mallory imprints with the serviceman's name and address.

Also included in the agreement is a four-color electric sign for use either in the window or on the counter. A certificate attesting to the plan is also supplied.

At the time the agreement is signed, \$2.50 is paid to the distributor, and copies of the agreement are furnished to both the serviceman and the distributor.



This famous-make FM antenna has been advertised and sold for many times the low price MID-AMERICA asks! Covers both FM bands. Delivers FM reception at its best. Complete with 60 ft. of 300-ohm twin lead-in. Line is standard approved flat-type, solid dielectric with weather-resisting insulation. Mounts anywhere easily... vertically or horizontally to match polarization of trans-

mitting station. Illustrated instructions and all necessary hardware. A screwdriver is only tool needed for assembly. Dynatenna is seamless, heat-treated, all aluminum... will withstand severest weather.

**\$4.95**  
each  
\$4.45 each  
in lots of 3



## PERMEABILITY TUNER

Build a really HOT 5 or 6 tube AC-DC superhet receiver! Takes place of old-style gang condenser, rf and antenna coils; regular 455 KC intermediate frequency. Complete with permeability tuned oscillator coil, 4" x 2 1/2" x 2 1/2" diameter dial drum. Order MA-2169 Loop Antenna 15c; and MA-2914 drilled, punched Chassis 39c. MA-2167.....

**\$1.24**

## CONTROL BOXES—19c Each!

MA-2135—5 position switch, volume control and jacks for PL-55 and PL-68. 3" x 4 1/2" x 2 1/4". Aluminum finish.

MA-2093—3-position switch, two wired jacks for PL-55 plugs, internal jack strip, circuit diagram. 3" x 3 3/4" x 2". Aluminum finish.

MA-2095—6-position, 5-prong female receptacle. Black crackle finish. 2 1/2" x 4 1/2" x 1 1/2".

MA-2126—Volume control, jacks for PL-55, PL-68. 2 1/2" x 3 1/2" x 1 1/2". Aluminum finish.  
MA-2092—4-position switch. Aluminum finish. 2 1/2" x 2 1/2" x 1 1/2".

## RG/8-U COAXIAL CABLE

Get your share of this fine-quality coaxial cable. Solid, moisture-proof polyethylene dielectric; fully shielded. 52 ohms nominal impedance. Not sold in less than 100-foot lengths.

MA-5018—100 feet.....\$2.89

## Coaxial Cable Connectors

PL-259—Low-loss connector for RG-8/U and RG-11/U, or use adapter for other coaxial cables. Silver-plated, machined brass. Inserts are low-loss mica. Exceptional quality at a low price. MA-2828. **29c ea.**

## Use a PUNCHED CHASSIS!

Save time and effort with a punched chassis. Takes the hard work out of building receivers, amplifiers, etc.

MA-2913—16" x 5" x 2" 10 tube..... 59c

MA-2910—14" x 6 1/2" x 2 1/2" 8 tube..... 49c

MA-2903—10 1/2" x 5 1/2" x 3 1/2" 7 tube..... 29c

MA-2914—10" x 5" x 2" 6 tube..... 39c

MA-2907—10 1/2" x 3 1/2" x 1 1/2" 6 tube..... 29c

MA-2911—10 1/2" x 3 1/2" x 1 1/2" 7 tube..... 29c

MA-2912—10" x 3 1/2" x 2" 5-tube (for chassis lock sockets)..... 29c

MA-2915—5 1/2" x 1 1/2" x 3 tube..... 15c

## ORDER FROM THIS AD!

Quantities are limited, so get your order in now! Minimum order shipped, \$2.50. Send 25% deposit; balance COD. Get on our mailing list to receive BIG BARGAIN BULLETINS that list latest, greatest buys in radio parts, electronic equipment. Send orders to store address, Desk RM-58

**MID-AMERICA CO. Inc.**

2412 S. Michigan Avenue  
Chicago 16, Ill.

# Look!

## Send for FREE BULLETIN

Sent you every month. It's crammed full of real buys. A post card with your name and address brings it to you. You can't afford to miss its bargains. Mail your card today.

## QUALITY ITEMS AT LOWER PRICES



**OZ4's  
at 73% OFF!**  
Until sold out—RSE offers 15000 new guaranteed OZ4 tubes. You know who made them—You can't go wrong at **59c**



**GENERATOR CONDENSERS**  
Made by nationally prominent eastern manufacturer. Standard merchandise—.5 mfd— $\frac{1}{8}$ " x  $1\frac{1}{2}$ "— $\frac{3}{8}$ "— $3\frac{1}{2}$ " lead - slotted mounting strap. Present list \$1.00. Discount 87%. While **13c**  
8000 last they're yours



**UNIVERSAL PHONO CRYSTALS**  
One model will replace all the following types: L22, L25, L26, L27, L32, L40, L70, L75, L76, W41A, W42A, W57A. Size  $\frac{1}{4}$ " x  $\frac{3}{4}$ " x  $2\frac{1}{8}$ ". List price \$4.45. **THEY COST YOU \$1.39**  
10 for \$12.90



**.5 mfd—300 VOLT CONDENSERS**  
Made by one of the big four.  $\frac{3}{4}$ " x  $2\frac{1}{2}$ ", with tinned leads. New fresh stock—all guaranteed. Only 10,000 available at **6c each**  
10 for 49c  
100 for \$3.95

**ORDER INSTRUCTIONS**  
Minimum order—\$2.00. 25% deposit with order required for all C.O.D. shipments. Be sure to include sufficient postage—excess will be refunded. Orders received without postage will be shipped express collect. All prices F.O.B. Detroit.

**RADIO SUPPLY & ENGINEERING CO., Inc.**  
127 SELDON AVE. DETROIT 1, MICH.

## SWEEP GENERATOR FM AND TV

→ From Page 26

Frequency stability again is not as important in a sweep generator as in an unmodulated r.f. generator. This is because it will be used for visual alignment of i.f. amplifiers having selectivity curves from 150 kc. to possibly 6 mc. wide. Obviously slight frequency drift, in terms of a few kilocycles, would not be apparent upon such wide curves. Nevertheless, good engineering principles dictate that frequency drift be minimized as much as possible. In the instrument discussed, drift has never been found to be more than a very few kilocycles—less than 3 kc.—during 8-hour runs. The really superb stability this represents can best be understood when it is realized that it was checked under the worst possible conditions—2 mc. output provided by two oscillators operating at 112 and 114 megacycles respectively! A long-time drift of 10,000 cycles in two oscillators operating at an average of 113,000,000 cycles amounts to 1 part in 11,300—a percentage so small as to rival the best of crystal control.

### Using the Instrument

In using a frequency-modulated sweep signal generator, the output thereof is fed into the receiver circuit to be visually aligned or checked, and the 'scope vertical amplifier terminals are connected across the receiver detector load resistor. As the center-frequency of the sweep generator is swept back and forth above and below the center-frequency set up upon its dial, the oscilloscope will trace out upon its screen a picture of the receiver selectivity curve—if the horizontal sweep rate of the 'scope is a suitable multiple, or sub-multiple, of the frequency used to sweep the r.f. generator. The horizontal sweep required for the 'scope may be self-generated by the sweep circuits included in it, or this sweep voltage may be provided by the same source which sweeps the signal generator. The trace most useful for FM i.f. alignment is obtained when the horizontal sweep to the 'scope is of the same frequency as that used to sweep the r.f. generator. This will

produce two selectivity curves upon the 'scope screen, superimposed one upon the other. One trace results from the upward sweep of the r.f. generator across the desired pass-band; the second, from its downward sweep across the receiver selectivity curve. With such a 'scope horizontal sweep rate, it is possible to adjust i.f. amplifier trimmers so that two curves are exactly superimposed, thus assuring symmetry of the i.f. amplifier pass-band.

The 'scope horizontal sweep voltage must be substantially saw-tooth in character, in order to sweep the 'scope beam slowly across the screen to trace out a curve, then snap it back practically in "no time flat" to start the next selectivity trace. It has been discovered that such a voltage, at exactly the desired 2X power line frequency, may be taken off through a condenser connected to the power supply rectifier cathode. This is done in Model 909 generator, it is believed, for the first time commercially through capacitor C6a and suitable shielded output cable. An added advantage of this method is that it simultaneously provides upon the 'scope screen a horizontal "base-line" trace most useful in a centering discriminator S-curve cross-over point.

Pages of instructions covering the use of the sweep generator in practical alignment work could be written. Suffice it to say that they accompany any good instrument to guide the user to maximum results. There is therefore no point in burdening the reader of this article with precise details here. Rather, certain general points may be profitably emphasized. In FM i.f. alignment everything is simple and straightforward, receivers made by different manufacturers requiring only the single technique of feeding the sweep generator output into the mixer grid circuit. The scope vertical amplifier is connected across the first limiter grid resistor to align the i.f. amplifier and the scope is reconnected across the discriminator load resistors to establish correct discriminator transformer S-curve. When a ratio detector is used, the scope vertical amplifier is connected across the ratio detector "audio take-off point," with the large by-pass condenser disconnected from across the ratio detector stabilizing resistor for i.f. alignment and a  $1\frac{1}{2}$  volt dry battery temporarily substituted for this large



# GET MORE FOR YOUR MONEY WITH A *Walter Ashe* TRADE-IN

Getting far more for your used equipment means paying much less for the new... that's the important money-saving advantage in dealing with Walter Ashe. Cash in now on the bigger-than-ever allowances offered by Walter Ashe on your used Test Instruments. Wire, write, phone or use the handy coupon below.

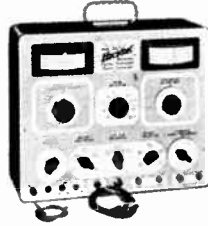

**MODEL 288X  
SIGNAL GENERATOR**  
Xtal controlled output 100Kc. to 110Mc. AM and 100Kc. to 160Mc FM. 0-15 Kc. variable audio output or 400 Cy fixed mod. Self contained DB meter.

**NET \$165.82**

**MODEL 195 OSCILLOGRAPH**  
Big 5" screen. Extra hi-gain amps. 7 to 20 times more sensitive than comparably priced units. This deluxe Hickok instrument can be yours at a substantial saving on a Walter Ashe trade-in deal.

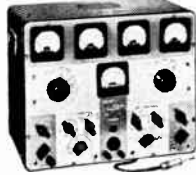

**MODEL 156A  
TRACEOMETER**

Simultaneously checks and locates faulty section of receiver without removing a test lead. Checks R.F., Mixer, Oscillator, I.F., Detector, Discriminator, Limiter, A.F., power supply and wattage.

**NET \$191.10**

TRADE-IN FEATURE  
OF THE MONTH

**NET \$129.36**



SEND FOR YOUR  
**FREE**  
COPY OF OUR  
1948 CATALOG

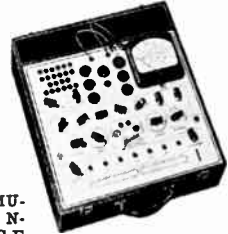

**MODEL 532P  
TUBE  
TESTER**

The true MUTUAL CONDUCTANCE

(TRANSCONDUCTANCE) TUBE TESTER. Actually measures MICROMHOS. Noise and gas tests. Tests all present day tubes.

Model 532P Net **\$126.44**

ALL PRICES F. O. B. ST. LOUIS

TIME  
PAYMENTS  
AVAILABLE

**MODEL 534  
TUBE TESTER**

Same as Model 532P, but in addition, has VOM, Capacitance, Inductance, Leakage and DB measurements. 20,000 ohms per volt D.C. sensitivity.

Model 534 Net **\$146.02**

**Walter Ashe**  
RADIO CO.  
"Test Equipment Headquarters"  
1125 PINE ST. ST. LOUIS 1, MO.  
PHONE CHESTNUT 1125

## SMASH VALUES IN USED, GOOD-AS-NEW TEST EQUIPMENT

Use this coupon to get Walter Ashe's "Surprise" Trade-In Allowance on your used factory-built test equipment.

**WALTER ASHE RADIO CO.** RM 5  
1125 Pine St., St. Louis 1, Missouri

Am Interested in the following top condition, slightly used Test Equipment..... (list preference)

I want to trade..... (describe used equipment)  
for .....  
(show make, model of new Test Instrument desired)

Rush my **FREE COPY** of the big, New 1948 Walter Ashe Catalog.

NAME .....

ADDRESS .....

CITY ..... ZONE..... STATE.....

capacitor when aligning the discriminator.

TV receiver i.f. systems are "a horse of another garage." Before attempting to visually align any TV video i.f. amplifier, the set manufacturers alignment instructions *must be consulted to determine the proper video i.f. amplifier curve shape for the particular receiver.* Alignment to provide such curve shape is then not difficult—if certain precautions are observed. Do not connect sweep generator output to video mixer grid at socket contact underneath the chassis—else "spray" to nearby wiring and parts will occur which will invalidate any alignment performed. Instead, wrap a short piece of wire around the mixer tube grid pin *above the chassis* where all i.f. transformers, wiring, etc., are shielded, and clip the sweep generator r.f. output clip onto this short-as-possible wire. It is often well to connect a .01 to .02 mfd. paper capacitor temporarily in shunt with the receiver's video detector load resistor, also shunted by the *shielded* scope vertical amplifier input leads. If these precautions are observed, in addition to muting the receiver oscillator by temporarily short-circuiting its grid to ground during TV (and FM) i.f. alignment, no troubles will be experienced. Alignment of TV receiver sound i.f. amplifiers and discriminators is as simple as described for any FM receiver—but only when using a sweep generator, such as described, in conjunction with a good sensitive cathode-ray oscilloscope.

**JUST OUT!**

# FM TRANSMISSION and RECEPTION

by John F. Rider and Seymour D. Uslan

**New BROADCAST OPERATOR'S HANDBOOK**  
by HAROLD E. ENNES,  
Engineer, Station WIRE

Here are coordinated facts, standards of good operating practice written by an operator in operators' language.  
288 Pages..... \$3.30

**NEW RIDER 99'r**  
160 PAGES

Bound in Cloth .....\$1.89  
Paper Binding ..... 99c

**JUST OUT!**

UNDERSTANDING VECTORS AND PHASE — Vector presentations ore widely used in conveying latest radio technical information This book is a must for students.

**416 FACT-PACKED PAGES**  
(substantial paper cover) **\$1.80**  
Hard back cloth cover, \$2.70

BY THE PUBLISHER OF  
**RIDER MANUALS**

**JOHN F. RIDER PUBLISHER, INC.**  
404 FOURTH AVENUE, NEW YORK 16, N.Y.

## POCKET FM GENERATOR

and two 20 mfd condensers. Filament voltage for the 12BA6 is obtained from the power line through the 700 ohm line cord resistor.

B minus is separated from ground (chassis) by a .01 mfd condenser. Thus the power line does not connect directly to the chassis and the operator is protected against shock and short circuits resulting from contact

with an oscilloscope. The most appropriate use, however, is for "on the spot" checks and alignment when the receiver chassis is not to be removed from the cabinet. Frequency deviation, which is not variable, is the order plus or minus 500 kc on the three RF settings, 88, 98 and 108 mc, and somewhat less on the 10.7 mc setting.

The radio frequency output is the second harmonic of the actual frequency of the oscillator in each case. The 10.7 mc intermediate frequency is a fundamental. The modulation

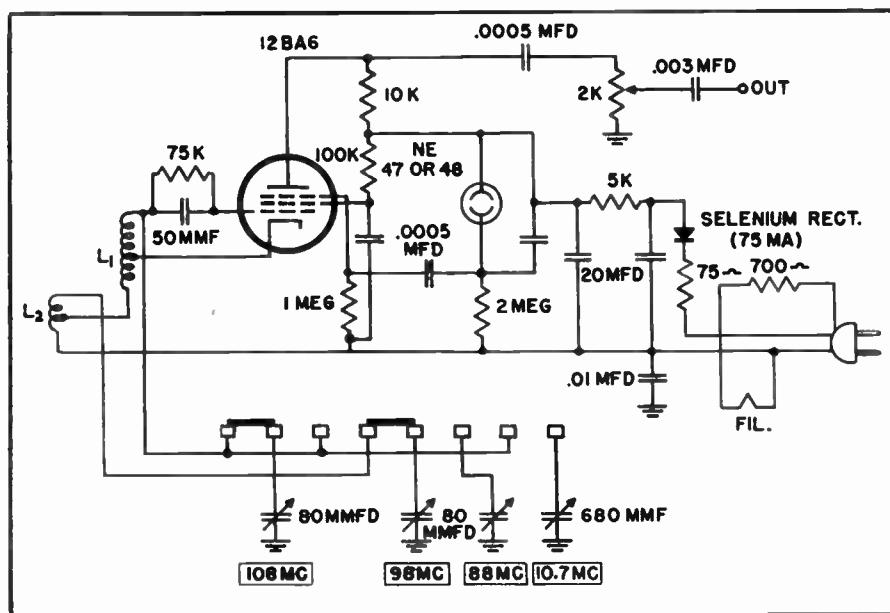

Fig. 2 Schematic diagram of the pocket signal generator.

with an external ground.

As can be seen in the diagram of Fig. 2, two condensers isolate the output lead from the plate of the oscillator tube. This prevents DC short circuits and excessive loading.

Tests made on the unit under practical working conditions show that quite satisfactory visual alignment curves can be obtained when used

(sweep) frequency is fixed at approximately 400 cycles. There are some variations of this modulation frequency with line voltage changes, but the stability of the RF oscillator is quite satisfactory.

As mentioned above, RF output is at the second harmonic of the actual oscillator frequency. This means that signals can also be obtained at the fundamental frequencies of 44, 49 and 54 mc. The first two frequencies fall in the prewar FM band and can be helpful if you are called upon to align one of the old tuners (many are still in use with and without converters.)

Everything considered, this pocket-size FM signal generator is a useful tool, especially in these days of mushrooming FM activity. < < <

A new FM Series is starting soon.

## TECHNICAL MANUALS

Custom designed to your specifications

**Planned, written and illustrated by a select staff . . . experts in creating radio and electronic manuals for civilian & military use.**

When you call upon Boland & Boyce to create your manuals you are relieved of every detail in their preparation. The entire operation is taken over and completed by a specialized staff with years of experience in publishing books & manuals.

First the requirements for your manual are completely surveyed. The working conditions to which they will be put are studied and the operations or equipment described in the manual are thoroughly analyzed. A complete outline is then prepared and submitted for your approval, along with a dummy of the manual as it will appear when finished. Upon your approval the job is completed and delivered with your satisfaction guaranteed.

Boland & Boyce manuals incorporate only the most modern editorial and illustrative style. Each project is treated with individual attention in technique of presentation and editorial approach. The Boland & Boyce military and civilian manuals now in use throughout the world are our best recommendations.

U. S. Navy  
U. S. Signal Corps  
Sylvania Electric Products, Inc.  
The National Company  
Western Electric Co.  
Bell Telephone Laboratories  
Maguire Industries, Inc.  
Allen B. Du Mont Laboratories, Inc.  
General Electric Co.  
Mine Safety Appliances Co.

Write or Wire Boland & Boyce today for more information.

**BOLAND & BOYCE INC., PUBLISHERS**

Publishers of: Radio Data Book,  
Radio Maintenance, Video Handbook,  
Technical Manuals

Manual Division M-3  
Montclair, N. J.

MAY 1948 • RADIO MAINTENANCE

### TUBULAR ELECTROLYTICS

Fresh stock Fully guaranteed

20 mfd. 150 V. . . . . 10 for \$1.70  
20-20 mfd. 150 V. . . . . 10 for 2.40  
8 mfd. 450 V. . . . . 10 for 1.85

Postage extra. 25% deposit on C.O.D.  
Write for our free bargain lists featuring  
"AMERICA'S BEST BUYS"

**POTTER RADIO CO.**

1314-M McGee Street Kansas City 6, Mo.

### RADIO TUBES

First Quality R.M.A. Guaranteed

50% DISCOUNT  
off the regular flat price

Plenty of hard to get numbers. Order any tubes  
you need. 25% Deposit on C.O.D. If you send  
cash we pay postage.

**MIDWAY RADIO TUBE CO.**

3838 South Parkway Chicago 15, Illinois



# LINE ANTENNAS

TWO types of built-in antennas are used in modern sets, the loop antenna, comprising a tuned RF input circuit, and the line antenna, consisting of a capacity, coupling the antenna terminal to the power line. Either one will usually provide excellent results under average conditions. Where operation of line-antenna sets is poor, connect an outside antenna to the live side of the power line through a .01 mfd. condenser, as in Fig. 1. With this arrangement, the antenna picks up the signals, feeding them into the power line from where they go to the set. This system also works nicely in the home where the set is moved from room to room. There is

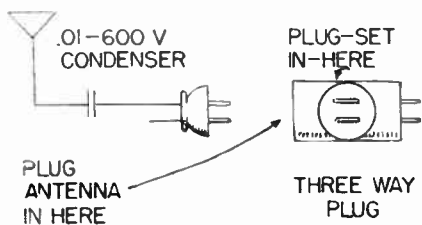

one other thing that will seriously reduce signal pickup with a line-antenna set. Practically all sets other than line-antenna sets have a line bypass condenser across the line from one side to ground. When such sets are used in the vicinity of line antenna sets this condenser will bypass nearly all RF in the line. To overcome this, insert an RF filter between the line cord and wall outlet of these sets. Such a filter may consist of a standard RF line filter, many of which are on the market, or RF chokes, or a separate inductive-type line antenna attachment. If the latter unit is used, no connection is necessary to the antenna and ground provision of the unit. It is used only to decouple the set from the line. If necessary, any number of sets can be run from this unit providing its wattage rating is not exceeded. ✓✓✓

# INTERFERENCE

→ From Page 22

engineers of the various filter manufacturing companies do his designing for him. Commercial filters are available for specific frequency ranges, and even for specific pieces of apparatus.

## Carbon Element Type

Simple resistances inserted in series with the lines leading to or from the interfering device. Common types are auto ignition suppressors, and oil burner spark suppressors. Their efficiency (when used alone) is low.

## Special Types

All filter manufacturing companies make special type filters for special jobs. Special shapes, special mountings, special electrical characteristics are no problem to them. Any serviceman can write for advice on any tough job he runs into, and they will be glad to help him. He should give them full details about the job, even if he must estimate the unknown factors. If part of the serviceman's business is servicing aircraft radios or marine equipment, the various companies will be glad to furnish a list of interference filters that they make especially for aircraft or marine application.

A special unit, for instance the SPRAGUE #4 Filterol mentioned earlier and pictured in Fig. 2, provides exceptionally high attenuation from 5 megacycles up to 150 megacycles and higher.

Filters vary widely in use and effectiveness. Although the construction of commercial units appears simple in many cases, actually a great deal of research is required in their design and in the selection of materials. It is important for the serviceman to be acquainted with the various types of filters, how to use them, where to use them, and just as important—how to install them.

Part 2 explains how to use filters, what filters to use, a chart that makes the selection of a filter for any job easy, how to locate the source of interference, and how to assemble a service kit of filters that takes care of about any job the serviceman is likely to run into. ✓✓✓

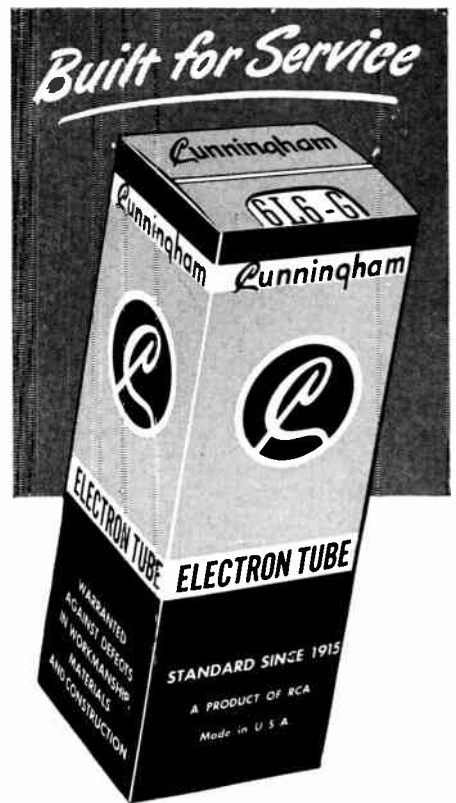

**Servicemen's choice!**

in . . .



• No need to put Cunninghams to a vote in the Sunshine State. Floridians favor Cunninghams because Cunninghams are built for long life and trouble-free service. Your days will be brighter if you replace with Cunninghams when new tubes are needed.

See your  
**CUNNINGHAM DISTRIBUTOR**

**KINKADE RADIO SUPPLY CO. . . Jacksonville**  
**KINKADE RADIO SUPPLY CO. . . . . Tampa**  
**ELECTRONIC SUPPLY CO. . . . . Miami**



DO YOU HAVE

IHT?

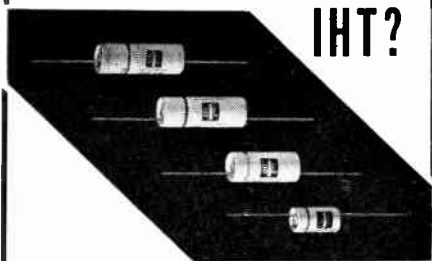

### ILLINI-HYCAPS . . .

Type IHT—tubular electrolytics are always ready to fill your need for capacitors of superior quality and ability. A complete line of these tubular electrolytic capacitors are now available.

Included in the list of old standbys are NEW types especially designed for use in voltage doubling circuits. With either tube or selenium rectifiers these units are superior because of their ability to stand up under higher temperatures, handle larger voltage and current surges, last longer because of their new and special engineering design.

**NOTE:** A new supplement, listing these new condensers, along with other high voltage, high capacity types, has been added to our catalogue. Write today for your copy.



**ILLINOIS CONDENSER CO.**  
1616 NORTH THROOP STREET • CHICAGO 22, ILL.



Free illustrated booklet tells the "Inside Story" of an amazing new servicing method. It also contains valuable "hints and kinks" for every radio man. Just send your name, address, and the words—"Inside Story"—on a post card and we will mail your copy at once, without cost or obligation. Do it now before you forget!

# FEILER

**FEILER ENGINEERING CO.**  
Dept. 5H8 945 George St.  
Chicago 14, Ill.



We have all come across some tough ones. Why not tell us about the ones that you have encountered and how you solved them so that we may pass them along to your fellow servicemen.

Give as clear and brief an explanation as possible, stating the symptoms, the cause and the remedy. Give the make, model number and, if possible, the year. Of particular interest are those receivers manufactured from 1937 to the present.

**RADIO MAINTENANCE** will pay two dollars for each case history published.

### SONORA MODEL WGFU242

#### *Weak and Distorted*

This set brings the complaint of weak and distorted reception. This is usually experienced in the sets before they are sold. It is caused by a poorly soldered joint at the stator lug of the antenna section of the tuning condenser. At the same time it is good to check the loop mounting screw. This has been found loose in every case and makes it difficult to replace the chassis which is hard to replace anyway.

### ARVIN MODEL 444

#### *Intermittent*

Intermittent reception has been experienced in every one of these sets that has been in for servicing. Jarring the chassis will bring the set on or cut it off. Much time was spent in probing around the wiring and joints but no trouble was experienced. Finally it was noticed that hitting the chassis lightly with a screwdriver near the tuning condenser would bring on the trouble. This was traced to the trimmer on the oscillator section of the tuning condenser. When the set was hit

or jarred the trimmer's adjusting screw would move slightly one way or the other. Adjusting the trimmer carefully and then sealing it with service cement was the remedy.

### ZENITH MODEL 6D015, CHASSIS 6C05

#### *Intermittent reception*

Three of these sets developed the same type of trouble—intermittent reception. Replacing any weak tubes boosted the volume but had no effect on the intermittent condition. Probing about the connections did not reveal anything here yet when the set was hit or bumped in any way it would cut off or come back on to normal but then only when the set was in an upright position. This meant that the signal tracing was out. As a last resort each condenser and resistor was wiggled but good with a pair of plastic pliers. When the audio blocking condenser got the treatment the set acted up again. The trouble was in the 12SQ7 (or 12AT6 depending on the tube complement of the set) first audio plate connection. Examining the soldered joint revealed no trouble but a touch with a soldering iron did the job. Why all three sets experienced the same type of difficulty at the same joint is yet unknown.

### RADIOLA MODEL 61-5

#### *Weak, hum, distortion*

After being in use only a short time the volume would become very weak and there would be a considerable amount of hum and distortion present. Replacing the 35Z5 rectifier tube cured the hum and a routine check seemed to indicate that the volume control was at fault. Check-



ing its resistance showed it to be too high. A replacement brought the volume to normal and the distortion was cured by replacing the capacitor C7 connected between the arm of the control and the control grid of the 35L6 output tube.

#### CHEVROLET MODEL 985284

##### *Intermittent, noisy*

This auto radio came in the shop with a complaint of intermittent reception, noise, and distortion. On checking the tubes it was found that the 6J5 was gassy and that the 6N7G had one section shorted. This was the cause of the distortion. The intermittent condition was traced to the antenna coil clamp. This is a spring wire affair that holds the coil in its shield can. This had worked loose and dropped inside the can, thus shorting out the coil. In order to remedy the condition it was necessary to unsolder the leads to the coil, remove the coil and the clip and then reverse the process. This eliminated the noise as well.

John W. Findarle  
Modesto, California

#### PHILCO 46-1201

##### *Feedback at high volume, only when on "phono"*

Check the two rubber grommets on the pickup arm right where it connects to the support post. These grommets usually harden and transmit audio vibrations from cabinet and motor plate to the crystal cart-ridge where they are picked up and fed back into the audio end. Make sure to replace with units made from live rubber.

#### G-E MODEL GD-60

##### *Dead or intermittent:*

Replace the 2-watt 12,000-ohm converter screen dropping resistor which is common to the 6SK7 RF amplifier, the 6SA7 converter and 6SK7 IF amplifier. This resistor operates under a heavy load and should be replaced with a 12,000-ohm 5-watt unit.

D. South Travis  
Sherman, Texas

#### CROSLEY 66-TC

##### *Tunable hum:*

Check the lead running to the 6Q7G grid cap. This lead passes through the chassis and heat causes it to crack and short. When re-assembling the set, be careful not

to permit the twisted pair running to the On and Off switch to become caught under the trimmer condenser bracket as this will also result in hum.

A. Furman  
Chicago, Ill.

#### ADMIRAL 4-A-D-F

##### *Weak on low frequency end of the dial:*

A common complaint since low frequency padders were not built into this set. Swing the gang condenser to 550 kc, adjust the IFs for maximum, swing the gang back to the high frequency end and retrim the high frequency padders.

Martin Goebel  
Detroit, Mich.

#### FIRESTONE R-3121

##### *Distortion:*

This can often be traced to a leaky audio coupling condenser between the 6Q7 and the grid of the 25L6 which lowers the effective grid bias on the tube.

John Halsey  
Baltimore, Md.

#### PHILCO PT-61

##### *Hum, distortion, especially in damp weather:*

Disconnect the AVC bus from the unused rectifier socket lug. Socket leakage is impressing an AC voltage on the AVC lead.

L. Petra  
Los Angeles, Calif.

#### STEWART WARNER 900-B SERIES

##### *Set dead:*

First IF transformer plate winding checks open. Remove can, disconnect leads from soldering lugs. Scrape clean and check for continuity. The leads sometimes break inside the insulation right near the solder lugs because the wire is wrapped too tightly around the lug.

J. T. Thomson  
Chicago, Ill.

#### ADMIRAL P5, XP5

##### *Functions on battery, dead on AC line:*

Half the filament is open in the 3Q5. It is good practice to clean the contacts on the battery and line switch whenever one of these sets comes into the shop as this switch often becomes intermittent.

George Johns  
Atlanta, Ga.

→ To page 53



**Servicemen's choice!**  
**in . . .**



● In Louisiana, where good living counts, Cunninghams are a custom . . . because Cunningham tubes are famous for their quality and performance. Your customers are candidates for Cunninghams . . . so cast *your* vote for Cunninghams, too!

See your

**CUNNINGHAM DISTRIBUTOR**

**ELECTRONIC SUPPLY CO. . . Baton Rouge**  
**HALE & McNEIL . . . . . Monroe**  
**RADIO PARTS, INC. . . . . New Orleans**  
**LEE HARDWARE CO. . . . . Shreveport**



## New! Permanent PANEL SWITCH

Mounts on console panel—  
Eliminates groping behind  
radio to turn on and off.



## BATTERY ELIMINATORS

A COMPLETE LINE FOR EVERY REQUIREMENT

NEW MODEL "S" WITH SELENIUM RECTIFIERS—operates any 1.4 volt, 4, 5 or 6 tube radio from 115 volt, 60 cycle source.

MODEL "P"—Same as MODEL "S" except with tube rectifiers at lower cost.

MODEL "Q"—Operates any 1.4 volt 4, 5, or 6 tube radio from 6 volt storage or dry battery, or Wincharger. Ideal for farms, camps, autos, boats, etc.

MODEL "A"—Operates 2 volt 4, 5, 6 or 7 tube radio from 6 volt storage or dry battery, or Wincharger. (0.5 amp. filament max.)

Models to convert dry battery radio to AC receivers—other models for use with 6 volt storage battery. Costs but a few cents per hundred hours of operation. Completely filtered, hum free, silent and efficient. Sturdy construction with Harmerloid finish. No liquids or moving parts. Operate in any position.

CANADIAN REPRESENTATIVE: ATLAS RADIO CORP., TORONTO, CAN.

## ELECTRO PRODUCTS LABORATORIES

Pioneer Manufacturers of Battery Eliminators

549 West Randolph Street

Chicago 6, Illinois

# WELLER SOLDERING GUN

Time Saving-Money Making Features

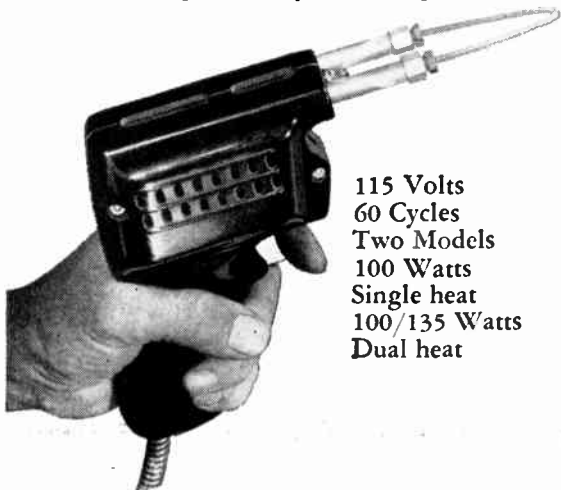

115 Volts  
60 Cycles  
Two Models  
100 Watts  
Single heat  
100/135 Watts  
Dual heat

See your radio parts distributor or electrical wholesaler. Or write direct for bulletin.

**WELLER Mfg. Co.**  
812 Packer St. • Easton, Pa.

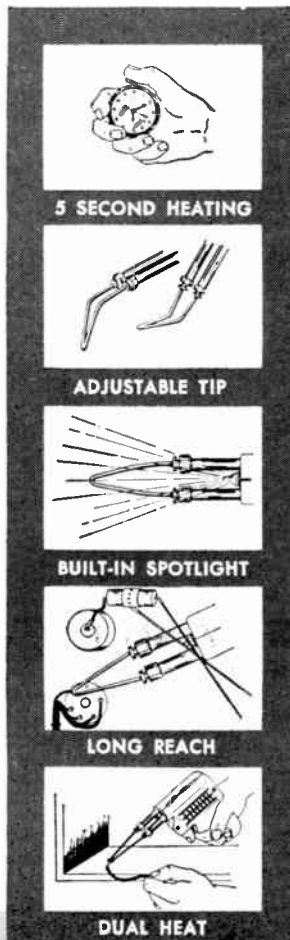

## LETTERS

Gentlemen:

... I was glad to see that you have started to publish letters from readers. It gives us a chance to "sound off" on subjects which interest us and share our mutual problems.

I'd like to see some opinions from other servicemen on things like licensing. Personally, I'm against the idea of licensing servicemen and I think organizations are a better way to solve the problem of quality of service.

Yours truly,  
Willard Scobey

This column will print any letters which we believe are of general interest. Readers are invited to "air" their opinions on important subjects of the day which have a direct bearing on the welfare of the trade.—Ed.

Gentlemen:

... I might suggest a series of construction articles on test equipment. The field is wide open for wide band television sweep generators, their design and construction with an explanation as to the various electronic sweep circuits. This information is what I would like to have personally and I know the other boys would too.

Yours very truly,  
Edward E. Emich

We do not publish construction articles if equipment is available commercially. Commercial equipment is almost invariably more efficient. Considering the time spent in construction at regular service rates will prove that commercial units are cheaper than the home grown variety.

### PHOTOGRAPH CREDITS

|                  |                |
|------------------|----------------|
| Page 20          | Aerovox        |
| Page 21          | Sprague        |
| Page 23          | Staff          |
| Pages 24, 25, 26 | McMurdo Silver |
| Pages 32, 44     | H. Leeper      |



## DISTORTION

→ From Page 19

in a push-pull stage due to parasitic oscillations. This can usually be remedied by inserting a resistor of from 25,000 to 50,000 ohms in the common grid return lead ( $R_1$  in Fig. 6). The filter components, especially the plate by-pass condensers, should be checked first, however. Inherent frequency discrimination in inter-stage audio transformers used may introduce frequency distortion. A more linear frequency response may

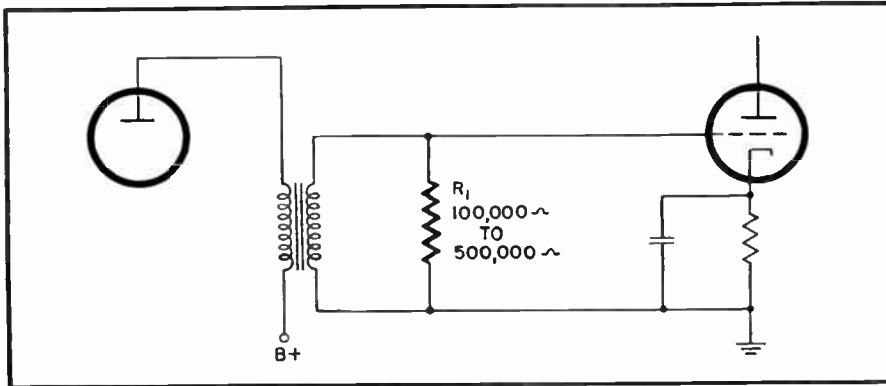

Fig. 7 Resistor  $R_1$  will often improve a receiver's quality.

often be obtained by connecting a resistor across the secondary winding of the transformer, as shown in Fig. 7. Some receiver manufacturers incorporate this resistor in their receivers. The optimum value of this resistor is that which will give improved frequency response without seriously reducing the amplification. This value will usually lie between 100,000 and 500,000 ohms. The lower the value, the better the tone quality and the lower the amplification.

If the output transformer has been replaced, it is well to make certain that it is the correct replacement, as a mismatch to either the output tube or the voice coil, or both, may result in serious distortion, and possibly

loss of volume.

An R-C filtering network is often connected across the primary winding of the output transformer that is used in conjunction with a beam power pentode. This filter network is for the purpose of giving the plate load the effect of a pure resistance and the values of the resistors and condensers are therefore very critical. If any component of this network becomes defective, or is of the wrong value, serious distortion will result. If there is any doubt about any of these, they should be replaced.

A by-pass condenser is not generally needed across the cathode biasing resistor in push-pull stages and usually one is not used. Current fluctuations, however, due to mismatched tubes and uncanceled odd harmonics can usually be materially reduced by the installation of a by-pass condenser, as shown in Fig. 6 ( $C_1$ ). The optimum value of this condenser may be determined by the

following formula:  $RC = \frac{1.6}{F}$

WHERE R is the value of the cathode resistor in ohms, C is the desired Capacitance in Farads, and F is the lowest audio frequency (in cycles-per-second) to be by-passed. ✓ ✓ ✓

## CASE HISTORIES

→ From Page 51

### STROMBERG CARLSON 1121 FM-AM

#### Converter trouble

Trouble in converter section. If the tube is OK, try replacing the 5,200 ohm, four watt section of the candohm that supplies the screen voltage to the 6SB7. The correct replacement, is part number 149,002. The failure of this part seems to occur frequently in this model.

### RCA 811

#### Intermittent distortion

This sound like an open filter condenser, or wrong bias voltages. This condition appears after the set has warmed up, and can easily be missed in a quick check-over. Measure the screen voltage on the 6K7 IF amplifier. The voltage should be 80 volts or higher. If it is not, replace the 82,000 ohm screen grid resistor with a one-watt unit.

Albert Loisch  
Darby, Pennsylvania

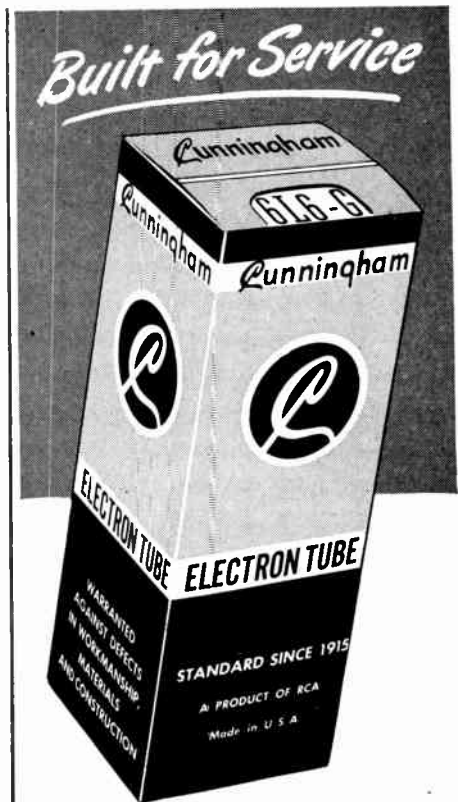

**Servicemen's choice!**  
in ...



● Cunningham tubes are rugged, too. That's why their long life and top performance have made them the favorite tubes in Minnesota for over 32 years. And reason enough why you should vote to replace with Cunninghams when new tubes are called for.

See your  
**CUNNINGHAM DISTRIBUTOR**  
NORTHWEST RADIO CO. . . . . Duluth  
LEW BONN CO. . . . . Minneapolis  
LEW BONN CO. . . . . St. Paul



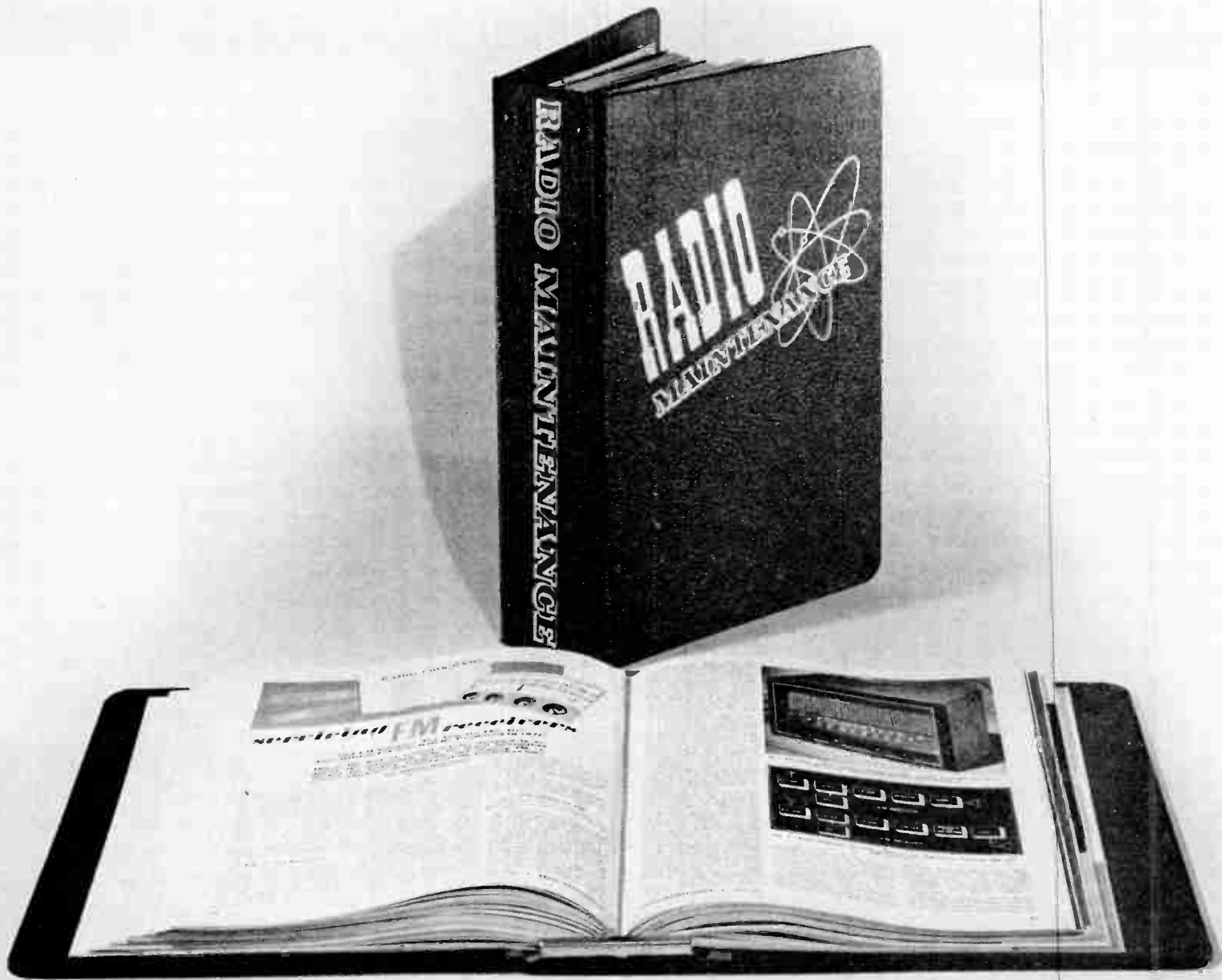

# BINDERS

**TO PRESERVE YOUR  
RADIO MAINTENANCE  
MAGAZINES**

Keep your back numbers of **RADIO MAINTENANCE** in these handsome green and gold binders. Each binder will hold up to 18 copies of the magazines without puncturing holes or mutilating them in any way. They are held securely but are easily removed if desired. With the index printed at the end of each year, your magazines will be a constant reference for . . . a valuable service library. Send for your binders now!

**RADIO MAINTENANCE**  
460 Bloomfield Avenue  
Montclair, N. J.

Please send me . . . binders at \$3.00 each.  
Total amount enclosed . . . . .

Name . . . . .  
Address . . . . .  
City . . . . . Zone . . . . .  
State . . . . .



## ADVERTISERS

|  |        |                                   |                |
|--|--------|-----------------------------------|----------------|
| Aerovox Corporation                    | 40     | Hytron Radio & Electronics Corp.  | 9              |
| Agency: Austin C. Lescarboura & Staff  |        | Agency: Henry A. Loudon, Adver.   |                |
| A. G. Radio Parts Company              | 55     | Illinois Condenser Co.            | 50             |
| American Electrical Heater Company     | 34     | Agency: Kuttner & Kuttner, Adv.   |                |
| Agency: Dudgeon, Taylor & Bruske, Inc. |        | P. R. Mallory & Co., Inc.         | 11             |
| Walter Ashe Radio Company              | 47     | Agency: The Aitkin-Kynett Co.     |                |
| Capitol Radio Engineering Institute    | 36     | McMurdo Silver Co.                | 8              |
| Agency: Henry J. Kaufman & Associates  |        | Agency: Edward Owen & Co.         |                |
| Centralab                              | 28, 29 | Mid-America Co., Inc.             | 45             |
| Agency: Klau-Van Pietersom-Dunlap      |        | Agency: E. H. Brown Adv. Agency   |                |
| Clarostat Mfg. Co., Inc.               | 3      | Midway Radio Tube Co.             | 48             |
| Agency: Austin C. Lescarboura & Staff  |        | Mort's Radio Shack                | 43             |
| Concord Radio Corp.                    | 38     | Agency: The Schram Co.            |                |
| Agency: E. H. Brown Adv. Agency        |        | Operadio Mfg. Co.                 | 37             |
| Electronic Development Co.             | 55     | Agency: Kennedy & Co.             |                |
| Electronic Development Laboratory      | 38     | Permoflux Corp.                   | 41             |
| Agency: Bartz Advertising Agency       |        | Agency: Turner Advertising Agency |                |
| Electro Products Laboratories          | 52     | Potter Radio Co.                  | 48             |
| Agency: Merrill Symonds Adv. Agency    |        | Precision Apparatus Co.           | 10             |
| Espey Mfg. Co., Inc.                   | 41     | Agency: Shappe-Wilkes, Inc.       |                |
| Agency: J. L. Purnies & Associates     |        | Radiart Corp.                     | 14             |
| Federal Telephone & Radio Corp.        | 6      | Agency: Ohio Adv. Agency          |                |
| Agency: J. M. Mathes, Inc.             |        | Radio Corporation of America      | 49, 51, 53, 55 |
| Feiler Engineering Co.                 | 50     | Agency: J. Walter Thompson        |                |
| Agency: Turner Advertising Agency      |        | Radio Supply & Engineering Co.    | 46             |
| General Electric Co.                   | 4      | Agency: Claude E. Whipple         |                |
| Agency: Maxon, Inc.                    |        | John F. Rider, Publisher, Inc.    | 47             |
| Hickox Electrical Instrument Co.       | 39     | Agency: Lanford F. King, Adv.     |                |
| Agency: White Adv. Agency              |        | Howard W. Sams & Co., Inc.        | 27             |
|  |        | Agency: George Brodsky Adv.       |                |

### BOOK: "TELEVISION RECEIVER CONSTRUCTION"

by A. Liebscher.

Describes in detail every operation in building the ESPEY TELEVISION TRAINER . . . how to test and align it . . . complete antenna data . . . how to operate the set . . . trouble shooting procedure . . . soldering technique for miniature tube wiring . . . and other valuable television information. Twenty photos and five drawings show progressive stages of assembly details alone . . . others picture T-V reception results, antenna, etc. . . . \$1.50 Your money back if not satisfied with this book, provided it is returned within five days. Available at your jobber's, or write:

**ELECTRONIC DEVELOPMENT COMPANY**  
of Pennsylvania  
7618 Fayette St., Philadelphia 38, Pa.

## TELEVISION NEEDS TRAINED MEN!

TEACH YOURSELF — learn as you build the Espey T-V Trainer— get familiar with basic circuits, production assembly technique, alignment methods — gain operating experience and have a complete portable set when finished. It is ideal for field strength checking and can be used on the roof for antenna orientation.

**GET T-V AT A. G.!**

RCA and ESPEY television parts in stock. Write today for free price list and order form.

**A. G. RADIO PARTS CO.**

3515 N. 17th St.

Philadelphia 40, Pa.

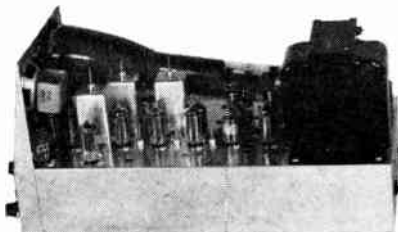

|                                      |        |
|--------------------------------------|--------|
| Shure Brothers, Inc.                 | 2      |
| Agency: Casler, Hempstead & Hartford |        |
| Simpson Electric Co.                 | 7      |
| Agency: Kreicker & Meloan, Inc.      |        |
| Sprague Products Co.                 | 31     |
| Agency: Harry P. Bridge Co.          |        |
| Sylvania Electric                    | 12     |
| Agency: Newell-Emmett Co.            |        |
| Triplet Electrical Instrument Co.    | 13     |
| Agency: Western Advertising Agency   |        |
| Ward Products Corp.                  | 5      |
| Agency: Burton Browne Adv.           |        |
| Webster-Chicago                      | 32, 35 |
| Agency: Fuller & Smith & Ross        |        |
| Weller Mfg. Co.                      | 52     |
| Agency: John Falkner Arndt & Co.     |        |



**Servicemen's choice!... to clock up more sales**



● Greatest sales catcher in Cunningham's history—this 15-inch, self-starting clock done in four colors will command attention wherever you hang it. Brilliant, uniform illumination is provided by two 15-watt lamps with aluminized reflector. All-aluminum construction and sealed movement make it weatherproof. Best news of all . . . it costs you only \$9.50! Get yours today . . . ask your Cunningham Distributor for Order Form 2F250.

# Cunningham Tubes

A product of  
**RADIO CORPORATION OF AMERICA**  
Harrison, N. J.

# BACK NUMBERS

GET THEM WHILE THEY LAST!

Get these back numbers to help complete your file of RADIO MAINTENANCE magazines. These copies, plus the copies you will receive in the months to come will form a valuable reference library to which you will turn for assistance in your daily work. The articles are listed under each month's heading to help you select the ones you wish to order, or you may want to order all eighteen back numbers listed below for the special price of \$4.25 (a reduction of \$1.05!) Send in for these copies today—insert them in your RADIO MAINTENANCE binders and you'll have a first-rate service library!

## JANUARY 1946

THE PROBLEMS OF ORGANIZATION  
TELEVISION RECEIVER INSTALLATION  
RADIO MAINTENANCE IN AVIATION  
USING THE OSCILLOGRAPH FOR  
DISTORTION MEASUREMENTS

## MARCH 1946

TROUBLESHOOTING TELEVISION RECEIVERS  
APPLICATIONS OF A LOW COST  
SIGNAL TRACER  
RADIO REPAIRMEN'S ASSOCIATIONS  
RADIO SERVICE ALONG THE AIRWAYS

## APRIL 1946

A MIDGET AUDIO FREQUENCY  
OSCILLATOR  
IF I WERE A SERVICEMAN  
AN EQUALIZED AMPLIFIER FOR  
MAGNETIC PICKUPS

## MAY 1946

PA SYSTEMS  
TEST PANEL FOR THE MODERN BENCH  
RINGING THE BELL

## JUNE-JULY 1946

FUNDAMENTALS OF TELEVISION  
VOLUME CONTROL TAPERS  
THE ELECTRONIC OHMMETER  
VECTOR ANALYSIS

## AUGUST 1946

AVC CIRCUITS  
FM TROUBLESHOOTING  
TELEVISION RECEIVER FUNDAMENTALS  
RECORD CHANGERS

## DECEMBER 1946

TELEVISION RECEIVERS . . .  
THE RF SECTION  
TUNING THE INDICATORS  
PART II—THE OSCILLOGRAPH . . . .  
HOW TO USE IT  
REPLACING AUTO CABLES

## JANUARY 1947

SERVICING BY EAR  
TELEVISION RECEIVERS . . . VIDEO  
CHANNEL  
PART III THE OSCILLOGRAPH . . .  
HOW TO USE IT  
MINIATURE TUBE CHART

## FEBRUARY 1947

THE OSCILLOGRAPH . . . HOW TO USE  
IT PART IV  
TELEVISION RECEIVERS . . . THE SOUND  
CHANNEL  
THE AUDIO OSCILLATOR  
SELENIUM RECTIFIERS

## MARCH 1947

ANTENNAS . . . FM AND TELEVISION  
PART I  
SERVICING AUTOMATIC RECORD  
CHANGERS  
OSCILLATORS AND CONVERTERS  
TELEVISION RECEIVERS . . . THE VERTICAL  
SWEEP

## APRIL 1947

ANTENNAS . . . FM AND TELEVISION,  
PART II  
PHASE INVERTER CIRCUITS  
A UNIVERSAL SPEAKER  
TELEVISION RECEIVERS . . .  
THE HORIZONTAL SWEEP

## MAY 1947

THE OPEN AND CLOSE CASES  
VOLTAGE DOUBLERS  
SIGNAL TRACER  
TELEVISION RECEIVERS . . . THE  
CATHODE RAY TUBE

## JUNE 1947

WHEN THE CUSTOMER ISN'T RIGHT  
TEST EQUIPMENT MAINTENANCE  
CRYSTAL CONTROLLED SIGNAL  
GENERATOR  
TELEVISION RECEIVERS . . . THE  
POWER SUPPLY

## JULY 1947

SERVICING FM RECEIVERS  
TEST EQUIPMENT MAINTENANCE, PART II  
TELEVISION RECEIVERS . . .  
FLYWHEEL SYNC

## AUGUST 1947

SPEAKER MATCHING  
TEST EQUIPMENT MAINTENANCE, PART III  
SERVICING FM RECEIVERS  
TELEVISION . . . HF POWER SUPPLIES

## JANUARY 1948

HOW TO IMPROVE YOUR SIGNAL  
TRACING TECHNIQUES  
SPECIAL FM CIRCUITS  
WHAT'S NEW IN VIDEO SECTIONS

## FEBRUARY 1948

USING SWEEP GENERATORS FOR  
FM ALIGNMENT PART I  
LET'S WORK TOGETHER  
VOLTAGE REGULATOR OPERATION  
TIME SAVERS

## MARCH 1948

HOW TO ELIMINATE HUM  
USING SWEEP GENERATORS FOR  
FM ALIGNMENT PART II  
LOW-COST TELEVISION  
AN FM SIGNAL SOURCE

RADIO MAINTENANCE MAGAZINE  
460 BLOOMFIELD AVE., MONTCLAIR, N. J.

Please send me the back numbers  
checked here . . .

I am enclosing 35c for each copy, or  
\$2 for any 8 copies, or \$3.25 for all 18.

- January 1946  
 March 1946  
 April 1946  
 May 1946  
 June-July 1946

- August 1946  
 December 1946  
 January 1947  
 February 1947  
 March 1947

- April 1947  
 June 1947  
 May 1947  
 July 1947

- August 1947  
 January 1948  
 February 1948  
 March 1948

Have selected 8 copies . . .  
enclosing \$2.00

Send me all 18 . . .  
enclosing \$4.25

NAME .....

ADDRESS .....

CITY .....

ZONE..... STATE .....



**DESIGNED FOR THE BETTER SERVICE SHOP . . .**

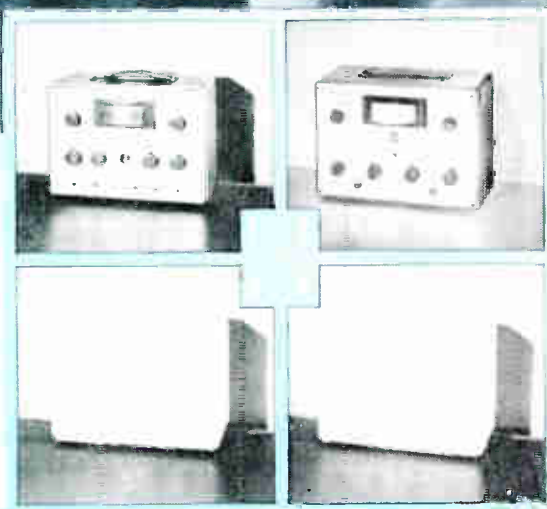
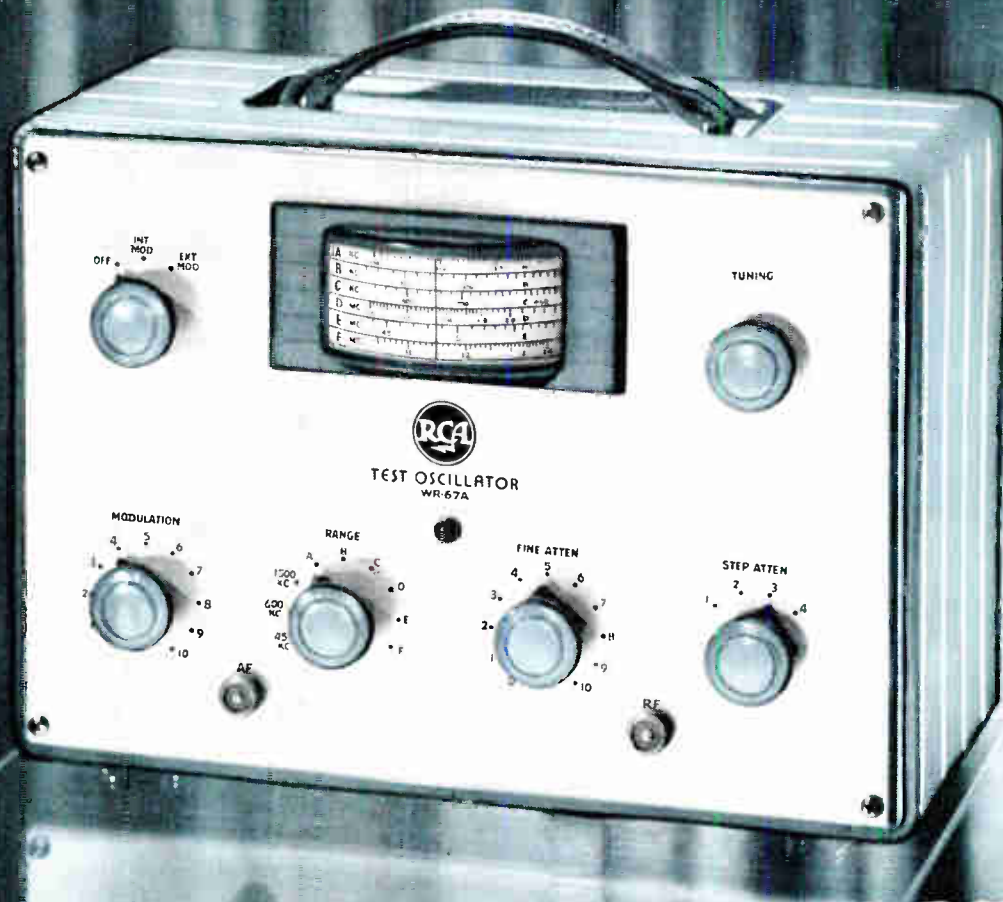

**ON THE WAY**—a superior line of test equipment that puts time-consuming service jobs on a profitable, production-line basis . . . that anticipates all FM and television needs. Matched styling of all instruments permits attractive, convenient grouping. Watch for announcements of the other units in this new line.

**Reduces testing and alignment time by as much as 50 per cent**

• The WR-67A is a time-saver that adds *profitable* hours to your service day . . . puts you dollars ahead.

When aligning a receiver, for example, you can switch from a pre-tuned i-f signal to pre-tuned broadcast-band signals without dialing or retuning. The range switch gives you three fixed frequencies: 1500, 600, and 155 kc. It also permits instant switching to any other frequency you select between 100 kc and 30 mc by presetting the smoothly variable tuning control.

Other outstanding features include: a signal injection probe for high-speed servicing . . . a four-step attenuator with fine control . . . double

shielding . . . miniature-type tubes throughout . . . a six-band drum dial with an easy-to-read, four-foot scale spread . . . adjustable modulation level for internal and external modulation . . . a two-stage power-line filter to minimize leakage, and a 400-cycle *audio* signal source.

Every RCA WR-67A is factory-tested with the finest precision measuring equipment. Heavy-duty components—plus the WR-67A's ability to withstand rigorous "drop," "shake," and humidity tests—add up to real on-the-job reliability. A new bulletin is yours for the asking. *Keep in touch with your RCA Test Equipment Distributor.*



**RADIO CORPORATION of AMERICA**  
**TEST AND MEASURING EQUIPMENT**  
**HARRISON, N. J.**



**Expensive Radios  
require precision  
servicing**

A larger percentage of home radios today are complex, high-quality models. Television sets are becoming numerous and FM sets even more so. The serviceman who has the precision test equipment to maintain these sets is the most successful serviceman in his community. For your top-quality test equipment and replacement parts come in and see us, or call or write today. Say you saw this ad in **RADIO MAINTENANCE** and we'll help you do a better job!

**DYMAC, INC.**

**RADIO PARTS & ELECTRONIC EQUIPMENT**

**2329-31 MAIN ST., BUFFALO 14, N. Y.**

**TSL PA 2300**