

DEVOTED ENTIRELY TO THE

25 CENTS

# RADIO SERVICEMAN

# RADIO

# MAINTENANCE

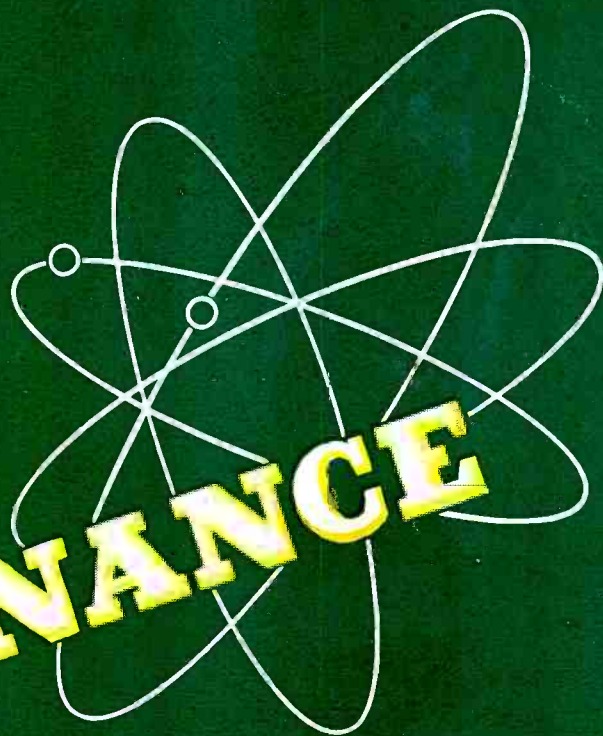

AUGUST 1947

SPEAKER MATCHING

TELEVISION RECEIVERS—  
HF POWER SUPPLIES

SERVICING FM RECEIVERS PART II

TEST EQUIPMENT MAINTENANCE  
PART III

BOLAND & BOYCE INC., PUBLISHERS



**BRANDED and  
PACKAGED for  
your protection**

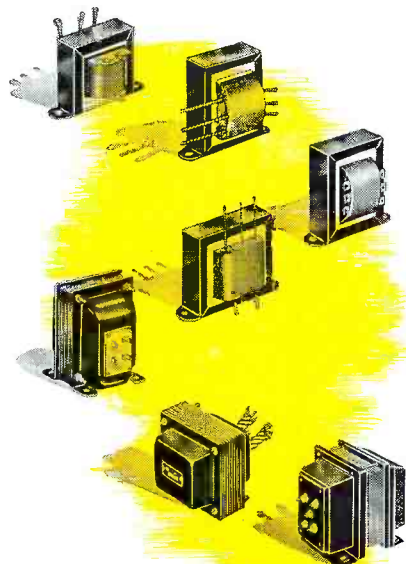
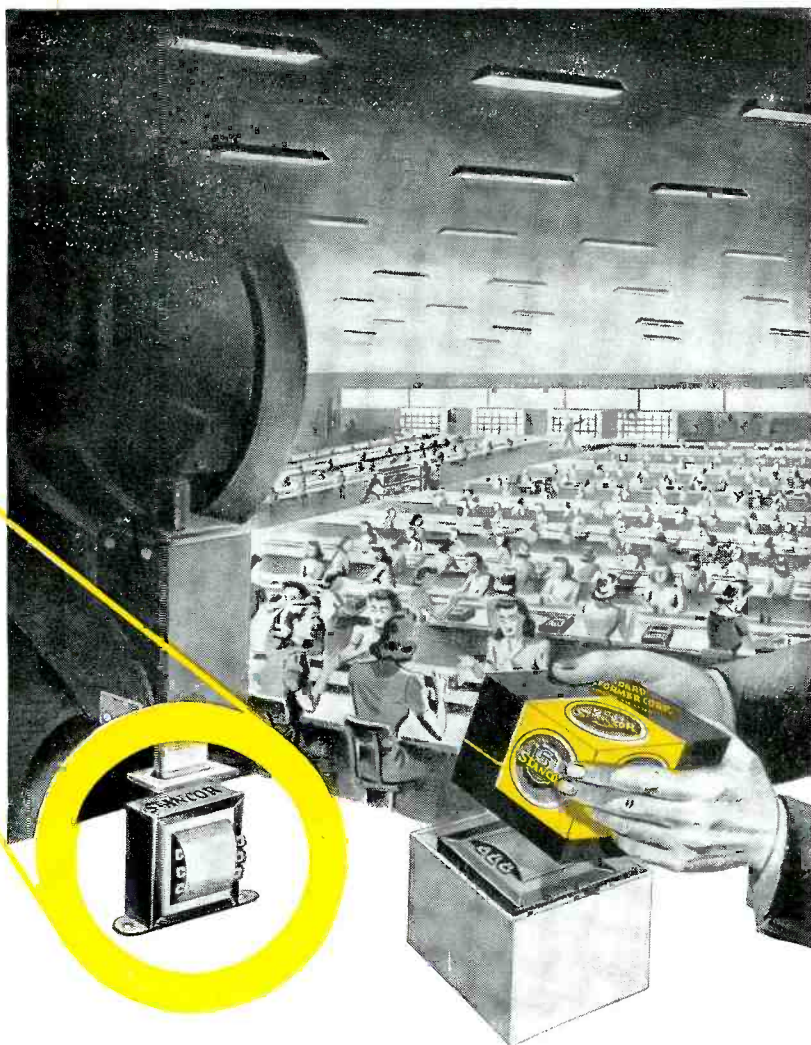

Satisfied customers' goodwill is your surest formula for building a successful service business . . . However—the finest craftsmanship of the serviceman's art is to little avail if not protected against installations of inferior merchandise.

Genuine STANCOR transformers, "first" in the field, is your customer-assurance of the finest, top-quality units . . . and when you use STANCOR you are installing genuine "PROTECTED PRODUCTS," for STANCOR transformers, packed with complete installation instructions, come to you *permanently stamped for guaranteed protection, and expertly packed for your fast identification* . . . Guarantee customer goodwill through STANCOR.

standardize on

**STANCOR**



**TRANSFORMERS**

STANDARD TRANSFORMER CORPORATION • ELSTON, KEDZIE AND ADDISON • CHICAGO 18, ILL.



**W.J. COUCH & CO.  
RADIO**

# A SIGN OF SUCCESSFUL SERVICING

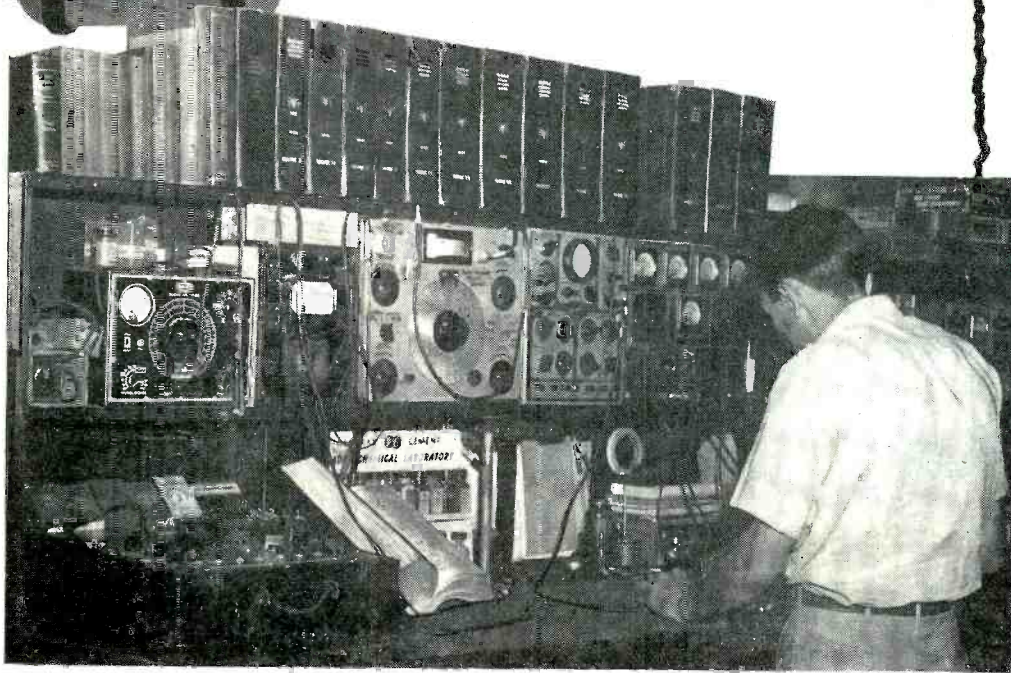

## Couch has all fifteen RIDER MANUALS

W. J. Couch & Company of Tullahoma, Tenn., was recently featured in a national radio publication because of the completeness of its servicing equipment. In the Couch shop, as in thousands of other successful servicing establishments, you'll find all fifteen Rider Manuals in daily use. From no other single source is such data available.

Comprehensive servicing information is essential to shops called upon to service all makes and all types of radio receivers—of all ages. That's why the first fourteen volumes of Rider Manual are so time-savingly valuable to the average shop. These volumes alone cover the years when 82% of the sets now in American homes were issued. (From 1920 to April 1942 inclusive.)

And, the information on these receivers is the OFFICIAL, AUTHORIZED servicing data direct from the service departments of the manufac-

turers who made the sets. No one knows better than the manufacturer what procedures are best for his product. That is the foundation on which Rider Manuals are built.

Volume XV, covering sets issued during 1946, plus some unpublished pre-war models, is the result of "Seventeen Years of Continuing Service to the Radio Servicing Industry". It is full of exclusive features. For example, the 520 "clarified-schematics", which break down composite diagrams of complicated multiband receivers into individual schematics of each circuit as it exists with each turn of wave band or equipment switch.

With each Volume XV is the 200-page "How It Works" book, a guide to the theory of operation of new technical features in latest receivers. Volume XV also has all popular "Ham" communication receivers, Scott receivers, Magnavox RA combinations and record player combinations. These you find only in Rider Publications.

Rider Manuals are an investment which keeps pouring out profits for you. Those who bought Volume I, 17 years ago, are still benefitting from it. Be sure your shop has the Sign of Successful Servicing—all fifteen Rider Manuals.

### VOL. XV JUST OUT!

2000 pages, plus  
200 page "How  
It Works" Book.  
\$18.00 complete

Volumes XIV to VII (each volume).....\$15.00  
Volume VI ..... 11.00  
Abridged Manuals I to V (one volume)..... 17.50  
Record Changers and Recorders ..... 9.00

# RIDER MANUALS

**MEAN SUCCESSFUL SERVICING**

SEND IN YOUR ENTRY  
NOW!

There are  
224  
Opportunities  
to WIN

## RIDER MANUAL CONTEST

**\$4,325.00**  
WORTH OF

## CASH PRIZES

AND  
SERVICING  
EQUIPMENT

JUST TELL WHY  
(in 100 Words or Less)

**'RIDER MANUALS  
MEAN  
SUCCESSFUL SERVICING'**

That's all you need do. Nothing to buy. Nothing difficult. No need for fancy writing. Write your entry on official blank, obtainable from your parts jobber, in plain everyday English. The first thing you write may win you one of the 224 valuable prizes. Call your jobber.

**GET THE OFFICIAL  
ENTRY BLANK  
FROM YOUR JOBBER  
TODAY!**

**JOHN F. RIDER  
Publisher, Inc.**

404-4th AVE., N. Y. 17, N. Y.

Export Division,  
Rocke International Corp.,  
13 E. 40th St., New York City  
Cable ARLAB



# Why Mallory-Made Vibrators make the Best Replacements:



**MORE MALLORY-MADE VIBRATORS ARE IN USE TODAY THAN ALL OTHER MAKES COMBINED**

There are excellent mechanical and engineering reasons why more Mallory-made vibrators are used in original equipment than all other makes combined.



**TWELVE MALLORY VIBRATORS ANSWER 90% OF YOUR REPLACEMENT NEEDS**

Make replacements easily and quickly. Thanks to the Mallory program of standardization, the number of vibrators you need to meet most of your requirements is materially reduced—only twelve in all.



**MALLORY HAS A COMPLETE VIBRATOR LINE**

In addition to the 12 basic units, Mallory also makes 39 other replacement vibrators so that even when you meet a rare or unusual service problem, your Mallory distributor can supply the answer. The Mallory line leaves *nothing out*—it's a complete line that rounds out your business.

See Your  
Mallory Distributor  
for a free copy of  
the 1947 Replacement  
Vibrator Guide.

P.R. MALLORY & CO. Inc.  
**MALLORY**

VIBRATORS . . . VIBRAPACKS\* . . . CAPACITORS . . . VOLUME CONTROLS . . . SWITCHES . . . RESISTORS . . . FILTERS . . . RECTIFIERS . . . POWER SUPPLIES.

\*Reg. U. S. Pat. Off.

**APPROVED PRECISION PRODUCTS**

P. R. MALLORY & CO., Inc., INDIANAPOLIS 6, INDIANA

# RADIO

# MAINTENANCE

INCLUDING  
ELECTRONIC  
MAINTENANCE

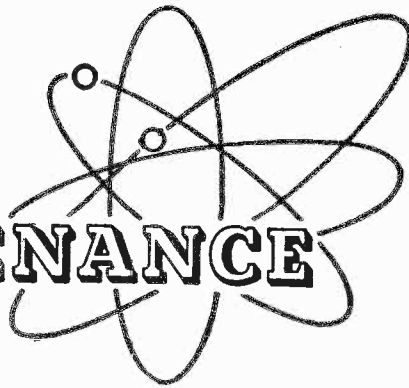

Volume 3

AUGUST, 1947

Number 8

## Contents

<b>Test Equipment Maintenance, Part III</b> . . . . .	<b>John B. Ledbetter</b>	<b>4</b>
Keeping your instruments useful		
<b>Speaker Matching</b> . . . . .	<b>L. A. Randall</b>	<b>6</b>
Solving PA distribution problems		
<b>HF Power Supplies</b> . . . . .	<b>Morton Scheraga</b>	<b>10</b>
New voltage supply techniques		
<b>Servicing FM Receivers</b> . . . . .	<b>Milton Kaufman</b>	<b>14</b>
Principles of FM receivers		
<b>Circuit Analysis</b> . . . . .	<b>J. Richard Johnson</b>	<b>20</b>
What's new in receiver schematics		
<b>The Organizations</b> . . . . .		<b>22</b>
News of group activity		
<b>The Industry Presents</b> . . . . .		<b>24</b>
New products		
<b>Over the Bench</b> . . . . .	<b>John T. Frye</b>	<b>29</b>
<b>Review of Trade Literature</b> . . . . .		<b>33</b>
Catalogs, books, etc.		

**WILLIAM F. BOYCE**  
Publisher

**JOSEPH J. ROCHE**  
Editor

**HOWARD L. SHONTING**  
Business Manager

**AL JOHNSTON**  
Circulation Manager

**J. RICHARD JOHNSON**  
Managing Editor

**THOMAS A. BYRNES**  
Field Service Manager

Midwestern Advertising

**VICTOR M. TURNER**  
Art Director

Eastern Advertising

**STUART J. OSTEN**  
228 No. La Salle St.  
Chicago, Ill.  
Tel.: Dearborn 3507

**A. J. POLHEMUS**  
Assistant Editor

**FRANK M. SCHMITT**  
460 Bloomfield Ave.  
Montclair, N. J.  
Tel.: Montclair 2-7101

**MORTON SCHERAGA**  
Contributing Editor

Copyright 1947, Boland & Boyce, Inc.

Radio Maintenance is published monthly by Boland & Boyce, Inc., at 34 No. Crystal St., East Stroudsburg, Pa., U.S.A.; Executive and Editorial Office, 460 Bloomfield Ave., Montclair, N. J. Subscription Rates: In U. S., Mexico, South and Central America, and U. S. possessions, \$2.50 for 1 year, \$4.00 for two years, single copies 25 cents; in Canada, \$3.00 for 1 year, \$5.00 for 2 years, single copies 30 cents; in British Empire, \$3.50 for 1 year, \$6.00 for 2 years, single copies 40 cents; all other foreign countries, \$4.00 for 1 year.

Change of address: Four weeks' notice required for change of address. When ordering a change, please furnish an address stencil impression from a recent issue if you can. Address changes cannot be made without the old stencil as well as the new one.

## ANNOUNCING

*...New*  
**OHMITE**  
**5-Watt**  
**BROWN DEVIL**  
**RESISTORS**

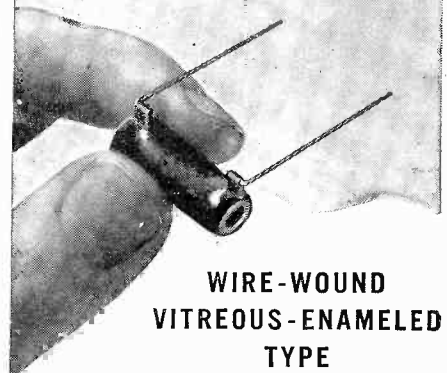

**WIRE-WOUND**  
**VITREOUS-ENAMELED**  
**TYPE**

**Provide Utmost Dependability**  
**in a New Small Size**

Now you can get an Ohmite wire-wound vitreous-enameled resistor... of proved reliability... in the 5-watt size. This new resistor has the same rugged construction... the same unfailing dependability... as larger Ohmite industrial units. Yet it is small enough to fit practically any installation. Easily mounted by its 1½-inch, tinned copper-wire leads. Tolerance ± 10%. Available in a wide range of resistance values. Where you need a small resistor that you can install and forget—use this new Ohmite unit.

**OHMITE MANUFACTURING CO.**  
Flournoy Street Chicago, Illinois

**NEW Ohm's Law Calculator**

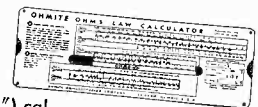

A new and improved handy pocket size (9" x 3") calculator. All computing scales are on one side. Shows RMA resistor color code. Mail 25c in coin for your copy.



*Be Right with...*

# OHMITE

**RHEOSTATS • RESISTORS • TAP SWITCHES**

# Test Equipment

## MAINTENANCE

part III

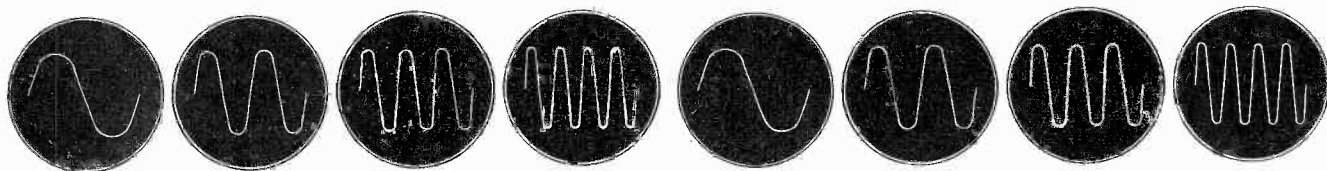

by  
John D. Ledbetter

**I**N PART II, we discussed the Beat Frequency method of calibrating audio oscillators in which an output meter or AC voltmeter was connected across the output of an audio amplifier to obtain zero beat (Fig. 1), under which conditions the meter does not move. Five or ten minutes after zero beat has been established, the frequency of any beat note developed (cycles per second) is the amount of drift during that time. Fig. 2 shows three arrangements for checking calibration and drift.

### Frequency Response

After calibration, the frequency response of the oscillator should be checked. Load the output terminals with a resistor equal to the output impedance (usually 250 or 500 ohms) and connect them to an output meter 0 db at 100 cycles. Then without touching anything except the tuning dial, take readings throughout the range from 30 to 15000 cycles. A good oscillator doesn't vary more than 2 db from the reading at 1000 cycles.

### Wave Form

A check should also be made on the wave form quality. Apply the output of the oscillator to the vertical plates of an oscilloscope and adjust the sweep to one-half or one-third of the oscillator frequency.

**The concluding part of a series on making your work easier and more profitable by proper care of instruments.**

A good sine wave form should be produced on any frequency in the range with the possible exception of the frequencies very near the high and low ends of the overall coverage. Fig. 3 shows proper and improper wave forms which might be obtained in a typical test.

### Cathode Ray Tubes

CRO maintenance, other than

general care and cleaning, involves an occasional tube replacement. Failure of the vertical or horizontal amplifiers to function normally is usually due to tube trouble in that stage. Low voltage or defective coupling condensers may be at fault when either of the centering controls will not operate properly.

Defective condensers may be found with an ordinary condenser

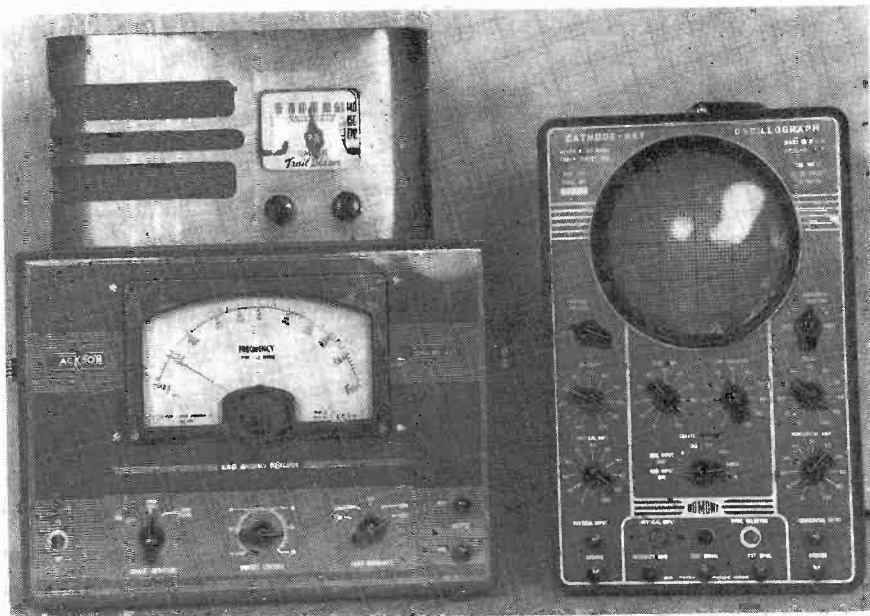

**Fig. 1** A typical arrangement of equipment suitable for making calibration, drift, frequency response and wave form tests on an audio oscillator. The output of the oscillator is fed into the audio section of the receiver. Output from the receiver is checked by ear from the speaker or observed on the oscilloscope. An output meter is added for frequency response measurements.



checker. Voltages can be checked at the socket with a vacuum-tube voltmeter, after the oscilloscope has been removed from its case and the safety switch short-circuited or clamped to its "ON" position. In such checks extreme caution must be used, since the high voltage (often over 1000 volts) will be ON. This high voltage may be checked on the proper voltmeter range as long as well-insulated test prods are used and the body is kept well away from the chassis. Never leave a bright, stationary spot on the screen as this will reduce tube life and burn a hole in the fluorescent material.

### Meters

Most DC meters employed in test instruments are of the moving coil type (See Fig. 4a). AC meters employing a moving vane (Fig. 3b) are occasionally found in test equipment, but more often in AC line voltmeters. AC meters in most test equipment employ movements of the DC moving coil type, with a copper-oxide, selenium or vacuum-tube rectifier.

Ordinarily, major repair of any type of indicating meter in the field is not recommended. The average serviceman is not equipped with the specialized training, instruments, or time necessary in such intricate work. Defective meters should be returned to the factory or to a meter repair specialist. The cost of repair and calibration is usually much lower than the price of a new meter and the serviceman is assured of "good-as-new" operation. Meters seriously damaged are often taken as trade-ins and a complete new movement installed.

Although factory repair is usually necessary in the case of burned-out meter coils, shorted coil turns, cracked jewels, and broken, sprung or tangled hairsprings, there are a number of minor adjustments and repairs which the serviceman may perform in his own shop, provided he exercises reasonable care and dexterity.

Some of the more common meter failures are due to: (1) burned-out or partially shorted moving coil, (2) shorted or open field winding in moving-iron (AC) meters, (3) defective series resistor (in voltmeters or multimeters), (4) dull, worn or misaligned pivot bearings, (5) cracked, dirty or broken jewels,

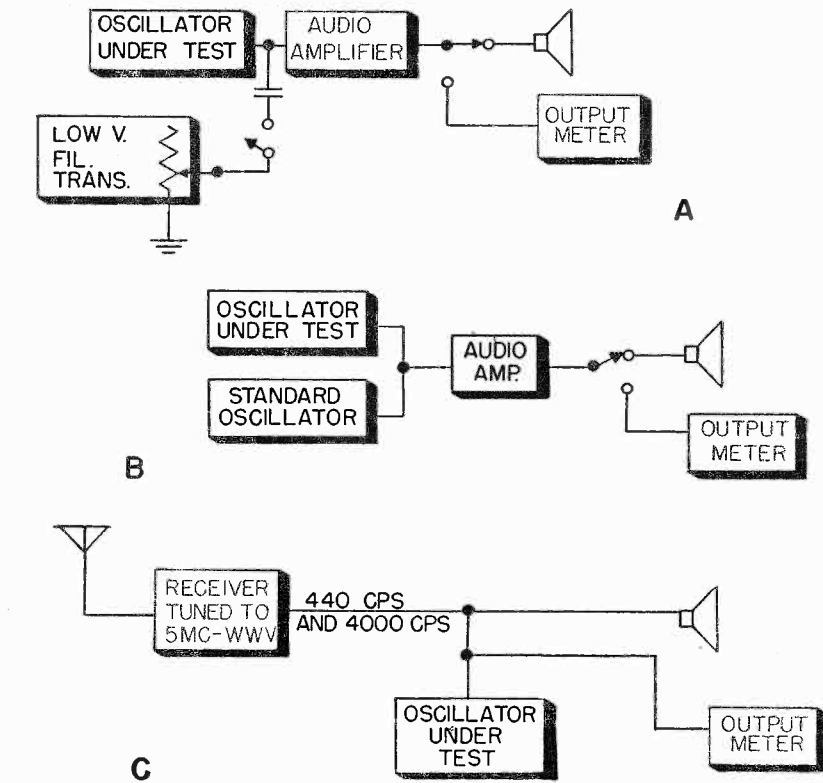

Fig. 2 Some methods of checking calibration and drift in an audio oscillator. A different comparison standard is used in each case. (A) Power frequency (B) a standard oscillator whose calibration is known to be accurate and (D) modulation from Bureau of Standards Station WWV.

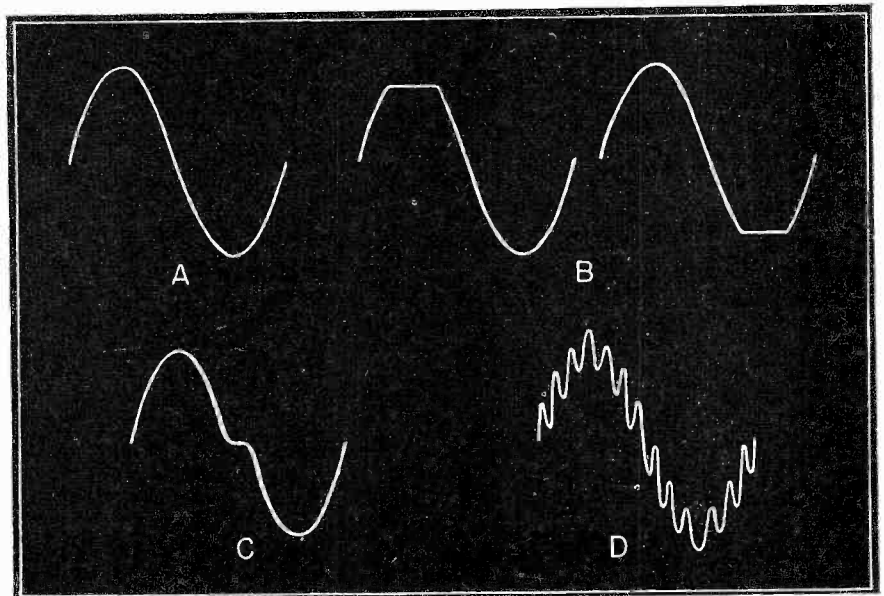

Fig. 3 How to recognize distortion in your audio oscillator: (A) Good sine wave (B) overload distortion (driving grid positive etc.) (C) distortion due to non-linearity (D) effect caused by presence of a ripple frequency higher than the audio fundamental.

(6) bent or broken hairsprings, (7) misaligned damping vane, (8) off-center or binding coil assembly, and (9) bent, broken or sticking pointer. (See Fig. 2.)

Open or burned-out meter coils are generally caused by (1) an instantaneous or continued overload, or (2) by the presence in the wind-

ing or connecting leads of corrosion due to moisture or chemical fumes. A shorted condition between adjacent turns is due to (1) overload, (2) corrosion, (3) insulation breakdown.

A zero reading on the meter indicates an open coil or series resistor,

→ To Page 28

WHEN INSTALLING a sound system, it is often necessary to divide the output of an amplifier between a number of speakers. The problem is usually complicated by the necessity of feeding a different amount of power to each speaker. The correct amount of power must be fed to each speaker without loss or distortion. Since almost all amplifiers are equipped with tapped output transformers, and multi-speaker installations usually include lines long enough to require speaker line transformers, we can solve our problem by using various combinations of output and line transformer impedances. Using this method, we can divide the output of the amplifier without loss of power and without causing distortion. In the method to be described, mathematics has been almost completely eliminated. Later in the article, a number of simple formulas will be given which will allow the reader to prove his results and make his own calculations.

#### Transformer Taps

The output transformers on most commercially built amplifiers are tapped for 4, 8, 15, 250 and 500 ohms. The larger amplifiers are usually equipped with additional taps. Some of the more common impedance values found in these units are 30, 60, 125 and 350 ohms.

Standard line transformer primaries are tapped for impedance values of 500, 1000, 1500, and 2000 ohms. Some transformers have additional taps which give impedances of 375, 600, 2500, 3000, and 4000 ohms.

#### Determining Requirements

We will assume that the installation we are making consists of three rooms, A, B, and C in Fig. 1. The three rooms are of different sizes and require different amounts of power to secure suitable volume. The first step is to determine the sound level necessary to give adequate coverage of each of our three rooms (See April 1946 issue of RADIO MAINTENANCE, "P A Systems," by C. G. McProud). Adding the power required for each of the three rooms and a suitable reserve, we will have the power required from the amplifier. In our case, we require 12 watts for room



The problem of dividing the output of a PA system among a number of speakers operating at different levels can be annoying and complicated unless you use a simplified, logical approach like this one.

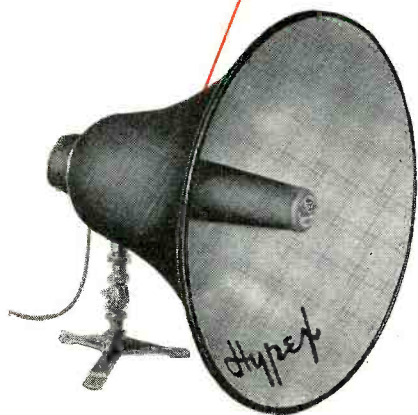

by

L. A. Randall

Stromberg-Carlson Co.



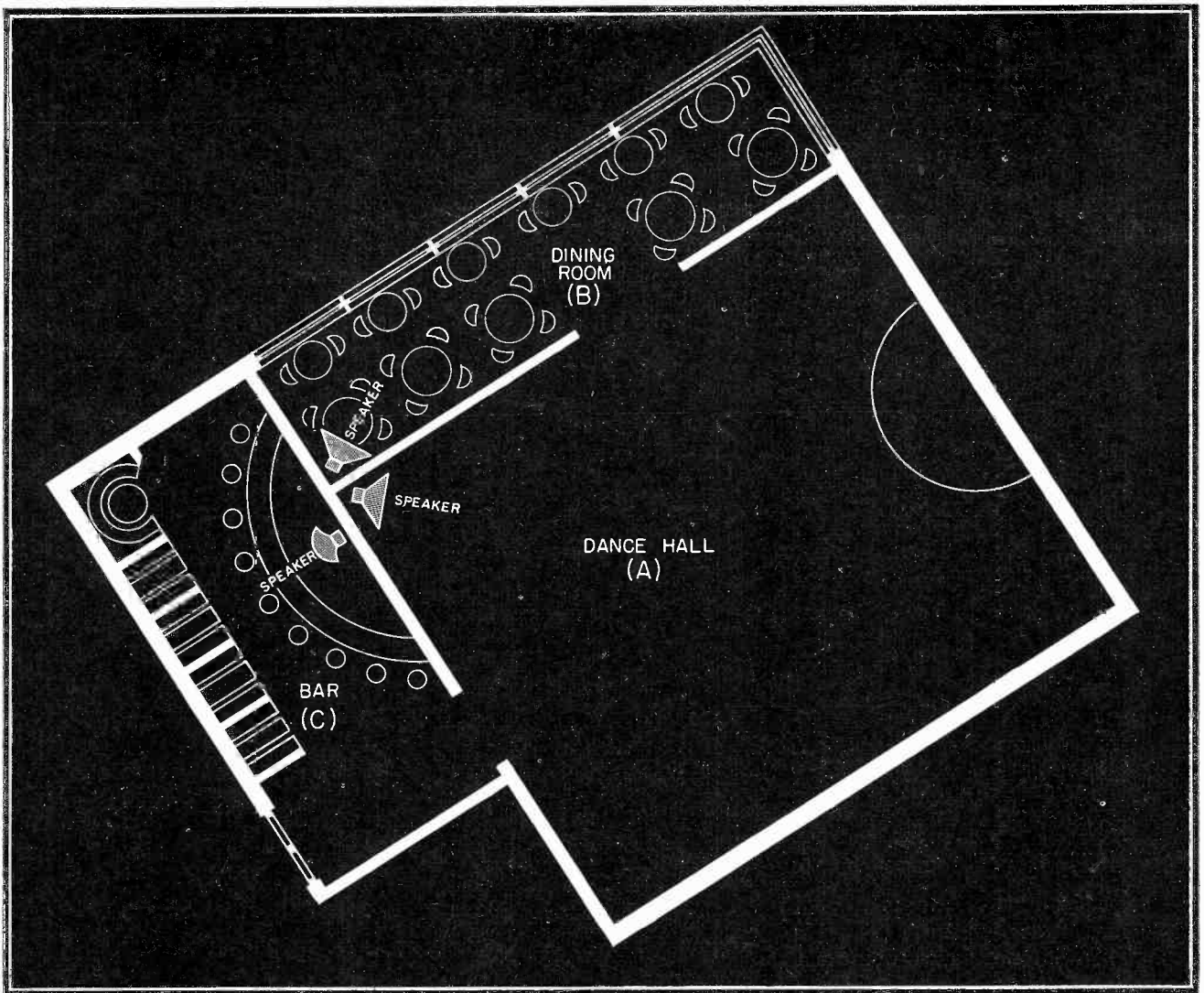

**Fig. 1** Illustration of the typical distribution problem discussed in the text. A different amount of power is necessary in each room; the proper power division is obtained by using the right combination of output and line transformer taps.

A, 4 watts for room B, and 3 watts for room C. Adding, we find the total power required to be 19 watts. By using an amplifier rated at 25 watts, we have a reserve of 6 watts which is sufficient.

The secondary of the output transformer of our amplifier is tapped at 4, 8, 15, 30, 250 and 500 ohms. The three line transformers located at the speakers have primaries tapped at 500, 1000, 1500 and 2000 ohms. The speaker voice coils are all 8 ohms and are connected to the 8 ohm taps on the secondaries of the line transformers.

#### Choosing Taps

Referring to Table I for a 25 watt amplifier, we locate the amplifier output transformer tap which will give us, as near as possible, the three values of power required when used with suitable line transformer taps. When the exact

amount is not given, choose the next higher value. Under the 250 ohm tap, we find 12.5 watts when the 500 ohm line transformer is used; 4.16 when using the 1500 ohm tap; and 3.16 when using the 2000 ohm tap. The values chosen are slightly in excess of the requirements. This gives us a safety factor and is, therefore, desirable.

#### Checking Total Impedance

The next step is to check the resultant impedance of the three lines when they are connected together at the amplifier. Using Table I, we determined that our line transformer taps will be 500, 1500 and 2000. Referring to Table II, we find that the reciprocals for these values are .002, .000666 and .0005. We then add our three reciprocals to get .003166. The total is then divided into 1 to secure the resultant line impedance at the amplifier. The line impedance is then

found to be 310 ohms. In connecting the lines to the amplifier, we should use the next lowest tap which is 250 ohms. While connecting the line to the 250 ohm tap will suffice, we can secure an even better match by using the tap at 30 ohms for one side of the line, and the 500 ohm tap for the other side of our line, as shown schematically in Fig. 2. This will give us an output transformer impedance of 285 ohms. Table III shows some of the output transformer secondary impedances which can be obtained by connecting the line across two of the taps rather than from common to one of the taps.

#### Load Capacity of Winding

If this system is used, a check should be made to make sure that the winding of the transformer will take the load without burning out and without causing prohibitive

**TABLE I**

6 Watt Amplifier				15 Watt Amplifier								
Line Trans.	Amplifier Taps			Line Trans.	Amplifier Taps							
Taps	4	8	15	Taps	4	8	15	350	385	415	500	
375	.064	.128	.240	375	.16	.23	.600	14.00	x	x	x	
500	.048	.096	.180	500	.12	.24	.450	10.50	11.55	12.50	15.00	
750	.032	.064	.120	750	.08	.16	.300	7.00	7.70	8.25	10.00	
1000	.024	.048	.090	1000	.06	.12	.225	5.25	5.77	6.25	7.50	
1500	.016	.032	.066	1500	.04	.08	.150	3.50	3.85	4.12	5.00	
2000	.012	.024	.045	2000	.03	.06	.112	2.62	2.88	3.12	3.75	
3000	.008	.016	.033	3000	.02	.04	.075	1.75	1.92	2.06	2.50	
4000	.006	.012	.022	4000	.015	.03	.056	1.31	1.44	1.56	1.87	
6000*	.004	.008	.015	6000	.01	.02	.037	0.875	0.96	1.03	1.25	

25 Watt Amplifier										
Line Trans.	Amplifier Taps									
Taps	4	8	15	170	190	250	350	385	415	500
375	.266	.533	1.000	11.33	12.66	16.66	23.33	x	x	x
500	.200	.400	0.750	8.50	9.50	12.50	17.50	19.25	20.75	25.00
750	.133	.266	0.500	5.66	6.33	8.33	11.66	12.83	13.83	16.66
1000	.100	.200	0.375	4.25	4.75	6.25	8.75	9.62	10.37	12.50
1500	.066	.133	0.250	2.83	3.16	4.16	5.83	6.41	6.91	8.33
2000	.050	.100	0.185	2.12	2.37	3.12	4.37	4.81	5.18	6.25
3000	.033	.066	0.125	1.41	1.58	2.08	2.91	3.20	3.45	4.16
4000	.025	.050	0.093	1.06	1.18	1.56	2.18	2.40	2.69	3.12
6000	.016	.032	0.062	0.70	0.79	1.04	1.45	1.60	1.72	2.08

50 Watt Amplifier										
Line Trans.	Amplifier Taps									
Taps	4	8	15	170	190	250	350	385	415	500
375	.533	1.06	2.00	22.66	25.33	33.33	46.66	x	x	x
500	.400	0.80	1.50	17.00	19.00	25.00	35.00	38.50	41.50	50.00
750	.266	0.53	1.00	11.33	12.65	16.66	23.33	25.66	27.66	33.33
1000	.200	0.40	0.75	8.50	9.50	12.50	17.50	19.25	20.75	25.00
1500	.133	0.266	0.50	5.66	6.32	8.33	11.66	12.83	13.83	16.65
2000	.100	0.20	0.375	4.25	4.75	6.25	8.75	9.62	10.37	12.50
3000	.066	0.133	0.25	2.83	3.16	4.16	5.83	6.41	6.91	8.32
4000	.050	0.10	0.187	2.12	2.37	3.12	4.37	4.81	5.18	6.25
6000	.033	0.066	0.125	1.41	1.58	2.08	2.91	3.20	3.45	4.16

loss. This is necessary because many transformers use smaller wire between the high impedance taps and large wire between the low impedance taps. As a rule, no trouble will be experienced if the lower tap of the two used does not have an impedance of more than 30 ohms.

Now let's review briefly the steps we followed:

A. We determined the amount of power required for each of the three rooms to be 12, 4 and 3 watts.

B. We referred to Table I, and looking under each amplifier output transformer tap impedance in turn, we found the one which would give us the three values of power available which exactly meet, or are slightly in excess of, the requirements. This tap was 250 ohms and the amounts of power available were 12.5, 4.16 and 3.16 watts. On the left side of the chart opposite the three values of power, we found the line transformer impedances to be used. They were 500, 1500 and 2000 ohms.

C. Next, we referred to Table II and located the reciprocals of

**TABLE II**  
Reciprocals Used in Determining Speaker Line Load

Line Trans. Tap	Recip.	Line Trans. Tap	Recip.
375	.002666	3000	.000333
500	.002000	4000	.000250
750	.001333	5000	.000200
1000	.001000	6000	.000166
1500	.000666	7500	.000133
2000	.000500	8000	.000125
2500	.000400	10000	.000100

**TABLE III**

Z	Z <sub>1</sub>	Z <sub>2</sub>	Z	Z <sub>1</sub>	Z <sub>2</sub>
* 0.64	8	4	85.0	125	4
* 1.00	15	8	106.0	200	30
* 3.00	15	4	150.0	250	15
* 4.80	60	30	170.0	250	8
* 12.10	125	60	190.0	250	4
* 21.00	250	125	* 215.0	500	60
24.00	60	8	285.0	500	30
32.50	60	4	350.0	500	15
* 43.66	500	250	385.0	500	8
71.00	125	8	415.0	500	4
* Light Loads Only					

each of our line transformer impedances. By adding these reciprocals and dividing 1 by the total, we found the effective impedance at the amplifier when the three lines are connected together. This was 310 ohms

D. Since the amplifier did not have a 310 ohm tap, we connected the lines to the next lowest tap.

E. Finally, we checked the impedances which would be available at the amplifier if we used the intermediate taps on the transformer.



Referring to Table III, we found that by connecting one side of the line to the 30 ohm tap and the other to the 500 ohm tap, an impedance of 285 ohms could be obtained. Since this gave a closer match, the line was changed over to these taps.

When we have completed the matching, each speaker is receiving the proper amount of power and there is a reserve of power available when needed.

### Equal Power Distribution

The system which has been outlined can also be used in cases where all the speakers are to draw the same amount of power. The following is an example of the procedure to follow when this situation arises. Assume that we desire to connect five speakers to a 50 watt amplifier. It has been determined that each speaker must draw 8 watts of power from the amplifier. Referring to Table I for a 50 watt amplifier, we find that by using the 250 ohm amplifier output transformer tap and the 1500 ohm tap on the line transformer, the speakers will draw 8.3 watts each. Next, we divide the line transformer tap by the number of speakers to find the impedance at the amplifier when all of the lines are connected together. Dividing 1500 by 5 gives us 300 ohms which is the impedance of the combined lines. The lines should, therefore, be connected to the 250 ohm output transformer tap. (See Fig 3.)

Briefly, then, the procedure followed consisted of three steps:

A. From Table I for a 50 watt amplifier the output and line transformer taps were chosen which give the required amount of power.

B. The line transformer impedance indicated in Table I was divided by the number of speakers to obtain the impedance of the combined lines. This impedance is 300 ohms.

C. The five lines were connected to the next lowest output transformer tap which is 250 ohms.

An alternate method for finding correct taps is provided by the alignment chart of Fig. 6. This chart has been specially prepared by the technical staff of RADIO MAINTENANCE to facilitate the required calculations.

To show its use, let us take the  
→ To Page 36

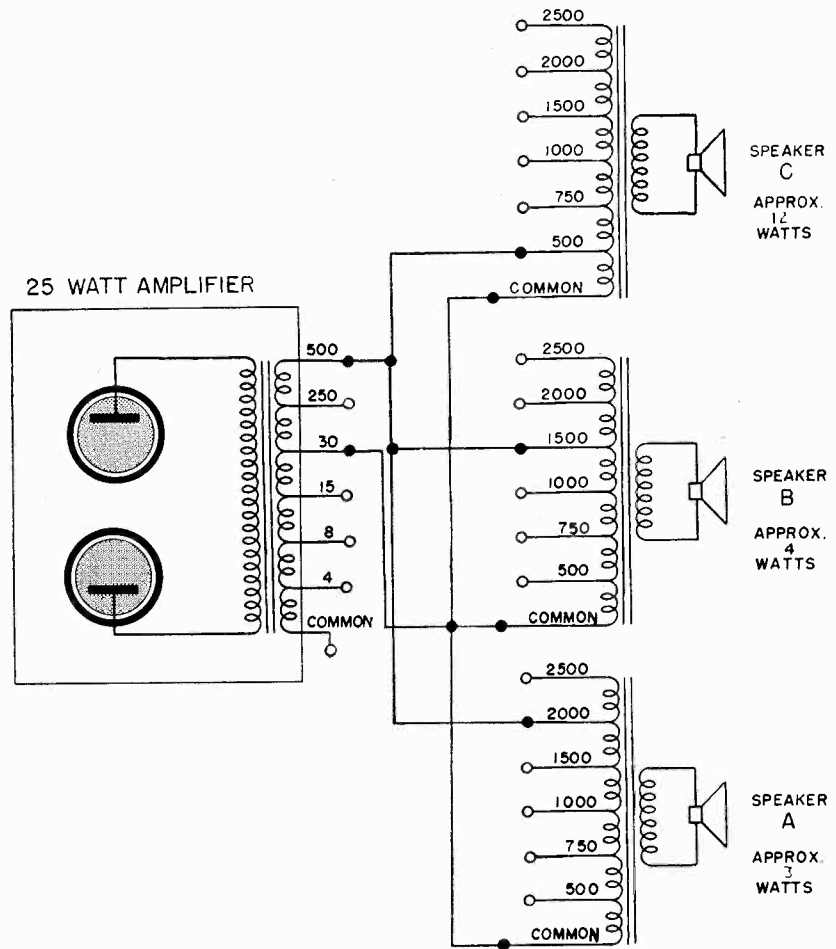

Fig. 2 Schematic diagram showing final connections which would be used in the example considered in the text.

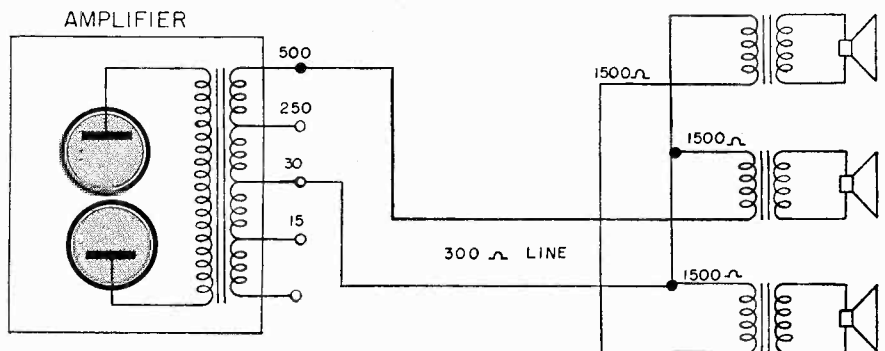

Fig. 3 A typical example of equal power distribution among speakers. This schematic corresponds to the second example considered in the text.

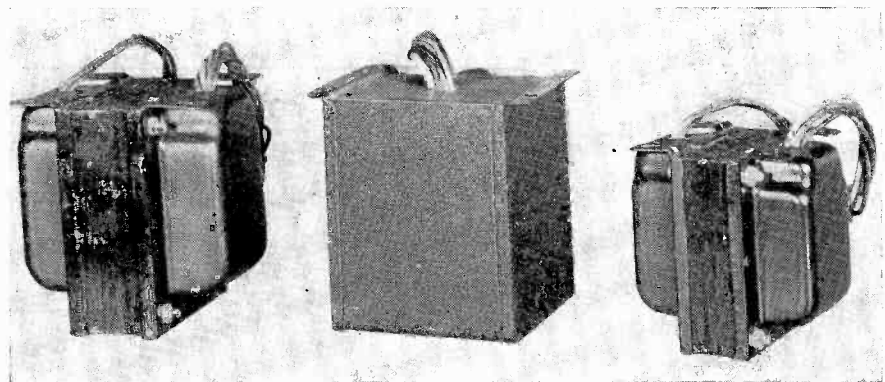
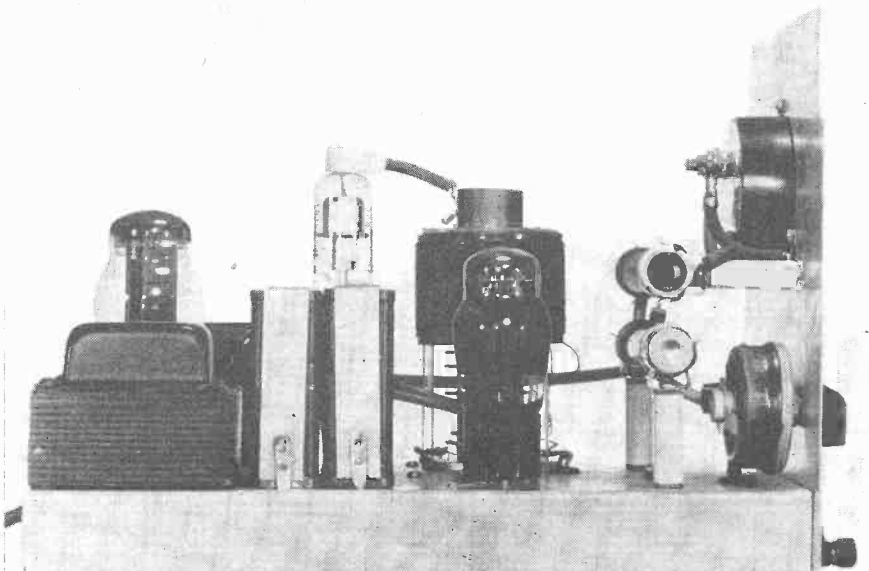

Fig. 4 Examples of types of output transformers used in PA systems. Proper use of various taps on amplifier and line transformers can produce the right output with a minimum of loss and distortion.



## HF POWER SUPPLIES

by  
**Morton Scheraga**  
 Allen B. DuMont Labs.

**The power supply requirements of a television receiver are considerably different from those of the ordinary receiving set. Here is information on the latest types of circuits and components used.**

**T**HERE ARE four main types of high voltage supplies which are being used to furnish the high potential for cathode-ray tubes in television receivers. In a recent issue the 60 cycle supply used in pre-war sets was discussed. Some new receivers still employ such high voltage supplies, but most manufacturers are replacing them with the newly developed high frequency high voltage power supplies. These are the rectified radio frequency type of supply, operating at from 50 to 300 kc; the pulse-type supply which generates pulses at the horizontal scanning frequency of 15,750 cps; and the so-called *kick-back* supply which steps up the voltage pulse generated in the horizontal deflection transformer and converts this wasted energy into useful high voltage DC for the cathode-ray tube.

The most serious objection to the 60 cycle supply is its danger to human life. With some television tubes operating at voltages as high as 30,000 volts, it would be a considerable hazard to have to use a 60-cycle supply of this rating in a receiver in the home. Consider the

problem of servicing such receivers. If the set were out of its cabinet and the high voltage supply exposed, the serviceman would find servicing and troubleshooting a very unenjoyable task. Sixty cycle supplies are bulky, heavy, and expensive, and are subject to frequent failure if quality components and conservative design are not used. The replacement of parts that fail is an expensive proposition for the customer whose initial outlay for a

receiver has already been considerably higher than that which he is accustomed to paying for radio sets. It is apparent, therefore, that such high voltage power supplies will eventually become obsolete in television receivers.

### Safety

The other three types of supplies decrease the shock hazard in that they operate at higher frequencies which require relatively small

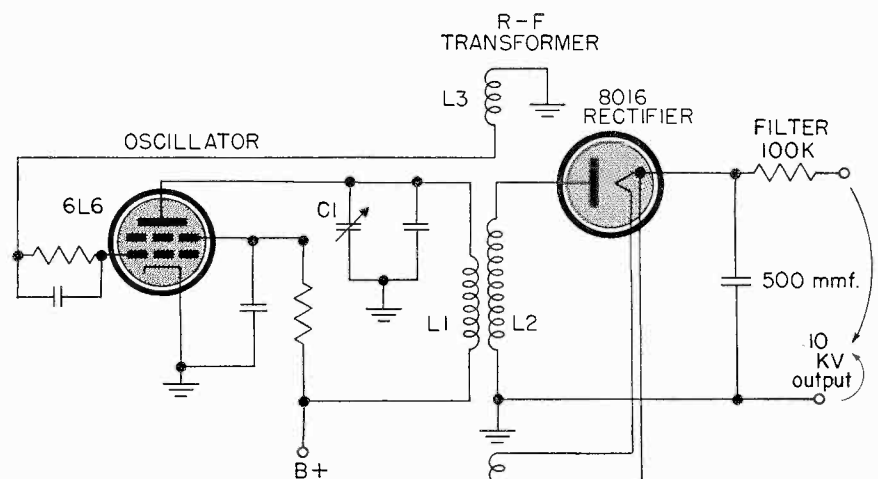

**Fig. 1 Typical 10 kv RF power supply circuit showing oscillator, transformer, rectifier and filter.**



capacitors for proper filtering. Hence, less energy is stored in the capacitors. Bodily contact with these supplies will cause a slight burn, but in no way will it compare with the possible lethal shock obtained with a 60 cycle supply.

### Oscillator Circuit

The rectified radio frequency supply consists of an RF oscillator which has a conventional tuned-plate, untuned grid tickler arrangement. A typical circuit is shown in Fig. 1. L1, the plate circuit coil, also comprises the primary of the RF transformer. The secondary coil, L2, which is closely coupled to the primary, contains a sufficient number of turns to step up the voltage to approximately 10 kv. The tickler coil L2 provides feedback from L1.

The high voltage developed across the secondary is fed to a rectifier tube such as the Type 8016. This rectifier tube requires only  $\frac{1}{4}$  watt filament power as compared with the 3.1 watts heater power consumed by a standard high voltage rectifier like the 2x2 or the watts needed for a 2V3-G. The very low power consumption of the 8016 heater makes it possible to draw this power from the RF oscillator by simply looping one or two turns of wire around the high voltage coil L2 and connecting this filament loop to the heater. Since the oscillator develops about 15 watts of power, the  $\frac{1}{4}$  watt absorbed by the heater is negligible. This method of obtaining the filament power eliminates the need for an expensive iron-core filament trans-

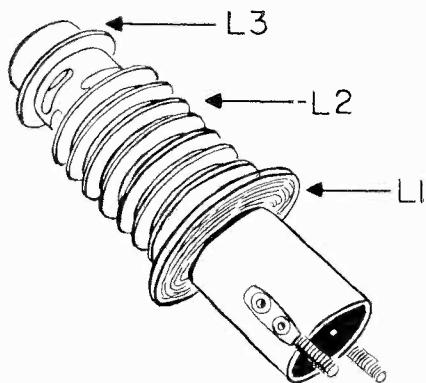

Fig. 3 RF transformer assembly for a 10 kv supply.

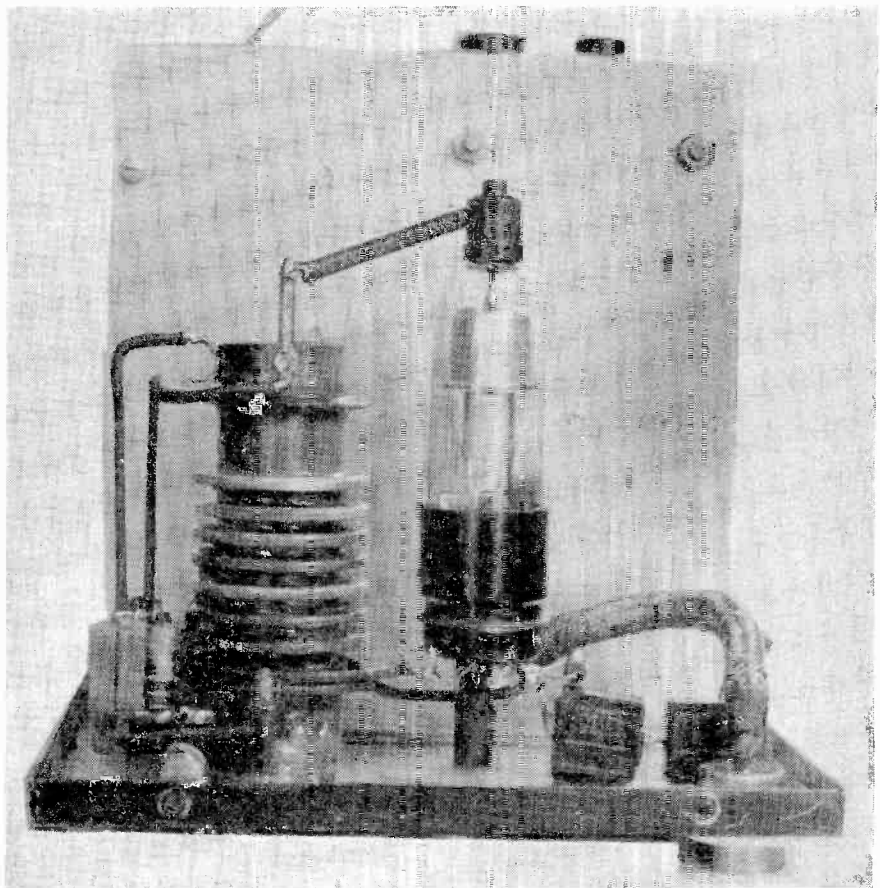

Fig. 2 Side view of an assembly of an RF transformer and an 8016 half-wave rectifier.

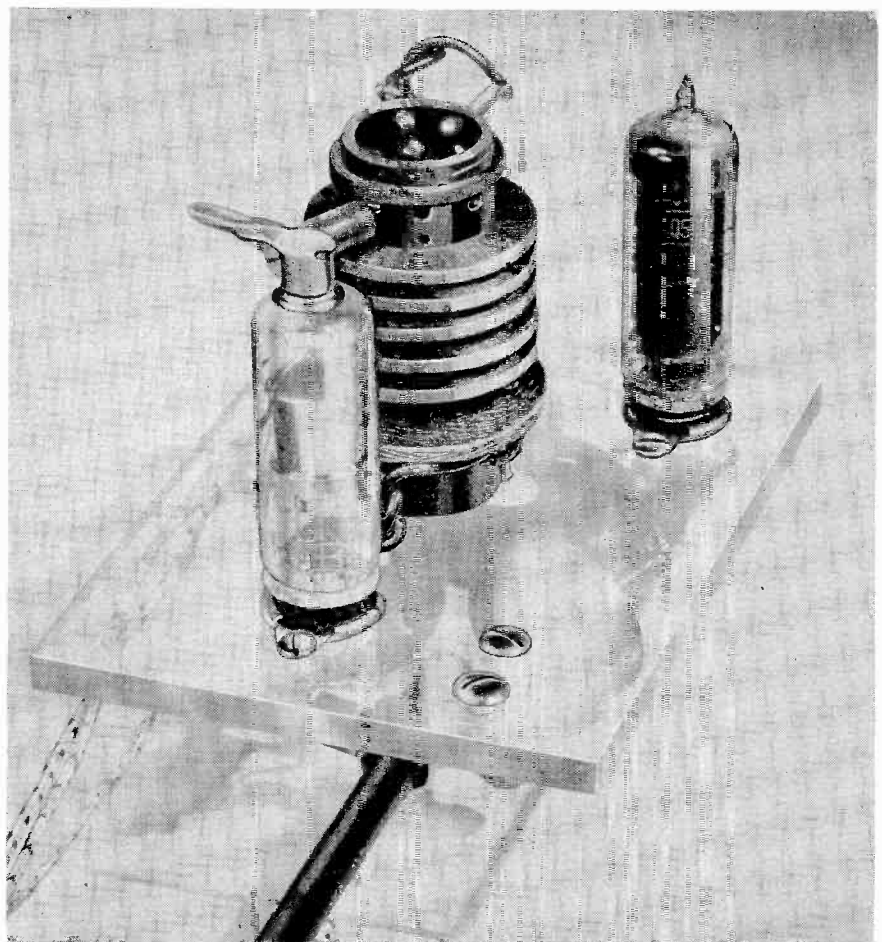

Fig. 4 Internal view of the Essex Electronics RF power supply.

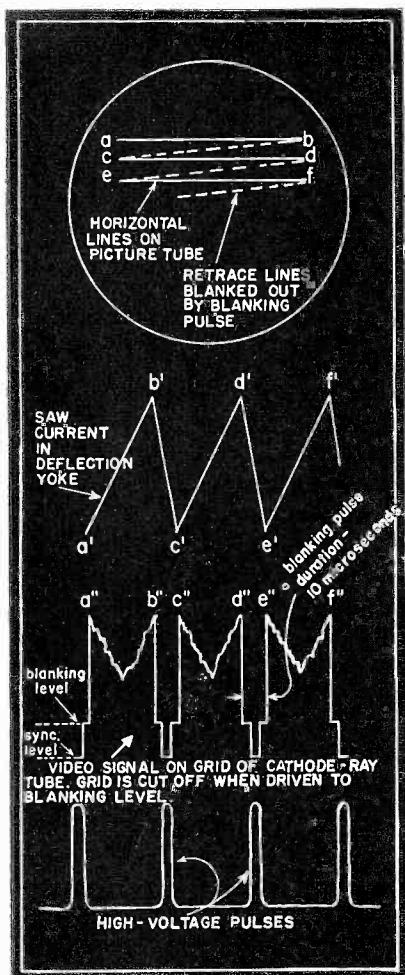

Fig. 5 High voltage pulses are generated by the pulse type supply during the horizontal blanking period so that no radiation appears on the picture tube.

former which would have to be insulated for at least 10 kv.

### Components

The components used in an RF supply differ considerably in appearance and size from those that one finds in conventional 60 cycle supplies. Fig. 2 shows a side view of a typical assembly of an RF transformer and 8016 half-wave rectifier. Note the construction of the RF transformer. It consists of several universal wound pies on a cylindrical core, usually made of synthane. A more detailed view of the transformer is shown in Fig. 3. The tickler coil L3 is located at the top, spaced sufficiently far from the high voltage winding L2 to prevent breakdown. The primary L1 can be wound close to the other end of L2 which is at ground potential (see the connection of L2 in the circuit diagram of Fig. 1). The filament winding is not put on the RF transformer but consists merely of a loop of insulated wire, supported over the low end of the secondary. The filament winding can be seen in Fig. 2.

The filter required for the rectified RF voltage is extremely simple, consisting of nothing more than a 500 uuf condenser and a 100,000 ohm resistor. These small, inexpensive condensers, developed especial-

ly for high frequency power supplies, have brought about an appreciable saving in cost of high voltage filters.

### Regulation

Rectified radio frequency supplies have been designed for voltages as high as 90 kv, using suitable transformers with higher step-up ratios; the highest voltages used at present, though, in television receivers are 30 kv for protection type tubes. Rectified RF supplies have good voltage regulation, having less than 5% fluctuations in voltage as the beam current in the cathode-ray tube varies under normal operating conditions from about 0-200 microamperes. Such fluctuations in voltage with load are permissible and will not cause any observable change in picture size. For this reason there is little need to provide voltage regulator circuits on RF supplies when used in television receivers.

### Servicing

Servicing RF supplies is both an electrical and mechanical problem. A quick and positive check to determine whether the supply is operating normally is to measure the high voltage with a voltmeter of sufficient range. (The meter should not draw more than 50 microamperes; else it

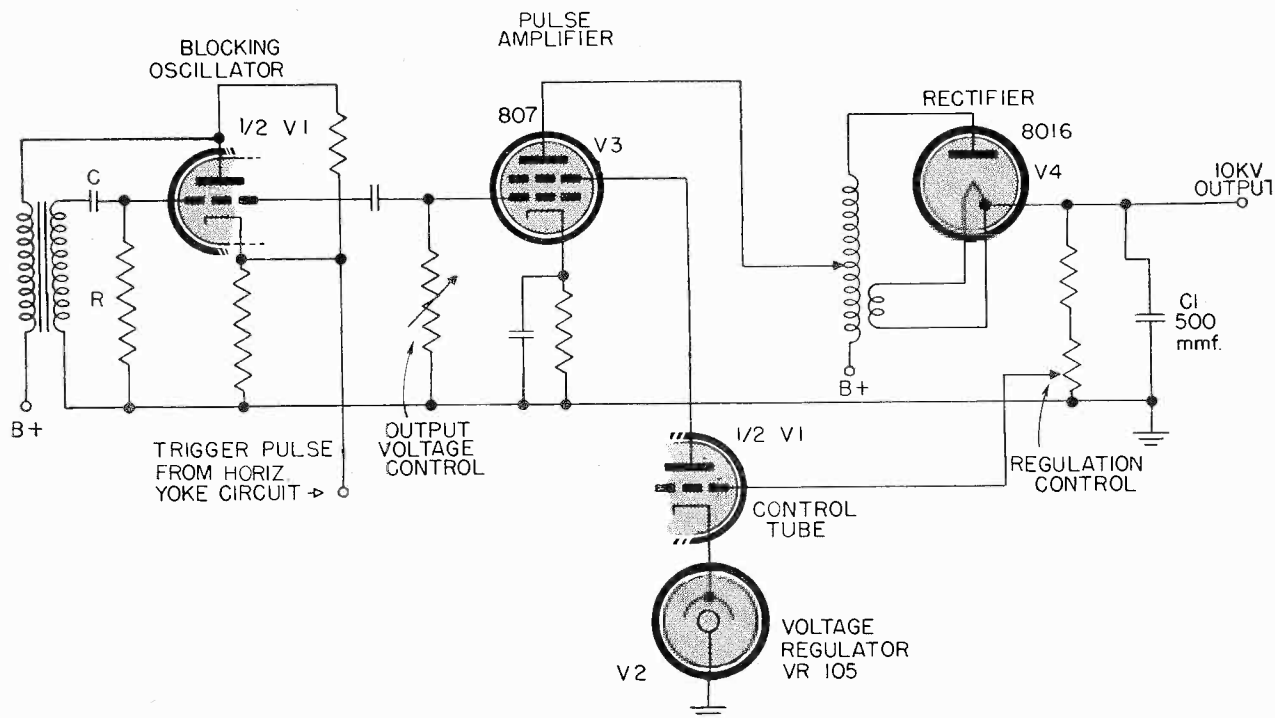

Fig. 6 Basic circuit of a high voltage regulated pulse type supply.



will load down the supply too much.) If such a meter is not available, the serviceman will have to judge from the amount of brightness obtained on the picture tube whether or not sufficient voltage is being generated.

### Possible Troubles

Electrically, the following troubles may arise:

The oscillator may have drifted from its operating frequency, thus causing a drop in voltage. By tuning condenser C1, in parallel with coil L1 (Fig. 1), and noting the output voltage either on a voltmeter or by observing the brightness of the cathode-ray tube, the maximum voltage can be obtained. Usually, tuning condenser C1 is the only adjustment that will have to be made.

Low output voltage may also be caused by a defective oscillator or rectifier tube. The Type 8016 rectifier tube filament is quite susceptible to damages caused by even momentary overload of the heater due to a sudden line voltage surge. Though the color of the filament may appear normal to the eye after the overload, the tube will have been permanently damaged. Substitution of a new tube is the simplest and quickest means of locating a defective rectifier.

The mechanical construction and layout of the power supply components are critical, for at these high operating voltages there can easily be many points of corona discharge which eventually break down completely. Any type of corona is a power loss, and when present in the RF coil windings, tends to be destructive to the fine strands of litz wire. Corona on the RF coil is generally due to the weakening of the vacuum varnish with which the coil is impregnated. The corona discharge becomes greater in humid weather, so that a coil may appear to operate normally in a dry atmosphere, but break down when more moisture is in the air. Applying a good grade of varnish to the trouble points on the coil will usually prove satisfactory to prevent corona.

Corona from points of high potential, particularly on poor solder joints and irregularly surfaced conductors is also common. The solder should be flowed in on all high voltage joints to prevent corona dis-

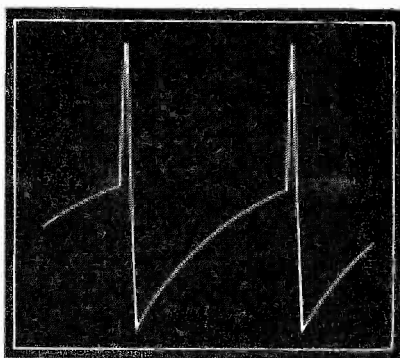

**Fig. 7 Pulse generated by the blocking oscillator at the rate of 15750 cps.**

charge. In general, it should be remembered that a smooth, round surface is less susceptible to corona than a sharp pointed one.

If the filament loop should fall off, or one end open, it should be replaced in the same position it originally occupied; otherwise the coupling to the RF transformer may be increased so that the rectifier filament is overloaded. Similarly, a looser coupling will not permit the filament to be heated sufficiently, resulting in a lower output voltage and poorer regulation.

### Shielding

RF supplies will almost always be housed in a completely enclosed metal container to prevent any radiated signal from getting into the video circuits and modulating

the picture signals. This shield should be properly replaced after any service work has been done on the supply. Also, care should be exercised in replacing any leads in the power supply that carry RF so that they do not come near the video circuits.

### Pulse Type Supply

The objection to radiation from rectified RF supplies is overcome by the pulse-type supply in that its generated pulse occurs during the horizontal blanking interval when the beam of the cathode-ray tube is shut off. Consider first the action of the electron beam during the horizontal scanning cycle (see Fig. 5). As the current in the yoke increases, the beam moves across the face of the tube from left to right. The deflecting current then falls rapidly so that the beam returns to the left again from which position it starts another cycle. During the time that the beam is retracing from right to left, a blanking pulse is applied to the grid of the tube so that the retrace lines are not visible. This blanking pulse lasts for about ten microseconds, during which time the beam is completely cut off.

If now a high voltage pulse, less than ten microseconds in duration is generated during these ten microseconds of blanking time, any radiation from the pulse supply will not

→ To Page 30

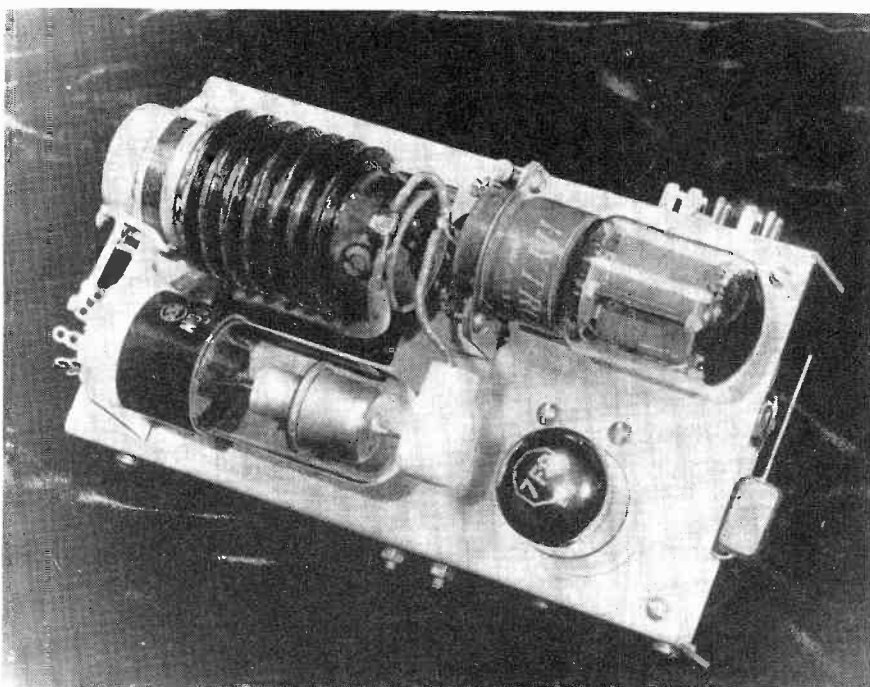

**Fig. 8 A complete pulse type supply showing the autotransformer, the 8016 high voltage rectifier, a 7F8 blocking oscillator tube, and a 6AR6 pulse amplifier tube. Note the filament winding on the transformer, connected to the 8016 heater with bus wire leads.**

# servicing

# FM



# receivers

by Milton Kaufman

More information on aligning, repairing and installing the latest FM receivers.

**F**REQUENCY MODULATION receivers must meet specific requirements which are much more difficult to fulfill than are the requirements of AM receivers. FM IF amplifiers must have a greater gain than those of AM receivers in order to insure saturation of the limiter circuit, if one is used. Only then can advantage be taken of the noise-reducing properties of the FM system. Band width requirements are greater in FM receivers, with the RF, IF, and discriminator circuits usually accepting a pass band of 200 kc as against 10 kc in the AM type. Tube requirements are more stringent in the RF mixer, and oscillator circuits, particularly with the recent increase in broadcast frequencies to 88-108 mc. There are not many tubes with low capacitance and high Gm which will function efficiently at these high frequencies. The audio amplifiers and speakers usually are designed for high fidelity of audio reproduction. These are, in the main, the features of greatest importance in the design of an FM receiver.

## RF Section

The main objectives of the RF amplifier in an FM set are image rejection and improvement of signal to noise ratio. At the new high frequency FM band 88-108 mc the inductance of the band switch and connecting leads are large compared to the tuned circuit values. This makes it more difficult to build stable circuits in production, as all parts must be held to more strict tolerances than for AM broadcast receivers. A simplified circuit taken from R.C.A. 612V1 is shown in Fig. 1. The input RF coil  $L_2$  is designed to match a low impedance balanced transmission line running from the antenna which is usually of the dipole or folded dipole variety. Antenna line impedance has recently been standardized by the RMA at 300 ohms. Capacitors  $C_5$  and  $C_{13}$  together with the movable tuning slugs of  $L_3$  and  $L_{11}$  are used for aligning adjustments, while capacitors  $C_4$  and  $C_{14}$  are ganged and varied for the actual tuning on the FM band.  $C_{83}$  and  $R_3$  make up a decoupling filter to eliminate feedback in the RF section. Bias

from the AVC bus is applied through this filter to the grid of the RF stage. The tuned circuit in the plate is shunt fed and connected at a tapped point instead of at the top. The tapping results in less loading on the tuned circuit and greater gain.

It is important that the gain preceding the mixer stage be as great as practicable because most of the tube noise generated in the receiver comes from the mixer stage. A tube used as an RF amplifier has a lower noise level and a higher mutual conductance than the same tube used as a mixer. The RF stage must provide sufficient signal to noise ratio to the mixer grid to override the mixer tube noise. The gain of the RF stage also improves the sensitivity of the receiver, providing efficient use of the limiter or weak signals.

Another important function of the RF stage is to reject images. If the local oscillator is operating above the carrier frequency, the image will be equal to the carrier frequency *plus* twice the IF. On the other hand, if the oscillator is

operating below the carrier frequency, the image will be the carrier frequency *minus* twice the IF. For example, assuming an IF frequency of 4 megacycles, an oscillator frequency of 94 megacycles, and a carrier would be 90 megacycles, the image would be

$$2 \times 4 + 90 = 98 \text{ mc.}$$

Since 98 megacycles is within the FM band, another station, if operating on 98 megacycles, might also be heard if no RF stage were preceding the mixer. The tuned circuit of the RF amplifier cannot reject signals which are within such a small *percentage* of the carrier frequency.

An additional safety measure would be to increase the IF frequency so that twice the IF added to or subtracted from the carrier would be a frequency outside of the FM band. This idea influenced the choice of the new RMA Standard FM IF of 10.7 megacycles. In the preceding example, therefore, the image would be

$$2 \times 10.7 + 90 = 111.4 \text{ mc}$$

which is above the upper FM band

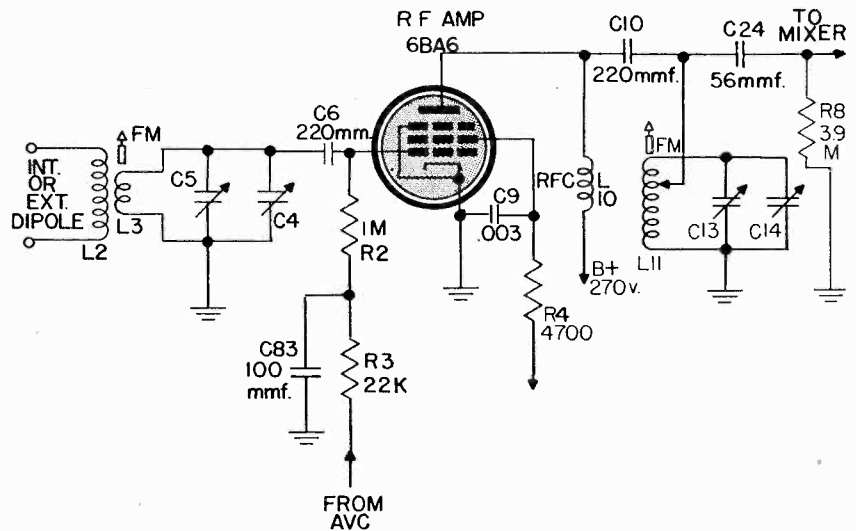

**Fig. 1** The RF amplifier section of the receiver shown in Fig. 2. Notice the use of shunt feed and "tapping down" of the tuned circuit L 11-C13.

limit. This does not prevent image interference from stations outside the FM band but places the image far enough away to be eliminated by the tuned circuit unless the interfering station is extremely strong.

In addition, the RF stage must also prevent carriers of stations operating on the IF frequency from

passing directly into the IF amplifier. However, the tuned circuits of the RF amplifier and mixer (ranging from 88-108 mc) are tuned so far from the IF carrier (10.7 mc) that the rejection of signals at the IF carrier frequency is virtually complete.

Choosing a suitable tube for operation as an RF amplifier is of

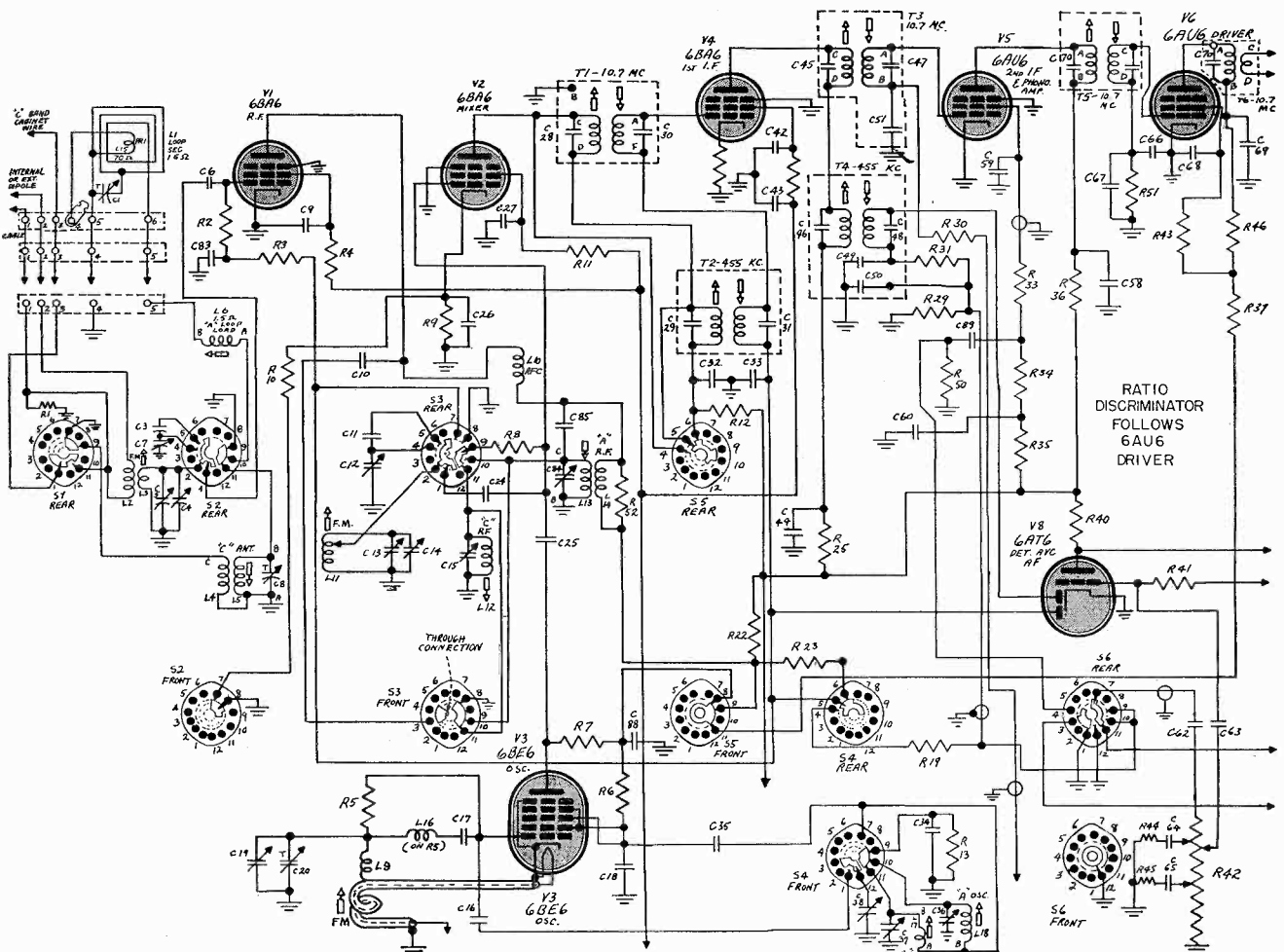

**Fig. 2** Simplified schematic diagram of the RCA 612V1 FM-AM receiver.



critical importance. The tube must have a high figure of merit which is equal to

$$\frac{G_m}{C_{in} + C_{out}}$$

$G_m$  = mutual conductance

$C_{in}$  = input capacity

$C_{out}$  = output capacity

New small glass pentodes such as the type 6BA6 are ideally suited for this purpose. With the proper choice of tube and circuit components, the gain of the RF stage can be expected to exceed 50.

### Oscillator Stage

A very important problem in the design of stable FM receivers is that of oscillator stability. Extreme amounts of oscillator drift will result in corresponding IF frequency drift, and resultant distortion of loud audio signals. Low level passages may not be distorted because of the small resultant frequency deviation.

Two important factors influencing oscillator drift are temperature and supply voltage variations. Most common materials have a positive temperature-expansion coefficient. As a result, an increase of temperature causes an increase of L and C in the oscillator circuit, and a decrease in frequency. The mechanical construction must be such that any bending or flexing movements of the chassis will not influence the oscillator frequency. Band switches and sockets should be made of ceramic rather than phenolic materials, as the ceramics have practically a zero temperature coefficient. To overcome the effects of increased C with temperature, a small condenser with negative temperature coefficient may be added across the oscillator coil. Compensation for increased inductance may be achieved by the use of suitable types of wire such as Invar and Nilvar, consisting of about 36% nickel and 64% iron, which have small linear expansion coefficients. Due to the low Q of this type wire, it must be copper or silver plated to reduce the skin resistance. It is interesting to note that while other receiving circuits require high L to C ratios for efficiency, a low L to C ratio is usually used in oscillators. If the capacitance is made relatively large it will tend to override the effects

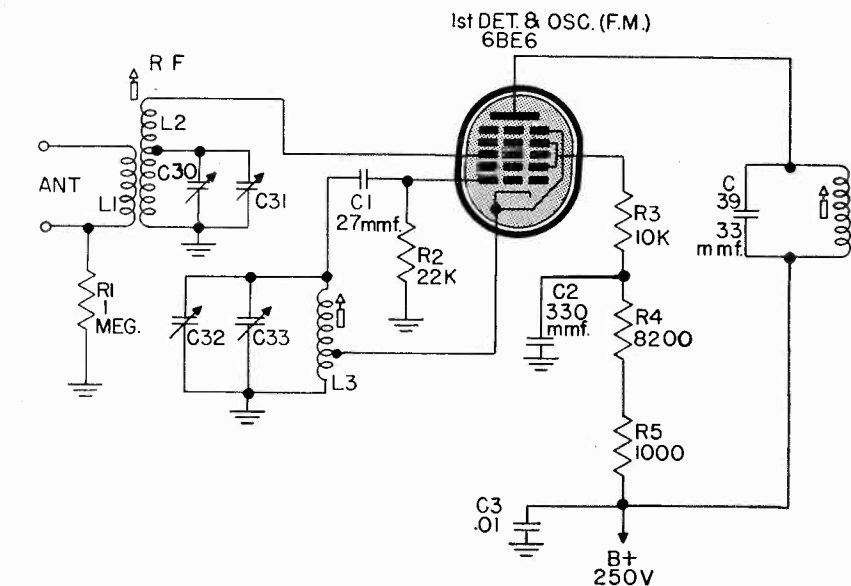

Fig. 3 Example of inner grid injection as used in the RCA 68R1 receiver.

of capacitance changes due to tube warm up and plate voltage variations.

It is necessary to use two completely separate tubes for oscillator and mixer in order to minimize oscillator "pulling." Pulling is the result of the tendency of an oscillator to want to "lock in" or approach the frequency of a signal near its own frequency which is fed into the circuit (in this case the incoming signal). Comparatively high interelectrode capacities in multi-grid converters make them undesirable at high frequencies because of this effect. Hence the frequent use of the separate oscillator arrangement. An interesting feature of this oscillator is the use of a coaxial line wound into the form of a coil and used as part of the oscillator tank. This arrangement permits tying the filament of the oscillator tube to its cathode so that, as a result, changes in filament to cathode capacitance with warm up do not introduce oscillator drift. The 6BE6 oscillator tube is connected in an electron coupled circuit which is extremely stable and not affected by RF tuning. Oscillator voltage is coupled to the common grid mixer through C25 which supplies sufficient voltage on all bands.

Frequency modulation of the local oscillator may be caused by microphonic tubes or parts, or by B+ variations due to the audio amplifier. If this occurs the discriminator will detect the frequency

variations as an interfering audio output. Automatic frequency control would help much in tuning the receiver properly but is not used for other reasons. On low volume passages of music the frequency may deviate only a small amount, and due to the wide band IF no distortion may occur if the receiver is detuned from center. However, when loud passages occur and the deviation is at a maximum of 75 kilocycles, the outer sidebands would be flattened resulting in distortion of the audio signal.

### Mixer

In a superheterodyne receiver, it is the function of the mixer to combine the incoming RF carrier wave with the locally generated oscillator signal to produce an IF wave. In order to produce this IF, the converter must operate as a non-linear device on the curved portion of the plate characteristic. The type of converter shown in Fig. 2 is known as the common grid type, wherein the RF and oscillator signals are both applied to a single grid. This circuit arrangement makes it possible to obtain stability of oscillator performance, and maximum gain from the converter by the use of a high  $G_m$  tube.

Another type of converter circuit which utilizes a single 6BE6 for both mixer and oscillator is shown in Fig. 3. This circuit is taken from RCA Model 68R1 and is known as inner-grid injection, wherein the oscillator signal is in-

→ To Page 18

# IMPORTANT ANNOUNCEMENT to my Servicemen friends:

In just one year, PHOTOFACT has become the leading Radio Data Service. I owe this success to you. Your support has made it possible for the SAMS organization to provide you with the most complete, accurate and uniform service information ever published. Your backing has encouraged us to extend our activities. As part of our continuous program in behalf of the Servicing profession, I am happy to announce two important new publications. Like PHOTOFACT Folders, they meet a real need—you've told us so. And like PHOTOFACT, these new publications are based on our own actual study of the equipment covered. I am confident these new books will help your business . . . To each and every one of you I say a heartfelt "Thanks!"

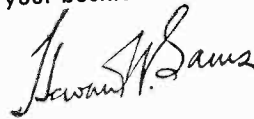

**NEW! HOWARD W. SAMS**

## DIAL CORD STRINGING GUIDE

**Only Book of its Kind!**



ONLY

**75c**

Handy pocket size  
Over 96 pages

Easy to read  
diagrams and data

There's only one *right* way to string a dial cord. And there's only one book that shows you how. It's the Howard W. Sams DIAL CORD STRINGING GUIDE. Here, for the first time, in *one* pocket-sized book, are complete dial cord diagrams and data covering 1938 through 1946 receivers. Actually, there are many ways you can go about stringing a dial cord—but only *one* is *right*. You know from your own experience that if you get started the wrong way, you can waste hours of your valuable time and work yourself into a nervous lather. You can say "goodbye" to wasted time when you have a SAMS DIAL CORD STRINGING GUIDE. It licks the knottiest dial cord problem in a matter of minutes. This low-cost book is a "must" for servicing. You'll want two copies—one for your tool kit and one for your shop bench.

**ORDER YOUR COPIES TODAY!**

**NEW! HOWARD W. SAMS 1947**

## AUTOMATIC RECORD CHANGER MANUAL

**There's Nothing Like It!**

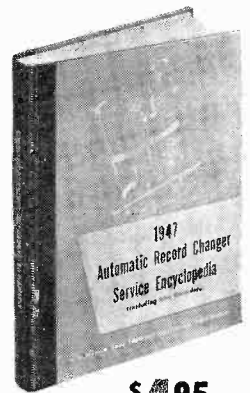

ONLY **\$4.95**

416 pages • Hard Cover  
Smythe-sewed—opens flat  
Hundreds of photographs  
and diagrams

COVERS MORE THAN 40 DIFFERENT POST-WAR MODELS! A DeLuxe volume, packed with ORIGINAL data based on actual study of the equipment covered. Absolutely accurate, complete, authoritative. No other information like it available; Shows exclusive "exploded" views; photos of top, side, bottom and rear views. Tells you manufacturers who use the equipment. Gives full change-cycle data. Complete information on all adjustments. Invaluable Service hints and kinks. Shows complete parts lists keyed to diagrams and photos. Uniform treatment for each piece of equipment. PLUS—for the first time in any publication—complete, accurate service data on leading WIRE, TAPE, AND DISC RECORDERS! No modern service shop can afford to be without this book!

**ORDER YOUR COPY TODAY!**

## New Aids Make PHOTOFACT FOLDERS More Useful Than Ever!



They're yours for the asking: **PHOTOFACT CUMULATIVE INDEX**—Complete Index to first 20 Sets of PHOTOFACT Folders; your guide to more than 1800 receiver models and chassis (1946 and 1947 models). **HOW TO FILE FOLDER**—shows 5 good ways to file PHOTOFACT Folders, including new "30-Second" filing method. Ask your parts jobber for FREE copies of these PHOTOFACT aids, or write us direct.



SETS NO. 22 AND NO. 23 } 160 pages of valuable, needed data covering  
NOW AVAILABLE! } current models. Same low price of \$1.50 per set.

**HOWARD W. SAMS & CO., INC.**  
INDIANAPOLIS 6, INDIANA

Export—Ad. Auriema—89 Broad St., New York 4, N. Y.—U. S. of America  
Canada—A. C. Simmonds & Sons, 301 King St., East—Toronto, Ontario

**PHOTOFACT SERVICE**

"The Service that pays for itself over and over again"

MAIL THIS ORDER FORM TO YOUR PARTS JOBBER TODAY—or send directly to HOWARD W. SAMS & CO., Inc., 2924 E. Washington St., Indianapolis 6, Ind.

My (check) (money order) for \$ . . . . . enclosed.

- Send . . . SAMS' DIAL CORD STRINGING GUIDE(S), at \$0.75 per copy.
- Send . . . SAMS' 1947 AUTOMATIC RECORD CHANGER MANUAL(S), at \$4.95 per copy.
- Send PHOTOFACT Set No. 22 (at \$1.50).
- Send PHOTOFACT Set No. 23 (at \$1.50).
- Send PHOTOFACT Volume No. 1 (including Sets Nos. 1 through 10) with DeLuxe Binder, \$18.39.
- Send PHOTOFACT Volume No. 2 (including Sets Nos. 11 through 20) with DeLuxe Binder, \$18.39.
- Send FREE Cumulative Index.
- Send FREE "How to File" Folder.

Name . . . . .

Address . . . . .

City . . . . . State . . . . .

jected into the #1 grid of the tube, a pentagrid converter.

A circuit of this type may be used with good efficiency provided that the proper tube type is chosen, and the circuit components are properly located, with compensation applied wherever necessary. The oscillator in this case is a series fed Hartley with the screen grid (#2) acting as the plate of the oscillator. Feedback is obtained through C2 and the lower portion of the tank coil L3. C1 and R2 are chosen so as to provide the correct operating bias of approximately -4 volts when grid current is drawn on the positive portions of the RF cycles. The RF carrier signal from the antenna circuit is injected into grid #3, the signal grid. Careful shielding is provided between grids #1 and #3. Mixing is accomplished by the combined effects of grids #1 and #3 on the electron stream of the tube, which is operating on the non-linear portion of its characteristic.

### IF Amplifier

Intermediate frequency amplifiers in modern FM receivers are of necessity one of the most complicated portions of the set. This is due in part to the fact that most FM receivers are also constructed to receive AM broadcasts and use a common IF system. As most AM receivers use an IF of about 455-465 kilocycles with a bandpass of 10 kilocycles, and the new standard for FM IF is 10.7 megacycles with about a 150 kilocycle bandwidth, it will be seen that the problem is not an easy one.

The FM band used before the recent frequency changes ranges from 42 to 50 megacycles. Since this covers a range of 8 megacycles, it is obvious that an IF of at least 4 megacycles is necessary in order that the image frequencies of twice the IF plus or minus the carrier frequency would fall outside of the FM band. A standard of 4.3 megacycles was adopted, due to the fact that the least amount of communications traffic in the region of 4 megacycles was being conducted on this frequency. With the advent of the new FM band and 88-108 megacycles covering a 20 megacycle width, it became necessary to choose an IF in excess of 10 mega-

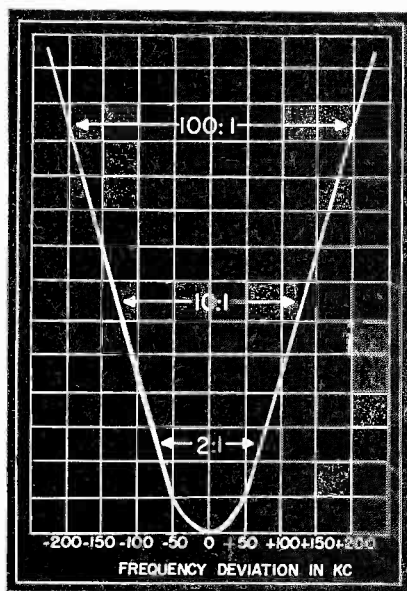

Fig. 4 Typical selectivity curve of an FM IF amplifier.

cycles, and outside of any active communications channel. Thus the frequency of 10.7 megacycles was selected.

Still other considerations would point out that a higher IF than 10.7 megacycles would be desirable. For instance, unless the IF frequency is greater than the total band range, it is possible for two FM stations separated by the IF frequency to act as each others' local oscillator. If one station were to operate at 90 megacycles and the other at 100.7 megacycles, the beat frequencies between both stations would be equal to 10.7 megacycles and both stations would be heard regardless of any tuning adjustments. The possibility of this happening is not too great, whereas the loss of gain at a higher IF frequency might be excessive with present day circuits.

The two most important functions of the IF amplifier are:

1. To produce most of the RF gain in the receiver.
2. To provide sufficient selectivity to reject adjacent channel interference.

The maximum gain possible at 10.7 mc with FM is much less than that realized at 455 kc with AM because:

1. Broader band width means less gain (FM band width is 20 times as broad as AM).
2. Stability can only be maintained at high frequencies if the gain is limited.
3. Shunting effects of tube and stray capacitances and conductances become serious at high frequencies. While gains as high as 500 are attainable in 455 kc AM stages, single 10.7 mc FM IF stages are limited to a gain of about 60 at the present stage of development.

At least two IF amplifier stages must be used, therefore, providing a gain of about 3600. Assuming a converter gain of 5 and an RF gain of 25, there would be an overall amplification of 450,000 times from antenna to limiter grid. If two volts of signal is the minimum needed to saturate the limiter then the minimum antenna pickup would have to be

$$\frac{2}{450,000}$$

or about 5 microvolts. Actually this figure is somewhat optimistic and in order to insure proper noise rejection, about 25 to 50 microvolts of signal at the antenna would probably be needed, although if the noise level is low enough the smaller figure might apply.

If the circuit gains prescribed above are to be realized at the high frequencies used, and stable operation obtained, great care must be taken in the correct placement of parts and wiring to minimize the possibilities of feedback, which would not only cause regeneration and oscillation but an attendant reduction in bandpass with its resultant distortion.

A typical selectivity curve for an IF amplifier is shown in Fig. 4. As

→ To Page 26

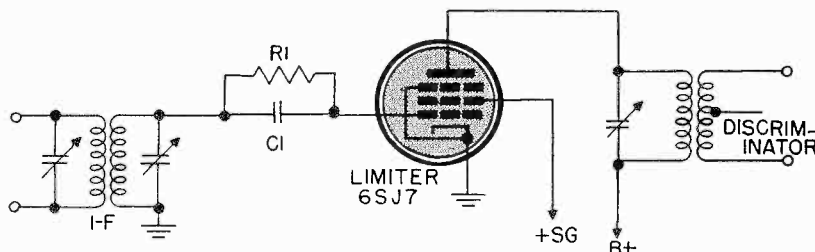

Fig. 5 Simplified diagram of a limiter circuit. This circuit is simply an IF amplifier adjusted to saturate at a relatively low signal level.



DESIGNED FOR THE BETTER SERVICE SHOP . . .



RCA's NEW TEST OSCILLATOR  
 . . . second unit of a  
 revolutionary new line

**Reduces testing and alignment time  
 by as much as 50 per cent**

• The WR-67A is a time-saver that adds *profitable* hours to your service day . . . puts you dollars ahead.

When aligning a receiver, for example, you can switch from a pre-tuned i-f signal to pre-tuned broadcast-band signals without dialing or retuning. The range switch gives you three fixed frequencies: 1500, 600, and 455 kc. It also permits instant switching to any other frequency you select between 100 kc and 30 mc by presetting the smoothly variable tuning control.

Other outstanding features include: a signal injection probe for high-speed servicing . . . a four-step attenuator with fine control . . . double

shielding . . . miniature-type tubes throughout . . . a six-band drum dial with an easy-to-read, four-foot scale spread . . . adjustable modulation level for internal and external modulation . . . a two-stage power-line filter to minimize leakage, and a 400-cycle *audio* signal source.

Every RCA WR-67A is factory-tested with the finest precision measuring equipment Heavy-duty components—plus the WR-67A's ability to withstand rigorous "drop," "shake," and humidity tests—add up to real on-the-job reliability. A new bulletin is yours for the asking. *Keep in touch with your RCA Test Equipment Distributor.*

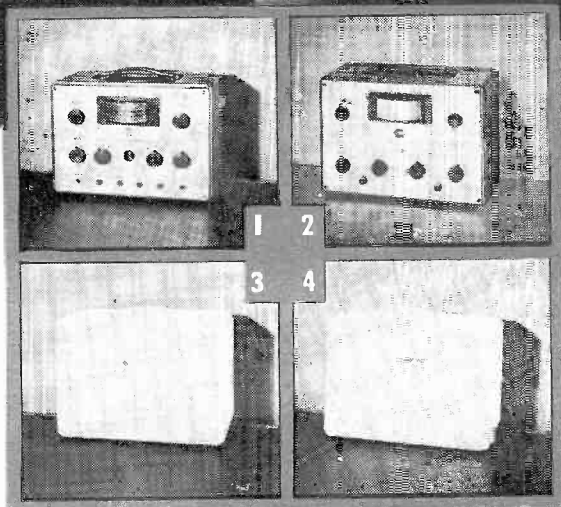

**ON THE WAY**—a superior line of test equipment that puts time-consuming service jobs on a profitable, production-line basis . . . that anticipates all FM and television needs. Matched styling of all instruments permits attractive, convenient grouping. Watch for announcements of the other units in this new line.



**TEST AND MEASURING EQUIPMENT  
 RADIO CORPORATION of AMERICA  
 ENGINEERING PRODUCTS DEPARTMENT, CAMDEN, N.J.**

In Canada: RCA VICTOR Company Limited, Montreal

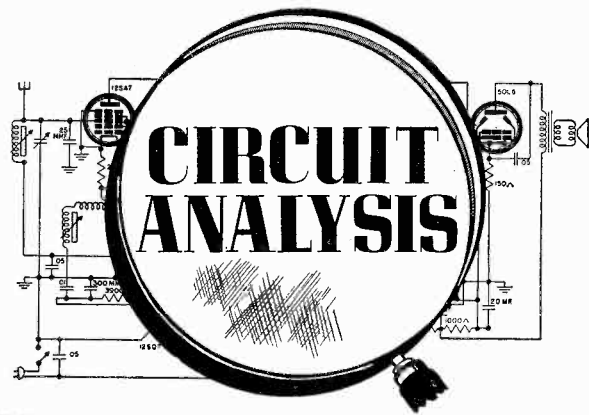

by  
**J. Richard  
 Johnson**

**V**ERSATILITY is one of the important features of the Espey model 581 receiver. It is designed to operate on AC or DC power lines, or on batteries as a portable. There are three frequency ranges, one giving broadcast coverage and two operating on short wave.

**IF Section**

One rather new and different feature of the circuit is the use of resistance coupling between the two IF stages. You will remember that normally we use an IF transformer, with both coils tuned. In this instance we have one of these IF transformers at the input to the first IF stage and another at the output of the second IF stage. But

between the two stages a resistance coupling network is used. Fig. 1 shows the circuit of the complete IF section. Notice that the resistance

coupled portion looks just like the circuit used in audio amplifiers, except for the values of the components. Smaller values are used for the resistance of the plate load and the capacitance of the coupling condenser. Resistance coupled stages have less gain than the transformer type; that is why this receiver uses one extra IF tube.

**Filament Circuit**

Slightly more complicated filament circuits are characteristic of this type of receiver, because of the choice between AC-DC and battery operation. A simplified diagram of

→ To Page 34

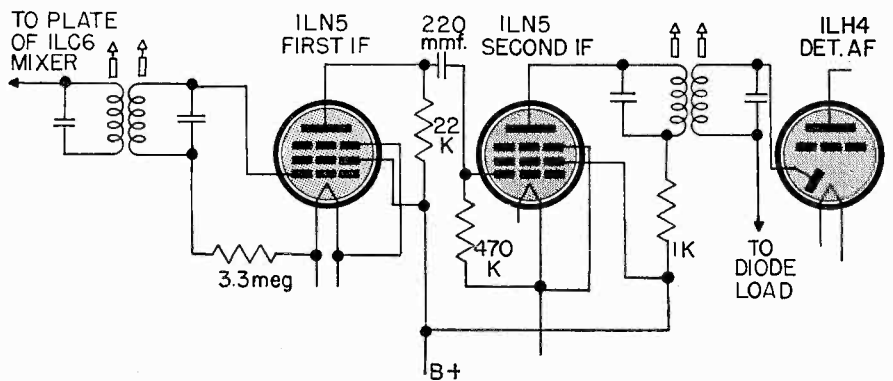

**Fig. 1** IF section of the Espey Model 581, showing the use of resistance coupling.

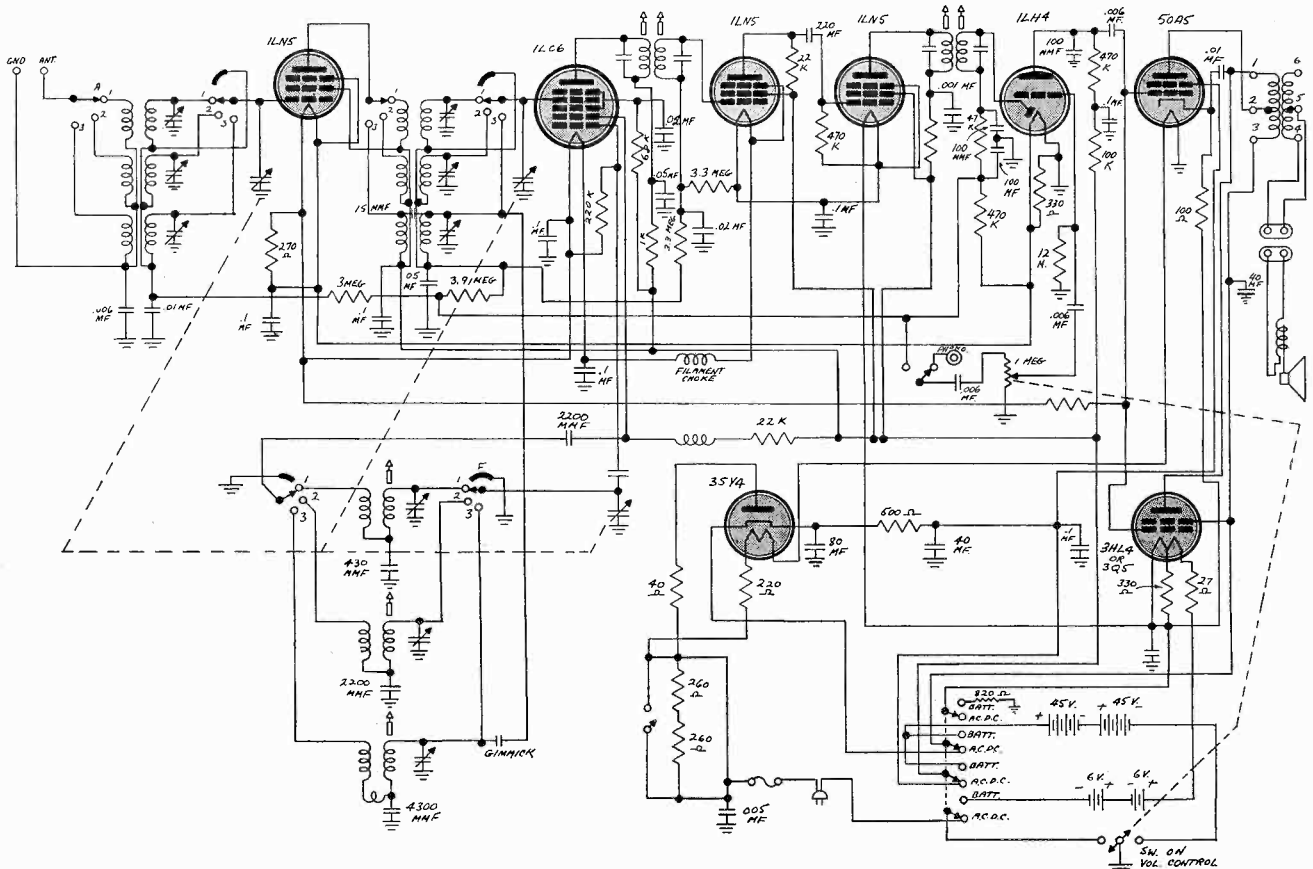

**Espey Model 581**

*Instantly—*

VOLTS OHMS MILS DECIBELS AMPERES MICROAMPERES

*are at your fingertip!....*



with the **NEW** Precision *Multi-Master* Series **858**

**20,000 AND 1,000 OHMS PER VOLT**

**High speed, 54 range, dual-high sensitivity AC-DC de-luxe multi-range test set. Ranges to 6,000 volts—600 megohms—12 amperes—70 DB—60 microamperes.**

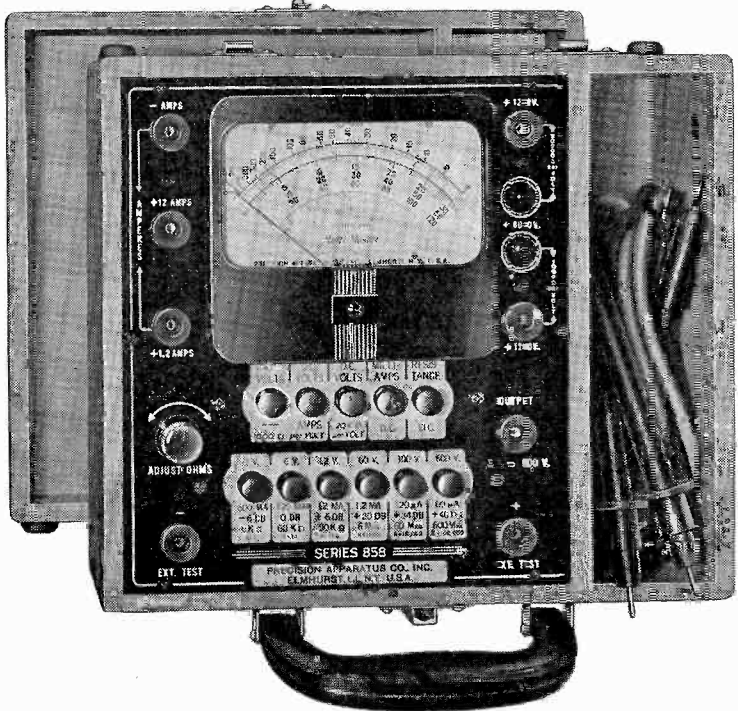

Series 858 MULTI-MASTER features "Precision" Automatic Push Button range and function selection, affording the ultimate in operational efficiency and simplicity.

A supersensitive test set particularly engineered for reliable, high speed measurements in modern electronic circuits • Large, easy reading, 50 microampere, 4½" meter • All standard functions available at only two polarized tip jacks • 600 megohm insulation resistance test range in addition to 5 self-contained ohmmeter ranges to 60 megohms • Recessed 6,000 volt safety jacks. Etched-Anodized aluminum panels resistant to moisture and wear • Conservatively and professionally designed, the Series 858 keynotes the Precision standards of accuracy, workmanship and quality.

**RANGE SPECIFICATIONS**

- ★ 8 D.C. voltage ranges to 6,000 volts at 20,000 ohms per volt. Initial range 0-3 volts.
- ★ 8 D.C. voltage ranges to 6,000 volts at 1,000 ohms per volt.
- ★ 8 A.C. voltage ranges to 6,000 volts at 1,000 ohms per volt.
- ★ 8 D.C. current ranges to 12 amperes. Initial range 0-60 microamperes.
- ★ 6 ohmmeter ranges to 600 megohms. Initial range 0-6,000 ohms with 35 ohms center scale.
- ★ 8 decibel ranges from -26 DB to +70 DB.
- ★ 8 output ranges to 6,000 volts.

Model 858-L; modern, shallow, bakelite laboratory type case, size 7 7/8 x 8 3/8 x 3..... \$47.94  
 Model 858-P; portable, hardwood case with tool compartment and cover, size 8 3/4 x 10 x 4 1/2..... \$49.94

( Complete with batteries and High Voltage test leads )

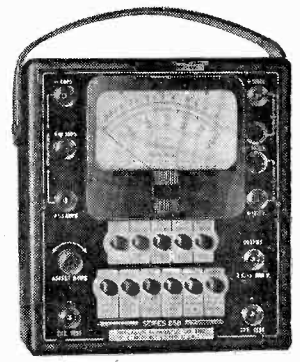

*Ask* to see the "Precision" line of Quality Test Instruments on display at all leading radio parts and equipment distributors. Signal Generators, Vacuum Tube Voltmeters, Tube Testers, Multi-range Test Sets, etc.

*Standard of Accuracy*

**PRECISION**  
 APPARATUS COMPANY INC.  
 92-27 HORACE HARDING BOULEVARD  
 ELMHURST 5, NEW YORK

**MANUFACTURERS OF FINE RADIO AND ELECTRICAL TEST EQUIPMENT**



# The Organizations

In the last few years, there has been a marked increase in organizational activity in the trade. Feeling that the reader would like to know more about the organizations and their activities, Radio Maintenance is inaugurating this column containing correspondence received from servicemen's organizations. If you are a member of an organization, we would like to hear about the activities of your group.

Here is interesting information from Del Brunner:

"The **Akron Radio Technicians Association** is now finishing its second year of post war operation.

"Under the leadership of the Vice-President, George Phillips (President Jack Gritton is now in sunny California) we are looking forward to a busy and interesting season.

"Our relations with the broadcast stations are more than amiable. The Mutual outlet has been putting forth three spot announcements daily to promote good will and the American outlet is giving a weekly fifteen minute questions and answers program. A private association telephone number has been set up in conjunction with the broadcasts and the local answering service receives all calls which are relayed through the secretary's office for distribution geographically. This has proven a very successful operation.

"The next meeting will be conducted by Mr. Joe Wellington of Hickok. This is to be an open meeting and ALL radio servicemen are most cordially invited.

"Incidentally, for the next sixty days the membership committee will operate under a dispensation reducing the application fee in order to increase the membership."

Del Bruner, Secretary

Kenneth Sloan, of **Phoenix Radio and Electronics Club** writes as follows:

"I have been appointed by the President of the Phoenix Radio and Electronics Club as correspondent for your magazine.

"The Phoenix Radio and Electronics Club was organized in August, 1945. The initiation fee is \$25, and dues are \$3 per month. Our meetings are a bit different from the average — no business is discussed at meetings, other than a few items of organization details. The meetings are strictly of a social nature, and every other meeting is open to wives of members. Every meeting is a dinner meeting, with an occasional splurge for entertainment or a party. Meetings are held the first and third Tuesday of each month.

"All members display the Club Emblem on decals in their windows, and for the past year we have been running ads in both the morning and evening papers in Phoenix. The name of a member is shown in each ad, and these names are changed daily. We have recently received considerable publicity from one of the new radio stations near Phoenix. They have been giving us frequent plugs. We have agreed to set push-buttons to their frequency, free of charge, on any set brought to a member's shop.

"Present officers of the Club are:

R. C. Null, Pres.; Pete Scrivano, Vice-Pres.; Bob Dill, Sec.; A. M. Smith, Treas.

"We are enclosing a copy of one of our ads, and a copy of the Club rules and regulations.

"I might add that we are also running an ad in the Classified Section of the Phone Directory, listing the names of all members."

Kenneth Sloan

Walter S. Koop, of **Philadelphia Radio Serviceman's Association** reports:

"The current activities of P.R.S.M.A. can best be described by the recent committee reports which are listed briefly below.

"Membership Committee

"Mr. George Greenberg, Chairman of the Membership Committee receives applications for membership and submits them to the general membership for approval after the applicants have passed a written examination. This committee also acts as a contact agency between manufacturers, distributors, and dealers, who desire trained radio and television servicemen of outstanding ability; thereby serving as an employment agency for P.R.S.M.A. members. A clear example of our co-operation with the local distributors was given this month when the local Philco Distributor called on us to supply men for the installation of their Television sets. We were able to supply about half of the total number of men required. These men were trained and instructed by the Philco Distributors, Inc., of Philadelphia, and then proceeded with the installation of over one thousand new

→ To Page 34

**DID YOU KNOW-**



**RAMSEY'S  
RADIO**

3703 North  
7th Street

is a  
member

**Radio Electronics Club**

# SPRAGUE TRADING POST

## FREE! This Giant Sprague TEL-U-HOW WALL CHART

— from your Sprague Distributor

Ask your nearest Sprague jobber for your copy of the SPRAGUE TEL-U-HOW WALL CHART. Just the thing for hanging on the wall of your shop. Its professional appearance impresses customers. The material it contains will help you do jobs easier, better, faster.

Beautifully lithographed in colors, size 22" x 28", the chart includes handy service application data; diagrams and descriptions of common circuit troubles involving capacitors; general replacement data on electrolytics; formulas; transformer, resistor and capacitor color codes; schematic; and similar invaluable service information. Everything is arranged for quick, easy reference. Popular Sprague Capacitors and Koolohm Resistors are illustrated. Don't miss it!



**FOR SALE**—Meissner 150-B transmitter, 300 watts input 80-40-3 meters phone and CW. Meissner E-20 tubes, coils, built-in antenna PI-section crystal mike input. Guaranteed A-1, used only few hours. \$325 f.o.b., Wayne R. Filmer, 4609 Airway Road, Dayton 3, Ohio.

**SELL OR TRADE**—Hallcrafters S-38 receiver good condition, used 6 months. \$45. Want BC-348 receiver. Robert Annable, 324 W. Park, Rome, N. Y.

**FOR SALE**—Nearly new set rider manuals including #15; approximately 1100 tubes; 30 vibrators; condensers; switches; volume controls and miscellaneous articles, all in original cartons. \$1200 for lot. Lester L. Roach, Box 414, Akron, Colo.

**SELL OR SWAP**—1923 RCA Radiola III-A; 12 issues 1918 Electrical Experimenter magazine in binder. W3VYG, 230 S. Prazier St., State College, Pa.

**WANTED**—Short-wave converter for auto radio or small short-wave radio with 6v vibrator. Cash, or will trade. Army C-3 late model and 25 calibre Colt automatic. Ed. Nicks, 2738 Pinard St., Dubuque, Iowa.

**FOR SALE**—Magnavox 33 1/3 rpm record player and playback machine. Has built-in 35mm still projector. Complete with tubes, loud speaker and connecting cable. Excellent for class lecture work, etc. Lyle E. Dodd, 307 Bomb Group, 370 Squadron, MacDill Field, Tampa, Fla.

**SELL OR TRADE**—New 15-tube transmitter receiver complete with extra tubes, mikes, phones, 30-foot antenna pole, whips and fittings. Ideal for amateurs. No reasonable offer refused. Also 90 new and used radio tubes all types. What have you? Charles Nicholas, 1433 West 29th St., Indianapolis 23, Ind.

**FOR SALE**—Hallcrafters SX-36 receiver. AM-FM-CW from 27 to 150 mc., tunes amateur bands and commercial FM broadcast band. Immediate sale at \$212. T. D. Smith, Route #3, Box 76, Vancouver, Wash.

**FOR SALE**—Hallcrafters SX-25 complete with Jensen 8" speaker in Bud matching cabinet. Excellent condition, \$100. Fred E. Franck, 724 N. Church St., Salem, Ore.

**SELL OR TRADE**—Columbia rotary converter d-c to a-c. D-C 115v-1.6 amps - a-c 87v. 100 watts. Used but in good condition. \$5 or signal generator. In my condition. A. F. Krupinski, Star route, Webster, Mass.

**SELL OR SWAP**—DeForest 1946 training course covering radio & television. 120 booklets. Want ohmmeter or any kind of test equipment or sell for \$30. John Saul, 916 S. Mercer St., New Castle, Pa.

**FOR SALE**—Hallcrafters S-38 perfect condition, \$40. Portable windup record player with Xtal pickup, \$10. Set of 4 Bud, 2 winding coils with condenser, \$3, and new Thordarson T-13A36, \$1.50. Fred Hatfield, 1009 Greenwood Ave., Zanesville, Ohio.

**WANTED**—25AC5 tubes, new or used, Stephen Pickrich, 4909 Plum Way, Pittsburgh 1, Pa.

**FOR SALE**—Triplett 1200G multimeter; also Clough Brengle OCA signal generator. \$25 each. R. E. Lewis, 2924 Jefferson St., Miami 33, Fla.

**FOR SALE**—Radio and electric shop, long established in town of 3,000. Com-

plete radio equipment reasonably priced. Selling because of ill health. Radio Shop, 114 E. 4th St., Blue Earth, Minn.

**FOR SALE OR TRADE**—6v. battery charger with meter, charging rate 5-7 amps. with fuse 110v 60 cycle a-c. \$5 plus shipping. Send 50% deposit. Have HF speakers and other items. What do you need? Paul H. Prokes, 9216 S. Menard Ave., Oak Lawn, Ill.

**FOR SALE**—RCA Voltomyst junior in perfect working condition. Two test leads but no d-c prod included. 30 day guarantee. \$30. Richard Kroeger, Schuyler, Nebr.

**WILL TRADE**—New 30-watt amplifier in portable case; P.M. speaker and mike; BC-654-A transmitter and receiver less power pack; Superior channel analyzer and V.T.V.M. combined; Redrite radio analyzer and clarinet. Want good make recorder. John Arnold, P.O. Box 84, Bluffs, Ill.

**FOR SALE**—Muter series 1200 resistance bridge; Leeds & Northrop galv., complete \$55; Aerovox 75 cup and resistance bridge with vacuum tube volt meter. \$38.50 plus postage. Louis Wolanin, Rt. 1, Box 120, Bridgman, Mich.

**SELL OR TRADE**—Back issues of QST. Want 33 Ford or other auto radios. W. Fuller, 4620 Stafford Road, S. Lansing 10, Mich.

**WANTED**—Stancor A-53C push-pull input transformer and 0-200 milliammeter. Must be reasonable. Jimmy Steffin, 442 N. Park Ave., Fond du Lac, Wis.

**FOR SALE**—Condensers 12mf/450v @ .43, .002/400v @ .05, .02/400v @ .05; resistors all sizes IRC .05, Generator input 12v output 350v/90ma. 14in 250ohm field speaker \$6, new Phono motors and turntables. \$3.25. Ed's Radio Service, 2863 Woodhill Road, Cleveland 4, Ohio.

**SELL OR TRADE**—Remington foursome electric shaver excellent condition. Also set, LoCoil kit. Need either multimeter or signal generator. Sam Barash, 21 Bennett Ave., New York 33, N. Y.

**FOR SALE**—Hallcrafters S-36 FM-AM receiver 27.5 to 145mc., continuous in three bands. Has tuning motor, BFO, AVC sw., 4 position tone, noise limiter, etc. Perfect condition. Shipped prepaid. \$227. Paul H. Prokes, 9216 S. Menard Ave., Oak Lawn Ill.

**SELL OR TRADE**—CV transformers. Variatan #V-3, Sola #30806. Power transformers new, U.T.C. R-12 and R-13; Thordarson T10R30; Red Arros \$TR-1024-A. Orators mike desk type H.V. Need Edprobe, record player, signal generator, etc. Enright, 302 East 71st St., New York 21, N. Y.

**SELL OR TRADE**—Superior channel analyzer, like new; has built-in vacuum tube voltmeter reading from 5 to 500 volts at 11 meg input resistance. Need good tube tester or audible signal tracer, or G.I. recording assembly. R. H. Morrell, 623 S. 11th St., Waco, Texas.

**FOR SALE**—ACR-111 communication receiver, 16-tube, range 550 to 10 meters. 8" speaker; also W.A.S. same receiver like new. \$275. M. L. Gregsby, Granger, Iowa.

**SELL OR TRADE**—Latest N.R.I. course including N.R.I. tester for \$50 cash or precision E-200 signal generator or Solar-Exam-eter, CP-1-60. Frank Wurst, 242 Dayton Ave., Clifton, N. J.

**WANTED**—Rider manuals from 6 to 13 inclusive. State price. John's Radio Service, Box 185, Monongah, W. Va.

**FOR SALE**—Rider's Manuals 10, 11, 12, 13 and 14, like new, \$13.50 ea. Also closing out transformers, BM speakers, crystal pick-ups, tubes, etc. Write for list. Plexico Hardware & Furniture Co., Edison, Ga.

**FOR SALE**—Carter generator 350 volt, 160 ma. continuous output from 3.5v input. Fine condition. \$14 or will swap. Also PR crystal 141144kc. and a few medium voltage power transformers. Used HP 100 and pair of TZ-20's. Miscellaneous odd items. What have you? Charles Ammerman, WMLN, 503 W. Beaver Ave., State College, Pa.

**WANTED**—A line of low-priced radios and radio tubes to distribute in the Virgin Islands. J. P. Miranda, Radio & Electrical Service, Christianssted, St. Croix, V. I., P.O. Box 175.

**FOR SALE**—162-C Rider Chanalyst \$135. Riders manuals complete set 1 to 14. \$135. Solar CF 1-60 condenser analyzer. \$52; Precision 35-200 signal generator. \$52; Precision 920-1P Tube checker and multimeter. \$72; Precision EV-10P vacuum tube multimeter, \$60; Supreme 592 multimeter, \$45. John T. Duty, 140 Union St., Auburn, Maine.

**FOR SALE**—Tubes including many locals, octals, and peanut. Also resistors, cords, battery tubes and other parts. What do you need? Charles C. Butler, 616 E. 5th St., Cherrysvale, Kansas.

**WANTED**—Bass reflex 12" cabinet; panadator and late model tube tester. C. Horn, 325 E. 163 St., New York 56, N. Y.

**FOR SALE**—Clough-Brengle, model 110, signal generator; broken dial shaft can be repaired by C.B.; \$30; cost \$55. Also brand new Special Products signal tracer. \$25. Cost \$35. Thomas Fenimore, 203 W. Broad St., Burlington, N. J.

**FOR SALE**—Television set, complete with cabinet and antenna, \$285. In kit form. \$165. Cabinet \$35. Sound f-m, all 13 channels. Will answer all inquiries. Stanley Schneider, 1041 Findlay Ave., Bronx 56, N. Y.

**WANTED**—Rider manuals and used radio and television correspondence course. Will trade Sprax signal tracer or pay cash. Ralph Wilson, 4360 Budlong, Los Angeles 37, Cal.

**FOR SALE**—Philco tube checker series R in perfect working condition. Henry B. Mole, 107 Terrace Ave., Hempstead, N. Y.

**FOR SALE**—Army signal generators 198A —7 to 15mc on fundamentals cw or modulated 400 cycle a-c operated in new condition \$12.95 ea. Ideal for alignment of f-m and television sets. Can be used for E.C.O. electron coupled, osc. Can supply any number, new, Bazan's Radio-Television, 1000 Van Nest Ave., Bronx, N. Y.

**POSITION WANTED**—Full-time position as radio serviceman or helper in established shop vicinity Brooklyn or New York. Two years experience servicing radios and can use all types test equipment. N.R.I. student. Ernest J. Botcher, 136 East 28th St., Brooklyn 26, N. Y.

**FOR SALE**—Mark II tank transceiver with speaker and 110v. power supply. Mike, phones and variometer. Simpson VOM meter and Silver ear bridge. Sell or trade. What have you? R. W. Graham, 2121 West 49th St., Minneapolis 10, Minn.

### YOUR OWN AD RUN HERE FREE

The Sprague Trading Post is a free advertising service for the benefit of our radio friends. Providing only that it fits in with the spirit of this service, we'll gladly run your own ad in the first available issue of one of the six radio magazines in which this feature appears. Write CAREFULLY or print. Hold it to 40 words or less. Confine it to

radio subjects. Make sure your meaning is clear. No commercial advertising or the offering of merchandise to the highest bidder is acceptable. Sprague, of course, assumes no responsibility in connection with merchandise bought or sold through these columns or for the resulting transactions.

Send your ad to Dept. RM-87

SPRAGUE PRODUCTS COMPANY, North Adams, Mass.

(Jobbing distributing organization for products of the SPRAGUE ELECTRIC COMPANY)

ASK FOR SPRAGUE CAPACITORS and \*KOOLOHM RESISTORS by name!

\*Trademark Reg. U. S. Pat. Off.

# THE INDUSTRY PRESENTS

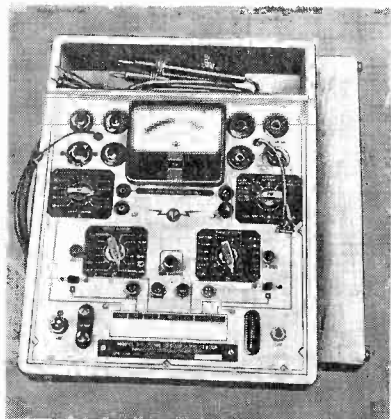
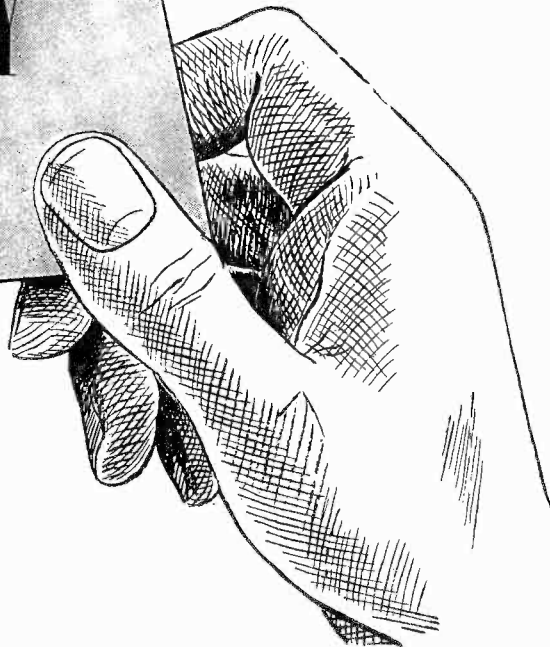

## TUBE-SET TESTER

A portable tube and set tester that has tube sockets for all standard base tubes (including types with miniature and sub-miniature bases) is being introduced by Radio City Products Company. Model 805B combines in one unit a volt-ohm-milliammeter, tube tester, battery and condenser leakage tester, mounted in an oak carrying case with a compartment for test leads and a self-latching cover. A built-in roll chart carries full data for tube settings. For AC measurements, this tester makes use of a Germanium type crystal diode rectifier. Additional information is available from Radio City Products Co., Inc., 127 W. 26 St., New York 1, N. Y.

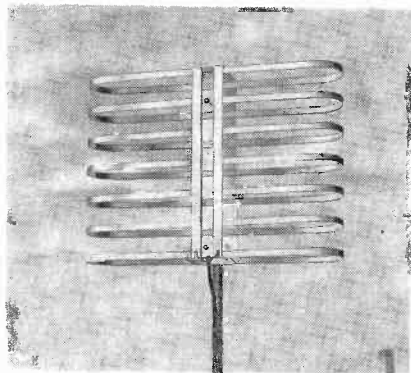

## FM ANTENNA

The Rauland new FM and television antenna, described as Model 150, is designed

specifically for use on the 88 to 108 mc FM band. It has an omnidirectional pickup pattern which results in FM signals being received from all directions, requiring no special orientation. High sensitivity (3 db over a conventional dipole) assures improved reception even at the outer limits of the FM broadcast range.

The Model 150 FM antenna is of all aluminum construction and small in size contributing to low wind resistance. In local metropolitan areas, the antenna can be located indoors satisfactorily. For further details, address The Rauland Corporation, 4245 N. Knox Ave., Chicago 41, Ill.

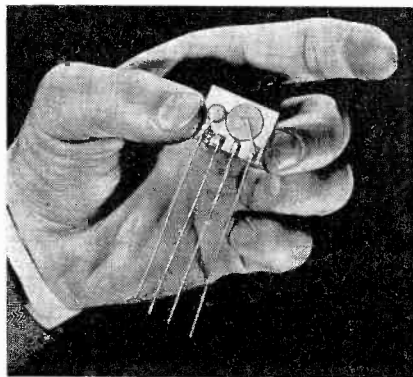

## PRINTED CIRCUIT

The *Couplate* is an assembly of two capacitors and two resistors bonded to a steatite ceramic plate, mutually connected by metallic silver paths "printed" and fired on the surface of the base plate. It is designed to replace the following components normally used in audio circuits when one tube is coupled to the grid of a following stage: Plate load resistor, grid resistor, plate bypass capacitor, coupling capacitor. Use of the *Couplate* is limited to applications where the current requirement does not exceed the 1/5 watt rating of the resistors. Only four soldered connections are used instead of the usual eight or nine, thereby saving as many as five soldered

connections in the coupling of audio stages. Further information may be obtained from Centralab Division of Globe-Union Inc., Milwaukee 1, Wis.

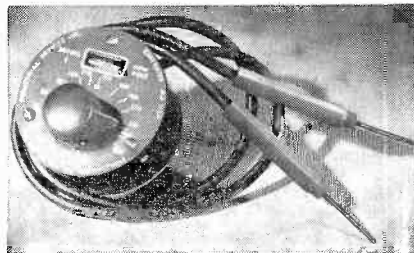

## NEON-GLOW VOLTMETER

A midget neon-glow meter that indicates AC or DC voltages, the Mini-Volt, has been announced by Industrial Devices, Inc., Edgewater, N. J. It is a simple meter of practical accuracy for use by servicemen. It is virtually burnout-proof. Housed in a neat bakelite case and provided with 12 inch flexible test leads with prods, it is rugged enough to be thrown into the tool box or carried in the pocket without danger of damage. Calibrated for use on AC from 65 to 660 volts, with an impedance of approximately 1/2 megohm, it is operated merely by turning the knob until the neon glow extinguishes, whereupon the voltage is read directly off the scale. For DC, which is indicated when only one electrode of the neon indicator glows, the reading is multiplied by 1.15.

This instrument may be used to check whether lines are 110, 220, etc. It may also be used to indicate blown fuses, and to check overloaded lines by taking readings at various points with the load on. Because of the high impedance value, it may be used to measure plate voltages in radio work and for checking leakage. The neon indicator is guaranteed for 10,000 hours of actual operation.

→ To Page 40





# RCA

## Microphones

supply quality input  
to All sound jobs

HERE ARE FIVE HIGHLIGHTS from the popular RCA package sound line. They are high quality RCA microphones . . . selected for the new line because their characteristics best meet the requirements of the types of sound jobs you handle. They are priced for easy sales and quick profit. They bring you the very highest customer acceptance and confidence.

All models are supplied in both high and low impedance types. They work perfectly with any of RCA's new package amplifiers. They provide exactly the right choice for speech or music . . . inside or outdoors.

Send for these folders

Descriptions and specifications of RCA microphones, amplifiers, loudspeakers and intercoms . . . just printed . . . waiting for you. Get them now. Address: Dept. 69-H, Sound Equipment Section, RCA Camden, New Jersey.



**JUNIOR  
VELOCITY  
MICROPHONE  
MI-4036**

Popular low-cost sensitive unit with smooth bi-directional response.

**VARACOUSTIC  
MI-6203,04**

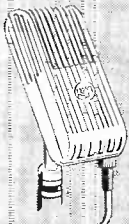

An extremely versatile velocity type. Has variable directional characteristics . . . a wider range of application.

**PROGRAM VELOCITY  
MI-12002,03**



Extremely small, highly sensitive . . . the ideal portable microphone.

**AEROPRESSURE  
MI-6206,07**

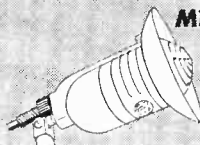

Heavy duty, indoor-outdoor type. Reversible baffle varies directional response.

**AERODYNAMIC  
MI-6226,28**



Very sensitive, close-talking dynamic . . . ideal where noise level is high. Weatherproof.



**SOUND EQUIPMENT  
RADIO CORPORATION of AMERICA  
ENGINEERING PRODUCTS DEPARTMENT, CAMDEN, N.J.**

In Canada: RCA VICTOR Company Limited, Montreal

## Servicing FM Receivers

→ From Page 18

previously stated, at 100% modulation, the deviation is equal to plus and minus 75 kilocycles. It might be expected, therefore, that the overall bandpass would be flat for at least 150 kilocycles to insure equal gain for all modulating frequencies. However, from Fig. 4 it is seen that at plus and minus 75 kilocycles, the voltage response is down by a ratio of 2 to 1. This is done for two reasons. First, the smaller the bandwidth, the greater is the possible gain, not only in the IF amplifier, but also in the mixer and RF circuits, and secondly, a narrowing of the selectivity curve in this way means better rejection of interference from adjacent channels. One might think that such a non-linear characteristic would produce a considerable amount of distortion. However, if the signal is sufficiently strong to saturate the limiter at all degrees of modulation, all of the resultant amplitude variations will be removed.

A simplified schematic (Fig. 2) of the RCA 612V1 shows the design of a modern IF system used for both AM and FM. IF transformers T1 (FM) and T2 (AM) are arranged so that when the receiver is in the FM position, the primary of T2 is shorted out, but with the receiver in the broadcast position (not shown), the switch (S5 rear) rotates two steps in the counter clockwise direction, placing the primaries of T1 and T2 in series. Since the impedance of T1 at 455 kilocycles is practically zero, only T2 is in operation at the broadcast band.

Similarly the primaries of T3 and T4 are in series. However, the secondary of T4 is fed to V8 where it is immediately detected and amplified and sent to the audio amplifier chassis, while the secondary of T3 (10.7 megacycles) goes to V5, the second IF, through driver tube V6 and then to the Ratio Detector, which will be discussed later.

### Limiter

In order to take advantage of the noise reducing possibilities of FM broadcasting, it is necessary to use a circuit which removes ampli-

tude variations from the signal, or to provide a discriminator which is insensitive to amplitude variations of the received signal. In prewar receivers, the most widely used method for accomplishing this was a limiter stage, still used in some new receivers.

A secondary function of the limiter is to restore uniformity of the signal over the pass band, which is necessary due to the shape of the IF selectivity curve (Fig. 4). A simplified limiter circuit is shown in Fig. 5.

While providing some amplification, the primary function of the limiter is to be easily saturated and driven below cutoff by a certain minimum grid swing. Thus noise pulses and other amplitude variations due to interfering signals will be clipped off and not detected. In order to accomplish this, certain characteristics of operation must be adhered to. The tube must be of the sharp cut-off variety such as a 6SJ7. Plate and screen voltages must be very low, 50 to 75 volts being satisfactory. Lowering the voltages reduces the amount of signal input needed to obtain limiting action.

The action of the limiter stage may be easily understood by reference to Fig. 6. Here it is seen that as long as the limiter input remains at a certain level, both positive and negative peaks of the sig-

nal will be clipped, and noise pulses removed. However, if the input signal is too weak, only the positive part of the cycle is clipped, and interference will be passed on to the detector. The values of the biasing system  $C_1 R_1$  are quite critical. Capacitor  $C_1$  charges up approximately to the peak value of the input signal, thus affording a clamping or DC restoring action in the grid circuit. This results in a bias at the limiter grid which varies inversely with the input signal, becoming more negative for a stronger signal. Thus if desired, a source of AVC potential is available across  $R_1 C_1$ . It should be noted, however, that this is seldom done since the constant output characteristic of the limiter makes AVC unnecessary.

The time constant of  $R_1 C_1$  must be short if the effect of noise pulses is not to be heard in the output. A time constant, it will be remembered is the product of R times C and is the time required for a condenser to charge to 63.2% of the applied voltage, or to discharge to 36.8% of the condenser voltage. The time fully to charge or discharge a condenser may be taken as 5 time constants or  $5 \times RC$ . Variations of bias voltage due to noise impulses must take place at a rate higher than any audible frequency. Taking the upper audio

→ To Page 32

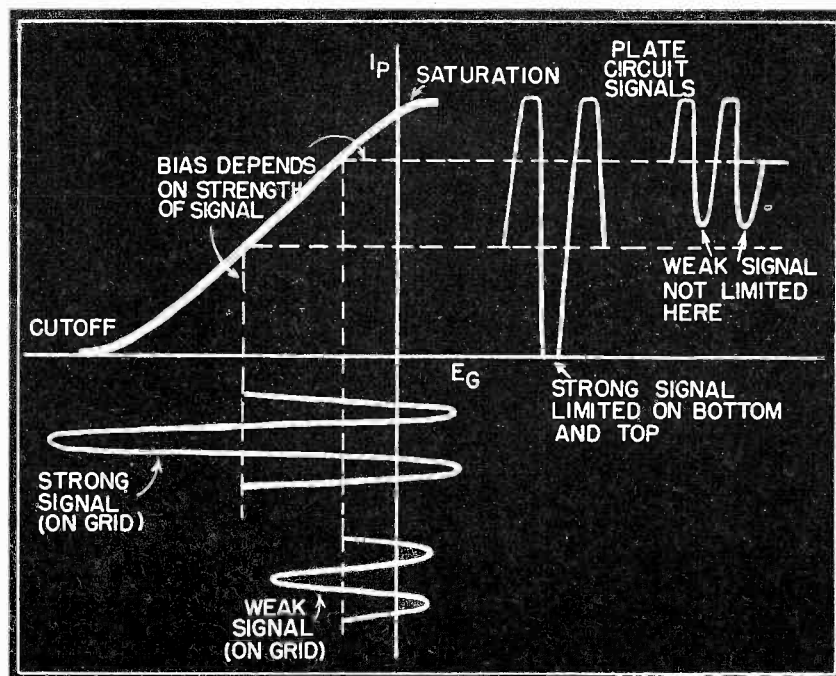

Fig. 6  $E_g-I_p$  curve of the limiter tube with signals superimposed to show action with weak and strong signals.



# You Can Add Up Your Income with a SOLDERING IRON!



**Y**ES, it's a fact that you may not have realized . . . but every minute your soldering iron is busy, you are busy making money. *And you can make even more money if you will suggest to your customers a complete "FIND AND FIX" treatment for sets.*

A complete "FIND AND FIX" reveals parts about ready to go as well as those that are shot, saves your customers extra trips, prevents the embarrassment of parts going sour right after leaving your shop.

IRC's Volume Control Cabinet, Resistor Assortment Kits and Basic Kit cut down unnecessary trips to your distributor for parts, give you more time for soldering . . . for making your time *pay*. Order from your local IRC Distributor today. International Resistance Company, 401 N. Broad Street, Philadelphia 8, Pennsylvania. *In Canada:* International Resistance Company, Ltd., Toronto, Licensee.

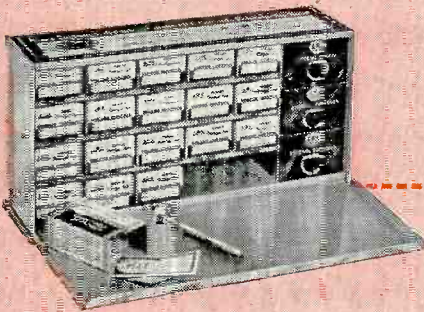

### The IRC Volume Control Kit

18 All-purpose controls, 6 switches and 5 special shafts in an attractive factory-packed steel cabinet.\*

### The 3 IRC Balanced Resistor Assortments in Resist-O-Cabinets\*

- No. 1. 59 assorted insulated composition and power wire wound resistors, including adjustable types.
- No. 2. 100 of the most used ranges in 1/2 watt insulated composition and insulated wire wound resistors.
- No. 3. 83 top quality resistors in the 1-watt range.

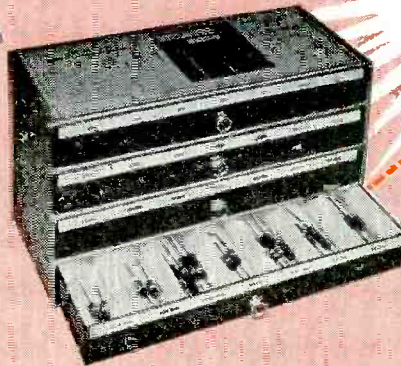

### The IRC Basic Kit

471 "basic" resistors in a wide variety of types and ranges, plus 6 additional bands for adjustable type. All metal cabinet.\*

\*Cabinets are furnished at no charge, not sold separately.

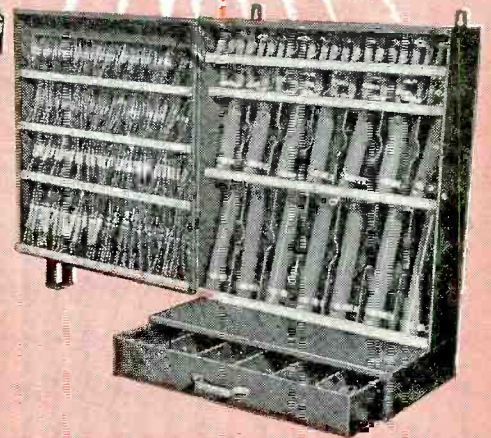

## INTERNATIONAL RESISTANCE COMPANY



Wherever The Circuit Says  $\Omega$

Copyright, 1947, International Resistance Company



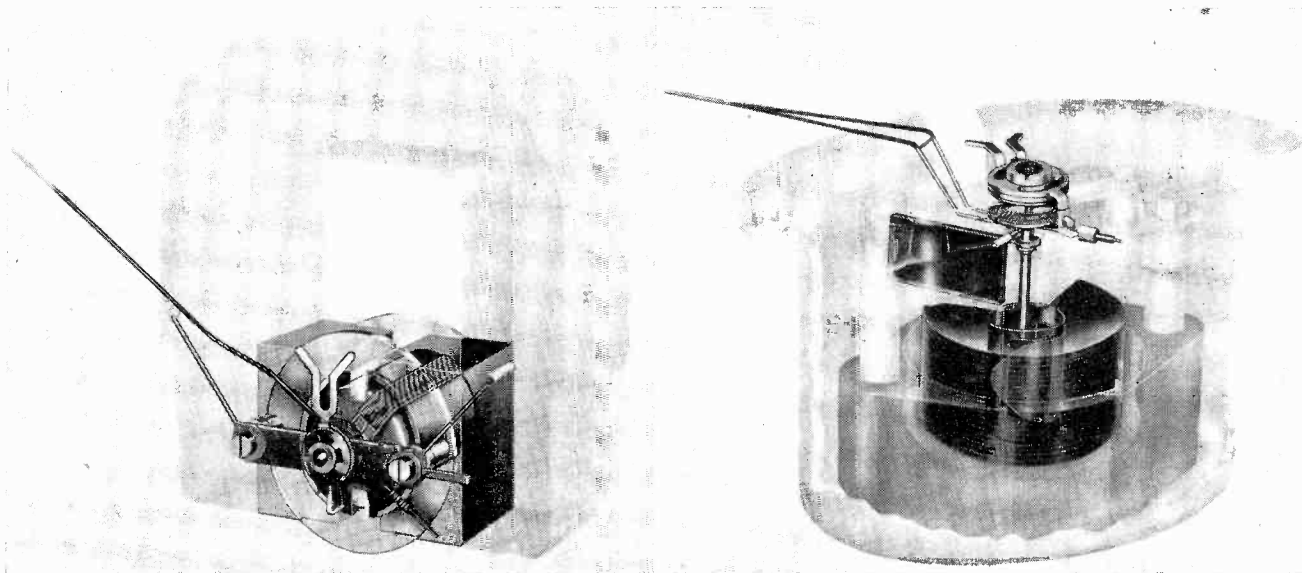

Fig. 4 Internal views of Weston meter movements of types discussed in the text. (A) Moving coil (D'Arsonval) type. (B) Moving vane type.

## Test Equipment Maintenance

→ From Page 5

or a struck movement. Readings considerably lower than normal (usually 10 per cent or more) are due to one or more shorted turns.

### Series Resistors

A defective series resistor should be replaced with a moisture-proof unit of identical resistance and wattage. If no replacement is available, the resistor may be rewound from wire obtained from a discarded or spare wire-wound resistor of sufficient resistance and wire size. Since current requirements for series resistors used in AC voltmeters are much higher than those for similar DC meters, the wire selected for their rewinding should be able to withstand peak currents at least 50 per cent higher than the maximum meter range. The entire resistor spool should be impregnated by boiling for several minutes in paraffin or wax and wiping the excess from the outer surface.

### Faulty Movement

Faulty operation of the meter movement may be determined simply by rotating the meter in a clockwise and counter-clockwise direction while holding in the hand. No movement of the pointer indicates defective bearings or jewels, or the presence of dirt in the movement. Dirt or foreign matter may be removed with a fine brush moistened with alcohol, or with small strips of Scotch tape.

The damping vane and moving element should be checked for alignment and binding at all points and realigned if necessary. The breath should not be blown into the movement to remove dirt or foreign particles, since moisture in any form is injurious to all parts of the meter.

Alcohol and a fine brush should be used.

If neither dirt nor foreign matter seems to be obstructing the motion of a stuck element, the trouble is probably caused by dirty, cracked, or broken jewels and bearings. There is also a possibility of a broken hairspring or glass. These troubles require the attention of an experienced meter man, preferably the manufacturer, and it is recommended that such meters be returned to the factory. Bent pointers (and hairsprings) may be straightened very carefully with a pair of tweezers.

### Power Supplies

Power supplies should be checked at regular intervals and kept free from dirt, dust, lint, and other particles. Such foreign matter hampers free circulation of air about the components and contributes to overheating. Carbonization of grease or smoke particles also tends to form leakage paths and arcing in high-voltage circuits.

Rectifier tubes and filter condensers should be checked regularly. Care should be taken to see that replacement fuses are of the correct current rating (usually 1 to 2 amperes in most supplies).

### Vibrators

Although vibrator repair is not recommended in commercial units, there are many times when vibrator life in test power supplies may be prolonged by filing and adjusting the points. Contacts may be

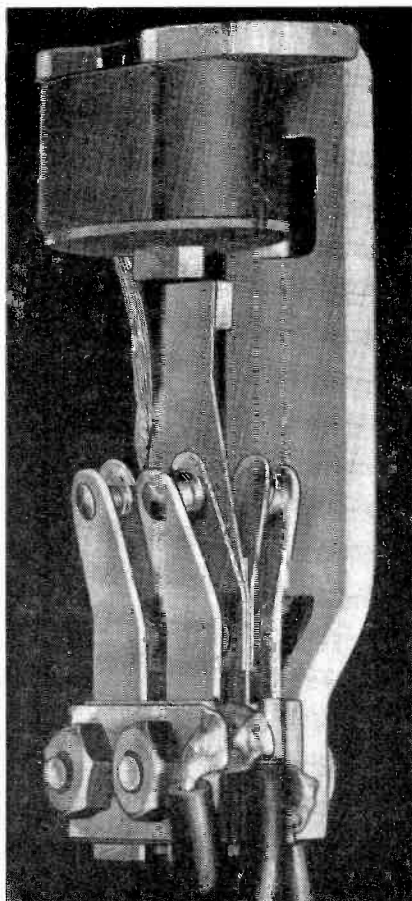

Fig. 5 Closeup of the working parts of a vibrator of the type used in many vibro-packs.

→ To Page 38



by John T. Frye

I WAS READING an article the other day in which it was stated that the average serviceman talks too much. I cannot honestly disagree with this statement. Most of us are too gabby for our own good. I insist, though, that there are several pretty solid reasons behind this lamentable loquacity of ours.

For one thing, we are working with a highly technical and abstruse medium; yet we are trying to please customers who have absolutely no understanding of our work. To employ a homely but apt simile, the average customer knows no more about radio theory than a hog does about Sunday; yet one and all come up with that innocent query: "What was the matter with it, anyway?"

What are we to do? If we explain curtly that the trouble and its cure are far too technical to explain to anyone without the proper background, we lose a customer. Not only is he insulted by our weak faith in his powers of comprehension; he strongly suspects that we are trying to conceal the fact that his own shrewd diagnosis of a "broken wire" was the true one.

On the other hand, if we try to answer the question honestly and adequately, we tie ourselves into verbal knots, stutter and stammer around in search of simple but true analogies, and otherwise give an excellent imitation of an individual who is not quite bright. The foggy impression that is left with him is not credited to his own lack of knowledge. Oh no! As he glibly explains to his friends, "The guy didn't sound like he knew what he was talking about."

Another thing that forces us to do a lot of talking is the "over-selling" practices of some dealers. Is there one of you who has not spent several minutes trying to straighten out a customer who wants to know

why he cannot receive television and FM on his set when the salesman told him plainly that it was equipped for these services when they became available? And just about time you think you have him convinced, he leads you around to the rear of the set and triumphantly points out the little jack that is plainly marked, as any fool can see, "For FM or Television!"

In casting about for a solution to this problem, we may well take a tip from the medical fraternity. Think back on your last visit to the doctor. Who asked the questions? Did he give you a glib explanation of what was wrong with you, or did he simply hand you a prescription and tell you to come back in a few days. Somehow or other, he managed to convey to you that he knew what was your trouble, that he could cure it, and that doing so was sufficiently difficult to be well worth the fee he charged. Very likely all of this was done without his going out on a limb with a flat and simple explanation of your ailment.

This same grave taciturnity will work equally well in radio servicing. You ask the questions. When the set is picked up, ask a few pertinent ones about the complaint and write these gravely down, whether you intend to use them or not. The customer will be flattered at your serious interest in his receiver's symptoms.

Try to ask questions that point up your mastery of your trade. For instance, when the customer starts out, "It will be playing along all right, and then it will suddenly drop in volume; but—"

"But if the refrigerator cuts in, or someone turns on a light, the volume pops back up, doesn't it?" you interrupt.

This routine invariably impresses

→ To Page 34

**BUILT FOR SERVICE**

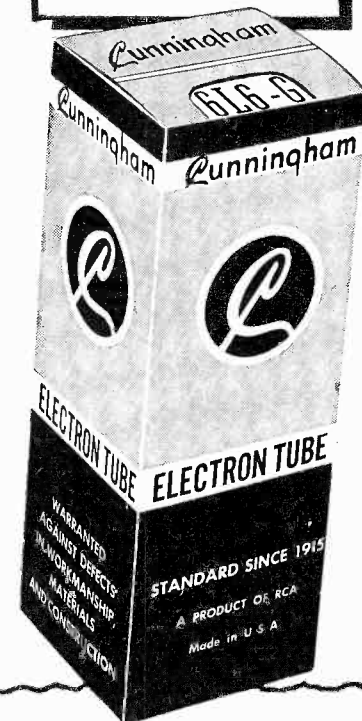

## Technical Tips

### Why Gassy Tubes Affect AVC Bias

The cancellation of negative bias voltage in an AVC line as a result of gassy tubes is more easily corrected than recognized as a cause of faulty performance. The major symptom—distortion of strong signals—is often diagnosed as due to some other cause.

The condition is brought about by the gassy tube drawing grid current. This current flows through the AVC line where it develops a voltage in opposition to the signal-developed AVC voltage. As a result, all AVC-controlled tubes operate at too low a negative bias voltage and, therefore, draw excessive plate current with resultant distortion.

Not all tube checkers will show up a gassy tube. Therefore it is advisable to track down the bad tube by replacing tubes in the receiver with tubes that are known to be good. Cunningham's are always a reliable choice.

For more service—TURN THE PAGE →

**Cunningham**  
Electron Tubes

A product of  
RADIO CORPORATION OF AMERICA  
Harrison, N. J.

## HF Power Supplies

→ From Page 13

be visible on the face of the tube.

In Fig. 6, one-half of tube V1 is used as a pulse generator. This circuit can be recognized as a conventional blocking oscillator which generates pulses as shown in Fig. 7. The blocking oscillator is designed to operate at the horizontal scanning frequency of 15,750 cps, so that a pulse is generated during each horizontal retrace period. These pulses are amplified by tube V3 (a type 807 or similar tube) and impressed on the high voltage autotransformer which increases the pulse to about a 10 kv peak. This transformer resembles in appearance the RF transformer shown in Fig. 3, except that it does not have the tickler or separate secondary windings. A typical transformer can be seen in Fig. 8 which shows a complete pulse-type supply.

The amplified pulse is rectified by a type 8016 diode (V4). The resultant positive pulse charges the filter condenser C1 almost to the full 10 kv pulse peak. The time constant of the RC filter is designed so that before the condenser can discharge appreciably, the next pulse comes along to recharge it. In this manner, a constant high DC voltage is developed across the condenser.

The regulation of such a pulse-type supply is about the same as the

RF supply discussed above. However, if even better regulation is desired, a regulator circuit as shown in Fig. 6 may be used. A portion of the 10 kv output is taken from the voltage divider and is fed to the grid of the regulator control tube, the other half of V1. Changes in the magnitude of the high voltage cause voltage changes across the output of the control tube. These changes vary the screen voltage of the pulse amplifier so as to compensate for the original high voltage change. The VR105 tube is used to keep the cathode of the control tube at a constant reference potential with respect to ground.

### Protection of CR Tube

Another important feature of the pulse-type supply is the fact that if the sweep circuits should fail, the high voltage is automatically cut-off thus preventing the spot from burning the screen. The cathode of the blocking oscillator is biased so that normally the tube is cut-off and will not oscillate. A signal is taken from the horizontal yoke circuit and is used to raise the cathode bias of the blocking oscillator in the high voltage supply so that it triggers. If the horizontal sweep should fail, the blocking oscillator ceases to operate and therefore, no high voltage pulses would be generated. This would result in no cathode tube

beam current. The automatic beam cut-off feature is not provided by either the 60 cycle or RF supplies.

The mechanical servicing problems outlined for the RF supply will also apply to the pulse-type supply. The autotransformer is pie wound with litz wire and subject to corona damage as is the RF transformer. The same precautions hold for the filament winding of the rectifier in the pulse-supply as were pointed out before in discussing the RF supply. In the supply shown in Fig. 8, the filament winding is mounted on the same synthane tube that supports the autotransformer. It will be noted that this winding has a greater number of turns than was required in the RF supply. This is because the energy available in the pulse is less than in a continuous sine wave. More turns must therefore be coupled to the transformer to obtain sufficient power for the filament.

### Voltage Adjustment

The output voltage of the supply is adjusted by setting the grid bias on the pulse amplifier tube. If a regulator circuit is included, the variable bleeder control is adjusted in combination with the pulse amplifier grid bias control for maximum voltage with the best regulation. Optimum regulation is achieved when the picture changes the least amount in size as the brightness control is varied over its full range.

The kickback high voltage supply approaches the ideal for a television receiver. It is by far the most eco-

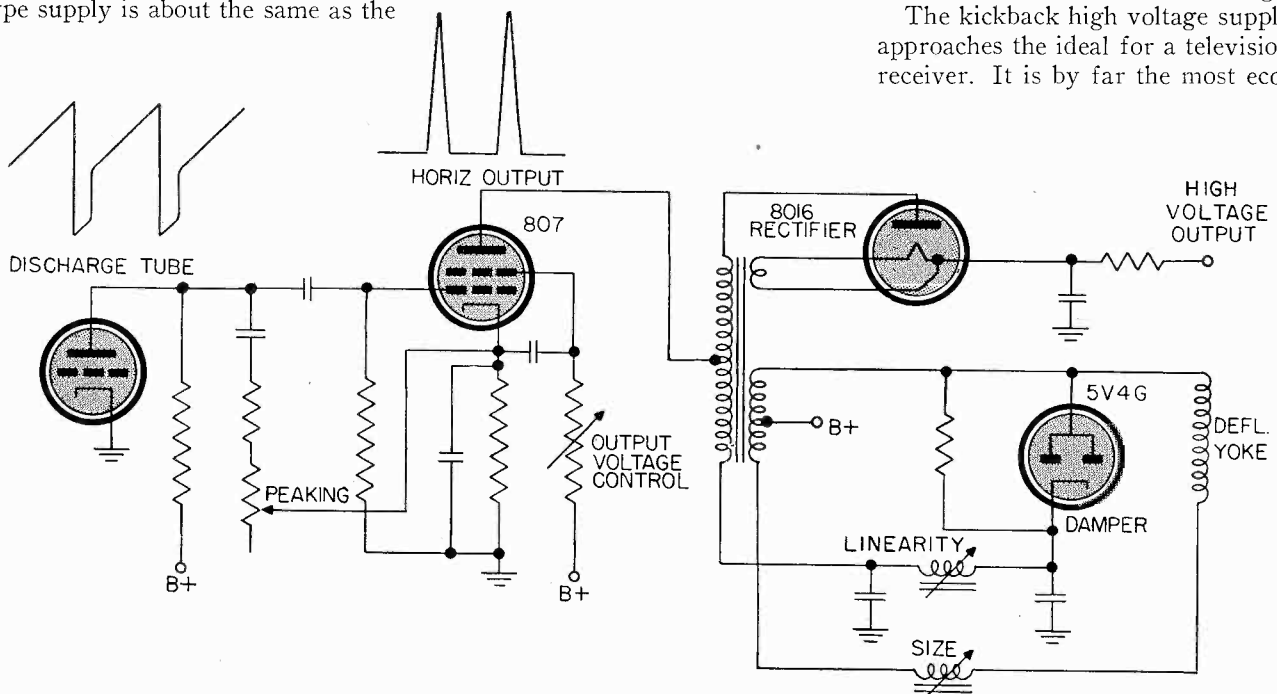

Fig. 9 High voltage kickback supply. The voltage pulse generated in the primary of the horizontal output transformer is stepped up and rectified.



**WANTED SERVICE MEN ALSO  
SERVICE ORGANIZATIONS**

for television sets in all television cities from New York to Los Angeles. Experienced. Apply in writing describing experience in full.

**UNITED STATES TELEVISION  
MFG. CORP.**

**3 West 61st Street,  
New York 23, N. Y.**

nomical from the standpoint of the number of components required as well as the amount of space they occupy on the chassis. To understand the operation of the kickback supply, refer to the horizontal deflection circuit shown in Fig. 9. Because of the rapid flyback of the horizontal saw-voltage on the grid of the deflection amplifier there is a sudden reversal of current in the primary of the output transformer in the plate circuit. This produces an induced pulse of about 5 kv across the primary. These pulses are stepped up further by an autotransformer winding added to the primary. The high voltage pulse is then rectified and filtered in the same manner as outlined in the pulse-type circuit. A loop of wire is also placed on the output transformer to supply power for the 8016 heater.

An output transformer used for operation in a kickback circuit is shown in Fig. 10. This design uses a sponge iron powder core which has lower energy losses than standard laminations at the horizontal frequency. It is thus seen that by adding only an autotransformer and

filament winding to the horizontal output transformer, plus the 8016 rectifier and filter components, a complete high voltage supply is obtained; also a separate oscillator circuit is not necessary.

There are two disadvantages however, to the kickback circuit, the more important being that its regulation is poorer than either the RF or pulse-type supply. The other drawback is the dependence of the high voltage on the setting of the horizontal sweep amplitude. A little experience, however, in adjusting these circuits will soon minimize this drawback. The deflection amplifier screen voltage is first set for maximum high voltage output. The size control choke in the yoke circuit is then varied for correct width of picture. Simultaneously the linearity control is varied. The adjustments on the size and linearity controls may then necessitate the re-setting of the screen voltage. This in turn will affect the picture size and linearity. By varying all three controls in sequence, maximum output voltage with the best linearity and proper picture size will be obtained.

The kickback supply offers some protection to the cathode-ray tube if the horizontal sweep circuit fails before the deflection amplifier. However, if the failure occurs, say, in the yoke circuit, the high voltage will still be generated.

To sum up:

(1) The high frequency power supplies eliminate the bulky and expensive components of the 60 cycle supply as well as the hazard to human life.

(2) The RF and pulse supplies have better regulation than the kickback supplies.

(3) Pulse and kickback supplies do not radiate spurious signals as do RF supplies since their high voltage pulses occur during the horizontal blanking time.

(4) The kickback supply is the cheapest of the three types. Manufacturers will weigh the advantages and disadvantages of each type in determining which design to put in their sets.

Next issue, we will describe the different types of cathode-ray tubes being employed in new television receivers. This discussion will include projection systems. ✓ ✓ ✓

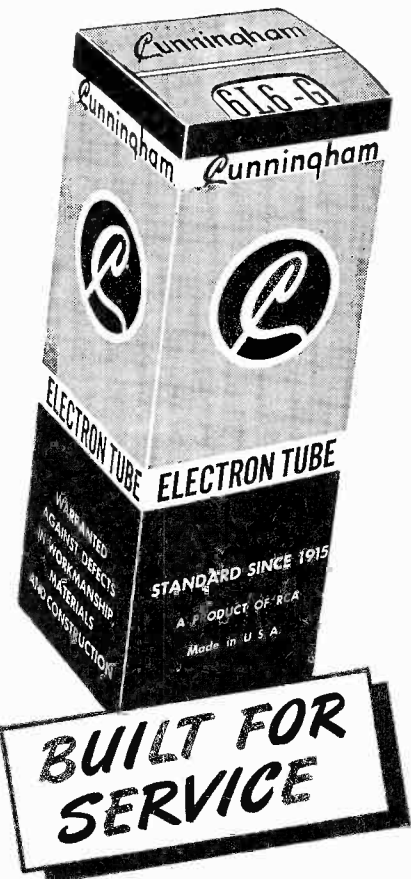

**New Customers —  
for 1 Cent!**



Send these friendly sales messages to your customers and see how they bring in extra radio tube and service business during and after the vacation period.

Printed on regular government postcard stock with your name and address, they cost you only a cent to buy and mail.

Here's an inexpensive way for you to remind your customers that periodic check-ups and new Cunningham tubes will insure top quality radio performance for their receivers. SEE YOUR CUNNINGHAM DISTRIBUTOR FOR DETAILS.

For more sales — TURN THE PAGE →

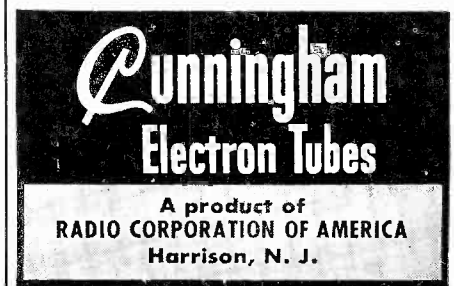

**S.S.S.**

**"Servicing by Signal Substitution"**

Learn about this modern dynamic approach to radio servicing with ONLY BASIC TEST EQUIPMENT.

... Fully described in a 120 page book available from your Precision Distributor or factory at 35¢.

... Schools are invited to inquire regarding quantity orders from our Educational Division.

**PRECISION APPARATUS COMPANY INC.**  
ELMHURST 2, N. Y.

Manufacturers of Fine Test Equipment  
RADIO • TELEVISION • ELECTRICAL • LABORATORY

# new



**free**  
Featuring Outstanding Values in:  
RADIO PARTS • RADIO SETS  
RECORD CHANGERS • PLAYERS  
HAM GEAR • AMPLIFIERS • TESTERS

This is it—the new 1947 Concord Catalog—a vast, complete selection of everything in Radio and Electronics—thousands of items available for IMMEDIATE SHIPMENT from CHICAGO or ATLANTA—hundreds now available for the first time—featuring new, latest 1947 prices. See new LOWER prices on RADIO SETS, PHONO-RADIOS, RECORD CHANGERS, RECORD PLAYERS, PORTABLES, AMPLIFIERS, COMPLETE SOUND SYSTEMS, TESTERS. See latest listings of standard, dependable lines of radio parts and equipment—tubes, condensers, transformers, relays, etc. Write for FREE COPY—NOW! Address Dept. RM-87

TIME PAYMENTS: Write us for details of time payment plan on Communications Receivers, Amplifiers, Test Equipment, Radios, Phono-Radios, etc.

**CONCORD**  
RADIO CORPORATION  
LAFAYETTE RADIO CORPORATION  
CHICAGO 7, ILL. ATLANTA 3, GA.  
201 W. Jackson Blvd. 235 Peachtree St.

**COOL OFF!** with Federated's **HOT** Summer Values

**REPLACEMENT CRYSTAL CARTRIDGE**  
Webster model E-9. Will replace As-tatic type L-40, L-26, L-70 cartridges. Very special value! \$1.39 each

**6-VOLT AUTO RADIO VIBRATOR**  
4-prong standard replacement type—exceptional buy, while present stocks last! each \$1.19

**CRYSTAL MIKE SPECIAL!**  
Here's a HOT value for YOU! High quality crystal mike, for ham work, home recordings, public address, etc. Can be used either as hand mike or desk mike. Hand mike slips out of base with one twist. Handsome brown lacquer finish. Equipped with 7-ft. R.C. cable. All Yours for only . . . \$3.95

**6" ALNICO PM SPEAKER**  
You can't beat this value! Fine quality PM speaker with heavy slug, suitable for general purpose work. Less trans. . . . \$1.49

MAIL ORDERS: 25% Deposit—Balance C.O.D.

Department "M"  
**Federated Purchaser**  
INCORPORATED  
distributors of RADIO-ELECTRONIC and SOUND EQUIPMENT  
80 PARK PLACE, N. Y. 7  
Phone: WH 4-2080

## Servicing FM Receivers

→ From Page 26

limit as 15,000 cycles, the time of one cycle is equal to 67 microseconds. If the bias changes due to a noise pulse, it must recover its normal value in somewhat less than 67 microseconds or it will be heard. To accomplish this, the time constant of  $R_1 C_1$  must not be more than about 10 microseconds, since 5 time constants will be equal to 50 microseconds. Since

$$F = \frac{1}{t}$$

the frequency represented by a

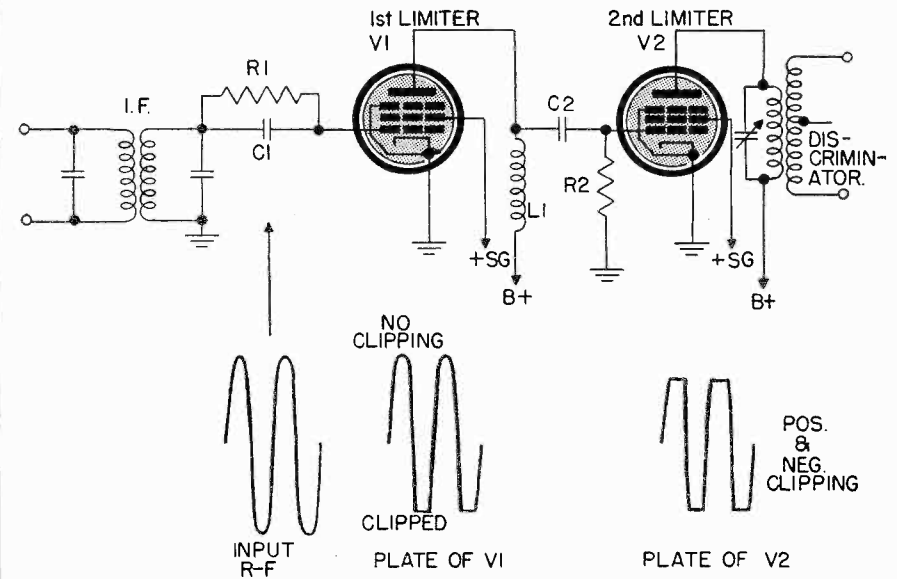

Fig. 7a Simplified schematic of dual limiter and the wave shapes to be expected during reception of an ordinary signal.

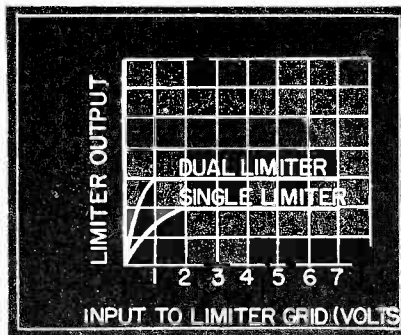

Fig. 7b Characteristics of single and dual limiters.

bias changing at the rate of 50 microseconds will equal

$$F = \frac{1}{50 \text{ us}} = 20,000 \text{ cycles}$$

# LCETI

A system of dual or cascade limiting is sometimes employed to improve the sensitivity of the limiting action. A typical circuit is shown in Fig. 7a, and a comparison of the effectiveness between single and double limiters in Fig. 7b. It will be noted that weak signals will not be limited at the negative part of the input cycle, and as a result the wave shape in the plate shows an unclipped positive wave. This wave is then applied to the second stage

which is above the audible range, which is operating at zero bias, and, therefore, easily saturated. The positive portion of the input is thus clipped, and practically perfect limiting results.

Next month's installment will discuss types of FM detectors, including recent developments not requiring limiters, as well as other special circuits. ✓ ✓ ✓

**A. C. 110-VOLT MOTORS**  
Selsyn Syncro Differential—New in Original Package.  
A Bargain at \$1.75 while they last.  
**LYELL HARDWARE**  
P. O. Box 5, Rochester 11, New York

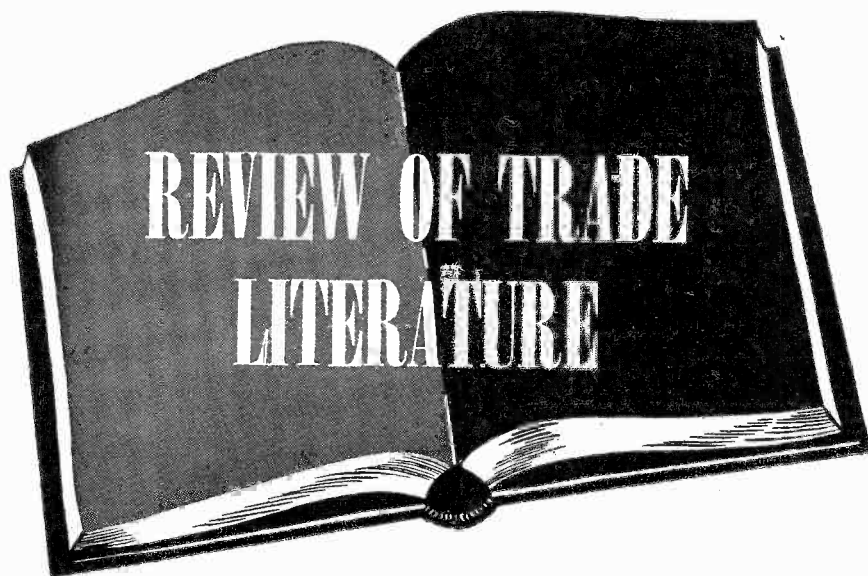

To avoid delay when writing to the manufacturer give issue and page number.

**T**HE General Cement Manufacturing Company announces a new, two-color, eight-page card display and hardware catalog. This catalog lists items by classification groups of products, making it easy to locate the ones desired. About 500 items are listed. The catalog can be obtained free of charge by writing to General Cement Manufacturing Company, 919 Taylor Ave., Rockford, Ill.

The "Radio Repairman's Price Guide" is made available by the Olson Warehouse, Inc. This 60-page booklet contains descriptions, illustrations, and prices of tubes, radio components and PA equipment. Also included is a selection chart for choosing speakers and amplifiers for different types of public address work. To obtain this booklet without charge, write to Olson Warehouse, Inc., 73 East Mill Street, Akron 8, Ohio.

The Tube Department of Radio Corporation of America has just issued a revised edition of the "Quick-Reference Chart on Miniature Tubes." It covers 48 miniature types and features functional classifications, illustrations, charted data, characteristics and socket connection diagrams for each type. A copy of the new chart, Form MNT-30A, may be obtained from RCA tube distributors or by sending request direct to Commercial Engineering, Radio Corporation of America, Harrison, New Jersey.

Now available from Shure Brothers Inc., are two new catalogs, describing phonograph pickups and microphones. Catalog No. 158 describes pickups, pickup cartridges, a cartridge "pack" and types of phono needles. Also included in this catalog are "Facts which you should know about pickups," which are explanations of various terms and factors which have to do with record playing equipment. The other catalog, No. 157, describes many types of microphones and related equipment suitable for P.A. equipment. These catalogs may be obtained from Shure Brothers Inc., 225 West Huron St., Chicago 10, Ill.

#### BOOKS

**National Electrical Code Handbook**, by Arthur L. Abbott, published by The McGraw-Hill Book Co. Price \$4.00.

This handbook, based on the 1946 Code is planned to enable electricians to understand the National Electrical Code and to do work in accordance with it. It gives all the Code requirements, restating involved rules in simple language, plus explanations, practical directions, and diagrams, showing what the rules mean and how to apply them. A special arrangement groups rules, making it easy to find all rules applying to any given job.

**Men and Volts at War**, by John A. Miller, published by The Mc-

→ To Page 38

**BUILT FOR SERVICE**

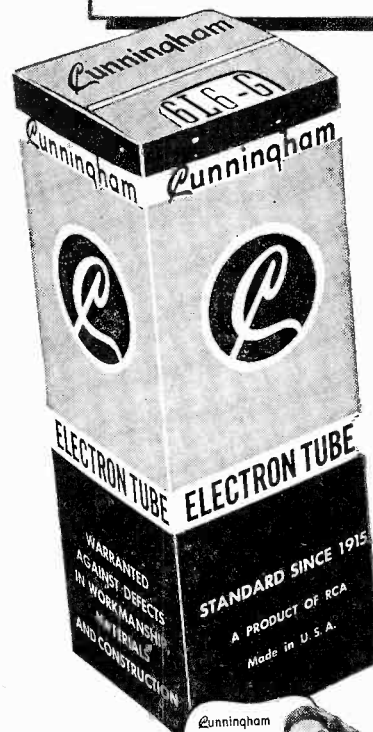

**Sally, the "sit-down girl," sells service**

Meet Sally Service—the Cunningham "sit-down girl"—whose only job in life is to help build more business for you. She's 21" tall, decked out in full color—and posed to sit on the giant illuminated Cunningham tube carton, or wherever else you have a comfortable seat for her in the window or in the shop.

Here's a display that will make your customers definitely conscious of Cunningham tubes and the service you sell. **GET ONE FROM YOUR CUNNINGHAM DISTRIBUTOR TODAY.**

For expert guidance—TURN THE PAGE →

**Cunningham**  
Electron Tubes

A product of  
RADIO CORPORATION OF AMERICA  
Harrison, N. J.





**Cement  
Inspection Lite  
Ne-O-Life Tester  
Hardware**

**G-C INSPECTION LITE**  
Ideal for servicing. Lights up hard-to-see corners. Perfect for repairmen, experimenters, etc. 110-120 volts AC-DC. No. 705—List \$1.50



**GENERAL GO CEMENT**  
The most reliable and longest lasting cement



**G-C Hardware Assortment**  
Complete assortment of necessary hardware items needed in everyday repair work. No. 6603-D—List \$8.00



**G-C RADIO SERVICE CEMENT**  
Best cement for speaker and radio work. Especially suitable for cementing replacement cones and repairing rattling and torn cones. Dependable, water proof, fast-drying. No. 30-2—2 oz. bottle, brush attached—List 50c

**G-C NE-O-LITE TESTER**  
Handy, inexpensive Ne-O-Life Tester that everyone should have for countless uses. Can be used on 60V. A.C. to 500 V. A.C. or D.C. No. 5100—Single tester on card. List . . . 50c

**Write for our catalog!**

**GENERAL CEMENT Mfg. Co., Rockford, Ill., U. S. A.**  
Manufacturers of over 3,000 products  
Sales offices in principal cities

asks for your candid opinion of his set. Married men, who have learned the wifely connotation of this "candid opinion" phrase in connection with a new dress, new hat, or the blonde across the street, will have no trouble in parrying this one; but single fellows must remember that when you criticize the receiver you are also criticizing the judgment of the customer in buying it. Find something good about the receiver. If there are no lows, admire the way the highs come through; if a violin sounds like a cello, admire the bass response; if it has neither highs nor lows, possibly the cabinet has a nice finish!

In conclusion, then, let us resolve to do as little talking as possible. Write out a complete summary of troubles found and corrected on the bill and refer the customer to that when he asks what was the matter. If there is a clerk who serves as a go-between between the serviceman and the customer, this is much easier to do, and such an arrangement has much to recommend it.

When you do talk, avoid these common pitfalls:

Do not allow yourself to be trap-

ped into offering an opinion as to what is the matter with a set without first making a thorough investigation. Even though you guess right, you have cheapened your profession by making it seem easier than it is.

Do not criticize your competitors. This always makes a bad impression.

Do not criticize the customer's set. He will simply think you are trying to conceal your own lack of ability by passing the buck.

Do not try to give the customer a short course in radio theory, such as trying to explain selective fading. You might as well lecture a Hottentot on the fourth dimension.

Above all, do not feel that you have to keep saying something while in the customer's presence. If he wants to talk, let him talk; if he remains silent, you can do the same. Keeping up a nervous line of chatter, no matter how glib it may be, will not add one whit to his opinion of your intelligence or ability. ✓✓✓

#### PHOTOGRAPH CREDITS

Page 6—Upper left—Cinandograph. Amplifier, center—RCA Others—Jensen  
Page 9—Stromberg Carlson  
Page 10—Dumont Labs.  
Page 11—Top — Allen B. Dumont Labs.  
Bottom—Essex Electronics.  
Page 13—Dumont Labs.  
Page 14—Stewart Warner.  
Page 28—Top—Weston Co.  
Bottom—Electronic Labs.

## ANTENNAS!

The Next Issue  
of  
Radio Maintenance  
will include

### FM AND TELEVISION ANTENNAS

Complete, Practical Information About  
All Available Types, Tabulated for Your  
Convenience.

### AUTO ANTENNA INSTALLATION

How to plan auto antenna installations  
for greatest profit and satisfaction.

These and Other Big Features

in September

**RADIO MAINTENANCE**

## JOHN RIDER SAYS ...

### Don't Starve Your Business



Generally speaking, a business must spend money to make money. This does not mean a wanton waste of money, but it does mean recognizing the full requirements of business. No organization can mark time without incurring financial losses—for expenses continue as long as the business is alive. Frugality, at the sacrifice of operating efficiency or of expansion of activity, is not sound business.

If national economics appear uncertain, and definite planning seems almost impossible, new ventures may be unjustified. But, those activities which are sound must be kept vigorous. Any act which tends to reduce income may lead to eventual liquidation, whereas every act which tends to reduce the cost of producing the income paves the way to greater success.

*Built for Service*

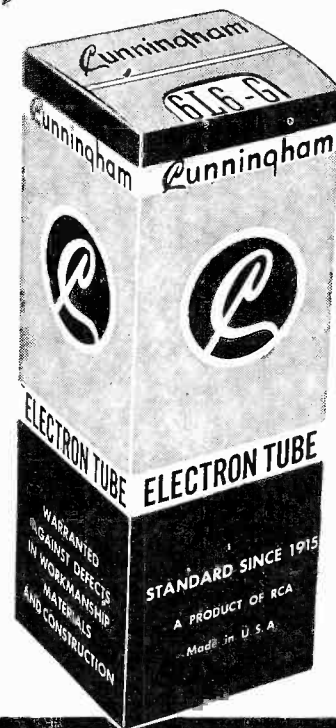

**Cunningham  
Electron Tubes**

A product of  
RADIO CORPORATION OF AMERICA  
Harrison, N. J.

# Speaker

## Matching

→ From Page 9

example used in the beginning of this article. Audio power must be supplied as follows:

Room A	12 watts
Room B	4 watts
Room C	3 watts

Actual total power 19 watts

First assume that we wish to use the 285 ohm output on the amplifier (30 and 500 ohm taps). Place a straight edge on the chart so that it lines up with the origin (point O) and the intersection between the vertical line representing the power to room A (12 watts) and the horizontal line representing the output tap impedance (285 ohms). The straight edge will then lie along line OA. Where this straight edge intersects the 19 watt vertical line, read the line transformer tap from the impedance scale. In this case it is close to 500 ohms. Light lines have been drawn into the chart to show this operation. The same procedure should then be repeated for

each of the other speakers and the line transformer taps similarly derived.

We now have a completed method for connecting speakers to an amplifier in such a way that the amount of power being fed to each speaker can be predetermined within reasonable limits. So far, tables and charts for choosing taps have been discussed. What can be done when tables and charts are not

available? A few simple mathematical calculations make it possible for us to make up our own charts for the amplifier with which we are dealing.

### Calculation Method

Rule up a piece of paper, as shown in Fig. 5, with a column across the top for each of the output transformer impedances available on the amplifier. Mark the

Line Taps	4	8	15	30	250	300
500	0.80	1.60	3.00			
750	0.53	1.07				
1000						
1500						
2000						

Fig. 5 Table showing power output of a 100 watt amplifier when various ratios of amplifier to line transformer taps are used. The text describes how to make these tables.

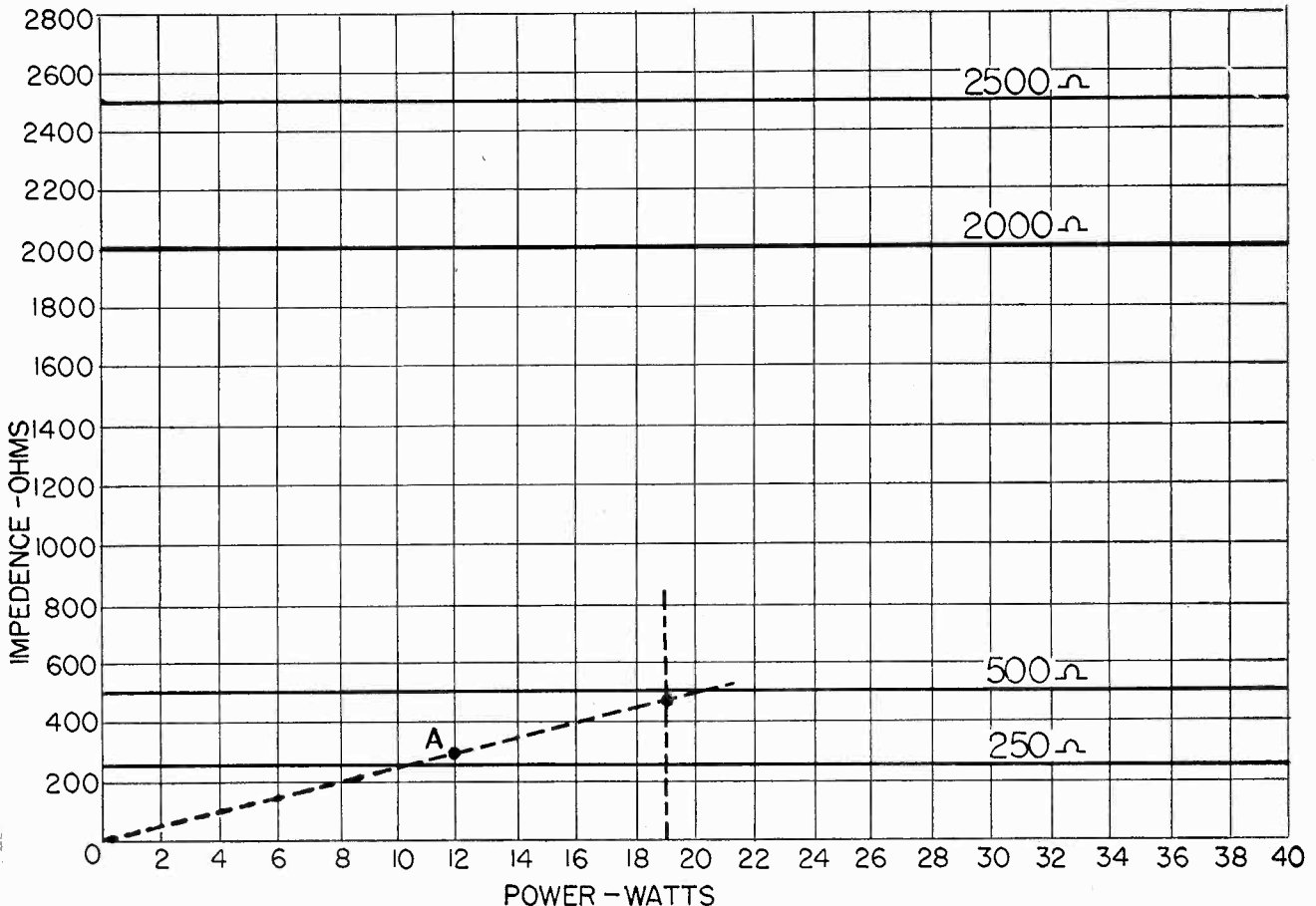

Fig. 6



vertical column on the left with each of the impedances available on the primaries of the line transformers to be used. For our example, we will assume that the rated output of the amplifier is 100 watts. Starting with the 4 ohm output transformer tap and the 500 ohm line transformer tap, calculate the resultant power for each combination, using the following formula.

$$\frac{Z_0}{Z_L} \times \frac{\text{Rated Power at amplifier}}{\text{power speaker}} = \text{Power at speaker}$$

$Z_0$  = Impedance rating of amplifier transformer tap

$Z_L$  = Impedance rating of line transformer tap

$$\frac{4}{500} \times 100 = P$$

$$100 \div 125 = P$$

$$0.8 = P$$

Mark 0.8 on the chart under 4 ohms and next to 500 ohms, and proceed to 4 ohms and 750 ohms. Continue until all combinations of taps have been covered. You now have a chart for a 100 watt amplifier and can make other charts for amplifiers of any rated power output.

### Total Impedance

Next, we must know how to calculate the resultant impedance when a number of lines are connected together. Let's take an example to illustrate the method used. A 1000 ohm line and a 500 ohm line are connected together; the result impedance is

$$\frac{1}{Z_T} = \frac{1}{Z_1} + \frac{1}{Z_2}$$

$$\frac{1}{Z_T} = \frac{1}{500} + \frac{1}{1000}$$

$$\frac{1}{Z_T} = 0.002 + 0.001$$

$$\frac{1}{Z_T} = 0.003$$

$$Z_T = \frac{1}{0.003}$$

$$Z_T = 333 \text{ ohms}$$

→ To Following Page

# SILVER

## AM PLUS FM 90 KC-210 MC

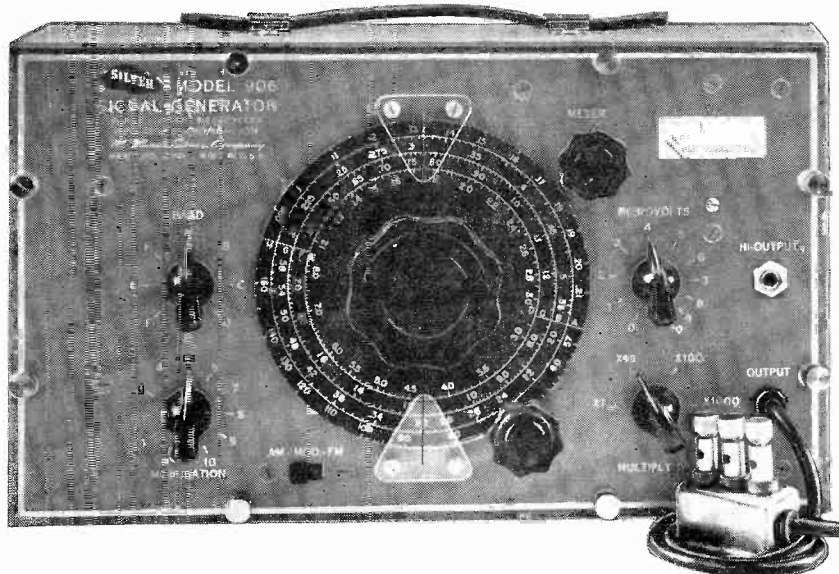

The one word "greatest" best describes new MODEL 906 Signal Generator . . . greatest frequency range of 90 kc. through 170 mc. AM; 90 kc. through 210 mc. FM . . . greatest calibration accuracy of 1% . . . greatest output range — metered and continuously variable from less than 1 microvolt to over 1 volt . . . greatest freedom from strays . . . greatest "buy" in history at only \$89.90 net.

Exactly as the unequalled excellence designed and built into "VOMAX" makes it outstanding the preferred, truly universal v.t.v.m., so SILVER engineering brings you in MODEL 906 a signal generator utterly without equal.

## "VOMAX"

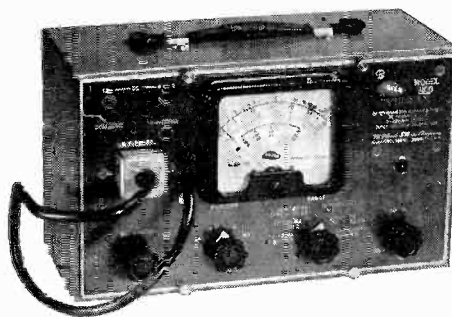

### NEW FLEXIBLE PENCIL R. F. PROBE

For two years "VOMAX" has stood head and shoulders above all other meters for a.c., a.f., i.f., r.f. and d.c. voltage range . . . unequalled current and resistance ranges . . . laboratory accuracy . . . high meter input resistance . . . for real value.

Now "VOMAX" is equipped with a new, pencil-thin r.f. probe extension 5" long plus companion grounding clip and lead. With it you can reach any point in the "tightest" midget receiver chassis . . . you can bend the probe around corners if you have to! This exclusive new SILVER

development maintains "VOMAX" as the finest, most complete meter you can buy . . . still for only \$59.85 net. Present "VOMAX" users can get the new flexible pencil probe kit for 35c from their jobber.

**NEW 16-PAGE CATALOG.** Mail a penny post-card for complete data on these and other new SILVER products . . . famous "SPARX" visual and aural signal tracer, laboratory condenser/resistor tester, new amateur xtal-controlled all-band exciter, 80 thru 6 meter 40-watt pre-tuned frequency multiplier, transmitters, receivers, etc.

OVER 36 YEARS OF RADIO ENGINEERING ACHIEVEMENT

*McMurdo Silver Co., Inc.*

1240 MAIN ST. HARTFORD 3 CONNECTICUT

LOOK  
*to*  
WARD

Ward FM antennas stand head and shoulders above the field for value. Available in straight or folded dipole types (with or without reflector kit), they adapt easily to varying individual requirements. Providing the maximum electrical efficiency needed for finest FM reception, they are easy to install securely. Their trouble-free operation assures you extra profits. Write for free catalog today.

WARD

EXPORT DEPARTMENT: C. W. Brandes, Manager, 4900 Euclid Ave., Cleveland 3, Ohio  
IN CANADA: Atlas Radio Corp., 560 King Street W., Toronto 1, Ontario, Canada



for  
OUTSTANDING  
FM  
*Antennas*

THE WARD PRODUCTS CORPORATION  
1523 EAST 45th STREET, CLEVELAND 3, OHIO

*Aerials*

→ From Preceding Page

In the above formula  $Z_T$  is the resulting impedance;  $Z_1$  is the impedance of one line;  $Z_2$  is the impedance of the other line. If more than two lines are used, they are added to the formula after  $Z_2$  as follows:

$$\frac{1}{Z_T} = \frac{1}{Z_1} + \frac{1}{Z_2} + \frac{1}{Z_3}, \text{ etc.}$$

#### Combination of Taps

The third and last formula required is the one used to determine the impedance which can be obtained by using two of the intermediate taps on an output transformer. The formula used is

$$Z = (\sqrt{Z_{II}} - \sqrt{Z_{I}})^2$$

As an example, let's take our original case where we used the 30 ohm and the 500 ohm taps

$$Z = (500 - 30)^2$$

$$Z = (22.36 - 5.48)^2$$

$$Z = 284.93$$

For our purposes, 285 is near enough. ✓✓✓

#### Trade Literature

→ From Page 33

Graw-Hill Book Co. Price \$3.75.

This book describes the work of General Electric in World War II. Starting in the first chapter with the theme "It Was An Electric War" Mr. Miller describes the mobilization of the skill and experience of G.E.'s more than 175,000 workers during the conflict.

It is generously illustrated with photographs of ships, tanks, guns, and many other types of equipment. Of particular interest to the serviceman is Chapter XIV, *Radio for Combat Communications*.

#### Test Equipment Maintenance

→ From Page 28

smoothed with a small file, hone, or crocus cloth if the pitted surfaces are not too deep and the tungsten facings have not been worn through by previous filings or softened by overheating. Vibrators with badly burned or pitted points should be replaced.

A new vibrator should not be installed until the buffer condensers

For Faster Soldering

WELLER

5-SECOND HEATING

Ready to solder in 5 seconds.

LESS TIP RETINNING

Heats only when needed.

FAST COOLING

Ideal for service calls.

SOLDERING GUN

100 Watts  
115 Volts  
60 Cycles



• You get fast, dependable soldering heat because the Weller Soldering Gun operates on a new principle. A specially engineered built-in transformer of light weight produces soldering heat in the loop tip. See your radio parts distributor or write for bulletin.

WELLER MFG. CO. 812 Packer St., Easton, Pa.

In Canada: Atlas Radio Corp., Ltd., 560 King St., N. W., Toronto, Ont.  
Export Dept.: 25 Warren St., New York 7, N. Y.

have been thoroughly checked and replaced if necessary with high-voltage (at least 1600 working volts) oil-filled units. Premature erosion of contact facings is due either to continuous overload, or (as in most cases) to open, shorted or leaky buffer condensers. An intermittent leak or shorted condition load is often found in condensers which will give satisfactory readings on ordinary condenser testers. Questionable buffer condensers should be double-checked.

A no-start condition may be noted in non-hermetically sealed vibrators exposed to extreme humidity, particularly if the vibrator is seldom used. A tungsten-oxide film appears on the contact surfaces. This may be removed in a few moments by connecting the vibrator as shown in Fig. 4. The AC voltage provides accelerated wiping action which quickly removes the film.

Spacing may be adjusted while the vibrator is in operation with the aid of a 110-volt two-watt neon bulb. The bulb is turned on and placed so that the vibrator points may be seen between its light and the operator. A stroboscope effect is thus obtained which makes the points appear motionless and simplifies adjustment.

### Generators, Motors

Common failures in small motors, generators and dynamotors used in mobile power supplies are (1) worn or dirty brushes, (2) dirty armature and commutator surfaces, (3) high mica, (4) worn, loose, or sticking bearings, (5) flat or warped shaft, and (6) open or shorted armature or field coils.

Dirty brushes should be removed, inspected and cleaned with carbon tetrachloride; worn brushes should be reconditioned by "seating" or smoothing the contact surfaces with fine sandpaper wrapped around a rod or stick the same diameter as the armature. Brushes which have become soft or worn should be replaced; brush springs should be checked for tension and contact pressure increased by stretching if necessary.

The armature should be cleaned with carbon tetrachloride and checked for oxidization, high mica, and scored segments. "High mica" is a condition in which the thin strips of mica insulating each copper segment protrude above the surface

## MASCO Brings You NEW BUSINESS on a SILVER PLATTER



**MASCO'S De Luxe Portable 16 in. Transcription Player with Built-in 5 Watt Amplifier Enjoys a Ready-Made Market**

Recording studios, broadcasting stations, schools, theatrical and advertising agencies and others who "sell" professional and radio entertainment are natural customers for Masco's De Luxe 16 in. Professional Transcription Player.

"One of the finest portable transcription players ever made," state outstanding factors in the industry who tested it.

List Price with tubes \$134.50  
West of Rockies add 5%

Contact your local Masco distributor for immediate delivery. For descriptive literature or other information write directly to factory, Dept.

### It has everything required:

- Built-in high fidelity amplifier of wide range frequency response.
- Heavy duty 10" P.M. Alnico V magnet speaker.
- Speaker mounted in removable cover of portable case which serves as an excellent baffle.
- Plays 16" and standard recordings 12" turntable.
- Operates at either 78 or 33 1/3 rpm.
- Master gain control.
- New low pressure high fidelity astatic Q-T-M cartridge in No. 400 arm.
- Two input channels, for microphone and phonograph.
- Individual bass and treble equalizers, allowing for accurate tonal settings.

# MASCO

**MARK SIMPSON MANUFACTURING CO., Inc.**  
32-28 49th Street, Long Island City 3, N.Y.

**SOUND SYSTEMS and Accessories**

RAvenswood 8-5810-1-2-3-4

of the segment and prevent its normal contact with the brushes. The excessive mica should be "undercut" or trimmed with a sharp knife or razor blade until its top edges are slightly below the commutator surface (See Fig. 5). Care must be used to prevent damage to the armature coil leads.

Oxidized armature surfaces may be cleaned by holding a piece of crocus cloth or fine sandpaper (glued to a small flat stick) against the armature surface as the shaft is rotated. A fine, even polish should be obtained.

Such detailed work as the turning of scored armatures, replacement of

worn bearings, truing of warped or flat shafts, and rewinding of armature or field coils usually requires a lathe and other equipment not often found in the radio repair shop. An electrical or automotive repair shop specializing in motor repairs should be consulted for this work.

After a motor or generator has been overhauled or cleaned, the bearings should be lubricated with oil of the proper density (as recommended by the manufacturer) and checked for end play. An excessive amount may be corrected by adding one or more fiber washers of the proper thickness at one or both ends

# RIDER Radio Publications

Builders of Successful Servicing

**YOU HAVE TO KEEP UP-TO-DATE  
IF YOU WANT TO KEEP AHEAD**

New fields of activity and profit are constantly being opened to radio men who are equipped with the knowledge to take advantage of the opportunities.

## RIDER CLASSICS

The Meter at Work . . .	\$2.00
The Oscillator at Work . . .	2.50
Vacuum Tube Voltmeters . . .	2.50
Automatic Frequency Control Systems . . .	1.75
A-C Calculation Charts . . .	7.50
The Cathode Ray Tube at Work . . .	4.00
Frequency Modulation . . .	2.00
Servicing by Signal Tracing . . .	4.00

**ORDER TODAY!**

By The Publisher  
of  
**RIDER MANUALS**

**JOHN F. RIDER PUBLISHER, INC.**  
404 FOURTH AVENUE, NEW YORK 16, N.Y.

## THREE OF RIDER'S LATEST!

### "Inside The Vacuum Tube"

Theory and operation of basic types of tubes \$4.50

### "Understanding Microwaves"

Foundation for understanding developments \$6.00

### "Radar"

Explains fundamentals \$1.00

Hour-A-Day-with-Rider Series—

- On "Alternating Currents in Radio Receivers"
- On "Resonance & Alignment"
- On "Automatic Volume Control"
- On "D-C Voltage Distribution" 1.25 each

structured with a small shell 7-pin duodecal base, the 10FP4 has an overall length of 18" and a maximum deflecting angle of 50°. Under typical operating conditions, the focusing coil current, DC, requires about 100 ma.

Further information on the new aluminum backed 10FP4 may be obtained from the Tube Division, General Electric Electronics Department, Schenectady, N. Y.

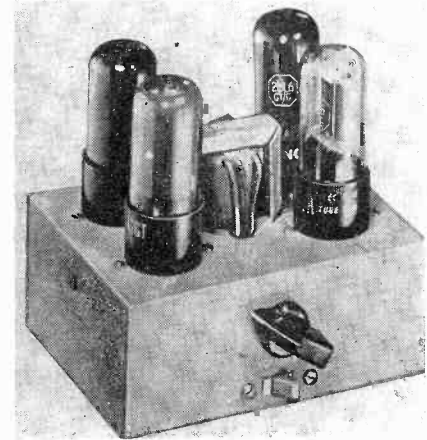

## PHONO AMPLIFIER

A new 4-watt phono amplifier, manufactured by Allied Radio, is specifically for record playing purposes. It has an inverse feedback circuit for wide frequency response and four watts of output which easily provide the drive necessary for an 8" or 10" speaker. It operates with any high impedance crystal pickup and 110 volt phono motor. The amplifier is small, measuring only 4" wide, 5 1/4" long, and 4 3/4" high, with tubes inserted, and thus can be combined with a speaker and turntable in a small cabinet as a complete record player. For complete information, write to Allied Radio Corporation, 833 West Jackson Blvd., Chicago 7, Ill.

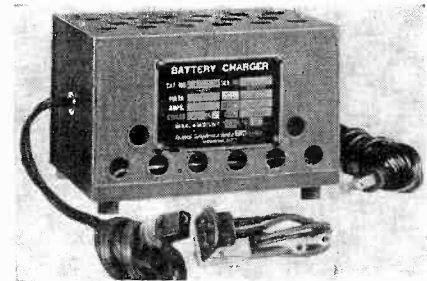

## BATTERY CHARGER

FTR 1342-AS is a small compact selenium rectifier 6 1/2" long, 4" wide, and 4 1/2" high, designed for charging any 6-volt lead-acid battery, at 6-3 amperes, from any 115-volt, 60 cycle, AC outlet. As a DC power supply, it is rated at 6 volts, 2 amperes. It is manufactured by Federal Telephone and Radio Corporation, Clifton, N. J.

## MINIATURE OUTPUT TUBE

The new Hytron miniature version of the 6K6GT, the 6AR5, is particularly desirable for use in low- and medium-priced automobile and home AC receivers because of its low heater power and low plate current drain. The lower heat dissipation makes the 6AR5 an especially good choice for compact equipment. Further details may be obtained from Hytron Radio and Electronics Corporation, 76 Lafayette St., Salem, Mass.

of the shaft. To correct end play, washers must be placed so that the commutator is not pulled out of alignment with the brushes.

The same type of care and maintenance as outlined should be extended to batteries, tools, and miscellaneous shop equipment. Instruments in good operating condition are a definite asset to the serviceman—it is up to him to keep them that way!

## Industry Presents

→ From Page 24

## FREQUENCY RECORD

The Universal Microphone Company's D61A frequency record is used for direct checking of the response characteristics of phonograph pick-ups and complete lateral disc recording and reproducing systems. It is also used for indirect checking of the response characteristics of recording heads, loud speakers, loud speaker installations, theater sound equipment, public address sound equipment, and almost any component of audio frequency equipment. It is a 12-inch recording at 78 rpm, pressed from flexible, unbreakable Vinylite, and recorded in three parts. The first section gives a continuously rising tone of 50 to 10,000 cps. Frequencies are voice announced in 15 "breaks." The second section consists of a 1000 cycle tone recorded

in steps of 2 db from plus 8 to plus 18. The final section provides a 400 cycle tone recorded at plus 18 db, with zero reference established at an arbitrary level.

Additional information on the D61A Constant Velocity Frequency Record may be obtained from the Universal Microphone Company, Inglewood 2, California.



## TELEVISION TUBE

G-E has a new 10" cathode-ray electronic tube, Type 10FP4, for television receivers. Employing magnetic focusing and deflecting, the tube is designed with an aluminum backed, direct-view screen. In addition to increasing the clarity, brilliance and definition of the image, this aluminum backing prevents the development of ion spots and intercepts cathode glow. Maximum ratings of the 10FP4 include an anode voltage of 10,000 volts; grid No. 2, accelerating electrode, voltage of 410 volts; grid No. 1, control electrode, of minus 125 volts. Con-



**FOR** { **MUCH FASTER**  
**STILL BETTER** **SERVICING . . .**  
**MORE-MONEY**

**it must be one of these three**

**DU MONT**

*Oscilloscopes*

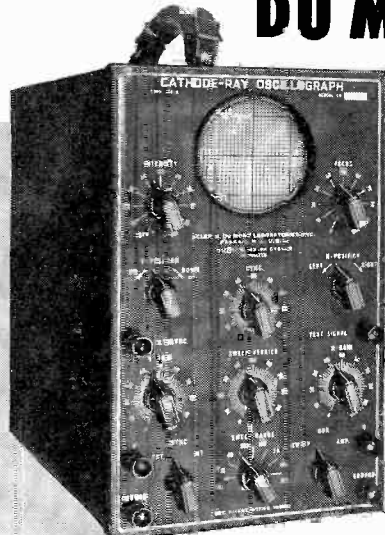

*If it's **Portability** you want first . . .*

**Type 164-E** ▶ The mighty portable cathode-ray oscillograph. Only 20 pounds. For work in and out of the shop. A superb instrument of laboratory quality. There's no service job it can't perform. Housed in steel cabinet. Du Mont 3-inch cathode-ray tube. Sweep circuit of unusually wide range. Consumes minimum power. Dimensions: 11 3/8" h. x 7 3/8" w. x 14" d.

*If it's **Bigger Patterns** you want first . . .*

**Type 274** ▶ Similar electrically to Type 164-E but designed for those who prefer the Du Mont 5-inch tube with clear, brilliant traces of larger size. Inexpensive. Highest quality. The five-inch tube permits the blowing up of even the most detailed waveforms. Weighs 35 lbs. Dimensions: 14" h. x 8 3/8" w. x 19 1/2" d.

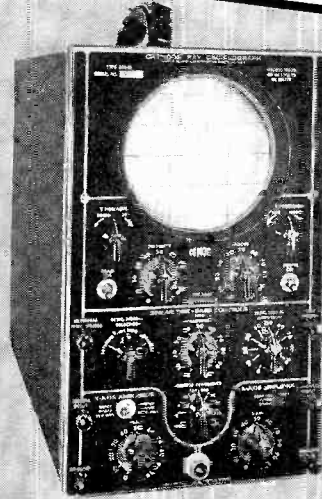
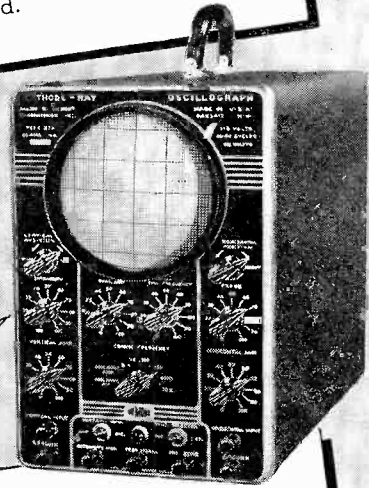

*If it's the **Post-Graduate** features you want first . . .*

**Type 208-B** ▶ Here's the exact same instrument you'll find in leading laboratories everywhere. Moderately priced yet amazingly versatile. Certainly the "class" in the service instrument field. With its Du Mont 5-inch intensifier tube operating at 1400 volts, this instrument is excellent for permanent shcp installation. As an extra-quality instrument, it has all the features of the 164-E and 274, plus many more. Outstanding are the wide-band amplifiers and the extreme sensitivity. Weight: 54 lbs. Dimensions: 14 1/2" h. x 8 3/8" w. x 20 1/4" d.

▶ **Make your selection from these three superb instruments. Descriptive literature on request.**

© ALLEN B. DU MONT LABORATORIES, INC., PASSAIC, N. J.

**DU MONT** *Precision Electronics & Television*

ALLEN B. DUMONT LABORATORIES, INC., PASSAIC, NEW JERSEY • CABLE ADDRESS: ALBEEDU, PASSAIC, N. J., U. S. A.





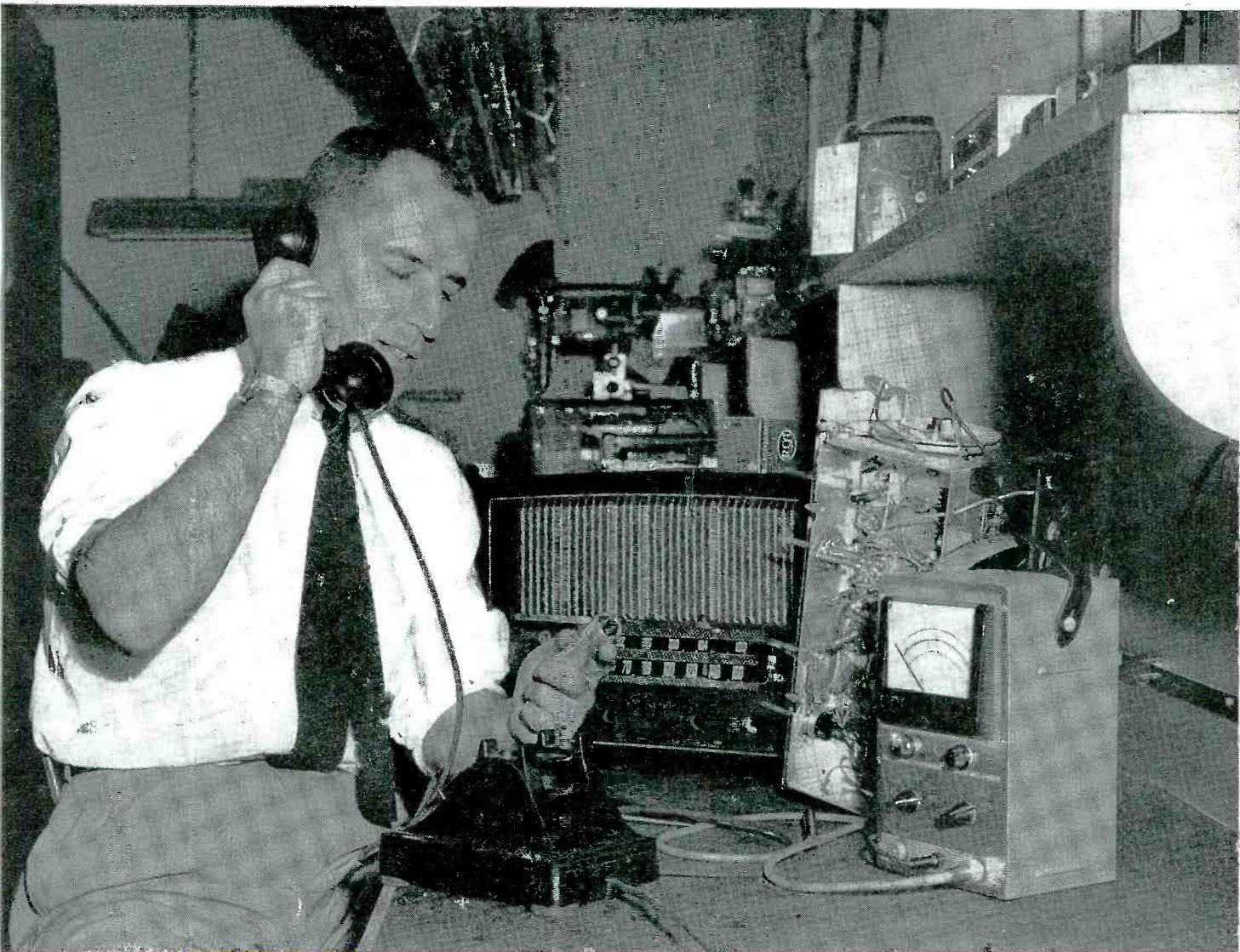

**The  
Quick  
Way**

**The  
Economical  
Way**

We'll supply you with *what you want when you want it . . .*  
No waiting . . . prompt service at all times for the busy serviceman!  
There are always times in the best stocked shop when a part is  
not on hand and is needed immediately . . . that's when we can  
save the situation! Only the best lines of products are sent to you.  
Give us a call, drop us a line or stop in today and say you saw  
this ad in Radio Maintenance. We'll give you the best, the fastest  
and most economical results!

**HOLUB AND HOGG**

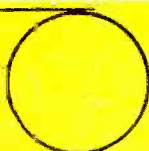

500 Reading Road  
Cincinnati 2, Ohio  
Parkway 3617

Wholesale

Radio and Electronic Components

P. A. Equipment