

HOW ELECTRONICS OUTSEES THE TELESCOPE

Science and Electronics

APRIL-MAY

75c

WHITE'S RADIO LOG

- TV Stations
- Worldwide SW
- Police/Emergency

formerly
Radio-TV EXPERIMENTER

LOAD LOOP METAL LOCATOR

Most sensitive ore finder we've ever published!

Science Fair Extra

WINDY the WHIRLER

Ingenious wind-speed indicator puts you one up on the weatherman

see page 29

DUO-LITE Q-CHECKER

Two lights keep you out of the dark by revealing a transistor's all

NEOPHYTE'S 2-METER CONVERTOR

Easy-to-build accessory tunes hams, MARS, CD nets on any BCB set



Beginning an all-new series: **FAMOUS MEN OF SCIENCE.**

Dazzle your friends with lightworks.



Sound n' Color®

The new dimension to music pleasure. EICO All Electronic Solid-State Audio-Color Organ's transform sound waves into moving synchronized color images. Connect easily to speaker leads of hi-fi or radio. From \$29.95



Translators

The electronics you need to create audio-stimulated light displays to your own imagination. Actuators, Light Display Units, Strobe Lites, any lamp configuration (Xmas trees, patio lights, etc.). From \$24.95 kit, \$39.95 wired.



Strobe Lites

High-intensity bursts of white light from Xenon tube flash in accordance with each beat of audio. From \$24.95 kit, \$39.95 wired.

Build the Stereo Kits praised by experts.

All amplifier power ratings according to IIF standards. Corina® designed and manufactured in U.S.A. and guaranteed by EICO.



70-Watt AM-FM Stereo Receiver including cabinet. Corina 3770. \$189.95 kit, \$279.95 wired.

70-Watt FM Stereo Receiver including cabinet. Corina 3570. \$169.95 kit, \$259.95 wired.



150-Watt Solid-State Stereo Amplifier including cabinet. For the audio perfectionist. Corina 3150. \$149.95 kit, \$225 wired.

70-Watt Solid-State Stereo Amplifier including cabinet. Corina 3070. \$99.95 kit, \$139.95 wired.

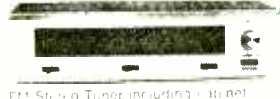

FM Stereo Tuner including cabinet. Corina 3000. \$79.95 kit, \$119.95 wired.



EICO Walkie-Talkie, MIKE \$9.95

Build for fun and use with Eicocraft jiffy project kits.

The newest excitement in kits. 100% solid-state and professional expandable, interconnectable. Excellent as introductions to electronics. No technical experience needed. Finest parts, pre-drilled etched printed circuit boards, step-by-step instructions. 26 kits to select from, \$2.50 to \$9.95. Just released: EC 2600 Super Snop \$8.95, EC-2700 Police & Fire Converter



(15 band) \$7.95, EC 2800 Aircraft Converter \$7.95, EC 2900 Police & Fire Converter (15 band) \$7.95, EC-3100 3-Station Int.-room (with tapes) \$10.95, EC 3200 Do-It-Yourself PC Etching Kit \$4.95, EC 2300 Audio Preamplifier \$8.95, EC-2400 Bullhorn \$8.95, EC 2500 Fuzzbox \$8.95.



EC 1404 TREASURE FINDER \$9.95

Shape up your own car/boat with EICO Engine Analyzer

For all 6V/12V systems, 4, 6, 8-cyl. engines. Now you can keep your car or boat engine in tip-top shape with this solid state, portable, self-powered on-zeal-it engine analyzer.

Completely tests your total ignition/electrical system. Complete with comprehensive Tune-Up & Trouble-shooting Manual. EICO #898. \$49.95 kit, \$69.95 wired.



The first and only solid state test equipment GUARANTEED FOR 5 YEARS

Only EICO binary systems liberally priced at \$14.95 kit at lowest cost.



EICO 240 Solid-State FET-TVOM \$59.95 kit, \$79.95 wired



EICO 379 Solid-State Sine Square Wave Generator \$69.95 kit, \$94.50 wired



EICO 242 Solid-State Deluxe FET-TVOM \$69.95 kit, \$94.50 wired

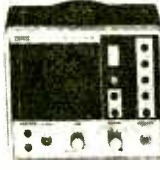

EICO 150 Solid-State Signal Tracer \$49.95 kit, \$69.95 wired



EICO 330 Solid-State RF Signal Generator \$59.95 kit, \$84.50 wired

You save up to 50% with EICO Kits. Since 1945, Best Buys in Electronics, Over 3 Million EICO Instruments Now in Use.

FREE 1970 CATALOG

Send me FREE catalog describing the full EICO line of 200 best buys and name of nearest dealer.

SE-4



EICO Electronic Instrument Co., Inc.
283 Malta Street, Brooklyn, N.Y. 11207
EICO Canada Ltd.
20 Millwick Drive, Weston, Ontario

Name

Address

City

State

Zip

Cast your ballot for a successful future!

266 ICS COURSES



You get the widest choice from ICS — oldest, largest home study school. Check the list. (Also available, programs tailored to your special needs.) You receive individual instruction, plus success-proved facts

and theory you can apply immediately. Mastery of subject is assured. No skimping. You earn your diploma.

Why mark time when you can mark the coupon and get a fast, sure fix on your best course to success.



ACCOUNTING
Accounting (U.S.A.)
Accounting (Canadian)
Accounting for Business Programmers
Accounting for Man'g'm't Decisions
Auditing
Business Law (U.S.A.)
Canadian Business Courses
Cost Accounting
CPA Review (U.S.A.)
General Accounting
Income Tax (U.S.A.)
Industrial Accounting
Junior Accounting
Office Accounting
Practical Accounting
Public Accounting
Small Business Accounting (U.S.A.)
Starting and Managing a Small Bookkeeping Service (U.S.A.)

ARCHITECTURE AND BUILDING
Architectural Drawing and Designing
Architecture
Building Contractor
Building Estimator
Building Inspector
Building Maintenance
Carpenter-Building
Carpentry and Millwork
Fundamentals of Urban Planning
House Planning and Interior Design
Mason
Painting Contractor
Reading Arch. Blueprints
Review in Architectural Design and Practice
Review of Mechanical Systems in Buildings

ART
Amateur Artist
Commercial Art
Commercial Cartooning
Illustrating with Options: —Magazine —Advertising Layout and Illustration
Interior Decorating
Oil Painting for Pressure Show Card and Sign Prod.
Show Card Writing
Sign Painting & Designing
Sketching and Painting
AUTOMOTIVE
Automatic Trans. Spec.

Automobile Air Conditioning Specialist
Automobile Body Rebuilding & Refinishing
Automobile Engine Tune-Up
Automobile Mechanic
Automobile Technician
Diesel-Gas Motor Vehicle Engines

BUSINESS
Advertising
Business Administration
Business Practice (Cond.)
Canadian Business Course
Condensed Marketing
Direct Mail and Mail Order Advertising
Industrial Psychology
Inventory Control
Magazine & Newspaper Advertising
Managing a Retail Business
Managing a Small Store
Marketing Management
Marketing Research
Modern Exec. Management
Office Automation
Office Management
Production Management
Purchasing Agent
Retail & Local Advertising
Retail Bus. Management
Retail Merchandising
Retail Selling
Systems and Procedures Analysis

BUSINESS: SALES
Creative Salesmanship
Real Estate Salesmanship
Salesmanship
Sales Management

BUSINESS: SUPERVISION
Basic Supervision
Industrial Foremanship
Industrial Supervision
Management, Salesmanship and Sales
Modern Woman as a Supervisor
Personality Development
Personnel-Labor Relations (U.S.A.)

SUPERVISION
CHEMICAL
Analytical Chemistry
Chemical Engineering
Chemical Laboratory Tech.
Chemical Process Equip. Design & Operation

Chemical Process Operator
Elements of Nuclear Energy
General Chemistry
Instrumental Laboratory Analysis

CIVIL ENGINEERING
Civil Engineering
Construction Eng'r'g Tech.
Highway Engineering Tech.
Principles of Surveying
Reading Highway Bl'p'ts
Reading Structural Blueprints
Sanitary Engineering Tech.
Sewage Plant Operator
Structural Eng'r'g Tech.
Surveying and Mapping
Water Works Operator

COLLEGE COURSES
American History
Calculus Economics

COMPUTERS
COBOL Programming
FORTRAN Programming for Engineers
Programming for Digital Computers
Programming the IBM 401 Computer
Programming the IBM System/360 Computer, Introduction

DRAFTING
Aircraft Drafting
Architectural Drafting
Design Drafting
Drafting Technology
Electrical Drafting
Electrical Eng'r'g Drafting
Electronic Drafting
Introductory Mech. Draft.
Mechanical Drafting
Pressure-Vessel and Tank Print Reading
Sheet Metal Layout for Air Conditioning
Structural Drafting

ELECTRICAL
Electrical Engineering —Electronics Option —Power Option
Electrical Appliance Ser. with Equipment Training
Electrical Contractor
Electrical Engineering Tech.
Electrical Home Maint. with Equipment Training

APPROVED FOR VETERANS

Accredited member, National Home Study Council.
Convenient payment plan.
Special rates to members U.S. Armed Forces

Electrical Instrument Tech.
Electric Motor Repairman
Industrial Electrical Tech. Power-Line Design and Construction
Power Plant Operator —Hydro Option —Steam Option

Practical Electrician
Practical Electrician with Equipment Training
Practical Lineman
Reading Elec. Blueprints
ENGINEERING (Refresher Courses for Graduate Engineers)
Chemical Civil Electrical Industrial Mechanical Sanitary Structural

ENGLISH AND WRITING
Better Business Writing
English for Spanish (U.S.A.)
Free Lance Writing for Fun and Profit
Introductory Tech. Writing
Modern Letter Writing
Practical English
Short Story Writing

HIGH SCHOOL
High School Business
High School (Canadian)
High School General
High School Mathematics
High School Secretarial
High School Vocational
High School College Preparatory—Arts
High School College Prep—Engineering and Science
Preparatory Course for High School Equivalency Test

MACHINE SHOP PRACTICE
Grinder Operator
Industrial Metallurgy
Lathe Operator

Machine Shop Inspection
Machine Shop Practice
Metallurgical Eng'r'g Tech.
Multicraft Maintenance Mechanic
Practical Millwrighting
Reading Shop Prints
Rigging
Tool & Die Making
Tool Engineering Tech.
Welding Engineering Tech.
Welding Process

MATHEMATICS
Advanced Mathematics
Math and Mechanics for Engineering Technicians
Math and Physics for Engineering Technicians

MECHANICAL
Mechanical Engineering
Aircraft and Power Plant Mechanic
Hydraulic and Pneumatic Power
Industrial Engineering
Industrial Eng'r'g Tech.
Industrial Instrumentation
Machine Design
Quality Control
Safety Engineering Tech.
Tool Design
Vibration Analysis and Control

PETROLEUM
Natural Gas Production and Transmission
Oil Well Technology
Petroleum Production
Petroleum Production Engineering Technology
Petroleum Refinery Oper.

PLASTICS
Design of Plastic Products
Plastics Technician
PLUMBING, HEATING AND AIR CONDITIONING
Air Conditioning
Air Conditioning Maint.
Domestic Heating with Gas and Oil
Heating
Heating & Air Conditioning with Drawing
Industrial Air Conditioning
Pipe Fitting
Plumbing and Heating
Plumbing & Heating Est.
Practical Plumbing
Refrigeration and Air Conditioning Servicing

PULP AND PAPER
Paper Machine Operator
Paper Making Pulp Making Pulp & Paper Eng'r'g Tech.

SECRETARIAL
Clerk-Typist Commercial Secretary, Engineering Sec'y, Legal Sec'y, Medical Secretary, Professional Shorthand Stenographic Typewriting

STEAM AND DIESEL POWER
Boiler Inspector
Industrial Building Eng'r
Power Plant Engineering
Stationary Diesel Engines
Stationary Fireman
Stationary Steam Eng'r'g

TEXTILES
Carding
Carding and Spinning
Dyeing and Finishing
Loom Fixing Spinning
Textile Mill Supervision
Textile Technology
Warping and Weaving

TRAFFIC
Motor Traffic Management
Traffic Management

TV-RADIO-ELECTRONICS
Color Television Principles and Servicing
Electronics Instrumentation and Servo Fundamentals
Electronics Technician
First Class Radio Telephone License
Fundamentals of Electronic Computers
General Electronics
General Electronics with Equipment Training
Hi-Fi Stereo and Sound System Servicing
Industrial Electronics Tech.
Numerical Control
Electronics & Maint.
Practical Telephony
Principles of Semiconductor Radio & TV Servicing
Radio & TV Servicing with Equipment Training
Second Class Radio Telephone License
Sound Systems Specialist
Telephony, Electronics, and Radio Communications

ICS
International Correspondence Schools
Division of Intext

ICS, Scranton, Pa. 18515
Canadian residents use this address for service from ICS Canadian, Ltd. in Hawaii: P.O. Box 418, Honolulu.

TAKE YOUR FIRST STEP... MAIL THIS COUPON TODAY—ICS, SCRANTON, PA. 18515. N4883B

I'm interested in a program of independent study. Send me, without cost, your booklet on the principles of success, sample text demonstrating famous ICS method, and your catalog for _____ (Print name of course. See list.)

Miss _____
Mrs. _____
Mr. _____ Age _____

Address _____
City _____ State _____ Zip Code _____

Occupation _____ Employed by _____ Working Hours _____ A.M. to _____ P.M.



Science and Electronics

-
- ★ 39 **SPECIAL CONSTRUCTION PROJECTS**
Treasure Witcher—*dig where the headphones buzz, and buried treasure might well be yours*
- ★ 51 Duo-Lite Q-Checker—*easy-to-build unit tells whether transistors are open, shorted, or leaky; npn or pnp; even measures beta!*
-
- ★ 29 **SPECIAL SCIENCE FAIR PROJECT**
"Windy" the Wind Gauge—*our anemometer accurately clocks wind speeds from a dead calm to a killer hurricane*
-
- ★ 77 **INTRODUCING OUR NEW DEPARTMENT**
Great Men of Science—*Lord Kelvin, alias William Thomson, a great physicist and engineer (1824-1907)*
-
- 72 **SCIENCE FEATURE SPECIALS**
Down Under a Mile and a Half High—*electronics in the world's newest—and highest—subway system*
- 74 Famous Patents—*Alexander Graham Bell's Photophone*
- 75 Bird Watchers Worth Watching—*homing in on the bionics of a pigeon in flight*
-
- 23 **ASTRONOMY**
The Skies Above Us—*the stars and our calendar*
- ★ 45 New Age of Astronomy—*how sophisticated electronics outdoes optics in man's never-ending quest to learn more of the heavens*
-
- 65 **S/E LABORATORY CHECK**
Fisher Model 500-TX AM/FM-Stereo Receiver
-
- 54 **COMMUNICATIONS CONSTRUCTION PROJECTS**
Doubletimer—*instant time zones on your wrist*
- ★ 55 SemiPro—*sure-fire converter feeds 2-Meter signals to your BCB receiver*
- 61 Station Blazer—*broad-band preamp puts zonk into any SW set*
-
- 28 **COMMUNICATIONS FEATURES**
How to Get Started in Radio—*cartoon page*
- 67 Ham Traffic—*who's minding the store?*
- 79 Horace Twipple Brought Back Radio—*funny fiction*
-
- 6 **DEPARTMENTS**
Bookmark—*by Bookworm*
- 8 Stamp Shack—*philatronics*
- 11 New Products—*showcase for shoppers*
- 16 Ask Me Another—*readers' Q & A*
- 26 Literature Library—*keep the mailman busy*

★ **White's Radio Log, Volume 52, Part 2—page 81**
Emergency Radio Service—Southern California—page 95

★
Cover
Highlights

Cover illustration by Joe Rack



The New 1970 Improved Model 257 **A REVOLUTIONARY NEW TUBE TESTING OUTFIT**

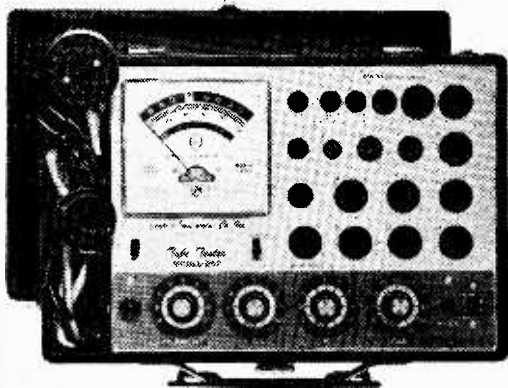

COMPLETE WITH ALL ADAPTERS AND ACCESSORIES, NO "EXTRAS"

STANDARD TUBES:

- ✓ Tests the new Novars, Nuvisitors, 10 Pins, Magnovals, Compactrons and Decals.
- ✓ More than 2,500 tube listings.
- ✓ Tests each section of multi-section tubes individually for shorts, leakage and Cathode emission.
- ✓ Ultra sensitive circuit will indicate leakage up to 5 Megohms.
- ✓ Employs new improved 4½" dual scale meter with a unique sealed damping chamber to assure accurate, vibration-less readings.
- ✓ Complete set of tube straighteners mounted on front panel.

The Model 257 is housed in a handsome, sturdy, portable case. Comes complete with all adapters and accessories, ready to plug in and use. No "extras" to buy. Only

BLACK AND WHITE PICTURE TUBES:

- ✓ Single cable used for testing all Black and White Picture Tubes with deflection angles 50 to 114 degrees.
- ✓ The Model 257 tests all Black and White Picture Tubes for emission, inter-element shorts and leakage.

COLOR PICTURE TUBES:

- ✓ The Red, Green and Blue Color guns are tested individually for cathode emission quality, and each gun is tested separately for shorts or leakage between control grid, cathode and heater. Employment of a newly perfected dual socket cable enables accomplishments of all tests in the shortest possible time.

\$52.50

NOTICE

We have been producing radio, TV and electronic test equipment since 1935, which means we were making Tube Testers at a time when there were relatively few tubes on the market, way before the advent of TV. The model 257 employs every design improvement and every technique we have learned over an uninterrupted production period of 34 years.

Accurate Instrument Co., Inc.

SEND NO MONEY WITH ORDER PAY POSTMAN NOTHING ON DELIVERY

Pay Cash or in EASY MONTHLY PAYMENTS AFTER 15 Day Trial!

Try it for 15 days before you buy. If completely satisfied remit \$52.50 plus postage and handling charge. (If you prefer you may **PAY MONTHLY ON OUR EASY PAYMENT PLAN.**) If not completely satisfied, return to us, no explanation necessary.

ACCURATE INSTRUMENT CO., INC. Dept. 719
2435 White Plains Road, Bronx, N.Y. 10467
Please rush me one Model 257. If not satisfactory I agree to pay at the terms specified at left. If not satisfactory, I may return for cancellation of account.

Name _____

Address _____

City _____ Zone _____ State _____

Save Money! Check here and enclose \$52.50 with coupon and we will pay all shipping and handling charges. You still retain privilege of returning after 15 day trial for full refund.

Olson ELECTRONICS FREE Catalog

Fill in coupon for a FREE One Year Subscription to OLSON ELECTRONICS' Fantastic Value Packed Catalog — Unheard of LOW, LOW PRICES on Brand Name Speakers, Changers, Tubes, Tools, Stereo Amps, Tuners, CB, and other Values. Credit plan available.

NAME _____
ADDRESS _____
CITY _____ STATE _____
GIVE ZIP CODE _____

If you have a friend interested in electronics send his name and address for a FREE subscription also.

OLSON ELECTRONICS

DEPT. M-DI 260 S. FORGE STREET, AKRON, OHIO 44308

It costs only



New Easy Dispenser Pak 60/40 18 S.W.G.*

1/100 of 1¢ more



Latest PC (Printed Circuit) Pak
60/40 Extra Thin 22 S.W.G.—028**

per solder joint to know you are using the world's finest cored solder

* Each only 59¢ per package at your dealer.

ERSIN **Multicore** FIVE-CORE
SOLDER

MULTICORE SALES CORP., WESTBURY, N.Y. 11590



BOOKMARK

BY BOOKWORM

Points the Way. Here, in one single volume, is the most important and useful tool you find for working with electronic meters—*Handbook of Electronic Meters: Theory and Application* by John D. Lenk. Designed for electronics engineers and technicians, it provides not only the "how-to" of a great variety of electronic test procedures, but offers detailed, easy-to-follow explanations of the reasoning behind each test. If your professional range includes the use of any type of electronic meter, this is a handbook you cannot afford to be without.

Detailing the greatest number of meter applications available in a single handbook, this manual covers a full range of practical solid-state and integrated circuit data. It spans the

HANDBOOK
OF
ELECTRONIC
METERS
Theory
and
Application

Hard cover
224 pages
\$3.95

entire subject, beginning with simplified presentations of operating principles and characteristics of typical laboratory and shop meters and accessory equipment. The descriptions include test connection diagrams for each operation and are all illustrated in block diagram or simplified schematic level, thereby offering an ideal source of easily accessible facts on meter theory and application. A valuable feature of this handbook is the self-contained aspects of each meter procedure and application, thus eliminating any need for cross-checking data elsewhere in the book. And since every practical, experience-proven application for modern meters is included, this handbook represents not only the most complete one available, but virtually the only one you will need to master the full range of basic modern electronic meter theory.

The author is no stranger to his magazine. His many articles in the past have been well received. To get your copy of this text, stop by your local bookstore or write to the publisher—Prentice-Hall, Inc., Englewood Cliffs, N.J. 07632.

Solid on TV. Unique in its field, *Introduction to Solid-State Television Systems* by Gerald L. Hansen is the only available book on television systems that is devoted entirely to the



Hard cover
180 pages
\$10.95

most modern, solid-state equipment—the equipment being used today. Its up-to-date information and broad, detailed coverage make it a "must" for anyone concerned with the vital, changing field of television today. No special technical knowledge is necessary to understand the clear, readable text. The author has chosen to by-pass complex mathematical formulas so that readers with a basic grasp of electronic and transistor theory will find the material readily comprehensible.

Principles and operation of television equipment of all types, used in both broadcast and closed circuit systems, are covered. Separate chapters are devoted to monochrome and color equipment. Various kinds of generation equipment, monitors, and receivers are discussed clearly and in depth.

The book begins with a consideration of the wide and varied uses of television today. An overview of the types of television equipment is followed by separate chapters devoted to in-depth examinations of the principles behind each type, as well as their operation. Among the many major topics: Principles of Optics; Scanning Systems; Video Amplification and Processing; Monochrome Television Monitors; Principles of Color Television; The Color Camera and Associated Circuits; Sync Lock Circuitry and Subcarrier Generators; Glossary of Television Terms.

Several photographs and detailed diagrams of the latest transistorized circuits accompany the highly readable text. Questions and simple problems covering important points in each chapter appear at the end of the text, as aids

AMAZING SCIENCE BUYS

For FUN, STUDY or PROFIT

VISUAL EFFECTS PROJECTOR SET

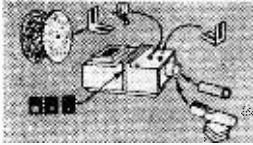

Dazzling, avant-garde visual effects. Fantastic variety. Incredibly beautiful. Special package offer contains all necessary apparatus. Creative lighting. Colorful, fiery bursts of color like "Symphony of Spheres," "Chromatic Starbursts," "Crystal Starburst". Features 35mm 500 W. fan cooled projector—produces big image at short distance. Accepts two 8" diam. wheels (Dry Kaleidoscope & Hexidoscope), 2 cylindrical accessories (8" Cloud & 5" Hexidoscope w/six internal mirrored walls). Perfect for entertaining, parties, photography. Complete instructions. Stock No. 71.212HP \$79.50 Ppd.

3 CHANNEL COLOR ORGAN BARGAIN

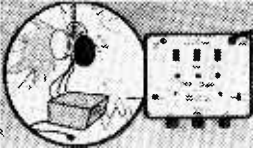

Create tremendous variety of unusual & beautiful lighting effects with this lowest top quality, 1500 Watt unit. (600 W per channel). Compares with others selling for twice the price. Has pilot light, plus individual sensitivity controls & channel indicator lights. Can operate ten 150 W "spots" or 200 Kinas lights. Use room, house current. Connects to audio source w/RCA type phono plug. 5 1/4" x 6 3/4" x 2 1/2". 2 1/2 lbs. Thermal setting plastic case. 6 ft. cord. Incl. compl. instruct. Stock No. 71.223HP \$34.95 Ppd.

LONG-WAVE BLACK LIGHT FIXTURE

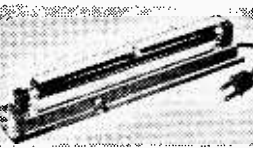

Extremely versatile, compactly designed, long wave (3200-4000 angstroms) black light (ultra-violet) fixture. Has 6-watt, 110-V lamp with built-in filter—eliminates harmful shorter wave ultra-violet rays. Use to identify minerals, fungus, bacteria—check for surface flaws, oil and gas leakage—perfect for displays with fluorescent paper, paints, chalk, crayons, face powder, fuel, adjustable aluminum reflector. Mount vert., hor., or on corner. 10 1/2" L. x 1 1/2" W. x 1 1/2" H. Stock No. 70.364HP \$12.50 Ppd.
Stock No. 60.124HP \$4.50 Ppd.

"FISH" WITH A MAGNET



Go treasure hunting on the bottom! Fascinating fun & sometimes profitable. Tie a line to our 1-lb. magnet & drop it overboard in bay, river, lake or ocean. Trawl it along bottom—your "treasure" haul can be outboard motors, anchors, other metal valuables. 5-lb. Magnet is war surplus. 110-V. Taper. Gov't. cost \$50. Lifts over 150 lbs. on land—much greater weights under water. Stock No. 70.571HP 3 1/2 lbs. \$14.00 Ppd.
Stock No. 70.570HP 3 1/2 lbs. \$18.75 Ppd.
Stock No. 70.572HP 7 1/2 lbs. \$18.75 Ppd.

A COOL ADVENTURE WITH LIGHT!



The almost hypnotic spell of ever changing firelight has been captured in a cool-light display box! With the liquid motions of a rising and cascading fountain blowing in the wind, psychedelic colors appear, intermingle and wash to rise again in new patterns, and drift away. This soothing light show housed in a handsome 11 1/2" square by 7" deep, walnut finished box is an effective addition to any room—your living room, bedroom, classroom, doctor's office. Especially effective among a wall picture group. Modern as tomorrow—available today! Stock No. 71.180HP LUMIA LIGHT BOX \$29.95 Ppd.

PSYCHEDELIC LIGHTING HANDBOOK



100 information packed pages! Fully explains the latest in psychedelic lighting equipment techniques, developments. Covers all facets of psychedelic light-show production including strobes, black lights, projectors, crystals, organic slides, mirrors, color organs, polarizer, color, light boxes, MusicVision, etc., 8 1/2" x 11" looseleaf paper punched for 3 ring binder. Stock No. 9100HP \$3.00 Ppd.

Order by Stock No.—Check or M.O.—Money-Back Guarantee
EDMUND SCIENTIFIC CO., 300 EDSCORP BLDG., BARRINGTON, N.J. 08007

MAIL COUPON FOR GIANT FREE CATALOG



Completely new 1970 edition. New items, categories, illustrations, 118 easy-to-read pages packed with 4000 unusual items. Dozens of electrical and electromagnetic parts, accessories. Enormous selection of Astronomical Telescopes, Microscopes, Binoculars, Magnifiers, Magnets, Lenses, Prisms. Many war surplus items; for hobbyists, experimenters, workshops, factory. Write for catalog #1P. Include Zip.

ORDER BY STOCK NUMBER - SEND CHECK OR MONEY ORDER - MONEY-BACK GUARANTEE
EDMUND SCIENTIFIC CO., 300 EDSCORP BUILDING, BARRINGTON, NEW JERSEY 08007

BOOKMARK

to comprehension. Available at bookstores or direct from the publisher, Prentice-Hall, Inc., Englewood Cliffs, N.J. 07632.

Calling all CBers. Here is an all-in-one book on Citizens Band radio, and how to make the best use of available equipment. Tabbed the *CB Radio Operator's Guide*, this text is authored by Bob Brown (he writes for this magazine) and Paul Lawrence. Now, a CB Radio user's "bible", the first really complete "how-to" book on Citizens Band two-way radio communications, tells you everything you want to know—and must know—to get on the air, from a description of what it is to what can, and can't be, done right down to the "nitty gritty" rules and regulations. What's more, the book con-



Hard cover
449 pages
\$15.00

tains expert advice on the type of equipment to buy, and how to get the best performance out of the "system."

The reader will learn about antenna systems, including how they are used in CB and the various types to use for specific applications such as for base and mobile installations (including a directory of suppliers). And to keep him operating to the letter of the law, there's a Chapter containing the complete FCC rules and regulations (*as well as Canadian rules*). A truly useful handbook for anyone interested in the subject. You can get your copy direct from the publisher—Tab Books, Blue Ridge Summit, Pa. 17214. ■

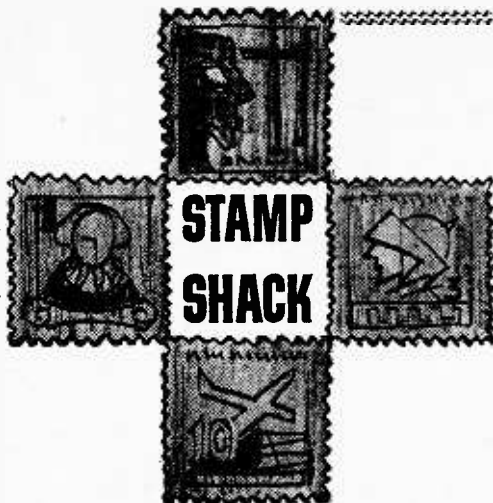
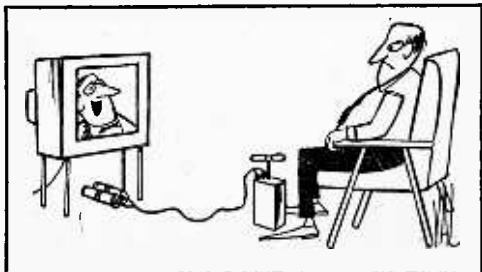

- ● The latest of "communications" stamps come from the Netherlands Antilles, which issued a pair on Feb. 5, to commemorate the fifth anniversary of *Trans World Radio-Bonaire*. The 10-cent, which is for use on postcards mailed within the six islands of the Caribbean nation, features a picture of the studio-office complex in Bonaire and one of 30 antennas used to transmit its signals. The 15-cent denomination, for foreign postcards and domestic first class letters, is purely symbolical in concept. Created by Curacao artist Charles S. Corsen, the design comprises a cross encircled by two rings representing radio waves, set against a background of land, sea and sky. Both are printed in yellow, red, blue and black.
- *Trans World Radio* is one of the more unusual of the world's networks. Back in 1952, Dr. Paul E. Freed, a successful evangelist, conceived TWR as a non-profit, interdenominational medium to reach a much larger audience for his faith ministry. He was working in Morocco at the time, and with funds he solicited from persons interested in his work, he opened a small radio facility which he originally called *The Voice of Tangier*.
- Gradually he built up an audience that listened to his gospel messages quite regularly as they were beamed to Europe and the Middle East. Within seven years, broadcasts were go-



Netherlands Antilles *Trans World R.-Bonaire*

SCIENCE & ELECTRONICS

ing out in 20 different languages and dialects from the Tangiers studio, which since had changed its name to *Trans World Radio*.

● In late 1959, when the Moroccan government nationalized all radio facilities, TWR was forced from Tangier, and for almost a year interrupted its work. Dr. Freed finally found facilities in Monte Carlo, and restored programs on Oct. 16, 1960. Intensifying his efforts, TWR-Monaco soon was broadcasting evangelistic programs in 31 tongues spoken on both sides of the Iron Curtain of Europe and Arabic dialects of the Mediterranean area. Eventually he opened additional offices and studios in Lebanon, France, Germany, Holland, Spain and England.

● By 1962, TWR planned American facilities and after studying the geography, decided that the Netherlands Antilles islands off the South American coast offered the best possible locale for its new transmitters. Permission was obtained to erect the necessary transmission buildings and equipment on the tranquil island of Bonaire. Funds were obtained and construction began.

● Facilities include three giant transmitters: one, for medium wave standard broadcasting is a 500,000-watt unit. The other two are short-wave: one with 260,000 watts, the other, 50,000 watts, to provide a total output power of more than three-quarters of a million watts.

● There are 30 steel towers in what is called an "antenna farm" all of which are used to beam TWR broadcasts to the entire Western Hemisphere, Europe, the Middle East, Africa, India, Australia and deep into countries of the Soviet-Communist bloc.

● Trans World Radio-Bonaire maintains a staff of 93 dedicated and talented missionary specialists who serve as program directors, script writers, commentators, engineers, technicians, Bible teachers and follow-up workers.

● The Netherlands Antilles Postal Administration intends to keep this pair of stamps on sale until Feb. 4, 1972, unless stocks are exhausted before then. Collectors may obtain them directly from the Philatelic Office of the PTT, Willemstad, Curaco, NE, by sending 13¢ (US currency) for each pair desired.

● ● The Seychelles is a small cluster of British colonial islands—with a total acreage of less than 100 square miles—off the African coast, just north of Madagascar in the Indian Ocean. But when NASA looked around the globe for sites suitable as tracking stations to keep its terrestrial eyes and ears on Space vehicles and satellites, these insular specks were selected for one of them.

● So, when Apollo XI's Astronauts landed on the Lunar surface, the Seychelles participated in this epochal triumph.

● It was not surprising, then, that the islands

new miniature electronic pliers



HOLD, BEND, CUT ALL FINE WIRES WITH EASE

CHAIN NOSE AND DIAGONAL CLOSE CUTTING PLIERS

SPECIAL TIP CUTTING PLIERS

RADIO AND TV PLIERS

Ideal for electronic, radio/TV, electrical service and assembly. Forged alloy steel construction. Precision machined. All have polished heads and shoulders. Comfortable "Cushion Grip" handles and coil spring openers speed work, reduce hand fatigue. Miniature round and flat nose pliers also available.

a complete line of regular pliers and snips, too

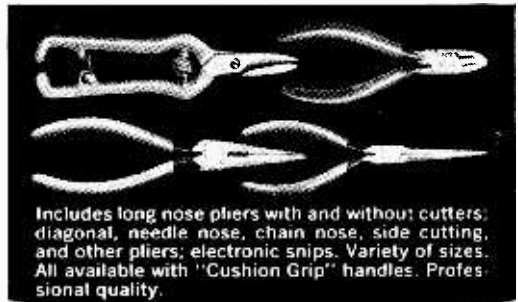

Includes long nose pliers with and without cutters, diagonal, needle nose, chain nose, side cutting, and other pliers; electronic snips. Variety of sizes. All available with "Cushion Grip" handles. Professional quality.

XCELITE

XCELITE, INC.

40 Bank St., Orchard Park, N. Y. 14127

Send Catalog 162 with information on miniature and regular pliers and snips.

name _____

address _____

city _____

state & zip _____



Seychelles Man-on-Moon Issue

would authorize a set of stamps, not only to commemorate Man's first walk on the moon, but also to call attention to their part in tracking the flight. The designs used for the king-size quintet are: 5 cent, Apollo XI launching at Cape Kennedy; 20¢, separation of the Lunar Module from Columbia; 50¢, Astronauts Aldrin and Armstrong walking around the Lunar surface near the Eagle; 2¼ Rupee, the earth as seen from the moon's surface and craters. The 85-cent denomination shows the sophisticated tracking station on the Seychelles.

● ● And speaking of Apollo XI stamps, one of the more striking ones of the hundreds designed for various nations, is that turned out by

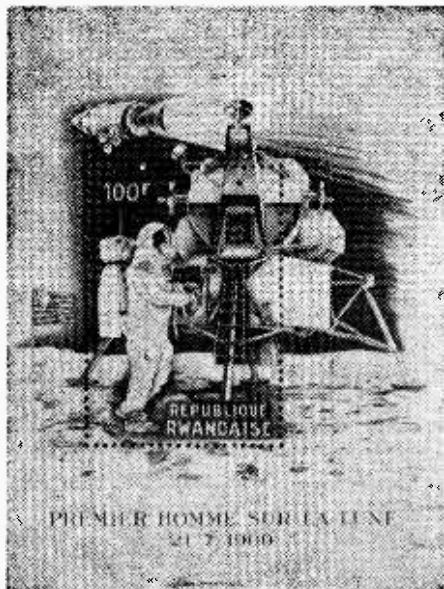

Rwanda Man-on-Moon Sheet

the small East African republic of Rwanda. The 100-franc stamp is set in the middle of a small sheet, with the picture running over into the margins. Shown is Col. Armstrong holding a TV camera at the foot of the Eagle, as Columbia orbits above. The flag of the United States, with its prop support, and the Astronauts' footsteps form side and bottom patterns.

What's New?

● Conscious of collectors' desires, now that hundreds of stamps have been released by countries in all parts of the world to commemorate the first Lunar stroll by American Astronauts Neil Armstrong and Buzz Aldrin, the Washington Press, of Maplewood, N.J. 07040, has added a "Moon Landing" volume to its "White Ace Album" series.

● Its pages, attractively illustrated and annotated, contain spaces for all stamps issued so far. Punched so they will fit any standard three-ring binder (or the special one also produced by Washington Press) the pages alone cost only \$1.85, and are available from most stamp dealers.

● The H. E. Harris Company, one of the world's largest stamp firms, is marking the 54th anniversary of its establishment by selling more than 2,500 of the world's most popular rarities and classics at discounts of up to 40%. A list of items available will be sent to interested collectors who write to the firm, Boston, Mass. 02117 and mention the Stamp Shack.

Also, H. E. Harris & Co. offer the best ten cent offer in the United States! It's the 1970 Edition of the Harris illustrated Collector's Catalog. This catalog includes up-to-date prices on U.S. postage stamps plus many new special listing, and accurately reflects the current active market for United States stamps. Get your copy today!



NEW PRODUCTS

HIGH-FIDELITY
AMATEUR RADIO
SHORT WAVE
RECORDERS
GIMMICKS
GADGETS
TOOLS
ETC.



Steer to Stereo

The star of Utah Electronics' broadened line of display-packed speakers is the SA-55, a deluxe stereo auto kit for car-door installation. The unit features cloth roll cone suspension, 5.5-oz. ceramic magnets, separate high frequency cones, and snap-on chrome grilles which



Utah Electronics SA-55 Stereo Auto Kit

eliminate all visible fastening devices. All its features are presented on the pack, so you don't have to go hunting up an un-busy salesperson. The SA-55 sells for \$29.95 and you can write for more information to Utah Electronics, 1124 E. Franklin St., Huntington, Ind. 46750.

Mod, Mod Modular

Here's a hot combo from Lafayette Electronics, the LSC-45 stereo modular hi-fi phono system. It combines a Garrard 4-speed auto-

Live Better Electronically With

LAFAYETTE RADIO ELECTRONICS

1970 Catalog 700 **FREE!**

Now OFF PRESS
BETTER THAN EVER
496 Pages



Stereo Hi-Fi • Citizens
Band • Ham Gear • Tape
Recorders • Test Equip-
ment • TV and Radio Tubes
and Parts • Cameras •
Auto Accessories • Musical
Instruments • Tools • Books

Featuring Everything in Electronics for
• HOME • INDUSTRY • LABORATORY
from the "World's Hi-Fi & Electronics Center"

LAFAYETTE Radio ELECTRONICS
Dept. 23050 P.O. Box 10
Syosset, L.I., N.Y. 11791

Please Send the FREE 1970 CATALOG 700

25030

Name
Address
City
State Zip

**COOPERATE
WITH THE ZIP CODE PROGRAM
OF THE POST OFFICE DEPARTMENT
USE ZIP CODE NUMBERS
IN ALL ADDRESSES**

Buy...

U. S. SAVINGS BONDS

WRITE
NOW FOR **McGEE'S**
1970 CATALOG
SENT FREE

1001 BARGAINS IN

SPEAKERS—PARTS—TUBES—HIGH FIDELITY
COMPONENTS—RECORD CHANGERS—
TAPE RECORDERS—KITS—
EVERYTHING IN ELECTRONICS

McGEE RADIO CO.,
1901 McGee St. (SE) Kansas City, Missouri 64108

SEND 1970 McGEE CATALOG

NAME.....
ADDRESS.....
CITY..... STATE..... ZIP.....

NEW PRODUCTS



Lafayette LSC-45 Stereo Phono System

matic record changer, a 20-watt solid-state stereo amplifier, and a pair of acoustically matched speaker systems. The record changer has tubular tone arm with stereo turnover cartridge and diamond LP needle, plus cueing control. It will play 7-, 10-, and 12-in. records at 16 $\frac{2}{3}$, 33 $\frac{1}{3}$, 45 and 78 rpm. Amplifier controls include Balance, Bass, Treble, Volume, Selector, Automatic Shut-off Switch, front panel stereo phone jack, auxiliary input jack for tuner or tape recorder. The speakers are 8 in. and you get a plastic dust cover, 45-rpm spindle, and speaker cable. The LSC-45 has walnut veneer cabinetry and the price is \$99.95 for all. Write for further specs to Lafayette Radio Electronics, 111 Jericho Tpke., Syosset, N.Y. 11791.

Get Your Signals Straight!

EICO's Model 150 solid-state signal tracer is just what the doctor ordered for troubleshooting AM, FM and TV receivers as well as hi-fi and PA systems. There are two separate probes for testing both radio and audio



EICO Model 150 Signal Tracer

frequency circuits. Results are judged from an audible output from an 8-ohm speaker or visually from a built-in meter. The unit has 400-mW continuous power output; power require-

ments are 105-132 VAC, 50-60 Hz, 5 VA. Handy-dandy size is 7 $\frac{1}{2}$ x 8 $\frac{1}{2}$ x 5 in., weight a mere 6 lb. Model 150 sells for \$49.95 in kit form, \$69.95 wired. For more info write to EICO Electronic Instrument Co., Inc., 283 Malta St., Brooklyn, N.Y. 11207.

Cleaner Heads Will Prevail

Robins Industries has come out with what they call "a pair of new combos and a couple of singles." The combos include the Test-N-Clean cassette Model THC-6 and cartridge Model THC-8, both listing at \$2.80. They'll remove accumulated oxide, grime and foreign matter and test heads for both alignment and stereo balance between channels. For gentler



Robins Cassette and Cartridge Cleaners

head cleaning, there's the lintless, non-woven polyester cloth Head-Kleen cassette Model THC-4, which sells for \$3.00. Finally, there's the Head-Kleen cassette Model THC-7, which cleans by means of polishing tape and sells for \$2.50. For more information write to Robins Industries Corp., 15-58 127th St., College Point, N.Y. 11356.

Switched-on Saser Beam

The Saser Beam antenna line, says Mosley Electronics, cuts through CB interference like a laser cuts through steel. Model DMS-3D is

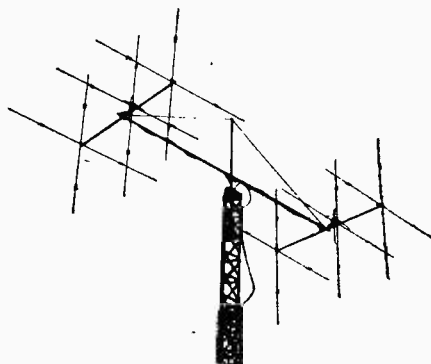

Mosley Saser Beam DMS-3D CB Antenna

a deluxe 12-element Saser Beam, a combination of two MS-3D beams stacked, and features the sturdy construction of a beam plus the choice of polarization usually found only in the quad design. Each of the six horizontal and six vertical elements has two high, "Q" coils, so powerful they can be used on a 10-meter ham antenna. A double "T" matching system provides balanced feed horizontally and vertically. A turn of the dial of the polarization switching control, located at the transceiver, permits selection of polarization. Complete with color-coded parts and instructions, the DMS-3D is priced at \$198.41. For complete specs, write Mosley Electronics Inc., 4610 N. Lindbergh Blvd., Bridgeton, Mo. 63042.

More CB Power

Shown is one of a complete new line of CB beams from Cush Craft, featuring high forward gain plus excellent side and back rejection. Their new design makes for more strength with less weight and wind load. Called Power Beams, they have 2-in. mast-mount pre-drilled and

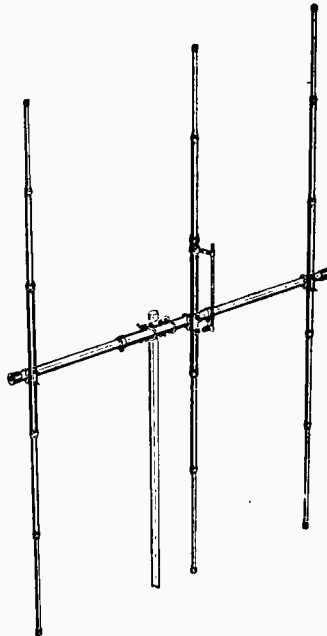

Cush Craft Power Beam CB Antenna

pre-marked components, heavy wall seamless aluminum tubing and KW matching. A stacking kit for mounting any two Power Beams is available. Prices go as follows: 3-element, 8 dB gain @ \$32.50; 4-element, 9.5 dB gain @ \$42.50; 5 element, 10.5 dB gain @ \$69.50. The dual beam stacking kit is \$49.50. Write for Citizens Band antenna catalog C-17 to Cush-Craft, 621 Hayward St., Manchester, N.H. 03103.

THOUSANDS OF BARGAINS TOP VALUES IN ELECTRONIC PARTS

Transistors, Modules, C. B., Speaker, Stereo, Hi-Fi, Photo Cells and Thousands of Other Electronic Parts.
Send for FREE Catalogue

ELECTRONIC DISTRIBUTORS INC.



EDI

Dept. TA-2, 4900 Elston
Chicago, Ill. 60630
 RUSH CATALOGUE

Name.....
Address.....
City.....
State..... Zip Code.....

Technical Excellence in Electronics

On our small friendly campus the emphasis is on Living as well as Learning. Extra-curricular social activities, student clubs, a student-operated radio station, student government, new dormitory, a full sports program help provide a world of your own in which to prepare the world of tomorrow. Diploma in Electronic Technology and Associate Degree in Electronic Engineering Technology. B.S. obtainable. GI approved.

VALPARAISO TECHNICAL INSTITUTE

DEPT. SE VALPARAISO, INDIANA 46383



TUBES! CORNELL TUBES!
FREE Send For FREE
CORNELL'S
New 1969
CATALOG
Many New Items

30¢ per tube
IN LOTS OF 100

33¢ per tube
WE SELL
PICTURE
TUBES

4219 E UNIVERSITY AVE., SAN DIEGO, CALIF. 92105



Keep up to date with SCIENCE & MECHANICS

Science & Mechanics—the only magazine that keeps you right up to date on developments in space technology, weapons, automobiles, medicine, boats, planes, tools, new products, and exciting world events.

Keep up to date. Make sure of your home delivered copy by returning the coupon today.

SCIENCE & MECHANICS, Dept. 235
229 Park Ave. S., N. Y., N. Y. 10003

12 issues \$4; 24 issues \$8; 36 issues \$12. Foreign: Add \$1 a year.)

Please enter my _____ year(s) subscription.

I enclose _____ Bill me. (No stamps)

Name _____ (Please Print)

Address _____

City _____ State & Zip _____

NEW PRODUCTS

Quick-Mount Flush Speaker

Those Poly-Planar people have come out with a new quick-mount speaker/grille assembly, model G51P. It's designed to permit customized surface or flush mounting with a minimum of effort by means of newly engineered mounting brackets and grille. The G51P requires only $\frac{7}{8}$ -in. mounting depth—great for custom-mounting in walls, ceilings, furniture, doors, under eaves. With its new brackets, no cutout of the mounting surface is required, and the brackets form a natural sound

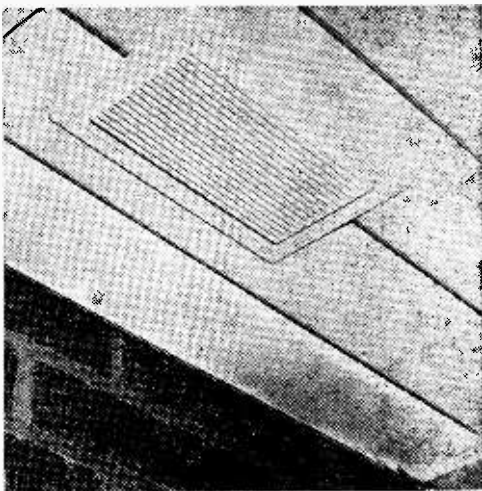

Magitran Poly-Planar G51P Speaker

chamber. Unit can be mounted in a few minutes. The Poly-Planar G51P has a power handling capacity of 5 watts, frequency range of 60 Hz to 20 kHz and input impedance of 8 ohms. Size of grille is 6 x 10 in., it comes in ivory, walnut, and black, and sells for under \$11.00. For more information write the Magitran Co., Moonachie, N.J. 07074.

100 Watts! Outta Sight!

The new Heathkit AR-29 AM/FM/FM-Stereo receiver kit is the result of a two-year project, and, they say, borrows liberally from the technology of the Heathkit AR-15. The AR-29 features FET and IC designs, ultra-sensitive FM tuner, selective IF design, built-in test circuitry, and the first use of computer-designed fixed-tuned L-C IF filters. Frequency response is 5 to 30,000 Hz with less than 0.25% harmonic distortion at any power level. There's a regulated power supply, and 4 heavy-duty individually heat-sinked output transistor protected against short-circuit conditions by a special dissipation-limiting circuit. Then there's a big break for the kit builder in the form of plug-in circuit boards, which simplify checking

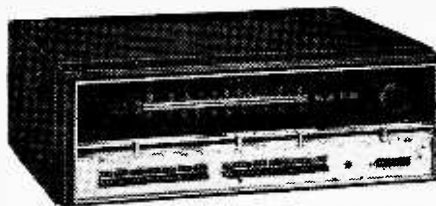

Heathkit AR-29 AM/FM/FM-Stereo Receiver

of circuits. You can eliminate on-station FM background noise and harsh noise bursts between stations by pushing a button activating the Noise Muters. Styling features the Black Magic panel lighting, revealing no dial or scale markings until set is turned on. The AR-29 is priced at \$285.00 and for further information, write Heath Co., Benton Harbor, Mich. 49022.

Cordless Brilliance

Campers, boaters, outdoor lovers, patio partyers, and just plain folk who have a power failure now and then will welcome the Porta Lite from Marathon Battery. Attractively styled, it's powered by a 6-volt No. 896 Marathon battery, molded from polyethylene in green or blue, and its No. 1651 bulb provides up to 100 hours of intermittent light. The shade can be moved up or down and there's a hang-up loop. Price is \$10.99 and for complete information contact Marathon Battery Co., Box 1246, Wausau, Wis. 54401.

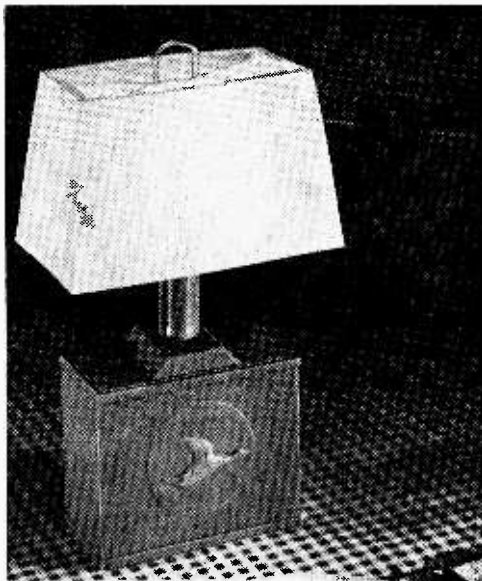

Marathon Battery Porta Lite

Maybe someday the other guys will have a guaranteed, million dollar reservation system like Max. Maybe.

When the other guys reserve a car for you, they assume it'll be there. National *knows*. Because right now—today—National has Max, a million dollar computer.

Max knows the whereabouts of every car in our fleet. When you call us toll-free at 800-328-4567, Max tells us instantly what's available so we can guarantee your reservation.

Max isn't the only difference, either. National has GM cars, S&H Green Stamps and a trusting nature that prompts them to accept any recognized credit card at any of their 1800 locations.

Maybe someday the other guys will have all of those things. But why wait? National guarantees your reservations now!

WITH US, MONEY
IS NO
EXPENSE.



We make the customer No. 1

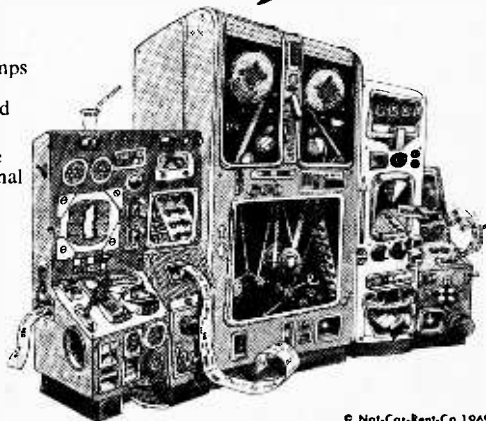

© Nat. Car. Rent. Co. 1969
In Canada and throughout the world it's TILDENInternational



Solid Ignition

How good are transistorized ignitions?

—J.P., Kansas City, Kans.

Excellent. You can buy kits by mail (watch the ads) or at auto accessory stores. If you're buying a new car, get a Detroit-installed unit.

Cheap Is Cheap

Is there any way I can modify my low-cost electronic organ for under \$200.00 to make it sound like a Hammond?

—K.E., Kirkland Lake, Ontario

Add a phono jack and play Hammond organ records through the amplifier and speakers. Otherwise, trade it in for a Hammond. If you would like to build an organ from a kit, then think about getting catalogs from Heath Co., Benton Harbor, Mich. 49022 and Schober Organ Corp., 43 W. 61st St., New York, N.Y. 10023.

101 Projects

Where can I get a handbook of circuit diagrams for projects that really work?

—P.S., Brooklyn, N.Y.

The Editor of Science and Electronics is currently preparing a new annual magazine to go on sale the same time as this issue, just about. The title is long—101 Electronic Projects for Under \$10—and so will be the time you retain this magazine as a reference. The projects were not picked up from other references as so many do. Each project has been wired and tested from parts that are currently easy to obtain. There are no CK-722 or 2N107 transistors that are impossible to find and date the projects to pre-1960. Pick up a copy and see why we are so excited about it.

Tricky Quiz

When I took a test for a job as a technician, I was shown a diagram and asked to state how

many amperes flow in the circuit. I don't dig it. What is the current?

—C.B., Rome, N.Y.

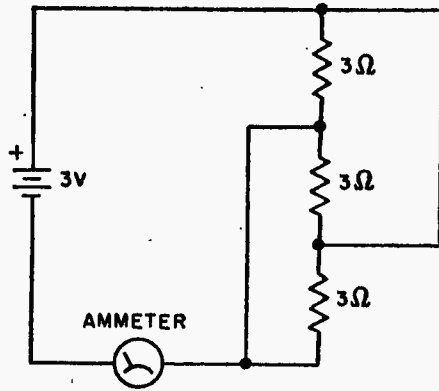

Redraw the diagram. The three resistors are in parallel and their total resistance is one ohm. The current must be 3 amperes since 3 volts applied to 1 ohm causes 3 amperes to flow.

50-Foot DXer

I would like to play my cassette tapes through a wireless oscillator so they can be tuned in with an AM-BCB radio. Can you give me a circuit?

—C.H., Chicago, Ill.

Why build when you can pick up a module for either AM or FM transmission? They're cheaper parts and work first time the battery's plugged in.

One-Up-Manship

Can you tell me how to increase the selectivity of my inexpensive FM receiver (see diagram) I use for listening to the sound channel of TV stations? As my diagram shows, it demodulates FM using the slope detection principle. At 1000-ft. elevation, I can pick up Channel 4 and 9 six miles away.

—D.B., Chelsea, Quebec

Your simple circuit is a very clever design. To get more selectivity, you need *more* tuned circuits than you have now. Perhaps the easiest way is to add a regenerative RF amplifier ahead of the slope detector (see our circuit). This increases the Q of the loop. The transistor is a field-effect type (FET). The 10,000-ohm potentiometer is the regeneration control which should be set just below the point where oscillation occurs. Choke L1 can be homemade. Wind a few turns of hook-up wire around a 1-watt carbon resistor. Try various numbers of turns until enough regeneration is obtained.

Here's an Old One

I have an old all-wave Silvertone radio, model 1570, which uses two 230, four 232, and one 233 tubes. The schematic shows a ballast. It was made by Radio Corporation of America, according to the patent sticker on the rear of the cabinet. I hope you can suggest a power supply for it.

—W. E. S., Reisterstown, Md.

The patent sticker only means that the actual manufacturer who made it for Sears, Roebuck & Co., had paid patent royalties to RCA. Your set requires 2 VDC for the filaments, 180 VDC for the plates, 67.5 VDC for the screens, and -3 V, -13.5 V, and -18 V for grid bias. Since you said there is a ballast, it probably is used to drop the voltage to 2 volts from a 3-volt battery. One good source for diagrams for old receivers is Supreme Publications, 1760 Balsam Rd., Highland Park, Ill. 60035. Why not write to them?

Some Call It Pot

What is the difference between a gain control and a volume control?

—E.T., Washington, D.C.

Many call a volume control a gain control. Often, and they are wrong. A volume control can be a level control as in diagram A and B. The potentiometer shown in A is *not* a gain control since its setting does not vary the gain of the amplifier itself. The potentiometer in B, an integral part of an amplifier containing a

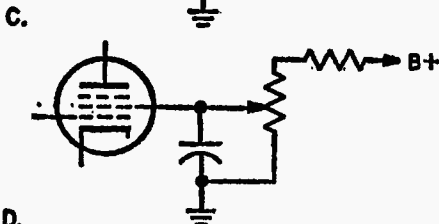
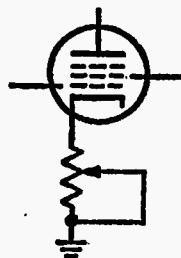
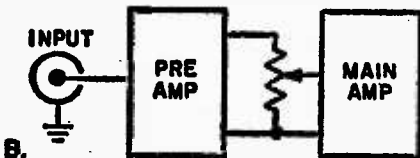
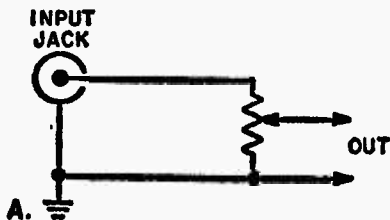

preamplifier, does vary overall amplifier gain even if it controls the output signal level of the preamp stage. The potentiometers in C and D are true gain controls; in C the pot controls grid bias, and in D the pot controls screen voltage to alter the gain of the tube and amplifier stage.

Transistor Subs

Where can I get a list of transistor substitutions?

—C. C. M., Yucca Valley, Calif.

You can buy a copy of "Popular Tube/Transistor Substitution Guide" for \$4.95 at most radio parts distributors or by mail from TAB Books, Blue Ridge Summit, Pa. 17214.

Down With Code

I read in WIRELESS WORLD that a British subject can get a ham license to operate phone only without having to take a code test. But, I understand that the FCC won't issue a ham ticket without the applicant passing a code test because of an international agreement. Isn't England bound by the same agreement? What

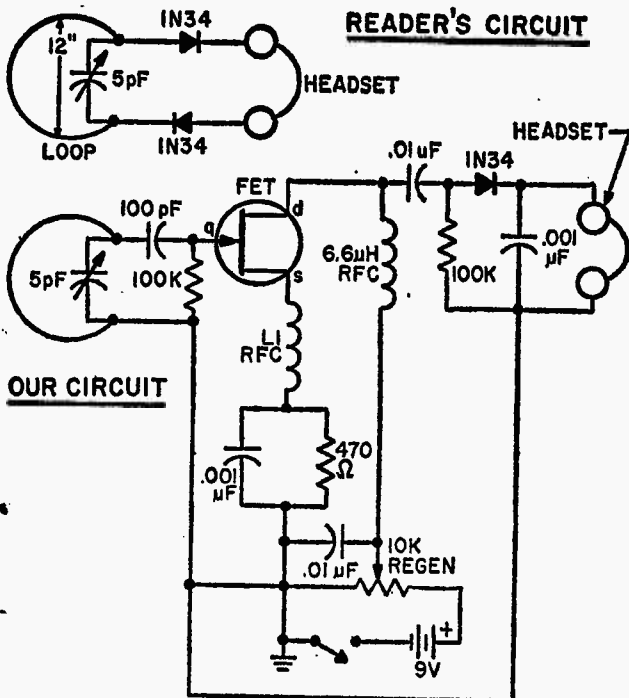

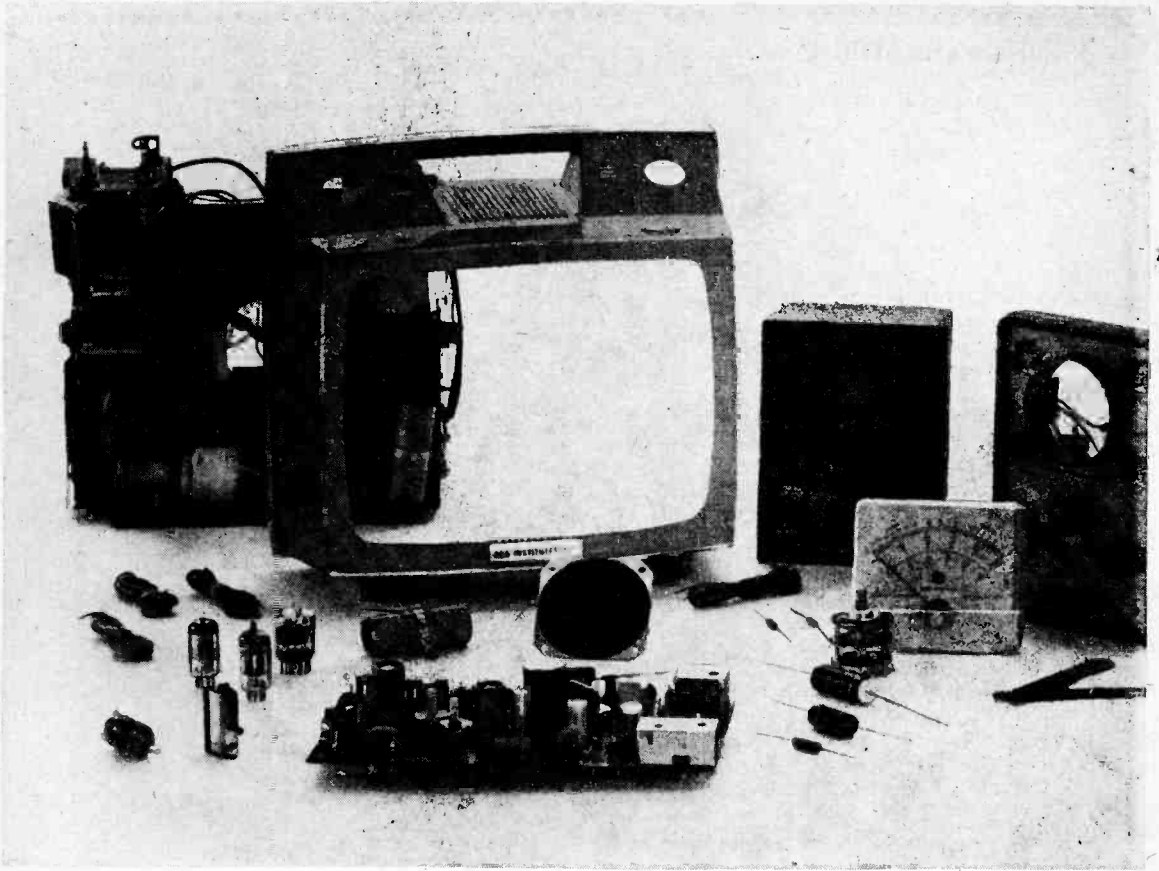

**Look! You get 25 kits...
more than ever before at no extra
cost...for your practical "hands-
on" learning of electronics and
TV with RCA Institutes Home
Training! Send postcard today!**

RCA

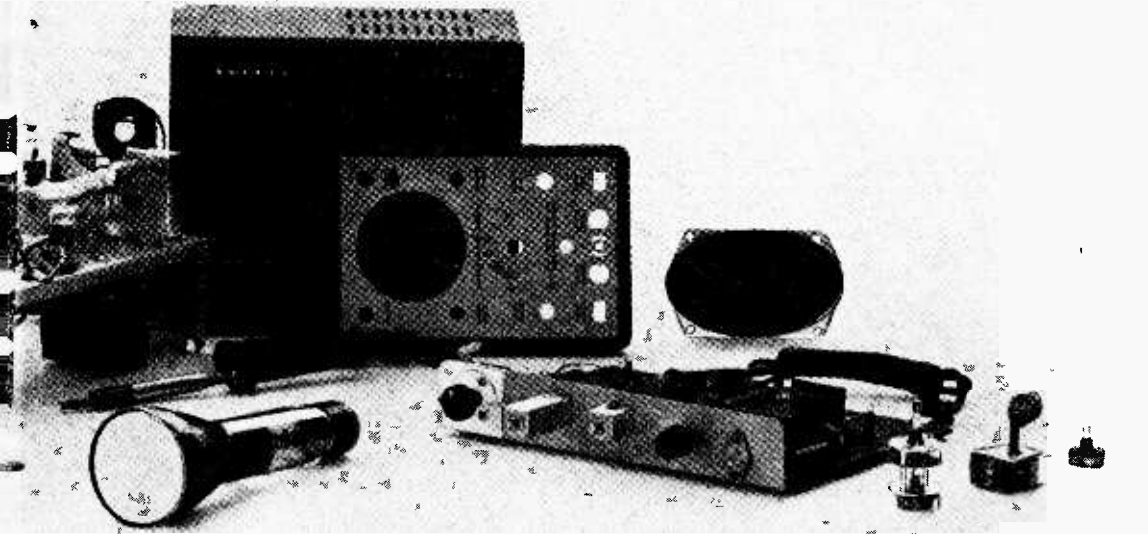

Now, RCA supplies 25 kits in its home-study career program—at no extra cost! Be sure to compare this with other home-study electronics programs. And note, you never have to take apart one kit to build another piece of equipment because there are literally thousands of parts making up the kits. Information on them is included in the catalogue which you'll get when you mail in the reply postcard or the coupon.

Absolutely practical, your kits are used to build such permanent, professional and useful equipment as an oscilloscope, a signal generator, a multimeter, and a fully transistorized breadboard superheterodyne AM receiver. They will give you years of valuable service.

In addition, an easy way to learn—the career programs are all based on the easy, step-by-step AUTOTEXT method. AUTOTEXT is unique and exclusive with RCA Institutes. Math and circuitry problems simply melt away! So check the wide range of electronics and TV career programs.

Eleven Career Programs: Television Servicing (including color TV and

CATV) • FCC License Preparation • Automation Electronics • Automatic Controls • Industrial Electronics • Nuclear Instrumentation • Electronics Drafting • *including these four all-new:* Semiconductor Electronics • Digital Electronics • Solid State Technology • Communications Electronics.

Also check the new Computer Programming course—trains you to work on today's largest data processing systems including IBM/360 and RCA Spectra 70, the Third Generation Computers.

You get tuition plans as flexible as you wish: pay-as-you-order or pay-by-the-month...you choose! No interest charges! No other electronics home study school offers both these choices.

Classroom training also available—day and evening coeducational classes start four times a year. No previous training required—you can take preparatory courses if you haven't completed high school.

Placement service, too—with RCA Institutes classroom training, you get the full benefits of the RCA Job Placement Service. RCA Institutes grad-

uates are now with companies that include Bell Telephone, GE, Honeywell, IBM, RCA, Westinghouse, Xerox, and major radio/TV networks. This placement service is also available to Home Study Graduates.

Veterans: enroll now—all courses are approved under the GI bill

Accredited Member National Home Study Council.

If reply postcard has been removed, mail this coupon.

.....

- RCA INSTITUTES, INC.
- Home Study Dept. 764-004-0
- 320 West 31 Street, New York, N.Y. 10001

• Please send me free illustrated career catalog.

• Age _____

• Name _____

• (please print)

• Address _____

• City _____

• State _____ Zip _____

• For GI information, check here

.....

ASK ME ANOTHER

Continued from page 17

can be done about getting the FCC to relax its stiff position and issue ham tickets without a code test and allow beginner hams to operate phone on some bands?

—W. H. H., San Francisco, Calif.

Many hams, through their American Radio Relay League lobby, fight any move to relax ham rules. We don't agree with them. Many frustrated CBers would rush out and buy ham rigs if the FCC would abolish the code test. Write to Hon. Dean Burch, Chairman, Federal Communications Commission, Washington, D. C. 20554, and tell him how you feel. Also write to your Congressman and Senators. The more people that write, the greater the chance of getting action.

Ham Bands Are Better

Can I modify an old 2-3 MHz marine radio-telephone into a CB transceiver?

—E. R., Stanwood, Wash.

No, not easily. In the first place it is higher powered than a CB rig. The modifications would be extensive and expensive. Furthermore, you would have to get it tested in a lab and submit full technical data to the FCC. On the other hand, it would be easy to modify it for the 80-Meter or 160-Meter ham bands by simply installing new crystals and retuning.

You Take the Low Road

I was told that the distorted reception I am encountering from some FM stations is due to multi-path reception. What's that?

—S.E., Palo Alto, Calif.

Vhf band signals from FM stations can travel direct (line-of-sight conditions from transmitting antenna to receiving antenna) and via reflected paths (see diagram). The signals could arrive at your antenna at the same time and be

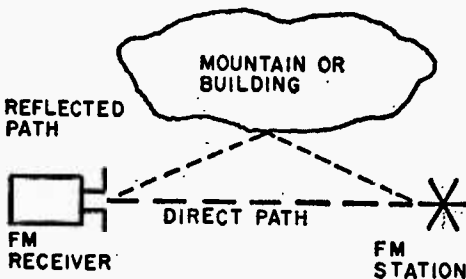

out of phase with each other. This can cause distortion and, when signals oppose each other, received signal level can be reduced. The cure is to use a directional FM antenna, preferably with a rotator. You can then pick up the strongest signal and attenuate the weaker ones that intermingle with the desired signal and cause distortion. Multi-path reception is the same trouble that causes ghosts on TV. ■

The Skies Above Us

by Dr. Roy K. Marshall

☆☆ By this time, the readers of this regular department for the past several months will be getting to know how the sky behaves. In February, Leo was low in the east, sitting up like a "nice doggie," perhaps begging Hercules not to strangle him, for this constellation represents the lion which was slain by the great hero as the first of his famous "twelve labors." The picture is not quite exact, however, as we can see in the April map, where Hercules is now seen low in the east and trails Leo, who swings high overhead, perhaps trying to escape.

☆ If you have a clear night and you don't have the map handy, here's the way to find Leo if, as almost everyone does, you know the Big Dipper and how the line drawn through the "pointers," as the two stars in the front of the "cup" of the dipper are called, point the way to the North Star. Just draw that pointer line the other way, about the same distance, and you'll end up in the middle of the back of Leo. The sickle-shaped group of stars marks his head, with Regulus in his chest; the triangle indicates his hind-parts, with Denebola the tuft or brush at the tip of his tail.

☆☆ The format for this series that I have adopted has been one in which, after a look-see at the current sky, I pick a theme for an essay on some facet of astronomy—preferably one that may answer some questions that have been lurking in the minds of my readers, perhaps even without their knowing it. In December-January, it was meteors; in February-March, it was the March 7 solar eclipse, which I hope you may yet enjoy, if you haven't already seen it.

☆ This time, the topic is one that might better have appeared earlier, except that, with the normal schedule of publication, it still is appropriate, because the great religions, the Hebrew and the Christian, celebrate solemn festivals in the spring of the year, and the dates

THE SKIES ABOVE US

☆ For more than two thousand years before Abraham, the Egyptians were a sedentary people, tending their crops and their flocks and fishing in the life-giving Nile. The orderly flow of the seasons was most important to them and, while in their twelve-month calendar they paid a small tribute to the moon whose recurring phases may have served them earlier, they finally dropped the phases of the moon.

☆ It was very different with the descendants of Ishmael and Isaac, who adhered to the moon as the primary timekeeper and do even today, in establishing their religious festivals. Of course, for communication with others outside their faiths in business matters, Arabs, Jews, Hindus, Chinese, and Christians all use a common calendar, the one that hangs on our walls and considers January 1 as New Year's Day and the current year as 1970.

☆ But about one-sixth of the world's population celebrates the beginning of the Islamic (Mohammedan) year 1390 on March 9, this year. Another 15 million people, the Hebrews, celebrated Rosh Hashanah (1 Tishri), the beginning of the year 5730, on September 13 last year; New Year's Day for 5731 will fall on October 1, 1970. These two calendars have been singled out at this moment to point up their similarities and their differences. Also, as a scientist, I should not fail to remind you that, as all those born as Christians are not members of churches, many Hebrews are not associated with synagogues nor are all Islamites faithful to their mosques or ritual devotions.

☆ The Mohammedan calendar ignores the year of the seasons and adheres strictly to the phases of the moon for counting of the years.

If the earth and moon were isolated in space, the moon at its present distance would revolve around the common center of gravity of the earth and moon in 27.3217 days. But we're rather close to the sun, and this period varies because of the gravitational interference from our star, which is about 330,000 times as massive as the combined earth-moon system. Similarly, the period of the moon's phases must vary from about 29 days 6 hours to 29 days 20 hours. Over a long period of time, the average interval between new moons or between full moons comes out as 29 days 12 hours 44 minutes, or 29.5306 days.

☆ The Mohammedan calendar tries to keep in step with this, with 12 months alternately 30 and 29 days long, but to make up for an error of almost nine

hours, an extra day is added to the last month, 11 times in 30 Mohammedan years, bringing the average lunar month up to 29.306 days which, as we can see, is the true average length of the cycle of the phases.

☆ But the length of the year of the seasons is 365.2422 days, while the average length of the Mohammedan religious year of 12 lunar months is only 354.3672 days, which falls short by 10 days 21 hours. The Mohammedans make no attempt to match the seasons with their calendar of religious celebrations, so in 33 Islamic years the gain accumulates to 359 days. If you happen to meet a Mohammedan who says he is 33 years old, he may really have seen only 32 cycles of seasons.

☆ The Hebrew calendar certainly must be different, as we can quickly see from the dates given for the beginnings of the years 5730 and 5731; the interval is 383 days. But this is not a regular occurrence; 5730 is an "embolismic" year—one in which an addition is made to maintain a proper average length. We have seen that the Mohammedan insertion of an extra day at the end of each 11 years in each 30 keeps the lunar month, on the average, in step with the actual phases of the moon. In our familiar so-called Gregorian calendar we are familiar with the insertion of an extra day at the end of short-changed February each four years (except in those end-of-century years that can not be divided exactly by 400);

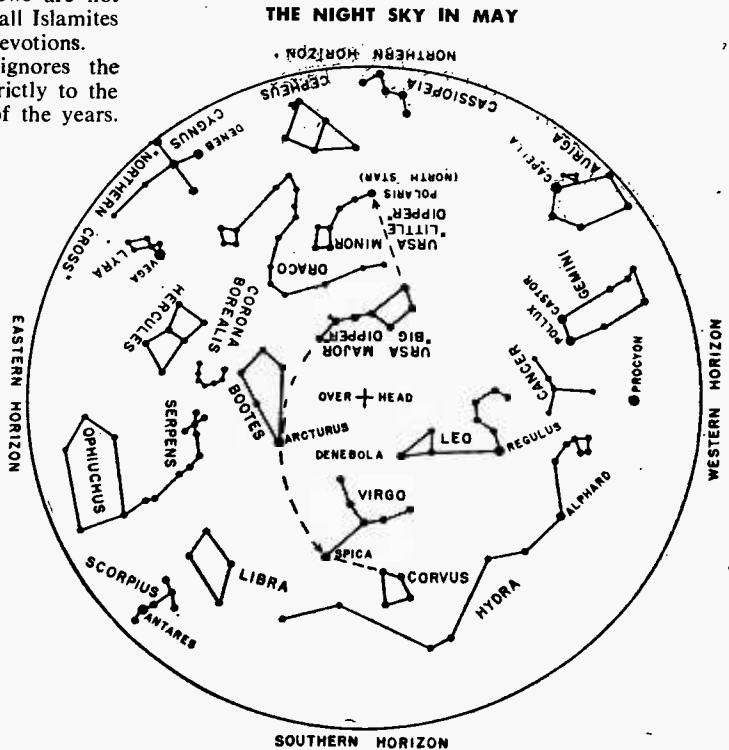

this keeps the calendar closely in step with the seasons. This kind of embolism is a good one; medical men use the word for a bad malfunction.

☆ In the Jewish calendar, the insertion is that of a whole month, according to a regular schedule that adds an extra month in seven of the years in a cycle of 19 years. There are 6939.6018 days in 19 years of the seasons and, with 12 lunar months in 12 years and 13 in the remaining 7, the total of the 235 months of 29.5306 days each comes to 6939.6910 days, an excess of 2 hours and a little more than 8 minutes. The average year is only 6.768 minutes too long, which builds up to a whole day in about 213 years. But by a judicious manipulation of the numbers of days in the months, even this small error can be forestalled.

There are two kinds of Jewish years; what we may call the civil year is the one that will begin on October 1 and it bears the official number. But the spiritual or sacred year begins in the spring. In ordinary years it begins at 1 Nisan, following the twelfth month, Adar, of the preceding year, and is the month in which the fourteenth day, when the full moon occurs, falls after March 21, when spring begins. In embolismic years, the thirteenth month follows Adar and is called a second Adar, or Adar II—sometimes called Veadar—and it is still 1 Nisan that opens the new sacred year.

The stars and time are endless. But, alas, this is not so for the space available to this columnist. So, we'll just have to continue our time discussion in the next issue of SCIENCE AND ELECTRONICS. ■

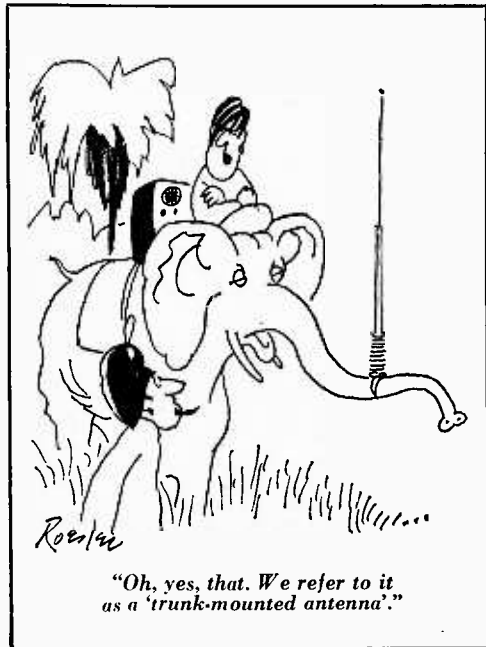

Science and Electronics

Volume 28

Number 2

JULIAN M. SIENKIEWICZ, WA2CQL
Editor-in-Chief

RICHARD A. FLANAGAN, KQD2566
Managing Editor

CHARLES S. HARRIS
Technical Editor

HELEN PARKER, KQD7967
News Editor

JIM MEDLER
Art Editor and Associate Art Director

**ARTHUR S. COOKFAIR; WEBB GARRISON;
ERNEST A. KEHR; MARSHALL LINCOLN,
K9KTL/W7DQS; ROY K. MARSHALL, PH.D.;
JACK SCHMIDT**
Contributing Editors

JOSEPH A. D'AMATO, Art Director
IRVING BERNSTEIN, Cover Art Director
BARBARA ALTMAN, Art Associate
DAVID F. MILLER, Advertising Director
CARL BARTEE, Production Director
GERTRUD BORCHARDT, Production Manager
MARILYN VARGAS, Assistant Production Manager
WILFRED M. BROWN,
Instruments Division Manager
ROGER G. CAVANAGH,
Circulation and Marketing Director

B. G. DAVIS, Chairman of the Board
JOEL DAVIS, President and Publisher
LEONARD F. PINTO,
Vice-President and General Manager
VICTOR C. STABILE, KBP0681,
Vice-President and Treasurer

SCIENCE AND ELECTRONICS is published bi-monthly by Science & Mechanics Publishing Co., a subsidiary of Davis Publications, Inc. Editorial, business, and subscription offices: 229 Park Avenue South, New York, N.Y. 10003. One-year subscription (six issues—\$4.00; two-year subscription (12 issues)—\$7.00; and three-year subscription (18 issues)—\$10.00. Add \$1.00 per year for postage outside the U.S.A. and Canada. Advertising offices: New York, 229 Park Avenue South, 212-OR 3-1300; Chicago, 520 N. Michigan Ave., 312-527-0330; Los Angeles, J. E. Publishers Rep. Co., 8380 Melrose Ave., 213-653-5841; Atlanta: Pirnie & Brown, 3108 Piedmont Rd., N.E., 404-233-6729; Long Island: Len Osten, 9 Garden Street, Great Neck, N.Y., 516-487-3305; Southwestern advertising representative: Jim Wright, 4 N. 8th St., St. Louis, 314-CH-1-1965.

EDITORIAL CONTRIBUTIONS must be accompanied by return postage and will be handled with reasonable care; however, publisher assumes no responsibility for return or safety of manuscripts, art work, or photographs. All contributions should be addressed to the Editor, SCIENCE AND ELECTRONICS, 229 Park Avenue South, New York, N.Y. 10003.

Second class postage paid at New York, New York and at additional mailing office. Copyright 1970 by Science and Mechanics Publishing Co.

LITERATURE



ELECTRONIC PARTS

2. Now, get the all-new 512-page, fully illustrated *Lafayette Radio* 1970 catalog. Discover the latest in CB gear, test equipment, ham gear, tools, books, hi-fi components and gifts. Do it now!

★5. *Edmund Scientific's* new catalog contains over 4000 products that embrace many interests and fields. It's a 148-page buyers' guide for Science Fair fans.

★4. *Olson's* catalog is a multi-colored newspaper that's packed with more bargains than a phone book has names. Don't believe us? Get a copy.

1. *Allied's* catalog is so widely used as a reference book that it's regarded as a standard by people in the electronics industry. Don't you have the 1970 *Allied Radio* catalog? The surprising thing is that it's free!

7. Before you build from scratch, check the *Fair Radio Sales* latest catalog for electronic gear that can be modified to your needs. *Fair* way to save cash.

8. Get it now! *John Meshna, Jr.'s* new 96-page catalog is jam packed with surplus buys—surplus radios, new parts, computer parts, etc.

★140. How cheap is cheap? Well, take a gander at *Cornell Electronics'* latest catalog. It's packed with bargains like 6W4, 12AX7, 5U4, etc., tubes for only 35¢. You've got to see this one to believe it!

135. *RCA Experimenter's Kits* for hobbyists, hams, technicians and students are the answer for successful and enjoyable building, creating, experimenting and learning. Find out for yourself by circling 135 now!

106. With 70 million TV and 240 million radios somebody somewhere will need a vacuum tube replacement at the rate of one a second! Get *Universal Tube Co.'s* Troubleshooting Chart and facts on their \$1.50 flat rate per tube.

10. *Burstein-Applebee* offers a new giant catalog containing 100s of big pages crammed with savings including hundreds of bargains on hi-fi kits, power tools, tubes, and parts.

★11. Now available from *EDI (Electronic Distributors, Inc.)*: a catalog containing hundreds of electronic items. *EDI* will be happy to place you on their mailing list.

6. Bargains galore, that's what's in store! *Poly-Paks Co.* will send you their latest 8-page flyer chock-full of *Poly-Paks'* new \$1.00 electronic and scientific "blis-dor" paks and equipment.

23. No electronics bargain hunter should be caught without the 1970 copy of *Radio Shack's* catalog. Some equipment and kit offers are so low, they look like misprints. Buying is believing.

CB—AMATEUR RADIO SHORTWAVE RADIO

102. No never mind what brand your CB set is. *Sentry* has the crystal you need. Same goes for ham rigs. Seeing is believing, so get *Sentry's* catalog today. Circle 102.

146. It may be the first—*Gilfer's* specialty catalog catering to the SWL. Books, rigs, what-nots—everything you need for your listening post. Go *Gilfer*, circle 146!

100. You can get increased CB range and clarity using the "Cobra-23" transceiver with speech compressor—receiver sensitivity is excellent. Catalog sheet will be mailed by *B&K Division of Dynascan Corporation*.

141. Newly-designed CB antenna catalog by *Antenna Specialists* has been sectionalized to facilitate the picking of an antenna or accessory from a handy index system. Man, *Antenna Specialists* makes the pickin' easy.

130. Bone up on the CB with the latest *Sams* books. Titles range from "ABC's of CB Radio" to "99 Ways to Improve your CB Radio." So Circle 130 and get the facts from *Sams*.

107. Want a deluxe CB base station? Then get the specs on *Tram's* all new Titan II—it's the SSB/AM rig you've been waiting for!

96. Get your copy of *E. F. Johnson's* new booklet, "Can *Johnson 2-Way Radio* Help Me?" Aimed for business use, the booklet is useful to everyone.

129. Boy, oh boy—if you want to read about a flock of CB winners, get your hands on *Lafayette's* new 1970 catalog. *Lafayette* has CB sets for all pocketbooks.

46. Pick up *Hallcrafters'* new four-page illustrated brochure describing *Hallcrafters'* line of monitor receivers—police, fire, ambulance, emergency, weather, business radio, all yours at the flip of a dial.

116. Pep-up your CB rig's performance with *Turner's* M+2 mobile microphone. Get complete spec sheets and data on other *Turner* mic's.

48. *Hy-Gain's* new CB antenna catalog is packed full of useful information and product data that every *CBer* should know. Get a copy.

111. Get the scoop on *Versa-Tronics'* Versa-Tenna with instant magnetic mounting. Antenna models available for *CBers*, hams and mobile units from 27 MHz to 1000 MHz.

45. *CBers*, Hams, SWLs—get your copy of *World Radio Labs'* 1970 catalog. If you're a wireless nut or experimenter, you'll take to this catalog.

101. If it's a CB product, chances are *International Crystal* has it listed in their colorful catalog. Whether kit or wired, accessory or test gear, this *CB*-oriented company can be relied on to fill the bill.

103. *Squires-Sanders* would like you to know about their *CB* transceivers, the "23'er" and the new "55S." Also, *CB* accessories that add versatility to their 5-watters.

TOOLS

★78. Need pliers to hold, bend or cut fine wires? Check *Xcelite's* new line of miniatures shown in Catalog 166 along with a complete selection of regular pliers and snips.

118. Secure coax cables, speaker wires, phone wires, etc., with *Arrow* staple gun tackers. 3 models for wires and cables from 3/16" to 1/2" dia. Get fact-full *Arrow* literature.

ELECTRONIC PRODUCTS

143. Bring new life to your hobby. Exciting plans for new projects—let *Electronics Hobby Shop* give you the dope. Circle 143, now.

★44. Kit builder? Like wired products? *EICO's* 1970 catalog takes care of both breeds of buyers. 32 pages full of hi-fi, test, *CB*, ham, SWL, automotive and hobby kits and products—do you have a copy?

★42. *Heath's* new 1970 full-color catalog is a shopper's dream. Its 116 pages are chock full of gadgets and goodies everyone would want to own. Mostly kits are shown but many factory-wired products are available. Get your catalog today!

144. Hear today the organ with the "Sound-of-Tomorrow," the Melo-Sonic by *Whippany Electronics*. It's portable—take it anywhere. Send for pics and descriptive literature.

12. *C. B. Hanson* new Automatic Control records both sides of a telephone call automatically—turns off automatically, too! Get all the details—today!

126. Did you dig *Delta's* new litera-

LIBRARY...

★ Starred items indicate advertisers in this issue. Consult their ads for additional information and specifications.

ture package chucked full of pics and specs on such goodies as an FET-VOM, SCR ignition system, computerized auto tach, hi-voltage analyzer, etc.? Man, then let *Delta* know you're alive! Circle 126 now!

109. *Seco* offers a line of specialized and standard test equipment that's ideal for the home experimenter and pro. Get specs and prices today.

★ **9.** Troubleshooting without test gear? Get with it—let *Accurate Instrument* clue you in on some great buys. Why do without?

145. *Alco Electronic Products* has 28 circuit ideas using their remote control relay. Get 100-and-one odd jobs done at home without calling an electrician. Get all the facts today!

SCHOOLS AND EDUCATIONAL

★ **136.** You can become an electrical engineer *only* if you take the first step. Circle 136 and *ICS* will send you their free illustrated catalog describing 17 special programs. *ICS* also has practical electrical courses that'll increase your income.

★ **74.** Get two free books—"How to Get a Commercial FCC License" and "How to Succeed in Electronics"—from *Cleveland Institute of Electronics*. Begin your future today!

★ **3.** Get all the facts on *Progressive Edu-Kits Home Radio Course*. Build 20 radios and electronic circuits; parts, tools and instructions come with course.

142. *Radio-Television Training of America* prepares you for a career—not a job. 16 big kits help you learn as you build. 120 lessons. Get all the facts today!

114. Prepare for tomorrow by studying at home with *Technical Training International*. Get the facts today on how you can step up in your present job.

137. For success in communications, broadcasting and electronics get your First Class FCC license and *Graham School of Electronics* will show you how. Interesting booklets are yours for the asking.

HI-FI/AUDIO

26. Get with 1970's hi-fi jet set. *H. H. Scott* sets the pace with their fantastic line of audio components, some in kit form, too! *Scott* will send you their 20-page catalog if you circle 26!

104. You can't hear FM stereo unless your FM antenna can pull 'em in. Learn more and discover what's available from *Finco's* 6-pages "Third Dimensional Sound."

119. *Kenwood* puts it right on the line. The all-new *Kenwood* FM-stereo receivers are described in a colorful booklet complete with easy-to-read-and-compare spec data. Get your copy today!

30. *Shure's* business is hi-fi—cartridges, tone arms, and headphone amps. Make it your business to know *Shure!*

17. Mikes, speakers, amps, receivers—you name it, *Electro-Voice* makes it and makes it good. Get the straight poop from *E-V* today.

99. Get the inside info on why *Koss/Acoustech's* solid-state amplifiers are the rage of the experts. Colorful brochure answers all your questions.

TAPE RECORDERS AND TAPE

14. You just gotta get *Craig's* new pocket-size, full-color folder illustrating what's new in home tape recorders—reel-to-reel, cartridge and cassette, you name it! It looks like a who's who for the tape industry.

123. Yours for the asking—*Elpa's* new "The Tape Recording Omnibook," 16 jam-packed pages on facts and tips you should know about before you buy a tape recorder.

31. All the facts about *Concord Electronics Corp.* tape recorders are yours for the asking in their free 1970 catalog. Portable, battery operated to four-track, fully transistorized stereos cover every recording need.

34. "All the Best from *Sony's*" is an 8-page booklet describing *Sony-Super-scope* products—tape recorders, microphones, tape and accessories. Get a copy today before you buy!

35. If you are a serious tape audiophile, you will be interested in the all new *Viking Telex* line of quality tape recorders.

TELEVISION

★ **70.** The all new Heathkit 1970 catalog is jammed with 7 color TV kits, plus buys on antennas, rotors, towers and other accessories, and TV test gear. Get your copy by circling item 70 below.

127. *National Schools* will help you learn all about color TV as you assemble their 25-in. color TV kit. Just one of *National's* many exciting and rewarding courses.

SCIENCE AND ELECTRONICS

Dept. 570

229 Park Avenue South
New York, N.Y. 10003

Please arrange to have this literature whose numbers I have circled at right sent to me as soon as possible. I am enclosing 25¢ to cover handling. (No stamps, please.)

Sorry, only 20 circled items maximum.



Indicate total number of booklets requested

1	2	3	4	5	6	7	8	9	10
11	12	14	17	23	26	30	31	34	35
42	44	45	46	48	70	74	78	96	99
100	101	102	103	104	106	107	109	111	114
116	118	119	123	126	127	129	130	135	136
137	140	141	142	143	144	145	146		

NAME _____

ADDRESS _____

CITY _____

STATE _____ ZIP _____

HOW TO GET STARTED IN RADIO

by Jack Schmidt

... establish the need



... open a charge account



... pick an antenna site



... locate the studio



... plug it in



... get a license



*Science and
Electronics*
APRIL-MAY 1970

“WINDY” the WIND GAUGE

by Edward A. Morris, WA2VLU

Peter, Paul and Mary made the tune “Blowing in the Wind” popular. But if you hope to find out just how fast the winds are a-blowing, the song’s lyric won’t help much. You’ll need an anemometer. Until now, if you’d had a need for an anemometer (wind gauge) or wanted one just because you were interested in keeping tabs on the prevailing winds,

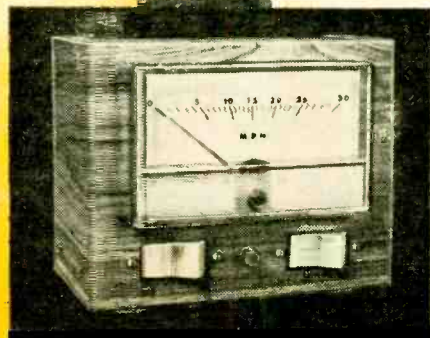

"WINDY"

you'd have had but two choices. Toy ones, though the price may be right, leave much to be desired in performance, reliability, and accuracy. On the other hand, the better-quality instruments, available from specialty stores, start at about \$125.00 and increase in cost very fast.

With our Windy you bridge the gap. Its accuracy is 5% or better, and its cost is reasonable, being in the \$30.00 range. Dual meter ranges cover 0-30 mph and 0-90 mph. Readout is indicated on a large, clear, easy-to-read meter scale. And its remote pickup head can be located up to 150 feet from the readout indicator.

Windy's low cost and high accuracy are achieved through use of two integrated circuits (ICs), which together replace 12 transistors and 24 resistors. A novel optical sensor in the remote pickup head speeds construction by replacing a more complicated mechanical design.

How Windy Works. Whenever the wind blows, it revolves the windcups. The remote pickup head, built into the housing that supports the windcups, is a photoelectric pulse generator whose pulse rate is directly proportional to the speed of the wind. A disc, having holes punched uniformly around its edge, is fastened to the end of the shaft opposite the windcups. Mounted above this disc is a light source that shines through the perforations into a variable-resistance photocell positioned below the

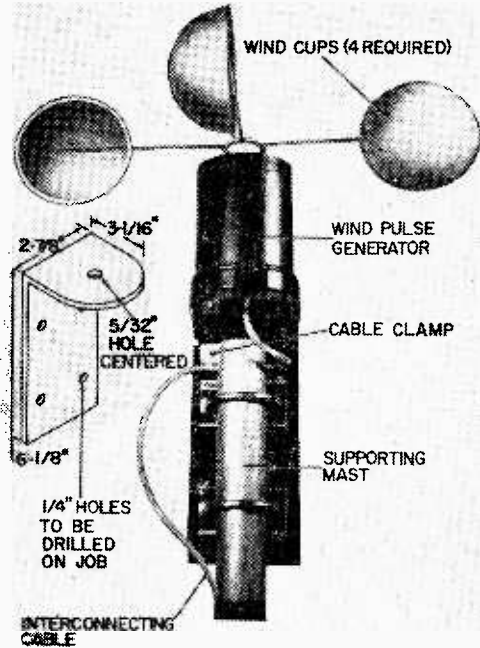
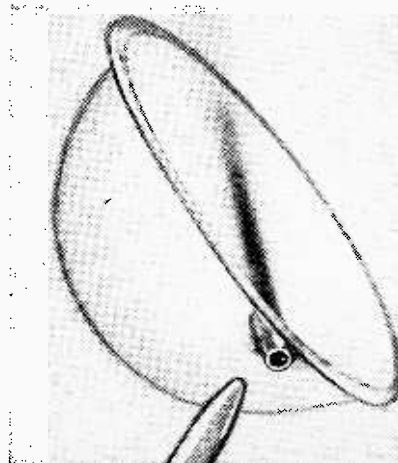
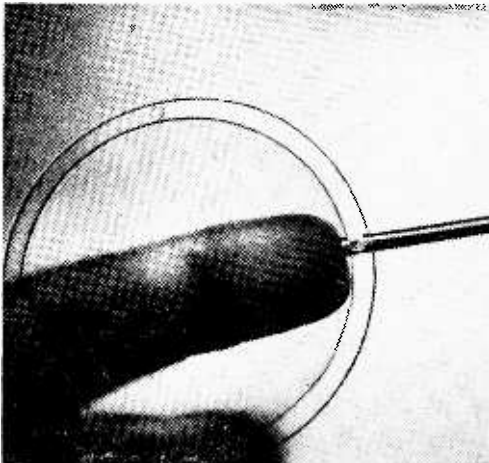
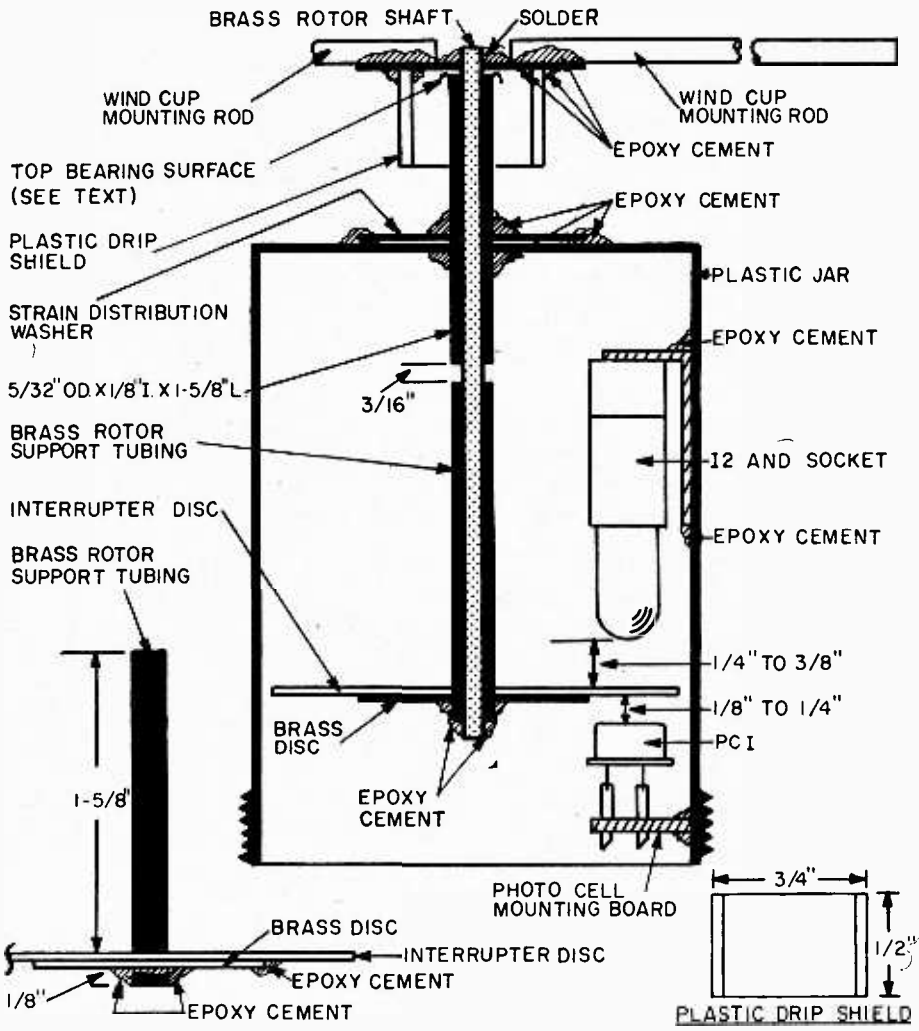

Photo above shows how Wind Cup generator is fastened to its mounting mast. Also, details on making the mounting bracket are shown. Photo below left illustrates how finger is used as a mandrel when punching holes in the polystyrene Wind Cups, with a tool made by sharpening a piece of 1/8-in brass tubing. In the photo below right pointer shows where epoxy is placed to fasten Wind Cups to brass mounting rods. On the opposite page are construction details for the Wind Cup generator. Though not shown in the drawing, leads from lamp 12 must be tacked to side wall of jar to keep them away from the rotor disc, to prevent disc binding.



WIND CUP PULSE GENERATOR



DETAIL SHOWS HOW INTERRUPTER DISC MOUNTED ON ROTOR SHAFT

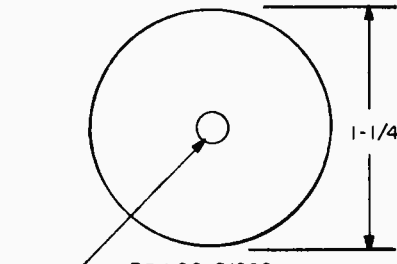

MAKE 3 DISCS; 2 WITH 5/32" DIA. HOLES, 1 WITH 1/8" DIA. HOLE;

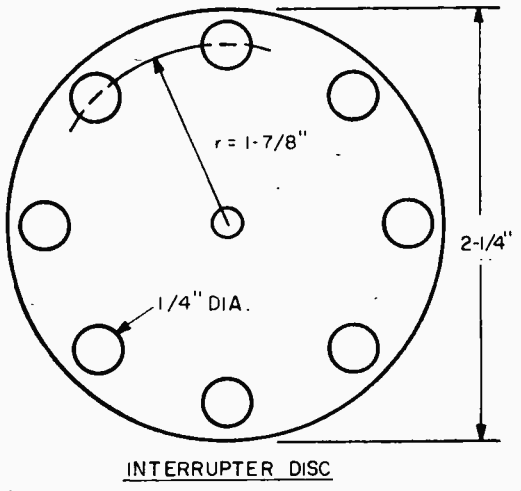

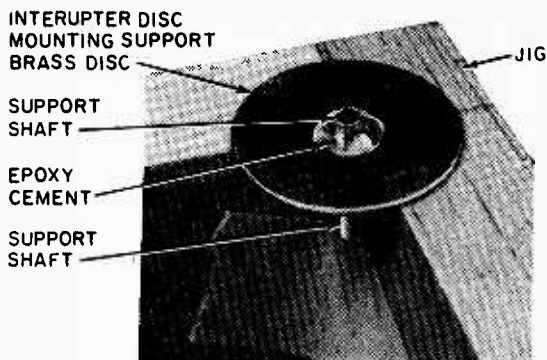
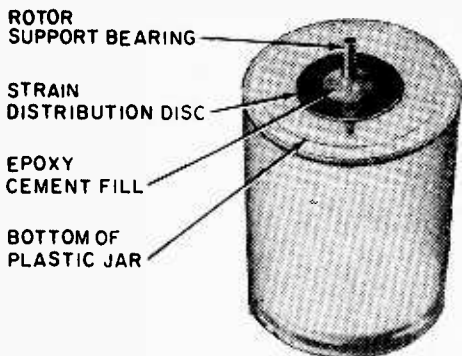

"WINDY"

disc directly under the light source (the disc is sandwiched between the light source and the photocell).

When the wind blows, the cups rotate the shaft, which, in turn, rotates the perforated disc. This allows light to alternately shine through to, and to be cut off from, the photocell. Each time light strikes the cell, its resistance drops sharply. The photocell and resistor R3 form a voltage divider across the power source. When the resistance of the photocell is momentarily reduced by excitation from the light source, the voltage in that part of the divider is reduced. A pulse results from the sharp increase in current and resultant voltage drop.

This pulse triggers the hex inverter (IC1) which shapes and amplifies the pulse signals appearing across the voltage divider. The first inverter of IC1, biased by resistor R4, operates as a class-A amplifier. Succeeding stages are connected in cascade and operate with no bias. This considerably improves the input pulse rise and fall time that is necessary for accurate performance. A small amount of positive feedback in stages 4 and 5 further improves the rise and fall time of the pulses. Capacitor C3 on the input acts as a high-frequency filter, eliminating false triggering that could be created by spurious signals picked up in the long lead line.

Stages 3, 4, and 5 of the IC are wired as a one-shot multivibrator that is triggered by the shaped and amplified pulses from the previous stages.

The sharp input pulses from IC1 are differentiated by capacitor C6 and resistor R5. The leading edge of the pulse triggers a constant-width, monostable multivibrator, formed by three of the inverters in IC2. Each time the one-shot multi is triggered, it flips from its stable state to an unstable state. The amount of time that it remains in this unstable state is determined by the values of resistance and capacitance in the coupling network. The *on* time is set by range selection capacitors C7 and C8, calibration control R6, and resistor R7. The output pulse from the one-shot multi is buffered and inverted by the remaining three inverters in IC2, which are connected in cascade (see schematic for ICs).

Protected Meter. When the one-shot is triggered, the output at pin 7 from IC2 drops from 3.6 V, the supply voltage, to a mere few tenths of a volt. This effectively

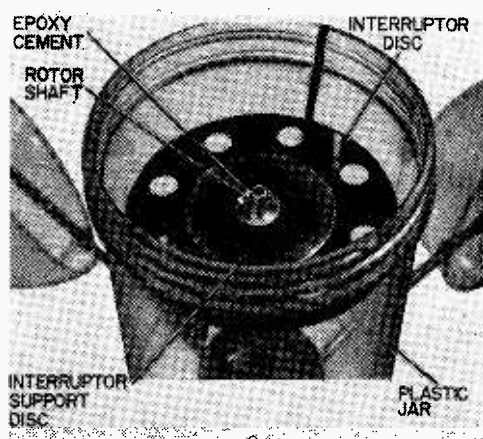

After installing I2, interrupter disc is held 1/8-in. from bottom of rotor shaft and cemented with epoxy to the rotor shaft.

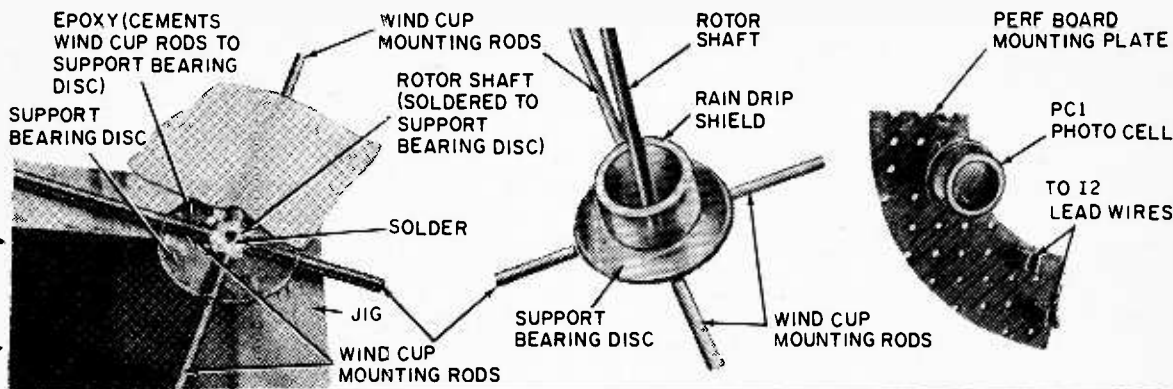

grounds the end of resistor R8 connected to the IC, and a pulse of current flows through meter M1. As the wind picks up speed, the one-shot is triggered more often, directly in proportion to the wind speed. The pulse rate increases, and meter M1 and capacitor C9 integrate the output pulses into a wind speed reading. Should the voltage across the meter exceed 0.6 volt, diode D6 conducts, shunting current around the meter and protecting it from overload.

A Zener-diode regulated power supply provides + 3.6 VDC power for the instrument. Output from the secondary of transformer T1 is rectified by a fullwave bridge rectifier comprised of diodes D1 through

D4. Capacitor C1 brute-force filters the rectified output; Zener diode D6 holds the voltage on the base of transistor Q1 at 4.2 V. Since transistor Q1 is connected as an emitter follower, the filtered DC output appears on Q1's emitter. Low-voltage AC power to operate exciter lamp I2 is provided by the 6.3-V secondary winding of the power transformer.

Construction Tips. Prior to starting the actual fabrication of the various units comprising Windy, we suggest you study our photos and illustrations to familiarize yourself with the basic units, how they were constructed, and their relationship to one another. Take into account the dimensions shown in relation to materials you have readily available. It may be necessary for you to compromise somewhat in order to use available sources.

Epoxy cement contributes a great deal to the building of Windy. In order to receive the most benefits from epoxy cements, the resin and the hardener must be thoroughly mixed as quickly as possible. Try to use the new 5-minute curing epoxies; they'll speed up the waiting time.

The remote pickup head, which actually

PARTS LIST FOR WINDY'S PULSE GENERATOR

I2 #755 single contact, miniature bayonet base, 6.3 V-0.15 A lamp bulb (Lafayette 32E69032 or equiv.)

P1 5-pin plug with hood and cable clamp (Amphenol 126-217 or equiv.)

PC1 Photocell, Clairex C L-703L

1 Miniature bayonet base, pilot lamp holder (Lafayette 37E28079 or equiv.)

1 2 $\frac{3}{8}$ x 3 $\frac{1}{2}$ -in. plastic jar with screw-on cover

1 2 $\frac{7}{8}$ x 9 $\frac{1}{16}$ x $\frac{1}{4}$ -in. plexiglas for mounting bracket (see text)

1 $\frac{3}{4}$ -in. OD, $\frac{5}{8}$ -in. ID x $\frac{1}{2}$ -in. long plastic tubing for rain drip shield

4 3-in. dia. light plastic half hemispheres

4 Pieces $\frac{1}{8}$ -in. OD x 6-in. long brass tubing

1 Piece $\frac{3}{32}$ -in. OD, $\frac{1}{8}$ -in. ID x 1 $\frac{1}{2}$ -in. long brass tubing

1 Piece $\frac{3}{32}$ -in. OD, $\frac{1}{8}$ -in. ID x 1 $\frac{3}{4}$ -in. long brass tubing

3 $\frac{1}{32}$ -in. thick, half-hard brass discs, $\frac{1}{4}$ -in. OD (if discs not available cut from sheet brass)

1 Bakelite disc $\frac{1}{32}$ -in. thick x 2 $\frac{1}{4}$ -in. dia.

1 2 x 1-in. piece perfboard

Misc. Length as required (not to exceed 150 ft.)

Belden #8734 3-conductor cable with vinyl insulation and overall vinyl jacket (one conductor shielded), black spray paint, antenna mast mounting hardware (Lafayette 18E01950 or equiv.)

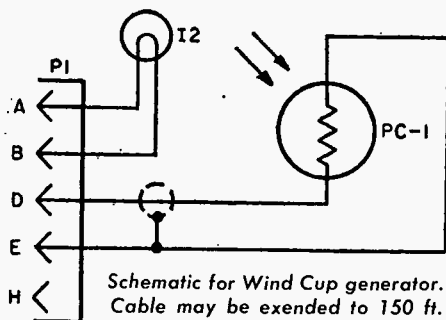

Schematic for Wind Cup generator. Cable may be extended to 150 ft.

"WINDY"

The schematic at the top details the circuit for the indicator unit of Windy, except for its power supply. The diagram shows proper orientation for the IC's, looking on them. The lower diagram details the power supply, which employs a 4.2 v Zener diode to regulate the output voltage that energizes the indicator unit electronics circuit.

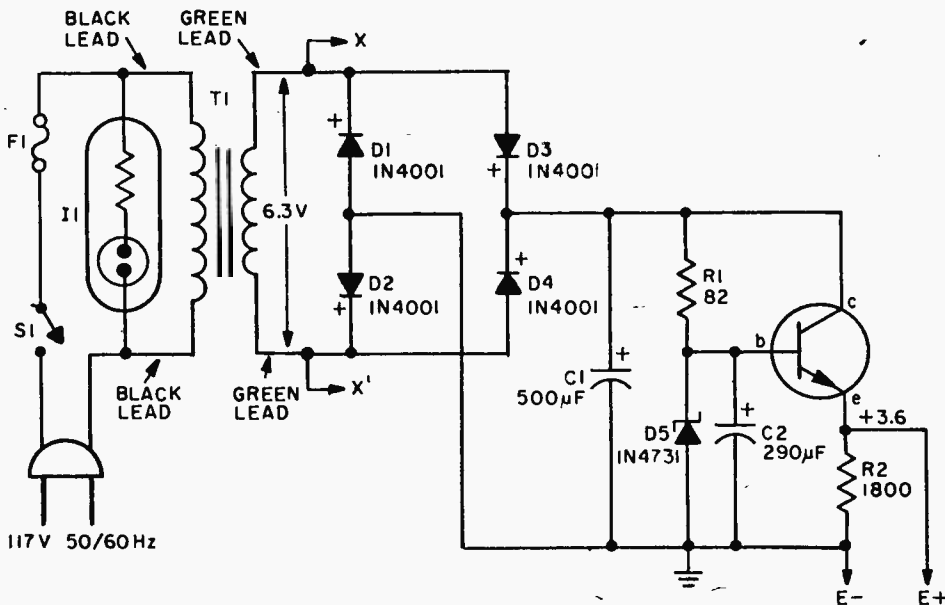
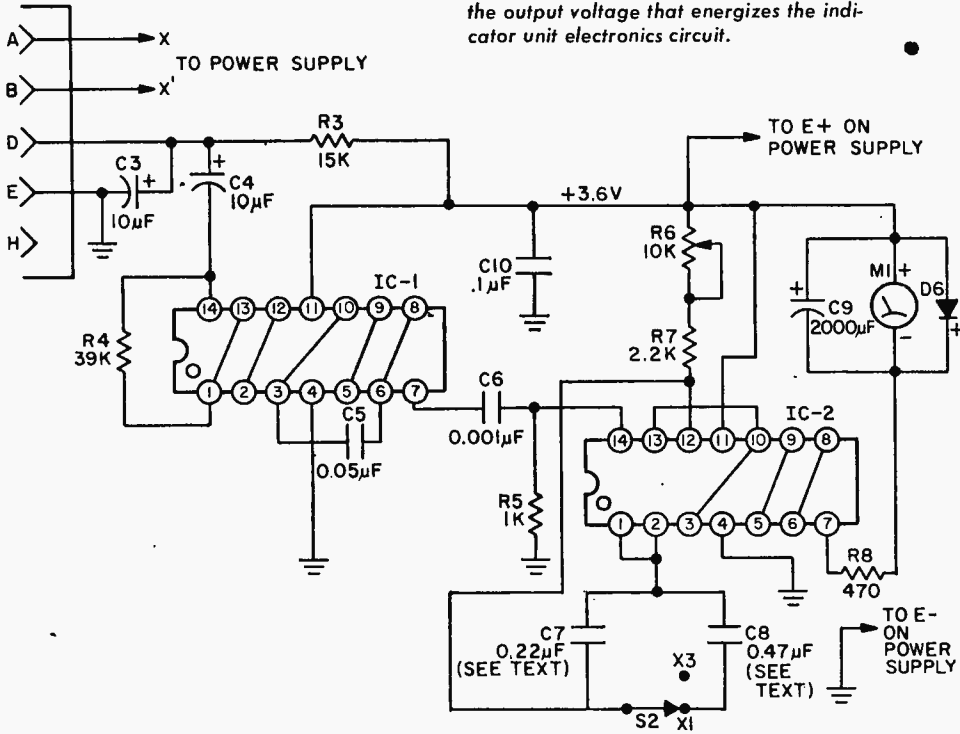

is a windcup pulse generator, is housed in a small plastic jar, preferably one with a screw-type cover. To ensure that no extraneous light reaches the photocell, we recommend that you spray the jar and its cover with several coats of flat black paint to completely opaque it. (We purposely did our painting after completion of construction in order that details in construction would show-up better in our photos.)

Drill a $\frac{5}{32}$ -in. hole in the lid of the jar to permit the lead cable to exit from the jar. Also drill the same size hole in the exact center of the bottom of the jar.

You'll need three discs made from $\frac{1}{32}$ -in. thick half-hard brass. The outside diameter of the discs is $\frac{1}{4}$ -in. Two should have a $\frac{5}{32}$ -in. hole drilled at the exact center; the remaining one should have a $\frac{1}{8}$ -in. diameter hole drilled in its center. One of the discs with a $\frac{5}{32}$ -in. hole serves as a strain distribution washer. The center holes in the strain washer and the bottom of the cup must be aligned to permit bearing support tubing to pass through both easily for free shaft rotation.

Prepare the bearing support tubing, made from a $1\frac{1}{8}$ -in. length of $\frac{5}{32}$ -in. OD, $\frac{1}{8}$ -in.

ID brass tubing for mounting in the base of the cup. It's important that the inner and outer surface of one end of this piece of tubing be as smooth as possible, since these surfaces are top bearing surfaces. The tubing should be chucked in a slow-speed drill (400-600 rpm) and smoothed both on inner and outer surfaces with a fine needle file. Bring the file against the rotating tubing to create a smoothed radius on one end.

We cannot emphasize too strongly the importance of a smooth surface for the bearing support tubing. Rough spots at this point can create future trouble either by slowing down the rotor because whatever produced the rough spot gouged the surface of the support bearing disc or, perhaps, when the atmosphere is quite humid and the temperature drops suddenly, the moisture trapped between the gouge in the disc and the bearing support tubing freezes and stops the rotor completely.

Cement this bearing support tubing in position to the bottom of the plastic jar with a blob of epoxy spread uniformly around the tubing both inside and outside the plastic jar to give added support to the bearing. The end of the tubing with the smoothed

PARTS LIST FOR WINDY'S INDICATOR

- | | |
|---|---|
| C1 500-uF, 15-VDC electrolytic capacitor (Sprague TVA1162 or equiv.) | Q1 Npn silicon transistor, type 2N697 |
| C2 290-uF, 12-VDC electrolytic capacitor (Sprague TE1139 or equiv.) | R1 82-ohm, $\frac{1}{2}$ -watt resistor |
| C3, C4 10-uF, 15-VDC electrolytic capacitor (Sprague TE1155 or equiv.) | R2 1800-ohm, $\frac{1}{2}$ -watt resistor |
| C5 0.05-uF, 12-VDC ceramic (Erie 5635-000 Y5FD-503M or equiv.) | R3 15,000-ohm, $\frac{1}{2}$ -watt resistor |
| C6 0.001-uF, 100-VDC ceramic capacitor (Erie 801-000X5FD102K or equiv.) | R4 39,000-ohm, $\frac{1}{2}$ -watt resistor |
| C7 0.22-uF, 12-VDC ceramic capacitor (Erie 5615-000Y5FD224M or equiv.) | R5 1000-ohm, $\frac{1}{2}$ -watt resistor |
| C8 0.47-uF, 200-VDC capacitor (Aerovox V1462-134 or equiv.) | R6 10,000-ohm, PC board mounted miniature potentiometer (Mallory MTC1L41 or equiv.) |
| C9 2000-uF, 25-VDC electrolytic capacitor (Cornell Dubilier BR2000-25 or equiv.) | R7 2200-ohm, $\frac{1}{2}$ -watt resistor |
| C10 0.1 uF, 12VDC ceramic capacitor (Erie 5655-000-Y5F0-104M) | R8 470-ohm, $\frac{1}{2}$ -watt resistor |
| D1, D2, D3, D4 1N40001 silicon diode, 50 PIV, 1 A | S1, S2 Spst rocker type switch (Cutler Hammer 8144K21A1M52 or equiv.) |
| D5 1N4731 Zener diode, 4.2 volt, 1 watt, 10% tolerance | T1 Low voltage power transformer; primary 117 V, 50/60 Hz, secondary 6.3 VAC at 0.6 A (Stancor D6465 or equiv.) |
| F1 Fuse, type 3AG, $\frac{1}{4}$ A | 1 Aluminum minibox 4 x 5 x 6-in. (Lafayette 12E83746 or equiv.—see text) |
| I1 Neon pilot lamp assembly, amber lens caps (Lafayette 34E52174 or equiv.) | 1 Dual fuse holder, 1 active, 1 spare (Lafayette 99E63372) |
| IC1, IC2 Integrated circuit, hex inverter (Motorola MC789P) | 1 Piece perfboard (0.2 holes on 0.1-in. grid pattern) Lafayette 19E83584 or equiv.) |
| J1 5-pin chassis socket (Amphenol 126-218 or equiv.) | 1 Heat sink for Q1 (Wakefield NF-209) |
| M1 0-1 mA meter (3 x $4\frac{1}{2}$ -in.) 100 ohms or less coil resistance (see text) | 2 Sockets for ICs (Lafayette 47A2152 or equiv.—optional, see text) |
| | Misc. Transfer letters (Datak or equiv.), bolts, nuts, hardware, push-in terminals and eyelets, pressure sensitive vinyl finishing material (Contac or equiv.), 5-minute curing epoxy, RTV Silicone Seal, rubber feet, AC line cord, wire, solder, etc. |

"WINDY"

radius should protrude $\frac{3}{8}$ -in. beyond the strain distribution washer.

The Interrupter Disc. This disc is made from thin, rigid plastic sheet. If not opaque, spray it with flat black paint after cutting to size and punching holes in it. Punch eight $\frac{1}{4}$ -in. diameter holes, in the disc, spaced uniformly around the circumference on a radius of $1\frac{1}{8}$ -in. Also drill a $\frac{5}{32}$ -in. hole in the exact center of the disc.

At this point make a jig from two pieces of wood, at least $\frac{3}{4}$ -in. thick by $3\frac{1}{2}$ -in. wide, fastened at right angles. This jig is used to assure proper alignment of the interrupter disc on its bearing disc to the rotor shaft.

Insert a $1\frac{3}{4}$ -in. long x $\frac{5}{32}$ -in. OD, $\frac{1}{8}$ -in. ID piece of brass tubing into the center hole of the plastic disc so that it protrudes $\frac{1}{8}$ -in. beyond the outer surface of the interrupter disc. Temporarily fasten the tubing with masking tape to the jig as shown in our photo. Next, epoxy one of the brass discs to the interrupter disc and cement both the perforated plastic interrupter and brass discs to the brass support tubing, spreading the epoxy uniformly around the tubing.

Rotor Shaft. A good time to prepare the rotor shaft is while the epoxy cement for the interrupter disc assembly is curing. It is made from a $3\frac{1}{16}$ -in. length of brass tubing $\frac{1}{8}$ -in. OD. Check it for trueness and fit in the bearing support tubing previously epoxied in the plastic jar. The rotor must fit inside the bearing tubing snugly, but must still rotate freely in it.

Right side of Indicator unit shows location of J1, exit hole for power cord and mounting screws for T1 and fuse mounting board.



Four lengths of brass tubing $\frac{1}{8}$ -in. OD by 6-in. long serve as support arms for the four wind cups. These arms are epoxy cemented to the top of the bearing support disc at right angles to one another. One end of each of the rods should be $\frac{5}{16}$ -in. from the center line of the rotor shaft to leave a clear area so that rotor shaft can be soldered to the disc. For balance it's important that the arms are each separated by 90° . You should use a protractor to double-check this placement.

As soon as epoxy on the interrupter disc assembly has cured, the jig can be freed for proper alignment of the rotor when fastening the rotor shaft to the brass support bearing disc. Solder the brass rotor shaft to the brass disc, employing the jig to ensure ac-

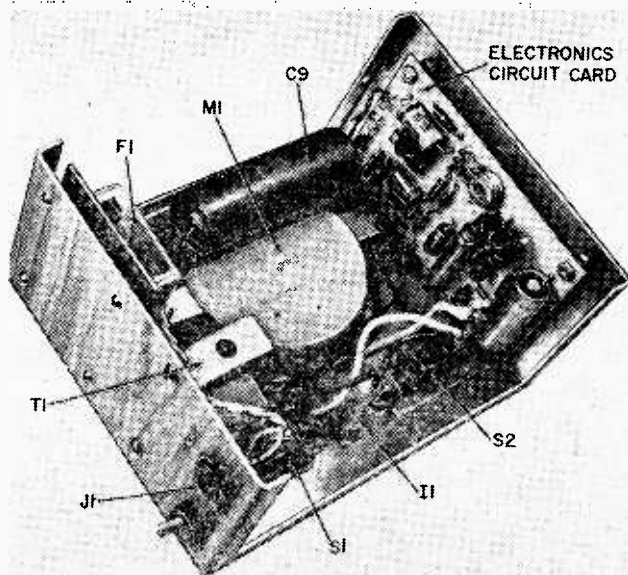
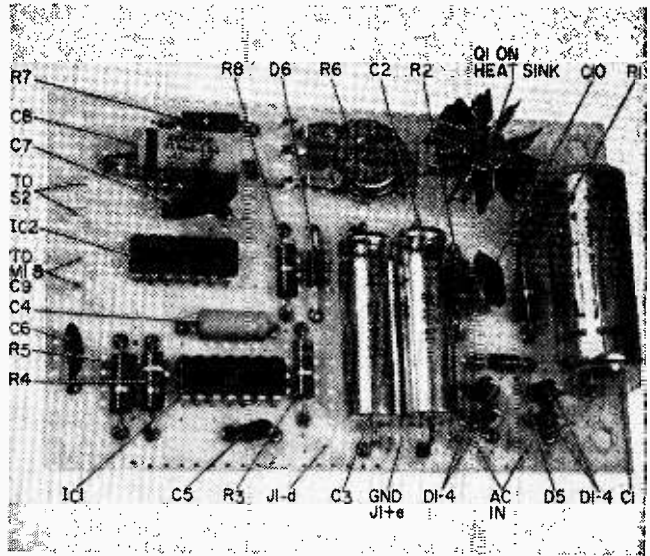

Photo shows the neat layout for the electronic components making up the Indicator unit. The power supply is located on the right (except for diodes and capacitors), the electronics card is on the left side and meter and controls on front.

The electronics circuit card is detailed here. Although the photo shows both C2 and C3 the same size, the author recommends C3 a 10 uF, 15v electrolytic.



curate alignment. Be careful not to bend wind cup mounting rods.

The rotor-shaft assembly and the interrupter-disc assembly are now ready to be mounted in the plastic jar. But first, a lamp holder, to which a pair of leads has been soldered, must be epoxied inside the plastic jar as shown in our illustration. At this stage you should also prepare a mounting board on which the photocell and terminals for the cable between the wind generator and the indicator are installed. The lead wires from the photocell and to the exciter lamp are contained in this cable.

Make the photocell terminal mounting board from a piece of perboard cut into a truncated pie section having an outside radius of 1¼-in. and an inside radius of ¾-in. Overall length of the board should be 1½-in. and it should be ½-in. wide. The photocell is mounted on push-in terminals. Terminal points between the lamp and photocell leads and the lead cable to the indicator are also push-in terminals.

Cement a rain shield, which is a ½-in. length of plastic tubing having a ¾-in. OD x ⅝-in. ID, to the bottom of the brass-support bearing disc. It should be positioned concentric to the disc, as shown in photo.

Note the clean long scale of the meter used to make it easy to read calibrations. Also note rubber feet on bottom (not mentioned in Parts List). Rocker type switches used for ranging and on/off control are easy to operate.

Assembly of Pulse Generator. Before final assembly it's best to insert the lamp in its socket and test it to be sure it's working. Once the assembly has been completed it will be difficult to reach the bulb. For this reason we've specified the 50,000-hour long life bulb instead of an electrically interchangeable #47 pilot lamp, which doesn't claim anywhere near that length of life before burnout.

At this stage opaque the housing with dark spray paint if your plastic jar requires it.

Silicone grease, the type used in heat-sinking power transistors, will prevent

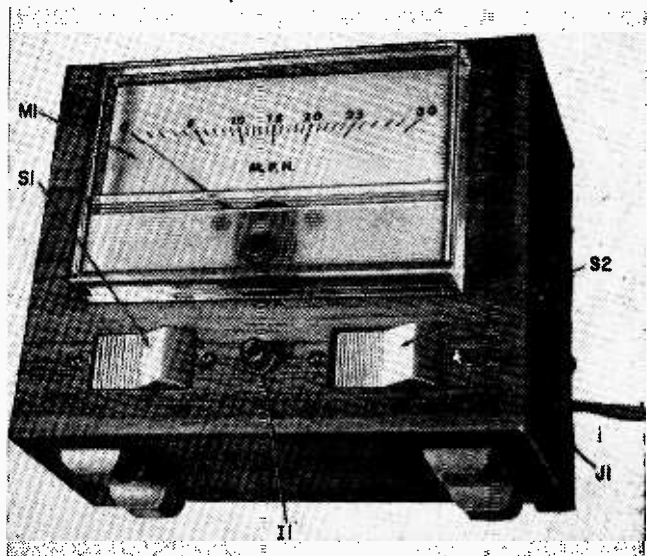

"WINDY"

freeze-up when the temperature drops and will also provide lubrication to allow the rotor to turn with little resistance. Place a pea-sized dab on the bearing surface of the support bearing disc. This lubricant should be applied each year before the start of cold weather.

Final Assembly. Insert the rotor assembly into the support bearing tube in generator housing. Now invert the housing and slip the interrupter disc assembly, with its support tubing, over the rotor so that the end of the support tube rides $\frac{1}{8}$ -in. below the end of the rotor shaft. Use a single drop of epoxy to cement the support tube to the rotor shaft. If you located the lamp socket correctly within the generator housing, the lamp bulb should clear the interrupter disc by $\frac{1}{4}$ - to $\frac{3}{8}$ -in. when the housing is positioned so that the interrupter disc faces down. In this position you should note about $\frac{3}{16}$ -in. up-and-down play in the rotor shaft.

With the photocell mounted in position (see illustration) on its circuit board, cement this assembly inside the generator housing directly below the lamp so that the space between the bottom of the housing and the circuit board is $\frac{3}{16}$ -in. The lead cable will be connected and the cover of the jar fastened in position after the wind cups have been epoxied in position. The reason for this is that the jar can rest on the bench during this assembly if the wire is not in position at this time.

Wind Cups. We made our wind cups from thin, styrene plastic, half spheres, 3 in. in diameter. You may use smaller ones, but no smaller than $2\frac{1}{2}$ -in. in diameter. Regardless of the diameter of the wind cups, the center-to-center spacing should not be changed, since this would affect overall calibration of the instrument.

Make a punch by sharpening one end of a scrap of $\frac{1}{8}$ -in. diameter brass tubing, for punching the holes in the plastic hemispheres, as shown in our photo. The cups should be epoxied to their respective lengths of $\frac{1}{8}$ -in. OD tubing, positioned as shown in the photos.

Mounting Bracket. The mounting bracket for the completed wind cup pulse generator unit can be made from plastic (which we

used), or from metal (iron or aluminum), or from wood.

If you use plastic, make the 90° bend by gently heating the plastic with a small butane torch, being careful not to touch it with the flame. When the plastic softens and becomes pliable, form it over a right-angled block. Keep the material in position over the block until it has cooled down, at which time it will be rigid. If wood is used the bracket is formed by nailing two pieces of wood together at right angles in the shape of the bracket shown in our photos. Metal is formed either in a brake or a bench vise.

Epoxy cement the plastic jar cap to the bracket so that the jar containing the pulse generator and wind cups can be screwed into the jar cap, thus holding it in position. Drill a hole in the bracket to permit the lead wires from the generator assembly to feed out of the jar.

Now The Indicator. The major mechanical construction is complete now and the only remaining assembly work is the indicator unit, which contains the electronics.

We started by trimming a standard 6 x 5 x 4-in. minibox to a 6 x 5 x 3-in. dimension. Since we used aluminum it was easy to pare 1 in. off the depth.

First step is to cut out the large round hole for the meter, and the rectangular holes for the rocker switches, and drill the hole for the pilot lamp, all on the front panel of the major half of the minibox. Also drill mounting holes for the power transformer, fuse holder, input jack, and AC cord on the right-hand side of the box and mounting holes for the circuit board on the left side.

To cut the meter hole and the rectangular switch holes, use a hand nibbler, or, if one isn't available, drill a series of small holes very close together around the periphery of the main holes. Then knock out the large pieces of metal and file the edges smooth to the exact sizes and shapes required. Deburr all holes before assembly. We used a rectangular 0.1 mA meter we happened to have in the spare-parts box. However, any 0.1 mA having a coil resistance of 100 ohms or less will work. Be sure you have enough room in the cabinet for the size meter you use.

Mount the fuse holder on a 2 x $2\frac{1}{2}$ -in. piece of perfboard. The mounting screws for this board should be 4-40s at least $\frac{1}{2}$ -in. long so that the board can be held away

(Continued on page 99)

by Charles D. Rakes

TREASURE WITCHER

If these headphones give you a buzz, dig where you hear the tone unless you think the ground is bewitched.

HUNTING treasure, or water pipes? Then you must, without delay, build our **TREASURE WITCHER**. With this super-sensitive solid-state instrument you'll greatly improve your odds of finding that long-forgotten treasure that could be only a few feet below the Earth's surface. But you say, why build the **WITCHER**?

Simple. With the **TREASURE WITCHER** you'll be able to locate large metal objects at greater depths than with a metal locator of the beat-frequency type. A large metal chest or a wooden box filled with metal—gold coins, say—will easily be detected several feet beyond the range of beat-frequency type units. Dig knowing where to dig! If so, read on and learn how you can duplicate this handy treasure finder.

Theory of Operation. No magic, only simple facts are needed to



Photo by David Petzal

TREASURE WITCHER

explain the operation of this sensitive metal locator. Two separate units are required in its makeup: a simple transmitter and a receiver, both of which use a loop coil in their tuned circuit. The loop coil also functions as a highly directional antenna.

When the two loop antennas are at right angles to each other, the signal coupled from the transmitter to the receiver is at a minimum and the meter will read zero. But bring a metal object within range of the WITCHER and the transmitted RF field will be distorted. Result is a small amount of RF energy will be reflected to the receiver loop. Picked up and amplified, it will be detected and indicated by the meter and heard on the earphones.

Transmitter Operation. As shown in Fig. 1, transistor Q1 and its associated components, L1, C1, C2, C3, R1, R2, and R3 form an oscillator. The operating frequency, which is in the RF range, is determined by the loop and the three capacitors. The three resistors are used to set the operating bias and output level of the oscillator.

Unijunction transistor Q2 operates as a relaxation oscillator and produces a low-frequency audio tone. This audio signal is coupled to the base of Q1 through C4 and modulates the RF oscillator (Q1). The modulated signal can then be received by a conventional receiver circuit, that extracts the signal that tells where the treasure is.

Receiver Operation. The receiver circuit (Fig. 2) is designed around a very high-gain, linear IC (integrated circuit) that contains three separate high-gain amplifiers, which, when connected in a cascade amplifier configuration, realize a gain of 129 dB.

The first IC amplifier stage is connected together with the tuned circuit as an RF amplifier, which is used to increase the minute signal available at the receiver's loop antenna to a level that can be demodulated into a useful audio signal. The network composed of D2, C7, and R3 performs the demodulation. The demodulated signal appears across gain control potentiometer R3 and is directed to the second amplifier stage through the pot's wiper. This audio signal is once more amplified by the remaining IC amplifier stage. The output is directed to the meter circuit and supplies an audio tone for the earphones, which plug into jack J1.

PARTS LIST FOR TRANSMITTER

- | | |
|--|--|
| B1—9-V transistor battery (Eveready 216 BP or equiv.) | R3—1000-ohm, 1/2-watt resistor |
| C1—50-pF to 380-pF midget trimmer (Lafayette 34E68337 or equiv.) | R4—180-ohm, 1/2-watt resistor |
| C2—3300-pF mica capacitor | R5—47,000-ohm, 1/2-watt resistor |
| C3—10,000-pF mica capacitor | S1—Spst miniature toggle switch (Lafayette 99E61624 or equiv.) |
| C4, C5—0.1- μ F, 200-V tubular capacitor | 1— $6\frac{1}{8} \times 5\frac{9}{32} \times 2\frac{5}{16}$ -in. plastic case (Allied 42A7886 or equiv.) |
| L1—34 turns of #22 enamel wire closewound outside of case | 1— $6\frac{1}{2} \times 5$ -in. cover (Allied 42A7888 or equiv.) |
| Q1—2N2924 transistor (GE) | 1— $2\frac{7}{8} \times \frac{7}{8}$ -in. perfboard |
| Q2—2N2646 unijunction transistor (Motorola) | 1—48-in. aluminum conduit |
| R1—150,000-ohm, 1/2-watt resistor | 1—Battery holder (Keystone 203P or equiv.) |
| R2—39,000-ohm, 1/2-watt resistor | Misc.—Hex spacers, hardware, wing nut, spring, solder, hookup wire, etc. |

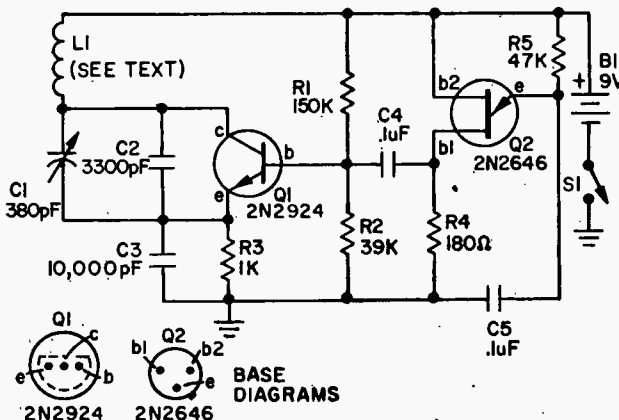

Fig. 1. Transmitter schematic details separate unijunction relaxation oscillator modulating npn transistor RF oscillator to produce the tracer's search signal.

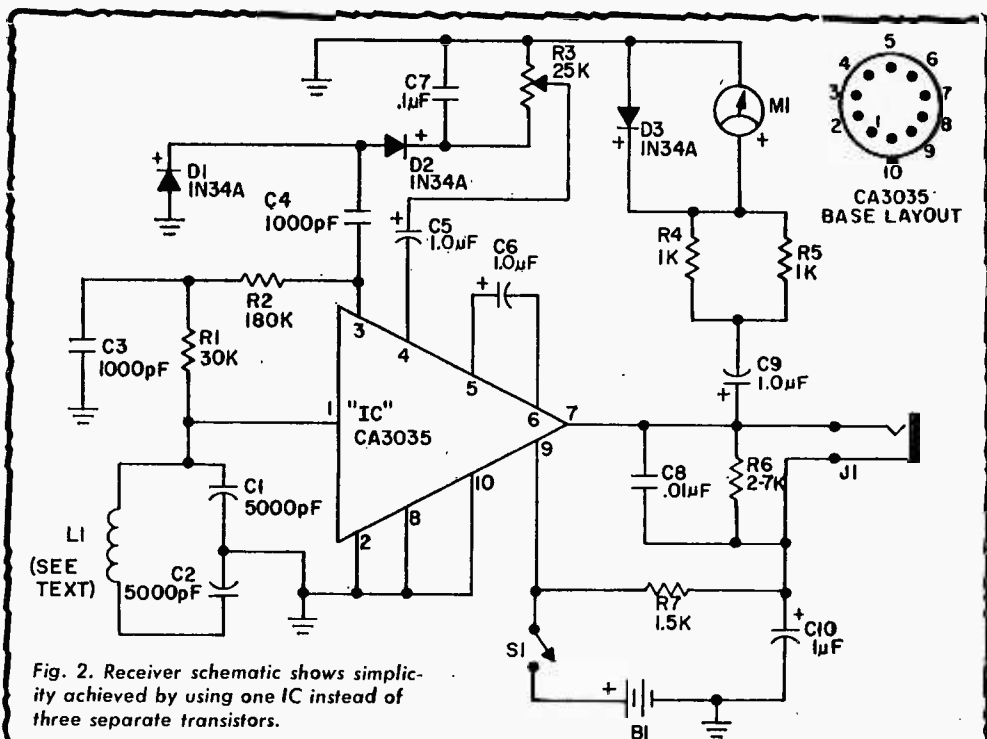

Fig. 2. Receiver schematic shows simplicity achieved by using one IC instead of three separate transistors.

PARTS LIST FOR RECEIVER

- B1—9-V transistor battery (Eveready 216BP or equiv.)
- C1, C2—5000-pF mica capacitor
- C3, C4—1000-pF disc ceramic capacitor
- C5, C6, C9, C10—1.0-μF, 50-V electrolytic capacitor
- C7—0.1-μF, 200-V tubular capacitor
- C8—0.01-μF disc ceramic capacitor
- D1, D2, D3—1N34A diode (RCA) or 1N90 diode (Sylvania)
- IC—CA3035 integrated circuit (RCA)
- J1—Open circuit phone jack
- L1—34 turns of #22 enamel closewound outside of case
- M1—500-μA DC milliammeter

- R1—30,000-ohm, 1/2-watt resistor
- R2—180,000-ohm, 1/2-watt resistor
- R3—25,000-ohm, linear taper potentiometer
- R4, R5—1000-ohm, 1/2-watt resistor
- R6—2700-ohm, 1/2-watt resistor
- R7—1500-ohm, 1/2-watt resistor
- S1—3-spst miniature switch (Lafayette 99E61624 or equiv.)
- 1—6 1/16 x 5 3/32 x 2 5/16-in. plastic case (Allied 42A7886 or equiv.)
- 1—6 1/2 x 5-in. cover (Allied 42A7888 or equiv.)
- 1—2 7/8 x 2 7/8-in. perfboard
- 1—Battery holder (Keystone 203P or equiv.)
- 1—Spool #22 enamel wire
- 1—2-prong small plug and matching socket
- 1—2000-ohm headphones

Putting It Together. Before beginning, there's one big thing to keep in mind. As in any construction project, it's important to take the necessary time and do the job right the first go-round. This advice may sound oversimplified, but in many cases the cause of a project failure is due to the man behind the gun—the soldering gun, that is—not taking enough time to aim straight. An important point to remember is that no metal locator will work worth a darn if the mechanical construction is sloppy or not completely rigid. This holds true for component mounting and wiring techniques.

The transmitter is a good choice to start

with since it will be needed to check and tune the receiver. First step is to take the case and drill and cut all holes so they correspond with those shown in Fig. 3. This must be done with care since the case material will damage easily if abused. After all cutting and drilling have been completed, the loop coil should be wound on the perimeter of the case (see Fig. 4). Following this, tape the coil with a good-quality cloth tape. This will help protect against coil damage during construction and treasure hunting. All components should be mounted and wired to correspond with the transmitter schematic and to match the layout

TREASURE WITCHER

as illustrated in our photos.

Transmitter Checkout. The transmitter can be checked to determine if both of the oscillators are working by turning it *on* near an AM broadcast radio and tuning the radio until you pick up a signal with a steady audio tone. The tone will sound like a high-speed buzz saw and will be easily recognized.

Receiver construction can follow the same basic steps as those for the transmitter, except that all circuit parts are located on

Fig. 5A. Photo right shows how transmitter parts are arranged within housing. Note that all components except battery are on perf-board.

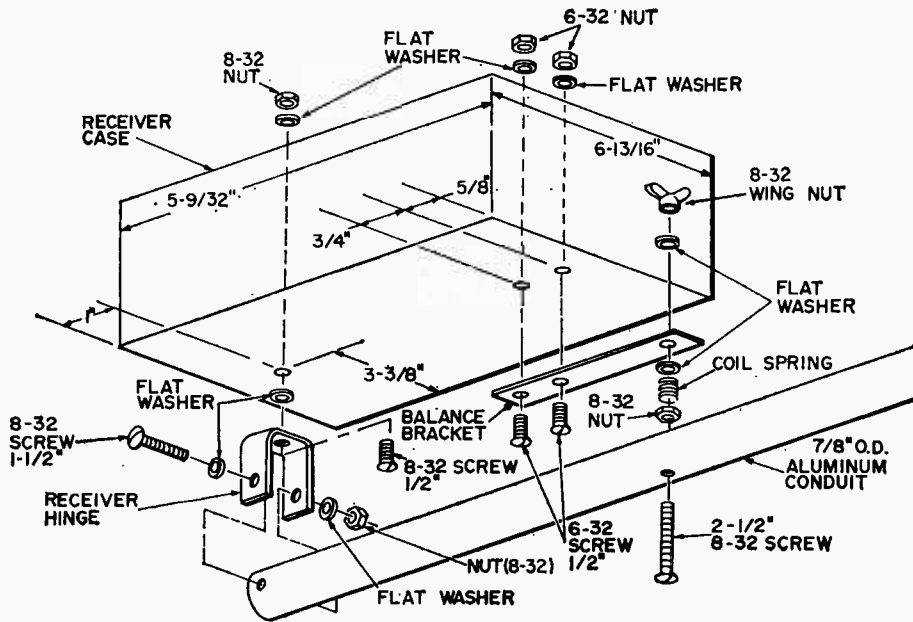
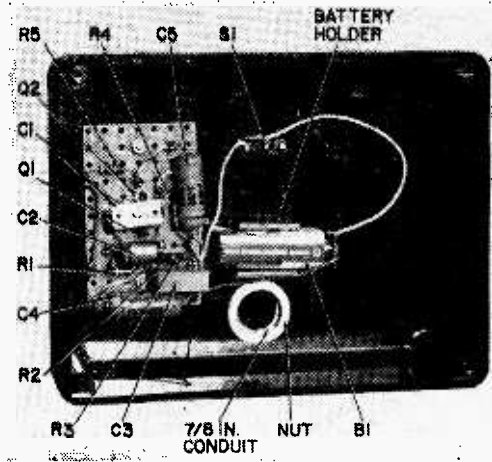

the cover instead of the case. Construction is done in this manner for ease of wiring and to take advantage of the structural strength of the case in mounting the receiver to the aluminum conduit.

The receiver will function best if construction matches our model (see Fig. 5). The metal case of the gain control (R3) must be connected to the negative circuit. This can be done by soldering a wire to the control's case and to the circuit ground. As for the loop coil, it should be wound to match the transmitter loop exactly (see

Fig. 5B. Photo right details receiver layout on box lid. Two contact connector used to separate receiver from loop for servicing.

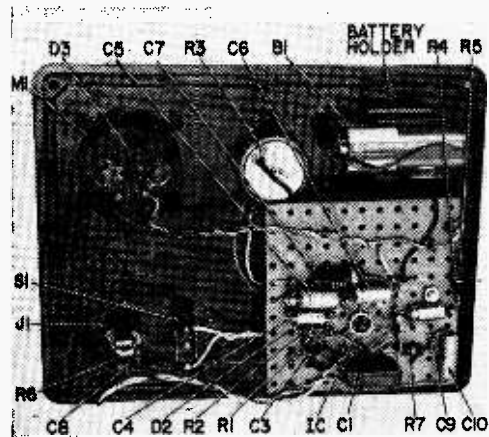

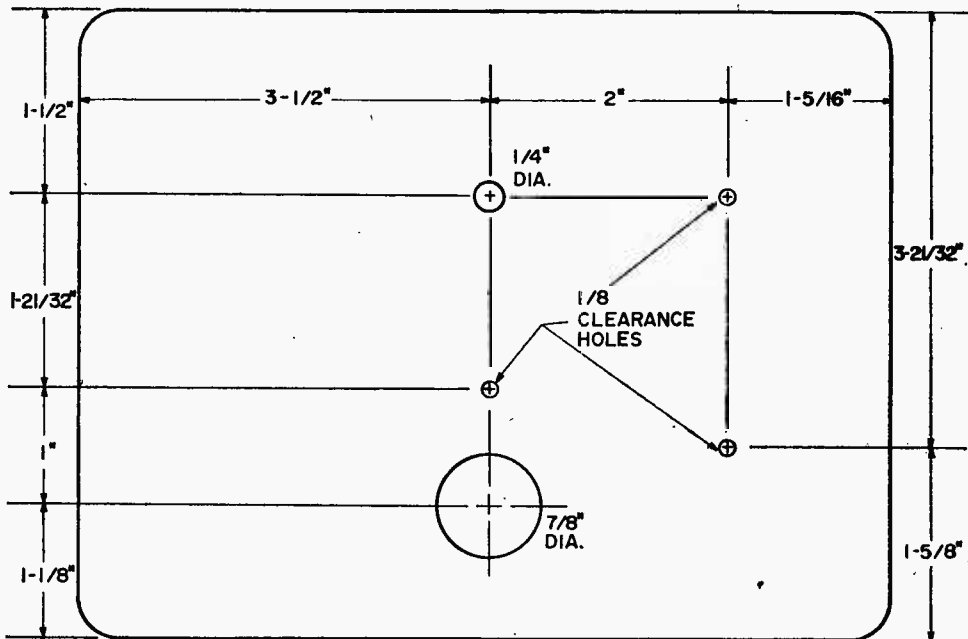
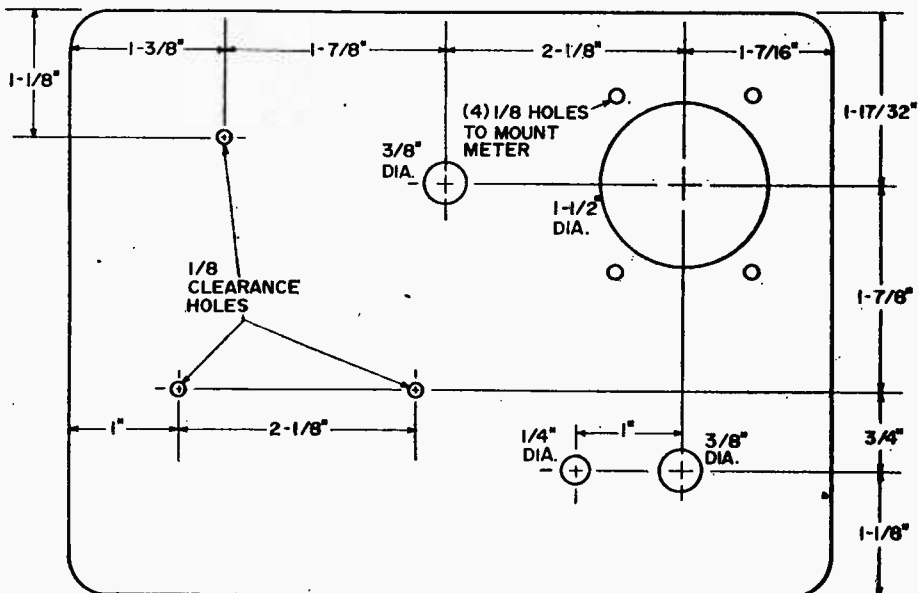

Fig. 3 (above) information for drilling the box to house the transmitter circuit card battery and power switch. Card is raised above bottom by extra nuts on mounting bolts. Complete receiver is mounted on its box cover. Drilling details are shown below. Opposite page (center), Fig. 6 details drilling and mounting details for receiver. Note hinged mount for receiver box. This allows receiver loop to be oriented to null the receiver before starting search.

Fig. 4). A plug and socket are used in the receiver to link the circuit to the loop antenna.

After the receiver has been completed, it's necessary to tune the transmitter to the receiver tuned frequency. To do this, first turn the two units *on* and place them several feet apart. Next, slowly tune transmitter trimmer capacitor C1 until the receiver's meter indicates a maximum current. If for any reason the transmitter will not tune to



TREASURE WITCHER

Fig. 4. Drill both transmitter and receiver boxes as shown for loop leads. Wrap coils with tape for support and protection.

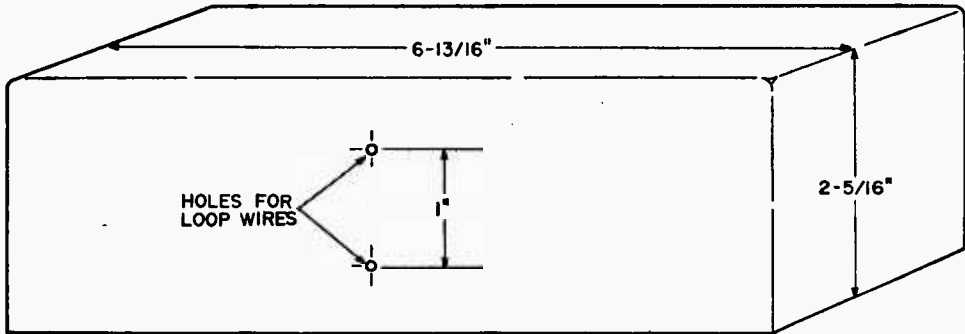

the receiver frequency, then try smaller or larger values for C2. After making a capacitor change carefully re-tune the trimmer until a maximum meter reading is obtained. With the units properly tuned the receiver should be capable of receiving the transmitter at a distance of at least 25 ft.

The WITCHER, when properly tuned, will be operating near 180kHz. but the frequency can vary by as much as 20 kHz without affecting the overall performance of the locator.

Final Assembly. The transmitter case is held on to the aluminum conduit with two nuts. As shown in our photo, the conduit goes through the case. The nuts are home-made and can be fabricated by taking a coupling (threaded to fit conduit) and cutting it into two parts. The two nuts must be filed flat so that an equal bearing surface will support the case without causing breakage.

The receiver case is connected to the balance bracket with two 6-32 screws and

matching nuts (see Figs. 6 and 7). The receiver hinge is mounted to the opposite side of the case with an 8-32 screw and nut. The receiver is then hinged to the aluminum conduit with a 1/2-in. 8-32 screw, two flat washers, and a nut. This screw, washer, and nut combination should be tight but with enough play to allow the balance adjustment to be made smoothly.

A 2 1/2-in. 8-32 screw is bolted to the aluminum conduit below the balance bracket and held in place with a washer and nut. A coil spring and flat washer separates the conduit and balance bracket. On top of the bracket is a flat washer and a wing nut which function as a balance adjustment. The handle (see Fig. 7) is made of conduit and should be shaped to match our photos and drawings. A 2 3/4-in. 8-32 screw, washer, and nut mount the handle to the conduit.

Putting It to Work. Turn both units on and set the receiver gain control to mid-position. (Continued on page 80)

Fig. 7. Dimensions and drilling information for aluminum conduit main support bar, handle and hinge parts for receiver.

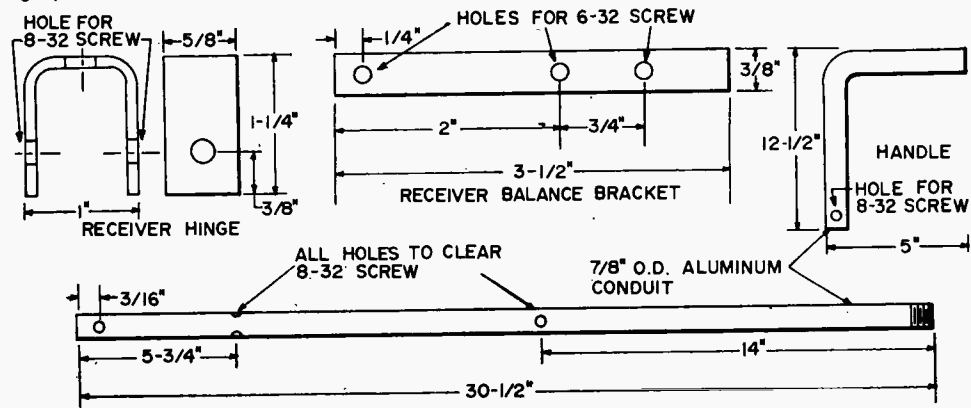

THE NEW AGE OF ASTRONOMY

Modern-day electronics has given man advanced tools to probe the mysteries of the heavens

Photos: The Lick Observatory, University of California.

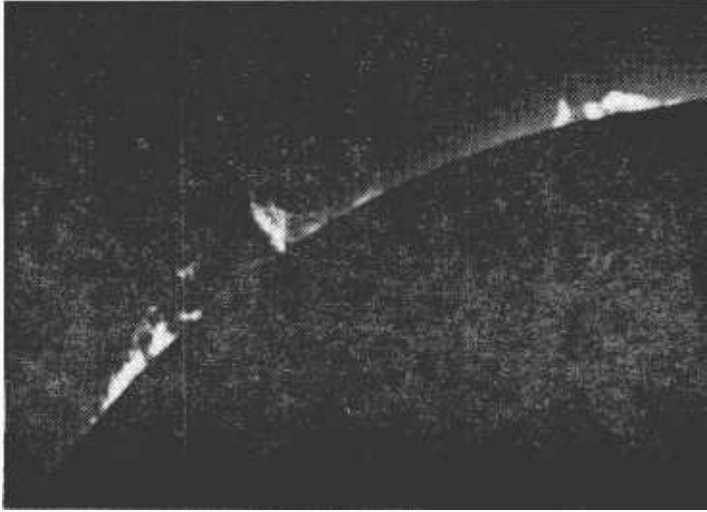

by Edward McIntyre/Courtesy RCA Electronic Age magazine

Significant and often profound discoveries made with electronic instruments have brought a new age of astronomy—one in which scientists are finding the universe to be stranger, yet far richer in pattern, than they previously suspected.

In 1962, for example, American astronomers launched a rocket, with X-ray sensing equipment aboard, to study the relatively weak rays known to emanate from the sun and, in particular, to find out whether or not they rebound off the moon. (X-rays from space can't be studied at the earth's surface since the atmosphere blocks them out.) To the total surprise of the experimenters, instrument readings radioed back to earth reported a stream of X-rays

coming from a distant point in space, a million times stronger than anything that could have been anticipated. It was a little like going out in the back yard to check on a leaking lawn sprinkler and finding a stream of water arching in from blocks away.

Later studies revealed the source of these rays to be a star in the constellation Scorpio. This was the first discovery of an X-ray star—one that puts out a major part of its energy in the form of X-rays rather than light. Since that time, about 30 such stars have been found. Yet, before this unexpected discovery, no one knew or even suspected that these phenomena existed.

Space Broadcasters. In another case, a year later,

measurements at the Mount Palomar Observatory indicated that a celestial body, several billions of light-years distant, was emitting rather strong radio waves. In order to reach the earth with such powerful signals, the object would have to be a titanically powerful "broadcaster," millions or even billions of times as strong as anything that the astronomers could then account for.

The Space Clock. Two years ago, startled astronomers at Cambridge University brought in radio signals from space in the form of fantastically regular pulses—far more precise in their timing than any ordinary clock. Since that time, a careful search on the same wavelength

THE NEW AGE OF ASTRONOMY

band has turned up about a score of these pulsars. It seemed that, for a time, man was at last tuning in on a beacon or signal from intelligent beings separated from earth by two light-years of space. However, earlier this year, scientists

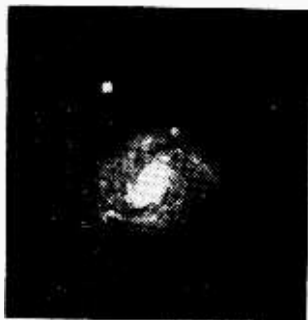

Emission-line spiral galaxy

visually identified a pulsar on an astronomical photograph. This optically strong pulsar is in the famous Crab Nebula—which is the remains of a supernova, or colossal star explosion—seen on the earth in 1024. The light from the pulsar goes up and down at the same rate as its radio signals, and both are slowing, just perceptibly.

These observations tie in with the current theory of the nature of pulsars. Astronomers now believe they are natural objects—rather than intelligence-generated phenomena. Described as neutron stars, pulsars are the unbelievably dense cores of large stars that collapsed after a supernova. All the atoms in a pulsar are packed together so tightly that a matchbook would weigh millions of tons. The pulsing of its

light and radio waves comes from the extremely rapid rotation of the star. The gravity and magnetic field of a neutron star must be billions of times as strong as anything scientists have dealt with before, creating a new and fascinating kind of physics.

The New Tool. All of these discoveries were made with new astronomical tools based on electronics. From the seventeenth century to the early twentieth, the optical telescope had been man's only means to study the universe. Now, radio, X-ray, infrared and ultraviolet telescopes have added new dimensions to the science of astronomy. They "see" many of the objects and events that are invisible to the optical telescope. Light is just a very thin slice of the electromagnetic energy emitted by hot objects in energy waves—broadcast by

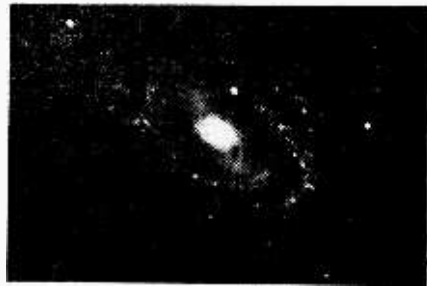

Barred spiral galaxy (NGC3992)

waves measured in centimeters and meters to X-rays and gamma rays, whose waves are only as long as a billionth or a trillionth of a centimeter.

Each range of waves requires a different kind of primary sensing instrument to detect it. The radio telescope is simply an ultrasensitive radio receiver. For the infrared instrument, astronomers use a phototube or phototransistor, or other electronic device that puts out electric signals when infrared waves fall on it. Similar electronic sensors are used for the ultraviolet, while X-ray telescopes are based on Geiger counters, electrometers or

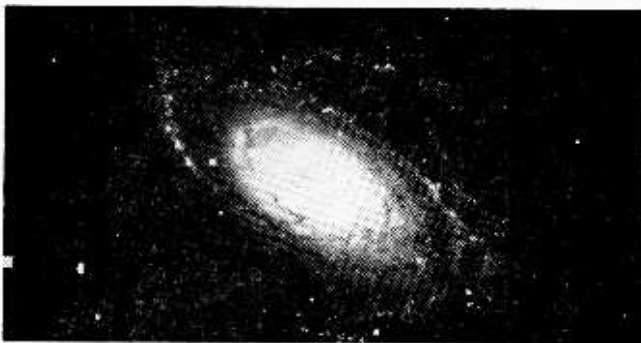

Spiral galaxy Messier 81 (NGC3031)

stars, nebulae, galaxies and interstellar particles—are the only source of knowledge of the universe beyond the solar system. They cover a vast range of wavelengths, from radio

other electronic devices sensitive to the penetrating, very short waves. However, radio telescopes, the oldest of the new astronomical instruments, are still the principal ones.

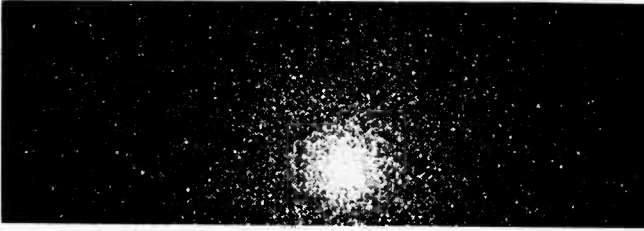

Globular cluster M3 (NGC5272)

At the Listener's End. Central in a radio telescope is the radio receiver, which must have the lowest possible internal noise to minimize interference with the faint radio signals from space. Many complex radio-reception techniques are employed, including the use of masers, the radio counterparts of lasers. The over-riding objective is to get the highest possible ratio of signal to noise.

But the great antennas of the radio telescopes are probably their trademark to most laymen. These enormous, steerable dishes—bowl-shaped reflectors that can be pointed toward any part of the sky—serve to focus into the receiver a large amount of the incoming energy, which is weak at best. The focusing property of the antenna also allows the astronomer to pinpoint the direction of the signals. They will be at maximum intensity when the antenna axis is pointed

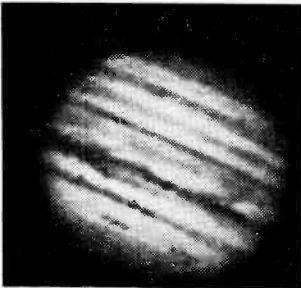

Planet Jupiter

directly toward them. The larger the dish the more energy it brings in, and the more precise its direction-finding.

Galaxy NGC5856 (seen edge-on with dark equatorial line)

But building a steerable dish larger than about 300 feet across—the size of the largest now operating in the United States—is enormously expensive and difficult. Like the curve of an optical telescope mirror, the curve of the radio telescope dish must preserve its shape to focus at optimal sharpness. Keeping such a great mass of moving metal adequately rigid as it shifts from one orientation to another has seemed so difficult that larger steerable dishes as yet have not been built. (Plans for a 600-ft. dish to be built by the U.S. government apparently have been shelved because of the enormous cost.)

The Big Dish! So, radio astronomers have used other antenna arrangements to get a maximum of energy pickup and direc-

tivity. At Arecibo, Puerto Rico, the United States has built a reflector 1000 feet in diameter in a bowl-shaped valley. This stationary reflector is beamed in different directions, activating the receiver when the rotation of the earth has brought the telescope in line with the object to be studied.

For the early pulsar studies, Cambridge astronomers used an array of more than 2000 interconnected small antennas

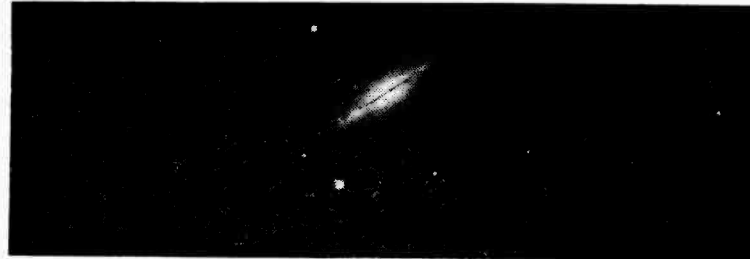

spread over several acres. This, too, was steered electronically and by the rotation of the earth.

Here's Looking at It.

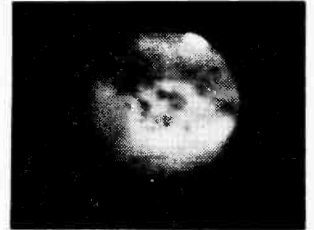

Planet Mars

Even more spectacular are several systems using widely spaced antennas and the interferometer principle: signals picked up at two or more separate points are combined and compared in various ways to increase sensitivity and provide more precise direction-finding.

THE NEW AGE OF ASTRONOMY

Very recently, radio astronomers used this technique of separated antennas to study radio signals from the clouds of oxygen-hydrogen (OH) molecules in space. Atomic theory specifies that these mole-

radio telescopes separated at first by a few miles, then by hundreds of miles and finally by continents. They employed one telescope in California, two in the eastern United States and one in Scandinavia. This al-

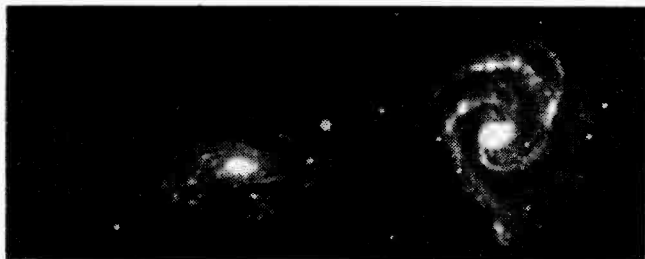

Intertwined spirals NGC 5432, 5435

cules should put out radio waves at certain particular wavelengths. A radiotelescope search of the sky, with the receiver set for those wavelengths, finally brought in astonishingly strong signals. But when the astronomers tried to pinpoint the sources, they found their radio telescopes did not have enough resolu-



Ring Nebula in Lyra

tion. It was a little like probing for the location of a pin hole with a broomstick.

So, they turned to long-base interferometry, with

lowed them to define clearly the directions, and thus the widths, of a number of sources of the OH signals, which were tiny on the cosmic scale, extending only a few hundredths of a second of arc in the telescope beam.

Direction-finding was accomplished by comparing precisely the time of the arrival of the signals at the California telescope, say, with the arrival of the same signals in Sweden. The technique has a biological counterpart. Human beings are aware of the direction

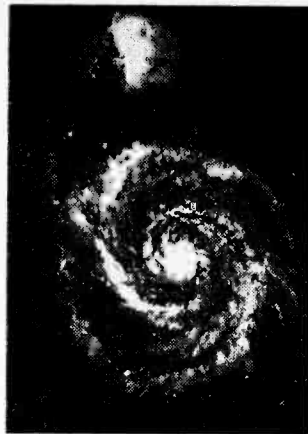

Whirlpool Galaxy in Canes Venatici

from which a sound is coming, in large part, by comparing the time it arrives at one ear with the time it arrives at the other. A sound to the right arrives at the right ear first. Man's intuitive timing system is good enough to tell how much to the right the

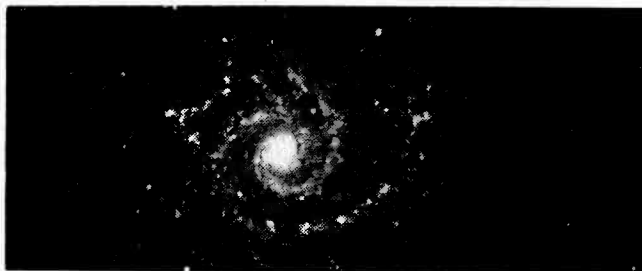

Open spiral Messier 74 (NGC 628)

sound is, down to a minute or two of arc.

It's About Time. Radio astronomers can use this technique because electronic recording systems, combined with one of the ultra-precise atomic "clocks," tell them, to fractions of

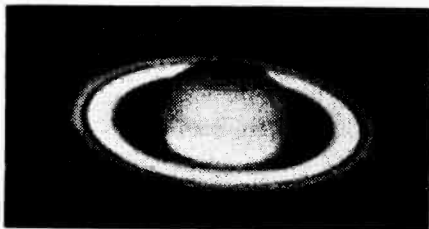

Saturn

one-millionth of a second, when a signal arrived at each antenna. By comparing the recording made in California with the one made in Sweden, they can determine the direction of the signal with the desired precision.

Recording and timing, carried out with precision down to billionth-of-a-second levels, are essential to a great many other astronomical studies. The exquisitely exact timing of pulsar pulses would not have been apparent without the precise electronic stan-



Andromeda Galaxy (NGC 224)

the earth is a part—because thick clouds of interstellar dust let through very little light. But radio and infrared wavelengths

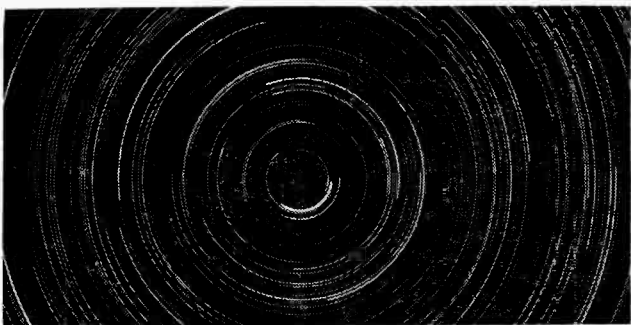

Polar star trails

dards of the atomic clock.

Radio astronomers at Maryland Point, Md., even now may be witnessing the birth of planets in a newly evolving solar system somewhere in space. They have detected radio emissions from what seem to be rings of dust and gas circling around a central object. It is believed that this object may be a fledgling star and that the rings may be condensing into its planets.

Both radio and infrared studies are important tools for exploring the very nature of the universe. Astronomers always had been balked in their attempts to see the center of the Milky Way—the galaxy of which

reaching earth have been monitored, and they indicate that the center is very thickly populated with stars. Events of extremely high energy are taking place there, as they are in the centers of many of the other galaxies visible in other parts of the universe.

Checking for Hot Spots.

A special telescope was

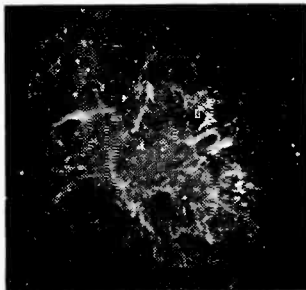

Crab Nebula in Taurus

built three years ago to allow California Institute of Technology astronomers to make an infrared map of the sky—to locate all the stars that put out infrared energy above a certain strength. They designed an instrument with a large reflecting mirror and infrared sensing equipment at its focus. This first infrared telescope scanned the sky automatically, driven by motors that moved it back and forth in a regular pattern while a continuous recording was made. One problem in such a scanning is the everpresent background of infrared radiation that comes from nearly every object on the earth and from widespread sources. It tends to obscure the faint infrared beams from the stars.

The astronomers managed to segregate the signals from the stars by giving their telescope a slight, 20-times-per-second wobble, in addition to its slow

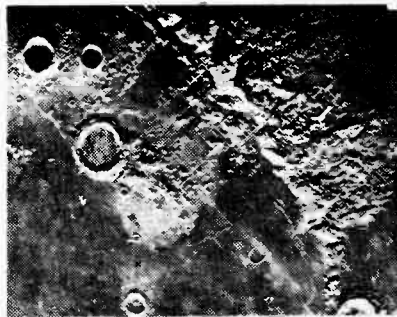

Moon craters

scanning motion. Whenever an infrared star passed into focus, the telescope responded with a tiny, 20-cycles-per-second signal. The background infrared, being nearly continuous in strength, produced a much more slowly varying, virtually direct-current signal.

By rejecting the back-

THE NEW AGE OF ASTRONOMY

ground signals, the astronomers produced a map of the "infrared sky" showing about 6000 stars, roughly equal to the number of stars seen on a clear night with the naked eye.

These primary instruments, including the optical telescope, are backed up by a sophisticated array of secondary electronic instrumentation that defines and refines space signals. Computers, for example, dig signals out of masses of noise that obscure them for ordinary analysis.

Frequency Spotting. Ba-

print in light. The spectrophotometer see those thumbprints.

Rockets and Satellites.

Space probes and orbiting satellites are also beginning to find important roles in astronomy. The Orbiting Astronomical Observatory (OAO), launched earlier this year, is radioing back large quantities of data on the ultraviolet radiation from many stars. The OAO carries various kinds of telescopes, all of which can be aimed remotely at stellar targets from earth. The primary value of the OAO is



Galaxy NGC253—a very large inclined spiral

sic to the new astronomy are the devices that reveal the wavelength, make-up and intensity of signals from space. These are the keys to the identification of the chemical makeup, temperature, and other vital facts of celestial bodies beyond the solar system. An ordinary prism crudely breaks a beam of light into its constituent colors (wavelengths). A spectrophotometer system, on the other hand, brings extremely high resolution to the analysis of light and measures strength at each wavelength. Each chemical element, raised to incandescence by the heat of a star, emits its own pattern of wavelengths—its thumb-

print in light. The spectrophotometer see those thumbprints.

that it is situated above the atmosphere, which ordinarily blocks out or disturbs almost all space signals. Radio-wave sensing equipment aboard the Mariner Venus space probe revised many theories concerning earth's nearest planetary neighbor. For example, there had been uncertainty about the temperature near the surface of Venus, with many scientists believing that it was cool enough to support life as it exists on earth. Optical telescopes had been unable to pierce the thick clouds in the Venusian atmosphere. However, analysis of radio signals monitored aboard the Mariner revealed oven-like temper-



Bubble Nebula Cepheus

atures of 500°F.

And on the more recent Mars probe, an infrared study was made to detect water on the red planet. Careful analysis indicated that all the water on Mars could be placed in a one-cubic-mile lake.

Old Reliable. Radar is also proving valuable at solar system distances since it takes only 17 minutes to reach the sun and echo back. By bounding signals off the planet Mercury, astronomers have corrected a long-standing error. Photography and the optical telescope had suggested that the planet turns on its axis approximately once every 88 days. Radar echoes now make it certain that its rotation period is actually about 59 days.

The surface makeup of the inner planets has been determined to some extent

(Continued on page 98)



Galaxy NGC2903 with small arms

Duo-Lite Q Checker

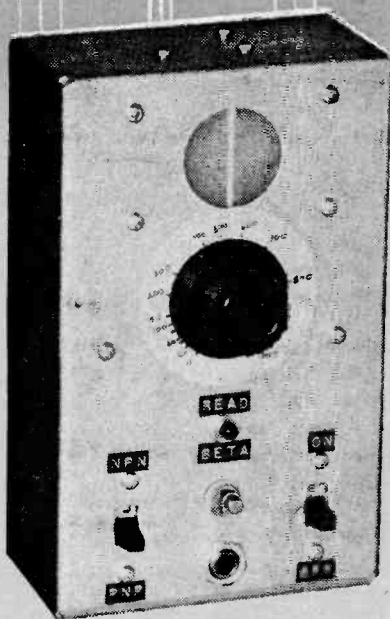

LET DUO-LITE REMOVE THE SHADOW OF DOUBT—
IT TELLS ALL ABOUT SURPLUS OR JUNK BOX TRANSISTORS

TRANSISTORS in your junkbox will turn into usable items when tested on our Duo-Lite. It will tell you whether a transistor under test is shorted, leaky, or open, and whether it's pnp or npn. What's more, it will also give you a beta reading.

Beta, as you may recall, is the current gain of a transistor from the base to the collector when the transistor is connected in the common-emitter configuration. Beta is perhaps the most significant parameter of a transistor and is used, for example, in determining overall stage gain. The standard notation for beta is h_{fe} .

Circuit Operation. As shown in Fig. 1, lamp I2, resistor R3, switches S2 and S3, and battery B1 form a simple series circuit. Current flow in that circuit can be determined by using Ohm's Law ($I = E/R$). E in this case is the battery voltage (4.5 V) and R here is the sum of the individual resistances of I2 (33 ohms) and R3 (43

Photo by Moto

by George A. Ellson, W7EKH

Duo-Lite Q Checker

ohms). Therefore I (circuit current) is $4.5/76$ or roughly 60 mA.

The remaining part of the circuit consisting of switches $S1$, $S2$, and $S3$; resistors $R1$ and $R2$; lamp $I1$; battery $B1$; and the transistor under test is a common emitter amplifier. Transistors to be checked are plugged into socket $SO1$ or connected to the alligator clip leads. The base current is controlled by adjusting $R1$ ($S1$ closed). This varies collector current and therefore the intensity of $I1$ —which can be made equal to $I2$. When this occurs, 60 mA is flowing through the collector circuit. If at this point, we could determine the base current, we'd be able to determine beta as the quotient of I_c/I_b —where I_c and I_b refer to the collector and base currents respectively. The base current for any position of $R1$ is tabulated in the calibration procedure.

The circuit determines a shorted transistor by the presence of a very high collector current and therefore a brilliant $I1$ with $S1$ open (zero base current). Leaky transistors are also spotted in this way, but the collector current is much less.

Switch $S3$ reverse biases the collector junction, which is a necessary condition if

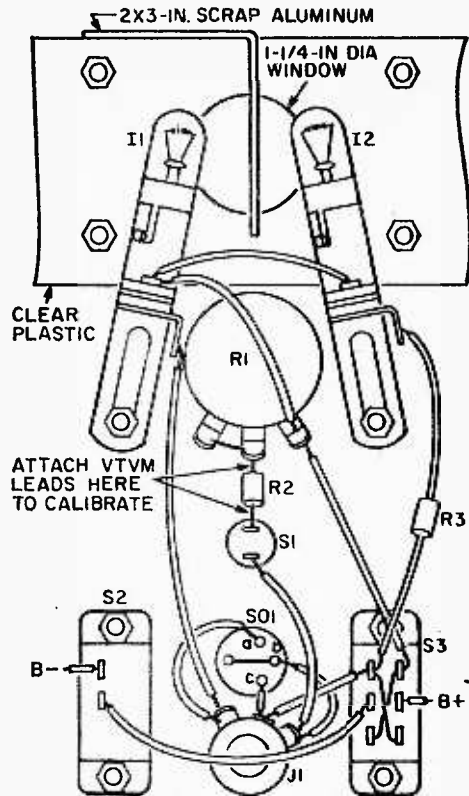

You can locate all of the parts on this pictorial which reveals neat layout of unit.

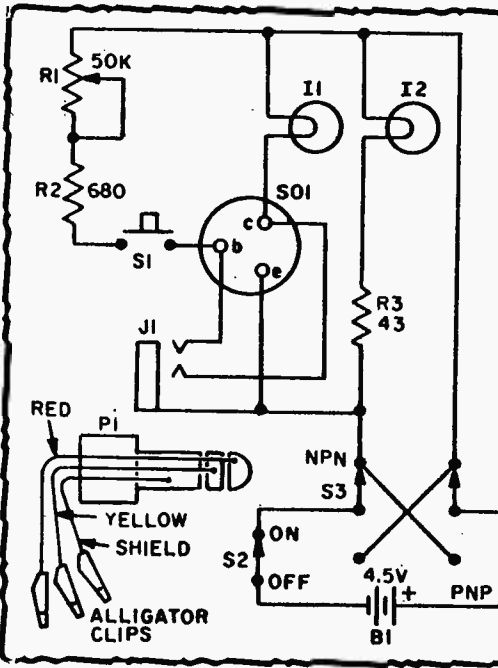

PARTS LIST FOR DUO-LITE

- B1—4.5-V battery (3 Eveready 915 or equiv. in series)
- I1, I2—#49 pilot lamp
- J1—3-conductor phone jack
- P1—3-conductor phone plug
- R1—50,000-ohm, linear taper potentiometer
- R2—680-ohm, 1/4-watt resistor, 5%
- R3—43-ohm, 1/4-watt resistor, 5%
- S1—Spst normally open miniature pushbutton switch (Lafayette 34E60011 or equiv.)
- S2—Spst slide switch
- S3—Dpdt slide switch
- 1—6 1/4 x 3 1/2 x 2 1/8-in. interlocking chassis (LMB 138 or equiv.)
- 1—Battery holder (Keystone 2191 or equiv.)
- 1—Translucent plastic soap dish or soft plastic freezer carton
- 2—Pilot lamp sockets (Cramer 7-06 or equiv.)
- Misc.—Transistor socket, hookup wire, solder, paper for dial, cement, knob, shellac, alligator clip leads, 3-conductor cable, etc.

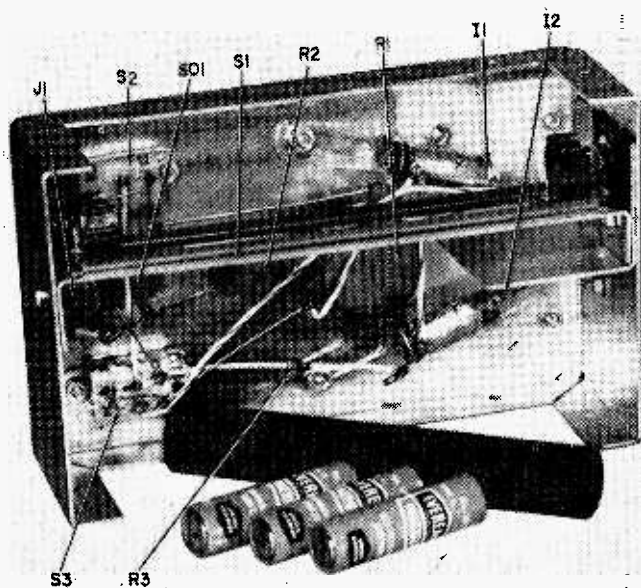

Bend tabs at each end of 7 X 1-in. bracket to form full length shelf to hold 3 penlite cells. From rear, RH tab 1 X 9/16-in. LH tab 1 X 3/4-in.

With R1 set at minimum, press S1 and measure ER2. Base current (I_B) can be calculated using Ohm's law; the equation in this instance is $I_B = ER2/R2$. I_B can be readily found since R2 and ER2 are known quantities. Assuming a 60-mA collector current, beta can be calculated by using the equation $\beta = I_C/I_B$. Mark this value of beta on the dial next to the knob pointer fitted onto R1. Repeat this procedure for as many different beta readings as you desire spaced

we want to know whether a transistor is open, pnp or npn, and what its beta is. Open transistors show no collector current regardless of the base current. With S1 pressed therefore, lamp I1 remains dark for all settings of R1.

Construction. As shown in our photo, all parts are mounted in a 6 1/4 x 3 1/2 x 2 1/8-in. interlocking chassis. Lay out all parts on the surface of the box and mark their locations. Drill and punch all holes. Mount the plastic window first, using 440 hardware. Next, install all remaining parts. The L bracket for separating the window into two sections is formed from a piece of 2 x 3-in. scrap aluminum. The battery holder is mounted on a 7 x 1-in. piece of scrap aluminum. Place a piece of electrician's tape at each end of the chassis before mounting the battery holder to prevent accidental grounding. The dial is made of paper cemented to the chassis and shellacked after calibration.

Beta Calibration. To start with you'll need a transistor that you know to be good (not shorted, leaky, or open). Plug it into the socket or attach it to the clip leads and connect a VTVM or VOM across R2. The higher the resistance of the meter the less loading there will be of R2 (and the more accurate the reading), so a VTVM is preferred.

around the dial. The author calibrated his dial with 15 positions from minimum to maximum but there's no reason why you couldn't use more or less.

Check Out. Plug in your transistor to be tested or connect to the alligator clip leads. Refer to a manual to determine the positions of the collector, emitter, and base of your transistor so that you can properly connect it in the circuit.

Turn on the Duo-Lite. If I1 glows brightly, the transistor is shorted. A dim glow indicates leakage. A shorted transistor is of no value to you but a leaky one can often be used in switching circuits. If the transistor isn't shorted or leaky, you should next check for opens. Set R1 to minimum and press S1 using first one and then the other position of S3. If I1 remains unlighted in both positions of S3, the transistor is open. Open transistors can be used as diodes (one junction is probably good—surprise, heh?).

If the transistor isn't shorted or open, now is the time to determine its makeup (pnp or npn). Refer back to the test for opens and note that in one of the positions of S3, lamp I1 is lit. This position of S3 is marked either pnp or npn (see photo), and *voila*, that's what your transistor is. Now you can determine beta by pressing S1 and rotating R1 until I1 and I2 are of equal brilliance. Beta is read off the previously calibrated dial. ■

DOUBLE-TIMER

by Frank Deems

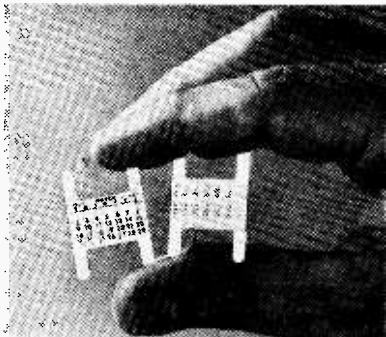

Outdated wristwatch calendar (left) is basic ingredient in our DoubleTimer. Actual chart (right) is typewritten, then copied with camera and close-up lens. Print, which should be exact size of wrist calendar, is held securely in place with epoxy cement.



THOSE little clip-on calendars that wrap around a watchband are mighty handy gadgets. But telling the day of the month doesn't need to be their only function in life. They also can be put to work to help keep track of at least two time zones.

Active people, such as radio operators, pilots, and traveling businessmen, often need to know the time of day simultaneously in two locations. One of those wristwatch calendars can be easily modified to handle this assignment with ease.

Greenwich Mean Time is frequently used by ham operators and by pilots, since it serves as a universal time recognized in all parts of the world. Nor is it affected by local time zones and changes from standard to daylight saving time. Businessmen also need

such convenience. But they generally want to know the time at their home office, plus some distant location, such as a district office or an important customer's plant.

Two On One. Our double-timing watchband can provide this convenience without the necessity of carrying two watches, or of buying a high-priced watch with an adjustable outer dial bezel for the second time zone. With this modified watchband, any wristwatch serves to tell the wearer the time in two places—any two places in the world!

Heart of the system is a simple chart which you affix over an outdated clip-on wrist calendar. The chart compares local time with GMT (or with any other time zone you may wish to use). You use the watch normally for local time, but refer to the chart to convert local time instantly to GMT, and vice versa.

The chart shown in the photos was prepared for use in the Mountain Standard
(Continued on page 64)

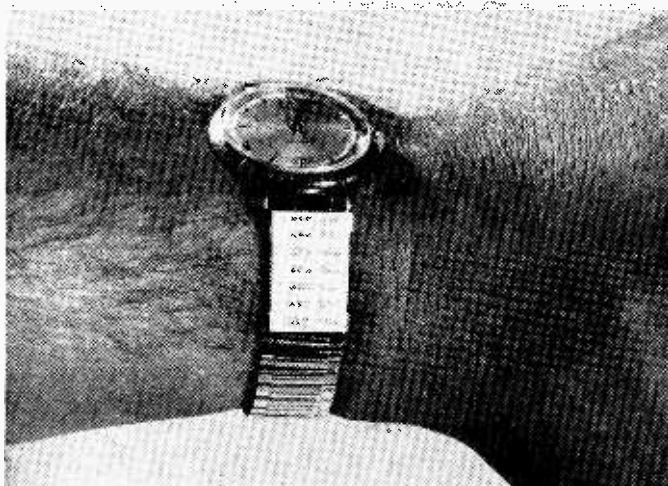

Completed DoubleTimer makes useful addition to any watchband. Varnish or clear Krylon spray protects it from wear; edges of print should ideally be beveled with fine sandpaper after epoxy has dried but before protective coating is applied to prevent them from snagging on shirtcuffs.

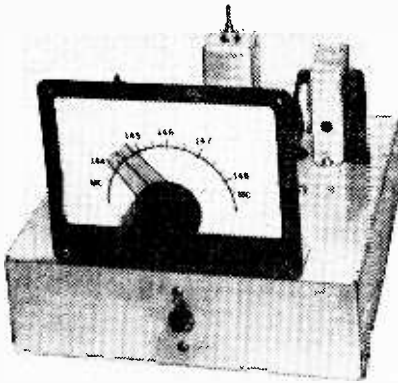
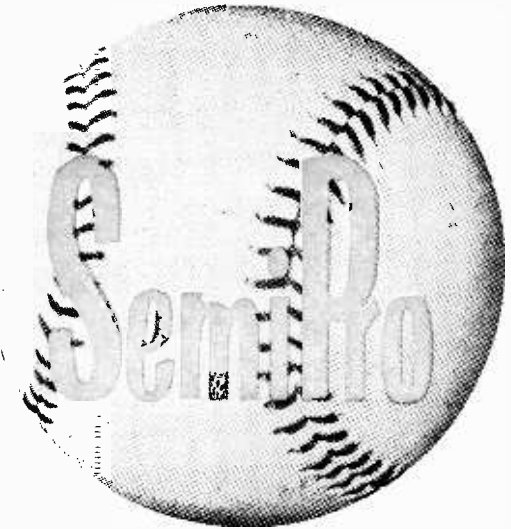

Photo By Moto



**Our
2-Meter
Converter
Puts your
BCB Receiver
On the
Beam**

**By Charles Green
W6FFQ**

WHY not become part of the friendly round tables, net activities, and leisurely conversations prevalent on the 2-Meter ham band throughout the U.S.? This band, extending from 144 to 148 MHz, is quite different in character from the lower-frequency ham bands with their fast QSOs and heavy QRM.

The MARS and CAP nets at the edges of the band and the Civil Defense nets within the band make interesting listening. Traffic nets pass messages from other bands for local delivery and experimental transmissions of all kinds are common in it.

You really don't have to spend a fortune for a receiver in order to join the listeners on the 2-Meter band. Our SemiPro, a 2-tube converter used in conjunction with a BCB receiver, converts the 2-Meter signals for reception at the high end of the broadcast band.

Circuitry. In reality, SemiPro is a conventional superheterodyne front end, consisting of an RF amplifier, an oscillator, and a mixer: its RF output signal at 1650 kHz will be amplified and detected by a standard BCB receiver it must be connected to. As a matter of fact, if your BCB receiver is a super (as are most modern BCB receivers), you wind up with a double-conversion 2-Meter superhet. Double conversion achieves the higher gain and selectivity normally associated only with high-performance, professional communications equipment. This accounts for SemiPro's high performance on 2-Meters when coupled to a superhet BCB receiver.

How It Works. The 2-Meter signals picked up on the antenna are fed through J1 to the



SemiPro

primary of L1, a broadband coil. Its secondary feeds the cathode of V1, a grounded-grid amplifier.

These amplified signals are tuned by L2 and C3A and coupled to the grid of V2A mixer stage via R2 and C4. The other half of V2 (V2B), the oscillator stage, is tuned by L4 and C3C to produce an RF output signal that is always 1650 kHz above the incoming signal frequency. The oscillator (V2B) output is coupled to the mixer (V2A) grid by C5 and the resulting heterodyne signal output is fed to the tuned circuit comprised of L3 and C7 and thence via J2 to a BCB receiver that has been tuned to 1650 kHz.

A built-in power supply furnishes both heater and B+ voltages for operating the converter.

Building the SemiPro. Because this is a high-frequency circuit, wiring and layout are critical. Therefore we suggest you follow our layout as shown in our photos.

SemiPro is built on a 7 x 7 x 2-in. aluminum chassis with a 3¾ x 4¾-in. heavy aluminum panel for mounting the dial, centered on the top front edge. Mount the dial to the panel and temporarily couple the ganged tuning capacitor (C3A, C3C) to it with an insulated flexible-shaft coupling. Cut the tuning gang shaft so that when this

capacitor is permanently mounted on the chassis, the front of the gang is 2 in. from the front of the chassis. Remove all but one rotor plate from each section of the ganged capacitor before permanently mounting it.

Locate and drill mounting holes in the chassis and shim the gang with nuts, spacers, or washers so that it's aligned with the dial and doesn't bind when tuning. Drill a ¼-in. hole in the chassis adjacent to each stator

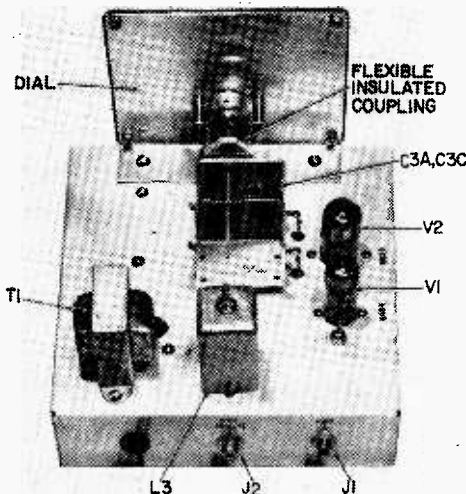

Since we are dealing in high frequencies parts layout is important. This view clearly indicates top of chassis orientation.

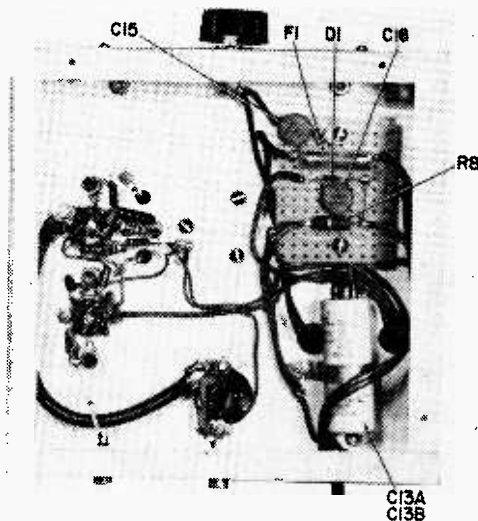

Except for the power transformer, which is mounted on top, all other parts of power supply are below chassis as shown here.

connecting lug. Bend these lugs so that they are centered over the holes, to keep connecting leads underneath the chassis as short as possible.

Locate the rest of the parts, keeping the same relative spacing between them, especially the tube sockets and the tuning capacitor, as shown in our photos. Coil L3 is mounted inside the shield can. Leads to it and capacitors C7, C8, and C9 are connected through a 7/8-in. hole in the chassis directly under the shield can.

Mount coils L1, L2, and L4 and associated resistors and capacitors around the sockets for V1 and V2 so that leads will be as short as possible. Connect center leads of sockets for V1 and V2 to chassis ground. Ground C6 and C12 to center post of V1 and be sure ground lugs are placed between mounting bushings and chassis when fastening L1, L2, and L3 to ensure short ground leads.

Remove tuning slug originally supplied

PARTS LISTS FOR SEMIPRO

- C1, C6, C12, C14—1000-pF, 500-V ceramic disc capacitor
 C2, C10—10-pF, 500-V, npo ceramic disc capacitor
 C3A/C3B/C3C/C3D with trimmer capacitors—6.6 to 23 pF, two-gang variable capacitor (J.W. Miller 1461-2, see text for modification)
 C4, C11—27-pF, 500-V ceramic disc capacitor
 C5—Gimmick capacitor (see text)
 C13A, C13B—50-50 uF, 150-V tubular electrolytic capacitor
 D1—1N2071 silicon diode, 600 PIV, 750 mA
 F1— $\frac{1}{2}$ -A, 250-V fuse type 3AG (solder pigtails to ends for mounting and connecting)
 J1, J2—RCA type phono jack (Switchcraft 3501F)
 L1—0.108 mH to 0.180 mH RF coil (J.W. Miller 20A157RB1)
 L2, L4—0.88 mH to 0.120 mH RF coil (J.W. Miller 20A107RB1) (J.W. Miller 30-202-5 brass tuning slug to modify L2—see text)
 L3—Oscillator coil (J.W. Miller A-5496-C mounted inside J.W. Miller S-33 shield)
 P1, P2—RCA type phono plug (Switchcraft 3501M)
 R1—330-ohm, $\frac{1}{2}$ -watt resistor
 R2, R5—12-ohm, $\frac{1}{2}$ -watt resistor
 R3—1,000,000-ohm, $\frac{1}{2}$ -watt resistor

- R4—22,000-ohm, $\frac{1}{2}$ -watt resistor
 R6—47,000-ohm, $\frac{1}{2}$ -watt resistor
 R7—2700-ohm, $\frac{1}{2}$ -watt resistor
 R8—1200-ohm, 2-watt resistor
 RFC—1.72 mH RF choke (J.W. Miller RFC 144)
 S1—Spst slide switch (Continental-Wirt GF1123 or equiv.)
 T1—Power transformer: primary 117-V, 50-60 Hz; secondaries 125V @ 15 mA and 6.3V @ 0.6A (Stancor PS8415 or equiv.)
 V1—Type 6AB4 tube
 V2—Type 6KE8 tube
 1—7 x 7 x 2-in. aluminum chassis (Bud AC405 or equiv.)
 1— $3\frac{3}{4}$ x $4\frac{1}{4}$ x $\frac{1}{16}$ -in. sheet aluminum with 1-in. mounting flange for mounting dial to chassis (see text and photos)
 1—Flexible coupling (Millen 39001 or equiv.)
 1—7-pin miniature tube socket with mounting plate (Cinch-Jones 7EB or equiv.)
 1—9-pin miniature tube socket with mounting plate (Cinch-Jones 9EB or equiv.)
 1—Vernier dial (J.W. Miller MD-4 or equiv.)
 Misc.—Perfboard, push-in terminals, ground lugs, tie strips, rubber grommets, plastic spaghetti tubing, hookup wire, solder, hardware, press-on letters (Datak or equiv.) RG-59/u, coax cable, etc.

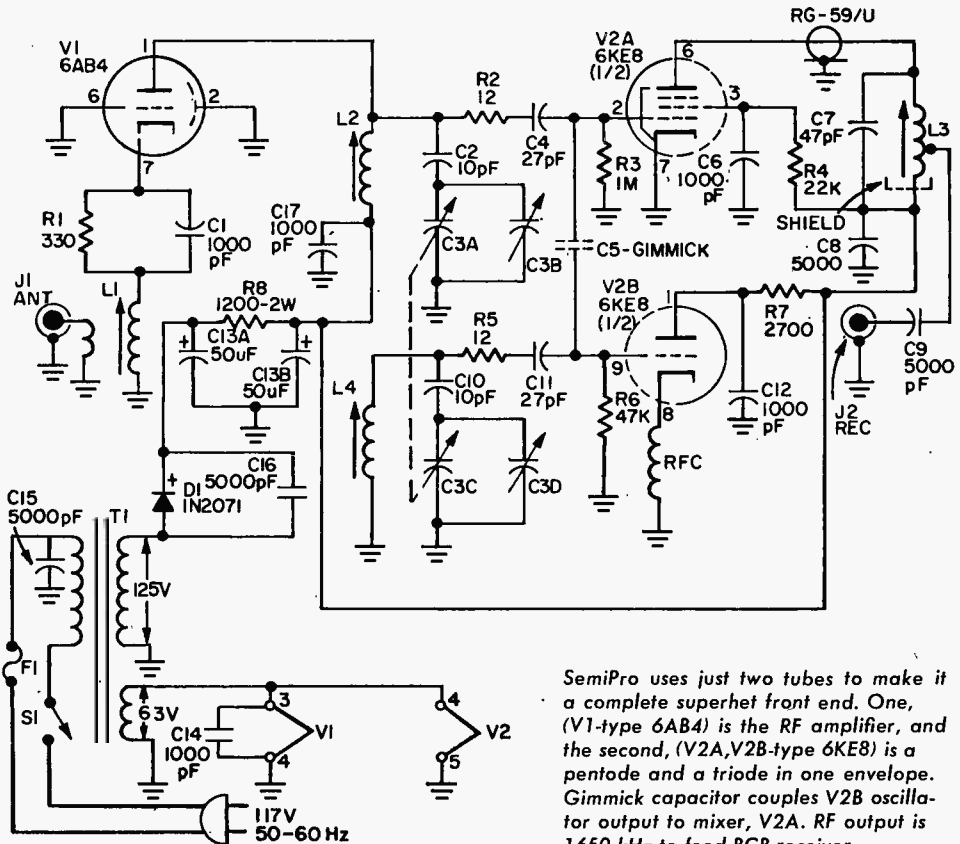

SemiPro uses just two tubes to make it a complete superhet front end. One, (V1-type 6AB4) is the RF amplifier, and the second, (V2A,V2B-type 6KE8) is a pentode and a triode in one envelope. Gimmick capacitor couples V2B oscillator output to mixer, V2A. RF output is 1650 kHz to feed BCB receiver.

SemiPro

with L2 and replace it with a brass slug (J. W. Miller 30-202-5). Primary for L1 is made by a single loop of wire wound around the coil, with one end connected to ground lug and the other directly to J1 (make as direct as possible).

Gimmick capacitor C5 is made by twisting two short lengths of hook-up wire into three twists and connecting one end of each lead to pins 2 and 9 of V2 respectively. The other ends of these leads are not connected. Capacitors C2 and C10 are connected to C3A and C3C tuning capacitor by short lengths of insulated bus wire.

With the exception of T1 and C13A and C13B, the balance of the power-supply components are fastened to a 1¾ x 2¼-in. piece of perfboard which is mounted under

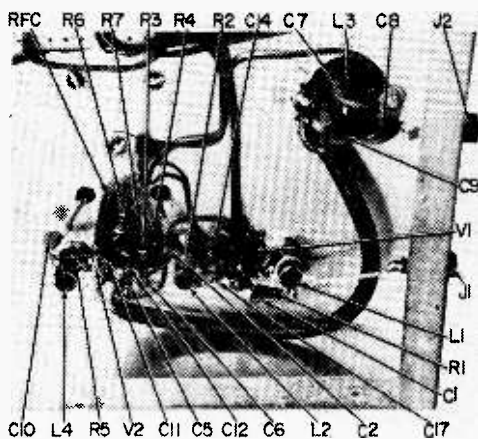

Short leads and good grounds are a must at high frequencies. Its best to use this layout to assure success of your SemiPro.

the chassis adjacent to T1. Transformer T1 is mounted on the top left hand (from the rear) corner of the chassis with leads fed through grommets to the rest of the power-supply components inside the chassis pan. Keep heater leads from T1 and B+ leads from power supply as far away from the RF circuits as possible.

A short length of RG-59/U coaxial cable is used to connect V2A plate to L3. Be sure the shield is grounded to the chassis at both ends of the cable.

Alignment. Once you have double-checked the wiring for accuracy and have allowed the tubes and other components to warm up,

you are ready to align your SemiPro for optimum results. A short length of RG-59/U coax cable is used between J2 (output jack) of the converter and the antenna and ground terminals of your BCB to interconnect the two. If your BCB receiver doesn't have antenna and ground terminals but does have a ferrite rod antenna, loop several turns of hook-up wire connected to the center contact of J2. If by chance your BCB receiver is an AC/DC set of the so-called "hot chassis" variety, make certain that there's no direct electrical connection between the two chassis to avoid placing the chassis of the converter at a dangerous electrical potential. Best way to prevent this is to place a small capacitor (0.01 μ F) in series with the grounding lead.

Tune the BCB receiver to a clear frequency at or near 1650 kHz. If the receiver doesn't tune that high, pick a clear spot as close as possible to the high-frequency end of its tuning range. You'll need a signal generator to be sure the converter's RF output is properly tuned to the high-frequency spot used on the BCB receiver. Connect the signal generator to the stator lug of C3A (mixer tuning capacitor) and chassis ground of the SemiPro. Adjust L3 of the converter for maximum signal output from the BCB receiver.

Once this has been done, disconnect the signal generator from C3A and connect it to J1 on the converter. Set trimmer capacitors C3B and C3D of the ganged variable capacitor on the converter to minimum capacity (screws backed out nearly full length) and turn the dial of the SemiPro to not quite full capacity (at 144 MHz on dial in photo). Set the signal generator for a 144-MHz modulated signal output and then adjust L2 and L4 tuning slugs for maximum signal output on the BCB receiver.

Next, turn dial on SemiPro to almost minimum capacity of tuning gang C3A/C3C (148 MHz on dial in photo), set the signal generator for a modulated output signal of 148 MHz, and adjust trimmer capacitors C3B and C3D for maximum output on the receiver. Repeat these adjustments to be certain optimum alignment has been reached.

At this point we calibrated the dial and marked it with press-on letters. We set the signal generator at each of the frequencies marked on the dial and noted the spot where they tuned to maximum on the SemiPro dial. Since the MARS and CAPS nets are at the extreme edges of the band we calibrated

(Continued on page 100)

Horace Twipple Brought Back Radio

by Charles Getts

SHAKESPEARE gave a perfect description of Horace Twipple when he wrote, "There are stranger people roaming around this Earth than you have ever dreamed of," Horatio.

Horace was a thin, middle-aged ham operator with a neck like a chicken's and a head as smooth as an egg. He had studied electronics until he could assemble a computer blindfolded. Yet every time he landed a job he fouled something up, usually within a week.

He went down to Guaymas, Mexico to take charge of the radar tracking station there and cover orbital flights. After four days on the job he sent out a *Red Alert*. Horace had picked up signals coming from a fleet of Russian submarines heading up the coast of Baja California toward Los Angeles.

After Washington, the Air Force and the Navy were alerted, and the Hot Line to Moscow activated, it was discovered that the signals were coming from radio transmitters and sonar *beeping* devices fastened to the backs of gray whales. San Diego scientists were determined to snoop on gray whales to find out where they go.

Being unpopular with the Government after this incident, Horace joined the sound division of the great C.S.B. television network as an operator of a portable overhead mike boom for TV shows. A step down, but a man has to eat.

Disaster struck the second week on this job. He was admiring the shapely legs of a chorus girl during the rehearsal of a musical special and in place of following



**"The stars can do anything,"
purred Madame LaZongle. And Lo!
if they didn't for a chicken-
necked ham name of Horace Twipple!**

Horace Twipple

the star, he absentmindedly swung his long mike-boom arm in the wrong direction. He hit the producer of the show on the head and knocked him cold as a halibut. The man was a nephew of a C.S.B. vice-president.

When he came to his senses, the producer rose to his feet. "You're fired!" he shouted at Horace in icy fury. "Get down off that stage! Get out of this studio! Go and get lost, you *stupid idiot!*"

Horace climbed down and walked over to face the irate man.

"Listen, Mr. Pidmore," he said, "just because you happen to be the nephew of the president of this lousy company you think you're sitting high up on the pole, don't you? Well, let me tell you something. No man calls Horace Twipple a *stupid idiot*. I'm fired, am I? Okay. The day will come when you will also be fired because I am going to buy the C.S.B. Company—lock, stock, and barrel."

That night in his ham shack he asked his fellow hams how they would go about buying a giant television network.

"Consult an astrologer," replied a man from Moosebutt, Canada. "The stars never lie. They told me that when Pluto crosses Venus is the time for me to look for a job. That doesn't happen until 1978 so my old lady is supporting me until then."

"Think of some way to bring radio back," advised a man from the Windy City. "TV is a habit of the public. Only way to break a habit is to form a stronger one. Think up something sensational to swing the people back to radio. Then you'll be able to buy C.S.B. for peanut shells."

After eating breakfast the next morning, Horace went out to Coney Island and walked into the booth of Madame La Zongle, Horoscopes, Tarot Card Readings and Hot Tips for the Racetracks. After giving her his day of birth and the time, the Madame quickly came up with his horoscope.

"You are a Taurus, the Bull," she told Horace. "You were born when the Moon was in conjunction with Neptune in the House of Pisces, the Fishes. Neptune is water . . . ah, you work on a fishing boat?"

"No, I'm not working anywhere," said Horace. "But I have a serious problem concerning television. Could the stars tell me

what to do about solving it . . . like thinking up brilliant ideas?"

"Of course. The stars can do anything, my good man. Television, you say? Ah yes, I see Pluto, the Hound, whose element is air, on the ascendent. Pluto the Hound symbolizes sniffing out something. My dear man, you are going to invent something spectacular. You may be the reincarnation of Galileo," she said, fluttering her false eyelashes at Horace hopefully. "Being a Taurus, your element is earth. Therefore you must seek the answer to your problem first in the earth, then in the sky. That will be ten dollars."

Horace returned to New York feeling disappointed. How was he going to find the answer in the earth? Maybe she meant he should go to Pittsburgh and get a job in the coal mines. He decided to stop in the Pussy-cat Club for a drink.

Over a double vodka he glanced at his neighbor, who wore a long, thick beard.

"Say, that's a pretty good display of wool you're wearing," he said. "Are you trying to close up the Gillette Company?"

"No, I'm an archaeologist," said the man. "I've just returned from Egypt and I've got to give a talk tonight at the Explorer's Club on the carbon-14 method of testing ancient relics so I stopped in here to fortify my nervous system with a little ambrosia."

"Carbon 14? Does that have something to do with radioactivity?"

"Right! All living things are radioactive. Cosmic radiation produces neutrons that give off radioactive carbon dioxide in the air. Plants live on carbon dioxide and become radioactive. Animals live on plants and become radioactive. There is a lot of radioactivity around. All living things maintain constant radioactivity during life. At death, it diminishes at a regular rate. By measuring the amount of activity remaining in any item we can determine its age. For example, we tested a human hair from an Egyptian mummy and found that it was 5800 years old," the man said calmly.

"Man, you have the life. Traveling around digging up the earth to find old junk. Wait a minute! Earth! The Madame said look in the earth first. Say, the stars are getting right on the job. Tell me more about this carbon 14. Is there any in the sky?"

"There is a dense mass of cosmic ray neutrons in the higher layer of our atmosphere, at 40,000 feet. They are caused by

(Continued on page 79)

Station **BLAZER**

Build our six-buck preamp in one evening and convert your so-so SWL receiver into a red-hot number.

By Edward A. Morris, WA2VLU

CHANCES are, if your general-coverage SWL or ham receiver cost much under \$100.00, it's lacking sufficient RF gain. Fact is, many of the more inexpensive receivers lack an RF stage altogether! If you're ever going to get out of the novice league when it comes to pulling in the rare ones, you'll have to correct the situation. You *could* go out and plunk down \$250.00 to \$600.00 for an all-band, do-everything, super-deluxe receiver. Thing is, there aren't too many of us who can afford to go that route.

As you may suspect by now, there's another answer—our Station Blazer. Station Blazer is a wide bandwidth RF amplifier that provides 12-15 dB of signal gain. That's an increase of about two S units. Station Blazer covers 3 to 30 MHz in one giant step. No tuning or signal peaking is necessary and the only control is an *on/off* switch.

All that signal helping gain is provided by a mere handful of parts. Total cost should run under \$6.00, and that's for a fancy version. Construction is simple and goes quickly. It's a one-evening project.

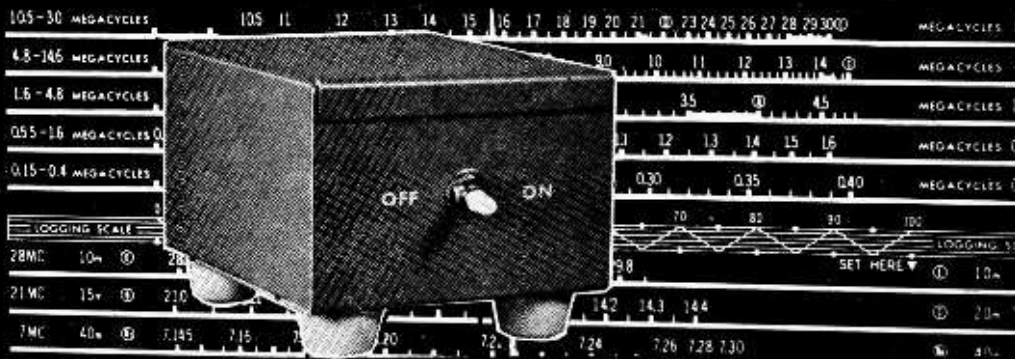

Station BLAZER

Schematic diagram shows how simple our Station Blazer is to build and how few components can be put together to make a very efficient preamp thanks to the FET.

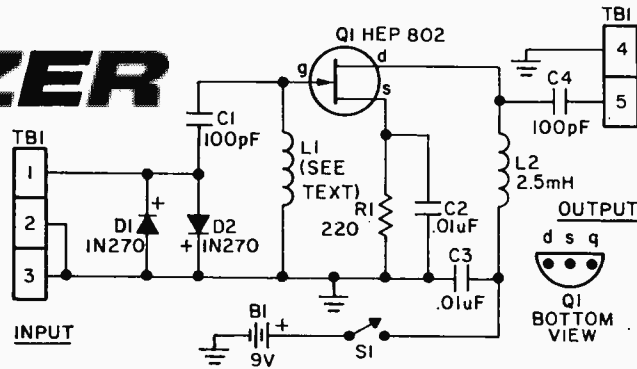

PARTS LIST FOR STATION BLAZER

B1—9-V battery (Eveready 2168P or equiv.)
 C1, C4—100-pF, 25-VDC disc ceramic capacitor
 C2, C3—.01 uF, 25-VDC disc ceramic capacitor
 D1, D2—1N270 diode (RCA)
 L1—See text
 L2—2.5-mH choke (National R-50-2.5 or equiv.)
 Q1—HEP 802 field-effect transistor (Motorola)
 R1—220-ohm, 1/2-watt resistor
 S1—Spst miniature toggle switch (Lafayette 99E61624 or equiv.)
 TB1—5-terminal screw terminal board

1—3/8-in. dia. x 1-in. long ferrite rod taken from a ferri-loopstick antenna (Lafayette 32E82019 or equiv.—see text)
 1—3 3/4 x 3 x 2 1/8-in. interlocking chassis (LMB-135 or equiv.)
 1—Battery holder made from 1/2 x 1 3/4-in. scrap aluminum
 1—Circuit board, copper clad on one side
 Misc.—Push-in terminals, vinyl covering material, rubber feet, hardware, solder, hook-up wire, RG8/u coaxial cable, etc.

How It Works. RF signals from the antenna are coupled from terminal 1 of terminal strip TB1 to the gate of field-effect transistor Q1 via coupling capacitor C1 (see Fig. 1). Coil L1 provides a DC return path to ground for the gate but blocks RF.

Transistor Q1 is biased for normal amplifier operation by resistor R1 in the source

ground leg of the circuit. Capacitor C2 bypasses R1, preventing degeneration and loss of amplifier gain. The amplified signals appear at the drain of the transistor and are coupled to terminal 5 of TB1 by capacitor C4.

Diodes D1 and D2 are connected across the input. Normally they don't affect circuit operation. They do come into action, how-

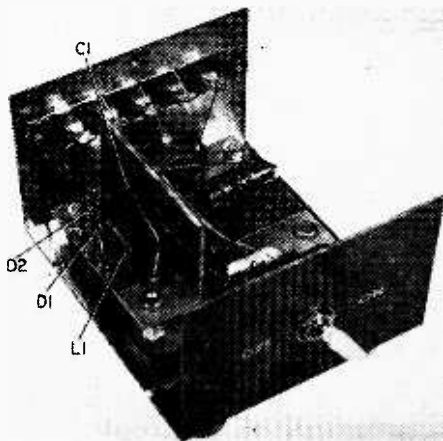
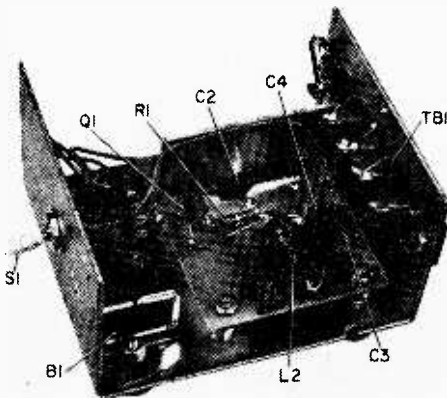

You can see how well the Station Blazer's laid out, with all components mounted on one sided copper foil board. Good HF wiring practices must be used for it to work.

You can see that all it takes to run our Station Blazer is just one control—the power switch on the front panel turns it on or off. It's easy to build and fun to use.

ever, to protect the FET from high voltages generated by lightning and static discharges as well as high-power transmitters located nearby. They conduct only on high-level inputs, grounding the signal, and thus protecting the FET from possible damage.

Begin construction by marking the chassis with the mounting positions of switch S1, terminal strip TB1, the circuit board and

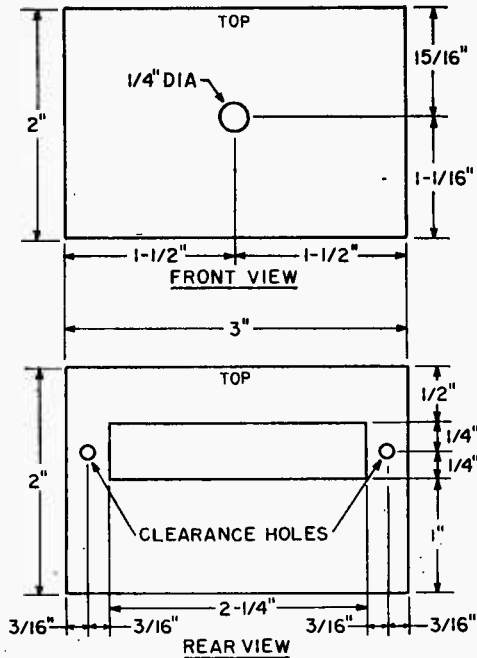

Drilling instruction for the minibox that houses our Station Blazer. If you don't have a hand nibbler available cut out the large openings by drilling and filing.

rubber feet (see Figs. 2 and 3). Once the parts layout has been determined, spot and center punch the holes to be drilled, then drill and deburr all holes. The cutout for the terminal strip is most easily made with a hand nibbler. With the necessary holes drilled and all other mechanical work on the case completed, finishing the case is the next step. The author's model was covered with a contact adhesive vinyl material. This type of material is widely available in a variety of colors and patterns.

Electrical Construction. The exact electrical layout isn't critical, as long as proper hf layout and wiring techniques are kept in mind. Remember the FET has lots and lots of gain. Couple this with its high input impedance, and you can see where sloppy layout and wiring can get you in trouble! Poor-

ly wired, Station Blazer will act more like an oscillator than an amplifier, and this we can do without.

The general component layout can be determined from our photos. Most of the parts are mounted on a copper-clad board. Take care to use short, direct leads. Note that coils L1 and L2 are mounted at right angles to one another. This is done to reduce inductive coupling between input and output. Further isolation is provided by shielding the input from the output circuit with a section of copper-clad board.

With the exception of the lead from Q1's gate to L1, all wiring is carried out on the component side of the board. Two strips, along opposite edges of the board, should be removed to provide insulated areas for push-in terminals and mounting nuts. To remove the strips score the material with a hobby knife and pull off the unwanted copper areas.

Transistor Q1 is soldered directly into the circuit. Precautions should be taken to prevent Q1 from damage due to excessive heat while soldering. This means that your old 250-watt lead melter is definitely out! Use a small (under 50 watts) well-tinned iron, and complete the job as quickly as possible. The source and drain leads are interchangeable. The gate leads, however, isn't interchangeable with any of the other leads and must go to L1 and C1.

Coil L1 is home-brew. Start with a 3/8 x 5-in. ferri-loopstick antenna (see Parts List) and unwind the turns. Cut off a 1-in. long section of rod and wind it with 40 turns of #26 PE wire closewound. Cement the turns

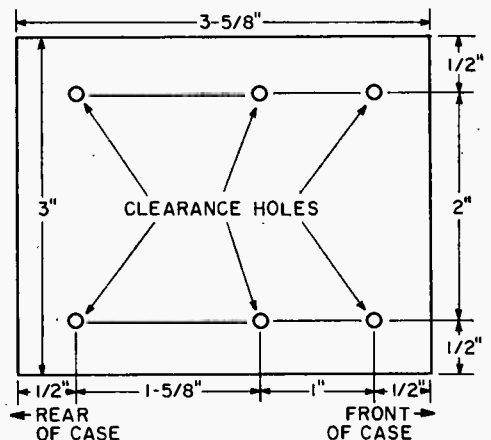

Drill the bottom of the minibox as shown to mount the circuit card and the battery holder. Be sure all holes are de-burred.

Station **BLAZER**

in place with Q-dope or Duco cement. The low-frequency coverage of Station Blazer can be extended down to 0.5 MHz by winding L1 with 150 turns on a 1½-in. long ferrite rod, closewound in 3 layers. Some loss of gain at the higher frequencies will result, however.

After the electronic card has been wired, check it against the schematic for possible errors and shorts. Mount the card in the case using 4-40 x ½-in. screws. Space the card about ⅜ in. off the chassis, using additional nuts under the board on the screws. Complete the few final connections between the card and the input/output terminals, battery B1, and switch S1.

Using It. All that's left to do is to connect

your receiver's input terminals to Station Blazer's output and your antenna to the input. Station Blazer is connected to your receiver using a short length (under 3 ft.) of RG-8/U coaxial cable.

For best results, a good ground is a necessity. However, when connecting ground wires to systems containing an AC/DC receiver you must use special precaution because a lethal shock hazard is present. The best procedure to follow is to first isolate the receiver from the power line using a 1:1 transformer.

All set? Snap in the 9-V battery and turn your Station Blazer *on*. Never knew there were so many signals, eh? Gain improvement is most noticeable on weak signals, about S1 or so. Boosted to a more respectable S3, these stations are much more readable. Best of all, signals you never even suspected of existing before can now be caught and logged.

Happy DXing! ■

Doubletimer

Continued from page 54

Time zone, and goes like this:

L	1	2	3	4	5	6	7	8	9	10	11	12
D	20	21	22	23	00	13	14	15	16	17	18	19
N	08	09	10	11	12	01	02	03	04	05	06	07

However, it can be modified for use in any time zone you prefer. The horizontal lines following the letter *L* indicate hours in local time. The lines following the *D* (for day) indicate GMT when local time is between 6 a.m. and 6 p.m. And, the lines following *N* (for night) indicate GMT hours when local time is between 6 p.m. and 6 a.m.

The chart was typewritten on a white card, then copied with a camera using a close-up lens. A print was made to the exact size of a wristwatch calendar, and glued to an old calendar with epoxy cement.

After the cement dried, the edges were beveled with fine sandpaper, then two coats of varnish applied to protect the surface of the chart from wear and smudges.

Using It. With such a chart attached to your watchband, use it this way:

✓ To convert local time to GMT, first look at the watch dial reading local time. Let's say it reads 8:32 and it's in the evening. Locate 8 in an *L* line on the chart. You see it's opposite 3 in the *N* line and 15 in the *D*

line. Since it's night time, disregard the *D* line and use the *N* line. This tells you that 8 p.m. local time (in the Mountain Standard Time zone, for which this chart was prepared) is 0300 GMT. Add to this the number of minutes shown on your watch dial and you have 0332 GMT.

✓ To convert GMT to local time. Suppose a ham in Europe told you he'd be on the air at 1700 hours GMT, and you want to listen for him. Look at the chart for 17. You see it's opposite 10 and in the *D* line. This tells you local time will be 10 o'clock in the daytime, or 10 a.m.

What could be simpler?

For use in other time zones, set up your chart this way: 0000 GMT equals 8 p.m. in EDT, 7 p.m. in EST and CDT, 6 p.m. in CST and MDT, 5 p.m. in PDT, and 4 p.m. in PST. Once you have this key hour filled in, the rest of the chart follows logically.

If at first glance the chart seems complicated, never fear. After you've used it a few times, you'll marvel at how simple . . . and handy . . . it is to use.

Now, with any inexpensive watch, you can carry GMT (or some other time zone) with you all the time. And of course if you still want to know the day of the month, you can wear a conventional clip-on calendar for the current month, plus your GMT conversion chart on a separate clip-on.

Sure beats carrying a sun-dial around, doesn't it? ■

FISHER MODEL 500TX

Pushbutton Memory Tuning AM/FM-Stereo Receiver

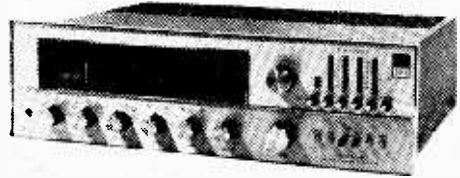

TAKEN at face value (or rather at front-panel value) the Fisher 500TX looks like any other feature-packed AM/FM-stereo receiver, only more so. It has all of the usual controls plus a section of the front panel titled: TUNE-O-MATIC, which looks like a flight-control panel from the latest jet. As a matter of fact, TUNE-O-MATIC is just one of the many extra features resulting from Fisher's use of a complex FM front end incorporating an unique electronic tuning system.

You name a desirable feature and the 500TX in all probability has it, since it contains more features than one normally expects from a commercially-built unit.

Most interesting, to our way of thinking, is the electronic tuning scheme for the FM band, a completely new tuning system not previously available in consumer equipment. It's interesting because of the total absence of a ganged variable tuning capacitor for the FM portion of the receiver.

In addition to electronic tuning, Fisher has also incorporated automatic signal search (or AUTO-SCAN, as Fisher names it), as well as manual tuning from the front panel, plus complete, foolproof continuous remote tuning, and pushbutton selection of four of your favorite FM stations.

How ET Works. Electronic tuning (ET) is

uncomplicated and is accomplished by using *varactor* diodes in place of the conventional tuning capacitor. A *varactor* diode is a special type of diode whose capacitance across the anode and cathode leads, under reversed polarity conditions, varies with the applied DC voltage.

In the 500TX, Fisher uses a somewhat different three-terminal *varactor* diode. It is, actually, a twin back-to-back diode that provides for a greater than usual capacitance range along with temperature stabilization. The FM front end employs five varactors, one for input and two for output tuning of the RF amplifier, one for tuning the oscillator, and one providing AFC correction. In addition, FETs are used in the RF amplifier, mixer and IF amplifier, which also includes a crystal filter.

The AM portion of the 500TX is quite conventional, employing the usual ganged variable tuning capacitor. A potentiometer coupled to, and mounted on the rear of the AM tuning gang, provides the variable voltage for electronic tuning of the FM portion of the receiver.

Push a switch and the voltage control is switched to any one of four preset potentiometers to select any of your four favorite FM stations. These potentiometers are mounted so that their adjustment is in-

This view of chassis rear apron details input-output and accessory items connections. Note the two switched AC convenience outlets and switch for selection of high or low gain phono inputs. Also jacks marked high level input for connecting a reverb.

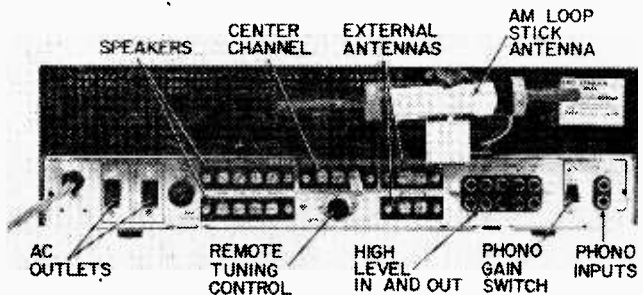

LAB CHECK

indicated by vertical positioning of slide levers mounted behind four slots in the receiver's front panel. These slots have frequency calibration indications for the preset tuning.

Another pushbutton actuates the AUTO-SCAN which automatically sweeps over the band at a slow rate, thus allowing the listener to hear each receivable signal in the band. This circuit consists of 18 transistors plus an integrated circuit (IC). Or, you can push a sixth pushbutton and the Auto Scan selects the next station above or below the last station selected. The electronic tuning auto-

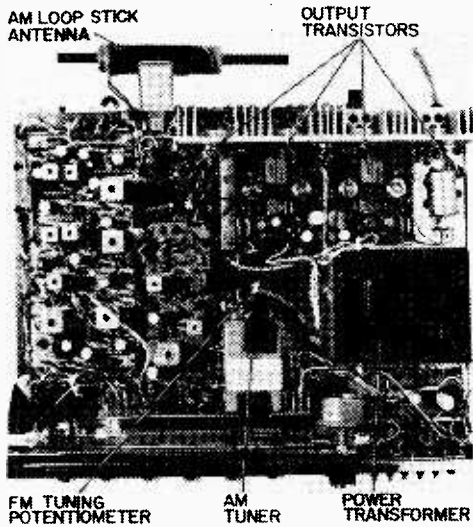

You get a good idea of the general chassis layout from this topside view with FM tuning pot, AM tuner and loopstick identified.

matically centers on the desired channel.

So you want to be lazy—all you need do to remotely tune the FM band from your favorite easy chair is to plug in the optional remote-control accessory.

For manual tuning, the receiver employs a conventional straight line dial calibrated for both AM and FM tuning ranges. When tuning electronically, the top portion of the signal strength meter, which is panel-mounted, is illuminated and indicates the electronically tuned frequency. Calibration of the manual dial is quite accurate, as you should expect. However, the electronic tuning calibration is only a relative indication,

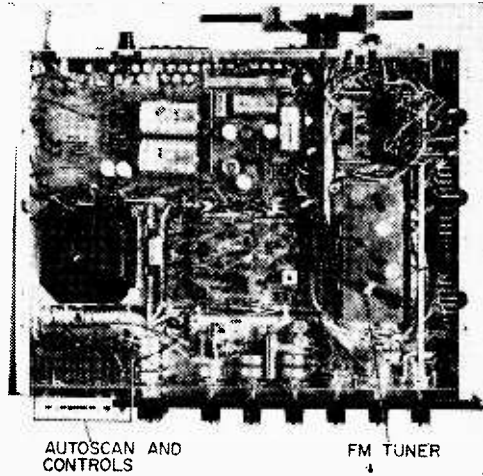

By looking under the chassis you see both the FM tuner assembly at right of picture and AUTO-SCAN assembly at left of picture.

accurate within 2 MHz. Obviously the meter calibration should be improved.

Additional features. Other features of the 500TX include: a) 65-W rms output into 8 ohms impedance for each channel; b) provision for connecting main and remote speakers as well as a center channel mono output at speaker level and outputs for phones and a tape recorder. Want a reverb? Input and output connections for a reverb device are prewired on the rear chassis panel. Also on this rear panel are connections for phono input with high- and low-gain selector switch, auxiliary, recorder, tape

(Continued on page 102)

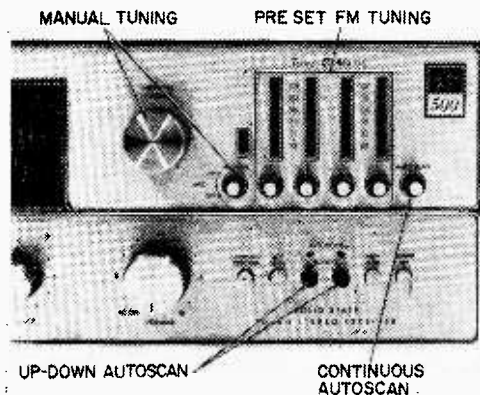

This closeup of the right side of front panel shows FM pushbutton calibrators in addition to AUTO-SCAN controls.



HAM TRAFFIC DE W7DQS

by MARSHALL LINCOLN

Who's Minding the Store?

WHAT is the purpose—or purposes—of ham radio? Do you know? Can you jot down a list of them?

I used to think I could. But with the events of the past year or so, I'm beginning to wonder if any of us can.

Developments . . . or disappointments . . . in the status and future of ham radio should give all of us something serious to think about.

We're all accustomed to change in hamming habits and principles, or at least we should be. Yet some of the changes being aimed at us from the hallowed halls of Washington, D.C. don't look very healthy for hamming in the future, I fear.

Look at the Facts. Let's take a look at the record, review some recent events, and see where these events seem to be leading us.

First, let's turn the calendar back just a few years and recall the big furor raised over the issue that became known as incentive licensing. This all began with some strong hints by influential officials at the FCC who said ham radio in the U.S. was deteriorating in quality, and that something should be done about it so the hams could present a strong case at the next international frequency allocations conference. They warned that hams would have to demonstrate through their actions that they were seriously interested in radio communications as a constructive activity, rather than just a plaything.

With this as a background, the American Radio Relay League (ARRL) proposed a revamping of the license requirements. To get full use of all ham bands, a feller or gal would have to upgrade him or herself by passing a stricter exam. This led to dividing up the bands into General, Advanced, and

Extra Class segments.

A lot of tempers were lost in the verbal battle that ranged across the country. Eventually, the basic idea was written into the regs . . . except that the Friendly Candy Company split up the bands in a much more complicated way than had been proposed.

Up . . . And Down. Despite this needless complexity of the regs, the general result has seemed to be beneficial for ham radio. Certainly a lot more hams have taken—and passed—the higher-class license exams than did so when the Extra Class License was merely a hollow no benefit achievement.

Most observers have said some of the slopiness which was becoming commonplace on the bands has been cleaned up in the band segments reserved for the higher-class operators. This gives validity to the original theory of incentive licensing—that the result would be an improvement in technical knowledge and in operating ability.

Thing is, just when the idea seemed to be paying off . . . with at least a part of the ham population proving they really wanted to improve themselves . . . along comes the Friendly Candy Company with some more changes and proposed changes. Couped with them is a profound lack of really progressive spirit that may well cancel out the benefits we might have reaped from incentive licensing.

Getting down to the nitty-gritty, the Feds have partly cancelled out their original incentive licensing regulations by deciding that some of the restricted frequencies which were supposed to go into effect in the second year of the system won't go into effect after all. In other words, they set up an incentive system, gave it only a year's trial,

(Continued on page 101)

NRI "hands-on" training in TV-Radio, Electronics can give you as much as 2 years of on-the-job experience.



EARN YOUR FCC LICENSE - OR YOUR MONEY BACK

NRI Communications training programs will qualify you for a First Class Commercial Radiotelephone License issued by the FCC. If you fail to pass the FCC examinations for this license after successfully completing an NRI Communications course we will, on request, refund in full the tuition you have paid. This agreement is valid for the period of your active student membership and for six months after completion of your training. No school offers a more liberal FCC License agreement.

Experience is still your best teacher

... here's how you get it with
unique NRI training at home

Ask any teacher, job counselor, engineer, technician or prospective employer about the need for practical application of theory in Electronics. He'll tell you Electronics is as much a "hands-on" profession as dentistry or chemistry. That's how you learn at home with NRI. You prove the theory you read in "bite-size" texts, by actual experimentation with the type of solid-state, transistor and tube circuits you'll find on the job today — *not* hardware or hobby kits. You introduce circuit defects, analyze results, discover quickly the kind of trouble-shooting and design techniques that will make you employable in Electronics.

Train with the leader — NRI

NRI lab equipment is designed from chassis up for effective, fascinating training — not for entertainment. The fact that end results are usable, quality products is a bonus. In Communications, for example, you build and analyze, stage by stage, your own 25-watt phone/cw transmitter. It's suitable for use on the 80-meter amateur band, if you have an interest in ham radio. In TV-Radio Servicing your practical training gives you your choice of monochrome or color TV sets. All training equipment is included in the low tuition — you pay nothing extra. Discover for yourself the ease, excitement and *value* of NRI training. Mail postage-free card today for new NRI Catalog . . . or use the coupon below. No obligation. No salesman will call on you. NATIONAL RADIO INSTITUTE, Washington, D.C. 20016.



NRI Achievement Kit is educator-acclaimed and the original "starter" kit in home study training. Imitated but never duplicated, this kit is designed and personalized for you and your training objective. It has one purpose — to get you started quickly and easily.



"Bite-Size" Texts average an easily-digested 40 pages of well-illustrated, scientifically prepared subject matter in the course of your choice. Questions in each book are carefully hand-graded and returned to you with helpful instructional notes. You get unlimited personal help from the day you enroll.



Designed-For-Learning Equipment

Like this phone-cw transmitter (Kit #7 in the Communications course) is engineered from chassis up to demonstrate principles you must know. NRI does not use modified hobby kits for training, but the finest parts money can buy, professionally and educationally applied.

APPROVED UNDER NEW GI BILL

If you have served since January 31, 1955, or are in service now, check GI line on postage-free card or in coupon.

MAIL THIS COUPON IF CARD IS GONE



NATIONAL RADIO INSTITUTE

Washington, D.C. 20016

Please send me your new NRI Catalog. I understand no salesman will call and there is no obligation.

Name _____ Age _____

Address _____

City _____ State _____ Zip _____

Check for facts on new GI Bill

ACCREDITED MEMBER NATIONAL HOME STUDY COUNCIL



Down Under a Mile and a Half Above



Photos on this page show interiors and exterior views of the new Metro Mexico. Note the subway stop above with its symbols for Indios who haven't learned to read as yet. Bottom—subway riders are bored all over.

RAPIDO! Mexico City is a mile-and-a-half high. This makes their new subway system the highest underground transit system in the world. Always great builders in stone, Mexican architects have constructed their subway with glass-domed entrances, and cars moving silently on rubber wheels filled

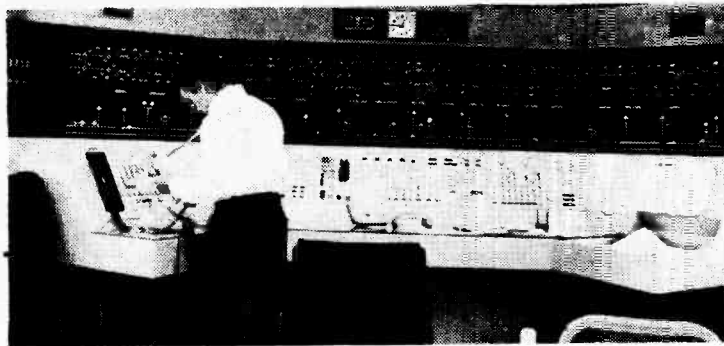

Subway dispatcher, south of the border and two miles high. He operates this model board which lights up all the workings of the subway system and enables him to watch and control action on the rail-lines. With the cooperation of French engineers, the Mexicans were able to surmount many problems, among them being earthquakes and shifting subsoil. Ole!

Brain of Metro-Mexico system is this electronic computer, which is housed in midtown Mexico City in a 6-story building. Mexicans point with pride to this—one of the most modern dispatching systems in the world—and they're justified!

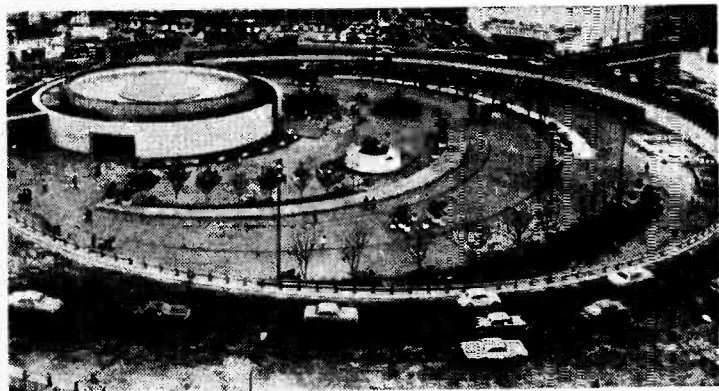
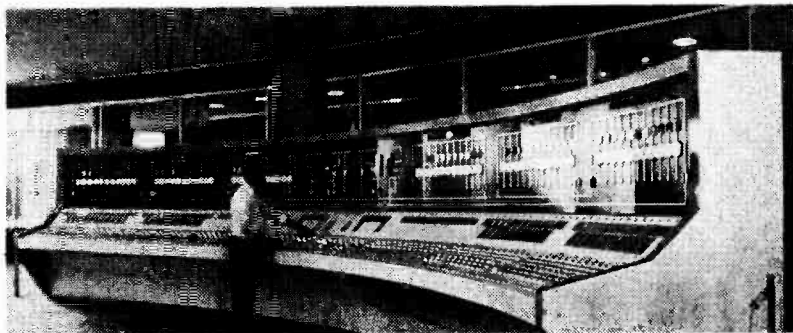

Aerial view from outside the Insurgentes station. The modern ramp uncoils like the fabled plumed serpent of Mexico. Down you go and for the equivalent of 9¢ have a quiet, comfortable ride. New York Transit Authority, please copy!

Over 5000 pieces of ancient Aztec art were unearthed during construction. Here we show an Aztec temple which the architects incorporated into the design.

with nitrogen to prevent overheating, traveling eight miles on shining rails through brightly lit tunnels.

Crucial to the transportation needs of Mexico City's nearly seven million people, Metro Mexico will be extended another 20 miles for the estimated 11 million gente by 1980. ■





FAMOUS PATENTS

No. 235,199

ALEXANDER G. BELL'S PHOTOPHONE

FOR Alexander Graham Bell, the invention of the telephone was the highlight of a lifetime devoted to helping people communicate. But it was by no means the end of his brilliant research. In 1880, six years after his invention of the telephone, he created the "Photophone"—a wireless telephone that transmitted speech on a beam of light.

Radio was still in the future when plans for the first wireless telephone system began to form in Bell's mind. The idea was triggered by the discovery of the unusual properties of *selenium*—the rare chemical element that was to form the heart of the photophone. In 1875, scientists working on the Atlantic cable had investigated the possibility of using selenium as an electrical resistor.

Their investigation uncovered a curious fact: the resistance of the element changed according to the amount of light falling on it. News of the strange phenomenon suggested a new line of research to the famous inventor.

In a telephone receiver, variations in resistance and current are reproduced as sound. Why, Bell reasoned, couldn't selenium be incorporated in the circuit in such a way that variations in light falling on it would be transformed into sound? Bell and his associate, Summer Tainter, set up a small laboratory in Washington, D.C. and began to experiment.

The problem was two-fold: First to modu-

(Continued on page 78)

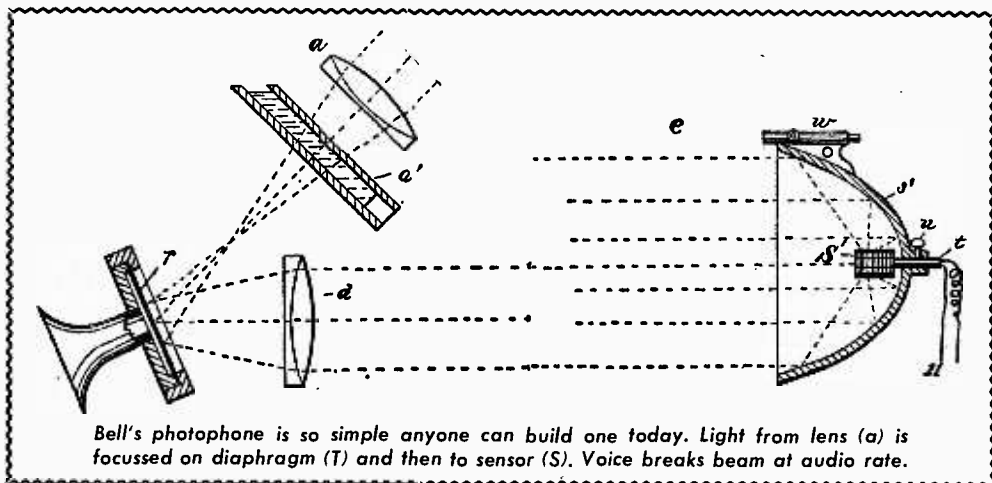

Bell's photophone is so simple anyone can build one today. Light from lens (a) is focussed on diaphragm (T) and then to sensor (S). Voice breaks beam at audio rate.

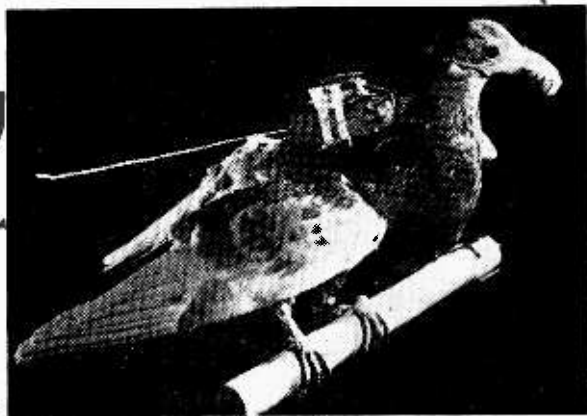

BIRD WATCHERS WORTH WATCHING

Scientists
have discovered
birds burn up
energy

faster
than most others
in the animal
kingdom.

The next time you see a bird wing overhead to flit on out of sight again, accept it as an act of nature. For if you don't, you may be caught up in the mysteries science is trying to answer today. Wilbur and Orville began the modern period of scientific bird study which culminated in the birth of the Boeing 747 superjet. However, as we learn more about birds, we soon discover how much more there is to unravel.

A Flock of 'Em. A team of biologists and engineers at the National Research Council of Canada has completed a five-year study of bird flight physiology. Their work has helped to unravel some of the mysteries of bird flight which have baffled scientists for decades.

The studies, undertaken by biologists in NRC's Division of Biology and engineers in the Radio and Electrical Engineering Division, exemplify the degree of collaboration which exists among NRC scientists. Dr. J. S. Hart, Head of the Animal Physi-

ology Section of the Division of Biology was in charge of the physiological studies. O. Z. Roy of the Medical Electronics Section of REED developed the sophisticated telemetric equipment used in the experiments.

The work produced new information on breathing, body temperature regulation and metabolism in flight. Transmitters weighing less than an ounce carried on the back of homing pigeons, ducks, gulls, and other birds, monitored information on breathing, wing beat, heart rates, and other events during flight, which was recorded by transducers placed in a rubber mask over the beak or on various parts of the body. A long nylon fishing line attached to a harness on the bird was used to prevent its escape and pull it down to earth after each test.

Dr. Hart says that answers were sought on three main questions. Is breathing during flight co-ordinated with wing action? How much does body temperature, metabolism and heart activity increase during flight?

BIRD WATCHERS

How is the heat production lost—through evaporation of water from lungs and air sacs or mostly by air convection through the feathers?

They're Hot. Measurement of body temperature, done for the first time in free flight of pigeons, showed that the normally high temperatures of these birds were elevated even more during flight to a record level of 113°F, compared with a maximum of about 104°F in man during heavy exercise. The temperature of a pigeon at rest is 107°F.

Real Flappers. In the pigeon and in the crow, it was found that breathing and wing beats were perfectly co-ordinated,

Complete telemetry transmitter only 1 3/4-in. long.

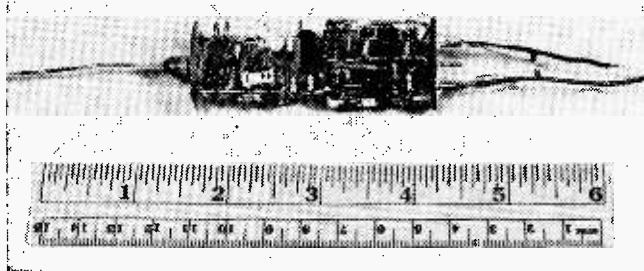

with inspiration (inhalation) occurring always on the upstroke of the wing, but in most species wing action was much faster than breathing. Basically the two functions are independent, which provides a basis for interrupted song during flight, but there was usually a co-ordination ranging from three to five wing strokes per breath.

Measurements of lung ventilation and oxygen content of the air exhaled from the mask gave very high estimates of heat production in flight. This ranged from 12 to 15 times basal (the rate at which heat is given off by an organism at complete rest) and

was equivalent, to near maximal increases in well trained animals during heavy exercise. Dr. Hart says, "the expenditure of energy in flight might very well be among the highest of energy capabilities in the animal kingdom."

They Have Heart. The heart frequency in flight is remarkably high with rates up to 20 beats per second in small birds compared with three per second in man during heavy work. From the oxygen consumption and heart rate, it is estimated that a small bird would circulate at least twice its weight of blood every minute.

With the high energy expenditure, the heat dissipation during flight becomes a problem, particularly under warm conditions. Contrary to older theories it was found that about 85 percent of this heat is lost by convection. In other words, it is dissipated mainly by air cooling through the feathers rather than water cooling; by evaporation from lungs and the many air sacs in the bird's body. This has the advantage of greatly reducing dehydration in long migratory flights, but raises the mystery of how this is accomplished in a heavily feathered bird. ■

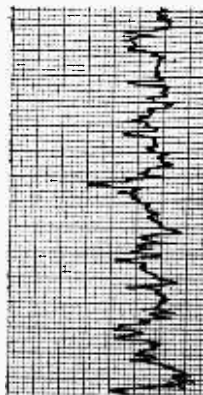
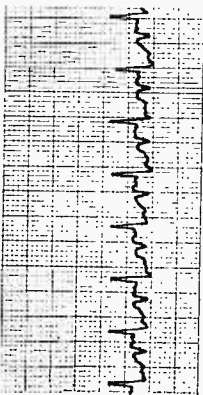

Note differences in heart beat of pigeon in flight (chart on right) and of pigeon at rest (chart on left).

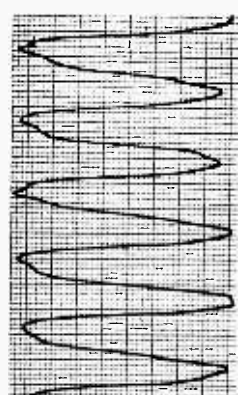
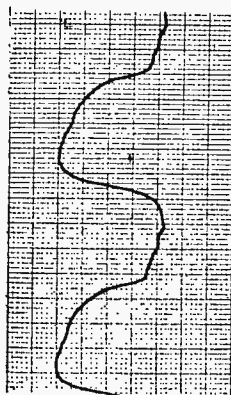

Respiration of pigeons in flight and at rest. Chart at left taken from pigeon landing and at right from pigeon in flight.

Lord Kelvin—a great physicist and an even greater engineer

GREAT MEN OF SCIENCE



by Webb Garrison

WULLIE TAMSON wants a room. He says he and his students must perform experiments." Tongues clucked and heads wagged among assembled dignitaries of Glasgow University. A few scholars smiled at the slur implied by use of the vernacular form of Thomson's name.

"Wants a room, does he?" responded a white-haired professor. "Move out the barrels, and give him the old wine cellar!"

That suggestion was accepted. Within weeks 22-year-old Professor William Thomson had installed simple equipment and was giving demonstrations in Great Britain's first physics laboratory. Colleagues laughed at him but he paid no attention. All his life he had been a non-conformist.

Youngest of six children, William never attended secondary school. He learned Latin from his father (himself a professor at Glasgow) and from age 10 attended lectures along with college students. At 17 he entered Cambridge. There he won few friends, but before his graduation in 1845 had gained fame as a mathematical genius.

Honors were old hat to Thomson; he'd won his first prize at 12 for translating a Latin tract. Before he was 15 he had won a prize in natural philosophy (a discipline then roughly equivalent to present-day "science"). At 18 he won a prize in astronomy

plus a university medal for an essay on earth's shape.

Modesty was not one of his attributes. Still, his first scientific paper appeared in the *Cambridge Mathematical Journal* under a pseudonym. He fumed and fussed, finally agreed to use it because his father's friends said an undergraduate shouldn't be publishing original papers. Twelve of his research papers were in print before he won his diploma; but he didn't publish under his own name until he held a university degree.

Long before he won it, his father and he had set their eyes on a coveted prize. Meikleham, venerated professor of natural philosophy at Glasgow, was getting old. A successor would be needed soon.

When Meikleham died in May, 1846, the Thomsons moved quickly. Within weeks Glasgow University electors had 30 testimonials, all from eminent scientists, attesting the brilliance and great promise of young Thomson. He was elected to the faculty at 22—and within a few weeks was asking for space outside his lecture room where he could arrange "demonstrations."

Even before the physics lab was launched, he set out to prove himself in the eyes of fellow teachers. Within a month after beginning his duties he produced a brilliant paper, just 4 pages long, showing that forces

of electricity and magnetism can be represented by distortions of an elastic solid.

As the years passed, he investigated practically all the physical sciences and made important theoretical contributions to many. He formulated the basic laws of thermodynamics, suggested adoption of the absolute scale of temperature that still bears his name, refined existing theories about electricity and magnetism, calculated the age of the earth as "not more than 100,000,000 years."

Later discoveries challenged his conclusions about our planet's age, but all his life he clung stubbornly to his own estimate.

In public and in private he was completely unpredictable. When he lectured on sound, he was likely to smuggle a rifle into his classroom and fire it without warning. He kept memo pads in his pockets, often ignored guests at dinner parties as he turned his attention to mathematical problems.

Still, this man absorbed with the abstract

was so intensely practical that he is often termed "the world's first electrical engineer." He developed both the principles and the equipment vital to success of the first trans-Atlantic cable. Reluctant to adopt the telephone, British leaders fought its introduction. Single-handed, Thomson badgered authorities until a company was formed to bring Bell's invention to the island kingdom.

His success with the Atlantic cable brought him knighthood; his 70 engineering patents brought him wealth. In old age his contributions to pure science brought him elevation to the peerage as Baron Kelvin of Largs.

He published more than 650 scientific papers, left a fortune of £171,000 from royalties on his patents. But he never stopped searching and probing. After resigning the professorship he had held for 53 years, in 1899 he mingled with undergraduates in the registration room and enrolled himself as "Lord Kelvin, Research Student." ■

Famous Patents

Continued from page 74

late a light beam with the sound vibrations from a human voice; and then to transform the modulated light back to sound.

The two scientists tested dozens of transmitting and receiving circuits before arriving at a workable system. Finally, on a clear day in February 1880, the invention was ready to be tested. Tainter carried the transmitter to the roof of a nearby school building, focused a beam of sunlight through the transmitter toward the laboratory window, an eighth of a mile distant, and spoke into the mouthpiece. In the laboratory, as the light was beamed through the window, Bell heard the sound of Tainter's voice in the receiver.

Bell filed a patent application and, before the end of the year, U.S. Patent 235,199 was granted on the photophone. Later patents on inventions relating to the photophone were granted to both Bell and Tainter. Bell had high hopes for commercial development of his wireless system when, under an existing agreement, he assigned the patent rights to the newly-formed Bell Telephone Co.

But the invention was destined for obscurity. As things turned out, the struggling young company was in the middle of a long legal battle over the basic telephone patent and had no resources to spare for the development of Bell's latest invention. So the

photophone was pigeon-holed. During the next two decades, a more practical form of wireless (radio) arrived on the scene and the light beam approach of the photophone was all but forgotten. It became another fascinating but little-known invention.

In the version of the photophone shown here (taken from Bell's original patent) light is concentrated through a lens to the polished metal diaphragm of a telephone transmitter. The light is reflected by the diaphragm through a focusing lens and beamed to the receiver. There it is concentrated by a parabolic mirror to a selenium cell which is part of the telephone receiver circuit. When the operator speaks into the transmitter mouthpiece, the diaphragm vibrates, scattering the light and varying the amount of light that falls on the selenium cell. This, in turn, varies the resistance of the cell and the current in the receiver circuit. The fluctuating current is reproduced as sound by an electromagnetically controlled diaphragm.

It may be that the photophone—dormant for nearly a century—has been re-discovered. With the advent of the laser, physicists are once again investigating the use of light for communication. The powerful, coherent light of the laser may provide the key to a modern version of Alexander Graham Bell's photophone.

Copies of Alexander Graham Bell's Photophone patent are available for fifty cents each from the U.S. Patent Office, Washington, D.C. 20231. In ordering, give the number of the Patent—No. 235,199. ■

Horace Twipple

Continued from page 60

a secondary radiation after the rays first strike the earth. We believe that this concentration is highly radioactive in carbon."

That night Horace sat in his apartment thinking.

"Carbon 14 . . . Geiger counters . . . cosmic ray neutrons at 40,000 feet . . . a mummy's hair 5800 years old. How does this stuff add up to bringing radio back?" He gave up and turned on the TV set to watch an old film of Cleopatra starring Theda Bara. When it was over he went to bed—not to sleep, but to think.

"I wonder what Cleopatra really whispered in Marc Antony's ear on that barge? Too bad I can't just tune my shortwave set in on sound waves from other times. Someone ought to invent some . . ."

He sat up suddenly. The Madame's words came back, "You are going to invent something spectacular." That was it. Sound waves reproduced from the past. That was what Pluto was sniffing in the sky.

"Let's see now. Sound waves spread out in all directions. Some of them would go up and reach this 40,000-foot layer of concentrated radioactive, carbon-coated neutrons. Why wasn't it possible for them to fuse with the neutrons? The cosmic rays would keep them alive by means of radioactivity." But how could he separate them to find one year from another? He would fuse his shortwave signals from his transmitter with carbon isotopes of mass 14 and use the archaeologist's carbon 14 method to send up the correct strength into the neutron layer. When his shortwave signals bounced back they would bring the radioactive sound waves with them.

There must be millions of ready-made radio programs floating around in the Twipple Belt (as he named it), waiting for him to bring them down and record them on tape. If he sold each one for five thousand dollars he'd have more money than any Swiss bank.

He was up early the next morning working on diagrams. Where was he to get the radio telescope, computers, and other equipment he needed to make a test? His old pals down at the Guaymas tracking station would let him use the equipment. He packed his bags.

When he arrived at Guaymas, he found

that Professor Wolfgang Brawn from the Houston Space Center was visiting the station. Horace decided to confide in the professor as he needed someone to serve as a reputable witness or the world would never believe his tapes were authentic.

By concentrated work, everything was wired up for a test that same night. Horace decided to record Cleopatra's voice for the test. He gave the computer the location of the ancient city of Alexandria, Egypt. Then he set the carbon-14 Geiger counter device back to 2014 years ago as the beautiful queen had lived from 68 to 30 BC. The last adjustment was to the computer to translate the Egyptian language into English before recording on the final tape.

Horace held his breath as he watched the telescope slowly swing in an arc under the guidance of the computer until it stopped. The shortwave set was wired in relay and he pressed the switch for a few seconds. Almost immediately the signal returned and the computers went into action as everyone shouted in excitement and waited. The radioactive, carbon-coated sound signals were amplified, put into transducers, and converted to electric signals. The output was then recorded.

Horace's hand shook as he prepared to play the reel back and turned on the recorder. "Listen, Marc, my love," came the dulcet tones of the seductive Cleopatra. "If you think you're going to slip into my pad just for kicks, you're off your Roman rocker. Just get up and put your toga back on and get the —out of here. Besides, you've got cold feet. Come back when you can give me Rome. Don't slam the drapes when you leave."

The voice and the tape came to an end as Professor Brawn cried, "You've done it. You are a *genius*, Mr. Twiddle, a *genius*!"

"The name is Twipple," said Horace gently as he smiled.

The following hours were spent in excited activity as the little group recorded tapes from various places and times in the past. The professor had phoned his Space Center as well as the *New York Times* to give them full information of the amazing discovery. When Horace stepped off his plane in New York the next day he found himself facing a barrage of news reporters and microphones.

"When will we hear some of your amazing tapes, Mr. Twipple?"

"Watch the radio programs in the daily

papers," he replied with gusto!

He took a cab to the buildings of the American Radio Corporation on Fifth Avenue and a few minutes later was seated in the private office of P. R. Gomple, president of the vast organization.

"Your discovery is absolutely incredible, Mr. Twipple," said Gomple. "Did you bring along any of the tapes you recorded?"

"Yes. I have one of Noah talking to some friends after his trip in the Ark. I have a violin solo by Nero. Also, I have Lincoln giving the Gettysburg Address. Of course I can record anything you ask for," said Horace calmly. "I will sell you exclusive rights for this country for two broadcasts for . . . twenty thousand dollars per tape."

"Agreed. I'll have a contract drawn up immediately," said Gomple. "Man alive, just watch the Hoople rating go down on the programs of that lousy C.S.B. television outfit when I put on some of these tapes." He pressed a desk button to call his secretary.

The next weeks were busy ones for Horace. He signed contracts at fabulous prices to record the philosophic speeches of Plato to be issued in book form. He signed radio rights for the use of tapes in foreign countries. He signed contracts with Hollywood. His bank account was so large they couldn't get the figure on one page.

Finally, when he learned that the stock of C.S.B. was at an all-time low, he bought

controlling interest of the company and moved into the office of the late president. After having his secretary type a few words on a slip of paper he walked down to Studio B.

A panel show produced by Mr. Pidmore was on the air and before the TV cameras. Horace walked into the middle of the set.

"Good morning, you TV viewers," he said as he faced the live camera. "May I interrupt the show briefly. I am Horace Twipple, the new president of C.S.B. and I see Mr. Pidmore, the producer of this show sitting over there. Will you come up here, Mr. Pidmore?"

There was a ripple of polite applause from the small studio audience as the white-faced producer walked slowly up to Horace.

"Will you kindly read this announcement, Mr. Pidmore?" said Horace as he handed the man the small slip of paper.

"I . . . I . . . am . . . a *stupid idiot*," said Mr. Pidmore in a weak voice as the audience began to laugh. "Mr. Twipple is a brilliant genius."

"Thank you, Mr. Pidmore, and on with the quiz show," said Horace as he walked out of the studio and went to find the chorus girl he had admired a few months previous. She probably would like to have a sports car or a mink coat or two. No, Horace did not fire Mr. Pidmore—Horace knows what damage an unemployed man can do. ■

TREASURE WITCHER

Continued from page 44

tion. The receiver should respond to the transmitter by giving a meter indication and producing an audio tone in the earphones. Start with the balance bracket at its upper limit of adjustment and slowly turn the wing nut clockwise until the meter reading drops near zero. Then raise the gain and re-adjust the balance until a minimum meter reading is again obtained.

If a plastic handle is used over the conduit, as in the author's model, a slight unbalance will occur when the wing nut is touched. With care, however, a balance adjustment can be easily accomplished.

Hitting the Road. If everything checks out AOK then you're ready for a trial run with your WITCHER. If you haven't previously used a transmitter-receiver metal locator, a

little practice may be in order. Place coffee cans, pie pans, or any good-sized metal object on the ground and use the WITCHER to locate the metal objects to get a good idea of its operation. (Actually, the unit is more sensitive when the balance adjustment is set where the meter will read up scale a division or two—this adjustment should be made away from any metal.)

If treasure hunting isn't your brew, then perhaps locating buried water, gas, or other hidden pipes will be more up your alley. Use your WITCHER and enjoy it! ■

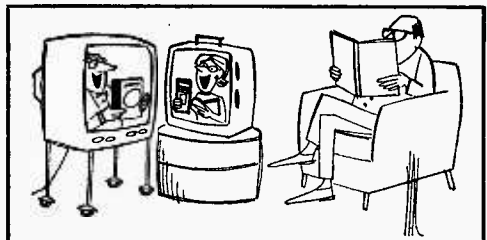

WHITE'S RADIO LOG

An up-to-date Directory of North American AM, FM, and TV Stations, including special sections on World-Wide Shortwave Stations and Emergency Stations for Selected Areas

WHITE'S RADIO LOG CONTENTS FOR 1969-1970

S & E Issue	Listing	Page
Aug./Sept. 1969	U.S. FM Stations by States	82
	Canadian AM Stations by Location	88
	Canadian FM Stations by Location	88
	World-Wide Shortwave Stations	89
	Emergency Radio Services—Boston Area	92
Oct./Nov. 1969	U.S. AM Stations by Call Letters	84
	World-Wide Shortwave Stations	96
	Emergency Radio Services—Philadelphia Area	99
Dec./Jan. 1969-70	U.S. FM Stations by Call Letters	82
	Canadian FM Stations by Call Letters	92
	Canadian AM Stations by Call Letters	92
	World-Wide Shortwave Stations	93
	Emergency R. Services—Washington-Baltimore Area	96
Feb./March 1970	U.S. AM Stations by Frequency	82
	World-Wide Shortwave Stations	96
	Emergency Radio Services—Florida	100
April/May 1970	U.S. TV Stations by States	82
	Canadian TV Stations by Cities	84
	Canadian AM Stations by Frequency	86
	World-Wide Shortwave Stations	91
	Emergency Radio Services—Southern California	95
1970 June/July	U.S. AM Stations by Location	(See next issue.)
	World-Wide Shortwave Stations	
	Emergency Radio Services—Detroit Area	

WHITE'S RADIO LOG

Location	C.L. Chan.
La Grande	KTVR 13
Medford	KOBI 5
Portland	KMED-TV 10
	KATU 2
	KOIN-TV 6
	KGW-TV 8
	↑KQAP-TV 10
	↑KPTV 12
Roseburg	KPIC 4
Salem	KVDO-TV 3

PENNSYLVANIA

Allentown-Bethlehem	↑WLVT-TV 39
Alltoona	WFBG-TV 10
Bethlehem	WKAP-TV 60
Clearfield	↑WPSX-TV 3
Erie	WICU-TV 12
	WJET-TV 24
	WSEF 35
	↑WQLN 5
Harrisburg	WHP-TV 21
	WTPA 27
Hershey	↑WTFV-TV 33
Johnstown	WJAC-TV 6
	WARD-TV 56
Lancaster	WGAL-TV 8
Lancaster-Lebanon-Philadelphia	WLYH-TV 15
	KYW-TV 3
	WFIL-TV 6
	WCAU-TV 10
	WPHL-TV 17
	WTAJ-TV 29
	↑WUHY-TV 35

Philadelphia (Burlington, N.J.)	WKBS-TV 48
Pittsburgh	KDKA-TV 2
	WTAE-TV 4
Lead	KHSD-TV 11
	WICV-TV 11
	↑WQED 13
	↑WQEX 16
	WPGH-TV 53
	WRPA-TV 51
Reading-Scranton & Wilkes-Barre	WNEP-TV 16
	WDAU-TV 22
	↑WVIA-TV 44
Wilkes-Barre & Scranton	WBRE-TV 28
York	WSBA-TV 43

RHODE ISLAND

Providence	WJAR-TV 10
	WPRI-TV 12
	↑WSBE-TV 36
Providence (New Bedford)	WTEV 6

SOUTH CAROLINA

Allendale	↑WEBA-TV 14
Anderson	WAIM-TV 40
Charleston	WUSN-TV 2
	WCIV 4
	WCSC-TV 5
	↑WITV 7
Columbia	WIS-TV 10
	WNOK-TV 19
	WOLO-TV 25
	↑WRLK-TV 35
Florence	WBTW 13
Greenville	↑WJPM-TV 33
Greenville	↑WNTV 29

Location	C.L. Chan.
Spartanburg & Asheville	WFBC-TV 4
	WSPA-TV 7
	WLOS-TV 13

SOUTH DAKOTA

Aberdeen	KXAB-TV 9
Bookings	↑KESO-TV 8
Deadwood-Lead	KDSJ-TV 5
Florence	KDOL-TV 3
Watertown	KHDS-TV 11
Lead	KORN-TV 5
Mitchell	KTSD-TV 10
Pierre	KOTA-TV 3
Rapid City	KRSD-TV 7
	↑KBHE-TV 9
	KPLO-TV 6
Reliance	KELO-TV 11
Sioux Falls	KS00-TV 13
Vermillion	↑KUSD-TV 2

TENNESSEE

Chattanooga	WRBC-TV 3
	WTVC 9
	WDEF-TV 12
	WBBJ-TV 7
Jackson	WJHL-TV 11
Johnson City-Bristol-Kingsport	WATE-TV 6
Knoxville	WBIR-TV 10
	WTVK 26
Lexington	↑WLJT-TV 11
Memphis	WREC-TV 3
	WMC-TV 5
	↑WKNO-TV 10
	WHBO-TV 13
	↑WDCN-TV 2
	WSM-TV 4
	WLAJ-TV 5
	WSIX-TV 17
	WMCV 17
	↑WSJK-TV 2

TEXAS

Abilene	KRBC-TV 9
Amarillo	KGNC-TV 4
	KVII-TV 7
	KFDA-TV 10
	KTBC-TV 7
	KHFT-TV 8
Austin	KFDM-TV 6
Beaumont	KBMT 12
	KNCT 46
Beton	KWAB-TV 4
Big Spring	KBTX-TV 3
Cryan	KIII 8
Corpus Christi	KRIS-TV 8
	KZTV 10
Dallas	↑KERA-TV 13
Dallas-Fort Worth	KRLD-TV 4
	WFAA-TV 7
	↑KMEC-TV 33
	KDTV 39
	KROD-TV 4
	KTSM-TV 9
	KELP-TV 13
El Paso	XEPM-TV 2
	XEJ-TV 5
El Paso-Juarez	WBAP-TV 5
Fort Worth-Dallas	KTVI 11
	KFWT 21
Galveston	KVVV-TV 16
Harlingen	KGST-TV 4
Houston	KPRC-TV 2
	↑KUHT 8
	KHOU-TV 11
	KTRK-TV 13
	KHTV 39
	KGNS-TV 8
Laredo	XEFE-TV 2
Laredo (Nuevo Laredo)	↑KTKT-TV 5
Lubbock	KOBD-TV 11
	KLBK-TV 13

Location	C.L. Chan.
Lufkin	KSEL-TV 28
Midland & Odessa	KKBC-TV 34
Monahans	KTRE-TV 9
Odessa	KMID-TV 2
Odessa	KNOM-TV 7
Odessa	KOSA-TV 9
Port Arthur	KJAC-TV 4
Beaumont	↑KRET-TV 23
Richardson	KACB-TV 3
San Angelo	KCTV 8
	WDAI-TV 4
San Antonio	KENS-TV 5
	KSAT-TV 12
	KWEX-TV 41
San Antonio-Austin	↑KLRN-TV 9
Sweetwater	KTXS-TV 12
Abilene	KCEN-TV 6
Temple	KLTV 7
Waco	KXIX 19
Tyler-Longview	KAVU 10
Victoria	KWIX-TV 10
Waco	KWIX-TV 10
Westaco	KRGV-TV 5
Wichita Falls	KFDX-TV 3
	KAUZ-TV 6

UTAH

Logan	↑KUSU-TV 12
Ogden	↑KOET 9
	↑KWCS-TV 18
Provo	↑KBYU-TV 11
Salt Lake City	KUTV 2
	KCPV-TV 4
	KSL-TV 5
	↑KUED 7

VERMONT

Burlington	WCAX-TV 3
	↑WETK 33
Burlington-Plattsburgh	WVNY-TV 22
Rutland	↑WVTR 28
St. Johnsbury	↑WVBT 20
Windsor	↑WVTA 41

VIRGINIA

Bristol-Kingsport & Johnson City	WCVB-TV 5
Hampton-Norfolk	WVEC-TV 13
	↑WHRO-TV 15
	WSVA-TV 3
Harrisonburg	WLVA-TV 13
Lynchburg	WTRT-TV 3
Roanoke	WYAH-TV 27
Portsmouth	
Portsmouth-Norfolk-New-Port News	WAVY-TV 10
Richmond	WTVR-TV 6
	↑WVBT 1
	↑WCVB-TV 23
	↑WCVW 57
Richmond-Petersburg	WXEX-TV 8
Roanoke	WDBJ-TV 7
	WLSL-TV 10
	↑WBRA-TV 15
	WRFT-TV 27
	↑WVPT 51

WASHINGTON

Bellingham	KVOS-TV 12
Kennewick	KUEW 42
Port Angeles	
Kennewick-Richland	KEPR-TV 19
Pullman	↑KWSC-TV 10
Richland-Pasco	
Kennewick	KNDU 25
Seattle	KOMO-TV 4
	KING-TV 5

Location	C.L. Chan.
Spokane	KIRO-TV 7
	↑KCTS-TV 9
	KREM-TV 2
	KXLY-TV 4
	KHQ-TV 6
	↑KSPS-TV 7
	KITV 13
	↑KPEC-TV 56
	↑KTPS 62
Tacoma	KTNT-TV 11
	KNDQ 23
Tacoma-Seattle	KINT-TV 29
Yakima	↑KYVE-TV 47

WEST VIRGINIA

Bluefield	WHIS-TV 6
Charleston	WCHS-TV 8
Huntington	WBOY-TV 12
Clarksburg	WSWP-TV 9
Grandview	WMUL-TV 33
Huntington	
Huntington-Charleston	WSAZ-TV 3
	WHTI-TV 13
	↑WVWU 24
Morgantown	WOAY-TV 4
Oak Hill	
Beckley	WTAP-TV 15
Parkersburg	
Marietta	WDTV 5
Weston	
Clarksburg	
Wheeling	
Steuenville	WTRF-TV 7

WISCONSIN

Eau Claire	WEAU-TV 13
Fond du Lac	KFIZ-TV 34
Green Bay	WBAY-TV 2
	WFRV-TV 5
	WLUK-TV 11
	WKBT 8
	WISC-TV 3
	WMTV 15
	↑WHA-TV 21
	↑WKOW-TV 27
	WTMJ-TV 4
	WITI-TV 6
	↑WMSV 10
	WISN-TV 12
	WVTV 18
	↑WMTV 36
Rhineland (Wausau)	WAEO-TV 12
Wausau	WSAU-TV 7
	WAOW-TV 9

WYOMING

Casper	KTWO-TV 2
Cheyenne	KFCB-TV 5
Lander	
Riverton	
Thermopolis	
Worland	KWRB-TV 10

U.S. POSSESSIONS

GUAM

Agana	KUAM-TV 8
-------	-----------

PUERTO RICO

Aguadilla	
Mayaguez	WOLE-TV 12
Caguas	
San Juan	WKBW-TV 11
Mayaguez	↑WIPM-TV 3
	WORA-TV 5
	WRIK-TV 7
	WSUR-TV 9
	WKAQ-TV 2
	WAPA-TV 4
	↑WIPR-TV 6
	WTSJ 18

VIRGIN ISLANDS

Charlotte	WBNB-TV 10
Amalie	WSVI 8
Christiansted	

Canadian Television Stations by Cities

Canadian stations listed alphabetically by cities. Abbreviations: Chan., channel; C.L., call letters. Listing indicates stations on the air up to January 1, 1970.

Location	C.L. Chan.	Location	C.L. Chan.	Location	C.L. Chan.	Location	C.L. Chan.
Bon Accord, N.B.	CHSJ-TV-1 6	Bratone, B.C.	CFGR-TV-15 5	Burns Lake, B.C.	CFTK-TV-3 4	Canning, N.S.	CJCH-TV-1 10
Bonnyville, Alta.	CKSA-TV-2 9	Brandon, Man.	CKX-TV 3	Canaboo, Que.	CKRT-TV-4 4	Canoe, B.C.	CHBC-TV-8 3
Boss Mountain, B.C.		Brooks, Alta.	CFCN-TV-3 3	Calgary, Alta.	CFCN-TV 4	Canoe Mountain, Near	
			CJLH-TV-2 3		CHCT-TV 2	Valemont, B.C.	CFGR-TV-14 8
Bonavista, Nfld.	CFCN-TV-2 10	Bullhead Mountain, B.C.		Callander, Ont.	CFCH-TV 10	Carleton, Que.	CHAU-TV 5
Boston Bar, B.C.	CFGR-TV-9 5	Burns, Alta.	CJDC-TV-2 8	Campbellton, N.B.	CKCD-TV 7	Carlyle Lake, Sask.	CFSS-TV 7
Bowen Island, B.C.	CBUT-4 3	Burnaby, B.C.	CJLH-TV-3 8	Camp Woss, B.C.	CFNV-TV-1 3	Cassiar, B.C.	CBTD-TV 7
	CHAN-TV-2 3		CHAN-TV 8	Canal Flats, B.C.	CBUT-1 12	Castlegar, B.C.	CBUT-2 3

5 New Better-Value Kits From Heath

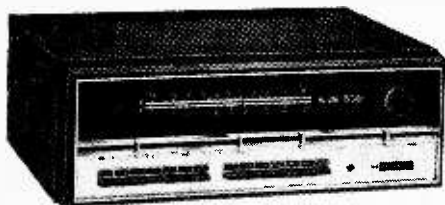

Kit AR-29
\$285^{00*}

New Heathkit 100-Watt AM/FM/FM-Stereo Receiver

World's finest medium power stereo receiver ... designed in the tradition of the famous Heathkit AR-15. All Solid-State ... 65 transistors, 42 diodes plus 4 integrated circuits containing another 56 transistors and 24 diodes. 100 watts music power output at 8 ohms — 7 to 60,000 Hz response. Less than 0.25% distortion at full output. Direct coupled outputs protected by dissipation-limiting circuitry. Massive power supply. Four individually heat sunk output transistors. Linear motion bass, treble, balance and volume controls. Push-button selected inputs. Outputs for 2 separate stereo speaker systems. Center speaker capability. Stereo headphone jack. Assembled, aligned FET FM tuner has 1.8 uV sensitivity. Two tuning meters. Computer designed 9-pole L-C filter plus 3 IC's in IF gives ideally shaped bandpass with greater than 70 dB selectivity and eliminates alignment. IC multiplex section. Three FET's in AM tuner. AM rod antenna swivels for best pickup. Kit Exclusive: Built-In Test Circuitry lets you assemble, test and service your AR-29 without external test equipment. The AR-29 will please even the most discriminating stereo listener.

Kit AR-29, (less cabinet), 33 lbs. \$285.00*
AE-19, Assembled oiled pecan cabinet, 10 lbs. \$19.95*

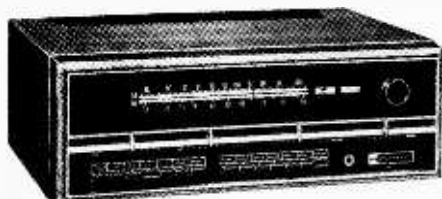

Kit AR-19
\$225^{00*}

New Heathkit 60-Watt AM/FM/FM Stereo Receiver

The AR-19 circuitry reflects many of the advanced concepts of the AR-29. It uses 108 transistors and 45 diodes including those in 5 integrated circuits. It delivers 60 watts music power at 8 ohms. At any power level, Harmonic and IM Distortion is less than 0.25%. Frequency response ranges from 6 to 35,000 Hz. Direct coupled outputs are protected by dissipation-limiting circuitry. A massive power supply includes a section of electronically regulated power. The assembled, aligned FET FM tuner has 2.0 uV sensitivity.

A preassembled and factory aligned FM IF circuit board gives 35 dB selectivity. The multiplex IC circuit provides inherent SCA rejection. It features two switched noise muting circuits; linear motion controls for bass, treble, volume and balance; input level controls; outputs for 2 separate stereo speaker systems; center speaker capability; two tuning meters; stereo indicator light; front panel stereo headphone jack. The Modular Plug-in Circuit Board design speeds assembly. Built-in Test Circuitry aids assembly, simplifies servicing. "Black Magic" panel lighting, black lower panel, chrome accents. Compare it with any model in its price range. ... the AR-19 will prove itself the better buy.

Kit AR-19, (less cabinet), 29 lbs. \$225.00*
Assembled AE-19, cabinet, 10 lbs. \$19.95*



Kit GD-109
\$74^{95*}

New Heathkit Deluxe 18-Watt Solid-State Stereo Phono

Looks and sounds like it should cost much more. Here's why: 16-transistor, 8-diode circuit delivers 9 watts music power per channel to each 4 1/2" high-compliance speaker. Speaker cabinets swing out or lift off ... can be placed up to 10' apart for better stereo. Has Maestro's best automatic, 4-speed changer — 16, 33-1/3, 45 & 78 rpm. It plays 6 records, shuts off automatically. Ceramic stereo cartridge with diamond/sapphire stylus. Has volume, balance & tone controls. Changer, cabinet & speaker enclosures come factory built ... you build just one circuit board ... one evening project. Wood cabinet has yellow-gold & brown durable plastic coated covering. This is a portable stereo you can take pride in.

Kit GD-109, 38 lbs. \$74.95*



Kit MI-29
\$84^{95*}

New Heathkit Solid-State Portable Fish-Spotter

Costs half as much as comparable performers. Probes to 200 ft. Spots individual fish and schools ... can also be used as depth sounder. Manual explains typical dial readings. Transducer mounts anywhere on suction cup bracket. Adjustable Sensitivity Control. Exclusive Heath Noise-Reject Control stops motor ignition noise. Runs for 80 hrs. on two 6 VDC lantern batteries (not included). Stop guessing — fish electronically.

Kit MI-29, 9 lbs. \$84.95*



Kit MI-19
\$69^{95*}

New Heathkit Solid-State Depth Sounders

Let its flashing indicator light guide you through strange waters ... day or night. Sounds to 200 ft. Has Noise Rejection and Sensitivity controls. Operates from your 12 VDC boat battery. Sun-shielded dial. All solid-state.

Kit MI-19-1, (with thru-hull transducer), 7 lbs. \$69.95*
Kit MI-19-2, (with high speed transom mount), 7 lbs. \$69.95*

NEW IMPROVED 1970 HEATHKIT® COLOR TV

New Lower-Than-Ever Prices

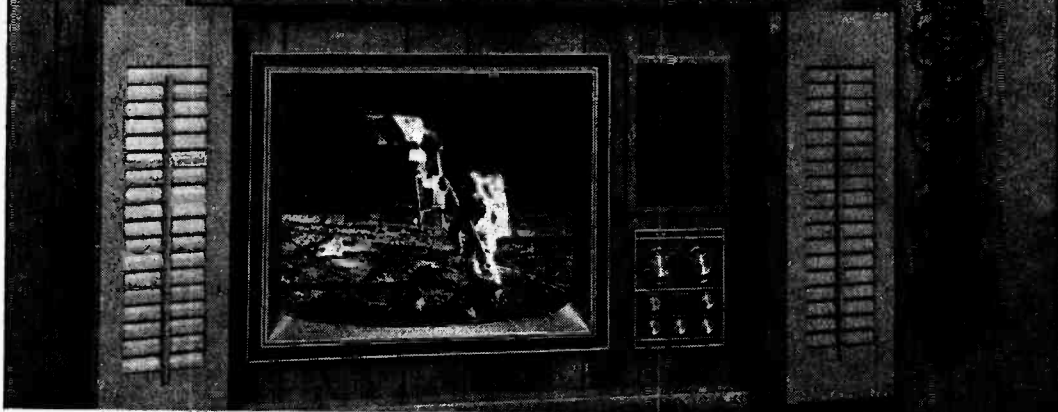

Here's How The Color TV That Thousands Call Best Became Even Better and Lower In Price

Since the very first model was introduced, thousands of owners, electronic experts, and testing labs have praised the superior color picture quality and extra features of Heathkit ColorTV. Now Heath has made improvements that make the 1970 models even better.



Sharper, More Detailed Pictures. Latest design improvement in the circuitry of Heathkit Color TV video amplifiers has increased their bandpass capabilities. The result is an increase in the number of lines of resolution . . . greater than in any other brand of color TV we have tested. This improvement means you get sharper, more detailed pictures as shown by test pattern measurements. You not only get the superior color pictures Heathkit Color TV has always been noted for, but you also get sharper pictures.

New Brighter Tube. Now all Heathkit Color TV models include the new brighter picture tube you've read so much about. These new tubes produce noticeably brighter pictures with more life-like, natural colors and better contrast. (We also offer the RCA Hi-Lite Matrix tube as an extra-cost option for the Heath GR-681 and GR-295 kits.)

New Safety Features. As an added safety precaution, AC interlocks have been added to all Heathkit Color TV cabinets.

Now The Best Costs Less. How can Heath make improvements in its Color TV Models and still reduce the prices? We have passed on to you the savings which have accrued due to reduced picture tube prices. The result is your 1970 Heathkit Color TV will cost you \$20 to \$55 less depending upon which model you choose . . . proof that Heathkit Color TV is a better buy than ever.

All Heathkit Color TV's Have These Superior Features

- New brighter American brand rectangular color tube with bonded-face, etched anti-glare safety glass • Exclusive built-in self-servicing aids so you can adjust and maintain the set for best performance always • Automatic degaussing plus mobile degaussing coil • New broader video bandwidth for better resolution • 3-stage video IF • Improved retrace blanking • Gated automatic gain control for steady pictures • Automatic color control • Exclusive Magna-Shield surrounds picture tube for better color purity • Deluxe VHF tuner with "memory" fine tuning and precious metal contacts (models with automatic fine tuning also are available in all 3 picture tube sizes) • 2-speed UHF solid-state tuner • Completely shielded hi-voltage supply • Extra B+ boost for better definition • 2 hi-fi sound outputs for built-in speaker or your hi-fi system • 300 ohm & 75 ohm antenna inputs • Circuit breaker protection • Optional wireless remote control can be added anytime • Factory assembled and adjusted tuners, IF section, and hi-voltage supply • Exclusive 3-way installation capability — in a wall, custom cabinet or Heath cabinets

Choose Your Heathkit Color TV Now . . .

It's Better Than Ever in Performance . . . and A Better Buy Than Ever



NEW FREE 1970 CATALOG!

Now with more kits, more color. Fully describes these along with over 300 kits for stereo/hi-fi, color TV, electronic organs, guitar amplifiers, amateur radio, marine, educational, CB, home & hobby. Mail coupon or write Heath Company, Benton Harbor, Michigan 49022.

New Lower-Than-Ever Prices On All Models

Heathkit GR-681 (295" AFT) save \$30
Now only **\$46995***



Heathkit GR-681MX (with Matrix tube) save \$55
Now only **\$47995***



Heathkit GR-295 (295") save \$30
Now only **\$41995***



Heathkit GR-295MX (with Matrix tube) save \$55
Now only **\$42995***



cabinets from \$65*

Heathkit GR-581 (227" AFT) save \$20
Now only **\$39995***



Heathkit GR-227 (227") save \$20
Now only **\$35995***



cabinets from \$39.95*

Heathkit GR-481 (180" AFT) save \$30
Now only **\$32995***



Heathkit GR-180 (180") save \$30
Now only **\$29950***

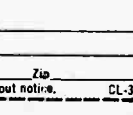

cabinets from \$27.50*



HEATH COMPANY, Dept. 19-4
Benton Harbor, Michigan 49022

Enclosed is \$ _____ plus shipping.

Please send model(s)
 Please send FREE Heathkit Catalog. Please send Credit Application.

Name _____

Address _____

City _____ State _____ Zip _____

*Mail order prices; F.O.B. factory. Prices & specifications subject to change without notice. CL-375

WHITE'S RADIO LOG

kHz	Wave Length	W.P.
CFNL Fort Nelson, B.C.	250	
CKEY Toronto, Ont.	10,000	
CKRS Jonquiere, Que.	1,000	
CFTK Terrace, B.C.	1,000	
VOCM St. John's Nfld.	10,000	

600-499.7
 CBNA St. Anthony, Nfld. 10,000
 CFCF Montreal, Que. 5,000
 CFCF Callander, Ont. 10,000

CFQC Saskatoon, Sask. 5,000
 CJOR Vancouver, B.C. 10,000
 CKCL Truro, N.S. 1,000

610-491.7
 CHNC New Carlisle, Que. 10,000
 CHTM Thompson, Man. 1,000
 CJAT Trail, B.C. 1,000
 CKML Mount Laurier, Que. 1,000
 CKYL Peace River, Alta. 10,000
 CKTB St. Catharines, Ont. 10,000

620-483.6
 CFCL Timmins, Ont. 10,000
 CKCK Regina, Sask. 5,000
 CKCM Grand Falls, Nfld. 10,000

630-475.9
 CFCO Chatham, Ont. 10,000
 CFCY Charlottetown, P.E.I. 10,000
 CHED Edmonton, Alta. 10,000
 CHLT Sherbrooke, Que. 10,000
 CJET Smiths Falls, Ont. 5,000
 CKAR Huntsville, Ont. 1,000
 CKOV Kelowna, B.C. 5,000
 CKRC Winnipeg, Man. 1,000

640-468.5
 CBN St. John's Nfld. 10,000

680-440.9
 CHFA Edmonton, Alta. 5,000
 CHFI Toronto, Ont. 2,500
 CHLO St. Thomas, Ont. 1,000
 CJCM Grand Falls, Nfld. 10,000
 CJOB Winnipeg, Man. 10,000
 CKGB Timmins, Ont. 10,000

690-439.5
 CBF Montreal, Que. 50,000
 CBU Vancouver, B.C. 50,000

710-422.3
 CHYR Leamington, Ont. 10,000
 CFRG Gravelbourg, Sask. 5,000
 CKVM Ville-Marie, Que. 10,000
 CJOX Grand Bank, Nfld. 1,000

730-410.7
 CHIR Leamington, Ont. 250
 CJNR Blind River, Ont. 1,000
 CKAC Montreal, Que. 50,000
 CKDM Dauphin, Man. 10,000
 CKGA Gander, Nfld. 5,000
 CKLG North Vancouver, B.C. 1,000

740-405.2
 CBL Toronto, Ont. 50,000
 CBX Edmonton, Alta. 50,000

790-379.5
 CFR Dartmouth, N.S. 5,000
 CFCW Camrose, Alta. 10,000
 CKMR Newcastle, N.B. 1,000
 CKSO Sudbury, Ont. 10,000
 CHIC Brampton, Ont. 5,000

kHz	Wave Length	W.P.
800-374.8		
CFOB Fort Frances, Ont.	1,000	
CHAB Moose Jaw, Sask.	500	
CHRC Quebec, Que.	10,000	
CJAD Montreal, Que.	5,000	
CJBO Belleville, Ont.	50,000	
CJLX Fort William, Ont.	10,000	
CKOK Pentteton, B.C.	1,000	
CKLW Windsor, Ont.	10,000	
VOWR St. John's, Nfld.	5,000	

810-370.2
 CHQR Calgary, Alta. 10,000

850-352.7
 CJJC Langley, B.C. 1,000
 CKRD Red Deer, Alta. 10,000
 CKVL Verdun, Que. 1,000

860-348.6
 CBH Halifax, N.S. 10,000
 CFPF Prince Rupert, B.C. 10,000
 CHAK Inuvik, N.W.T. 1,000
 CJBC Toronto, Ont. 50,000

900-333.1
 CHML Hamilton, Ont. 5,000
 CHNO Sudbury, Ont. 10,000
 CJBR Rimouski, Que. 1,000
 CJVI Victoria, B.C. 10,000
 CKBI Prince Albert, Sask. 1,000
 CKDR Dryden, Ont. 1,000
 CKDH Amherst, N.S. 1,000
 CKJL St. Jerome, Que. 1,000
 CKTS Sherbrooke, Que. 10,000
 CKVD Val D'Or, Que. 2,500

910-329.5
 CBO Ottawa, Ont. 5,000
 CFCO Kamloops, B.C. 10,000
 CFSX Stephenville, Nfld. 500
 CHRL Roberval, Que. 1,000
 CJDV Drumheller, Alta. 5,000
 CKLY Lindsay, Ont. 1,000

920-326.9
 CFRY Portage La Prairie, Man. 1,000
 CJCH Halifax, N.S. 10,000
 CJCC Woodstock, N.B. 5,000
 CKCY Sault Ste. Marie, Ont. 1,000
 CKNX Wingham, Ont. 10,000

930-322.4
 CFBC Saint John, N.B. 10,000
 CJCA Edmonton, Alberta. 10,000
 CJON St. John's, Nfld. 10,000

940-319.0
 CBM Montreal, Que. 50,000
 CJGX Yorkton, Sask. 10,000
 CJIB Vernon, B.C. 10,000

950-315.6
 CFAM Altona, Man. 10,000
 CKBB Barrie, Ont. 10,000
 CKNB Campbellton, N.B. 2,500
 CHER Sydney, N.S. 10,000

960-313.3
 CFAC Calgary, Alta. 10,000
 CHNS Halifax, N.S. 10,000
 CKWS Kingston, Ont. 10,000

970-309.1
 CKCH Hull, Que. 5,000
 CBFZ Fredericton, N.B. 10,000
 CJR Edson, Alta. 10,000

980-305.9
 CBV Quebec, Que. 5,000

kHz	Wave Length	W.P.
CFPL London, Ontario	10,000	
CHEX Peterborough, Ont.	5,000	
CKM Montreal, Que.	10,000	
CKNW New Westminster, B.C.	5,000	
CKRM Regina, Sask.	50,000	

990-302.8
 CBW Winnipeg, Man. 50,000
 CBY Corner Brook, Nfld. 10,000

1000-299.8
 CKBW Bridgewater, N.S. 10,000

1010-296.9
 CBR Calgary, Alta. 50,000
 CBRF Toronto, Ont. 50,000

1050-285.5
 CFCG Grande Prairie, Alta. 10,000
 CHUM Toronto, Ont. 50,000
 CJIC Sault Ste. Marie, Ont. 10,000
 CJNB North Battleford, Sask. 2,500
 CKSB St. Boniface, Man. 10,000

1060-282.8
 CFCN Calgary, Alta. 50,000
 CJRP Quebec, Que. 10,000

1070-280.2
 CBA Moncton, N.B. 50,000
 CFXA Victoria, B.C. 10,000
 CHOK Sarnia, Ont. 10,000

1080-277.6
 CKSA Lloydminster, Alta. 10,000

1090-275.1
 CHEC Lethbridge, Alta. 5,000
 CHRS St. Jean, Que. 10,000

1110-272.6
 CBD Saint John, N.B. 10,000
 CFML Cornwall, Ont. 1,000
 CFTJ Galt, Ont. 250d
 CHOT Edmonton, Alta. 10,000

1130-265.3
 CKWX Vancouver, B.C. 50,000

1140-263.0
 CBI Sydney, N.S. 10,000
 CKL Calgary, Alta. 10,000

1150-260.7
 CHSJ Saint John, N.B. 10,000
 CJRC Ottawa, Ont. 5,000
 CKOC Hamilton, Ont. 10,000
 CJTR Trois-Rivieres, Que. 10,000
 CKX Brandon, Man. 10,000

1170-256.3
 CFNS Saskatoon, Sask. 1,000

1190-252.0
 CFSL Weyburn, Sask. 10,000

1220-245.8
 CHSC St. Catharines, Ont. 1,000
 CJOC Lethbridge, Alta. 5,000
 CJSS Cornwall, Ontario 1,000
 CJRL Kenora, Ont. 1,000
 CKDA Victoria, B.C. 25,000
 CKCW Moncton, N.B. 10,000
 CKSW Shawinigan, Que. 1,000

1230-243.8
 CBDR Schefferville, Que. 250
 CFBV Smithers, B.C. 1,000
 CFRR Bridgeburg, Sask. 250
 CFFK Kapuskasing, Ont. 100
 CFLA Port Arthur, Ont. 1,000
 CHFC Churchill, Man. 250

kHz	Wave Length	W.P.
CHVD Dolbeau, Que.	1,000	
CJSA Ste. Agathe des Monts, Que.	250	
CJTT New Liskeard, Ont.	1,000	
CKLD Thetford Mines, Que.	250	
CKTK Kitimat, B.C.	1,000	
VOAR St. John's, Nfld.	250	

1240-241.8
 CFLM La Tuque, Que. 1,000
 CFLS Lévis, Que. 250
 CFVR Abbotsford, B.C. 1,000

CJAF Cabano, Que. 250
 CJAV Port Alberni, B.C. 1,000
 CJCS Stratford, Que. 500
 CJRW Summerside, P.E.I. 250
 CJWA Wawa, Ont. 1,000
 CKWL Williams Lake, B.C. 250
 CKBS St. Hyacinthe, Que. 250
 CKLS La Tuque, Que. 250
 CKOO Osoyoos, B.C. 1,000

1250-239.9
 CBOF Ottawa, Ont. 10,000
 CHWO Oakville, Ont. 1,000
 CHSM Steinbach, Man. 10,000
 CKBL Matane, Que. 10,000
 CKJD Sarnia, Ont. 1,000
 CKOM Saskatoon, Sask. 10,000

1260-238.0
 CFRN Edmonton, Alta. 50,000

1270-263.1
 CFCG Alma, Que. 1,000
 CHAT Medicine Hat, Alberta 10,000
 CHWK Chilliwaug, B.C. 10,000
 CJCB Sydney, N.S. 10,000

1280-234.2
 CHAM Hamilton, Ont. 10,000
 CHGM Powell River, B.C. 1,000
 CJMS Montreal, Que. 50,000
 CJSL Estevan, Sask. 1,000
 CKCV Quebec, Que. 10,000

1290-232.4
 CJOE London, Ont. 10,000

1300-230.6
 CBAF Moncton, N.B. 5,000
 CJME Regina, Sask. 1,000

1310-228.9
 CFCM Richmond Hill, Ont. 10,000
 CHBG La Pocatiere, Que. 2,500
 CKOY Ottawa, Ont. 50,000

1320-227.1
 CHQM Vancouver, B.C. 50,000
 CJSO Sorel, Que. 10,000
 CKEC New Glasgow, N.S. 5,000
 CKKW Kitchener, Ont. 1,000

1330-225.4
 CKKR Rosetown, Sask. 10,000

1340-223.7
 CFCB Happy Valley, Nfld. 1,000
 CKGF Grand Forks, B.C. 1,000
 CKGN Ste-Anne-des-Monts, Que. 250

CFKC Creston, B.C. 250
 CFLH Hearst, Ont. 100
 CFYK Yellowknife, N.W.T. 1,000
 CHAD Amos, Que. 250
 CJLS Yarmouth, N.S. 250
 CFOM Ville Vanier, Que. 250
 CKAR-I Parry Sound, Ont. 250
 CKCR Revelstoke, B.C. 1,000
 CKFL Lac Megantic, Que. 1,000
 CKNR Elliott Lake, Ont. 250

kHz	Wave Length	W.P.	kHz	Wave Length	W.P.	kHz	Wave Length	W.P.	kHz	Wave Length	W.P.
CKOX	Woodstock, Ont.	1,000d 250n	CJFP	Riviere du Loup, Que.	10,000d 250n	CHUC	Cobourg, Ont.	1,000 1,000d 250n	1500—199.9		
1350—222.1			CKCB	Collingwood, Ont.	250	1460—205.4			CKAY	Duncan, B.C.	1,000
CHOV	Pembroke, Ont.	1,000	CKRN	Rouyn, Que.	250	CJOY	Guelph, Ont.	10,000d 5,000n	1510—199.1		
CJDC	Dawson Creek, B.C.	1,000	CKSW	Swift Current, Sask.	1,000d 250n	CKRB	Ville St. Georges, Que.	10,000d 5,000n	CJRS	Sherbrooke, Que.	10,000
CJLM	Joliette, Que.	1,000	1410—212.6						CKOT	Tillsonburg, Ont.	1,000
CKN	Kentville, N.S.	1,000	CFMB	Montreal, Que.	10,000	1470—204.0			1540—195.0		
CKLB	Oshawa, Ont.	10,000d 5,000n	CKSL	London, Ont.	10,000	CFOX	Points Claire, Que.	10,000d 5,000n	CHIN	Toronto, Ont.	50,000
1360—220.4			CKVN	Vancouver, B.C.	50,000	CFRW	Winnipeg, Man.	5,000	1550—193.5		
CKBC	Bathurst, N.B.	10,000	1420—211.1			CFW	Welland, Ont.	1,000d 500n	CBE	Windsor, Ont.	10,000
1370—218.8			CJMT	Chicoutimi, Que.	1,000	1480—202.6			1560—192.3		
CFLV	Valleyfield, Que.	10,000d 5,000n	CJVR	Melfort, Sask.	10,000	CHRD	Drummondville, Que.	10,000	CFRS	Simeoe, Ont.	250d
1380—217.3			CKPT	Peterborough, Ont.	5,000	1490—201.2			1570—191.1		
CFDA	Victoriaville, Que.	1,000	1430—209.7			CFMR	Fort Simpson, N.W.T.	25	CFOR	Orillia, Ont.	10,000d 1,000n
CKLC	Kingston, Ont.	10,000d 5,000n	CKFH	Toronto, Ont.	10,000	CFRC	Kingston, Ont.	100	CHUB	Nanaimo, B.C.	10,000
CKPC	Brantford, Ont.	10,000	1440—208.2			CHYM	Kitchener, Ont.	10,000d 5,000n	CKLM	Montreal, Que.	50,000
1390—215.7			CFCP	Courtenay, B.C.	1,000	CJSN	Shaunavon, Sask.	1,000d 250n	1580—189.2		
CHOO	Ajax, Ont.	10,000	CKPM	Ottawa, Ont.	10,000	CKAD	Middleton, N.S.	1,000d 250n	CBJ	Chicoutimi, Que.	10,000
CKKC	Nelson, B.C.	1,000	1450—206.8			CKBM	Montmagny, Que.	1,000d 250n	1600—187.5		
1400—214.2			CBG	Gander, Nfld.	250	CFWB	Campbell River, B.C.	1,000d 250n	CJRN	Niagara Falls, Ont.	10,000
CFLD	Burns Lake, B.C.	250	CFAB	Windsor, N.S.	250						
			CFJR	Brookville, Ont.	1,000d 250n						
			CHFF	Granby, Que.	1,000d 250n						
			CHRT	St. Eleuthere, Que.	250						

White's World-Wide Shortwave Stations

Prepared by Don Jensen

A number of readers report hearing a station announcing as Tropical Radio and Telegraph Co., Panama City, Republic of Panama. Its announcement, repeated endlessly it seems, also gives a "plug" for the 11th annual Olympics of Central America.

Is this a new station, some have asked? How can I get a QSL, queried others?

Actually, Tropical Radio and Telegraph Co. is no newcomer to shortwave. But it isn't even a broadcasting station. It is a fixed service, or point-to-point operation whose purpose is to transmit messages between two points in this hemisphere, rather than to air programs for general reception. DXers commonly refer to operations like this as utility stations.

What listeners are hearing is a voice mirror, or a repeated, tape recorded identification for tuning purposes used by the receiving station to make the proper circuit adjustments before actual traffic is sent. While eavesdropping on the messages is legally a *no-no*, nothing prohibits you from tuning and reporting these repeated test identifications.

Tropical Radio and Telegraph transmitters use a number of different frequencies and several transmission modes, including normal amplitude modulation (AM), single sideband (SSB) and code (CW). Most DXers find the AM transmissions during the evening hours most easily heard.

T.R.T.'s Panama City transmitters include HOD78, 7,872.5 kHz., HPI, 9,132.5 kHz., HPH, 10,670 kHz., and HOD24, 20,727.5 kHz., to name a few.

Reports, including the exact voice mirror text

you hear, may be sent to the Chief Engineer, Tropical Radio and Telegraph Co., Panama, Panama. Return postage, in the form of International Reply Coupons, available for 15¢ at your post office, or unused Panamanian stamps, should be enclosed.

Other T.R.T. stations operating in the fixed service from Central America are TGB, 11,580 kHz., Barcenas, Guatemala; YND3, 3,190 kHz., YNA2, 4,807.5 kHz., and YNA3, 7,600 kHz., all in Managua, Nicaragua; HRB4/HR14, 6,905 kHz., Tegucigalpa, Honduras; and HQL2, 5,780 kHz., La Lima, Honduras.

Happy News. On November 19, 1928, a young Dutchman named Edward Startz began his broadcasting career with the experimental Philips Light and Radio Company's shortwave station, PCJ, now part of Radio Nederland. Though hired for "straight" announcing, he found the routine a drag and soon began injecting some of his own personality to "hypo" up the dull programming. Soon listeners learned to know PCJ by Startz's new slogan, "The Happy Station of a Happy Nation!"

His brand of broadcasting caught on and for more than 40 years he spread the message of Peace, Cheer and Joy (the initials, of course, spelling PCJ) throughout the world with his Happy Station programs each Sunday. But now, after two score years, he has handed the program over to other hands—rumor has it not altogether willingly—and retired.

His departure came as sad news to followers of the Radio Nederland show. Over the years his trademark was his sense of humor and a light touch characterized the Happy Station

Science and Electronics Propagation Forecast for April/May 1970

Prepared by C. M. Stanbury II

LISTENER'S STANDARD TIME	ASIA (except Near East)	EUROPE, NEAR EAST & AFRICA (N. of the Sahara)	AFRICA (S. of the Sahara)	SOUTH PACIFIC	LATIN AMERICA
0000-0300	31	41	(41), 49e, (60e)	41, (75), (90)	49, 60
0300-0600	41, 49	(31)	49w	49, 60, 90	49, 60
0600-0900	25	16, 19	19	25, 31	31
0900-1200	19, 25	16, 19	19, 25	(19)	19
1200-1500	19	16, 19	19, 25	(19)	19
1500-1800	19, (41), (49e)	25, 31	41w, 60, 90e	19, 25	25, 31
1800-2100	16, 19	25, 31	25, 31e, 60, 90w	16, 19	49, 60
2100-2400	16, 19, (31w)	31, 41, 49	60, 90	19, 31w	49, 60

To use the table put your finger on the region you want to hear and lag, move your finger down until it is alongside the local standard time at which you will be listening and lift your finger. Underneath your pointing digit will be the shortwave band or bands that will give the best DX results. The time in the above propagation table is given in *standard time* at the listener's location, which effectively compensates for differences in propagation characteristics between the East and West Coasts of North America. Abbreviations: w—Western North America and e—Eastern North America. When w or e follow a band listing, it means the band is only good for that part of the continent. The shortwave bands in brackets are suggested as possible second choices. Refer to White's Radio Log for our world-wide Shortwave list.

programs. Many recall his slogans, "Keep in touch with the Dutch," and his familiar "nice cup of tea." His listeners were the "W.L.H.," the "World's largest happy family." The show was populated with his imaginary animal gang (the horses, Happy, Pappy, Bright and Breezy, Pasha the dog and Ella the cow.). Then there was the repeatedly asked question, "Is every-

body happy?"

Except for the war years, when the Dutch station was operated as a Nazi propaganda outlet, Startz's motto was "The show must go on." And so it will.

His successor is another Radio Nederland announcer, 32-year-old Tom Meyer. Meyer was born in Amsterdam in 1938 and his parents smuggled him out of occupied Holland when he was three. Via France, Spain and Cuba he reached the Netherlands West Indies, where he spent his childhood. Then after three years in Singapore, he returned to the Netherlands in 1949. First a law student, then a musical entertainer, he joined Radio Nederland's staff in 1965.

Like Eddie Startz, Meyer is a linguist and will continue the Happy Station program in both English and Spanish versions. Frankly, it won't seem the same without Eddie's familiar voice, but we suspect his basic aim over the years—creating a happy mood for all Happy Station listeners—will continue.

If you're one of the few who've never tuned the program, try next Sunday at 1830 GMT on 15,220 kHz., or, relayed from Bonaire at 0200 GMT Monday on 11,730 kHz.

This Issue's Shortwave Contributors

Gerry Dexter (Wis.); Marlin Field (Mich.); Bill Sparks (Cal.); Edward Shaw (Cal.); Gregg Calkin (Canada); F. Earle Hall (Mass.); Alvin Sizer (Conn.); Richard Wood (Hawaii); George Schnabel (N.Y.); Dan Ferguson (Fla.); Del Hirst (Tex.); Stanley Cabral (Cal.); Bill Berghammer (N.Y.); David Potter (Fla.); Tom Williamson (Canada); A. R. Niblack (Ind.); C. Vernon Hyson (N.J.); Mark Koukol (Ill.); Grady Ferguson (N.C.); Dick Heggis (Canada); Syd Wells (Wash.); Joseph Breton (Mass.); Harold Honnold (Cal.); Bob Hagerman (Mich.); Gladys Sienkiewicz (N.Y.).

Newark News Radio Club, 215 Market St., Newark, N.J.

North American SW Association, Box 989, Altoona, Penna.

Sun Up! Medium wave DXers know that sunrise and sunset are great times for DXing U.S. and Canadian stations in the AM broadcast band. Propagational conditions are in a state of flux during these times and some really good distant listening is possible. Also, because FCC regulations limit many stations to daylight operating hours, it is useful to know when old Sol rises and sets at various locations across the continent.

So, broadcast band listeners will be interested in a 13-page booklet called "Average Monthly Local Sunrise and Sunset Times." This map-packed pamphlet prepared by the International Radio Club of America should help in tuning some of the more distant, low powered domestic medium wave stations. And, the best thing about it is that it's a freebie!

kH.z.	Call	Name	Location	GMT
2350	YVPH	R. Guarico	San Juan de los Morros, Venezuela	0200
2410	4VU	R. Lumiere	Cayes, Haiti	1000
2474	—	—	Hangchow, China	1300
2510	—	Korean Bc Svc	Seoul, Korea	1330
2800	—	People's Liberation Army	Fukien, China	1300

90-Meter Band—3200 to 3400 kHz

3204	—	Nigerian Bc Corp	Ibadan, Nigeria	0430
3215	YVOE	Ondas Pan-americanas	El Vigia, Venezuela	1000
3260	—	Rdif TV Nigerienne	Niamey, Niger	2145
3265	ZYK2I	R. Tamandare	Recife, Brazil	0400
3270	HCEH3	R. Progreso	Loja, Ecuador	0400
3279	OBX2E	R. San Miguel	Piura, Peru	0545
3285	—	Emisora da Educacao Rural	Natal, Brazil	0200
3295	—	R. Cultura de Serguipe	Aracaju, Brazil	0200
3300	—	R. Belize	Belize, Br. Honduras	0400
3315	ZYL2I	R. Gazeta de Alagoas,	Maceio, Brazil	0215
3316	—	Sierra Leone Bc Svc	Freetown, Sierra Leone	2230
3322	—	R. Bougainville	Kieta, Bougainville	1115
3325	YVRA	R. Monegas	Maturin, Venezuela	0330
3340	HIBD	L.V. de la Romana	La Romana, Dominican Rep.	0330
3350	—	R. Ghana	Accra, Ghana	2245
3360	TGVN	V. de Nahuala	Nahuala, Guatemala	0300
3375	YVMI	L.V. de la Fe	Maricao, Venezuela	0100
3380	—	R. Chortis	Jocotan, Guatemala	0315
3385	—	R. Rabaul	Rabaul, New Britain Is.	1100

60-Meter Band—4750 to 5060 kHz

4675	TIH8G	R. Reloj de Costa Rica	San Jose, Costa Rica	0145
4723	—	Burmese Bc Svc	Rangoon, Burma	1320
4725	—	V. de Comercio	Armenia, Colombia	0245
4726	—	R. Ghana	Accra, Ghana	2245
4755	ZYF23	Rdif. do Maranhao	Sao Luiz, Brazil	0100
4760	OAX3W	R. Tingo Maria	Tingo Maria, Peru	0430
4780	HRRZ	R. Juticalpa	Juticalpa, Honduras	0345
4790	YVQN	Ondas Portenas	Pto. la Cruz, Venezuela	0100
4793	CR6R6	R. Comercial	Sa da Bandeira, Angola	2120
4800	—	All India Radio	Hyderabad, India	1300
4834	—	R. Mali	Bamako, Mali	0600

Don Ecrikson, 6059 Essex Street, Riverside, California, 92504, is the man to write for your free copy. Though Don didn't say so, we imagine he'd appreciate a stamped, self-addressed, large-sized envelope with 18-cents postage affixed. There are about 600 copies left, so beat the rush and send for yours today.

And, while we're on the subject of aids for the medium wave listener, we'd recommend the National Radio Club log. It is a dandy, with schedules and mailing addresses for all medium wave stations in the U.S. and Canada, listed by frequency. When used together with our own White's Radio Log, it's a great help to BCB listeners.

You can get yours for \$1.22, postpaid, from National Radio Club, P.O. Box 99, Cambridge, Mass., 02138.

kH.z.	Call	Name	Location	GMT
4835	—	R. Malaysia Sarawak	Kuching, Sarawak	1300
4545	HRVH	R. San Isidro	La Ceiba, Honduras	0140
4850	—	R. Botswana	Gaberones, Botswana	0400
4855	—	R. Nat. de Mauritanie	Nouakchott, Mauritania	2200
4865	—	R. Republik Indonesia	Palembang, Indonesia	1345
4870	—	R. Brunei	Berakas, Brunei	1100
4880	YVMS	Rdif. du Dahomey	Cotonou, Dahomey	0515
4885	—	R. Universo	Barquisimeta, Venezuela	0200
4890	—	V. of Kenya	Nairobi, Kenya	1330
4910	HIN	Rdif. du Senegal	Dakar, Senegal	0615
4912	—	R. HIN	Santo Domingo, Dominican Rep.	0430
4912	—	R. Tarawa	Tarawa, Gilbert and Ellice Is.	0645
4920	VLM4	Australian Bc Corp	Brisbane, Australia	1130
4933	—	Nigerian Bc Corp	Benin City, Nigeria	0500
4940	4VM	Rdif. Haitienne	Port au Prince, Haiti	2345
4940	—	R. Kiev	Kiev, USSR	0500
4970	—	R. Malaysia Sabah	Jesselton, Sabah	1300
4980	YVOC	Ecos del Torbes	San Cristobal, Venezuela	0200
5010	—	R. Garoua	Garoua, Cameroons	2130
5015	—	—	Vladivostok, USSR	1230
5020	HJFW	Trasmisora Caldas	Manizales, Colombia	0900
5026	CP75	La Cruz del Sur	La Paz, Bolivia	0230
5035	HJIC	V. de Caqueta	Florencia, Colombia	0345
5035	OAX6U	R. Ilo	Ilo, Peru	0215
5040	—	Burmese Bc Svc	Rangoon, Burma	1230
5040	YVQH	R. Maturin	Maturin, Venezuela	0345
5070	TGMJ	R. Nacional	Mazatenango, Guatemala	0130
5095	HJIW	R. Sutatenza	Sutatenza, Colombia	0315

49-Meter Band—5950 to 6200 kHz

5804	—	R. Sana	Sana, Yemen	0300
5965	ZYU60	R. Guatiba	Porto Alegre, Brazil	2330
5980	ZFY	R. Demerara	Georgetown, Guyana	1000
5980	—	Gronlands Radio	Godthob, Greenland	1015
5990	—	R. Sweden	Stockholm, Sweden	0100
5995	—	O.R.T.F.	Fort de France, Martinique	2220
6000	PRK5	R. Inconfidencia	Belo Horizonte, Brazil	0030
6005	—	R.I.A.S.	Berlin, W. Germany	0250
6005	CP58	R. Progreso	La Paz, Bolivia	1030

WHITE'S SHORTWAVE SECTION

kHz.	Call	Name	Location	GMT
6010	CJCX	Cape Breton Bc	Sydney, N.S., Canada	1100
6025	—	R. Portugal	Lisbon, Portugal	0215
6030	CFVP	V. of the Prairies	Calgary, Alta., Canada	1330
6045	OCY4H	R. Santa Rosa	Santa Rosa, Peru	1100
6055	XERMX	R. Mexico	Mexico City, Mexico	0330
6065	—	R. Singapore	Singapore	1030
6080	ZL7	R. New Zealand	Wellington, New Zealand	0600
6081	OAX4Z	R. Nacional	Lima, Peru	0430
6085	—	R. Tallinn	Tallin, Estonia, USSR	2120
6090	XECMT	Rdif. XECM	Ciudad Mante, Mexico	0130
6090	—	R. TV Kaduna	Kaduna, Nigeria	0500
6090	VL16	Australian Bc Corp	Sydney, Australia	1000
6090	—	—	Irkutsk, USSR	0300
6095	HJIW	L. V. del Centro	Espinal, Colombia	0330
6095	OAX4H	R. Mil Ochenra	Lima, Peru	0430
6095	—	R. Baghdad	Baghdad, Iraq	1930
6100	—	Observatorio Naval	Caracas, Venezuela	1000
6100	—	Deutsche Welle	Cologne, Germany	0030
6110	—	British Bc Corp	London, England	2330
6120	—	Swiss Bc Corp	Berne, Switzerland	0200
6120	LRX1	R. El Mundo	Buenos Aires, Argentina	2305
6125	—	R. TV Belge	Brussels, Belgium	0050
6130	—	R. Lao	Vientiane, Laos	1100
6135	—	Korean Bc Svc	Seoul, South Korea	1130
6140	—	L. V. de la Revolution	Bujumbura, Burundi	0430
6140	—	R. Nacional de Espana	Madrid, Spain	0115
6145	—	R. Biafra	Orlu, Biafra	2100
6155	—	Far East Network	Tokyo, Japan	0800
6155	—	Oesterreichischer R.	Vienna, Austria	2300
6160	CKZN	Canadian Bc Corp	St. Johns, Newf., Canada	0950
6165	—	R. Vietnam	Saigon, Vietnam	1100
6170	—	R. Maroc	Sebaa-Aioun, Morocco	2340
6195	HJEZ	V. de Cali	Cali, Colombia	0200
6234	—	R. Budapest	Budapest, Hungary	2130
6250	OAX7A	R. Cuzco	Cuzco, Peru	0415

41-Meter Band—7100 to 7300 kHz

7118	—	R. Republik Indonesia	Denpasar, Indonesia	1200
7125	—	R. Warsaw	Warsaw, Poland	2030
7125	—	Rdif. Nationale	Conakry, Guinea	2230
7140	—	R. Riga	Riga, USSR	0300
7140	—	R. Republik Indonesia	Ambon, Indonesia	1200
7165	—	Libyan Bc and TV	El Beida, Libya	0405
7170	—	R. Noumea	Noumea, New Caledonia	1030
7175	—	R.A.I.	Caltanissetta, Sicily	0500
7200	—	R. Omdurman	Omdurman, Sudan	0400
7205	—	R. Australia	Melbourne, Australia	1030
7220	—	R. Australia	Melbourne, Australia	1045
7275	—	V. of Nigeria	Lagos, Nigeria	0630
7292	—	Trans World Radio	Monte Carlo, Monaco	0630
7301	—	R. Biafra	Orlu, Biafra	0435
7320	—	R. Tirana	Tirana, Albania	0430
7345	—	R. Prague	Prague, Czechoslovakia	0300

31-Meter Band—9500 to 9775 kHz

9009	4XB31	Kol Israel	Jerusalem, Israel	2330
9380	—	R. Alma Ata	Alma Ata, USSR	1030
9475	—	R. Cairo	Cairo, Egypt	0210
9500	—	R. Tirana	Tirana, Albania	0200
9505	—	R. Japan	Tokyo, Japan	1230
9510	—	R. TV Algeri- enne	Algiers, Algeria	0600
9515	TAT	R. Ankara	Ankara, Turkey	1935

kHz.	Call	Name	Location	GMT
9520	VLT9	Australian Bc Corp	Port Moresby, Papua Territory	0625
9525	—	R. Havana Cuba	Havana, Cuba	0200
9540	ZL2	R. New Zealand	Wellington, New Zealand	0630
9545	—	R. Ghana	Accra, Ghana	2100
9550	—	Windward Is. Bc. Svc	St. Georges, Grenada	1230
9550	LLD	R. Norway	Oslo, Norway	0330
9553	YSS	R. Nacional	San Salvador, El Salvador	0430
9565	ZYK3	R. Jornal do Comercio	Recife, Brazil	0100
9570	—	R. TV Kaduna	Kaduna, Nigeria	0500
9570	—	R. Bucharest	Bucharest, Rumania	0230
9576	YSV	V. del Comercio	San Salvador, El Salvador	1750
9600	—	R. Tashkent	Tashkent, USSR	1200
9600	—	British Bc Corp	Ascension Island	0730
9610	LLG	R. Norway	Oslo, Norway	0200
9610	—	V. of Ethiopia	Addis Ababa, Ethiopia	0330
9610	VLX9	Australian Bc Corp	Perth, Australia	1200
9613	—	R. Pynongyang	Pynongyang, N. Korea	1130
9620	—	R. Belgrade	Belgrade, Yugoslavia	2200
9625	OAX8K	R. Atlantida	Iquitos, Peru	0330
9625	4XB71	Kol Israel	Jerusalem, Israel	1900
9625	—	R. Australia	Darwin, Australia	1400
9645	—	Vatican Radio	Vatican City	0630
9660	CR6RZ	A Voz de Angola	Luanda, Angola	0530
9670	—	Saudi Arabian Bc	Jeddah, Saudi Arabia	0230
9680	ETLF	R. Voice of the Gospel	Addis Ababa, Ethiopia	0415
9690	LRA32	R. Nacional	Buenos Aires, Argentina	0345
9695	—	R. Nationale Khmer	Phnom Penh, Cambodia	1335
9695	—	R. Moscow	Moscow, USSR	0400
9700	—	R. Sofia	Sofia, Bulgaria	2115
9705	—	R. RSA	Johannesburg, South Africa	0200
9715	KGEI	V. of Friendship	San Francisco, U.S.A.	0330
9745	HCUJ	V. of the Andes	Quito, Ecuador	0400
9760	—	R. Nacional de Espana	Madrid, Spain	0230
9770	OAX80	R. Amazonas	Iquitos, Peru	0300
9770	4VEH	Evangelistic V. of West Indies	Cap Haitien, Haiti	1200
9915	—	R. Peking	Peking, China	1145
9776	—	Yemeni Royalist Radio	Unknown	0415
10530	—	R. Alma Ata	Alma Ata, USSR	0215

25-Meter Band—11700 to 11975 kHz

11330	—	R. Peking	Peking, China	2350
11672	—	R. Pakistan	Dacca, Pakistan	2030
11715	—	R. TV Belge	Brussels, Belgium	0100
11715	—	Swiss Bc Corp	Berne, Switzerland	0500
11725	—	Vatican Radio	Vatican City	0100
11750	—	Far East Network	Tokyo, Japan	0700
11765	—	R. Yerevan	Yerevan, USSR	0430
11780	—	R. Clube de Mozambique	Lorenco Marques, Mozambique	0400
11782	—	R. Baghdad	Baghdad, Iraq	2000
11790	—	R. Lebanon	Beirut, Lebanon	0230
11793	—	R. Republik Indonesia	Diakarta, Indonesia	0745
11795	WINB	World International Bc	Red Lion, USA	2100
11795	PR139	R. Nacional	Rio de Janeiro, Brazil	0045
11799	—	R. Ceylon	Colombo, Ceylon	1130
11800	—	R. Nacional de Espana	Tenerife, Canary Is.	0200
11810	—	R.A.I.	Rome, Italy	0100
11815	—	R. Free Europe	Lisbon, Portugal	0745
11825	—	R. Tahiti	Papeete, Tahiti	0430
11835	CXA19	R. El Espectador	Montevideo, Uruguay	2300
11835	—	R. Omdurman	Omdurman, Sudan	1730
11835	4VEH	Evangelistic V. of West Indies	Cap Haitien, Haiti	1130

kH.z.	Call	Name	Location	GMT	kH.z.	Call	Name	Location	GMT
11855	—	Saudi Arabian Bc	Jeddah, Saudi Arabia	1700	15220	—	R. RSA	Johannesburg, South Africa	0230
11855	—	All India Radio	Delhi, India	1300	15260	—	Cyprus Bc Corp	Nicosia, Cyprus	1900
11875	—	R. RSA	Johannesburg, South Africa	0230	15265	—	R. Afghanistan	Kabul, Afghanistan	1800
11875	—	R. Nacional	Managua, Nicaragua	0303	15280	ZL4	R. New Zealand	Wellington, New Zealand	0500
11915	HCJB	V. of the Andes	Quito, Ecuador	0130	15310	—	British Bc Corp	Tebrau, Malaysia	0900
11920	—	R. Abidjan	Abidjan, Ivory Coast	2230	15345	—	R. Havana Cuba	Havana, Cuba	1850
11925	—	R. Tashkent	Tashkent, USSR	1200	15350	—	R. Peace and Progress	Moscow, USSR	1430
11940	—	R. Bucharest	Bucharest, Rumania	2100	15380	ZYC7	R. Tupi	Rio de Janeiro, Brazil	2215
11947	ZPA5	R. Encarnacion	Encarnacion, Paraguay	0130	15430	—	V. of Free Korea	Seoul, Korea	0230
11949	—	R. Vietnam	Saigon, Vietnam	0900	16-Meter Band—17700 to 17900 kHz				
11950	—	R. Nederland	Hilversum, Netherlands	0300	17605	—	R. Peking	Peking, China	0815
11970	—	R. Nepal	Katmandu, Nepal	0120	17735	—	V. of America	Tinang, Philippines	0100
11975	ELWA	Sudan Interior Mission	Monrovia, Liberia	2045	17770	—	R.A.I.	Rome, Italy	1845
11975	—	Windward Is. Bc. Svc	St. Georges, Grenada	0130	17800	—	Deutsche Welle	Kigali, Rwanda	2300
19-Meter Band—15100 to 15450 kHz					17810	DZ16	Far East Bc Co	Manila, Philippines	0100
15014	—	V. of Vietnam	Hanoi, N. Vietnam	1903	17855	—	R. Peking	Peking, China	0100
15080	—	All India Radio	Bombay, India	1800	17875	—	Cyprus Bc Corp	Nicosia, Cyprus	1530
15085	—	R. Euzkadi	Unknown	2250	17890	BED40	V. Free China	Taipei, Taiwan	0215
15090	—	R. Peking	Peking, China	0000	17930	—	R. Pakitsan	Karachi, Pakistan	0810
15105	—	R. Sweden	Stockholm, Sweden	1230	13-Meter Band—21450 to 21750 kHz				
15105	ZYZ32	R. Rural	Rio de Janeiro, Brazil	2530	21480	—	R. RSA	Johannesburg, South Africa	1900
15110	XERR	Rdif. Comerciales	Mexico City, Mexico	0230	21540	—	Swiss Bc. Corp	Berne, Switzerland	2000
15125	BED60	V. of Free China	Taipei, Taiwan	0230	21580	—	O.R.T.F.	Paris, France	1930
15135	—	R. Iran	Tehran, Iran	2000	21600	—	R. Berlin	Berlin, E. Germany	1330
15135	—	O.R.T.F.	Paris, France	0245	21685	—	R. Kuwait	Kuwait	1530
15155	ZYB9	Rdif. Sao Paulo	Sao Paulo, Brazil	0100	21740	—	R. Veritas	Manila, Philippines	0815
15185	—	Finnish Bc. Co	Pori, Finland	1500	21740	—	R. Australia	Melbourne, Australia	0130
15215	WNYW	R. New York Worldwide	New York, USA	2300					

White's Emergency Radio Station Listings for SOUTHERN CALIFORNIA

SCIENCE AND ELECTRONICS furnishes this exclusive listing of emergency radio stations as an aid to our many readers now engaged in the fascinating and rapidly growing hobby of monitoring emergency radio communications. We have and will be publishing similar lists devoted to different metropolitan areas in forthcoming issues so that you'll be able to accumulate a sizable array of this difficult-to-obtain data. Refer to the index on page 81 for our 1969/1970 program of emergency radio station listings.

If you desire to obtain similar lists from other areas in the United States that have not been published in this magazine in 1969, then we suggest you write to Communications Research Bureau, Box 56, Commack, N.Y. 11725. They may have a list of emergency radio services that covers your locality. Include a stamped, self-addressed envelope with your request.

All frequencies are megahertz (MHz) unless otherwise noted.

LOS ANGELES CITY POLICE DEPT.

Base Stations:	
37.14	KDZ358 (Radio Service Units)
39.48	(to Sheriff Emerg net)
39.52	(to Sheriff Spec Enforcement)

45.62	KMG511	KMM273 (Harbor Patrol)
154.77	KMA367	KGW723-6 KMA786 (Tactical #2)
154.83	KMA367	KBL403 KMA786-7 KME476 KMH570
	KMJ227	KMM571 KMM577 (Tactical #1)
155.07	KMH570	
155.28	KFG564	(Central Receiving Hospital)
155.43	KMB45	KMB51 KMC55 KMK94 KVM53 (Intercity)
158.865	KMA785	
158.91	KMA367	KMA992 (Dispatcher B)
159.03	KMA785-6	KMA367 KMA787 KMM577 KMM992 (Dispatcher D)
		KMA992 (Dispatcher A)
159.15	KMA367	
158.18	KLR483	
159.75	KMF354	
453.15	KMJ451	
453.35	KMF926	KGR383
458.35	KMW79	KNT95 KVM67

Base/Mobile Channel Matching:
(Mobiles operate on same channels as base stations with the following exceptions)

Bases	Mobiles					
158.91	154.65	154.89	155.19	155.25	155.52	155.565
159.03	154.785	154.95	155.01	155.07	155.535	155.58
159.15	154.71	155.13	155.37	155.415		
453.35	458.45					
—	39.06	(walkie talkies)				
—	39.66	(to Sheriff bases on 39.20)				
—	45.74	(to Sheriff bases on 45.98)				
—	45.98	(to Sheriff bases on 45.98)				
	155.31					
	155.55					

LOS ANGELES CITY FIRE DEPARTMENT

Base/Mobile Channels:	
33.48	33.52 33.56 33.60 33.70 33.82 33.86 33.90 33.94 460.525
Mobile-only Channels: 33.50 46.30 465.525	
Stations:	
Glendale	KEP615 KLP907

SOUTHERN CALIFORNIA

Los Angeles KBQ236 KDG872 KEP616 KJR266 KMA705-7
 KLP905 KLP909 KME585
 Rolling Hills KLP908
 Saugus KMM274
 Venice KMA403

LOS ANGELES CITY CD & DISASTER

47.50 KMF297-301 KMM307
 47.66 KFG593 KMF202 KMF404 KMJ339-44
 KMJ440 KMM276

LOS ANGELES CITY LOCAL GOVERNMENT NETWORKS

39.90 KJP422-9 KJW654
 153.80 KAQ247 KAY530-3 KET364-5 KFV841 KJW855
 KJZ990 KMK356 KMM575 KMM614
 158.895 KJZ819-21
 453.05 KMG202
 453.25 KMF546
 453.80 KCO300 KMK875-7 (Schools)
 458.05 KBL21-2 KC558-60 KDM43 KDQ74-6 KHQ39
 KJQ33 KMG202 KNT97 KVE71-2 KYT60
 458.25 KRF77-9
 458.80 KND88-91

LOS ANGELES COUNTY SHERIFF

Chan	Base	Mobile	Use	Calls
	37.36	37.36		KMF287
4	39.20	39.66	Dispatch	KMA628 KJV978
3	39.24	39.70	Dispatch	KMA628 KJV978 KMF288
2	39.28	39.74	Dispatch	KMA628 KJV978 KMF288
5	39.32	39.78	Dispatch	KMA629 KMF288
7	39.36	39.76	Dispatch	KMA628-9 KCR920
1	39.48	39.48	Emergency	KMA628-9 KCR920 KJV978
6	39.52	39.52	Spec Enf	KMA628-9 KCR920
	39.98	39.98		KMP964
	45.82	45.82		KCU833
	45.98	45.98		KFR576 KFR578 KGK569
	46.02	46.02		KCU833 KGW761-7
	159.15	-		KCV52
	453.15	-		KFF390-1 KMJ451
	-	42.18	to CHP bases on	42.34
	-	42.34	to CHP bases on	42.34
	-	155.64	to Downey PD base	
	-	155.73	to Whittier PD base	

L.A. SHERIFF BASE CALLSIGNS

Call Sign	Location	Call Sign	Location
KCR920	Mt Ada	KGW764	W Covina
KCU833	Los Angeles	KGW765	Pasadena
KCV52	Lancaster	KGW766	Downey
KFF390	Saugus	KGW767	W Los Angeles
KFF391	Castaic	KMA628	LA & other locs
KFR576	Baldwin Pk	KMA629	LA & Lancaster
KFR578	Gardena	KMF287	Ring Hls & Plos Vrds
KJV978	Los Angeles	KMF288	portable
KGK569	Downey	KMF964	Los Angeles
KGW761	Van Nuys	KMJ451	San Dimas
KGW762	Compton		
KGW763	Torrance		

LOS ANGELES COUNTY FIRE DEPARTMENT

Bases & Mobiles: 154.34 154.40 154.43
 (Stations marked % also operate 154.265 & 154.295 intersystem communications)

Location	Call Sign	Location	Call Sign
Agoura	%KMB352	El Monte	KDX523
Artesia	KME463/5	Gardena	KMG348/66
Bellflower	KME467	Glendora	KLU240-2
Burbank	KDV841	Hauser Peak	KBG521
Chatsworth	KMD778	Huntinton Pk	KMH451
Compton	KMG364/5	La Canada	KFB844
Culver City	KME456	La Mirada	KBO582
Diamond Bar	KLD753	"	KME458
Lake Hughes	KEY816	Norwalk	KME466
Lakewood	KME460	"	KMJ547
"	KMJ548	Paramount	KJA934
Lancaster	KBG521	"	KMG362
Lawndale	KMG360	Pico	KMG216
Lennox	KMG359	Pico Rivera	KMK949
Lomita	KME459	Rolling Hills	KME455
Long Beach	KMG357	"	%KMG941
"		Rolling Hls Ests	KLV964
Los Angeles	KBO583-4	San Dimas	%KMG941
"	KDP290	San Pedro	KMH450
"	KJD880	Singal Hill	KLH962
"	%KMA896	Tejon Peak	KJP458

Location	Call Sign	Notes	Call Sign
"	"	KMG356/8	Torrance
"	"	KMG361/3	Whittier
"	"	KMH448-9	"
Marina Del Rey	KFG504	portable base	KME461
			KME464
			KME218
			KMG584

LOS ANGELES COUNTY EMERGENCY STATIONS

KMC218 Malibu & Redondo Beach 47.54
 KQP480 Los Angeles (hospital) 155.34

LOS ANGELES COUNTY FORESTRY CONSERVATION NETS

44.84 151.16 159.27 169.475 171.875 406.125 412.625

LOS ANGELES COUNTY LOCAL GOVERNMENT NETWORKS

27.235 KDX415
 45.56 KAV476 KBG918 KCK780 KEO389 KML382
 153.98 KBH339 KKB398 KEN492 KEU926 KFT504
 KGK556
 KGL473 KJ1449-50 KML385-6 KML670
 453.15 KIZ618 KMG240
 453.725
 435.90 KCU23
 453.975
 458.15 KTU52-3 KUW89
 458.90 KCU22

CALIFORNIA HIGHWAY PATROL NETWORKS

Bases	Mobiles	Notes
42.12	42.12	Yellow Freq. "Y"
42.34	42.18	Blue Freq. "B"
42.40	42.40	
42.44	42.44	Red Freq. "R"
42.56	42.88	White Freq. "W"
45.86	45.86	
72.26	-	repeaters
73.22	-	point-to-point
73.42	-	point-to-point
74.14	-	repeater
154.92	154.92	CLEMARS (Calif. Law Enf Mutual Aid Radio System)
155.43	-	intercity

Base Stations:	Networks
Baldwin Park	KBO571 W
Banning	KBQ804 B
Barstow	KME264 W & 45.86
"	KJS953 154.92
Buellton	KBQ614 Y
Chatsworth	KCX987 B
Chino	KLK464 154.92
Claremont	KBO577 W
Corona	KDG272 B & 42.40
Culver City	KBO570 R
"	KMA801 R
"	KLI325 154.92
Descanso	KCR394 G
E Los Angeles	KBO572 Y
Escondido	KML20 74.14
Ft Tejon	KDE674 B
Gardena	KBO575 R
Glendale	KBO573 Y
Glendora	154.92
Imperial Bch	KLSS46 154.92
Indio	KMD892 B & 45.86
"	KMJ201 B
"	KMJ62 73.22 73.42
Laguna Beach	KMJ214 G & 42.40
Lancaster	KMH724 B
Los Angeles	KJN840 154.92
"	KL1324 154.92
"	KMB443 Y & 45.86
"	KMD602 Y (Dept Justice)
"	KMD770 W
"	KMK518 Y
"	B & 45.02
Malibu	KBO574 R
Montebello	KJS750 154.92
Mantclair	KLU423 154.92
Mt Palomar	KCS568 G
Mt Soledad	KMD711 G
Needles	KML956 W
Newhall	KME315 W
Oceanside	KMH722 G
"	KM121 73.42
Orange	KBV892 G & 154.92
Palmdale	KFO791 B
Pomona	KLW288 154.92
Redlands	KMJ458 B
Riverside	KBQ743 B
"	KMD453 B
Running Springs	KDE677 B
Sacramento Mtn	KEV331 W
San Bernardino	KCX980 B

" " KJS984 154.92
 " " KMD952 B
 San Clemente KBT579 G B G 42.40
 San Diego KME357 G
 " " KFR34 73.22 73.42
 " " KMD454 G & 42.40
 Santa Ana KBO576 Y
 Santa Fe Spgs KME354 B
 Santa Paula Twp KMB55 74.14
 Strawberry Peak KME311 B
 Tejon Lookout KLO454 154.92
 Torrance KDC275 B
 Ventura KMB521 B
 " KMH962 W & 45.86
 Victorville KLO478 154.92
 W Covina KLV287 154.92
 Whittier KJP311 42.40
 Yorba Linda KMD891 B
 Yucca Valley KMJ63 72.26
 " " KMF454 all
 portable base KMF588 155.43

CALIF. DEPT. OF JUSTICE NETWORKS

Chatsworth KDY265 154.68
 Corona KB464 154.68
 La Cumbre Pk KFX368 154.68
 Los Angeles KBE461 154.68
 " KBZ89 155.46
 " KDC41 155.46
 " KJP325 154.68
 " KMD602 42.12 154.68
 Pine Valley KBT203 154.68
 Redlands KDS632 154.68 155.46
 San Bernardino KBT580 154.68
 " KDL32 155.46
 " KDV373 154.68
 San Diego KBT571/9 154.68
 " KDL21/31 155.46
 Santa Ana KLY748 154.68
 " KPH73 155.46
 Santa Barbara KDK709 154.68
 " KFM35 155.46

CALIF. STATE PENAL INSTITUTIONS

Bases & Mobiles: 39.10
 Chino KMA961 Fullerton KJY635
 " KML503 Long Beach KBT572
 El Rio KBP765 Norco KET216
 Fronteria KFM441 Whittier KFZ780

CALIF. STATE FIRE MARSHALL NETWORKS

33.66 33.98 45.00 153.83 154.01 154.16
 154.22 154.28

CALIF. STATE FORESTRY CONSERVATION NETWORKS

30.86 31.26 45.04 72.78 74.46 151.205 151.25
 151.265 151.28 151.295 151.325 151.34 151.355
 151.37 151.385 151.40 151.415 151.43 151.445
 151.46 151.475 153.755 159.24 159.27 159.285
 159.30 159.315 159.33 159.345 159.36 159.375
 159.39 159.405 159.42 159.435 159.45 169.475
 171.875 172.375 406.125 412.625

CALIF. STATE OFFICE OF DISASTER COMMUNICATIONS

Bases: 47.58 Walkie Talkies: 47.62
 Inglewood KMM53 Redlands KMW85
 Long Beach KMM52 Santa Ana KMM54
 Los Angeles KMM47-8 Saugus KMM55
 Pasadena KMM49 portables KMM38 KMR84

CALIF. STATE LOCAL GOVERNMENT NETWORKS

27.235 KG3310 (mobiles)
 153.815 KMM469
 154.98 KBA41 KC159 KRO90 KRO92 KRR29 KSB44
 " KVVZ99
 158.475 KHQ28 KRX43-5

COUNTY AGENCIES: ORANGE COUNTY

Coordinated PD Radio Network
 Base Mobile Calls/Areas
 — 39.06 Walkie-Talkies
 — 42.34 To CHP bases on 42.34
 45.10 45.10 KMA752 KMG796 KMG780 (Anaheim,
 Buena Pk, Olinda, Orange, Sta Ana)
 45.14 45.14 KMA752 KMG796 (Anaheim, Brea,

Costa Mesa, Cypress, Ftn Valley,
 Grdn Grove, Huntingtn Bch, Laguna
 Bch, La Mesa, Los Alamitos, New-
 port Bch, Orange, Placentia, Seal
 Bch, Stanton, Tustin, Westminster
 45.22 45.22 KMA752 KMG796 (Costa Mesa, Laguna
 Bch, Orange, San Clemente, Sta Ana
 Santiago)
 45.26 45.26 KMA752 (Brea, La Habra, Placentia)
 45.30 45.30 KMA752 (Sheriff HQ, University
 Campus PD)
 45.34 45.34 KMA752 (Ftn Valley, Huntingtn Bch,
 Los Alamitos, Seal Bch, West-
 minster)
 45.38 45.38 KMA752 KMG796 (Cypress, Grdn Grv,
 La Mesa, Stanton)
 45.66 45.66 KMA752 (Orange, Sta Ana, Tustin)
 154.80 158.80 KMA782 Laguna Bch, Orange)
 155.43 — KMB85 (Intercity)
 158.79 — KMG294 (Santiago Pk)
 453.10 458.10 KMA752 (Lomas, Orange)
 453.75 — KMR35 (Point-to-point)
 460.025 465.025 KMA752 (Olinda)
 460.05 465.05 KMA752 (Olinda)
 460.10 465.10 KMA752 (Olinda)
 460.20 465.20 KMA752 (Lomas)
 460.25 465.25 KMA752 (Lomas)
 460.275 465.275 KMA752 (Lomas)
 460.325 465.325 KMA752 (Lomas)
 460.425 465.425 KMA752 (Laguna Bch)
 460.475 465.475 KMA752 (Laguna Bch)
 460.50 465.50 KMA752 (Laguna Bch)

Transmitter Locations:
 KMA752 Laguna Bch, Lomas, Olinda, Orange, Santiago Peak,
 Westminster
 KMB85 Orange
 KMG294 Santiago Peak
 KMG780 Buena Park
 KMG796 Santa Ana
 KMR35 Orange
 (KBP774 is a portable base on all channels)

ORANGE COUNTY FIRE DEPARTMENT

Bases: 46.14 (#=also 46.06)
 Mobiles: 46.06 46.14 46.26 46.28
 Repeaters: 154.31 (KMR63)
 Point-to-point: 458.55 (KMQ27)

Bases:
 Bolero Peak KMG491 San Juan Cap KMD644
 Capistrano B KMK503 Santa Ana KJA906
 Cypress KMD648 KJL310
 El Toro KMD640 #KMD649
 Emerald Bay KMD647 KMH569
 La Habra KMD650 Santiago Peak KMJ277
 Laguna Bch #KLY949 Silverado KMD660
 Laguna Hls KJA907 S Laguna KJ1435
 Los Alamitos KJA907 KMD654
 Midway City KMD62 Sunset Beach KMD655
 Mission Viejo KDU529 Trabuco Canyon KMD658
 Modjeska KMD646 Tustin KMD652
 Olive KMD645 Villa Park KAZ437
 Orange #KMD639 Yorba Linda KMD656
 #KMG880 portable base KJL311

ORANGE COUNTY EMERGENCY STATIONS

Newport Bch KLI275 45.92
 Orange KIZ620 155.40 (County Hospital)
 KMK358 44.64 (Forestry Conservation)

ORANGE COUNTY LOCAL GOVERNMENT NETWORKS

45.40 KJV341 KLI931
 153.92 & 158.94 KAQ954 KCY558 KMK457

COUNTY AGENCIES: RIVERSIDE COUNTY

Riverside County Sheriff
 Base Mobile Calls/Use
 — 39.06 Walkie-Talkies
 — 42.18 To CHP bases on 42.34
 — 42.34 To CHP bases on 42.34
 155.43 — KMC56 KML46 KMV53 (Intercity)
 158.85 158.85 KMA878-80 KMA583 (Dispatchers)
 159.09 — KMH970-1 KMJ989 (Repeaters)

Transmitter locations:
 KMA583 Indio
 KMA878 Banning, Mt David, Whitewater
 KMA879 Blythe
 KMA880 Box Springs Mtn, Riverside
 KMC56 Riverside
 KMH970 Blythe

SOUTHERN CALIFORNIA

KMH971 Indio
 KMJ989 Desert Center
 KML46 Indio
 KMY53 portable base

RIVERSIDE COUNTY FIRE DEPARTMENT

Mobile units: 154.28 154.445

Bases:
 Bonning KDT237 154.28 154.445
 Beaumont KDT238 154.28 154.445
 Indio KLR283 154.28
 Riverside KEO271 154.28 154.445

RIVERSIDE COUNTY LOCAL GOVERNMENT NETWORKS

154.10 & 156.00 KGJ782-3 KML669

COUNTY AGENCIES: SAN BERNARDINO COUNTY

San Bernardino County Sheriff

Base	Mobile	County Sheriff
—	39.06	Walkie-Talkies
154.74	154.74	KMA795
155.43	—	KMC79 (Intercity)
—	155.55	—
—	155.91	—
155.97	155.97	KAZ309 KGH698 KGV219 KMA793 KMA795 KMB899 KMB900 KMD329 KMH621-2
159.21	—	KMC79 KMM616
453.25	—	KMT57 (Point-to-point)
458.25	—	KMT56 (Repeater)

Bases:			
Barstow	KMT56	San Bernardino	KMA795
Big Bear Lk	KGK698		KMM616
Fontana	KAZ309		KMC79
Needles	KMA793		KMT57
Ontario	KMD329	29 Palms	KMJ494
Rodman Pk	KMH621	Victorville	KMB899
		Yucca Valley	KGV219
		Yucaipa	KMH622

SAN BERNARDINO COUNTY FIRE DEPARTMENT

Mobile units: 154.07 154.19 154.28

154.07 Net		154.19 Net	
Barstow	KBJ659	Alta Loma	KJW568+
Hesperia	KBO904	Big Bear Lk	KMK686
Joshua Tree	KDN564	Bloomington	KMF642
Lucerne Val	KBI977	Chino	KMB351+
Palms	KBO239	Fontana	KMF643
Victorville	KCX403	Loma Linda	KJF927+
Yucca Valley	KDL789	Muscoy	KME271
		San Bernadno	KMB886+
			+ = also on 154.28

SAN BERNADINO COUNTY EMERGENCY NETWORKS

Flood Control
 Box Springs Mtn KNK28 170.225
 Bases & Mobiles 31.58 151.145 151.745
 Repeater 453.65
 San Bernardino KNK27/9 171.975
 Forestry Conservation nets

SAN BERNADINO COUNTY LOCAL GOV'T NETWORKS

27.275 KJP378 KKH951
 153.905 & 155.775 KEE90 KJP510 KK170 KQK59
 153.965 & 155.115 KEIN94 K-D41 KGJ603 KQ845 KQ850
 KTX94-5

COUNTY AGENCIES: SAN DIEGO COUNTY

San Diego County Sheriff
 Base Mobile Calls
 — 39.18 To Blythe PD base
 45.70 45.70/45.78 KCW737 KMJ212 KMJ519-21
 45.90 — KCW737
 45.94 45.94 KMJ212
 158.8.5 — KFR33 KLA61 KRO97 (Unif. Po.)

Bases:
 Descanso KCW737
 Lyons Peak KMJ521
 Monument Peak KMJ520
 Mt Palomar KMJ519
 San Diego KMJ212 KFR33 KLA61 KRO97

SAN DIEGO COUNTY FIRE DEPARTMENT

Bases: 154.250 154.235 154.28 154.325 154.385
 Mobiles: 154.235
 Stations:
 Descanso KQN902 La Costa KGL535**
 Dutzura KQN901 Palomar KQN903
 ** = Only operates 46.46

SAN DIEGO COUNTY MISC. EMERGENCY NETWORKS

CD network— 37.98
 Emerg. Unit— KFK605 Santee 155.325
 DA— mobiles only KD2618 39.38
 Local Government Networks—
 27.255 KJV238 KQM692
 153.875 & 154.055
 153.995 KD1968
 155.82 & 155.94 KD1501-2 KDJ505 KFM381 KMJ734-6
 KMJ945

COUNTY AGENCIES: VENTURA COUNTY VENTURA COUNTY SHERIFF

Base	Mobile	Calls	
155.43	—	KMB74 (Intercity)	
—	158.73		
159.21	159.21	KMA930 KME545 KMF707 KMG405 KMH693	
458.55	—	KDD25 KMQ49 (Point-to-point)	

Stations:
 Frazier Pk KME545 Ventura KMB74
 Meiners Pk KMF707 KMQ49
 Santa Paula KMH693 KMG405
 Simi KDD25 portable base KMA930

VENTURA COUNTY FIRE DEPARTMENT

Mobile & Bases: 154.01 (+ = also 154.37
 Camarillo KL1239 Santa Paula ++ KMB552
 Malibu Simi KAS604
 Newbury Pk KCP583

VENTURA COUNTY LOCAL GOVERNMENT NET

159.745 KVX41

Astronomy

Continued from page 50

by radar. Studies have indicated that the surface of Mercury is rough and crater-marked, like the moon, while radar reflections from Venus point to a surface covered with silicon-composition rocks.

One of the most important determinations made possible by solar-system radar was a more precise figure for the mean distance from the earth to the sun. Many important calculations depend on both this mileage, including the navigation of both manned and unmanned space vehicles. Radar measurements have proven that the

earth-sun distance is about 92,944,000 miles. Before, astronomers figured that it was close to 93-million miles but were uncertain about the exact figure.

The scientific study of the heavens that began with Galileo's crude telescope in the seventeenth century is now undergoing tremendous upheavals and enrichment.

"WINDY"

Continued from page 38

from the metal box with extra locking nuts. The circuit board is mounted in the same way.

When all holes have been drilled cover the outer surface of the minibox with wood grained pressure-sensitive adhesive vinyl (Contact or equiv.) to make an attractive-looking instrument. A word of caution: when tightening mounting screws be sure to hold the heads of the screws rigid with a screwdriver and tighten mountings by using a socket wrench on the nuts; otherwise, the vinyl sheeting will be pulled and stretched by the bolt heads. Trim vinyl around the holes with a razor blade before mounting components.

To make your project really professional-looking, letter the controls with press-on letters (Datak or equiv.). Spray lettering with several coats of clear acrylic for protection.

Electrical Assembly. Most of the electronic circuit parts are mounted on the circuit board. We suggest you use G or P pattern perfboard as the hole spacing matches the pin spacing of the ICs we used. The components are mounted flat on the board and push-in clips and/or eyelets are used to facilitate mounting and connecting. The leads of the ICs are pushed through the perfboard and bent outward against the board. This holds the IC in place and provides a tab to which leads are soldered. Inter-component wiring is made with #26 bare copper wire. Where wires cross over they are insulated with plastic tubing.

Wire the circuit card in accord with the schematic. Be sure electrolytic capacitors and diodes are properly polarized before soldering to them. Also make certain that the ICs are correctly positioned before you solder them in.

Alternate IC Mounting. You may want to use a socket for the IC. As a matter of fact, the investment of less than a dollar for a socket is well worth it. You solder to the socket, rather than to the IC, thus reducing the possibility of damaging the IC with excess heating. You also have the advantage of being able to plug in the IC for proper orientation and or replacement should this be necessary.

Use an alligator clip temporarily clipped to a lead when soldering Q1 and the diodes.

If you elect to solder in the ICs, you should use the heatsink on each of their leads, too.

The circuit card is mounted on the left side of the indicator housing with four 4-40 bolts and nuts so that the card is supported away from the metal of the housing, as mentioned earlier. Inter-connect the various components not part of the card except for the meter.

Meter Modification. Any 0.1 mA meter having a coil resistance of under 100 ohms can be used for M1; the one we used measures approximately 14 ohms. However, the meter scale will have to be changed from 0.1 mA calibrations to 0-30 mph. See the Sept./Oct. 69 ELEMENTARY ELECTRONICS "Meter Scales You Can Count On," for details on how to do this most effectively. You can just turn it over, spray it with flat white, and then follow the steps outlined in referenced article. To mark the scale, use press-on letters.

Checking It Out. Plug in the remote pulse generator, turn *on* the AC power, and give the rotor a spin. If all has gone well you should get an indication on the meter. Check both ranges (X1 and X3).

If nothing happens, start out by checking all wiring for possible glitches, cold soldered joints, shorts between pins of ICs and transistor Q1, etc. See if + 3.6 V is present on pin 11 of both ICs. Also check to see if the exciter lamp in the pulse generator is lit. Doublecheck the polarity of all electrolytics and diodes and also check to be sure the ICs are oriented correctly.

Calibration. When you get an indication on the meter by rotating the wind cups, the meter reading in the X1 position should be three times the reading in the X3 position for a given speed of the rotor. While maintaining rotor speed by hand, switch back and forth to determine if meter readings are correct.

Tracking between these two ranges is dependent on the capacitances of C7 and C8. The capacitance of C7 should be exactly half that of C8. Since capacitors can vary as much as $\pm 20\%$ or more from the nominal value indicated on them and still are considered commercially acceptable, you should check their capacitance on a bridge if at all possible. If not, you can trim them by adding small capacitors until the desired meter range is reached.

To do this turn the rotor by hand to produce a reading of 15 mph in the X1 range. If the reading drops below 5 mph in the X3

Windy

Continued from previous page

range add capacitance in small increments until it reads 5 mph. If it indicates more than 5 mph add capacitance to C8. Add capacitance in steps of 0.01 μF or 0.02 μF to align the two ranges.

Adjusting Meter Reading. Once the proper range tracking has been established, probably the easiest way to complete the calibration is to do it in your car where you have a reasonably accurate speedometer to serve as a calibration standard. Unless you happen to have a car with a 6-V battery (very rare these days—most use 12-V batteries) you will need 6 VDC, either from 4-D cells in series, or a 6-V lantern battery. Disconnect one side of T1 and bring out a pair of leads, one of which is connected to the indicator's ground and the other to the collector of Q1. The ground lead is connected to the negative and the collector lead to the positive of the 6-VDC source.

Also remove the leads connected to X and X¹ on the secondary of T1. Connect a pair of leads between pins A and B of J1 and the external battery. This provides current to light exciter lamp when operating Windy from an external DC power source while calibrating in a car ride. Once the calibration has been completed remember to restore this modified wiring to its original

condition as well as the modification to the battery wiring.

You'll need a friend, either to drive the car while you make adjustments or to make the adjustments for you while you drive. Calibration should be done on a calm, windless day if at all possible. Should there be a light breeze you'll have to average the calibration by checking readings obtained by driving in both directions.

With the car traveling at 30 mph (according to its speedometer) and Windy's indicator set on X1 range, adjust R6 until the meter reads 30 mph. This is the only calibration necessary as you have already corrected the ranging, as previously mentioned. (Of course you've temporarily mounted the wind cup pulse generator outside the car so as to be in the wind's stream.)

Installation. Now that Windy has been built and calibrated, where is the best location for the remote wind cup pulse generator to give a true indication of wind speed?

The pulse generator unit should be mounted 5 to 10 ft. above the building on which it's being used. It should not be mounted in the lee of a taller building and the arms of the rotor should remain level as they rotate.

We recommend that easily-available TV antenna mounting hardware (e.g., mast clamps, mast mounting base, etc.) be used to mount the remote unit above the roof of the building.

The lubrication recommended won't be affected by temperatures below 0 F. ■

SemiPro

Continued from page 58

the SemiPro from 143.75 to 148.25 MHz.

A final adjustment before disconnecting the signal generators; set the generator for a 145 MHz output signal and the SemiPro dial to the 145 MHz calibration. Adjust L1 for maximum signal output on the BCB.

Operating SemiPro. Since propagation of 2-Meter signals is line of sight and doesn't follow the curvature of the earth, an outdoor antenna erected as high as possible will be required for best reception.

At the personal preference of the ham operator, his signals may be either horizontally or vertically polarized. Suitable antennas are listed for both types in most parts suppliers' catalogs. A ground-plane antenna is used for vertical polarization and a halo

or beam antenna for horizontal polarization. You may find a conventional TV antenna suitable for stronger signals. Always use a coax cable matched to the impedance of the antenna as a lead-in from the antenna to the SemiPro.

A last word, a tip on tuning the SemiPro: tune the dial slowly, else you can easily pass over signals due to the high selectivity. Once you have a signal try slight rocking of the BCB dial as a bandspread for best results. Another tip—the 2-Meter band is generally more active during evening hours and on weekends, since most 2-Meter enthusiasts can't take time from their work to participate in the pleasure of hamming on the 2-Meter band during working hours. Once the boss's yoke is lifted the boys really hop to it for the pleasure of keeping the rig going strong making QSLs whenever they raise signals. That's when you can enjoy hearing all of the action with your SemiPro. ■

HAM TRAFFIC

Continued from page 67

then killed part of it—even though it was definitely showing good results. This recent FCC decision has been nothing but a slap in the face of the serious, hard-working hams who were sincerely trying to upgrade their abilities. It makes the Federal government something of a turncoat and leaves a lot of hams wondering just which way the wind will blow next.

As other evidence of a lack of firm, meaningful direction at the Candy Company, take the extension of the Novice license term to two years. This didn't seem too bright to me when it was done, but then the felony was compounded when the Candy Company began allowing previously-licensed hams to obtain Novice licenses. This seems pretty silly, and certainly is diametrically opposed to the incentive regulations which are intended to encourage hams to improve their abilities.

Look at it this way: one regulation encourages hams to upgrade themselves by taking a harder exam; the other encourages the lazy ham to drop out for one year, then get back on the air with a Novice ticket. With it he can operate for two years, then drop out for a year, then get another Novice ticket for two years . . . and learn nothing in the process. Does this make sense? Is this likely to inspire the gray beards at an international frequency conference?

Where Are Incentives? And what about the proposal for opening up the entire 2-Meter band to Technicians? With more and more of the serious ham work being done on the higher frequencies, is this any way to demonstrate that the U.S. is encouraging hams to upgrade themselves? It looks more like giving a reward to those who are content to get a lower-class license and stick with it, doing nothing tangible to improve their knowledge or skills. How will this move look at an international frequency conference? The same can be said for the movement to give part of the 10-Meter band to Technicians.

Another big gap in the regulations that has rankled many hams is the fact that technical standards for ham operations are so vague in the FCC regs. All sorts of laxity in equipment operation must be tolerated merely because Uncle has said so little about

just what is considered proper from a technical standpoint. Some of us hoped, after incentive licensing was written into the regs, that additional regulations would be forthcoming, setting more precise technical guidelines for equipment operation. This would be a natural development to match the increasing technical knowledge that many operators acquired to obtain a higher-class license.

Hams Aren't Alone. This poor job the Feds have been doing of minding the store isn't limited to hams, either. The commercial boys are constantly tugging and pulling, trying to get Uncle to rearrange some of the TV and government frequencies to allow more growth room for commercial channels, which are busting at the seams.

When the Candy Company couldn't figure out the answers, they spent some of our tax money to hire the Stanford Research Institute to study the situation. And you know what? When the Stanford crew issued their report, they blamed the FCC for "inadequate frequency management"! They said proper use of the available frequency spectrum might relieve most of the commercial congestion problems.

We do have a reward, though . . . in typical Washington bureaucratic style. There's now talk of raising our license fees! They're always thinking of us down on the Potomac, aren't they?

Just as with the many other taxes which the Feds keep piling on us, these radio operating taxes wouldn't be so hard to take if we got a better shake for our money. Which brings me to the whole point of this rambling piece of typewriter fodder.

We Need A Plan. No human activity can last long, or achieve much, unless it follows a plan. And that's what ham radio seems to be almost without just now.

A couple of years ago, it looked like the principle of incentive licensing was going to give us a flag which serious, constructive hams could rally around. It still is to some extent. But its effect appears to be watered down by more recent actions and musings by the Candy Company, which is the outfit that gave birth to the incentive idea in the first place!

Apparently, the real incentive to prove our worth must originate in the ranks of hams themselves.

Somewhere, somehow, there must come a statement of goals for ham radio and a course to follow to achieve them. ■

Somehow we must come up with a clear-cut plan . . . or statement of principles . . . to guide the future development of amateur radio. We are rapidly dividing into individual groups according to our specialized radio interests. We must not allow this specializing process to also divide us *in spirit*. It appears we won't get much leadership from Washington, and the equipment manufacturers have pretty much abandoned us as a group in favor of more lucrative prospects in other radio services. This leaves it pretty much up to us to improve the status of all hamdom.

Through individual effort, and through our many clubs and associations, we must make it clear that we want a constructive plan for the future development of ham radio so that hamming can continue to be a fruitful technical training ground, a public service facility, and a source of world-wide unity and goodwill. If this isn't done, we will see ham radio deteriorate into an idle plaything that has little value to anyone. We've seen that happen in just a few years to another radio service which once seemed to have great promise. We don't want that to happen to ham radio, too! ■

Fisher Model 500-TX

Continued from page 66

monitor, and, of course, the reverb unit.

Located on the front panel is a stereo beacon lamp and a lamp for indicating when interstation noise muting is *on* (because noise muting also mutes very weak stations that usually are unsuitable for good stereo reception).

The front panel contains variable controls and switches for bass and treble, balance, volume, input selection, speaker selector, mode, preset tuned frequencies, AUTO-SCAN, manual tuning, loudness contour, high and low filters, and FM muting. On the rear arc two switched AC outlets and an AM ferrite rod antenna as well as external AM antenna terminals.

Performance. Rather than displaying the usual performance curves that require the reader to calculate actual performance data, we'll state the facts as we measured them. You'll not have to apply a straight edge to a curve to find performance characteristics.

The IHF FM sensitivity checks out at 0.5 to 1.7 μV , depending on frequency, which is excellent. Frequency response is essentially ruler-flat from 20 Hz to 15 kHz at 0.35% total harmonic distortion (THD) through the power amplifiers. That's *real* performance!

At the clipping level the power amplifier delivered (per channel) 62W rms into 8 ohms, 41W rms into 16 ohms, and 62W rms into 4 ohms. THD at full power is no greater than 0.18%, which is excellent.

Frequency response at full power output (not at IHF one watt test level) measured -2 db, +0 db, from 20 Hz to 20 kHz.

Again, at the 1-watt test level response is ruler flat from 10 Hz to 20 kHz. Tone-control range provides 23 dB boost and cut at 50 Hz and 22 dB boost and cut at 10 kHz.

Phono input hum and noise level is 60 dB down (practically dead quiet). AM receiver performance is average, not bad but not outstanding either.

Summing Up. The Fisher 500TX is a feature-packed receiver having outstanding FM sensitivity and superb tone reproduction quality. Though the price of \$449.95, plus an optional walnut finished cabinet at \$22.95, may be too steep for your budget at present, make a trip to your local Fisher dealer to see and hear the 500TX—you'll really want one after that.

For additional information, write Fisher Radio Corp., Dept. JS, 11-40 45th Rd., Long Island City, N.Y. 11101. ■

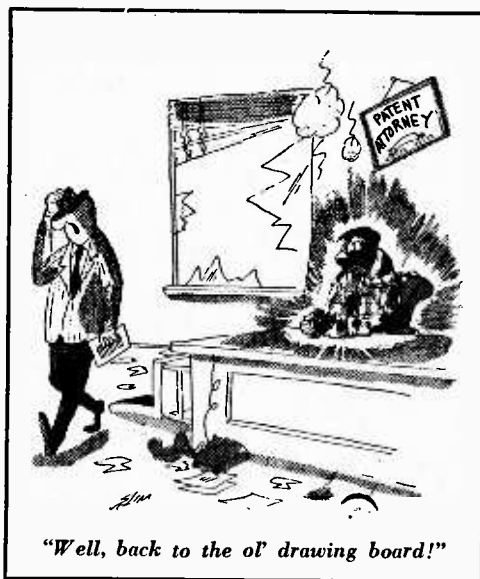

CLASSIFIED Market Place

FOR BIGGER PROFITS! NEW CAREER OPPORTUNITIES!
READ AND REPLY TO THESE CLASSIFIED ADS

Classified Ads 65¢ per word, each insertion, minimum 10 words, payable in advance. To be included in the next available issue of **SCIENCE & ELECTRONICS** (formerly RTV-Exp.) copy must be in our New York Office by May 10th. Address orders to C. D. Wilson, Manager, Classified Advertising, **SCIENCE & ELECTRONICS**, 229 Park Avenue South, New York, N. Y. 10003.

ADDITIONAL INCOME

REPAIR Television Tuners. Free Tricks. F. Bocek, Box 833, Redding, Calif. 96001.

MAKE Your Classified Ad Pay. Get "How To Write a Classified Ad That Pulls." Includes certificate worth \$2.00 toward classified ad. Send \$1.25 to C. D. Wilson, Science & Mechanics, 229 Park Avenue South, New York, N. Y. 10003.

BOATS, MOTORS & MARINE SUPPLIES

PLANS, Kits: canoes, kayaks, sailing rigs, accessories. Free catalogue, Quick-silver, 115 McGavock Pike Nashville, Tenn 37214.

HOUSEBOAT 40' x 16' under \$850.00. Write Route 1, Box 444, Bonita Springs, Fla. 33923.

BUSINESS OPPORTUNITIES

I MADE \$40,000.00 Year by Mailorder! Helped others make money! Start with \$10.00—Free Proof! Torrey, Box 318-T, Ypsilanti, Michigan 48197.

FREE Book "990 Successful, Little-Known Businesses." Fascinating! Work home! Plymouth 411-W, Brooklyn, N. Y. 11218.

MAKE Big Money raising chinchillas, rabbits, guinea pigs for us. Catalog—25¢. Keeney Brothers, New Freedom, Penna. 17349.

\$200.00 DAILY in Your Mailbox! Your Opportunity To Make Money Like Mail-order Experts. Free Details. Associates, Box 627-SE, Holland, Mich. 49423.

EARTHWORMS

BIG Money Raising Fishworms and Crickets. Free Literature. Carter Farm-O, Plains Ga. 31780.

EDUCATION & INSTRUCTION

EARN College degree at home. All subjects. Florida State Christian College, 4307 North Andrews Avenue, Ft. Lauderdale, Florida 33309.

BENTLEY INSTITUTE OF TRAINING—P.O. Box 891, Kenner, La. 70062. Thousands Of Courses, Leadership Training.

THERE is no charge for the Zip Code. Please use it in your Classified Ad.

ELECTRONIC COMPONENTS & KITS

UFO's—notes on Detection using your TV. Photo-electric Detector Circuits, all for \$1.40. Radar & Electronic Publications, 1, Stowmarket Road, Needham Market, Suffolk, England.

FOR SALE

SUBMINIATURE LISTENING DEVICES, low priced, high performance—direct from manufacturer. Dealers Welcome. Auditorionix, RT-14, 156 Fifth Ave., New York, N.Y. 10010.

INVENTIONS WANTED

WE either sell your invention or pay cash bonus. Write for details. Universal Inventions, 298-5 Marion, Ohio 43302.

MAGIC TRICKS, JOKER NOVELTIES & PUZZLES

MAKE Magic Your Hobby. Catalog 25¢. Jokes Magic Novelties, Sparks Fun House, 1722 Hymer Ave., Sparks, Nev. 89431.

MISCELLANEOUS

"ADULT" Books, Magazines. . . Free illustrated catalog! State age. (Send stamp.) Clifton's, Box 1068-SM3, Saugus, California 91350.

HOW TO TRAVEL without being rich. Booklet \$1.50. Anna Williams House, 158 Cedar Swamp Road, Coventry, Conn. 06238.

PSYCHEDELIC Catalog 50 Pages. Send 25¢. Hole In The Wall, 6065-SM, Lankershim, No. Hollywood, Calif. 91606.

DACRON SAILS—American Fabrics and Craftsmanship at Import Prices. Bill Schmit, Sallmaker, 402—37 Avenue, N.E., Puyallup, Wash. 98371. Phone (206) TH5-3831.

MONEYMAKING OPPORTUNITIES

OVER \$16.50 an hour. Spare time at home! Rubber Stamp industry needs small manufacturers. We furnish all equipment and know-how! Particulars free! Write: Roberts, 1512 Jarvis, Room CR-105-D, Chicago, Ill. 60626.

SELL YOUR PHOTOS REPORT Tells HOW, WHERE. **COLOR SLIDE MARKETS** \$1.00. Fam-Lee Sales, 703 2nd Street, East Northport, N.Y. 11731.

MONEYMAKING OPPORTUNITIES Con't.

CAMERA OWNERS. MAKE EXTRA MONEY. Sell your photos. Huge demand. Report tells how, where. Color slide markets. Only \$1.00. Ivyhart Sales, 600 West Bristol Road, Warminster, Pa. 18974.

PERSONAL

ELIMINATE Debts Without Borrowing! Particulars Free. Helper, 10639 Riverside, No. Hollywood, Calif. 91602.

FREE! List of low Cost books, success, happiness, personality, wealth, love. McRand Gifts, Camp Camden, Camden, Ala. 36726.

PROFITABLE OCCUPATIONS

LEARN Handwriting analysis—fun, profit. Thompson, 16105-M Delrey, Cleveland, Ohio 44128.

RADIO & TELEVISION

THOUSANDS AND THOUSANDS of types of electronic parts, tubes, transistors, instructions, etc. Send for Free Catalog. Arcurus Electronics Corp. MRT, 502-22nd Street, Union City, N. J. 07087.

POLICE—Fire—Aircraft—Marine—Amateur calls on your broadcast radio! Free catalog. Saleh Company, Woodsboro EE14, Texas 78393.

RADIO & TV Tubes 33¢. Free Catalog. Cornell, 4217 West University, San Diego, California 92105.

RECEIVING & INDUSTRIAL TUBES, TRANSISTORS. All Brands—Biggest Discounts. Technicians, Hobbyists, Experimenters—Request Free Giant Catalog and Save! Zalytron, 469 Jericho Turnpike, Mineola, N. Y. 11501.

"ONE TUBE DXER" Handbook—50¢. 15 Distance One tube Plans—25¢. Catalog. Laboratories, 12041-H Sheridan, Garden Grove, Calif. 92640.

SPECIALIZED Repair Service on Citizens Band Transceivers. Your rig put in like new condition for only \$11.95, plus net parts. Inquire, or ship prepaid to Wholesale Radio Service, P.O. Box 1049, Washington, N.C. 27889.

SPECIAL SERVICES

INFORMATION On Anything! Authoritative! \$2.00 (deductible.) Metzler Research, P.O. Box 2206MO, Long Island City, N. Y. 11102.

For Greater Classified Profits why not try the new combination classified ad medium

Your classified ad will appear in **SCIENCE & MECHANICS MAGAZINE** as well as in a minimum of four other **SCIENCE & MECHANICS PUBLICATIONS**. Write now for information to C. D. Wilson, Manager, Classified Advertising, **SCIENCE & MECHANICS**, 229 Park Avenue South, New York, N. Y. 10003.

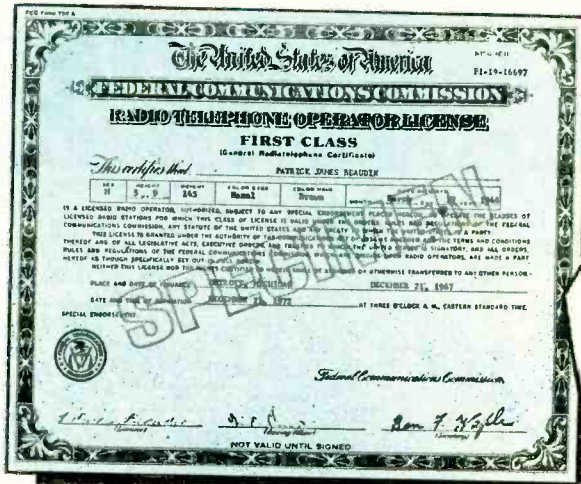

Better than
 9 out of 10
 CIE men win
 their "ticket"
 the very first
 time they try
 (NATIONAL AVERAGE
 IS ONLY 1 OUT OF 3)

Cleveland Institute of Electronics WARRANTY

of success in obtaining a
 Government FCC License

The Cleveland Institute of Electronics hereby warrants that upon completion of the Electronics Technology, Broadcast Engineering, or First-Class FCC License course, you will be able to pass the FCC examination for a First Class Commercial Radio Telephone License (with Radar Endorsement);

OR upon completion of the Electronic Communications course you will be able to pass the FCC examination for a Second Class Commercial Radio Telephone License;

AND in the event that you are unable to pass the FCC test for the course you select, on the very first try, you will receive a FULL REFUND of all tuition payments.

This warranty is valid for the entire period of the completion time allowed for the course selected.

G. O. Allen

Dr. G. O. Allen
 President

You can earn more money if you get an FCC License

...and here's our famous CIE warranty that you will get your license if you study with us at home

NOT SATISFIED with your present income? The most practical thing you can do about it is "bone up" on your electronics, pass the FCC exam, and get your Government license.

The demand for licensed men is enormous. Ten years ago there were about 100,000 licensed communications stations, including those for police and fire departments, airlines, the merchant marine, pipelines, telephone companies, taxicabs, railroads, trucking firms, delivery services, and so on.

Today there are over a million such stations on the air, and the number is growing constantly. And according to Federal law, no one is permitted to operate or service such equipment without a Commercial FCC License or without being under the direct supervision of a licensed operator.

This has resulted in a gold mine of new business for licensed service technicians. A typical mobile radio service contract pays an average of about \$100 a month. It's possible for one trained technician to maintain eight to ten such mobile systems. Some men cover as many as fifteen systems, each with perhaps a dozen units.

Coming Impact of UHF

This demand for licensed operators and service technicians will be boosted again in the next 5 years by the mushrooming of UHF television. To the 500 or so VHF television stations now in operation, several times that many UHF stations may be added by the licensing of UHF channels and the sale of 10 million all-channel sets per year.

Opportunities in Plants

And there are other exciting opportunities in aerospace industries, electronics manufacturers, telephone companies, and plants operated by electronic automation. Inside industrial plants like these, it's the licensed technician who is always considered first for promotion and in-plant training programs. The reason is simple. Passing the Federal government's FCC exam and getting your license is widely accepted proof that you know the fundamentals of electronics.

So why doesn't everybody who "tinkers" with electronic components get an FCC License and start cleaning up?

The answer: it's not that simple. The government's licensing exam is tough. In fact, an average of two out of every three men who take the FCC exam fail.

There is one way, however, of being pretty certain that you will pass the FCC exam. And that is to take one of the FCC home study courses offered by the Cleveland Institute of Electronics.

CIE courses are so effective that better than 9 out of every 10 CIE-trained graduates who take the exam pass it. That's why we can afford to back our courses with the iron-clad Warranty shown on the facing page: you get your FCC License or your money back.

There's a reason for this remarkable record. From the beginning, CIE has specialized in electronics courses designed for home study. We have developed techniques that make learning at home easy, even if you've had trouble studying before.

In a Class by Yourself

Your CIE instructor gives his undivided personal attention to the lessons and questions you send in. It's like being the only student in his "class." He not only grades your work, he analyzes it. Even your correct answers can reveal misunderstandings he will help you clear up. And he mails back his corrections and comments the same day he receives your assignment, so you can read his notations while everything is still fresh in your mind.

It Really Works

Our files are crammed with success stories of men whose CIE training has gained them their FCC "tickets" and admission to a higher income bracket.

Mark Newland of Santa Maria, Calif., boosted his earnings by \$120 a month after getting his FCC License. He says: "Of 11 different correspondence courses I've taken, CIE's was the best prepared, most interesting, and easiest to understand."

Once he could show his FCC License, CIE graduate Calvin Smith of Salinas, California, landed the mobile phone job he'd been after for over a year.

Mail Card for Two Free Books

Want to know more? The postpaid reply card bound-in here will bring you free copies of our school catalog describing opportunities in electronics, our teaching methods, and our courses, together with our special booklet, "How to Get a Commercial FCC License." If card has been removed, just mail the coupon at right.

2 NEW CIE CAREER COURSES

1. BROADCAST (Radio and TV) ENGINEERING... now includes Video Systems, Monitors, FM Stereo Multiplex, Color Transmitter Operation and CATV.

2. ELECTRONICS ENGINEERING... covers steady-state and transient network theory, solid state physics and circuitry, pulse techniques, computer logic and mathematics through calculus. A college-level course for men already working in Electronics.

THESE CIE MEN PASSED THE FCC LICENSE EXAM... NOW THEY HAVE GOOD JOBS

Matt Stuczynski,
Senior Transmitter
Operator, Radio
Station WBOE



"I give Cleveland Institute credit for my First Class Commercial FCC License. Even though I had only six weeks of high school algebra, CIE'S AUTO-PROGRAMMED lessons make electronics theory and fundamentals easy. I now have a good job in studio operation, transmitting, proof of performance, equipment servicing. Believe me, CIE lives up to its promises."

Chuck Hawkins,
Chief Radio
Technician, Division
12, Ohio Dept.
of Highways



"My CIE Course enabled me to pass both the 2nd and 1st Class License Exams on my first attempt... I had no prior electronics training either. I'm now in charge of Division Communications. We service 119 mobile units and six base stations. It's an interesting, challenging and rewarding job. And incidentally, I got it through CIE's Job Placement Service."

ENROLL UNDER NEW G.I. BILL: All CIE courses are available under the new G.I. Bill. If you served on active duty since January 31, 1955, OR are in service now, check box on reply card for G.I. Bill information.

Cleveland Institute of Electronics
1776 E. 17th St., Cleveland, O. 44114

Please send me without cost or obligation your 40-page book "How To Succeed in Electronics" describing the job opportunities in Electronics today, and how your courses can prepare me for them.

Your book on "How To Get A Commercial FCC License."

I am especially interested in:

- | | |
|--|--|
| <input type="checkbox"/> Electronics Technology | <input type="checkbox"/> Electronic Communications |
| <input type="checkbox"/> Broadcast Engineering | <input type="checkbox"/> Industrial Electronics |
| <input type="checkbox"/> First Class FCC License | <input type="checkbox"/> Electronics Engineering |

Name _____ (PLEASE PRINT)

Address _____

City _____

State _____ Zip _____ Age _____

Check here for G.I. Bill information

EX-37

CIE Cleveland Institute of Electronics
1776 East 17th Street, Cleveland, Ohio 44114

BUILD YOUR OWN RADIO

and Electronics Circuits

Reg. U. S.
Pat. Off.



Training Electronics Technicians Since 1946

PROGRESSIVE "Edu-Kit"^{no.} HOME RADIO COURSE

Now Includes

- ★ 12 RECEIVERS
- ★ 3 TRANSMITTERS
- ★ SQ. WAVE GENERATOR
- ★ SIGNAL TRACER
- ★ AMPLIFIER
- ★ SIGNAL INJECTOR
- ★ CODE OSCILLATOR

- ★ No Knowledge of Radio Necessary
- ★ No Additional Parts or Tools Needed
- ★ EXCELLENT BACKGROUND FOR TV
- ★ SCHOOL INQUIRIES INVITED
- ★ Sold In 79 Countries

YOU DON'T HAVE TO SPEND HUNDREDS OF DOLLARS FOR A RADIO COURSE

The "Edu-Kit" offers you an outstanding PRACTICAL HOME RADIO COURSE at a rock-bottom price. Our Kit is designed to train Radio & Electronics Technicians, making use of the most modern methods of home training. You will learn radio theory, construction practice and servicing. THIS IS A COMPLETE RADIO COURSE IN EVERY DETAIL. You will learn how to build radios, using regular Schematics; how to wire and solder punched metal chassis as well as the latest development of Printed Circuit chassis.

You will learn the basic principles of radio. You will work with the standard type of RF and AF amplifiers and oscillators, detectors, rectifiers, test equipment. You will learn trouble-shooting, using the Progressive Code Oscillator. You will learn and practice Progressive Dynamic Radio & Electronics Tester, Square Wave Generator and the accompanying instruction material.

You will receive training for the Novice, Technician and General Classes of F. C. C. Radio Amateur Licenses. You will build Receiver, Transmitter, Square Wave Generator, Code Oscillator, Signal Tracer and Signal Injector circuits, and learn how to operate them. You will receive an excellent background in television, Hi-Fi and Electronics.

Absolutely no previous knowledge of radio or science is required. The "Edu-Kit" is the product of many years of teaching and engineering experience. The "Edu-Kit" will provide you with training in electronics and Radio, worth many times the low price you pay. The Signal Tracer alone is worth more than the price of the kit.

THE KIT FOR EVERYONE

You do not need the slightest background in radio or science. Whether you are interested in Radio & Electronics because you want an interesting hobby, a well paying business or a job with a future, you will find the "Edu-Kit" a worth-while investment. Many thousands of individuals of all

ages and backgrounds have successfully used the "Edu-Kit" in more than 79 countries of the world. The "Edu-Kit" has been carefully designed, step by step, so that you cannot make a mistake. The "Edu-Kit" allows you to teach yourself at your own rate. No instructor is necessary.

PROGRESSIVE TEACHING METHOD

The Progressive Radio "Edu-Kit" is the foremost educational radio kit in the world, and is universally accepted as the standard in the field of electronics training. The "Edu-Kit" uses the modern educational principle of "Learn by Doing." Therefore you construct, learn schematics, study theory, practice trouble shooting—all in a closely integrated program designed to provide an easily-earned, thorough and interesting background in radio.

You begin by examining the various radio parts of the "Edu-Kit." You then learn the function, theory and wiring of these parts. Then you build a simple radio. With this first and trouble-shooting. Then you build a more advanced radio, learn more advanced theory and techniques. Gradually, in a progressive manner, and at your own rate, you will professional Radio Technician.

Included in the "Edu-Kit" course are Receiver, Transmitter, Code Oscillator, Signal Tracer, Square Wave Generator and Signal Injector Circuits. These are not unprofessional "breadboard" experiments, but genuine radio circuits, constructed by means of professional wiring and soldering on metal chassis, plus the new method of radio construction known as "Printed Circuitry." These circuits operate on your regular AC or DC house current.

THE "EDU-KIT" IS COMPLETE

You will receive all parts and instructions necessary to build twenty different radio and electronics circuits, each guaranteed to operate. Our Kits contain tubes, tube sockets, variable electrolytic, mica, ceramic and paper dielectric condensers, resistors, tie strips, hardware, tubing, punched metal chassis, Instruction Manuals, hook-up wire, solder, selenium rectifiers, coils, volume controls and switches, etc.

In addition, you receive Printed Circuit materials, including Printed Circuit chassis, special tube sockets, hardware and instructions. You also receive a useful set of tools, a Tester. The "Edu-Kit" also includes Code Instructions and the Progressive Code Oscillator, servicing with the Progressive Signal Tracer and the Progressive Signal Injector, a High Fidelity Guide and a Quiz Book. You receive Membership in Radio-TV Club, Free Consultation Service, Certificate of Merit and Discount Privileges. You receive all parts, tools, instructions, etc. Everything is yours to keep.

Progressive "Edu-Kits" Inc. 1189 Broadway, Dept. 559NN, Hewlett, N. Y. 11557

UNCONDITIONAL MONEY-BACK GUARANTEE

Please rush my Progressive Radio "Edu-Kit" to me, as indicated below:
Check one box to indicate choice of model

- Regular Model \$26.95
- Deluxe Model \$31.95 (Same as Regular Model except with Superior Parts and Tools plus Valuable Radio and T.V. Tube Checker).

Check one box to indicate manner of payment

- I enclose full payment. Ship "Edu-Kit" post paid.
- Send me FREE additional information describing "Edu-Kit."

Name _____

Address _____

City & State _____ Zip _____

PROGRESSIVE "EDU-KITS" INC.

1189 Broadway, Dept. 559NN, Hewlett, N. Y. 11557

FREE EXTRAS

• SET OF TOOLS

- SOLDERING IRON
- ELECTRONICS TESTER
- PLIERS-CUTTER
- VALUABLE DISCOUNT CARD
- CERTIFICATE OF MERIT
- TESTER INSTRUCTION MANUAL
- HIGH FIDELITY GUIDE - QUIZZES
- TELEVISION BOOK & RADIO
- TROUBLE-SHOOTING BOOK
- MEMBERSHIP IN RADIO-TV CLUB
- CONSULTATION SERVICE & FCC
- AMATEUR LICENSE TRAINING
- PRINTED CIRCUITY

SERVICING LESSONS

You will learn trouble-shooting and servicing in a progressive manner. You will practice repairs on the sets that you construct. You will learn symptoms and causes of trouble in home, portable and car radios. You will learn how to use the professional Signal Tracer, the unique Signal Injector and the dynamic Radio & Electronics Tester. While you are learning in this practical way, you will be able to do many repair jobs for your friends and neighbors, and charge fees which will far exceed the price of the "Edu-Kit." Our Consultation Service will help you with any technical problems you may have.

FROM OUR MAIL BAG

J. Statutin, of 25 Poplar Pl., Waterbury, Conn., writes: "I have repaired several sets for my friends, and made money. The "Edu-Kit" paid for itself. I was ready to spend \$240 for a course, but I found your ad and sent for your kit."

Ben Valerio, P. O. Box 21, Magna, Utah: "The Edu-Kits are wonderful. Here I am sending you questions and also the answers for them. I have been in radio for the last seven years, but like to work with Radio Kits, and like to build Radio Testing Equipment. I enjoyed every minute worked with the different kits; the Signal Tracer works fine. Also like to let you know that I feel proud of becoming a member of your Radio-TV Club."

Robert L. Shuff, 1534 Monroe Ave., Huntington, W. Va.: "Thought I would drop you a few lines to say that I received my Edu-Kit, and was really amazed that such a bargain can be had at such a low price. I have already started repairing radios and phonographs. My friends were really surprised to see me get into the swing of it so quickly. The trouble-shooting kit that comes with the kit is really swell, and finds the trouble, if there is any to be found."

PRINTED CIRCUITY

At no increase in price, the "Edu-Kit" now includes Printed Circuitry. You build a Printed Circuit Signal Injector, a unique servicing instrument that can fix many Radio and TV troubles. This revolutionary new technique of radio construction is now becoming popular in commercial radio and TV sets.

A Printed Circuit is a special insulated chassis on which has been deposited a conducting material which takes the place of wiring. The various parts are merely plugged in and soldered to terminals.

Printed Circuitry is the basis of modern Automation Electronics. A knowledge of this subject is a necessity today for anyone interested in Electronics.