

RTJ

Radio & TELEVISION JOURNAL



TV SALES TARGET FOR '50

FEBRUARY 1950

RJ D
 HAROLD R MOLTE
 ONRD
 WISC

Sec. 562, P. L. & R.
 U. S. POSTAGE
PAID
 NEW YORK, N. Y.
 Permit No. 10521

From: RADIO & TELEVISION JOURNAL
 A KOLBE PUBLICATION
 RKO BUILDING, RADIO CITY, 1270 SIXTH AVE.
 NEW YORK 20, N. Y.
RETURN POSTAGE GUARANTEED
 Postmaster: If undeliverable FOR ANY REASON, notify sender.
 stating reason, on FORM 3547, postage for which is guaranteed.

SMASH VALUE!

Lowest-Priced Vernier Drive Superhet!

Jewel "NUGGET"

MODEL
955

\$9.95

SUGGESTED RETAIL
in gleaming Ebony as illustrated
Walnut—\$11.95 suggested retail
Ivory—\$12.95 suggested retail

100
5 1/2" high
7 1/2" wide
4" deep

JEWEL

- Pre-war prices and post-war features!
- New Jewel drive with full sweep dial.
- Exclusive new dial drive eliminates old-fashioned stringing.
- Superheterodyne circuit. Alnico 5 speaker.

- No customer complaints because of shipped point. Cabinet is color-molded throughout of PURE BARELITE OR UREA, usually found only in higher-priced sets. Withstands dust, heat and discoloration better than other plastics.
- Jewel booklets and ad mats ready NOW!

Jewel RADIO CORPORATION

10-40 45th Avenue, Long Island City 1, N. Y. Cable Address: JEWELRAD, New York

All prices slightly higher West of Rockies.
Prices subject to change without notice.

**“NOTHING IS TOO GOOD
FOR MY FAMILY—**



WE BUY THE BEST—Sheldon!”

YOUR CUSTOMERS WANT THE BEST tube possible in the television sets in their homes. They want their families to enjoy pictures as only Sheldon “Telegenic” Tubes can show them—where Black is Black, White is White . . . and between, all the natural intermediate shadings. They want their families to have ‘round-the-clock’ viewing in daylight, artificial light or darkness *without glare, without eyestrain.*

Sheldon

NATURAL IMAGE



SOFT GLOW

Picture Tube

Give them Sheldon “Telegenic” Picture Tubes!

WRITE for Descriptive Literature on these NEW All-Glass Tubes:
10", 12½" and 16" Velour Black • • • 16" 52° Deflection Angle,
interchangeable with glass-metal 16AP4 • • • 16" Rectangular •
Short 16" 70° Deflection Angle 17½" overall • • • 19" 70° Deflection Angle.

SHELDON ELECTRIC CO.

Division of Allied Electric Products Inc.

68-98 Coit Street, Irvington 11, N. J.

Branch Offices & Warehouses: CHICAGO 7, ILL., 426 S. Clinton St. LOS ANGELES 6, CAL., 2559 W. Pico Blvd.

SHELDON TELEVISION PICTURE TUBES • CATHODE RAY TUBES • FLUORESCENT STARTERS AND LAMP HOLDERS • SHELDON REFLECTOR & INFRA-RED LAMPS
PHOTOFLOOD & PHOTOSPOT LAMPS • SPRING-ACTION PLUGS • TAPMASTER EXTENSION CORD SETS & CUBE TAPS • RECTIFIER BULBS

→ VISIT THE SHELDON BOOTH NO. 326 AT THE I.R.E. SHOW, MARCH 6-9, GRAND CENTRAL PALACE, N. Y. C. ←

FEBRUARY • 1950

VOL. 67 No. 2

Television • Radio • Appliances • Records-Component Parts

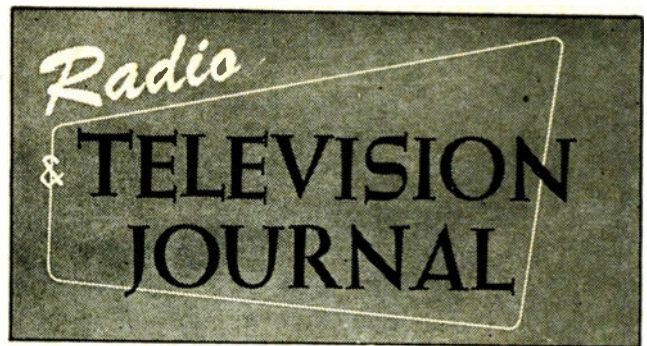

Publisher
ALEX H. KOLBE

Editor
NAT BOOLHACK

Associate Editor
JOHN A. RICHARDS

Business Department
AARON LAFER

Art Director
VINCENT T. COSTELLO

Circulation Manager
MARY LOUISE KAUFFMAN

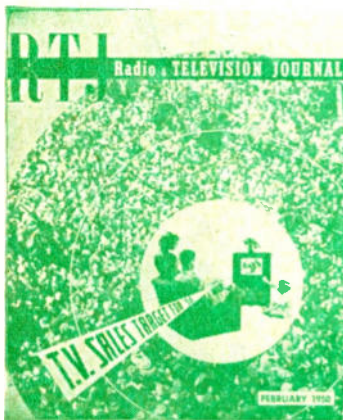

The Cover Today everybody . . . but everybody . . . is interested in television. Out of the vast, interested crowd, dealers must single out the individual family units for conversion from prospects to satisfied customers in competitive 1950.

Member of



OVER 36,000

Controlled Circulation Audit, Inc.

IN THIS ISSUE

Television Roundup	6, 10
A concise review of the month's happenings in radio and television.	
You Ought to Know Leonard Ashbach	10, 12
Does your store have personality?	14, 15
The first of a new series of articles on the principles, problems, and solutions on store design and layout.	
Not so "Mad Man" Muntz	16, 17
What home demonstration selling can mean to dealers in the way of profits.	
It's Service That Counts	20, 21
A West Coast organization has made a profitable service of service.	
Veterans Insurance Dividends	22
How dealers can get a legitimate share of sales resulting from the veterans' insurance dividend windfall.	
Illustrated Industry News	28, 29
Photographic highlights of industry events.	
The Parables of Modern Selling	32-34
Some Biblical lessons which "teacheth Ye how to go out and maketh customers parteth with their cash."	

DEPARTMENTS

Picture Pages	28, 29
New Products	36, 37, 40, 44, 46, 48
(Radios, Television, Consoles, Phonographs, TV Accessories)	
News and Notes of Manufacturers and Distributors	52
Appointments	55
Editorial	58
Advertisers' Index	58

RADIO & TELEVISION JOURNAL with which is combined RADIO & APPLIANCE JOURNAL and ELECTRIC APPLIANCE JOURNAL is the complete business magazine for retail dealers who buy and sell Radios, Television Receivers, Appliances, Phonographs, Records, Master Servicing Component Parts; and is published monthly for Radio & Appliance Dealers, Jobbers, and Service Men by Kolbe Publications, Inc., Radio City, 1270 Sixth Avenue, New York 20, N. Y. Phone: Circle 7-5842. Alex H. Kolbe, President and Treasurer. Subscription \$3.00 per year in U. S. A., its possessions, South America, Canada and all other countries \$4.00 per year payable in American currency in advance. Price 35 cents per copy. No material in RADIO & TELEVISION JOURNAL may be reprinted without consent of publisher.

Printed in U.S.A.

You have what they want

Big-as-Life

*on these great new 19-inch
Stromberg-Carlsons!*

Yes, your customers want bigger pictures.

Here is the biggest direct-view of all—203 square inches on a 19-inch tube!

So big you can actually see the stars in close-up big as life!

And on top of that, you have these other great Stromberg-Carlson value features to talk about—

- ▶ **TOP TUNING**—no bending or crouching to tune station or picture. Tuning controls cleverly concealed at top front.
- ▶ **BUILT-IN "TELATENNA"**—eliminates need for outdoor or indoor antennas in good signal areas.
- ▶ **BRIGHT, CLEAR PICTURE**—can be viewed close up or from across the room.
- ▶ **TRUE-TO-LIFE TONE**—with balanced acoustical system, tone control, and 12-inch speaker.

In big-as-life pictures, in solid value all along the new 1950 line, Stromberg-Carlson has what your customers want—it has what you want—to make this your **BIGGEST** year in television!



The NEW YORKER

BIG-AS-LIFE 19-inch picture. True-to-life tone. Exceptional performance even in "fringe" areas. Cabinet designed for traditional or modern setting, in selected mahogany veneers. (TC-19-LM2) . . . **\$539⁵⁰***

In blond avodiré veneers. (TC-19-LA2) . . . **\$549⁵⁰***

*Plus excise tax. Slightly higher in South and West.

® There is Nothing Finer than a

STROMBERG-CARLSON

Stromberg-Carlson Company, Rochester 3, N. Y. — In Canada, Stromberg-Carlson Co., Ltd., Toronto

TELEVISION ROUNDUP

Up and Up

Production of television receivers during the last quarter of 1949, RMA reported, represented 42 per cent of the year's output and exceeded the combined production figures for both the first and second quarters of the year. This was despite a slowdown to 292,061 TV sets during the month of December, a month characterized by diminished production because of the Yule holidays and the changeover to 1950 models and current showings.

With last quarter figures in, RMA estimated 2,800,000 TV receivers were made by the whole industry, and that over 10,000,000 radios were made all during last year. These figures boosted the TV totals since the war to almost 4,000,000. Radio receiver production was running about two-thirds that of the 16,500,000 sets made in 1948, and a little more than half the record 1947 output. While radio was far from dead, doing well in the face of a market in flux, television figures kept climbing up and up and up. Where it would stop nobody exactly knew. Because of TV, though, profitableness for the industry was not likely to stop for a long time to come.

Seven Keys

The seven economic factors which should act to sustain a high level of sales for appliance retailers in 1950, as stated recently by Fred J. Walters, vice-president, Hotpoint, Inc., should make radio and television dealers happy also. Mr. Walters listed these elements which point to a year of good business ahead: low inventories, veterans' refunds, high production, continued investment and construction, government support of farm prices, possible tax reductions, and stable prices.

TV and Employment

More efficient and scientific methods of distribution and marketing research, if adopted throughout the radio and television industry, may bring about more stabilized employment in the radio and television field. This was one of the points emphasized at a recent industrial relations seminar conducted at the Hotel Statler, New York, under the general theme, "The Search for Security."

A. F. Watters, assistant director of personnel, RCA Victor Division, Cam-

Symbol of Super-Colossal TV

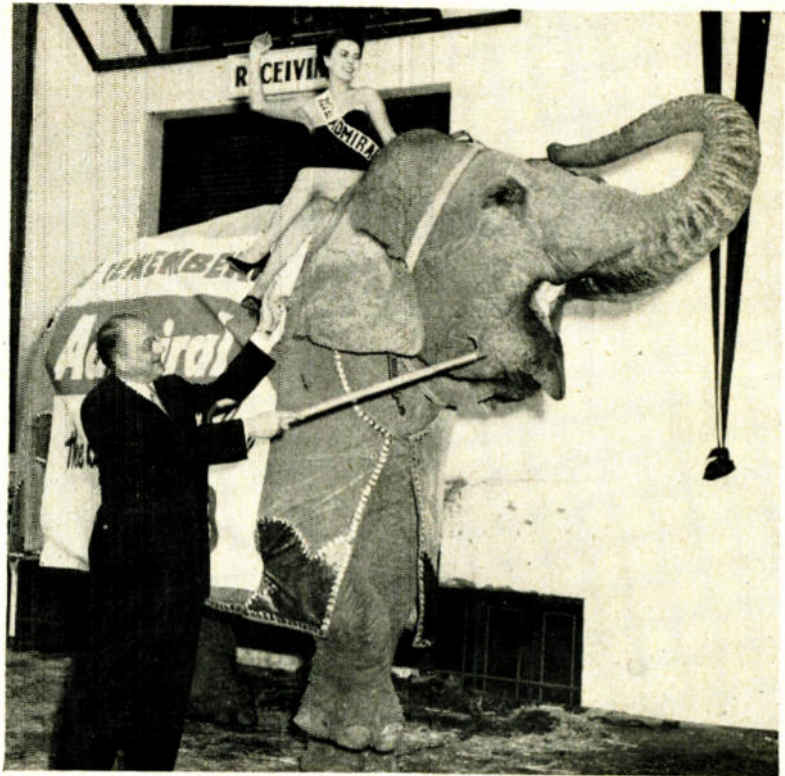

The pachyderm ridden by pretty Linda Ames at a recent open house reception for 5,000 dealers, held by Herbert H. Horn, Inc., Los Angeles Admiral distributor, symbolizes the size of business drummed up at the reception. Horn himself is amused at the elephant's antics, but he is also smiling over the \$10,000,000 in TV orders he netted.

den, N. J., told RMA industrial relations and personnel directors that "peak-and-valley" employment and production in the field was costly, but could be corrected by better appraisal of the market and the gearing of production to consumer demand. At the same conference, Godfrey P. Schmidt, New York industrial relations attorney, discussed the values and limitations of collective bargaining, citing intelligent handling of that aspect of the industry—both by management and labor—as the way to avoid possible bureaucratic controls. Throughout the two-day meetings, television was seen as the greatest factor contributing to steady employment in the industry.

Parts Show Plans

Specific recommendations for insuring the success of the 1950 Parts Distributors' Show scheduled for Chicago, May 22-23, were forthcoming from a recent New York meeting of the advisory committee. Radio Parts and

Electronic Equipment Conference and Shows, Inc. The recommendations were outlined by show manager Kenneth C. Prince as follows: 1) A "grass roots" program of conferences, clinics and talks covering such problems as financing increased inventories; turnover; cycle inventory methods of control; sales promotion; sales techniques; the relation of volume to profit, and other topics recommended for discussion and analysis by the distributors themselves; 2) simplification of registering procedure by advance mail registration and the elimination of credentials committees at the Show; 3) inclusion of pertinent subject matter in the All-Distributor Dinner; 4) a Show attendance committee, composed of all member-exhibitors and all five sponsoring associations, which will determine the planned attendance at all conferences and seminars, and 5) the preparation and distribution of portfolios and working material on each conference and talk, which will facilitate effective use of Show data at a future time.

1950 is the PHILCO YEAR in TELEVISION!

THE announcements made by Philco at the turn of the year have been hailed by dealers everywhere as conclusive evidence that Philco, the industry leader for 19 straight years, is ready to assume its full role of leadership in television for 1950. Conclusive evidence, too, that the buying public may look to Philco . . . as they have over the years . . . for the *value leaders of the television world!*

At Every Price, PHILCO CHALLENGES ALL COMPARISON for Performance and Quality

Leadership in value is only one part of the 1950 Philco story in television. Leadership in performance, picture quality and dependability is an even greater and more important part. New circuit developments and a sensational new High Sensitivity Tuner give these new Philco models, at their lower prices, better performance than ever before . . . *yes, performance that challenges all comparison at every price!* And in addition, a rigid system of quality control that will reflect itself in *lower service costs and satisfied customers* for every Philco dealer.

The cue for television dealers everywhere in these new Philco announcements is that *Philco is the line to concentrate on in 1950 . . . the line that simplifies your investment and gives you the biggest opportunity for television profits. Sensational values . . . unmatched performance . . . unsurpassed quality . . . unequalled consumer demand . . . yes, 1950 is the Philco year in television!*

PHILCO for '50 . . . QUALITY FIRST!

Now Ready from Philco . . .
Another TV Bombshell!



16 Inch
"No Glare"
Console
Ensemble

One of a series of new 16 inch Philco television sets. Model 1600.

\$299⁹⁵*

Plus Tax and Warranty

Big, 145 sq. in. picture, "No Glare" Optical System, and Electronic Built-In Aerial. Mahogany veneer cabinet. Also, new console models 1632 and 1633.



12 1/2 Inch Television Combination

Philco 1476-W Sensational value with 12 1/2 inch picture and Philco 3-Speed Record Changer . . . plays all records, all sizes, all speeds automatically. FM-AM radio. Electronic Built-In Aerial. Walnut veneer cabinet. Also, 1476-M in exquisite Mahogany!

\$399⁹⁵*

Plus Tax and Warranty

**Prices slightly higher in South and West.*

Here is the greatest Store Traffic,

EMERSON PERFORMS

Emerson Sets ALL TIME Value Record
With Magnificent New Models, Exclusive Performance Features,
Greatest Dollar-for-Dollar Buys In The Industry
READY FOR IMMEDIATE DELIVERY...



MODEL - 654

12½" Console with Emerson expanded GLAREPRUF picture tube. 12" Sealed Unit Dynamic Speaker. Automatic, pre-tuned, built-in Antenna. Choice, polished mahogany cabinet.



MODEL - 629

16" filtered, GLAREPRUF picture tube. Easy Twin-Dial Simplimatic tuning. 12" Speaker. Built-in Antenna. Luxurious, satin finished mahogany cabinet in decorator design.



MODEL - 649

235 Sq. In. colossal projection screen. Razor sharp, super powered Long Distance reception. Built-in Antenna. A sensational *first* in the low-price field for Home-Theater TV.

Emerson Radio



THE SET UP TO

Turnover, Profit Story in the Industry—

WHERE OTHERS FAIL!



MODEL — 651

16" Life-size picture tube. Staticlear FM tone. Long-distance circuit. Built-in Antenna. Simple Twin-Dial controls. Compact mahogany cabinet. Greatest value in LIFE-SIZE television



MODEL — 650

12½" truly magnificent table model. Superpowered circuit for Long-distance reception. Automatic, pre-tuned built-in Antenna. Genuine mahogany custom-made cabinet. Compact.



MODEL — 648

10" *Expan-Scope* picture tube. Remote control button from up to 20 feet away *doubles* image for giant close-ups. Powerful Built-in Antenna. Smartly styled, compact, lightweight.



MODEL — 653

AC-DC all new, superpowered super-heterodyne circuit. Inclosed Super Loop antenna. Sealed Unit Alnico 5 Speaker. In rich walnut or ivory Bakelite with modern designed grille.

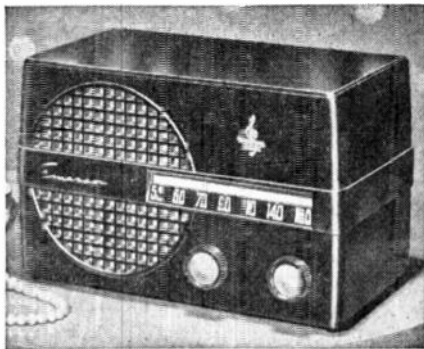

MODEL — 652

LEADER in performance and value. Another Emerson Style *First*. Extra sensitive circuit. New sturdi-grip controls. Beautiful ebony or ivory Bakelite cabinets.



MODEL — 634

3-SPEED record player and powerful superheterodyne radio. Plays *all* size records, all speeds *automatically*. Shock-proof tone arm. Powerful internal antenna. Smart, easy-to-carry mahogany cabinet with lid.

and Television

GET YOUR NET UP



REG. T. M.

Personalized TV Selling

Sylvania Television has personalized a television selling aid for the benefit of its dealers and distributors which may catch on quickly with other dealers and distributors throughout the country. The novel merchandising idea consists of a large map, which gives prospective set owners all the information they want about their particular television area. The map shows where a prospective television owner lives in relation to available TV transmission. Depending on a dealer's locality, more than one map may be used—an urban street guide and a road map for suburban and rural coverage. By the use of colored crayons, major landmarks, especially high structures which may interfere with reception, can be charted on the maps. The map is designed to explain in non-technical terms how expert installation will provide the best possible reception.

A further suggested application for the map is for dealers to place it on a table under plate glass, using blocks of wood or similar devices to demonstrate the "line-of-sight" factor in television reception. This can be an effective means of showing a TV set prospect how a hill, tall building, or unusual topography of any kind can influence the performance of a television receiver. For dealers looking for ways and means of modernizing their selling techniques, Sylvania's map idea provides a novel selling attack—personalized merchandising in terms any prospective TV buyer can understand.

Town Meeting Plans

A score of television manufacturers responded to a call to a recent conference at the Stevens Hotel, Chicago, by R. C. Sprague, chairman, RMA's "Town Meetings" committee and formulated plans to promote more educational "Town Meetings" of television dealers. Plans are to be carried out by a new industry committee composed of representatives both from RMA members and from non-member companies. Tentative plans for the television dealers' meetings follow those prepared with the aid of Howard Browning, committee consultant, proposing TV distributor-dealer meetings in 60 principal cities. At such meetings a presentation of four 20-minute films on major subjects would be made, all presentations designed to assist dealers. The newly-formed committee is further studying the plans, and dealers throughout the country can expect beneficial meetings to be the outgrowth of these tentative plans.



You Ought to Know Leonard Ashbach

By NAT BOOLHACK

LEONARD ASHBACH, a powerfully-built man who can double as a wrestler if ever he feels like taking time out from his duties as president of the Garod Radio Corporation, is a man of action who thinks and speaks quickly. But back of this gruff and ready exterior is the man of thought who carefully weighs and analyzes every move in the fascinating game of merchandising which has been his field all his life. Making every move with sure-footed confidence. Ashbach recently purchased the old Majestic name and goodwill, a famous and popular trademark in the old radio days, and he is now manufacturing a new and handsome line of television receivers under this name.

The decision to buy the Majestic name is characteristic of Ashbach, symbolic of the zeal with which he enters new ventures and makes them succeed. He bought Majestic because, as he puts it, "every kid knows the name which the old Majestic Company spent millions in promoting to the trade and the public."

Ashbach has been in selling and merchandising since he was sixteen years old. His first job was with a jewelry company in Chicago where he began as a stock boy. He had quit his formal schooling when fourteen, and continued his education in the school he proudly calls the "college of hard knocks." He soon displayed such imagination that he was made store manager

at Hartman's Furniture, then one of Chicago's leading stores, but when the management discovered he had lied about his age and was actually several years younger, he was fired. By the time he was twenty, he had chalked up the amazing record of having sold a million dollars worth of furniture, at the retail level. Such an achievement would have been phenomenal for any salesman, but for a youth of twenty, it was little short of miraculous and pointed the way to Ashbach's future career in selling.

Recently, during one of Ashbach's frequent visits to New York City where Garod's main plant is located, and where he maintains a suite at the Warwick, a friend asked him how it was possible for a stripling of less than 21 to sell a million dollars worth of home furnishings. Ashbach, who seldom drinks, had had one highball and was in a warm, genial mood. "That was possible," said Ashbach, "because I'm basically an idealist in selling. The biggest things start small, and my philosophy of selling has always been—build basically. For instance, at Hartman's, there were a number of salesmen on the floor, all of them trying to earn a living. I soon realized that I had to have something different if I was to stand out, so I gave myself the title of Interior Decorator and set myself up as a 'consultant' on all problems of home decoration. I read books, studied

(Continued on page 12)

Performance Wins

in the long run!



...And THOMAS leads all the way!

Performance alone, in any field, is the only sound basis for picking a winner.

So why not run your own tests — prove in your own laboratories that Thomas picture tubes are definitely superior! Twenty-eight separate inspections and strict adherence to the highest engineering standards ensure this superiority.

See for yourself that Thomas tubes produce the finest television picture obtainable! Your receiver deserves the best — install a Thomas tube!

GUARANTEED fully against any and all defects in workmanship and material.

THOMAS ELECTRONICS, Inc.

118 Ninth Street

Passaic, New Jersey



Leonard Ashbach

(Continued from page 10)

color combinations, knew all about the various period and types of design, and soon became something of an authority in the store. The customers came to me, and I sold."

What Ashbach omits is that in selling home furnishings, he always kept his eye on the ball and never thought in terms of just the particular table or sofa the customer had in mind. He took the time and effort to analyze the buyer's entire home and needs, and most of the time this resulted in selling a complete new home.

Hartman's, which had refused to change with the times, went out with the depression of 1929. Goldblatt's, one of the midwest's leading department stores at that time and still one of Chicago's most aggressive merchandisers, came over to give the defunct Hartman's the once-over with a view to buying the property. Ashbach keenly remembers how the 'old man' Goldblatt, whom he considers one of the great merchants of his time, overheard Ashbach expound his philosophy of selling. The scene was a cocktail party, and Ashbach, as is his custom, was telling a group of listeners what he would do if he had the responsibility for running a retail store. Goldblatt hired him right on the spot, and the next seven years were spent in Goldblatt University.

How did Ashbach ever get into radio? That transition, in itself, shows one of the major elements for his success. Even while he was at Hartman's, Ashbach had always had great curiosity for this new-fangled item called radio, and whenever time allowed, he would come into the then new department to try his hand at selling radios. He thought radio had a great future and decided to find out all he could about it.

By 1932, he was made radio buyer at Goldblatt's and within a short time after that was placed in charge of the entire merchandise division. When he assumed the post, the store had been doing \$30 million a year. When he left, in November 1939, to manage the Good Housekeeping chain of stores, Goldblatt's was doing in excess of \$80 million a year. While at Goldblatt's, Ashbach created and merchandised the Freezmaster line of refrigerators which achieved significant success.

Ashbach is modest about his accomplishments at Goldblatt's. "The men who cooperated with me built my business and will continue to do so," he told a visitor several weeks ago. While taking pride in being a self-made man, Ashbach differs from the usual garden variety type of success in that he has always had great respect for the ability of men who work with him. "I've never

been afraid to hire a person who knew more than I. Some executives, whenever they see ability in their departments freeze up with fear that this might endanger their own position. Such men are unsure of themselves. The ability to find and direct talent should be rewarded just as much as talent itself, and that will always be my goal," says Ashbach. That he has continued this philosophy in his own business is indicated by the kind of men who surround him at Garod Radio. Louis Silver, Garod's vice-president and general manager, is Ashbach's closest and most trusted executive and was retained by him when he purchased the Garod Company from Max Weintraub in 1947. Silver himself has a reputation for being one of the shrewdest minds in radio and television and the two men just seem to complement one another.

But to return to Ashbach's skyrocketing career, he left Goldblatt's in November, 1939 to assume the helm at Good Housekeeping Stores which had formerly been known as Levinson's Radio. By July, 1942, with the war in progress, retail stores had nothing to sell, and Ashbach decided he had better try to get into the scrape. By now, he was 37 years old and had a wife and four children. He tried enlisting in several departments, but the armed services thought they wanted younger men. With nothing to sell, and for a man of Ashbach's temperament this was tantamount to slow death, so he went to the Eversharp Company, purchased \$14.00 worth of ball point fountain pens and went out making calls. Within a few weeks, he had sold \$50,000 worth of pens. Ashbach was really beginning to feel his strength. He then bought up all the mattresses at the Congress Hotel in Chicago which was being taken over by the Army. The shortage in mattresses at this time was acute, and Ashbach was displaying such imagination in locating hard-to-get items that he was soon sought out by the Army and Navy Procurement Divisions to assist them in getting critical material.

In October, 1942, Ashbach went into business for himself by purchasing a wholesale firm. He began by accumulating odd lots of radios and components; went to the armed forces who needed hard-to-get components and made a series of successful bids which resulted in millions of dollars worth of business. By now, Ashbach was in his real element—not only was he serving his country by supplying the armed forces with critical components, but he was making money and having fun doing it.

In 1944, he began to build refrigerators, the Ramsay refrigerator, and in 1945 was the first manufacturer in the country to deliver a complete postwar

refrigerator—the "Lashco."

In 1945, with the war over, Ashbach approached Max Weintraub, then owner of Garod Radio, and proposed that he be made Chicago distributor for the firm's products. By this time, he was doing over four million dollars a year.

The next two years were, of course, excellent for the radio business as the country tried to buy new radios. In July, 1947, the Garod Company brought out an attractive small radio named "The Starlet" which it priced to sell for \$34.95. Ashbach came to New York, sat down with Weintraub and Silver and asked them to produce the item to sell for \$29.95 instead of the higher figure. Weintraub, who had been manufacturing radios for a long time, became incensed and challenged Ashbach to turn out the radio for \$29.95 and still make a profit. Ashbach, never one to quit under fire, immediately realized that here was his opportunity of a lifetime. Within five minutes, he bought the Garod Company in August, 1947 at the book value of the firm, and for cash. Weintraub moved away from the desk. Ashbach took over, and then began a period of progress in which Ashbach tied the company to the kite called television. The company's sales are today somewhere up there in the clouds as Ashbach and Silver aim their sights at ever higher production and sales figures.

With his recent purchase of the Majestic name for \$70,000 (including tools, dies, advertising material and goodwill) Ashbach immediately launched into making a popular priced line of TV receivers to complement the quality line being marketed under the Garod name. More than 40,000 former Majestic dealers have been notified and the response, says Ashbach, has been terrific. Ashbach was talking with a friend in New York several weeks ago, and the talk got around, as it always does when one is with Ashbach, to the philosophy of selling. Ashbach grinned an infectious smile as he waved a finger at the friend, saying, "Selling is not a philosophy, it's a psychology. The fundamental concept of selling goes back to ancient times when the rabbis realized that they must first convince their people about the concept of one God before they could develop the idea of an organized religion. To me, my whole life and fun has been in selling. I believe that one must 'build-up' to a customer before trying to sell him, and for me, the 'slow-build-up' is all important for the long pull. I'm proud to call myself an idealist in selling. I suppose I'll always be a salesman, which after all, is the basis for getting anything done. If the President of the United States wants certain legislation, he must first sell the Congress, and so it is in every field of life. Selling is the life-blood of action."

TV'S BEST BUY

16" Tube

147 Sq. Inch Picture

only

\$279⁹⁵

IN WALNUT

in Mahogany \$299⁹⁵

"Automatic Tuning"
Built-in Antenna

Long Range Reception

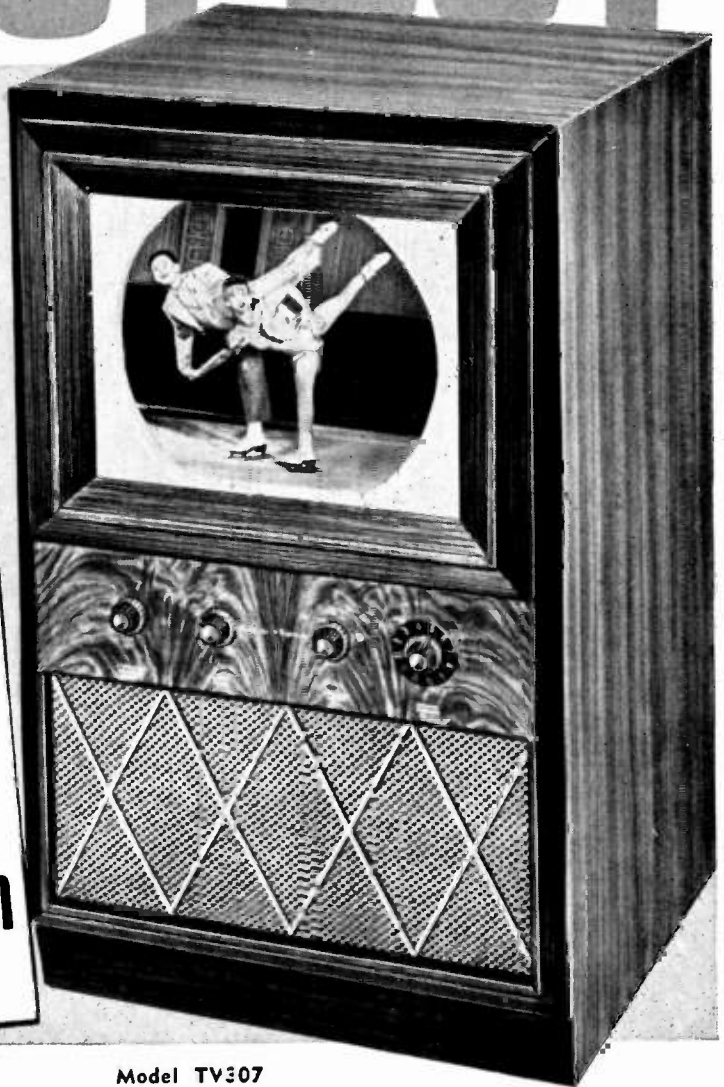

Model TV307

Tele-tone

RADIO CORP.
540 West 58th Street
New York City, N. Y.

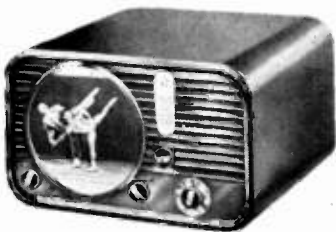

Model TV300. 63 sq. in. picture. Built-in antenna. Ebony phenolic cabinet\$129.95
All prices slightly higher in Southwest and Far West.



Model TV301. 63 sq. in. picture. Built-in antenna. Mahogany phenolic cabinet.....\$169.95

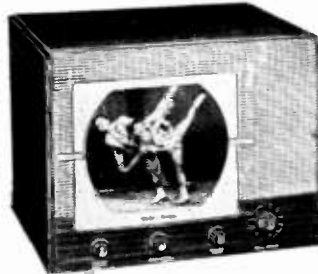

Model TV305. 97 sq. in. picture. Built-in antenna. Smartly styled Honduras mahogany veneer cabinet\$189.95



Model TV306. 16" Rectangular Tube. Built-in antenna. Handsomely decorated mahogany veneer cabinet\$249.95

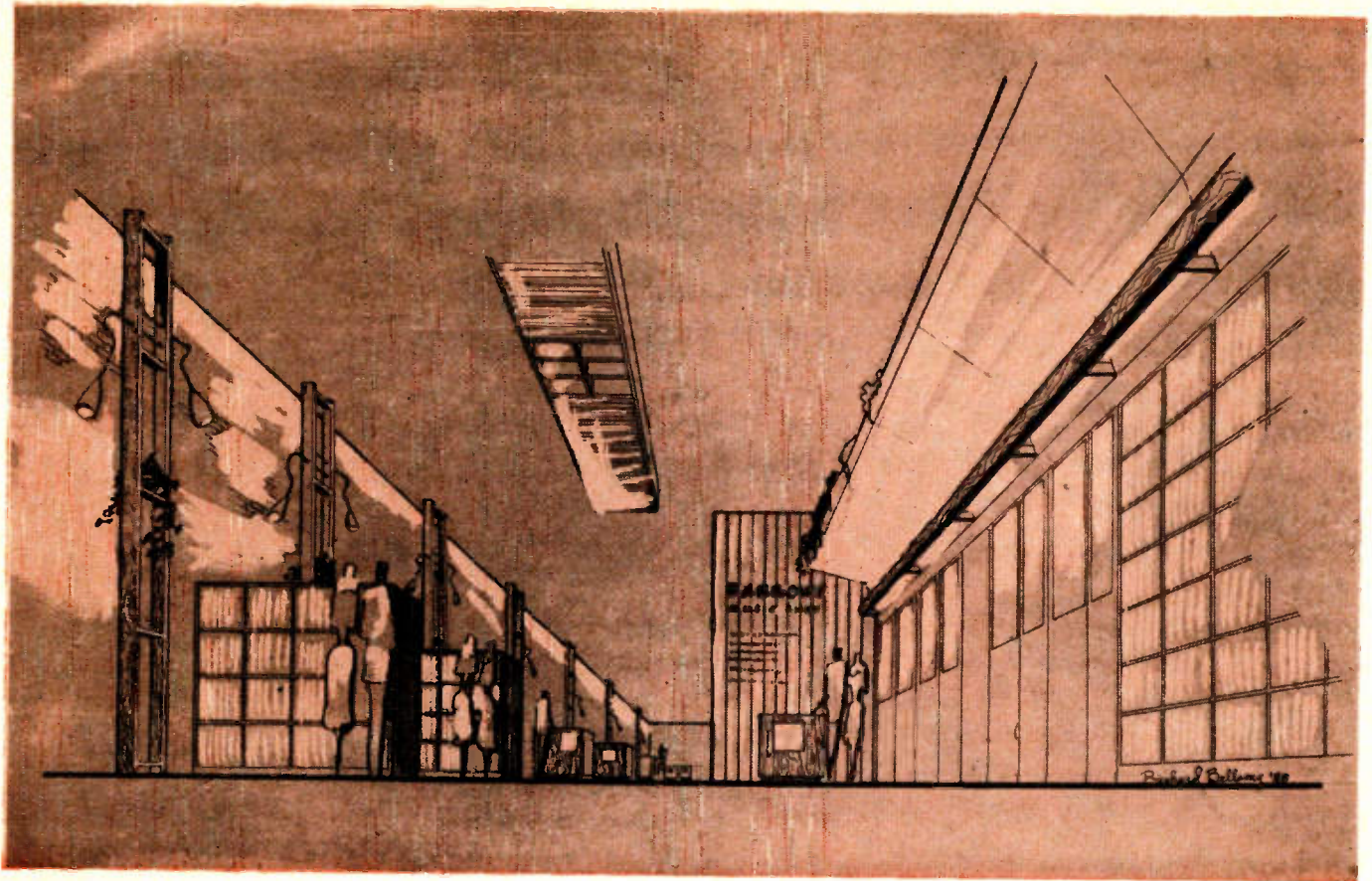

DOES YOUR STORE HAVE *Personality?*

ANY merchant, except one of "cracker-barrel" vintage, knows what *personality* means when it comes to selling his wares. He knows that the salesman with that mysterious charm known as *personality* will "clinch the sale" where the salesman who lacks it might muff it. In short, having *personality* makes the job of selling easier.

Now, with that as an accepted maxim, I would like to present and prove to you radio and television store merchants that your store likewise must have *personality* to make the selling job easier.

But first, what is *personality*? Most everyone has a good idea of what the term means when it is applied to human beings. But what does it mean to a store designer in terms of its application to a retail store. My definition of the *personality of a store*, especially a radio and television store, is that it has these *personality* traits: 1) atmosphere, and 2) method of selling.

Atmosphere

In physical appearance, does your store create some definite atmosphere the moment a person walks in the door? If you are located in a suburban neighborhood, do your customers feel at home in an interior which draws from the surrounding architecture to create *personality* and charm? If your store is in a busy metropolitan location, does it bespeak "streamlined efficiency" and a moderate "sophistication?"



Modernized store interior, Music Center, Garden City, L. I.

An unusual example of personality created by atmosphere can be found in the Garden City Music Center, Garden City, Long Island. As an architectural feature, I included in its interior a 50-foot flower box directly over the record shelving, and had it painted in domestic colors. Similarly, in the forthcoming modernization of Barrows Music Store in suburban Great Neck, Long Island, I have planned a 53-foot simulated-brick garden wall with trellis, which will serve as a background for television, radios, and records. Every store should acquire those traits of atmosphere which develop its personality to the fullest.

Selling Method

Does your store have a studied and definite approach to its method of selling? In the two radio and television stores mentioned above, selling methods differ significantly. One store has no record listening booths. The other has five such booths. Still another store, which recently called me for consultation, has 50 feet of self-service record racks, in comparison with the other two, which have none at all. Why is there this variance? The answer lies in the personality behind the method of selling.

The store with no listening booths has a clientele of rabid music lovers who, when they make their purchase, simply say, "Don't bother playing it for me. I know the record." The store with five listening booths is located in a well-to-do suburban community and has a clientele which likes to spend a lot of money and a lot of time on their records. This store caters to that eccentricity. The store with the 53 feet of self-service record racks is located in an average small town. The clientele of this store falls mainly in lower income brackets and is addicted to "pops" and light classics. This store puts records right out where they can be found quickly and easily.

Announcing

A NEW RTJ SERVICE

Richard M. Bellamy, young modernist in the store design field, was recently called in to redesign the Garden City Music Center, Garden City, Long Island, N. Y. His modernization of that store brought immediate acclaim and he was soon commissioned to redesign Barrow's Music Shop in Great Neck, Long Island. Other progressive radio, television, and music merchants are now calling him for consultation, and it would appear that he is on his way to becoming a specialist in the radio, television, and record field.

Radio & Television Journal has persuaded Mr. Bellamy to conduct a Dealer Clinic for the benefit of Journal readers. We invite you to read Mr. Bellamy's first discussion of radio and television store design problems, and to send along to him any questions you would like him to discuss in future issues.

Mr. Bellamy came to New York from Houston, Texas, and completed his architectural education in the progressive Modern School of Architecture at New York University. He received his Bachelor of Architecture in 1942, and, except for work with the U.S. Navy



RICHARD BELLAMY

Engineering Department during the war, has been in the design field ever since. He is a store designer with practical merchandising experience, having been "brought up" in his father's department store in Texas. Radio & Television Journal is convinced that its readers will benefit greatly from this young man's experience in and knowledge of the store design field.

In summation, then, I say that the temperament of your clientele must be studied carefully, and must be catered to just as carefully by your method of selling. Along with creating atmosphere, selling method gives a store that personality which singles it out from the general run of stores. Has your store personality? Or does it completely lack personality? Look at your

store. Analyze its personality on the basis of the two personality traits described. You may discover that your store has no personality at all. Then again, you may find that you have limited its effectiveness by giving it a wrong type personality trait for the location and for the clientele that frequents your store.

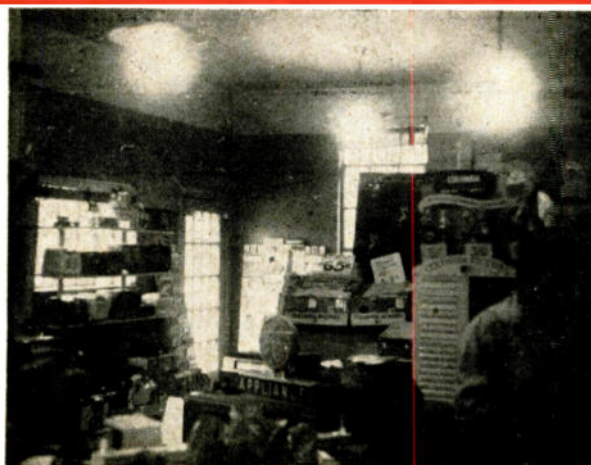

BEFORE

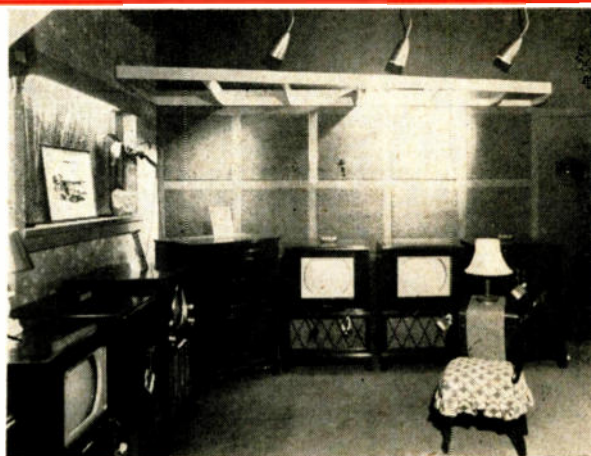

AFTER

Photos by T. Anthony Caruso



● *Pep songs at high noon are not uncommon with Muntz sales organizations from coast-to-coast.*

NOT SO MAD M

IT is not often that the unorthodox merchandiser can fly in the face of accepted methods of selling and still maintain a prosperous business. It looks as though at least one such merchandiser is doing it in the radio and television business, however. And dealers who form the normal backbone of the distribution channel could do worse than give a moment's thought as to how it is being done. If nothing else, it will inform them on the nature of their competition.

The merchandiser is none other than Earl Muntz, the madman of used car fame. Only this time he has stepped out of the used car arena and has marched right into the television business. He has opened the veritable fairy tale book of selling, the one that recounts the marvels of door-to-door selling, of old fashioned demonstration methods, and of prospect lists and how to turn them into live and profitable sales lists. While many dealers are still getting mentally accustomed to rock bottom buyer's market days, Muntz has made old fashioned selling the pillar of his own selling. He is not waiting for earthy selling to become a vogue. He has accepted the trend and has geared his business to it. Dealers who have as yet failed to attune their own operations to the new merchandising vogue will soon find that it has become a dealer must, especially as the

competitive battle stiffens in the coming year.

Demonstration Blitz

Muntz has been letting no grass grow under his feet so far as selling television sets is concerned. He started with an uncommon handicap, however. Having spent considerable sums on publicizing himself as "Madman Muntz" to push sales in the used car field, Muntz had to take a more dignified tack when he entered the television field. He had to show the public he had entirely recovered his sanity. But in doing so, he also evolved a method of operating which hits home at the weak spot in many dealers' selling armor. It was

really one part of the old fashioned selling techniques, with a new twist.

In a given television city, for instance, the Muntz organization would take over a combination warehouse-factory-showroom. With this as a base of operations, fully manned by an office force and expert technicians, a fleet of service trucks was made ready for the demonstration blitz on the television-conscious populace. Skywriters carried the Muntz message to the populace. Radio and newspaper advertising awoke the townspeople to the fact that Muntz TV was available for free home demonstrations, upon request. And the organization was ready for the flood of such requests. Within an hour, a Muntz demonstration

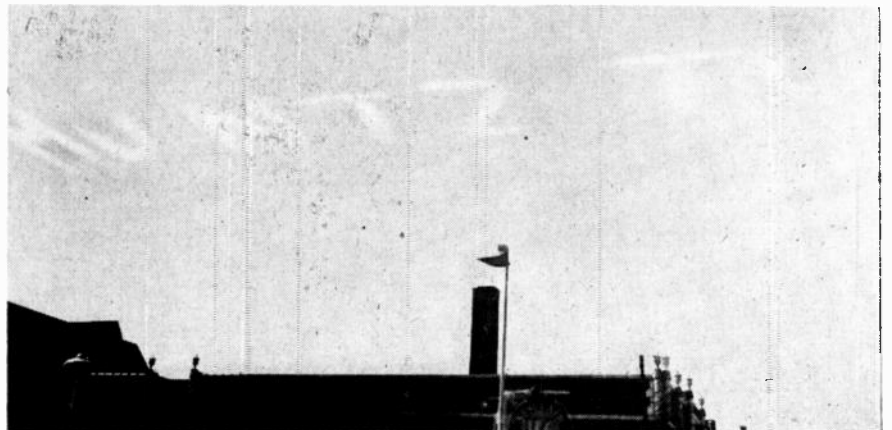



● This fleet of Muntz trucks poised on Northern Boulevard, Queens, L. I., N. Y., can answer a call within an hour.

UNTZ

car could be dispatched from a large fleet to accommodate the request of a television receiver prospect.

Spreading Sales

The same tactics have been employed by the Muntz organization in city after city, proving that the home demonstration method can be an effective sales booster. The receivers are marketed now in New York, Newark, Philadelphia, Boston, Washington, Baltimore, Detroit, Cleveland, Chicago, St. Louis, Los Angeles, and Long Beach. Other cities are exposed to the demonstration selling methods as they come within television reception range. With his high-powered organization—an administrative staff to cope with the flood of home-demonstration requests, technicians to conduct the demonstrations, fleets of trucks to speed sets to any home, and an advertising program to pace the whole operation—Earl Muntz is doing the next to impossible, profitably and on a grand scale. The old fashioned demonstration method of selling is not so old fashioned, it seems. Dealers who take the trouble to perfect an orderly routine of selling television by the home demonstration method will, like Muntz, find untold profits lurking in every prospective customer's home.



● Earl Muntz, the not so "Mad Man" behind the Muntz TV organization, beams over one of his sets. Muntz sparks the home demonstration method of selling himself, and lines up all merchandising and promotion programs. Using radio and TV spots and shows, newspaper ads and trucks, and sky-writing, all are his idea. Once when a 16-inch console set was too big for one salesman to carry, Muntz directed that demonstrator models be sawed in half, and put together in the customer's parlor.

Announcing the newest **WORLD'S**

Featuring the automatic Electronic Servant— 7 amazing services — no increase in prices!

★Nearing the million mark, General Electric Clock-Radios reach an all-time high in popularity. Now, with more features per dollar than any other radio made, G-E Clock-Radios with the new automatic Electronic Servant are headed for sensational new sales records. What other radio wakes you to music, lulls you to sleep, turns appliances on and off (coffee-makers and a dozen other electric appliances), tells time even in the

dark, is an accurate G-E electric clock, a fine-tuned radio and an electronic reminder? Here's radio's hottest item that knows no season! What a natural for red-hot promotion—and it's ready for you now! If you want to share in this success, don't lose a minute in getting the whole story from your G-E radio distributor, or write to *General Electric Company, Receiver Division Electronics Park, Syracuse, New York.*



CLOCK-RADIOS



Model 508—Performs all 7 amazing services. This new, deluxe G-E Clock-Radio comes in a bleached mahogany plastic cabinet. **\$39.95***



Model 505—World's most useful radio in a rich rosewood plastic cabinet. Performs all seven amazing services. Note the same low price. **\$34.95***



Model 506—All 7 sensational services of the new G-E Clock-Radio in a smartly styled ivory plastic cabinet. **\$36.95***

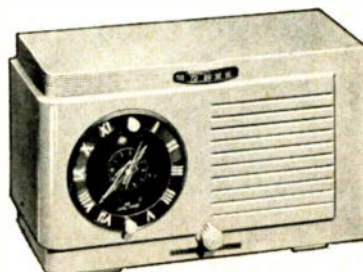

Model 501—G-E "Wake-up-to-music" Clock-Radio. If you daze off, it buzzes until you da get up. G-E electric clock has luminous hands. Lively ivory plastic cabinet. **\$31.95***



Model 500—Same General Electric "Wake-up-to-music" Clock-Radio as Model 501, left, but in a handsome rosewood plastic cabinet. G-E price leader—tremendous value. **\$29.95***

**Prices slightly higher West and South—subject to change without notice.*

MOST USEFUL RADIO

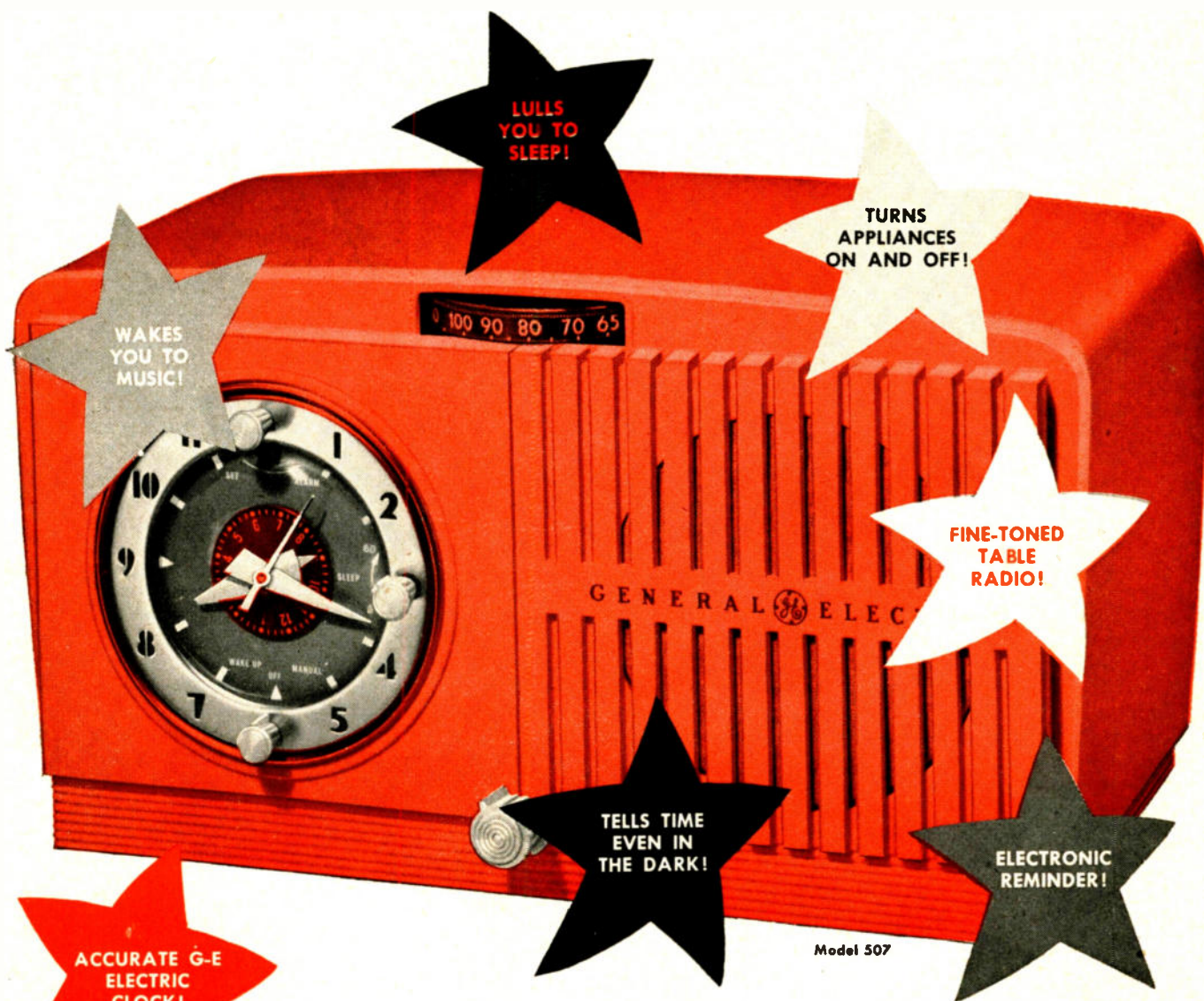

Model 507

STUNNING NEW PLASTIC CABINET IN BRILLIANT BURGUNDY!

All 7 features of the world's most useful radio . . . all the beauty, the sales-appeal of a cabinet in stunning burgundy plastic. Radio has G-E

Dynapower speaker, built-in antenna, superheterodyne circuit. G-E Electric Clock has luminous hands and dial markings. Model 507. **\$35.95***

You can put your confidence in—

GENERAL  **ELECTRIC**



● The streamlined TV Craftsmen organization has found that efficient service can be profitable.

It's Service That Counts

AS a television service contractor, Al Schwartz of the Television Craftsmen Corp., Los Angeles, Calif., is a hard-headed business man. So is his partner, Bill Scott. Consequently they have adopted as a guiding maxim "Make the other guy look good," a somewhat odd-sounding saying for a TV service organization. But it makes a great deal of sense.

Who is this second party? Dealers with long and bitter experience with faulty service can find the answer without looking very far. In the case of Television Craftsmen Corp., the partners quickly name their clients, the television dealers. Without the dealers they would not be in business. Upon the success of those dealers depends their success. They freely admit that a reputation makes or breaks a product, and efficient service can make or break that reputation. In TV, service determines the long-run worth of a receiver. That makes the dealer and the TV service contractor mutually dependent. They must both deal in reputable products, or both are out of business. They must both conduct business on a sound and efficient basis.

Promptness and Quality

To meet the shifting demands of service, Television Craftsmen Corp. has a basic staff of 20 men comprising service

teams. Holiday demands, such as during a Christmas spurt last year and heavy calls for installations in time for the Rose Bowl football game, swell the total of men in these teams, sometimes to as high as 40 and 45 in all. At such times, the eight trucks are supplemented by private automobiles, the working day is lengthened, even to past midnight, and swamped workers, like the traffic manager, are given assistants.

What this special effort strives for is basic with a service organization. It must give *quality* service *promptly*. Otherwise such an organization is fumbling along, doing no one, particularly the dealers, much good of any sort. This Los Angeles organization strives for one response from customers whom they have done work for. They want them to say, "It's amazing how little trouble I've had with my TV receiver. I'm going to advise my neighbor to go to the same place and to buy the same make." There's no sweeter music to the dealer's ear. And it was his service contractor who made it possible.

Television Craftsmen Corp. operates on the basis of quality repair and service for the simple reason that it is more economical to fix a receiver properly than to have a haphazard job done on it. In the first case, the number of repeat calls are brought down to zero, whereas slipshod work means expensive, time-consuming return calls. Re-

turning to the scene of the repair is like returning to the scene of the crime. Too many repeat calls and a customer soon finds out about inferior work. For that reason, quality service becomes synonymous with any reputable service contractor. However, promptness in providing quality service is also fundamental to such an operation. But at Craftsmen, promptness is sometimes sacrificed to efficient handling of service jobs, all for smoothness of organization operation.

The Traffic System

All calls, for instance, are funneled through the traffic manager. Through careful routing, he is able to cut down the time necessary to dispatch each problem. By quickly sizing up a job, determining its complexity and the extent of work required, he can relay information to field workers and can overlap calls or stagger them as the need arises. Trucks going out in the early morning, for instance, have crews assigned to make calls covering only part of the day. As they complete jobs in the field, they make periodic checks with the office to learn of any new calls in the territory they are covering that day. As a result, the organization is able sometimes to receive, route, test and service a television receiver within

a matter of hours. To further expedite the handling of calls and dispatching crews to complete service trips on them. Craftsmen contemplates adding a two-way intercommunication system between trucks and the shop.

Schooled Technicians

Just as there is no substitute for quality work, there is no substitute for excellent technicians to accomplish that work. With Television Craftsmen Corp. it is a policy to see that technicians are trained in every phase of television servicing. As a first step in training, any form of specialization is shunned. A new man is assigned to alternate in the shop and in the field. This continues until a training technician demonstrates excellence in some specialty. In some instances, the organization was materially strengthened by specialization in certain sets, allowing Craftsmen to surmount what appeared to be impossible problems.

To allow technicians to function at peak capacity, owners Schwartz and Scott have seen to it that their firm has the best servicing equipment available. They are constantly adding various test and repair instruments to an already abundant supply. In addition, the men themselves discover homemade rigs which are suited to special jobs. When any such equipment is discovered to be adaptable for use by all crews, it becomes a part of the standard gear.

The Working Set

Probably the most telling way to cut down on service calls and to insure satisfactory reception is for the initial installation to be as perfect as possible. To this end, Craftsmen crews check a set thoroughly for possible factory flaws or for damage. Once it is sent along to the customer's home the greatest pains are taken with the original installation. From then on the elaborately-equipped trucks have the job of keeping these sets away from the shop. When it is impossible for truck crews to make on-the-spot adjustments, a shop test is made, the receiver being subjected to bench examination for several hours. When sets keep coming back even after these thorough shop tests, an explanation is sought elsewhere. Perhaps peculiarity of a territory is responsible, perhaps an owner is not using the set properly, or perhaps that particular model has flaws. In any case, the answer is passed along to the entire staff so that in all future cases the peculiarities can be corrected long before the trouble starts.

(continued on page 50)



To give quality service promptly a service organization like TV Craftsmen cannot fumble along. Every operation that shortcuts inefficiency and high costs must be coordinated by President Schwartz.



There can be no substitute for quality work, therefore there can be no substitute for competent technicians. Personnel are trained in all phases of television servicing, do not specialize, but work in shop and field.



TV Craftsmen Corp. goes on the assumption that a TV set in proper working order is a set that will require few service calls. Extensive tests for flaws or damage are used in the shop to cut down later service calls.

About

VETERAN'S INSURANCE DIVIDENDS

The \$2.8 billion windfall which almost 16 million veterans acquire sometime before next Fall has created a vast new market for radio and television dealers

TWO and eight-tenths billion dollars are now being distributed to some 16 million World War II veterans in refunds on their National Service Life Insurance, and radio and television dealers should be more than just aware of it. Each veteran knows of the dividend, how much it will amount to approximately, and just about when he expects to have it in hand. Dealers in every other industry know about this insurance refund bonanza, too, and they are exerting every effort to direct the expenditure of the individual sums on items and products that will benefit their exclusive operations. Besides that, there are constant pressures coming to bear from sharpster sources, and these are siphoning off monies that would otherwise go toward better living purchases.

Radio and television dealers have a distinct edge when it comes to selling to the veterans who are recipients of the insurance windfall. Most veterans are ripe for the purchase of the products of the industry. Most of them are married, have children, and are anxious to give their families the advantages of modern living. During the war years the desires of these veterans were channeled into planning for a home and car in the immediate postwar years. But by the time they were back in civilian clothes, television became an additional factor in their lives. And with the arrival of television receivers priced for the mass market, these veterans had to include this new medium of entertainment in their list of desires. At first television tailed a home and a car, in that order, on the list of preferred buying items. Now it is no longer running third. Veterans reason that a new car means a long haul for the family budget, and a new home

means an even more difficult financial load. But a television set, offering a more immediate and more satisfying form of entertainment and enjoyment, is more within each veteran's reach.

How They Spend

Acknowledging specific buying desires, will the veterans spend money on products a radio and television dealer has to offer? A sound answer to this question can be found in a glance at the record of how veterans spent their terminal-leave bonds in 1947-48. Clothing, food, and other non-durable goods led the list with 28 per cent of the purchases. But money spent for either automobiles, appliances and furniture came to 23 per cent. Emergencies, back bills, taxes, savings, new homes, stocks and bonds, and vacations ran anywhere from 11 to two per cent. This pattern definitely fixes a considerable chunk of the dividend money within the sphere of radio and television dealer operations. There is reason to believe that the same proportion, 23 per cent and possibly more, of the purchases will fall in the automobile and general home furnishings fields. With the tremendous popularity television is enjoying, dealers should be able to capitalize on the sale of the miracle of modern living to veterans who want the finest in life for their families.

How to Sell Vets

By the end of June, 1950, \$2,500,000,000 of the refund total will be distributed to eligible veterans. Thereafter the remaining \$300,000,000, representing refunds to veterans who have not yet applied, will be distributed over

several months. During this period dealers can plan their selling to coincide with the arrival of the G.I. checks. One very important step should be obtaining a list of veterans in the dealer's locality. With this list as a guide, a special informative mailing piece should be compiled and sent out to veteran prospects. Presented in an assured and dignified manner, this mailing can point out the advantages of buying radio and television products. In the case of television, there is not a single item on which a veteran might spend his money with as much assurance that it will give him and his family as much long-term enjoyment. It is important for dealers to tell prospective customers this by enumerating TV's advantages.

In addition to putting the mails to work for him, a dealer can arrange special demonstrations of television for veterans groups and organizations. He might care to set aside special nights or hours for elaborate group demonstrations in his store. He can set up a special service to give veterans an opportunity to see a demonstration of television right in their own home. Within the store itself, window streamers and displays, and interior alcoves and salons can carry elaborate sales messages for prospective veteran customers. On the selling floor salesmen who are themselves veterans can be assigned to take over the job of selling to the ex-G.I.'s. The profit potential in veteran prospects are limitless for the radio and television dealers who are alert to the meaning of the 2.8 billions which will be spent in some way or another by next fall. To get his legitimate share of this windfall, every dealer must settle down to aggressive selling of the veteran market.

These Birds Know Where to Roost!

You're right — in the COVRALL nest they live happily . . . wisely . . . *profitably!* Hear them sing about the gleam that lights customers' eyes when they mention the low prices. So join these trade leaders NOW while the nest still has room. **Fly in early — Stock COVRALL for '50.**

TYPICAL FEATURES THAT SELL COVRALL PHONOGRAPHS ON SIGHT

- Ultra-new tropical two-tone alligator covering in Red, Blue or Tan.
- Special high gain electronic amplifiers
- Individually packed in air-cushioned cartons
- All COVRALL units have:
High fidelity tone control
Volume control

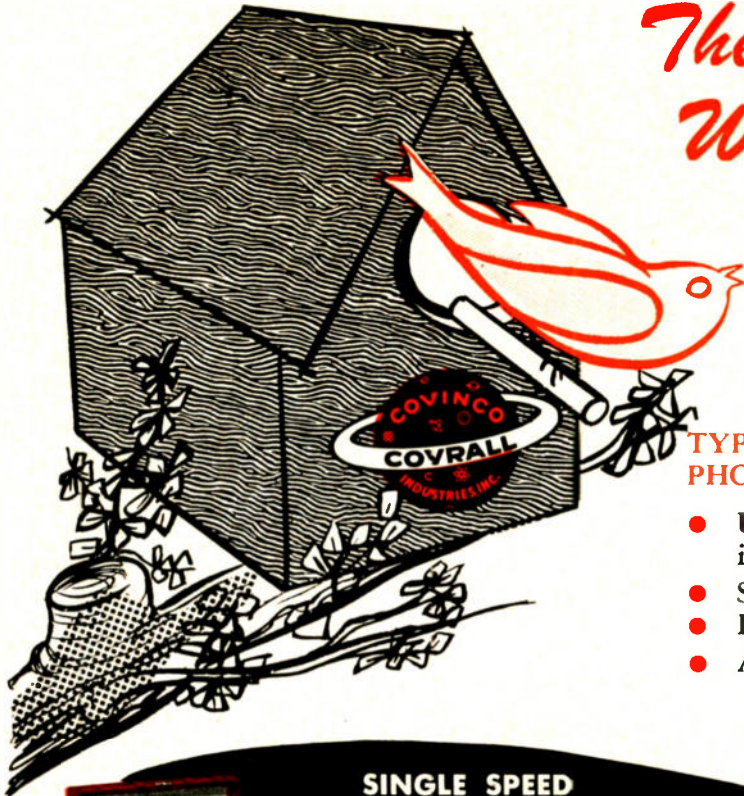

SINGLE SPEED RECORD PLAYERS

(78 RPM)



No. 101

Suggested list price — \$19.95
Special padded stitch top.



No. 109

Suggested list price — \$24.95. Plays all size records up to 12" with cover closed.



No. 108

Suggested list price — \$25.95
Miracle retractable arm feature
Will not break or crack records no matter how abused.

3 SPEED RECORD PLAYERS

(33 1/3 — 45 — 78 RPM)



No. 301

Suggested list price — \$34.95
Plays all records with cover closed. Same feature as No. 300



No. 305

Suggested list price — \$64.50
3 speed automatic record changer.



No. 300

Suggested list price — \$29.95. Lowest priced 3 speed phonograph with reversible type cartridge for quick change over. Special motor mechanism to facilitate change from speed to speed.

We also carry a complete line of Juvenile Phonographs.

Write today for your copy of Covrall for '50, your **FREE** invitation to profits

DISTRIBUTORS:

Rollan Sales
Chicago, Ill.

Mercury Dstr.
Boston, Mass.

Carnegie Radio Co.
Cleveland, Ohio

J. G. Storminger
San Francisco, Cal.

George Rosen Co.
Baltimore, Md.

Covrall INDUSTRIES, Inc.
"Famous for Fine Phonographs"

55 FERRIS STREET, BROOKLYN 31, N.Y.

**SIGN OF THE WORLD'S
MOST Profit-Protected
television dealers... all set to
STRIKE IT RICH in 1950**

**FRANCHISED
DEALER**

Starrett

 **Opticlear**

TELEVISION

**PROTECTED PROFITS FOR
SELECTED FRANCHISE DEALERS**

- direct-to-dealer selling!
- discounts up to 40%!
- exclusive in your selling-area!
- generous promotion cooperation!
- decorator designed cabinets!
- America's most complete price line, \$199.95 to \$1295!
- best merchandising ideas in T.V.!
- **AND THE ONLY WARRANTY** that gives your customer "maker-to-user" assurance: the sensational Starrett Opticlear Warranty Record Album!

The LINCOLN, 16" tube Console, AM-FM, 3-speed automatic record changer. \$1095.00

The WASHINGTON, same model, with Breakfront top. \$1295.00



STARRETT TELEVISION Corp.

601 West 26th Street, New York 1, N. Y.

The JAMES MONROE, 16" tube Console, AM-FM, 3-speed automatic record changer. \$479.95



The JOHN HANCOCK, 16" tube Console, AM-FM, 3-speed automatic record changer. \$799.00



The CLEVELAND, 16" tube Console, AM-FM, 3-speed automatic record changer. \$895.00



Starrett



TELEVISION

with exclusive, scientifically Film-Freed* picture tube, and built-in antenna

America's most complete price line \$199.95 to \$1295

The HENRY HUDSON, 16" tube Table Model. \$299.95



The COSMOPOLITAN, 16" tube Breakfront, AM-FM, 3-speed automatic record changer. \$1295.00

The GOTHAM, same model, without Breakfront top. \$1095.00



The NATHAN HALE, 12 1/2" tube Table Model. \$199.95



The ROBERT E. LEE, 16" tube Console, with doors. \$399.95
The HENRY PARKS, same model, without doors. \$369.95



The JEFF. DAVIS, 12 1/2" tube Console, with doors. \$299.95
The SAM HOUSTON, same model, without doors. \$279.95



DISCOUNTS
up to **40%**

AND FOR EVEN MORE BUSINESS in 1950
Starrett BRINGS YOU
THE FABULOUS, NEW
"Room-Service"
Starrett COOLATRON
AIR-CONDITIONER
with exclusive built-in DE-FUMIDOR

Exclusively selected for the:
"Good American Home"



STARRETT TELEVISION Corp.

601 West 26th Street, New York 1, N. Y.

*pats. pending

\$299⁹⁵*

Lowest Price Ever
for Big 16-Inch
Eye-Witness Television

The RCA Victor T-164

Here's the amazing RCA Victor set that brings big, 16-inch Eye Witness Television into the low-price field!

You'll turn prospects into buyers—fast—when you point up the giant, 16-inch screen; the fine cabinet with choice of lovely finishes; RCA Victor Eye Witness Picture Synchronizer; built-in antenna; phono-jack to plug in RCA Victor's Victrola "45" automatic record changer . . . and many more outstanding features!

The T-164 is proof once again that RCA Victor will continue to bring you your best-selling television instruments . . . your biggest profit-makers!

*Suggested list price—plus \$1.31 Federal Tax.
Factory-Service Contract Extra; Matching Console Base Extra.



ONLY RCA VICTOR
HAS THE
"GOLDEN THROAT"

ONLY RCA VICTOR
MAKES THE VICTROLA

RCA VICTOR



"Victrola"—T.M. Reg. U.S. Pat. Off. DIVISION OF RADIO CORPORATION OF AMERICA

Here's why your profits are greater with this RCA VICTOR

*Higher quality and outstanding selling points of
ALL RCA VICTOR instruments keep turnover high!*

These features turn Model T-164 prospects into buyers!

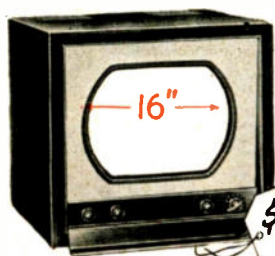

\$299.95

*Lowest Price Ever For Big
16 Inch Eye-Witness Television!*

Challenge customers to compare this RCA Victor 16-inch receiver with other sets priced at only \$299.95*.

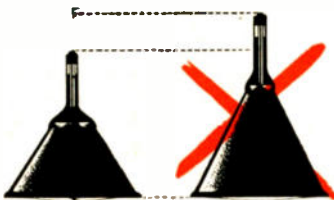

*New Short Tube
Saves Room Space!*

Show customers how RCA Victor's new short tube reduces cabinet depth from front to back by about two inches in the T-164.



LOOK!

*a new Victrola "45"
best-seller
45 EY... only \$29.95
Lowest price ever for
a Victrola phonograph!*

Here's one of the new Victrola "45" instruments we're turning out as fast as we can. It's a completely automatic phonograph at the lowest price ever!

Reports indicate that instruments featuring "45" outsell others 2 to 1. With over 2,000 selections to choose from... "45" record sales are 35% to 50% of total for many dealers!

Push the 45EY... push "45" ... and '50 will be your biggest record year ever!



Matching Console Base!

Point out to prospects how this attractively styled base matches the cabinet finish of their choice. And the extra cost is very moderate.

*Suggested list price—plus \$1.31 Federal Tax, Factory-Service Contract Extra; Matching Console Base Extra.



*RCA Victor
Factory-Service Contract*

Remind customers that with T-164 they may buy the RCA Victor Factory-Service Contract. RCA experts install and adjust set, provide standard antenna where necessary, guarantee performance for a full year.

RCA VICTOR—World Leader in Radio... First in Recorded Music... First in Television



Five men who were with Pilot Radio Corp. when the firm first conducted telecasts over experimental station W2XCL 21 years ago. Left to right, Harry Givre, James Benjamin, Isador Goldberg, president, Emanuel Gilmore and Solomon Eskanozy. Picture of set above, a 12 1/2-inch unit, is a far cry from postage stamp size pictures of long ago.



The Southwest Distributing Company, headed by Albert F. Morris, has been appointed distributor of Stewart-Warner radio and television products for the Kansas City territory. Southwest is located at 2025 Broadway, Kansas City, Mo. The territory it covers will include Topeka, Kansas; St. Joseph, Mo., and Sedalia, Mo.



An assembly line at the Air King Products Co., Inc. modern plant in Brooklyn, N. Y. With over 200,000 square feet of manufacturing space, Air King manufactures radios, wire recorders and television receivers. TV production is expected to reach new highs in 1950, and the firm recently announced full capacity production of its 16-inch rectangular tube TV models.



Left to right, W. A. Brees, general sales manager, the Crosley Division, Avco Mfg. Co., John W. Craig, general manager, and Bert Cole, vice-president and general manager of the Crosley Distributing Corp., have reason to smile. Crosley sales in the New York area increased more than 35 per cent during 1949 over the previous year.



J. Gower Chapman, vice-president and general manager, Major Appliance Co., Lansing, Mich., signs up as distributor for Admiral Corp. products in central and northern Michigan. Left, W. C. Johnson, Admiral v-p in charge of sales, and W. M. Davis, Admiral district manager.



Frank H. Merritt, right, Capehart-Farnsworth regional sales manager, outlines sales points of a Capehart combination to E. D. Bozeman, Jr., left, president, and J. M. Baesman, sales manager, Woodson & Bozeman, Inc., Memphis, Tenn. The firm is the new distributor for the Capehart line for Western Tennessee, Northern Mississippi, the southeastern tip of Kentucky, and the northeastern corner of Arkansas.



At DuMont Television's first national convention in Chicago recently, Ricardo Muniz, extreme right, explains a point of quality control to the assembly. At his right is Ernest A. Marx, general manager, receiver sales division, Allen B. DuMont Labs., N. Y. Advertising and merchandising plans for 1950 keyed the convention.



Before a capacity crowd at Rochester's annual Chamber of Commerce dinner, Lee McCanne, left, vice-president of Stromberg-Carlson Co., Rochester, N. Y., was installed as 60th president of the city's C. of C. Mercer Brugler, president of the Pfaunder Co., and outgoing president, reviews the Chamber's 1950 plans with his successor.



Louis Silver, vice president and general manager of Garod Radio Corp., Brooklyn, N. Y., reflects confidence and optimism at the prospects for peak TV sales under the name of Majestic, the famous radio trademark which was recently purchased by Garod. The company will now manufacture TV receivers under the names of both Garod and Majestic.



Relaxing during the Christmas and New Year holidays at the pleasant Hollywood, Florida, winter resort are, left to right, Benjamin Abrams, president, Emerson Radio & Phonograph Corp., N. Y., and, right, Manuel Eskind, president, Capitol Radio & Television Co., Nashville distributor for Emerson, with son, Robert.



This television viewing salon is a feature of the new appliance display center completed by General Electric Supply Corp., St. Louis, Mo., to kick-off its 1950 season of aggressive merchandising. Dealers and their retail consumers may see GE television demonstrated in modern settings and comfortable homelike atmosphere.



Some 7,500 window display kits featuring this Philco Christmas theme were used to advantage during the past holiday season. The kits were shipped to dealers throughout the country and their message was supported by 24-foot posters, by newspaper and magazine copy, and by additional point-of-display material. Sales volume again justified this sort of intense seasonal promotion.

New 1950 Models



Admiral



First
in performance

First
in value

First
in features

36X36—(16" Tube). Custom-quality 18th Century TV console combination. Superpowered chassis. Dynamagic FM/AM Radio. "Triple Play" Phonograph. Hand-rubbed walnut, mahogany or blonde cabinet. In walnut,

\$499⁹⁵



12X12—(12½" Tube). New low price table television sensation. In smart mahogany color cabinet. **\$179.95**



32X15—(12½" Tube). Thrilling new television combination. Walnut or mahogany. In walnut only **\$299.95**



32X27—(12½" Tube). New television combination sensation in mahogany or blonde cabinet. Mahogany, **\$399.95**



32X36—(12½" Tube). Admiral 3-way TV combination in traditional walnut or mahogany. Walnut, **\$379.95**

1st in television

WITH THE CLEAREST PICTURE OF THEM ALL!

- Sensational superpowered chassis . . . brings in pictures as clear as the movies even in outlying "fringe" areas.

- 12½", 16" and 19" full-vision tubes . . . new rectangular 4 x 3 "aspect ratio" tubes. Wide choice of cabinet styles.

- Built-in directional Roto-Scope antenna . . . one-knob automatic tuning . . . automatic gain control . . . balanced contrast circuit . . . improved sharp focus.

- "Triple Play" Automatic Phonograph . . . one spindle . . . one tone arm . . . one needle for all RPM speeds, all record sizes.

- Dynamagic FM/AM Radio . . . most compact . . . powerful.

22X12—(12½" Tube). TV Console at a sensational price. Pictures clear as the movies. Built-in Directional Roto-Scope antenna. Sturdy modern cabinet. Mahogany color,

\$199⁹⁵



26X46—(16" Tube). Admiral TV combination. Rectangular tube. Walnut or mahogany. In walnut, **\$299.95**

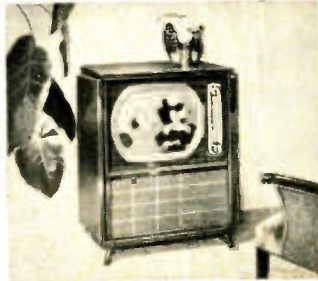

29X16—(19" Tube). Ultra modern mahogany- or blonde television console. In walnut, a sensation at **\$495.00**

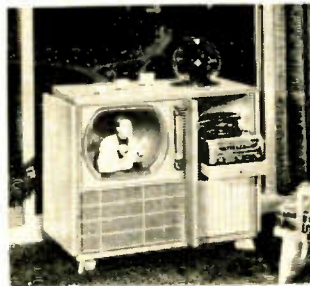

39X17—(19" Tube). Superb new TV combination in modern mahogany or blonde. Mahogany, **\$695.00**

Admiral

Presents Two Great Shows Every Week on Television

"Stop the Music," ABC-TV NETWORK, THURSDAYS, 8 PM, EST

"Lights Out," NBC-TV STATIONS, MONDAYS, 9 PM, EST

Prices slightly higher south and west . . . subject to change without notice. Tax extra.

Admiral Corporation, Chicago 47

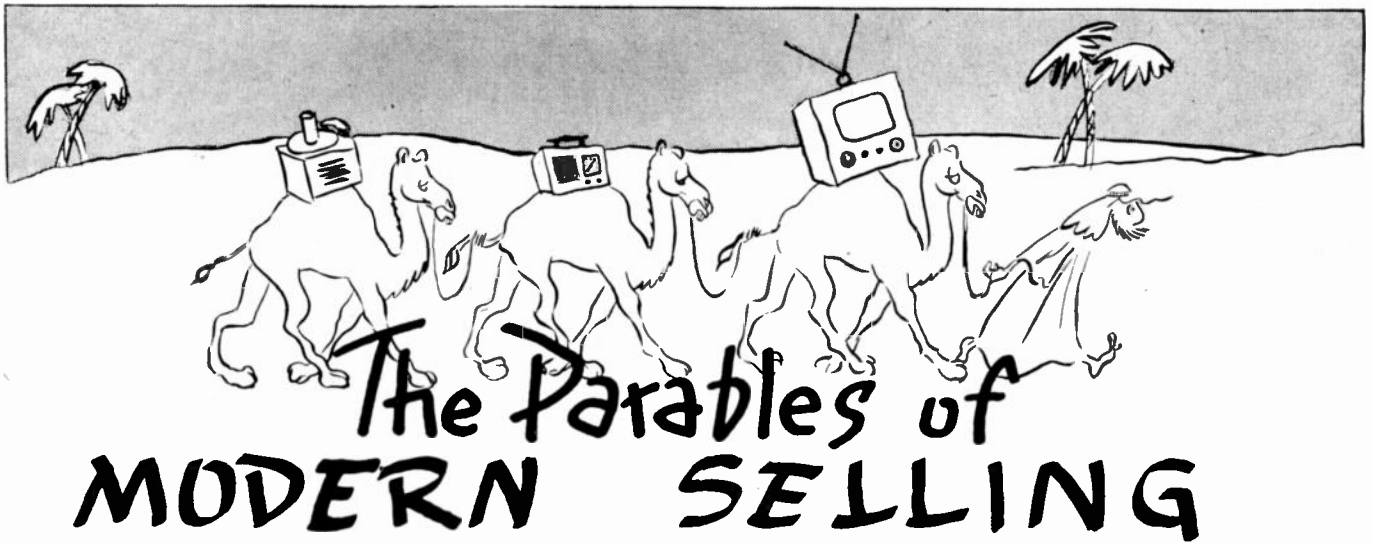

The Parables of MODERN SELLING

IT becomes more and more evident that the problems for 1950 in the radio and television business will be those which are common to other industries. These shape up into problems of effective merchandising and selling. In survey after survey the weaknesses in retailing techniques and in productivity of sales personnel are glaringly evident. One of the most recent surveys on salesmanship was one discussed by Maxwell I. Schultz, executive vice-president, the Willmark Service System, Inc., specialists for more than 30 years in efficiency programs for retail stores personnel. A compilation of the results of an annual cross-sectional survey has put the finger on sales weakness as the gravest fault in retail selling.

Productivity of sales personnel, for example, approximates a little more than 70 per cent of an acceptable norm. This indicates that constructive salesmanship, the weakest link in retail selling, must be very much improved before top merchandising results can be forthcoming. On an over-all basis, the Willmark survey showed that sales persons were 1.2 percentage points more efficient in 1949 than in 1948. But their competence in closing sales deteriorated, as contrast 78 per cent in 1949 and 92.4 per cent for 1948. This shows a decline over the earlier year of 14.4 percentage points. In the creative phases of selling, the performance in suggestive selling is still 76.6 per cent below an accepted standard and "trading up" efforts 45.2 per cent below par.

Sifted Data

The information on merchandising and selling was compiled from a broad cross-sectional sampling of 40,000 "selling quotient builder" reports prepared by field workers sampling on a country-wide basis. The personnel covered and considered appropriate for the survey included all types of selling persons in

a wide variety of merchandise classifications.

Tests of the personnel surveyed included securing attention, suggestive selling, the approach to the customer, attempts to establish customer interest, trading up, and closing the sale. The final, over-all results indicate that the merchandising and selling picture is not very flattering. Stores at the retail level could have rung up more sales if sales personnel had given more attention to the art of selling. Potential customers were allowed to walk out of the store in far too many instances. Dealers in the radio and television business cannot have sales personnel slip into the status of mere order-takers and change-makers. Passive selling cannot become the dominant selling characteristic of their operations. Salesmen have tended to fall into the rut of such negative selling habits, and it is up to the individual dealer to lead them back along the road to the art of constructive selling.

Merchandising Pitfalls

The slipshod selling within a radio and television dealer's operation is not the only merchandising handicap that 1950 brings. Poor store layouts, careless buying that forces markdowns and stock clearances, inefficient service, falling for competitive malpractices like price-cutting, these are all the hazards which dealers sometimes heap upon themselves, seriously curtailing their annual sales. In the competitive battle for sales that lies ahead, dealers can take solace in those positive attitudes about running a business which continue high sales volume.

Expenditures that sell a dealer's name, or store, or product, bring in volume sales and extra profits. They create business and are all wrapped up with customer service. The standards of customer service, of course, has gone through a great change since the end

of the war. When customers were glad to get merchandise, the service aspect of selling slipped into insignificance. Now customers are shopping for values, and turn their backs promptly on poor or discourteous service. Dealers sometimes take losses on stock clearances, or refuse, on the other hand, to clear their stocks periodically. The latter are forgetting that people are always on the lookout for new goods. The former have not been too cautious about their purchases. When markdowns are necessary on radio and television products, dealers have either let an excess of products accumulate or their sales force is neglecting important items of merchandise.

To Better Sales

Since competition is really here to stay, dealers have a positive way of flourishing in the face of competitors down the street. Carrying bigger and better basic stocks and using store location, signs, windows, interiors, and departments with effectiveness are ways in which any dealer can keep out in front, despite wide competition. Fresh ideas, imaginative sales promotions, and a positive approach to all aspects of selling will help do the trick, too. Not the least of the essentials for successful sales in 1950 is a healthy, cooperative attitude toward the customer.

Nothing dramatizes the major points in modern, competitive selling in quite as entertaining and effective a fashion as "The Parables of Luke the Leonardman," a booklet written in Biblical terminology and published by the Leonard Division, Nash-Kelvinator Corp., under the direction of Walter Jeffrey, sales manager. On the following two pages are found the parables. If radio and television dealers will go over them with their staffs, there is every reason to believe the industry will witness a rebirth rather than the death of a salesman.

...Wherein Great Evil Doth Befall Certain Sellers who Hadst Gone Unprepared



Now a certain Sultan didst observe from afar off a caravan wherein didst ride a maiden of Rare Beauty and other Outstanding Points. And the Love-Bug biteth the Sultan, and he resolveth saying, Verily must I knock off this Lovely Tomato for mine own as wife.



And his Advisors agreeth, saying, Verily is she a Catch, for she is daughter unto a Wealthy Merchant whose Business she hand-dleth with Skill. And they spake further, saying, She goeth by the name Dee Licious, and she abideth in a distant city, even Hellangone.

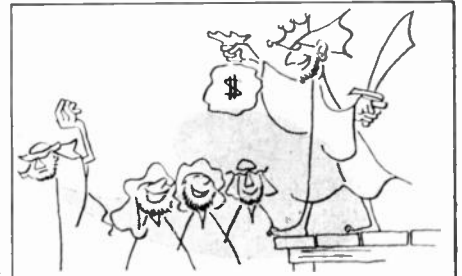

Now in those days was it Not Good Taste to Go Acourtin' in person. Therefore issueth the Sultan a proclamation, saying, He who winneth Dee Licious for me will I enrich. But any who fail will be Slain. Thus was it Risky, yet went several Confidently unto Hellangone.



And the first cometh unto Dee Licious, to speak on behalf of his master. And he didst Botch the job. And he returned, and didst confess his failure, and thereupon was Beheaded. Then went a second, and likewise failed, and likewise didst promptly Lose His Noggin.

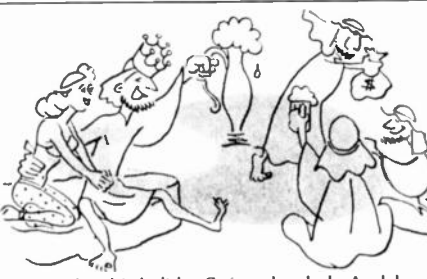

But the third didst Swing the deal. And he returneth in Triumph, and receiveth from the Sultan a thousand shekels, plus Expenses. And Dee Licious cometh unto the palace of the Sultan. And there were they Spliced amidst feasting and many Drinks On The House.



And the Sultan inquireth later of Dee Licious, saying How cometh it that my first two Representatives didst fail, while my third didst win thee for me? And Dee Licious replieth, saying, Verily learned I much About Selling in the business of the merchant my father.



And she explaineth, saying, Verily is Successful Wooing like unto Successful Selling. Thy First Representative was unschooled in the Fundamentals of Getting Attention, Stimulating Interest and Creating Desire. And thy second Flubbed badly his story of thy Good Points.



Whereas, O Sultan my husband, thy Third Representative didst Work Me Up unto the Drooling stage, by following perfectly the Steps necessary in any sale. Then didst he so Glorify thee in my eyes that I didst know that thou wast unquestionably my One and Only.

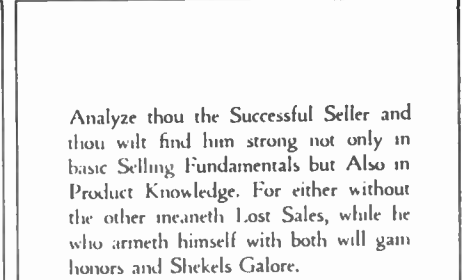

Analyze thou the Successful Seller and thou wilt find him strong not only in basic Selling Fundamentals but Also in Product Knowledge. For either without the other meaneth Lost Sales, while he who armeth himself with both will gain honors and Shekels Galore.

Luke the Leonardman



The Moral

In this delightful parable, it is evident that selling is both an art and a science. The modern television merchant has a rare opportunity to apply the principles outlined above. Not only must he and his salesmen know their basic selling fundamentals but also, they must be fully acquainted with the

products they sell. Reminds us of the story we heard about the man who walked into a dealer's store to buy a TV set. The salesman showed him various models with different screen sizes. The customer finally asked, "what's the difference between the 12 1/2-inch and 16-inch sets?" The salesman replied, only 3 1/2 inches!"

...Wherein is it recommended that Sellers Give not Up When the Customer Saith "I am Not Interested"



Now there falleth upon the land a period of Tough Competition, whereof people didst say, This separateth the Men from the Boys. And amongst the Sellers of the land were there many who hadst sold not Value but Price. And these were Caught Short, and didst say, Woe is us.



Yet were there many of Stout Heart and Imagination. And these didst diligently Seek Buyers, and didst prosper. But others didst look unsuccessfully for Greener Pastures, and others didst Foolishly partake of strong drink, and didst fly unto the company of Laughter-Provoking women.



And one Seller gazeth upon the Emptiness of his store. And he reasoned with himself, and spake, saying, The heck with it. And he didst depart, saying, Wherefore profiteth it me to Knock Myself Out. Therefore went he home unto his loving wife, the fair Sue Perdooper.



Now as husband unto Sue Perdooper was the seller Happy, for in Looks was she a Good Catch, and in Brains also. And she didst question him, saying, Do things go well at The Store, Sweetie Pie? And he replieth Sourly, saying, Business doth Smell to High Heaven.



And he puzzleth, saying, Our merchandise is The Best, and verily do people have Shekels. Yet say they only, We are not Interested. And Sue Perdooper pondereth. And having pondered, she spake, saying, Before our marriage, long pursued thou me, and always said I, I am not interested.



And the seller her Husband didst reply, saying, Now what The Heck doth that have to do with my lack of sales? Then spake Sue Perdooper yet again, saying, Behold, there is a similarity between thy pursuit of me and thy pursuit of customers. And the Seller Pooh-Poohed her.



And Sue Perdooper persisteth, saying, Even as I didst tell thee I was not interested in marrying thee, so also do thy customers today use the same excuse for not buying thy merchandise. And the Seller her husband beginneth to See The Light. And he replieth unto her, saying, Uh huh.



And she spake, saying, So Eager wert thou that thou didst seek why I was not interested. And having found why, thou didst answer the objection. And the seller thereafter Gave Not Up on interest-lacking customers. But always sought he Why, and didst again Prosper.

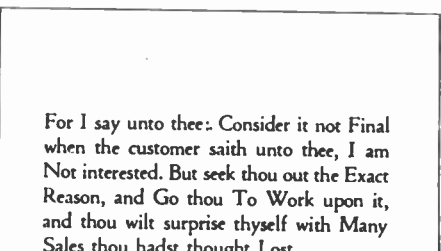

For I say unto thee: Consider it not Final when the customer saith unto thee, I am Not interested. But seek thou out the Exact Reason, and Go thou To Work upon it, and thou wilt surprise thyself with Many Sales thou hadst thought Lost.

—Luke the Leonardman



The Moral

This parable speaks about the period of tough competition which befell the land of old. That was as nothing compared with the tough competition which the radio, television and appliance business is going to see in 1950. The period of easy selling is over, but

this means that now the boys are going to be separated from the men. As Luke sayeth: Do not take the customer's No for a final answer. Find out why he does not wish to buy, and then go about working out the answers to his objections.

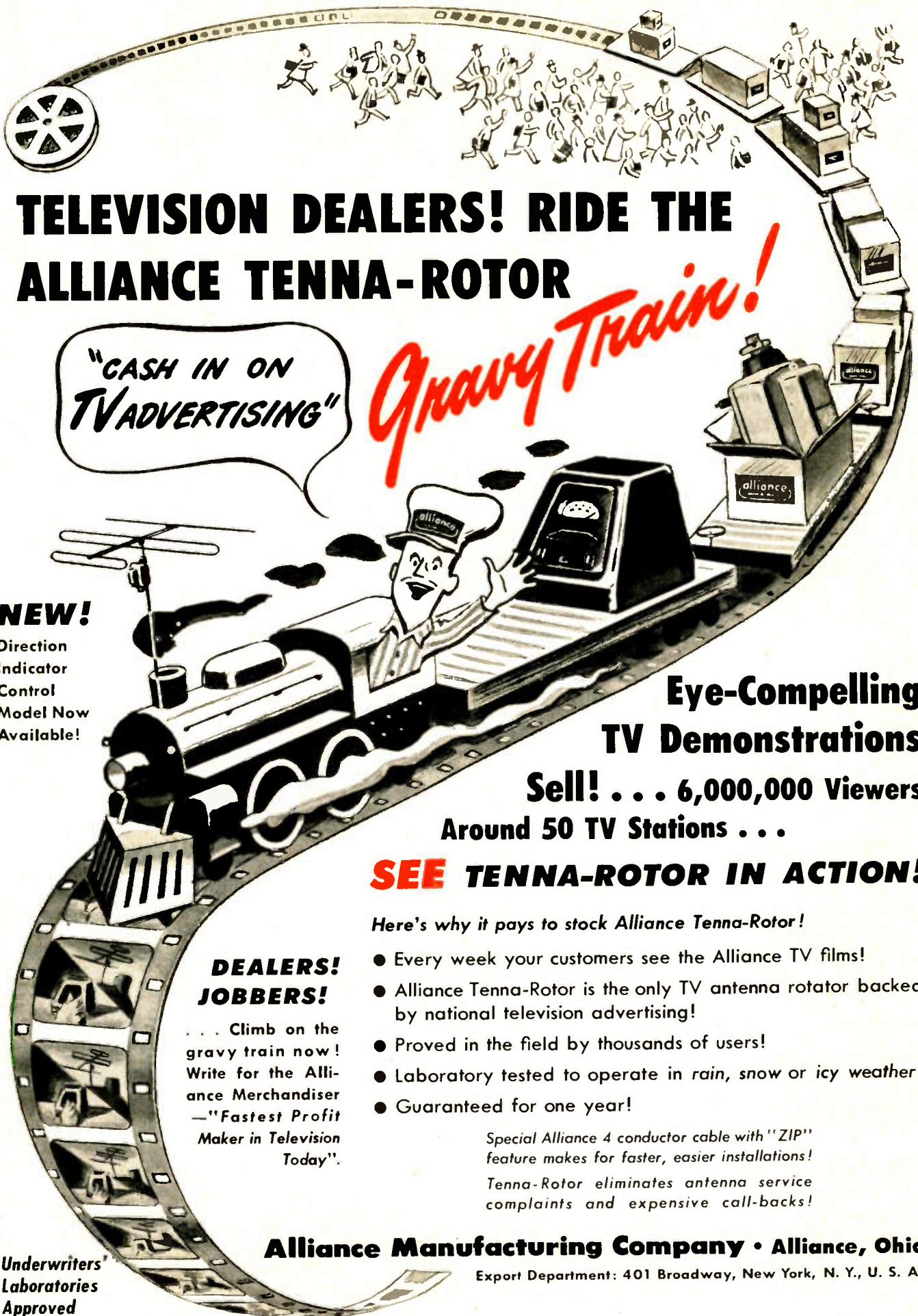

TELEVISION DEALERS! RIDE THE ALLIANCE TENNA-ROTOR

"CASH IN ON TV ADVERTISING"

Gravy Train!

NEW!
Direction Indicator Control Model Now Available!

Eye-Compelling TV Demonstrations

Sell! . . . 6,000,000 Viewers Around 50 TV Stations . . .

SEE TENNA-ROTOR IN ACTION!

Here's why it pays to stock Alliance Tenna-Rotor!

DEALERS! JOBBERS!
... Climb on the gravy train now! Write for the Alliance Merchandiser — "Fastest Profit Maker in Television Today".

- Every week your customers see the Alliance TV films!
- Alliance Tenna-Rotor is the only TV antenna rotator backed by national television advertising!
- Proved in the field by thousands of users!
- Laboratory tested to operate in rain, snow or icy weather!
- Guaranteed for one year!

Special Alliance 4 conductor cable with "ZIP" feature makes for faster, easier installations! Tenna-Rotor eliminates antenna service complaints and expensive call-backs!

Alliance Manufacturing Company • Alliance, Ohio
Export Department: 401 Broadway, New York, N. Y., U. S. A.

Underwriters Laboratories Approved

RTJ

New Products For 1950

Radios
Television

Consoles
Recorders

Phonographs
TV Accessories

New Motorola TV

Manufactured by Motorola, Inc.,
4545 Augusta Blvd., Chicago 51, Ill.



New "flywheel" automatic frequency control circuit, for clearer and steadier picture, is incorporated in this 12½-inch television receiver. Has Bilt-In-Tenna and target tuning. Available in a mahogany cabinet with a brushed gold finish on screen frame and trim. Price: \$269.95.

Say you saw it in *Radio & Television Journal*, February, 1950

Admiral's 19-inch TV

Manufactured by Admiral Corp.,
3800 W. Cortland St., Chicago 47, Ill.

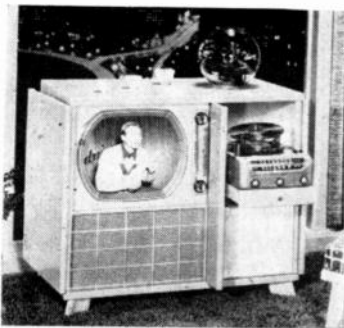

With a 19-inch viewing tube, a slide-out FM-AM radio, and a phonograph that plays all three sizes of records on a single spindle, this console combination provides complete home entertainment. Cabinet comes in either mahogany or blonde.

Say you saw it in *Radio & Television Journal*, February, 1950

Tele King's Large Screen TV

Manufactured by Tele King Corp.,
601 West 26th St., New York, N. Y.

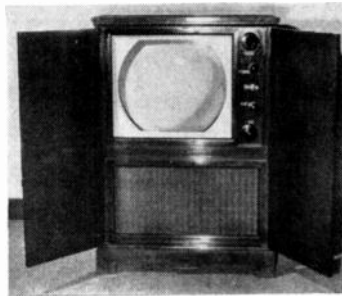

Custom-crafted cabinet of mahogany holds this 19-inch picture tube television receiver. Picture screen area comes to 250 square inches. Doors on the console are full length. Has Tele-Lock picture feature. Priced at \$459.95.

Say you saw it in *Radio & Television Journal*, February, 1950

New 8½-inch Arvin TV

Manufactured by Noblitt-Sparks Industries, Inc.,
Columbus, Indiana

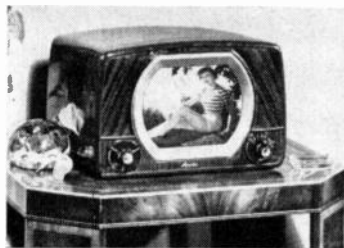

Selling for \$129.50, this 8½-inch screen television receiver has 16 tubes and two rectifiers. Uses an electromagnetic rather than electrostatic circuit for minimized servicing. Has glare-free "black" tube for greater picture contrast. Sound system is inter-carrier type. Cabinet is metal.

Say you saw it in *Radio & Television Journal*, February, 1950

Raytheon's "The Rover"

Manufactured by Raytheon Manufacturing Co.,
Chicago, Illinois



Silver Anniversary TV model featuring a 12½-inch black picture tube in a table receiver. Gives 110 square inches of circular viewing surface. Has built-in antenna. Maroon tooled leatherette cabinet stands 18 inches high, is 19 inches wide, and 19 inches deep. Retail price: \$199.95.

Say you saw it in *Radio & Television Journal*, February, 1950

New Emerson Table TV

Manufactured by Emerson Radio & Phonograph Corp., 111 Eighth Ave., New York 11, N. Y.



A table model television receiver which has a 16-inch picture tube. Incorporates built-in antenna and simplified tuning. Receiver's circuit designed for fringe area reception. Set designed to provide maximum picture area in compact dimensions. In variety of wood finishes, receiver lists at \$289.50.

Say you saw it in *Radio & Television Journal*, February, 1950

Olympic's "Gladiator"

Manufactured by Olympic Radio & Television, Inc., 34-01 38th Ave., Long Island City, N. Y.



With 19 tubes, including 16-inch kinescope, this television console has AC split-sound circuit with adjustable turret tuner, and removable coil plates for conversion to UHF channels. Also has built-in Gyro-tenna covering high and low frequency bands. Cabinet is in mahogany.

Say you saw it in *Radio & Television Journal*, February, 1950

New TV by Garod

Manufactured by Garod Electronics Corp., 70 Washington St., Brooklyn 1, N. Y.



Featuring an 18th century mahogany cabinet with a piano finish, dual speakers, and side controls, this 19-inch television receiver affords a 203-square-inch picture. Includes the firm's new electronic built-in antenna. Has "picture-lock" tuner. Retail at \$489.95.

Say you saw it in *Radio & Television Journal*, February, 1950

More new products on pages 40, 44, 46, 48

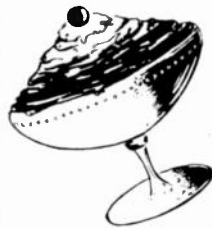

'the proof of the PUDDING!..

Impartial and exhaustive tests prove that the new **MODEL IT4-SUPER SONIC TV/FM AMPLIFIER** delivers a higher usable gain with full bandwidth and higher signal to noise ratio than other leading brands at any price!



model
IT4

SUPER SONIC TV/FM AMPLIFIER

\$ **32**⁵⁰
List

- Improves TV reception in weak signal areas, with or without outdoor antenna.
- Continuous tuning of all 12 TV channels, also FM with ONE knob control.
- Reduces electrical, diathermy interferences and minimizes "ghosts and snow" effects.
- Frequency range: 50 mc to 220 mc, continuously tuned.
- Bandwidth: 6 mc. minimum all channels.
- Insertion gain: Minimum of 18 db at any frequency with 300 input and output impedances.
- Highest signal to noise ratio.
- Input and Output Impedances: 300 ohm balanced to ground and 72 ohms unbalanced.
- Inductances wound with PURE SILVER wire.
- All moving contacts heavily silver plated.

CHOICE TERRITORIES STILL AVAILABLE

Write for Free Brochure to Dept. RJ1

SONIC INDUSTRIES INC.

"MANUFACTURERS OF DUOSONIC PHONOGRAPHS"

221 WEST 17th STREET, NEW YORK 11, N. Y.

Sales Dynamite!



BLACK-

It's NEW! It's TERRIFIC!
140% GREATER RANGE OF PICTURE TONES



ORDINARY TELEVISION

*Blacker Blacks!
 Richer Greys
 Whiter Whites!*



For a sales-clincher, just show G-E Black-Daylight TV next to ordinary TV. Your customers can sit further away from G-E Black-Daylight TV, yet they'll see it even better! At the same distance it appears closer, more alive! They'll see TV as the camera sees it. There's no annoying glare or reflection.



G-E BLACK-DAYLIGHT TELEVISION

A SIMPLE DEMONSTRATION SHOWS THE ASTONISHING DIFFERENCE — CLINCHES SALES!

Now—you can sell TV which offers your customers the *full* black-to-white range of picture tones . . . TV which is not only finer by actual test but *so much* finer that a dramatic yet simple side-by-side comparison *proves* it beyond all doubt. Here is a TV picture so incredibly advanced that it puts new wallop in the old phrase: sells on sight! Your G-E distributor will gladly prove that THE

AMAZING, ENTIRELY NEW G-E BLACK-DAYLIGHT TELEVISION OFFERS YOU ALL THIS SALES DYNAMITE:

1. Amazing black-daylight picture, tests show 140% greater range of picture tones than ordinary television
2. Hand-rubbed, polished cabinets veneered in matched, genuine mahogany
3. Deepest blacks for finest contrast—greater picture detail

4. Daylight brightness for greater eye comfort of lighted room viewing
5. No annoying glare or reflection
6. Automatic Sound . . . just tune picture . . . sound is right every time
7. Built-in antenna, wide-angle screen, simplified controls
8. G-E developed Alnico 5 speakers, acclaimed for superb tone

**Plus tax, installation. Prices slightly higher West and South—subject to change without notice.*



MODEL 12T3—12½" picture tube table model. Beautiful cabinet veneered in genuine mahogany with inlaid trim. **\$229.95***



MODEL 12C107—12½" tube console. Genuine mahogany veneered cabinet on swivel casters, adjusts to any viewing angle. **\$279.95***

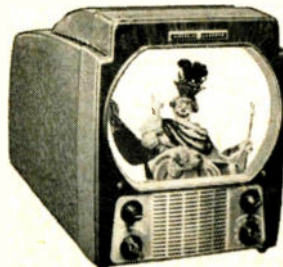

MODEL 10T6—G-E price leader! Compact, rich rosewood molded plastic cabinet—fits any table. 10 inch picture tube. **\$179.95***

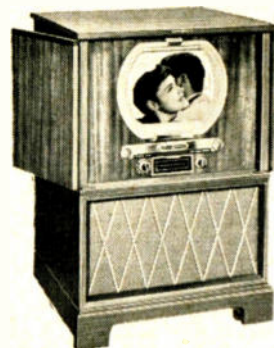

MODEL 12C109—12½" picture tube. Genuine mahogany veneered cabinet on swivel casters. Smartly styled doors. **\$299.95***

DAYLIGHT TELEVISION

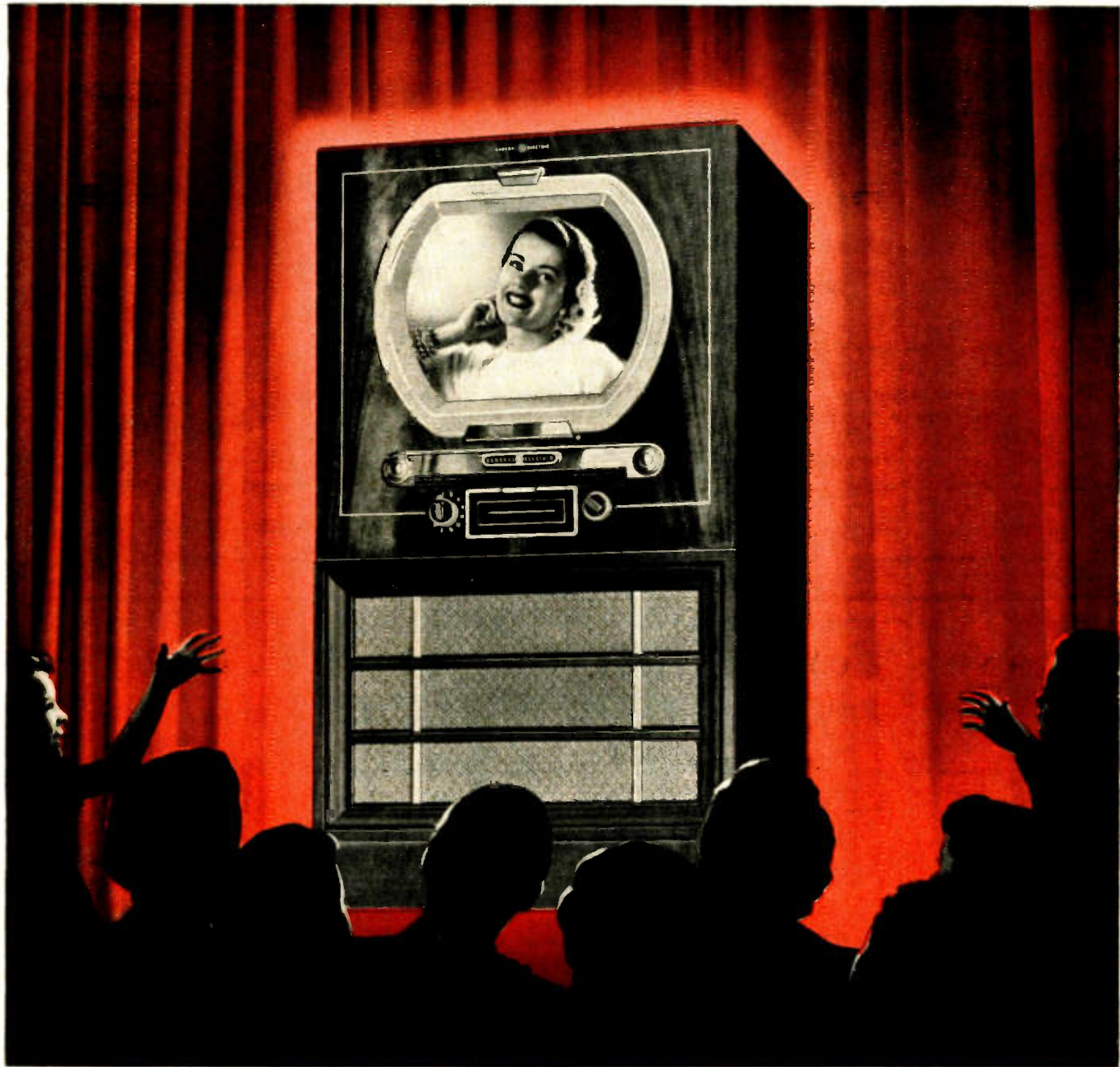

You can put your confidence in—

GENERAL  **ELECTRIC**

New RCA Console TV

Manufactured by RCA Victor Division,
Camden, New Jersey



One of the first of the firm's television receivers to incorporate the new, shortened, 16-inch picture tube with "Filterglass" face. The four-door console is in traditional styling, with figured door panels. Depth is 22 $\frac{3}{4}$ inches. Suggested list prices: \$399.50, walnut or mahogany; \$419.50, limed oak.

Say you saw it in *Radio & Television Journal*, February, 1950

New Atwater TV

Manufactured by Atwater Television Co.,
360 Furman St., Brooklyn 2, N. Y.

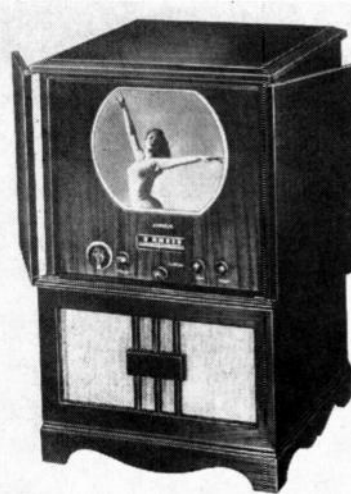

This console television set features a 16-inch picture tube, a built-in antenna, automatic gain and frequency control. Contains FM radio and has an attachment for any type phonograph. Cabinet is in crotch mahogany, with three-quarter length doors. Priced at \$349.95.

Say you saw it in *Radio & Television Journal*, February, 1950

Majestic's 16-inch TV

Manufactured by Majestic Radio & Television Corp., 70 Washington St., Brooklyn, N. Y.



This new television console features a 16-inch screen and provides 140 square inches of picture area. Has a built-in "channelized" antenna and the firm's latest electrical circuit innovations. Cathode-ray tube is the new "black" tube. Receiver is housed in a hand-rubbed mahogany cabinet. Price: \$299.95.

Say you saw it in *Radio & Television Journal*, February, 1950

Here's how to STEP-UP your TV Sales with this TVD-8-DISTRIBUTION UNIT

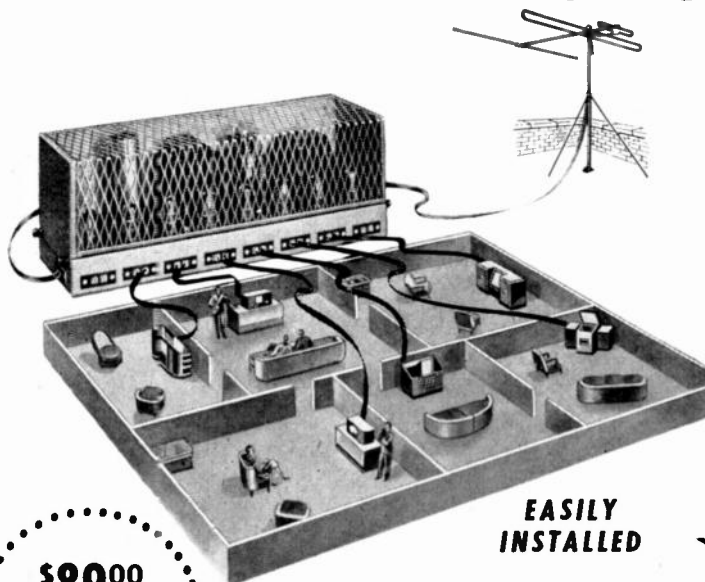

EASILY
INSTALLED

Permits 8 Non-interfering Set Operations from Single Antenna... Prevents Interference Between Receivers

Here is the answer to the TV dealer's demonstration problem! This set-up will operate 1 to 8 TV sets of any make at one time on a single antenna without inter-set interference. Leading set manufacturers now recommend it. There is less attenuation than with resistive distribution networks. It's compact, priced complete with tubes, easy to install, beautifully engineered by specialists. Order NOW!

\$89.00
NET TO DEALERS
INCLUDING
TUBES

ELECTRO ENGINEERING AND MFG. CO.
627 W. Alexandrine • Detroit 1, Michigan

ONLY
5,000-10,000
MICROVOLTS
NEEDED AT THE
ANTENNA

**YOUR SYLVANIA TUBE
CARTONS ARE WORTH 2¢
IN TRADE!**



**Ask your
distributor
TODAY—
about Sylvania's
big tube carton
trade-in deal!**

**DURING FEBRUARY, MARCH AND
APRIL YOUR EMPTY SYLVANIA CAR-
TONS ARE WORTH 2¢ EACH AT YOUR
DISTRIBUTOR'S when applied against
the purchase of...**

- SYLVANIA ADVERTISING MATERIAL
- MORE SYLVANIA TUBES
- SYLVANIA TEST EQUIPMENT

SYLVANIA  ELECTRIC

RADIO TUBES; CATHODE RAY TUBES; ELECTRONIC DEVICES; FLUORESCENT LAMPS, FIXTURES, WIRING DEVICES, SIGN TUBING; LIGHT BULBS; PHOTOLAMPS

only WALSCO

**gives so much
for so little...**

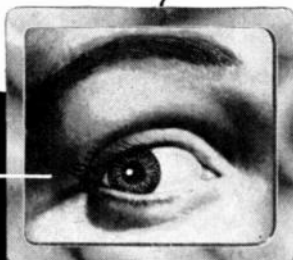

crystal-clear TV reception.

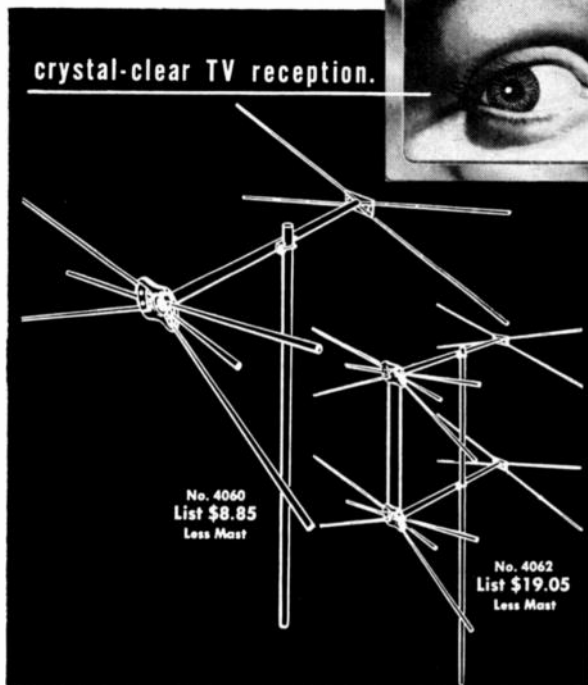

**amazing antenna
out-sells all others!**

- only** WALSCO features a silicone-treated styron molded insulator to assure crystal-clear TV reception.
- only** WALSCO uses marine type high tensile dural for elements . . . with a "yield point" 94% higher than ordinary aluminum.
- only** WALSCO uses a butt-seamed tubing for elements to assure the highest elasticity.

WRITE FOR FREE ILLUSTRATED CATALOG 49-T

WALSCO New TV Alignment Tools are used everywhere. Available at your local jobber.

WALTER L. SCHOTT CO.

Beverly Hills, California
Chicago 5, Illinois

Folsom Honored for Service to Humanitarian Causes

Frank M. Folsom (left) president of RCA, is shown being presented with a plaque honoring his many years of service to humanitarian causes, by Albert M. Greenfield (center),



treasurer, and John B. Kelly, chairman, of a dinner held recently at the Bellevue-Stratford Hotel, Phila., to celebrate the 50th anniversary of the National Jewish Hospital at Denver, at which the RCA chief was guest of honor. Over 800 prominent industrialists, civic and social leaders participated in the ceremonies highlighted by the citation to Mr. Folsom for his "meritorious service in providing free tuberculosis treatment to the needy of all faiths as trustee of the National Jewish Hospital at Denver."

Battle on Color Continues

While the public remains as much in the dark about the progress being made on color television, with much misinformation being bandied about in the press and on television itself, the trade is involved in a complicated debate as to whether color TV is ready for commercial application. To help throw some light on the situation, RMA has announced the creation of a National Television System Committee to attain industry-wide agreement on technical developments needed for the expansion of television to all sections of the country and for the establishment of basic standards which will bring color television to reality. The Committee will cooperate very closely with the FCC, which resumed its hearings on color this month. In announcing the formation of the new committee, Raymond C. Cosgrove, RMA president said: "While color television is not yet ready for commercial application, laboratory development has progressed to a point where pooling of information and concerted action from all sources is essential to creation of standards which will eventually bring it out of the laboratory and controlled broadcast stage and into the home. Television manufacturers are eager to present color to the public just as soon as research and field testing have made it practical for broadcasting and home use—but not before.

In the meantime, in a new booklet entitled "Is Color Television Ready for the Home?" just released by RMA, it is pointed out that there are three basic color systems under discussion at the FCC hearings at the present time. These three are enumerated as: "The Columbia Broadcasting System, which has proposed a "mechanical" system similar to one offered at prior FCC hearings in 1946, but with certain refinements. The Radio Corporation of America has proposed a newer, all-electronic system, based on scientific principles not fully developed in 1946. Color Television, Inc., of San Francisco, also has presented data on still another all-electronic system."

Editor's Note: The RMA booklet referred to above was received too late for complete reporting in this issue. The information contained in it is so important, that it will be reprinted in full in the March issue of Radio & Television Journal.

Focused on the facts for '50!

These are the facts!

- 1 1950 is slated to be the best year yet.
- 2 Picture-size preference is predominantly for the 12½" and 16" tube sizes.
- 3 Price alone will not sell sets... consumers have their eye on quality features.



THE WESTINGHOUSE 610T12,

shown here, is designed to help you capitalize on these facts:

Pricewise, it's competitive.

Productwise, it has performance and quality that can't be matched at anywhere near this price.

The Westinghouse 610T12 is a natural for *home demonstration*. The sensational ELECTRONIC MAGNIFIER, with choice of *full vision* picture or GIANT CLOSE-UP, plus superb tone make this set a sales clincher. A bonus feature for you is the fact that its quality will assure trouble-free service for a long time to come, building good will and repeat business for you.

The Westinghouse 610T12 has a full complement of tubes (no short-cuts in circuit performance). It is super-sensitive for long-range reception, has improved "road block" circuit features that eliminate interference troubles, and automatic controls for simple operation (with no concealed control knobs).



Compare

THESE SALES FEATURES:

- **BIG 12½-INCH "BLACK" GLASS TUBE** — non-glare brilliance and sharper contrast.
- **AMAZING ELECTRONIC MAGNIFIER** — with a flip of the control knob you switch from *full vision* to GIANT CLOSE-UP picture, with the center of interest as large as a 16" tube gives. Exclusive eyelid shutters automatically frame picture.
- **BUILT-IN ANTENNA** — Electronically tuned.
- **DISTINCTIVE CABINET** — Model 610T12 (mahogany); Model 614T12 (blond, frosted oak) smartly simple in design.
- **PHONOGRAPH PLUG-IN & SWITCH** — permit use of record player attachment.
- **PRE-TUNED** — pre-tuned to receive all U. S. channels, complete with ultra-high frequency adapter plug-in.

Feature for feature Westinghouse wins, with a complete TV line!

See your Westinghouse Distributor about this pace-setting low priced set, now!

YOU CAN BE SURE... IF IT'S **Westinghouse**

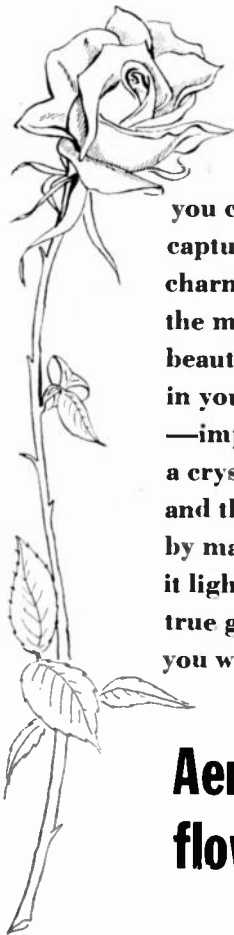

If
 you could capture the charm of the most beautiful rose in your garden —imprison it in a crystal bubble— and then, as if by magic, make it light up in true garden colors you would have an

Aerolux flowerlite

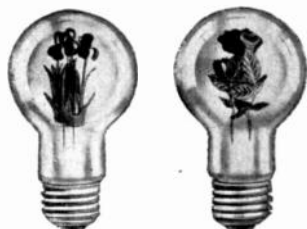

Truly, there is nothing so alluring, so delightful, so full of good cheer as this most unique product.



See Beautiful Aerolux at New York Gift and New York Notion Shows

Write for Catalog

AEROLUX LIGHT CORP.

653 ELEVENTH AVENUE
 NEW YORK 19, N. Y.

16-Inch TV by Bendix

Manufactured by Bendix Radio Division,
 Baltimore 4, Maryland



Seventeen tubes, including 16-inch picture tube, and two rectifiers are featured in this console television receiver. Has built-in antenna, turret tuning on 12 channels, FM inter-carrier sound, and 10-inch Alnico V dynamic speaker. Cabinet comes in mahogany veneers.

Say you saw it in *Radio & Television Journal*, February, 1950

Starrett's "Sam Houston"

Manufactured by Starrett Television Corp.,
 601 West 26th St., New York 1, N. Y.



New 19-tube chassis, including two rectifiers and 12½-inch cathode-ray tube, is contained in this television console. Set has built-in antenna, automatic all-channel station selector, "ex-static" FM sound circuits, and Alnico PM speaker. Cabinet comes in mahogany. Price: \$279.95.

Say you saw it in *Radio & Television Journal*, February, 1950

THE NEW DIAMOND ANTENNA

By



EASY TO MOUNT . . .
 EASY TO SELL

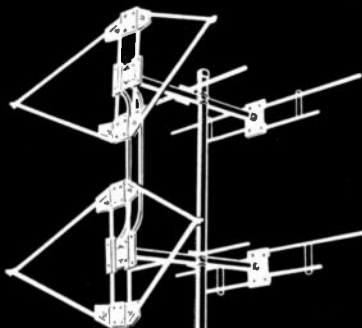

Pat. pending.

Manufactured with single diamond (No. RW 102), or double diamond, as illustrated with ¼ wave transformer (No. RW 104).

Territories are still available for distributors. Write for our fine ANTENNA BOOKLET . . . FREE.

- ◆ Fast assembly...no loose ends to become victims of adverse weather conditions
- ◆ Stacked array offers high DB gain on both bands
- ◆ High signal to noise ratio
- ◆ Channel 2 to 13 plus FM
- ◆ For use with 72, 150, or 300 ohm transmission line
- ◆ U-Bolt clamp provided to facilitate proper spacing and independent orientation of each bay.

Pat. pending.



ENGINEERING, Inc.

BOX 325

LONG BRANCH, N. J.

Not One—but *Two Great*

BUSINESS NAMES

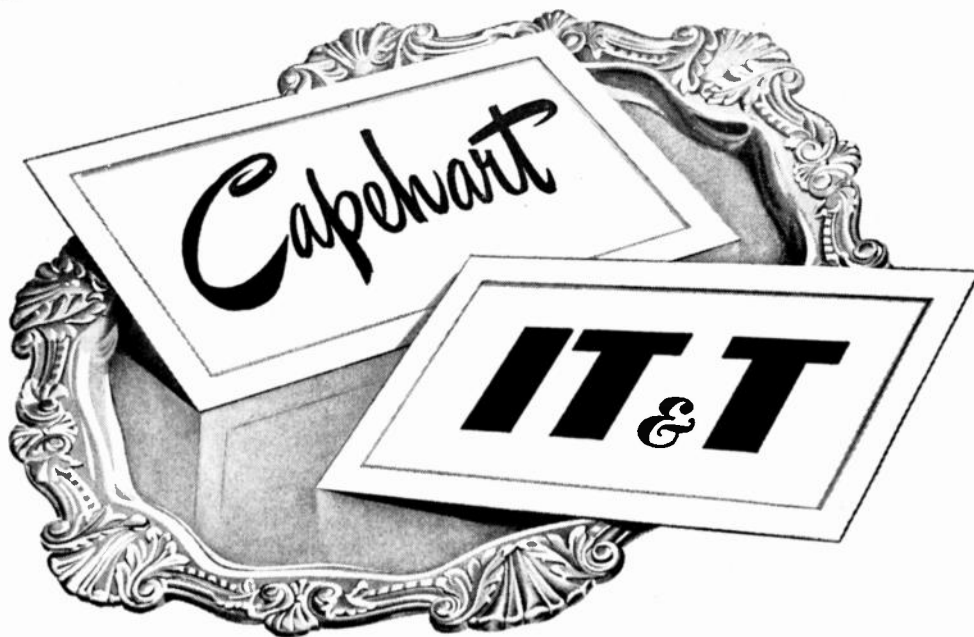

... combine to make *Capehart*

the TELEVISION Leader!



The Capehart Nocturne. Big 16-inch picture tube. Needle sharp television. Master-crafted cabinet in mahogany finish. With Polatenna, Capehart's built-in aerial.

All Capehart dealers profit from the world-wide engineering, manufacturing and merchandising experience of not one—but *two* great organizations.

Today full-color national advertising campaigns featuring the Capehart television line in nine leading magazines and two newspaper Sunday supplements are being run by *both* Capehart-Farnsworth Corporation and Interna-

tional Telephone and Telegraph Corporation. Dealer selling aids including display material, local newspaper advertising material, and literature support these campaigns to the hilt.

So, behind the sales efforts of every Capehart television dealer are not one but *two* great business organizations dedicated to making Capehart *the* television success of the year!



CAPEHART-FARNSWORTH CORPORATION
Fort Wayne, Indiana

Federal's Electronic Magnifier

Manufactured by Federal Television Corp.,
139 Duane St., New York, N. Y.

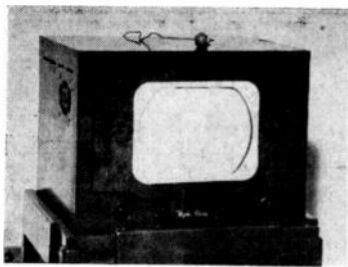

Operated by remote control with a push button which can be as distant as 25 feet, this electrode television magnifier enlarges the TV image without distortion, and without loss of brilliance and focus. Press of button returns image to normal size. Unit sells for \$24.95.

Say you saw it in *Radio & Television Journal*, February, 1950

New TV by Philco

Manufactured by Philco Corp.,
Tiago & C Streets, Philadelphia, Pa.



Featuring a 12½-inch picture tube, this table model provides a 97-square-inch picture. has 20 tubes and two rectifiers. Incorporates the firm's electronic built-in aerial system for tuning in all TV stations. Cabinet comes in walnut. Priced at \$199.95.

Say you saw it in *Radio & Television Journal*, February, 1950

TV by Stromberg-Carlson

Manufactured by Stromberg-Carlson Co.,
Rochester, N. Y.

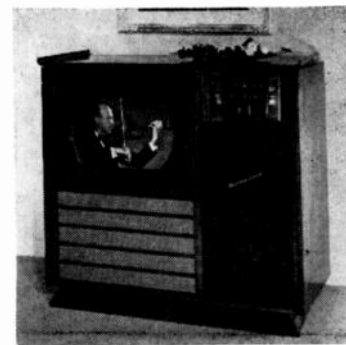

This 19-inch television receiver console contains FM-AM radio and automatic three-speed record changer. Has keyed automatic gain control, firm's tuner, built-in antennas, and 12-inch PM speaker. Cabinet is in mahogany veneers, Chinese carving reproduction on doors. Eastern price: \$965.

Say you saw it in *Radio & Television Journal*, February, 1950

GE 12½-inch TV

Manufactured by General Electric Co.,
Electronics Park, Syracuse, N. Y.



A 12-channel table television receiver with a 12½-inch picture tube, simplified tuning, and built-in antenna. Black Daylight feature in the face plate added to Daylight Television. Cabinet is hand-rubbed mahogany. Eastern list: \$239.95.

Say you saw it in *Radio & Television Journal*, February, 1950

Meck Radio Boom

John Meck Industries, Inc., Plymouth, Ind., is enjoying an unprecedented demand for AM table radios and has recently moved facilities to a modern, two-story building in Argos, Ind., to cope with increased production. The move makes additional room for TV set production at the firm's main plant.

A CLOSED CIRCUIT CAN PROVIDE a means for top echelon executives to expound policy and plans, to demonstrate products, and to submit to question and answer periods for the benefit of a firm's distributing group. This is what the "DuMont Closed Circuit Convention" offers as a service to business and industry. Through special circuits any presentation from headquarters can reach staff members throughout the country simultaneously.



LOW PRICE—HIGH PROFIT
Operates like magic



Hide-A-Tenna
Inverted



Hide-A-Tenna
in "hide"
position

\$795
LIST

Concealed TV Antenna Outperforms Others!

Adjustable...Hides Behind Set...Turns 360°

- Eliminates unsightly "V" arms.
- Mounted quickly without special tools.
- Exceeds performance of built-in types.
- Excellent reception in "hide" position from both high and low channels.

Cash in on this big profit-maker! Walward "Hide-A-Tenna" allows for maximum clarity, signal strength, high gain, and rejection of interference. When directional difficulties are acute, Hide-A-Tenna may be flipped above the set to permit 360° rotation for super-selective turning. Outperforms conventional built-in antennas...giving the "hide" advantages without the channel and clarity limitations. Has folded dipole...universal mounting. A sure seller!

DISTRIBUTORS AND JOBBERS
Long Discounts - Prompt Delivery
REPRESENTATIVES: Protected territories now being allocated...**WRITE AT ONCE!**

Ward MANUFACTURING COMPANY
80 East Jackson Blvd., Chicago 4, Illinois
Phone: HAarrison 7-1034

SPECIFICATIONS: Constructed of frosted-finish aluminum, with pleasing Burgundy-color ceramic insulator. Universal mounting plate. Dipoles extend from 21 to 35 inches... rotate 360 degrees. Packed in cartons: 12 cartons to the case.

DU MONT LEADS THE INDUSTRY... WITH

*quality
control*

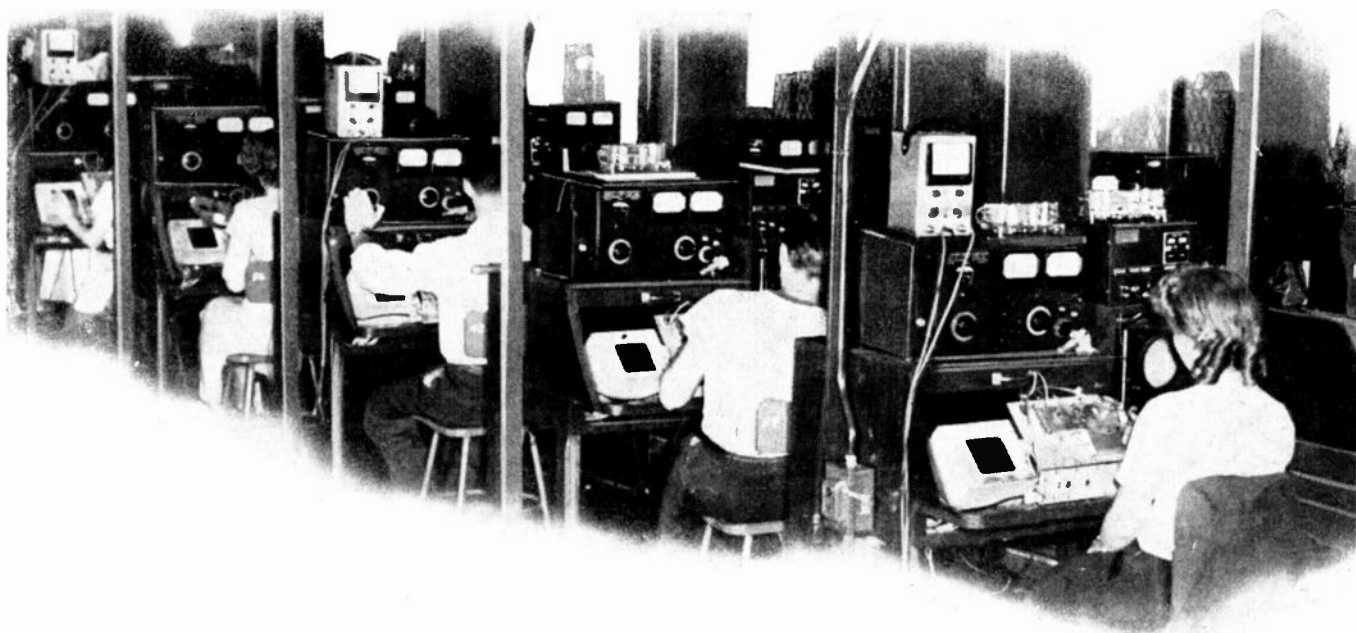

Among component manufacturers, Du Mont is known as the most exacting buyer in the industry. Du Mont inspectors are in the suppliers' plants regularly; then all parts are checked again and re-tested as they are received at the Du Mont assembly plant.

Du Mont Quality Control extends through the entire manufacturing process, guarding against the possibility of defective parts or workmanship at every point.

Du Mont vigilance in manufacture and testing is a big help to the Du Mont dealer — it means the kind of customer satisfaction that builds a successful business.

Invite your prospects to see the Morcy Amsterdam Show over the DuMont Television Network. Morey is a great salesman.

DU MONT *First with the finest in Television*

Copyright 1950, Allen B. DuMont Laboratories, Inc.

Allen B. DuMont Laboratories, Inc. Television Receiver Div., East Paterson, N. J., and the DuMont Television Network, 515 Madison Ave., N. Y. 22, N. Y.

TV Cabinet by Wolff

Manufactured by Robert Wolff Woodcraft Corp., 1125 Union Ave., New York 59, N. Y.

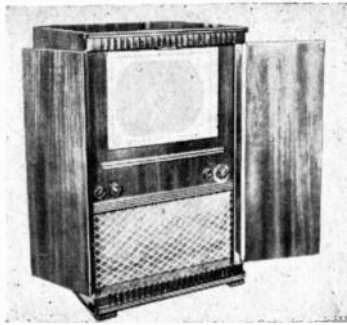

One of the deluxe line of television receiver cabinets made by master craftsmen with the facilities of a firm which has been manufacturing wood products for 45 years. Cabinets are now made in various woods at all prices.

Say you saw it in *Radio & Television Journal*, February, 1950

Ward's "Hide-a-tenna"

Manufactured by Ward Manufacturing Co., 80 East Jackson Blvd., Chicago 4, Ill.

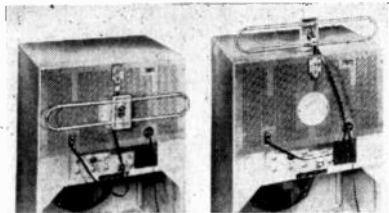

Constructed of aluminum, with ceramic insulator, this antenna operates in both a "hide" position behind the TV set or in a projected position above the set. Dipoles extend from 21 to 34 inches. Complete 360-degree rotation for sensitive tuning is possible. Antenna lists for \$6.95.

Say you saw it in *Radio & Television Journal*, February, 1950

New Trio Antenna

Manufactured by Trio Manufacturing Co., Griggsville, Illinois

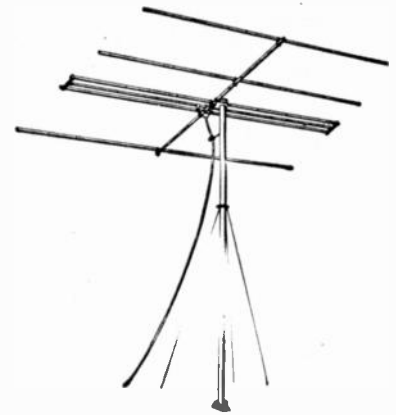

A 4-element television antenna providing high forward gain and with unique directional characteristics, this aerial uses a double folded dipole. Available for all 12 channels, it comes with a 6-foot section of 1 1/4-inch aluminum mast, adjustable roof bracket and guy wire ring. Adjustable clamp allows installation of more than one antenna on a single mast.

Say you saw it in *Radio & Television Journal*, February, 1950

HERE IT IS! THE EASY TO ERECT **ENERGY** HYDRAULIC TELEVISION MAST

An all hydraulic sectional Television Mast extended with hand pump or power unit. Raised and lowered as service requires.

EASY INSTALLATION.

ENERGY Masts can be installed in a short time, either clamped to side of building or set in concrete away from buildings. Only two men needed. Weight of 60 foot Mast is 300 pounds, 22 feet in length collapsed. Hand or power pumps can be furnished.



ONE MAST CAN SERVE MANY OUTLETS. MAST WILL WITHSTAND 100 MILE WIND. MANUFACTURED IN THREE AND FOUR SECTIONS. No guy wires needed. RECOMMENDED FOR TWO-WAY TAXI RADIO INSTALLATIONS.

ENERGY PORTABLE HYDRAULIC DEMONSTRATION ANTENNA.

Smooth quick operation ideal for commercial car demonstration. For any test location, can be set up in a few minutes.

Write today for literature and prices.

ENERGY FARM EQUIPMENT CO.
Monticello, Iowa

NEW LEAD-IN SUPPORTS THAT GIVE BETTER TELEVISION and FM RECEPTION!

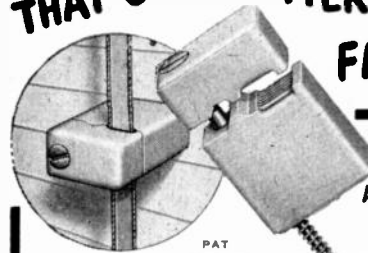

PAT APPLIED FOR
No. 9418

OTHER ANTENNA AND LEAD-IN ACCESSORIES



No. 1925
Insulated Screw Eye, Overall length 7-1/4", 5/16" insulator hole.

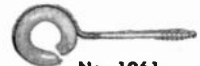

No. 1961
Split Bridge Ring Insulated Screw Eye, Overall length 3-5/8", 5/8" insulator hole, 1/4" diagonal slot.



Specially designed TUBE for flat 3/8" wide 300 ohm twin-wire TV-FM Lead-in Conductors. Outside diameter 1 1/2" — fits hole made by standard 3/4" drill bit. Finest electrical porcelain, rectangular hole prevents conductor from twisting. Write for folder.

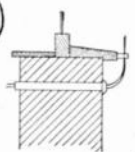

Porcelain Products, Inc.
FINDLAY, OHIO

BLACK TUBE—with built-in neutral density filter for sharper images

AUTOMATIC TUNING—For easy consumer operation

SHORT NECK 16" TUBE—For new console beauty

NON-GLARE SAFETY GLASS—Cuts interfering reflections

They've Got Everything
INCLUDING PRICE!

H-F INTER-CARRIER SYSTEM—Fewer components, less trouble, better performance

TWO-KNOB CONTROL—For simplified tuning, for easy selling

BUILT-IN ANTENNA—Amazing performance without expensive installation

RECTANGULAR TUBE—For table model compactness



2 Marvelous New Sentinels

*to Spark
Midwinter
Sales!*

Exciting! Live! Positively nothing like this ever before! Sentinel here shows you the way to reach and hold profitable volume throughout the winter and spring! Two new models that round out the red hot Sentinel line. All priced to give you the fast turn-over that you need. Contact your Sentinel Distributor or Sentinel directly—now!

Sentinel Radio and Television
EVANSTON, ILLINOIS

On TV Freeze and Color

David B. Smith, vice-president of Philco Corp., Philadelphia, Pa., stated before a joint meeting of the Franklin Institute and the Institute of Radio Engineers recently that the prolonged "freeze" of applications for new television stations allowed only two-thirds of the people in the United States who should be able to receive TV programs actually to enjoy TV service. His conservative estimate placed the number of people within reach of TV service at 47,000,000, with the actual coverage of 98 TV stations at probably 65,000,000. A serious problem for the industry, Smith maintained, was seeing to it that "20,000,000 citizens will not be deprived of TV programs."

Recalling that the FCC had frozen all new TV station applications some 17 months ago, Smith expressed the opinion that 20 per cent of those people receiving TV service get their programs from a single station, and that they could have more service if it were not for the "freeze." He estimated there are 351 applications pending. On color, Smith felt existing receivers would eventually be able to receive color programs without modification. Color receivers, compatible and of high quality, are still in the laboratories and will not be ready for some time. Smith concluded.



This two-door television console is designed for chassis powering 16" and 19" tubes. Built with all miter-locked corners, front panel removable for tube service. Record-changer optional. In mahogany, walnut, blond, all other finishes. Swivel and stationary TV tables also available. Brochure sent on request.

ORadell 8-2598



RIVER EDGE INDUSTRIES

5 River Edge Rd., River Edge, N. J.

"45-RPM" Awarded



The 1950 Merit Award of the American Society of Industrial Engineers is presented to the RCA Victor Division, Radio Corp. of America, Camden, N. J., in recognition of the company's achievement in developing the 45-rpm system of music reproduction. Robert L. Crinian, left, national president of the society, is shown tendering the award to D. F. Schmit, vice-president in charge of engineering, RCA Victor. At right is Benjamin R. Carson, designer-inventor responsible for the original concept of the 45-rpm system. Mr. Crinian described the introduction of the 45-rpm system as the "climax of a half-century of acoustical, electronic, and mechanical development in the reproduction of recorded music."

It's Service That Counts

(Continued from page 21)

Costs and Efficiency

Strong emphasis on preventive methods of reducing service calls and shortening the time on all calls made is a boast Television Craftsmen Corp. makes. And the whole organization is proud of the firm's record on that score. Finding the answer to every little field problem means that only major repair jobs wind up in the shop. It makes for a pleasant cycle. Peak efficiency, for instance, reduces costs, and reduced costs make for better service. In this, the cost accountant plays a lead role with Television Craftsmen. His contribution to service is in dollars saved from wasteful operations. Every penny the firm cuts from needless drags on dollars goes into new equipment and experimental work on new techniques.

So far as the relationship Television Craftsmen Corp. enjoys with dealers as service contractor, it has proven a more than satisfactory one. They have given over entirely to dealers the function of retailing television receivers. Thus they have been able to concentrate on one job—servicing. Any form of specialization required in such an arrangement accrues to the benefit of the consuming public. This firm is providing quality service, promptly. Hard-headed business man Al Schwartz is thereby unlocking the door that leads to perfect television service.

No More Car Radios

A drastic decision on the part of the board of directors, Zenith Radio Corp., Chicago, Ill., was relayed to distributors of the firm by E. F. McDonald, Jr., president of Zenith. The firm, faced with the need either to build additional plant facilities or to curtail one aspect of its business, chose the latter. It will cease the manufacture of automobile radios on or about April 30 of this year and will probably convert the radio assembly lines to television assembly. For many years these Zenith automobile assembly lines supplied equipment which went into Fords, Mercurys, Lincolns, and Hudsons. It has been estimated that the firm at one time enjoyed close to one-fourth the total automobile business done by the radio industry.

For taking care of the considerable automobile radio business, Zenith had to devote considerable plant space along with topnotch technicians and supervisors. With television going through a phenomenal stage of growth, these plant facilities and the personnel may now be utilized to further expand television production at Zenith.

**THE FIRST IN THE ALL NEW
1950 BEST VUE LINE**

**The "PHENIX"
Model 250 CRHL**

**HIGH & LOW
FREQUENCY CONICAL**

Also available without
straight bar
reflectors

Model 250 CHL

High
Frequency
Optional

**Here is the Fastest Growing Antenna
Line on the Market Today !!!**

**BECAUSE . . . Best Vue antennas are
GUARANTEED for:**

- Low Cost
- Excellent Reception
- Rugged Mechanical Construction
- Fast Assembly and Installation

**BECAUSE . . . Best Vue engineers are
constructing antennas to fit all installa-
tion and location needs.**

**BECAUSE . . . Best Vue antennas are
at the same time—Highest Quality and
Lowest Cost.**

Write today for illustrated brochure B
"The Best Vue line for '50."
Jobber inquiries invited.

Best Vue Products

247 CENTRE STREET, NEW YORK 13, N. Y.

THE ONE AND ONLY TRADE-WIDE GUIDE

TRADE-IN DATA ON ALL MAKES OF HOUSEHOLD REFRIGERATORS MARKETING NATIONALLY SINCE 1928

- ADMIRAL
- APEX
- BELLEVILLE
- CAVALIER
- CHILRITE
- COLDSPOT
- COOLERATOR
- COPELAND
- CROSLLEY
- DALCO
- DAYTON
- ELECTROLUX
- FAIRBANKS-MORSE
- FIRESTONE
- FRIGIDAIRE
- GALE
- GENERAL ELECTRIC
- GIBSON
- GILFILLAN
- GRINNELL
- HOTPOINT
- JEWETT
- KELVINATOR
- LEONARD
- LIBERTY
- MAYFLOWER
- MERCHANT & EVANS
- MONTGOMERY WARD
- NORGE
- O'KEEFE & MERRITT
- PHILCO
- RICE
- SEACO
- SERVEL
- SPARTON
- STEWART-WARNER
- UNIVERSAL COOLER
- UNIVERSAL (LF&C)
- WESTINGHOUSE
- WILLIAMS ICE-O-MATIC

NEW! FREEZER SECTION INCLUDES DATA ON ALL MAKES OF HOUSEHOLD FREEZERS MARKETING NATIONALLY SINCE 1938

- ALCO
- AMANA
- AMC
- AMERICAN
- ARCTIC TRUNK
- ATLANTIC
- BEALL
- BEN BAR
- BEN-HUR
- BISHOP
- BTC
- CARRIER
- COLDSPOT
- COOLERATOR
- CO-OP
- CORONADO
- DEEPFREEZE
- ESKIMO FREEZE
- FIRESTONE
- FREEZ-ALL
- FRIGID KING
- FRIGIDAIRE
- FROSTAIR
- GENERAL ELECTRIC
- GIBSON
- GROSS
- HARDERFREEZ
- HOTPOINT
- IDEAL
- KELVINATOR
- KOLDMASTER
- LEONARD
- LOCKERATOR
- LOUDON
- MARQUETTE
- MARVEL
- MASTERFREEZE
- MAYTAG
- ORLEY
- PAK-A-WAY
- PANELECTRIC
- PHILCO
- QUICFREZ
- QUILLEN
- STANZERO
- SUB-ZERO
- VICTOR
- WHITING
- ZEROSAFE

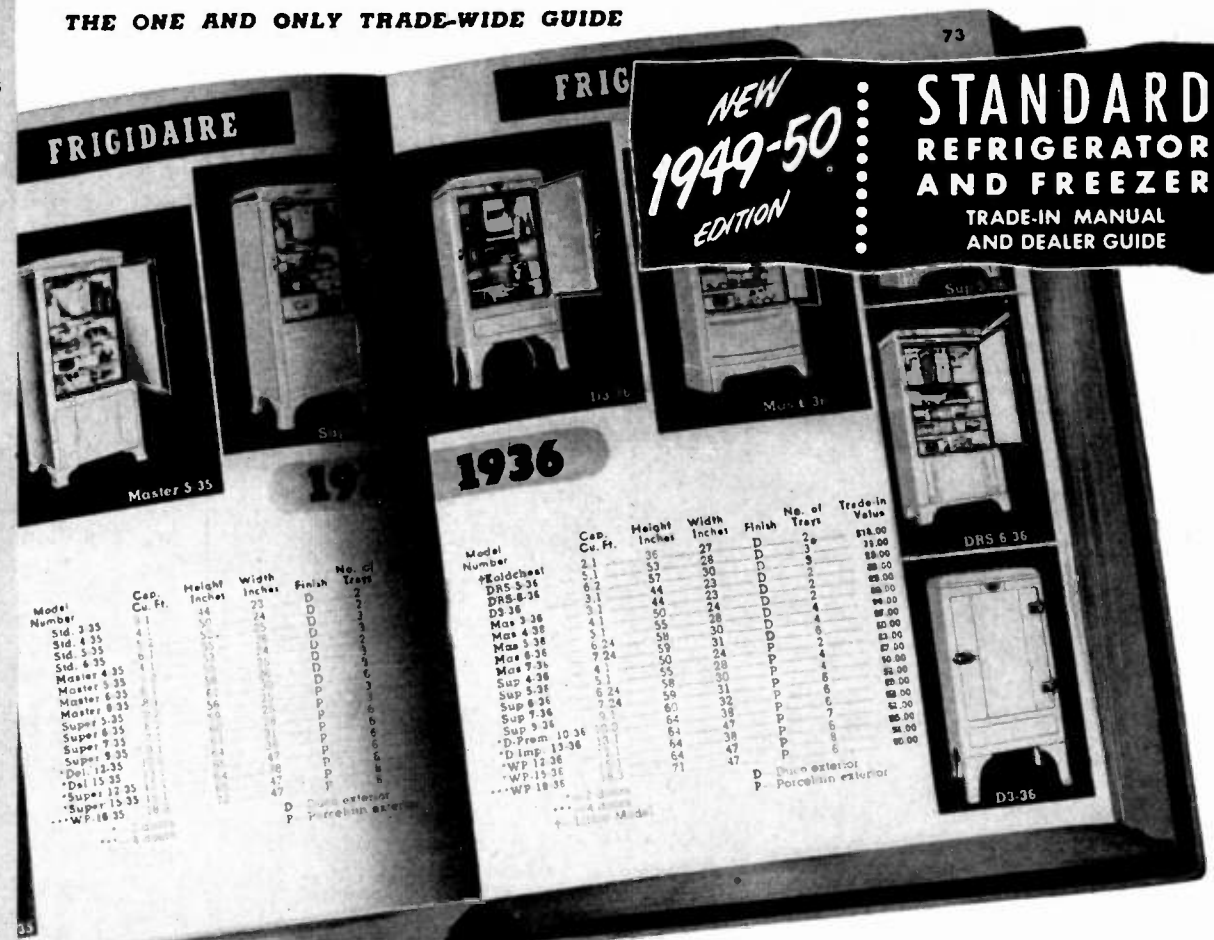

• More than 1200 photographs
 • More than 3500 detailed listings
 • Authentic trade-in valuations
 • Operating information on Merchandising, Promotion and Reconditioning

Use the Standard Trade-In Manual for correct identifications and sound valuations. Arranged and indexed for quick reference.

The internationally accepted trade-in authority on refrigerators! The standard reference source throughout the United States and 27 foreign countries. USED by retailers, service operators, associations, power companies, wholesalers, manufacturers, exporters, banks, publishers, economists, government agencies, libraries—in fact, everyone who is interested in household refrigerator and freezer market data.

Standard Refrigerator and Freezer Trade-In Manual and Dealer Guide—1949-1950 Edition—Case-bound, covered in washable green cloth, gold stamped. Pocket size, 4 3/4 x 6 1/4 inches. Lithographed, with more than 1200 photographic illustrations. 320 pages. Price—per copy—\$10.00 (U.S.A.). Foreign Price—\$12.50. Quantity price list available on request.

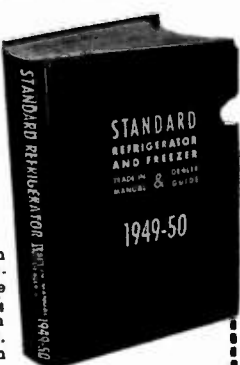

PROTECT YOUR REFRIGERATOR AND FREEZER PROFITS!

All appraisals have been revised to reflect current market factors.

BE PREPARED FOR YOUR 1950 REPLACEMENT SALES

ORDER YOUR 1949-1950 STANDARD TRADE-IN MANUALS NOW!

Radio & Television Journal, 1270 Sixth Ave., New York 20, N. Y. Please send me at once:

_____ copies of 1949-1950 Standard Refrigerator & Freezer Trade-In Manual @ \$10.00* each. (Outside U.S.A. \$12.50.) *N.Y.C. orders, please add 2% N.Y.C. Sales Tax

Name _____
 Company _____
 Street Address _____
 City _____ Zone _____ State _____

Enclosed find check or money order for \$_____ in full payment.



© Copyrighted 1949 by Nelda Publications, Inc.

NEWS AND NOTES OF MANUFACTURERS AND DISTRIBUTORS

• Orders for television sets, refrigerators, ranges and other products placed by **Philco Corp.** distributors at regional meetings in December and the firm's recent national distributor convention in Chicago total over \$80,000,000, according to James H. Carmine, executive vice-president. Most of these orders are for shipment in the first quarter of 1950.

• **Allen B. DuMont Laboratories, Inc.**, N. Y., has inaugurated an intensive coast-to-coast training drive which will effect between four and five thousand sales personnel of TV distributors and dealers. Walter L. Stickel, national sales manager, receiver sales division, demonstrated the program in Chicago recently.

• Net earnings after taxes of **Emerson Radio & Phonograph Corp.**, N. Y., for the fiscal year ended October 31, 1949 amounted to \$3,035,652, the highest in the firm's history. The figure compared with net earnings in 1948 of \$2,401,769. Consolidated net sales for 1949 amounted to \$40,543,925.

• **Radio Merchandise Sales Co., Inc.**, 550 Westchester Ave., N. Y., exhibited its advertising and sales promotion program for 1950 at a regional meeting of company sales representatives recently. Hy Bloom, sales manager, explained the program, displaying jobber aids, colorful streamers, counter literature, new catalogs, and the direct mail circulars for service-men-dealers.

• **Allen B. DuMont Laboratories, Inc.**, N. Y., has named the Allegheny Home Appliance Co., 1801 Adams Ave., Huntington, West Virginia, as DuMont distributor for the Huntington and Charleston, West Virginia areas.

• Major appliances, Inc., 925 W. Flagler St., Miami 36, Florida, has been appointed distributor for **Motorola, Inc.** radios and television for the state of Florida, relinquishing an RCA records and home instrument franchise and discontinuing as distributor of Sylvania television for the area.

• C. K. Baggs, sales manager, **Colonial Radio Corp.**, Buffalo, N. Y., announced the appointment of Electrical Wholesalers, Inc., Atlanta, Ga., as Sylvania Television distributor for the Georgia territory. F. H. Dendy, Sr., is president of Electrical Wholesalers and J. Q. Forrester is sales manager.

• **Tele King Corp.**, 601 West 26th St., N. Y., has announced the formation of a new company for the distributorship of Tele King television in New York. The new corporation is the exclusive distributor in the New York area and is headed by Duke Wellington, president of Tele King Distributors. Calvin E. Bell is secretary-treasurer.

• S. H. Lynch & Co., San Antonio, Texas, distributor for **Allen B. DuMont Laboratories, Inc.**, has initiated a sales contest for the salesmen of the local Joske's Stores in San Antonio. The four week TV receiver sales drive is to be climaxed by the presentation of DuMont TV receivers to the three top salesmen.

• **Covrall Industries**, 55 Ferris St., Brooklyn 31, N. Y., announces the appointment of the following distributors: Rolland Sales, 527 So. Wells St., Chicago, Ill.; George Rosen & Co., 40 Hopkins Place, Baltimore, Md.; Cleveland Carnegie Radio Co., 2536 Prospect, Cleveland, Ohio.



Deluxe Model

Manufacturers since 1904

ROBERT WOLFF WOODCRAFT CORP.

STOCK LINE

TELEVISION CABINETS

16" & 19" to fit RCA and other Chassis

AT THE RIGHT PRICE

Walnut, Mahogany, Blonde
Chinese Chippendale

QUALITY CABINETS
FOR THE TRADE

PROMPT DELIVERIES

Write for catalogue JR showing
complete line & prices, or visit
our showroom and look over our new line.

1125 Union Av, NY 59, NY
Dayton 3-3400

1 OUT OF EVERY 2 OUTDOOR INSTALLATIONS IS MADE WITH SOUTH RIVER PRODUCTS

*Write for catalog describing
Chimney Mounts, Wall Brackets,
Pipe Mounts, etc.*

**WARNING . . . South River
Chimney Mounts are patent
protected. Imitations and
infringements are being
prosecuted. See U. S. Pat-
ent No. 2482575.**

**SOUTH RIVER
Metal Products Co., Inc.
Dept. RJ, 17 Obert Street
South River, New Jersey**

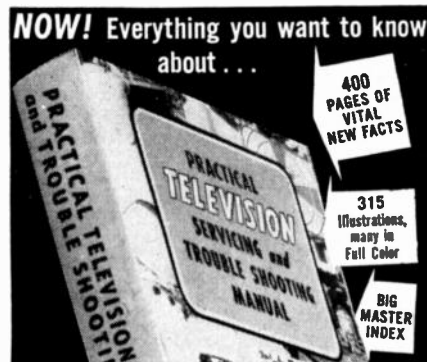

NOW! Everything you want to know about . . .

**New! Illustrated! Authoritative!
Includes COLOR TELEVISION**

Just off the press; a GOLD MINE OF INFORMATION about television servicing and trouble-shooting, fully illustrated, clearly explained. It's a complete, up-to-the-minute explanation of television, including UHF, Color TV, new adapters, converters and practical applications. Shows you step-by-step, how to repair, adjust, align, service all makes . . . how to locate and correct troubles in a hurry. Edited by COYNE television experts. Easy-to-follow instructions. The perfect reference book and practical working guide for radio and TV servicemen and retailers, broadcasters, instructors, students, industrial libraries . . . for everyone interested in keeping up with the swift advance of modern television. At your book dealer or get your copy today on 7-Day Trial Offer.

**SEND NO MONEY
INSPECT 7 DAYS
AT OUR RISK**

ORDER TODAY—TRIAL OFFER COUPON

Educational Book Publishing Division
COYNE ELECTRICAL & RADIO SCHOOL
500 S. Paulina St., Dept. 20-E4,
Chicago 12, Ill.

YES! Rush your new PRACTICAL TELEVISION SERVICING and Trouble-Shooting Manual on trial offer. I will pay postman \$4.25 plus postage. Book may be returned in 7 days for prompt refund.

Name.....
Address.....
City.....Zone.....State.....
 I am enclosing \$4.25. You pay postage.
Same Money-Back Guarantee.

When Mickey and Felix were our leading “TV” stars...

Those celebrated “movie actors”—
Mickey Mouse and Felix the Cat—were
pioneer helpers in television research

No. 1 in a Series Tracing the High
Points in Television History

Photos from the historical collection of RCA

● Strange though it seems, two toys had much to do with television as you now enjoy it! As “stand-ins” during television’s early days, Mickey Mouse and Felix the Cat helped RCA scientists and engineers gather priceless information.

Choice of this pair was no accident. Their crisply modelled black-and-white bodies were an ideal target for primitive television cameras. The sharp contrast they provided was easy to observe on experimental kinescopes.

Would living actors have done as well? No, for what RCA scientists were studying—as they trained their cameras on the two toys—was the effect of changes and improvements in instruments and telecasting techniques. With living actors it could never have been absolutely certain that an improve-

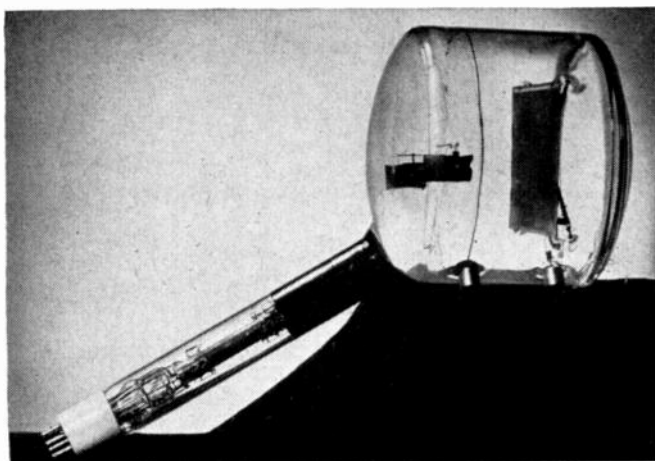

The iconoscope, electronic “eye” of television, invented by Dr. V. K. Zworykin, of RCA Laboratories.



Felix the Cat and Mickey Mouse were, during television’s experimental period, the most frequently televised actors on the air. Using them as “stand-ins,” RCA engineers gathered basic data on instruments and techniques.

ment in the televised image came from an improvement in equipment and techniques—or from some unnoticed change in an actor’s appearance, clothing, make-up. Mickey and Felix provided a “constant,” an unchanging target which led to more exact information about television . . .

Problem after problem was met by RCA scientists, with the results you now enjoy daily. For example: In the “Twenties” and early “Thirties,” there were still people who argued for *mechanical* methods of producing a television image, despite the obvious drawbacks of moving parts in cameras and receivers. Then Dr. V. K. Zworykin, now of RCA Laboratories, perfected the iconoscope, to give television cameras an all-electronic “eye”—without a single moving part to go wrong. Today, this same all-electronic principle is used in the RCA Image Orthicon camera, the supersensitive instrument which televises action in the dimmest light!

Also developed at about this time, again by Dr. Zworykin, was the *kinescope*. It is the face of this tube which is the “screen” of your home television receiver, and on its fluorescent coating an electron “gun”—shooting out thousands of impulses a second—creates sharp, clear pictures in motion. Those who may have seen NBC’s first experimental telecasts will remember the coarseness of the image produced. Contrast that with the brilliant, “live” image produced by the 525-line “screen” on present RCA Victor television receivers!

Credit RCA scientists and engineers for the many basic developments and improvements which have made television an important part of your daily life. But don’t forget Mickey Mouse and Felix. They helped, too!



Radio Corporation of America
WORLD LEADER IN RADIO—FIRST IN TELEVISION

NELDA 1950 LOOSELEAF SERVICE

**KEEPS
YOU
UP-TO-DATE
with the
CONSTANTLY
CHANGING
MARKET!**

What this unique service does for you:

The NELDA 1950 LOOSELEAF SUBSCRIPTION
brings you regularly the latest
PICTURES, PRICES and SPECIFICATIONS
of America's standard brands of

**TELEVISION—RADIOS—MAJOR APPLIANCES—
TRAFFIC APPLIANCES—CAMERAS, ETC.**

in compact, convenient digest form for your
everyday use as a reference manual,
sales builder and buying "bible".

IMPARTIALLY EDITED, PROCESSED AND CLASSIFIED TO ENABLE
YOU TO COMPARE QUICKLY ALL COMPETITIVE MODELS AND PRICES.

YOU GET \$250,000.00 WORTH OF SERVICE FOR LESS THAN A DOLLAR A WEEK.

That's what it costs per year to maintain the NELDA LOOSELEAF SERVICE.

Yet it costs you only \$50.00 for a full year!

NO OBLIGATION ON YOUR PART!

*If you are not completely
satisfied, return it
in one week and
you pay nothing!*

**REGULAR MONTHLY SUPPLEMENTS
AND REGULAR WEEKLY PRICE REVISION BULLETINS**

**KEEP THIS SERVICE
PERPETUALLY UP-TO-DATE**

RADIO & TELEVISION JOURNAL, 1270 Sixth Ave., New York 20, N. Y.

Please enter immediately my subscription for NELDA'S 1950 LOOSELEAF SERVICE.

Bill me as per attached purchase order no. _____ and I will either return the Subscription within one week or remit \$50.00 plus postage.

Enclosed is remittance in full (\$50.00). Stamp the Binder as follows: _____

If I am not completely satisfied, I will return the Subscription within one week and you will refund my money.

Name _____

Company _____

Address _____

City _____ State _____

SPECIAL OFFER: YOUR NAME IN GOLD FREE!

If full remittance accompanies your order we will STAMP YOUR NAME IN GOLD on the DeLuxe Binder and PREPAY THE POSTAGE!

New Appointments



BENJAMIN A. POLLET
tific Corp., N. Y.

● Benjamin A. Pollet, for 14 years senior accountant executive with the Compton Advertising Agency, has been appointed advertising and sales promotion manager, *Pioneer Scientific Corp., N. Y.*

● Ray L. Hoefler, with 20 years' experience in eastern markets, has been named supervisor of the New York territory, *Zenith Radio Corp., Chicago, Ill.*



RAY L. HOEFLER

PHOENIX
Speed-Tennas
DO A BETTER JOB!

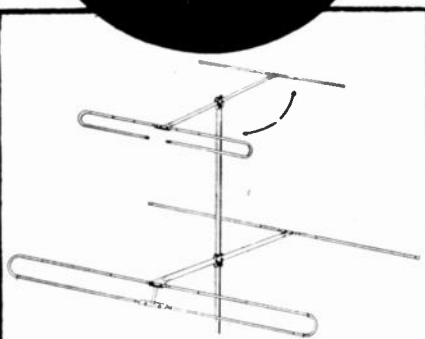

Strong—light in weight—fast, easy installation. Engineered to give highest quality electrical performance . . . and designed to withstand the toughest weather conditions. Pre-assembled—no loose hardware.

PHOENIX
ELECTRONICS, INC.
 Lawrence, Mass.

AT LEADING JOBBERS
 Write for folder V of complete line of television accessories.

Pollet advertising and sales promotion manager at Pioneer Scientific, R. L. Hoefler to N. Y. territory for Zenith, Davis merchandising coordinator for GE, Connor and Viebranz named to new Sylvania Electric positions, RCA elects five to vice-president category

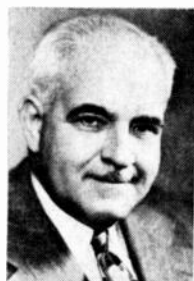

H. G. BAKER



J. S. CARTER



P. A. BARKMEIER



H. R. MAAG



R. T. ORTH

● *Radio Corp. of America*, Camden, N. J., announced the election of the following five vice-presidents recently: Henry G. Baker, VP and general manager, Home Instrument Department; John S. Carter, VP and director.

Finance Department; Paul A. Barkmeier, VP and general manager, Record Department; Harold R. Maag, VP and western manager, RCA Victor Division, and Richard T. Orth, VP and general manager, Tube Department.

● David Davis, until recently corporate radio and TV manager for all R. H. Macey's stores, has been appointed merchandising coordinator for radio and television receivers in the Electronics Department, *General Electric Co., Electronics Park, Syracuse, N. Y.*



DAVID DAVIS

NEW! COLOR ON YOUR TELEVISION!

Simply attach TELECOLOR FILTER to front of your set, and enjoy favorite programs in a glorious color tone, instead of dull black and white. 'TELECOLOR' Filter is one of the latest discoveries. It has a special formula fluorescent coloring, that gives brilliant pleasing color tone. You will find new happiness in the enjoyable color depth, reduced glare, fog, snow and less eye strain.

Everyone is talking about and waiting for 3 color Television costing hundreds of dollars. For a small sum you can enjoy color tanning now. TELECOLOR FILTER is a wonderful gift to friends or relatives who own sets.

Trade discounts 10	inch tube	\$3.00	
	12½	inch tube	\$4.00
	16	inch tube	\$6.00

HARVARD LABORATORY
 659 FULTON STREET BROOKLYN 1, N. Y.



G. C. CONNOR



A. C. VIEBRANZ

● George C. Connor has been named general sales manager for the Photo-flash Division, and Alfred G. Viebranz has been appointed general sales manager of the Electronics Division, *Sylvania Electric Products, Inc., Emporium, Pa.*

CLEAR VINYL TUBING

Clear plastic tubing for insulating and protecting wiring (up to 5,000 volts). May also be used for decorative purposes and as fluid hose. Write for complete list of prices and sizes:

AMC SUPPLY COMPANY

P. O. Box 1440-R
Fort Worth, Texas

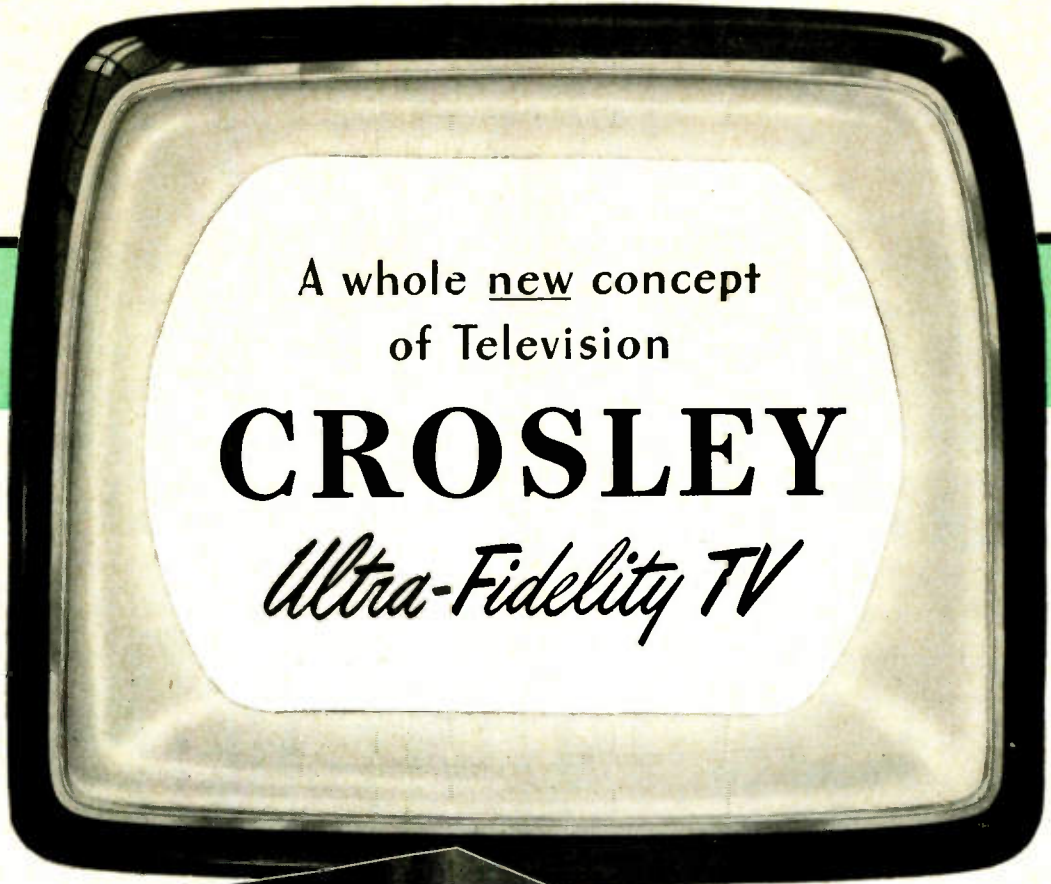

A whole new concept
of Television

CROSLEY

Ultra-Fidelity TV

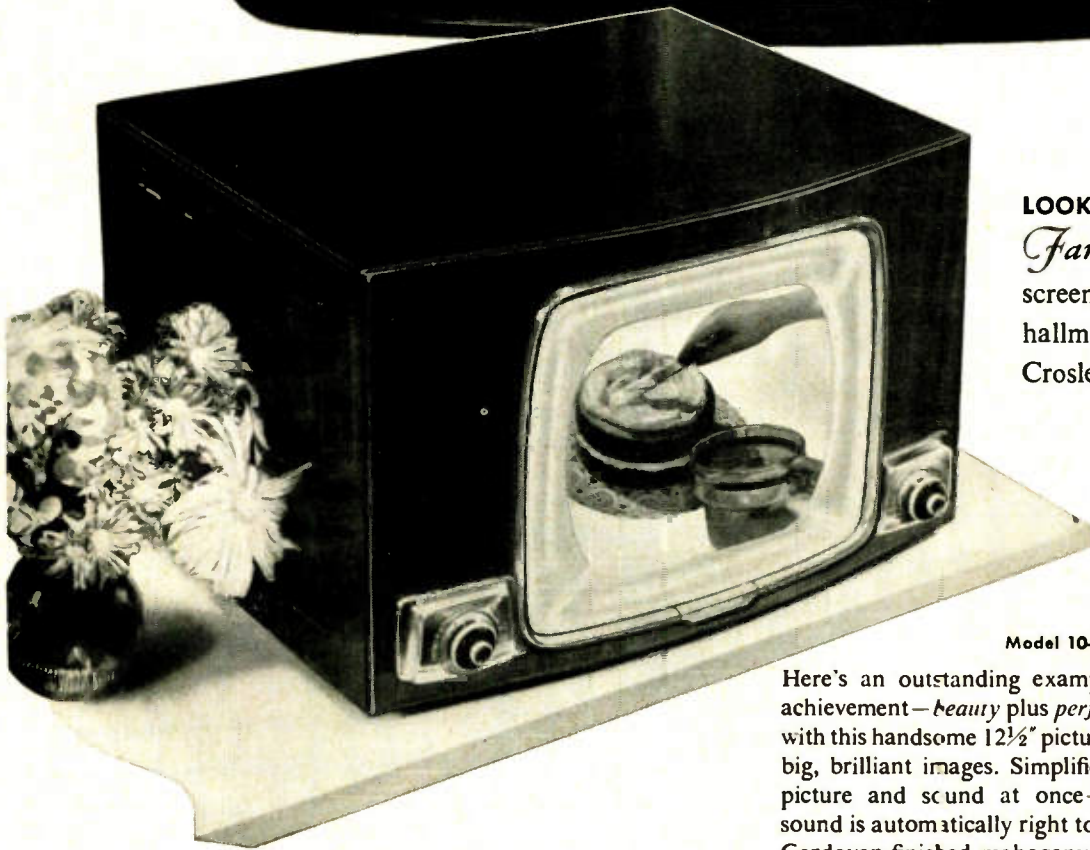

LOOK FOR THIS
Family Theatre
screen, exclusive
hallmark of
Crosley TV receivers.

Model 10-404

Here's an outstanding example of Crosley television achievement—*beauty plus performance!* You'll sell both with this handsome 12½" picture tube table model. Gives big, brilliant images. Simplified controls tune in both picture and sound at once—when picture is right, sound is automatically right too. Styled in hand-rubbed Cordovan-finished mahogany veneer.

From any viewing angle



THE clearest PICTURE!

Vision

THAT BUILDS TV SALES!

Crosley adds *sales vision* to every phase of product development, relying on more than technical skill and experience to build the kind of TV sets your customers will buy. Here, from Crosley, is the TV line designed from every angle to make 1950 your greatest television year.

Crosley's **New Concept of Performance**—new wide-angle screen . . . Unituner that makes TV tuning as easy as radio tuning . . . fade eliminator that virtually eliminates fading, "airplane flutter," and other interference . . . high sensitivity for long distance . . . built-in antenna . . . *independently mounted cathode ray tube that makes servicing far easier.*

Crosley's **New Concept of Beauty**—superbly designed cabinets . . . handsome furniture that any woman will be proud to have in her living room for years to come . . . planned for family convenience, with a big viewing screen at the comfort level . . . simple controls located for easy, relaxed tuning—when picture is right, sound is right too . . . picture tube framed by the well-designed contours of a theatre proscenium arch.

The Crosley Trademark is your assurance that the product embodies the finest engineering and skilled manufacturing for today's ultimate in TV performance.



Model 10-412

Here's a handsome console with a big, bright 12½" picture tube. The cabinet is rich Cordovan-finished mahogany veneer (Model 10-418 has similar cabinet without doors).



Model 10-401

This beautiful, low-priced table model has a big 10" picture tube. Carefully engineered to give Crosley Ultra-Fidelity TV performance in a beautiful cabinet of polished mahogany-finished plastic.

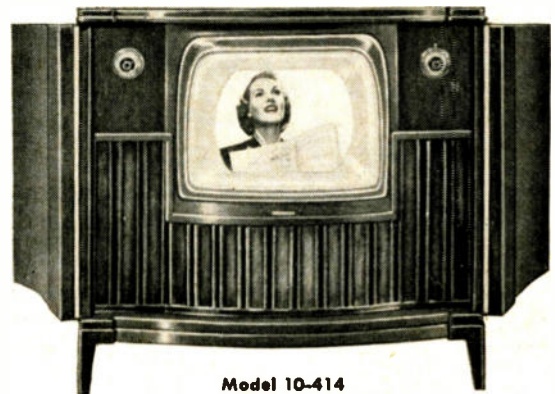

Model 10-414

A magnificent new Crosley TV console, styled in fine Cordovan-finished mahogany veneer. Bright clear pictures on a huge 16" picture tube (Model 10-416 has same big 16" picture tube, but special open face cabinet).

CROSLEY

1329 ARLINGTON STREET, CINCINNATI 25, OHIO

DIVISION



Better Products for Happier Living

Shelvador* Refrigerators . . . Home and Farm Freezers . . . Electric Ranges . . . Electric Kitchens . . . Steel Cabinets
Sinks . . . Electric Disposers . . . Electric Water Heaters . . . Radios . . . Radio Phonographs . . . Television



FEBRUARY • 1950 • VOL. 67 • No. 2

Television and Excise Taxes

The proposal by Secretary of the Treasury John W. Snyder for a 10 per cent manufacturer's excise tax on television sets has struck this industry at a time when every manufacturer is involved in bringing lower prices to the public. In thus halting the move to bring the benefits of increased production economies to the buyer, the proposed tax will be particularly harmful, and on that basis alone should be opposed with vigor by RMA and every segment of the radio and television industry.

The growing television market does not wish to escape its fair share of reasonable taxation, and manufacturers have been paying excise taxes on all radio components in television receivers. But this new tax, coming at a time when the whole subject of excise levies is being discussed in Congress with the object of eliminating or reducing them, certainly indicates that the Treasury is more interested in tax dollars than in tax equity. Merely shifting the tax burden from cosmetics and jewelry to television may be profitable from the standpoint of new revenue but it is not sound tax policy. Another unfortunate aspect about the proposed tax is that it will hit the television business at a time when volume normally and seasonally declines and therefore will further accentuate the late Spring and Summer doldrums. We are not defending the tax at any time, but if it did have to come, it would be far timelier for it to have started in the Fall, when the TV business is on the upswing.

But aside from these considerations, the tax is basically a bad tax because it negates the great efforts of the television manufacturers to make sets available to an ever-widening market at prices which most people can afford. One prominent set maker has estimated that if the tax is approved, the 10 per cent levy at the manufacturer's level would result in a 15 per cent rise at the retail mark. Millions of families desire and hope for television and such a price hike will prevent their purchases. Even more important and germane to the problem is an analysis of the nature and function of television. As R. A. Graver of Admiral Corporation points out, "We believe that television, because of its ability to instruct through both sight and hearing, will eventually become America's greatest medium of mass education. To impose a tax on an educational facility is certainly not compatible with the country's welfare."

That is the crux of the matter. Television is not just another perfume or piece of costume jewelry that merits the tax collector's eagle eye. Television is fast becoming a way of life—the most important medium for mass education and enlightenment—and to impede its progress through taxation is both unwise and unforgivable.

ADMIRAL CORPORATION	30, 31
Agency: Cruttenden & Eger	
AEROLUX	44
Agency: J. Andrew Squires	
AIR KING PRODUCTS CO.	Third Cover
Agency: The Joseph Katz Co.	
ALLIANCE MFG. CO.	35
Agency: Foster & Davies, Inc.	
AMC SUPPLY CO.	55
Agency: Parker Willson Adv.	
AVCO-CROSLLEY DIVISION	56, 57
Agency: Benton & Bowles, Inc.	
BEST-VUE PRODUCTS	50
Agency: Shaw-Shon, Inc.	
CAPEHART-FARNSWORTH CORP.	45
Agency: J. M. Mathes, Inc.	
COVRALL INDUSTRIES	23
Agency: Shaw-Shon, Inc.	
COYNE ELEC. SCHOOL	52
Agency: Phil Gordon Agency	
ALLEN B. DU MONT LABS., INC.	47
Agency: Buchanan & Co., Inc.	
ELECTRO ENG. & MFG. CO.	40
Agency: Wolfe-Tickling-Dow & Conkey	
EMERSON RADIO & PHONOGRAPH CORP.	8, 9
Agency: Foote, Cone & Belding	
ENERGY FARM EQUIP. CO.	48
Agency: Peterson Adv.	
GENERAL ELECTRIC COMPANY	18, 19-38, 39
Agency: Mazon, Inc.	
HARVARD LAB.	55
Agency: Direct	
JEWEL RADIO CORPORATION	Second Cover
Agency: Harold A. Jacobs Co.	
NELDA PUBLICATIONS, INC.	51, 54
Agency: Louis J. Albert	
PHILCO CORP.	7
Agency: Hutchins Adv.	
PHOENIX ELECTRONICS	55
Agency: Milton Richards	
PORCELAIN PRODUCTS, INC.	48
Agency: Beeson-Fuller-Reichert	
RADIO CORP. OF AMERICA	26, 27-53
Agency: J. Walter Thompson Co.	
RIVER EDGE INDUSTRIES	50
Agency: Conti Adv.	
WALTER L. SCHOTT CO.	42
Agency: Tilds & Cantz	
SENTINEL RADIO CORP.	49
Agency: W. W. Garrison & Co.	
SHELDON ELECTRIC CO.	3
Agency: Corbin Adv.	
SHORE ENGINEERING	44
Agency: Leland K. Howe Assoc., Inc.	
SONIC INDUSTRIES	37
Agency: Jaman Adv., Inc.	
SOUTH RIVER METAL PROD. CO.	52
Agency: Art-Copy Adv.	
STARRETT TELEV. CORP.	24, 25
Agency: Ray-Hirsch Co., Inc.	
STROMBERG-CARLSON COMPANY	5
Agency: Federal Adv.	
SYLVANIA ELECTRIC PROD., INC.	41
Agency: Cecil & Presbrey, Inc.	
TELE-TONE RADIO CORP.	13
Agency: Moore & Hamm, Inc.	
THOMAS ELECTRONICS, INC.	11
Agency: Conti Adv.	
WARD MFG. COMPANY	46
Agency: Homer J. Buckley & Assoc.	
WARD PRODUCTS	Fourth Cover
Agency: Burton Browne	
WESTINGHOUSE ELEC. CORP.	43
Agency: Fuller & Smith & Ross, Inc.	
ROBERT WOLFE WOODCRAFT	52
Agency: Equity Adv.	

the 1950

Remember . . .

May is Market Month!



PARTS DISTRIBUTORS CONFERENCE AND SHOW

"The only all-industry sponsored Conference and Show in Electronics"

MAY 22-25 1950 • STEVENS HOTEL • CHICAGO

Soft-Lite Full View
rectangular
16" tube



AIR KING '50 LINE
Hit of Furniture Market

First Sets Ready for Delivery!

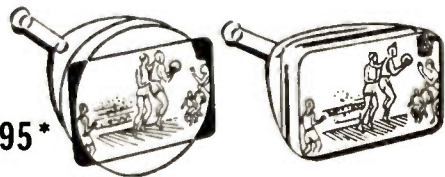

A-2017R **\$27995***
 THE PRINCESS

Exactly as telecas! Pictures received in "perfect shape"... no lost corners, no waste screen area... glare-free filter glass face gives soft light, sharper contrast! New screen fits in more compact cabinets—more beautiful than ever—makes possible amazingly low prices. Get your orders in NOW!

* Prices slightly higher West of the Rockies



A-2016R **\$29995***
 THE REGINA



...has everything!

AIR KING PRODUCTS CO., INC. • 170-53rd St., Brooklyn 32, N. Y.
 NATIONAL DISPLAY—1454 Merchandise Mart, Chicago 54, Illinois

THE SATURDAY EVENING
POST

AUGUST 20, 1949

BURT SHOTTO
Realtor

WARD

*is the Nationally
Advertised
Line!*

Ward Products Corporation, the largest and oldest exclusive manufacturer of television and auto radio aerials, supports distributors and jobbers with an aggressive advertising campaign in the Saturday Evening Post.

Ward, maker of the World's Finest Aerials, is the nationally advertised line. If you don't handle Ward aerials, you are missing the impact of the Post's four million plus circulation. Cash in on this regular national schedule.



*If your
Pictures
look like this →*

**YOUR TELEVISION
WILL BE IMPROVED WITH**

**A WARD OUTDOOR
AERIAL**



*to give you
Pictures
like this -*

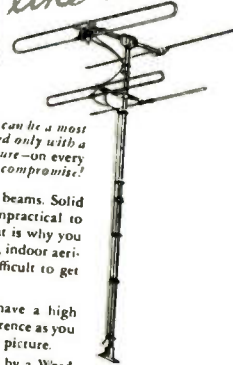

The modern miracle of pictures by air can be a most satisfying means of entertainment, but be satisfied only with a picture comparable to a class "A" motion picture—on every station in your area. It is unnecessary to compromise!

HERE'S WHY. Television waves are like light beams. Solid objects reflect and refract them, making it impractical to pick up all stations from an indoor aerial. That is why you get double images on some stations. In addition, indoor aerials may have poor signal pickup, making it difficult to get good pictures on all stations.

FURTHERMORE, your indoor antennae may have a high noise level which increases the amount of interference as you advance the contrast control to bring up a weak picture. All of these technical difficulties are eliminated by a Ward outdoor aerial installed by a competent radio service man. In every case a Ward outdoor antenna will improve reception over an indoor aerial; also, Ward aerials are so well designed they are attractive on a house. It's unnecessary to compromise.

WARD is the largest and oldest exclusive maker of television and auto radio aerials.



Does the antenna on your automobile need repair? Replace it with WARD'S 8-BALL — world's largest selling auto aerial.



WARD PRODUCTS CORPORATION
1523 E. 45TH STREET, CLEVELAND, OHIO
Division of The Gabriel Company

WARD
WORLD'S FINEST
Aerials

WARD PRODUCTS CORPORATION
1523 E. 45TH STREET • CLEVELAND, OHIO
Division of The Gabriel Company