

# RTJ

## Radio & TELEVISION JOURNAL

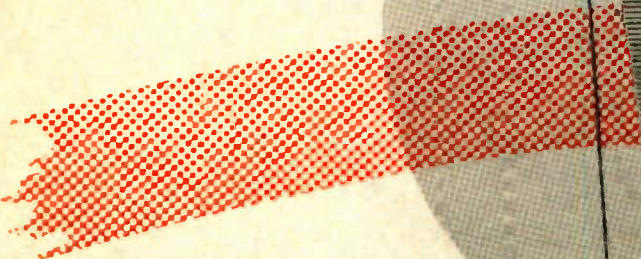
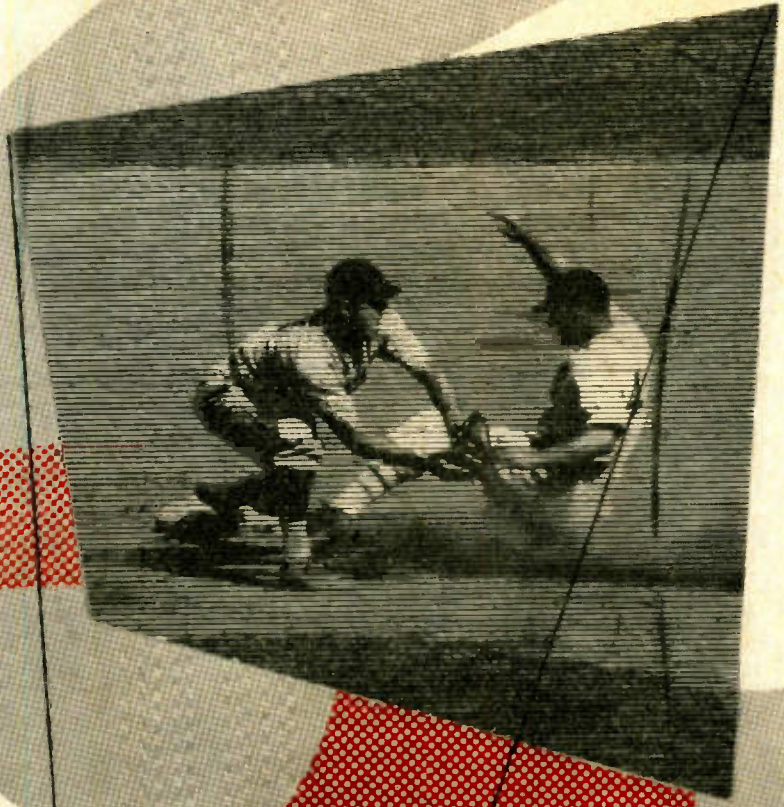

RJ D  
OMROLD R MOLTIE  
WISC

**PROJECTION  
TELEVISION  
big picture...  
bigger future**

MAY 1949

Sec. 562, P. L. & R.  
U. S. POSTAGE  
PAID  
NEW YORK, N. Y.  
Permit No. 10521

From: RADIO & TELEVISION JOURNAL  
A HOME PUBLICATION  
RKO BUILDING, RADIO CITY, 1270 SIXTH AVE.  
NEW YORK 20, N. Y.  
RETURN POSTAGE GUARANTEED  
Postmaster: If undeliverable FOR ANY REASON, notify sender.  
Noting reason, on FORM 3547, postage for which is guaranteed.



# Snyder

PHILADELPHIA

# means BUSINESS

## Radio-Television Aerials & Accessories

### TELE-PORT Portable TV Aerial

3 section telescopic dipoles. All channels. All-way orientation. Admiralty brass xxx chrome plated staffs. Brown bakelite and chrome appointments. Complete with cable.

**\$5<sup>95</sup>**

List



MODEL P-TV

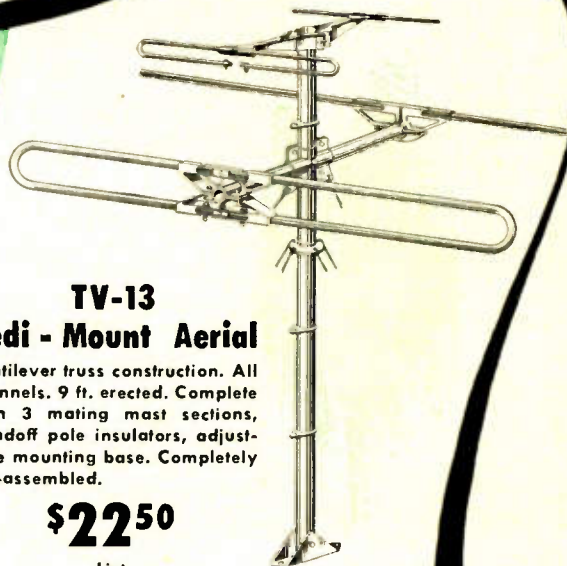

### TV-13 Redi - Mount Aerial

Cantilever truss construction. All channels. 9 ft. erected. Complete with 3 mating mast sections, standoff pole insulators, adjustable mounting base. Completely pre-assembled.

**\$22<sup>50</sup>**

List

### C-3W Auto Aerial

3 section 66" extended. Complete with tenite insulators, static ball, shielded low-loss lead.

**\$2<sup>95</sup>**

List

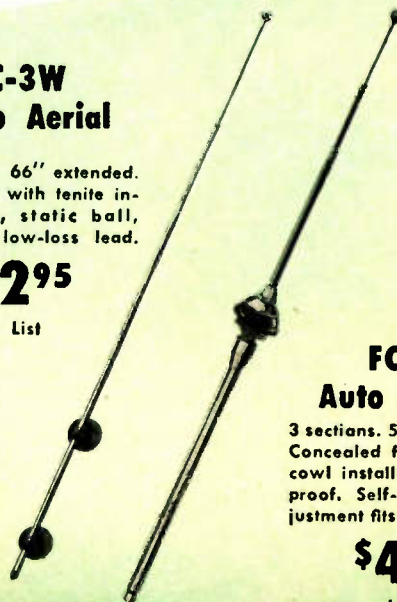

### FC-3 Auto Aerial

3 sections. 52" extended. Concealed fender or top cowl installation. Waterproof. Self-aligning adjustment fits all contours.

**\$4<sup>95</sup>**

List

### WB-2 Wall Bracket

Heavy duty rustproof steel. Adjustable to desired angle. Adjustable span.

**\$6<sup>25</sup>**

List

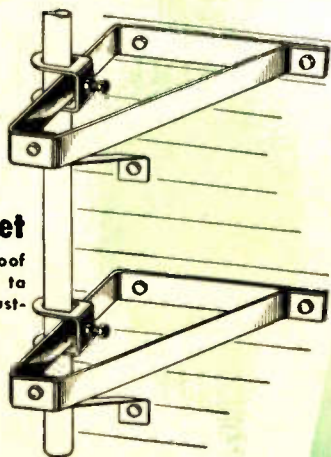

WRITE FOR OUR COMPLETE CATALOGS

# SNYDER MFG. CO.

ANTENN-GINEERS\*

22nd & ONTARIO STS., PHILADELPHIA 40, PA., U.S.A.

\*TM REG U.S. PAT OFF

EXPORT DIVISION ROBURN AGENCIES, INC. NEW YORK 7, N.Y.

*The Fastest Selling Line!*

# TELE KING

- ✓ BIGGEST PROFIT MARGIN
- ✓ LOWEST PRICES
- ✓ FINE QUALITY, PRECISION SETS

**THOUSANDS OF ENTHUSIASTIC OWNERS!**



**THE WILSHIRE**

Magnificent mahogany 12½" console. Big clean-cut TELERAMIC picture with automatic "tele-lock." All TV channels. New 10" speaker high-fidelity sound.

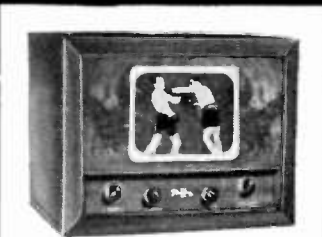

**THE STUART**

Stunning mahogany veneer 12½" table model. All TV channels with automatic "tele-lock" to keep the large TELERAMIC picture steady and clear.



**THE REGENT**

Perfect period console in gorgeous walnut or mahogany. 10" TELERAMIC picture, all TV channels, automatic "tele-lock," high-fidelity 8" speaker.



**THE GRAMERCY**

Unequaled walnut or mahogany veneer 10" table model with razor-sharp TELERAMIC picture. All TV channels, automatic "tele-lock."

**\$229<sup>95</sup>**

in walnut, plus federal tax.

TELE KING, the fastest selling TV line today, already boasts a history of thousands of elated, more-than-satisfied users. Everyone from dealers, service-men, to consumers hail Tele King as the television they've been waiting for. And here's why: Tele King sets are precision-engineered in our large plant for trouble-free perfect performance. All Tele King cabinets are fine furniture, appealing to every woman's decorating taste. And best of all, Tele King is low priced for the mass-volume market. No wonder everybody proclaims: **Tele King, no better television at any price!**

*Tele King* CORPORATION  
*Showpiece of the Home*

601 West 26th St., New York, N. Y.

Get in touch with Tele King today . . . write, wire, phone Mr. Profit, Tele King Corp., 601 West 26th St., New York, N. Y.

MAY • 1949

VOL. 66 No. 5

Television • Radio • Appliances • Records-Component Parts

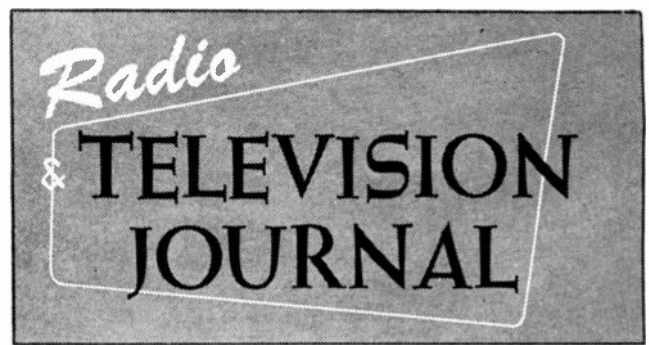

### IN THIS ISSUE

**Television Roundup** .....6  
A concise review of the month's happenings in radio and television

**Radio Parts and Electronic Equipment Show** .....7-22

“The Rep”—An Increasing Responsibility to the Television Industry....8  
How to Find People at the Show .....8  
The Impact of Television on the Parts Show .....10  
For a Successful 1949 Show .....10  
Directory of Exhibitors and Products .....12, 13, 14, 16, 18  
RMA's “Silver Anniversary”—a Brief History of 25 Momentous Years in Radio and Television .....12, 13, 14, 16, 18

**Projection Television Today—a Special Section** .....23-51

Projection Television 1949.....23  
Why Projection Television Is Here to Stay.....24  
Projection Packs a Profit Potential .....28, 29  
Latest Projection Models Are Styled to Sell .....32, 33  
How Projection Works.....36, 37  
West Coast Dealer Uses Aggressive Promotion to Sell Projection.....40  
New Projection Displays Attract Throngs of Interested Dealers.....42  
New Type of Projection “Throws” Three-by Four-Foot Image.....43  
“We Chose Projection”.....47  
“Projection Is TV of the Future”—Abrams .....48

Publisher  
**ALEX H. KOLBE**

Editor  
**NAT BOOLHACK**

Associate Editor  
**JOHN A. RICHARDS**

Business Department  
**AARON LAFER**

Art Director  
**VINCENT T. COSTELLO**

Circulation Manager  
**MARY LOUISE KAUFFMAN**

#### This Month's Cover



Like television itself, projection is here to stay. Read all about this big picture television system in the special section, pages 23 to 51, in this issue.



### DEPARTMENTS

**New Products** .....52, 54, 56, 58, 60, 64, 66  
*Radios, Television, Consoles, Phonographs, TV Accessories)*

**News and Notes of Manufacturers and Distributors** .....70

**New Appointments** .....72

**Editorial** .....74

**Advertisers' Index** .....74

Member of



OVER 30,000

Controlled Circulation Audit, Inc.

RADIO & TELEVISION JOURNAL with which is combined RADIO & APPLIANCE JOURNAL and ELECTRIC APPLIANCE JOURNAL is the complete business magazine for retail dealers who buy and sell Radios, Television Receivers, Appliances, Phonographs, Records, Master Servicing Component Parts; and is published monthly for Radio & Appliance Dealers, Jobbers, and Service Men by Kolbe Publications, Inc., Radio City, 1270 Sixth Avenue, New York 20, N. Y. Phone: Circle 7-5842. Alex H. Kolbe, President and Treasurer. Subscription \$3.00 per year in U. S. A., its possessions, South America, Canada and all other countries \$4.00 per year payable in American currency in advance. Price 35 cents per copy. No material in RADIO & TELEVISION JOURNAL may be reprinted without consent of publisher.

Printed in U.S.A.



# At Last ! ! !

# Lyte Sky Tuner...

...The **PERFECTED** antenna rotator — product of many months exhaustive research and field testing by Lyte engineers!!

## BUILT TO LAST...

The perfect rotator must meet the severe demands imposed by antenna weight, wind, and weather, without malfunctions or breakdowns. The Sky Tuner is **GUARANTEED** to do this, **GUARANTEED FOR ONE FULL YEAR**, against any and all defects in workmanship and material. Lyte is able to do this for two reasons; as antenna engineers and manufacturers they know the needs and demands of antennas; and they have spared no effort perfecting Sky Tuner before releasing it for the consumer market.

Sky Tuner turns your TV and FM antenna to the exact position for peak signal reception from each sending station simply by pressing a button on the remote-control cabinet. Rotates antenna either right or left and automatically locks in position upon release of button. Pin-point beaming vanishes "ghosts" and man-made interference.

- Fingertip control stops antenna instantly—no coasting.
- Operates on 25 volts from any 110 volt AC wall outlet. Three-conductor cable between control unit and motor.
- Will take any antenna installation. Shipped ready to install, with instructions.
- Self-protecting feature prevents accidental damage due to improper operation.
- 370 degree rotation in either direction
- Scientific speed of rotation aids quick selection of peak reception — one revolution every 45 seconds.
- Permanently weather-sealed in cast aluminum housing designed for rigidity, durability.
- Withstands antenna weight of 150 lbs. Shipping weight 8 lbs.
- Three-wire control is simple to install, more economical.
- No dead spots

### DEALERS — DISTRIBUTORS

A limited number of Lyte dealerships are still available; to secure part of this lucrative market prompt action is necessary.

For information write:

## LYTE PARTS CO.

15 Washington Ave. Plainfield, N. J. 199 Main Street, Dubuque, Iowa



**BEST BY TEST**



Remote control unit is attractively designed in molded plastic to fit mood and color scheme of decorations. Signal light indicates end of antenna revolution.

**CONTROL UNIT**

# TELEVISION ROUNDUP

## Telling Figures

More than half the dollar sales of set manufacturers in the radio and television industry fall in television, Max F. Balcom, RMA president, told a windup gathering of Town Meeting of Radio Technicians in the Ashland Boulevard Auditorium, Chicago, Ill., recently. Television can be expected to move steadily ahead of radio in dollar volume from now on, Mr. Balcom felt, even though radio set production in units was still far ahead of television unit production. At the same time, he warned technicians not to assume that "radio is on its way to extinction like the Dodo bird." Looking at the TV figures, he declared that the public had about half a billion dollars invested in some 1,500,000 TV sets, that this year the industry is shooting for the two million mark in production, for the three million mark in 1950, and that by 1951 there should be at least six million TV sets, representing about \$1.8 billion in public investment in them, in operation throughout the U.S. Mr. Balcom pointed out the expansive business this meant for capable servicemen.

Bearing out the RMA president's statement on television's surge to the fore in dollar sales, RMA's transmitter division and the National Electrical Manufacturers Association received cathode-ray tube sales reports for 1948 which pegged the television picture tube sales at 1,265,472. These were valued at \$31,985,461 and compared with the 274,008 valued at \$7,756,203 for 1947. Aggregate electron tube sales for the year, including high vacuum, gas or vapor, photo, velocity modulated and miscellaneous types, came to 4,820,435 units valued at \$60,513,248. Radio tube sales in the early months of 1949 were falling below comparable months for 1948. This year's February sales of radio tubes came to 12,643,788. Last year 17,097,461 radio tubes were sold in the second month of the year.

## TV Across the Waters

The number of television set owners in Britain is nowhere near the number of enthusiasts in this country who are willing to make the final purchase. A recent figure gives the total number of TV set owners licensed in that country as 120,000. At the time of this tally the number of radio and television set owners in Britain and Northern



*More than a million and a quarter persons see this display daily in the heart of New York's Times Square. That's promoting television in a big way.*

Ireland had increased to more than 11,639,500.

## For TV Facts

To start the information wheels rolling, RMA President Balcom last month appointed the television public relations committee, which will issue authoritative industry statements on TV technical, merchandising and other problems, and will post the industry on policies and orders of the FCC, both present and future. Paul V. Galvin, president of Motorola, Inc., is chairman of the committee and has the following associated with him: Benjamin Abrams, president of Emerson Radio & Phonograph Corp.; Dr. W. R. G. Baker, vice-president of General Electric Co.; H. C. Bonfig, vice-president of Zenith Radio Corp.; James H. Carmine, vice-president of Philco Corp.; James W. Craig, vice-president of Crosley division, Avco Mfg. Corp.; Dr. Allen B. DuMont, president of Allen B. DuMont Laboratories, Inc.; Joseph B. Elliott, vice-president of RCA Victor division, and Wm. J. Halligan, president of The Hallicrafters Co.

## More TV Facts

If the thinking about television is borne out by actions, about 1,500,000 very good prospects will buy TV during 1949, according to a survey of "Attitudes of Non-Owners of Television" released by Sylvania Electric Products, Inc. The survey actually unearthed 2,710,000 families in television areas which may purchase TV sets in the course of the year. Under present conditions of salesmanship, promotion,

programming, and confusion regarding pricing, frequencies and screen size, the industry sales volume is more likely to be the smaller figure, however. As many as 4,600,000 families were discovered with a serious interest in television, a figure which represents 28 per cent of all non-owners in television areas.

These disclosures were in sharp contrast to a similar analysis survey conducted by Sylvania in 1945, when less than half the families in television areas had purchased, intended to purchase, or were favorable to television. Current comparable interest reveals three out of four families either purchased or intend to purchase. The number of prospects today can be projected to 16,600,000, whereas in 1945 most optimistic figures set prospects at about 9,603,000 families. Reasons for not buying were largely "waiting for a cheaper set" or "can't afford it right now." Minor reasons were waiting for a "larger variety of programs" and "better quality programs."

## Phonovision Survey

Zenith Radio Corp. has taken the trouble to conduct a postcard survey in 25 American cities to determine whether telephone subscribers are willing to pay one dollar a picture to see first-run movies on television sets in their own homes. Initially, cards were sent to 5,000 names selected at random from telephone directories of five cities (Chicago, Los Angeles, Syracuse, Tucson, Ariz., and Great Falls, Mont.). On the cards returned, 83.5 per cent indicated they were willing to pay a fee for seeing first-run movies in their homes on TV. An additional 20,000 people in 20 different cities were polled, and the results were substantially in agreement with the five-city survey.

"It is obvious from these figures," said Commander E. F. McDonald, Jr., Zenith president, "that the American people do not expect to see new movies free of charge, and that they are perfectly willing to pay to see them on television." The same survey that showed about four out of five telephone subscribers were willing to pay for TV movies disclosed that a great majority of Americans never see a large number of feature pictures. Of 21 Hollywood productions released in the last 10 years which grossed over \$5,000,000, the survey respondents had seen an average of about half of them.



# 1949

## RADIO

## PARTS

and

## ELECTRONIC

## EQUIPMENT

## SHOW

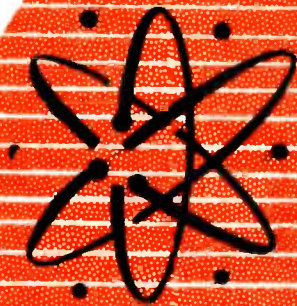
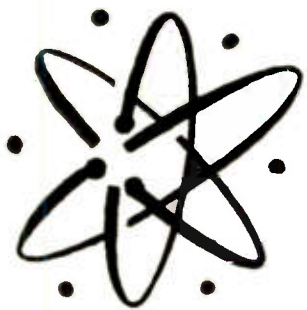
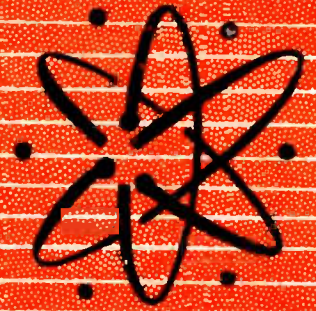

HOTEL STEVENS  
• CHICAGO •  
WEEK OF MAY 16-20



AN RTJ SPECIAL SECTION . . . MAY 1949



**all eyes**  
WILL BE ON

*Booth 42*

**TRI-O-SPEED  
TRI-O-MATIC**



at the  
**MAY PARTS SHOW**  
17th, 18th, 19th, 20th  
Hotel Stevens, Chicago

**W-M**  
*Corporation*

**BENTON HARBOR, MICHIGAN**

**TELE-TAPE**  
**T V ANTENNA**

**\$2.00**  
retail

Channels  
2 to 13  
plus  
FM

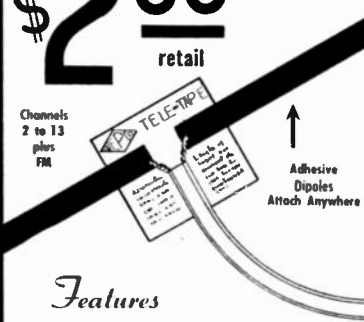

Adhesive  
Dipoles  
Attach Anywhere

*Features*

- 2 minutes installation
- Installs under rugs, on baseboards, window sills, etc.
- Lowest cost
- Store traffic item

See your distributor or order direct from—

**WALTER E. PEEK, Inc.**  
2842 W. 30th STREET  
Indianapolis 22, Ind.

## "The Rep"—An Increasing Responsibility to The Radio and Television Industry

By L. C. McCarthy, National Secretary-Treasurer of  
"The Representatives"

With the annual May trade show now a reality, members of "The Representatives" of Radio Parts Manufacturers, Inc. are helping to set the stage for another and very promising year for manufacturers, distributors and dealers alike.

That an increasing responsibility toward the entire industry is being assumed by "The Representatives" is evidenced by their participation on all fronts. In addition to the Information Center, members will contribute their time to serve on the Credentials Committee Panel to assist in the processing of requests for Exhibition Hall badges for all sales representatives. Sixty members have already volunteered their services to the Show Corporation for this purpose.

"The Radio Industry Special Trains," long-associated with "The Representatives" and now an eagerly anticipated part of each year's Show, are again arriving in Chicago early Sunday morning, May 15th.

During the past year, "The Representatives" have started several new projects, all designed to be of greater service to the industry. A major item on this agenda was the whole-hearted cooperation of various regional chapters who supported the "Town Meeting" programs in New York, Boston, Atlanta, Los Angeles, and Chicago. Local chapters underwrote a share of the expenses, handled registration, served as ushers, organized meetings and, in

the final Chicago meeting, offered their services to sign and distribute copies of the "Certificate of Leadership in Television" to all servicemen who attended the meetings and earned the award.

In an attempt to create greater harmony among the various trade associations within the industry and to integrate all efforts more closely, they have increased the circulation of their monthly newsletter to members, "The REPresentor" to include all officers and directors of every other association. This was just another step toward increasing industry-wide cooperation and the results thus far are most encouraging.

In addition to the many activities sponsored by the national organization, local chapters have instituted educational campaigns to improve the service of members to their own principals and jobbers. These programs covered a wide variety of subject material, both technical and sales, and included such special projects as the organization of the new "Electronics Club" in San Francisco, the Gopher Caravan in Minnesota, the Missouri Valley Conference, and the first Southwestern I. R. E. Conference. All of these projects will be continued after the May show closes to further increase unity among local manufacturers, jobbers, sales representatives, and dealers for the competitive years ahead.

### How to Locate Others at the Show

One of the unusual features at this year's "Trade Show" at the Hotel Stevens is a brand new Information Center conveniently located in the middle of the fifth floor lobby at the Stevens, immediately adjacent to the two-floor display area. The Information Center, which is being sponsored by "The Representatives" is divided into two sections—one to locate people you wish to see, and the other to leave messages for persons you cannot locate yourself. It will be "manned" by attractive girls who will be able to answer all questions about the

Exhibits, and in addition will supply train and plane information. The message section will be supplied with specially-designed memo pads and pencils so that everyone will have his own reference book throughout the Show. A booth telephone will enable visitors to reach others, either in the Stevens or at any other hotel in Chicago. It is hoped that the Information Center will serve to keep everyone in touch so that no one will leave this year's Radio Parts Show with a "Sorry, I missed you at the Show" apology later.





**Built-in antenna**

**12 1/2"  
"Spotlite Brite" TV**

**full-size console  
at \$349.95!**



Air King Products Co., Inc. • 170 — 53rd St., Brooklyn 32, N.Y.

Wait till your customers see the new Air King A-2001 and A-2002. 12 1/2" "Spotlite Brite" tube for a sharper, clearer, bigger picture... plus the rich tone of a full sized 10" speaker... plus a built-in dipole antenna and every other feature in the book! Air King has everything at this unbelievable low price!

The 12 1/2" A-2001 and A-2002, or the 13" A-1001A and A-2000 available in beautifully hand-rubbed wood—mahogany or blonde mahogany. A-1001A 10" Console priced at \$299.95, A-2000 10" Table model at \$239.95. Order now!



See Air King's Display at  
Chicago Radio Parts Show  
Blackstone Hotel • Ivy Room  
Monday, May 16th through 19th

Table 12 1/2"  
\$299.95

it's new!

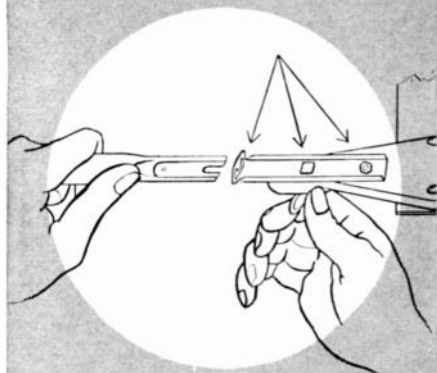

The **RMS** TV  
ANTENNA LINE with the  
New, Exclusive feature

**SPEE-D-LOK\***

assembly

Dealers and service men across the country recognize these facts about the RMS Antenna Line:

1. GREATER EFFICIENCY—  
BETTER RESULTS
2. SPEEDIER INSTALLATION IN  
MATTER OF SECONDS
3. MODERATELY PRICED



See the RMS Antenna Line at the  
Parts Show, Stevens Hotel,  
Chicago, Booth 31.

Send for the NEW Spring  
1949 Catalog # 215.

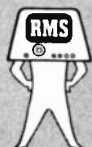

**RADIO MERCHANDISE SALES, INC.**  
550 Westchester Avenue, New York 55

## "Television's Impact on the Parts Industry"

By **L. B. Calamaras**  
Executive Secretary, NEDA

All those who attend the 1949 Radio Parts Show will be impressed by the many new features making their initial appearance. The entire industry will gather under the canopy of the May Show to celebrate the Silver Anniversary of the Radio Manufacturers Association. During its 25 years' existence, RMA has not only served the industry capably, but also through the exemplary administration of its affairs has elevated the stature of the industry to its present position of pre-eminence in American social and economic life.

The first real impact of television upon the parts industry has made itself felt for the first time during the past year. This has been impressively reflected both in increased volume of business and the changing nature of the parts business itself.

We expect that the May Show will give greatest emphasis and prominence to components and



equipment devised and streamlined for television use. We don't know what they will be like, but it is certain that the interest is greater than ever before and it is only natural to predict that those who plan to attend, expect to see a great deal that is new. One thing is certain—the 1949 Show will, to all appearances, enjoy the largest attendance ever.

## For a Successful 1949 Show

Industry representatives at the Radio Parts and Electronic Equipment Conference and Show will find some novel changes this year. Early arrivals, for instance, will find that they may skip association meetings and still make good use of the time, since displays in Exhibition Hall will be open for inspection on Monday, May 16th. Also, for the first time, visiting hours in the Hall have been allocated on Wednesday, Thursday, and Friday so that distributors' groups will have exclusive periods. The vexing problem of keeping track of personnel in attendance at the Show has been ironed out (See Page 8). And, finally, the annual dinner normally held the night before the opening has been scheduled to coincide with the Radio Manufacturers Association's Silver Anniversary Dinner on Thursday, May 19th.

Under the direction of Kenneth C. Prince, Show manager, the procedure at the Show has been streamlined and everyone attending immediately will be aware of the seven-point program promulgated by the management for assuring the success of the entire affair. Pre-registration for exhibitors, with a listing of booths, display rooms, and sleeping rooms—all shown in the Di-

rectory—has gone forward without a hitch. To avoid any jam at the opening, members of the industry who have not been pre-registered will be accommodated in special booths in the lower level of Exhibition Hall. With more Hotel Stevens rooms allotted this year, concentration of more of the industry in a smaller space will facilitate all contacts. Display room area will make exhibit inspection simpler, too. Badges that were mailed early will speed up admissions to all restricted areas without long waiting periods. Message and directory service will facilitate the location of all manufacturers, distributors and sales representatives. There will be no meetings scheduled during show hours, and finally, an educational program for all distributors will be offered under the guidance of L. B. Calamaras.

A testing ground for new products and new sales promotions, the Show will have more than 230 separate display units this year. Exhibition Hall will be utilized to the capacity of its 161 exhibit areas. Sixty display rooms on the fifth and sixth floors of the Stevens have been made available, and there will be a complete Press Row of trade publications.



f e d e r a l  
TELEVISION  
CORPORATION

Trade Mark

... "your 1950 Television line!"  
featuring . . . 3 magic dials  
to perfect performance!

An astounding minimum of tuning effort — with a maximum degree of tuning accuracy! This is the triumphant result of Federal Television's revolutionary 3-dial control! No vertical, horizontal, brilliance or focus controls. Picture and sound tune in simultaneously with one easy turn of the dial! Pictures are brilliant and "flicker-free" . . . details amazingly sharp . . . FM reception wonderfully clear. Federal Television works so simply . . . even a child can operate it!

3 MODELS  
REPRESENTATIVE OF  
FEDERAL TELEVISION'S  
"MODERN MIRACLE" LINE

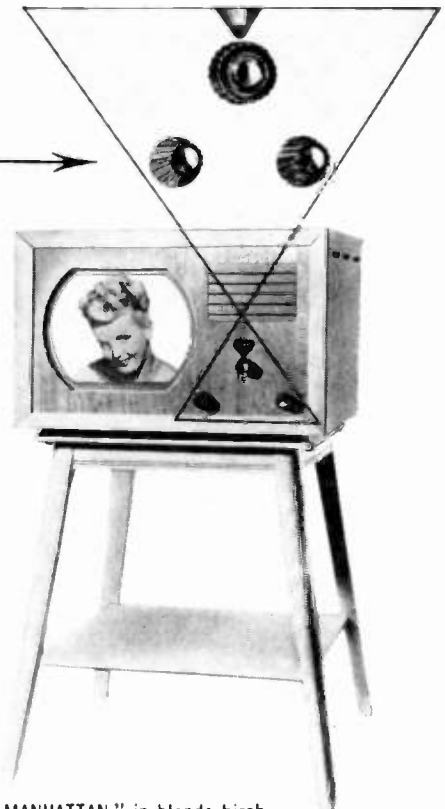

"THE MANHATTAN," in blonde birch. Big 132 sq. in. picture . . . FM receiver . . . matching table.

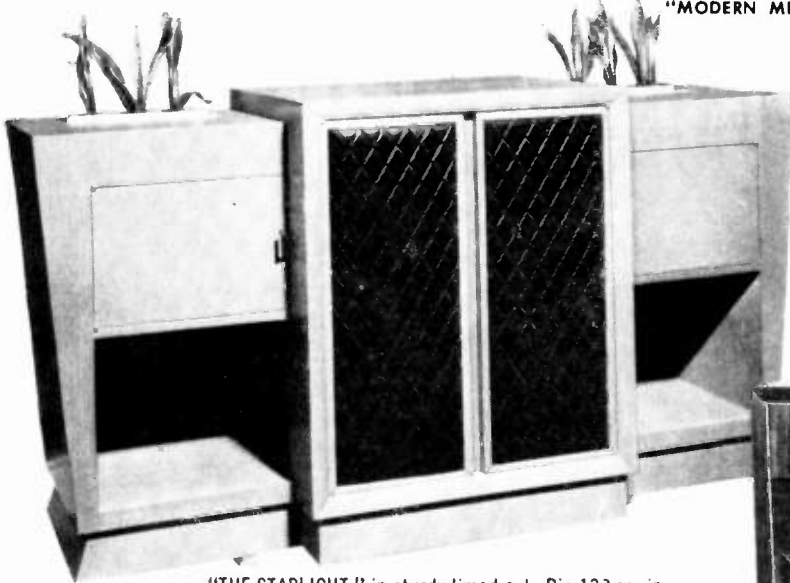

"THE STARLIGHT," in sturdy limed oak. Big 132 sq. in. picture . . . 12" PM dynamic speaker . . . AM-FM radio . . . 3-speed record player.

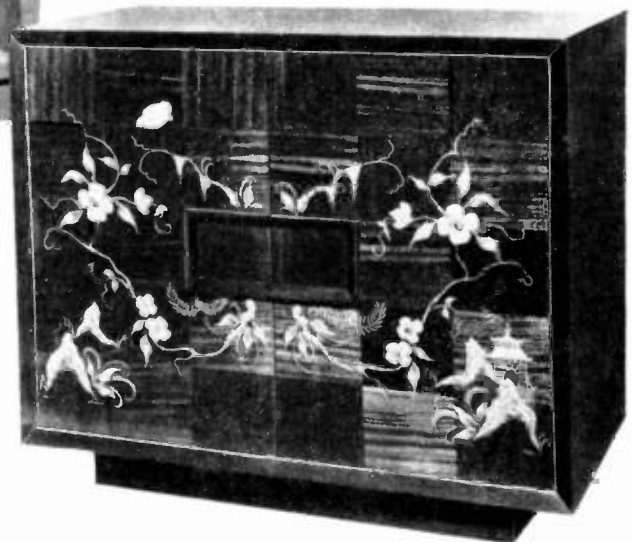

"THE FLEETWOOD," in rich mahogany with Chinese decor. Big 132 sq. in. picture . . . 12" symphonic speaker . . . FM radio . . . 3-speed record player.

**OTHER OUTSTANDING FEDERAL TELEVISION FEATURES**

- DISTINCTIVELY DIFFERENT STYLING! ● UNSURPASSED PICTURE BRILLIANCE, STEADINESS, DEFINITION AND CLARITY!
- POWERFUL NEW CIRCUITS! ● AUTOMATIC GAIN CONTROL!
- FULL CHANNEL COVERAGE! ● AUTOMATIC PICTURE LOCK!

All Federal Television Receivers carry a "slave" unit receptacle which enables viewing programs in more than one part of the house — or outside the house — at the same time. All table models are equipped with phonograph receptacles too!

f e d e r a l  
T.M. TELEVISION  
CORPORATION

137-9-41 DUANE ST. • NEW YORK 13 • FACTORIES: NEW YORK • CONNECTICUT

DISTRIBUTORSHIPS AND TERRITORIES AVAILABLE! WRITE, WIRE OR PHONE FOR DETAILS!

# Presenting DURANITE

## the SUPERIOR CAPACITOR



● An entirely new tubular capacitor—featuring Aerolene, the new impregnant; new processing methods; new DURANITE casing.

Such is DURANITE—the toughest tubular yet offered for use in stay-put assemblies. Therefore don't confuse DURANITES with conventional molded tubulars. DURANITES are different.

Drop, bang, scratch—no damage to the permanent, non-varying, rock-hard DURANITE casing. Unaffected by high temperatures—nothing to melt or burn. Thoroughly moistureproof. No shelf deterioration. Pigtailed won't pull out. And so on.

Order DURANITES from your Aerovox jobber. Popular capacities. 200 to 1600 v. D.C.W. Try them. You'll be amazed!



**FOR RADIO-ELECTRONIC AND  
INDUSTRIAL APPLICATIONS**

AEROVOX CORP., NEW BEDFORD, MASS., U.S.A.  
Export: 13 E. 40th St., New York 16, N.Y. • Cable: 'ARLAB'  
In Canada: AEROVOX CANADA LTD., Hamilton, Ont.

# DIRECTORY of EXHIBITORS

*Official Listing of*  
MERCHANDISE DISPLAYED AND  
PERSONNEL IN ATTENDANCE

1949 RADIO PARTS and ELECTRONIC EQUIPMENT SHOW

ADVANCE ELEC. & RELAY CO. ... new type relays.	29	BURLINGTON INSTRUMENT CO. ... AC-DC electrical indicating instruments, new designed regulator control package, new model instruments. C. E. McGuigan, W. S. Kramer, H. L. Luth.	22
AEROVOX CORP.	86	BUSSMAN MFG. CO. ... Small dimension fuses. A. A. Sommer.	106
AIRCRAFT-MARINE PROD.	23	CAMBURN, INC. ... Television antenna. Max Bernstein.	6
ALLIANCE MFG. CO. ... phonograph, heater, recorder motors, etc. The "Tenna-Rotor". R. F. Doyle, John Bentia, A. E. Smith and P. J. Zuccherro.	145	CARTER MOTOR COMPANY ... Wire and tape recorder portable converters, dynamotors, genemotors, magmotor rotary power supplies. Robert W. and E. J. Carter.	37
ALPHA WIRE CORP. ... Wire and cable. Peter Bercoe.	95	CENTRALAB ... Capacitors.	39
ALTEC LANSING CORP.	107	CHICAGO TRANSFORMER DIVISION ... Transformers. Newton Cook.	160
AMERICAN CONDENSER CO. ... Condensers.	155	CINAUDAGRAPH SPEAKERS ... Regular line of speakers and new extra heavy duty 12 and 15 inch speakers with 2" voice coil and 35 ounce Alnico 5 magnet. D. B. Hickman.	9
AMERICAN MICROPHONE CO. ... Microphones, phonograph pickup arms and cartridges. Gramer Yarbrough.	113	CINCH MANUFACTURING CO. ... Multi contact plugs and sockets, barrier type terminal strips, terminal panels, fuse mounts, etc.	97
AMERICAN PHENOLIC CORP. ... Microphones, shock absorbers, antennae, components.	109	CLAROSTAT MFG. CO. ... Resistors and other electronic parts. James Youngblood, Fran Chamberlain.	51
AMERICAN RADIO HARDWARE CO.	14	COLUMBIA WIRE AND SUPPLY CO. ... Electrical insulated wire, cords, television cable and wire. Leon Harris, Francis Florsheim.	130
AMERICAN TELEVISION & RADIO CO. ... ATR auto radio vibrators, DC-AC inverters, battery eliminators.	82	CONDENSER PRODUCTS CO. ... HiVolt power supplies. M. H. Levenberg.	144
AMPEREX ELECTRONIC PROD. CO. ... Radio and television tubes.	91	CONSOLIDATED WIRE & ASSOC. COMPANIES ... Wire and cables, slide rule television aerial, aerial accessories. J. G. & J. J. Mann, R. C. Graham.	134
AMPERITE COMPANY ... New delay relay and ribbon microphone. S. Rutenberg.	55	CONTINENTAL CARBON CO. ... X type "Nobleoy" precision resistor, M type "Carbomite" composition resistors. William M. Wood.	148
ASTATIC CORPORATION ... First pickup cartridge with ceramic element and replaceable needle. W. J. Doyle.	141	CONTINENTAL ELECTRIC CO. ... Tubes and lead sulfide photo conductive cells. Edward C. Hanson.	27
ATLAS SOUND CORPORATION ... Loudspeakers, Loudspeaker stands and supports, microphone stands. Robert C. Reinhardt.	96	CORNISH WIRE CO. ... Wires & cable. J. S. Miller.	48
AUDAK COMPANY ... Electronic recorders.	116	CRESCENT INDUSTRIES ... Speakers, wire recorders.	78
AUDIO DEVICES ... Discs and points. Bryce Haynes.	24	CRONAME, INC. ... Accessory items for radio and television.	84
BARKER & WILLIAMSON, INC. ... Coils, capacitors, components.	123	DRAKE ELECTRIC WORKS, INC. ... Exhibition room 556. Soldering irons, "instant heat" solder gun, thermostatically controlled heat control.	149
BELDEN MFG. CO. ... Radio electronic wire and cable.	90	DUOTONE COMPANY, INC. ... Needles, recording blanks, lenses, television filters. Stephen Nester, Wm. A. Boeger, Jr.	122
BELL SOUND SYSTEMS ... Sound equipment, amplifiers, recorders.	40	EAGLE ELECTRONICS, INC. ... Television and radio kits, television chassis. W. Kranz.	156
BLILEY ELECTRIC CO. ... Quartz crystals and crystal controlled oscillators.	7		
BOGEN COMPANY, INC., DAVID ... Complete line of sound equipment. David and Lester Bogen, Sidney Harman, Alfred Zuckerman.	44		
BRITISH INDUSTRIES CORP. ... Ersin multicore solder. Book on loudspeakers, automatic record changers. Leonard Carduner.	67		
BRUSH DEVELOPMENT CO. ... Acoustic products.	41-A		
BUD RADIO, INC. ... Radio and electronic transmitting components.	69		
BURGESS BATTERY CO. ... New flat-cell construction. L. H. Harris.	12		



Company	Booth
<b>ECKSTEIN RADIO &amp; TELEV. CO.</b>	<b>26</b>
. . . Multi-band and fixed frequency mobile receivers for cars and trucks. E. A. Eckstein.	
<b>EITEL-McCULLOUGH, INC.</b>	<b>158</b>
. . . Eimac vacuum tube line, variable and fixed vacuum capacitors, new tetrodes. O. H. Brown, J. A. McCullough.	
<b>ELECTRONIC INSTRUMENT CO.</b>	<b>133</b>
. . . Mechanical signal generator and kit, oscilloscope and kit. Harry Ashley.	
<b>ELECTRONIC SOLDERING IRON CO.</b>	<b>47</b>
. . . Soldering irons.	
<b>ELECTRO PRODUCTS LABORATORIES</b>	<b>57</b>
. . . Regular line battery eliminators and supplies, Model "R" 6 volt 20 ampere power supply, model "F" simplified for 5, 6, 7 and 8 tube battery radio sets. R. C. Crossley.	
<b>ELECTRO-VOICE, INC.</b>	<b>81</b>
. . . Twilt phono pickup cartridge, microphones (models 611 and 911). A. R. Kahn, W. F. Soules.	
<b>ELECTROVOX CO.</b>	<b>50</b>
. . . Walco lenses for TV sets, Walco phonograph needles, Robert Walcutt, Gene Lucas.	
<b>ELLAR WOODCRAFT PRODUCTS</b>	<b>33</b>
. . . full line of television cabinets. Sam Rappaport.	
<b>ERIE RESISTOR CORPORATION</b>	<b>142</b>
. . . Ceramic capacitors, ceramic trimmer condensers, button silver mica capacitors. Allen K. Shenk.	
<b>ESPEY SALES CORPORATION</b>	<b>85</b>
. . . AM-FM chassis, portable AM-FM receivers, television kits, power amplifiers. W. W. Jablon.	
<b>FREED TRANSFORMER CORP.</b>	<b>113</b>
. . . Transformers, reactors, test equipment. Lawrence Freed.	
<b>GEE-LAR PRODUCTS CO.</b>	<b>45</b>
. . . Radio knobs.	
<b>GENERAL CEMENT MFG. CO.</b>	<b>127</b>
. . . T.V. accessories and displays. R. G. Ellis, S. B. Valiulis.	
<b>GENERAL ELECTRIC COMPANY</b>	<b>75</b>
. . . Tubes, parts, components and accessories.	
<b>GENERAL INDUSTRIES CO.</b>	<b>70</b>
. . . Electric phonograph motors, home recording assemblies, combination record changer-recorders and recording motors. Harry Moon.	
<b>GENERAL TRANSFORMER CORP.</b>	<b>62</b>
. . . Transformers.	
<b>GIRARD-HOPKINS CO.</b>	<b>71</b>
<b>GUARDIAN ELEC. MFG. CO.</b>	<b>19</b>
. . . Co-axial relays, focus coils. J. J. Rowell.	
<b>HALLDORSON COMPANY</b>	<b>15</b>
. . . Transformers.	
<b>HALLICRAFTERS CO.</b>	<b>153</b>
. . . Communications and television receivers. William J. Halligan. Rooms 604A and 605A.	
<b>HARDWICK, HINDLE, INC.</b>	<b>54</b>
. . . Resistors, rheostats.	
<b>HEXACON ELECTRIC CO.</b>	<b>28</b>
. . . Solder - Master royal blue line. George A. Allen.	
<b>HICKOK ELECTRICAL INST. CO.</b>	<b>8</b>
. . . Room No. 526A. Radio service instruments. H. D. Johnson.	
<b>INDIANA STEEL PROD. CO.</b>	<b>83</b>
. . . Tape recording head, new magnetic recording tape.	
<b>INDUSTRIAL CONDENSER CORP.</b>	<b>79</b>
. . . Eliminators, capacitors.	
<b>INSULINE CORP. OF AMERICA</b>	<b>2</b>
. . . Room No. 509A. ICA super wasp indoor portable TV antenna, TV servicing and aligning tools, replacement parts and antennas. S. J. Spector.	
<b>INTERNATIONAL RESISTANCE COMPANY</b>	<b>115</b>
. . . Regular line, new merchandise kits. R. D. Ferree.	

(Continued on page 14)

Century's FIRST with...

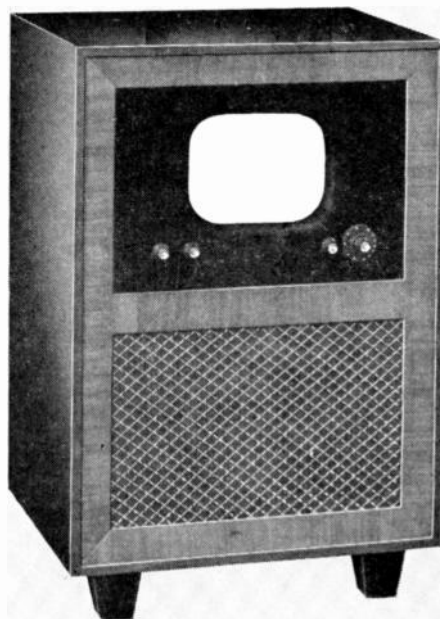

# VISUAL TUNING

It's the natural thing to do. You tune by eye instead of ear. You tune the picture, not the sound. Now you can see what you're doing. Customers are thrilled with the new ease of tuning and with Century's superb picture quality.

ITI's new Century line of home receivers brings you advanced circuit design—superior performance, fewer service calls. 16" remote control units for the class market—12" receivers for the mass market. Semi-automatic tuning with just two picture controls. Magnificent Swedish modern cabinets. Lower power consumption—about 33% less. A complete\* line.

If you want to make longer profits and avoid tie-in buying . . . stay ahead of competition with ITI, the vision in television.

\*The line includes: Remote Control Combination with 16" viewing unit (Model 226) and choirside TV control unit with AM-FM-Phonograph (Model 234); Table top Model (Model 521); Console (Model 221); Console with doors (Model 421); and 5-way Combination with AM-FM-TV, plus Regular and LP automatic phonograph (Model 321). All available in dark or blond mahogany.



**INDUSTRIAL TELEVISION INC.**  
359 Lexington Avenue  
Clifton New Jersey

# SPRAGUE PHENOLIC-MOLDED TELECAP\* TUBULARS



**THE MOST  
TRULY  
DEPENDABLE  
PAPER  
TUBULAR  
CAPACITORS  
EVER OFFERED  
TO THE  
SERVICE  
PROFESSION**

- Extra Dependability at No Extra Cost
- Withstand Heat and Humidity, Shock and Vibration
- High Insulation Resistance
- High Dielectric Strength
- Unequaled for Sizzling AC-DC Midgets, or "Hot" TV and Auto Sets.

See Your Jobber Today!

**SPRAGUE PRODUCTS CO.**  
North Adams, Mass.

\*Trademark

## DIRECTORY OF EXHIBITORS

Company	Booth	Company	Booth
<b>JACKSON ELECTRICAL INST. CO.</b>	98	<b>PHILMORE MFG. CO.</b>	21
... 5" scope .018 sensitivity 4.5 MC band width, low-priced dynamic tube tester, AM-FM oscillator. J. M. Fulker-son, R. C. Apple, P. F. Jackson, Wm. Hagstrum.		... Television kits and wired chassis. M. L. Granat.	
<b>J. B-T INSTRUMENTS, INC.</b>	66	<b>POTTER &amp; BRUMFIELD</b>	13
... Measuring instruments, meters, testers.		... Super midget model SM relay.	
<b>J. F. D. MANUFACTURING CO.</b>	117	<b>PRECISION APPARATUS CO.</b>	94
... Antennas, antenna brackets and accessories, ballasts, radio parts. Al and Ed Finkel, Al Friedman.		... Complete TV service shop. G. N. Goldberger.	
<b>JENSEN INDUSTRIES</b>	52	<b>PRESTO RECORDING CORP.</b>	159
... Phonograph needles. Peter Jensen.		... Room 557. Tape recorders, micro-groove disc recorders, turntable equip-ment, transcription player. Thomas B. Aldrich.	
<b>JENSEN MANUFACTURING CO.</b>	36	<b>PYRAMID ELECTRIC COMPANY</b>	1
... Room No. 505. Wide-range loud-speakers, customode cabinets. Thos. A. White, Ralph T. Sullivan, Chas. A. Hansen, Bayard H. Clark.		... TV electrolytics for 85 degree C operation, ceramic-cased paper capaci-tors for applications up to 100°C. Sylvan A. Wolin.	
<b>E. F. JOHNSON CO.</b>	35	<b>QUAM-NICHOLS CO.</b>	132
... Radio transmitting and electronic products.		... Complete line of speakers. John O'Brien, A. A. Foosner, H. A. Stan-land.	
<b>KELLOGG SWITCHBOARD &amp; SUPPLY CO.</b>	137	<b>RACON ELEC. MFG. CO.</b>	76
<b>KENYON TRANSFORMER CO.</b>	3	... Speakers, trumpets, reentrant horns, driver units, marine speakers. A. I. Abrahams.	
... Transformers, reactors. R. B. Shimer.		<b>RAD-EL-CO MANUFACTURING CO.</b>	87-A
<b>KESTER SOLDER COMPANY</b>	3	... TV antennas. Sidney Ludwig, R. R. Cull.	
... "Resin-Five" flux-core solder. J. H. Humble, L. M. Skelton.		<b>RADIARD CORP., THE</b>	32
<b>LA POINTE PLASCAMOLD CORP.</b>	20	... Indoor and outdoor TV antennas, antenna rotator, auto aerials, vibrator power supplies, inverters, "A" battery power supply. Milton A. Roth.	
... Antennas and accessories. Jerome E. Respass.		<b>RADIO CITY PRODUCTS CO.</b>	119
<b>LEACH RELAY CO.</b>	53	... Combination oscilloscope and sweep generator, marker, marker and sweep generator, vacuum tube volt-meter, audio oscillator and squarewave generator, 5" cathode ray oscilloscope, tube tester, tube and set tester, signal generator. Mr. Reiner.	
<b>LECTROH'A, INC.</b>	54	<b>RADIO CORPORATION OF AMERICA</b>	135-A
... Vitreous enameled resistors. V. J. Mueller, Ralph Wester.		... Tubes, battery, test and measuring equipment, electronic components, sales promotional material. Julius Haber.	
<b>LENZ ELECTRIC MFG. CO.</b>	104	<b>RADIO CRAFTSMEN, INC., THE</b>	112
... Wire and parts.		... RC 8 tuner, RC 2 amplifier, SR 1 slide rule antenna, custom television chassis. Howard Christianson.	
<b>MALLORY &amp; CO., INC., P. R.</b>	58	<b>RADIO MERCHANDISE SALES, INC.</b>	31
... 16/16" volume and tone control—the Mallory Midgetrol. W. E. Harvey.		... Will show pictorially the local area adjacent to the transmitter, the suburbanite installation, the fringe area installation with appropriate an-tenna shown. Sid Pariser, Hy Bloom.	
<b>MARKEL ELECTRIC CO.</b>	88-A	<b>RAULAND-BORG CORPORATION</b>	143
<b>MERIT COIL &amp; TRANSFORMER CORP.</b>	150	<b>RAYTHEON MFG. CO.</b>	99
... Merit's 25th anniversary, com-plete line of TV replacements, outdoor weather-proofed transformers, Univer-sal line transformers for use with con-stant 70.7V line. W. J. Barron.		... Tubes.	
<b>MILLER MFG. CO., JAMES</b>	140	<b>RECORDISC CORP.</b>	103
... Transmitters and parts.		... Recording wire and discs. Sidney S. Gould, Lawrence Friedman.	
<b>NATIONAL COMPANY, INC.</b>	61	<b>RECOTON CORP.</b>	49
... Receivers and radio parts.		... Phonograph needles.	
<b>NATIONAL UNION RADIO CORP.</b>	10	<b>REK-O-KUT COMPANY</b>	72
... Complete line of electron tubes featuring "Videotron" 2-V picture tube. E. J. Maginot.		... Recording equipment.	
<b>NEWCOMB AUDIO PRODUCTS CO.</b>	80	<b>JOHN F. RIDER, PUBLISHER</b>	114
... Room 522. "H" & "K" series line. Robert Newcomb.		... Rider AM-FM-PA-TV Service manuals, radio-tv text books, promo-tional display material. Bill Marcus, John Rider.	
<b>OHMITE MFG. CO.</b>	152	<b>HOWARD W. SAMS &amp; CO.</b>	131
... 1-watt "Little Devil" insulated composition resistor assortment in plastic cabinet, rheostats, resistors, tap switches. R. S. Laird.		... Suite 1400-01A. Photofact publi-cations. Howard W. Sams, Paul H. Wendel.	
<b>OPERADIO MFG. CO.</b>	87	<b>SANGAMO ELECTRIC CO.</b>	154
... Suite No. 519-A, 520-A. DuKane tape recorder, radio replacement, pub-lic address speakers, sound equipment, Flesifone intercom. Fred D. Wilson.		... Capacitors. J. G. Twist.	
<b>PAR-METAL PROD. CORP.</b>	136	<b>WALTER L. SCHOTT CO.</b>	120
... Radio cabinets, chassis, metal. Oren H. Smith.		... TV tools, new chemicals, new line "99" hardware. W. L. Schott.	
<b>PARK METALWARE CO., INC.</b>	125		
... Combination nut and screwdriving sets. F. B. Farrington.			
<b>PERMOFLUX CORP.</b>	43		
... Room 607-A. Replacement speak-ers. M. B. Leskin, Marshall E. Neil.			
<b>PERMO, INC.</b>	38		
... Phonograph needles			
<b>PHALO PLASTICS CORP.</b>	30		

(Continued on page 16)



# THIS DISPLAY REALLY SELLS VUE-SCOPE



## ***This Hard-Hitting Store-Tested Display IS YOURS WITHOUT COST!***

Actual tests in TEN RETAIL STORES prove that this terrific display **DOUBLES** and **TRIPLES** your Vue-Scope sales! This revolving "silent salesman" shows how your *three fastest-selling Vue-Scope Lenses* look and work on the television set—demonstrates the sensational new "Magic-Mount" Bracket. Lenses *sell themselves!* Get yours **NOW!** Regular Value \$25.00

**Write Now!** 

*Write us direct or ask your distributor how to get a VUE-SCOPE Television Magnifying Lens Display without charge. Do it TODAY!*

**CELOMAT CORPORATION**

Dept. J

521 West 23rd Street, New York 11, N. Y.

Gentlemen: Yes, I'm interested in hearing more about this sensational new Vue-Scope Display. Please send me complete details!

Name \_\_\_\_\_

Address \_\_\_\_\_

City \_\_\_\_\_ Zone \_\_\_\_\_ State \_\_\_\_\_

Eliminate the Variables  
in  
Television Installation  
with the



**FIELD STRENGTH METER**  
Do not depend on pictures—  
Use absolute measurements—  
Direct Meter Readings!



Improves Installation !!  
Saves 1/2 the Work !!

Has numerous features and advantages, including— (1) Measures actual picture signal strength . . . (2) Permits actual picture signal measurements without the use of a complete television set . . . (3) Antenna orientation can be done exactly . . . (4) Measures losses or gains of various antenna and lead-in combinations . . . (5) Useful for checking receiver re-radiation (local oscillator) . . . (6) 12 CHANNEL SELECTOR . . . (7) Amplitudes of interfering signals can be checked . . . (8) Weighs only 5 lbs. . . (9) Individually calibrated . . . (10) Housed in attractive metal carrying case . . . (11) Initial cost of this unit is covered after only 3 or 4 installations . . . (12) Operates on 110V, 60 Cycles, AC.  
Model FSM-1, complete with tubes . \$99.50

Transvision offers a complete line:

- Television Kits and Cabinets
- Field Strength Meter
- Sweep Signal Generator
- All-Channel TV Booster
- Remote Control Units
- Tuners • Lenses • Antennas
- Accessories and Parts

All prices fair traded . . . 5% higher west of the Mississippi River.

See Your Local Transvision Outlet, or

Mail this coupon today to:—

**TRANSVISION, INC.**  
NEW ROCHELLE, N. Y.

Please ship THROUGH YOUR NEAREST LOCAL OUTLET:—

RJ-5

( ) Field Strength Meters

I am enclosing 10% DEPOSIT in the amount of \$ . . . . ., balance C.O.D.

( ) Send details of Dealer Plan.

Name . . . . .  
(please print)

Address . . . . .

City & State . . . . .

## DIRECTORY

(Continued)

Company	Booth
<b>HERMAN HOSMER SCOTT, INC.</b> . . . . .	64
. . . . . Room 609. Dynamic noise suppressor products, new triode dynamic noise suppressor amplifier. H. H. Scott.	
<b>SHUR-ANTENNA-MOUNT</b> . . . . .	102
. . . . . Antennas.	
<b>SHURE BROTHERS</b> . . . . .	124
. . . . . Microphones.	
<b>McMURDO SILVER CO., INC.</b> . . . . .	41
. . . . . Model 914 TV antenna aligner, Model 915 Tubeless grid dip adapter, Model 918 high voltage probe for Models 900 & 900-A. Howard L. Page, Douglas H. Carpenter.	
<b>SIMPSON ELECTRIC COMPANY</b> . . . . .	139
. . . . . Test equipment, Model 480 TV genescope, Model 479 TV signal generator, Model 184-micro-tuner, Model 351 TV antenna compass. H. A. Bernreuter, M. O. Buehring, O. Simpson, J. T. Kenney, R. T. Brown.	
<b>SIMPSON MANUFACTURING CO., MARK</b> . . . . .	46
. . . . . Suite 605-607. AC-DC and straight AC intermix intercom systems, school and hospital systems, high fidelity amplifiers, tape recorders. Miryam Simpson.	
<b>SNIDER TELEVISION CORP.</b> . . . . .	157
. . . . . Home television receivers, 122AM. Mike Muckley.	
<b>SNC MANUFACTURING CO.</b> . . . . .	59
. . . . . Transformers.	
<b>SNYDER MANUFACTURING CO.</b> . . . . .	128
. . . . . Auto antennas, TV aerials, TV accessories. Ben Snyder, Dick Morris, Sam Wiley, Len Pill.	
<b>SOLA ELECTRIC CO.</b> . . . . .	74
. . . . . Transformers.	
<b>SPIRLING PRODUCTS</b> . . . . .	25
. . . . . TV and auto antennas. Bill Goldman.	
<b>SPRAGUE PRODUCTS CO.</b> . . . . .	89
. . . . . "Discon" ceramic capacitors, "Telecap" molded paper capacitors, "Atom" and "Twistlok" television electrolytic capacitors, "Prokar" high temperature molded capacitors. Harry Kalker.	
<b>STANDARD TRANSFORMER CORP.</b> . . . . .	88
. . . . . Suite 601-602A has industrial display . . . . . Suite 1005 conference room for distributors. HF & WF series of high fidelity audio transformers, replacement components. Earl T. Champion.	
<b>STAR PRODUCTS COMPANY</b> . . . . .	34
<b>STEPHENS MFG. CO.</b> . . . . .	4
. . . . . Loudspeakers, microphones, amplifiers. Robt. Lee Stephens.	
<b>STROMBERG-CARLSON COMPANY</b> . . . . .	100
. . . . . Telephone systems, intercom systems, sound equipment.	
<b>SUPREME, INC.</b> . . . . .	118
. . . . . Test equipment.	
<b>SYLVANIA ELEC. PROD. INC.</b> . . . . .	65
. . . . . Tubes. C. W. Shaw, T. Cunningham.	
<b>TALK-A-PHONE CO.</b> . . . . .	17
. . . . . "Chief forty-niner" line.	
<b>TECHNICAL APPLIANCE CORP.</b> . . . . .	111
. . . . . TV and FM antennas. T. Lundahl.	
<b>TELEX</b> . . . . .	63
. . . . . Telex Monoset, radio pillow speaker, Telex twinset and Telex earset. N. J. Paymoville, Jr.	
<b>THORDARSON ELEC. MFG. DIV.</b> . . . . .	110
<b>TRICRAFT PRODUCTS CO.</b> . . . . .	147
. . . . . TV-FM antennas.	
<b>TRIMM, INC.</b> . . . . .	146
. . . . . Plugs, potentiometers and regular line. Paul A. Bortorff.	
<b>TRIPLET ELEC. INST. CO., THE</b> . . . . .	121
. . . . . Test equipment. N. A. Triplett.	

(Continued on page 18)

NO CUSTOMER REJECTS  
WITH COCOON COATED

**ATLAS TEL-OPTIC  
MAGNIFIERS**



ATLAS now has "COCOON COATING" . . . .

Exclusive new Atlas Strip-off protective coating guarantees, to your customer, the delivery of an optically perfect, crystal-clear lens. It is impossible to scratch or disfigure the lens surface in handling or shipping.

ATLAS now has new "TROMBONE" BRACKETS. . . .

All bracket models now come with the new sensational "Trombone" slide mounting . . . Operates with the precision of a fine instrument . . . One screw attachment to all cabinets . . . All sizes . . . All shapes . . . Console or table . . . Under or over . . . Quick . . . Simple . . . Fool-proof . . . Three minute installation.

ATLAS now has PLASTIC FRAMES . . . .

All models shielded against "light piping" with a plastic form-fitted frame. Eliminates side angle distortion . . . Enhances appearance.

ATLAS now has ALL TYPES,

sizes and mounting arrangements. Contact . . . Bracket . . . Floor Stand . . . A complete line of quality-engineered super-magnifiers.

**ENLARGE YOUR PROFITS  
REDUCE YOUR SALES EFFORTS  
SELL ATLAS "TEL-OPTIC" MAGNIFIERS**

Ask For Our  
Complete Catalogue.



**ATLAS SOUND CORP.**  
1441 39th St., Brooklyn 18, N. Y.

# *Who Really Built This Great New JFD Plant?*

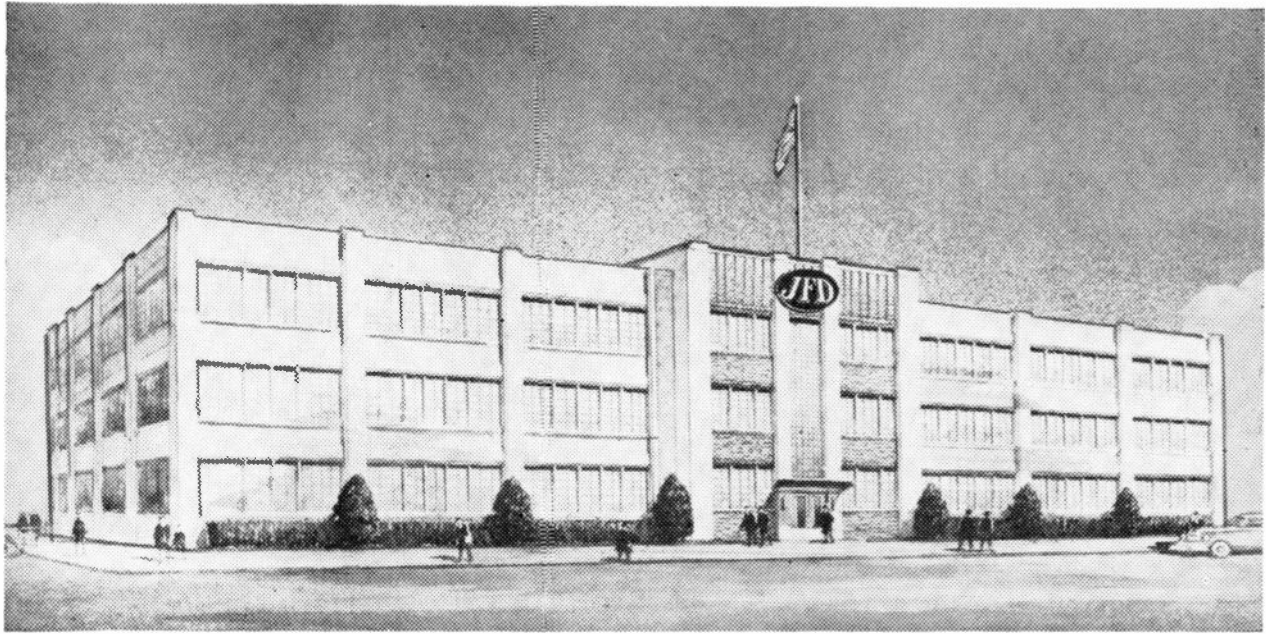

**YOU did, and thousands of other distributors, dealers and servicemen with loyal patronage of JFD products.**

The JFD Manufacturing Co., Inc., thanks to customers like you all over the country, has completed the greatest expansion program in its 21 years of experience.

This fine building has been built on the sales of thousands of Dial Belts and Cables, Auto Radio Antennas and Accessories, Ballasts, Resistance Line Cords and many other essential radio service parts that you have required.

No expense has been spared in making this new and ultra-modern JFD plant the last word in production efficiency. It is your assurance that JFD will continue to keep pace with the growing needs of the television industry with the design and manufacture of the latest Television and FM Antennas, Brackets and Accessories.

We feel confident that this investment will pay our customer valuable dividends in the form of better-than-ever workmanship and production from the smallest JFD radio part to the most elaborate television array.

*"Pioneers In the Radio Parts and Antennae Industries Since 1929"*

**JFD MANUFACTURING CO. Inc.**

6103 16th AVENUE • BROOKLYN 4, NEW YORK

*"The Largest Manufacturers of the Widest Variety of Television Antennas in the Industry"*



# CLICK!

★ For quick, correct, profitable control replacements, use **Pick-A-Shaft Clarostats.**

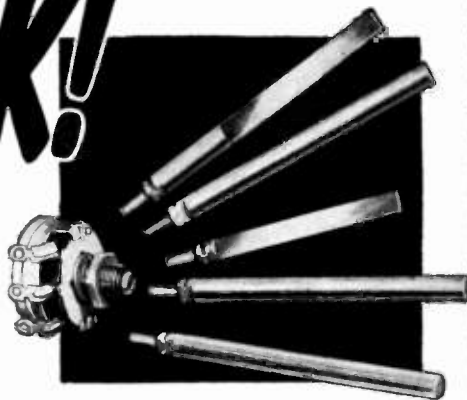

## THE RIGHT CONTROL & THE RIGHT SHAFT EVERYTIME!

Select the right control electrically — ohmage, taper, tap, etc. Then select the right shaft mechanically — ten types to choose from. Aluminum shafts for ready cutting to exact

length. Insert shaft in slot and bang it — CLICK! You've got a trouble-free job — no wiggle, no wobble, no trouble. A free shaft with each Pick-A-Shaft Control.

Ask our jobber for **Pick-A-Shaft Clarostat controls.** You'll like them. Catalog on request.



CLAROSTAT



# Controls and Resistors

CLAROSTAT MFG. CO., INC. • DOVER, NEW HAMPSHIRE • In Canada: CANADIAN MARCONI CO., LTD. Montreal, P. O. and branches

# What a difference!

WHEN SEEN THROUGH AN

# Alphabest

**ENLARGING LENS**

TELEVISION revolutionized! Full enjoyment of every program assured. No more eyestrain in the endeavor to see details at uncomfortably close range.

Alphabest Enlarging Lenses produce an image of satisfying size . . . clearer, sharper, better . . . without distortion or blur. Not just "curved glass" but optically correct liquid-filled lenses made to a scientific formula.

### REASONABLY PRICED FOR EASY, QUICK SELLING

Any Alphabest Lens will be furnished in blue tint at no additional cost Brought to you by an old-established manufacturer with a reputation for engineered plastic products.

REPRESENTATIVES: Choice territories still open. Get in touch with us at once.

See us during THE SHOW at the STEVENS HOTEL

**ALPHABEST PRODUCTS CORP.**  
181 Navy Street  
Brooklyn 1, N. Y. MAin 4-1844

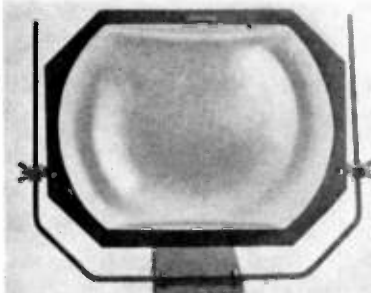

**TILTLOCK TABLE MODEL** —Can be tilted at any angle in a few seconds. Held in position rigidly by means of wing nuts. Sizes 7" and 10".

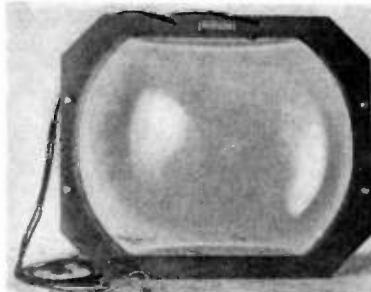

**CONSOLE MODEL**—Brocaded cords with hooks go over top of set and hook in rear. Rubber bumpers prevent cabinet from being scratched. Sizes 7" and 10".  
**FLOOR STANO**—(Not illustrated). Adjustable to any height. In 12" size only.

## What a Life!



*Les Logan, left, popular factory rep for Centralab, Workshop Associates, and Turner Microphones in Northern California, points with pride to "a day's catch" of swordfish. His fellow fisherman is George Weiss, owner of San Francisco Radio & Supply Co. The boys go fishing every so often on the west coast of Mazatlan, Mexico, to "get away from it all." We repeat, "What a life!"*

Company	Booth
<b>TUNG SOL LAMP WORKS</b> Display room 537-A, headquarters Room 2405-6. Tubes. P. R. Dawson.	68
<b>THE TURNER COMPANY</b> Microphones. R. P. Evans, Wm. J. Nezerka, Paul Thompson.	16
<b>UNGAR ELECTRIC TOOL CO., INC.</b> Soldering pencil iron. Leon B. Ungar.	101
<b>UNITED TRANSFORMER</b> Transformers, coils, audio filters. Ben Miller.	92
<b>UNIVERSITY LOUDSPEAKERS, INC.</b> Driver units, tweeters, microphone, coaxial loudspeakers. Irving Golin.	151
<b>VACO PRODUCTS CO.</b> Testers, screw and nut drivers.	60
<b>V-M CORP.</b> Record changers. Earl Rush, Dick Grose.	42
<b>WALDOM ELECTRONICS</b> Speaker cone assemblies and parts.	73
<b>WARD LEONARD ELEC. CO.</b> Resistors, rheostats, relays. Kenneth Hathaway, Frank Beede.	11
<b>WARD PRODUCTS CORP.</b> Minute man series of antennas. Julius L. Fine.	105
<b>WEBSTER-CHICAGO CORP.</b> Record changers, pickups, etc. N. C. Owen.	93
<b>WEBSTER ELEC. CO.</b> Phonograph crystal cartridges and pickup arms. R. P. Krogh, W. E. Dent, J. S. Kaupie.	138
<b>WELLER MANUFACTURING CO.</b>	135
<b>WILCOX-GAY CORPORATION</b> Display room 502. Tape Recorder, dual-speed AM-FM portable recording-radio-phonograph combination, portable Recordette, discs, etc. Verne Roberts.	77
<b>WINCHARGER CORP.</b>	126
<b>WIRT COMPANY</b> Resistors, switches. Paul G. Duryea.	47
<b>WORKSHOP ASSOCIATES, INC.</b> Television antennas. Gardiner Greene, William L. Page.	56

# STROMBERG-CARLSON

*celebrates its Silver Anniversary in radio  
by presenting this new*

## AM-FM TELEVISION CONSOLETTA

Twenty-five years of Stromberg-Carlson experience in the radio business are behind this great new television chassis — bringing new levels of performance and satisfaction to your customers.



**\$565**

*Excise tax \$7.54. Plus installation.  
Slightly higher in South and West.*

*See it Better!*

*92 Square Inch Direct View! The picture is really big — an eye-opener for your most exacting prospects! You can sell 'em on sight!*

*Hear it Better!*

*Famous Stromberg-Carlson Sound Fidelity! Show your prospects the big, "Full-Floating" speaker — let them hear the difference on TV, FM and AM. You'll close them quickly!*

### The WEYMOUTH

TS-125-LM. New TV-FM-AM Console. With 92 square inch direct-view picture of unexcelled clarity, kept steady by automatic frequency control. With magnificent tone quality from precision-engineered audio system and exclusive "Full-Floating" 12-inch PM speaker. Phonograph jack for connecting with any type record changer. Selected hand-rubbed mahogany veneers. Learn full details of this spectacular new model from the distributor or branch office serving your territory.

STROMBERG-CARLSON  
*on its Silver Anniversary  
salutes R M A  
on its  
Silver Anniversary*

In television, as in radio, there is nothing finer than a

# STROMBERG-CARLSON

Stromberg-Carlson Company, Rochester 3, N. Y. — In Canada,  
Stromberg-Carlson Co., Ltd., Toronto

# RMA's "Silver Anniversary" Marks 25 Years of Progress

Motion picture, radio, television, and vaudeville stars will brighten the gala, all-industry banquet celebrating RMA's 25th "Silver Anniversary" at the Hotel Stevens on Thursday night, May 19. The affair will climax a four-day convention crammed with significant meetings for the radio and television industries, and hundreds of industry leaders will be on hand for the silver jubilee. And there will be many things which RMA can celebrate about.

Organized in April, 1924, by a pioneer group of radio manufacturers from Chicago, RMA obtained a charter from the state of Illinois to operate as the Associated Radio Manufacturers. That was on the 16th of the month. By April 26, the name was changed to the Radio Manufacturers Association and the infant organization was in the thick of a fight that was to give it initial strength and prestige in the radio industry. Congress had proposed a 10 per cent Federal tax on all radio

products. RMA sent an emissary to Washington, and by May 19 Ernest M. Reichmann, counsel for the organization, reported that the tax proposal had been defeated. At about the same time, RMA tackled a proposed Chicago municipal ordinance, which would have required a radio purchaser to employ a licensed electrician to install it and to pay the city a fee for inspecting the installation. This, too, was defeated.

As listed in the Illinois charter, the organizing directors in those early RMA days consisted of Herbert H. Frost, Frank Reichmann, Fred Wellman, W. H. Huth, E. T. Flewelling, Frederick W. Will, and A. J. Carter, all of Chicago, and Mr. Frost became the first president of the Association. Its major objective was, "To promote an enlarged acquaintance and more friendly intercourse among its members, and in all reasonable and proper ways to promote the best interests of the radio indus-

try." Eventually, of course, this last was revised to read "of the radio and electronics industry."

## An Important Cog

Atlantic City was the scene of the RMA's first national convention, July 10-11, 1925. Fifty-eight manufacturers answered the roll call, and 12 new members were admitted. By 1927 it had taken a leading role in advising governmental agencies seeking to stabilize broadcasting, and officers participated in conferences called by the then Secretary of Commerce. Herbert Hoover. President Coolidge also invited officers to his summer retreat in the Black Hills of South Dakota to discuss recommendations for radio broadcasting legislation. The first Radio Act in 1927 felt the influence of RMA, since it was represented on the Radio Coordinating Committee, along with the NAB and the Federated Radio Trades, when formal legislative proposals were drawn up. (Continued on Next Page.)

## for the FINEST in TELEVISION FURNITURE... look to ELLAR!

### NEW!

Smart cabinet for RCA 8TS30, using 15" or 16" tube.

Exquisitely styled in walnut, mahogany, or bleached blond.

Beautiful louvres, decorating speaker grilles on both sides, and graceful front mask-frame are made of solid mahogany or walnut.

Exclusive ELLAR feature: mask optically designed for distortion-less, all-angle viewing.

Knob holes drilled. Fits RCA 8TS30 perfectly without cutting or trimming.



Eye-catching beauty, practical utility, and economy—these are the features which distinguish ELLAR Television furniture, the most popular among buyers everywhere. ELLAR manufactures a complete line of console and table cabinets, as well as TV tables for the entire industry.

NOW SEPARATELY AVAILABLE: ELLAR masks described above, for 10", 12", 12½", 15", and 16" tubes.

JOBBERS: Write today for new catalog.

DEALERS: Write for address of your nearest jobber.

SEE US IN BOOTH 31 AT THE SHOW!

WESTERN JOBBERS: Save freight. Showroom and warehousing facilities have been established at the following locations:  
 G. G. Willson & Co.      Kay Sales Co.      Ellar Woodcraft Corp.  
 2030 Harold St.      3760 Broadway      925 S. Grand Ave.  
 Houston, Tex.      Kansas City, Mo.      Los Angeles, Calif.



**WOODCRAFT CORP.**  
 431 WEST 28th STREET  
 New York 1, N. Y.

## ALL YOU NEED CM-100 CHIMNEY MOUNT

\$390  
 PAIR LIST



- Extremely Easy To Install (ONE MAN OPERATION)
- Rigid-All-Steel Construction (1/2" STEEL, WELDED)
- Two Separate Sections (DISTANCE BETWEEN SECTIONS VARIABLE - AS REQUIRED)
- Fits Any Chimney (SQUARE SIZE, ETC.)
- Fits Any Size Mast (1/4" to 1 1/2")
- Weather Resistant (Heavily Plated)
- All Hardware & Instructions Included

**GUY WIRE**  
 A complete line of standard galvanized steel guy wire ranging in size from 4 strands No. 20 to 6 strands No. 20, and 6 strands No. 18. Available in 50, 100, 500 and 1,000 foot rolls.  
**STEEL STRAP**  
 Heavily galvanized, perforated steel strapping — 3/4" wide. Available in 12, 25 and 100 foot rolls. WRITE FOR PRICES.

## TO INSTALL ANY TV ANTENNA FM-306 WALL MOUNT

\$250  
 LIST PRICE COMPLETE 6 in. SIZE

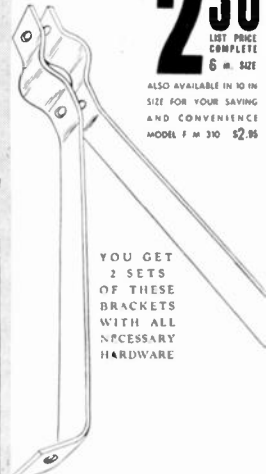

ALSO AVAILABLE IN 10 IN. SIZE FOR YOUR SAVING AND CONVENIENCE MODEL F M 310 \$2.95

YOU GET 2 SETS OF THESE BRACKETS WITH ALL NECESSARY HARDWARE

Made of the highest grade spring steel and heavily plated against the weather, the FM-306 is ideal for your "against the wall" mounting problems. The FM-306 comes complete with all hardware less the lag or expansion bolts, as these vary with the installation requirements. Simple and easy to mount, the FM-306 or its companion, the FM-310 is not only a time saver, but in economy as well.

Write for details of our attractive price and discount structure. Dealers contact your local jobber. If he does not stock TV PRODUCTS send us his name and address. Write now Dept. T-5. WE'RE AT THE CONGRESS. WHERE ARE YOU?

## T-V PRODUCTS

122-10 15th AVE. COLLEGE POINT NEW YORK



In that year a New York office was opened under the newly-elected executive vice-president, Bond Geddes. Judge John W. Van Allen became general counsel at that time, also. By 1932 the New York office was closed, however, and Mr. Geddes returned to Chicago. Since then liaison with governmental agencies became increasingly important and on January 10, 1933. RMA closed its Chicago office and moved to Washington, D.C. In the same year four divisions of members were formed: set, tube, parts, and amplifier and sound equipment.

### In the Industry's Interest

By waging frequent and successful battles against proposed state taxes on radios and efforts of state and city authorities to ban the use of radio sets in automobiles, RMA saved the industry and the public millions of dollars in taxes down through the years. When necessary, RMA carried its fights on behalf of the radio industry and the public to the courts. One of the most significant and far-reaching decisions obtained by RMA, in cooperation with a North Carolina broadcasting station, WBT, was a Federal Court ruling in 1931 holding a South Carolina license tax on radio receivers unconstitutional on the grounds that radio is interstate commerce.

At its ninth convention in June, 1933, RMA took its first major step in a long series of contacts with governmental agencies on behalf of the radio industry. A committee, under Chairman W. Roy McCanne, was set up to draft a voluntary NRA code to bring the radio industry under the "Blue Eagle." By July 29 the RMA committee submitted its code proposal to the NRA. Two weeks later, however, NRA placed radio under the electrical industry. Dissatisfied, radio producers drafted a new code at its 1934 convention and submitted it to the NRA. The new code covered the radio industry alone, but before a decision was reached, the "Blue Eagle" agency itself had been declared unconstitutional by the U.S. Supreme Court.

### In the Realm of Promotion

RMA was always promotion-minded, even in its earliest days, and took an active part in programs to interest the public in the industry's merchandise. In the twenties RMA concentrated on arousing the public's interest in radio—the new medium of home entertainment. In the early and middle thirties it tried to stimulate sales in a de-

(Continued on Page 22)



*Television is "Tops"*  
WITH  
**TENNA · ROTOR**

Operates in any weather.  
Fits most types of antenna.

**GETS STRONGER SIGNALS**

**ROTATES TV AND FM ANTENNA**

**LIST PRICE \$39.95**

**CONTROL BOX**  
Size of box 5" x 5"  
Ship. wt. complete—12 lbs.

**alliance**  
TENNA · ROTOR

Model AYR  
Size of rotor unit 7 3/4" x 5 1/4" x 8"

Alliance Tenna-Rotor is an electric antenna rotator. It assures correct antenna "beaming"—gives positive control of antenna rotation to select the exact position for "peaked" reception! Tenna-Rotor is quick and easy to install—the electric powered rotor unit resists corrosion—is enclosed in a split zinc, die-cast housing, and is operated from a plastic control box which plugs into any 110 volt, 60-cycle house circuit. A 3-position switch rotates antenna clockwise or counter clockwise and stops it at the right point. Four-conductor interconnecting cable from rotor to control box is made available at 5 1/2¢ per foot. TV and FM dealers, service men and users, will find that the Alliance Tenna-Rotor simplifies and improves new and existing installations! Amateurs can use it for transmitting and receiving. Takes maximum O. D. centerpost of 1 1/4".

Write for catalog sheet and illustrated folder.

**alliance motors**

**ALLIANCE MANUFACTURING COMPANY • ALLIANCE, OHIO**  
Export Department; 401 Broadway, New York, N. Y., U. S. A.

## BIG PICTURE = BIG PROFITS

### Model 15 TV Console

116 square inch direct view picture on 15" tube with finest noise-free sound.

## COMPARE!

COMPACT SIZE • PICTURE STABILITY  
NOISE-FREE TONE • SIMPLICITY OF CONTROLS

**\$495 LIST**

- ONLY THREE CONTROLS—VOLUME, CHANNEL SELECTOR and CONTRAST.
- New design Automatic Frequency Control locks picture in step with transmitter.
- Newly designed Audio Amplifier minimizes distortion.
- Special Picture Amplifier has sufficient band width to insure a picture of the utmost clarity.
- 26 Tubes including 3 rectifiers. Finest materials used throughout.
- Simplicity of Electronic and Mechanical Design permits easy and quick servicing.



**DEALERS — JOBBERS — REPRESENTATIVES**  
**SOME CHOICE TERRITORIES STILL AVAILABLE**

WRITE FOR FURTHER DETAILS AND PRICE LISTS.  
ATTRACTIVE DISCOUNTS MEAN BIG PROFITS FOR YOU.

**VIDEODYNE INC.**

33 JEFFERSON STREET

STAMFORD, CONN.

pressed market. Sometimes it worked alone, sometimes in cooperation with the National Association of Broadcasters and retail and wholesale trade groups. Always it was striving to widen the group of radio listeners and radio set owners.

As early as 1929 it sponsored a series of weekly broadcasts, financed by member contributions. Even National Radio Week was celebrated as early as 1926. It developed various slogans, such as "Listen Before You Vote"—prior to a national election campaign — "Radio Christmas," "Radio Prosperity Campaign," and "Buy RMA." These were

really earlier versions of the postwar "Radio-in-Every-Room" campaigns conducted since the end of the war by the RMA Advertising Committee. In 1939 RMA joined NAB in sponsoring the formation of local "Radio Councils" to promote radio listening.

When set manufacturers began incorporating short-wave reception facilities in radio receivers in 1935, RMA immediately inaugurated a short-wave program service for newspapers. It supplied the newspapers with weekly programs of foreign short-wave stations which could be heard in the United States. As many as 600 newspapers

were reported using these programs in the fall of that year.

### On the Technical Side

RMA has consistently striven to standardize and make uniform practices by manufacturers within the industry. As early as the fall of 1934 it was sponsoring an "Interference Conference" and similar activities in cooperation with the Institute of Radio Engineers in a joint effort to reduce man-made interferences that retarded the industry and development of industry products. Since the early thirties Dr. W. R. G. Baker has directed the engineering and standardization work of the RMA. As chairman of the Engineering Division in 1934, he reorganized the Association's operation, later helping establish the Engineering Department as it exists today on October 30, 1938. Dr. Baker directed that department ever since.

In the spring of 1936, RMA took the lead in a move to stabilize the radio industry in the field of merchandising. Led by President Muter, a committee by James M. Skinner formulated a proposed trade practice agreement, submitting this as the basis for Federal regulations to the Federal Trade Commission. Although the proposal was favorably received, it was not until three years later on July 22, 1939, that the Commission issued the Trade Practice Rules for the Radio Receiving Set Manufacturing Industry, which are still in effect.

### Later Years

In the days preceding the war and during the war years, RMA, under the leadership of James S. Knowlson and Paul V. Galvin, facilitated military preparedness and fought to maintain materials for civilian services. In the post-war years, RMA turned its resources over to FM and television, once more providing the FCC with invaluable information on these new broadcasting services. Already in 1928 it had sponsored the first industry television conference and began standardizing TV terms for guidance of the research engineers. In 1940, the National Television Systems Committee, under Dr. Baker was formed. It was later lauded by the FCC for its "monumental work for the industry and the government."

As it celebrates its 25th anniversary, RMA is in the thick of an industry that, in the words of present President Max F. Balcom, "will rank with the largest industries in the U. S. within a few years."

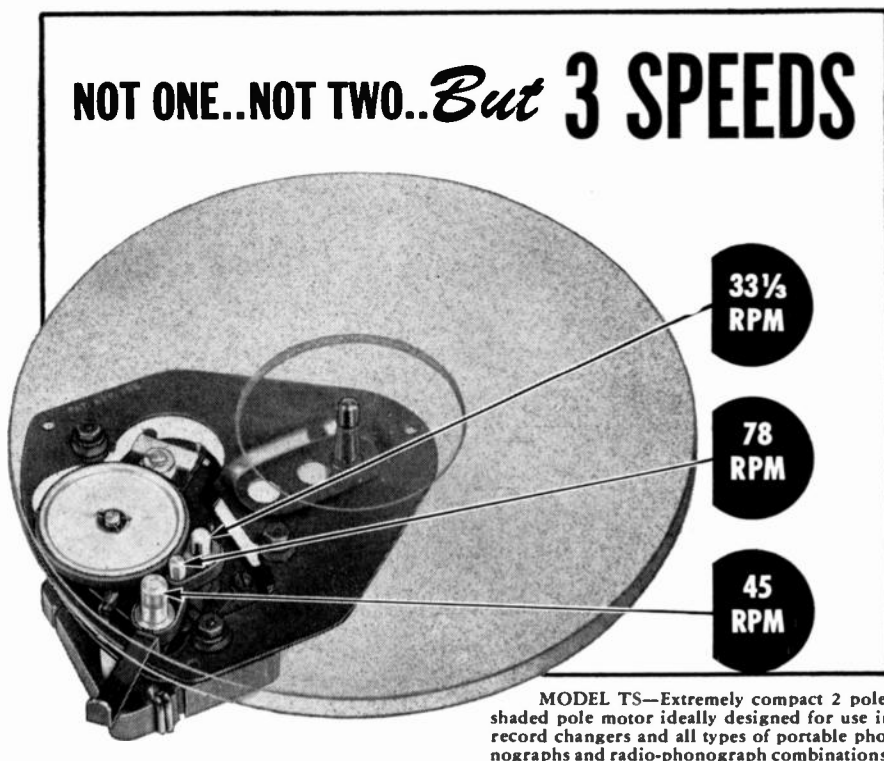

## with this revolutionary New PHONOMOTOR!

Here it is . . . General Industries' newest development in phonomotors . . . a dependable, single-powered unit for *all-three* types of records—78 RPM, 33 1/2 RPM and 45 RPM.

Speed shifting is accomplished by means of an external shift lever which ingeniously positions various spindles in contact with the idler wheel. At 78 RPM, the rotor shaft is in direct contact with the idler wheel. For the slower speeds, the rotor shaft is automatically disengaged and one of two secondary spindles is moved into contact with the idler wheel to produce the desired speed. Both secondary spindles are driven from the rotor shaft by specially compounded oil-resistant Neoprene belts.

*For additional information—specifications, blue-prints and quotations—write, wire or phone today.*



**The GENERAL INDUSTRIES Co.**

DEPARTMENT F • ELYRIA, OHIO



# PROJECTION TELEVISION TODAY

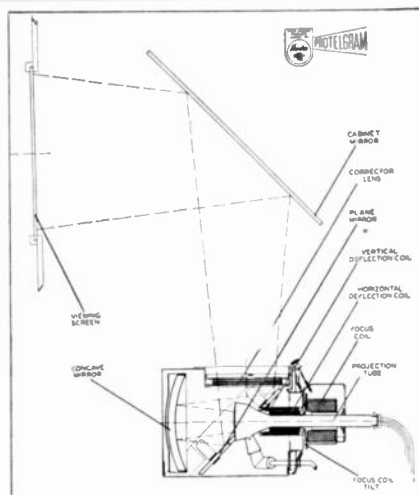

AT the start of 1948, television stretched its young, untried legs, flexed its muscles and embarked on giant strides that has carried it farther than any other industry in a comparable space of time. America's new miracle industry captured the imagination of the press, and soon the word television was on everyone's lips. TV stations began to sprout all over the map, clustering around the major population centers like bees around a hive. Soon the 7-inch direct view cathode tube gave way to the 10-inch screen; followed by the 12 and 15-inch tubes. The arrival of the 16-inch metal tube seemed to herald a new pinnacle in set development, a new era for merchandisers. Unquestionably, the first bright years of the immense television boom was centered on direct view receivers. But will that trend continue? It's hard to say, but the shape of things to come presents some interesting speculations.

What is the principle of projection and why does its future loom big? The scientific principle is essentially simple: the belief that the size of the picture which could be created on the face of a direct view tube would always be too small to meet the public's demand for *big* pictures, and secondly, to manufacture a cathode-ray tube which would be big enough to permit an enjoyable picture would be too costly and not the correct technological answer to satisfactory television picture tubes. With that philosophy as a basis, an organization called the Phillips Company, a Holland manufacturer that had decades of experience with making tubes and x-ray equipment became interested in the development of cathode ray tubes. After much experimentation, Phillips designed a projection type television set in 1936, using a 3-inch cathode ray tube in combination with a system of refractive optics to "throw" a picture of approximately 9 x 12 inches. Three years later, they developed a 2½-inch tube, combined with a modified Schmidt optical system, but the war halted all further progress for the duration. By 1945, engineers of the North American Phillips Company had re-engineered the design, and by 1948 the first pilot run of Protelgram units (the name given to Phillips projection system) was started in a United States plant at Dobbs Ferry, N. Y.

Like every other development in television, projection is just on the horizon, as far as the public is concerned. Whether it will ever replace direct view is a moot point. Has a Cadillac ever replaced a Ford? What is important is that projection offers still another exciting new rung in the ever-climbing upward ladder called television. Smart merchants need not kick the direct view ladder out from under while reaching for the new rung above.

Nat Boolhack, Editor



**L. J. Chatten**  
**Vice-President and General Commercial Manager**  
**North American Philips Company, Inc.**

**T**HE swing to projection is here. Why? Because . . .

Projection gives the public what it wants!

First, projection makes possible a bigger picture, and the demand today, as every dealer knows, is for big pictures. Second, projection gives a better picture—softer, easier on the eyes, “photographic” in quality, more pleasant to watch. And third, projection gives greater picture area per dollar, plus greatly reduced tube replacement costs. It’s as simple as that, but there’s more to the story.

Customers are becoming more discriminating. Gone are the days when any television receiver will satisfy, just so long as the viewer can watch moving figures on the screen.

Today’s prospect demands a good quality picture—also tastefully designed, well proportioned cabinets are becoming a “must” in television, too. And projection gives him both.

Take, for example, the Norelco Protelgram projection system, already adopted by a number of leading manu-

facturers and soon to be announced by several others.

The image on the face of the small, 2½-inch Protelgram tube is projected, from an “optical box” only 8½ x 8½ x 16½ inches, to a screen which may be any practical size—the most popular being between 16 and 18 inches in height and between 12 and 13½ inches in width, some four times the size of that produced by a 10-inch tube. And this larger, better quality picture can be produced in a television unit of just about the same size as the average 10-inch direct-view receiver.

When it is remembered that to produce a picture comparable in size to Protelgram’s larger image, the large direct-view cathode-ray tube requires an extraordinarily deep, or complicated and expensive “turret-type” cabinet which is currently unacceptable to the majority of prospective purchasers, and further, that this larger tube costs several times as much as the small Protelgram tube, the answer is obvious.

The better quality of the projected picture, with its fine range of tones from black through the grays to white,

is becoming increasingly evident to viewers as quality projection receivers are demonstrated and sold.

When the prospect is permitted to watch such a set in operation for half an hour or more, under normal home lighting conditions, he will be satisfied with nothing less.

Of course projection can produce much larger pictures than those (approximately 200 square inches) appearing on the built-in screens of conventional cabinets. Now available to manufacturers is a Protelgram unit, almost identical to the model mentioned above, which will project a clear image of 3 x 4 feet, on a home movie screen. This flexibility is an important factor in the swing to projection, and extends its usefulness to a wide range of installations: large homes, clubs, schools, churches and hospitals.

In view of these facts, what is the future for projection? While direct-view will retain a segment of the market, satisfying those customers who do not demand larger pictures, projection is destined to “steal the show” in the growing big picture market.



Norelco  
Presents  
Miraculous New

# Life-Size <sup>more</sup> Life-Like

## Television

A Great New  
Television Development...

# PROTELGRAM

by

NORTH AMERICAN PHILIPS  
COMPANY, INC.

...from this small 2½" tube



Available now—or soon  
in these famous  
quality TV Receivers

ANSLEY · EMERSON

FADA · FISHER

PILOT · SCOTT

STEWART WARNER

INTERNATIONAL  
TELEVISION

BRUNSWICK

and others soon to be announced

**PROTELGRAM**

for  
life-size,  
more  
life-like  
television

★ **HERE'S WHAT PROTELGRAM PROVIDES . . . .**



NEW

Life-Size  
Picture



★ **PROTELGRAM** gives a *life-size, life-like* picture nearly 200 square inches in area (20" diagonal). It can be viewed with equal satisfaction from five feet or fifty. So real, so clear, so full of life—nearly *four times* the area of a 10" direct-view image.

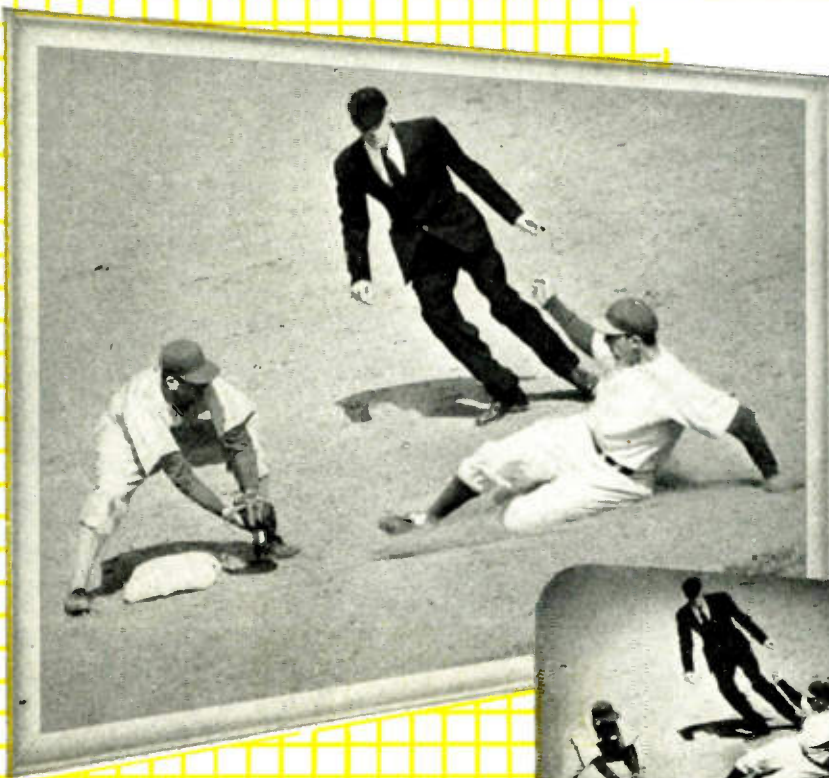

NEW

Life-Like Picture



**PROTELGRAM** is a true-to-life picture of high photographic quality—*easier on the eyes*—with a pleasing blending of glare-free whites, soft grays, and velvety blacks. The complete absence of flicker, glare and distortion puts **PROTELGRAM** in a class by itself.



*An exclusive development of* **NORTH AMERICAN**





## NEW... *Low Replace- ment Cost* Cathode-Ray Tube

This miracle, small-size, long-life PROTELGRAM tube is but 10" long with a picture face only 2½" in diameter—yet it projects a perfectly lighted, perfectly defined image measuring in excess of 16" x 12". Microscopically fine-grain phosphor-screen permits unsurpassed image definition.

## NEW...

### All-Angle Viewing



PROTELGRAM's scientifically designed, precision-engineered optical system permits all-angle viewing, completely free from reflection of room lights. The picture reproduces *all* the TV camera sees, on a flat and optically correct viewing screen—all the way to the corners. No need to sit directly in front of the screen to get perfect viewing.



## NEW...

### High Quality and Dependability

PROTELGRAM-equipped receivers combine the circuit-wizardry of progressive TV set manufacture with the latest television engineering development from the world's greatest electronics laboratories. Extensive quality control is the customer's assurance of a set high in reliability, that remains in adjustment and has minimum service requirements.

## NEW...

### Compactness of Unit

PROTELGRAM's small size and low weight afford flexibility in cabinet and chassis space requirements, make possible a life-size, life-like 16" x 12" picture even in compact table models and consolettes.

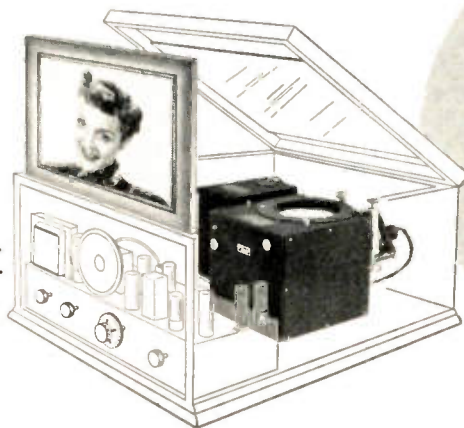

**PHILIPS COMPANY, INC.**

# A Great New Television Development by North American Philips Company, Inc.

*PROTELGRAM is the greatest improvement since the advent of television!*

PROTELGRAM has been developed as the result of a persistent demand by consumers for a better and larger television picture. Unlike the hurried attempts and untested expedients that characterized the first rush for projection systems, PROTELGRAM is a carefully engineered, thoroughly field-tested compact system that provides a larger high fidelity television picture. It has already been selected by a number of important manufacturers of quality television receivers to meet the consumer's demand for larger television pictures.

It is the result of nearly fifteen years of research by the world's greatest electronics laboratories. From these same laboratories have come the world's first successful long-distance, short-wave broadcasts and, literally, hundreds of designs, refinements and components that have advanced radio to its present high peak of excellence.

Every dealer in television receivers in the country should be informed about PROTELGRAM . . . now! Whether or not you stock PROTELGRAM-equipped receivers at the present time, you will want to know more about this *exclusive* system. Your customers will get a new thrill in viewing television by PROTELGRAM. Present production is limited, but when you do offer PROTELGRAM—and you will—your customers will be sharing with others throughout the country a typical NORELCO contribution to the art and science of human enjoyment and satisfaction.

## The Life-Size Picture Screen

Years ago, when PROTELGRAM was in its early stages of development, the question naturally arose: "What screen size?" Extensive audience preference tests show that a 16" x 12" picture, giving almost 200 square inches, leads in popularity for enjoyable, easy-on-the-eyes home viewing. However, the very nature of the PROTELGRAM design makes possible a wide variety of picture sizes which offer good viewing at less than 5 feet, clear, sharp distant observation and fatigueless viewing from all angles.



**PROTELGRAM**

Dept. P G-5, 100 East 42nd St., New York 17, N. Y.





Dealers who are profiting from projection have discovered that dollar-for-dollar comparisons with what direct-view has to offer are tipping the scales in favor of projection set sales. Cathode-ray replacement costs are a big factor in over-all, long-term costs.



The projection set placed in a show window and left running long after closing can be a keen stimulant to sales. Until the time it turns off automatically each night, crowds can gather on the sidewalk and watch special programs. Out of these crowds will emerge prospects and eventual purchasers.



Many dealers who had their doubts about projection finally discovered its outstanding merchandising features only after they installed a set in their own home or watched its performance at a friend's.



Jean Gillio and Jean Nova make pretty props for displaying the 2½-inch picture tube used with the Norelco Protelgram system. Three screen sizes are shown on display in North American Philips' New York show room. The 192-square-inch, 20-inch diagonal set on left is like most manufacturers models.

# Projection Packs

*Long ignored by most  
"has everything" say*

**"I**F I had one in my game room at home, I could sell a dozen sets a week." That was how enthusiastically one dealer reacted to a special demonstration of a Protelgram-equipped projection television set.

He was visualizing a projection set in the environs of his own home. He was not, however, taking into account common show room merchandising handicaps against which projection television has been laboring: bad lighting; inadequate floor space; isolation from direct-view TV sets, and even playing wallflower to a variety of white goods.

There are, in spite of this, dealers who have waxed enthusiastic over projection television long before this latest convert quoted above. These dealers have quietly gone about the business of getting to know projection. Sold on it themselves, they are now selling greater and greater numbers of their customers. And they've even boosted their television sales by selling projection under the most adverse conditions.

## Rugged Selling

The shop of Norman Bloom, for instance, is not nestled beside gaudy show windows. It's located on upper

Broadway, New York City, just beyond a short-order restaurant, a green truck store, and a dress shop. A customer has to wade through a variety of merchandise, including golf clubs, to reach Bloom's television corner. But Mr. Bloom is sold on projection television. An expert, sincere salesman who finds no problem which defies solution, he is in a position to convince his customers about what he himself believes in. Hence, with very little exertion he has sold some 25 projection sets priced at around \$800 in less than two months.

"I like it myself," is what he admits. "So I take time to answer questions, explain how good it is, and demonstrate it. I've even installed it 'on approval' so the customer could see it in his own home. Today people are shopping, and want the best value for their money, and you have to take time to sell quality merchandise."

What about the higher prices of projection? "Well," says Mr. Bloom. "if they just want a little set for their mother-in-law's room, that's one thing. But if they want a fine cabinet and large screen, projection costs less than a direct-view set producing a picture of comparable size. Then, of



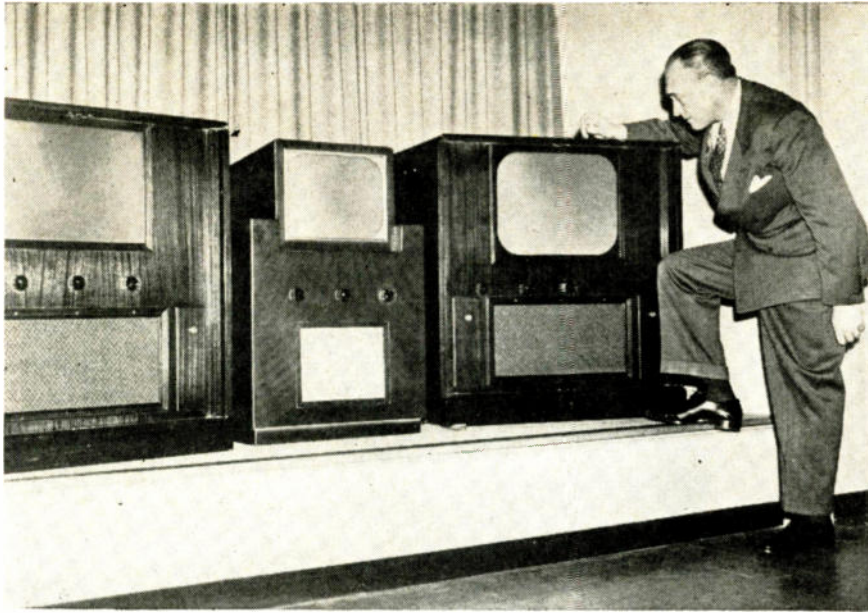

Pieter van den Berg, president of North American Philips Co., Inc., takes a close look at the 234-square-inch, 20-inch diagonal screen of one of the show room models using the Protelgram projection unit. Center set is 130-square-inch, 16-inch diagonal screen size, with rounded corners, smallest on display.

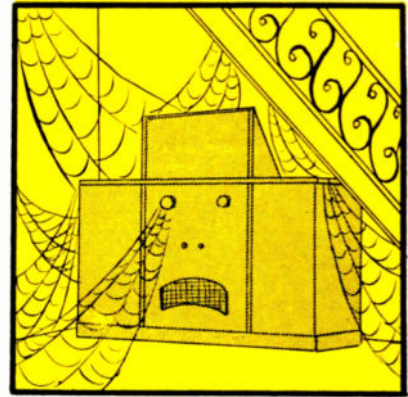

Projection may have had tough sledding earlier because of imperfections. But the dealer who lets a projection set gather dust in a cluttered corner or a back room is cutting his own sales volume. Today projection sales are increasing and every dealer can share in the profits.



Slipshod selling methods cannot sell projection anymore than they can move any other items. A set in operation within pleasing surroundings can help sales, but aggressive merchandising is still up to every dealer and his sales force. And projection has enough features to sell.



There's no surer way to sell projection than to be sold on it yourself. And there's no surer way to sell yourself than to find out something about the system. With a minimum of study, a dealer can readily understand projection and how it works.

# Profit Potential

*dealers, projection  
these TV merchants*

course, I never show an expensive set first. The customers might think of only the high price and leave. I work up gradually, showing the difference in sets, so they know how much value they're getting."

And display? And the fact that a small direct-view picture looks so bright? "I let them see for themselves. I put a direct-view next to a projection set and tell them to look for a half hour, if they have the time. Usually they stay to look, and find themselves looking mostly at the larger, easy-on-the-eyes image. If they can afford the difference, that usually does it."

## **Sidewalk Appeal**

Another dealer, David Greenfield, in Philadelphia, has used aggressive merchandising display to help him sell. He has, for example, put a projection set in his show window, and he keeps it operating until 9:30 p.m. By then, when the automatic timer turns it off each night, dozens of extra prospects have seen it in action.

Some dealers have trouble explaining why the projected picture's brightness "falls off" at the sides. Actually, the explanation is quite simple. The greatest brightness is at the center of the picture and, as at a movie,

the best viewing position is in that area directly in front of the screen. Just as at a movie, also, side positions place viewers at points where the picture proportions change. But no one crowds up close to a television screen to view it, either from the front or from a side angle, so a dealer should have no trouble with complaints about brightness "falling off" at the screen's sides. In fact, furniture arrangement in most homes prohibits huddling close to a set, and projection permits large groups to view television from as comfortable a distance as 20 feet away.

Among dealers whose customers are in the higher economic and cultural brackets, and whose showrooms have an exclusive, quiet look, there are fewer problems, of course.

## **Quality Appeal**

At both Haynes-Griffin and Fisher, in New York City, they say there's no problem selling to people who know and appreciate the finest in performance and cabinet design. But, they add, there is a great need for more consumer education. There are still countless people who can afford projection, but who have never seen a fine set in operation, or who don't even

*(Continued on page 34)*

Stewart-Warner always gives you

*Now*



## RECORD CHANGER

*Plus*

- ★ 78 rpm record changer
- ★ 33 $\frac{1}{3}$  rpm record changer
- ★ finest AM or AM-FM radio

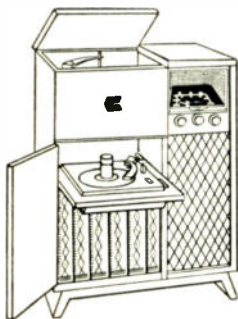

Stewart-Warner owners can play  
*their choice* of all types of records!

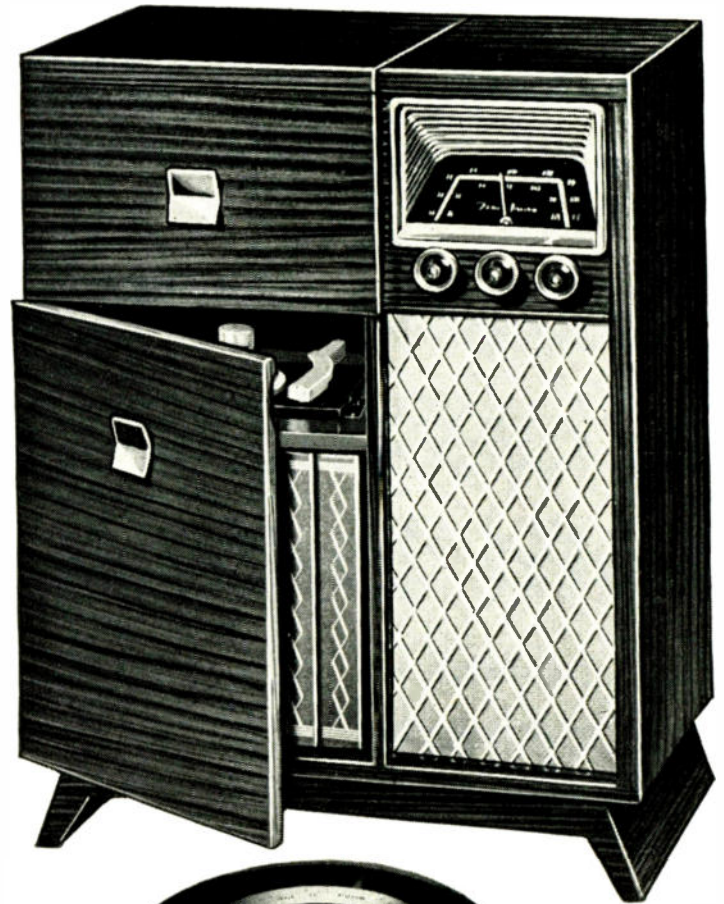

# Stewart

TELEVISION • FM RADIOS AM • RADIO-PHONOGRAPHS • STEWART-WARNER



the latest Selling Features • • •

*Coming* Life Size <sup>more</sup> Life Like

NEW  
BIG  
16" x 12"  
PICTURE  
SCREEN!



## PROTELGRAM TELEVISION

Once more, a great new development... and soon Stewart-Warner will bring it to you! You'll find the whole story of "Protelgram" in the magazine you are reading—the bigger, life-like, life-

size TV picture that widens the viewing angle and can be seen clearly from 5 feet or 50!

For television with powerful *plus* values . . . see Stewart-Warner!

*-Warner*

ELECTRIC • DIVISION OF THE STEWART-WARNER CORPORATION, CHICAGO 14

# Latest Projection "Styled"

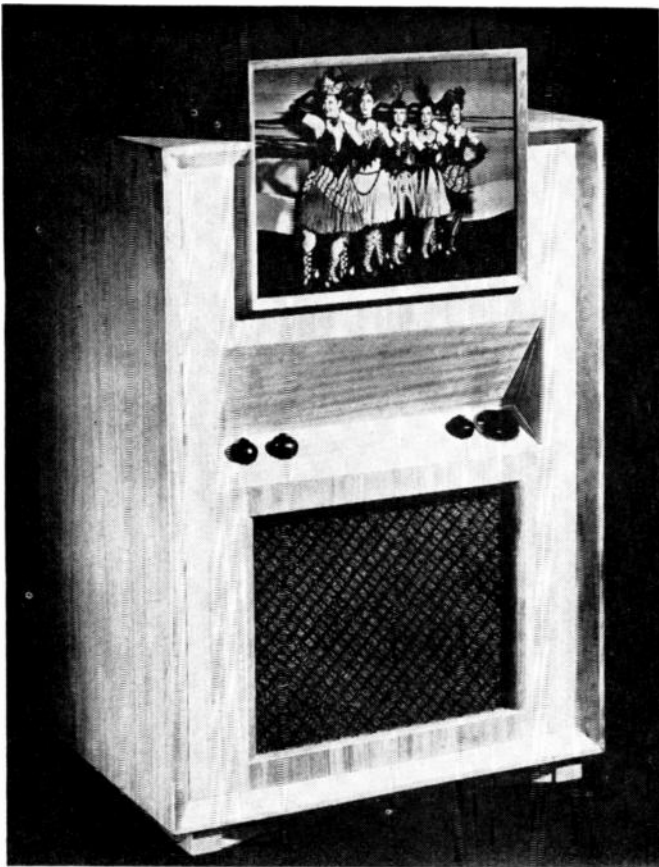

**FISHER** A mahogany-blond console equipped with Protelgram projection television. Named the "Allegro," its 12-by-16-inch screen gives a picture 192 square inches in size. Chassis contains a 12-inch speaker. Stands 41½ inches high, is 27 inches wide, and 20 inches deep.

**EMERSON** The 192-square-inch screen of this console folds away and becomes a flat-surface top suited for decorative purposes. The wood is Honduras mahogany, solid or veneer as desired. Set stands 39 inches high. Twenty-nine tubes—including rectifiers—and one Protelgram picture tube unit.



**PILOT** Combination television-radio (FM/AM)-phonograph. Thirty-five tubes, including four rectifiers and 2½-inch Norelco cathode-ray tube, which yields picture 192 square inches in size. Radio has 13 tubes. Equipped with 12-inch speaker. Cabinet stands 39¼ inches high and is mahogany.

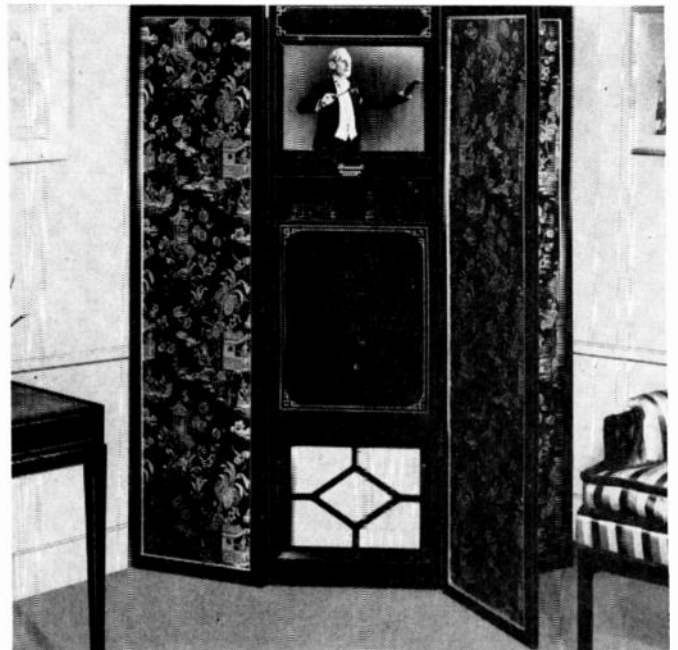

**BRUNSWICK** The "Cathay" featuring Protelgram projection television. Three-panel screen made of custom selected fabrics aids viewing and interior decorating. Twelve-by-16-inch screen yields a 192-square-inch picture. Stands 66 inches high, center panel is 19½ inches wide, wings 17½ inches, and depth 22¾ inches.

# Models are to Sell"



**FADA** A 45-inch-high console, featuring a 12- by 16-inch projection television screen, this Model 880 is available in mahogany or bleached blonde mahogany veneers. Utilizes Norelco Protelgram system. Has a 10-inch, Alnico-5 speaker. Width of cabinet is 31 inches, depth 22 inches.



**ANSLEY** Concealing the television-radio-phonograph combination unit by full-length doors when not in use, the "Revere" features 192-square-inch Protelgram projection television. Also has AM-FM radio and a two-speed record changer which accommodates both regular and long-playing records.

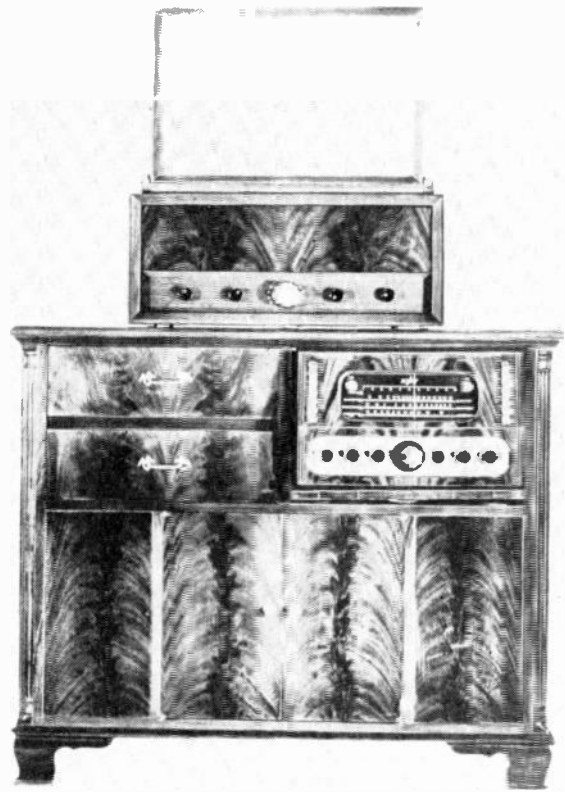

**SCOTT** Atop a radio-phonograph combination, Model 400A projection television utilizing Norelco Protelgram can use its own independent sound system or can play through the elaborate combination. Viewscreen and reflecting mirror, which provides a 192-square-inch picture, fold into top of receiver.

**INTERNATIONAL** The "Consul" is a basic unit 48 inches high and 24 inches wide around which wing extensions can be installed for appropriate adaptations in recreation rooms, clubs, or living rooms. Protelgram projection unit provides a 192-square-inch picture on a 12- by 16-inch screen. Cabinet of plywood, finished in leatherette of six colors.

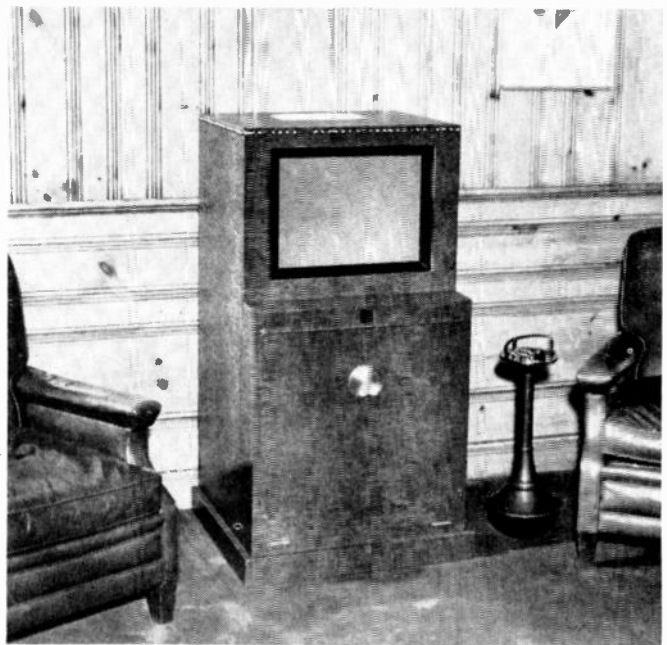



# Projection Packs a Profit Potential

(Continued from Page 29)

know what projection is. There are countless others who know only the early projection, with its really unsatisfactory reception. With the growing popularity of larger pictures, advertising, publicity, and the personal efforts of dealers, who can explain and actually show projection's advantages to their customers, projection sales are destined to pick up.

The situation at the Fisher salon is unique in that this concern, which produces its own custom-quality instruments, sells *only* projection units. "We chose projection," says President Avery Fisher, "because it is, in our opinion, the best system." Sales problems because of projection? "None," says Mr. Fisher. "We urge prospects to sit and watch a TV program on our receivers for a half hour, or more. After such a demonstration, the prospect has become a projection enthusiast."

## The Finer Points

In explaining the advantages of projection, it's a wise and successful dealer who makes a point of lack of eye fatigue, especially if there are young children in the customer's family. In the first place, it's easier on the eyes not to "look into a flashlight," as you must to see the picture at the end of a direct-view tube. The projected picture, on the other hand, is seen on a flat, dark gray screen. The viewer is looking *at a picture* instead of *into a lamp*. And since this picture is large, and of full tone range from black through the grays to white, details come out clearly. It is comparable to a salontype photograph instead of a glossy print—and it is really pleasant to look at.

The more scientific explanation of why projection does not cause eye fatigue is interesting, too. In direct-view, the whiteness of the tube face is the maximum black obtainable. Therefore, to make the viewer "see black as well as white," it is necessary to throw a great amount of light on the parts of the image which must be seen as white. So much light in the white parts of the picture dulls the optic nerve and lowers the sensitivity of the eye to such a degree that the white of the tube face appears to be black in the unexposed areas. This may account for certain types of eye fatigue experienced in watching direct-view. In projection, the image is seen on a dark gray screen. It is not necessary to throw nearly so much light to get white on the dark screen image, as it is to get black on the white

direct-view. When you look at projection television, "your eyes act normal all the time."

## To Be Remembered

Good cabinet design is a talking point, too, especially if the customer wants a large picture and a small cabinet. One projection table model is only 25 inches wide, 22 inches deep, and 14 inches high. The components take up so little space that the cabinet, console or table model need not be bulky, nor "stick way out from the wall."

Naturally, projection's advantages are better seen if the set is well displayed. For example, don't have a bright light shining directly on it. Do try to place it so the customer can view it comfortably, preferably from seven to 10 feet away. And don't make it easy for the customer to stand close to the set, at the side.

Finally, remember the extra economic advantage for the customer who buys a projection set: replacement cost of the projection tube is only \$39.85.

## Sales Boosting

Actually, successful dealers have resorted to neither magic nor luck. Mostly, they've "resorted to themselves." Here's what they've done—what you can do, too:

1. *Sell yourself.* It's worth having a set properly installed in your own home, for a week-end at least. Think about it. Get your family's and friends' comments.

2. *Do some merchandising.* At the very least, have a set, properly focused, operating in your store. You may be lucky enough to have space for an attractive, screened-off, home-like section, with a comfortable chair or two. Or you may have to sell it right alongside of a direct-view. Perhaps you'll give it a window for a month or so. But just don't miss your profits by doing what one dealer did: He had one projection set, not installed, patiently collecting dust in the back of the store. One of his salesmen had never seen a projection set work.

3. *Analyze your customer.* If he is interested in bigger pictures (most people are) and if he seems able to afford it, plan to try to sell him a projection set.

4. *Give him a demonstration.* Let him see for himself that the picture is clear, detailed, easy-to-look-at. Explain that there's no eye fatigue, no "looking into a flashlight." But don't high-pressure him. Some dealers prefer to concentrate on projection's own ad-

vantages; others do better by a factual comparison of projection and direct-view, then let the customer make his own decision.

5. *Don't show an expensive projection set first*—you might scare him away. Instead, "trade him up" gradually, first letting him see smaller screens. Then point out the advantages of projection, so he'll know how much value he's getting.

6. *Take your time*, if he seems really interested. Explain, simply, "how the picture gets seen"—the small tube, the mirrors, the projection of the picture "something like a small movie." Mention replacement cost of the tube. Call his attention to good cabinet design and workmanship. Ask in what room he's going to use it. Perhaps make a trip to his home, and if he's a good customer perhaps offer to install it "on approval."

7. *Be prepared for comments* on the lack of brightness (as compared to direct-view) and the "falling off the sides" business. Explain that projection is for long-time home viewing, where excessive brightness is not good for the eyes, and where it is not necessary under either daylight or conventional artificial lighting. (A projection picture is about four times as bright as that of the average movie screen.) Point out that no decorator plunks a chair down right at the side of a television set. And show him that the brightness does not "fall off" from a side view at a distance of say eight feet or so. There's also the point that direct-view looks distorted from a close-up side view. It is direct-view's greater brightness, not a clearer picture, that the viewer really sees.

8. *Be able to answer all your own questions*, and you'll be able to answer those of your customers. The more you know, the more you can teach others to appreciate projection. And since projection sales are increasing you'll be right on the sales bandwagon. And on the dollar bandwagon, too—because big picture sales bring in those bigger profits.

**Are you** neglecting sales opportunities in projection television? If you have any questions about projection TV, please write to Radio & Television Journal, 1270 Sixth Ave., N. Y. and we'll be glad to give you complete and up-to-date information.—Editor.

# The Quality Line for '49

It's

# ANSLEY

## TELEVISION—RADIO—PHONOGRAPH

*In Decorator-Styled Cabinets*

*featuring NORELCO PROTELGRAM system*



*The*  
**REVERE**

12 x 16 Projection Television, AM-FM Radio, Dual Speed Ansley Record Changer for both regular and LP records.



### **Attention Dealers!**

**YOU CANNOT SHOW A PROFIT ON MERCHANDISE THAT CARRIES LESS THAN 30% MARKUP**

**Protect your profits with the Ansley exclusive franchise, which assures you of exclusive Ansley representation in your trading area.**

\*TRADEMARK REGISTRATION APPLIED FOR U. S. PATENT OFFICE

**ANSLEY**  
RADIO  
AND  
TELEVISION  
INC.  
41 ST. JOES AVENUE  
TRENTON 9, NEW JERSEY

**Please forward complete information on all ANSLEY television models and the ANSLEY EXCLUSIVE FRANCHISE**

Dealer \_\_\_\_\_

Street No. \_\_\_\_\_

City \_\_\_\_\_

# How

*Don't let fear  
sales opportunities*



**Focusing the Protelgram projection unit is not at all complex. Here Virginia Forsythe, on the public relations staff of North American Philips, rotates the complete "tail piece" slightly. Even inexpert, feminine hands can make this corrective adjustment if the picture slants or leans to one side.**

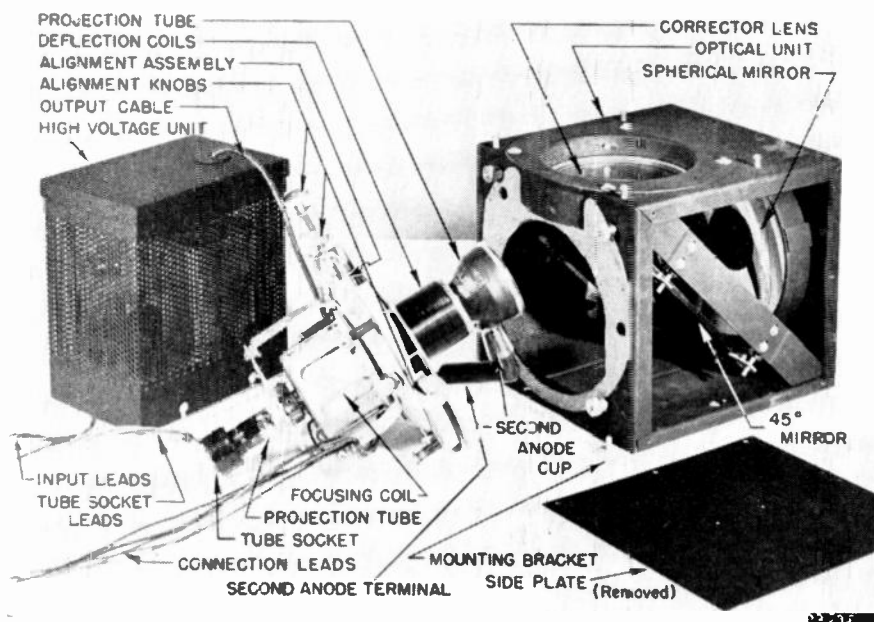

**Compactness is a feature of this Protelgram system. At left is the high-voltage unit necessary for bringing in the picture. At the extreme right of the optical box, right, can be seen the 45-degree-angle flat mirror. Corrector lens is at top of box. Tube tail piece fits snugly into this box.**

**D**EALERS who shy at projection, visualizing some intricate mechanism which their servicemen will not be able to understand, are being unnecessarily pessimistic. These same dealers may have qualms about the system because they find it difficult to grasp and feel their customers will be equally confused by the system. Nothing can be further from the truth.

In the first place, a television receiver is a much more complex piece of equipment than a radio receiver. And yet technicians all over the land have proven they can take care of television receiver servicing. Except for the projection unit and an internal cabinet mirror, projection television has the same chassis problems that are presented by direct-view. An understanding of how the projection unit can be taken care of, both by the service technician, by the dealer, and even by the customer himself will clarify this matter. The Protelgram projection unit, as perfected by North American Philips Co., Inc., and now being used by nine licensee manufacturers, serves as an excellent example for pointing up the ease of putting a projection unit into operation.

Isolated, the Protelgram projection unit consists of a high voltage unit and an optical box, into which fits the projection tube and its appurtenances. The high voltage unit is the least of servicing worries. If anything goes wrong with it, four leads running to the bottom of the chassis are disconnected and the unit is shipped back to the factory. Two standard tubes, 6SR7 and 6BG6G, should be checked before concluding that the voltage unit is at fault, however.

### *Like a Trap*

The optical box, where the picture is trapped and then reflected, is another segment of the whole Protelgram unit which needs no attention. It has a concave mirror, a plane mirror and a corrector lens. All these elements are aligned at the factory with precision equipment. Should anything go



# Projection Works

*of servicing projection hamper  
in this 'big picture' market*

wrong with any of these elements, the box is sent back to the factory for proper alignment. In the main, the balance of the system is packaged so that engineering has cut down the number of parts to bother with. Most important, of course, is placing the tube properly into the "tail piece" and making the proper optical alignment. This single precaution can make good or bad pictures. Focusing for the best picture is comparable to that done in a home movie projector, except that there are three knobs to turn rather than one lens to adjust. Concentration on the picture produced is essential during all focusing adjustments.

## **Important Steps**

When the projection tube is moved snug against the yoke and the five thumb-nuts which lock the optical adjustments in place are loosened, picture focusing can begin. Three knobs, "O" for "Over-all Focus," "H" for Horizontal Focus," and "V" for "Vertical Focus" do the trick. Knob O moves the tube forward and backward in relation to the concave mirror. By watching the center of the picture only, an operator can bring it into focus. Knob H adjusts the face of the tube so that it is parallel to the face of the concave mirror. An operator must watch the sides of the picture, bringing both into equal focus. Knob V brings the top and bottom of the picture into focus.

If the picture should slant or lean toward one side, by rotating the complete tail piece and watching the screen, the picture can be readily straightened. Four nuts hold this tail piece in place inside the box. If the picture is not properly centered, or does not completely fill the screen, by adjusting the three tilt screws provided at the bottom of the optical box, the picture can be centered and made to overlap the screen by one-quarter to one-half inch, as is proper.

## **Final Checks**

All this turning and rotating, of

course, involves very little motion, since precision engineering has narrowed the adjustment to fine fractions. If the proper focusing procedure has been followed, checking of the steps taken should not be necessary. However, a

quick check of the focus, "O", "H", and "V" in that order, can readily verify the correctness of the operations made. The five thumb-nuts must be locked to hold secure the optical adjustments that have been made. A final dusting of the corrector lens with a soft cloth and the Protelgram unit is ready for operation.

Projection television is as easy to put into operation as described for Protelgram. The special projection unit which goes with the system has been so packaged, so precisely engineered, and so carefully aligned, that the unit requires a minimum of attention. Focusing, as has been seen, is not at all complex. As for the care or replacement of parts and components, television technicians can readily solve any problem that comes up—either in the projection unit or in the chassis itself.

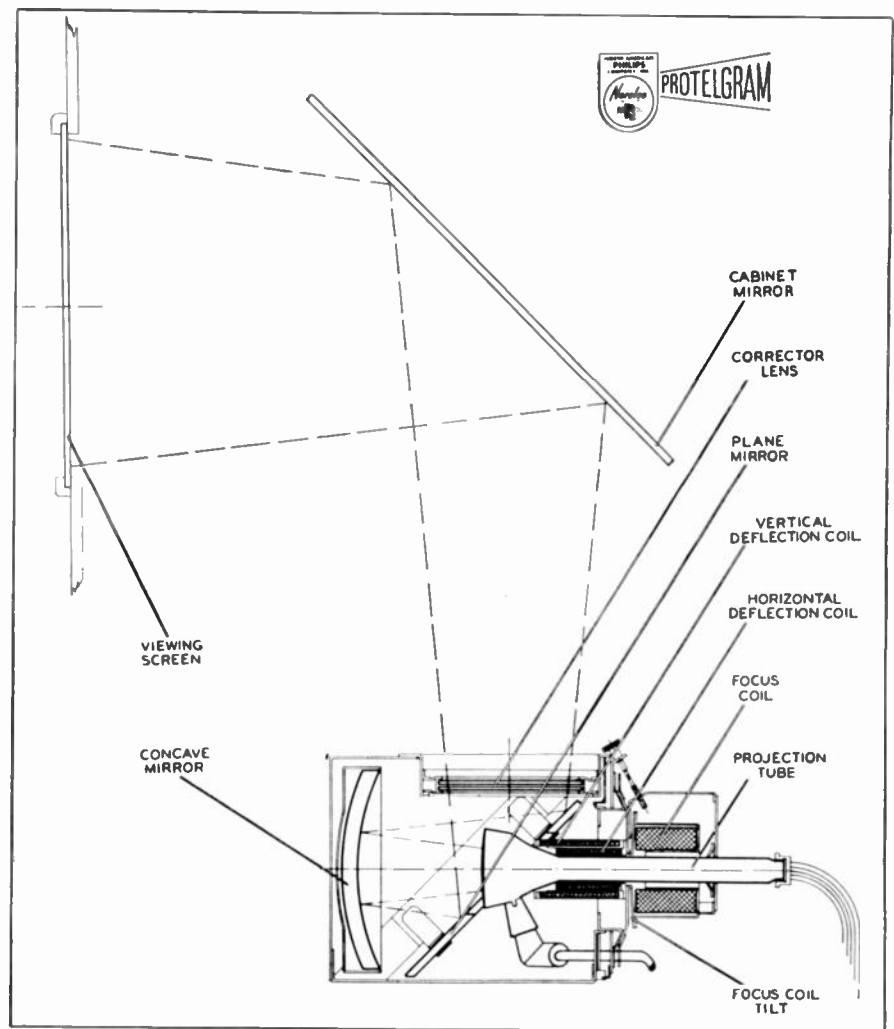

*It's all done with mirrors. With the help, of course, of a small, ingenious cathode-ray tube and a high-voltage unit. Here is a graphic representation of the complete projection system. The picture which appears on the face of the 2½-inch picture tube is projected on the concave mirror at the front of the optical box. The image is bounced off this to the plane mirror, thence through the corrector lens to the tipped cabinet mirror. Thus the picture has appeared on four glass surfaces before it finally emerges on the viewing screen.*

# FADA AND

## PROJECTION TELEVISION

### MODEL 880

## THE IDEAL FOR PERFECT

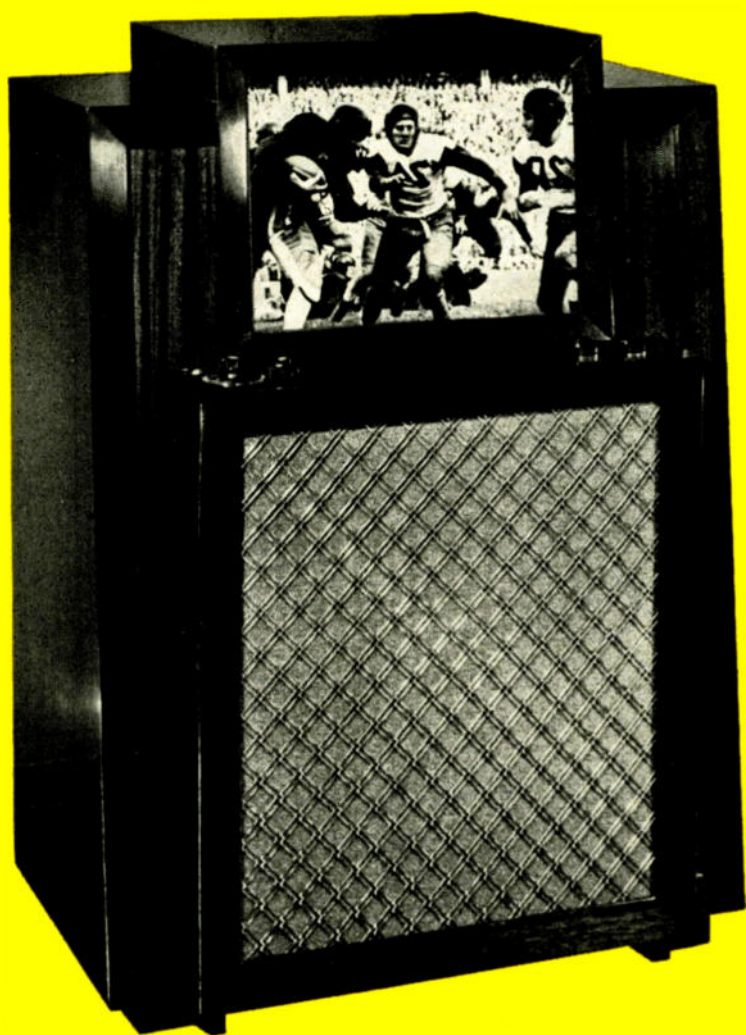

Fada selects the Norelco Protelgram projection system to provide the best quality, definition and high contrast ratio demanded by discriminating viewers in Fada Projection Model 880. The 192 Square Inch image is completely distortion-free with a total absence of discoloration made possible by use of the incomparable Norelco Protelgram.

- ★ Wide angle visibility and superb picture stability
- ★ 36 Tubes including Kinescope and 6 Rectifiers
- ★ Sharp, pure black and white pictures. No glare or eye-strain.
- ★ Field range 10 Inch 'Alnico V' Permanent Magnet Speaker.
- ★ 192 Square Inches of picture viewing area providing unsurpassed picture detail.
- ★ Operates on 117 Volts, 60 Cycles A.C.
- ★ Luxurious hand-rubbed Genuine Mahogany or Genuine Bleached Blonde Mahogany veneer cabinets.
- ★ See it! Hear it! Learn why Model 880 Television Projection Console with Norelco Protelgram is the last word in Television viewing.

Those who have seen Fada Model 880 say, "I never realized that television viewing could be so wonderful." No dealer can afford to be without this model on his show-room floor.

FADA MODEL 880 . . . In genuine Mahogany or Bleached Blonde Mahogany veneer console cabinets.

# FADA

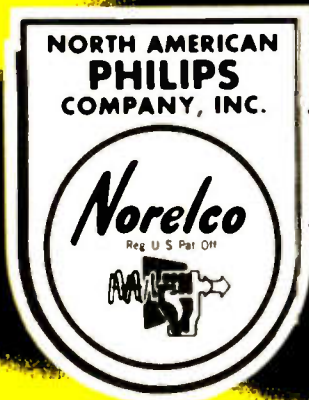

# PROTELGRAM

## COMBINATION TV PROJECTION

### *192 Sq. Inches!*

OF MOST COMFORTABLE VIEWING

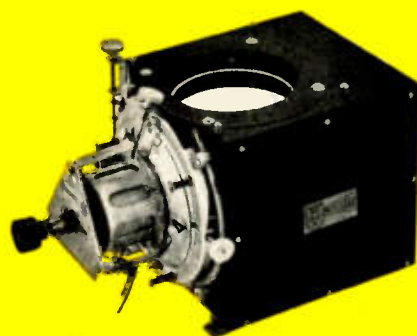

The PROTELGRAM projection system consists of a specially developed 2½" projection tube, an optical box with focus and deflection coils, and a 25 kv regulated power supply unit. The compactness and flexibility of this system make possible the large-picture television in Fado Model 880.



FADO MODEL 880 . . . Exquisite  
Genuine Bleached Blonde Mahogany  
Veneer Console houses the incompar-  
able 880 Projection Television with  
Norelco Protelgram.

*"Pioneers in Radio and Electronics Since 1920"*

# RADIO & ELECTRIC CO. INC.

## Belleville . . . . New Jersey



# West Coast Dealer Uses Aggressive Promotion for Projection

By W. E. Moffett  
Birkel-Richardson Co.

Our company started the promotion and sale of projection television last October. After having a sample shipped to us and thoroughly checked by our service department and tried out in the homes of several of our people in different parts of the area, we came to the conclusion that projection television, and particularly Scott using the North American Phillips tube, was tops in television. Although this was our conclusion, it was necessary to lay a foundation for sales promotion and to go ahead with a sales program that would convince the public and the television buyer that it was worth while to pay a higher price for the larger projection screen than for the ordinary 10 or 12 direct tube television. To make this convincing to the buyer we placed two or three of the Scott models in our television sales rooms directly in comparison with leading make direct tube sets, and during the time when television was on we always had a set working so that as soon as a customer came in the door of the particular sales room they would be met with the larger size picture. Incidentally, our television sales rooms are of good size, being 20 x 21 in dimension, and the picture is ideal at a distance of 15 or 20 feet away from it, while most of the direct tube sets do not show up so well at that distance.

A newspaper campaign, particularly set for coverage in the better class home areas was worked out so that we had a continuous small ad running in a choice location in the paper, calling attention to the large size picture on Scott television—copies of some of these ads are attached. Approximately two weeks after starting our advertising program, we began a consistent direct mail selling campaign, including in this: mailings to our customers who had purchased fine radio-phonograph combinations or grand pianos, leading doctors, moving picture studio directors and personnel, and others whom we considered to be in the class of good prospects for television. This campaign really started right after election, a time when almost everything else in the radio, television and luxury lines started downward, but our sales program has enabled us to keep up a much better average volume on projection television than the volume shown in other lines, both television and other type merchandise.

**Birkel-Richardson**  
THE HOUSE OF MUSIC SINCE 1901

**SCOTT Remote Control MUSIC SYSTEMS**  
RADIO PHONOGRAPH TELEVISION

INDIVIDUALLY ENGINEERED FOR HOME ENTERTAINMENT . . .

Music, faultlessly performed . . .  
Now for every part of your home or estate with the precision Scott push button remote control system. Custom-designed, engineered and installed by Birkel-Richardson technicians. Estimates gladly furnished without obligation.

**THE WORKS OF A SCOTT**

Open each remote control station you own

- 1—Turn on or off
- 2—Select radio station desired
- 3—Control volume and tone
- 4—Change from radio to phonograph
- 5—Reset any record instantly

**TELEVISION COMBINATION**  
Model 800 BT

Large (192 inch) 16x17-inch picture that is clear and sharp, yet soft as a phonograph. Radio-phonograph with AM & FM bands, 15-inch coaxial dual speaker and the world famous Scott tone.

**1975 plus installation**

ANNOUNCING THE NEW SCOTT RECORD PLAYER . . . HANDLES 78 RPM AND LONG PLAYING 45 RPM & 33 1/3 RPM RECORDS

**BIRKEL-RICHARDSON**  
The House of Music

Open Monday Evening  
**LOS ANGELES**  
738 W. 7th St. Phone VA. 1241

Open Every Evening  
**ALHAMBRA**  
Music Dept. & S.M.BURN'S, 419 E. Main St.

Our sales people have been instructed when waiting on a prospect to demonstrate to them the difference in the eye strain between the projection model and any of the direct-view television sets. They also sell the advantage of the larger picture, making it possible for a greater number of people to see whatever is going on and compare it with the better grade of home moving pictures.

Our experience in selling has shown us that there are many people perfectly willing to pay the price for a fine three-way combination which includes this projection television, and we have been able to sell all of the DeLuxe model three-way combinations that we could get.

## TV 'Trade-Ins'

For the first time in the comparatively short "history" of television, a trade-in of sets has been established as a definite merchandising policy by a retail dealer. The man responsible for this application of an old selling device to the new television industry is Albert V. Saphin, president of the Monarch-Saphin Stores of New York City. Working on the principle established by used car dealers, Mr. Saphin, who has built a reputation for being a shrewd and forceful merchant in the tough market called New York, plans to resell the old TV sets at reduced prices. All trade-in machines will be rebuilt by Monarch's own service technicians and will be released with a guarantee. The trade-in policy will include all makes of television receivers. Financing of the re-built units will be offered on a deferred payment plan, similar to the regular operation of Monarch-Saphin's retail stores, which also handle a full line of home appliances.

Saphin explains that he took this action in order to protect the buying public from obsolescence in their TV sets, many of which are now three years old. He thus hopes to encourage new sales to previous TV set owners who have hesitated because of fear of taking tremendous losses on old sets. These set owners have had no place where they could re-sell their television sets in the manner traditional with the automobile trade. Saphin is also causing a stir in retail circles with his blunt statement that "Prices on television sets, today, are way out of line. Not only are the sets over-priced, but video sets that were purchased two and three years ago have become of little or no value." (It should be pointed out that many responsible trade sources differ sharply with this point of view, stating that many receivers that are ten years old are still giving excellent service). At any event, this new event to the TV merchandising picture, (prices on the re-conditioned sets will range from \$125 to \$150, complete with installation) is bound to cause repercussions.

not just television...  
but

# SCOTT

PROJECTION TELEVISION

incorporating the highly-preferred

NORELCO



PROTELGRAM



Model 400A is shown both open and closed. The view screen and reflecting mirror fold quickly and easily into the top of the receiver. The set is only 25 inches wide, 22 inches deep and 14 inches high. List price . . . \$695.00 plus nominal installation charge.



Here, truly, is big-picture television in a table model. 192 Square inches. The model 400A is shown, with view screen raised. The image has no distortion; it is sharp and true right to the corners. No glare. No eye strain. Mahogany, walnut or blond bisque finish.

## SCOTT TELEVISION . . . The Incomparable

THREE-WAY  
COMBINATION

•  
TABLE MODEL

•  
16" x 12"  
192 SQ. IN.

•  
FLAT SCREEN



Shown here on a SCOTT radio-phonograph combination, the model 400A is a completely independent instrument with its own sound system. Or, it may be played through the better types of combinations. Self-contained with TV and sound, it is a boon to the man who needs television only.



Television that is something to behold. Model 800BT three-way combination, with doors swung back and view screen in position. Its precisely engineered record-changer will play all three types of standard and long playing records. The pickup is designed to match the full fidelity range of the SCOTT. Cabinet in wide-ribbed mahogany veneers, beautiful beyond description. List price . . . \$1975.00 plus nominal installation charge.

Words fail to express the excellence of SCOTT television.

For those who want the finest. SCOTT enables you to offer the very shrine of perfection in a three-way combination — television, radio and phonograph, merged and blended in one exquisitely designed console, suited to the pretentious home or small apartment and, above all, capable of three-way performance such as SCOTT alone has achieved.

Many will prefer the compactness and portability of the SCOTT table model whose perfection and picture-size are identical to the larger models, yet designed for flexibility in use — by itself, on or near a radio-phonograph, or in another part of the home.

The more your customers know about television the more they will want a SCOTT — the instrument of astounding perfection.

Write for full details.

**SCOTT**  
**RADIO LABORATORIES, INC.**  
4541 RAVENSWOOD AVENUE  
Chicago 40, Illinois



## New Projection Displays Draw Throng of Interested Dealers

The power of projection and the galloping strides it is making in capturing the interest of all sections of the television business was recently illustrated when Fada Radio and Electric Company, one of the manufacturers licensed to use the Norelco Protelgram projection system, held showings on its new line of receivers for dealers in New York and New Jersey. Although Fada makes a complete line of direct-view receivers in addition to its console projection model, the hundreds of dealers who attended the showings displayed marked interest in projection. Many dealers who heretofore have been sceptical about selling projection, claiming that the picture definition and clarity did not "hold a candle" to direct-view, arched their eyebrows as they witnessed *big pictures* on projection that had remarkable black and white contrast and excellent definition. We overheard one large dealer comment: "I don't intend to give up direct-view sets; they'll continue to be the major portion of my TV sales, but what I see here convinces me that projection is the answer to big screens, and I mean *real* big pictures."

Fada is now in the process of holding these exhibits in various sections

of the country and they report unabated enthusiasm on the part of distributors and dealers for projection. If the trend indicated in these shows is any bell-weather, it is evident that projection is at last taking hold and should start to make itself felt in merchandising circles by early autumn.

Projection television is beginning to capture the imagination of dealers who are tired of seeing 10-inch sets referred to as "big picture" in loosely worded advertisements. Above, Jack Marks (hand on dial), President of Fada Radio & Electric Company, Belleville, New Jersey, demonstrates how large and effective a picture can be brought in on Fada's projection console set. Fada's projection model 880 utilizes the Norelco Projection System, provides a 192-square-inch picture and is housed in a handsome modern console cabinet.



The current series of Fada showings of the new line (Fada makes a complete range of direct-view as well as projection TV) is attracting a large turnout of dealers who are showing mounting interest in the projection models. "Customers are demanding bigger and bigger pictures," say dealers, adding, "and projection seems to be the answer."





Television's newest look is an eyeful. This is how a "screened" telecast featuring a motion picture shows up when projected by a Protelgram unit on a home movie screen.

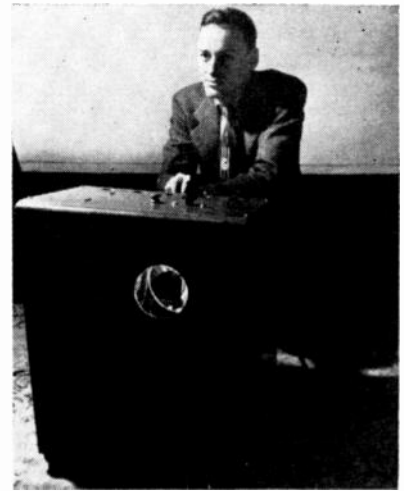

The television cabinet which produces the 3- by 4-foot picture on the left. End of 2½-inch projection tube is visible through corrector plate on optical box just inside the porthole.

## New Projection System "Throws" 3x4 Foot Image

The versatility of projection television, already a feature of several leading projection receiver manufacturers, was further demonstrated to the trade several weeks ago when the North American Phillips Company, inventors and manufacturers of the Protelgram projection system, displayed a television picture that measured four feet wide by three feet high. This giant image was projected on a conventional home movie screen from a small cabinet containing a complete television receiver and a slightly modified Protelgram optical unit.

Actually, the only modification of the standard unit, which produces a 20-inch diagonal picture of some 200 square inches in conventional cabinets with built-in screens, was a change in the positioning and optical features of the corrector lens. The new unit is being made available to qualified manufacturers for incorporation in receivers of their own design. "Since throw and magnification in the Schmidt optical

system used by Protelgram are determined entirely by the optical components, a simple change in the Protelgram 'Optical Box' makes possible picture sizes ranging from the 16- and 20-inch diagonal characteristic of the present unit to any size up to the 60-inch diagonal picture we have demonstrated," said Pieter van den Berg, president of the company, in commenting on the new system.

This new development comes on the heels of much discussion about the place of large screen television in theatres, which it is expected will soon become available generally. One television consultant, Ralph Austrian, recently told the Society of Motion Picture Engineers that large screen television will be the greatest single factor in arresting any movie box office decline due to television in the home. This statement is based on a survey just completed by Dr. Thomas Coffin of Hofstra University, Long Island, which disclosed that after one year of



Double version of a TV beauty. The same tube in the hands of the model is responsible for both picture sizes.

use, a television set owner begins going to the movies more frequently. The decline in movie attendance among those who own sets for less than one year is 36 per cent, while the decline is 23 per cent among those owning sets for more than one year, the survey showed. In any event, this new Norelco "large screen" projection TV is expected to have a profound effect on the public's conditioning to screen size, whether it be in the home or at the movies.

**IN TELEVISION ...**

Seeing is  
Believing

*International's "Consul" has what the whole industry has been clamoring for — "Movie-Quality" Television! Using the North American Phillips Co. Norelco Protelgram, International's engineers have created a receiver which eliminates eye-straining glare while maintaining the full, rich range of picture tones — reproducing true whites, grays and blacks without distortion or discoloration.*

*See it and you'll know*

*why we call it "Movie-Quality" Television.*

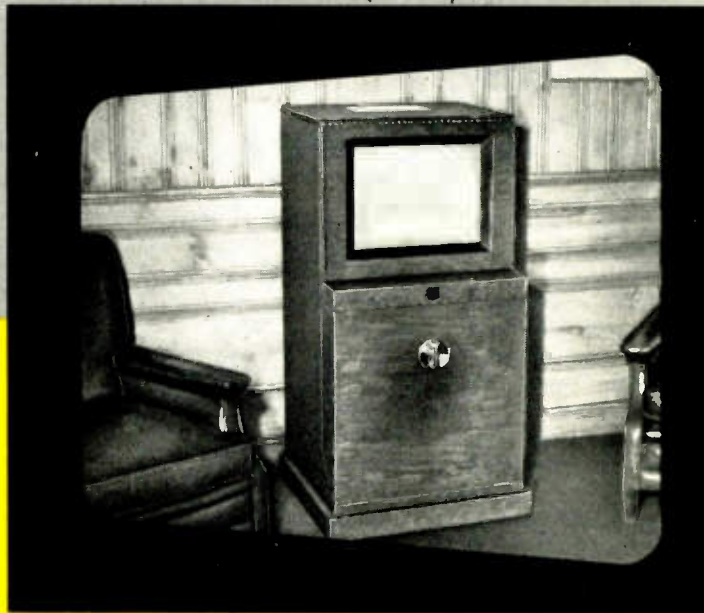

INTERNATIONAL



TELEVISION CORPORATION

238 William Street,  
New York 7, N.Y.

# THE "CONSUL"

MODEL CP-16

**screen** . . . Dimensions: 12" x 16"—an area of 192 square inches. Specially fitted. Non-directional. No glare.

**chassis** . . . Modified 630 TS. 35 tubes, 5 rectifiers. Full response, high fidelity, 8" PM speaker. Finest quality components with high temperature ratings. Full range channel reception. Standard control panel with special simplified fine tuning and precision focus controls.

**optical system** . . . Norelco Protelgram projection. Completely sealed. Dust proof. 8.6 linear magnification with 6-inch spherical mirror. Distortion-free.

**cabinet** . . . Designed by an expert and executed by the finest craftsmen. Sturdily constructed of top quality, 3/4" plywood. Dimensions: 24" x 24" x 48".

**cabinet finish** . . . Covered with Gilcolite, the best quality plastic-coated, fabric-backed leatherette. Fire resistant, water repellent, does not crack or peel, will not be injured by alcohol, acids or grease. Easily cleaned with ordinary soap and water. In six attractive colors: red, blue, green, brown, tan and blond. Wide range of special colors to match existing decors available at slight additional cost.

**servicing** . . . The two major components — the Norelco Protelgram and the 630 TS chassis are standard pieces of equipment familiar to all repairmen as the most easily serviced units on the market. In addition the cabinet is specially designed: the chassis is mounted on the front panel, which is hinged and swings down to facilitate servicing. All wires are color coded and cabled.

## attention dealers!

The "Consul" is ideal for commercial installation. Just set it up on the back bar, plug it in, turn it on and you've got the best commercial television in town.

The same receiver is available in furniture-styled cabinets of varied design — both antique and modern — in a variety of wood finishes.

International's sets are available in unlimited quantities. Inquiries from dealers are invited.

## BAR WINGS TO MATCH

International has available specially designed bar wings, which, together with the "Consul" make a compact recreation unit that is ideal for playroom, club or living room.

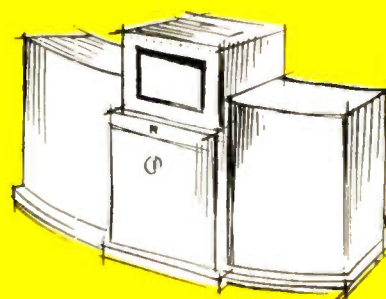

Glue and screw construction of 3/4", five-ply plywood is utilized throughout. The bar top is Goodyear marble-ized rubber and the entire wing is covered in Gilcolite to match the receiver.

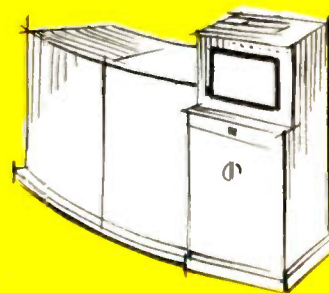

Each wing has two shelves, an electric socket with two outlets for mixers and other gadgets, and six feet of rubber cord. Dimensions are 18" x 36" x 42".

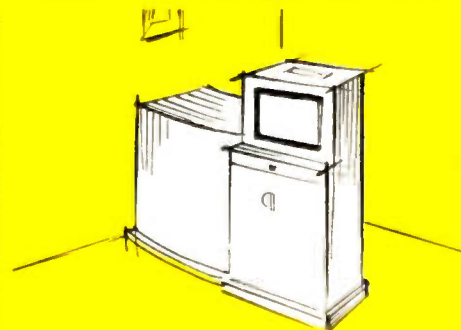

One or more can be combined with the "Consul" to make a number of attractive combinations.

**INTERNATIONAL TELEVISION CORPORATION**

238 WILLIAM STREET,  
NEW YORK 7, N. Y.



AMERICA'S FINEST

*For America's Finest Dealers*

# THE FISHER

## TELEVISION RECEIVER

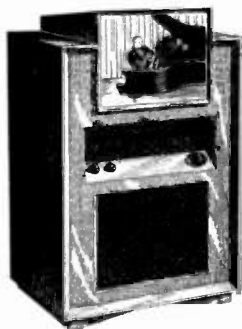

NO QUALITY instruments have so completely captured the esteem of dealers and buying public alike as the FISHER Television Receiver and Television-Radio-Phonograph, with their 192 square-inch picture.\* In offering this equipment to their top bracket patronage, FISHER dealers enjoy not only the enormous advantage of an exclusive franchise but also the unshakeable knowledge that they are offering equipment that *looks* the best, *sounds* the best, and *is* the best by a margin obvious to everyone.

If you are interested in a top line that really is top, if you want that line on the only basis that can fully protect your investment and promotional efforts, an *exclusive* franchise for your territory, write us now. Address: AVERY R. FISHER, *President*.

FISHER RADIO CORPORATION

43 EAST 47TH STREET

NEW YORK CITY

*\*featuring the NORELCO PROTELGRAM system.*

# "We Chose Projection"

*Known as the "Tiffany" of radio, Avery Fisher sells only projection TV to his discriminating "Carriage Trade"*

**I**N A cozy salon right on the fringe of New York's East Fifties and Grand Central areas, a projection television retail operation is capturing the fancy of the quality trade and is proving what a bonanza projection can be to a dealer. The salon is the show and sales room of the Fisher Radio Sales Co., Inc., retailers of radios, television, and combination consoles, and nestles snugly alongside other carriage trade shops at 41 East 47th Street, between Madison and Park Avenues.

Like most other salons in radio and television retail outlets, the Fisher show room has table and console models ranged decoratively around the walls, has carpeted floors, and has soft arm-chairs for the comfort of customers. It also has subdued gray-painted walls, which help create an ideal atmosphere for demonstrating television. But here the parallel with other retail salons ends.

## **The Quality Approach**

The receivers in the Fisher show-place, whether radio or television, are of one kind. They are all made by the Fisher Radio Corp., renowned manufacturer of custom-built, quality radio receivers, and, more recently, projection television sets. That only projection sets comprise the complete Fisher television line is no accident. It goes back to the origins of the firm and the guiding spirit behind it, Avery Fisher.

Mr. Fisher comes from a musical family, has loved music from boyhood, and is himself an amateur violinist. In his boyhood he used to tinker with the family phonographs along with his father, and he grew up a hobbyist at trying to better radio reception and record reproduction. He studied at New York University, tried book designing and advertising for a while, and finally wound up turning his hobby into his business, establishing the Philharmonic Radio Corp. in 1937. Under the Philharmonic trademark, Fisher's radio-phonograph sets won renown among music critics and musicians themselves, but eventually he sold the original company and with it went the tradename. Philharmonic now tagging sets in a lower price bracket made by an entirely different firm.

As for Fisher, he formed the Fisher Radio Corp. after the war in 1945, and proceeded to make radios and radio-phonograph combinations, both table and console models, of top quality. "The Fisher", as his set was called, was retailed through the Fisher Radio Sales Co. in the New York shop, and was merchandised nationally through selected, franchised dealers in all important cities throughout the country. The high-fidelity sets became a byword among customers who sought an instrument which reproduced music with depth, texture, clarity and realism above the usual run of radios and radio-phonograph combinations. The appeal of Fisher's instruments was, and is, largely to music lovers and professionals in the middle and upper income brackets. Fisher's reputation spreads by word of mouth.

## **Enter Projection**

Until a year or so ago, the Fisher Radio Sales Co., Inc. had no television receivers on display in its salon. But by then, the plunge into television was in the offing. Before anything was undertaken, however, the entire television field was carefully analyzed. Fisher and his staff of engineers and technicians had a look at all the direct-view sets on the market, considered all future developments in the direct-view field. Then they tore into projection television, analyzing its advantages and disadvantages, comparing its features with those of direct-view. At length, direction was given to television so far as Avery Fisher was concerned. He decided to manufacture projection television, and therefore sell nothing but projection television in his retail outlet and to his franchised dealers.

Fisher chose projection television for specific and significant reasons. The TV picture produced, he feels, is a natural image, reproduced on a flat screen where it is seen just as it is broadcast by the transmitter. The "barrel" effect of conventional receivers, in which figures moving out of the scene appear to roll off the ends as on a merry-go-round, is missing in projection. The projection picture is also large enough to suit anyone's taste, about four times that of a 10-inch tube.

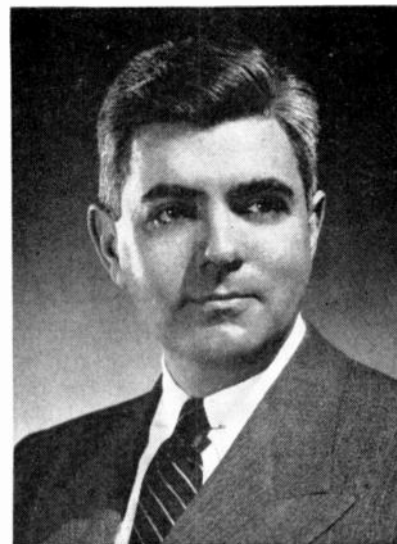

AVERY FISHER

It also has brilliance without glare, enabling viewers to watch for four to five hours without suffering any eye fatigue. And when it comes to replacement, the projection tube can be purchased at a nominal cost in comparison with the cost of direct-view, cathode-ray tube replacement. Although projection television produced a larger picture and incorporated other advantages, the size of the cabinet holding the chassis and projection system was no larger than direct-view television sets, a further factor in projection's favor.

## **Protelgram**

Once Fisher set his sights on the direction his television manufacture and merchandising would take, he had only to shop around and select a projection system to use in his own cabinets along with his own chassis components. The decision was largely academic by then, because in examining the pros and cons of projection in comparison with direct-view, it was necessary to shop the major projection systems on the market. Fisher finally settled on Protelgram, the system developed by the North American Philips Co., Inc., and the television sets now sold by Fisher Radio Sales Co., Inc. are exclusively projection, using nothing but the Protelgram system of projection.

Behind Avery Fisher's present methods of manufacturing and merchandising is fundamental acknowledgment that no receiver can be all things to all men. Each has its features, and every customer must make a choice from that standpoint. As far as he is concerned, however, he stakes his reputation on a quality set above the average price range, makes everyone a custom-built job, and goes on selling through customer satisfaction.

The keenest critics are of a mind that the firm's radios and radio-phonographs are of a quality set above the average price range, makes everyone a custom-built job, and goes on selling through customer satisfaction.

*(Continued on page 50)*

## ***“Projection is TV of the Future”—Abrams***

Television of the future lies in projection. This is the prediction of Benjamin Abrams, president of Emerson Radio and Phonograph Corp. This firm belief in projection by one of the leaders of the television industry was made recently by Mr. Abrams in an address before the New York Society of Security Analysts. Despite a rather inauspicious start, Mr. Abrams is convinced that projection will become the dominant type of receiver for the future.

Development of the projection system is proceeding very rapidly, said Mr. Abrams, and his company is now engaged in work on a remote control box, 12 x 12 inches, which will enable the viewer to adjust the controls while seated 10-12 feet away from the receiver.

The Emerson Company at present is at the peak of its television activity, making 500 sets a day, and a rate of 1,000 a day is expected to be reached this year. While in 1948 television comprised only 25 per cent of total sales, this year it is expected that TV will account for 60 per cent of total production. This will be accompanied by a substantial decrease in radio production, which is currently proceeding at a rate of 3,500 to 4,000 a day. This compares with 10,000 per day last year.

Analyzing competitive factors in the radio and television market, Mr. Abrams pointed to the fact that many radio and television producers also make such appliances as washers and refrigerators. When these appliances were in short supply immediately after the end of the war, tie-ins of radios were a common practice, but now that there is no longer a shortage, each product must be sold on its own merits.

Pointing out that *good dealer acceptance* is the most important factor responsible for his company's success, Mr. Abrams stressed that Emerson's cooperative advertising policy with its dealers and distributors will be continued, and will be supplemented by an expenditure of between \$500,000 to \$700,000 of company advertising.

### ***“Objections Over-ruled”***

Television is such a new development that many people are held back from buying sets because of perfectly natural doubts, fears, and reservations. How to overcome these objections is the theme of the leading feature articles in the June issue of RTJ. Don't miss it!



*Benjamin Abrams, left, with well-wishing friends, Mr. and Mrs. Witz, before sailing aboard the “Queen Elizabeth” in April. The president of Emerson Radio & Phonograph Corp. conferred with leading radio manufacturers during his stay in London, visiting also in France, Belgium, Holland, Switzerland, and Germany, before continuing on to the Far East.*

## **Is Radio Doomed?**

One of the most provocative articles on the subject of radio's future, now that television is gaining ground more rapidly than anyone's wildest hopes, was one by Merlin H. Aylesworth in a recent issue of *Look* magazine. “I predict that within three years the broadcast of sound, or ear radio, over giant networks will be wiped out”, Mr. Aylesworth stated right off in his article. Coming from the man who served as the National Broadcasting Company's first president, and who has since been closely tied to the media fields, this was a significant prediction.

What Mr. Aylesworth foresaw was network television taking the place of network radio, with weather reports and recorded programs remaining in the domain of radio, chiefly among independent ear radio stations. Stars of present radio would become the stars in television. Citing the present state of distribution of television sets as an example of the way television areas can become saturated with set owners, Mr. Aylesworth pointed out the scope of the

potential purchaser market. It was his belief that television is tending to become a necessity rather than a luxury in the home.

The meaning for dealers is clear. Here is confirmation from another source of television's glorious future. When Mr. Aylesworth goes on to recommend to his readers that they pick themselves a reputable dealer and get along with the business of buying a television set, he is steering customers to those aggressive dealers who are keeping in step with the times. He refers to dealers who are following sound business and merchandising policies to help themselves and to help the industry progress.

In the light of Mr. Aylesworth's sentiments on the future decline of radio and the enhanced role television is destined to play as an entertainment medium, what Benjamin Abrams has to say elsewhere on this page about projection television takes on added significance. Projection, it would seem, is also destined to go places.



# THE PERFORMANCE, STYLE AND VALUE LEADER IN PROTELGRAM—PROJECTION TELEVISION



List Price Only

\$599<sup>50</sup>

## *Emerson* **LONG DISTANCE** *Television*

The quickest, surest way to capture your share of the expanding market for BIG SCREEN PROJECTION SETS is to concentrate on Emerson Long Distance PROTELGRAM TELEVISION. Giant-size 192 square-inch, brilliant, "easy-on-the eyes" pictures. Sensitive long-range circuit. Beautiful Honduras mahogany veneer console with "Fold-away" picture screen. Once again, Emerson gives you value leadership to increase sales and profits.

EMERSON RADIO & PHONOGRAPH CORPORATION • NEW YORK II, N. Y.

Radio & Television JOURNAL • May, 1949

## The Social Impact of Television

"There are 1,429,000 television sets in operation in the United States today. Approximately 40 per cent of these are located in the New York Metropolitan area. By the New York Metropolitan area, I mean those counties in addition to the five boroughs of New York City which are generally included on all marketing maps labeled "New York Metropolitan Area." This means, therefore, that there are 571,000 sets in this area. The United States Bureau of Census figures indicate that there are in the same area a total of 3,900,000 electrically wired dwelling places. We can quickly see, therefore, that a 14½ per cent saturation point has already been achieved in the short span of two years of commercial television set production. A simple calculation would seem to indicate that complete saturation of this area would be reached in seven years. I feel, however, that with the growing popularity of television due to the constant betterment of programs and the steady decrease in price of sets, a saturation point of between 90 per cent and 100 per cent in this area will be reached in no more than five years. I assume, of course, that there will be no interruption to the normal growth of television by war, governmental regulations or other unpredictable circumstances.

"The greatest stimulation to complete saturation of the rest of the country is not, as so many people think, extension of the co-axial cable or the radio relay system to the rest of the cities of the country, but the quick production of a television set with a satisfactorily sized picture to retail complete somewhere between \$100.00 and \$125.00. I confidently expect that such an instrument will be available to the public in a very few years. When that happens, our co-axial cable networks or other means of relaying will be extended across the nation in a surprisingly short length of time. I am sure that all of us have already seen for ourselves the effect television is having on the usual day-by-day activities of set owners and their

friends. There is hardly a magazine or newspaper you can pick up that does not have an article by someone about what television has done or will do to other established industries.

"Let's first consider what is going to happen to network radio. I think we can best approach this interesting subject by studying the effect of sound motion pictures on silent motion pictures. In five years 22,544 silent motion picture houses disappeared from this country and in their stead there were 15,273 wired theatres which reached a total at the end of 1948 of nearly 21,000. In other words, the people of the United States decided with lightning-like speed that they no longer wanted to look at pictures with their ears stopped up. Why should anyone have any other belief than that the American people will not want to listen to radio with their eyes closed. I think that network radio as it now exists today is about to enter the first stages of a rapid decline. This decline will accelerate rapidly during the next five years and at the end of five years be so difficult to maintain because of lack of the advertiser's dollar that it will give way to local and regional broadcasting and be superseded by coast-to-coast network television."

Such were some of the highlights of an address given by Ralph B. Austrian, television consultant, before the 65th convention of the Society of Motion Picture Engineers at the Hotel Statler, N. Y. last month. In commenting on the decline of silent motion picture houses and their replacement by wired theatres, Mr. Austrian gave significant annual figures.

In 1929 the number of silent theatres stood at 22,544; in 1930—14,140; in 1931—8,865; in 1932—4,835; in 1933—4,128; in 1934—2,504; in 1935—none. It took five years for them to disappear. Meanwhile, wired theatres had jumped from 100 in 1928 to 15,273 in 1935.

Magazines, newspapers, phonograph records, sports, nightclub attendance and a host of other fields would also feel television's impact, Mr. Austrian felt.

## We Chose Projection

(Continued from page 47)

graphs have established The Fisher as the Rolls-Royce of the radio-phonograph industry. Consequently, when the Protelgram system of projection television was chosen for all Fisher television sets, it came up to certain stringent requirements formulated by the head of the organization himself. Avery Fisher felt it was right for a custom-quality television receiver. It gave a picture of optimum size for the home; it yielded a natural, high-quality image that is pleasant to watch; brightness was provided without the need of filters; installation, operation, and servicing were made easy, and the projection system, along with the rest of the chassis, could be installed in well-proportioned cabinets that were not grotesque in size.

### Merchandising Secret

Even though Avery Fisher admittedly has been merchandising his projection television receiver for something like a year, sales of projection sets have increased significantly during that time. Models in the 47th Street show room vary from the \$695 table model to the \$1195-1795 price range for the three-way combinations. The reasons for the quickened movement of these varied models off the show room floor and into customers' homes cannot be entirely explained. There is a definite feeling that the search by TV prospects for the biggest value for their money is causing them to lean more and more to projection. Combinations are the rage among customers who can afford them.

Through it all, the salon between Madison and Park Avenues on 47th Street goes on serving as a retail shop and sales office for all the dealers who handle Fisher projection sets. It is also a clearing house for new ideas on the needs and wants of customers who patronize the Fisher salon. No lavish advertising promotes the TV sets which incorporate the Protelgram system of projection within their cabinets. Avery Fisher simply sells a television receiver of maximum quality, having the greatest convenience and usefulness, the least eyestrain, and the most compactness his firm has been able to manufacture. And he directs his sales to those customers in the middle and upper income bracket for whom the set has been designed. He sells one customer and others flock to his salon. Satisfaction—with Fisher television receivers and the Protelgram projection system which it incorporates—just continues to spread by word of mouth.



PILOT TV-952

Expert opinion everywhere says:

Nothing Finer in PROJECTION TELEVISION  
*than "Big Theatre" Television by*  
**PILOT RADIO**

with  
 projection system by



**PROTELGRAM**

EXPERTS in the trade — men who recognize the finest in television — are hailing Pilot's magnificent new "Big Theatre" Television for its thrillingly clear reception . . . amazing sensitivity . . . large 192-square-inch screen that can be viewed at any angle up to 45° with virtually no distortion or loss of light! Famed Pilot engineering — backed by over 20 years of television pioneering — plus the brilliant Protelgram system — offers an unsurpassed top-performance combination.

Write for complete details to:

- NEW PILOT TV-952 TELEVISION - RADIO - PHONOGRAPH features:**
- ✓ North American Philips "Protelgram" projection system
  - ✓ High Sensitivity—1 RF, 1 converter and 4 IF stages
  - ✓ Powerful 35 tube TV chassis (including 4 rectifiers and cathode ray tube); powerful 13 tube FM-AM radio chassis (including 1 rectifier, 1 tuning indicator)
  - ✓ Radio with 12" PM speaker; TV with 12" electro-dynamic speaker—each chassis operating independently
  - ✓ 192-square-inch Eastman Kodak screen, 16" x 12"
  - ✓ Exquisite hand-rubbed mahogany cabinet, 52½" wide x 22½" deep x 40¼" high.
  - ✓ Same TV chassis available also in Pilot TV-42 (TV Console only)

**PILOT RADIO CORPORATION, 37-06 36th Street, Long Island City, N. Y.**



# RTJ

## New Products



Radios  
Television

Consoles  
Recorders

Phonographs  
TV Accessories

### New Motorola Products

Manufactured by Motorola, Inc., 4545 Augusta Blvd., Chicago 51, Ill.

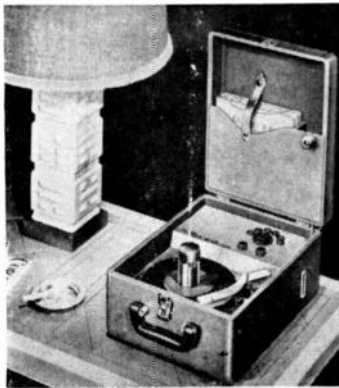

A lightweight portable radio-phonograph that is especially designed for the new 45-rpm. records. Set weighs 12 pounds and is only a foot wide, but accommodates eight records for 40 minutes of continuous music. Has storage space in lid. Comes in smart luggage-type case with plastic handle.

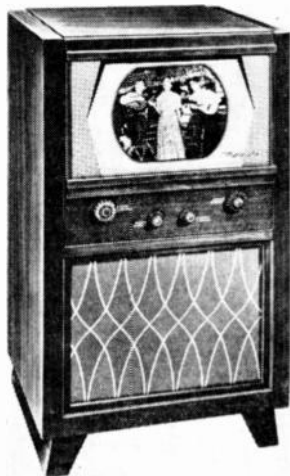

With a truncated circle to allow a 10-inch picture tube to give a 61-square-inch viewing area, this console is prealigned at factory for coverage on 12 television channels. Automatic control of horizontal synchronization helps eliminate interferences to picture from cars, electrical appliances and the like.

Say you saw it in *Radio & Television Journal*, May, 1949.

### Tele King's "Stuart"

Manufactured by Tele King Corp., 601 West 26th St., New York, N. Y.



In a mahogany veneer finish, this table model has contrasting swirl-grain panelling. Incorporates a 12½-inch tube and gives a 75-square-inch Teleramic picture. Model is 18½ inches high, 24¼ inches wide and 20½ inches deep.

Say you saw it in *Radio & Television Journal*, May, 1949.

### Television by Meck

Manufactured by John Meck Industries, Inc., Plymouth, Indiana



Using a 10-inch picture tube, offering a 65-square-inch picture, this table model television receiver has an automatic control system, which "locks" the picture against most normal noise bursts. High voltage power regulates contrast and brilliance. Measuring 15 inches high, 21 inches wide, and 19 inches deep, cabinet comes in hand-rubbed mahogany.

Say you saw it in *Radio & Television Journal*, May, 1949.

### TV Credenza by Admiral

Manufactured by Admiral Corp., 3800 W. Cortland St., Chicago, Ill.



Featuring a 12½-inch picture tube, this direct-view television combination radio-phonograph is housed in a mahogany cabinet. Incorporating the firm's "Triple-Play" automatic record changer, it plays every size record, both standard and LP, at all three turntable speeds. Also has "Dynamagic" radio, permitting FM-AM circuits to be combined with changer in single unit.

Say you saw it in *Radio & Television Journal*, May, 1949.

### TV by Video Corp.

Manufactured by Video Corp. of America, 385 Flatbush Ave. Ext., Brooklyn, N. Y.

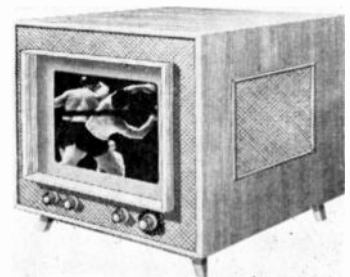

Table model television which gives a 135-square-inch, direct-view picture. Heat producing components which tend to deteriorate parts have been eliminated. Is double fused for added safety. Incorporates a new circuit, the "plakron compensator." Model is available in a variety of finishes.

Say you saw it in *Radio & Television Journal*, May, 1949.

here come PROFITS!  
 here come FAST SALES!  
 here comes the new

# Motorola SPRING PORTABLE PROMOTION

starting May 1st and continuing  
 through your biggest  
 portable selling season

You can benefit from the impact of this whopping promotion covering the **WHOLE** portable market—from young girls in **SEVENTEEN** to sportsmen in **OUTDOOR LIFE** . . . from discriminating **ESQUIRE** readers to the homebodies that live by **BETTER HOMES & GARDENS**. These dynamic yellow and black ads give your customers all the facts on Motorola portable radios . . . Motorola portable television . . . and the exciting new 45 R.P.M. portable radio-phonograph, so . . .

**GET YOUR SHARE!**

Identify your store  
 with the national program . . .

Profit from this big national promotion by tying in with Motorola mat ads in your local newspaper on the days the national ads hit the stands. These mat ads are closely related to the national promotion—giving a retail sales pitch in copy. Don't fail to make a new record for portable profits this season! Remember . . .

The time to sell **PORTABLES**  
 is when **PORTABLES** are being used!  
 Radio & Television **JOURNAL** • May, 1949



**2** FULL PAGE ADS  
 IN **16** BIG CIRCULATION  
 MAGAZINES

contact  
 your Motorola distributor  
 today . . .

*Motorola Inc.*

4545 AUGUSTA BLVD. CHICAGO 51, ILLINOIS

### Mattison's "Embassy"

Manufactured by Mattison Television & Radio Corp., 220 Fifth Ave., N. Y.

This compact television set uses a 15-inch picture tube and has a 30-tube chassis. Reflector circle mask gives depth and allows picture to be spread to the full extent of the tube. Picture frame is one piece of piano finish wood beveled to meet safety glass. Available in mahogany, walnut and blond.

Say you saw it in *Radio & Television Journal*, May, 1949.



### Stewart-Warner Players

Manufactured by Stewart-Warner Corp., 1826 Diversey Pkwy., Chicago 14, Ill.



# DEALERS' CHOICE

## THREE DUOTONE NEEDLES PUT PEP IN ACCESSORY SALES



**THE "STAR"**—A top-quality sapphire-tipped needle, the Duotone "Star" has rolled up sales records in stores across the country. Entirely hand made, long-wearing, individually tested and inspected. Packed in individual transparent lucite containers. Free display cards and national advertising boost sales. List price \$5.00.

**THE DURPOINT**—The Duotone Durpoint answers the steady demand for a good, permanent needle at low cost. Plays thousands of records without changing. Takes additional polish from record groove, reducing surface noise and record wear. Twelve needles on an eye-catching display, each packed on individual card. List price each needle, \$1.00.



**THE SHOCKPROOF NYLON**—The Duotone Shockproof Nylon needle is really shockproof, will absorb shock when whole tone arm is bounced on record. Twelve needles in individual transparent plastic containers on three-dimensional self-demonstrating display. Free demonstration needle and two counter signs with each card. List price each needle, \$2.50.



Radio-phonograph combinations by Stewart-Warner are now equipped with four different versions of players. Above is a combination with a 78-rpm. changer, having an adjustment for playing 33 1/3-rpm. records of all sizes, also a second changer for 45-rpm. records. Others have 78-and 33 1/3-rpm. or 78- and 45-rpm. arrangements. Standard 78-rpm. changer alone is also available.

Say you saw it in *Radio & Television Journal*, May, 1949.

### Privat-Ear

Manufactured by Electronic Systems Corp., 112 West 18th St., Kansas City, Missouri



Weighing six ounces, this novel portable radio is battery-operated. Fits into a coat pocket or a handbag, can be hung over the shoulder. Equipped with a built-in telescopic antenna and reception is by earphone which is inserted in the ear. Has volume control and station selector. Reception range is 50 miles. Case is in maroon.

Say you saw it in *Radio & Television Journal*, May, 1949.

THE **DUOTONE** COMPANY, INC.  
799 Broadway New York 3, N. Y.

THE WORLD'S MOST LOVED PRODUCTS SEE PAGE **72**



**ACCLAIMED** FOR PRICE • FOR PERFORMANCE

# Tele-tone's *New!* Television



TV-208

**\$149<sup>95</sup>**  
plus \$1.30 excise tax

## Tele-tone

### Portable Television with Built in "Roto-V" Aerial

- The ONLY portable with built-in aerial . . . recedes into set when not in use.
- Weighs only 26 lbs. Plays wherever AC current is available.
- It's the LOWEST PRICED, HIGHEST QUALITY portable on the market.



## Tele-tone Console with oversize 12½" screen

The best in EXTRA LARGE picture performance . . . at the LOWEST PRICE on the market. Designed of beautiful mahogany veneers. Cabinet doors close giving it a fine-furniture look. Compare its beauty . . . its perfect image reception.



TV-282

**\$349<sup>95</sup>**  
plus \$1.95 excise tax  
installation extra

# Tele-tone RADIO CORPORATION

540 WEST 58TH STREET • NEW YORK, 19, N.Y.

Every model a leader in the field! Every price under the market! Every feature the very latest in television engineering . . . including the amazing "picture-lock" for image steadiness and the new "super-sensitive tuner" for greater range, greater power! Tie-in with Tele-tone and you tie-in with the fastest moving radio and television line in the industry.

## TELE-TONE PORTABLES

Profitably Priced for Sensational Summer Sales!



**Model #185.** The portable that sells on sight . . . defies comparison. A 3 way, 5 tube set that plays anywhere . . . on AC or DC current or self-contained batteries. Handsomely styled with gleaming gold grill . . . **\$29.95** less batteries.



**Model #200.** A 5 tube, 3 way portable. Plays on AC or DC current or on self-contained batteries. Available in smart sand color polystyrene cabinet. **\$22.95** less batteries.



Tele-tone Model #195

The set that rocked the industry. Full tube, powerful superheterodyne circuit. Permanent magnet Alnico speaker. In ebony polystyrene . . . **\$9.95**  
In ivory polystyrene . . . **\$11.95**



Tele-tone Model #205

A powerful 5 tube superheterodyne set in handsome walnut polystyrene cabinet. With built in loop antenna and permanent magnet Alnico speaker . . . **\$12.95**. In ivory, sand or maroon with carrying handle, model #215 . . . **\$14.95**



Tele-tone Model #214

A 5 tube 3-way portable. Plays on AC or DC current or on self-contained batteries. In ebony polystyrene . . . **\$19.95**. Model #190 in maroon and model #200 in sand . . . **\$22.95**

NOW...  
ANOTHER  
GREAT

**Recordisc**  
PRODUCT...

**Super-Tone**

REG. U.S. PAT. OFF.

**RECORDING  
WIRE**

RECORDISC, the greatest name in home and professional recording... long the world's largest producers of blank recording discs, now adds another fine product to its long list of sales successes.

Made of high fidelity stainless steel with typical RECORDISC precision, Super-Tone' is the key to steady increased sales in the wire recording field. Superb sound reproduction, and the very name RECORDISC spell satisfaction to every wire recording enthusiast, and strapped-up sales for you, the dealer.

**NEW, 1949  
RECORDISC  
CATALOG  
IS READY**

SEND FOR YOUR COPY TODAY

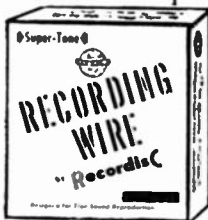

"You Take No Risk With Recordisc"

**THE  
Recordisc  
CORP.**

395 Broadway, New York 13, N. Y.

**Three-Speed V-M Changer**

Manufactured by V-M Corp., Benton Harbor, Mich.



Using a Tri-O-Speed changer, which plays 78-, 33 1/3-, and 45 rpm. records, this portable player is styled in neutral beige autumn gold. Uses a 3-tube, high-gain amplifier and a 4-inch by 6-inch speaker, with tone and volume control completing the unit. Reproduces deep broad base notes and mellow highs at normal room volume.

Say you saw it in *Radio & Television Journal*, May, 1949.

**Trav-Ler TV Console**

Manufactured by Trav-Ler Radio Corp., 571 W. Jackson Blvd., Chicago, Ill.

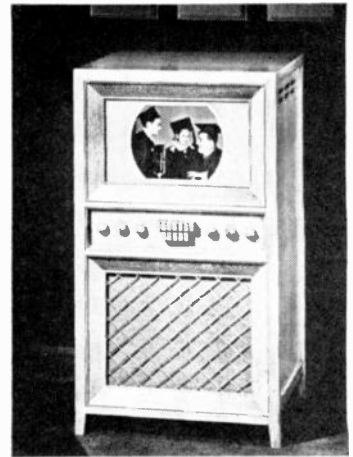

This 12-inch picture tube TV receiver gives an 82-square-inch picture, by utilizing maximum area of the tube. Station coverage is all channels, and station selection is by push button. Has automatic gain control circuit, intercarrier sound circuit, and automatic lock-in picture circuit. Equipped with 20 tubes, two rectifiers, plus picture tube. Cabinet is hand-rubbed, limed oak.

Say you saw it in *Radio & Television Journal*, May, 1949.

**EXTRA Protection for EVERY Service Job!**

**FIXED OR ADJUSTABLE**

**VITROHM RESISTORS**

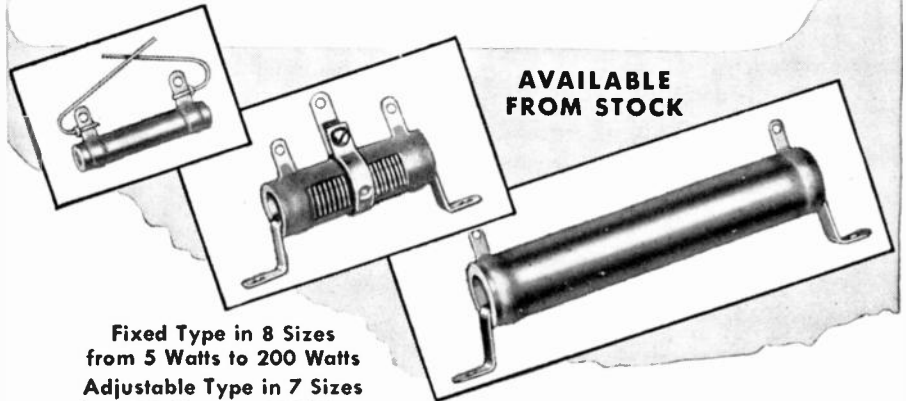

**AVAILABLE  
FROM STOCK**

Fixed Type in 8 Sizes  
from 5 Watts to 200 Watts  
Adjustable Type in 7 Sizes  
from 10 Watts to 200 Watts

You can guarantee dependable, trouble-free performance when you install VITROHM wire-wound resistors. Windings are held in place and protected by a special WL vitreous enamel which is tough, crazeless, moisture and acid-resistant. They give long service, avoid call-backs, build satisfied customers and greater profits. Available in wide range of resistance values.

Authorized Distributors Everywhere

WARD LEONARD ELECTRIC CO., Radio and Electronic Distributor Division, 53-J W. Jackson, Chicago 4

**SEND FOR FREE CATALOG**

Write for Catalog No. 130. Gives complete data and information.

**WARD LEONARD**  
RELAYS • RESISTORS • RHEOSTATS

Electric control devices since 1892



# Summer Time or ANY Time...



## THE Emerson Radio and Television Franchise is Your Most Valuable Asset



*Emerson Self-Powered Portable  
Model 560*

America's fastest selling portable. Superb tone, super-powered, low battery drain. Handsome maroon or green plastic cabinet. *Less Batteries*

**16<sup>95</sup>**

For Hot Weather Action—for better values, better promotion, quicker turnover and more profitable inventory investment—feature Emerson Radio and Television.

Nationwide "BIG AD" newspaper promotion starts week of May 9th on Emerson Super Portables, the fastest selling Portable line in America. This to be followed by a coast-to-coast campaign on the sensational Emerson Television line. Phone, write or wire your Emerson distributor for details.



*Emerson Compact Model 587*

AC-DC Superheterodyne. All advanced features, walnut plastic cabinet, gold-colored dial, airplane-designed grille. A tremendous value!

**16<sup>95</sup>**

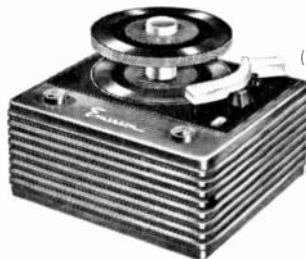

*Emerson 45 RPM  
Automatic Phonograph—Model 623*  
Precision engineered. Plays 10 records automatically. Changes records in 2 seconds. Powerful amplifier. 5-in. Alnico PM speaker, variable tone control.

**39<sup>95</sup>**



*Emerson Long Distance Television  
Model 611*

Big 61 sq. in. screen. Sensitive long-range circuit. Miracle picture-lock. Simpli-matic tuning, Stati-Clear FM sound. Mahogany veneer cabinet.

**269<sup>50</sup>**





**CONTACT**  
GIVES WIDE ANGLE VIEW



**DE LUXE**  
WITH ADJUSTABLE BRACKET

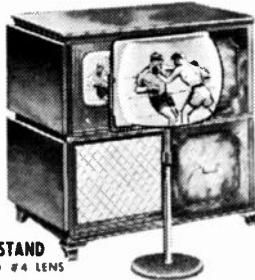

**FLOOR STAND**  
FOR #3 AND #4 LENS

AVAILABLE TO DISTRIBUTORS & JOBBERS

An  
**ENLARGING LENS**  
for television by  
**OPTI-GEM inc.**

manufacturer of precision optical elements... this lens is developed by an optical manufacturer who made lenses and prisms to exacting government specifications

Opti-Gem lenses are low-priced and top quality. They come in a full range of sizes from \$9.95 for the 3" Pilot, to \$37.95 for the 16" picture tube. All sizes are available in clear, blue and smoke.

- OPTI-GEM lenses retail for**
- " 1 for the 7" screen.....from \$11.95
  - " 2 for the 10" screen.....from 16.95
  - " 3 for the 10" or 12" screen....from 24.95
  - " 4 for the 10" 12" or 16" screen..from 32.95

- OPTI-GEM filters control glare**
- 7" .....\$1.00 list 12" ..... 2.98 list
  - 10" ..... 1.98 list 15" ..... 3.50 list

Sold through leading stores  
Write or phone for nearest dealer

**OPTI-GEM inc.**

LENSES AND FILTERS FOR ALL SIZE TELEVISION SCREENS  
320 EAST 39th STREET, NEW YORK 16, N. Y. MURRAY HILL 3-1126

**Lyte "Sky Tuner"**

Manufactured by Lyte Parts Co., Inc.,  
Plainfield, N. J.; Dubuque, Iowa

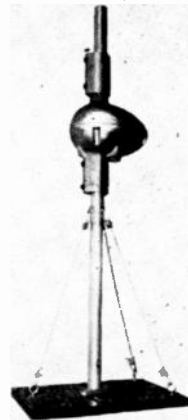

Operating from chairside through a remote-control cabinet connected to the motor unit by a three-conductor cable, this antenna rotator turns in both directions and locks in place by button release. Housing is cast aluminum, and universal fittings accommodate any installation. Operates on 25 volts from any 110-volt, AC outlet. Withstands pressure up to 30,000 pounds per square inch and weighs up to 150 pounds.

Say you saw it in *Radio & Television Journal*, May, 1949.

**New Antenna Converter**

Manufactured by Tele-Matic Industries, Inc.,  
32 Wyckoff St., Brooklyn, N. Y.

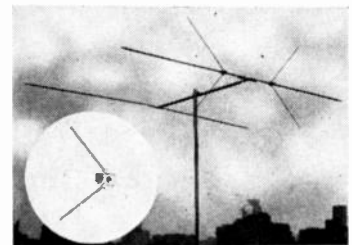

By adding Adap-Ta-Wings, any straight dipole antenna can be quickly and inexpensively converted to a broadband, conical-type antenna. Adap-Ta-Wings improve over-all reception, and increase gain in high-frequency channels. Can be installed in few minutes with only a screw driver.

Say you saw it in *Radio & Television Journal*, May, 1949.

Set Owners, Dealers, Servicemen...  
Everyone is singing the praises of

**DEWALD**  
10" - 12½" - 16"  
**TELEVISION**

Backed by a quarter-century  
of proven quality



DEWALD C-800 FM-AM Receiver

in  
RADIO  
and  
TELEVISION

for  
SOMETHING  
BETTER,  
it's

**DEWALD**



DeWALD CT-102 High Definition TELEVISION

During the NEDA SHOW in Chicago, May 16-20 the New DEWALD LINE of TELEVISION and RADIO will be on display at the Blackstone Hotel.

**Be Sure To See It!**

**DEWALD RADIO MFG. Corp.**  
35-15 37th Ave., Long Island City 1, N. Y

**"Objections Over-ruled"**

Television is such a new development that many people are held back from buying sets because of perfectly natural doubts, fears, and reservations. How to overcome these objections is the theme of the leading feature articles in the June issue of RTJ. Don't miss it!

# In **PROJECTION TELEVISION** it's **RCA VICTOR!**

**More sets sold than any other make!**



**SHARPEST**

**BLACK-and-WHITE**

**PICTURE CONTRAST**

**EVER ACHIEVED!**



**New! This Month — Model 9-PC-41**

**THE SET WITH EXTRA FEATURES —**

**and a screen nearly newspaper-page size  
15" x 30"—300 square inches big**

● Here is a projection television set you'll find easy to sell. Why? Because this console offers your prospects all the latest styling and engineering developments from RCA Victor . . . because this console gives your customer more value for his television dollars.

**A Demonstration Model on your floor will Clinch Sales**

This set is really impressive! Its lovely Traditional styling is accented by the huge 15- by 20-inch screen. Here are 300 square inches of bright, clear, steady pictures. And they're the sharpest

black-and-white pictures ever, because they're projected by a big 5-inch RCA Victor *All-Silicate Face* Kinescope. And remember, only when you sell RCA Victor can you offer all these famous "sell" features: Eye Witness Picture Synchronizer, Automatic Multi-Channel Station Selector, "Golden Throat" Tone System and the RCA Victor Television Owner Contract.

All these convincing sales points make your selling job easier, more profitable. And don't forget, with RCA Victor you make greater profits through quicker turnover



**REMOTE CONTROL UNIT**

Here's another great feature of RCA Victor Model 9-PC-41. It makes your selling job easier. With this remote control unit, the set can be adjusted for contrast and brilliance from an easy chair.

Yes, it's another great feature that helps to maintain RCA Victor's leadership in projection television.

**RCA VICTOR**  

**World leader in radio . . . first in recorded music . . . first in television**

# TOP MERCHANDISER, DAVE WAGMAN

RADIO AND TELEVISION SALES MANAGER

BRUNO-NEW YORK... says:



"The Polaroid Television Filter has proved to be our fastest selling most profitable accessory!"

CALL OR WRITE THE POLAROID TELEVISION FILTER DISTRIBUTOR IN YOUR AREA:

**ALBANY**

R. T. A. Distributors, Inc., 36 Broadway—Menands

**ATLANTA**

Yancey Co., Inc., 340 W. Peachtree Street, N. W.

**BALTIMORE**

D & H Distributing Company, Inc., 31-37 E. Lee Street

**BOSTON**

The Eastern Company, 620 Memorial Drive Cambridge, Mass.

**BUFFALO**

Progress Distributing Corp., 151 Genessee Street

**CHICAGO**

R. C. A. Victor Distributing Corp., 445 No. Lake Shore Drive

**CINCINNATI**

Ohio Appliances, Inc., 659 E. Sixth Street

**CLEVELAND**

Goldhamer, Inc., 2239 East 14th Street

**DAYTON**

Ohio Appliances, Inc., 430 Leo Street

**DETROIT**

R. C. A. Victor Distributing Corp., 7400 Intertale Street

**HARTFORD**

Radio & Appliance Distributors, Inc., 673 Connecticut Blvd.

**INDIANAPOLIS**

Associated Distributors, Inc., 210 S. Meridian Street

**MILWAUKEE**

Taylor Electric Company, 112 N. Broadway

**MINNEAPOLIS**

F. C. Hayer Co., 300 Washington Avenue N.

**NEWARK**

Krieb-Radisco, Inc., 422-432 Elizabeth Avenue

**NEW YORK CITY**

Bruno—New York, Inc., 460 West 34th Street

**PHILADELPHIA**

Raymond Rosen & Company, Inc., 32nd & Walnut Streets

**PITTSBURGH**

Hamburg Bros., 305 Penn Avenue

**PROVIDENCE**

Wm. Dandreta & Co., 129 Regent Avenue

**RICHMOND**

Wyatt-Cornick, Inc., Grace & 14 Streets

**ST. LOUIS**

Interstate Supply Company, 10th & Walnut Streets

**TOLEDO**

Main Line Distributors, 374 S. Erie Street

**WASHINGTON**

Southern Wholesalers, Inc., 1519 L Street N. W.

**WEST COAST**

Harold B. Shomler (Mfg. Rep.) 3543 Angelus Ave., Glendale, Calif.

a product created by

**PIONEER SCIENTIFIC CORP.**

© by Polaroid Corp

295 LAFAYETTE STREET, NEW YORK 17, N. Y.

**How Portables Have Changed**



Twenty-seven years ago Miss Eleanor Swartfigure, secretary at General Electric's Electronics Park, Syracuse, N. Y., might have had the fancy rigging on the doll's carriage, left, if she wanted reception on a portable radio. The 8-pound, AC-DC (or dry batteries) GE portable in the foreground is a long stride forward from the early days. If that's what the radio industry can do in 25 years, television will be something to see in a few decades.

**BIGGER SCREENS at LOWER COST!**

**FEATURE**

*Videola*

**COMPLETE LINE OF 91 and 135 sq. inch TELEVISION RECEIVERS**

In every way you get more from Videola. Bigger Dealer Discounts—No Tie-in Deals—Exclusive Advanced RCA Electronic Features!

*Videola* A Symphony of Sight and Sound!

Write to Dept. D for new brochure of our complete line. Distributors: Some territories still open. Wire—Write today.

*Video Corporation of America*  
229 WEST 28th STREET • NEW YORK CITY





**SAVE TIME!**

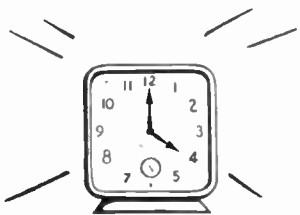

**SAVE MONEY!**



**SAVE SPACE!**

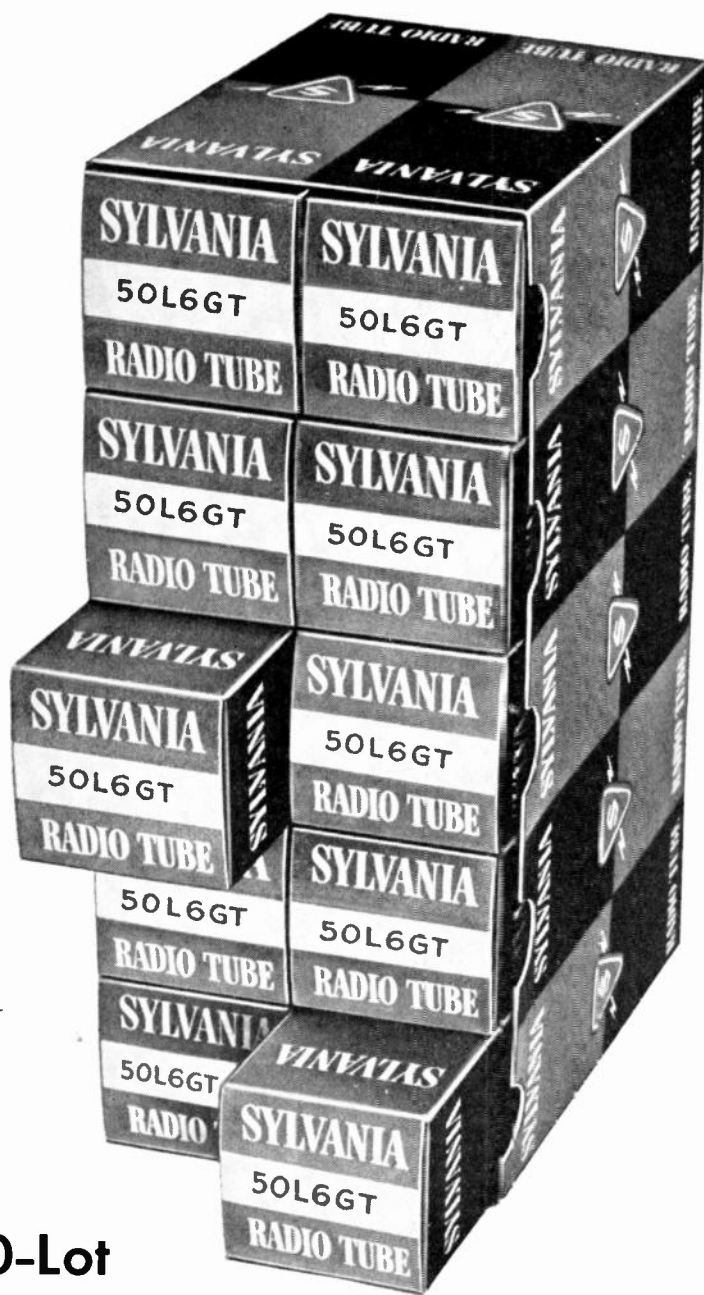
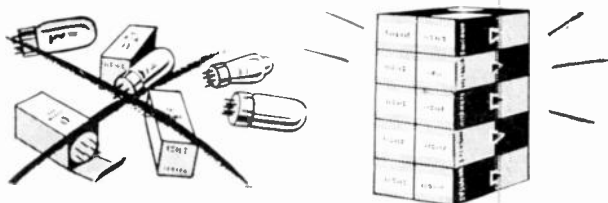

with Sylvania's New 10-Lot  
Cartons of *fastest-moving radio tubes!*

HERE'S the new, handy 10-lot package, developed by Sylvania to make your job easier! You save time, you save money by keeping plenty of fast-moving tube types *on hand*. No need to make numerous trips to your distributor to buy a few tubes at a time—especially when you're just one type short on a service job!

This new package is easy to handle, easy to stock—no more loose tubes and cartons to take

up unnecessary space! Now your shelves will be neatly arranged, making it possible to store more tubes in the same space. Buying Sylvania tubes the 10-Lot Carton way simplifies your inventory and re-ordering job since you can inventory on the basis of 10 and re-order the same way! See your Sylvania Distributor today for any further details! *Sylvania Electric Products Inc., Radio Division, Emporium, Pa.*

**SYLVANIA  ELECTRIC**

RADIO TUBES; CATHODE RAY TUBES; ELECTRONIC DEVICES; FLUORESCENT LAMPS, FIXTURES, WIRING DEVICES, SIGN TUBING; LIGHT BULBS; PHOTOLAMPS

Radio & Television JOURNAL • May, 1949

SEE THIS AMAZING  
\$250,000.00 SERVICE  
AT OUR EXPENSE

SEE FOR YOURSELF  
Why Dealers and Distributors Everywhere  
ACCLAIM IT A "MUST"

**FREE**  
EXAMINATION

**NELDA 1949** LOOSELEAF  
SUBSCRIPTION

... Brings you the

**LATEST PICTURES + PRICES + SPECS**

of America's Leading Brands of

**TELEVISION • RADIO • MAJOR APPLIANCES  
TRAFFIC APPLIANCES • CAMERAS • Etc.**

in compact convenient form for your everyday use as a

**SALES BUILDER . . .**

An attractive, comprehensive display for easier selling, in your store and outside in customer's home or office . . . kept CONSTANTLY UP-TO-DATE!

**BUYING "BIBLE" . . .**

Verify prices, descriptions and model numbers . . . see who makes it. Compare competitive models and prices . . . kept CONSTANTLY UP-TO-DATE!

**Reference Manual**

First and only authentic compilation of Standard Brands . . . complete with Pictures, Prices and Specifications . . . kept CONSTANTLY UP-TO-DATE!

**REGULAR**  
WEEKLY and MONTHLY  
**SUPPLEMENTS**  
KEEP THIS SERVICE

*Constantly Up-to-Date*

YOU CAN'T AFFORD TO BE WITHOUT IT  
BECAUSE THIS \$250,000.00 SERVICE  
**COSTS YOU LESS THAN \$1.00 PER WEEK!**

**EXAMINE IT ENTIRELY AT OUR RISK**

**No Obligation on your Part!**

*If you are not completely satisfied,  
return it in one week and you pay nothing!*

Radio & Television Journal, 1270 Sixth Ave., New York 20, N. Y.

Please enter immediately my subscription for Nelda's 1949 Looseleaf Service.

Bill me as per attached purchase order no. \_\_\_\_\_ and I will either return the Subscription within one week or remit \$50.00 plus postage.

Enclosed is remittance in full (\$50.00). Stamp the Binder as follows:

If I am not completely satisfied, I will return the Subscription within one week and you will refund my money.

Name \_\_\_\_\_

Company \_\_\_\_\_

Address \_\_\_\_\_

City \_\_\_\_\_ State \_\_\_\_\_

**Fill in this coupon NOW!**

**SPECIAL OFFER: YOUR NAME IN GOLD FREE!**

If full remittance accompanies your order we will STAMP YOUR NAME IN GOLD on the DeLuxe Binder and PREPAY THE POSTAGE!

WRITE FOR PRICES ON MULTIPLE SUBSCRIPTIONS  
AND SPECIAL SALES CREW OFFERS.



# The Who's Who of America's Standard Brands:

For Your Convenience... every page in the Looseleaf Edition of the Standard Merchandise Manual is printed on one side only, to allow space for your own notes.

... with your **NELDA 1949** LOOSELEAF SUBSCRIPTION **YOU GET ALL THIS:**

The **ADVANCE 1949 EDITION** of the **STANDARD MERCHANDISE MANUAL** — containing 992 illustrations, 1793 price listings, thousands of specifications and the *Blue Book Register of Manufacturers*. Here are the current models of America's foremost manufacturers in one compact compilation.

plus

**WEEKLY PRICE-REVISION BULLETINS** — Every week you receive a bulletin with price changes listed page-by-page, to keep your Standard Merchandise Manual constantly up-to-date with latest prices.

plus

**MONTHLY NEW-MODEL ILLUSTRATED SUPPLEMENTS** — Specifications and prices on new models released during the month, classified by type and brand-name, to keep your Standard Merchandise Manual constantly up-to-date with latest models.

plus

**DeLUXE LOOSELEAF BINDER** — A specially constructed seven-ring metal binder, covered in blue leather-grain fabricoid. Stamped with your company name or your own name in gold (see special offer).



- ABC
- ADMIRAL
- AMERICAN
- AMERICAN BEAUTY
- AMPRD
- ANSCO
- APEX
- ARVIN
- BELL AND HOWELL
- BENDIX
- BISSELL
- BLACKSTONE
- BROOKING
- BROIL-O-MAT
- CARLTONWARE
- COMMUNITY
- CONLON
- CORY
- COUNSELOR
- CREAM KING
- CROSLLEY
- CROWN GRAPHICS
- DEEFPREEZE
- DEJUR
- DETECTO
- DETROIT-JEWEL
- DISHAMATIC
- DUMONT
- EBERHARD FABER
- EDWARDS
- EKCO
- ELECTRESTEEM
- EMERSON
- ESTATE
- EUREKA
- EVERHOT
- EVERSHARP
- FARBERWARE
- FARNSWORTH
- FILTER QUEEN
- FLEX-SEAL
- FLOOR-O-MATIC
- FRIGIDAIRE
- FREE-WESTINGHOUSE
- GAROD
- GENERAL ELECTRIC
- GENERAL MILLS
- GILBERT
- GLENWOOD
- GRAFLEX
- HAMILTON
- HAMILTON-BEACH
- HANDYHOT
- HANKSCRAFT
- HANOVIA
- HOBART
- HOLLYWOOD
- HOOVER
- HOTPOINT
- ICE-O-MAT
- IRONRITE
- JOHNSON
- JUICE KING
- JUICE-O-MAT
- KELVINATOR
- KEM
- KITCHENAID
- KODAK
- KNAPP-MONARCH
- LAUNDERALL
- LEWYT
- LIONEL
- MAGIC CHEF
- MANNING-BOWMAN
- MAYTAG
- MELL-O-CHIME
- MONITOR
- MOTOROLA
- MUSAPHONIC
- NAXON
- NESCO
- NEW HOME
- NORGE
- NU-TONE
- ODIN
- ONEIDA
- OSTER
- PARKER
- PETIPOINT
- PHILCO
- PILOT

- PREMIER
- PRESS-TO-MAGIC
- PRESTO
- PROCTOR
- RCA VICTOR
- REGINA
- REMINGTON
- REMINGTON-RAND
- REVERE
- RITTENHOUSE
- RIVAL
- ROGERS BROS. 1847
- WM. ROGERS & SONS
- RDLLS
- ROPER
- ROYAL
- SAMSON
- SCHICK
- SEMTZEL
- SILEX
- SIMMONS
- SIMPLEX
- SMITH-CORONA
- SODA KING
- SON-CHIEF
- SPEED GRAPHICS
- STEWART-WARNER
- STEAM-O-MATIC
- STROMBERG-CARLSON
- SUNBEAM
- SUNKIST
- TAPPAN
- TELECHRON
- THOR
- TOASTMASTER
- TOAST-O-LATOR
- TRACY
- TUDOR
- UNDERWOOD
- UNITED STATES
- UNIVERSAL
- VICTOR
- WEAREVER
- WESTINGHOUSE
- WESTON
- WHIRLPOOL
- WILCOX-GAY
- YALE & TOWNE





### Mars' "Princeton"

Manufactured by Mars Television, Inc.,  
29-05 40th Road, Long Island City, N. Y.  
Here is a 15-inch table model manu-  
factured in hand-rubbed mahogany  
or blond finish. Contains 31-tube  
chassis and uses high-voltage circuit.  
Also features concealed knobs by  
means of a front panel, which opens  
downward for set operation. Illumi-  
nated dial is also concealed by panel.  
Say you saw it in *Radio & Television  
Journal*, May, 1949.

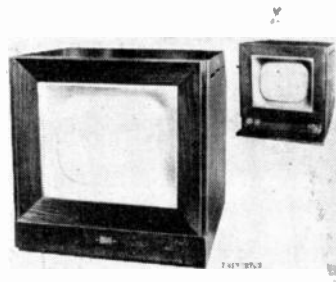

### Zenith Adapter

Manufactured by Zenith Radio Corp.,  
6001 W. Dickens Ave., Chicago 39, Ill.

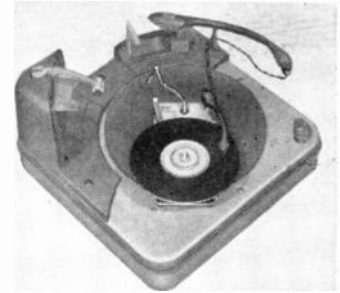

For use with Cobra-equipped changers,  
this "Micro-Cobra" adapter plays all  
three speeds. Dual speeds are manu-  
ally controlled by a shift lever. Short-  
ened arm exerts only 4½ grams  
pressure. Unit fits over record spindle  
of radio-phonograph combination and  
derives power from turntable of  
parent mechanism. Cable plug hooks  
adapter to audio system of combina-  
tion.

Say you saw it in *Radio & Television  
Journal*, May, 1949.

### Videodyne Television

Manufactured by Videodyne Inc., 33 Jefferson  
St., Stamford, Conn.



Its 15-inch tube giving a 116-square-  
inch picture, this new Videodyne TV  
receiver is operated with three con-  
trols—volume, channel selector, and  
contrast. Picture is locked by auto-  
matic frequency control. Has 26  
tubes, including three rectifiers. New  
audio amplifier minimizes distortion.

Say you saw it in *Radio & Television  
Journal*, May, 1949.

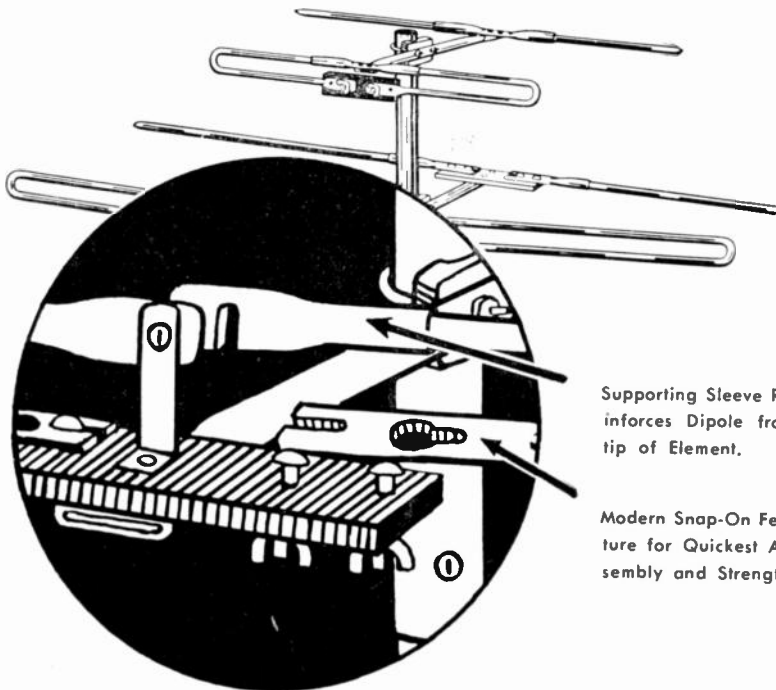

Supporting Sleeve Re-  
inforces Dipole from  
tip of Element.

Modern Snap-On Fea-  
ture for Quickest As-  
sembly and Strength.

## SENSATIONALLY NEW!

### VERI-BEST MODERN DESIGN TV ANTENNA Series 500

**LATEST FEATURE.** Specially designed slotted  
elements snap into place easily and firmly.  
Dipoles and Reflectors are clearly labeled.

**SPECIAL FEATURE.** High Frequency Antennas are  
packed completely assembled, ready for attach-  
ment to the mast.

**ADDED FEATURES.** All elements reinforced with  
supporting sleeves for added strength where  
needed. Increased signal voltage due to greater  
transmission surfaces at contact ends of Dipole.

COMPLETE LINE OF OUTDOOR AND INDOOR ANTENNAS  
SALES REPRESENTATIVES AND DISTRIBUTORS SOLICITED

Mr. H. Lieberman, Sales Manager, will be at  
the Hotel Stevens during the Radio Ports Show.

WRITE FOR CATALOGS AND PRICES

**VERI-BEST TELEVISION PRODUCTS, INC.**  
233 SPRING STREET · NEW YORK 13, N.Y.

**SOMETHING NEW AND COMPLETELY CHARMING**

SEE  
PAGE

72



"Madame X" was the code name, during research and development, for an entirely new system of recorded music . . . perfected by RCA.

## *The remarkable background of "Madame X"*

Now the identity of "Madame X," the *unknown* in a long search for tone perfection, has been revealed. From this quest emerges a completely integrated record-playing *system*—records and automatic player—the first to be entirely free of distortion to the trained musical ear . . .

The research began 11 years ago at RCA Laboratories. First, basic factors were determined—minimum diameters, at different speeds, of the groove spiral in the record—beyond which distortion would occur; size of stylus to be used;

desired length of playing time. From these came the mathematical answer to the record's *speed*—45 turns a minute—and to the record's size, only 6<sup>7</sup>/<sub>8</sub> inches in diameter.

With this speed and size, engineers could guarantee 5½ minutes of distortion-free performance, and the finest quality record in RCA Victor history!

The record itself is non-breakable vinyl plastic, wafer-thin. Yet it plays as long as a conventional 12-inch record. The new RCA Victor automatic record changer accommodates up to 10 of the new records—1 hour and 40 minutes of

playing time—and can be attached to almost any radio, phonograph, or television combination.

Not only records are free of surface noise and distortion—the record player eliminates faulty operation, noise, and cumbersome size. Records are changed quickly, quietly . . . RCA Victor will continue to supply 78 rpm instruments and records.

This far-reaching advance is one of hundreds which have grown from RCA research. Such leadership adds *value beyond price* to any product or service of RCA and RCA Victor.



**RADIO CORPORATION of AMERICA**

*World Leader in Radio — First in Television*

**New TV by Federal**  
 Manufactured by Federal Television Corp.,  
 139 Duane St., N. Y.

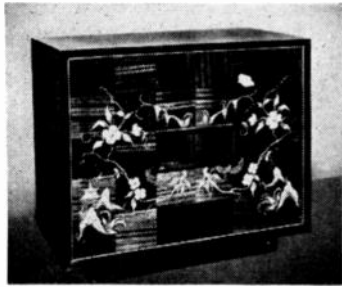

Incorporating a 15½-inch picture tube, "The Fleetwood" produces a 132-square-inch picture. Has record changer adapted for three speeds. Equipped with symphonic 12-inch speaker and FM receiver. Has album space. Cabinet in rich mahogany with Chinese decor. "The New Yorker" is a television table model receiver with a 12½-inch picture tube giving an 84-square-inch picture. Like other TV sets in the new Federal line, this model has three dials for tuning and incorporates an FM receiver.

Say you saw it in *Radio & Television Journal*, May, 1949.

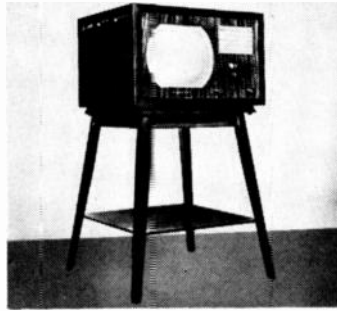

"The New Yorker" by Federal

**RMS' TV Parts Catalog**

A new television accessory catalog has been published by Radio Merchandise Sales, Inc., 550 Westchester Ave., N. Y. The 24-page booklet describes the company's extensive line of TV accessories, including antennas, antenna mounts, screw eyes, masts, brackets, glare filters, and image enlarger lenses.

Say you saw it in *Radio & Television Journal*, May, 1949.

**JFD TV Antenna**

Manufactured by JFD Manufacturing Co., Inc.,  
 6101 16th Ave., Brooklyn, N. Y.

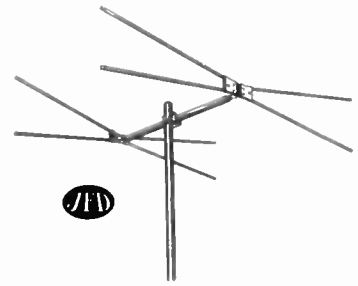

A broad-band, conical antenna designed for performance through the entire TV-FM frequency spectra, the "D-Xer" features a 15-degree broad-side tuning angle, 4-point support of structural members, unlimited positioning possibilities, and a bracket support for dipoles and reflectors. Can be coupled directly to 72-, 150-, or 300-ohm transmission lines with little energy transfer loss. Installation time is less than 60 seconds.

Say you saw it in *Radio & Television Journal*, May, 1949.

**NEW LEAD-IN SUPPORTS THAT GIVE BETTER TELEVISION and FM RECEPTION!**

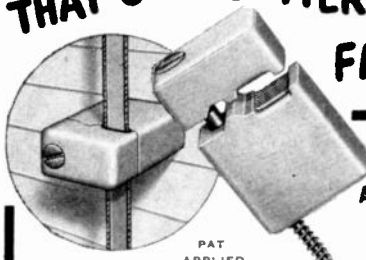

PAT APPLIED FOR  
**No. 9418**

Porcelain Products' exclusively designed lead-in supports give rigid support preventing lead-in wire from twisting in wind or going slack. Quick moisture drainage prevents short circuits. Made of highest quality porcelain, resistant to weather extremes, factory assembled, screws rust-proofed, no maintenance, low initial cost. For all popular types of lead-in cables.

**OTHER ANTENNA AND LEAD-IN ACCESSORIES**



**No. 1925**  
 Insulated Screw Eye. Overall length 7-1/4", 5/16" insulator hole.

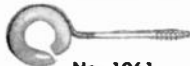

**No. 1961**  
 Split Bridle Ring Insulated Screw Eye. Overall length 3-5/8", 5/8" insulator hole, 1/4" diagonal slot.



Specially designed **TUBE** for flat 3/4" wide 300 ohm twin-wire TV-FM Lead-in Conductors. Outside diameter 1 1/16" fits hole made by standard 3/4" drill bit. Finest electrical porcelain, rectangular hole prevents conductor from twisting. Write for folder.

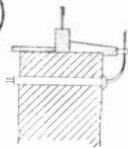

**Porcelain Products, Inc.**  
 FINDLAY, OHIO

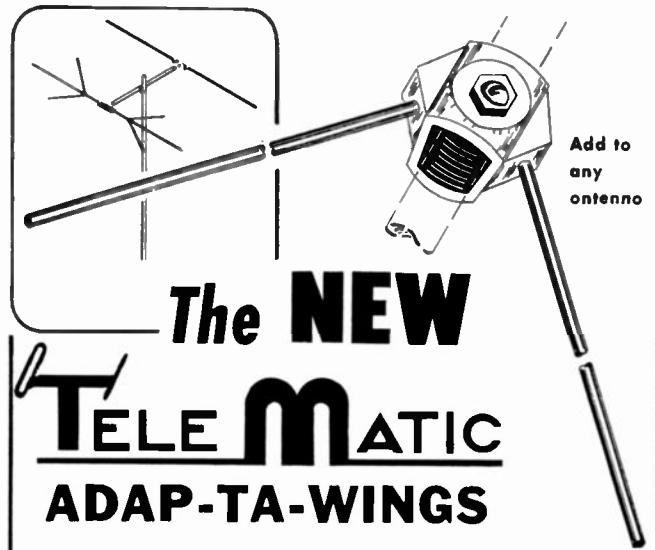

Add to any antenna

**The NEW TELE-MATIC ADAP-TA-WINGS**

- PEP UP HIGH FREQUENCY CHANNELS
- IMPROVE OVER-ALL RECEPTION
- Converts present straight dipole antenna into a broad band conical type antenna.
- Easily attached in a few minutes. A screw driver is all you need.

Write for details. A few choice territories still open for jobbers.

**TELE-MATIC INDUSTRIES, Inc.**  
 Manufacturers of Antennas, Brackets and Accessories  
 32 Wyckoff St., Brooklyn 2, N. Y.



# NOW—A COMPLETE LINE! ZENITH TELEVISION

WITH  
GIANT CIRCLE SCREEN *and* BULLS EYE AUTOMATIC TUNING



**THE ZENITH GOTHAM.** Zenith Television with "Big B" Giant Circle Screen; "Twin Cobra"† Tone Arms; Genuine Zenith-Armstrong FM and Zenith long distance AM radio; all superbly combined in a console of breathtaking beauty in imported mahogany veneers. **\$695\***  
*(plus Federal excise tax.)*



**THE ZENITH MARLBOROUGH.** Super deluxe! Zenith Television with "Giant C" Giant Circle Screen. Plus "Twin Cobra" Record Player; FM-AM and Short Wave Radio. In an authentic Regency console of hand glazed Honduras mahogany veneers, a masterpiece of the furniture craftsman's art. **\$1150\***  
*(plus Federal excise tax.)*

From the ultra-magnificent combinations to the beautifully streamlined table models, every Zenith Television set hits the "bulls eye" for sales appeal. Every one has the sensational Zenith advancements found in *no* other television set . . . the Giant Circle Screen for a bigger, brighter, clearer picture . . . and Bulls Eye Automatic Tuning—one knob, one twist, there's your station, your giant picture, your sound . . . automatically pre-tuned to perfection!

Yes, Zenith has what it takes to assure the ultimate in customer satisfaction and bring you the most beautiful profit picture in television.

## SEE YOUR ZENITH DISTRIBUTOR

ZENITH RADIO CORPORATION  
6001 Dickens Ave., Chicago 39, Ill.

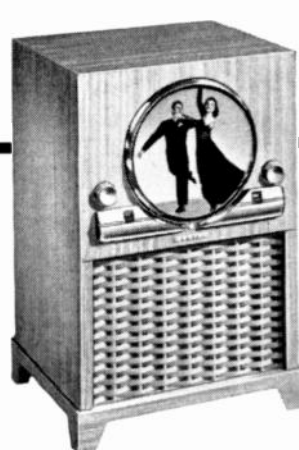

**THE ZENITH WALDORF.** Modern television console of imported Afara veneers in blonde finish. With "Big B" screen. **\$489.95\***

WILSHIRE model with "Super A" screen, \$449.95.\* Both models also available in mahogany finish.

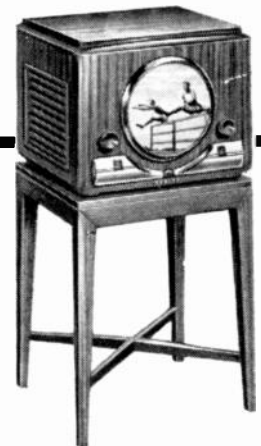

**THE ZENITH MAYFLOWER.** Period table set in mahogany-finished veneers of imported Afara. Has "Super A" television screen. **\$389.95\***

Matching table, 26 inches high, available at \$29.95.\* Receiver and table also in blonde finish.

**ZENITH HAS THE GREAT VALUES**  
**TELEVISION**  
and long distance **RADIO**

\*Suggested retail price.  
West Coast prices slightly higher.  
Prices subject to change  
without notice.

### Peek Tele-Tape

Manufactured by Wolter E. Peek, Inc.,  
2842 W. 30th St., Indianapolis, Indiana

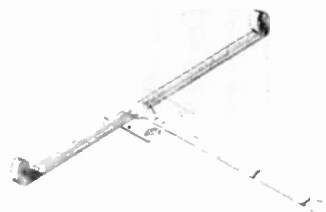

Featuring out-of-sight installation, Tele-Tape is designed for mounting under rugs, on baseboards, cornice boards, window panes, and the like. Equipped with adhesive backed metallized tape elements, the antenna adheres to any surface and can be adjusted to provide reception on all channels. Two wires at end of a plastic strip transmission line are attached to antenna terminals at television set.

Say you saw it in *Radio & Television Journal*, May, 1949.

**MODEL T-10**  
27" high—20"x26" top

**Presenting . . .**  
**The SWIVEL TOP TELEVISION TABLE**

Sateen Full Swivel action puts an end to juggling of table and set or shifting furniture for best view of screen. Wherever placed, Sateen Swivel Top faces viewers. Beautifully designed Queen Anne table finished with an exquisite Walnut or Mahogany grain that will add to the beauty of any home or any set. Ideal unit for set manufacturers to offer TV trade.

*Distributors and Dealers — write for booklet on this and other model tables.*

**SATEEN PRODUCTS CO., INC.**  
264-6 47th Street, Brooklyn 20, N. Y.  
Tel. GEdney 9-8102

### New Emerson Items

Manufactured by Emerson Radio & Phonograph Corp., 111 Eighth Ave., N. Y.

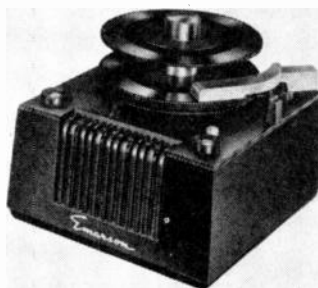

Equipped with a 5-inch, Alnico 5 speaker, tone control, and 3-tube amplifier, this self-contained electric record player handles the new 45-rpm. records. It is one of two player models recently introduced by Emerson and is encased in a walnut plastic cabinet with an ebony base.

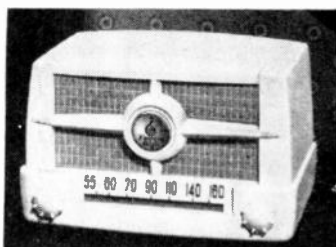

Here is one of two new popular compact table radio models now available in ivory plastic at low prices. This set is built with contrasting gold grille.

Say you saw it in *Radio & Television Journal*, May, 1949.

### Electronic Analyzer

To help dealers cut down needless expenses in a service department, the RCA tube department has come up with an invaluable instrument, which has already found its way into some 15,000 service shops. It is an electronic analyzer called the RCA-Rider Chanalyst. Virtually a self-contained test bench, the Chanalyst is 1) an RF and IF frequency meter, level monitor, and stage-gain indicator; 2) an oscillator frequency meter and level monitor; 3) an AF monitor and stage-gain indicator; 4) a power-input wattmeter, and 5) a wide-range electronic voltmeter. The folder which goes with the instrument is devoted to the profit-versus-loss theme on radio service operations, showing how the Chanalyst can efficiently handle 20 per cent of the service jobs which can waste up to 50 per cent of a serviceman's time.

### New Tradivision

Manufactured by Trad Television Corp.,  
1001 First Ave., Asbury Park, N. J.

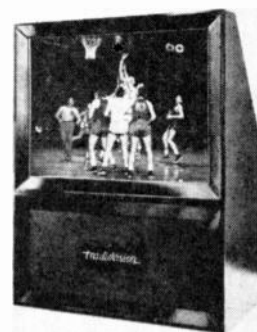

Latest of Trad's big screen television for institutional and similar use is the model above. Picture is four by three feet in size. Cabinet stands 71 1/4 inches high, is 54 inches wide and 29 1/2 inches deep. Operated by remote control unit 10 5/8 inches high, 15 3/4 inches wide and 11 7/8 inches deep.

Say you saw it in *Radio & Television Journal*, May, 1949.

★ **PROJECTION TELEVISION** ★  
★ **SPELLMAN F1.9 PROJECTION TV LENS** ★

★ Dimensions: Length 7", Diameter 4 1/4" ★  
★ F1.9 EF.5 in. (127.0 mm.) This lens ★  
★ incorporates in barrel a corrective ★  
★ lens for use with a 5TP4 projection ★  
★ tube. It is easily removable for use ★  
★ with flat type tubes. Lens can be ★  
★ utilized to project picture sizes from ★  
★ several inches to 7 x 9 feet. ★  
★ **Only \$90** complete with ★  
★ mounting ring. ★  
★ Machined slotted Mounting Ring ★  
★ available for hand focusing adjust- ★  
★ ment. Has 4 holes for easy mounting ★  
★ on plate. \$8.00 extra. ★  
★ 30 KV RF POWER SUPPLY including low ★  
★ voltage DC Supply. Variable from 15 KV ★  
★ to 30 KV. Includes a focus control and ★  
★ voltage tap variable from 4 KV to 6 KV ★  
★ for use with 5TP4 Projection Kinescope ★  
★ Tube. The high voltage 30KV-6KV cables ★  
★ are 3 ft. 11 inches in length and are of ★  
★ the safety type. ★  
★ **PRICE COMPLETE** .....\$99.50 ★  
★ Include 25% with Order, Balance C.O.D. ★  
★ **SPELLMAN TELEVISION CO., INC.** ★  
★ Dept. RTJ ★  
★ 130 West 24th St., New York 11, N. Y. ★  
★ Telephone AL 5-3680 ★

**A LOVELY PRELUDE TO THE REST OF YOUR HOUSE**

SEE PAGE **72**

CLEAR THE ROOFTOPS FOR...

*Another Vertrod First!*

SENSATIONAL  
 "4'n1"  
 TV ANTENNA

1. Folded dipole
2. Straight dipole
3. 72 ohm line
4. 300 ohm line

**EXPLODED VIEW**

No loose parts—all parts on assembled units pre-captured at factory.

ASSEMBLES IN RECORD TIME—  
 NO TOOLS REQUIRED!

(—that's right! Not even a screwdriver!)

ALL IN ONE—SETS UP AS REQUIRED BY SIMPLE ADJUSTMENT OF JUMPER LINKS

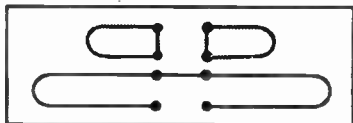

← HF straight dipole  
 LF folded dipole

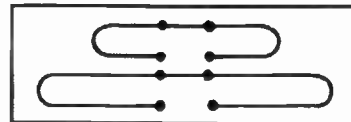

← HF and LF folded dipole

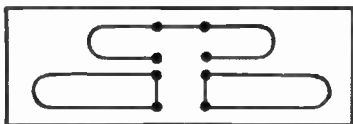

← HF folded dipole  
 LF straight dipole

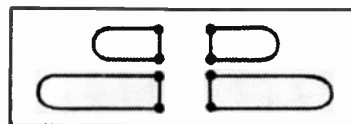

← HF and LF straight dipole.

- Plated steel lock-seam 1" dia. tubing. Models available with 5 and 10 foot masts.
- All tubular elements of hard tempered aluminum.
- Bakelite insulators which are non-hygroscopic.
- No loose parts—all parts on assembled units pre-captured at the factory.

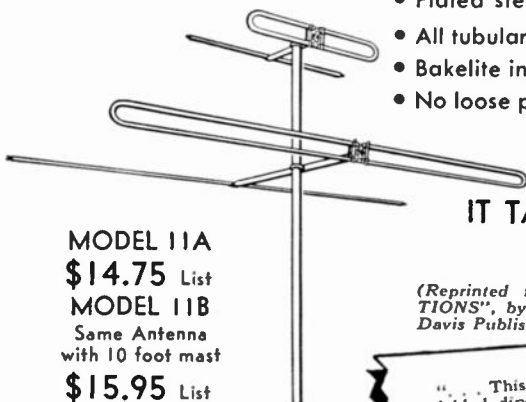

MODEL 11A

\$14.75 List

MODEL 11B

Same Antenna  
 with 10 foot mast

\$15.95 List

ATTRACTIVE TRADE DISCOUNTS

MANUFACTURED BY



... FROM CARTON TO ROOFTOP  
 IT TAKES LESS TIME TO INSTALL A VERTROD "4 'n 1"

READ WHY VERTROD has the only broad-band straight dipole:

(Reprinted from the book "TV-FM ANTENNA INSTALLATIONS", by Ira Kamen and Lewis Winner: Published by Bryan Davis Publishing Co., Inc., 52 Vanderbilt Ave., N. Y. C.)

"... This dipole has a broad-band characteristic since each straight dipole is a half-section of the folded dipole, and therefore the straight dipole effectively has a larger cross-sectional area than a simple straight tubular rod. It is a theoretical fact that the resistance of an antenna element increases more rapidly than its inductance as its cross-sectional area increases, and since Antenna Q = Inductance/Resistance it is apparent that a dipole made up of two half-sections of a folded dipole will have a relatively low Q characteristic and therefore a broad-band response.

For information, contact your distributor or write direct.

DISTRIBUTORS: Exclusive franchises available in some territories. Write for details.

11 PARK PLACE • NEW YORK 7, NEW YORK



## NEWS AND NOTES OF MANUFACTURERS AND DISTRIBUTORS

• **Federal Television Corp.** recently unveiled its new line of television receivers at show rooms on Duane St., N. Y., and distributors and dealers from points as distant as Chicago, Cleveland, and Boston were on hand for the show. General Manager Joseph Petit made known the sets, which feature over-size screens and simplified controls, are ready for immediate shipment.

• **Admiral Corp.**, Chicago, Ill., set a new high for first quarter earnings and sales, even though production lines were changing over to new lines. Sales for the quarter totaled \$23,513,097 as compared with \$12,004,168 for the corresponding quarter last year. Earnings for the quarter came to \$1,536,217 compared with \$530,410 for the first quarter of 1948. Stockholders in the firm voted to increase authorized common stock from 1,000,000 to 1,200,000 shares of \$1 par value recently.

• **Radio Electronic Supply Co.**, 443 So. Division St., Grand Rapids, Mich., has been designated distributors for **Teletone Corp.**, N. Y. Active in the radio and electronic devices field since 1925, the new distributor will handle Teletone's complete line of radios, television sets, and record players.

• **John E. Kane**, Easton, Pa., has been appointed district salesman by the **R. W. Fordyce Co.**, Ardmore, Pa., district merchandising firm for **Bendix Radio and Television**, Baltimore, Md

• **J. Jules Bressler** has been appointed metropolitan New York representative for **Tele-Matic Industries, Inc.**, Brooklyn, N. Y., manufacturers of TV antennas and mounts.

• **Ward Leonard Electric Co.**, Mt. Vernon, N. Y., has moved its offices from the factory building at 31 South St. to a general office, including executive and sales headquarters, at 115 So. MacQuesten Pkwy., Mt. Vernon.

• **Industrial Television, Inc.**, Clifton, N. J., has appointed the **D. J. Roesch Co.**, 2200 So. Figuero St., Los Angeles, distributor in the southern California territory for I. T. I. remote control commercial "Teleceivers" and the "Century" line of TV receivers.



• Meeting with **Paul Ware**, left, representing **Allen B. DuMont Laboratories, Inc.**, N. Y., **Herbert Suesholtz**, general manager of **Transvision, Inc.**, New Rochelle, N. Y., negotiates the contract appointing Transvision national distributor of the DuMont TV-FM inputuner. The kit manufacturer has been granted the exclusive right to use the inputuner in its TV kits.

## WANTED

**National Distributor For  
Revolutionary New Indoor  
Television Antenna.**

It's here. Amazing new-type television indoor antenna that eliminates most installation headaches. Exclusive in principle and design. Amazing signal strength. Occupies small space. Plenty of eye-appeal. Beautiful plastic cabinet. Finger-tip operation. Quality through and through. Laboratory tested and proved under all conditions. To retail under \$10.00. This unit certain to get big share of the indoor antenna market. Samples ready about June 1. Inquiries invited from established, aggressive firms. Write manufacturer, c/o

**AGENCY SERVICE CORPORATION**  
66 E. SOUTH WATER STREET  
Chicago 1, Illinois

## HY-LITE presents a New "SNAP-OUT" TV ANTENNA

Built of the same fine, rigid construction of hi-grade dural aluminum—the S O 30 S is completely assembled at the factory for ease of erection and saving of time at point of installation. **NO TOOLS REQUIRED.**

**\$17<sup>40</sup>**  
LIST

STANDARD  
Jobbers  
Discounts

**SAVES  
TIME**

**FACTORY  
ASSEMBLED**

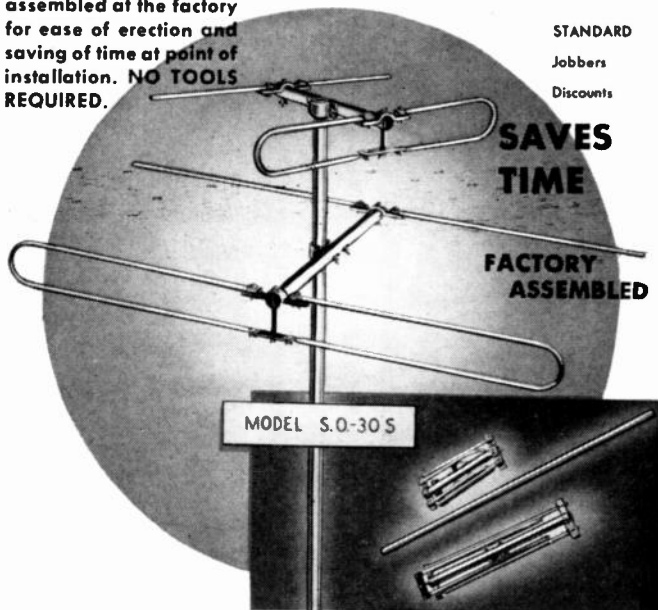

**HY-LITE Antennae INC.**  
Makers of Fine Antennas for AMATEUR · FM · TELEVISION  
528 TIFFANY ST., BRONX 59, N. Y.

Photo shows the compact shipping position. No loose parts—complete—ready to "snap-out" and install. Complete instructions. **JOBBERS:** Many choice districts open—**WRITE NOW** and request our free catalog showing our complete line J

S-9.

**LIKE SOMETHING OUT OF FAIRYLAND SEE PAGE 72**

# REVOLUTIONIZES TV WIRE STRIPPING!

## FLEXTRON WIRE STRIPPER

Patent Applied for



Strips 300 ohm lead-in  
safely — quickly — easily.  
A "must" for every TV  
Serviceman's Kit!

**\$3.95**

*individually  
packaged*

DISTRIBUTORS: Write for distributors' prices and circulars. SERVICEMEN: If your distributor does not yet have FLEXTRON Wire Stripper, write to:

MANUFACTURED BY  
**ELECTRO-STEEL PRODUCTS, INC.**  
112-14 N. SEVENTH ST. PHILA. 6, PA.

## FLEXTRON

10" Suspension Magnifying  
Lens — specially good for  
console models.

List: Clear or Blue \$27.50



## NEW ITEM

### Flextron Brings Out New Console Style Suspension Magnifier

With an ever alert eye toward stepping up TV sales, *Flextron* announces the new #10 *Suspension Magnifying Lens*—designed for the increasingly popular console models. Fits table models or consoles, too.

*Priced at \$27.50*, the #10 was created for use on a 10-inch screen. It gives a big, non-glare picture—boasts quick, 2-way focussing for a clearer, sharper image. And, as in the case of all fine Flextron lenses, there is masking on all four sides to prevent glare and eyestrain. Design of the new #10 is of the easy-to-attach overhang type—with felt base, handsome metal band. (See illustration below.)

With the release of the new #10, Flextron rounds out a complete line of high-grade magnifying lenses. There is a Flextron magnifier for every type TV set—each available in Glareproof Blue at same price as Clear.

Write today for circular giving full information on complete Flextron line—magnifying lenses, filters, antennas.

Address: *Electro-Steel Products, Inc.*  
112-14 N. Seventh St., Phila. 6, Pa.

**DEPEND ON FLEXTRON FOR THE LATEST DEVELOPMENTS IN TV ACCESSORIES!**

# New Appointments

R. C. Tait named president of Stromberg-Carlson, Fassler manager of advertising and sales for GE's receiver division, J. D. Mendelson now sales manager for Tele-tone New York Corp., Perry to general sales manager post of Federal Telephone and Radio Corp.

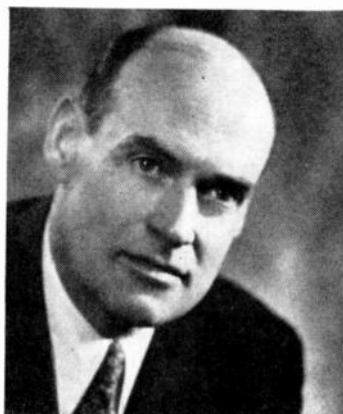

ROBERT C. TAIT

• Robert C. Tait was named president of the **Stromberg-Carlson Co.**, Rochester, N. Y., recently to succeed Dr. Ray H. Manson, now retired and chairman of the board of the company. Experienced in sales, advertising and manufacturing, Mr. Tait is a native of Rochester and was vice-president of the Mellon National Bank and Trust Co. of Pittsburgh at the time of his recent appointment.



S. M. FASSLER

• S. M. Fassler has been appointed manager of advertising and sales promotion for the receiver division of **General Electric's** electronics department, Syracuse, N. Y. Mr. Fassler was formerly engaged in various advertising and sales promotion assignments in the company's appliance and merchandise department at Bridgeport, Conn.



JACK D. MENDELSON

• Jack D. Mendelson has been appointed New York sales manager for **Tele-tone New York Corp.**, N. Y. Mr. Mendelson was formerly with Emerson Radio & Phonograph Corp., where he served in various sales executive positions for over 10 years. He was also associated with Olympic Radio & Television Corp. as assistant national sales manager.

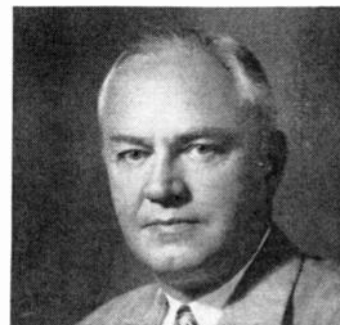

RAYMOND S. PERRY

• Raymond S. Perry has been named general sales manager of the **Federal Telephone and Radio Corp.**, Clifton, N. J. Mr. Perry was formerly president of the Eicor Corp., Chicago, Ill., where he primarily concerned himself with the development of new products. He will direct all commercial activities of Federal, American manufacturing associate of International Telephone and Telegraph Corp.

increase your income without adding to your overhead.....

Sell Musical Merchandise—Steady Market, Attractive Profit.  
No Big Inventory Required

Beat high operating costs, protect yourself against slack periods, by adding a line of musical merchandise. Make present facilities and personnel do double duty, pay double profit.

**Steady Market:** Instruments, strings, reeds, mouth pieces, etc., offer a steady, profitable year-round market unaffected by season or style changes.

**No Big Inventory:** Stock only fast-moving items. Sell other items direct from the big, new catalog of Targ & Dinner, Inc., established 1920.

Send coupon today for free catalog and recommended plan of operation. T & D, one of world's largest wholesalers, offers complete lines, full cooperation, guaranteed satisfaction.



Targ & Dinner, Inc.,  
425 S. Wabash, Chicago 5

Without cost or obligation send us new 177-page catalog, with plan of operation.

Name .....

Address .....

**AEROLUX FLOWERLITES • You'll Love Them!**  
**WRITE FOR CATALOG AEROLUX LIGHT CORP. • 653 11th Ave. • New York**



# MAKE EXTRA PROFIT WITH TELEKIT LINE

**TELEKIT NOW \$59.50**

**JOBBER AND DEALERS:**

**WRITE FOR**

**CONFIDENTIAL DISCOUNT PRICES**



This new modern Telekit 10-B is easy to sell and easy to keep sold. Sell it in kit form. All your customer needs is a soldering iron, pliers and screw driver. Over 18,000 Telekits have been successfully assembled. A big easy-to-follow illustrated instruction book guides simple assembly each step of the way. Jobbers and dealers

have no service worries—Telekit Guarantee includes free factory service and parts replacement.

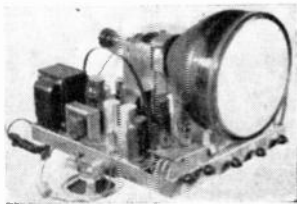

Note the clean simple tube line-up of the new Telekit 10-B. This sparkling new kit features a factory-built, pre-aligned tuner with stage of R.F. Video tube mounted directly on chassis. Everything has been engineered for simple construction. LIST PRICES: Telekit 10-B kit, \$99.50. Tube kit, including 10BP4 and all other tubes, \$59.30. 10-B cabinet \$24.50.

New 7-B kit (same as above but designed for 7 inch tube) \$59.50. Tube kit, including 7JP4, \$42.08. 7-B cabinet, \$24.50. ALL ABOVE PRICES LIST.



**13 CHANNEL  
TUNER NOW  
\$19.95 LIST**

THIRTEEN CHANNEL TUNER is a small compact unit with stage of R.F. Made to conform with Telekit or any other TV set having video I.F. of 25.75 Mc. Complete with tubes, pre-wired, pre-aligned; only three connections to make.

Send for free catalog of Telekit line, including antennas, boosters, television kits, tubes, tuners and parts.

## TELEKIT

**ELECTRO-TECHNICAL INDUSTRIES**  
1432 N. BROAD ST. PHILADELPHIA 21, PA.

# AMPHENOL ANTENNAS

for every FM or TV Requirement

An efficient, high-gain antenna is imperative for TV reception, and Amphenol leads with the finest attainable. Highly trained and highly skilled Amphenol engineers have produced the most effective high and low band antennas and are continually making improvement as new ideas are developed. Constructed of aluminum tubing and aluminum alloy castings, Amphenol antennas have high forward gain combined with high front-to-back and front-to-side ratios, insuring maximum pickup and lasting enjoyment to the user.

**TV**

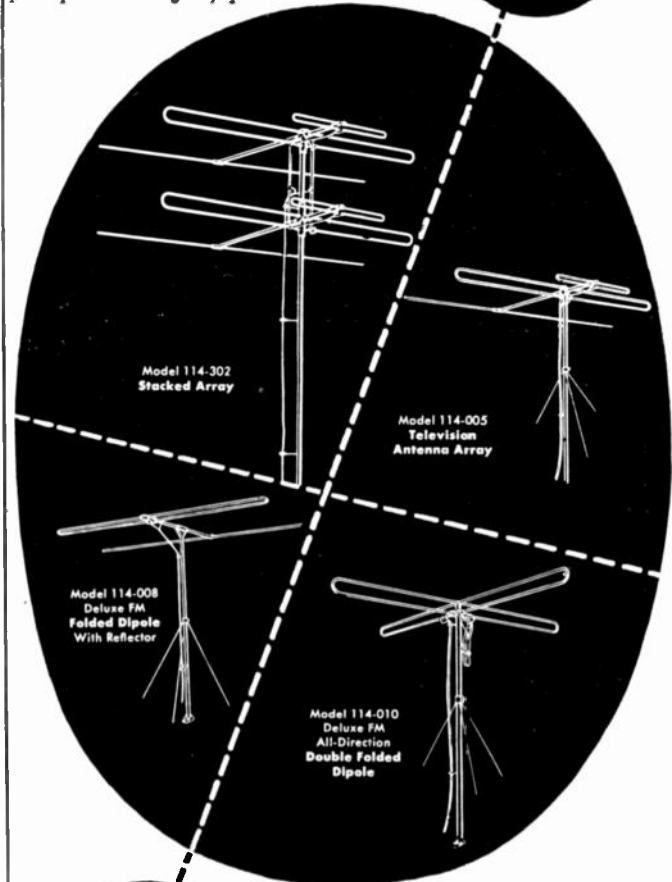

**FM**

Specifically engineered for finest FM performance, Amphenol FM antennas provide interference-free and general long distance reception which is unmatched in the FM antenna field. For rural, suburban or close-in installations. Amphenol FM antennas combine efficient operation with clean-cut, attractive design . . . antennas are entirely constructed of rust-proof aluminum. For consistent, top-quality service. Amphenol FM antennas are chosen again and again.

## AMPHENOL

**AMERICAN PHENOLIC CORPORATION**  
1830 SOUTH 54TH AVENUE  
CHICAGO 50, ILLINOIS



## Television—A National Safeguard

One of the fascinating things about television is that everyone talks about it. Just try making a test some evening by inviting some friends over. Chances are that within an hour after the first drink has been served, the talk will come around to television. And even the ladies will have joined in the conversation. That's television — its magnetism attracts everyone without regard for age, sex, religion or economic status. To paraphrase Churchill, 'Never has an industry received so

much free publicity from so many sources in so short a time.'

This vast and priceless public relations job being done for us by the people has marked significance for the television industry. One element of that significance was summed up last week by Brig. Gen. David Sarnoff, chairman of the board of RCA, when he reported to RCA stockholders that television is "one of the safeguards against a serious economic recession."

Now that's a big statement to make in this 'touch-and-go' period. But Gen-

eral Sarnoff is not given to meaningless remarks, and this particular comment is worth close scrutiny. Already, says Max Balcom, president of RMA, television is accounting for more than half the dollar volume of the entire radio business. Already, current TV set production (over 200,000 units in March) is consuming huge quantities of steel, aluminum, glass, lumber and hundreds of electrical components. Already, in less than two years, advertisers on TV have increased by 2,500 per cent, and \$25,000,000 will be spent by sponsors on television this year. Already, television advertising is performing miracles in selling appliances and other products too numerous to mention.

These are brief facts. The true story about TV's amazing expansion is happening too fast to record now in any definitive way, but it is evident that this industry you are in has become an integral part of America's economic life in a very short time. We mention these facts to reassure those "Summer Soldiers" who have shown signs of fright at the emergence of a buyers' market. The outlook for television is bright for many years to come, and its glow may serve to light many dark corners of our nation's economic life.

AEROLUX LIGHT CORP. <i>Agency: Direct</i>	72
AEROVOX CORPORATION <i>Agency: Austin C. Leacourhoura</i>	12
AGENCY SERVICE CORP. <i>Agency: Direct</i>	70
AIR KING PRODUCTS CO., INC. <i>Agency: Joseph Katz Co.</i>	9
ALLIANCE MFG. CO. <i>Agency: Foster &amp; Davies, Inc.</i>	21
ALPHABEST CORP. <i>Agency: Tudor Advertising, Inc.</i>	18
AMERICAN PHENOLIC CORP. <i>Agency: Burton Browne</i>	73
ANSLEY RADIO & TELEV., INC. <i>Agency: Direct</i>	35
ATLAS SOUND CORPORATION <i>Agency: Julius J. Rowen Co., Inc.</i>	16
CELOMAT CORPORATION <i>Agency: Tracy, Kent, &amp; Co., Inc.</i>	15
CLAROSTAT MFG. CO., INC. <i>Agency: Austin C. Leacourhoura</i>	18
DE WALD RADIO MFG. CORP. <i>Agency: Morton M. Magidson</i>	58
DUOTONE COMPANY <i>Agency: Peter Hilton, Inc.</i>	54
ELECTRO-STEEL PROD., INC. <i>Agency: David Cooperson</i>	71
ELECTRO-TECH. INDUSTRIES <i>Agency: H. Leaseraur</i>	73
ELLAR WOODCRAFT	20
EMFRSON RADIO & PHONOGRAPH CORP. <i>Agency: Grady &amp; Wagner Co.</i>	49, 57
FADA RADIO <i>Agency: Sternfield-Godley, Inc.</i>	38, 39
FEDERAL TELEVISION CORP. <i>Agency: Lancaster Adv.</i>	11
FISHER RADIO SALES CO., INC. <i>Agency: Vanguard Adv.</i>	46
GENERAL INDUSTRIES CO. <i>Agency: Meldrum &amp; Fewsmith, Inc.</i>	22

## ADVERTISERS' INDEX

May • 1949

HY-LITE ANTENNAE, INC. <i>Agency: Adrian E. Clark, Jr.</i>	70
INDUSTRIAL TELEVISION, INC. <i>Agency: St. George &amp; Keyes, Inc.</i>	13
INTERNATIONAL TELEVISION CORP. <i>Agency: Direct</i>	44, 45
JFD MANUFACTURING CO.	17
LYTE PARTS COMPANY <i>Agency: Conti Advertising</i>	5
MOTOROLA, INC. <i>Agency: Gourfain-Cobb Adv.</i>	53
NELDA PUBLICATIONS, INC. <i>Agency: Louis J. Albert</i>	62, 63
NORTH AMERICAN PHILIPS CO. <i>Agency: Erwin, Wasey &amp; Co., Inc.</i>	25, 26, 27
OPTI-GEM, INC. <i>Agency: Graham Bernbach</i>	58
WALTER E. PEEK, INC. <i>Agency: Direct</i>	8
PILOT RADIO CORPORATION <i>Agency: Alfred Paul Berger Co.</i>	51
PIONEER SCIENTIFIC CORP. <i>Agency: Cayton, Inc.</i>	60
PORCELAIN PRODUCTS, INC. <i>Agency: Berson-Faller-Reichert, Inc.</i>	66
RADIO CORPORATION OF AMERICA <i>Agency: J. Walter Thompson Co.</i>	59, 65, Fourth Cover
RADIO MERCHANDISE SALES, INC.	10
RECORDISC CORPORATION <i>Agency: Cromwell Adv.</i>	56
SATEEN PRODUCTS CO. <i>Agency: Direct</i>	68

SCOTT RADIO LABS., INC. <i>Agency: See AFK</i>	41
SNYDER MFG. CO.	Second Cover
<i>Agency: Brooks &amp; London Adv.</i>	
SPELLMAN TELEVISION CO., INC. <i>Agency: Chelsea Adv., Inc.</i>	68
SPRAGUE PRODUCTS COMPANY <i>Agency: Hurry P. Bridge Co.</i>	14
STEWART-WARNER CORPORATION <i>Agency: O'Grady-Anderson</i>	30, 31
STROMBERG-CARLSON COMPANY <i>Agency: Federal Advertising, Inc.</i>	19
SYLVANIA ELEC. PROD., INC. <i>Agency: Newell-Emmett Co.</i>	61
TARG & DINNER, INC. <i>Agency: Bachrodt, Newell, O'Kane &amp; Gano</i>	72
TELE KING CORPORATION <i>Agency: Whitbey Assoc., Inc.</i>	3
TELE-MATIC INDUSTRIES, INC. <i>Agency: Lee-Murray Co.</i>	66
TELE-TONE RADIO COMPANY <i>Agency: Leator Harrison, Inc.</i>	55
TRANSVISION, INC. <i>Agency: H. J. Gold Co.</i>	16
TRANS-VUE CORPORATION <i>Agency: Harry J. Lazarus &amp; Co.</i>	75
TV PRODUCTS COMPANY <i>Agency: Adrian E. Clark, Jr.</i>	20
VERI-BEST TELEV. PROD. INC. <i>Agency: London &amp; Escoffery, Inc.</i>	64
VERTROD CORPORATION <i>Agency: Adair &amp; Director</i>	69
VIDEO CORP. OF AMERICA <i>Agency: Chelsea Adv. Agency</i>	60
VIDEODYNE, INC. <i>Agency: Direct</i>	21
V-M CORPORATION <i>Agency: Mayard Sales &amp; Adv.</i>	8
WARD LEONARD <i>Agency: Henry H. Teplitz Adv.</i>	56
ZENITH RADIO CORP. <i>Agency: Critchfield &amp; Co.</i>	67

**Are You in the  
Commercial  
Television Picture** . . . . .

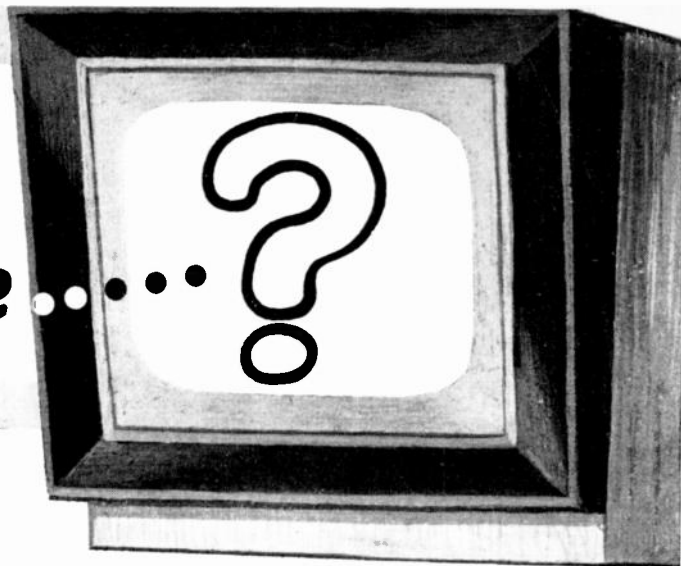

**Let Trans-Vue**

**Entertainer Build Profits for You!**

Every Hotel . . . Theater Cafe . . . . . tavern, cocktail lounge and restaurant a sale. The untouched commercial television market is at your command . . . and waiting for Trans-Vue Entertainer. The only commercial television set with Multiple Remote Control Units. A number of viewing units may be placed separately in any part of the room or rooms . . . yet controlled simultaneously from a conveniently placed Master Tuner. These multiple remote control units give all angle — 360 Degree Visibility. Simplified control "locks" the television picture into sharp flicker-free focus easy on the eyes . . . three control knobs on the Master Tuner . . . quick, sure, simple!

**Another TRANS-VUE EXCLUSIVE!**



New Polaroid one-way filter . . . for greater contrast, sharper definition . . . eliminates fluorescent, incandescent and daylight glare . . . Trans-Vue—and only Trans-Vue now gives your patrons the sharpest, clearest television picture . . . with no "television eyes"!

Trans-Vue puts YOU in the profitable commercial television picture!

**Limited areas open for distributorships. For full details, write, wire or phone!**

**Trans-Vue**

**CORP.**

1139-41 S. WABASH AVE.  
CHICAGO 5, ILLINOIS





*The very picture of profit...*  
**by the greatest name in radio**

● RCA and *only* RCA, can offer you this preferred line of related products for greater sales volume throughout the year.

You benefit by handling RCA Tubes, Batteries, TV Components, Speakers, Parts and Accessories . . . because you can get them all from *one* dependable source of supply . . . because the RCA monogram on

any product gives it immediate customer acceptance. Also, you'll save time and give greater customer satisfaction with the outstanding new line of RCA Test Equipment in your service shop.

See us at the  
**CHICAGO PARTS SHOW**  
 Hotel Stevens, May 17-20

ALWAYS KEEP IN TOUCH WITH YOUR RCA DISTRIBUTOR



**RADIO CORPORATION of AMERICA**

HARRISON, N. J.