

RADIO TELEVISION JOURNAL

September, 1945



Architect of Peace

WHY *Motorola* ENGINEERS

KNOW **F-M**



FREQUENCY MODULATION IS

NOTHING NEW TO *Motorola*

Radiant, concert quality tone—with virtually no static, interference or fading! These briefly are the reasons that so many of your customers will *demand* F-M in their postwar radio.

Motorola knows supreme quality F-M! During the war years Motorola has been making war-essential radio-electronic equipment exclusively, *and by far the largest percentage of this equipment* has been F-M. The famous Motorola "Walkie Talkie" is an F-M unit. Highway police of 36 states and over 1500 communities use Motorola F-M units for emergency communication. These are units that *must not fail*—they are depended on to deliver under the most difficult conditions. Motorola knows supreme quality F-M!



THE BATTLE-TOUGH MOTOROLA
"WALKIE TALKIE" IS AN F-M UNIT

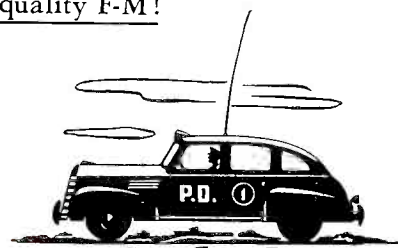

HIGHWAY POLICE OF 36 STATES
USE MOTOROLA F-M EQUIPMENT

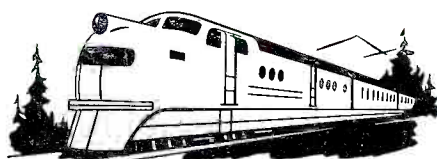

HUNDREDS OF RAILROADS AND
OTHER PUBLIC SERVICES DEPEND
ON MOTOROLA FOR F-M



THE FINEST F-M HOME RADIOS BEFORE
THE WAR WERE MADE BY MOTOROLA

GALVIN MFG. CORPORATION • CHICAGO 51, ILL.



Motorola **A-M** **F-M** Radio

F-M & A-M HOME RADIO • AUTO RADIO • PHONOGRAPHS • TELEVISION • POLICE RADIO • AIRCRAFT RADIO • RADAR • MILITARY RADIO

THE EXTRA MEASURE

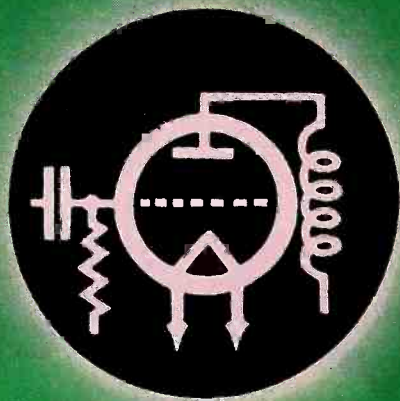

... AND WHAT IT MEANS TO MEN WHO WILL SELL
GAROD RADIOS

The *Garod extra measure* is symbolic of a new and broader conception of radio design, engineering and performance. It means custom-character radios produced by modern, scientific manufacturing methods. It means an exciting new adventure in tonal reproduction. It means eye-catching cabinets of unusual beauty, in every price bracket. It means trouble-free satisfaction over a longer period of time. In short, it means the kind of radios you like to sell—the kind of radios that will stay sold.

The *Garod extra measure* also means bold ideas in merchandising and promotion. It means an awareness of your needs and problems. It means dramatic themes in national and retail advertising. It means new techniques in display and selling aids. It means a conscientious effort to cooperate with you all along the line. This, then, is the *Garod extra measure*. Your distributor will gladly give you the details of a most interesting proposition.

GAROD



RADIO

GAROD IS READY!

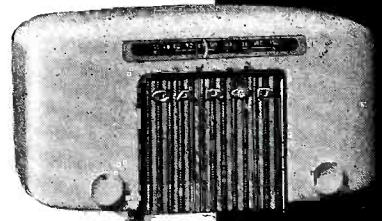
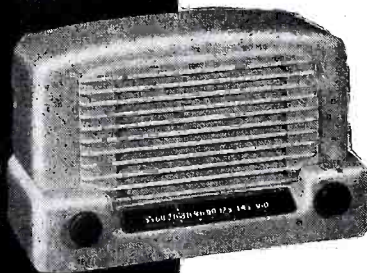
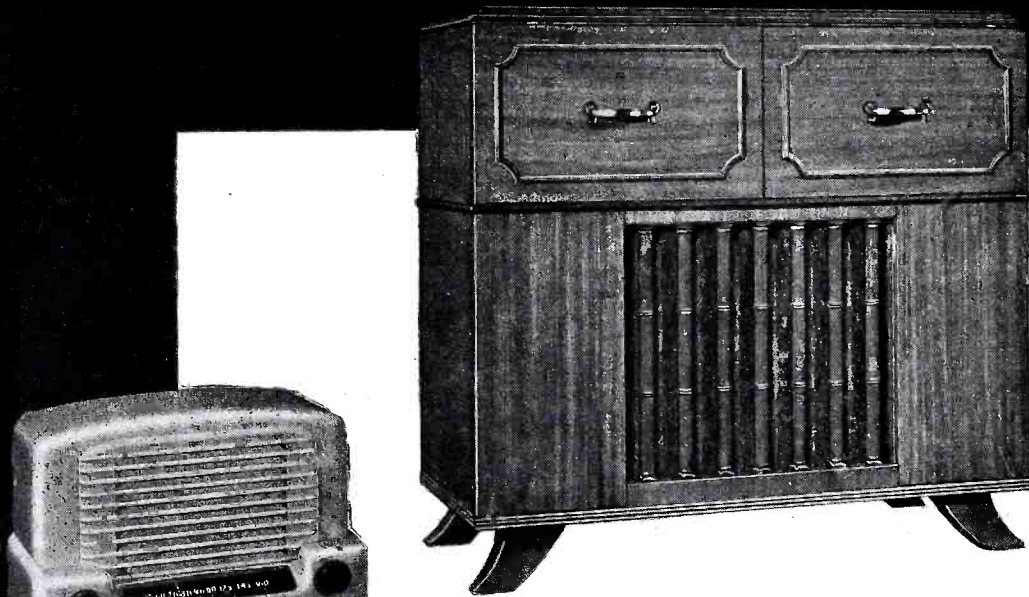

The Garod Radios shown here are actual samples from our postwar line . . . completely engineered and tested. These are only a few of the many models—portables, radio-phonograph combinations, table sets, farm sets, AM, FM, etc., and Television, when available—that Garod is ready to produce without delay. Starting with a strong set-up in table models, the Garod line will cover all other fields competitively up to \$350.00. And every model in every price group will be a sure-fire seller.

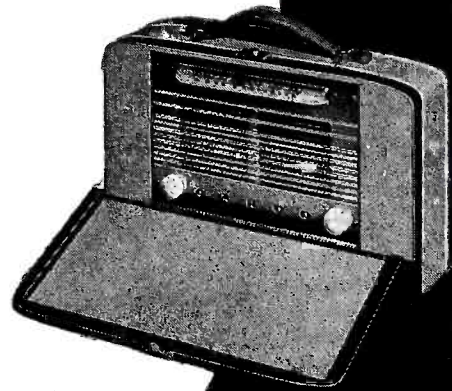



THEY WANT GAROD RADIOS

- Men and women who are established in the entertainment world are splendid judges of tonal reproduction. **They want Garod Radios.**
- Men and women who sell and service radios cannot be fooled when selecting a set for their personal use. **They want Garod Radios.**
- Men and women who are critical shoppers know and appreciate inherent value as well as outer beauty. **They want Garod Radios.**

And GAROD will help you reach them ALL

With national advertisements featuring **BIG NAMES** of stage, screen and radio.

With expensively prepared, full-color window and counter display cards.

With unusual cartoon ads that carry a sales punch with every chuckle.

And with 14 other selling aids—folders, advertising mats, displays, brochures, etc.

PLUS—the Extra Measure of Manufacturer-Distributor service . . . a service that will mean much to you in the years immediately following the war's end.

AND NOW—
TAKE HANDS WITH THE MEN WHO
WILL DISTRIBUTE GAROD RADIOS . . .



The following pages are devoted to America's "blue ribbon" distributors. Men of long experience, high reputation and keen judgment, each one is prepared to help you lay the foundation for future sale of Garod Radios. Welcome the Garod Distributor—a good friend and a reliable guide, he will stand four-square behind you, now and in the prosperous years ahead.

SHAKE HANDS WITH

BERNARD SAMUELS
ALLIED ELECTRIC SUPPLY CO.



"You can take it straight from us that there will be no 'lemons' in the radios put out by Garod. There won't be any sets that will require a genius to sell them. We've seen the postwar models, and they certainly are the sweetest designs ever to sit in the parlor, porch or bedroom. We like 'em, you'll like 'em, and so will your customers."

EXCLUSIVE DISTRIBUTOR
GAROD RADIO

TERRITORY: WESTERN PENNSYLVANIA,
WEST VIRGINIA PANHANDLE.

ALLIED ELECTRIC SUPPLY CO.

928 PENN AVENUE • PITTSBURGH 22, PA.

SHELBY TUCKER
SHELBY TUCKER COMPANY



"Garod is no 'war baby' . . . their name has been part of the radio industry ever since its infancy. Their reputation is based on the value, quality, eye-appeal and trouble-free performance of their radios. Only a limited circle made their acquaintance before the war, but you just watch their smoke as soon as they get going."

EXCLUSIVE DISTRIBUTOR
GAROD RADIO

TERRITORY: WESTERN THIRD OF TENNESSEE—
NORTHERN HALF OF MISSISSIPPI—8 WESTERNMOST
COUNTIES OF KENTUCKY—4 SOUTHEASTERN COUN-
TIES OF MISSOURI and 10 EASTERNMOST COUNTIES
OF ARKANSAS.

SHELBY TUCKER COMPANY

1002 JACKSON AVENUE • MEMPHIS 4, TENN.

THE GAROD "EXTRA MEASURE" MEANS EXTRA BUSINESS FOR YOU

YOUR GAROD DISTRIBUTOR

G. LOU RIFKIN
ASSOCIATED DISTRIBUTING CORP.



"Let's put it on the line, gentlemen. All of us are in business to make money, and that's one of the reasons why we ourselves are all-out for Garod radios. We've got every reason to believe that there will be a huge demand for Garod sets and that, in any man's language, means good healthy volume and comfortable profit."

EXCLUSIVE DISTRIBUTOR

GAROD RADIO

TERRITORY: MARYLAND AND DISTRICT OF COLUMBIA.

ASSOCIATED DISTRIBUTING CORPORATION

CHARLES & LOMBARD STREETS • BALTIMORE, MD.

MAURICE E. GOLDEN
GOLDEN APPLIANCE CO.



"As an 'extra measure' of dealer cooperation Garod is planning to have a corps of Traveling Representatives out in the field at all times. The objective of these men will be to help you do a better selling job, and they will also come prepared with many ideas to help stimulate trade throughout your entire store."

EXCLUSIVE DISTRIBUTOR

GAROD RADIO

TERRITORY: CLEVELAND TERRITORY plus NORTH CENTRAL OHIO.

GOLDEN APPLIANCE CO.

1761-67 E. 18th ST • CLEVELAND 14, OHIO

GAROD FOR BETTER PERFORMANCE OVER A LONGER PERIOD OF TIME

THE MAN WHO KNOWS

MAX KATZ
K STORES COMPANY



"The Garod bunch has always been way up among the leaders when it comes to new developments. Take television, for instance. Do you know that Garod introduced the first practical, low-priced television kit? That happened in September, 1938. From the looks of things Garod will again come through when peacetime television is ready."

EXCLUSIVE DISTRIBUTOR

GAROD  **RADIO**

TERRITORY: EASTERN HALF OF MASSACHUSETTS
EAST OF and INCLUDING WORCESTER COUNTY.

K STORES COMPANY
1310 BOYLSTON STREET • BOSTON, MASS.

FRANCIS E. STERN
STERN & COMPANY



"The good taste in cabinet design of Garod radios has always impressed me. This taste, I find, applies not only in the higher brackets but throughout the entire line. Since every man who sells radios knows that outer appearance is highly important, the great appeal of Garod cabinet design will prove a powerful sales factor."

EXCLUSIVE DISTRIBUTOR

GAROD  **RADIO**

TERRITORY: FAIRFIELD, NEW HAVEN and
MIDDLESEX COUNTIES IN CONNECTICUT.

STERN & COMPANY
210 CHAPEL STREET • HARTFORD 1, CONN.

A GAROD DEPARTMENT IS ALL YOU NEED FOR GOOD, STEADY VOLUME

IS YOUR GAROD DISTRIBUTOR

HOWARD W. HEAGLE
GIL SCHAEFER DISTRIBUTOR



VICTOR E. TEDE
TEDE & ETCHINGHAM



"Garod is the kind of radio you can recommend to your best friend, and that, in my opinion, is just about the highest compliment you can pay to any radio receiver. You won't have to be modest when talking Garod to a prospective customer because their radios have just what it takes to give greater satisfaction over a long, long time."

"Pre-tested performance is something you can talk about when you handle the Garod line. And just what does pre-tested performance mean? It means that every radio leaving the Garod plant will be carefully checked and inspected by exclusive Garod laboratory methods to make sure that from inside-out everything is perfect."

EXCLUSIVE DISTRIBUTOR

GAROD  RADIO

TERRITORY: WESTERN HALF OF MICHIGAN

GIL SCHAEFER DISTRIBUTOR

101 WESTON ST., S.E. • GRAND RAPIDS 2, MICH.

EXCLUSIVE DISTRIBUTOR

GAROD  RADIO

TERRITORY: IDAHO, UTAH, NORTHERN HALF OF WYOMING.

TEDE & ETCHINGHAM

234 WEST BONNEVILLE • POCATELLO, IDAHO

GAROD RADIOS FOR THE EXTRA MEASURE OF LISTENING PLEASURE

TAKE A TIP FROM

RAY T. RINGLER
MAGA DISTRIBUTORS, LTD.



After you've sold as many radios as I have, you begin to know something about fine construction. That's where I hand it to Garod. They have the one line in a million when it comes to construction. And that means oversize components, heavy speakers, good wiring. It means extra care in assembly operations. It means radios you can sell with pride."

EXCLUSIVE DISTRIBUTOR

GAROD  **RADIO**

TERRITORY: STATE OF GEORGIA

MAGA DISTRIBUTORS, LTD.

614-18 NEW ST., P. O. BOX 1173 • MACON, GA.

E. L. CHAMBERS
CHAMBERS RADIO SUPPLY CO.



"Garod radios will be built to last, to take a lot of 'playing' without breaking down. Except for an occasional replacement of tubes, your customers will find Garod sets to be trouble-free. This means less headaches for you, and more enjoyment for them. Why not investigate the interesting proposition that we have to offer you?"

EXCLUSIVE DISTRIBUTOR

GAROD  **RADIO**

TERRITORY: CINCINNATI plus S.E. CORNER OF INDIANA, NORTHEASTERN KENTUCKY.

CHAMBERS RADIO SUPPLY CO.

1104 BROADWAY • CINCINNATI 10, OHIO

DECIDE TO CARRY QUALITY FROM THE START—CARRY GAROD RADIO

YOUR GAROD DISTRIBUTOR

C. E. WYMAN
TEL-RA APPLIANCE COMPANY



Based on the kind of work the company is now doing, it can be stated that no set on the market will be ahead of Garod in electronic improvements and advancements. Greater selectivity and sensitivity, natural tonal qualities, superior all-around performance will be incorporated in all models and all prices. Garod radios will speak for themselves."

EXCLUSIVE DISTRIBUTOR

GAROD  **RADIO**

TERRITORY: RHODE ISLAND plus BRISTOL, BARNSTABLE, DUKES and NANTUCKET COUNTIES IN MASSACHUSETTS.

TEL-RA APPLIANCE COMPANY

122-130 W. EXCHANGE ST. • PROVIDENCE, R. I.

MYRON L. ALPERT
NATIONAL RADIO DISTRIBUTORS, INC.



"We'd like our dealers to know that all Garod cabinets are originals, designed by top industrial designers. There will be plastics in solid colors and two-tone combinations. There will be woods, in all popular finishes. There will be modern and period styles to suit all tastes and all home settings."

EXCLUSIVE DISTRIBUTOR

GAROD  **RADIO**

TERRITORY: FLORIDA EXCEPT 10 NORTHWESTERN COUNTIES.

NATIONAL RADIO DISTRIBUTORS

INCORPORATED

CONGRESS BUILDING • MIAMI, FLORIDA

ROD WILL BACK YOU WITH ADVERTISING, DISPLAYS, SELLING HELPS

MARK THE WORDS OF



GILBERT BROTHERS, INC.

826 S.W. SECOND AVE. • PORTLAND 4, ORE.

JAY J. GOODMAN

J. R. GROSSMAN



"Show us the man who's interested in full value for his money, and we'll show you a potential Garod customer. We say, without fear of argument, Garod radios in appearance, in performance, in length of life are worth every penny of their price. And the result? A self-selling radio line that will click throughout our community."

EXCLUSIVE DISTRIBUTOR

GAROD



RADIO

TERRITORY: OREGON plus COUNTIES COWLITZ, CLARK, WAHAKIUM, SKAMANIA and KLUCKITAT in WASHINGTON.

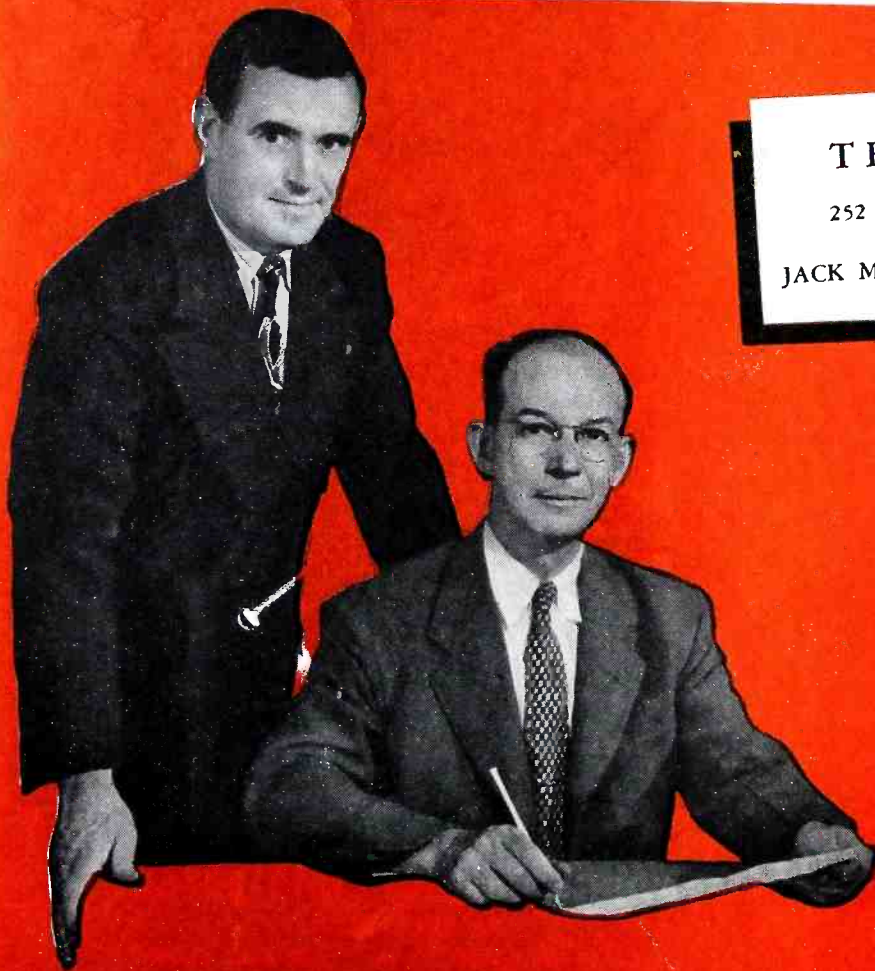

TEL-RA APPLIANCE CO.

252 ASYLUM STREET • HARTFORD, CONN.

JACK MURPHY

C. E. WYMAN

"We believe in talking straight from the shoulder, and that's what we're doing now. All signs indicate that Garod radios will sell fast, and won't come back. Every radio merchant knows what this means, and that's why we're going to handle these fine sets. The product will be right, and the price will be right. 'Nuf said'."

EXCLUSIVE DISTRIBUTOR

GAROD



RADIO

TERRITORY: LITCHFIELD, HARTFORD, TOLLAND, WINDHAM and NEW LONDON COUNTIES IN CONNECTICUT.

GET SET FOR THE GREEN LIGHT—PLACE YOUR ORDERS FOR GAROD NO

OUR GAROD DISTRIBUTOR



THE JAKE HAYUTIN & SONS CO.

1426 LARIMER STREET • DENVER 2, COLO.

JAKE HAYUTIN

MARVIN HAYUTIN



"Everybody knows that tone quality is one of the most important features of any radio. Most companies boast about the tone of their expensive sets, but Garod, even in the smallest portables, will feature an exceptionally wide tonal range. Their engineers have achieved extreme fidelity in every price range, and your ear will tell you so."

EXCLUSIVE DISTRIBUTOR

GAROD  **RADIO**

TERRITORY: COLORADO, SOUTHERN THIRD OF WYOMING and NORTHERN THIRD OF NEW MEXICO.

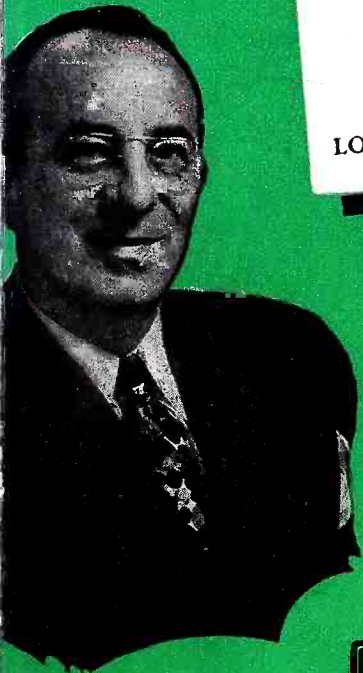

NATIONAL SALES COMPANY

365 NORTH STREET • ROCHESTER 5, N. Y.

LOUIS SOLOMON

WILLIAM J. LEVINE



"Here's what we like about Garod radios—it's the wide scope of the line. Customers with limited cash as well as those with lots of money in the bank can, therefore, be satisfactorily taken care of. Also, you'll be able to satisfy model preferences, whether they be AM, FM, portable, console, radio-phono combination, etc."

EXCLUSIVE DISTRIBUTOR

GAROD  **RADIO**

TERRITORY: WEST CENTRAL NEW YORK

GAROD RADIOS—PRECISION INSTRUMENTS OF BEAUTY AND VALUE

STRAIGHT TALK FROM

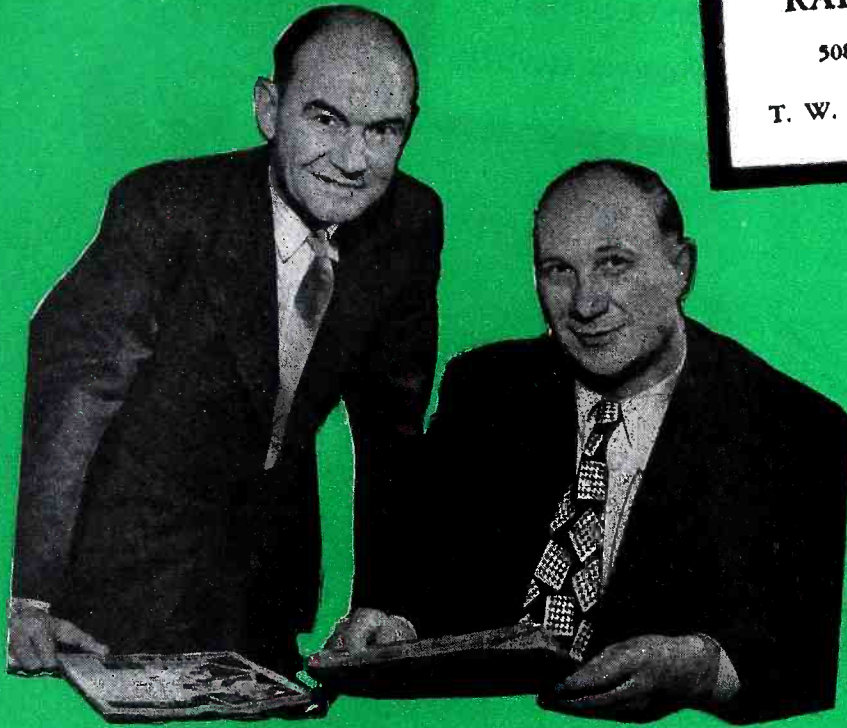

RADIO TUBE MERCHANDISING CO.

508 CLIFFORD STREET

FLINT 3, MICH.

T. W. MOWAT

C. E. PHILPOTT

"This is our understanding of the Garod 'extra measure'—price for price, Garod will put a little more than is expected into each set, and it's this little more that will count when customers make comparisons between Garod radios and their competitors. In our territory we're proud to be the exclusive Garod distributors."

EXCLUSIVE DISTRIBUTOR

GAROD  **RADIO**

TERRITORY: EASTERN HALF OF MICHIGAN NORTH OF DETROIT.

W. & K. WHOLESALE DISTRIBUTORS

1308-10 MAIN ST.

FORT WORTH, TEXAS

C. G. ADAIR

L. E. DUCKWORTH

"A satisfied customer means more to us than anything else, and so we've picked the Garod line of radios because we honestly feel that the products of this company will amply meet our high standards. If you agree that customer satisfaction comes first, then we suggest that you get together with us at your earliest convenience."

EXCLUSIVE DISTRIBUTOR

GAROD  **RADIO**

TERRITORY: NORTHERN PORTION OF TEXAS SOUTH TO and INCLUDING SHELBY COUNTY ON A LINE GOING WEST DIRECTLY ACROSS and INCLUDING McLENNAN COUNTY WEST TO and INCLUDING TOM GREEN COUNTY.

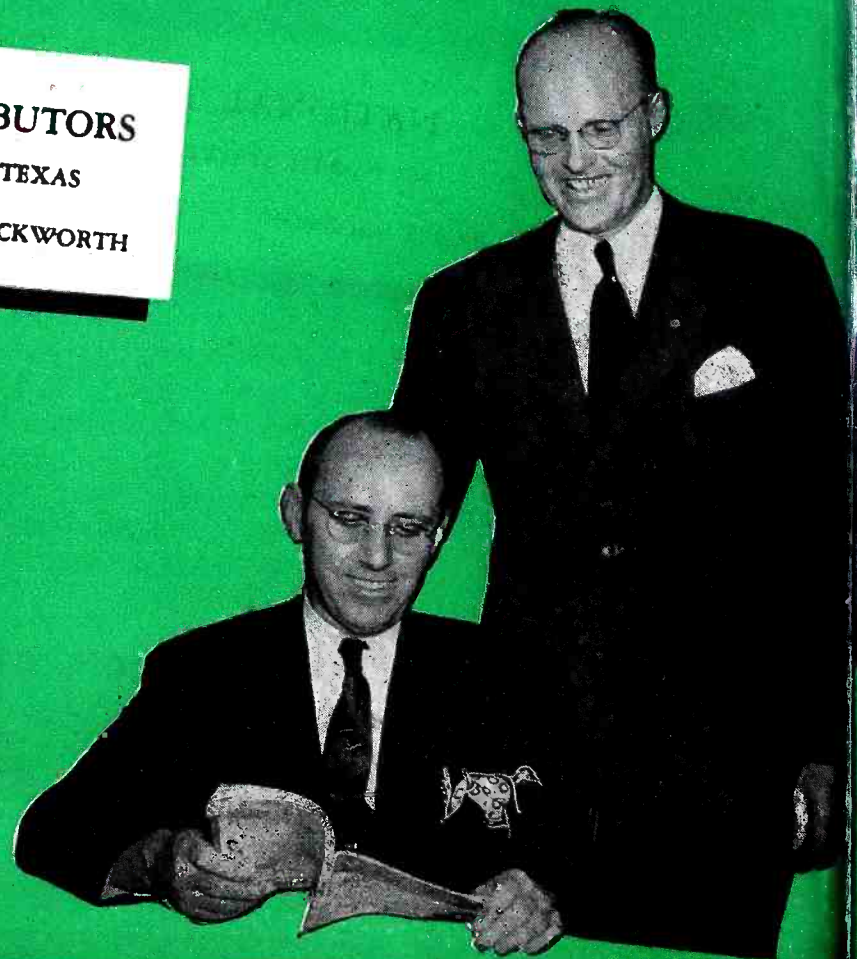

GAROD—DISTINGUISHED CABINETS IN MODERN AND CLASSIC TYPE

YOUR GAROD DISTRIBUTOR

HERB E. ZOBRIST COMPANY

2125 WESTLAKE AVE. • SEATTLE 1, WASH.

HERB E. ZOBRIST

A. E. HOYT

"The way many of our dealers plan to sell Garod post-war radios is to take their customers into the radio department, give them a comfortable chair, and just let them listen to the programs they want to hear. The clear tone, the crackle-free reception of Garod postwar radios will be just about the most convincing sales-clinchers we know of."

EXCLUSIVE DISTRIBUTOR

GAROD RADIO



TERRITORY: STATE OF WASHINGTON EXCEPT FOR THE COUNTIES OF WAHKIAKUM, COWLITZ, CLARK, SKAMANIA and KLICKITAT.

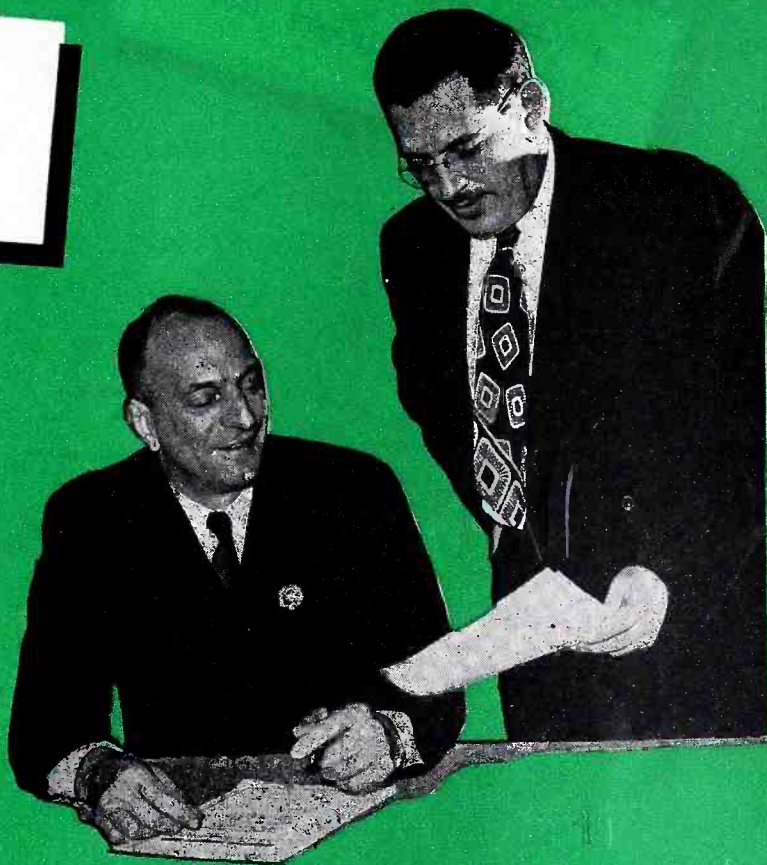

THE FURBAY-SOMMER CO.

115 SCHROYER AVE.

CANTON 2, OHIO

RALPH E. FURBAY

HOMER D. SOMMER

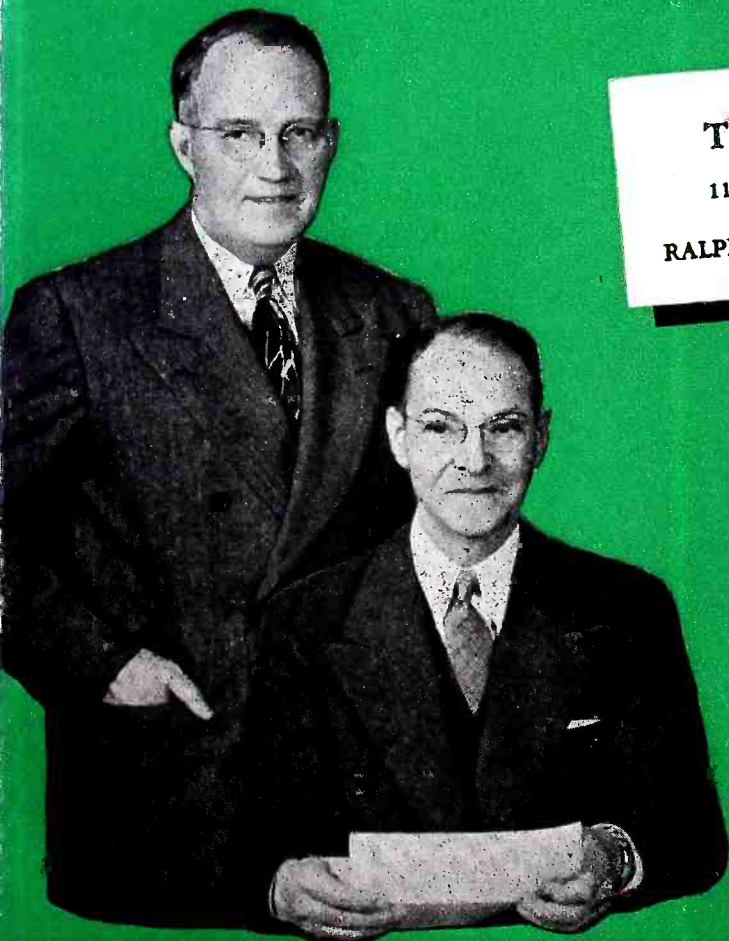

"Nobody will be an orphan when he carries the Garod line of radios. We and Garod offer a square-shooting deal to little fellows as well as the big boys. Based on your needs, we're going to do our best to satisfy you, and to back you up with every resource at our command. In other words, we aim to please, to help you sell, to help you grow."

EXCLUSIVE DISTRIBUTOR

GAROD RADIO



TERRITORY: EAST CENTRAL OHIO

GAROD DEPARTMENT WILL LEND ADDED PRESTIGE TO ANY STORE

GET IN TOUCH WITH

I. H. VASSAR, Jr.
ADKINS & COMPANY, INC.



"Battery-operated radios are an important factor in our territory. We have seen Garod's contribution to this market and we are satisfied that our dealers will have everything they will need to do a swell job."

EXCLUSIVE DISTRIBUTOR

GAROD  **RADIO**

TERRITORY: SOUTH CENTRAL VIRGINIA

ADKINS & COMPANY, INC.

315-324 TWELFTH ST. • LYNCHBURG, VA.

ARTHUR J. CAPLAN
PARAMOUNT DISTRIBUTORS, INC.

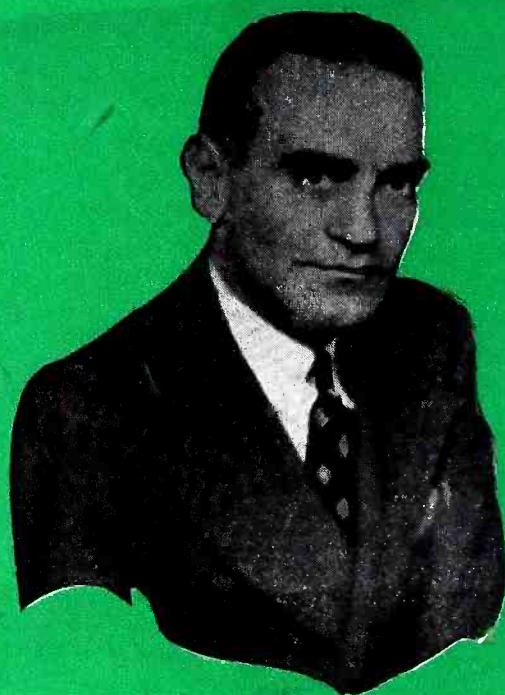

"If you want our advice, we suggest that you make up your mind to carry quality from the start—it will pay off in future years. A quality product like Garod will not only move better, and give you less trouble, but it will also help move other items in your store. In our judgment, the Garod line is your best all-around bet."

EXCLUSIVE DISTRIBUTOR

GAROD  **RADIO**

TERRITORY: WESTERN HALF OF MASSACHUSETTS
WEST OF WORCESTER COUNTY.

PARAMOUNT DISTRIBUTORS, INC.

42 HAMPDEN STREET • SPRINGFIELD 3, MASS.

A M — F M — TELEVISION — JUST NAME IT — GAROD WILL HAVE I

YOUR GAROD DISTRIBUTOR

H. R. SILVEY
SOUTHWEST WHOLESALE RADIO
& APPLIANCE COMPANY



WILLIAM H. MANOFF
LIFETIME SOUND EQUIPMENT CO.



"Speaking of the 'works', Garod radios will have plenty of reserve power to handle those sudden volume peaks that add so much brilliance to music and also make voices so interesting. People who especially like symphonies and such will really appreciate this outstanding advantage of Garod radios. These sets will sell like hotcakes."

"Garod knows the retail field as few manufacturers know it. Lots of their boys have been in the 'game' for a good many years, and they know your problems pretty well. All Garod planning, therefore, from set design and pricing to advertising and promotion is 'keyed' to help you do a more productive selling job."

EXCLUSIVE DISTRIBUTOR



TERRITORY: STATE OF ARIZONA

**SOUTHWEST WHOLESALE RADIO
& APPLIANCE COMPANY**
22 SOUTH THIRD STREET • PHOENIX, ARIZ.

EXCLUSIVE DISTRIBUTOR



TERRITORY: TOLEDO AREA

LIFETIME SOUND EQUIPMENT CO.
1101-1103 ADAMS STREET • TOLEDO 1, OHIO

GET ON THE GAROD PROFIT BANDWAGON . . . SIGN UP FOR GAROD RADIOS

YOU CAN DEPEND ON GAROD AND YOUR GAROD DISTRIBUTOR



INCANDESCENT SUPPLY CO.
825 EAST THIRD STREET LOS ANGELES, CAL.
IRVING HARRIS MAXWELL ROSEN



"This is the pledge we and Garod make to Garod dealers: Custom-crafted radios of outstanding excellence—extensive range of models, sizes and prices—eye-appealing cabinets in woods and plastics—top-grade components and materials—precision construction for long, trouble-free performance."

EXCLUSIVE DISTRIBUTOR

GAROD  **RADIO**

TERRITORY: SOUTHERN CALIFORNIA

C. C. BROWN COMPANY

26 NINTH STREET SAN FRANCISCO 3, CAL.
C. C. BROWN E. E. TRUXTON

SAN FRANCISCO BRANCH

26 NINTH STREET
SAN FRANCISCO, CAL.

"We like the way the Garod fellows talk. They don't use five-dollar words and make things sound like a mystery story. They're business men, they know that what we want and what you want are radios that will sell in volume and at a good profit. We're ready to talk Garod radios to you any time you're ready."

SACRAMENTO BRANCH

1714 TENTH STREET
SACRAMENTO, CAL.

EXCLUSIVE DISTRIBUTOR

GAROD  **RADIO**

TERRITORY: NORTHERN CALIFORNIA

GAROD EXCELS IN QUALITY — IN AM — FM — TELEVISION

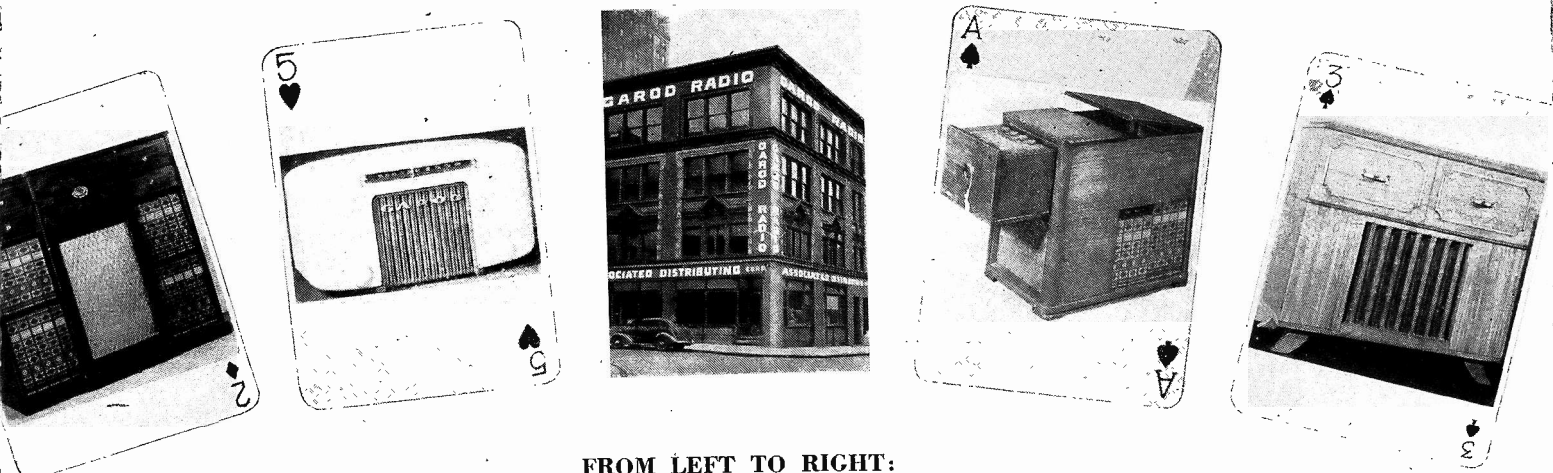

FROM LEFT TO RIGHT:

1. Breakfront cabinet finished in walnut and mahogany. Radio concealed behind door on right, phonograph in drawer in center of cabinet.
2. Five tube AC-DC superheterodyne, plastic cabinet in two colors. Lucite dial scale.
3. New home of the Associated Distributing Corp., Garod outlet in Baltimore.
4. Chairside combination radio and phonograph. Domestic and foreign reception.
5. Bleached mahogany cabinet, AC super het radio, phonograph with 2-post record changer.

GAROD GIVES YOU THE WINNERS

The Garod Radio Corporation has just concluded the most successful sales meeting in its entire history, the recent New York City assemblage of Garod distributors from all over America serving the dual purpose of exhibiting the complete line of Garod radios and of announcement and discussion of an aggressive merchandising program on a national scale.

Reflecting the many advances in engineering and design that required only the end of the war to be translated into reality, the Garod exhibit

revealed the fullest possible utilization of both woods and plastics so as to command maximum consumer acceptance.

The distributors saw six different table model radios, in both wood and plastic, which offered the purchaser a variety of styles, sizes and finishes. Supplementing this group is a table phonograph combination, also in plastic and in wood, as well as a combination having an automatic record changer. Several three-way portables were shown, a feature of which

was the design for easy portability.

Outstanding for beautiful design and maximum utility was the series of ten console combinations, including two chair-side models. Most of the console combinations will be in both walnut and mahogany . . . in addition, there will be models featuring bleached mahogany finishes. These consoles reflected a wide range of period designs including Sheraton, 18th Century, Hepplewhite, Neo-Classic, and a breakfront cabinet.

(Continued on page 88)



3-gang tuning. AC-DC ribbed grill. Concealed loop antenna.

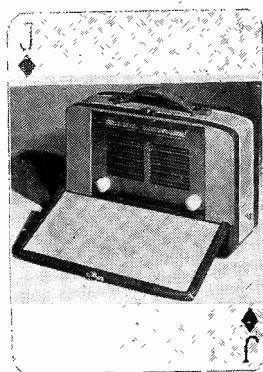

Portable 3-way radio, 2 tone leatherette case.

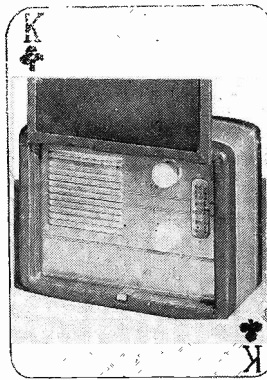

Farm console. 1000 hour battery pack. 6 tube circuit.

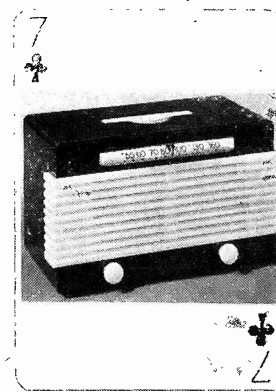

Drop handle. 2 tone. AC-DC. Super. Untuned RF Stage.

OLDEST

dealer publication in the radio field

1916... 4 years before the first radio broadcast, the forerunner of today's Radio Television Journal was aiding dealers and distributors do a better job for the hundreds of advertisers who used its pages 29 years ago.

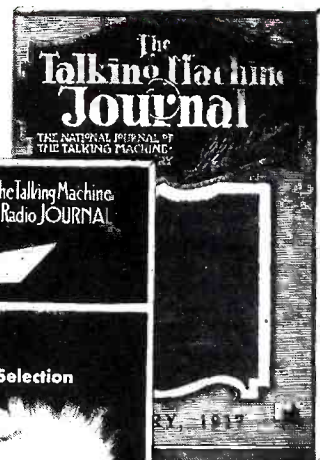

1930... it was late 1928 before the first "house current" battery-less sets were produced and the radio industry was definitely on its way. Keeping pace with its growth, the Talking Machine Journal added Radio to its title to better illustrate the scope of its service to this new industry.



1932... consolidation with Electric Appliance Journal further broadened Radio Journal's coverage and materially aided many of its readers to get into this new, important household equipment field. Today, Electric Appliance Journal is a separate, companion publication to Radio Journal, both published by Kolbe Publications, Inc.

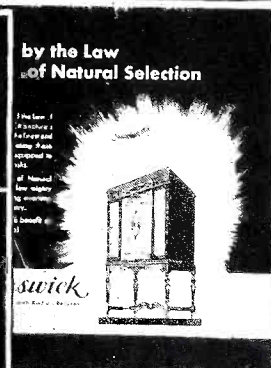

1941... purchase of the old Talking Machine World and Radio Music Merchant added thousands of valuable subscribers to Radio Journal's readers. With the advent of Television, this new, generic term was added to the title.

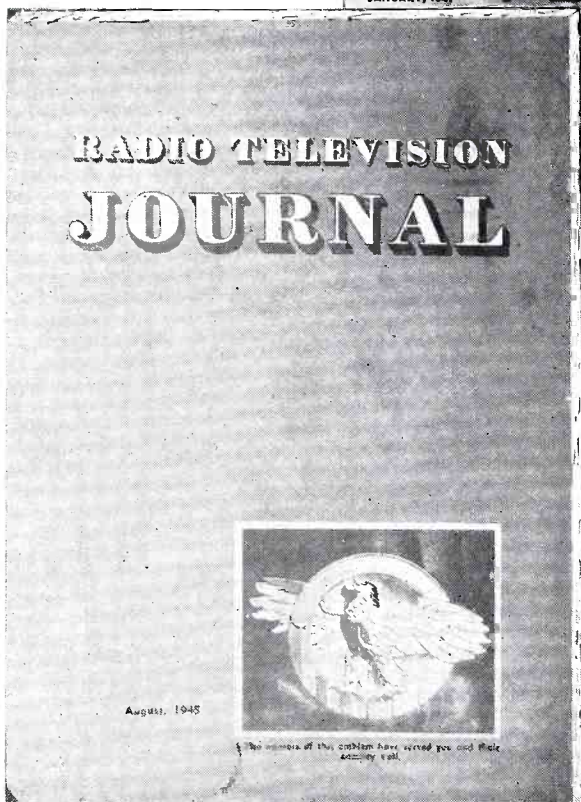
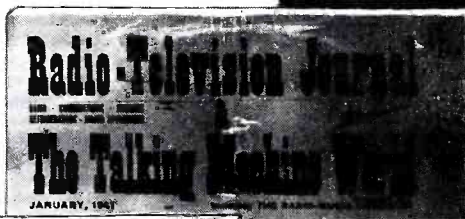

The Modern

Radio Television Journal

is ready to continue another three decades of service to the radio and television industry exclusively. Always recognized as the leading *merchandising* publication in the field, Radio Television Journal has almost 30 years of practical, down-to-earth *industry* experience to offer its readers and advertisers. Not a new venture by magazine gamblers who hope to skim the cream from the industry's bright immediate future... Radio Television Journal has the loyalty, friendship and respect that can come only with a long record of honest, straightforward service to the industry.

During its three decades of existence, Radio Television Journal has invested over ONE MILLION DOLLARS in editorial and production costs in publishing the finest magazine in the field. Now, at war's end, we plan to bring you an even greater Radio Television Journal to help you keep pace with the great strides in merchandising that peacetime will bring.

AND NOW 1945... Radio Television Journal is the industry's fastest-growing, most talked-about publication with a conceded record of more Editorial firsts, during its long history, than any other dealer publication serving the industry. And... effective October 1, 1945, it will have the largest circulation of any exclusive, radio service-dealer publication.

Remember, you can't buy experience, you have to earn it... and only Radio Television Journal has almost 30 years' experience in the radio industry to offer you. No other dealer publication can make this statement.

RADIO TELEVISION JOURNAL

CHICAGO

1270 SIXTH AVENUE
NEW YORK 20,
N. Y.

LOS ANGELES

Follow

through



A new, unusual
program of advertising
and promotional assistance
will help Stewart-Warner dealers
follow through to greater
sales and
profits!



**STEWART-
WARNER**
Radios
CHICAGO 14, ILLINOIS

The Stewart-Warner logo, featuring the letters 'STW' in a stylized font, with 'STEWART' on the left and 'WARNER' on the right, all enclosed in a shield-like shape with wings.

Editorially Speaking

MAL PARKS

Editor

Alex H. Kolbe

Publisher

NOW that final victory has come, you and I have been plunged right into the middle of that "postwar era" we have discussed together so often on these pages during the past few years.

BECAUSE our whole philosophy of publishing can best be expressed in the viewpoint that we are operating Radio Television Journal in trust for its readers and the industry we serve, I believe that it will be a good idea to give you a brief outline of our thinking as it concerns the future of your magazine.

FOR one thing, we have definitely decided that your Radio Television Journal will be a radio industry publication exclusively. I believe that the problems we will have to meet and solve, and the future potentials of the industry itself, warrant a publication whose sole purpose is to work with and for the radio industry and every person in it. For this reason you will not see advertisements for appliances, magazines, and products which in the final analysis provide terrific outside-of-the-industry competition. We feel that there will be ample competition within the radio industry itself, without going out of our way to help alien industries put their products in direct competition with our own.

WE also believe that we are equipped to do a real job for you in the vital merchandising era which lies ahead. Radio Television Journal is the oldest dealer *merchandising* publication in this industry. It has consistently led the parade in bringing you the best merchandising ideas ever since it was first published way back in 1916. You have my promise that no expense will be spared to bring you the kind of practical, down-to-earth editorial material which our long experience in the radio field has proved to be most useful to you.

AND finally, effective with the October issue, your Radio Television Journal will have the largest circulation of any exclusive radio dealer publication. With the revival of our Master Servicing section we hope to integrate dealers and servicemen into a homogeneous group of active and progressive merchandisers, and judging from the enthusiastic reception which this idea has received from readers and advertisers alike, we feel safe in predicting that your Radio Television Journal will maintain the industry leadership that it has enjoyed for almost thirty years.

BUT, we just can't do it all by ourselves. We need your help and advice. We will be grateful for your comments, suggestions and criticisms, and I personally will appreciate it if each one of you will constitute yourself an editorial committee of one to give us the benefit of any ideas you may have to help us do a better job for you. Always remember, Radio Television Journal is your magazine. It has served you and the industry faithfully for more years than any other publication. Its Editors' sole job is to work for you, so please send along your ideas, suggestions or problems . . . and, *don't forget that we are just as close to you as your nearest mailbox.*

Mal Parks

Whole Number 357
Volume 59

READY?

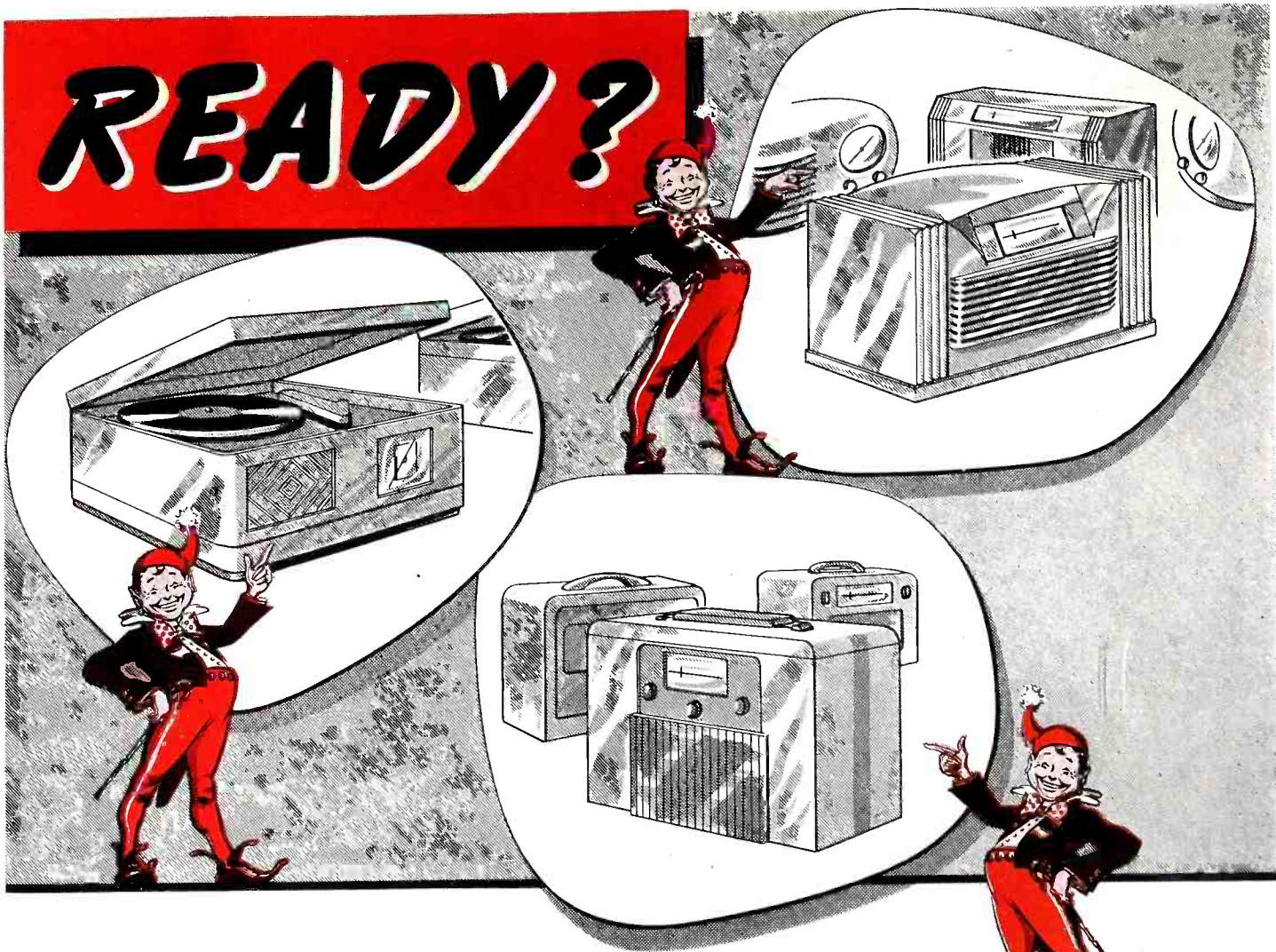

Automatic's BIG SALES BUILDERS

ARE you ready for the rush? Automatic's new, improved models are designed to tempt the great pent-up buying power of the mass market. They meet express consumer demand. Every family wants at least one set. Many want two or three.

However, despite expanded manufacturing and research facilities, increased skills and new, war-tested methods and materials, Automatic will not be able to turn out more than enough to supply its own bona fide distributors.

For this reason, it will pay recognized distributors to sign a priority with us now. If your territory is still open, we will then grant an exclusive franchise.

Write or wire us for details.



Automatic

RADIO MANUFACTURING CO., Inc.
122 Brookline Avenue, Boston, Mass.



YOU CAN BE *first*

WITH A NEW RADIO SET

direct from factory by **SPECIAL RUSH SHIPMENT**



**ASK YOUR
MECK DISTRIBUTOR**

about
the special Meck offer to ship
your first radio set direct from
factory (transportation paid
by us). . . .

Ask him for your special Meck
order form today . . . or write

JOHN MECK INDUSTRIES, Inc.
35 EAST WACKER DRIVE
CHICAGO 1, ILL.

"FIRST IN PRODUCTION"



MECK RADIOS

TABLE MODELS • PORTABLES • AM-FM • TELEVISION
CONSOLE COMBINATIONS • PHONOGRAPHS

25 Years Ago in The Journal

Interesting Items Culled from the September, 1920 Issue of the JOURNAL

Advertising urging all dealers to stock up for the coming holiday season is already making its appearance in this issue. One of the Journal advertisers states that freight conditions are very bad and are expected to get much worse, and therefore dealers should stock up now to avoid being without any quality merchandise all during the holiday market.

* * *

With the so-called Jazz-Age at its height, considerable space is devoted to a comprehensive article outlining methods whereby dealers can put some jazz into their advertising. Some of the suggestions included using poetry on occasion, and making every effort to use colloquialisms in the advertising, it being maintained that the average ad was too stilted and dry to arouse any amount of enthusiasm in an enthusiastic era.

* * *

Credits are another thing that worried many then, even as today. The business of being a successful credit man was gone into at length, and many helpful pointers regarding actual practice and customer attitude are fully explained.

* * *

Among the many merchandising suggestions submitted to Smith C. McGregor this month is an exhibition of new parts compared with older model parts. This, the author asserts, will do a great deal to combat the current trend to disparage new merchandise, on the premise that older models had higher quality materials, and were built better. As a supplement to the regular advertising, this seems like an excellent suggestion.

* * *

In the same column it was noted that many people still are under the illusion that inferior and stencil brands are "just as good" as quality lines. The dealers are instructed to point out the fact that repairs are always possible on the quality line, while in many instances they are out of the question on the stencil brand because the firm has gone out of business. Also the quality line has a much higher trade in and second hand value when the owner decides to replace the instrument with a newer or better one.

When reading some current article on the marvelous effects that music played over P.A. systems in industrial plants has on increasing the production, you might keep in mind the fact that the Journal reported that a laundry in England had the same results with a phonograph in 1920. They ground out all the current popular songs and discovered that production increased, and that the general attitude on the parts of their girl employees was greatly improved. Labor turnover was also reduced.

* * *

The farm market is now coming into its own during these Fall months. Now that the harvests are in the farmers have both time and money for needed merchandise. About the best way to merchandise your line, the Journal states, is to set up display booths at all the local state and county fairs in your territory. Based on past experience this is the most effective way of making valuable farm contacts at low cost.

* * *

The New Comfort Phonograph Company announces that they have developed a floating sound chamber that greatly reduces vibration, and improves tone in the critical ranges. This is based on a well-known test whereby a violin is fastened securely to a table and played. Then the same instrument is held freely in the hands and played. There is a considerable difference in tone noted in this test.

* * *

Pathe announces that they are invading the lateral cut record field this month. The firm is planning to market their lateral-cut discs under the brand name "Actuelle." The company states that this will enable set owners who do not have universal tone arms to enjoy the traditional Pathe high quality without resorting to attachments.

* * *

Among the personnel changes we learn that J. J. Davin has been made Eastern Manager for Reincke-Ellis, Sidney Goodwin has joined the Cigaret & Accessories Company, Harry C. Hawker has joined the firm of Ormes, Inc., Victor distributors, and Joseph Honig has affiliated with the Ebenstein Company.



• They were mighty tough before Pearl Harbor, these Aerovox oil-filled Xmitting capacitors. And now they are still tougher because of outstanding service on many fighting fronts. Soon they'll be generally available again for those better "ham" rigs or electronic assemblies you'll be building. Remember Aerovox "05" capacitors!

Convenient, moderate-priced, oil-filled capacitors.

Reinforced round metal can. Oil-impregnated, oil-filled.

600 to 3000 volt D.C.W. ratings. Capacitance values from 1.0 to 4.0, depending on voltage.

Immersion-proof terminals with "double rubber bakelite," porcelain-pillar-insulator terminals.

Adjustable mounting ring for upright or inverted mounting.

• Ask your Aerovox jobber about these and other types now becoming generally available. Ask for catalog — or write us.

AEROVOX
Capacitors
INDIVIDUALLY TESTED

AEROVOX CORP., NEW BEDFORD, MASS., U. S. A.
In Canada: AEROVOX CANADA LTD., HAMILTON, ONT.
Export: 13 E. 40 St., NEW YORK 16, N. Y. Cable: 'ARLAB'

What RMA Is Doing TO AID RECONVERSION

A STATEMENT BY BOND GEDDES, EXECUTIVE VICE PRESIDENT OF RMA



BOND GEDDES

With the arrival of V-J Day several months sooner than many radio dealers expected, reconversion has gotten off to a rather chaotic start. Government restrictions have been abruptly lifted, materials have been released and the green light given to manufacturers. The exact meaning of these steps to radio manufacturers is analyzed here by Bond Geddes, executive vice president of the RMA, who presents a clear picture of what the RMA is doing to facilitate speedy reconversion.



With its membership larger than ever before in its history and with its services and facilities for serving the radio industry enlarged, the Radio Manufacturers Association has lost no time in taking steps to expedite the transition of radio component and end equipment manufacturing from war to peacetime production.

Following the lifting of WPB controls on civilian production, and the release of plant facilities by heavy military cutbacks, only the problem of OPA pricing now threatens to retard the reconversion of the radio industry.

After preliminary conferences with OPA officials, RMA appealed directly to John W. Snyder, Director of the Office of War Mobilization and Reconversion, for a solution to this problem so that closed plants could be reopened and thousands of dismissed employees could be rehired for civilian production.

RMA has set up committees to handle expeditiously for the industry all major reconversion problems. An Industry Reconversion Committee, headed by A. S. Wells, of Chicago, already has tackled some of the major production problems, including postwar prices and the disposal of war surpluses.

Desirous of doing its share to contribute to reemployment and of reinstating war veterans, RMA has established an Employment and Personnel Committee headed by G. W. Thompson, of Columbus, Ind., to handle these problems in the interest of full postwar employment.

While it is too early to estimate what the postwar radio industry's employment may be, I believe that it will

far exceed the prewar peak of about 110,000. During the war the industry reached a peak of over 500,000, but at least 25 per cent of these employees was of a temporary character and included many persons who will not want to continue working with the resumption of their normal family relationships.

RMA is preparing to serve the industry better after V-J Day than before the war by providing complete statistics on receiving sets, tubes, transmitting equipment and probably later on parts and accessories. Fred D. Williams, of Philadelphia, is chairman of RMA Industry Statistics Committee.

RMA also is promoting the use of radio receiving equipment in public schools, veterans' hospitals and other public institutions through a committee headed by Lee McCanne, of Rochester, N. Y.

Several important projects designed to focus public attention on the important role of radio in the war are being pushed by the RMA Advertising Committee, of which John S. Garceau, of Fort Wayne, Ind., is chairman. One is a War Museum which would have on exhibit some of the historic radar and electronic equipment which helped win the war.

Throughout all of its planning RMA, while primarily representing the manufacturer, is fully conscious of and sympathetic with the problems of the radio jobbers and dealers. It is the aim of RMA to keep these important divisions of the overall radio industry fully informed of our projects and programs and to improve generally the relationship between them and the manufacturers.

Don McNeill and the "Breakfast Club"

Now Sells

PHILCO

Refrigerators and Freezers



... to his millions of loyal listeners!

Yes, beginning September 3rd, a great salesman goes to work for Philco dealers all over America. It's *Don McNeill*, the favorite of millions of early morning radio listeners, and his *Breakfast Club* with Nancy Martin, Jack Owens, Marion Mann, Sam and Aunt Fanny.

It's a scoop for Philco and Philco dealers! The *Breakfast Club* has the largest and most loyal following of any breakfast program on the air. And now, every morning in the week from Monday through Friday, over the full American (Blue)

Network, Coast to Coast, they will be selling the great new Philco Refrigerators and sensational Philco Freezers to their highly receptive listening audience from coast to coast.

Philco dealers know from past experience what it means *in sales* to have a popular radio favorite selling Philco merchandise over the air. And when Don McNeill and his group of merrymakers start beating the drums for Philco Refrigerators and Freezers, you can depend upon it—there'll be ACTION on Philco dealers' floors!

Yes, we're getting ready for the Greater Philco of Tomorrow!

This is the first advance step in the vastly enlarged program of promotion which will back Philco dealers in refrigeration. It is a hint of the great things that are to come in merchandising and advertising which will make Philco the most profitable and most valuable dealer franchise in the appliance field.



The Breakfast Club Cast in Action

RECONVERSION

(Continued from previous page)

crease public interest in television sets.

* * *

Westinghouse's postwar plans to inaugurate a new system of television and FM broadcasting from stratosphere airplanes cruising six miles in the air are expected to give video another boost in the realm of future sales. If tests to be made by Westinghouse this fall prove successful, stratosphere will make coast-to-coast television and FM broadcasting possible at a reasonable cost. Furthermore, the new system will permit these services to be broadcast to even the most isolated farm homes many years ahead of any previously suggested system.

* * *

As a final word on the promotion of television, RCA has just released an illustrated brochure describing the potentialities of video as an advertising and merchandising medium in department stores. RCA lists three main ways in which department stores can profit: (1) by operating a complete station, (2) by operating a studio within the store itself, (3) by using an intra-store video system for various types of sales promotion. Extensive use of television by the large urban stores will prove immensely valuable in making the general public aware of television, and ultimately will do its share to promote retail sales.

* * *

Pent-up demand in the radio and similar fields seems to be based on solid fact, and is not just wishful thinking. Early responses to offers of merchandise that had been almost entirely off the market, and which some stores were fortunately able to secure recently, have been tremendous. Several department stores have found that any large-scale promotions of such items practically produce a riot. From this it appears that extensive advertising of new radios will prove extremely profitable, and

should be utilized by independent dealers wherever possible.

* * *

Manufacturers will probably do more than their share in this vital field of promotion, for example, the first postwar step planned by the Emerson Radio Corporation is a series of advertisements in more than 300 newspapers in 160 cities throughout the United States in the next three months. These new ads will be further supplemented by local dealers' announcements, general magazine, billboard and point-of-sales advertising. With the Emerson name kept before the public, subsequent announcements by dealers will bring quick results.

* * *

One fly in the ointment that may cause considerable damage in the production world is the troublesome question of surplus goods. If the disposal of surplus property gets tangled up in delays of red tape, people may be idle because of the government's cumbersome methods rather than because of the absence of jobs available. This situation may reflect adversely on the radio manufacturing industry, where many radio plants are now geared for the production of radar and similar electrical equipment. Factory space is at a premium, and it will be up to the government to dispose of its war machinery promptly if it hopes to keep unemployment at a minimum.

* * *

Melvin E. Karns, director of the WPB's radio and radar division, has given an official estimate of 3,500,000 radios to be produced before January first. This is the most optimistic view of the situation to appear in print, and coming from the WPB it carries considerable weight. Mr. Karns based his estimate on the "sweeping cancellations" of military contracts for electronic equipment. He added that he foresaw no particular problems in the matter of parts, and that in general the supply appeared to be adequate to meet most of the industry's needs. "Some items may be short," he asserted, "but in

most such instances it will be possible to use substitutes."

* * *

In line with his prediction is the good news that most controls have been lifted on lumber. Prior to this announcement, many manufacturers were hesitant about predicting a high rate of production this year, but with lumber comparatively easy to obtain another major obstacle to reconversion in the radio industry has been removed. L-335 was drastically revised and modified August 22, and the free movement of lumber through regular channels of distribution was virtually restored. This means that mills can now fill their unrated orders after they have filled all their rated orders.

* * *

More news from Washington predicts the end of the Electronics Research Supply Agency of the WPB by September 30. During the war this agency has operated as a source of components for military and civilian research and development laboratories. Since contract cancellations will now provide adequate component supplies for this purpose, ERSA's services will no longer be needed.

* * *

According to several economic leaders, the spendable income of consumers in the next few months will be adequate to support consumer spending near the war peak. The amount of spending, however, may not bear a direct proportion to the amount of capital in the buyer's pocket: he may spend freely convinced of an era of prosperity, or he may be frightened by inflationary pressure and hold back. The immediate sharp decline in total spending is expected to be temporary, and will reverse when consumer durable goods, including radio, become available.

* * *

The first public retail offering and sale of postwar television receivers was made in Hearn's Department Store, New York City, on August 23. After the demonstration, orders were taken for the set, which is Viewtone's \$100 model. Considerable public interest was evinced in the demonstration, and department stores are doing a lot of work to promote television.



Faster, Bigger post-war radio profits WILL go to Sentinel dealers because Sentinel's New Radios will be built to MOVE... Move men and women to look—then buy... Move your profits UP! And Sentinel's all-time record of less than 1% for servicing charges keeps your profits up!

There will be a Sentinel to catch every

fancy—fill every need! AC or DC—FM or AM—table or console—radio-phonograph or portable—battery or electric—their new materials, styles, and colors will attract—their Performance-Perfection will sell! Learn about Sentinel's new angle for quicker, bigger, more lasting dealer profits! Call your Sentinel distributor TODAY.

FOR STUDIO TONE IN YOUR HOME

Sentinel Radio

2020 RIDGE AVENUE, EVANSTON, ILLINOIS





By

Heather

DISTRIBUTION in the POST-WAR ERA

It is axiomatic that American industry can produce all the goods that a peacetime American can consume.

The job before us now is to answer the question "how much can I sell, where and how?" and top management must assume leadership in getting the right answers to this distribution problem.

Distribution involves the manner of getting to the maximum number of people the maximum of products and services which meet and fill their wants and needs, at minimum prices commensurate with services rendered.

A Definition of Distribution

Distribution has been well defined as "the total of all activities involved in the progression of goods from producer to consumer.

"It includes warehousing, trans-

portation, advertising; wholesale and retail marketing, and a substantial part of research, engineering, accounting and financing."

But primarily distribution is concerned with people, and with the approach to people. Distribution, therefore, requires of industry that it act on the responses consumers give to the questions:

"What do you want?"

"How do you want it?"

"What price do you want to pay for it?"

As the president of a small but representative business, and president of an association whose 13,400 member-companies represent practically every phase of business and industry, large and small, I insist that the responsibilities of industry ex-

tend far beyond the mere mechanical processes of manufacturing a product. I believe that our responsibility continues on through the distribution set-up and into the home or business of the ultimate consumer.

Today's Challenge

This is the foremost domestic challenge of our times, and industry will accept this challenge.

Industry is and has for some time been focussing its resources upon the distribution job which must be done.

For industry realizes that only through mass consumption by mass markets, stimulated through advertising and serviced through economical mass distribution, can this nation achieve and maintain the high volume of production on which depend high-level employment and the con-

tinuance of the American standard of living and the American way of life.

Markets Are People

Markets are people, and because the wants and needs of customers, not industry, nor agriculture, nor retailing, make jobs, our primary concern is with people. Else we shall have a return to boondoggling.

The consumer is the real employer of both the producer and the distributor, and of all of us engaged in business. By his purchases the consumer determines who of us remains in business and the extent of our business. And he is the final authority who determines the extent of local and regional and national employment.

The Consumer Is Boss

For, let me emphasize, all of us are workers, consumers and/or employers every day. We are workers in shops, at offices, on farms. When we buy, we are consumers and, indirectly, employers as well, for we hire, for the moment, some one to make and distribute and sell the product which satisfies our want or need.

By our free choice of brand names, we even say how we want it made and by whom.

We are direct employers when, for example, we buy an insurance policy the premium for which is invested by the insurance company in somebody's business so that, in addition to making possible a worthwhile productive addition to the total economy, our investment will earn enough to pay our benefits.

For the only reason we exist as businessmen is to produce and sell at a profit the goods that people need and want at prices they can afford to pay.

But we must first learn what people want, how they want it, where they prefer to buy it, and at what price.

Urges Market Research

Manufacturers must learn the answers to these questions before tooling up for mass production, and sales managers must first learn what the market potentials are and what percentage of those potentials they have a reasonable expectancy of obtaining from each salesman, before sending their sales force into the field. And these salesmen must be trained. They must be merchandisers and councillors as well as salesmen. The day of the order-taker is over.

We have ignored too long that production is only a means to an end, not an end in itself. We must realize that production must be for use.

No Sellers' Market

And that we shall not have a sellers' market during the next few years, not even immediately after reconversion. We have a selling job ahead of us, but first we must know what are the potentials for absorption of the vastly increased productive capacity of our vast industry.

What good are plans for product development, changes in product line, for purchasing commitments, for production, scheduling, for financing and postwar employment, until we have the answer to the one question "How much can we sell?" and its parallel "What can we sell to whom, where and when?"

For businessmen who make their plans on the idea that the public is so starved for products that they will buy anything are merely enjoying wishful thinking.

We must learn the degree of truth or falsity in the statements we hear on all sides:

"They'll take the stuff right off the shelves!"

"I can get plenty of salesmen."

"My national advertising will force distribution."

"Human nature hasn't changed."

"I'll get all my old dealers back."

Urges Advertising Investment

And we must advertise; invest in informative, resultful advertising and sales promotion just as we invest in plant and facilities, in tools and materials.

Advertising represents a cost which the customer pays because, through its information and prompting, it gives him the satisfaction of ownership; provides him, especially during times of rapid improvements in goods and services, with freedom of choice, and includes him in the overall benefits accruing to him through mass production serviced through mass distribution channels.

It was brought out at the recent clinics on distribution held for top management executives by the NAM that despite accumulated savings of an estimated 135 billion dollars, and obsolete automobiles, outmoded house furnishings, worn out household appliances, people aren't just going to run wild in their buying.

Surveys show that most folks are going to hold on to their savings. Maybe, it's the first nestegg they ever had. They are not going to exchange it for just any old product. Only advertising, backed up by bare-handed selling, will overcome this inertia.

Certainly there's some pent-up demand. But there's another pretty important angle to be learned. Where there's demand there's likely to be plenty of new competition to supply it, not only in production but in distribution.

Distribution Is Big Business

Distribution may well challenge production for the title of Big Business. Department stores are planning increased buying combinations. They are giving increased attention to manufacturers of unbranded merchandise who offer the stores their own custom-made brands.

The chains of variety stores have some rather revolutionary new mer-

(Continued on next page)

Your Editors are indeed privileged to bring you this exclusive article written especially for RADIO TELEVISION JOURNAL by Mr. Ira Mosher, president of the National Association of Manufacturers. Representing an organization of almost 15,000 leading manufacturers, Mr. Mosher's views constitute a valuable contribution to today's problems in postwar retailing.

MOSHER

(Continued from page 37)

chandising plans.

The super-market chains, frill-less, with little service and less delivery luxuries, may well achieve greater sales in soft goods as well as hard goods, than many prewar "big name" outlets.

Western Auto Supply stores will expand their soft goods business, and J. C. Penney is planning to sell house furnishings.

The major oil companies plan to make "general stores" of their well-located service stations, and the automobile tire people, it is understood, will greatly increase their non-automotive lines.

Product retailing is pretty well scrambled. Toilet articles are sold in supermarkets, clothing in cigar stores, household appliances in drug stores, books in auto accessory outlets.

The great growth of self service is another change in distribution. Surveys show that many families, particularly younger people, prefer self services not only in the buying of food but in the selection and purchase of clothing, cosmetics, even home furnishings. And retail outlets will give the buying public what it wants. For, let me repeat, the customer is indeed boss.

How Much Service?

Usually the difference between competing methods of distribution is a difference in the amount of service to the consumer. There is the difference between grab-it-yourself, pay cash, and lug it home, with varying degrees of post-purchase service; and buy on credit or partial payments, home delivery, and service at the home by trained service men.

The customer has free choice in his selection of distribution methods and channels. We do not have, thank God, standardized products brought through standardized outlets. The necessary experience with such merchandising in England during the war showed pretty well that people don't like standardized products, and our own experience with standardized, unbranded stoves, for example, has left a lot of stores with large stocks on their hands.

Simpler and less expensive distribution systems and methods are perfectly conceivable. Packaged goods cost more than products in bulk. But how many of us want to go back to the open cracker barrel days?

If people were required to go to a certain retail store at certain hours and stand in line to receive standardized products without an opportunity of selection, paying cash and taking unwrapped goods, the present costs of retailing could be cut greatly.

Customers Determine Prices

The margins over manufacturers' price at which goods were sold before the war were determined by the customer in an intensely competitive system, the American system. To shrink these margins in the transition period by government edict is dangerous tinkering with our vital mechanism of exchange of goods and services.

OPA should recognize the general increases in cost caused by the generally higher wage level and establish ceilings wherever necessary at levels which permit the earnings of prewar margins by manufacturers and distributors on these costs.

Such a policy can prevent inflationary price spirals and will be no more inflationary than is necessary to insure large volume production and distribution.

American production has been the marvel of the world because we have been producing for war. In order to produce for peace, American producers and distributors must be able to pay out of the price it receives from the customer, all of its costs — costs of material, wages, depreciation and obsolescence, taxes and the rental of capital.

Price regulation which makes management unable to pay the rental of capital will decrease employment by discouraging investment. For the investor in production and distribution is just as free to decide whether or not to invest as is the customer whether or not to buy.

New Times, New Markets

For practically all types of manufacture, the war has introduced disturbing influences which will make the study of markets, sales potentials

and distribution methods far more difficult than ever before, but at the same time even more imperative.

Industrial and population shifts; changes in income markets and the number of families in the conventional income groups; possible changes in consumption habits; disintegration of selling organizations and loss of dealer contacts; developments in the field of transportation and communication; new materials, new technologies, and scientific discoveries; war product developments applicable to civilian uses, all these and many other factors are disruptive elements which will make it dangerous for manufacturers in many industries to proceed on the basis of prewar experience without careful study.

During this critical period of transition, when so very much depends upon an accurate knowledge of marketing facts and an accurate analysis of the problems involved in the sale and transfer of goods and services, it is doubly important that the matter be approached with a scientific attitude. There must be more dependence upon testing, measurement, methodical analysis; less upon hunches and intuition.

And if any distinction can be drawn between the larger and smaller manufacturers in respect to the importance of this factual, analytical approach, we must conclude that it is the smaller producer who can least afford to chart his course by guess. He simply cannot afford the high percentage of error that is certain to result, particularly under the disturbed and highly competitive conditions which may be expected in most industries in the immediate post-war period.

Facts Not Hunches

Most manufacturers have sound factual information in regard to their potential productive capacity. Time and money have been spent in the development of production plans, engineering plans, product design. For these purposes they have turned to experienced men. *You don't go by hunches here.*

Having completed the engineering or scientific and factual phase in these directions, you are still faced

(Continued on page 44)

**At Last! Merchandise
For Sale . . . NOW!**



- ★ **Makes a Radio-Phono-graph of any radio.**
- ★ **Plays twelve 10-inch or ten 12-inch records automatically.**
- ★ **Trouble-free! Only 3 moving parts while changing records.**
- ★ **Just 5 seconds to change records.**
- ★ **Fool-proof tone arm movable at any time without damage.**

5RP47—Admiral Automatic Record Changer without case. Sturdily built with streamlined base. List price

\$22⁹⁵

Prices slightly higher in south and far west

Admiral

AUTOMATIC Record Changer

The day you have long been waiting for is here at last! Merchandise from Admiral is available for sale now! Admiral's sturdy Automatic Record Changer Model No. 5RP47—with beautiful streamlined base—is available for *immediate* delivery.

Thousands of these new, Admiral Automatic Record Changers will be manufactured before the end of this year! There's a rich harvest in store for you—if you *act now to get your share*. Contact your Admiral Distributor, *today!*

Admiral Corporation

Chicago 47, Illinois



World's Largest Manufacturer of Radio-Phonographs With Automatic Record Changers

Dual-Temp Refrigerators • Home Freezers • Electric Ranges

RADIO-TELEVISION JOURNAL, SEPTEMBER, 1945

ACCESSORIES



FREE NEEDLE DISPENSER

Get this sales-building display! Shows individually packaged, pedestal mounted, Admiral Lifetime Jewel Needle in "stage" setting. Beautiful 2-tone lacquer finish. Locked compartment holds needle supply. FRFE with initial order for 25 needles.

Ensign BATTERIES

Ensign Radio Batteries for portable and farm radios now available in most types. Built of finest quality materials. Guaranteed for long life and dependable performance.

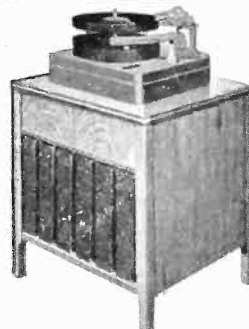

RECORD ALBUM CABINETS

A sure-fire companion sale for an Admiral Automatic Record Changer. Not only provides convenient Record Changer stand, but handy storage space for ninety-six 12-inch records in albums. Sturdily built with beautiful walnut veneer top and sides.

ADMIRAL TUBES



Get your share of the huge radio tube replacement business. Admiral Radio Tubes are guaranteed for excellence and high fidelity performance.

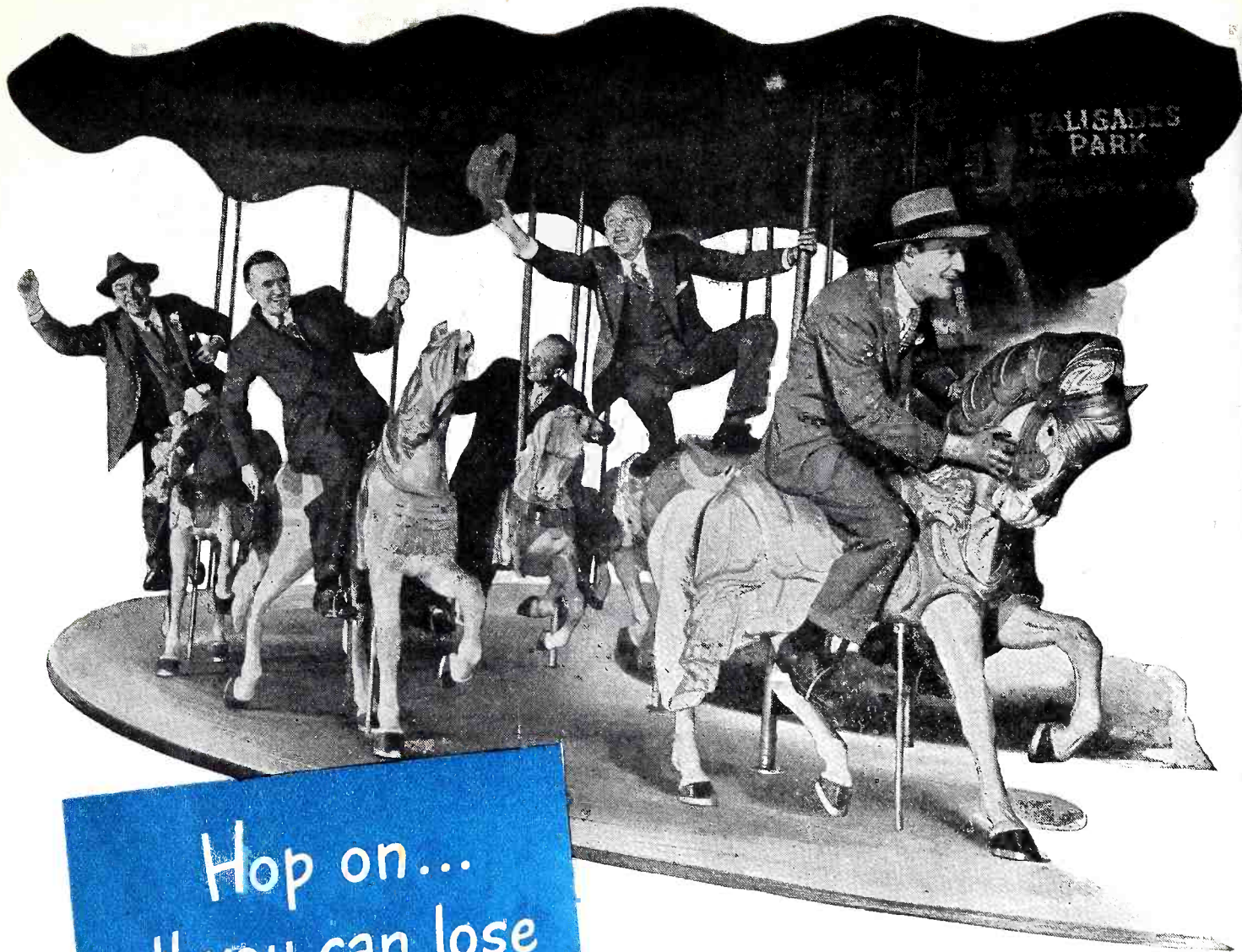

Hop on...
all you can lose
is your shirt!

SURE! It's going to be a swell ride for *anybody* . . . with almost any kind of radio to sell . . . during the merry-go-round months right after the war.

But many will find it all too short a ride, for remember this: Postwar periods always raise many contenders for leadership . . . but only a few go up to the top.

That's why wise heads in the trade are doing their heavy thinking now. Lining up all the facts. Comparing the brands. Making sure the lines they pick are equipped to take the hurdles *normal* competitive selling will strew along the course.

See for yourself whether anywhere you've found the facts so clearly, completely covered as they are in the new Olympic Radio brochure, "A Man Has To Think Twice." Backed by more than 10 years' leadership in the export radio field, Olympic now makes an announcement of unusual significance to you.

Send the coupon below . . . you'll receive your brochure promptly.

Olympic
REG. U.S. PAT. OFF.
The only Radio with Tru-Base

MAIL THIS COUPON TODAY!

Olympic Radio & Television Division
Hamilton Radio Corp.
510 Sixth Avenue, New York 11, N. Y., Dept J-9

Please send me the Olympic Radio brochure, "A Man Has To Think Twice."

Name _____ Title _____

Store Name _____

Street Address _____

City _____ State _____

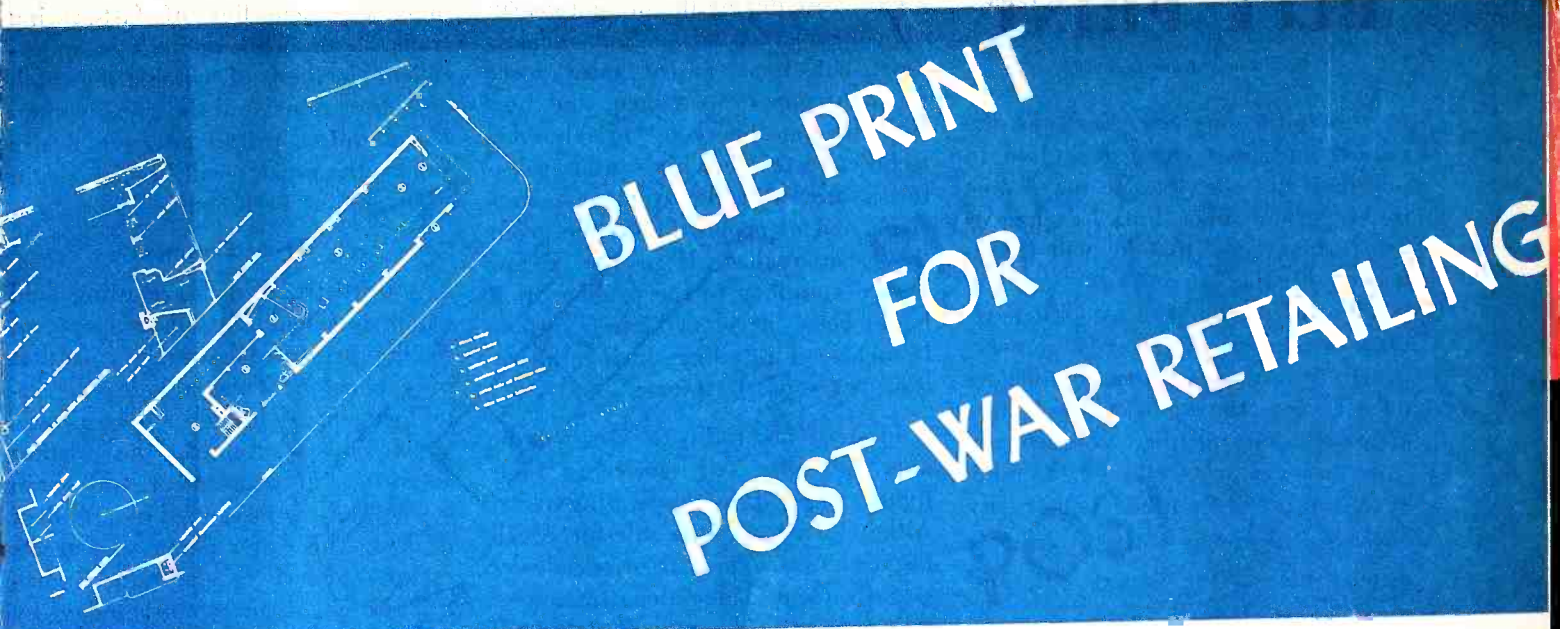

BLUE PRINT FOR POST-WAR RETAILING

The postwar era poses a serious challenge for every radio retailer—can you shift from a war to peace economy profitably? Will you be able to meet competition and keep pace with the times, or will your store be left with slow-moving merchandise and low profit sidelines? In order to insure your position among the leading dealers of your town, be prepared to face the multitudinous problems of reconversion as they come and let sound merchandising be your guide. This special article will show you how.

With V-J Day finally a reality, many retailers are now facing the multitudinous problems of reconversion on comparatively short notice. Although the ultimate defeat of the Japanese was a certainty for many months, few radio dealers or manufacturers believed V-J Day would arrive before another six months or year. Today, radio dealers throughout the country are trying to discover exactly what the peace will mean in concrete terms of dollars and cents. Will consumer demand continue at a satisfactory level after the initial scramble for radios? Will cutbacks come through fast enough to insure a fairly equal distribution of the profits? Will it be worthwhile for dealers to retain wartime traffic items?

The most accurate way to answer these questions is to study the various trends that have developed during the war years, and to apply them to the long-awaited post-war era. In many ways the wartime period has been an age of experimentation—substitutions for standard lines of goods have been developed, new products have been offered to the public for merchandise which has disappeared for the duration, and prices have skyrocketed in various boom-town sections of the country. All of these factors have resulted in a complex, con-

stantly changing pattern of retail development, and the radio industry is no exception to the rule. For one thing, the radio dealer of today will find himself up against many types of new competition, and will have to sell the public on the idea of buying their new sets from radio dealers. This is only one trend in retailing which has been aggravated by wartime conditions, and alert dealers will find it extremely profitable to study the merchandising picture of the wartime years in order to understand today's complex problems.

Tangled Distribution

Perhaps the most outstanding development that the war brought in its wake is the increasing tendency on the part of all retailers to carry a "little of everything." Due to the difficulties of obtaining their regular lines of merchandise, dealers have joined in the scramble for quick-selling products, and the result has been the conglomeration of ill-assorted merchandise now seen on the shelves of drug, furniture, stationery and hardware stores. Thus, the logical distributor of each product, such as a jewelry store for jewels, is no longer the biggest distributor in his line. A recent survey taken by John Allen Murphy reveals that before the war installment jewelry stores were

the largest retailers of small electric appliances and were the principle retailers of household appliances. In the same way, furniture stores did a large business in radios. This trend has been aggravated by the war, and although both radios and appliances have virtually disappeared from the market, furniture stores are planning to resume a very profitable trade in radios once they re-appear on the market. Consequently, radio dealers must face postwar competition not only from fellow dealers, but also from hardware, drug, furniture, music, jewelry, department and general store. This development carries two-fold dynamite for all radio retailers—not only is their competition increased materially by every alien type of dealer that enters their field, but in many cases their new competitors will be able to undersell them. Due to the comparatively high profits that large stores can derive from numerous lines of quick-selling goods, these establishments will be able to apply a policy of mark-down on many brands of portable, table and even console radios. If they ultimately enter the field of television, they will be able to apply the same tactics to higher price merchandise.

All of these factors mean that the average consumer will no longer turn

(Continued on page 42)

BLUE PRINT

(Continued from page 40)

to his radio service-dealer's as the logical and least expensive place to purchase his new set. He may come to his dealer first, but the chances are just as good that he will be attracted by the lower prices and extensive advertising of some department or chain store. In order to overcome this problem, radio dealers must analyze the ways in which they are superior to all their competitors, and then impress these thoughts upon the buying public. As is easily obvious, the dealer's trump card is usually his service department, and this is apt to be his greatest drawing point. If he can guarantee speedy, efficient service on every set he sells (especially in regard to television) he may be able to get the jump on his big business competitors. Without some such solution, he is apt to find himself caught in a vicious price war, which will result in the inevitable scramble for low type merchandise. The radio industry does not want to be victimized by the tangled trends of retailing today, and in order to prevent such a catastrophe, dealers should plan their future business program now.

Low Cost Operation

Increased competition naturally brings in its wake a need for low cost operation, which is the second significant trend highlighted by the wartime situation. Retailers of every type have been faced with bare shelves, and in many cases their principle lines of merchandise disappeared for the duration. Since they have been forced to experiment with substitute lines and to derive their greatest profits from traffic items and side lines, their operating costs have been cut to the bone. Nor is the outlook favorable for raising their general expenses in the near future; new products will inevitably bring new competition. This situation is peculiarly applicable to the radio field, where overhead has been slashed to

a minimum during the present dearth of consumer goods. Many dealers have cut their entire sales force down to one or two men, and now that the time has come to rebuild a technically trained, high grade salesforce, they will find their expenses rising out of proportion to the profit they can realize. Here are a few partial solutions to the problem that have been developed in various branches of retailing during the recent years of shortages:

First of all, radio dealers will be able to utilize self service in their fight against heavy operating costs. Although a top notch salesforce will be a necessary part of every dealer establishment, some departments of the store can be turned into self service centers. Records, for example, often show the greatest profits when customers are allowed to browse at will in the record section, and only one or two clerks to wrap merchandise are actually necessary. Customers seldom have to be "sold" on records; often as not they come into the store with the exact disc they wish in mind. If the store can supply this record, and if they can hear it played, the sale is usually completed. The same type of merchandising can be applied to any lower priced goods dealers may carry such as tubes and batteries, and here there is no necessity for any demonstration of the product.

Another way to cut down expenses is to open a branch store in the low rent district of the city. In this way the actual expense of expanding your operations can soon be made up in the increased turnover of goods, and branch stores can carry a greater line of low priced items to step up sales. Furthermore, the dealer with a branch store has the added advantage of reaching many different classes of people; he can reach the higher income levels in his original establishment and sell to the lower income brackets through his branch store. Ultimately his profits will rise, and he will find expansion has brought enough surplus capital to invest in a

more complete line of fast-moving traffic items. This in itself is an excellent method of combatting high cost operations, and the greater number of lower priced goods a dealer stocks, the greater will be his margin of profit on each item.

Postwar Expansion

A third trend in the retailing field which is slated for full development in the present postwar era is that of expansion. This includes the establishment of branch stores as was previously mentioned, the further expansion of department and chain stores, and the merger of independent dealers. This latter point is of greatest significance to the radio industry, which is threatened today by encroachment from department stores as well as from alien type stores. It stands to reason that if big business operations like department and chain stores plan to expand their scope of activity in the future, their competitors, the independent dealers, must also expand in order to make themselves felt as a vital economic force. And one of the most profitable ways for a small radio dealer to expand is to merge his shop with that of another service dealer. In this way the two can combine their service talents, their promotional ideas, their selling force and the lines they carry, and the increased profits they derive will allow enough margin of profit to engage in high power advertising. Furthermore, since they will experience a satisfactory volume of sales, they will be able to apply a policy of low mark-up to many types of merchandise. This in itself will deprive the department store of their chief weapon against the smaller, independent dealer — that of underselling. Basically their big attraction to the buying public, discounting the factor of convenience at having so many types of merchandise under one roof, is their ability to offer goods including radio at a price considerably lower than that which the radio dealer can afford. However, once two independent dealers can merge their talents and

(Continued on page 44)

Symbol

OF A HAPPIER
TOMORROW...



Radio has deepened our appreciation of the American way of life. Out of the crucible of war, it has forged a new and better understanding of the vital forces that shape our future. It brings promise of a happier tomorrow.

For many years, FADA has symbolized the best in radio engineering and development. And — as quickly as Government restrictions are modified, Fada's great manufacturing capacity will be concentrated on producing the finest radios for the civilian market.

There are some Fada dealer franchises still available. If you are not familiar with Fada's far-sighted profit-building merchandising plans, we suggest that you communicate with your jobber — or write to us directly.

PLACE YOUR FAITH IN THE

FADA Radio

OF THE FUTURE

Famous Since Broadcasting Began!



FADA RADIO AND ELECTRIC COMPANY, INC., LONG ISLAND CITY, N. Y.

Blue Print For Postwar Retailing

(continued from page 42)

thus achieve a lowered price policy that is close to that of the department store, they will find their sales are stepped up in proportion. A recent survey conducted by John Meck Industries revealed that 25 per cent of the population plan to buy their postwar radios from radio dealers in any case, and 64 per cent were uncertain where they would make the purchase. It is this majority that the radio dealer must appeal to in order to come out ahead in the postwar sales

picture, and from the overall view of retailing today merging may well be his best solution.

Thus radio retailers will have several potent trends to analyze and apply to their own individual needs before they are able to adjust themselves to the postwar scene. Competition will be keen from now on and will come from new and unexpected quarters, low operating costs will be the order of the day and some form of expansion will be al-

most mandatory to keep pace with the times. The outlook is one that indicates hard work and high profits for those who emerge as leaders, and the field of merchandising radio, electronic devices and television is a constantly expanding one. The postwar dreams of many will be realized, but they will only take substance insofar as they are based on sound merchandising, adequate promotion and a healthy regard for your competitor's abilities.

Distribution In Postwar Era

(Continued from page 38)

with the question of who can buy your products, if anyone; who will want them and where are they?

Do you dare go by hunches here?

Because all of us as members of the general public, and, as businessmen, are living, and will be living even more surely, in an economic—and political climate pointed up toward maximum employment, the necessity for factual techniques in distribution are all the more necessary.

A recent survey made by the NAM among some 1,700 member-firms reveals that industry expects to employ 31 per cent more people after reconversion than it did in the year prior to the war.

Distribution and Employment

Numerically speaking, that means that industry which gave work to some 10 millions in 1939, will provide jobs for a total of some 13 to 14 millions. While this number is still approximately the same 25 per cent of the nation's total employment, more jobs in manufacturing mean more jobs in distribution, as clinics sponsored by NAM's Committee on Distribution, being held in major cities, shows.

Spokesmen for the distributive trades have asserted that the service

and distribution functions can and will provide seven million new jobs.

There were eight and a half million people employed in trade and services, excluding transportation, in 1940. This total has drastically decreased during the war, as we have all observed when shopping in small as well as large stores.

Irrespective of the total obtained when we add the seven million new jobs, to reach this new level of employment, as well as the highest levels in manufacturing, will require the retail and service trades to sell from forty to fifty per cent more goods—to quote their same spokesmen—than were sold in 1940.

Producer-Distributor Cooperation

Industry is working with the distribution services to rebuild the distribution system to ever higher levels of efficiency so that consumers may obtain greater service from and increased satisfaction in better products at lower prices, assuring industry of the mass production which can only be maintained by mass consumption, and making possible the high level employment we are determined to achieve and hold.

Industry will continue developing techniques of marketing, merchandis-

ing, sales potentials, in terms of people — their wants and needs. With this appreciation of a continuing sense of social obligation as basic policy, industry will develop factual studies on new products, new uses for existing products; pricing, packaging, styling, and servicing, placing added emphasis on use of the product, the satisfaction to be derived therefrom, rather than on the product itself.

Industry will particularly work with the thousands of returning servicemen who have expressed their desire to start their own individual enterprises. We already, individually as manufacturers, collectively as members of the NAM and other groups, have started to share our knowledge, to grant franchises, and to train these brave young men who are going to put in practice under our competitive economy the freedom of initiative and of enterprise for which they have so successfully fought.

If permitted to do so in free competitive business, American distribution and services can be depended on to stimulate consumption and employment, and to continually improve and make more efficient American distribution in all its phases.

Duotone

Manufacturers of the world's largest line of Phonograph Needles
Makers of the Five Dollar "Star" Sapphire Needle
799 BROADWAY, NEW YORK 3, N. Y.

The Filter Point
The Duomatic
The Duochrome
Cactus Needles

The Miro Point
The Durpoint
The Lifetone
The Regent

Transcription
Needles
Duodiscs
Record Preserver

This is Tommy Dorsey with the RCA VICTOR Show



... Another Powerful Unit in RCA Victor's "Big Three" Advertising Campaign Building Sales for You Tomorrow

EVERY Sunday, coast-to-coast over NBC, Tommy Dorsey and a great parade of stars spearhead RCA Victor's triple-powered national advertising program . . . pre-selling customers for dealers all over America.

In its second big year, the "RCA Show" ties in with two additional national campaigns running simultaneously . . . full-page advertisements fea-

turing radios and "Victrolas" in national magazines reaching millions . . . and a campaign in Time, preparing for RCA Victor leadership in television.

Think of the selling power of these campaigns. Think of RCA Victor's recognized engineering leadership. Think what these factors can mean to you in profits when radios, "Victrolas" and television receivers become available.



There's something in heredity . . .

You expect a great deal from the lines of a long line of champions—and you are right! Hereditary traits, such as you are buying pedigree for their own or for their radio sets.

Especially when it comes to a radio phonograph, you realize that the background and experience of its maker may be the single most important fact you should consider.

Where else, for example, in the field of recorded music will you find a forty-seven year heritage equal to that of Victor? Where in the field of radio

engineering will you find a twenty-six year background of achievement equal to that of RCA? And finally, in what radio phonograph other than those which bear the trade mark "VICTROLA," will you find combined the double background, double experience laboratories of RCA Victor?

Our new RCA Victor sets will include many great improvements—the result of experience gained in building 350 different types of war equipment, none of it ever manufactured by any-



one before. FBI and television, of course. Ballou and the famous Victrola (made only by RCA Victor) will range from excellent low priced table models to fine automatic consoles. See your RCA Victor dealer before you buy.



RCA VICTOR

RADIO CORPORATION OF

TOMORROW'S RCA Victor radios, "Victrolas" and television receivers will reflect the heritage of radio's finest musical and engineering background. Yes, there's something in heredity, and advertisements like this in big-circulation magazines are impressing the mark of the finest—RCA Victor. Wherever this mark appears inside—or outside—your store, it builds your prestige and profit.

A PROGRESS REPORT BY RCA

TELEVISION RECEIVERS

... Models for every need

RCA Victor Television Receivers will be available in a range of sizes and prices to suit all family requirements. First models expected one year after children manufacture is authorized.

What other manufacturer is authorized RCA Victor television receivers and is generally known to be the leader in television receiver development? RCA Victor television receivers are available in a range of sizes and prices to suit all family requirements. First models expected one year after children manufacture is authorized.

See your RCA Victor dealer for more information.

RCA VICTOR

BECAUSE readers of Time are a great cross-section of the people who will be tomorrow's most responsive market for television, RCA Victor is using a special series of double-spread advertisements in this important publication to fortify its television leadership and insure your profit in this great new field.



RCA VICTOR

RADIO CORPORATION OF AMERICA • RCA VICTOR DIVISION • CAMDEN, N. J.

In Canada: RCA Victor Company Limited, Montreal

The Honeymoon era for retailers will be brief indeed, and America must do an effective job of selling to insure prosperity.

There is no rosy road ahead for retailers. There may be a brief "honeymoon period" now while the supply of merchandise lags behind consumer demand.

But not for long.

America's capacity to produce—always greater than its *effective consumptive capacity*—has been greatly increased during the war. The manufacturer means to use his productive capacity to the limit, to utilize every machine in order to "make jobs" for his war-swollen payrolls, to make good his promise to G. I. Joe and, if possible, to keep peace with "the union."

The mad scramble for markets is already on. Not only are old, established firms planning to capture a larger share of the potential market; but new combinations of productive "know-how", backed by what seems to be endless capital resources, are eyeing the market. Dozens of firms, well established in one line of business, eagerly look across the competitive fence at what looks like "greener grass" in the other field.

Lack of product to sell definitely will not be a postwar problem. The danger lies in the other direction, **over-commitments**—swollen inventories with a large proportion of "orphan" merchandise.

The presently harassed merchant probably breathes a sigh of relief and says to himself, "Well, that's one thing I won't have to worry about!" But is it?

How many new items of merchandise are you planning in your own postwar program? Are you getting over into the other fellow's territory, selling a new product in competition with an old experienced hand? How many merchants in your territory are getting over in your field—a field, in your opinion at least, already overcrowded in the prewar days? How many new brand names have you committed yourself to handle in your own specialized field? Honestly now, can you do a top-notch job of merchandising these new lines? Is your sales force geared to this new competition? Are your "service" facilities adequate to serve your anticipated expanding market? Do you have the capital necessary to carry on under your budgeted higher sales vol-

ume in view of higher prices and sure-to-be-expanded easier credit terms?

Sales and Service

The two big problems are sales and service. In the period we are talking about, people will not come into the store to buy. They will have to be "sold". Today the consumer has a long list of unfilled needs. Now that the war is won, she will want radios, combinations, pianos, washing machines, refrigerators, and other types of appliances—but she also wants new automobiles, better housing, furniture, or that long deferred vacation. All take money—more money than our collective consumers will have readily available. The merchant with the best sales team is rightfully going to get a larger share of the consumer's dollar.

There is a lot of talk about "pent-up demand." Don't count upon it. We have always had a lot of people who

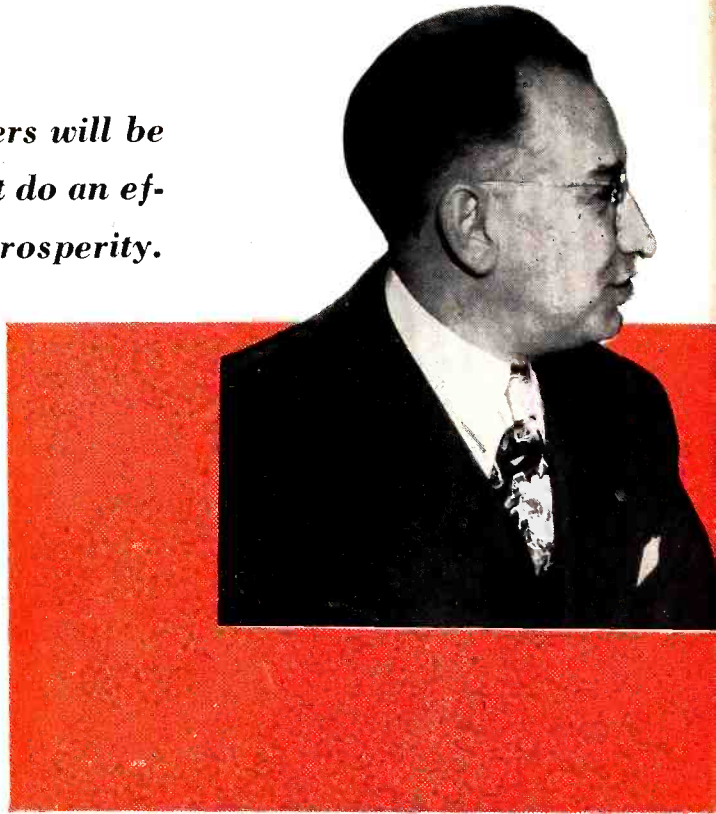

by *William A. Mills*
Executive Secretary,
National Association of Music Merchants

What The Peace Means To Retailers

wanted more than they could afford to buy—or, to put it another way, they didn't want the product with enough enthusiasm to incur the necessary financial obligations. I say that advisedly because if all of us bought only what we could afford, there would be a lot fewer automobiles, fur coats, trips to Florida or California, and so many other things which go toward making America's high standard of living.

Nor do we buy only what we need. During the late twenties and all through the thirties we needed housing but very few houses were built. We bought new automobiles by the millions when the old ones would have done just as well. The war has demonstrated that we did not have actual need of a new automobile every couple of years.

Retailer's Key Position

America's economic well-being rests with the retailers of the nation.

No matter how well the product is engineered, no matter how efficiently it is manufactured, how rapidly transported, effectively advertised, and attractively packaged—unless the clerk at the point-of-sale performs equally well, our whole system of production and distribution breaks down. The difference between profit and loss for the merchant—perhaps the difference between prosperity and depression for the nation—may depend upon the generally untrained, frequently underpaid sales clerk behind the counter.

The last three feet—the distance between the customer and the clerk is the weak link in our American enterprise system.

We will have to make our public "want" our merchandise. That's creative selling.

Sell Your Store

Before we sell the public we have a real selling job in our own estab-

lishments. The retail store has a big public relations job to do. The public is fed up on the independent attitude so characteristic of present-day sales personnel. So much has been written about clerk-customer relations under present circumstances, they need no elaboration here. Consumers are waiting for the chance to get even, and they mean it. When there is more merchandise than customers, the clerks behind the counter are going to take a lot of what they have been handing out. So you'd better start "training" right now. Fortunately, as the manpower shortage eases at the war plants, we are going to get a better type of person to train. But we must train.

You have a selling job to do right now. Sell your store. When the customer asks for something you do not have, take time to say "No" in a courteous manner.

(Continued on next page)

MILLS

(Continued from previous page)

Service Makes Sales

The second big problem is that of store service. A public relations-minded service department can be a supplemental sales force. I'm rather inclined to the theory that the store that gives the service will be the store that makes the sale. The type of durable consumers goods sold in the stores of the readers of this journal all require service.

Most of the products offered by our suppliers will be fundamentally sound, but not without their "bugs". Every manufacturer points with pride to "his newly improved model." Did you ever see a "new model" that didn't require "a little adjusting?" Most plants will be using new machinery, with workmen requiring re-

training. It will take time to accumulate the skills necessary to produce a perfect finished product. In the meantime it is the retailer—not the manufacturer—upon whom the temporarily dissatisfied consumer turns her wrath. A good service department will make friends for the store and save the manufacturer's reputation. A good service department does not just happen—like a good sales force, service men are trained.

Problems Ahead

In my opinion, based upon many years of study in the field of distribution—

- Now that the war is over, very soon there will be more merchandise than customers.
- There are great unmet consumer needs but the available product will be greater than the demand.

New needs must be created through selling.

- The competition will be keen, not alone between the same kind of product, but as between different kinds of products.
- To stimulate demand, present credit terms must eventually be relaxed.
- Prices will generally be higher, making it more difficult to sell and requiring substantial increases in prewar capital in order to sell the same quantity of merchandise.
- Most stores expect to increase—not only their dollar volume—but the number of units handled. This adds to capital requirements.
- Operating margins are likely to be lower, certainly as long as prices are regulated, requiring better expense control.

—Trade-ins will continue to be the great unsolved problem of merchandising. Competition in trade-in allowances will bankrupt the merchant who does not know his cost and play havoc with the profit of his competitors.

—Current inventory shortages will, in a number of instances, be followed by over-stocking or unbalanced inventory. The over-supply of goods will force prices down—the break may be fast. Many merchants may find their war profits and their working capital frozen in overpriced inventory. It happened after the last war. It can and probably will happen again.

—The salesman will once again come into his own. Only creative selling can possibly absorb American capacity to produce.

—Store service will be an all important factor in good store-consumer relations.

There's good business ahead if we are smart enough to sell.



ALLIANCE RESUMES PRODUCTION on One Standard Model

• We are now able to return to production of one standard variation of Alliance Model 80 Phono-motor, according to the following definite specifications and on the production plan explained below.

STANDARD SPECIFICATION No. 811—

Turntable No. Y-278-S2; 110 Volt, 60 cycle, 9" Model 80

Production must be on the following practical basis under present conditions where there are no large volume priority orders—namely, by accumulating a sufficient quantity of small orders with necessary priority and making periodical single production runs at such time as the quantity of accumulated orders is enough to make this practical. Priority orders (currently only orders of AA-3 or higher, with GOVERNMENT CONTRACT NUMBER and MILITARY END USE, or where certified to be used in Sound Systems, Intercommunicating or Paging Systems, as exempted from order M-9-C) must allow delivery time required to obtain a minimum practical production run; to procure material for all orders in hand, and make one production run of the one type standard unit only, for shipment on the various accumulated orders. • Check the above against your requirements, and if you have proper priority, communicate with us.

REMEMBER ALLIANCE—Your Ally in War as in Peace!

AFTER THE WAR IS WON, WE WILL TELL YOU ABOUT SOME NEW AND STARTLING IDEAS IN PHONO-MOTORS

ALLIANCE MANUFACTURING COMPANY
ALLIANCE, OHIO

WAR PRODUCTION SCHEDULE



All Set FOR PEACETIME PRODUCTION

FOR several months, we've been telling our friends in the trade that we of Eastern have completed our post-war plans and policies—have perfected the new line of Eastern sound equipment. Our peacetime production schedules are set up—BUT, we think winning the war is more important! We're still going all out on our war work,

building quality units for the Army Air Forces and the U. S. Navy. However (as of this writing), we're standing by for Uncle Sam's okay to start our peacetime production. For detailed information on Eastern's post-war line, fill out and mail the Coupon today! Eastern Amplifier Corporation, 794 East 140th Street, New York 54, N. Y.

EASTERN AMPLIFIERS

This is Your Ticket

for complete information on our post-war line and the details of our proposition.

EASTERN AMPLIFIER CORPORATION, Dept. 9-11
794 East 140th St., New York 54, N. Y.

We are JOBBERS, DEALERS, A SERVICE ORGANIZATION, SOUND SPECIALISTS. We're definitely interested in your post-war line, your policy, your proposition. Mail us complete information, without obligation.

COMPANY NAME

ADDRESS

CITYZONE.....STATE.....

INDIVIDUALTITLE.....



by *Elmer A. Lundberg, A.I.A.*

The store-front of the pre-war years can be compared to the instrument panel of a pre-war radio. Both had only one function to perform. The store-front served as a means of entry and the radio panel as a means to select a program and merely hear it—not see it. Tomorrow's store-front, like tomorrow's radio panel, will effectively use the all-important visual factor to create and hold customer's interest. No longer will the store-front be a static area suited only for entry or limited merchandise display, but through the use of invisible walls of highly polished weather-protecting plate glass, it will become alive with the dynamic motion of the entire store.

There is little doubt that the post-war radio television store will be somewhat changed from the pre-war design. This change will be based upon new and improved uses of glass arising from the nation's war program. The glass industry under wartime pressure has compacted nearly a quarter-century of progress into four years, and can make flat glass flatter, strong glass stronger and safety glass safer, and thus provide radio store owners and operators a structural material combining

beauty, strength and permanency. Architects and designers are taking advantage of these new developments and are planning stores with all-glass fronts, which will virtually compel customer entry.

All-Glass Front Forecast

New designs show that glass will play an increasingly important role in building and modernizing of the radio-television store. Current trends indicate that architectural beauty will be combined with building efficiency to achieve maximum sales effectiveness. Sales appeal will be incorporated into the actual store design and construction largely by the intelligent use of glass in its myriad shapes and forms.

The trend toward the adoption of the complete open-front type store utilizing large panels of clear polished plate glass to separate the interior from the exterior is the near ultimate in an architectural cycle started in the middle thirties. The open-front had its beginning with use of Herculite glass doors which permitted greater vision into the store proper. Later all-glass sidelights were added, increasing the vision area, and finally display windows with no back-

grounds were adopted. With the advent of the open-front, the store's interior will become one huge display area and will require particular treatment to utilize the sales effectiveness of an all-glass front. Inside the store solid partitions will be replaced with highly transparent glass panels permitting full display of all merchandise, as well as creating additional sales space. Carrara structural glass will be continued from the outside walls to the store interior to reflect the beauty of appointments and lend an added lustre. Mirrors will be placed strategically throughout the interior, optically enlarging certain areas, and will be used to create unusual merchandising displays. Glass block will serve to shut off wrapping or stock rooms and yet take advantage of illumination.

Means For Traffic Control

The remarkable wartime advances made in bending and shaping glass will afford the radio store operator an excellent means for controlling traffic within the store. For example, all-glass counters can be made that will follow the store's contours, eliminating straight aisles with their inevitable dead spots. Use of curved

(Continued on page 52)



Remind Yourself to as
Clarion
when Radios are again available

The Clarion
SUPER-FEATURE
RADIO

Exciting Radio Development
HAS COME OUT OF THE WAR.

BETTER RADIOS
at the Greater Cost

CAN YOU BUY CRYSTALS



Clarion RADIO

PAVES PROSPERITY HIGHWAY

CLARION RADIO national advertising, over the last year, has totaled more than **195,000,000** individual selling messages. They are paving Prosperity Highway over which prospects will travel to the CLARION RADIO dealer's store. . . . There is still time to join the CLARION dealer organization, if you act promptly. . . . *Write today for the name of your distributor.*

WARWICK MANUFACTURING CORP.
4640 West Harrison St. • Chicago 44, Ill.

**Clarion
RADIO**

of Tomorrow Watch for Them!

WARWICK'S post-war offerings— in design and engineering— all represent the advanced forces in the field of electronics.

Watch for CLARION— when its new 3000, 4000, 5000, 6000, 7000, 8000, 9000 and 10000 series are introduced for the civilian market.

WARWICK MANUFACTURING CORPORATION
4640 West Harrison Street
Chicago 44, Illinois

CUSTOMER TODAY IS UNCLE SAM. BUT THE POST-WAR ERA WILL RESTORE OUR FRIENDLY CONTACT WITH DEMAND GOOD RADIOS TO SUIT ALL PURPOSES AND ALL Purses

Clarion Radio

WARWICK MANUFACTURING CORPORATION
4640 West Harrison Street, Chicago 44, Ill.



ELMER A. LUNDBERG, A.I.A.
Director, Architectural Design Department,
Pittsburgh Plate Glass Company

GLASS

(Continued from page 50)

glass counters for small radios and record players provides the basis for arranging large items in similar flowing lines either in the center of the store or along opposite walls. Special type glass display cases can be used in the more inaccessible parts of the store to attract customers.

Lighting of the radio store is a very important item. The problem of lighting in a store interior is a great deal more complex than it would be in a factory or office building. The lighting engineer not only has the problem of obtaining the most efficient distribution of foot-candles at the merchandising level but must also take into consideration its effect on displays and the type and color of merchandise. The lighting industry has been working just as assiduously on these problems for the post-war store as have the manufacturers of other building materials, and are preparing many practical innovations. As most radio store operators know, the problem of lighting is a subject for the expert to handle.

Store Should Be A Setting

The basic aim of the open-front store and its accompanying interior use of glass is to accentuate the merchandise in as effective and practical manner as possible. The store, in-

cluding all the accoutrements, should serve as a setting for the radio and the television set. The extensive use of glass can accomplish this purpose perhaps more advantageously than any other material because of its natural characteristics of transparency and strength. For structural use, glass is a material having strength and durability comparable to metals and other solid building materials. By the Herculite process glass can be tempered in much the same manner as steel and its strength increased approximately four times.

Glass is not subject to the common elements causing deterioration. Its inorganic nature makes it immune to such things as rust and decay. This characteristic also makes it impervious to penetration by dirt, grime or dust, so that maintenance problems are greatly simplified. Simply washing a panel with warm water and soap as would be the case with glass is much easier than to have to employ some type of cleaning acid or surface removing agent. Emphasizing this fact, R. Glover Bauer, Jr., U. S. Fidelity and Guaranty Insurance Company, recently stated that "unlike marble, stone and other building materials, glass is non-porous and is not affected by moisture and atmospheric changes. Its colors are fast and can be kept fresh with simple cleaning methods."

By employing the tempering process and other finishing techniques,

The trend is definitely toward all-glass store fronts in the exciting new competitive era ahead. How much do you know about glass? What will it cost you in increased insurance? How much does it cost to keep clean? To replace? What are its advantages and disadvantages? Radio Television Journal brings you the answers to all these questions in this article "What About Glass?", which is the first of a series written by acknowledged leaders in many merchandising fields. These articles will bring you every detail of the latest information available on the newest developments in postwar modernization.

glass can be made with a surface sufficiently strong to resist all ordinary causes of abrasions and scratches. These characteristics of glass tend to make the over-all cost of an all-glass front low in proportion because, while the initial installation cost may be slightly high, the long-time savings in maintenance and repair make it most economical.

Glass Insurance Available

Such extensive use of glass as recommended by architects in the open-front type store brings to the mind of the radio store operator the question of insurance. Insurance companies have kept in step with the growing structural uses of glass and, as new types and applications have been developed, insurance rates have been set up to cover them. The standard glass policy of practically all companies is being constantly broadened to afford complete and economical coverage.

The average glass policy would include such coverage as the following: 1. The accidental breakage of glass with the exception of loss by fire, with such loss usually being covered by fire insurance, usually the first type of insurance acquired by the store operator. The damaging of glass, together with lettering or ornamentation, by accidental or malicious application of chemicals so that the glass is unfit for use. 2. The

(Continued on page 54)



**"You've got to needle
your customers, Joe—
that's the way to sell 'em!"**

**—AND WHEN I SAY, 'NEEDLE 'EM,'
I DON'T MEAN HIGH PRESSURE"**



When I get a prospect for a Crosley, all I do is play the Demonstration Record and let the Floating Jewel* and the Master Tone-Control do the talking. It's the "silence" that gets 'em interested.



I show them the striking difference between the Floating Jewel* and old-fashioned, rough-riding needles. "This is the system," I tell them, "that says 'Goodbye needle noise.' No more needles to buy, change, or hear."



Then I show them how the Master Tone-Control works with 64 different tone combinations... the Rainbow of Sound... then I let them select the tone combinations they like best... and they listen to recorded music as it should be heard. Yes, I sell 'em... but that's not all.

HEARING is Believing!

AS SOON AS WE can stock you with new Crosley Radio-phonographs and Radios, you'll discover how easy it is to sell your customers by following the simple steps shown here. The new Crosley line will actually talk for itself... sell itself. You can expect very modern improvement and development in radio and electronic engineering plus the amazing Floating Jewel* Tone System and Master Tone-Control. These are features typical of the complete Crosley line of home appliances... features that can be seen, heard, or felt and demonstrated. That means easier selling and better profit for you.



Old-fashioned sharp needles — "Sera-a-teh! Hi-i-sss! Chatter!"

Crosley Floating Jewel* plays the untouched sides of the groove.



Not by a long shot. Because my Crosley customers are my best boosters. They are so proud of their new instrument, they can't wait to demonstrate it to their friends... and when their friends hear the Crosley, I get a lot of new prospects. So "needle 'em," fella, and you'll do all right.

CROSLEY

THE CROSLEY CORPORATION, CINCINNATI 25, OHIO



**RADIOS • RADIO-PHONOGRAPHS • FM • TELEVISION • SHORT WAVE • ELECTRONICS • RADAR • REFRIGERATORS • HOME FREEZERS
LAUNDRY EQUIPMENT • RANGES • KITCHEN SINKS & CABINETS • HOME OF WLW, "THE NATION'S STATION"**

GLASS

(Continued from page 52)

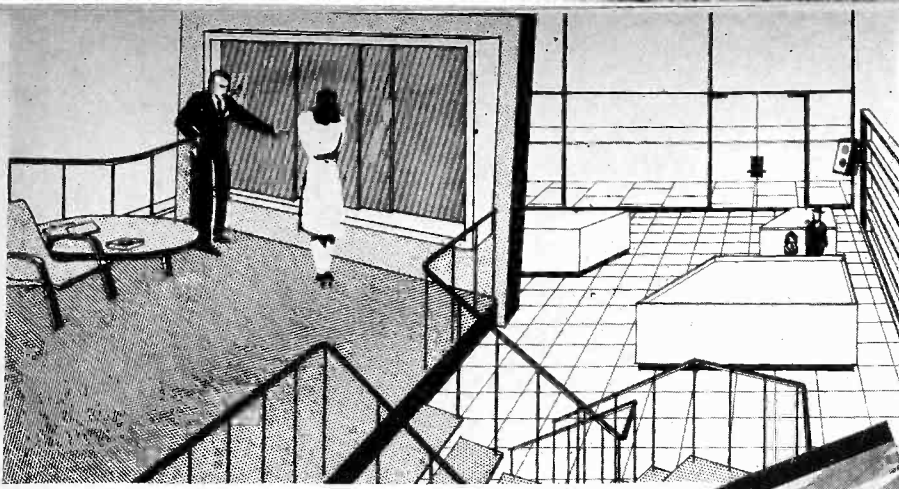

VIEW OF INTERIOR, FEATURING GLASS

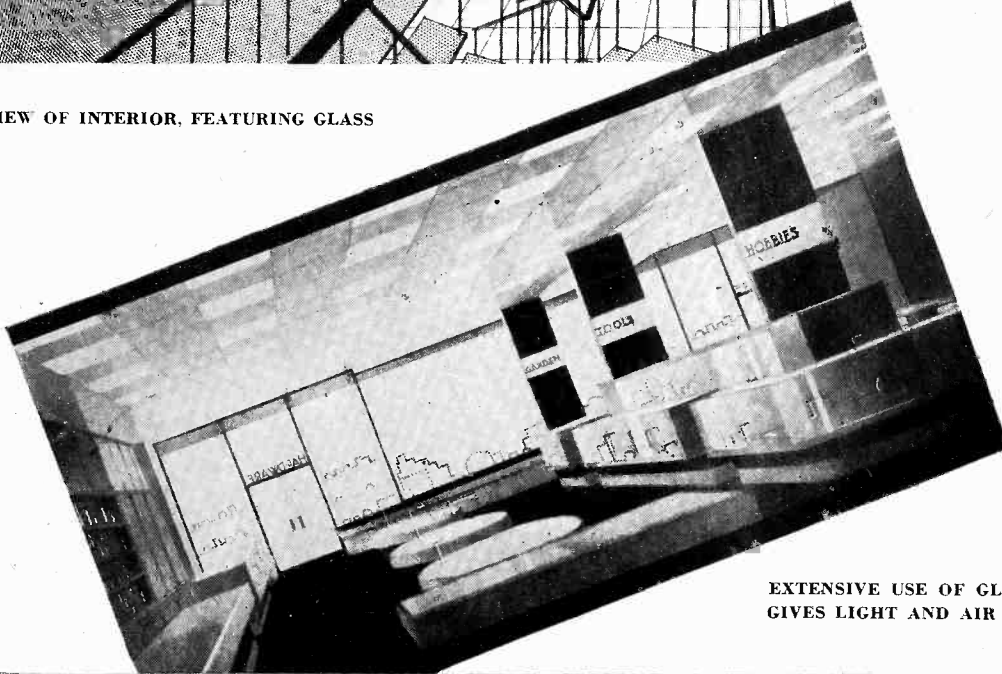

EXTENSIVE USE OF GLASS GIVES LIGHT AND AIR

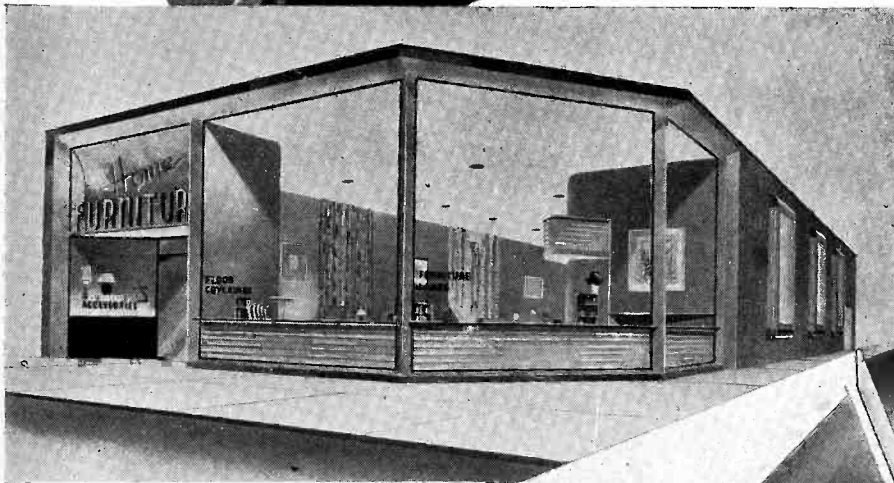

GLASS USED FOR ENTIRE STORE FRONT

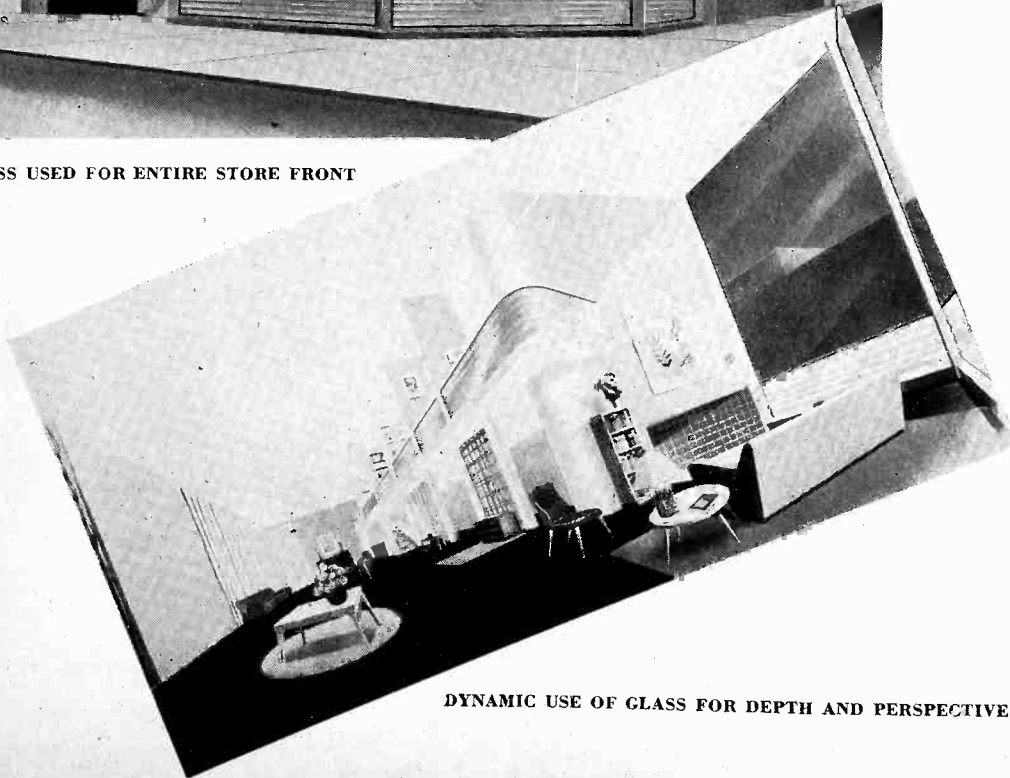

DYNAMIC USE OF GLASS FOR DEPTH AND PERSPECTIVE

cost, not exceeding \$75.00, of repairing or replacing with like material showcase frames and window sashes immediately encasing and contiguous to the insured glass, provided that such repairing or replacing is made necessary by the insured glass being damaged. 3. The cost, not exceeding \$75.00, of boarding up or installing temporary cover in the windows when such action is necessary due to delay in obtaining glass to replace the damaged glass. 4. The cost, not exceeding \$75.00, of removing or replacing any fixtures or other obstructions so that the damaged glass might be replaced.

Individual Store Treatment

Glass will afford the radio store operator endless opportunities for individual treatments in various type stores from the sidewalk to the rear shipping areas. Where and how glass will be used in individual instances rests ultimately in the plan arrived at by the store owner, the architect and others. Each store location presents different problems, and the variable factors call for individual treatment. Typical, however, of what might be achieved in the post-war radio store through the careful choice of glass as a structural and decorative material are the open-front unit shown on these pages and designed by architects Silverman and Levy. These conceptions which are applicable to small radio stores, including special display and sales units, are fine examples of the open-front store, based on the assumption that seeing something under favorable and pleasant conditions is an exciting experience for the customer and, therefore, good merchandising for the owner.

JUST ONE



JUST ONE of numerous government radio and electronic items now available through the Hallicrafters Co., Chicago, agent for Reconstruction Finance Corporation.

This is a Keyer TG-10-F, an automatic unit for providing code practice signals from inked tape recordings. Excellent for group instruction, sufficient power to operate up to 300 pairs of head phones. Can be adapted as amplifier of 10 to 15 watts output for use with crystal mike or phono pick up. Completely checked and reconditioned by Hallicrafters engineers. Send coupon for further details and lists of other available items.

THESE VALUABLE ITEMS *Available Now*
or very soon. Write, wire or phone for further information

- head phones • test equipment • component parts • marine transmitters and receivers • code practice equipment • sound detecting equipment • vehicular operation police and command sets • radio beacons and airborne landing equipment

hallicrafters RADIO

HALLICRAFTERS CO., AGENT OF RFC UNDER CONTRACT SIA-3-24

WORLD'S LARGEST EXCLUSIVE MANUFACTURERS OF
SHORT WAVE RADIO COMMUNICATIONS EQUIPMENT

CLIP THIS COUPON NOW

RFC DEPARTMENT 108, HALLICRAFTERS
5025 West 65th Street • Chicago 38, Illinois

- Send further details and price on Keyer TG-10-F
 Send listings of other available items

Especially interested in.....

NAME.....

ADDRESS.....

CITY.....ZONE.....

STATE.....

**COLLAPSE AFTER WORLD WAR I
BUSINESS FAILURES**



In the 5 years following the World War I price collapse, 105,996 businesses failed.

This was 40% more than total failures in the 5 years before the war.

After the last war—COLLAPSE!

It took prices 5 years, 10 months to reach their peak, from the start of World War I.

But collapse came in 13 months.

WHOLESALE PRICES

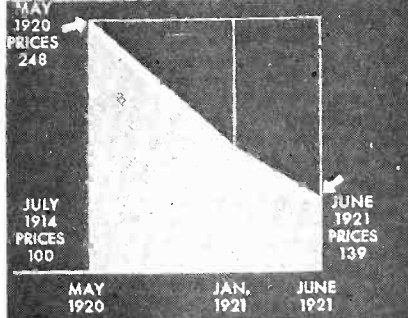

Month	Year	Price
MAY	1920	248
JULY	1914	100
JAN.	1921	-
JUNE	1921	139

This brought tragedy to millions of people.

**COLLAPSE AFTER WORLD WAR I
THERE WAS GROWING UNEMPLOYMENT**



1920
1921

Factory employment shrank 31%

**UNEMPLOYMENT INCREASED
5,624,000
between 1919 and 1921**



1920
1922

\$246,000,000 (Weekly) \$136,000,000 (Weekly)

Factory payrolls shrank 44%

THESE CHARTS DEMONSTRATE GRAPHICALLY THE CHAOS THAT OVERTOOK AMERICAN INDUSTRY AFTER THE LAST WAR. THIS TIME RECONVERSION MUST PREVENT A SIMILAR CATASTROPHE.

RETAILING...

The Key to Postwar Prosperity

by

Fred Merish

Business Management Editor

A goal of \$140 billions national income has been set as essential to the maximum employment of 65 millions in the post-war period, and this means a retail sales volume of \$75 billions annually. When we consider that in 1943, with war-time income at peak, retail sales volume was only \$63 billions, we get some idea of what retailers must do now that Japan is licked—and every radio retailer must do his share.

In 1939 retail sales were \$42 billions. The post-war years must increase this figure 80 per cent to maintain maximum employment and keep free enterprise in the saddle. You, Mr. Radio Dealer, can't pass the buck to the wholesalers, manufacturers or distributors supplying this industry. It's a retail job primarily and all dealers, large or small, must do their share or our post-war goals won't be achieved. That \$42 billions of retail sales volume in 1939 was done by 1,770,335 retailers, average sales per establishment: \$23,748, with 4,600,200 employees, or about 3 to an establishment, so the small retailer is an important element in our national economy. Much depends

upon him in the attainment of post-war goals and national prosperity. He must do his bit to increase sales and employment.

Too often the dealer doing less than \$50,000 yearly (he is considered a small businessman by economists and Government agencies), assumes that his contribution to our economy is negligible, so it doesn't make much difference whether he extends himself or not, but, in the aggregate, he has always accounted for a major portion of the national income and, being the contact man with the consumer, he can negate the best efforts of producers and other distributors.

Comparing 1939 figures with post-war goals, we can get some idea of the increase in sales that you should anticipate after the guns cease firing. If your sales volume was \$50,000 in 1939, you should do 80 per cent more in each post-war year, or \$90,000 annually. This calculation may open your eyes or create some incredulity, but retailers can't saddle this increase on anybody else; each dealer must do his proportionate share, and our figures are based upon statistics provided by the De-

(Continued on page 60)

VIEWTONE

TELEVISION for EVERYONE

Dealers and newsmen marvel

The set that scooped the industry

QUOTED FROM THE N. Y. TIMES, AUG. 3, 1945

MIDGET TELEVISION RECEIVER IN DEBUT



APPROX.
\$100

What appears to be the first low-cost table-model television receiver ever constructed was successfully put through its paces . . . image . . . clarity appeared to equal that ordinarily achieved in larger and more expensive receivers. This line is for the vast market that will be open after the war for adequate but low-cost merchandise. A number of low-cost broadcast sets and record players also were demonstrated.

And here is what the WORLD-TELEGRAM said:

"Television has been pushed an important step forward by the Viewtone Co. . . which has perfected a receiving set to retail for \$100. At this low price a wide market undoubtedly can be developed, a prerequisite to commercial success in the field.

. . . By lowering the price of the receiving sets to \$100 from \$500 or more, Viewtone helps to remove much of the resistance against a wide distribution of these instruments.

The new \$100 instrument seemed to us to do as good a job as any of the higher-priced machines we have seen in operation."

Here it is! Low cost television — Television at a price your customers formerly paid for a table model radio set — And they said it couldn't be done!

Here is safe, practical television for VOLUME SALES and LARGE, STEADY PROFITS. Simple installation . . . and servicing . . . television to sell over-the-counter.

CALLING ALL DEALERS—DISTRIBUTORS

VIEWTONE is the name to tie up with NOW. In research since 1931, VIEWTONE IS CERTAIN TO BE A LEADER IN THE TELEVISION FIELD.

And we'll be ready at the word "GO" with a complete line of low price television receivers, FM and AM radios and combinations, all of them sales magnets — new in every feature.

Here's what a VIEWTONE FRANCHISE means:

- A company recognized and respected in the radio and television field.
- A complete stock plan for dealers.
- The backing of a whirlwind of consumer advertising and publicity.
- A product that is "right" . . . a plan that assures healthy sales and steady profits.

WRITE FOR THE FACTS TODAY

VIEWTONE COMPANY

Office: 203 E. 18th St., New York 3, N.Y. • Factory Site: B'klyn, N.Y.



Westinghouse are getting local



POP SAYS THAT THE NEW WESTINGHOUSE RADIO IS GONNA BE WONDERFUL!

TONE SO TRUE, YOU SEEM TO BE THERE!

ROOM TO STORE A STACK OF RECORDS ALMOST AS TALL AS I AM!

A RECORD CHANGER THAT WILL KEEP ON WORKING... EVEN FOR ME!

Your Westinghouse radio retailer displays this Gold Seal Emblem - When the new Westinghouse radios are ready you will see them at his store

Westinghouse RADIO TELEVISION

Radio's

Westinghouse advertising appears in Life, Post, Collier's, and Time — 30,000,000 readers.

The Gold Seal Emblem which identifies franchised Westinghouse Radio Retailers appears in Westinghouse Radio Magazine Advertising.

©1947 by John Charles Thomson Co., Inc. 230 P. St. 1947-482
East Pittsburgh, Pa. U.S.A. M. 1-27-48-482

Radio Retailers promotion...NOW!

The Westinghouse Radio Franchise is backed by an organized promotion plan. Now, for example, the plan is designed to establish a strong Westing-

house Radio Identity for franchised retailers. Coming campaigns will step up the pace until the day when Westinghouse can open up with their outstanding product story.

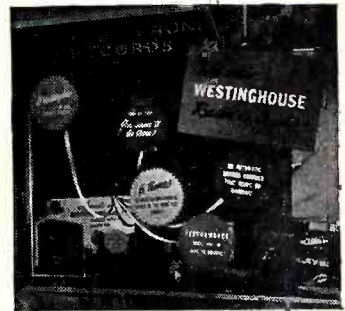

1st A seven piece Gold Seal window display featuring your appointment

Here's the first Promotion Package! Every month franchised Westinghouse Radio Retailers get a new display.



2nd A three-dimension Gold Seal medallion 24" in diameter



3rd Another seven piece window display package

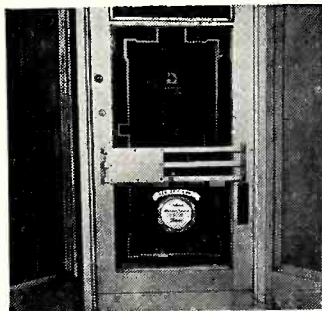

4th A Gold Seal decal-comania personalized with your name

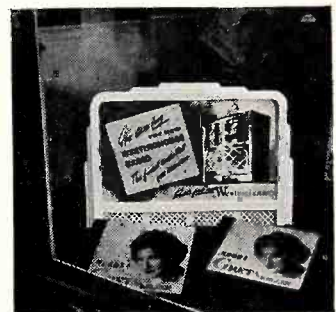

5th A miniature billboard made of durable wood construction...new posters 12 times a year

first name is

All of this display material is ready now!
Every piece tells your customers they'll be able to buy a Westinghouse Radio at your store.

Westinghouse

RADIO TELEVISION

MERISH

(Continued from page 56)

partment of Commerce for the year 1939 and post-war retail distribution, based on projections of the Committee for Economic Development, so it pays to read and heed. If you, and you, and you, do not chip in and do your share, the post-war goal of \$75 billions retail volume won't be reached because you are on the firing line contacting the consumer, and you number all-told 1,770,355 souls, more than half the business establishments in the country, from the United States Steel Corporation to the little tourist camp; and if \$75 billions in retail sales aren't forthcoming in the post-war period—annual sales, remember—65 millions employment will go by the boards and bureaucracy will more than likely take over. There's the picture in a nutshell.

Ways to Increase Volume

Now, what are you doing to increase volume 80 per cent in the post-war period? Unless you begin now to set up post-war quotas based on the estimated national increase in retail sales volume, and unless you start thinking about how you will achieve this goal and what effect it may have on your operating ratios, you will find yourself floundering around helplessly in post-war mire. This poses the big problem of the post-war period and demands deliberation and action.

In general, there are four ways by which the dealer can hit for that 80 per cent increase in sales volume:

1—Increase dollar volume by increasing prices in the post-war period.

2—Increase dollar volume on the same lines now carried.

3—Increase dollar volume by adding new lines.

4—Increase dollar volume with expanded facilities.

The first method is not so good. It savors of inflation and that's bad. Moreover, the Government is against it and will take steps to prevent it if inflation rears its ugly head. If the post-war goal of \$75 billions retail sales is begotten by inflation, sooner or later, dire results will follow; in fact, the post-war trend may be in the opposite direction. Businessmen do not like to hear talk like this, but an honest interpretation of all factors in our economy is wholesome and the only way to reach a sound conclusion. Many in Government circles and some businessmen contend that pre-war prices for many commodities were too high, considering the cost of manufacture. These

in the right groove. But we do venture that an increase of 80 per cent in business won't be achieved by big price increases over pre-war or war years. This increase must be born of better merchandising and business management.

Increasing Volume on Lines Now Carried

Expansion is on the post-war agenda for many dealers, but it will be more modest than 80 per cent of present capacity; hence, the post-war increase in sales volume, to a large extent, must be achieved by increasing dollar volume on the lines now carried or adding new lines. This will necessitate a much better job of sales promotion than the average radio retailer has even staged before.

The addition of new lines related to radio is probably the best bet because it ties in with the promises of manufacturers that they will have many new items in short order, some of them revolutionary developments of pre-war products, other items entirely new. Some of these promises may be too optimistic, but it isn't unreasonable to assume that the war has brought improvement to production that will drift into post-war markets and create additional sales volume for aggressive merchandisers.

You Make Prosperity

The post-war increase in business is no longer only a matter of more profit; it has tremendous social implications. If you increase your business, you can employ more people directly and indirectly and do your bit in achieving national prosperity and a satisfied people. Big manufacturers employ many on production, but unless production is sold, production stops and out of work go the Kellys and the Smiths, so the dealer is the key man to full employment. He must unload production and service on the consumer at a pace fast enough to keep 65 millions

(Continued on page 62)

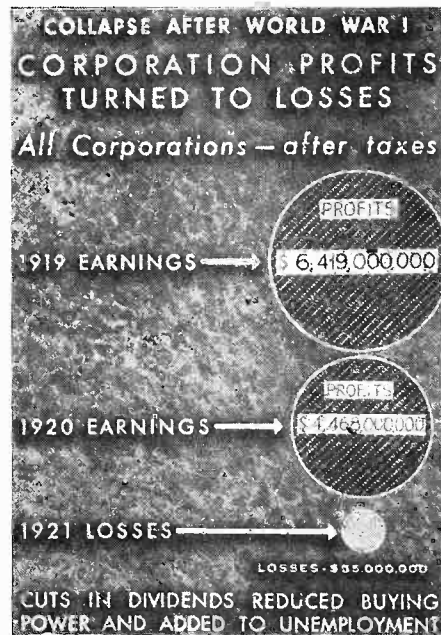

Such a collapse can be prevented by individual effort.

men insist that distribution cost must be reduced in order to bring consumers lower selling prices, or else post-war goals of full employment and \$140 billions national income cannot be achieved. The pre-war business philosophy was: "Higher prices mean more employment, more everything else." These individuals, propagators of lower prices, contend that the post-war business credo should be: "Lower prices mean more buyers for more goods, more employment, more prosperity for all." We do not take sides here, but merely give you the scope of economic thought so that your perspective is



This
Maestro's Tune
will last on

*"The Wire
that Remembers"*

Give it all you've got, Sonny. It's a swell tune you're playing — the finest in the world to Mommy and Dad.

And now they can hear it again tomorrow — again and again — years from now — just as clear and fine as they hear it today.

This can all be done because Lear has developed "the wire that remembers." It's a simple, easy, quick way of recording sound — a way that makes it yours for keeps. Yet, if you wish, everything can be erased simply by recording something else over it.

It's all done with a long, hair-size wire that glides swiftly across the poles of a magnet. Silently it picks up every note, tone and inflection. It holds them magnetically — ready to be played over and over whenever you wish. The recording can be a few words — or hours long.

It's something you will have in the new Lear Radio along with all the finest developments of FM, television, easy-tuning world-wide short wave, and phonograph-combination automatic record-changing. It will be ready as soon as Lear production for war ends. Be sure to see it.



Designed and Made
in Grand Rapids

**LEAR
RADIO**



LEAR, Incorporated

HOME RADIO SALES:
230 E. Ohio St.
Chicago 11, Illinois

RADIO DIVISION:
Grand Rapids 2, Michigan

National magazines for August will carry this advertisement for Lear Home Radios. It is the opening gun of a whole new campaign planned to support Lear dealers. Families all over America will see it and read about Lear Radios and Learecording.

Another thing! Beginning Sunday, September 16th, Lear will be on the air with a network radio show starring Orson Welles.

Over the American Broadcasting System — 1:15 P.M. to 1:30 P.M. E.W.T. Be sure to listen — tell all your friends to listen.

All this is part of Lear's planned aggressive merchandising and promotion. If you want to share in the results of these campaigns — if you want to be able to offer Lear Radios — write for information on the Lear Franchise.

AVAILABLE
NOW!

**New, Colorful,
Double — Purpose**

RECORDISC

Merchandiser Display



**A Display Card and
Merchandiser In One!**

**Here's the complete package —
and it's all FREE:**

- 2-Color Display Card, 18 x 24 inches.
- Rack for Holding 60 Recordisc Blanks, assorted sizes.
- Quantity of 2-Color, Interest-Stimulating Consumer Folders.

Place this Recordisc Merchandiser-Display anywhere, and watch it do a job for you. Rush your request for it to your nearest Recordisc jobber.

THE RECORDISC CORP.

395 BROADWAY, NEW YORK 13, N. Y.
Cable Address: Recordisc, New York, N. Y.
Export Dept: Royal National Company, Inc.
89 Broad Street, New York

MERISH

(Continued from page 60)

on the job. On him rests the tremendous burden of keeping unrest at minimum and free enterprise as our way of life. Yes, there is more than the profit angle to that 80 per cent increase in post-war sales. That's why it is almost as important to reach that quota as it is to hit tops in a war-bond drive.

Taxation comes into the picture too. The country, heavily in debt, will never get out of the barrel unless national income is kept high so that the tax "take" will also be high. Low wages, low sales mean low tax revenue and more deficit. On the other hand, now that Japan is licked, there will be a big demand for lower taxes and politicians will more than likely oblige. Already certain features of our taxation are being scrutinized with a view to giving businessmen tax relief in the near future. If rates are lowered substantially, volume and profit must be kept higher than in wartime to pay war bills and current post-war Government expenses. It follows that the Government will more than likely do everything possible to aid in the attainment of a national income of \$140 billions in the post-war period, removing impediments to this objective in order to get adequate tax revenue.

Free Enterprise

In short, labor, influential businessmen, economists, the Tax Department and Washington big-wigs have fixed on \$140 billions national income, which means \$75 billions in retail sales as necessary to our way of life. The OPA and other Governmental agencies have gone sour with the public, and there is a definite trend toward giving free enterprise an opportunity to bring order out of chaos. If it makes the grade

sans apple vendors and WPAs, there will be no planned economy. If free enterprise fails in the post-war period, the pendulum will swing back to the bureaucrats, and that's just how important it is to you, Mr. Radio Dealer, to do your utmost to get your share of that 80 per cent increase in retail sales in the post-war period.

You must write your own ticket on how to obtain that 80 per cent increase, whether through expansion, better sales promotion on lines now carried to "up" volume or the addition of more lines of merchandise. We offer the foregoing merely to emphasize the mammoth merchandising job you will be called upon to do in the present postwar period. Your quota as a small dealer is easily computable. Just take your volume in 1939 and tack on 80 per cent, then size up your present facilities and try to figure out how you will hit the mark, whether you will need more space to do the job, whether you can hit the jackpot with the same facilities and more lines, or can carry the ball to the goal with present lines plus an improved brand of sales promotion. This analysis should include an appraisal of pre-war costs and war costs as a basis for an estimate of post-war costs, so that you can arrive at some idea of the net profit resulting from post-war operations.

Can you increase sales 80 per cent in the post-war period? If not, you will not do your bit to reach the post-war goal on retail sales set at \$75 billions, 80 per cent more than \$42 billions retail sales in 1939.

ATTENTION MANUFACTURERS

If in need of aggressive sales representation with twenty years acquaintance in the Hardware, Electrical and Department store field in Texas, Oklahoma, Arkansas, Louisiana, Mississippi and Memphis, Tenn. on Commission basis. Write today, Box 256.

Depend on
ARVIN
 to Help You Sell

You can depend on Arvin for effective radio sales help—from consumer advertising to store display. Arvin national advertising is stimulating family desires now—to help you sell later, when radio deliveries can be made. Reproduced below is a typical Arvin consumer page—one of a series of pages appearing in current issues of leading magazines.



RINGS ON HER FINGERS...BELLS ON HER TOES

She Shall Have Music

WHEREVER SHE GOES

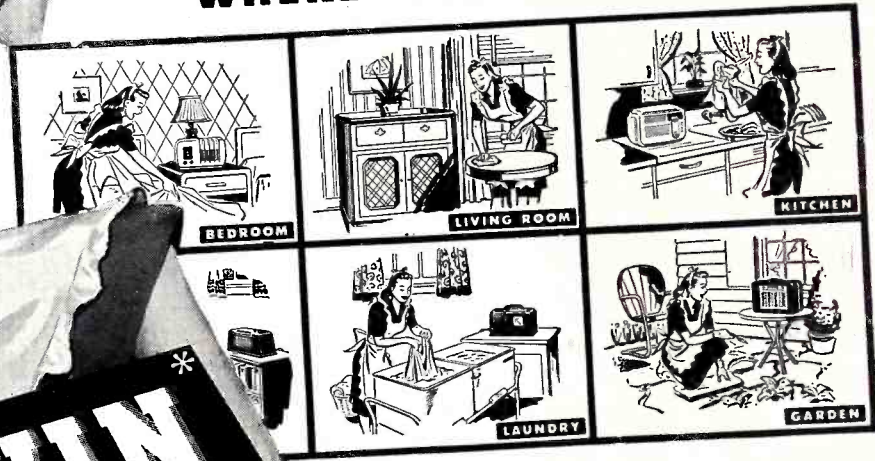

ARVIN
Top Flight
RADIOS
 ALL THROUGH THE HOUSE

* THIS NAME IS
 GETTING BIGGER
 ALL THE TIME

Coming: As peacetime production begins, there'll be a wide range of useful Arvin products for your home... Arvin Top Flight Radios... Arvin Metal-Chrome Dinette Sets... Arvin Outdoor Metal Furniture... Arvin Portable Electric Heaters... Arvin Automatic Electric Irons and Other Appliances... Arvin Roll-a-Round Laundry Tubs... Arvin All-Metal Ironing Boards... Arvin Car Heaters.

Upstairs Downstairs

... all through the house

MOTHER works all day, all over the house... upstairs, downstairs... and outdoors, too. And wherever she goes she can have music, news, a ball game, whatever she pleases... if there are Arvins all through the house. Mother deserves this pleasure, as she goes about her daily household tasks. And on Saturdays and Sundays, or any evening, when Dad and Nancy and Jimmie are at home with her... each wanting a different radio program, everybody can be happy. There'll be an Arvin for each and every one.

The new line of Arvin Top Flight Radios will include a wide choice of large and small models. There'll be radio-phonograph combinations with automatic record changers and FM, floor and table models, portables and farm battery sets. With them you can radio-equip your home completely and economically. And there'll be other Arvin Products, too, to add to the comfort and pleasure of your home.

ARVIN FAMILY PRODUCTS are engineered and built by NOBLITT-SPARKS INDUSTRIES, INC., Columbus, Indiana
 25 years' experience in manufacturing Eleven plants in five Indiana cities

Distributor News

Majestic Radio Announces Formation of Distributor Panel

Nine Majestic radio and record distributors met with executives of Majestic Radio & Television Corporation at St. Charles, Ill., recently in the first of a continuing series of Majestic Distributor Panel meetings.

The Panel, which hereafter will be comprised of twelve Majestic distributors on a rotating membership basis, discussed product design, merchandising policies and other subjects pertinent to Majestic's postwar marketing activities.

In opening the meeting, E. A. Tracey, Majestic's president, told the group that the Distributor Panel is destined to become a valuable merchandising tool by making it possible for factory executives constantly to check their judgment and strategy with a sound group of distributors.

In addition to Mr. Tracey, other Majestic executives participating in the morning and afternoon sessions were Lester Kulp, assistant to Mr. Tracey, Parker H. Erickson, director of sales, and Ben Selvin, director of artists and repertoire for Majestic Records, Inc.

Two Firms Appointed Bendix Radio Distributors

The Van Deren Hardware Company, Lexington, has been appointed Bendix Radio distributor for the territory of eastern Kentucky, it was announced recently by Leonard C. Truesdell, general sales manager for radio and television, Bendix Aviation Corporation's radio division.

The Lexington Company has been engaged in wholesale distribution in Kentucky for over fifty years, selling to furniture, appliance, department and general stores.

At the same time the appointment of the A. B. Gray Company of Fort Wayne as distributor in northern Indiana and northwestern Ohio for the forthcoming line of Bendix AM and FM radios and radio-phonograph combinations was announced by Mr. Truesdell.

The Fort Wayne Company is headed by A. B. Gray, veteran wholesaling and retailing executive who spent nineteen years with the Firestone Tire and Rubber Company as retail store manager and manager of the company's Toledo branch office.

New Stewart-Warner Distributor in Atlanta

Cowan-Boze Company, Inc., Atlanta, Ga., has been appointed distributor of Stewart-Warner home radios for the Atlanta territory, the radio division of Stewart-Warner Corporation announced August 6.



H. W. SOMMERWERCK

H. W. Sommerwerck, vice-president and general manager of the Cowan-Boze Company, will head up dealer sales in the territory. A native of Baltimore, Mr. Sommerwerck was associated with a Baltimore sporting goods house for 20 years prior to his present position. The Cowan-Boze Company distributes wheelgoods and floor covering products in addition to radios.

Motorola Distributor Names New Sales Head

The Electro-Pliance Distributors, Inc., Milwaukee, distributors of Motorola Home and Auto Radios, announce the appointment of John F. Mehr as sales manager of their Major Goods Division. Mr. Mehr is new to the Electro-Pliance organization, but is no tyro in the field of radio distribution, having been vice-president of the Roth Appliance Distributors of Milwaukee, and prior to this a long-standing member of the Philco selling organization in Wisconsin. Mr. Mehr indicated that Electro-Pliance is planning an expansion of their sales force as soon as manpower regulations are relaxed

MAJESTIC DISTRIBUTOR PANEL HOLDS FIRST MEETING



Distributors and factory executives who met at St. Charles, Ill., last week included (standing, left to right) Parker H. Erickson, Director of Sales, Majestic Radio & Television Corporation; R. E. McGreevy, Chicago-Majestic, Inc., Chicago; Edgar L. Fink, La Salle Electric & Mill Supply Co., Detroit; Otto N. Rothlin, Manager, Electric Appliance Division, McCormack & Company, San Francisco; D. F. McCormack, McCormack & Company, San Francisco; L. M. Evans, Elliott & Evans, Inc., Cleveland; J. J. Pocock, J. J. Pocock, Inc., Philadelphia; J. W. Scott, Major Appliance Corporation, Watertown (Boston). Seated are (left to right) M. Mitchell Gruhn, Colen-Gruhn Company, Inc., New York; J. N. Thompson, Maco Appliance Distributors, Kansas City, Mo.; E. A. Tracey, President, Majestic Radio & Television Corporation, and C. L. Carper, Sidles Company, Omaha.

G.E. GAVE UNCLE SAM } Superior
 G.E. WILL GIVE YOU } Quality

Look! GENERAL ELECTRIC HAS
 BUILT MORE WAR-TIME
 RADIO AND RADAR THAN ANY
 OTHER HOME RADIO MANUFACTURER!

Here's why! AT G.E. —
 CONSTANT RESEARCH; EXPERT DESIGN;
 ENGINEERING; SKILLED WORKMEN;
 MODERN PRODUCTION FACILITIES;
 FINEST MATERIALS AND COMPONENTS
 ... ALL OF THESE ADD UP TO
 SUPERIOR QUALITY!

**Here's what this means
 to YOU!**

ANOTHER
 OF THE 8 BIG REASONS*
 WHY POST-WAR AMERICA
 WILL BUY THE COMING

 **Electronic**
 RADIO LINE

**G.E. is first in
 Radio and
 Television
 FIRSTS!**

● The same men who have been singled out by Uncle Sam to build more of his wartime radio and radar than any other home radio manufacturer will design, engineer and produce the coming line of G-E radios. Naturally, many of the new ideas and improvements combined in radio throughout the war will be found in the coming G-E line.

For you, this means *satisfactory turnover,*

customer confidence, repeat business . . . profits! For your customers, it means *quality radios, designed for eye, ear . . . and pocketbook appeal!*

The General Electric line will be complete in all respects and will assure superlative reception on all bands. For additional information, consult your nearest G-E Radio Distributor or write *Electronics Department, General Electric Company, Bridgeport, Conn.*

- *1. G-E Alnico 5 Speakers
- 2. G-E Radio-Phonographs
- 3. G-E Superior Quality
- 4. (See next Ad)

- 5. (See coming Ad)
- 6. (See coming Ad)
- 7. (See coming Ad)
- 8. (See coming Ad)

GENERAL  ELECTRIC

175-09

PORTABLES • TABLE MODELS • CONSOLES • FARM SETS
 AUTOMATIC PHONOGRAPH COMBINATIONS • TELEVISION

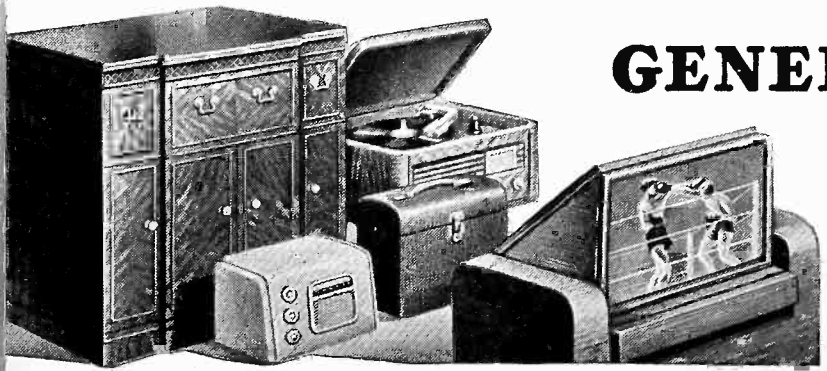

DESIGN COUNTS



COMPARE a modern sewing machine with the old-time model shown here. The difference is an example of how careful attention to design brings about a high level of efficiency.

Realizing this, design is one of the most carefully considered factors in the production of antennas at **THE WARD PRODUCTS CORPORATION**. It is only through superior design that the benefits of experience and the finest production facilities can be best brought to the user.

For the finest antennas for all applications... for home and automobile use... look to **WARD**.

WARD
Antennas

BUY WAR BONDS
THE WARD PRODUCTS CORPORATION
1523 EAST 45TH STREET - CLEVELAND 3, OHIO

Export Dept.

C. C. BRANDES, Mgr.
4900 Euclid Avenue
Cleveland 3, Ohio

Canadian Office

ATLAS RADIO CORP.
560 King Street, W.
Toronto 1, Ont., Can.

Minnesota Electric Co. New Stewart-Warner Distributor

Appointment of Minnesota Electric Supply Company, Willmar, Minn., as distributor of Stewart-Warner home radios in the Willmar and Minneap-



H. W. LINDER

olis territories, was announced recently by the radio division of Stewart-Warner Corporation.

M. R. Owen and H. W. Linder, owners of the Minnesota Electric Supply Company, operate jointly or separately several enterprises in western Minnesota, including radio station KWIM, at Willmar, a machine works which produces war material and an auto equipment distributing business. They have announced plans to operate several wholesale display rooms in their territory with service facilities at each, and plan an extensive radio and newspaper promotional campaign on radios and other major appliances.

Columbus Firm Named Distributor for Bendix Radio

American Sales and Distributors, Inc., Columbus, has been appointed distributor in central Ohio for the forthcoming line of Bendix AM and FM radios and radio-phonograph combinations it was announced recently by Leonard C. Truesdell, general sales manager for radio and television, Bendix Aviation Corporation's radio division.

The Columbus firm, which was incorporated in 1921, has been active in wholesaling radios in Central Ohio since 1922. The company is headed by Mr. A. Goldenberg, president, who founded the original business in 1904.

Howard Radio Announces New Distributors

In line with its policy of merchandising to independent dealers through independent wholesalers, the Howard Radio Company, Chicago, announce the following distributor appointments:

Appliance Wholesalers, Inc., 1745 W. Lafayette Boulevard, Detroit, Michigan; Arizona Hardware Company, Phoenix, Arizona; Bowers Wholesale Corporation, 1605 Granby Street, Norfolk, Virginia; Harris-Patrick Electric Supply Co., 179 Second Avenue, Nashville, Tennessee; E. G. Hendrix Company, 729 South Flores Street, San Antonio, Texas; Kent Wholesale Distributor, 2247 Union Avenue, S. E., Grand Rapids, Michigan; Terry-Durin Company, 409 7th Street, Cedar Rapids, Iowa.

Wallberg Promoted By Connelly Co.

Kenneth A. Connelly, president of the F. B. Connelly Company, appliance and radio distributors for the States of Washington and Oregon, announces the appointment of Neal G. Wallberg as service manager for his company.

Mr. Wallberg has been associated with the F. B. Connelly Company for the past 12 years and has served in many capacities which gives him a very outstanding background for this position. He has served as shipping clerk, salesman, service man during the time of his employment with the F. B. Connelly Company.

Prior to his association with the F. B. Connelly Company, he was employed by a local radio manufacturer and built the first radios in 1920. He was employed as a salesman for an appliance dealer and branch manager for an appliance distributor.

Ted McElroy
World's Largest Manufacturer of
Wireless Telegraphic Apparatus
COMPLETE CENTRAL OFFICE EQUIPMENT
McElroy Manufacturing Corp.
82 Brookline Avenue • Boston, Massachusetts



RAYTHEON

Radio Tubes

Peak Performance

Raytheon High-Fidelity Tubes are the *serviceman's* tubes . . . performance-engineered and precision-built to provide complete satisfaction for your customers.

To protect your interests, they are distributed only by legitimate wholesale radio parts distributors in your area.

Switch to Raytheon Tubes *now* . . . and be on the lookout for a revolutionary merchandising program developed by Raytheon to help qualifying service-dealers increase their profits through building public trust and confidence.

Copyright 1945

Raytheon Manufacturing Company

RADIO RECEIVING TUBE DIVISION

NEWTON, MASS. • LOS ANGELES • NEW YORK • CHICAGO • ATLANTA



Listen to
"MEET YOUR NAVY"
AMERICAN
BROADCASTING CO.
Every Monday Night
Coast to Coast
181 Stations

ALL FOUR DIVISIONS HAVE BEEN
AWARDED ARMY-NAVY "E" WITH STARS

DEVOTED TO RESEARCH AND THE MANUFACTURE OF TUBES FOR THE NEW ERA OF ELECTRONICS

Stromberg-Carlson Appoints Dealers in Maine and Texas

The Stromberg-Carlson Company announced in August that two more top-ranking distributing organizations—one in Texas, the other in

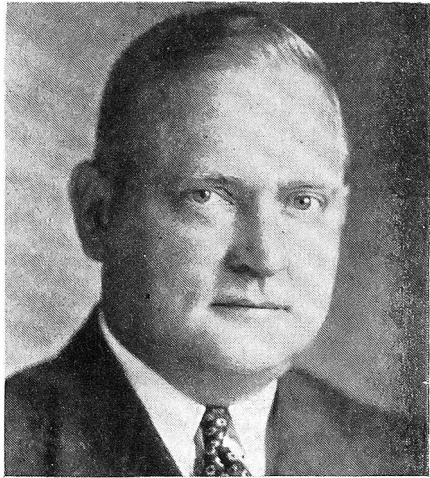

CHRISTIAN OLESEN, JR.

Maine—had joined the Rochester, N. Y., firm's radio sales family.

Clifford J. Hunt, manager of radio sales for the fifty-one year old

communications firm, said that the Central Supply Company of Brownwood, Texas, and the Farrar-Brown Company of Portland, Me., had been appointed exclusive area distributors for the company's radio, FM and television receivers.

Known as one of West Central Texas' most enterprising distributing firms, the Central Supply Company of Brownwood, was built on the success formula of the wide business experience of its three key founders. D. T. Wilkerson, vice-president and general manager of the Southwestern States Telephone Company, is president of the new organization, and L. V. Ford, comptroller of that telephone company, is secretary and treasurer.

The Farrar-Brown Company, headed by Christian Olesen, Jr., has a twenty-eight year old history marked by sound merchandising success and accomplishment. With six thriving branches, the company has grown to be one of New England's largest distributors of major appliances.

Olympic Radio Announces Southwest Distributors

Hamilton Radio Corporation, manufacturers of Olympic Radios, have announced a series of distributor appointments throughout the country.

The list includes: Pacific Coast Heating & Appliance Company, Seattle, Washington; Allied Distributors, Inc., Wichita, Kansas; Victor Shaw Company, Charlotte, North Carolina; United Appliance Company, Fort Worth, Texas; Tommy Thompson's Home Appliance Company, Denver, Colorado; Southwestern Distributors, Inc., Little Rock, Arkansas; Sioux Tire & Battery Company, Sioux City, South Dakota; Memphis Rubber & Supply Company, Memphis, Tennessee; Roanoke Hardware Company, Inc., Roanoke, Virginia; Pettit's Warehouse Company, Fort Wayne, Indiana; Monarch Sales Company, Indianapolis, Indiana; Modern Retreaders, Nashville, Tennessee; Jelco Milwaukee Company, Milwaukee, Wisconsin; Electric Products, Inc., Pittsburgh, Pennsylvania; Custom Tire Company, Billings, Montana; Cayot-Wellman Company, Cheyenne, Wyoming, and El Paso Building Material Company, El Paso, Texas.

Garod Names Toledo Distributor

The Garod Radio Company of Brooklyn, N. Y., manufacturers of quality radios since 1922, have appointed The Lifetime Sound Equipment Company of 1101 Adams Street, Toledo, as distributors for Garod radios and television sets in 18 counties of Northwestern Ohio and South-eastern Michigan.

Wm. H. Manoff, general manager of the Lifetime Sound Equipment Company is now appointing dealers in this territory to handle the complete Garod line which consists of radios priced from \$17.50 to \$350.00—both F.M. and television sets. Many styles of phonograph needles in modernistic plastic cases are also included in the Garod line.

The Lifetime Sound Equipment Company has been manufacturing microphones and sound equipment since 1932, and their products have been shipped to all parts of the world.

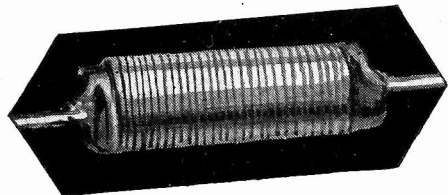
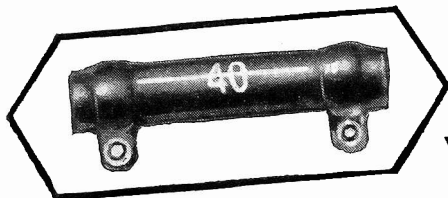
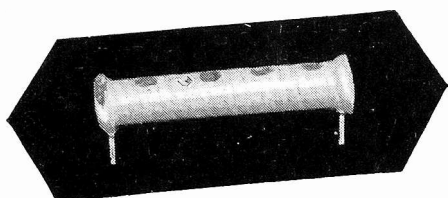

HI-Q
CERAMIC CAPACITORS
WIRE WOUND RESISTORS
CHOKE COILS

The line to "get a line on" for your postwar sales.

ELECTRICAL REACTANCE CORPORATION
FRANKLINVILLE, N. Y.

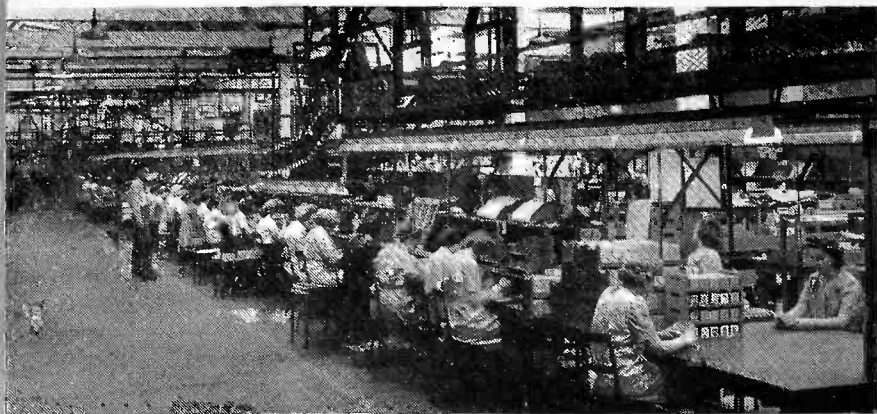

Radio Receiver Production line and stock conveyor system.

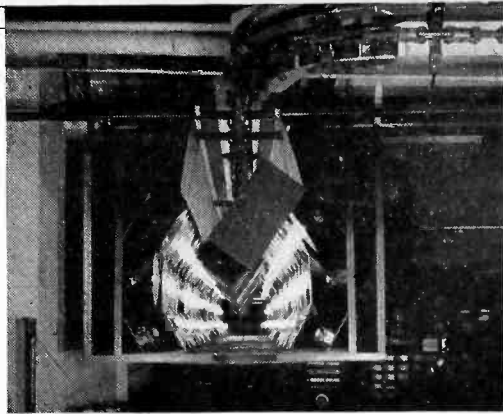

Infra-red drying oven.

Sparton Will Deliver!

5 Modern Plants Assure Quality Radios in Volume

Sparton's exclusive dealer *will* have radios—plenty of them! That's a promise.

Back of that promise are five completely modern plants, each equipped with up-to-the-minute precision machinery (much of it specially built by Sparton engineers) designed with overhead carriers for high speed assembly. These Sparton plants provide unexcelled production facilities for the manufacture of quality radios.

Thus, Sparton dealers will not miss the golden era of radio retailing sure to be with us soon, now that civilian production has started.

For complete particulars on the exclusive *SCMP franchise for your territory, write today to—

Ed. Bonia—Sales Manager
Sparks-Withington Company
Jackson, Michigan



Flash testing and calibrating department.

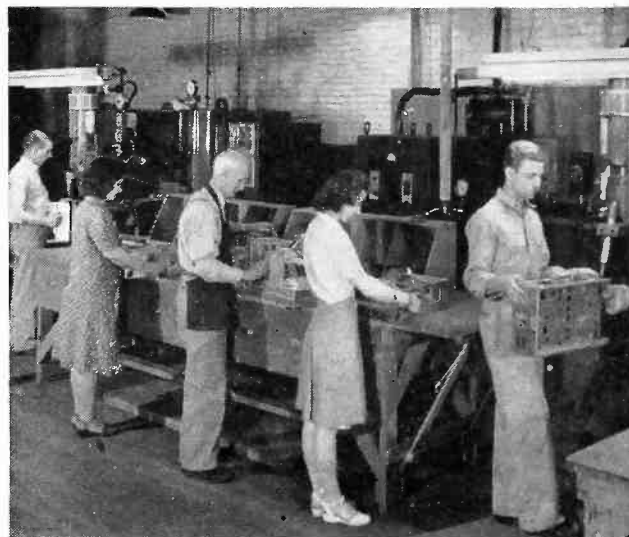

Aluminum chassis spot welding department.

THE SPARKS-WITHINGTON CO., JACKSON, MICH.

SPARTON

RADIO'S RICHEST VOICE SINCE 1926



Army-Navy "E" awarded five Sparton plants simultaneously for production excellence.

*SPARTON COOPERATIVE
MERCHANDISING PLAN

**NATIONAL
COVERAGE
FROM
COAST TO COAST**

RADIO Television JOURNAL NEWS

**LAST MINUTE NEWS
ABOUT PEOPLE
AND EVENTS
IN THE INDUSTRY**

Volume 59, Number 3

SEPTEMBER, 1945

25c per copy

Littelfuse, Inc., to Mfg. Nite-T-Lite

The National Safety Council estimates reveal that 50 per cent of the nation's accidents occur in the home, many of them happening to night-prowlers who fall over things in the dark. Recognizing the need for lighting devices which could be placed throughout the house to burn all night, Littlefuse, Inc., has perfected Nite-T-Lite. This new product is now ready for distribution.

Nite-T-Lite fits into your wall plug or any electrical outlet and casts a subdued rosy glow. It illuminates "danger" points; it indicates the location of lamps or electric light buttons. It will, the manufacturers say, be especially useful in bedrooms, baths, nurseries, halls, kitchens and stairways.

Packed in cartons of two dozen each, Nite-T-Lite will retail for 29 cents. The light has exceptional long life and can be operated continuously for less than a cent a month.

Littlefuse, Inc. supplies fuses to the manufacturers of airplanes, automobiles, radios and electronics equipment. Early in the war they were awarded the Army and Navy "E".

LITTELFUSE'S NEW NITE-T-LITE

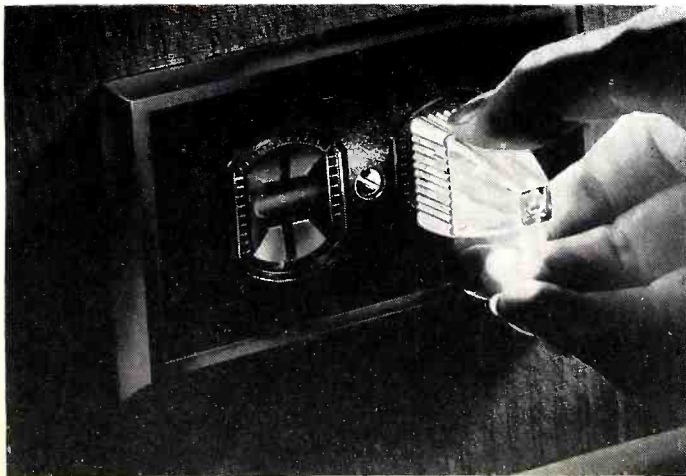

Shown above is the new Nite-T-Lite, which fits into a wall plug. It casts a rosy glow and helps eliminate the danger of home accidents, especially in halls, bedrooms or kitchens.

Cohen Joins Emerson Radio

Haskell Cohen, war correspondent, magazine writer, and publicist, has joined the



HASKELL COHEN

public relations staff of Emerson Radio and Phonograph Corporation of 111 8th Avenue, New York City. According to an announcement by President Ben Abrams, Mr. Cohen will serve in the capacity of publicity director for the firm.

Mr. Cohen recently returned from Italy.

Admiral Begins Reconversion Manufacturing

Reconversion manufacturing is actually under way at Admiral Corporation, Chicago



ROSS SIRAGUSA

electronics and electrical appliance manufacturer.

Ross D. Siragusa, president of Admiral, announced that the company began production on Wednesday, August 22, of a record-changer attachment for radios, and that "sizeable quantities" will be coming off the assembly line within 15 days.

MECK CONDUCTS CONSUMER SURVEY

The graph charts below, the results of a survey made in 17 cities for John Meck Industries, radio manufacturers. The consumer check indicated that there would be a postwar market the first full year of production of between \$250,000,000 and \$500,000,000 of radio sales. The survey was made to assist the company in its merchandising plans and it indicated that consumers were not pre-determined as to a retail point of purchase.

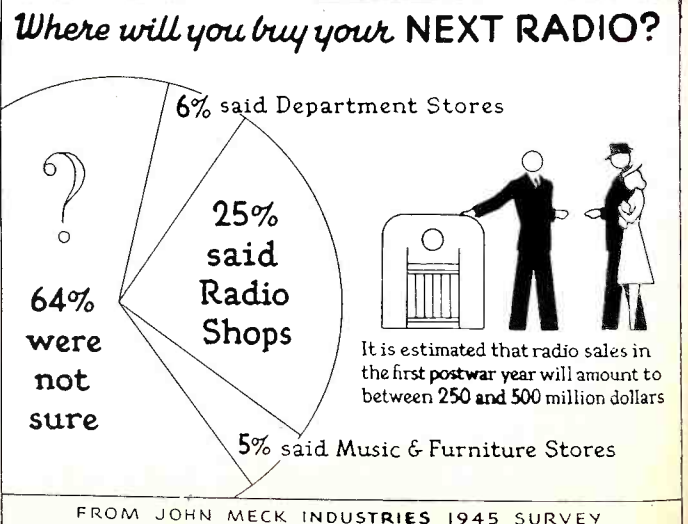

MORE TUBES RELEASED SOON!

Get Your Share of RCA Tubes — *Order Now*



As the war ends, RCA is immediately ready to make larger and larger quantities of tubes for civilian requirements.

Since it will take some time to satisfy all new set requirements, your customers will have to depend on you to keep their old sets working.

Be sure to make the most of this opportunity by assuring yourself of a supply of RCA tubes. They have been, and will continue to be, *best sellers*—because they carry the *best-known name in tubes*.

Your RCA distributor will see that you get your share of any increased quantities of RCA tubes if he knows your requirements well in advance. You stand to gain a lot if you order your next 60 days' supply of RCA tubes from him *today*.

And remember, it's good business to do business with RCA. It pays to have the RCA name selling for you.

Listen to
"The RCA Victor Show,"
Sundays, 4:30 P. M.
EWT, NBC Network



62-6636-96

RADIO CORPORATION OF AMERICA

RCA VICTOR DIVISION • HARRISON, NEW JERSEY

LEADS THE WAY...In Radio...Television...Tubes
Phonographs...Records...Electronics

Metal, Miniature, or Glass,

THE FOUNTAINHEAD OF MODERN

TUBE DEVELOPMENT IS RCA

Westinghouse Plans Nationwide Airborne Television

Plans to inaugurate a new system of television and FM radio broadcasting from stratosphere airplanes cruising six miles in the air, as soon as permits and equipment can be obtained, were announced here August 9 by the Westinghouse Electric Corporation.

Initial flight tests of the system, known as Westinghouse Stratovision, are expected to be made this fall, it was disclosed by Walter Evans, Westinghouse Vice President.

"If as successful as all our specific information and ultrashortwave experience indicates it to be," Mr. Evans stated, "Stratovision would make coast-to-coast television and FM broadcasting possible at a reasonable cost and would permit these services to be broadcast to even the most isolated farm homes many years ahead of any previously suggested system."

He explained at a meeting of editors and writers at the Waldorf-Astoria that the Stratovision system was originated by C. E. Nobles, 27-year-old Texas-born Westinghouse engineer.

"The Stratovision system simply puts the antenna and transmitter in an airplane flying in lazy circles 30,000 feet above the earth, out of sight of human eyes. The shortwaves sent out from this airborne antenna would blanket the earth's surface like a great inverted ice cream cone; covering an area 422 miles across or equal to about the combined area of New York, Pennsylvania and New Jersey."

Viewtone Company Introduces Popular Priced Television

First to announce a television receiver out of the luxury class, the Viewtone Company, of 203 East 18th Street, New York City, demonstrated at a dinner at the St. Moritz for newsmen and trade paper representatives its new set, which they claim is designed for low-cost mass production.

Described by their sales representative, Mr. Charles Rob-



THE NEW VIEW-TONE MODEL

bins, as the first television set in the low price market incorporating all the advances of new engineering principles in the electronic field, it will retail for about \$100.

The set is a small table model in a simple walnut cabinet which will blend unobtrusively with other home furnishings. It uses a seven-inch viewing tube which affords sharp, clear-cut images and surprisingly comfortable viewing with a minimum of eye strain.

Among the unusual features of the set, in addition to its size, says Mr. Robbins, is its simplicity of operation, installation and servicing.

Vest Pocket Radio Set Planned by Sentinel

What is described by its creator, the Sentinel Radio Corporation, Evanston, Ill., as an innovation in radio set convenience and utility, is the new vest pocket Sentinel radio planned for early production.

To be inconspicuously carried in vest pocket, shirt pocket, handbag, or concealed about the person, the new vest



VEST POCKET SET

pocket Sentinel will be several times smaller than the smallest camera or personal type radio sets manufactured prior to the war. It will provide good radio reception at all times. Its batteries are self-contained, and its aerial is contained in the wire leading to the ear-piece.

The "speaker" or ear-piece of the new Sentinel vest pocket radio will be entirely inconspicuous—of the approved hearing-aid type. The complete unit includes radio, batteries, tubes in the small, marvelously compact case—not much larger than a cigarette case—illustrated here.

Farnsworth Enters Railroad Communications Field

Entering the important post-war radio field of transportation communication and control, Farnsworth Television & Radio Corporation has acquired all of the assets of Halstead Traffic Communications Corporation including important patents relating to railway and highway radio communications.

In making the announcement, E. A. Nicholas, president of Farnsworth, stated that the Halstead acquisition unites two pioneer engineering organizations. The Farnsworth company has a background of some twenty years of pioneering work in television and holds many of the important patents in that field.

Most of the key personnel of the Halstead organization, including members of the engineering staff who have had long experience in railroad radio traffic control, have been added to the Farnsworth staff. William F. Halstead, president of the Halstead company, will serve Farnsworth as consulting engineer on radio communications equipment and traffic control as well as on other phases of electronics. John A. Curtis, vice president of Halstead and chairman of its management committee, has been appointed manager of the Farnsworth Communications Division.

Mr. Nicholas pointed out in his statement that, while radio has been widely used in communications and traffic control at sea and in the air for many years, recent developments have made possible the practical application of such systems to the railway.

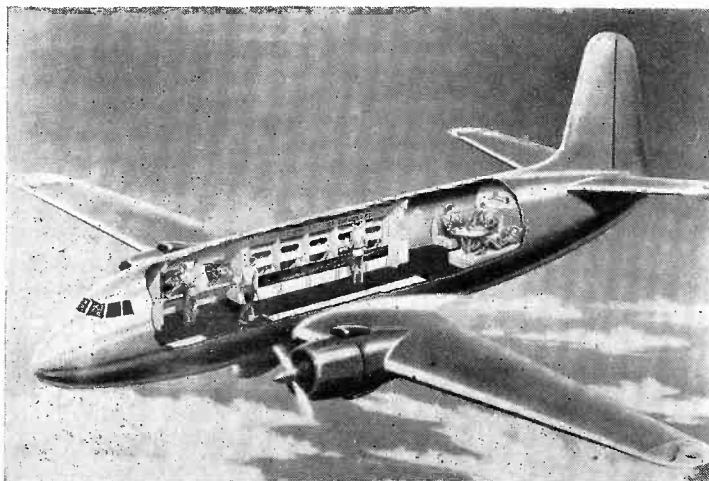

LAYOUT OF ONE OF THE GLENN MARTIN PLANES TO BE USED IN WESTINGHOUSE STRATOVISION.



C. E. NOBLES, (center), ORIGINATOR OF STRATOVISION, DISCUSSES IT WITH WALTER EVANS, (left), and WILLIAM EBEL.

The Farnsworth Authorized Dealer Display is designed to stop both window and store traffic. Mounted reproductions of current four-color Farnsworth national magazine advertisements keep the display timely.



A Good Deal for Good Dealers

NOT MANY RADIO DEALERS can have this new, modern display. It is the badge of a *good* dealer who has made a *good* deal—he holds a

Farnsworth Selected Dealer Franchise

with its many profit advantages. The Farnsworth

dealer organization will include less than one-quarter of the number of dealers representing the average popular pre-war radio line.

The Farnsworth dealer will handle a line of radios and phonograph-radios backed by years of sound research, progressive engineering and practical pre-war manufacturing experience. In his showroom will be distinctive “idea” cabinets designed for maximum customer appeal and satisfaction.

Record changers—already proved in pre-war—have been further improved and will provide care-free performance and careful record handling—will help build the dealer’s record business.

An impressive national advertising campaign has already built a strong demand for Farnsworth—and this advertising will be continued—thereby building a still stronger public demand for the Farnsworth line.

The Authorized Dealer Display stamps you as *the* dealer in your area worthy of the Farnsworth Selected Dealer Franchise—based on profitable volume at established prices and proper margins.

F A R N S W O R T H

Television · Radio · Phonograph-Radio



**The Franchise
that leaves you
FREE to carry the
best in every field**

When you take your pen in hand to place on the dotted line the signature that makes you an authorized Zenith Radio dealer, you are truly signing the radio dealer's Declaration of Independence.

For—in so doing—you sign a franchise which is dedicated to the policy of

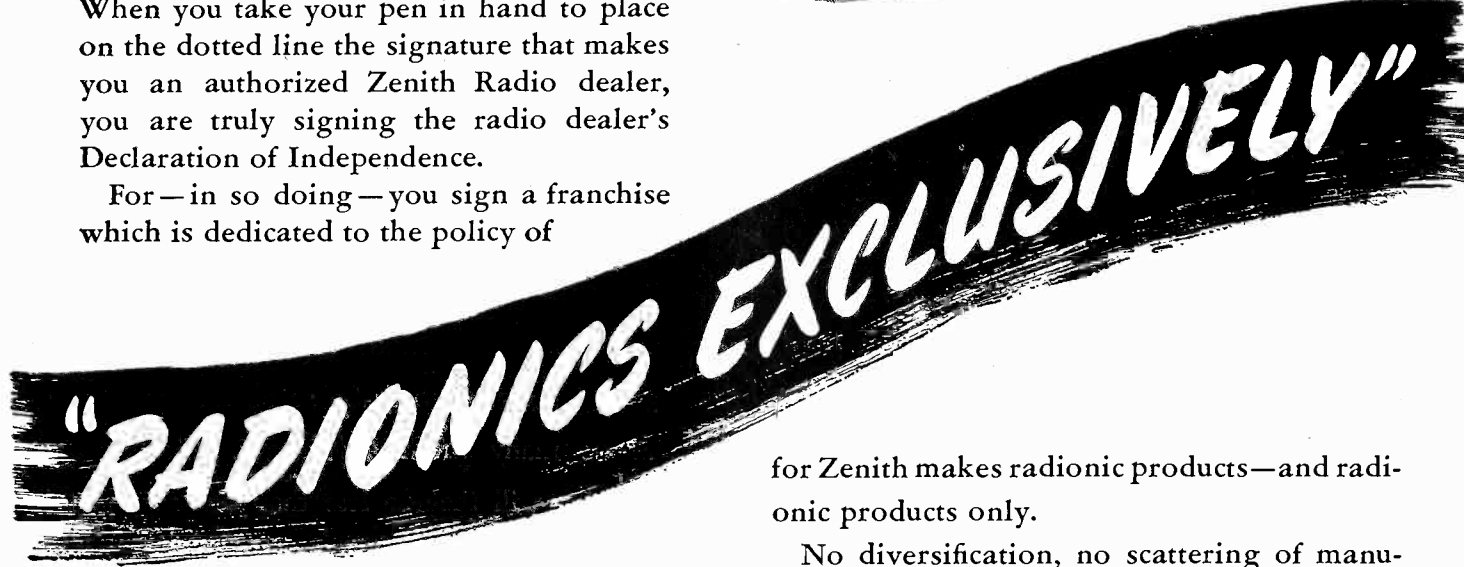

—expressed again and again by Zenith through the years of its continuous progress to the outstanding supremacy it now enjoys—thanks to you radio merchants of America.

To be free to choose the best in every field to present to your local public is representative of the American way of doing things. A Zenith franchise carries no forced combinations of refrigerators, washing machines, ranges, etc.,

for Zenith makes radionic products—and radionic products only.

No diversification, no scattering of manufacturing effort among many products—rather, extreme concentration on *one thing for you—the finest possible "Advanced Engineering" line of Zenith Radionic Radios.*



Watch Zenith!

Keep in touch with your Zenith Distributor. He is being kept informed on latest factory developments.

ZENITH RADIO CORPORATION • CHICAGO 39

Keep Your Eye on ZENITH for the Best in Radio!

REG. U. S. PAT. OFF.
LONG DISTANCE RADIO
REG. U. S. PAT. OFF.

**RADIONIC PRODUCTS EXCLUSIVELY—
 WORLD'S LEADING MANUFACTURER**

RADIO • FM • TELEVISION • RADAR • SHORT WAVE • RADIO • PHONOGRAPHS • HEARING AIDS

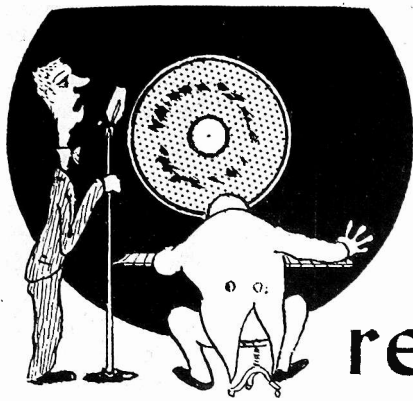

record

Releases

COLUMBIA

- Set M-MM-573 *Tristan Und Isolde*—Helen Traubel, soprano with Philharmonic Symphony Orchestra, Artur Rodzinski, conductor
- Set M-574 *Kostelanetz Conducts*—Andre Kostelanetz and Orchestra
- Set M-576 *Russian Music for Two Pianos*—Vronsky & Babin
- Set X-MX-252 *Symphony No. 1, Opus 9*—Bruno Walter conducting the Philharmonic Symphony Orch.
- 36831 *Taps Miller*—Count Basie and Orchestra
Jimmy's Blues — Jimmy Rushing vocal, Count Basie Orchestra
- 36832 *On the Atchison, Topeka and the Santa Fe* — Kate Smith
Johnny's Got a Date With a Gal in New York — Kate Smith
- 36833 *I'll Buy That Dream*—Harry James' Orchestra, Kitty Kallien vocal
Memphis in June — Harry James
- 36834 *The Wish That I Wish Tonight*—Ray Noble and Orchestra
So-o-o in Love—Trudy Irwin vocal, Ray Noble Orchestra
- 36835 *June Comes Around Every Year*—Woody Herman and Orchestra, Woody Herman vocal
Northwest Passage — Woody Herman
- 36836 *No Can Do* — Xavier Cugat and Orchestra, Leah Ray vocal
You Forgotcha Guitar — Xavier Cugat
- 36837 *Tired* — Pearl Bailey vocal, Mitchell Ayres Orchestra
Fifteen Years — Mitchell Ayres Orchestra
- 6746 *I've Taken All I'm Gonna Take From You* — Spade Cooley Orch.
Forgive Me One More Time — Tex Williams vocal, Spade Cooley Orchestra

DECCA

- 18694 *From Out of Nowhere* — Helen Forrest, Victor Young Orchestra
Strange As It Seems—Helen Forrest
- 18695 *Counting the Days* — Glen Gray Orchestra, Skip Nelson vocal
All By Myself — Glen Gray Orch.
- 18696 *Stars in Your Eyes* — Guy Lombardo Orch., Jimmy Brown vocal
Small World — Guy Lombardo Orchestra
- 23424 *Ave Maria* — Schubert, Philharmonic Orchestra of Los Angeles, Alfred Wallenstein director
- 23434 *Some Sunday Morning* — Dick Haymes and Helen Forrest, Victor Young Orchestra
I'll Buy That Dream—Dick Haymes and Helen Forrest.

- 23435 *From Out of Nowhere* — Johnny Green and Orchestra, Ralph Blane vocal
The Steam Is On The Beam—Johnny Green Orchestra

MAJESTIC

- 7132 *Sweetheart of All My Dreams*—The Three Suns
Don't Apologize — The Three Suns
Dream — The Three Suns
- 7133 *It's Dawn Again* — The Three Suns
- 7134 *Bell Bottom Trousers* — Louis Prima and Orchestra
Caldonia — Louis Prima and Orch.
- 7135 *I Was Here When You Left Me*—Louis Prima and Orchestra
Please No Squeeza Da Banana—Louis Prima and Orchestra
- 7136 *Up Jumped Love* — The Three Suns
Out of This World—The Three Suns
- 7137 *Clarinet High Jinks* — Jerry Wald and Orchestra
A Friend of Yours—Jerry Wald and Orchestra

VICTOR BLUEBIRD

- 33-0530 *Shame On You* — Bill Boyd and his Cowboy Ramblers
At Mail Call Today — Bill Boyd and his Cowboy Ramblers
- 33-0531 *Colin Kelly, Will You Tell the Boys Up Yonder* — The Buchanan Brothers
Troubles in My Heart — The Buchanan Brothers
- 33-0532 *Swaller Tail Coat* — Boyd Heath with Orchestra
Wailee, Sweet Wailee — Boyd Heath with Orchestra
- 34-0732 *Watch Shorty* — Lonnie Johnson
Some Day Baby—Lonnie Johnson

VICTOR POPULAR

- P-140 *Stephen Foster Favorites* — Sammy Kaye and Orchestra
- SP-5 *Gershwin Show Hits*—Dinah Shore
- SP-6 *Porgy and Bess* — Charlie Spivak and Orchestra
- 20-1710 *Nevada* — Tommy Dorsey
That's It — Tommy Dorsey

Center kindness to records

Finer reproduction

Filtered record scratch

Patented self-locking design

Longer needle life

Floating point construction

Horizontal and vertical shock absorption

All These Benefits
shower down on users of the
Fidelitone Master
 FLOATING POINT PHONOGRAPH NEEDLE

\$1.50 ATTRACTIVELY PACKAGED IN A USEFUL RECORD BRUSH

FM benefits turn into long green—profit—for dealers who prominently display the overwhelmingly popular Fidelitone MASTER longlife needle.

PERMO Incorporated 6415 Ravenswood Ave. Chicago 26



● Performance of General Industries phonograph mechanisms pleases every critic. Owners applaud the instant starting and quick pick-up, giving faithful reproduction of every note and syllable.

Manufacturers and dealers like the fine, trouble-free design and construction that reduce service to a minimum and keep every user content.

For postwar selling, put General Industries *Smooth Power* motors, recorders and combination record-changers-recorders in the front row—center!



THE GENERAL INDUSTRIES COMPANY
DEPT. M • ELYRIA, OHIO



Olympic Unveils Radio Invention

Before its distributors from metropolitan New York, New England and the Middle Atlantic states, Olympic division of Hamilton Radio Corporation unveiled its postwar radio line at the Hotel Astor on August 1.

Chief feature of the meeting was a demonstration of Olympic's wartime discovery, "true-base," a basic advance in the radio circuit which makes possible in compact or table sets the wide range of tone heretofore known only in the larger console types.

Opening the meeting with a resume of Olympic's pre-war activity in the manufacture of radios for use around the world, and its wartime record as producer of some of the most complex radio and radar equipment for the government, Jack F. Crossin, national sales director, declared that this experience has produced in the postwar Olympic a radio of exceptional selectivity and sensitivity which, like excess power in a car, pays off in the pinches.

Taking issue with what he termed "the popular fear of chaotic competition among radio brands, when the green light is flashed," Mr. Crossin stated that a careful survey of manufacturers planning to enter the field on a national distributor basis revealed less than 30 such companies. "And Olympic," he declared, "now has 100 per cent distributor representation throughout the United States."

"In addition to the demonstrable advantage of 'true-base,'" he stated, "Olympic can offer the public a line styled in what might be called

the modern—but not modernistic—manner. Style for style, model for model, the Olympic line will be fully competitive."

Shown at the meeting were five table models, one of them a radio-phonograph combination, and a portable to operate on either house current or self-contained batteries.

In closing the business session, Mr. Crossin stated that Olympic has placed orders for component parts for the production of a minimum of 190,000 Olympic Radio sets during the first six months of civilian manufacturing. This goal will be subject only to government regulations and availability of component parts.

Solar Announces Net Earnings

Peak net sales of \$7,681,268 yielded the Solar Manufacturing Corp., manufacturer of radio and electronic devices, a record net income of \$282,555 after Federal income and excess profits taxes in the six months ended June 30, contrasted with net profit of \$213,606 on sales of \$7,085,229 in the corresponding six months of 1944, it was announced recently.

Earnings for the half year were equivalent, after preferred dividends, to \$1.04 a share on 249,239 common shares outstanding and compared with 95 cents a share on 225,000 common shares a year ago. Pre-tax earnings for the latest period aggregated \$1,020,775, against \$809,632, while net provision for Federal income and excess profits taxes amounted to \$738,220, compared with \$596,025.

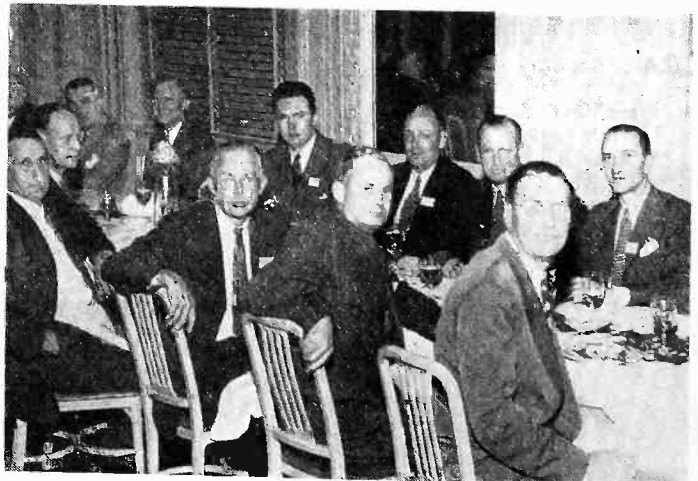

SOME OF THOSE WHO ATTENDED OLYMPIC DISTRIBUTOR MEETING
RADIO-TELEVISION JOURNAL, SEPTEMBER, 1945

Master Servicing

With this issue we revive the Master Servicing Section of Radio Television Journal, which will be welcomed by the thousands of radio service dealers who depended on it for the latest technical developments in radio and television servicing prior to its suspension as a separate section after Pearl Harbor. With the new age of electronics about to reach its fullest expression, we take pride in bringing you our Master Servicing Section as a regular monthly feature.

MASCO

Starts the New Era of Peace with profound

THANKS

from all Masco Employees and Sales Representatives

To All Our Suppliers...

for their whole-hearted cooperation and splendid support in helping us to produce war materials for our government.

To All Our Jobbers...

for their patient understanding of MASCO's war tasks.

To All Our Dealers...

for a mounting appreciation of MASCO quality and performance of our growing line of equipment.

WE PLEDGE...

Rapid reconversion. Maintenance of Quality. Clean channeling of all our goods through jobbers exclusively.

MARK SIMPSON MANUFACTURING CO.

MANUFACTURERS OF

Masco Sound Systems and Accessories

186-194 WEST FOURTH STREET :: NEW YORK 14, N. Y.

Telephone CHelsea 2-7112-3-4



How To Service Receivers With Minimum Test Equipment

by John Bowles

SECOND IN A SERIES OF THREE ARTICLES

The ability to find trouble quickly in these days of not too much test equipment is a necessity.

In trouble shooting physical and visual inspection of parts plus the substitution method will find 90 per cent of the faults. Usually a volt-ohmmeter is all that is needed to find the other 10 per cent.

In the August issue of RADIO Television JOURNAL, *Trouble Shooting with a Minimum of Test Equipment, Part I*, suggested a method of signal tracing for isolating the trouble. This part goes ahead with further ideas for running down the fault. Really excellent results can be obtained after a little practice. Therefore, give it a trial, even though you have plenty of test equipment. It will speed up your servicing. Save the test equipment for really stubborn cases.

Weak Reception

Most of the weak reception encountered is caused by bad tubes. The best method of testing a tube is to try a new one in its place. A tube tester does not always reveal whether a tube will perform a certain function. For example, a tube that is slightly gassy might not work as an automatic volume control or as an oscillator. Therefore, when reception is weak it is suggested that the best thing to do is remove the old set of tubes and try an entire new set. If the trouble is cleared up, the old tubes should be replaced, one at a time, until the bad one is found.

Low emission in a tube will produce low volume. Usually a low emission tube can be found by touching.

amount of plate current it will feel cooler than normal. If an entire new set is not available, try touching each. With a little practice you will soon be able to tell the normal temperature of the different classes of tubes.

Another thing to look for is the wrong type of tube being used. The tubes should be removed and the number on the tube compared with that on the socket or chassis near

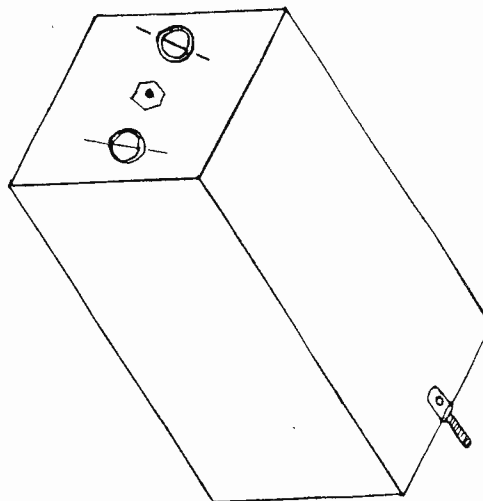

FIG. 1.

Mark the position of the adjustments of the i-f transformers with a pencil. Screws should be returned to the original position if volume is not increased by adjustment.

the socket. Many sets have a piece of paper pasted in the cabinet showing the tube line-up.

Shorted and loose tube elements are another source of low volume. Loose elements are usually characterized by a popping noise with a rise or fall in volume. Tapping the tube with the finger will tell if it has loose elements. Shorted elements may be found with an ohmmeter. Only two prongs of the tube should show continuity, except in certain rectifier tubes with tapped

filament for a pilot light. An example of such a tube is the 35Z5. The tube should be removed from its socket. One ohmmeter lead should be connected to one of the filament prongs and the other lead touched to each of the other elements in turn. Any reading denotes a short to the filament. If the tube is the cathode type the lead should be shifted from the filament to the cathode and each element tried again.

After the tubes have been eliminated as a source of trouble, the power supply should be examined. Low voltage might be causing the trouble. It is necessary to check the voltage between the plate of the power output tube and the chassis. This gives a check on the complete rectifier system. If the voltage is low, the power pack should be examined for shorted or leaky filter and by-pass condensers, a shorted transformer winding or a voltage divider that has changed its resistance.

The next point to check is the receiver proper. The tuned stages may be out of alignment. If the set is the tuned radio frequency type, a broadcast signal at about 1,400 kilocycles should be tuned in. With the volume turned low, the trimmers on each condenser should be adjusted to maximum volume. Next find some station where the first split segment of the rotor is in full mesh with the stationary plates. This segment should be bent in or out for the loudest signal. As many adjustments should be made as there are segments. Many times the increase in volume obtained is amazing.

Often the i-f stages in a superheterodyne can be brought into better

(Continued on page 80)

SYLVANIA NEWS

RADIO SERVICE EDITION

September Published by SYLVANIA ELECTRIC PRODUCTS INC., Emporium, Pa. 1945

SYLVANIA SERVICEMAN SERVICE

by
FRANK FAX



Radio servicemen looking for a simplified explanation of the science of electronics are urged to add to their reading list *A Primer of Electronics* by Don P. Caverly.

Simplified Language

It gives you, without formulas or much mathematics, just what you want to know about electronic principles and how they are applied in working devices.

Here is an especially clear and simple explanation of electronics and electronic tubes and circuits, written by a Sylvania engineer for all concerned with the application, servicing, operation, or manufacture of industrial or household devices based on this science. Basic enough for beginners, yet technically authoritative and complete.

Has Many Illustrations

Containing 235 pages of concise, easily understood language, the book is further clarified by having 125 specially prepared drawings and photographs. It is published by McGraw-Hill and is available for \$2.00 from your Sylvania distributor or, as a Sylvania service, directly from us.

RADIO SERVICEMEN CAN NOW OBTAIN FORMER GOVERNMENT TUBES

(Sylvania Tested and Guaranteed)

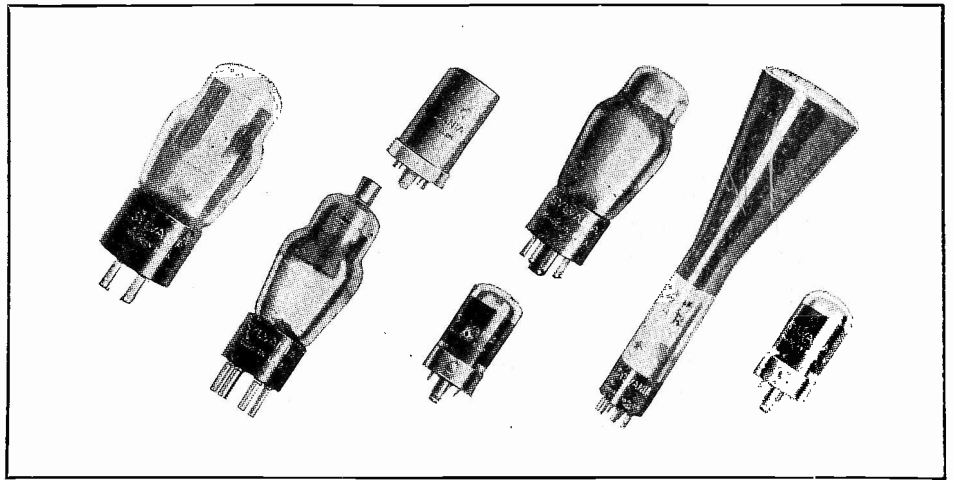

Sylvania Electric announces the following tube types available to radio servicemen.

Several of the types released are of particular interest to amateurs and experimenter. With this market in mind, Sylvania has inserted similar announcements in representative "ham" publications.

The current list is as follows:

38—Well known standard output pentode.

39/44—Well known standard R.F. Amplifier.

2X2/879—The standard high voltage, low current rectifier for oscilloscope use.

7C4/1203A—A small lock-in diode rectifier suitable for use in vacuum tube voltmeter probes. 6/3 volt 150 ma. heater.

7E5/1201—A lock-in triode for use as a low power oscillator or amplifier up to 750 mc. 6.3 volt 150 ma. heater.

46—Standard power amplifier. Suitable for Class B or C amplifiers and used in many amateur transmitters.

OD3/VR150—Radio servicemen recognize this well known voltage regulator.

EF-50—A 9 pin completely shielded R.F. Amplifier somewhat similar to Type 7W7. Heater rating 6.3 volts at 300 ma.

1626—A transmitting triode requiring 12.6 volts, 250 ma. heater supply. Four watts output at 250 volts plate (max.).

1629—Same characteristics as Type 6E5 except for octal base and heater rating of 12.6 volts. 150 ma.

38142 (VT-52)—Similar to Type 45 except for its filament rating of 7.0 volts. 1.18 amperes.

5BP1—Well known 5" cathode ray tube with the usual green trace. Makes a good scope with 1500 to 2000 volt anode supply.

5BP4—Same as 5BP1 except for the screen which gives a white trace.

VT-25A—This is the same as the regular Type 10 but has a low loss base. This item should be interesting to amateurs.

All tubes are available under the familiar L-265, or on rated orders, through Sylvania distributors.

SYLVANIA ELECTRIC

Emporium, Pa.

MAKERS OF RADIO TUBES; CATHODE RAY TUBES; ELECTRONIC DEVICES; FLUORESCENT LAMPS, FIXTURES, WIRING DEVICES; ELECTRIC LIGHT BULBS

RADIO-TELEVISION JOURNAL, SEPTEMBER, 1945

BOWLES

(Continued from page 78)

alignment thereby increasing the volume. If no oscillator is available, it is necessary to tune-in a station on the high-frequency end of the scale. Before making any adjustments on the i-f transformers, the position of the adjusting screws should be marked with a pencil, as shown in Fig. 1, so that if the adjustment fails to increase the volume it may be returned to its original position. By trying each adjustment in turn, one may be found which has strayed out of alignment.

Noise

One of the best procedures for finding the source of noise is to first determine if the noise originates in the set itself is picked up from an outside source. If working in the customer's home a station should be tuned-in where the noise is bothersome. After shorting the antenna and ground, the noise should disappear if it is coming from the outside. Of course, a set brought to the shop by the customer for noise would naturally eliminate the out-

side interference. So the set would need to be thoroughly checked for internal noise.

Much of the noise originating within a set comes from a dirty or worn out volume control. There is a very simple and effective test for determining if the control is causing the trouble. By wiggling the volume control knob up and down, and from side to side, while the set is playing you can tell if the trouble is caused by it.

A faulty tube is another common cause of noise. The best method for telling is to thump each tube with the finger. The noise will increase during the tapping if the tube has loose or shorted elements. A corroded or loose tube socket spring may also be revealed by this test.

Noise caused by the tuning condenser can be found by rotating the tuning knob over the entire scale. If this causes the noise, it is necessary to look for dirty sliding rotor contacts; bent or shorting plates; or dust, dirt, or metallic fuzz between the plates.

Carbonized resistors, leaky coupling and by-pass condensers may be found by moving them around with an orange stick. Prying around on the soldered joints will often reveal a poor soldering job which is a source of noise.

Set Dead

In a.c.-d.c. sets the most common cause of no signal is a burned-out tube, open ballast, or an open line

resistor. This can be told by merely looking to see if the tubes light up. If there is no light, an ohmmeter should be used to check across the filament of each tube. If no filaments are open, a check should be made from the plug prong to the chassis and from the other prong to the point where the line enters the tube series. This check tells whether the line resistor or ballast is open.

In the straight a.c. set it is much simpler to find a burned-out tube. If one is suspected by observation, its filament should be checked with an ohmmeter.

When no tubes are burned-out, the suggestion given in the topic *Weak Reception* should be followed. Sometimes the oscillator tube fails to function. If this condition is suspected, two or three different new tubes may be tried until one is found that gives the best results. However, a simple test to determine if the oscillator is functioning is to touch the moistened finger to the ungrounded side of the oscillator circuit. A click should be heard when the finger is touched and another one when it is removed. Unless two distinct clicks are heard, the circuit is not oscillating. It is also a good idea to go over all of the joints in the oscillator circuit with a hot soldering iron. A high resistance joint prevents oscillation.

Some of the a.c.-d.c. receivers have a series pilot light which is

(Continued on page 82)

Immediate Delivery

Hytron and Ken-Rad Tubes
Halldorson Vacuum Sealed
Transformers
Silver Vomax VTVM AA-5
59.85

Duotone Recording Blanks
Vaco Tools
Vibrapower Vibrators
Cinaudagraph Speakers

Phone 2509

Radio Supply Service
221 North Aurora
Ithaca, N. Y.

WE BUY USED 16MM
MOVIE EQUIPMENT

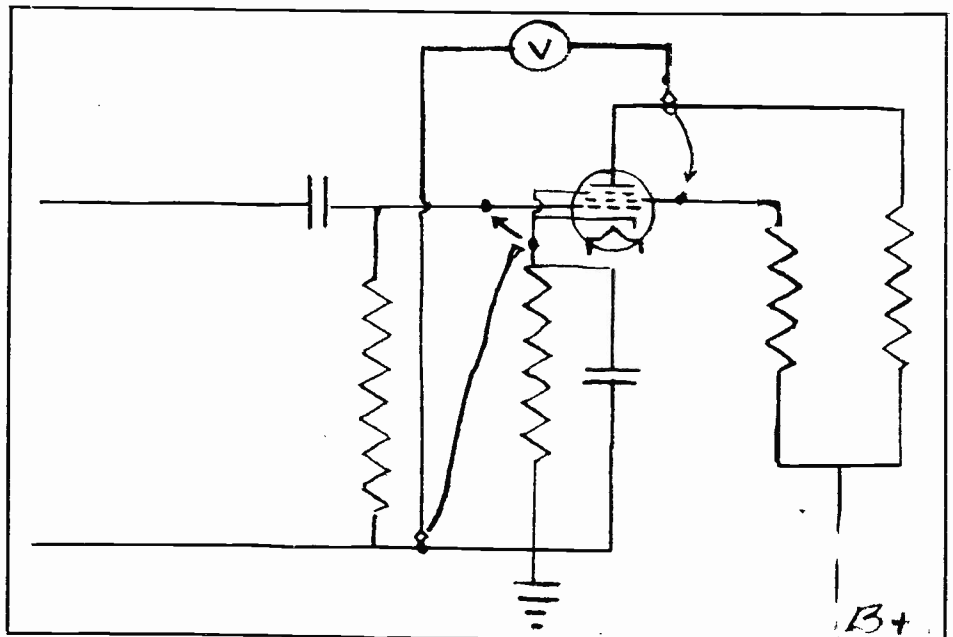

The plate, screen grid, cathode, and grid circuits of a stage may be checked quickly with a voltmeter. Readings should be taken from plate to chassis, plate to control grid, and plate to cathode. From the screen grid to the chassis indicates the condition of the screen resistor.

NO BUBBLE!

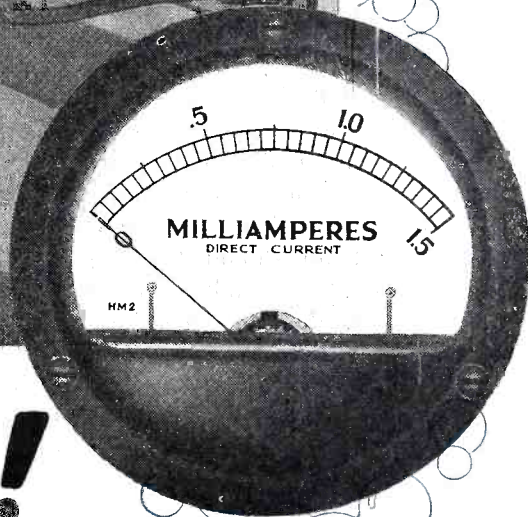

NO TROUBLE!

Production vacuum checking of Marion Glass-to-Metal Hermetically Sealed Electrical Indicating Instruments is no haphazard operation . . . After sealing in our dehydrating rooms, the instruments are submerged in glass jars which are partially filled with alcohol. A vacuum of 25 inches is drawn in accordance with newest JAN-1-6 specifications. During the test we watch for air bubbles — no bubble means no trouble. Spot checks for a period of four hours are made in a 29 inch vacuum.

The testing apparatus, illustrated above, is a Marion development, and demonstrates our sincerity of purpose in producing hermetically sealed instruments. We take nothing for granted — we neither suppose nor assume. Because imperfectly sealed instruments entrap condensation, we make certain that every hermetic instrument bearing our name is — perfectly sealed.

Marion Glass-to-Metal Truly Hermetically Sealed 2½" and 3½" Electrical Indicating Instruments

Write for our new, 12-page brochure. Manufacturers and users of radio and electronic equipment are invited to inquire into the advantages of Marion Glass-to-Metal Hermetically Sealed Instruments for postwar use.



MARION ELECTRICAL INSTRUMENT CO.

MANCHESTER, NEW HAMPSHIRE

Jobber Sales Division: Electrical Instrument Distributing Co.
458 BROADWAY NEW YORK, N. Y.

IF YOU WEIGH OVER 110 POUNDS, THE RED CROSS CAN USE A PINT OF YOUR BLOOD

BOWLES

(Continued from page 80)

used as a fuse. When it burns out the tubes in the set do not work. When replacing these lamps one rated at a slightly lower voltage than the original may be used. These lamps require more current to light brightly and therefore last longer.

After the tubes are eliminated as a source of trouble, the power supply should next be inspected. An over-all check for shorted filter or by-pass condensers can be made by checking with an ohmmeter between the filament or cathode (depending on the type of tube) of the rectifier and the chassis. If the resistance is much less than 2,000 ohms, a short probably exists. In some sets the speaker field is connected directly across the power supply. The resistance of such speakers usually averages about 2,000 ohms. However, some may run as low as 1,000. If there is any doubt, each condenser should be cut loose and tested individually. On filter condensers the ohmmeter hand should flash up a small amount and fall back gradually until it almost reaches infinity. A steady resistance reading of a fairly low value indicates a bad leak and the unit should be changed. A shorted by-pass condenser shows a reading on the meter. A good one shows no reading.

The filter choke and the voltage divider may be checked for shorts to chassis and for continuity with an ohmmeter. Both are sometimes found open or shorted.

If the power supply is putting out its normal voltage, the receiver proper should be tested. The plate, screen and grid circuits should be checked. The quickest way to make such a check is with a d.c. voltmeter. The voltmeter should be connected

between the plate or screen grid, depending on which you wish to test, and the chassis. Voltage here means there is no open circuit. The grid circuit can be easily checked by moving the voltmeter lead from the chassis to the grid cap or control grid prong. If the meter still shows voltage, there is no open in the grid circuit. This test gives a check on primary and secondary of the radio frequency coils, primary and secondary of audio transformers, plate resistors and grid resistors. Fig. 2 illustrates how to make the test.

Hum

To determine what is causing the hum in a set it is first necessary to classify the kind of hum. The hum may exist at all times whether the receiver is tuned to a station or not. It may be heard only when a loud station is tuned-in. Or it may come from a part and not through the speaker.

A hum that is fairly constant but which is not as loud as the tuned-in program, is usually due to inadequate filtering. This is usually due to an open filter condenser or one that has lost part of its capacity. The best method for testing this is to merely substitute a good condenser of the correct capacity across the suspected unit.

When the set warms up and the hum is so loud and constant that no station can be tuned in, a complete break-down is indicated. The rectifier tube should be carefully observed. If the elements, particularly the plate, get red-hot and a blue glow arises between the elements, it is almost definite indication that a filter or by-pass condenser is shorted. The rectifier tube and filter condensers are so intricately tied up that the failure of one usually causes the failure of the other. It is safe

to replace the tube only after making certain that there is no short in the filter or by-pass condensers.

Hum that can be tuned in with a loud station is caused by a.c. voltage getting into the r-f section of the receiver. The line cord should be moved around to various locations to see if it is causing the hum. The grid leads of the radio frequency tubes should be moved to new locations, if possible, to see if this stops the hum. If this does not help, it is next necessary to see if it looks as if any shielding has been removed from the set. If the hum still persists, an isolation test should be made with a pair of headphones in series with a .1mfd. condenser. The leads should be connected between the chassis and plate of each tube, starting with the speaker and working progressively towards the antenna and ground, until the stage with abnormal hum is located. When the stage is found, careful observation will usually reveal the defect. Things to be looked for are: open or high resistance joints in the grid circuit, control grid cap of the tube not properly soldered, open screen or cathode by-pass condenser, or wrong type of tube.

Mechanical hum can usually be found by listening directly in front of the speaker. If the hum is not coming through the speaker, it is coming from some vibrating part. Such vibrations will in most cases be loose laminations in either the power transformer or filter choke. Tightening the bolts that hold the unit together should stop the hum. The bolts mounting the transformer to the chassis should also be tightened. If the bolts do not tighten the laminations, a small wooden wedge may be driven between the laminations.

PILOT RADIO

*your beacon to a better business
in better radios*

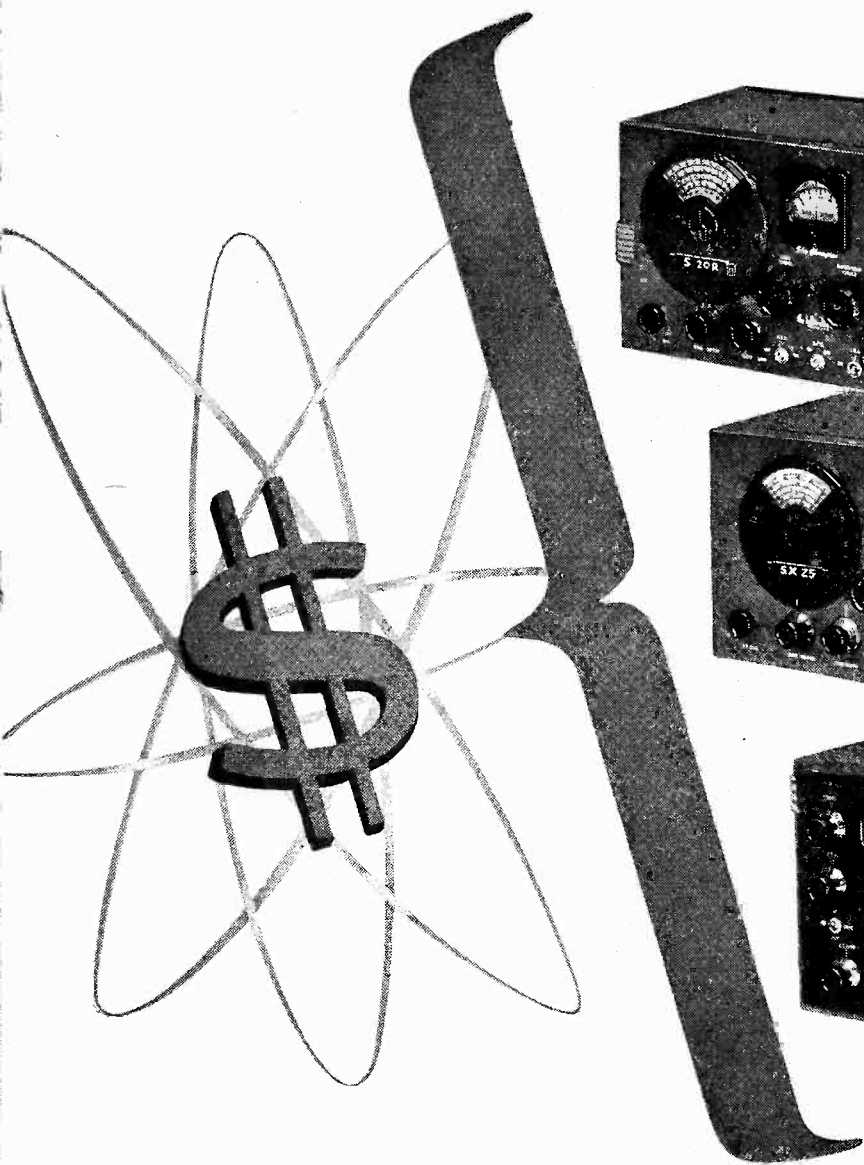

MODEL S-20R



MODEL SX-25

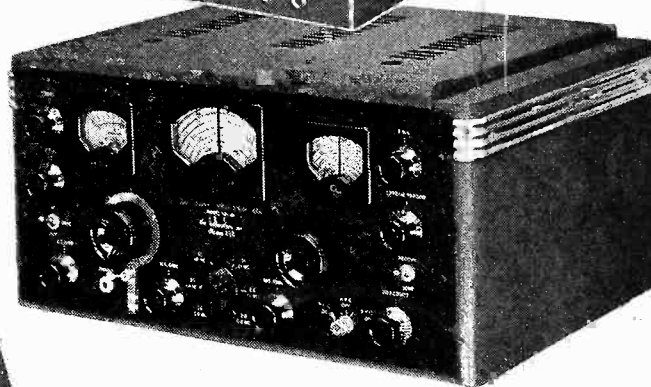

MODEL SX-28A

A Special, **VERY IMPORTANT
SECTION OF THE RADIO MARKET
MUST CONSIDER HALLICRAFTERS**

We mean the amateur market—the thousands and thousands of radio pioneers who know and demand the best. This market is growing—swelled by the rapid strides in communications training brought about by the war. The post war amateur market will be bigger, better than ever—with more than 186,000 amateurs expected to apply for licenses, according to recent FCC testimony by the American Radio Relay League. To this primary market Hallicrafters will be able to offer a line of high frequency receivers and transmitters that will be the most complete ever offered for amateur use.

hallicrafters RADIO

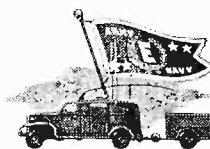

BUY A WAR BOND TODAY!

THE HALLICRAFTERS CO., WORLD'S LARGEST EXCLUSIVE MANUFACTURERS OF
SHORT WAVE RADIO COMMUNICATIONS EQUIPMENT, CHICAGO 16, U. S. A.

COPYRIGHT 1945
THE HALLICRAFTERS CO.

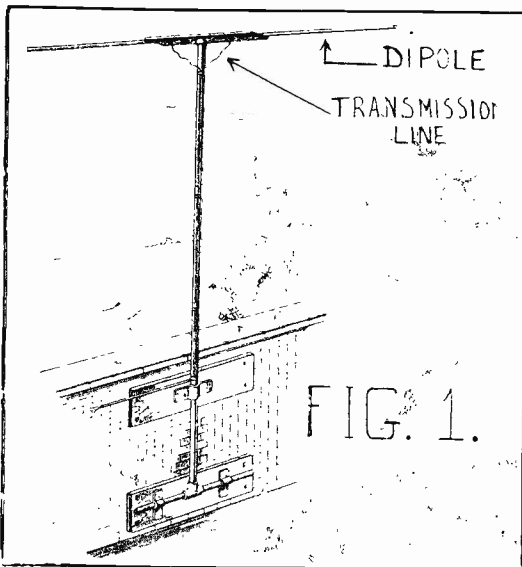

How to Install the Television Receiver

by Joseph Oxenhorn
Technical Editor

The installation of the home radio receiver has been simplified and perfected to the point where practically any purchaser of a radio set can do his own installation. It must be remembered, however, that even this simple type of installation was not practiced by the consumer until radios had been on the market for many years. The installation of the television receiver presents a far more complex problem for two reasons: First, the installation and orientation of the antenna is of vital significance in the satisfactory operation of the receiver; second, important adjustments on the set itself require the services of an expert serviceman and cannot be performed by the man in the house on some Saturday afternoon. Furthermore, the use of high voltage and dangerously evacuated tubes, renders the operation far from safe for the average layman. Add to this the fact that television sets are new and strange "gadgets,"

and you can easily see that the serviceman will play a great part in this phase of television.

Location of Receiver in Room

The first problem you are going to buck up against in television installations is the location of the receiver in the room. This may present a problem, in that the spot previously occupied by the radio set is no longer satisfactory for a television set because it is in a direct glare from a window or from a lamp at night. You will have to convince the consumer—with much patience and tact—that it may be necessary to do a little moving of the furniture. Remember that a direct glare will materially affect the contrasting blacks and whites in the picture. If necessary, close the blinds, put on the artificial lighting system and use this as a guide for proper location for night-time viewing.

Antenna Types

The conventional wire and lead-in

type of antenna is unsatisfactory in most instances of television receivers. The reason for this is that actual reflections may be caused by the lead-in wire and thus give rise to ghost effects (double images) on the screen. For this reason, the dipole type of antenna is the one that will give the best results. Two types of dipoles which are widely used will be discussed here. These are the *Simple Dipole* (Figure 1), and the *Stacked Dipole* (Figure 2). Either of these types may be fitted with a *Reflector* (Figure 3) if circumstances warrant its use.

The *Simple Dipole* consists of two metal rods of a length and diameter dictated by the existing television channel allocation and characteristics of the transmitter and receiver characteristics. It is placed on a vertical mounting shaft and can be polarized vertically or horizontally. Each of the dipole members is equipped with

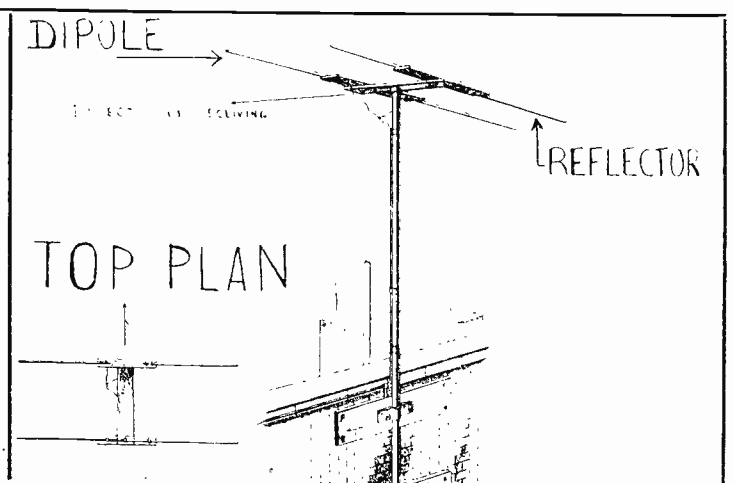
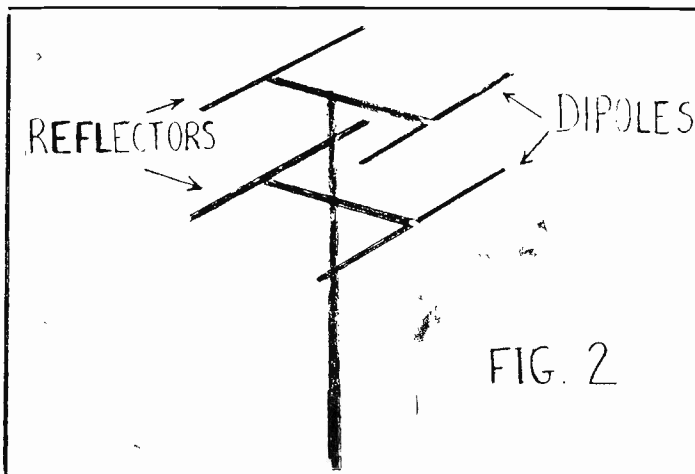

a lug to which the transmission line is soldered. The length of the dipole varies with the channel to be picked up. It is computed from this width to give the required half wavelength and 90% of this length is then used as the length of the dipole, that is both members end to end. The computation is as follows:

$$\text{Wavelength} = \frac{984}{\text{no. megacycles (mid frequency of the channel)}}$$

$$\text{Length of Dipole} = 90\% \text{ of } L/2$$

Each Member of the Dipole is $\frac{1}{2}$ of this figure.

The table on the next page gives the fully computed values for the dipole lengths required for the new television channels (as adopted by the FCC, May 25, 1945).

The most important feature in regard to this antenna is its orientation in reference to the transmitter. This will be discussed below.

The *Stacked Dipole* consists of two dipoles mounted one over another on the vertical mounting shaft. This type of antenna provides for greater sensitivity and can cover a wide band of frequencies. The two dipoles are separated by a distance of half a wavelength.

A *Reflector* is an additional set of rods placed parallel to the dipole, but with no connection to the dipole or the transmission line. Its function is to prevent reflected signals giving rise to ghost effects (double images) on the screen. The reflector is somewhat longer than the dipole. It is mounted about a $\frac{1}{4}$ wavelength behind the dipole. Not only does it prevent reflections, but also increases the signal strength.

Transmission Lines

The conventional type of lead-in wire cannot be used for satisfactory results in television receivers. The reason for this is that the lead-in itself is capable of signal pickup and thereby may be a cause of reflections. Consequently one of the following three types of transmission lines is used: *parallel wire type*; *coaxial type*; *twisted pair type*.

The most widely used types are the twisted pair and coaxial lines. The twisted pair is use with satisfactory

(Continued on next page)

IN TRANSFORMERS...

STANCOR Gives More!



- MORE ADAPTABILITY
- MORE ENGINEERING
- MORE BUILT-IN FEATURES
- MORE YEARS OF SERVICE

MORE than 80% of all radio transformer replacement requirements are met by the Stancor Uni-dapt Power Transformer line—"universally adaptable." The features wanted by radio service men, amateurs, and electronic engineers have been expertly engineered into this transformer line: (1) Ready interchangeability of mounting, assured by four auxiliary mounting brackets permits adaptation to a variety of mounting positions; (2) Heavy insulated leads, tinned for easy soldering; (3) Electrostatic shielding for minimum line interference; (4) Efficient core and coil design plus Stancor quality impregnation provide longer life and trouble-free service.

For transformer replacements, think first of Stancor. Write for details.

STANDARD TRANSFORMER CORPORATION

1500 NORTH HALSTED STREET CHICAGO 22, ILLINOIS



STANCOR UNI-DAPT
(UNIVERSALLY-ADAPTABLE)
REG. U. S. PAT. OFF. PHDG.

POWER TRANSFORMERS

OXENHORN

(Continued from page 85)

results where the line is not required to be too long. Where the length of the lead-in is too great, the coaxial (hollow conductor) type is employed.

Installation Procedure

1. *Receiver Location.* Place receiver in room in the location that will avoid a glare on the screen of the picture tube.

2. Determining Antenna Position.

- a. Determine position of transmitter.
- b. Whenever possible, erect the dipole so that it will be in line of sight with the transmitter.
- c. The long dimension of the antenna must be perpendicular to the direction in which the video waves are traveling.
- d. If on a street with heavy traf-

Tele- vision Channel	Wave- length	L/2	90% L/2	Each Member
1	20.9	10.5	9.5	4.8 ft.
2	17.2	8.6	7.7	3.9 ft.
3	15.6	7.8	7.0	3.5 ft.

fic, place the antenna towards the rear of the building.

e. Do not install antenna so that a tall structure stands as an obstacle between antenna and transmitter. That is, mount the antenna free of obstructions. Do not mount the antenna so that a tall structure is directly behind it.

f. Mount the antenna as high as possible.

3. *Antenna Mounting.* Mount the vertical shaft. Then mount the dipole (and reflectors, if used).

4. *Transmission Line Installation.* Solder the transmission line to the lugs on the dipole members. Run the line into the receiver and connect to input circuit.

Installation Adjustments

1. Adjust the receiver to produce a scene on the screen.

2. If necessary (probably), adjust the antenna to give best results.

3. Make further adjustments as indicated in Table II, if required.

TABLE II Installation Adjustments

- Symptoms or Trouble
1. Picture unsteady vertically
 2. Picture out of line with center of opening
 3. Out of Focus
 4. Picture out of place horizontally
 5. Unsatisfactory width of picture 666.
 6. Picture too narrow; out of proportion vertically
 7. No picture, only light and dark spaces

- Adjustment Control
1. Vertical Frequency Control
 2. Vertical Positioning Control
 3. Astigmatic Positioning Control
 4. Horizontal Positioning Control
 5. Horizontal Size Control
 6. Vertical Size Control
 7. Horizontal Frequency Control

RADIO ENGINEERS

... here is your personal

Postwar Opportunity

AN EXCEPTIONALLY fine postwar opportunity is available for two high type experienced radio engineers who know what the score is on chassis design, circuits, etc. We are an old established, well financed, highly thought of New England company which has earned a real acceptance in the industry during the pre-war years.

We offer you:

Pleasant working conditions.

Congenial associates who will work with you.

A good starting salary.

A chance to grow with us.

Security for the postwar era.

If you think you can qualify for these important jobs please write in full detail about your experience, background, salary requirements and anything else you feel we would need to know to arrange for an interview at our expense. All replies will be held in strictest confidence. Address your letter to

BOX 845

RADIO TELEVISION JOURNAL

1270 Sixth Avenue

New York 20, N. Y.

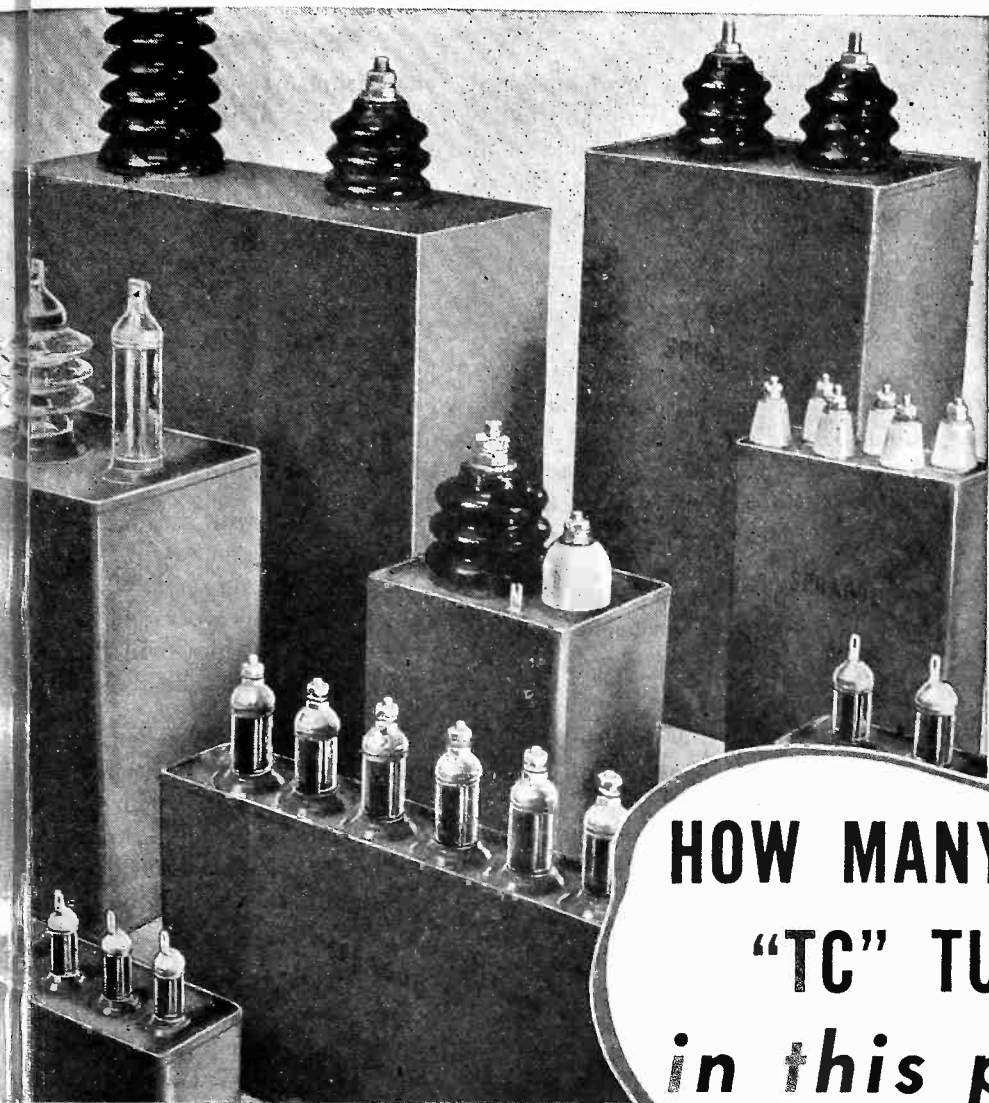

HOW MANY SPRAGUE "TC" TUBULARS in this picture?

THESSE big energy storage capacitors are recent Sprague Electric Co. types developed for flash-photography, high-voltage networks, welding and other exacting wartime uses.

Consider thousands upon thousands of these giants in terms of the vast quantities of "TC" Tubular Capacitors and other service types that could have been made with the same investment of time and materials, and the Sprague wartime record looms even more impressive.

Every replacement type that has occasionally been missing from jobbers' stocks has been

more than accounted for by the FIVE separate Army-Navy "E" citations that Sprague has achieved. Moreover, a constant and steadily increasing supply of Sprague Atoms and "TC" Tubulars still makes it possible to match 9 out of 10 replacement requirements "on the nose!"

Watch for forthcoming Announcements of new Sprague postwar types.

Sprague Products Company
North Adams, Mass.

(Jobbing Sales Organization for Products of the Sprague Electric Co.)

SPRAGUE



**"NOT A FAILURE
IN A MILLION!"**

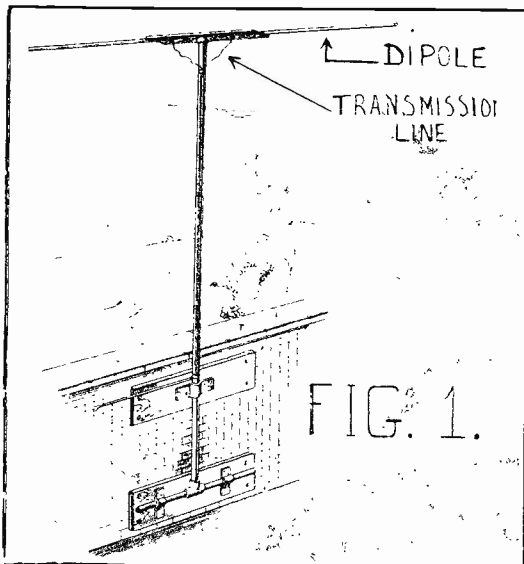

How to Install the Television Receiver

by Joseph Oxenhorn
Technical Editor

The installation of the home radio receiver has been simplified and perfected to the point where practically any purchaser of a radio set can do his own installation. It must be remembered, however, that even this simple type of installation was not practiced by the consumer until radios had been on the market for many years. The installation of the television receiver presents a far more complex problem for two reasons: First, the installation and orientation of the antenna is of vital significance in the satisfactory operation of the receiver; second, important adjustments on the set itself require the services of an expert serviceman and cannot be performed by the man in the house on some Saturday afternoon. Furthermore, the use of high voltage and dangerously evacuated tubes, renders the operation far from safe for the average layman. Add to this the fact that television sets are new and strange "gadgets,"

and you can easily see that the serviceman will play a great part in this phase of television.

Location of Receiver in Room

The first problem you are going to buck up against in television installations is the location of the receiver in the room. This may present a problem, in that the spot previously occupied by the radio set is no longer satisfactory for a television set because it is in a direct glare from a window or from a lamp at night. You will have to convince the consumer—with much patience and tact—that it may be necessary to do a little moving of the furniture. Remember that a direct glare will materially affect the contrasting blacks and whites in the picture. If necessary, close the blinds, put on the artificial lighting system and use this as a guide for proper location for night-time viewing.

Antenna Types

The conventional wire and lead-in

type of antenna is unsatisfactory in most instances of television receivers. The reason for this is that actual reflections may be caused by the lead-in wire and thus give rise to ghost effects (double images) on the screen. For this reason, the dipole type of antenna is the one that will give the best results. Two types of dipoles which are widely used will be discussed here. These are the *Simple Dipole* (Figure 1), and the *Stacked Dipole* (Figure 2). Either of these types may be fitted with a *Reflector* (Figure 3) if circumstances warrant its use.

The *Simple Dipole* consists of two metal rods of a length and diameter dictated by the existing television channel allocation and characteristics of the transmitter and receiver characteristics. It is placed on a vertical mounting shaft and can be polarized vertically or horizontally. Each of the dipole members is equipped with

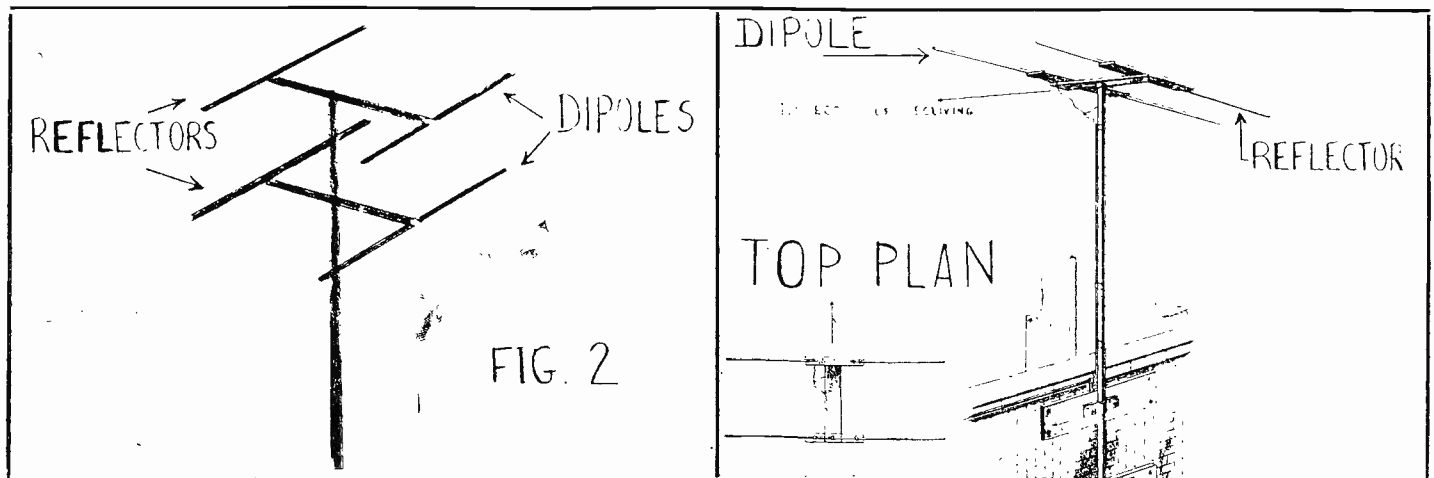

a lug to which the transmission line is soldered. The length of the dipole varies with the channel to be picked up. It is computed from this width to give the required half wavelength and 90% of this length is then used as the length of the dipole, that is both members end to end. The computation is as follows:

984

Wavelength = $\frac{984}{\text{no. megacycles (mid frequency of the channel)}}$

Length of Dipole = 90% of L/2

Each Member of the Dipole is $\frac{1}{2}$ of this figure.

The table on the next page gives the fully computed values for the dipole lengths required for the new television channels (as adopted by the FCC, May 25, 1945).

The most important feature in regard to this antenna is its orientation in reference to the transmitter. This will be discussed below.

The *Stacked Dipole* consists of two dipoles mounted one over another on the vertical mounting shaft. This type of antenna provides for greater sensitivity and can cover a wide band of frequencies. The two dipoles are separated by a distance of half a wavelength.

A *Reflector* is an additional set of rods placed parallel to the dipole, but with no connection to the dipole or the transmission line. Its function is to prevent reflected signals giving rise to ghost effects (double images) on the screen. The reflector is somewhat longer than the dipole. It is mounted about a $\frac{1}{4}$ wavelength behind the dipole. Not only does it prevent reflections, but also increases the signal strength.

Transmission Lines

The conventional type of lead-in wire cannot be used for satisfactory results in television receivers. The reason for this is that the lead-in itself is capable of signal pickup and thereby may be a cause of reflections. Consequently one of the following three types of transmission lines is used: *parallel wire type*; *coaxial type*; *twisted pair type*.

The most widely used types are the twisted pair and coaxial lines. The twisted pair is use with satisfactory

(Continued on next page)

IN TRANSFORMERS...

STANCOR Gives More!



- MORE ADAPTABILITY
- MORE ENGINEERING
- MORE BUILT-IN FEATURES
- MORE YEARS OF SERVICE

MORE than 80% of all radio transformer replacement requirements are met by the Stancor Uni-dapt Power Transformer line—“universally adaptable.” The features wanted by radio service men, amateurs, and electronic engineers have been expertly engineered into this transformer line: (1) Ready interchangeability of mounting, assured by four auxiliary mounting brackets permits adaptation to a variety of mounting positions; (2) Heavy insulated leads, tinned for easy soldering; (3) Electrostatic shielding for minimum line interference; (4) Efficient core and coil design plus Stancor quality impregnation provide longer life and trouble-free service.

For transformer replacements, think first of Stancor. Write for details.

STANDARD TRANSFORMER CORPORATION

1500 NORTH HALSTED STREET CHICAGO 22, ILLINOIS



STANCOR UNI-DAPT
(UNIVERSALLY-ADAPTABLE)
REG. U. S. PAT. OFF. PHDG.

POWER TRANSFORMERS

OXENHORN

(Continued from page 85)

results where the line is not required to be too long. Where the length of the lead-in is too great, the coaxial (hollow conductor) type is employed.

Installation Procedure

1. *Receiver Location.* Place receiver in room in the location that will avoid a glare on the screen of the picture tube.

2. Determining Antenna Position.

- a. Determine position of transmitter.
- b. Whenever possible, erect the dipole so that it will be in line of sight with the transmitter.
- c. The long dimension of the antenna must be perpendicular to the direction in which the video waves are traveling.
- d. If on a street with heavy traf-

Television Channel	Wave-length	L/2	90% L/2	Each Member
1	20.9	10.5	9.5	4.8 ft.
2	17.2	8.6	7.7	3.9 ft.
3	15.6	7.8	7.0	3.5 ft.

fic, place the antenna towards the rear of the building.

e. Do not install antenna so that a tall structure stands as an obstacle between antenna and transmitter. That is, mount the antenna free of obstructions. Do not mount the antenna so that a tall structure is directly behind it.

f. Mount the antenna as high as possible.

3. *Antenna Mounting.* Mount the vertical shaft. Then mount the dipole (and reflectors, if used).

4. *Transmission Line Installation.* Solder the transmission line to the lugs on the dipole members. Run the line into the receiver and connect to input circuit.

Installation Adjustments

1. Adjust the receiver to produce a scene on the screen.

2. If necessary (probably), adjust the antenna to give best results.

3. Make further adjustments as indicated in Table II, if required.

TABLE II
Installation Adjustments

- Symptoms or Trouble**
1. Picture unsteady vertically
 2. Picture out of line with center of opening
 3. Out of Focus
 4. Picture out of place horizontally
 5. Unsatisfactory width of picture
 6. Picture too narrow; out of proportion vertically
 7. No picture, only light and dark spaces

- Adjustment Control**
1. Vertical Frequency Control
 2. Vertical Positioning Control
 3. Astigmatic Positioning Control
 4. Horizontal Positioning Control
 5. Horizontal Size Control
 6. Vertical Size Control
 7. Horizontal Frequency Control

RADIO ENGINEERS

... here is your personal

Postwar Opportunity

AN EXCEPTIONALLY fine postwar opportunity is available for two high type experienced radio engineers who know what the score is on chassis design, circuits, etc. We are an old established, well financed, highly thought of New England company which has earned a real acceptance in the industry during the pre-war years.

We offer you:

Pleasant working conditions.

Congenial associates who will work with you.

A good starting salary.

A chance to grow with us.

Security for the postwar era.

If you think you can qualify for these important jobs please write in full detail about your experience, background, salary requirements and anything else you feel we would need to know to arrange for an interview at our expense. All replies will be held in strictest confidence. Address your letter to

BOX 845

RADIO TELEVISION JOURNAL

1270 Sixth Avenue

New York 20, N. Y.

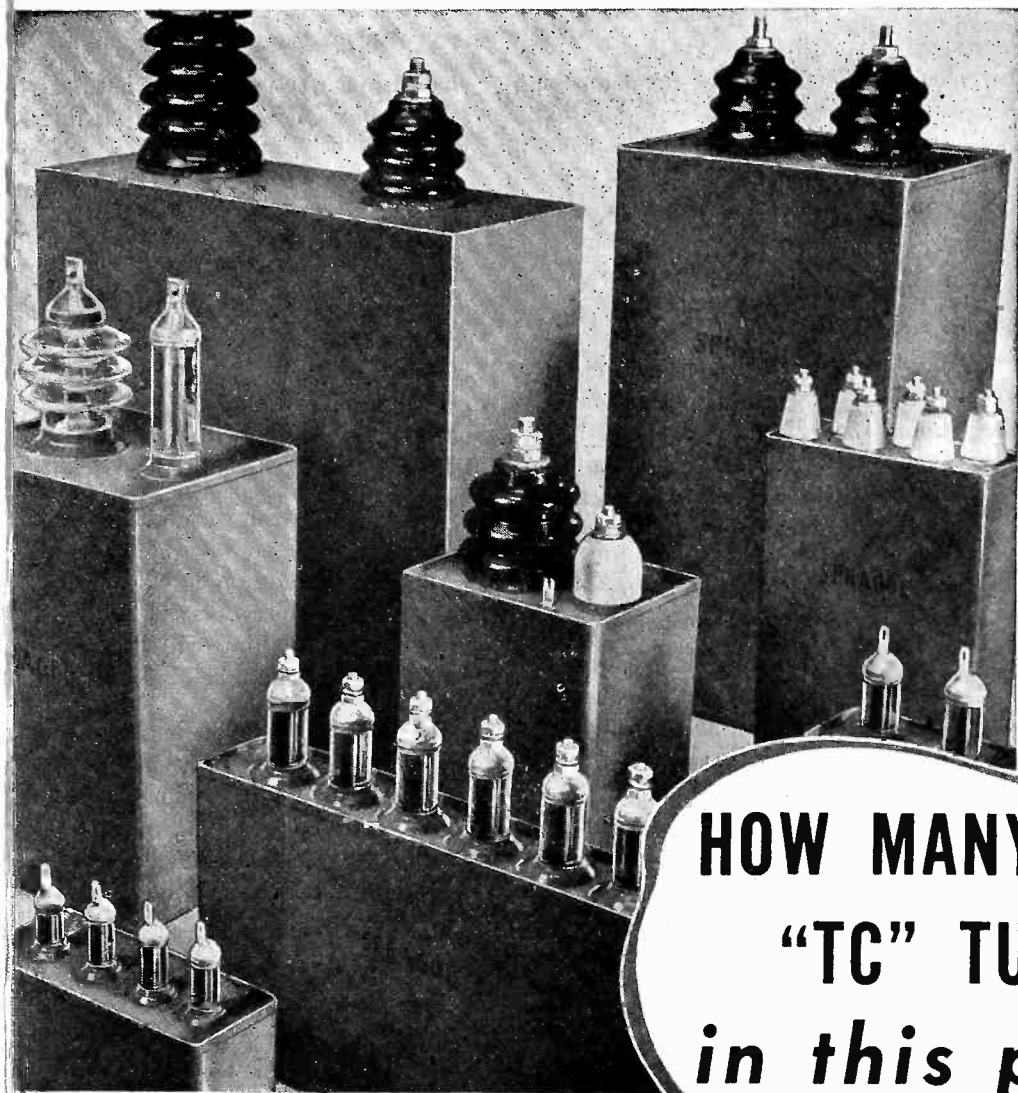

**HOW MANY SPRAGUE
"TC" TUBULARS
in this picture?**

THESSE big energy storage capacitors are recent Sprague Electric Co. types developed for flash-photography, high-voltage networks, welding and other exacting wartime uses.

Consider thousands upon thousands of these giants in terms of the vast quantities of "TC" Tubular Capacitors and other service types that could have been made with the same investment of time and materials, and the Sprague wartime record looms even more impressive.

Every replacement type that has occasionally been missing from jobbers' stocks has been

more than accounted for by the FIVE separate Army-Navy "E" citations that Sprague has achieved. Moreover, a constant and steadily increasing supply of Sprague Atoms and "TC" Tubulars still makes it possible to match 9 out of 10 replacement requirements "on the nose!"

Watch for forthcoming Announcements of new Sprague postwar types.

Sprague Products Company
North Adams, Mass.

(Jobbing Sales Organization for Products of the Sprague Electric Co.)

SPRAGUE



GAROD

(Continued from page 21)

The distributors were reminded emphatically that Garod has made FM combinations before the war and, therefore, was in a most advantageous position of having the "know-how" necessary to insure both precision engineering and quick delivery of sets incorporating this most important technological advance of the radio arts.

Backlog of Experience

Similarly, the Garod position relative to television is enhanced by a great backlog of many years of experimentation and manufacture. In fact, Garod introduced the first low-priced television kit, in knocked-down form, in September, 1938. Garod experience in television is an assurance that the company will at least keep pace with future television developments.

"For many years distributors and dealers have been asking for a line of radios incorporating features which reflect consumer preferences. These thoughts have guided our progress in the production of every model that you see here, based on a survey of dealer-consumer prefer-

ences. The fruits of precision engineering, beauty in design, and maximum utility are, we think, evident in the models displayed here. Superb tonal quality has always been a major concern of Garod manufacture, and we know that this new line of radios will sustain handsomely this Garod tradition. The tremendously expanding demand for recorded music, as well as the rapid development of home recordings is reflected by the incorporation of record storage space in our portable combinations as well as in the majority of our other models."

Advertising Campaign

A highlight of the meeting was the announcement of a comprehensive advertising and promotional campaign formulated to win widespread consumer acceptance for Garod radios. Every available means of communication will be utilized to put over the Garod story. A detailed presentation of the campaign was given by Louis Shappe, of Shappe-Wilkes Inc., advertising counselors for Garod.

Indicative of the tremendous enthusiasm generated among the distributors by the showing was the observation of Francis E. Stern, of Stern & Co., distributors for lower Connecticut, who expressed amazement that so many fine features had been combined in a line that still offered the advantage of competitive pricing. Mr. Stern stressed the point that Garod, unlike many manufacturers who utilized the table model chassis in combinations, had produced a specialized chassis for phono-combinations.

Leonard Ashbach, distributor for Garod in Chicago, stressed the point that bleached cabinets would exert a strong appeal in his territory particularly, and in general throughout the mid-west. The consensus of distributor opinion was expressed by Clarence E. Wyman, Tel-Ra Appliance Co., distributor for Rhode Island, who said that the Garod line combined to an unusual degree all the requirements for successful mer-

chandising, irrespective of what basis for comparison with competing lines was used.

The Garod Radio Corporation recently announced the appointment of the following sales representatives:

C. R. "Connie" Strassner, of Los Angeles, California, who has offices in San Francisco as well as Los Angeles. Connie, who is extremely popular on the Coast, will cover the entire states of California and Arizona.

Pete Bach, with headquarters in Portland, Oregon, will represent Garod in Oregon and Washington. Pete, with many years of solid experience behind him, will do an excellent job, Garod officials predict.

The area of Eastern Pennsylvania, Maryland and Virginia will be handled by Sam Levine, with offices in Philadelphia. Well-known in his territory, Sam is now busily engaged in signing up dealers for Garod radios.

Pat Haggerty has been appointed to represent Garod in the state of Michigan, the northwestern corner of Ohio, including Toledo. He promises to lend a strong shoulder to dealers whenever necessary.

Assigned to the South, with offices in Atlanta, Georgia, is Reid H. Cox, who knows practically every dealer by first name in the seven states he will cover. And he expects to "burn 'em up" with Garod.

Announce Purchase

Anticipating the huge pent-up demand for radios and appliances, the Associated Distributing Corp., headed by G. Lou Rifkin, exclusive distributors of Garod radios for the State of Maryland and the District of Columbia, have purchased a new building to house their postwar radio and appliance lines.

Located at the corner of Charles and Lombard Streets in Baltimore, this building will give prominent outside display to Garod radios, as shown in the photograph on page 21. Mr. Rifkin also announced that a sales branch of the company will be located in Washington, D. C. to service dealers in that area.

**LOCATES TROUBLE INSTANTLY
IN ALL ELECTRICAL DEVICES**

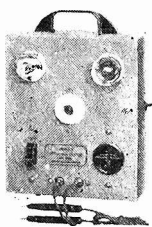

Pat. Pending

HANLAN

Appliance Tester
In this single unit are combined all the necessary tests for examining every appliance. Checks thermostats under actual working conditions. Tells instant it opens or closes. Controls the heat on soldering irons—Prevents overheating. Tests continuity, open circuits, etc. Checks automatic irons, vacuum cleaners, motors, shavers, bulbs, fuses, appliances with 3-way switches, etc. Great time, effort and money saver! Only \$9.50 complete. WRITE FOR LITERATURE.

FREE with each Tester . . . New, Complete Practical Course in electrical appliance repairing. HANLAN CO., 1419-T West Jefferson, Los Angeles 7, Calif.

ADVERTISERS' INDEX

SEPTEMBER

1945

ADMIRAL CORPORATION	39	JOHN MECK INDUSTRIES	26
Agency: Cruttenden & Eger Agency		Agency: The Fensholt Company	
AEROVOX CORPORATION	27	NOBLITT-SPARKS INDUSTRIES, INC.	63
Agency: Austin C. Lescarbourea & Staff		Agency: Sidener & Van Riper	
ALLIANCE MANUFACTURING COMPANY	48	PERMO, INC.	75
Agency: Foster & Davies Advertising Agency		Agency: Wm. Hoffman & Associates	
AUDIO INDUSTRIES	92	PHILCO RADIO & TELEVISION CORP.	31
Agency: W. J. Kennedy & Co.		Agency: Hutchins Advertising Company	
AUTOMATIC RADIO MFG. COMPANY, INC.	25	PILOT RADIO CORP.	82
Agency: Henry A. Loudon Advertising		Agency: Al Paul Lefton Company, Inc.	
CROSLY CORPORATION	53	RADIO CORPORATION OF AMERICA	45
Agency: Roy S. Durstine, Inc.		Agency: J. Walter Thompson	
DUOTONE COMPANY	44	RCA-VICTOR DIVISION	71
Agency: Maxon, Inc.		Agency: Kenyon & Eckhardt, Inc.	
EASTERN AMPLIFIER	49	RADIO SUPPLY SERVICE	80
Agency: Roberts and Reimers, Inc.		Agency: Direct	
ELECTRIC REACTANCE CORP.	68	RAYTHEON MANUFACTURING CO.	67
Agency: Scheel Advertising Agency		Agency: Burton Browne Advertising Co.	
FADA RADIO & ELECTRIC COMPANY	43	RECORDISC CORPORATION	62
Agency: Sternfield-Godley, Inc.		Agency: Shappe-Wilkes, Inc.	
FARNSWORTH TELEVISION & RADIO CORP.	73	SENTINEL RADIO CORPORATION	35
Agency: N. W. Ayer & Son, Inc.		Agency: W. W. Garrison & Co.	
GALVIN MFG. CORP.	2	MARK SIMPSON MFG. CO.	77
Agency: Gourfain-Cobb Advertising Agency		Agency: Hamburger Advertising	
GAROD RADIO CORP.	3-20	SPARKS-WITHINGTON COMPANY	69
Agency: Shappe-Wilkes, Inc.		Agency: Brooke, Smith, French & Dorrance, Inc.	
GENERAL ELECTRIC COMPANY	65	SPRAGUE PRODUCTS COMPANY	87
Agency: Maxon, Inc.		Agency: Harry P. Bridge Co.	
GENERAL INDUSTRIES COMPANY	76	STANDARD TRANSFORMER CORP.	85
Agency: Fuller & Smith & Ross, Inc.		Agency: Burnet-Kuhn Advertising Co.	
HALLICRAFTERS COMPANY	83	STEWART-WARNER CORPORATION	23
Agency: Burton Browne Advertising		Agency: Henri, Hurst & McDonald, Inc.	
HALLICRAFTERS COMPANY (RFC)	55	SYLVANIA ELECTRIC PRODUCTS, INC.	79
Agency: Burton Browne Advertising Co.		Agency: Newell-Emmet Co.	
HAMILTON RADIO CORPORATION	40	TRAV-LER KARENOLA RADIO & TELEVISION CORP.	29
Agency: Sherman K. Ellis & Co., Inc.		Agency: Jones Frankel Co.	
HANLAN COMPANY	88	VIEWTONE COMPANY	57
Agency: Direct		Agency: Lester Harrison Assoc., Inc.	
LEAR, INC.	61	WARD PRODUCTS COPORATION	66
Agency: Arthur Kudner, Inc.		Agency: Burton Browne Advertising	
LITTELFUSE, INC.	91	WARWICK RADIO MFG. CO.	51
Agency: United States Advertising Corp.		Agency: Agency Service Corp.	
McELROY MFG. CORPORATION	66	WESTINGHOUSE ELECTRIC & MFG. CO.	58-9
Agency: Shappe-Wilkes, Inc.		Agency: Fuller & Smith & Ross, Inc.	
MARION INSTRUMENT COMPANY	81	ZENITH RADIO CORP.	74
Agency: Shappe-Wilkes, Inc.		Agency: Critchfield & Co.	

Journal's End by MAL PARKS

he's going to make a real success of his new job out there in Detroit . . . here's every good wish for a real future, George . . .

Hi there, fellows . . . gosh, a lot sure has happened since we visited together back here last month. . . . I never thought the war would be won this fast and it certainly did catch us kinda off guard . . . but, it will be great to get back to the new era of merchandising when we'll all have to meet the challenge of selling again . . . apropos of that, hope you don't mind my mentioning that your Radio Television Journal is the industry's oldest dealer **merchandising** publication and every member of your staff is a trained merchandiser . . . so, just watch the **new** Journal we plan to bring you every month from here on out . . .

. . . Really sorry to hear about the sudden passing of **Mrs. Raymond C. Cosgrove**, the very wonderful wife of Crosley's general manager . . . there's just nothing much you can say to help assuage a fellow's grief at a time like that, but we are truly sorry. . . .

. . . One of my friends over at Maguire Industries tells me that under the new Meissner set-up, **Vince Rockey** and **Oden Jester** will receive positions of even more importance . . . the way I hear tell, Vince will head up **all** sales for Maguire while Oden will be in full charge of all radio sales . . . both are to be elected vice-presidents of Maguire Industries . . . well, here's our best wishes for lots of luck, fellows . . .

. . . Grand letter from Good-year's radio buyer, **Paul Leslie**, telling me that his predecessor, Vern Kamin, is now a Lt. Colonel with the Signal Corps . . . with fellows like Paul handling their radio buying, Goodyear figures to be stiff competition as time goes on. . . .

. . . Swell talk with G. E.'s **Art Hirsh**, who leaves their New

York operation on Sept. 1st to head up sales for Boston's fast-growing Equipment Distributors . . . a nicer fellow couldn't have gotten the job and we predict that Boston will see some real merchandising and selling now that Art is up here . . . any you fellows can give Art a helping hand, it will certainly be appreciated by both of us . . .

. . . The reason Howard Radio's **Harry Byrne** can't keep buttons on his vest any more is because they have kept popping off ever since August 21st, when Mrs. Byrne presented Harry with a bouncing 8 lb. 2 oz. baby boy . . . I'm still waiting for that cigar, Harry, and be sure it's a good one . . .

. . . Wish you could have been here when good reader **A. L. Figueiredo** visited us from Lisbon, Portugal . . . it's real interesting to get an idea of how European business men operate and I can tell you, that so far as export and import business is concerned, they're right on their toes . . . looking over the figures I find that we've received over 50 new subscriptions from Europe since the victory in Europe . . .

. . . Just got a copy of the Dartmouth "Log" from **Mal, Jr.**, and he purposely marked the one that goes like this . . . Our motto up here is "We all like to see a broad smile. Especially when she smiles at us" . . . and that's what we send our boys to College for . . . oh, well, it's a long time ago but I guess I was young once, too . . .

. . . Surprised to see that **George Bodem** has left Tung-Sol after 25 years to go with Int'l Detrola as vice-president in charge of sales . . . it won't seem the same without George over there at Tung-Sol, but we know

. . . Congratulations are in order for Jensen's **Hugh Knowles**, who was just signally honored by his election as President of the Acoustical Society of America . . . one of my nicest recollections is having lunch with Hugh, **Tom White** and the rest of the Jensen gang out there in Chicago way back last winter . . . that restaurant had the best deep-dish apple pie I ever ate . . . I only had three pieces, but I can still remember it . . . anyway, congratulations again, Hugh . . .

. . . **Les Kelsey** certainly got a well-deserved boost when he was just made vice-president of Hallicrafter's and general manager of the Echophone Division . . . don't know anybody who's had much more experience than Les, in fact, last time I saw him out there at Belmont's he told me he'd been in radio for 24 years . . . you can be pretty sure that Echophone will be a real factor in home receiver sales with Les at the helm . . . at any rate, best wishes and lots of luck, Les . . .

. . . Well, fellows, now we face the problems of peace and they are sure to be many . . . when I get those two o'clock in the morning worries I always think back to my old Scotch grandmother whose favorite expression was, "Och, laddie, things are nae ever as gude as they seem, and ne'er as bod, neither" . . . so, no matter how difficult the times ahead may seem now, I know that they're going to straighten out and I look for some real prosperity for our industry and everyone in it . . . now that things have definitely eased up, just as soon as possible I look foward to making a nice leisurely trip around the country so I can meet and visit with you in person . . . looks like it might be soon, too, so, until then, so long and keep your chin up . . .

F

LITTELFUSE EXTRACTOR POSTS



A Littelfuse "first"—a development featuring quick, shockproof fuse replacement adapted for use in radio, appliance, aircraft, instrument and electronic fields.

The practicability of this space-saving fuse mounting is easily recognized—side terminal electrically welded—thoroughly insulated spring activated contacts insuring maximum electrical conductivity.

Littelfuse full range of posts includes sizes for 3, 4, 5 and 8 AG; 3, 4 and 5 AB and Hi-Amp fuses with either finger or screwdriver type (meets Underwriters' requirements) knobs, also Fusible Binding Post, Fusible Meter Post.



LITTELFUSE INCORPORATED

4757 No. Ravenswood Ave., Chicago 40, Illinois

Plants in Chicago and El Monte, California

First in Circuit Protection

QUALITY SERVES

Quality is built on the firm foundation of unselfish service. Before men can desire to build quality into their work, they must first desire to serve their fellow men well. Mediocre and inferior men build quality through pressure of competition or fear of censure. Leaders of men give and maintain quality because in so doing they render the kind of service they believe is worthwhile, and because they desire the satisfaction, recognition and rewards their leadership merits. Not the least of these satisfactions is the improvement of standards in those who must follow the leader.

True service demands the best quality.

President

LITTELFUSE



Incorporated

New!



ULTRATONE PHONOGRAPHS



Radio and record dealers will recognize the tremendous market for phonographs, a market pre-sold by millions of phonograph records. Besides, there's a greater profit in this higher unit of sale. The "ULTRATONE" line features phonographs for every need—non-automatic and automatic record changer models—portables—table models—battery amplified, spring driven models and wireless record players. WRITE TODAY FOR FULL DETAILS!

... No Radios ...
Phonographs Exclusively

Audio **INDUSTRIES**
MANUFACTURERS OF *ULTRATONE* PHONOGRAPHS • MICHIGAN CITY, IND., U. S. A.