

The RADIO ENGINEERS' DIGEST



AUGUST 1945

VOL. 2, No. 1

... CONTENTS ...

An Advanced Crystal Pickup Design.....	<i>Radio</i>	1
SHF Power Measuring.....	<i>Electronic Industries</i>	5
AGC—Noise Considerations in Receiver Design	<i>Electronics</i>	10
The Presentation of Technical Developments Before Professional Societies.....	<i>Proceedings of the I.R.E.</i>	15
Output Design in P-A Amplifiers.....	<i>Service</i>	20
Unique Volume Expander and Compressor	<i>Radio News</i>	25
What's Being Read This Month.....		30

Published by **THE HUDSON AMERICAN CORPORATION**
A subsidiary of **REEVES-ELY LABORATORIES, INC.**

Our First Anniversary

In celebrating this, the first anniversary of our magazine, we pause for a moment to take stock of the past year's accomplishments; to note wherein we have succeeded in attaining our objectives and to discover in what way we may be of greater service to our readers.

As we stated last August in our introductory issue, THE RADIO ENGINEERS' DIGEST began publication with a definite goal in mind; a goal whereby we could render a useful service to our friends in the radio industry by reprinting each month from the leading trade and professional magazines a group of outstanding technical articles.

Now in order to determine just how well we have met this goal, we need the advice and constructive criticism of our readers. What subject or subjects do they find most interesting? What types of articles do they prefer? And in what manner or way do they sincerely believe our magazine can best serve their needs? We hope that all our readers will accept our invitation to send us their comments and suggestions. They will indeed be welcome!

THE RADIO ENGINEERS' DIGEST

JOHN F. C. MOORE, *Editor*

Copyright 1945 by The Hudson American Corporation

A subsidiary of Reeves-Ely Laboratories, Inc.

Vol. 2, No. 1

August 1945

Published monthly at New York, N. Y., by The Hudson American Corporation

A subsidiary of Reeves-Ely Laboratories, Inc.

For free distribution to its friends in the radio and electronics industries

Editorial Office, 25 West 43rd Street, New York 18, N. Y.

Printed by Criterion Products Corporation, New York, N. Y., U. S. A.

AN ADVANCED CRYSTAL PICKUP DESIGN

Reprinted from Radio

By Roy Dally

Consulting Engineer, Electrovox Co., Inc.

Data on a new pickup design with improved performance

THE CONSTANT objective in pickup research and design has been the reduction of necessary vertical pressure consistent with a useful voltage output. Such useful output for commercial radio-phonograph combinations may be between .5 volts and 1.0 volt, rms. Pre-war designs commonly used produced about .5 volt, and tracked adequately at 1.25 oz., vertical pressure, although some would track at 1.0 oz., under ideal conditions.

The practice of considering pickups in the light of vertical pressure vs. output is really a measure of efficiency. Efficient designs having a minimum of energy loss have higher lateral compliance for a given voltage output, and hence will track at lower pressures.

The minimum practical pressure for changer operation is that required to trip the changer when a record is completed. This varies with changer designs and the type of trip mechanism used. For the purposes of discussion, we shall consider the minimum pressure to be .5 oz., and the maximum to be 1.0 oz.

Low pressure pickups are desirable from every standpoint. Record life may be greatly increased. The life of long playing needles, particularly sapphire tipped, goes up tremendously when operated at pressures below 1.0 oz. Reproduced surface noise and scratch are reduced irrespective of the frequency range being reproduced. Such noise is a product of the friction between the groove surface and the needle tip, and obviously will decrease as the pressure is decreased. Mechanical reproduction and noise directly from the pickup, so objectionable in the conventional design, are greatly reduced.

Of great importance is the vastly improved reproduction made possible with such a design. Freedom from poor tracking, transients and harmonic distortion open up possibilities of quality not thought possible from commercial shellac recordings.

DESIGN REQUIREMENTS

In order to obtain these desirable features, the moving system must have a minimum of mass, and maximum stiffness. Any condition which tends to retard the necessary reciprocal motion of the moving system must be reduced or eliminated. In this respect, particular reference is made to damping. A high degree of damping has always been necessary in conventional designs in order that mechanical resonances of the moving parts be reduced. Such damping material, in order to be efficient, must have a considerable internal resistance. Such material serves a useful purpose only at some resonant frequency, and it adds an additional load to the moving system at all frequencies being reproduced, requiring additional work to be done to overcome the losses. A further undesirable feature is due to the unstable characteristics of the material with temperature changes, resulting in a varying frequency response with temperature. The elimination of damping material is highly desirable.

In order to do so, the moving system must be sufficiently light and stiff to avoid resonance in the useful frequency range. If some resonance does appear,

it should be stiffness-controlled, which causes a flattening off of the response curve, and covering a very wide range of frequencies. Such resonance has very little adverse effect.

Fig. 1 illustrates a conventional crystal cartridge design. Half shells are not shown. The element is clamped between mounting blocks of resilient material. The chuck engages the element through a resilient rubber clamp. The chuck is held between the half-shells by means of the sleeve bearings in such a way that reciprocating motion is possible. The needle is held in the chuck by means of a needle screw. The chuck assembly is damped with one or two damping blocks held in compression between the chuck and half-shells. Lateral motion from the record groove applied through the needle to the chuck produces torsional stress in the crystal element, and voltage is produced.

Chucks are usually die-cast from the zinc alloy, aluminum or magnesium. The mass incidental to the chuck assembly, consisting of the needle, needle screw, and chuck is appreciable. This is particularly true of a zinc alloy chuck. This mass, in conjunction with the inherent stiffness of the system, will produce resonance at some frequency between 4000 and 7000 cycles. This resonance must be damped out by means of the damping blocks in order that sharp voltage peaks

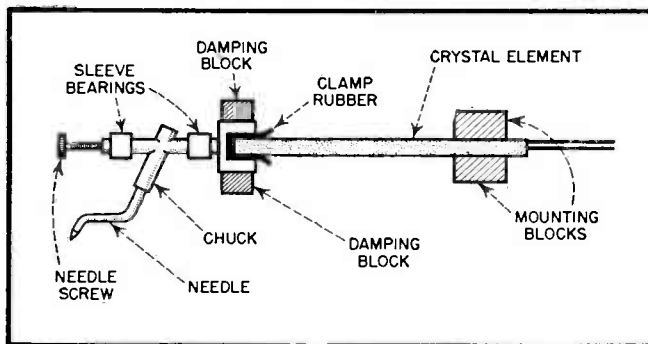

Fig. 1. Conventional crystal cartridge design

and distortion be reduced. The amount of work required to overcome the mass and inertia of the chuck assembly plus the losses in the damping material and bearings is quite appreciable, and can only be obtained by additional vertical pressure of the needle in the groove. Some idea of the importance of mass and inertia in the moving system may be had by considering the fact that the entire system must start and stop 20,000 times per second in order to reproduce 10,000 cycles. In addition, the groove wave form of a musically recorded record is exceedingly complex.

DESIGN FEATURES

Fig. 2 illustrates an advanced design. The secondary moving system consists of the element clamped between conventional mounting blocks, a metal sleeve cemented to the opposite end of the element, and a rubber bearing. The mounting blocks and the bearing are in turn clamped between half-shells, not shown. The sleeve should be made of magnesium or dural, for minimum weight and maximum stiffness. With proper sleeve design and element selection, the entire system is extremely stiff, and when clamped by suitable mounting blocks, is effectively free from resonance over the frequency range used.

The primary moving system consists of a chuck, a needle, a needle screw, and two bearings. The chuck is a metal sleeve, magnesium or dural, large enough in

diameter only to contain a #1 set screw, made of dural. The needle is of special design, sapphire tipped. The mass of the entire primary moving system is less than that of many conventional long-playing needles. The bearings may be made of a number of resilient materials, depending on the voltage output and characteristics required. Voltage may also be controlled by the length of the bearings. The only damping applied to the primary moving system is incidental to these bearings. Since such bearings may be made from materials effectively free from temperature effects, the high frequency response characteristics of the pickup are remarkably stable.

The primary moving system is inserted into the secondary moving system sleeve through a slot cut in the sleeve, less than half the sleeve diameter. The bearings engage the inside surface of the sleeve, and the needle and chuck are

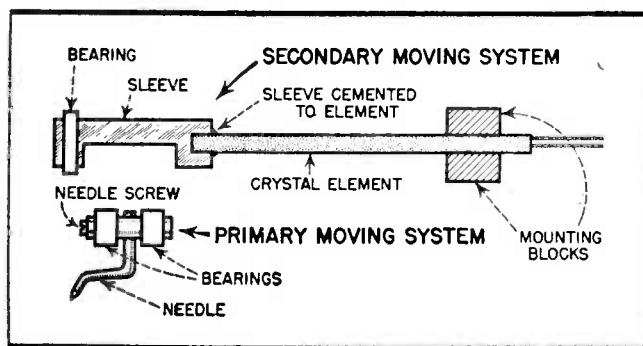

Fig. 2. How the new pickup is designed

free to reciprocate laterally in the sleeve, being limited only by the amount of work necessary to overcome the resistance of the bearing material. The primary moving system is held in the sleeve by two additional rubber sleeves, not shown, passed around each end of the combined assembly. Fig. 3 illustrates the complete assembly.

It becomes apparent now that we have eliminated the work made necessary in overcoming losses in the damping blocks, the work done in the clamp rubber, and have transferred a very considerable amount of mass incidental to a conventional chuck from the primary moving system to the secondary moving system, i.e., the sleeve, where it has no appreciable effect on tracking. The only work being done is that energy appearing in the bearings, which is utilized in actuating the element. This energy is no greater than that lost in conventional chuck and bearing assemblies. There is some loss in the secondary moving system through the bearing and the mounting blocks, but it is sufficiently small to be ignored. The efficiency of the system is proved by the fact that .5 volt may be obtained readily with .5 oz. pressure, with an adequate safety factor on tracking. Under favorable conditions the pressure may be further reduced without reduction in voltage output. Added voltage output may be had by lengthening the bearings and applying additional vertical pressure to insure tracking.

The frequency response may be adjusted over a wide range by proper design of the needle. Fig. 4 illustrates two such variations. Once determined, the response is extremely stable, since damping material is not employed to control the characteristics.

The most satisfying aspect of the design is the reduction of mass and inertia, with the attendant reduction of transient response and harmonic distortion. The reproduction is remarkably clean, rich in detail, with the noise level sufficiently

low as to be inaudible except during extremely low level passages. The entire dynamic range is handled with ease. Records heretofore thought to be poor recordings, were reproduced without difficulty.

If desired, the design may be made with a permanently built in needle, utilizing a sapphire. The slight gain made in mass reduction, however, is not suf-

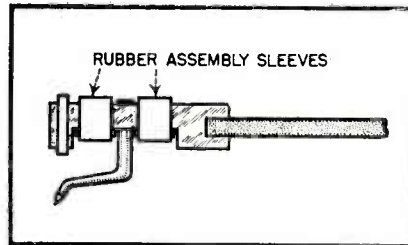

Fig. 3. Assembly of primary moving system

ficient to overcome the desirable features of a replaceable needle. In the event of changer failure or mis-handling, resulting in damage to the needle, the needle may be replaced quickly, and at low cost to the user, by means of a small screwdriver. The performance of the cartridge with a set screw is of such high order as to make unnecessary the disadvantages of a built in needle.

The moving system described may also be applied to generators or modulators other than crystal, such as magnetic or FM reproducers. It may also be utilized for reproduction of vertical recordings as well as lateral.

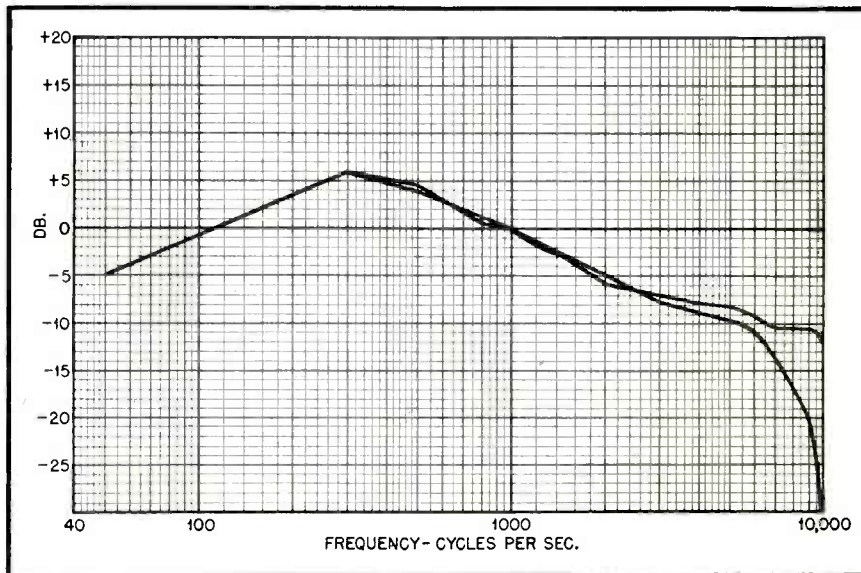

Fig. 4. Effect of different needle designs on frequency response

SHF POWER MEASURING

Reprinted from *Electronic Industries*

By *H. Gregory Shea*

Associate Editor, *Electronic Industries*

Modern technics involved in the accurate measurement of power in wave guides at frequencies over 1000 mc

MEASUREMENT of high frequency power delivered out of a wave guide or coaxial cable in the ranges above 1,000 megacycles presents problems quite different from those existing in the lower frequencies. Even a slight amount of consideration makes it evident that leading the current into an indicating meter and obtaining a direct reading of the required quantity is impossible, because one of the principal points to keep in mind concerning centimeter waves is the ease with which they are attenuated, dispersed or reflected.

Consequently, not only must the basic method of measurement be sound, but there must be assurance that the power measured is actually the power available at the point where it is to be used. It must also be kept in mind that the power generated may, and in fact almost always does, contain harmonics of the frequency in which the user is interested. Therefore a question to be decided is whether the power to be measured is the total power of the fundamental plus the harmonics, or just the power of the fundamental. In the latter case, the question of harmonic suppression would be introduced immediately.

To illustrate the problem and a solution, let us assume that it is desired to measure the power of a wave of 3cm. length (in free air) appearing at the opening of a rectangular wave guide, and that adjustments are to be made in the supply apparatus to produce at this point a power level of 2 milliwatts. How can this be done to a high order of accuracy?

HEATING EFFECT

At present, the only satisfactory method is to make the measurement by a determination of the heating effect of this rf power. Since heat is difficult to measure directly with any degree of accuracy, a secondary effect derived from the influence of heat must be measured. An easy way of doing this is to measure a change of resistance produced by this heat in a resistance element.

However, it is necessary to make the rate of escape of heat reasonably constant with respect to the rate of input of heat, as otherwise, the temperature reached by the detecting element, and therefore its resistance change, would vary more or less from measurement to measurement. The more sensitive the resistance element is to temperature changes, and the more nearly it is operated at a temperature close to the ambient temperature, the greater the precautions will have to be to prevent variations in ambient conditions from affecting the readings.

The basic circuit of the power measurement method is shown in Fig. 2. Naturally, the first problem is to determine the material to be used as a power sensitive device whose resistance will vary with temperature. Two kinds of material have been successfully employed, namely fine fuse wires, and Thermistors.* Both of these materials have negative temperature coefficients. That is, their resistance

* See pp. 76, *Electronic Industries*, Jan. 1945

drops as their temperature increases. Fine fuse wires suitable for this work have been obtained from small ten mil. glass enclosed fuses, but they have almost no overload capacity and hence burn out very readily.

HIGH SENSITIVITY

Certain metallic oxides, when formed as a junction blob between two fine wires, the whole being enclosed in a glass bead about $\frac{1}{4}$ in. long, are marketed under the name of Thermistors by the Western Electric Co. These have a much sharper change in resistance with temperature and are therefore more sensitive. They also possess substantial overload capacity. Changes from an initial value of about 800 ohms to about 40 ohms can be produced in such beads by direct currents increasing in value from one to 30 milliamperes as shown in Fig. 1.

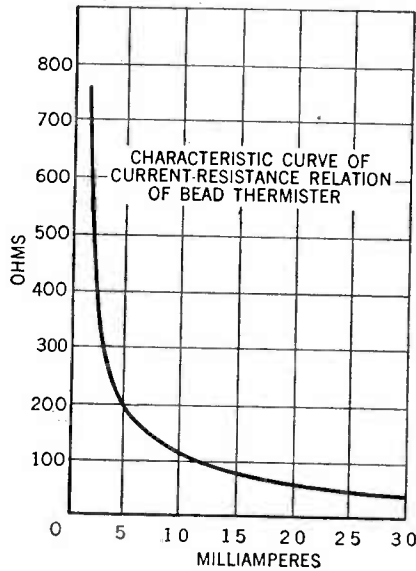

Fig. 1. Resistance in open air of a bead Thermistor when dc is passed through it.

Before power is turned on the circuit of Fig. 2 can be balanced either by changing the variable arm of the bridge, or by changing the amount of direct current flowing through the Thermistor, thus altering its resistance. For reasons to be explained shortly, both of these methods are used.

When the power is turned on, some of it will be absorbed by the Thermistor, and dissipated therein as heat. This will change the resistance of the Thermistor, unbalancing the bridge and causing the galvanometer to read a value depending on the amount of unbalance. To make this reading quantitatively accurate, it is necessary to know the meaning of the relationship between power flow and meter readings.

TEMPERATURE CONTROL

Thermistors are not linear devices. The change in resistance with change of current flowing, or correspondingly, with change of temperature, depends on the operating temperature. Therefore, to permit the initial temperature of the Thermistor to change is, if high accuracy is desired, to introduce undesirable complications. Furthermore, to measure the power in the wave, it is necessary that all

of the power be absorbed by the Thermister. This means that no reflections can be permitted to exist, as these would seriously decrease the measured power by dissipation along the wave guide.

The wave guide is a transmission line having a characteristic impedance which should be purely resistive. To avoid reflections, it is necessary that the termination, or power absorbing device at the end of the line match the characteristic impedance of the guide exactly. If, during measurement, the resistance of the Thermister is allowed to change, exact matching will be lost and reflections will immediately be created. Hence, to make a correct measurement, it is obligatory to make the Thermister resistance equal to the characteristic impedance of the guide and keep it there during the measurement.

BALANCE MAINTAINED

Before starting, therefore, an accurate dial decade box, previously checked with a good Wheatstone bridge, is substituted for the Thermister, as shown in Fig. 3, and is set at the value of the characteristic impedance of the guide. The bridge circuit shown is then balanced by changing the variable arm of the bridge until the meter reads null. The Thermister is then reintroduced, and the dc

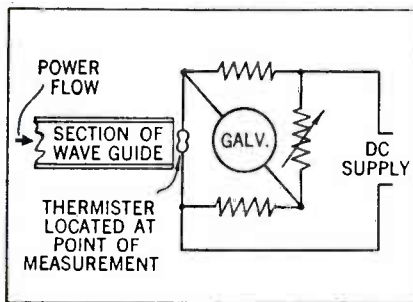

Fig. 2. Power dissipated in Thermister heats it and unbalances bridge

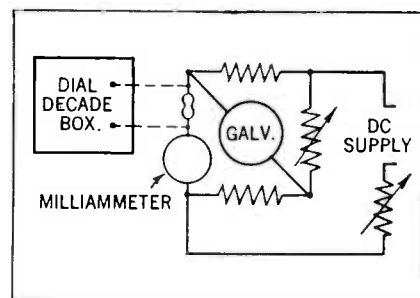

Fig. 3. Bridge is first balanced with known resistance equal to characteristic impedance of wave guide

supply is adjusted, thereby changing the Thermister resistance until the circuit is again balanced. After this, it is well to recheck the resistance with the decade box, as the change in total bridge current may have affected the value of one of the other arms, particularly if poor quality resistors have been used.

Now, when rf power is turned on, and the galvanometer in Fig. 3 deflects, indicating a change in Thermister resistance, it can be brought back to null by a decrease of dc bridge current. This restores the resistance of the Thermister to its previous value. If the dc through the Thermister was I_1 , amps before rf power was turned on, and I_2 , amps after, the power in the wave which has been substituted for the dc power to keep the Thermister at the same temperature and resistance value, can be calculated from the equation:

$$P = (I_1 - I_2)^2 R$$

Where P =Power in electric wave in watts, R =Constant resistance of Thermister in ohms.

It would not be unusual to wish to measure 100 microwatts with an accuracy of 2%. If the Thermister resistance is 200 ohms, 2% of 100, or 2 microwatts can be indicated by a change in current of 100 microamps. The dc meter used should therefore have a sensitivity such that this value can be read easily.

In order to avoid reflections, the Thermister must be placed in a mount which can be matched to the wave guide so that there is no change of surge impedance at the junction point.

STANDING WAVES

To make sure of the absence of reflections or standing waves, it is necessary to introduce into the wave guide a pickup probe which can be moved along the guide and to which is connected a rectifying crystal and meter. Such a section of wave guide, called a slotted section, will indicate, by the variations in readings, the presence of nodes of voltage, or standing waves.

If the voltage is uniform as one progresses along the axis of the wave guide, there are obviously no standing waves. If the voltage is not uniform, the ratio of peak to valley voltages, or voltage standing wave ratio, will indicate the amount of reflections being introduced by some discontinuity further along the guide toward the power receiving end. By proper adjustment or alteration of the part creating the discontinuity, and simultaneous measurement of the voltage standing wave ratio until it reaches unity, it is possible to obtain optimum power transfer. For sensitive detection of variations in voltage picked up by a slotted line probe, it is often necessary to employ a high gain amplifier to actuate the indicating meter. Such an arrangement is shown in Fig. 4.

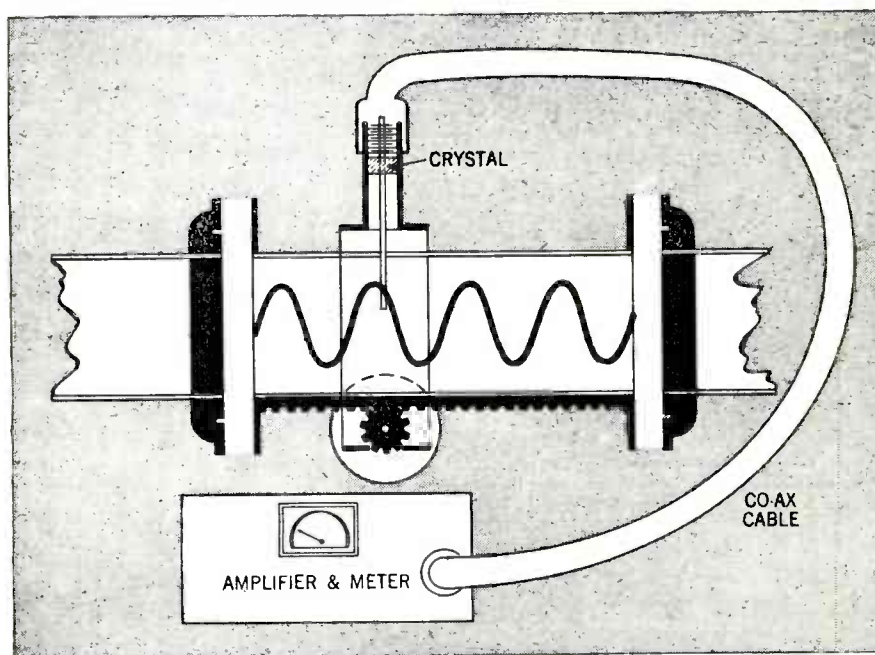

Fig. 4. Slotted section of wave guide with movable crystal bearing probe connected to high gain amplifier used to detect presence of standing waves

While the discussion so far has been related to very short waves, the method described is of equal usefulness with waves of about 1,000 megacycles, or around 30 centimeters. Here, wave guides are not used as their dimensions would be too large, and the wave, or current is handled by means of coaxial cables. The current to be measured is led to the Thermister by wire connection instead of by

an electric field in space, but the same bridge measuring circuit can be used. Reflections can be eliminated by mounting an open or closed end stub of variable length near the Thermister. This is illustrated in Figs. 5 and 6. These illustrations also indicate the method of eliminating harmonics from the measured

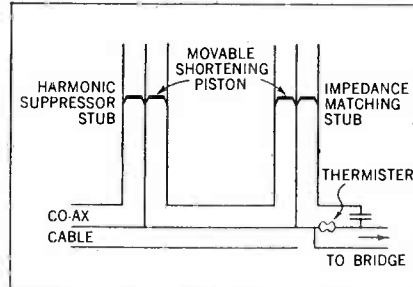

Fig. 5. Application of bridge to coaxial cable output. Stubs used to eliminate harmonics.

power by placing a variable stub in the line. Its length is made equal to a half wavelength of the harmonic to be suppressed, and since it is shorted at the end its input impedance at the frequency in question is zero, and it effectively short circuits it.

The adjustment of the length is of course critical and must be done by obtaining a minimum power reading. The process is to make the adjustment in length while watching the bridge galvanometer and looking for the least deflection. The terminal impedance matching stub must be adjusted in the same manner except that in its case a maximum deflection must be looked for, indicating the least amount of reflections.

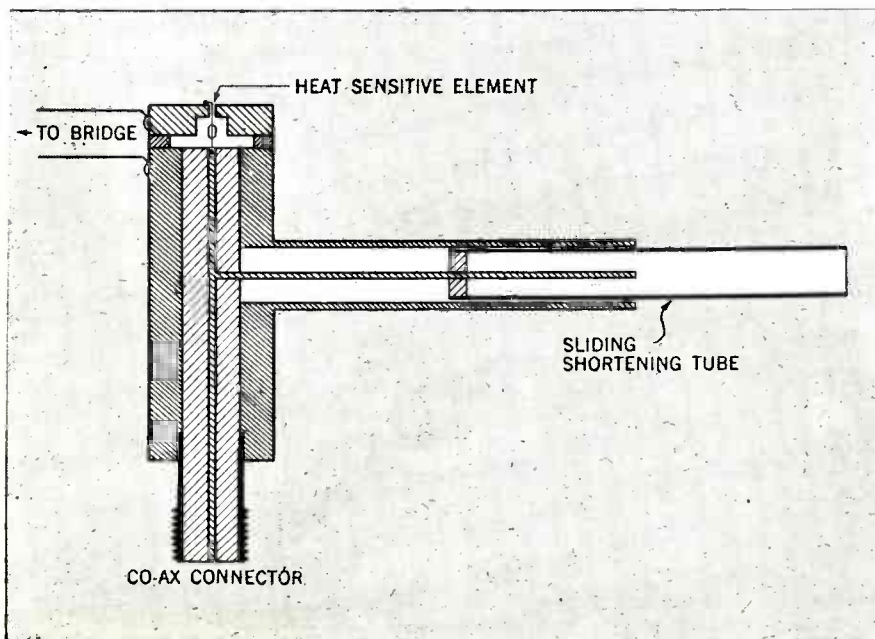

Fig. 6. Construction details of a power measuring device for 1000 mc. The cap at top is insulated from main body

AGC-NOISE CONSIDERATIONS IN RECEIVER DESIGN

Reprinted from *Electronics*

By *John B. Moore*

RCA Communications, Inc., New York, N. Y.

Automatic gain control is considered for communications receiver service from the standpoint of its effect on signal-to-noise ratio at various signal voltages. The desirability of employing high gain in controlled stages and the limitations of such use are pointed out

AUTOMATIC control of the output volume of radio receivers is so universally employed that there is apt to be a tendency to simply incorporate it in any design as a matter of course. It is the purpose of this present treatment to point out and discuss some of the factors that are not always obvious but that are important where the best possible performance must be obtained, as in commercial communications service; also, to deal with certain compromises that often must be made.

The simplified diagram given in Fig. 1 is a generalized schematic arranged to show the functional sub-divisions of a complete receiver. Control of the output volume is obtained in this generalized receiver by means of a manual volume control in the a-f amplifier (for phone service) or in the tone keyer (for telegraph service). The output volume thereby can be adjusted independently of the gain of the r-f and i-f amplifiers. For this reason, which is important in many types of equipment for commercial service, the commonly-used term *automatic volume control* (avc) is not applicable. The preferable term, which will be employed in this discussion, is *automatic gain control* (agc).

Figure 2 gives a generalized schematic circuit of a three-stage r-f amplifier, with agc, such as might be used in the complete receiver of Fig. 1. A particular feature to be noted in this circuit is the use of taps on the tuned-circuit inductances. The purpose of these is to make it possible to obtain any desired value of overall gain, up to the maximum, without the necessity for changing the tube voltages or operating points from their optimum values. Other features of the circuit are conventional, except perhaps for individual r-f filtering of the supply voltages to each tube. This latter is essential in any high-gain r-f amplifier operating at the higher frequencies.

DIODE OUTPUT vs. CARRIER AMPLITUDE

The usual criterion of agc action is the shape of the characteristic of rectified output vs r-f carrier input. Such a graph shows how nearly constant the output is maintained over the indicated range of r-f input voltage. For some purposes, this is sufficient. Such data do not, however, show what the signal-to-noise ratio in the output will be. For reasons which will be brought out in following paragraphs, this signal-to-noise performance may be quite different over a wide range of r-f input voltages than one would be led to expect from a statement of noise equivalent of the receiver.

In Fig. 3 are shown two typical graphs of output noise level, expressed in db below 100 percent modulation, plotted against r-f carrier input signal in

Copyrighted 1945, (all rights reserved) by McGraw-Hill Publishing Co., Inc. 330 W. 42 St., New York City

(*Electronics*, May 1945)

microvolts. For the moment, let us consider only the general features of these two characteristic graphs.

Between the points indicated by *A-A'* and *B-B'*, the graphs are linear. A check of various points will show that the noise equivalent, in microvolts at the input of the receiver, is essentially constant over these linear portions of the graphs. For example, a noise level of 20 db below 100-percent modulation at a carrier input value of 2.6 microvolts (average) gives a noise equivalent of 0.26 microvolts at the receiver input. This method of expressing noise levels is convenient and useful because it provides a figure which can be compared directly with values of r-f signal input in microvolts.

EFFECT OF INCREASED SIGNAL

The ideal condition is that one in which the noise equivalent, at the receiver input, is constant regardless of signal strength. Then, and then only, is the full benefit of increased signal strength realized. In the curves of Fig. 3, it will be observed that the characteristic does not continue linear at the higher values of input signal. Instead, each characteristic levels off. Increasing the signal input

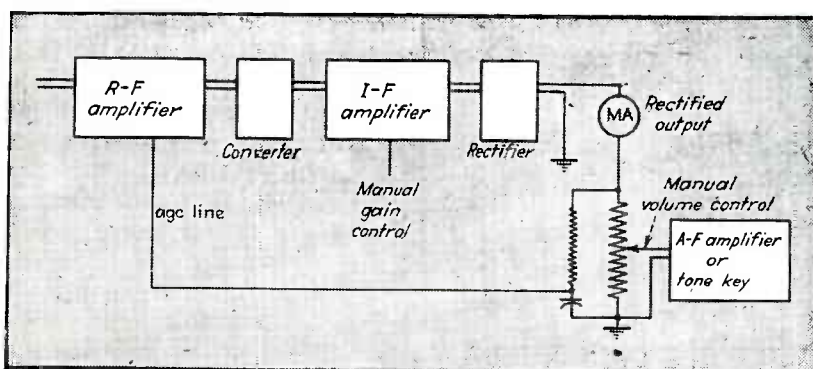

Fig. 1. Stages in a typical communications receiver having automatic gain control of the r-f amplifier

ten times, from 100 microvolts to 1,000 microvolts, does not produce a corresponding improvement in signal-to-noise output of the receiver. A further increase from 1,000 microvolts to 10,000 microvolts produces an even smaller improvement. As a practical matter, there is no object in having such characteristics continue linear down to extremely low levels in the design of radio receivers for general use. The level at which the characteristic will be permitted to flatten off is, therefore, determined by practical considerations of the performance required.

In order to compare different performance curves directly, some common base or starting point must be used when making the measurements. For the curves of Fig. 3, the starting point was a diode output of 0.1 ma for zero r-f input signal. The particular equipment used in the tests maintains a diode output of approximately 0.6 ma at normal operating values of signal strength. In other equipment, a similar ratio between normal output and starting-point output of the diode could be used. Adjustment to the desired value of rectified output for zero r-f signal input is obtained by means of the manual gain control associated with the i-f system as shown in Fig. 1.

The flattening-off level, for such curves as those of Fig. 3, is determined by the amount of r-f gain employed between a given input stage and a given converter (Fig. 1). Three stages are shown to give the required r-f selectivity and

also the desired agc action as judged by constancy of output over a wide range of r-f signal input. The overall gain is fixed at a desirable value by proper choice of the positions of the taps on the coils of the tuned circuits. This permits obtaining the desired reduction of maximum gain without changing tube voltages and operating points and thereby sacrificing agc performance.

To explain the foregoing, let us assume some values of noise equivalent and of gain. The noise equivalent at the input of the receiver may be taken as 0.3 microvolt; and that at the grid of the converter as 3 microvolts. Assume a value of r-f gain, from receiver input to converter grid, of 1000/1 with agc acting and an input of 1 microvolt. This point is chosen from Fig. 3 as one which is near the start of the linear portion of both characteristic curves.

CONVERTER NOISE

The values of amplified signal and noise appearing at the converter grid for different values of r-f input are given in the accompanying table. These are based on the somewhat idealized assumption that the agc action holds an absolutely constant output and therefore a constant signal level at the grid of the r-f converter. The assumption also is made, for the purpose of this simplified illustration, that the second and third stages contribute no appreciable portion of the noise. For purposes of illustration, these assumptions are justifiable; the errors involved being too small to appreciably affect the validity of the illustration.

Input Signal, μv	R-F Gain	At Conv. Grid.		Converter Noise Equiv., μv	Converter Total Noise, μv	Signal Noise Ratio
		Signal, μv	Noise, μv			
1	1000	1000	300	3	300	3.3
10	100	1000	30	3	30	33.3
100	10	1000	3	3	4.2	238
1,000	1	1000	0.3	3	3	333
10,000	0.1	1000	0.03	3	3	333
1	100	100	30	3	30	3.3
10	10	100	3	3	4.2	23.8
100	1	100	0.3	3	3	33.3
1,000	0.1	100	0.03	3	3	33.3
10,000	0.01	100	0.003	5	3	33.3

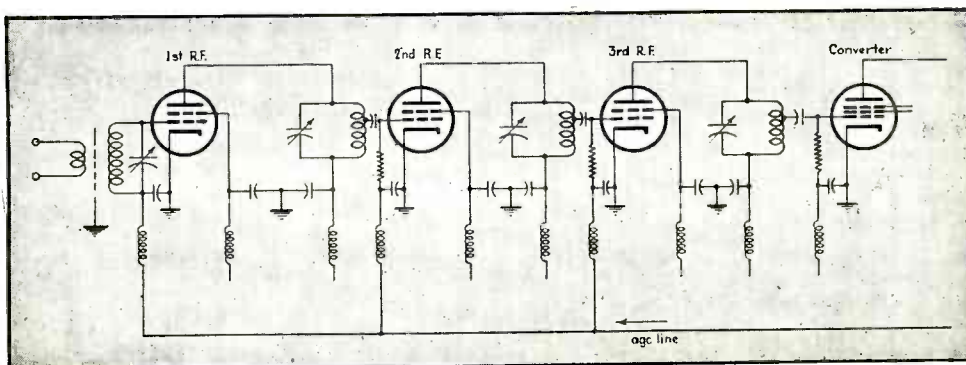

Fig. 2. Three-stage r-f amplifier and converter used for purposes of discussion by the author. Taps on the inductances permit adjustment for any desired value of gain without changing other operating conditions

The tabulated figures show that at low levels of input signal the final signal-to-noise ratio in the output of the receiver is determined by the signal-to-noise ratio existing at the input of the receiver. As the signal input is increased, and the agc action comes into play, the amplified noise appearing at the converter grid becomes less in magnitude compared to the noise equivalent of the converter itself. The result is that, at the higher levels of signal, the signal-to-noise ratio of the output of the receiver is determined not by that existing at the input but rather by the noise equivalent of the converter. The agc-characteristic of signal-to-noise vs r-f input therefore flattens off as shown in Fig. 3

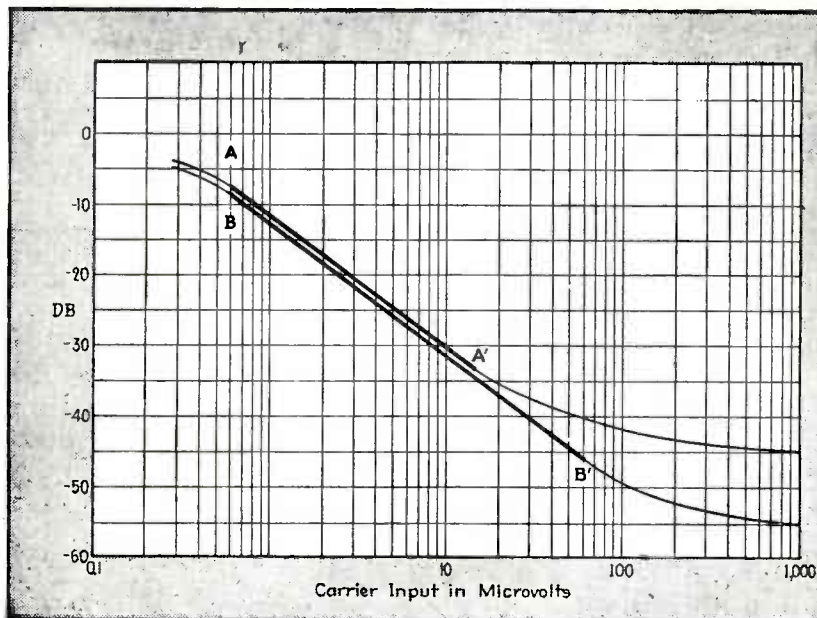

Fig. 3. Output noise level in db below 100-percent modulation, plotted against r-f carrier input signal in microvolts

In the lower portion of the table, the r-f gain is assumed to be 100 instead of 1000. This lower value of r-f gain results in poorer signal-to-noise ratios at the higher values of signal input. The curve for this case therefore would flatten off at a considerably higher level of noise. This is illustrated by the two curves of Fig. 3, which are plotted from actual data rather than from the assumed data tabulated in the table for purposes of simplified explanation.

USE OF HIGH GAIN

The foregoing discussion indicates the desirability of employing high gain in the r-f amplifier to which agc is applied. There are certain limitations, though, to the amount of gain that can be safely used. One is stability, or freedom from self-oscillation, at all frequencies. A second is protection of the r-f converter tube from being overloaded by stronger signals on channels adjacent to the desired signal.

If the r-f gain and the agc hold the desired signal at 10,000 microvolts at the grid of the converter, and a signal 100 times as strong as the desired one is received on an adjacent channel, the interfering signal will have a voltage of about one volt at the grid of the converter. This is apt to produce serious overloading and interference.

In actual use of a receiver such as depicted in Fig. 1 and having agc-noise characteristics as shown in Fig. 3, it is customary to manually readjust the i-f gain in order to obtain optimum performance on very weak and also on very strong signals. In this way the agc-noise characteristic may be shifted from its positions shown on Fig. 3 to best handle existing conditions and ranges of signal strength, noise, and interference. Obviously, the design of the agc system should be such as to cover the greatest possible range of input signal without the need for manual re-adjustment of the i-f gain.

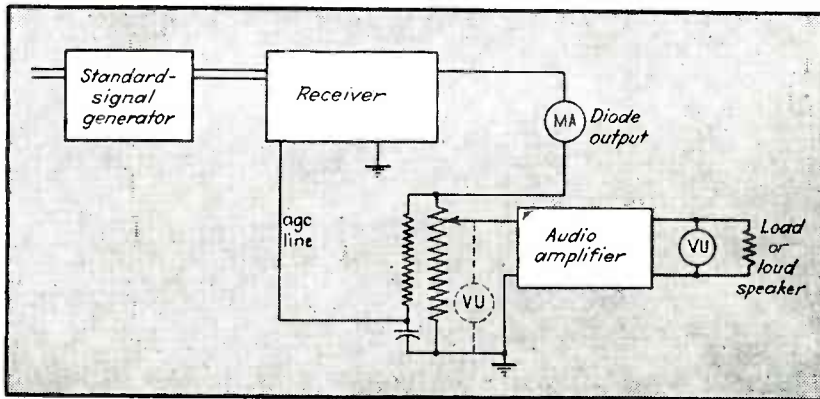

Arrangement of equipment used to determine the output current of a diode at various carrier signal levels

The final design generally must be a compromise between the various factors discussed; the exact compromise being determined by the performance required and the conditions under which the equipment will be used.



Reading maketh a full man, conference a ready man, and writing an exact man.

FRANCIS BACON

THE PRESENTATION OF TECHNICAL DEVELOPMENTS BEFORE PROFESSIONAL SOCIETIES★

Reprinted from Proceedings of the I.R.E.

By *W. L. Everitt*†, Fellow, I.R.E.

SUMMARY—*The professional man has an obligation to give wide dissemination to new discoveries and developments. This may be done by publication and by oral presentation before technical groups. The proper presentation of a paper requires the co-ordination of four groups or individuals. A check list of their duties is given which may be used as a reference in the planning of technical sessions.*

THE NATURAL result of professional activities, particularly in science and engineering is the development of new ideas and methods which are important, not only to the solution of a special problem but also to the general development of the art. It is not only the *privilege* but also the *obligation* of the professional man to make this knowledge available to other workers in his field and to the general public at the earliest possible time compatible with his own interest or that of his employer. Except when military security dictates otherwise, this information should be given as wide and early dissemination as possible, since its originator cannot know to whom and to what extent this new knowledge may be useful for the benefit of mankind.

It is to the advantage of the engineer and of his profession first to present publicly important developments and ideas of general utility in his field before a recognized professional society, where they may be discussed, developed, and perhaps questioned by his associates. By so doing, the engineer may be spared embarrassment or even discredit to himself or to his professional associates which sometimes follows premature disclosure to the public press.

The general dissemination of new technical ideas to the profession should be done in one or both of two ways:

- (1) By the presentation of a paper before a technical session of a professional society.
- (2) By the publication of a paper in the journal of a professional society or in a technical magazine.

It is preferable that both methods be used for many developments. If the presentation is before a technical session where the attendance necessarily is limited, it is desirable to submit a paper for publication consideration to the society which sponsored the session, so that all members may be informed. When both methods are used, the published paper should include material which is developed in the discussion at the technical session, including a correction of errors which the discussion may bring forth.

Papers which provoke oral *discussion* are the type which will give the most profit to the author, the society, and the public by presentation first before a

* Decimal classification: R660. Original manuscript received by the Institute, April 11, 1945.

† President, The Institute of Radio Engineers, Inc.

technical session. The papers committee in charge of the session, together with the author, should examine proposed papers with this point in view. The author should also keep this in mind in preparing his presentation. Unless early release is essential, there is little profit to anyone merely in reading a paper before a group. Papers which require extended mathematical development, or detailed study to grasp their implications, are not suitable for presentation at technical sessions unless they can be briefed, and the important conclusions presented, so that the audience can participate in the discussion.

A strong distinction should be drawn between *reading* and *presenting* a paper before a technical session. The reading, word for word, of material which later is to be published, without adequate opportunity for discussion, as has been done all too often, is a waste of everyone's time and fulfills no useful purpose.

The proper presentation of a paper before a technical session requires the team action of at least four different individuals or groups. They are usually

- (1) The Papers Committee
- (2) The Arrangements Committee
- (3) The Chairman of the Technical Session
- (4) The Author.

A mutual knowledge of the duties and responsibilities of each member is desirable to obtain team action.

The following suggestions are proposed for the duties of the team members in the conduct of technical sessions. While they are intended primarily for convention sessions, where there are a number of authors, most of the suggestions are applicable to section meetings. If you are a member of such a team, use this as a check list to be sure you are performing your functions.

DUTIES OF THE PAPERS COMMITTEE:

The Papers Committee, or an individual performing its functions, determines:

- (1) The general theme of the technical session (industrial electronics, radio antennas, etc.)
- (2) The time and date of the session
- (3) The length of the session
- (4) The chairman of the session (and contacts and secures him)
- (5) The number of papers
- (6) The time allotted to each paper
- (7) The proposed topics (examining them to be sure either that they can stimulate discussion, or that they should be presented to advance the date of release of the information).

The Papers Committee also

- (8) Contacts the author to obtain the paper
- (Note: Items 7 and 8 may occur in either sequence.)
- (9) Handles all correspondence with the author, forwards suggestions as to the author's duties, determines from him what aids such as lanterns, blackboards, motion-picture projectors, power outlets, manual assistance, and the like he will require in his presentation.
 - (10) Notifies the Arrangements Committee of the date and time, probable space required, and the requirements of the author in the way of lanterns, blackboards, and other supplies. Also indicates whether stenographic recording is desired.
 - (11) Arranges for the introduction of the chairman, unless he is a section officer or otherwise acting in an official capacity so as to be known to the audience.

DUTIES OF THE ARRANGEMENTS COMMITTEE

The Arrangements Committee, or an individual performing its functions, arranges for:

- (1) The meeting place
- (2) The mailing of notices and other publicity (unless under the jurisdiction of a separate committee)
- (3) Janitor service
- (4) Projectors, blackboards, chalk, erasers, pointers, etc.
- (5) The lantern operator
- (6) Smooth control of the darkening of the room from the lantern operator's position by remote control, or by signaling to an attendant at the room-lighting switch
- (7) Means for signaling between the speaker and the lantern operator
- (8) A public-address system where (and only where) needed. (When provided, the public-address system should have a lapel microphone if at all possible.) Check that it is in proper operating condition and that the gain is set properly.
- (9) Contact with the chairman of the session to apprise him of the services provided and their operation, and to determine other services which may be desired. Inform him of any special conditions applying to the concluding of the session and vacating of the premises.
- (10) Power outlets for demonstrations
- (11) Assistance for bringing in and removing demonstration equipment
- (12) Shipping instructions for the disposal of demonstration equipment after the meeting
- (13) Chairs
- (14) Tables
- (15) Reading lights
- (16) Distribution of material which is to be passed out to the audience (and its collection if necessary)
- (17) Recording of attendance, if desired
- (18) Stenographic recording of discussion, if desired
- (19) Meeting of the speaker at section meetings, if he comes from out of town, and making sure that his time is occupied to fit his convenience. (Have this done by a friend of the speaker if possible.)

DUTIES OF THE CHAIRMAN OF THE TECHNICAL SESSION:

The Chairman:

- (1) Presides at the meeting and is responsible for the tempo and character of the whole session
- (2) Introduces speakers and outlines method of conducting discussion
- (3) Contacts authors, lantern, and light-control attendants in advance of the session to acquaint them with each other and with himself and to issue special instructions, including information on
 - (a) Facilities available
 - (b) Method of disposition of lantern slides
 - (c) Method of signaling operators
 - (d) Time schedule and method of adherence thereto
 - (e) Operation of public-address system
 - (f) Location of pointers, chalk, erasers, and any other supplies
 - (g) Method of conducting discussion

- (4) Ascertains from authors whether they know of members who will discuss papers
- (5) Receives information from members who have prepared discussions
- (6) Conducts business where such is scheduled
- (7) Is *responsible* for adherence to time schedule
- (8) Calls for discussion
- (9) Recognizes discussors in order, giving preference to those who have indicated preparation in advance. At conventions, he makes sure each speaker on the floor stands up and gives his name and business connection clearly. If he cannot be heard, the chairman should require him to come forward and face the audience and to use the public-address system if possible. Remember, a member of the audience in the center of the room has his back to half the audience
- (10) Makes sure that questions from the audience are heard by all, and repeats them if necessary before the author replies
- (11) Confines discussion to the topic
- (12) Closes discussion when completed or at expiration of allotted time
- (13) When desirable, requests that discussions, containing comments which are important, be submitted in written form to the author and to the Editor of the PROCEEDINGS. Forwards to the Editor discussions which are available in written form at the time of the meeting.

**SUGGESTIONS TO THE AUTHOR IN THE PRESENTATION OF A PAPER
BEFORE A TECHNICAL SESSION:**

It is beyond the scope of this article to develop the rules for effective public speaking, as there have been many publications on this subject. However, it is believed that adherence to certain technical and almost mechanical rules will improve the presentation of any paper. The following suggestions apply. Remember that a stimulating discussion is beneficial to the author, the audience, and the society.

- (1) Prepare a draft of the paper in advance. Keep in mind that your mission is to teach rather than to demonstrate how much you know. Be sure the paper is presented from a professional viewpoint and not as an advertisement of your commercial connections. *Make it interesting.* Your efforts are wasted if the audience is bored.
- (2) Appear at the meeting sufficiently in advance of the scheduled time to meet and confer with the chairman.
- (3) *Do not read the paper.* Brief it and present it orally, emphasizing its high points, especially any items over which there may be controversy. Be sure the material is in logical sequence.
- (4) Speak clearly and distinctly, look at your audience, and evidence your interest in them and in your subject.
- (5) Show the relation of the development discussed to the progress of the art.
- (6) Distribute properly the time assigned to oral presentation, demonstration, and discussion.
- (7) Practice and time yourself beforehand.

- (8) Adhere to the time schedule. Expect the chairman to require you to do so. Use a watch which is constantly within your view. Modify your talk if you find you are running overtime.
- (9) Arrange for demonstrations if possible; they always provoke more interest.
- (10) Notify Papers Committee of lanterns, blackboards, power outlets, and other facilities you will need.
- (11) Provide adequate illustrations, preferably on standard 3¼- by 4-inch lantern slides. You may have to provide your own projector if non-standard slides are used. Be sure the thumb marks are properly placed, and the slides are in order with the thumb marks facing the operator and in the upper right-hand corner. Use a slide container which will keep all slides in order.
- (12) Use simplified block diagrams on slides where possible. Do not put too much detail on any slide; it is confusing in the short time during which it is shown. (This cannot apply to photographs of equipment.)
- (13) Make proper use of the public-address system. Keep at a constant distance from the microphone and in the same relative position at all times. Even if you have a powerful voice, it is disconcerting when the public-address system fades out due to increased separation of the speaker from the microphone, or due to the turning of the head.
- (14) Never turn your head away from the audience while you are talking, even to point out items on the projection screen, unless you are wearing a lapel microphone. If necessary, point to the screen and then turn and speak into the microphone or towards the audience.
- (15) Use the facilities provided to signal the lantern operator and point to the screen.
- (16) Give credit to others who serve as a source for your statements.
- (17) Make clear which statements you consider facts and which you consider conclusions or opinions.
- (18) In advance of the meeting, send copies of your manuscript to competent members who may attend the meeting. Ask them to come prepared to take part in the discussion. Do this particularly to individuals who may differ with you or oppose your views. Opposition may develop interest in your ideas and promote their acceptance if they are worth while, or save you from embarrassment later if you are in error. Notify the chairman of the meeting of any discussion you expect, and help him contact their source.
- (19) Rewrite your paper for publication, giving consideration to the points which were developed in the discussion. Send at least three copies to the Editor of the PROCEEDINGS as soon as possible.
- (20) Secure copies of the discussions in typewritten form, if possible. The chairman may assist you in this.

Again, and above all, *speak clearly and logically and adhere to the time schedule.*

OUTPUT DESIGN IN P-A AMPLIFIERS

Reprinted from Service

By Willard Moody

EVERY p-a installation usually requires specialized attention. Thus it is impossible to provide any standard rules to follow. However, many of the tube circuits are standardized and thus rapid choice of tubes and systems are possible. For instance, assuming the electrical output is known, we can decide on the types of output tubes to use. Today the pentode and beam power types are widely used because they offer high audio output with low excitation requirements. Suppose, for example, we wish to use a pair of 6L6 tubes in a push-pull output stage, Fig. 1. Since resistance coupling is employed we cannot use class *B* amplification. Therefore, the tubes are going to operate in class *A*. This means that the plate currents will not vary too much and the need for extra power supply regulation is reduced. From the RCA tube manual we note that for cathode-resistor bias, and plate and screen voltages of 270, the maximum signal power output will be 18.5 watts. The

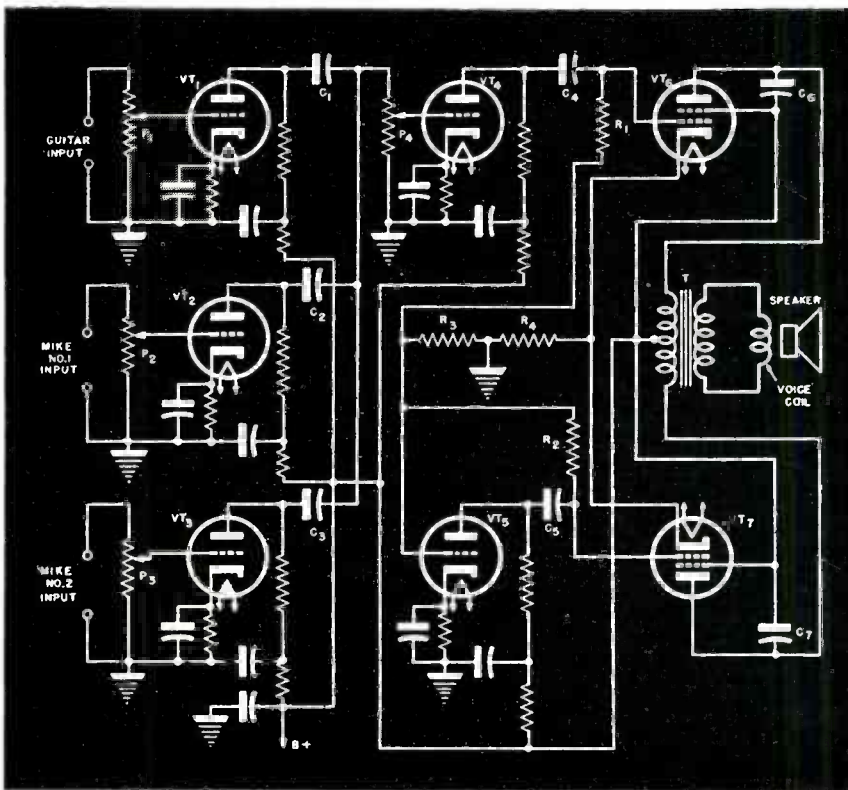

Fig. 1. High-gain amplifier with push-pull output stage. Electronic mixing and phase inversion are featured.

peak audio voltage, grid-to-grid, is 40 volts. If we assume that $\frac{1}{2}$ of this voltage appears between either 6L6 grid and ground, we have 20 volts between the grid and ground, or 20 peak audio volts across R_1 and R_3 . The peak voltage is roughly 1.5 times the effective or root-mean-square value read on an ordinary a-c voltmeter. Therefore, the peak divided by 1.5 will give us the rms. value. In this case this would be $20/1.5$ or about 13 volts. Assuming a value of 100,000ohms for R_3 and 400,000 ohms for R_1 , in Fig. 1, the power in the grid circuit is: $P = E^2/R = 13 \times 13/400,000 + 100,000 = .0003$ watt, approximately.

In view of the small amount of power, the grid resistors may be rated at $\frac{1}{4}$ watt each. We have indicated that the maximum output is 18.5 watts. Assuming an output of 18 watts maximum and an output transformer efficiency of 80%, the power delivered to the voice coil circuit would be:

$$\text{Power out} = \text{power in} \times \% \text{ efficiency} = 18 \times 80/100 = 14.4 \text{ watts.}$$

Suppose that the power is somewhat less than 14.4 or 12 watts. Then, the power ratio would be $12/.0003$ watt, or 40,000. The logarithm of 40,000 is 4.602. Multiplying by 10, we find that the power gain is 46 db approximately.

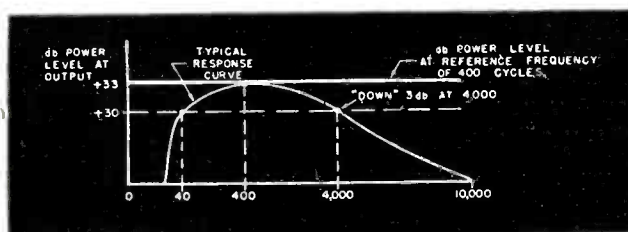
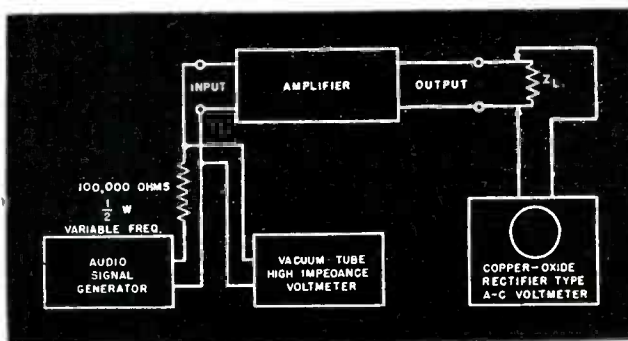

Figs. 2 (above) and 3 (below). Fig. 2, a setup used to test audio response. The vacuum-tube voltmeter connected to the input checks the input signal level, which should be kept constant as we vary the frequency. Output meter may be of the power level indicator type, which shows the output in db in reference to the standard level of .006 watts. Z_L = dummy load resistance = 1.5 x voice coil resistance. Fig. 3, variation in audio power output as a function of frequency.

The db gain of the amplifier varies with frequency. To test the response, we can use the setup of Fig. 2. A vacuum-tube voltmeter is connected to the input to check the input signal level which should be kept constant as the frequency is varied. The output meter may be a special type, such as the Weston power level indicator, which will show the output in decibels with reference to standard level of .006 watt. Then, the departures can be read in db directly without calculations. The reference frequency usually selected is 400 cycles, but 1,000 cycles is occasionally used. If we assume that the output is 12 watts at 400 cycles, the ratio

with respect to the reference level of .006 watt is $12/.006$ or 2,000. The logarithm of 2,000 is 3.30 approximately and multiplying by 10 we get the db equivalent of 33 db. Thus, the power level is 33 db above .006 watt standard level.

Suppose the power level indicator shows that the output for a test frequency of 4,000 is 30 db. We are *down* 3 db and theoretically we want a flat response from 40 to 10,000 cycles within 1 or 2 db for *high fidelity*. Actually, the response of the amplifier may be varied later to make up for deficiencies in the installation of mikes and loudspeakers. However, when beginning the design we do strive for flat response. Indiscriminate peaks and valleys in the response curve of the amplifier make it virtually impossible to accurately control (later) the response of the system overall to secure the desired overall curve.

The response curve can be plotted as shown in Fig. 3. We note a decided slope in the curve between 4,000 and 10,000 cycles, showing that the high frequency gain is lower than it should be. To bring up the high end of the curve, we may use smaller values of coupling capacity between the grid and plate circuits in Fig. 1. These capacitors are identified as C_1 , C_2 and C_3 . To equalize the outputs of VT_1 , VT_2 and VT_3 , all three capacitors would need to be changed. To avoid critical circuit problems, C_1 , C_2 and C_3 may remain constant in value and C_4 can be varied. Decreasing the value of C_4 tends to provide a high-frequency improvement, since the reactance of C_4 decreases as the frequency is raised. The reduction in gain

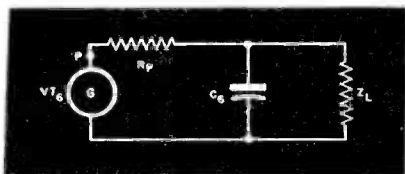

Fig. 4 (above). This circuit illustrates the reflection of the voice coil load, which is largely resistive. As the frequency rises, we have an increased shunt effect for C_6 and more of the available current flows in C_6 than in Z_L . Thus if C_6 is decreased the h-f output will rise.

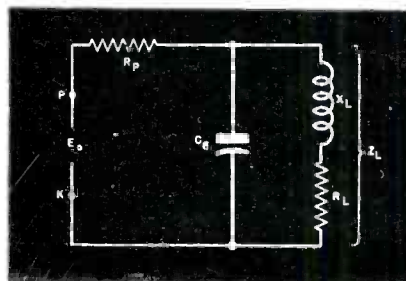
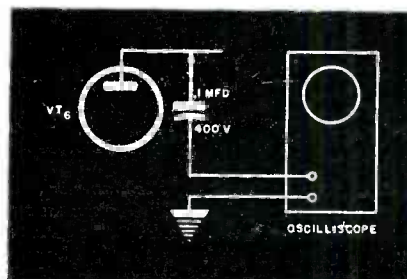

Fig. 5. (Top, right). Here we have a circuit illustrating the effect of X_L . As this becomes larger, feedback may result due to resonance or to the fact that the plate load is higher in value than the grid-plate impedance of the tube. Fig. 6 (right). An oscilloscope setup to check output.



is not desirable in some cases. Up to a certain point the high-frequency response of the amplifier can be raised by *decreasing* the values of C_6 and C_7 . The impedance reflected by the voice coil load is largely resistive. We then have the equivalent circuit shown in Fig. 4. One-half of the push-pull stage is shown for simplicity. As f rises we will have an increased shunting effect for C_6 and more of the available current will flow in C_6 than in Z_L . Therefore, if C_6 is lowered in capacity the high-frequency output will rise. Since the voice coil has some inductive reactance and at high audio frequencies it may be appreciable, the equivalent circuit shown in Fig. 5 results. As X_L becomes larger, it may cause feedback, due to resonance

or decreased to the fact that the plate load is higher in value than the grid-plate impedance of the tube. Therefore, there is a limit to how little capacitance may be used before regeneration or uncontrolled oscillation and parasites start to cause distortion.

The distortion in the output can be measured in a variety of ways. One method is to check the relative intensities of the harmonic and fundamental voltages. Many Service Men, however, merely listen carefully to the output and then decide whether the distortion is appreciable or tolerable. The amount of distortion which can be tolerated is tied in with hearing phenomena and psychology. As we know the hearing of an individual will depend upon the conditions under which hearing is practiced, whether the room is noisy, distance from source, etc., and upon the physical condition and age of the person making the auditory tests. Further, some people cannot hear equally well with both ears. In view of all this, it is desirable to check on our own ears and hearing by using electrical measuring instruments.

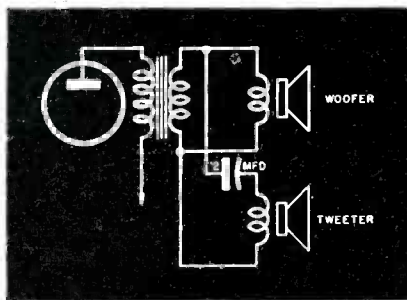

Fig. 7. Simple frequency dividing network applied in some p-a system installations.

An oscillograph can be connected across the output of VT_6 , as shown in Fig. 6. When the waveform becomes kinky or changes from a sine wave, distortion is present. With the amplifier gain control first at maximum, audio generator at minimum, the output of the a-f generator can gradually be raised. At first the scope will show a sine wave. Then, as the output of the generator is raised to the point where distortion sets in, the waveform will change. At that particular point, the level at the input of the audio amplifier can be tested with the vacuum-tube voltmeter to learn the maximum permissible input signal level before distortion become noticeable. The plate connection to the output tube is desirable in single-ended amplifiers since the usual oscillograph has a limited deflection sensitivity and better results will be obtained. The signal voltage in the plate circuit of the output tube may be fairly large, 10 or 20 volts not being uncommon, while the voltage across the voice coil or dummy load may only be 2 or 3 volts in many cases.

In laboratories a wave analyzer may be available for checking the fundamental and harmonic voltages individually. Usually, when the distortion becomes readily noticeable the second harmonic voltage may be 5% or 10% of the fundamental. In a push-pull stage the second harmonic voltage in the plate circuit of either of the push-pull tubes may be appreciable, whereas the second harmonic measured across the voice coil or dummy load, due to the push-pull cancellation

action, may be small. Therefore, as a general thing it is better to check for distortion in a push-pull system by connecting the indicating instrument across the voice coil. If the oscillograph lacks adequate gain, a small a-f amplifier stage may be built up to boost the signal. Care must be taken to see that the extra stage has flat characteristics and that the bias on the pre-amplifier tube is higher than the peak value of the signal voltage, to prevent overloading of the pre-amplifier stage and the generation of harmonic distortion in that stage. A plate-to-plate connection could be used, but it has the disadvantage of putting one side of the oscillograph above the ground potential which may lead to the reduction of spurious voltage and incorrect conditions in testing.

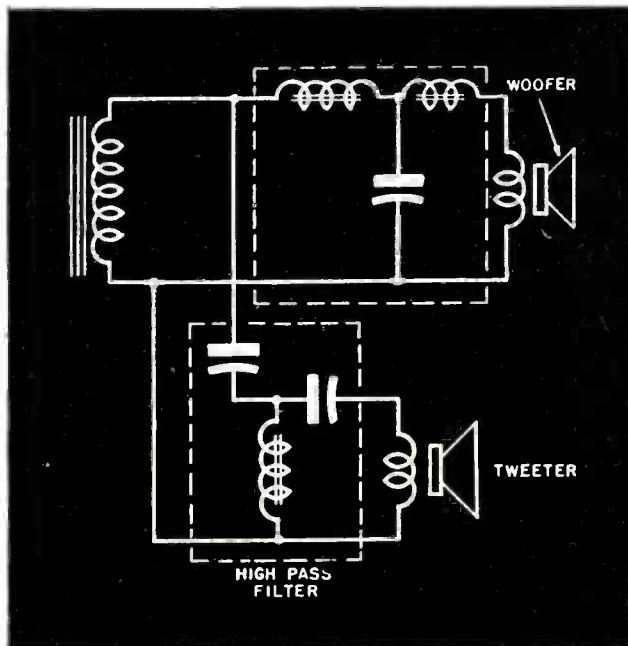

Fig. 8. An improved type of frequency dividing network, using high-pass filters. This system is used in the more expensive types of p-a amplifier systems.

UNIQUE VOLUME EXPANDER AND COMPRESSOR

Reprinted from Radio News

By Craig Stevens

The operation and design of two very clever volume expanders. By simply reversing the circuit design, volume compression can be obtained.

AN EXPANDER, properly used in its place, can enhance the enjoyment of certain kinds of recorded music. It is well-nigh impossible to squeeze the enormous dynamic range of a full symphony orchestra into the closely-spaced record or transcription disc.

For the home recordist this problem is even more acute, as the usual home recorder, as well as the semiprofessional models, records an ever greater number of lines per inch, which places more severe limitations on the volume range.

Added to this are such items as inexpensive recording heads; inability to cope with high-volume levels without severe distortion; lack of sufficient power in the output stages, to drive the cutting head to reproduce high levels without serious distortion; and scarcity of sapphire styli and first quality discs which increase the noise level, further reducing the available dynamic range. It might be stated at this point that it is not unusual in a commercial recording setup to see a 50-watt amplifier using two 50-watt tubes driving a 3-watt cutting head so that the attendant distortion will be negligible.

It may be seen, then, that the dynamic range impressed upon the record is not that which was possessed by the original rendition of the music. Certain kinds of music need more elbow room than others. Notable among these are most symphonic selections ranging from a muted violin solo to the full output of a 100-piece orchestra. A large amount of the beauty of these selections lies in the composer's manipulation of not only notes, chords, melodies, etc., but in his portrayal of feeling and mood with the volume as his tool.

An expander, then, is indicated. However, we do not have to re-endow our selection with all its original range, but we may materially increase its realism by extending it to a certain degree. We may do this in a way which also will tend to make the music even more pleasing.

Most commercial records, particularly of late, have a high hiss or scratch level which certainly does not improve with use. This scratch is particularly annoying on low-level passages where the scratch may well be as loud as the music. The mere attenuation of the high frequencies will eliminate the scratch, but it eliminates the highs also, wherein is contained a large part of the brilliance and tonal intelligence imparted by the composer.

However, we can strike a compromise. Suppose we use an expander that attenuates the highs on the low passages and accentuates them on the loud passages. We get an over-all sense that the scratch is missing from our records without being too cognizant of the slight loss of high frequencies at low levels. Furthermore, at low levels of sound we tend to concentrate on the music so that the loss is not as noticeable as one might think.

If we are of the "genus Recordist," we may invert our expander and use it as a compressor which will enable us almost to double the effective range that we can squeeze on our disc; also, we may record at a higher average level, improving our signal to noise level, further reducing our annoying hiss level *without* the attenuation of high frequencies.

Expanders have consisted usually of a multitude circuit consisting of a variable- μ tube such as 6L7, the gain of which is controlled by the signal level by rectifying it and applying this d.c. voltage which is equal to the average signal level to the μ controlling grid, or by using a medium- μ triode and controlling its bias voltage.

Both of these systems have inherent distortion because of the moving about of the tube's operating point on its plate characteristic. Furthermore, in some expanders built by the author, it was necessary to try a half-dozen tubes before a satisfactory one could be found. This procedure is fantastic now in light of the extreme difficulty in obtaining even a few tubes of the more common numbers.

Two expanders are therefore proposed, which offer several singular advantages. The first has as one of its important sales points the absurd total cost of not over fifty cents and a few hours work. It comprises two parts: number one, a resistor, and number two, a dial lamp. These two components are hooked up as in Fig. 1A across the output winding of the output transformer. The tap between them is returned to an appropriate point in one of the earlier stages of the amplifier and consists of a negative feedback arrangement. With a low volume signal, the resistance of the lamp R_2 is very low so that the amount of feedback is large and the gain of the amplifier is reduced by as much feedback as can be used without oscillation.

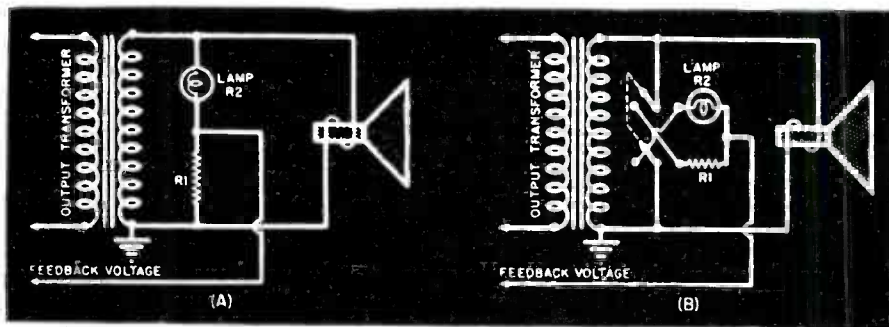

Fig. 1. (A) Diagram of the simplest form of expander, employing only two components: a resistor, R_1 , and a pilot lamp. R_1 should be approximately one-half of the speaker's voice-coil impedance. The type of pilot lamp, R_2 , depends on the output of the amplifier used (refer to article for explanation). (B) The same circuit, with the addition of a d.p.d.t. switch, which can be used to obtain either volume expansion or volume compression.

When a strong signal appears at the output transformer, the lamp will heat, and in doing so, its resistance increases rapidly. This reduces the feedback, increasing the gain of the amplifier, because naturally, the ratio of the voltage at the tap to the voltage across the winding, is equal to the ratio of R_1 to $(R_1 + R_2)$. The amazing part is that when the device is operating at low levels, its distortion is less than the amplifier operating without the expander at all!

Now, if we introduce a network in the feedback lead; i.e., from the tap between the resistors, which will feed back predominantly high frequencies, then on

low levels the gain at high frequencies will be reduced more than the low frequencies, reducing hiss and giving the illusion of cleaner reproduction. When a loud passage comes along, however, the gain at the higher frequencies is increased more rapidly than the gain at low frequencies and the loud passages come out in all their natural brilliance. This lamp circuit is *not* suitable for popular music as its time constant is too long, being in the order of .5 to 1 second, the lag being due to the time taken in heating the lamp filament.

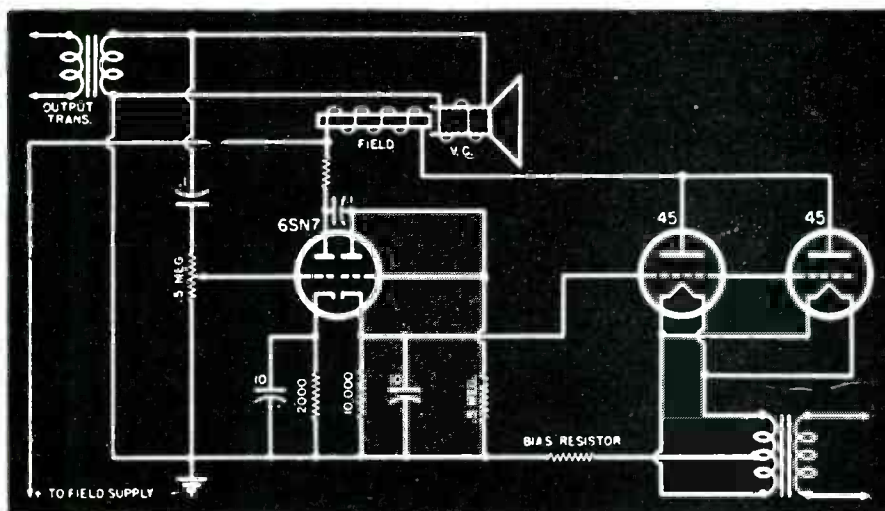

Fig. 2. Schematic diagram of a volume expander which depends upon a variation of the speaker's field coil excitation as its basis of operation

This, however, is not a serious detriment to most classical selections and it tends to follow the average level of the music, smoothly and without any abrupt changes. Fig. 3 shows several possible ways to introduce feedback connections into several types of amplifiers. As a general rule the better the transformer in the amplifier, the more feedback can be used which means, of course, more expansion.

The simple inclusion of a double-pole double-throw switch (Fig. 1B) changes our expander into a compressor, as the action will now be reversed and an increase in volume will decrease the gain of the amplifier. Incidentally, this is, in fact, a real compressor whose action is not just to clip the peaks from loud passages and introduce serious distortion, but its compressive action is gauged smoothly by the level present at any instant.

Furthermore, it reduces distortion at high levels to some extent because of the increased degeneration. To the recordist this means that within reasonable limits, a close watch of level meters and eye tubes may be dispensed with and a higher average level may be recorded without the attendant danger of overcutting and distortion!

One so-called disadvantage of this system is that it does consume power, but it is a small fraction of that which is available at the output transformer and does not appreciably affect the power output of an amplifier of any but the smallest systems. It operates effectively at about .5 watt if a .15 ampere blue-bead dial lamp

is used and slightly less than two watts if a brown-head .25-ampere bulb is used. The lower current bulbs are desirable. Two bulbs may be hooked in series to give more expansion or to obtain a lower power loss.

This circuit does not have to be used on the low-impedance output winding of the output transformer. The 250- or 500-ohm winding may be utilized on large amplifiers of the 12- to 30-watt breed. A 7-watt, 110-volt medium base bulb can be used here together with a higher series resistor. It may be noted here that if R_1 is made a rheostat or variable, it may be adjusted so that the lamp operates on its most sensitive point; i.e., the steepest part of its resistance temperature characteristic so that maximum expansion may be obtained. It must be kept in mind that when this network is shunted across the output winding, the combination load impedance as seen by the tubes, too, is lowered. If a lower tap on the output transformer is available, it should be used. If not, then the resistance R_1 should be kept as high as possible and still give the desired expansion. The feedback will tend to minimize this effect. All in all, however, it comprises a simple, effective, inexpensive expander-compressor, and best of all, it uses no priority items!

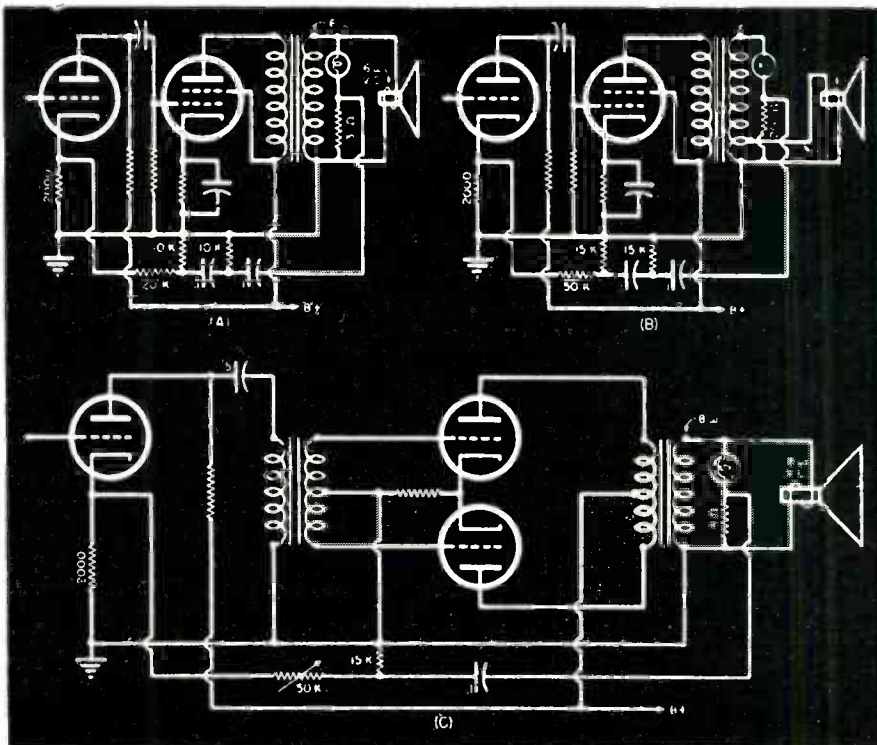

Fig. 3. Wiring diagram showing several possible ways to introduce feedback (degeneration) and this unique expander in present-day amplifiers

For the expander enthusiast who has a good sized field type speaker, there is another system which has merit. If we hook a diode to the output winding of our output transformer, we get a d.c. voltage proportional to the average level of the signal output. If we apply this voltage to the grid of a triode such as a 2A3, 45, etc., as bias, we will vary its resistance. If we place this triode in series with the field supply to our speaker, we will vary the field power supplied to the speaker.

This would comprise an expander. It has the advantage that a speaker's sensitivity to high frequencies is determined by the number of lines in the gap in which the voice coil operates, so that as the signal voltage is increased, the speaker's response to high frequencies would increase, within limits, considerably faster than its sensitivity to low frequencies.

So we again produce the desirable characteristic of expanding the high frequencies more than the low ones. Of course, if we exceed certain limits on the field voltage of our speaker, we will introduce distortion, but if we set the no-signal field voltage of the speaker so as to obtain about 30% recommended field power, by applying a required amount of bias on our triode, and we expand to about 125% of recommended field power, we will not introduce any serious distortion.

Incidentally, on very loud passages we actually increase our speaker's ability to handle power, reducing high-volume distortion in the speaker.

If our speaker is of the twelve or 15 inch, 15 or 20 watt variety, then we will have to put two or three triodes in parallel. There is quite a selection of tubes to choose from as we may triode connect such pentodes as 41, 42, 6F6, 6L6, 6V6, etc. The average triode or pentode can pass 30 ma. average and 50 ma. for a short time, so we can figure how many tubes we need for our system. It may be necessary to introduce an amplifier in front of our diode rectifier to obtain enough d.c. voltage to swing the grid of our triodes the required amount. This would allow an expansion control to vary the amount of expansion. If we can utilize a 500-ohm winding, however, this amplifier would be unnecessary.

Fig. 2 shows a tentative hookup for this system. The number of speakers which the experimenter may have, the large number of different amplifiers, and the variety of tubes available, makes it hard to specify exact values, but the circuit is simple and any tube manual plus the field resistance of your speaker, plus the field-supply voltage available, is all that is necessary to figure the values of the few components used.

Needless to say, this system could be used as a compressor by reversing the polarity of the diode output d.c. voltage and decreasing the bias on the triode, so that an increase in signal would decrease the field power. This would introduce distortion if carried too far and would, of course, be of no great use to the recordist unless he were to pick up the speaker's output with a microphone.

Either of these expanders will work well and they both have plenty of elbow room for the experimenter to exercise his originality in the exact connection of his equipment to meet his individual needs.

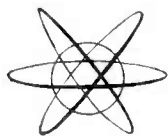

WHAT'S BEING READ THIS MONTH

As a regular feature of our magazine, we take pleasure in presenting each month a complete list of the articles which have appeared in the current issues of the leading trade and professional magazines. The list for this month is as follows:

COMMUNICATIONS (July 1945)

<i>ELECTRIC MEGAPHONES</i>	<i>Arthur J. Sanial</i>
<i>CALIBRATION OF DECIBEL METERS</i>	<i>Paul K. Hudson</i>
<i>COMMUNICATIONS SYSTEM ABOARD DC-3 AIRCRAFT</i>	<i>Ralph G. Peters</i>
<i>MULTI-SECTION FILTER-DESIGN PROCEDURE</i>	<i>Paul Selgin</i>
<i>PRODUCING NEARLY CONSTANT ALTERNATING VOLTAGES FOR CALIBRATION</i>	<i>William Stockman</i>
<i>REMOTE CONTROL OF OUTPUT LEVEL</i>	<i>Raymond P. Aylor, Jr.</i>
<i>RESISTIVE ATTENUATORS, PADS AND NETWORKS (PART VI)</i>	<i>Paul B. Wright</i>
<i>INTERPLANT RR RADIO SYSTEM</i>	
<i>V-H-F TRANSMISSION LINE ELEMENT CHART</i>	<i>Frederick C. Everett</i>

CQ (August 1945)

V-H-F ADAPTER FOR AUTOMOBILE RADIO

How to use the car radio as a modulator, amplifier and power supply — and still have it for standard broadcast.....*Loyal Stephen Fox, W2AHB*

FM-AM SUPERHET FOR THE 144-MC BAND

This up-to-the-minute receiver features acorn tubes, double conversion, and provision for 10-mc i-f channel equipment.....*Leroy W. May, Jr., W5AJG*

SIMPLE ONE OR TWO TUBE RECORD PLAYER

Constructional data for a one- or two-tube player.....*Herbert S. Brier, W9EGQ*

PORTABLE MOBILE XMTTR

This rig can be used for 112-mc WERS operation and for ham work on the new 144-mc band
John Wonsowicz, W9DUT and Herbert S. Brier, W9EGQ

FREQUENCY ALLOCATION CHART

A complete chart of final frequency allocations from 25 to above 30,000 mc

YL OPERATORS

Introducing the LSPH's and describing the part they are playing in the Young Ladies' Radio League during the war.....*Anita Calcagni Bien, W8TAY*

RADIO AMATEUR'S WORKSHEET, NO. 3 — NOTES ON PUSH-PULL MODULATORS OR DETECTORS

A BRIEF FOR THE HAM.....*Lt. Col. David Talley, S.C.*

ELECTRONICS (August 1945)*SURPLUS EQUIPMENT DISPOSAL PLAN*

Details of government-designed machinery under which obsolete military electronic gear is marketed.....*G. T. Montgomery*

MOTOR NOISE UNIT FOR AIRCRAFT TRAINER

Noise resembling that of an airplane motor is produced by a multivibrator and sub-harmonic generators.....*Byron E. Phelps*

REMOTE TUNING WITH REACTANCE TUBES

Receivers are tuned over a limited band, by means of d-c transmitted over telephone lines.....*H. Bard*

ELECTRONIC CONTROL FOR MAGNETIC CLUTCHES

A present motor speed is maintained within 0.1 percent for all load variations up to full load.....*Ralph L. Jaeschke*

F-M ANTENNA COUPLER

Feeding an f-m antenna without shorting an a-m tower on which it is mounted.....*John P. Taylor*

INDUCTION AND DIELECTRIC HEATING EQUIPMENT

Performance and cost data on commercially available induction and dielectric heating equipment

SURVEY OF D-C AMPLIFIERS

Causes of drift, performance characteristics of 12 different circuits, and oscilloscope applications.....*Maurice Artzt*

HIGH-Q IRON-CORED INDUCTOR CALCULATIONS

Analytic approach to core and coil calculations results in highest-Q inductor.....*Stephen L. Javna*

HARMONIC SUPPRESSION FOR AIRCRAFT GENERATORS

Procedure for designing low-cost series resonant filters to suppress harmonics in output.....*F. W. Jaksha*

STUDIO AND CONTROL-ROOM DESIGN

Equipment and space requirements for studio and control room of student-operated station.....*William Reugh Hutchins*

QUARTZ CRYSTAL IMPROVEMENTS

Advances in crystal manufacturing methods hold promise for future.....*C. W. Franklin*

SQUARE-WAVE DIFFERENTIATING CIRCUIT ANALYSIS

Development of charts giving pulse amplitude and length for input of finite wave-front slope.....*G. P. Ohman*

GRAPHICAL SYMBOLS FOR ELECTRONIC DIAGRAMS

Most-used schematic symbols abstracted from ASA bulletins and arranged in chart form for convenient reference

STABILIZED NEGATIVE IMPEDANCES, PART II,

Charts for predicting effects on negative impedances of frequency variations in amplifier characteristics.....*E. L. Gunton*

FCC ANNOUNCES FINAL F-M AND TELEVISION ALLOCATIONS

ELECTRONIC INDUSTRIES (August 1945)*THERMISTOR TECHNICS*

Application of new forms of negative temperature coefficient resistors in automatically maintaining levels.....*J. C. Johnson*

SELENIUM RECTIFIERS FOR AIRCRAFT NOMOGRAPH FOR COILS

A chart for determining the length of wire to fill a given spool. Example calculations on wire wound resistors

TELEVISION OPTICS

Comparison of optical characteristics of refractive and reflective (Schmidt) projection systems for home television receivers.....*Dr. K. Pestrecov*

SURPLUS DISPOSAL

Government bodies, linked with industry, seek to make effective an orderly program to prevent market chaos

44-108MC ALLOCATIONS

Engineers generally approve final adoption of revised Alternative No. 3 putting FM upstairs and television down

MAGNETIC POWDERS

Many physical and chemical characteristics bear on the usefulness of metallic and compound iron powders.....*H. Gregory Shea*

*STRAIN-GAGE PIANO PICKUP**VOLTAGE STABILIZERS*

Engineering developments in the design and construction of automatic equipment to compensate for voltage fluctuations.....*J. A. Utal*

COAX CABLE PROTECTION

Ground currents from lightning discharges can crush or puncture underground cables in cross-country networks.....*L. S. Inskip*

SHIPBOARD ANNOUNCERS

Three independent high volume loudspeaker systems and controls permitting cross-ties provide battle safety.....*L. B. Cooke*

STREET LIGHT CONTROL

Largest such system operated by carrier, permits remote control of lighting through 1300 pole receivers.....*Jesse L. Haley*

MEASURING THICKNESS

Gamma rays from radium source are used to measure wall sizes by detecting the reflections from molecules

*TUBES ON THE JOB —**MECHANICAL PRODUCTION OF GRIDS*

Development of high speed machine equipment for turning out 4000 vertical bar grids daily for transmitting tubes

ELECTRONIC INDUSTRIES (August 1945) continued*SIGCIRCUS — ARMY'S P563*

Largest mobile station ever built is rated 60 kw and capable of transmitting and receiving 200,000 words per day

SHIELDING HF INTERFERENCE

Attenuation ratios as high as 10,000,000 to 1 can be obtained with shielded rooms.....*Albert F. Murray*

*ARMY FM MOBILE UNIT**METEORS AND VHF BURSTS*

Effect of Leonid and Perseid meteoric showers in producing interference due to ionization streaks.....*Dr. Harlan T. Stetson*

FM AND TELEVISION (July 1945)

LICENSEES COOPERATE ON FM FOR NEW BAND.....*Milton B. Sleeper*

UNATTENDED, AUTOMATIC FM RELAY.....*William M. Lee*

TELEVISION STATION WRGB.....*James D. McLean*

NEW EMERGENCY FM EQUIPMENT.....*H. F. Mickel*

FM HANDBOOK, CHAPTER 6.....*René T. Hemmes*

PROCEEDINGS OF THE I.R.E. (August 1945)*ARTHUR VAN DYCK**THE INTERDEPARTMENT RADIO ADVISORY*

COMMITTEE*E. M. Webster*

SOME AIDS TO FACILITATE THE ENGINEER'S

ACADEMIC TRAINING.....*B. Dudley*

RADIO-RELAY COMMUNICATION SYSTEMS IN THE

UNITED STATES ARMY.....*W. S. Marks, Jr., O. D. Perkins, and W. R. Clark*

A NEW TYPE OF AUTOMATIC DIRECTION FINDER.....*Cecil C. Pine*

*EXPERIMENTAL DETERMINATION OF IMPEDANCE**FUNCTIONS BY THE USE OF AN ELECTROLYTIC*

TANK.....*W. W. Hansen and O. C. Lundstrom*

THE CALCULATION OF NONSINUSOIDAL VOLTAGE

GENERATORS.....*M. V. Kiebert and A. F. Inglis*

THE REACTANCE THEOREM FOR A RESONATOR.....*W. R. MacLean*

"N"-PHASE RESISTANCE-CAPACITANCE OSCILLATORS.....*R. M. Barrett*

Q S T (August 1945)*FCC ALLOCATES 44-108 MEGACYCLES*

Our 5-meter band becomes 50-54 Mc. in speeded-up action; television gets low end; F.M. moves upstairs

QST GOES VOYAGING ON A U.S.M.S. TRAINING SHIP

Four days aboard the "American Navigator".....*A. David Middleton, W2OEN*

GROUND-PLANE ANTENNAS

Design data for the 112-Mc. band.....*E. Dillon Smith, W3PZ*

TAMING THE VACUUM-TUBE VOLTMETER

Part II — Construction of a practical instrument.....*McMurdo Silver*

QST (August 1945) continued*A BETTER ELECTRONIC KEYS*

More dependable semi-automatic dots and dashes...*Harry Beecher, RM1c, W2ILE*

NEW TUBES

Types 6N4, 2CA0, GL-3C22, IB48, CK51OAX, 6AJ5,
2523N1/128AS, OA2, 4-25A, 822-S

RADAR TECHNIQUES

Part IV — Boundries.....*Clinton B. DeSoto, W1CBD*

A VOLUME EXPANDER FOR AUDIO AMPLIFIERS

Reducing time constant for more rapid re-
sponse.....*Lt. Henry K. Weidemann, USNR, W6HKN*

RADIO (July 1945)*AN AUDIO-CARRIER-FREQUENCY R-C OSCILLATOR*

This resistance-capacity oscillator covers a range from
20 to 200,000 cycles and has many unusual features.....*Robert C. Paine*

THE APPLICATION OF METALS IN RADIO RECEIVER DESIGN

Practical data for radio engineers on a subject with
which many are unfamiliar.....*A. C. Matthews*

FCC REPORT ON FM

The Federal Communications Commission presents their
case for assigning higher frequencies for FM

FREQUENCY ALLOCATION CHART

A complete chart of final frequency allocations from
25 to above 30,000 mc

A CIRCUIT FOR PHASE MODULATION

This article describes a new method of phase modulation
which has proved successful in a commercial FM
transmitter *Bernard Grob*

A CRL IMPEDANCE BRIDGE

Complete data on a laboratory bridge which is direct-reading.....*Athan Cosmas*

RADIO DESIGN WORKSHEET, No. 38: IMAGE SUPPRESSION;

Considerations involved in the choice of intermediate
frequencies

RADIO BIBLIOGRAPHY: 18 — VELOCITY MODULATION,

PART 2 *F. X. Rettenmeyer*

RADIO CRAFT (August 1945)

TELEVISION AND THE SERVICEMAN.....	Gene Conklin
FACTORY RADIOMEN.....	E. A. Witten
NEW IDEAS IN RECEIVERS.....	Fred Shinaman
NEW AUTOMATIC RADIO COMPASS.....	J. M. Lee and Fred W. Heden
MICROWAVES, PART II.....	Capt. E. F. Skinner
ELECTRONIC METRONOME.....	C. C. Gray
PARASITIC OSCILLATIONS, PART II.....	Dem. Stockett Edmonds, Jr.
NEGATIVE FEEDBACK.....	J. W. Straede
POWER SUPPLY DESIGN.....	James E. Dolan
DETECTOR CIRCUITS, PART I.....	Robert F. Scott
UNBALANCED-BRIDGE CHECKER	
TUBE REPLACEMENTS, PART II.....	J. Queen
PLANNING THE SERVICE SHOP.....	Robert Dixon
RADIO VOLTAGE TESTS.....	Jack King
MORE ON BATTERY SET CONVERSIONS.....	Gerald Evans
SAVE THE BATTERY SETS.....	Earl T. Hartline
NEW SHORTWAVE CONVERTER.....	Wm. Nimmons

RADIO NEWS (August 1945)

"QRM" A THREAT TO AMATEUR RADIO.....	T/Sgt. George Mobus, W0UAC
BUILD THIS VICTORY TRANSMITTER.....	Guy Dexter
COMPARISON OF VISUAL AND ORAL RECEPTION.....	Harvey Pollock
TELEVISION FOR THE AMATEUR.....	Oliver Reed, W6ETI
5" OSCILLOSCOPE DESIGN.....	Rufus P. Turner
100MC. TRANSMITTER.....	William Maron
QTC.....	Carl Coleman
LET'S TALK SHOP.....	Joe Marty
TONE CONTROL CIRCUITS.....	J. Carlisle Hoadley
PRACTICAL RADIO COURSE.....	Alfred A. Ghirardi
TELEVISION SOUND CHANNEL.....	Edward M. Noll
PLOTTING ENGINEERING DATA.....	R. G. Middleton
"JUKE BOX" SERVICING PROVES SUCCESSFUL.....	Eugene A. Conklin
LINE CORD VOLTAGE BANK.....	Sgt. H. L. Davidson
FOR THE RECORD	
INSTRUMENT LANDING SYSTEM.....	Lt. R. J. Hennessy
PRACTICAL RADAR.....	Jordan McQuay
11,500 MILE RADIO NET	
EUROPEAN NEWS REVIEW.....	Leon Liden
WHAT'S NEW IN RADIO	

RADIO NEWS - Radio Electronic Engineering Edition (Aug. 1945)

<i>SPECIAL CATHODE RAY TECHNIQUES</i>	<i>B. M. H. Michel</i>
<i>ELECTRONIC VOLTAGE REGULATORS</i>	<i>Lt. J. F. Sodaro</i>
<i>OUTGASSING VACUUM TUBES</i>	<i>H. S. Cooke</i>
<i>IMPEDANCE CONVERSION CHART</i>	<i>Robert C. Paine</i>
<i>GRAPHICAL METHODS OF SOLVING TRANSMISSION LINE PROBLEMS</i>	<i>Bowen C. Dees</i>
<i>REDUCTION IN GAIN CAUSED BY FEEDBACK</i>	

SERVICE (July 1945)

<i>RESISTORS IN TUBE SUBSTITUTIONS</i>	<i>A. A. Ghirardi</i>
<i>VOLUME CONTROLS</i>	<i>Robt. L. Martin</i>
<i>WAVE TRAPS</i>	<i>Willard Moody</i>
<i>ANALYSIS OF CATHODE-RAY TUBES</i>	
<i>First of a series</i>	<i>S. J. Murcek</i>
<i>TUNING CONDENSER REPAIR</i>	<i>Edw. Arthur</i>
<i>SER-CUITS</i>	<i>Henry Howard</i>

BUY *and* HOLD WAR BONDS



• THIS IS OUR FUTURE •



IT'S THAT SIMPLE!

You may be miles at sea with nothing on the horizon but water . . . but you will never be out of touch with home or business ashore when you are equipped with a Hudson Marine Radio Telephone.

Superlative efficiency and fool-proof dependability have been engineered into Hudson equipment by experts with a "war-full" of scientific know-how.

Proof of this is Hudson's combat record of thousands of hours of unflinching performance under the most difficult of conditions . . . and *it is vital assurance to you!*

When it's your freedom of movement at stake . . . your peace of mind . . . your safety . . . you want the best in communication equipment.

So for your pleasure jaunts after the War . . . make sure you're equipped with one of the four compact models of the Hudson Marine Radio Telephone.

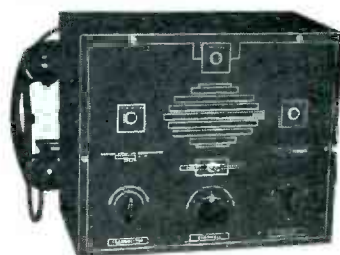

THE "SEAFARER"

HUDSON *Marine* RADIO TELEPHONE

A product of the HUDSON AMERICAN CORPORATION • 25 West 43rd St., New York 18, N. Y.

(A SUBSIDIARY OF REEVES-ELY LABORATORIES, INC.)

