

AUGUST, 1934

# Radio Engineering

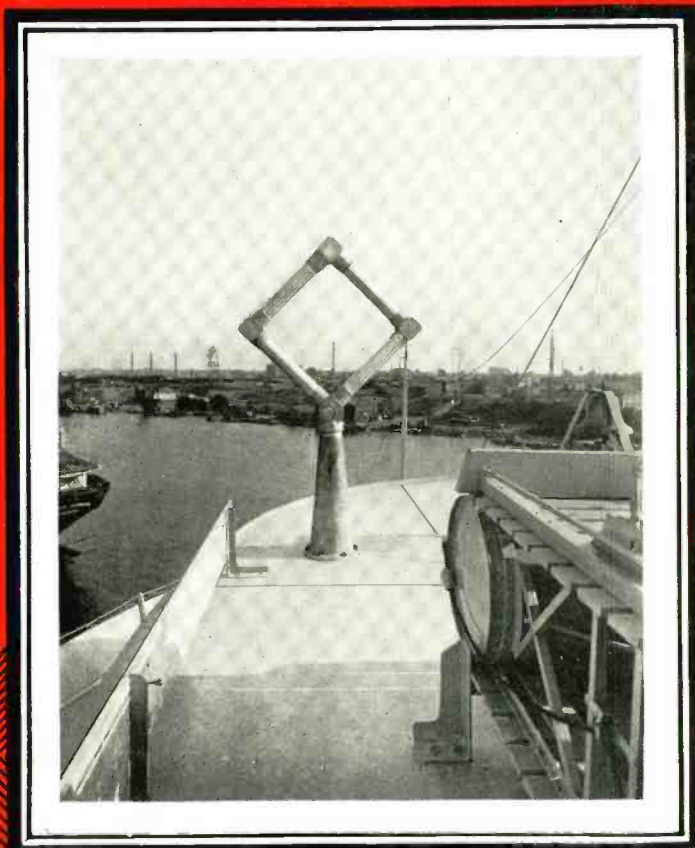
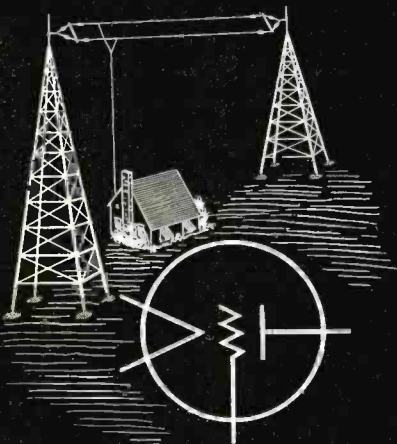

VOL. XIV

NO. 8



The Journal of the  
Radio and Allied Industries

# October 15 !



We're amazed at the new engineering developments in the immediate offing in the field of radio communication and broadcasting. There's an astonishing wealth of new, important data (and the editors are collecting more every day) waiting already for publication in the first number of "COMMUNICATION and BROADCAST ENGINEERING".

**October 15th is the mailing date for  
the first number**

**NOTE**—The circulation of "COMMUNICATION and BROADCAST ENGINEERING" will be rigidly limited to approximately 5,000 leading executives and engineers connected with radio, wire and cable communication and broadcasting.

*The subscription rate is \$3.00 yearly (in Canada and foreign countries, \$4.00).*

**DO NOT SEND REMITTANCE NOW!**

If interested, send us your name, address and official capacity, and we'll send you further details concerning "COMMUNICATION and BROADCAST ENGINEERING" by return mail.

**BRYAN DAVIS PUBLISHING CO., Inc.**

19 East 47th Street

: :

New York City

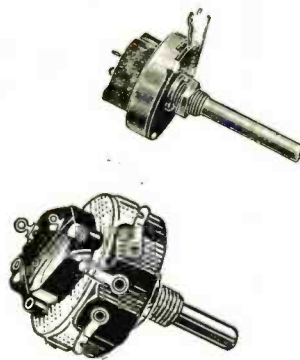
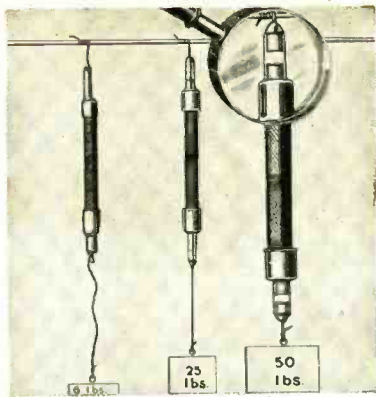

# CLAROSTAT'S NEW RESISTOR and VOLUME CONTROL LINE Will Solve Your Special or Mass Production Problems

## LINE RESISTORS

**EXTERNAL TYPE:** These line reducing resistors are equipped with both male and female plugs in five varying combinations, are especially suitable for the export market and designed to reduce line voltage.

**INTERNAL TYPE:** This line of fixed resistors has been designed especially for use in reducing the voltages of 110 volts and 220 volts DC line, to the values required by the filament circuit of receivers. These new units eliminate the necessity of using protective housings over such resistors. They readily mount into standard tube sockets and operate at lower temperatures due to their efficient design.

## VOLUME CONTROLS

**WIRE WOUND TYPE:** For years leading receiver manufacturers have employed our units because they are manufactured carefully to the specifications set for them and are reliable, compact, rugged and include an ample safety factor. Only the finest quality materials are used. Recent improvements in design and manufacturing facilities permit us to offer better controls than ever before.

**COMPOSITION ELEMENT TYPE:** Our new series of composition element volume and tone control rheostats and potentiometers, embodies an improved and time tried resistance element which is immune to humidity and contact erosion. These controls are available in various resistance gradients.

## FLEXIBLE RESISTORS

**FLEXIBLE RESISTORS:** We have just perfected a new series of flexible resistors of superior quality at prices competitive with carbon resistors. In design they are trim. In accuracy, the commercial tolerance is maintained at  $\pm 10\%$ . In ruggedness and tensile strength, their new design permits them to exceed manufacturers requirements from 250% to 500%. The R.M.A. color code for resistance values is used throughout. Production facilities permit unlimited quantities on short notice.

**METAL CAN RESISTORS:** Our complete line of asbestos covered, enclosed in metal can resistors may be had in straight resistors, tapped resistors and in many other varieties. They are so constructed to mount flush to the chassis; or raised off the chassis to your specifications; or upright mounting position; the entire height not exceeding the height of the radio set's tubes.

ALL CLAROSTAT PRODUCTS ARE FULLY COVERED BY PATENTS

*We solicit inquiries on mass production or special resistor problems, for radio, sound, communication or industrial application.*

NEW CONTROL REPLACEMENT GUIDE UPON REQUEST



**CLAROSTAT MFG. CO., Inc.**

285 North 6th Street

Brooklyn, N. Y.

*"AD-A-SWITCH" was originated by Clarostat*





# RADIO ENGINEERING

Reg. U. S. Patent Office

*Editor*  
M. L. MUHLEMAN

*Member*  
Audit Bureau of Circulations

*Associate Editor*  
RAY D. RETTENMEYER

Vol. XIV

AUGUST, 1934

Number 8

## CONTENTS

	PAGE
COVER ILLUSTRATION RCA DIRECTION FINDER LOOP	
EDITORIAL .....	4
NEW POLICE TRANSMITTER.....	7
RADIO INDUSTRY IMPROVING.....	10
NEW MACKAY STATION ON WAY.....	11
RMA REQUESTS EXEMPTION FROM ELECTRICAL CODE.....	12
CALCULATING SERIES AND PARALLEL IMPEDANCES <i>By Carlton A. Mizen</i>	14
FEDERAL COMMUNICATIONS COMMISSION UNDER WAY.....	16
BOSTON TWO-WAY POLICE RADIO SYSTEM.....	17
BLEEDER RESISTANCE IMPROVES POWER SUPPLY REGULATION <i>By Reuben Lee</i>	18
BOOK REVIEW.....	21
VETERAN WIRELESS OPERATORS ASSOCIATION NEWS.....	24

## DEPARTMENTS

NOTES AND COMMENT.....	20
A CHRONOLOGICAL HISTORY OF ELECTRICAL COMMUNICATION—TELEGRAPH, TELEPHONE AND RADIO—PART XXXII	23
NEWS OF THE INDUSTRY.....	25
NEW PRODUCTS.....	26
INDEX OF ADVERTISERS.....	30

## RMA "FIVE POINT" PLAN

RMA HAS BEGUN distribution of the preliminary draft of the radio industry's "Five Point" Plan for national promotion. Powel Crosley of Cincinnati, chairman of the RMA Committee, working with the Radio Wholesalers Association on the national radio promotion project, has had printed copies, outlining details of the nationwide plan of operations sent to larger companies of the RMA, to secure initial and, it is hoped, favorable reaction of companies maintaining distributing organizations. Chairman Crosley and his committee recently concluded the printed draft of the promotion plan at a New York meeting with a similar meeting representing the Radio Wholesalers Association.

Legal contracts and other procedure in developing the sales promotion plan are in process of preparation and the RMA and RWA will unite this summer and early fall to enlist the widest possible industry support of the promotion project.

BRYAN S. DAVIS  
*President*

JAS. A. WALKER  
*Secretary*

*Published Monthly by the*  
Bryan Davis Publishing Co., Inc.  
19 East 47th Street  
New York City

SANFORD R. COWAN  
*Advertising Manager*

A. B. CARLSEN  
*Circulation Manager*

Chicago Office—608 S. Dearborn St.—C. O. Stimpson, Mgr.  
Cleveland Office—10515 Wilbur Ave.—J. C. Munn, mgr.

St. Louis Office—505 Star Bldg.—F. J. Wright, Mgr.  
Wellington, New Zealand—Tearo Book Depot.  
Melbourne, Australia—McGill's Agency.

Entered as second class matter August 26, 1931, at the Post Office at New York, N. Y., under Act of March 3, 1879. Yearly subscription rate \$2.00 in United States. \$3.00 in Canada and foreign countries.

# SHAKEPROOF

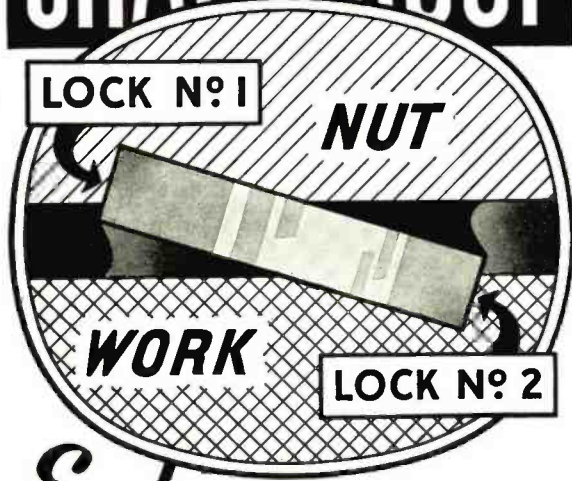

*Each TWISTED TOOTH forms a double lock!*

● When you turn a nut or screw down on a Shakeproof Lock Washer, you can rest assured vibration cannot shake it loose. Each twisted tooth bites into both nut and work surfaces, forming a double lock that never lets go. As vibration increases, each biting edge digs in deeper and only applied force can release their hold. Now, also realize there are several twisted teeth on each Shakeproof Lock Washer which means that the holding power of each tooth is multiplied many times. That is why Shakeproof offers you the best possible protection for the performance of your product and, if you doubt it, we ask you to make a test of this positive locking principle in your own shop. Write for free testing samples today!

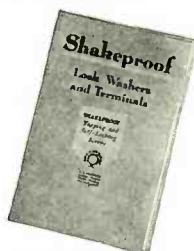

Send today for your free copy of this complete Shakeproof Catalog. Explains thoroughly the many advantages that Shakeproof offers—also shows new patented Shakeproof products.



## SHAKEPROOF Lock Washer Company

Distributors of Shakeproof Products  
Manufactured by Illinois Tool Works

2509 N. Keeler Ave. Chicago, Ill.



© Ewing Galloway, N. Y.

*"I used to say 'ship it'...  
Now I call*

## RAILWAY EXPRESS"

Experience speaking—experience who *knows*... knows all about the uncertainties and "buck-passing" of irresponsible shipping organizations—and of the aggravating delays and difficulties that threaten when shipments are "merely shipped".

Knows, too, all about the passenger train speed of Railway Express... the convenience of Railway Express door to door pick-up and delivery service... of the Railway Express receipt system at both ends... and of the responsibility and dependability of this nation-wide organization equipped with modern methods to tackle any shipping problem, whether it be the handling of delicate tubes or the sturdiest units. Telephone your local Railway Express Agent for service or information.

*The best there is in transportation*

SERVING THE NATION FOR 95 YEARS

# RAILWAY EXPRESS

AGENCY, Inc.

NATION-WIDE SERVICE

# EDITORIAL

---

## LINK BROADCASTING

---

SINCE THE WRITING OF the Editorial, "Small Broadcasters" for the July issue of RADIO ENGINEERING, President Roosevelt has announced his plan for the decentralization of industry. He has invited the heads of industry to visit him at Washington, with a view to obtaining opinions and cooperation on a long-range movement to break up industrial plants into smaller units and locate these in areas where workers may work the land in the event of another industrial soft spot. The process is to extend over a period of years, with the possibility of the movement taking place within the very near future.

If President Roosevelt's plan goes into effect, it is bound to have an effect on the distribution of broadcast facilities. Should the plan be shelved for any reason, it is still probable that broadcast coverage will have to be more uniform, as population has been shifting steadily for the past ten years with an ever-increasing momentum.

Contrary to the common belief, the decentralization of population will not stop and go into reverse with a return to better times. The railroads of the nation will be forced to modify their transportation systems if they are to survive at all. The present trend is toward the employment of light-weight, diesel-powered trains, capable of greater speed and vastly reduced cost of operation per mile. The effect of such transportation will be to extend the "suburbs" out to 100 or 200 miles from the cities, with the time and cost of the transportation remaining equal to present rail travel over a span of 15 to 20 miles.

Rail travel is but one of many factors influencing metropolitan and suburban populations. The problem of the future will be to serve numerous thinly-populated residential areas and widely spaced self-contained industrial units.

We have previously offered the opinion

that, without any regard for the future, there is a definite and immediate need for better broadcast coverage and service. This need, we believe, is generally recognized, but the manner in which the need should be filled remains to be decided upon. Either the nation is to be served by a comparatively small number of super-power broadcast stations, or dotted with a large number of small broadcasters. Which arrangement is the most desirable?

It has been proven rather definitely that a given area, of, say, 100 square miles, is better served by a number of low-power broadcasters than by a single high-power broadcaster. The high-power station places too large a signal in receiving antennae close by and too small a signal in receiving antennae in the outlying districts. On the other hand, a group of well-placed low-power stations, linked in a common system, provides a far better distribution of signal energy over an equivalent area. With a uniform field strength over a wide area, the possibility of inter-station interference is automatically reduced. Moreover, field strength can be maintained at a level sufficiently high to over-ride static and man-made interference.

Suppose such a group of small stations were to be operated on a common frequency. A wide area could be covered without the audio phase difference being great enough to create disturbances to the service. In the event that the group of stations was not tied in with land lines but rather was individually fed by a central transmitter operating in the vicinity of five meters, very few problems would exist. A single feeder station might be sufficient for an entire group of small broadcasters, providing towers 200 feet or so in height were used at the transmitter and receiver locations. An alternative would be the use of a series of five-meter "booster" or relay stations to bridge the gaps.

Will not the present shortcomings of the overcrowded broadcast spectrum make the remodeling of our present system a matter of necessity?



# Weston scores again!

## WITH A NEW TUBE CHECKER

**\$ 29<sup>25</sup>**  
*Net*  
WITH EITHER  
COUNTER OR  
PORTABLE CASE

The new Weston Model 682 Tube Checker, priced sensationally low for a quality instrument, is a combination servicer and merchandiser. Attractively finished in colors and with a scale with a "good tube" area, it makes an appealing and convincing counter merchandiser when mounted in the counter type case. For field servicing, the instrument can be slipped into a leatherette carrying case. Other features make Model 682 the outstanding value in tube checkers today. Here are some of them:

1. Attractively finished in two tones of fawn with silver edging.
2. Instrument can be used as counter merchandiser or portable checker.
3. Counter type case at "easy reading" angle.
4. Single arc scale shows good tubes as "good."
5. Tests tubes commercially used today. Spare sockets for future tubes.
6. Line voltage control.
7. Short check for 4, 5, 6 and 7 prong tubes.
8. Tests cathode leakage by operating switch.
9. Individual tests on all plates of rectifier tubes.
10. "On" and "off" switch.
11. Simple to operate—only one setting of indicator necessary.



Panel view of Tube Checker

Be sure to see this low-priced Model 682 at your jobber's today, or write for information... Weston Electrical Instrument Corp., 612 Frelinghuysen Ave., Newark, N. J.

# WESTON

*Radio Instruments*



*Create*  
**BUY-APPEAL**  
*by adding*  
**EYE-APPEAL**

**W**HATEVER attracts the eye helps unloose the purse strings.

Inasmuch as you're in business to push up the sales curve, why not make your production line a stronger right arm of your sales organization by improving the appearance of your chassis.

Goat Form-Fitting Tube Shields create buy-appeal because they are neat in appearance. Anyone can quickly see that they are tailor-made to fit the product.

And quality—aside from modern appearance—is reflected in better performance, which, too, is a sales objective in modern, high fidelity receivers.

Goat engineers are prepared to help you make Goat Form-Fitting Tube Shields a sales asset.



**GOAT**  
**RADIO TUBE**  
**PARTS, INC.**  
314 Dean Street  
BROOKLYN, N. Y.

# ALLEN-BRADLEY RADIO RESISTORS



Type J Bradleyometer showing mounting with C-washer.

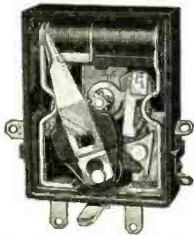

Type A Bradleyometer showing tapped resistor.

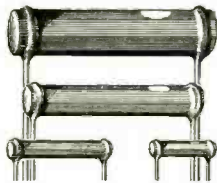

Bradleyunit resistors, standard R. M. A. color-coded. Furnished with leads.

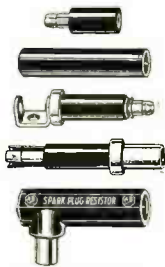

Bradley Suppressors for every automotive application.

## BRADLEYOMETER—TYPE J

The most compact continuously adjustable radio resistor on the market. It is not a film-type unit—the resistor is solid-molded. Any resistance-rotation curve shape is obtainable. Bradleyometer Type JS is provided with built-in line switch. Types J and JS Bradleyometers are attached to panel with C-washer—no threaded bushing and nut. Shaft is insulated. Guaranteed for long life and dependable performance.



TYPE J RESISTOR—A solid molded ring, so constructed that any resistance-rotation curve is obtainable.

## BRADLEYOMETER—TYPE A

The most outstanding adjustable resistor for volume control. Available in several standardized designs for volume and tone control applications. Allen-Bradley engineers will gladly co-operate in designing low-level tone compensation systems using the Type A Bradleyometer.



TYPE A RESISTOR—A column of resistor discs interleaved with silver discs upon which contact arm travels. Produces any resistance-rotation curve.

## BRADLEYUNITS

These solid-molded fixed resistors are used by the leading set manufacturers. They have exceptionally low voltage coefficient. Moisture and age do not affect Bradleyunits, and uniformity of construction assures resistors that are quiet in performance. Specify Bradleyunit resistors for stable receiver performance after long service.



FIXED RESISTOR — A solid molded unit. Over 30 years of manufacturing experience is behind the design and production of Bradleyunits.

## BRADLEY SUPPRESSORS

The prominent car manufacturers use Bradley Suppressors for dependability and superior performance. They do not open circuit in service; they do not drop in resistance and fail as suppressors; they do not fail from exposure to oil and water. Bradley Suppressors do not break due to car or engine vibration. Write today for data and performance curves on resistors for your requirements.



SUPPRESSOR RESISTOR—Solid-molded resistors encased in bakelite tubes (not fragile ceramic containers). They survive abusive treatment in automotive service.



ALLEN-BRADLEY CO., 126 W. Greenfield Ave., MILWAUKEE, WIS.



# RADIO ENGINEERING

FOR AUGUST, 1934

## New Police Transmitter

- Description of the new Western Electric transmitter and rectifier units for moderate area coverage. A crystal-controlled oscillator is used. Ganged switching permits quick frequency shifts.

THE NEW WESTERN ELECTRIC 50-watt radio transmitting equipment was developed especially to provide police radiophone communication for cities having a population under 100,000. It is designed to be operated at any frequency from 1500 to 3000 kc.

### GENERAL DESCRIPTION

The equipment consists of two units: the transmitter proper, illustrated in

Fig. 1, and the rectifier unit, illustrated in Fig. 2. The transmitter is mounted on top of the rectifier unit, as shown in Fig. 3.

Improved facilities for monitoring are provided. Terminals are included for connecting headsets, through which the operator may listen to the rectified output of the modulated transmitter, this output being directly comparable to the

signal. Where two or more transmitters are located near each other and operated on the same frequency, monitoring on the carrier channel is done by means of a radio receiver.

The transmitter equipment and the antenna-ground system need not be installed in proximity to each other. Through the use of an r-f transmission line and antenna tuning unit, the transmitter may be installed at a convenient location with the antenna-ground system as far as 300 feet away at a point which insures most satisfactory transmission. When the transmitter is located close to a short antenna and a good ground, the transmission line and antenna tuning unit are not used.

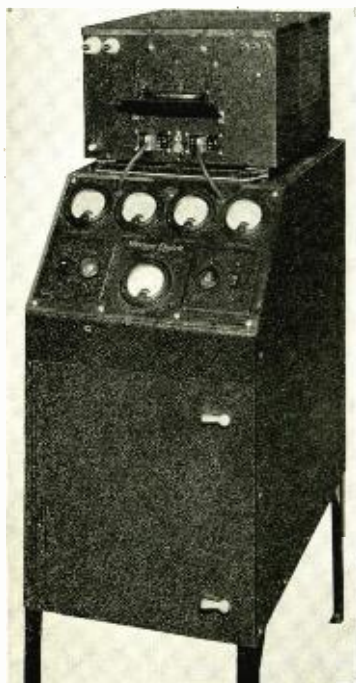
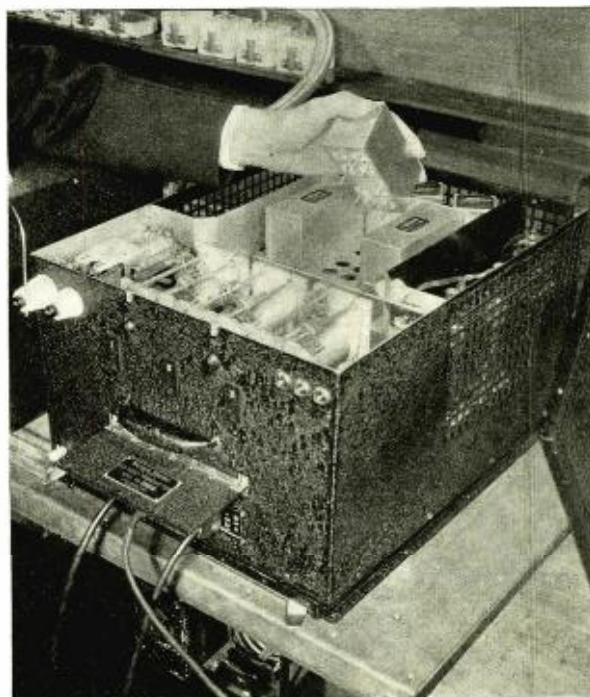

Fig. 3. Left, front view of rectifier and transmitter. The transmitter "plugs" to the rectifier unit and is easily removed for repairs, etc.

Fig. 1. Right, interior of transmitter unit, showing one of three multiple inductance units being plugged into its socket.



**THE TRANSMITTER**

The transmitter will deliver sufficient power to assure full 50-watt radiation from the antenna at any frequency from 1500 to 3000 kc. It is capable of full modulation. All of the tubes are air cooled.

A quartz crystal frequency control maintains frequency stability well within the limits prescribed. The crystal unit is electrically heated and thermostatically controlled.

The design of the transmitter is such that additional equipment may be ob-

tained to provide either one or two additional frequencies. When equipment for more than one frequency is added, changing from one frequency to the other is done by means of a manually-operated switch.

Adequate protection from high voltages is provided. The transmitter has an electrically dead exterior. In addition to this safety factor, a safety switch breaks the circuits when the top of the transmitter is removed, while the plug-in connection from the rectifier to the transmitter in the rear must be entirely disconnected before the rear panel can be removed.

**CIRCUIT DESCRIPTION**

The transmitter is controlled by a push-button, located on the microphone desk stand. Plate voltage is applied to the transmitting tubes only when the push-button is depressed. This prevents emission of the carrier wave between talking intervals. When the push-button is depressed relay S5 is energized and the contacts of this relay close the transmitting tube plate circuits. Another set of contacts on the relay S4 make and break the filament circuit of the tubes. Thus, during periods of si-

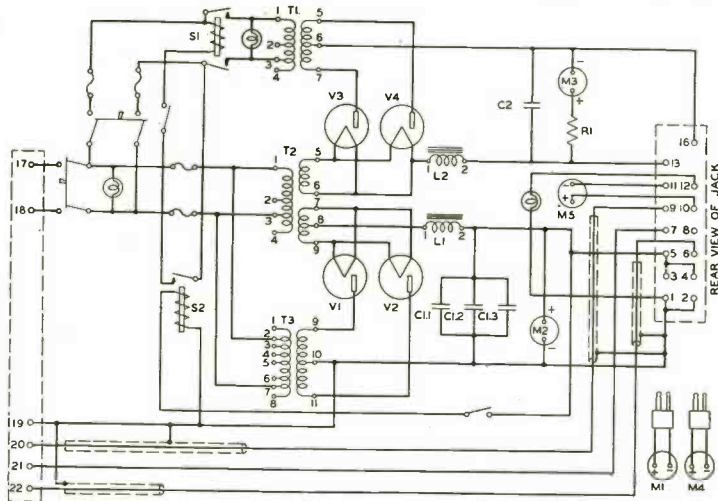

Fig. 5. Schematic diagram of Western Electric 10-A Rectifier.

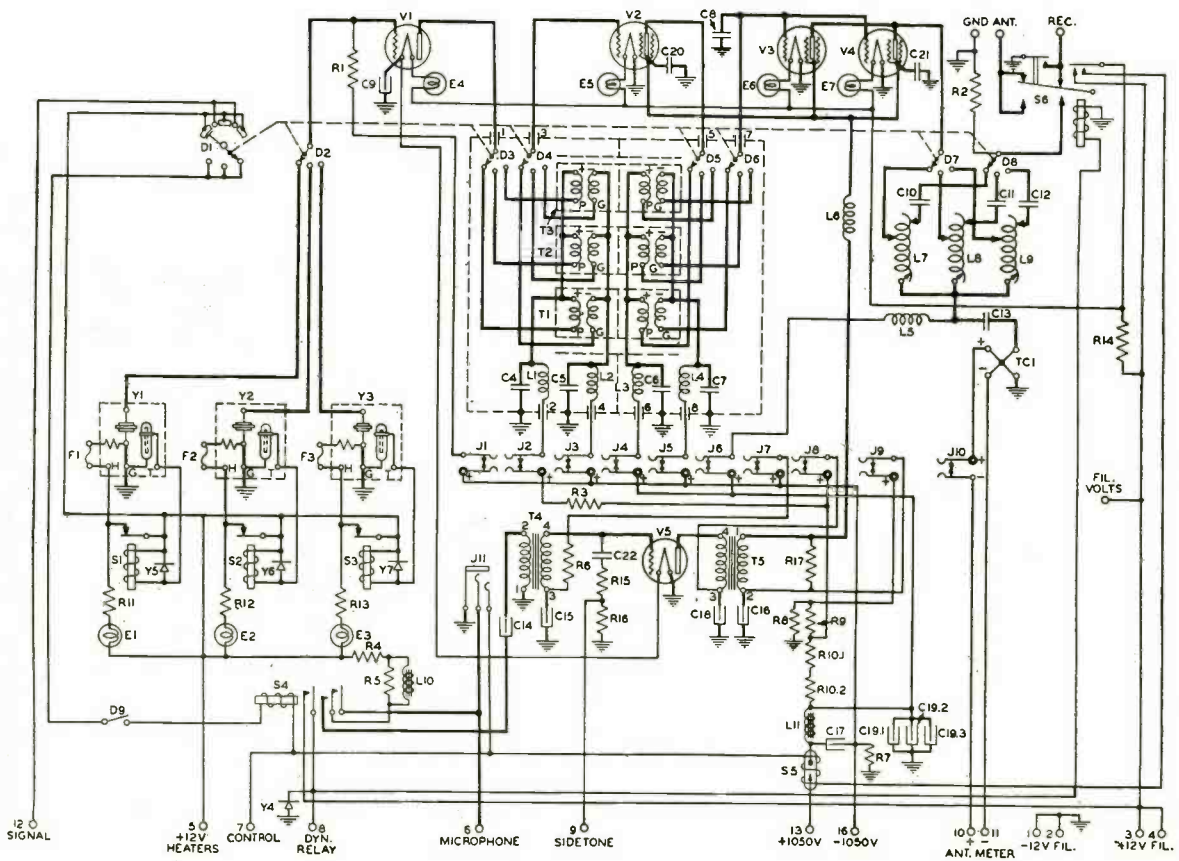

Fig. 4. Schematic diagram of Western Electric 13-A Transmitter.



lence no filament or plate voltages are applied to the tubes, these respective circuits being closed only when the talking button is depressed.

Referring to Fig. 4, the transmitter circuit consists of a crystal controlled, 5-watt oscillator tube, V1. The quartz crystal is in the grid circuit of this tube, the crystal frequency being equal to one-half of the carrier frequency. Three plug-in sockets are provided in the transmitter for the quartz crystal frequency controls Y1, Y2 and Y3. In the single-frequency transmitters only one of the sockets and its crystal are in circuit at a time. Spare crystal controls may be kept in the two remaining sockets and maintained at the proper operating temperature so as to be ready for instant use.

A 50-watt tube, V2, is used as an r-f amplifier and supplies radio-frequency voltage to the grids of two other 50-watt tubes, V3 and V4, which are connected in parallel. The output of this power stage works into the antenna coupling circuit.

A 5-watt tube, V5, is used in the single stage audio-frequency amplifier. Modulation of the carrier power is effected by applying the output of this a-f amplifier to the grids of the three r-f tubes.

Fig. 4 is the circuit for a three-frequency transmitter. The quartz crystals Y1, Y2, and Y3 are, in this case, of different frequency. It will be seen that each socket has its own relay which automatically operates a thermostat control and an indicating lamp. When the crystal reaches its operating temperature, the relay breaks the circuit to both the crystal heater and the lamp. Intermittent lighting of the lamp, therefore, indicates proper operation of the crystal heaters.

Frequency changing is accomplished by throwing a tandem switch. Section D2 of this switch selects the proper crystal. Sections D3 to D6 select the proper values of grid and plate inductance. Frequency changing in the antenna circuit is accomplished by sections D7 and D8.

The jacks J1 to J10 permit testing and adjustments to be made in the grid and plate circuits of the transmitter tubes.

#### THE RECTIFIER

The circuit of the rectifier is shown in Fig. 5. The rectifier unit is designed to operate from 105 to 125 volts, single phase 50/60 cycle commercial power main, and supplies all power voltages necessary for the operation of the transmitter.

This rectifier employs a simplified push-button switch control which automatically causes the circuits to be energized in the proper sequence. In addition

Fig. 2. Interior of rectifier unit showing Tungar bulbs for filament supply, and mercury-vapor rectifiers for plate supply.

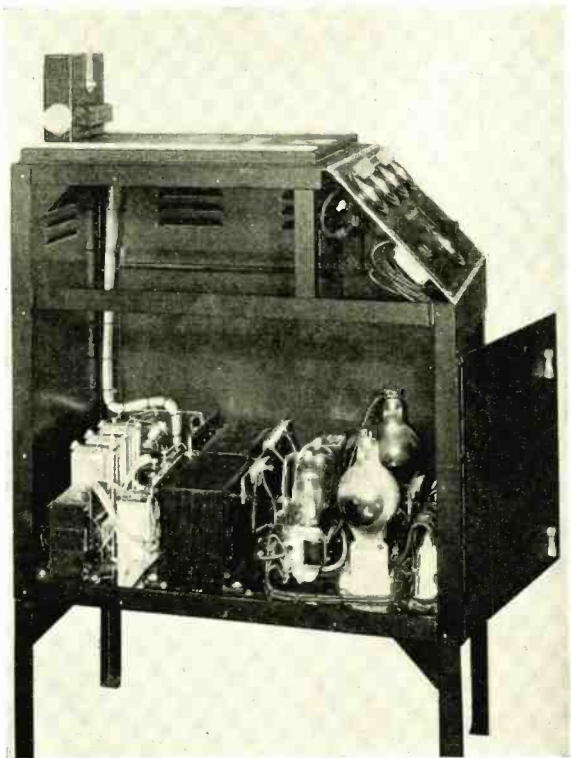

tion to magnetic switches and sequence relays, the control circuits include protective devices which prevent damage to the equipment should there be a voltage overload or filament failure. A switch automatically shuts off the high voltage supply when the door is open. The door must be closed and the plug in the transmitter firmly engaged with the jack of the rectifier before high voltage can be applied to the transmitter.

Two full-wave rectifier circuits are provided, each employing two half-wave rectifiers. The plate supply section employs two 253D mercury-vapor rectifiers, V3 and V4, and contains all the necessary filtering and control devices, the filter consisting of the choke L2 and the capacity C2. The filament supply circuit utilizes two Tungar rectifier bulbs, V1 and V2 and also contains filtering and control devices, the filter consisting of the choke L1 and the capacities C1.1, C1.2 and C1.3. Grid bias voltage is obtained in the transmitter itself by means of the voltage drop across the resistances in the plate-supply return circuit.

The front upper portion of the rectifier has a sloping panel, as shown in Fig. 3, on which is located the switches and meters necessary to properly operate the system.

The antenna circuit meter indicates the approximate antenna output and degree of modulation, although it does not indicate the exact antenna current.

In addition to the antenna circuit meter, there is located on the meter panel: voltmeters for reading the voltage of the plate and filament supplies; two current meters which, by means of cords and plugs engaging with jacks on the face of the transmitter, make it possible to read the grid and plate currents of any of the tubes in the transmitter.

A pilot lamp is provided on the rectifier control panel which remains lighted as long as the main power supply to the rectifier is passing through a switch located between the mains and the rectifier. This lamp, therefore, serves as an indication of failure of the commercial power supply source. A similar lamp is provided on the high-voltage supply switch which indicates the application of high voltage.

#### "SHARED CHANNEL BROADCASTING"

In the article, "Shared Channel Broadcasting," that appeared in the June, 1934, issue of RADIO ENGINEERING, the third sentence in the section on "The Square-Law Rectifier," page 9, should read: "The three curves are for different values of the noise level, the figure appended to each curve indicating the equivalent percentage modulation."



# Radio Industry Improving

## RADIO SALES TO ESTABLISH NEW PEAK IN CURRENT YEAR

INTEREST IN RADIOS now has reached the highest pitch in several years, and some retailers describe current demand as measuring up to that when satisfactory sets were first so widely distributed back in 1924. Instead of the usual Summer lull, the trend of sales continues steadily upward, although at a slower rate than during the first six months of the year. For, wholesale and retail volume during that period rose 50 to 75 per cent above the level reached during the comparative months of 1933, and with some of the large distributors the increase ran as high as 100 to 150 per cent for several of the nationally-known sets. This substantial gain is not attributable to the stimulus of low prices, as these have held steady, but almost entirely to the widening popularity of the radio, aided by the constant improvement in the entertainment provided by broadcasting companies, the achievement of manufacturers in bringing the short-wave sets within the reach of the average buyer, and the possibility of enjoying satisfactory programs throughout the entire twenty-four hours of the day.

Based on the advanced inquiries for new merchandise, volume during the second six months of the current year will run ahead of the comparative figures for 1933 by 25 to 40 per cent, despite the small returns from the drought-stricken areas, as retailers in all parts of the country are expecting demand to swing abruptly upward, as soon as the new models will have been displayed. This will bring sales for 1934 to a conservatively-estimated total of 4,550,000 sets, as compared with the record of the peak year of 1929, when 4,438,000 sets were sold, with a retail value of \$592,068,000, less tubes. Sales of automobile radio sets alone are expected to run to 750,000 units.

Radio wholesalers are operating under the General Wholesaling Code and the supplementary Radio Wholesaling Code. It is expected that the Radio Wholesale Code Authority will be functioning in all detail soon, which will lead to the elimination of some of the encumbering excrescences which have been retarding the progress of the trade, according to a survey of the radio industry, which has just been completed by Dun & Bradstreet, Inc.

### PROFITS BECOMING GENERAL

Gross revenues of broadcasting companies for the first six months of the

year ranged from 25 to 50 per cent higher than in 1933, with the percentage of gain during the third and fourth quarters expected to be equally as large. As deficits of the year preceding have been replaced by profits, the cash position of the leading manufacturers has been improved, and with the present firmness of prices and the greater stability of the listed securities of these companies, 1934 gives indication of closing with the industry, as a whole, in the best position reached in five years. While the decided improvement in general economic conditions has been the largest single factor in the remarkable showing made, the radio industry itself has contributed a major portion to the progress, due to the ceaseless efforts of manufacturers to improve their product. Even during the unfavorable years of 1930 and 1931, new designs for the appearance and performance of the sets were being passed on constantly to consumers, thus maintaining employment and pay rolls at a relatively higher degree than most of the other large industries.

In the Analysis of the 1933 Operating Averages of 229 Retailers of Radios, made by the Statistical Department of Dun & Bradstreet, Inc., it was found that a net profit was made by 142 concerns, or 62.01 per cent of the total number. These concerns had total 1933 net sales of \$3,151,700, or 72.57 per cent of the total volume. Of the 229 retailers reporting, with total 1933 net sales of \$4,342,700, a net loss was shown by only 87 concerns, or by 37.99 per cent of the total number. These concerns had total 1933 net sales of \$1,191,000, or 27.43 per cent of the total volume. In the analysis by Federal Reserve Districts, it was revealed that net profits were largest in Dallas, Kansas City, Philadelphia, San Francisco, Richmond, New York, and Cleveland, in the order named.

---

Trend of sales continues steadily upward, with forecast of 25 to 40 per cent jump in volume for second half of current year. Credit cleanups and price increases have steadied the general market.

---

### CONSUMER INTEREST BROADENING

One of the most encouraging features of the current demand is the decided trend toward sets of the better grades. This is indicated by the fact that the average unit sales price is being raised steadily. The interest shown last year in sets which would pick up police stations rapidly is switching to those that will pick up foreign stations. The manufacturers are meeting this demand by producing moderate-priced sets that are able to deliver foreign reception satisfactorily. The all-wave sets, along with automobile radios have served chiefly to bolster volume thus far this year, although since the early part of June there has been a decided increase in the sales of portable sets.

Volume of sales during June and July in some of the Eastern States fell below the comparative totals of 1933, but in the Southwestern, Middle Western, and South Atlantic States, gains of 15 to 20 per cent were reported generally for these two months. In the Pacific Coast States, the strike of the longshoremen, which started early in May and was not settled until the middle of July, brought sales practically to a standstill in the major distributing centers.

### PRICE ADVANCES EXPECTED

Despite some weakness that has developed in the price structure, the leading manufacturers are holding to code prices, and any alterations in present listings are expected to be in an upward direction. Prices generally have been steady since the first of the year at a level ranging from 10 to 20 per cent above the 1933 quotations. The medium sets and automobile units have held unusually firm, the instances of weakness reported being almost entirely period console types.

Careful supervision of credits now is practically universal in the radio field. Since the elimination of a considerable number of merchants whose chief forte appeared to be the forcing of sales, regardless of collection difficulties, there has been either a tightening of credits or an insistence on such security as would provide manufacturers with the means of recovery. This has been the case particularly with merchants selling under the deferred-payment system. Wholesale distributors have been working in close unison with their suppliers through which a close checking is possible.

(Continued on page 22)

# New Mackay Station on Way

LONG ISLAND STATION WILL SUPPLANT SAYVILLE WHEN COMPLETED

MACKAY RADIO has outgrown the famous radio station at Sayville, L. I., and is building a larger and more powerful short-wave station near Brentwood, L. I., which is to be the hub of the company's transmitting operations on the Atlantic Coast. Announcement of the acquisition of an 1100-acre tract and plans for the immediate construction of the station were announced by Mr. A. Y. Tuel, Vice President and General Manager of Mackay Radio.

## SAYVILLE CROWDED

In the announcement Mr. Tuel stated: "The widespread expansion of Mackay Radio's marine service and the rapid growth of our radiotelegraph network within the United States and with foreign countries is beginning to crowd Sayville's capacity. This in spite of the fact that we have added all the transmitters possible at Sayville and have relieved it with four powerful marine stations on the Atlantic Coast all of which have been erected since 1929."

The new property was leased from Arbuckle Brothers, coffee and sugar concern of 17 Water Street, and was almost entirely virgin land. It is being cleared and building operations have started.

According to Mr. Haraden Pratt, Vice President and Chief Engineer of Mackay Radio, who is in charge of the project, the station will be in service some time this fall, although it will be several years before its full size is attained. The move from Sayville to the new station will be made in an extremely gradual manner and both stations will be operating before it is completed, for under no circumstances will the move be permitted to interfere in any way with constant radio service.

## REMOTE OPERATION

Super-powered transmitters designed especially for the new station are in process of manufacture by the Federal Telegraph Company, Mackay Radio's manufacturing association in Newark, N. J. These and other transmitters to be built later, added to the existing facilities at Sayville, will provide the capacity and power sought, and will make the new station one of the largest and most powerful in the world, it is said.

This station will be operated by remote control from Mackay Radio's operating center in the International Telephone Building at 67 Broad Street, New York.

Several of Sayville's marine transmitters may be moved to Mackay Radio's new station WSE at Amagansett, near Montauk, L. I., for it is stated that the exceptionally fine operating results obtained there have proved that its location at the eastern tip of Long Island is a superior one for ship-to-shore radio operation. Mackay Radio has coastal stations also near Thomaston, Maine; Jupiter, Florida, and at New York City on the Atlantic Coast; and Los Angeles, San Francisco and Portland, Oregon, on the Pacific Coast.

The extension of its radiotelegraph network in the United States is the principal factor at present in Mackay Radio's need for increased transmitting facilities. This system now operates between twelve of the principal cities of the country and it is expected that several other cities will be added within the next few months.

## HISTORY OF SAYVILLE

The property and buildings at Sayville are under lease from the U. S. Navy Department, and, when the new station at Brentwood is completed, the plant at Sayville is to be returned to the Navy.

The Sayville radio station has been one of the most famous in the world for its glamorous history as well as for its size and power. It was erected be-

fore the War by a German concern, the Atlantic Communication Company, for direct communication between the United States and the Nauen station near Berlin.

When the War came in 1914 and the German cables were cut by the Allies, the Sayville plant was enlarged and it became almost the sole direct communication link between the United States and Germany.

When the United States entered the War, the station was seized by the Navy Department, which erected additional buildings and installed a 200-kw arc type transmitter manufactured by the Federal Telegraph Company. This greatly increased the value of the station, in as much as this apparatus was considerably superior to that which the German owners had installed in 1914 and 1915. Sayville played an important part in the radio communication system of the Navy until 1924, when it was no longer needed and was silenced.

Mackay Radio took it over in 1928, completely rehabilitated the plant, installed its own transmitting equipment for ship-to-shore communication and for short-wave transoceanic and trans-continental services, and reestablished it as one of the world's most powerful stations with many remarkable distance records to its credit.

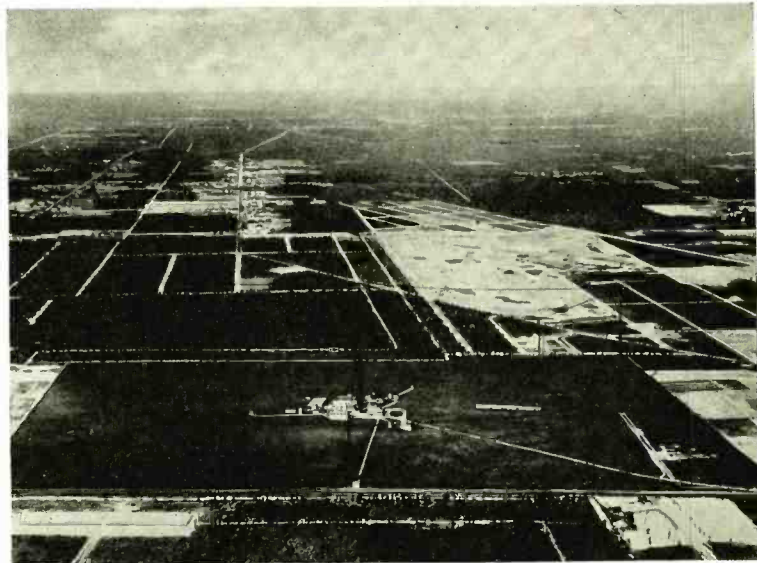

The famous radio station at Sayville, L. I., which is to be returned by Mackay Radio to the Navy Department. Mackay Radio is now constructing a short-wave station of greater size and power near Brentwood, L. I., to replace the Sayville station as the hub of its transmitting operations in the East.



# RMA Requests Exemption

- Officials state independent code both desirable and necessary for radio industry, adding as reason that the radio industry is a separate and distinct unit with little in common with electrical industry. RMA and its membership "truly representative" of radio industry, says Captain Sparks.

WASHINGTON, D. C.—An order is expected soon from the National Recovery Administration granting the RMA application for exemption of radio and television manufacturers from the NEMA electrical code and providing for a separate code for the radio industry.

Confidence of success in the industry's procedure with NRA was expressed by RMA officers and code committee members following the formal hearing held before the National Recovery Administration at Washington on Monday, July 23. The electrical code will continue in full force and application upon radio manufacturers until final action by the NRA on the proposed separate code for the radio industry.

## OFFICIALS AT HEARING

President Leslie F. Muter of the RMA; Captain William Sparks, chairman, and members of the RMA Special Code Committee; Bond Geddes, executive president-general manager; John W. Van Allen, RMA general counsel, and others, including many RMA members making special trips to Washington, appeared at the hearing, which lasted the entire day. Also appearing in support of the RMA application for exemption from the electrical code were the Radio Wholesalers Association represented by President David M. Trilling, and representatives of several radio labor organizations, including the American Federation of Labor.

The National Electrical Manufacturers Association, represented by Managing Director W. J. Donald and General Counsel Neagle, vigorously opposed the code efforts of the radio industry.

The NRA hearing was conducted by Colonel James G. Cowling, Deputy Administrator, with his executive, legal, labor, consumer and other advisors in the Rose Room of the Washington Hotel. The hearing began at 10:00 o'clock

and all witnesses concluded at 4:30 when the case was submitted to the NRA. If, as expected, favorable decision is made by NRA exempting the radio industry from the electrical code, immediate consideration will be given to the proposed new radio code providing independence and a separate code authority for radio and television manufacturers.

## MUTER OPENS HEARING

President Muter of the RMA, presented by Mr. Geddes, opened the July 23 hearing with a recital of the unanimous action of RMA directors and members, at their Chicago Convention last June, for exemption of the radio industry from the electrical code. Mr. Muter presented Captain Sparks, chairman of the RMA Code Committee, which includes A. S. Wells of Chicago, James M. Skimmer of Philadelphia, S. W. Muldowny of New York, chairman of the RMA Tube Division and supervisor of the electrical code for tube manufacturers, and Arthur Moss of New York. Also associated with the RMA committee was Arthur T. Murray of Springfield, Mass., chairman of the RMA Set Division and supervisory agency, under the electrical code, for set manufacturers. Hugh H. Eby of Philadelphia, a founder and former RMA director, and E. J. Ellig of Cincinnati were other witnesses, and among the RMA delegation were Fred D. Williams of Indianapolis, past president of the RMA, B. G. Erskine of New York and Roy Burtlew of Owensboro, Ky. Many telegrams from RMA members supporting its code application were read at the hearing and incorporated in the transcript.

## STATEMENT SUPPORTING INDEPENDENT CODE

A lengthy statement detailing the many reasons in support of an independent code for the radio industry, with a volume of supporting evidence, statistics, etc., was presented to the NRA tribunal

by Captain Sparks. It stressed:

(1) That the radio industry is a separate and distinct industry.

(2) That the Radio Manufacturers Association and its membership is "truly representative" of the industry, and

(3) that good cause exists for a separate code instead of continuing under the electrical code.

Copies of the RMA statement as presented by Captain Sparks are being sent to all Association members. The representative membership, invested capital, annual sales, labor employment, RMA engineering development and its many services to members were emphasized in stressing the long existence of the radio industry as a separate and distinct industrial group. Its distinct merchandising problems and distribution channels also were cited and the NRA was urged to secure the U. S. Treasury excise tax returns to prove mathematically that the RMA is "truly representative" of the industry as required by the law.

The statement of Captain Sparks also emphasized that NEMA entirely withdrew from the radio industry and abolished its radio division many years ago and that the RMA was strongly advised and influenced last year by former Deputy Administrator W. L. Allen of the NRA to withdraw the original radio code and attempt to operate under the electrical code.

The RMA statement submitted many details of impractical and unworkable operations under the NEMA code, including loss of RMA members to NEMA, and of the industry's need for radio trade practices.

That onerous expenses had been experienced under NEMA and that the radio industry not only was entitled to a separate code, but could administer it much less expensively for radio manufacturers and much more efficiently for NRA also was emphasized.

## CLAIMS RADIO INDUSTRY WITHOUT VOICE IN NEMA

"We cannot now be said to be a self-governing industry," said the RMA statement presented by Captain Sparks, "because the code authority of the electrical industry is NEMA, upon whose board the radio industry has no representative nor do we have any voice in our own destination nor vote in connection with any code matters or administration, the final authority resting with an association with which we have no problems in common, nor would it be possible for the radio industry when



# From Electrical Code

combined with such large and diverse products as represented in the National Electrical Manufacturers Association, to be any more than a small minority with no final authority in the determination of its own self-government. We would be but one of many (approximately 160) sections and groups.

"We requested exemption from the electrical code and it was not opposed at the hearing and we were granted it without objection. It has never been contended that we were not an industry by ourselves or 'truly representative.' We accepted temporary administration under the electrical code in order to bring the industry immediately into line with the policies of the President and the National Recovery Act and have done our best. We accepted it most reluctantly under the extreme urgency of the NRA Administration and with, what we consider, assurances that if it did not prove satisfactory or proved impracticable and not fitted to us, we might have a separate code of our own.

"Time has proven the correctness of our original position and the necessity for withdrawal from the electrical code for the reasons set forth above. We are facing as an industry the problem of whether we shall be wholly dominated by a large but powerful group not concerned with our problems or familiar with them and whose policies in competition can be destructive of the best interest of our industry.

"We wish to continue as a separate industry to work out our own destiny, to maintain our own trade Association and to be assured of that kind of self-government which is contemplated by the National Recovery Act."

## STATEMENTS MADE BY NEMA

It is reported NEMA denied that there was a separate industry or that the RMA was "truly representative." A lengthy statement presented by Managing Director Donald referred repeatedly to the "so-called" radio industry and even went so far as to contend that NEMA manufacturers, because some make radio parts, were really "representative" of radio manufacturing. The NEMA statement contended that radio engineering standards were founded not by RMA but by NEMA; that trade shows and trade promotions were the principal function of RMA and that RMA members belonged to the Association only for business purposes.

"It is not an industry but an aggregation of employers," said Mr. Donald, adding that NEMA had no objection to



President Muter: Opens NRA hearing in Washington.

the continued life of RMA as a trade promotion organization and said it could be a separate section under NEMA "with proper supervision." Mr. Donald admitted that NEMA had vigorously opposed the "Buy RMA" plan under which RMA members cooperatively support each other in their parts and other purchases and contended it was improper.

Counsel Neagle of NEMA said that RMA was "an organization of assemblers," not really manufacturers, and charged the RMA with lack of cooperation under the code to avoid code costs for the organization and its members. He denied that NEMA code costs were excessive.

## TRILLING SUPPORTS RMA REQUEST

Strongly supporting the RMA request for separation from NEMA and a separate code, President Trilling of the Radio Wholesalers Association cited the recent supplemental code secured for radio wholesalers and dealers and the necessity for coordinating merchandising practices with a separate code for radio manufacturers.

"The proposed radio code would go far toward improving conditions," Mr. Trilling told the NRA hearing. "And a separate code authority would operate best."

Joseph Mitton, chairman of the Radio and Metal Workers Industrial Union, representing workers in several metropolitan districts, also urged the NRA

to grant a separate radio code. He declared the electrical code did not provide against seasonal employment and "has done away with standards of living." In the Philadelphia-Camden area he said that RMA manufacturers had paid wages much better than provided in the electrical code and declared that code "a downright failure."

Samuel Niesen, representing the Radio and Metal Workers of New York, also spoke in favor of a separate radio code, to enable radio labor to deal directly with its own employers.

Representing the American Federation of Labor, Waldo C. Holden also supported the RMA application, declaring the electrical code has many serious weaknesses and that a separate radio code would provide adequately for labor relations of the industry. And another labor witness supporting the RMA application was George G. Meyer, secretary of the Radio and Television Workers Union.

Walter Mitchell, Jr., secretary of the Furniture Code Authority, objected to inclusion of radio cabinet manufacturers in the code submitted by RMA, declaring that furniture manufacturers who also make cabinets, representing eighty per cent by volume, preferred to operate under the furniture code. He did not object to proposed withdrawal of the radio industry from the electrical code.

(Continued on page 22)

# Calculating Series and

By **CARLTON A. MIZEN**

WHILE THERE IS admittedly a certain completeness about the customary analytic or formula methods of representing a mathematical function, there are also many advantages in time and labor saving in the use of graphic or pictorial representation that an extended discussion of the latter method might be justified. In the January issue of *RADIO ENGINEERING*, a special type of composite graph was discussed, and an endeavor was made to show that, for several routine problems in the calculation of pure reactance circuits, the graphic or picture representation was more convenient than the analytic or formula representation.

Of course, while pure reactance circuits are very important in radio-frequency work, a discussion of circuit

analysis by graphic methods would not be complete without some consideration of those circuits in which resistance is also included. In this article we present a useful picture of the absolute impedance, the phase angle, and the power factor of series circuits, and also the speedy solution of parallel impedance circuits which are usually solved by the relatively tedious process of vector product divided by vector sum.

## CALCULATION OF SERIES IMPEDANCES

If we are given the simple case of a resistance in series with a pure reactance, in which it is required to find the absolute magnitude of the impedance and the phase angle, we usually recall a familiar text book diagram in which R

(the resistance) and X (the reactance) are expressed as vectors, X being directed at right angles to R by the vector operator J. R and X are thus the two sides of a right triangle, and the problem is (a) to find the length of the hypotenuse, and (b) to find the angle-whose tangent is X/R. The length of the hypotenuse, which we call Z, is from geometry,  $\sqrt{R^2+X^2}$ .

From geometry we also obtain the analytic expression for a circle, which is  $r = \sqrt{R^2+X^2}$ , R and X here being coordinate distances. By the similarity of these formulas, if not the identity, we are justified in representing various impedances by concentric circles, one quadrant shown in Fig. 1.

Suppose we have a 1,000-ohm resistance in series with an inductive reactance which at a specified frequency is 700 ohms. In order to find the impedance we locate the vertical 1,000-ohm line in Fig. 1, and follow it to its intersection with the horizontal 700-ohm reactance line. This point of intersection lies on the radial line marked 35°, and is about one-fifth of the way between the circle marked 1,200 and the circle marked 1,300. In other words, the distance of this point from the center of the concentric quarter circles is 1,220 units. The answer to the problem is therefore that the impedance is 1,220 | +35°. The angle is positive because the 700 ohms was inductance (positive) reactance. If the 700 ohms had been in capacity reactance, the impedance would, of course, have been 1,220 | -35°. For the sake of clarity, the concentric circles, now confined to the first quadrant in Fig. 1, might be extended into the fourth quadrant, and all angles in the fourth quadrant marked negative, and used only for capacity reactance problems.

The radial lines are all phase angle lines, and once the point of intersection of the resistance and reactance lines has been found, the phase angle of the represented impedance may be computed by interpolation between the nearest phase angle lines. When the required radial phase angle line has been located, it may be followed to the outside reference circle, and directly upward to the horizontal scale on which the cosine of the phase angle has been calculated, this cosine being simply the power factor.

## CALCULATION OF PARALLEL IMPEDANCES

In the elementary study of pure resistance circuits, we find that the total

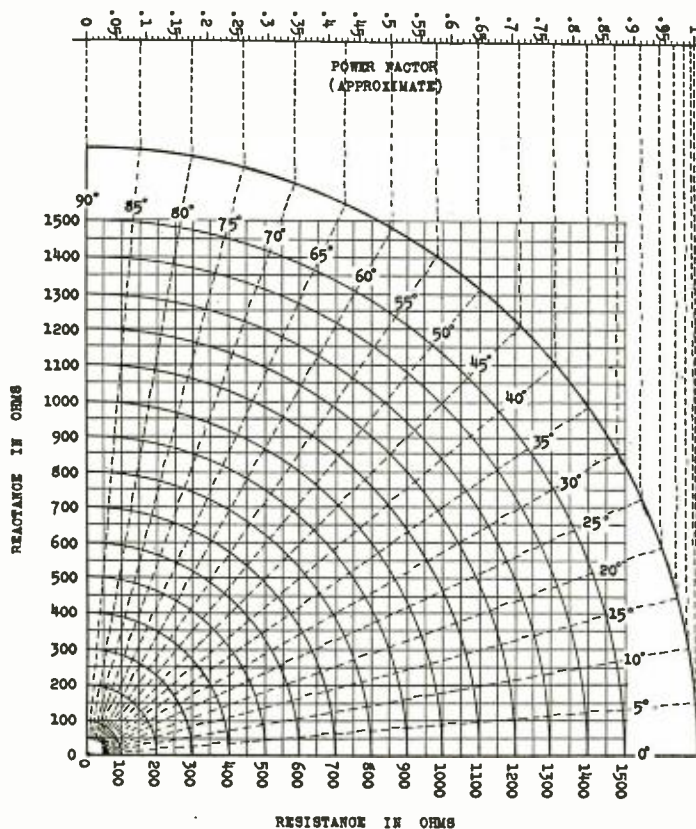

Fig. 1. A chart for obtaining the resultant impedance and phase angle of a resistance and a reactance in series.



# Parallel Impedances

resistance R of a circuit comprising several resistances in parallel bears the following relation to the separate resistances:

$$\frac{1}{R} = \frac{1}{r_1} + \frac{1}{r_2} + \frac{1}{r_3} \dots \text{etc.}$$

Expressed in words, the reciprocal of the total resistance is equal to the sum of the reciprocals of the separate resistances. To express this pictorially, we need only a simple reciprocal scale such as is shown in Fig. 2-A. If we examine this scale, we find that one end is arbitrarily marked 50. The other end is marked  $\alpha$  (infinity). The number 100 lies midway between  $\alpha$  and 50, that is, 50/100 of the way; the number 200 lies one-quarter of the way from  $\alpha$  to 50, that is, 50/200 of the way, and so forth.

Now, if we take a ruler or a pair of dividers and measure the distance from the point  $\alpha$  to the point 300, for instance, and then lay off this distance beyond some other given number, say 200, we find that the distance from  $\alpha$  to 300 plus the distance from  $\alpha$  to 200 is equal to the distance from  $\alpha$  to 120. By adding the length of one reciprocal to the length of another, we have thus graphically found the sum of two reciprocals, which in this case is the reciprocal of 120. Applied to resistance measurement, if we had a resistance of 300 ohms in parallel with a resistance of 200 ohms, the total resistance would be 120 ohms.

## INCORPORATION OF THE PHASE ANGLES

This scale might be used for the measurement of any two impedances in parallel, provided that their phase angles were equal. Since this special condition is not likely to occur except in cases of pure resistances and reactances, the graph in Fig. 2-B has been designed to accommodate differences in angle.

The operation of this graph is perhaps best described by the use of an example. Assume that we are given an impedance  $150/-30^\circ$  in parallel with an impedance  $200/60^\circ$ . We follow the radial line marked  $-30^\circ$  to its intersection with the circle 150 and mark this point. Then follow the radial line marked  $60^\circ$  to its intersection with the circle 200 and make another point. If we hold a straight-edge ruler between the points thus defined, and mark a final point midway between the first two, this final point will have the following important properties: (a) It will lie on the radial line which represents the phase angle of the resulting impedance; in this prob-

lem it lies about  $68/100$  of the angular distance between  $0^\circ$  and  $+10^\circ$ , or at an angle of  $6^\circ 50'$ ; and (b) its distance from the center of the concentric circles (the point marked  $\alpha$ ) will be just half of the distance which must be laid off on the reciprocal scale to obtain the absolute magnitude of the resulting impedance; in this problem this distance laid off twice on the scale will bring us to the point 120. To summarize the result, the total impedance of  $150/-30^\circ$  in parallel with  $200/60^\circ$  is  $120/6^\circ 50'$ .

For the sake of accuracy, the radio engineer may find it profitable to construct graphs of the general character of Figs. 1 and 2-B, making them on a much larger scale than we are able to produce them on these pages. The ranges of usefulness of these graphs (0 to 1500 in Fig. 1, and 100 to 1000 in Fig. 2-B) are quite arbitrary and may be increased or decreased in any ratio, provided all of the magnitudes are changed by the same ratio. The phase angles are fixed, however, and are independent of the magnitude of the scales.

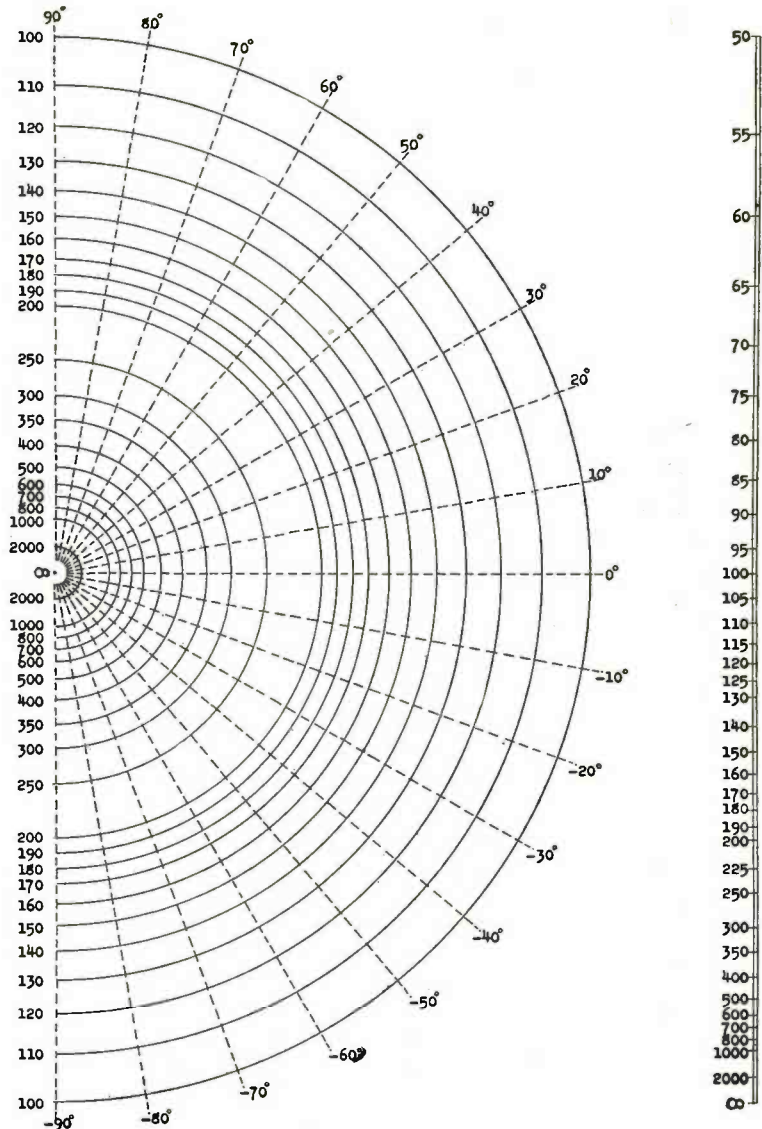

Fig. 2-B. A chart for finding the resultant of impedances in parallel.

Fig. 2-A. The above scale is used to obtain the resultant value of resistances, or impedances with identical phase angles, in parallel.



# Federal Communications Commission Under Way

THE FUTURE WORK OF the Federal Communications Commission is to be handled by three separate divisions, in accordance with the formative conference held in Washington, July 17. These three divisions will tackle the problems in the field of communication.

## THE BROADCAST DIVISION

According to an official statement, the Broadcast Division . . . "shall have and exercise jurisdiction over all matters relating to or connected with broadcasting."

This is Division No. 1, and has as its members Commissioner Gary, Chairman; Commissioner Brown, Vice Chairman; and Commissioner Sykes.

## THE TELEGRAPH DIVISION

Division No. 2, the Telegraph Division . . . "shall have and exercise jurisdiction over all matters relating to or connected with record communication by wire, radio or cable, and all forms and classes of fixed and mobile radio-telegraph services and amateur services."

The members of this division are Commissioner Stewart, Chairman; Commissioner Payne, Vice Chairman; and Commissioner Sykes.

## THE TELEPHONE DIVISION

Division No. 3, the Telephone Division, has as its members Commissioner Walker, Chairman; Commissioner Case, Vice Chairman; and Commissioner Sykes. This Division is to have and . . . "exercise jurisdiction over all matters relating to, or connected with telephone communication (other than broadcasting) by wire, radio or cable, including all forms of fixed and mobile radio-telephone service except as otherwise specifically provided for."

## BLANKET JURISDICTION OF DIVISIONS

It is reported that the whole Commission . . . "shall have and exercise jurisdiction over all matters not herein otherwise specifically allocated to a division; over all

- The Federal Communications Commission organized its Divisions on July 17, in keeping with the Communications Act. Three Divisions, composed of three members each, were created, to cover broadcast, telegraph and telephone services.



Dr. C. B. Jolliffe, Chief Engineer,  
Federal Communications Commission.

matters which fall within the jurisdiction of two or more of the divisions established by this order; and over the assignment of bands of frequencies to the various radio services."

## RADIO SERVICES AND CLASSES

The following radio services and classes of stations were allocated to the three divisions established as follows:

### I. To the Broadcast Division

<i>Service</i>	<i>Class of Station</i>
Broadcast	Broadcast
Temporary	Broadcast Pickup
Experimental	Experimental Visual Broadcast
	Experimental Relay Broadcast
	Experimental Broadcast
	General Experimental (1)
	Special Experimental (1)

- (1) All matters relating to or connected with this class of station concerning the development of apparatus for any service assigned to the Broadcast Division.

## 2. To the Telegraph Division

Service	Class of Station
Aviation	Aeronautical Aeronautical Point-to-Point Airport Aircraft
Aviation Public	Aeronautical Aircraft
Public Coastal	Coastal Telegraph Coastal Harbor (Telegraph) Coastal Telephone (2)
Private Coastal	Coastal Telegraph Coastal Harbor (Telegraph) Coastal Telephone (2)
Experimental	General Experimental (3) Special Experimental (3)
Geophysical	Geophysical
Fixed Public	Point-to-Point Telegraph Point-to-Point Telephone (2)
Fixed Private	Point-to-Point Telegraph
Emergency	Municipal Police State Police Special Emergency Marine Fire
Agriculture	Point-to-Point Telegraph
Marine Relay	Marine Relay
Mobile Press	Mobile Press
Fixed Public Press	Point-to-Point Telegraph
Amateur	Amateur
Temporary	Motion Pictures First Class (4) Second Class (4)
Ship	Third Class (4)

(2) Stations in Alaska only.

(3) All stations of this class except those assigned by designations (1) and (6) to the Broadcast Division and Telephone Division, respectively.

(4) Except ship telephone stations connecting through coastal telephone stations with the public telephone network.

## 3. To the Telephone Division

Service	Class of Station
Fixed Public	Point-to-Point Telephone
Public Coastal	Coastal Telephone (5) Coastal Harbor (Telephone) (5)
Private Coastal	Coastal Telephone (5) Coastal Harbor (Telephone) (5)
Experimental	General Experimental (6) Special Experimental (6)
Ship	First Class (7) Second Class (7) Third Class (7)

(5) Except stations in Alaska.  
 (6) All matters relating to or connected with the research, development and operation of public telephone service.  
 (7) Ship telephone stations connecting through coastal telephone stations with the public telephone network.

### APPOINTMENTS

Herbert L. Pettey, of Kansas City, Mo., was appointed secretary of the Federal Communications Commission on July 11.

Mr. Pettey was appointed secretary of the Federal Radio Commission on March 31, 1933, and served in that capacity until that body was abolished by the creation of the new Communications Commission.

Colonel Thad H. Brown, Vice Chairman of the Broadcast Division, announced on July 25 the appointment of Joseph E. Keller of Dayton, Ohio, as his secretary, effective August 1, 1934.

Dr. C. B. Jolliffe, formerly Chief Engineer of the old radio commission, has been held over as Chief Engineer of the new Federal Communications Commission.

### MEETINGS

The Broadcast Division held its first meeting on Wednesday, July 18, the Telegraph Division on Thursday, July 19, and the Telephone Division on Friday, July 20.

## BOSTON TWO-WAY POLICE RADIO SYSTEM

A MOBILE TWO-WAY radio system developed for use by the Boston police department was demonstrated recently in Schenectady by engineers of the General Electric Company. A radio prowl car, with provisions for carrying on a conversation with headquarters while traversing the city streets, was inspected by Timothy A. J. Hayes, head of the police signal department of Boston.

For the demonstration a light sedan, bearing no telltale evidence of an antenna or other special equipment, was used. The transmitter was installed in its rear trunk. A French-type telephone was installed in a convenient position on the instrument panel, where it could be used by the passenger, or even the driver, if necessary. For the other half of the two-way system, a transmitter was located in one of the General Electric buildings, and a nearby office was converted into a temporary "headquarters."

When the car was called by headquarters and the 'phone was lifted from its hook, the mobile transmitter, on a

different wave length from the stationary one, began to function immediately. It was then possible to carry on a running conversation with the cruising car as it drove about the city. The transmitter used in the car had a power of 15 watts and operated on the ultra-high frequency corresponding to a wave length of 8 meters.

A temporary one-way system operating on medium-high frequencies has already been installed in Boston for police work. This will be replaced with the new ultra-high frequency system. At first only one precinct will be equipped with two-way communication, but it is planned to change over the other precincts with additional equipment as soon as the system becomes adjusted to operating conditions in Boston.

The initial Boston installation of two way communication will be made in the 9th Division, comprising part of Roxbury, and eventually 15 of the 19 divisions in Boston will be so equipped. The plan was worked out by the Boston Police Commissioner, Eugene C. Hult-

man, in co-operation with Jackson & Moreland, consulting engineers, also of Boston.

The stationary transmitter for the Boston system will be located at headquarters, and will be connected with precincts or division houses by telephone lines. Power transmitters in different divisions will have different frequencies, but the receivers of all cars will be tuned to the headquarters' frequency. The receivers in the division houses will be tuned to the car transmitters in their respective divisions.

The communication range of ultra-high frequency equipment, such as that planned for Boston, is normally limited to a few miles, because the signal is propagated somewhat as a beam of light and, as a result of the earth's curvature, is projected off into space not long after it leaves the transmitter. For this reason, those division houses that are remotely located from the center of the division will have a special pick-up receiver located on the opposite side of the division, which will be connected to the division house by a telephone line.

# BLEEDER RESISTANCE Improves Power Supply Regulation

By **REUBEN LEE**

Engineer  
WESTINGHOUSE ELECTRIC and MFG. CO.

- A simple mathematical analysis of the problem of voltage regulation in power-supply circuits, with reference to their correction by means of bleeders.

A FAMILIAR CONDITION to radio engineers is the poor voltage regulation exhibited by rectifier power supplies. It is especially prevalent in single phase rectifiers, and occurs even when the straight dc resistance of the transformer, tubes and chokes is very low. As long as the load is kept constant, this effect may not be objectionable, but with varying load such as a

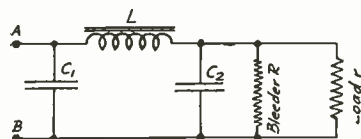

Fig. 1. A single-phase, full-wave rectifier circuit.

Class B audio stage, serious distortion results.

## THE FILTER ACTION

The single-phase, full-wave rectifier of Fig. 1 produces the characteristic rectified voltage wave of Fig. 2 across the filter input terminals A-B. Neglecting the resistance drop in the rectifier and chokes, the average value  $E_{av}$  of this rectifier wave also appears across the load  $r$ , but not the peak value  $E_{pk}$ . This is because the filter suppresses the peaks and fills in the valleys of the rectified wave of Fig. 2, ironing out this wave to a constant voltage  $E_{av}$  plus a smaller superposed ripple voltage  $E_r$ , as illustrated by Fig. 3.

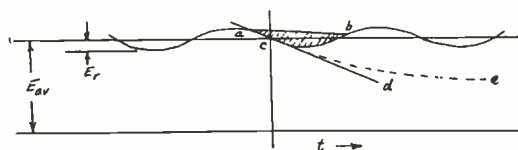

Fig. 3. Illustrating the voltage appearing across the load  $r$  due to the suppressing effect of the filter.

If the load  $r$  is high in ohms, corresponding to a light load in milliamperes, the filter condenser  $C$  may charge up to a voltage higher than  $E_{av}$ , thus increasing the average voltage across the load  $r$ . The value of this voltage depends upon the relative values of  $L$ ,  $C$  and  $r$ . If there were no load at all on the rectifier, that is, if  $r$  were infinite, the condenser would charge up to the peak voltage  $E_{pk}$ , and this would be the constant dc output voltage.

## VOLTAGE REGULATION

The heavy line of Fig. 4 is a voltage regulation curve for a rectifier voltage such as that shown in Fig. 1. This curve starts with peak voltage  $E$  at zero load and drops down to the straight line  $OF$  at current  $I_1$ . The voltage  $E_1$  is the load voltage at full load, and is less than  $E_{av}$  only by the  $IR$  drop in

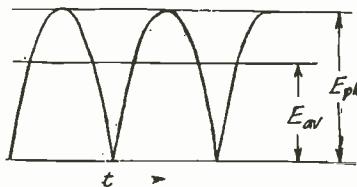

Fig. 2. The characteristic rectified voltage wave across the filter input terminals A-B of the rectifier.

the circuit, which can be made very small by good design. No matter how small this resistance component of regulation is kept, however, the voltage

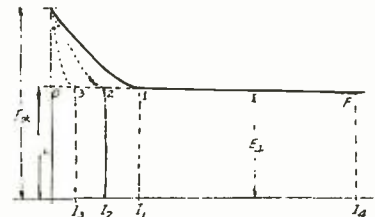
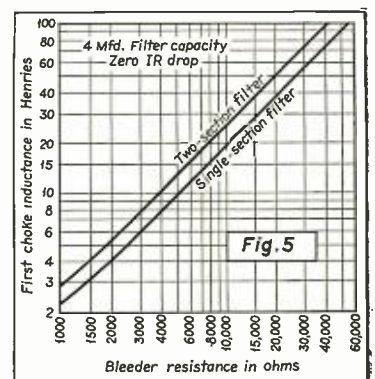

Fig. 4. The voltage regulation curve for the rectifier under consideration.



The first choke inductance-bleeder resistance curve for a single- and two-section filter.

regulation is poor if the load is decreased below point 1. It is common practice to use a bleeder resistance  $R$  as in Fig. 1 to make the minimum load current correspond to point 1 and keep the regulation low.

A bleeder current  $I_1$ , corresponding to point 1 is a considerable portion of the total load current  $I_0$ , and is therefore a waste of power. It is possible to increase the input choke inductance to produce the dotted curve which requires the smaller bleeder current  $I_2$ , and by still higher inductance to obtain the very low bleeder current  $I_0$ . Evidently there is a relation between the choke inductance and bleeder current.

## CONDENSER ACTION

As a first step toward finding this relation, consider what happens when the condenser charging effect begins.



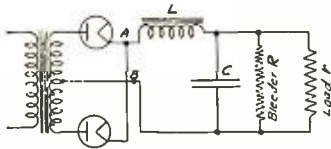

Fig. 6. A constant load circuit designed to take advantage of the condenser effect.

Referring to Fig. 3, if the condenser discharges slowly into the load, as represented by line a-b, it fills in part of the valley of ripple voltage  $E_r$ , each cycle and raises the average output voltage. Hence to avoid this effect it is necessary that the condenser discharge at a rate equal to or faster than the maximum ripple-voltage slope. This is shown in line c-d, having a slope equal to the initial slope of condenser discharge c-e.

#### BLEEDER-CHOKE RELATION

The ripple-voltage wave slope depends upon the type of rectifier (that is, whether single-phase half-wave, full-wave, etc.), and upon the extent to which the filter attenuates the rectifier ripple voltage. The exact relations between bleeder resistance and choke inductance are given by Fig. 5, the upper line referring to the single-section filter of Fig. 1 and the lower line to a filter composed of two such sections. The curves are for a 4-mfd filter condenser, and hold good for higher values of filter capacity, but not for lower values. The curves are given for the commonly used single-phase full-wave rectifier.

The inductance of the filter choke referred to in Fig. 5 is the value at bleeder

load (points 1, 2 and 3 in Fig. 4), and at the unfiltered value of ripple voltage. The bleeder resistance thereby obtained is the maximum permissible for good voltage regulation.

#### BLEEDER CURRENT

As an example, suppose a rectifier having a single filter choke of 30 henrys inductance followed by a filter condenser of 4-mfd capacity, has a dc output voltage of 600 volts. What must be the minimum bleeder current to keep the regulation good at no load? From Fig. 5 the bleeder resistance is 16,600 ohms; hence the minimum bleeder current is 36 ma.

This same condenser effect, so undesirable with varying loads, is often used to advantage when the load is constant, as for instance a Class A amplifier. In such cases, the power supply is deliberately operated at some load less than  $I_1$ ,  $I_2$  or  $I_3$ , Fig. 4, and when sufficient voltage cannot be obtained in this manner, an additional condenser is placed ahead of the first choke, as indicated by Fig. 6, to raise the voltage still higher. The amount of voltage rise obtainable is explained by Fig. 7 for 8-mfd filter capacity.

This scheme is likewise used when the condenser is the whole filter as in relay power supplies, etc., where high percentage ripple can be tolerated.

#### EXAMPLE CALCULATION

Example: A 60-cycle rectifier producing  $\frac{1}{2}$  ampere at 600 volts unfiltered dc is required to deliver 700 volts dc. How much input condenser capacity is necessary to obtain this voltage?

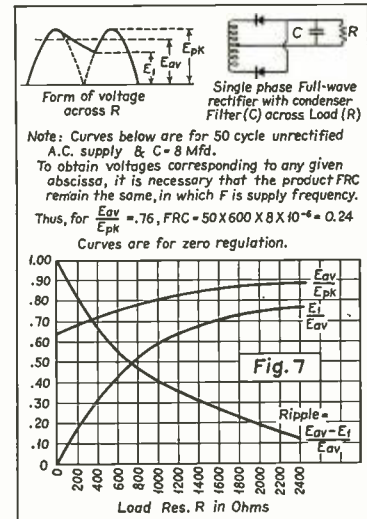

Curves for explaining the voltage rise obtainable with an 8-mfd filter capacity.

$$\text{Load resistance} = \frac{700}{.5} = 1400 \text{ ohms}$$

$$\text{Peak rectified voltage} = \frac{600}{.636} = 944 \text{ volts}$$

$$\frac{700}{944} = 0.742 = \frac{E_{av}}{E_{pk}}$$

From Fig. 7, this requires  
 $FRC = 50 \times 500 \times 8 \times 10^{-6} = 0.2$

$$\text{or } \frac{0.2}{60 \times 1400} = 2.38 \text{ mfd} = \text{necessary capacity.}$$

## RADIO TEST ROOM

A SPECIALLY designed room is being constructed for the United States Naval Research Laboratory at Bellevue, D. C., to simulate by the use of air conditioning equipment and insulated walls, floors and ceiling the atmospheric conditions encountered during high altitude flights, and in penetrating the stratosphere to study the problems of radio communication at extremely low temperatures and greatly reduced atmospheric pressures.

The test room itself will consist of an airtight, completely insulated vault, measuring 15 feet by 20 feet by 10 feet, and will be equipped with an air conditioning system by which it will be possible to maintain within the room any desired level of temperature between 50° below zero and 150° above zero, Fahrenheit. Control of humidity will be provided.

All doors can be closed and sealed to become airtight, and are capable of withstanding 16-inch vacuum within

the room. Quadruple plate glass windows are being provided to facilitate the observation of instruments.

## RADIO RECEIVER SURVEY

ACCORDING TO A SURVEY made by the Electrical Equipment Division, U. S. Department of Commerce, there are some 18,500,000 radio receiving sets in the United States. The estimates of receivers in foreign countries follow:

Country	Sets
United Kingdom.....	6,124,000
Germany .....	5,424,755
Japan .....	1,739,160
France .....	1,554,295
Canada .....	1,100,000
Spain .....	700,000
Sweden .....	666,368
Czechoslovakia .....	620,000
Argentina .....	600,000
Russia .....	600,000
Denmark .....	551,681
Austria .....	507,495
Australia .....	500,341

The total number of receivers in the

world, according to this survey, is 42,540,239.

## ROCHESTER FALL MEETING OF I. R. E.

FOR THE PAST several years special district meetings have been held in Rochester and have become known as the Rochester Fall Meetings. As has been the custom in the past this meeting will be held in November, the particular days, according to Virgil M. Graham, Executive Chairman, being 12, 13 and 14. The Hotel Sagamore is to be the headquarters for the meeting and considerable time will be given to the presentation of technical papers of a particularly interesting nature.

All papers, it is understood, will be presented in the informal manner which has characterized these meetings in the past. No information is available as to whether these manuscripts will be prepared and available for publication. It is sincerely hoped, however, that they will be.

# Design .. NOTES AND

## THEORY AND OPERATION OF A NEW ALL-WAVE NOISE-REDUCING ANTENNA SYSTEM

BRIEFLY, THE NEW system to be described is a single physical aerial, automatically split into two ideal antennae and lead-ins by the differing frequencies of broadcast and short-wave signals. Signals automatically select their own antenna and lead-in circuit for the most efficient results on the basis of their respective frequencies. Broadcast and shortwave signals can be received from

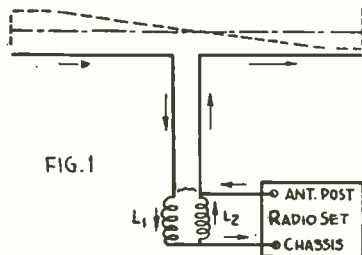

FIG. 1  
Showing paths of signal currents in antenna system.

the same antenna and lead-in, without cross-talk or interaction, and with the elimination of man-made static.

### PRINCIPLE OF OPERATION

In principle, the signal currents are made to travel in opposite directions down the transmission line, as shown by the arrows in Fig. 1. These currents will induce a voltage across the receiving auto-transformer L-1, L-2. The voltage is applied between the antenna and ground terminals of the radio set. At high frequency, the aerial acting as a dipole, induces such currents by virtue of difference in phase of wave-front at the ends of the doublet.

At broadcast-band frequencies a double transformer with reversed secondaries produces the same effect as a

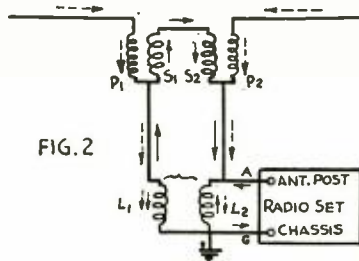

FIG. 2  
Showing paths of primary and secondary currents to double transformer.

doublet. In Fig. 2 the dotted arrows show the direction of flow of the primary currents which develop no voltage across the receiver terminals A-G by virtue of the fact that the mutual inductance between L-1 and L-2 is equal to the inductances L-1 and L-2, therefore the coupling between the two coils is unity.

The secondary currents indicated by the solid arrows are of the same nature as those produced at high frequencies by the dipole action, as in Fig. 1, and develop a voltage  $E = I\omega(L_1 + M)$  across A-G and become the source of signal voltage to the set.

### ELIMINATION OF INDUCED CURRENTS

Any emf induced in the transmission line will create equal currents flowing towards ground, as shown by the arrows in Fig. 3. The drop across A-G due to the currents is

$$I \sqrt{\omega^2 (L_1 - M)^2 + R^2}$$

but  $L_1 = M$  by construction. Hence,  $E = IR$ , and as  $R$  is negligible by con-

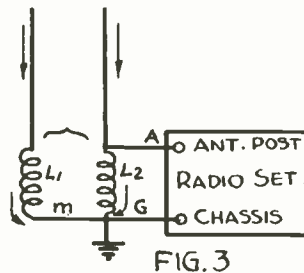

FIG. 3  
Elimination by opposition of currents induced in down-leads.

struction, the emf across A-G is vanishingly small.

### OBTAINING MAXIMUM VOLTAGE

A step-up transformer, Fig. 4, is used when the set impedance is much higher than the line impedance. This is often the case within the 0.5- to 1.5-megacycle band. At higher frequencies the set impedance is, as a rule, much smaller and matches between the impedance of the primary L-1 or L-2. For this reason there are the two positions 1 and 2 of the switch in the set unit. Position 3 permits the downlead to pick up signal energy when there is no interference.

### "T" OR DOUBLET AERIAL

The wavelength and the physical dimensions of the antenna, together with

the electrical constants of the top unit, Fig. 5, including the condensers C-1, C-2, primaries P-1, P-2, and secondaries S-1, S-2. At the lower frequencies the unit acts mainly as shown in the schematic circuit of Fig. 2. At the higher frequencies, like in Fig. 1, the condensers C-1, C-2, bypass the transformers and permit the currents to

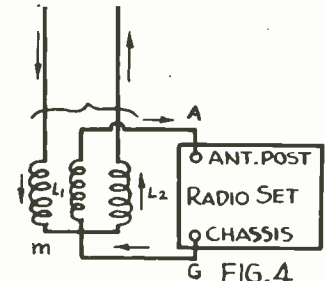

FIG. 4  
Step-up transformer connections used with high input impedance sets.

reach the downlead as if it was directly connected to the dipole. At intermediate frequencies there is a combined action resulting from both of the schematic circuits.

### PRECAUTIONS

There are a few precautions to be observed for proper operation of this antenna system. They are the same that suggest themselves to any skillful man engaged in the installation of receiving systems, but there is one of paramount importance in this system. By examination of the diagram of Fig. 3, it will be noted that the currents produced by the disturbances induced in the downlead flow in parallel, opposing through the downleads to m and from m to G. According to our theory, the drop across A-G due to disturbance currents is equal to  $IR$ , where  $R$  is the coil resistance, and by construction  $R$  is negligible. If, however, the lead mG has appreciable inductance or resistance, the total drop will be  $E = I \sqrt{\omega^2 L_o^2 + (R + R_o)^2}$  where  $L_o$  and  $R_o$  are the inductance and resistance of this lead. Unless both

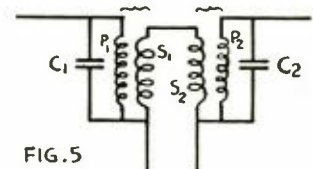

FIG. 5  
The condensers C-1 and C-2 bypass high-frequency currents.

# COMMENT . . . Production

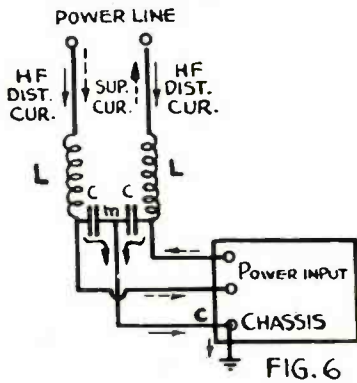

FIG. 6  
Circuit of power-line filter.

are very short, this drop will be sufficient to nullify the noise-elimination properties of the system. In practice, the length of the lead mG should not exceed three inches, measured from the chassis of the set to the center point m of the winding.

Connection of the receiver chassis to a water or steam pipe may in some cases help in the elimination of noises, depending on how "live" this piping line is with electric currents flowing through it.

If a power-line filter containing shunt capacities is used, the grounding point of these capacities should be connected by an extremely short lead to the receiver chassis. A single-section filter is shown in Fig. 6 where the mid-point m is connected to the chassis C by a short wire. The inductances L should be far away from the r-f tuned circuits of the receiver so that the magnetic coupling between them may be close to zero.

## SWITCH POSITIONS

The lower unit has a switching arrangement, as shown in Fig. 7, with three positions—S-1, S-2, and S-3. Point 1 provides best reception on the 0.5 to .5-megacycle band in most standard broadcast receivers of high input impedance.

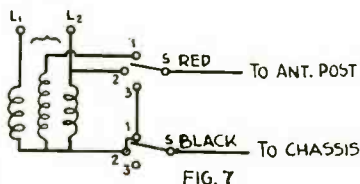

FIG. 7  
Circuit of "receiver" transformer, with switch connections.

Point 2 provides best reception of short-wave, and for broadcast reception of local and fairly distant stations on any receiver. This switch position is best adapted for low input-impedance sets.

Point 3 is for all-wave reception permitting downlead pick-up when there is no interference to be eliminated. In this case the aerial and transmission line constitute a "T" antenna.

For the vast majority of cases noiseless reception with good volume may be obtained at all frequencies with the switch in position 2.

J. G. Aceves,  
AMY, ACEVES & KING, INC.

## BOOK REVIEW

*SHORT WAVE WIRELESS COMMUNICATION*, by A. W. Ladner, A. M. Inst. C. E., and C. R. Stone, B. Sc. (Eng.), A. M. I. E. E., published by John Wiley and Sons, Inc., New York, N. Y., second edition, 384 pages, cloth covers. List price, \$3.75.

This book by Ladner and Stone, which was originally written as a textbook on a subject that was sadly lacking in literature, is of considerable value both as a text- and reference-book. The second edition is mainly a modernization of the first, some 36 pages of new material and 14 diagrams having been added to chapters II, III, IV, X, XI, XIII, XVII, and the appendix.

There are seventeen chapters and five appendices, the latter dealing with the introduction to load characteristics, expression for rms value of modulated high-frequency waves, calculation of characteristic resistance of feeders from dimensions (conductor loss only), and tube inter-electrode capacities.

The first chapter is of an introductory nature and includes a discussion of the requirements of communication systems, a comparison of the low and high frequencies, and the loss and gain notation in terms of decibels; while chapter II covers the history of wireless developments from the time of Hertz. Added in the second chapter is a resume of the developments in short waves since 1931, particularly in the range below 10 meters.

Chapter III is a rather complete and fundamental discussion of electro-magnetic waves. The addition in this chap-

ter includes a vector diagram of a circularly polarized wave with some 150-word explanation. The discussion on the production of electro-magnetic waves is excellent.

"The propagation of Short Wireless Waves" is the title of Chapter IV. Added mention is made of the fact that complete fadeouts of short waves, similar in effect to those due to magnetic storms but lasting only for short periods, have been noticed. No reason is assigned for these conditions which recent investigations have shown may be (and sometimes are) due to the effect of meteors. Also, some four or five pages of excellent discussion are devoted to the measurement of properties of the inosphere and of short-wave field strength. Much of this material was, of course, not available when the first edition was published.

Chapter V contains a theoretical discussion of the modulation of short waves and the relation of sidebands to carrier; and chapters VI, VII, VIII, and IX include the following respectively: push-pull, circuits for high frequency transmissions and self-oscillators, short-wave driven circuits, and constant frequency oscillators.

Chapter X, "Modulation Circuits," has a description of the method of obtaining plate modulation by connecting the modulator in series with a high-frequency amplifier. While this method is of too recent origin to have been treated in the earlier edition, it is so little used that there has been little published on the matter. As a result the authors should be commended for bringing this matter to the attention of their readers.

A discussion of feeders, and feeder systems used at high frequencies is considered in the eleventh chapter of this book. Five pages of additional material is given on transmission line losses as well as some experimental data on carrier types and sizes of transmission lines.

Chapter XII is comprised of the distribution of current, approximate zenithal polar diagrams, types, and losses and radiation in aerials used for high-frequency work; while Chapter XIII on "Aerial Arrays" considers the general requirements, polar diagrams, and a number of the different types of arrays. Four pages are devoted to a discussion of the Marconi-Franklin Series Phase Array of vertical quarter-wave loops. This is, of course, a recent de-



## RMA REQUESTS EXEMPTION FROM ELECTRICAL CODE

(Continued from page 13)

### STATEMENT BY VAN ALLEN

A vigorous statement closing the arguments for the RMA code committee was made by General Counsel Van Allen. He stressed that the RMA had been recognized as a separate industry organization by President Roosevelt, Congress, and many government departments and resented the frequent NEMA references to the "so-called" radio industry.

"We come here today asking for divorce from the electrical industry," said Mr. Van Allen. "If we could be as disgraceful, unreliable and untruthful a group, as speakers here have represented, why are they so anxious to keep us under their code? We have found incompatibility with NEMA. We have, and we think justly, fears of being controlled by such a large aggregation as constitute NEMA.

"We are here fighting for the right to be a separate and distinct industry. We ask why is it our friends do not want us to be a separate industry, although NEMA disbanded its radio section some years ago? We categorically deny that we have not established our own industry standards through our engineering department and working with the Institute of Radio Engineers.

Neither are we just 'assemblers'."

Declaring that costs of NEMA membership, including code operation, were heavy and onerous, Mr. Van Allen declared that RMA members could not afford to belong to NEMA, but could operate their own code much more inexpensively. He also cited that RMA had offered to pay a fair and equitable cost of temporary code operation to NEMA.

"We have our own peculiar problems and should have complete autonomy," Mr. Van Allen concluded. "We ask you to permit us to go our own way. We want to be ourselves and we do not want great aggregations to tell us how to run our own business and our own interests."

### MEMBERSHIP ASSESSMENTS

Numerous questions were propounded by Deputy Administrator Cowling and his staff to the RMA and also NEMA representatives. Colonel Cowling asked the NEMA Counsel what autonomy would be accorded if RMA became a NEMA sub-division. The NEMA Counsel replied that there was no provision in NEMA for membership of trade associations and while he contended that NEMA sections were largely autonomous and operated as separate trade associations, they were subject to the review of their actions by the NEMA Board.

In response to further questions by the Deputy Administrator, Mr. Geddes

stated that large membership assessments already made by NEMA upon the small group of tube manufacturers who had formed a NEMA section indicated that the cost of RMA members in NEMA would amount to \$100,000 to \$150,000 as compared with their present membership dues of only \$45,000 in RMA.

Concluding the hearing, Chairman Murray of the RMA Set Division made a most effective argument for industry independence and a separate code, denying NEMA statements that the RMA had offered \$25,000 to NEMA for operations under the electrical code. Mr. Murray is the present supervisory agency for set manufacturers under the electrical code, and he said that neither he nor Mr. Muter, code supervisory agency for parts and accessory manufacturers, had any recollection of the matter, declaring that RMA had always been willing to pay a fair charge while under the electrical code.

Mr. Murray recited his previous inclination and efforts to form a separate section of set manufacturers in NEMA but said that after nine months of operation under the NEMA code he had entirely changed his opinion of operating under the electrical code or NEMA.

"It simply won't work," Mr. Murray told the NRA. "The industry needs RMA and needs it badly. The only way to permit the industry to continue is to give it a code of its own."

## RADIO INDUSTRY IMPROVING

(Continued from page 10)

sible. Very few repossessions on delinquent-payment sales are being reported by retailers. Where slowness of collections has developed, merchants are endeavoring to obtain full payment or as large a down-payment as possible.

### FAILURES AT ALL-TIME LOW

Based on the trend during the past six months, the smallest number of failures in the history of the industry is to be recorded for 1934. Thus far, firms have been going into bankruptcy at the rate of 3 a month, whereas in 1933, the monthly average was 11. With the exception of the failure of one large wholesaler in January for more than \$1,000,000, the involved liabilities of the defaulting firms have been small, the total for the 20 failures for the first six months amounting to only \$1,465,906.

The complete insolvency record of the radio industry since 1930, including January of the current year, as compiled by Dun & Bradstreet, Inc., shows:

Year	Manufacturers	
	Number	Liabilities
1930.....	40	\$3,522,400
1931.....	15	4,088,445
1932.....	23	1,826,995
1933.....	25	3,719,519
1934*.....	4	24,330

Year	Wholesalers and Retailers	
	Number	Liabilities
1930.....	217	\$2,071,392
1931.....	160	4,979,359
1932.....	170	1,978,678
1933.....	109	1,813,980
1934*.....	16	1,441,577

(\*) January to June, inclusive.

## BOOK REVIEW

(Continued from page 21)

velopment and so far as this reviewer is aware has not been given the publicity it deserves. It appears to have a number of distinct advantages over other aerial arrays and promises, either in its present or modified form, to be used rather extensively.

Another chapter deals with reception problems and simple receiver circuits, while still another rather long chapter is devoted to commercial receiving sets,

and a third chapter contains material on commercial short-wave transmitters and circuits.

The last chapter in the book is entitled "Ultra Short Waves," and contains an addition of eleven pages of material, plus diagrams, curves, and the like. Some one and one-half pages are devoted to an explanation and an approximate method of finding the wavelength of oscillations in transmitting tubes, while six additional pages permit a much fuller discussion on the subject of magnetrons. The treatise on propagation characteristics has been increased.

The appendix, also, has been made a great deal more valuable by the addition of three and one-half pages on feeder efficiency calculation.

While the references given at the end of chapters III, IV, V, VII, IX, XI, XII, XIII, XIV, and XVII are not as complete as they might be, they still give a fairly comprehensive coverage of their respective subjects.

In conclusion, *Short Wave Wireless Communication* may be said to be an excellent reference-book for engineers and the amateurs that already have a knowledge of low-frequency systems.

# A Chronological History

## of electrical communication

### —telegraph, telephone and radio

This history began with the January 1, 1932, issue of RADIO ENGINEERING. The items are numbered chronologically, beginning at 2000 B.C., and will be continued down to modern times. The history records important dates, discoveries, inventions, necrology and statistics, with numerous contemporary chronological tie-in references to events in associated scientific development. The material was compiled by Donald McNicol.

#### PART XXXII

##### 1909 (Continued)

- (1241) G. Marconi receives the Nobel prize of \$20,000, in recognition of his wireless telegraph inventions.
- (1242) The net earnings of the American District Telegraph Company for the year are reported as \$84,563.
- (1243) The Western Electric Company this year has a gross business amounting to \$46,000,000.
- (1244) The Westinghouse Electric and Manufacturing Company, during the year had a gross business amounting to about \$30,000,000.
- (1245) Louis Cohen, in a Bureau of Standards bulletin gives the mathematical theory of coupled circuits in which the secondaries have distributed inductance and capacity.

##### 1910

- (1246) The Telepost Company, operating the Delany high-speed chemical automatic system of telegraphy, opens for service lines between Chicago, Indianapolis, Terre Haute, St. Louis and Sedalia. The company also has in operation lines in Massachusetts and Maine.
- (1247) A. E. Dolbear dies, February 23, (Born in U. S. A., 1837.)
- (1248) Major George O. Squier, of the United States Army, invents and patents a system of multiplex telegraphy and telephony, superimposing high-frequency signaling circuits upon existing wire lines.
- (1249) The United States Circuit Court affirms, March 8, the validity of T. A. Edison's moving-picture patents. The case has been in the courts eleven years. It is reported that Mr. Edison receives royalties amounting to \$7,000 weekly from eight American and three European manufacturers of moving picture film.
- (1250) The Postal Telegraph-Cable Company introduces a high-speed automatic telegraph system, employing Wheatstone transmission. At the receiver a moving band of paper tape is perforated by means of an electromagnet-operated punch invented by F. E. d'Humy.
- (1251) Night Lettergram service is introduced in the United States by the two large telegraph companies (March 7.)
- (1252) In the United States there are 118 engineering schools, with 4,700 graduates.
- (1253) The printing telegraph system invented by C. L. and H. L. Krum, Chicago, is installed on several trunk circuits of the Postal Telegraph-Cable Company. The printer is known as the Morkrum, the word being a combination of the names Morton and Krum, Mr. Morton being financially interested in the company.

- (1254) Theodore N. Vail, president of the American Telephone and Telegraph Company is elected president of the Western Union Telegraph Company.
- (1255) An International Conference of Telegraph and Telephone Engineers is held in Paris, France, September 4-11. J. J. Carty and C. E. Scribner, New York, are delegates.
- (1256) The number of patents issued to Thomas A. Edison up to this year is 1,328.
- (1257) During the year, 2,000,000 tantalum electric lamps are marketed in this country.
- (1258) An International Exhibition is held in Brussels, Belgium at which electrical exhibits are made.
- (1259) D. C. Jackson is elected president of the A. I. E. E.
- (1260) In the United States 1,250 miles of main line railroad are now operated by electric systems.
- (1261) Dr. George Seibt, during the past year associated with Dr. Lee de Forest, New York, in radio research work, returns to Berlin, Germany.
- (1262) The New York and New Jersey Telephone Company merges with the New York Telephone Company. Shareholders of the former company receive \$142 per share for their holdings.
- (1263) The Government arranges to transmit by radio from a station at Newport, R. I., weather reports to ships at sea.
- (1264) In New York there are 900 electric vehicles in commercial service. It is reported that in the entire country there are 1800 vehicles so operated.
- (1265) The National Electric Light Association has 4,500 members.
- (1266) The Thompson-Levering Company is organized in Philadelphia.
- (1267) E. Bellini and A. Tosi, of France, are granted U. S. patent 945,440 covering a system of directed radio signaling.
- (1268) P. M. Marko, New York, is granted U. S. patent 945,564 covering the invention of a type of storage battery.
- (1269) A. S. Hickley, Spring Lake, N. J., develops an electrolytic rectifier which is introduced in telegraph and telephone services.
- (1270) The United States Telephone Company, and subsidiary corporations pass to the control of J. P. Morgan and Company. Joseph S. Brailey, Jr., president is replaced by Frank A. Davis, of Columbus, Ohio.
- (1271) W. L. R. Emmet procures U. S. patent 945,925 for a system of electric propulsion for ships.
- (1272) E. Kleinschmidt, New York, procures U. S. patent 946,372 covering the invention of a keyboard telegraph transmitter.
- (1273) The Central Colorado Electric Power System now transmits energy at 100,000 volts, a distance of 150 miles.
- (1274) W. B. Garton, Brooklyn, N. Y., procures U. S. patent 946,542 for a new form of lightning arrester.
- (1275) The National X-Ray Reflector Company, recently organized, brings out a "Scoop" reflector for electric lamps, which is introduced in window display lighting.
- (1276) An elective course is given at Massachusetts Institute of Technology in wireless telegraphy under the direction of Prof. C. R. Cross of the department of physics.

(To be continued)



## VETERAN WIRELESS OPERATORS ASSOCIATION NEWS

### V. W. O. A. PRESIDENT

Introducing Fred Muller—unquestionably the most widely known marine radio man, held in the highest esteem by the entire radio fraternity for his amiable nature and splendid cooperative spirit.

Born at Riverside, N. J., August 1st, 1891, of Holland Dutch parents, his father and grandfather before him were widely known as marine consulting engineers and pioneers in the field of modern navigational development. Educated in the public grade and high schools of the City of New York, later attending Cooper Union Technical Institute as well as several other technical and business institutions of learning.

Served in U. S. Navy 1908-1912, graduating from the U. S. Navy Electrical and Wireless School at the Navy Yard, Brooklyn, N. Y.—followed by assignments to battleships of the Atlantic Fleet, progressed to position of Electrician in Charge of Light and Power—terminated his enlistment as Chief Wireless Operator under Admiral Usher on board the flagship Minnesota.

Without loss of time secured employment with Wireless Telegraph Department of the United Fruit Company at New York under A. F. Parkhurst, Superintendent; assigned to S. S. Metapan as second operator. Through sheer ability and initiative he was promoted to position of inspector in less than two months—assigned to work of conditioning all marine radio equipment.

In 1913, when the Tropical Radio Telegraph Company was organized as the communications subsidiary of the United Fruit Company, Mr. Muller transferred to that company, continuing in the role of inspector, to become Marine Radio Superintendent in 1927. Under his supervision the radio system employed aboard vessels of the United Fruit Company fleet was progressively advanced to the point that it was accorded international recognition as the foremost marine radio telegraph service afloat—employing the highest grade operators and the most modern equipment.

Prior to 1926, when vacuum-tube transmitting apparatus was adopted, the Fessenden 500-cycle synchronous rotary and quenched spark gap transmitters—noted for their clean cut signals of exceptional carrying qualities—were standard equipment. Subsequent additions of intermediate- and high-frequency vacuum tube transmitting and receiving equipments, automatic emergency gas-electric power plants, radio direction finders, centralized public-address and broadcast reception systems, and the elimination of all obsolete equipment, placed Mr. Muller in charge of a radio organization unexcelled in the maritime industry. At the time of his resignation—December, 1933—to engage in a consulting radio engineering practice, Mr. Muller had charge of all communication facilities of the New York Division of the United Fruit Company—cable, radio, telephone and mail—in addition to his duties as Marine Radio Superintendent in charge of the entire radio marine communication system of the Tropical Radio Telegraph Company.

Mr. Muller is a Fellow of the Radio Club of America, Member of the the Institute of Radio Engineers, Life Member of V. W. O. A., Secretary of V. W. O. A. 1930, President 1931-1934, holder of extra first class commercial radio operator's license (popularly designated "Pink Ticket"), issues of which have been held since the first—1914, as well as a "certificate of skill" issued in 1912 before the present system of licensing was adopted. Holds Class A amateur operator's license and operates amateur station W2MR. Married, living with wife and four fine children, two boys and two girls, on his estate at Monsey, N. Y. Hobby: Gentleman farming—all-round athlete with no mean ability as baseball player, though in recent years has confined his outdoor activities to the local golf course.

### "RECOLLECTION"

C. S. Anderson, Association Biographer and frequent contributor of interesting items, reminisces concerning V. W. O. A. activities in the past, as follows:

"On November 12, 1928, the ill-fated S. S. Vestris sank, carrying with her Chief Radio Officer Michael J. O'Loughlin, who died at his post of duty.

"Immediately following this disaster the V. W. O. A. went into action, and under the able leadership of Past-President J. F. J. Maher, organized a benefit performance directed by Phil Lord at the Colony Theatre, New York, Nov. 17, 1928, which netted \$1,408 for the mother and father of Michael J. O'Loughlin in Ireland, and \$200 to the surviving operators, James Taylor Forbes Macdonald, first assistant, and Charles Tullock Verchere, second assistant.

"Memorial services were held at the Old Trinity Church, New York, November 18, sponsored by the V. W. O. A.

"Appreciation and thanks were tendered the Association by Mr. Stanley W. Brown of the Association of Wireless and Cable Telegraphists in Great Britain, for the *esprit de corps* manifested by the V. W. O. A.

"And thus closed another episode of succor and sympathy played by the V. W. O. A. in its mission of giving recognition to merit."

### CHANGE OF ADDRESS

Members changing their mailing address are requested to inform the Secretary immediately. It will facilitate matters if such members also send a notice of change of address to RADIO ENGINEERING. Prompt action in this connection will insure early receipt of subsequent issues of the magazine and Association information.

### "CONGRATULATIONS"

We congratulate:

Captain S. C. Hooper, U. S. N., Director of Naval Communications, Honorary Member of our Association, ever helpful in furnishing us with facts relative to Naval Radio activities, upon the bestowal of the Institute of Radio Engineers Gold



Fred Muller  
President V.W.O.A.

Medal for his outstanding achievements in radio communications development.

Arthur F. Wallis, formerly Commercial Representative for Tropical Radio, more recently Commercial Representative for Mackay Radio—an extremely active member (Life) in the affairs of the Association, Executive Secretary 1931, Secretary 1932—upon his recent appointment to the position of Marine Radio Superintendent of Mackay Radio, with offices at 33 South William St., N. Y. C.

Fred Muller, our President, upon the opening of his office at 39 Cortlandt St., N. Y. C.

C. S. Anderson, of RCA Institutes, in New York, on his acquiring an excellent tan on his recent vacation automobile tour of the West during which he visited Ben Wolf, Engineer in charge of the Government radio monitoring station at Grand Island, Nebraska.

Edward J. Girard, until recently Marine Radio Superintendent of Mackay Radio, with headquarters in New York, upon his appointment as District Manager for Mackay Radio, with offices in Washington, D. C.

We wish them all an abundance of good health and continued success.

### "PERSONALS"

W. S. (Bill) Fitzpatrick continues to write his extremely interesting page in *RCA Broadcast News*. . . . B. R. Donges is Maintenance Supervisor with the National Broadcasting Company at Chicago. . . . "Bill" Lintz, admittedly one of the best radio direction finder technicians, at present associated with the Mackay Company, reports that "Steve" Wallis, Mackay Supt. was recently initiated into the N. Y. Harbor Pilots "Yawl" Club. Mr. Wallis accompanied "Bill" on a recent direction finder calibration trip down the harbor. . . . Stephen Kovacs was recently assigned to the Radio staff of the Leviathan. . . . George H. Clark, Association Historian, is again at the World's Fair in charge of the RCA Victor exhibits there. Cheer up, George, some of the Vets will be out to see you before the show closes. . . . V. H. C. Eberlin, Association Treasurer, continues his good work as Chief Radio Officer of the Fruit Company S. S. Uluu. . . .

(EDITOR'S NOTE: Communications to the Veteran Wireless Operators Association should be addressed to William J. McGonigle, Secretary, 112 Willoughby Ave., Brooklyn, N. Y.)



# NEWS OF THE INDUSTRY

## DUMONT HAS NEW ADDRESS

The Allen B. DuMont Laboratories, manufacturers of cathode-ray tubes and oscillographs, 9 Bradford Way, Upper Montclair, New Jersey, announce their moving into new and larger quarters at 542 Valley Road, Upper Montclair, New Jersey. This move has been caused by increased business and will also necessitate considerable additional labor and engineering help. They will offer to the trade new types and equipment in September.

## CONTINENTAL APPOINTMENT

At a recent meeting of the Board of Directors of the Continental Electric Co., St. Charles, Ill., R. E. Smiley was made Vice President in charge of Sales. This appointment was made in recognition of the splendid development of the Company's sales since Mr. Smiley joined the Company a little over a year ago.

## AUDIOLA CHANGES NAME

Fairbanks, Morse & Company of Chicago recently announced that the name of their wholly-owned subsidiary, the Audiola Radio Company, has been changed to Fairbanks-Morse Home Appliances, Inc.

The change in the corporate name, according to Mr. S. T. Kiddoo, Vice President and Treasurer, and also Director of the parent organization, was made that the name of the subsidiary company might more suitably and accurately indicate the close affiliation of the subsidiary company with the senior organization. Also, in view of the rapid progress that this subsidiary is making, Fairbanks, Morse & Company felt that it would be advantageous to have one of their own senior executives as President of this subsidiary. Therefore, Mr. S. T. Kiddoo has been elected by the directorate of Fairbanks-Morse Home Appliances, Inc., as President.

Mr. Mortimer Frankel, General Manager, continues in direct charge of all activities of Fairbanks-Morse Home Appliances, Inc., and is also Vice President.

Mr. John W. Million, Jr., continues as Chief Engineer and Production Manager. He is also Treasurer of the subsidiary corporation.

Mr. Addison Brown continues as Sales Manager.

## AIR EXPRESS TRAFFIC GAIN

For the thirty-third consecutive month air express showed an increase of more than 100% in the number of shipments over the corresponding period of the previous year, according to a semi-annual report made public by the Air Express Division of the Railway Express Agency. During this thirty-three month period the average monthly gain in air express traffic over corresponding periods of the previous year was 148%.

## GREEN WITH ACHESON COLLOIDS

The Acheson Colloids Corporation, Port Huron, Michigan, announce that Mr. George C. Green, M. E. of the class of 1934 of Stevens Institute of Technology, has joined the technical staff of their organization. Mr. Green will be located in New York City, where he will be first assistant to Mr. Raymond Szymanowitz, Technical Editor of that corporation.

## "MULLER'S RADIO SERVICE"

Establishment of this service with headquarters at 39 Cortlandt Street in New York City under the management of Fred Muller, until recently Marine Radio Superintendent of the Tropical Radio Telegraph Company, answers the need for a comprehensive radio service organization that provides, as it does, facilities for the procurement of radio technical and operating personnel, all types of radio and electrical equipment complete with installation and maintenance. Muller's Radio Service is open for manufacturer representative appointment and consultation services. (See *V. W. O. A. page for biography of Mr. Muller.*)

## TRAV-LER SOLD TO HOFFMAN

Harold J. Wrape, President of the Benwood-Linze Company, announces he and his associates have disposed of the Trav-Ler Mfg. Co., to Max Hoffman, of the Hoffman Mfg. Co., 1400 S. Michigan Blvd., Chicago, Ill.

The business of the Trav-Ler Mfg. Co. will hereafter be conducted from the Chicago address.

## CONTINENTAL MOVES N. Y. OFFICES

Due to the greatly increased business and general activity in the New York market, announcement is made by Continental Electric Co., that the eastern sales office, manned by Mr. F. V. L. Smith, has been moved to larger and more commodious quarters, located at 265 West Fourteenth Street, County Trust Building, New York City. Telephone Chelsea 2-4027.

The new quarters will greatly assist in better service and contact with the trade.

## PETERSON JOINS FEDERAL TOOL

A. B. Peterson, for many years Chief of the Division of Tool and Machine Construction for the Hawthorne (Ill.) Works of Western Electric Co., has accepted a directorship on the board of the Federal Tool Corporation, Chicago.

Mr. Peterson will take charge of the sales engineering for the tool company, and direct sales of their dies, precision tools, drop-forge dies and tools for the metal working industries.

Mr. Peterson, in his long contact with the Western Electric Company, has gained a wide reputation as a leader in the machine tool industry, and is known personally to nearly every tool and die supplier and designer in the country.

## AUSTRALIAN PURCHASER VISITS U. S.

Mr. Charles E. Forrest, Managing Director of the International Radio Company, Ltd., Sidney, Australia, is now paying his eighth visit to the United States and is making his headquarters at the International Forwarding Company, 431 S. Dearborn St., Chicago.

Mr. Forrest, who anticipates remaining in America some two or three months, is interested in radio, refrigerator, and associated products marketed by American manufacturers.

## ENGINEERS STUDY NAVY GUN FIRE

As guests of the Navy Department, three engineers from the Radio Division of the Westinghouse Company at Chicopee Falls are spending six days at sea on the Battleship Texas studying the effects of gun fire on delicate radio parts. By studying the requirements first hand these engineers will be better equipped to design and manufacture improved apparatus for the severe requirements of the Navy.

Represented in the group are J. A. Hutcheson, C. J. Bull and F. E. Rutzen, representing the three major steps in the manufacturing of radio apparatus. J. A. Hutcheson, who just recently returned from the 500-kw Crosley installation at WLW, is a specialist on power tubes and the design and application of radio- and audio-frequency circuits. C. J. Bull, a mechanical engineer, specializes on the layout of parts and the design of special features to enable proper operation of the radio equipment. F. E. Rutzen, Supervisor of Test at the Chicopee Falls Works, is responsible for the operation of all equipment leaving the factory.

## ADAMS JOINS STRUTHERS DUNN

Mr. James T. Adams, a graduate of the Massachusetts Institute of Technology and formerly with the General Electric Company, has joined Struthers Dunn, Inc., 139 North Juniper Street, Philadelphia, Pa., as a sales correspondent to assist in handling the engineering problems of their customers.

## EMPIRE BULLETIN

A bulletin on Empire Oiled Cloth Insulation, which has just been issued by the Mica Insulator Company, lists their fifty-six products in the line of electrical insulation. In addition there are a number of illustrations of such of their products as commutator segments, heater plates, commutator rings, limotape, and the like.

All inquiries should be addressed to 200 Varick Street, New York, N. Y.

## CROWE BULLETIN

Crowe Bulletin No. 55, issued by the Crowe Name Plate and Manufacturing Company, 1749 Grace Street, Chicago, Ill., covers name plates for tuning controls, remote controls, dials, grilles, metal cabinets and escutcheons for the 1935 receivers, and its fifty some pages are profusely illustrated. Incorporated in this booklet is a great deal of technical data and descriptions of the different products. For further information address the above company.

## "BAKELITE REVIEW"

The "Bakelite Review," a booklet issued by the Bakelite Corporation, is a digest of bakelite achievements that should be of interest to manufacturers and merchants.

Illustrated descriptions tell of the part that bakelite plays in the home, in the electrical and mechanical fields, in radio, building, packaging, display, paints and varnishes, and the like.

# NEW PRODUCTS

## N. U. ADDS 6 AMP RECTIFIER

National Union Radio Corporation of New York announced this week the development by its Engineering Department of a new 6 Ampere Rectifying tube for use in multiple battery chargers.

Six Ampere Rectifying Tubes used extensively in the automotive and radio fields as rectifiers for multiple battery charging units are commonly referred to as "Tungar Type". Outstanding features of the new National Union Rectifier include ability to withstand increased voltages and a construction which makes them not critical on voltage fluctuations, it is stated, these factors, of course, resulting in more output for less consumption of power. The new Rectifiers will be distributed through regular National Union distribution channels.

## DOEHLER DIE CASTING BOOKLET

"Brass Die Castings with the Strength of Steel" is the title of a 16-page booklet received from the Doehler Die Casting Co., 386 Fourth Ave., New York City, N. Y. This booklet includes a short history of die casting, and a description, including physical properties, of Doehler Brastil, Doehler Manganese Bronze Alloy, and Doehler White Nickel Brass. In addition a number of illustrations of parts made from the different materials is included. All requests for copies should be sent direct to the above company.

## A-F TEST RECORDS

The Audio-Tone Oscillator Company, 1382 Page Boulevard, Springfield, Mass., has recently announced a series of Technical Test Records, to be added to their line of Audio-Frequency Test Equipment.

One of these Technical Records is an audio-frequency recording, covering the entire range of frequencies from 50 to 7000 cycles, and differing from the usual frequency record in that the recording is continuous throughout the range of the record. This makes it possible to check the audio-frequency characteristic of phonograph reproducers, amplifiers, loudspeakers, or entire public-address systems. An underlay voice recording announces each important frequency.

These Audio-Tone Records have an accuracy of recording which agrees with the average of four types of commercial wax recorders with a maximum deviation of 1 db over the entire frequency range, it is stated. These records are of the double-face, 12-inch type.

## HEARING AIDS

Sound Systems, Inc., Cleveland, Ohio, offer a new unit for churches, to meet a specific need it has discovered in the rental field. It is primarily a unit to aid the hard of hearing.

A crystal microphone is supplied on a short desk stand to be placed on the pulpit. A small compact amplifier is supplied to be placed under the pulpit. For the pews, small phones mounted on lorgnette handles (which extend to 14 inches) are supplied with outlet boxes which contain constant impedance volume controls. The unit in-

cludes a set of six receivers and the amplifier is capable of taking care of a maximum of fifty.

Sufficient amplification is available for individuals who are unusually hard of hearing and the sensitivity of the microphone is great enough to reproduce the musical part of the service, even though the organ and choir are located at a considerable distance from the pulpit, it is stated.

Wiring diagrams for installation are supplied.

## NEW LEOTONE SPEAKER

The Leotone Radio Company, 63 Dey St., New York, N. Y., have announced a new "photophone-type" dynamic speaker, illustrated here, which is said to be capable of handling up to 18 watts power without distortion, and to have a maximum output of 25 watts.



The unit is ruggedly constructed, with chamois-floated, 15-inch corrugated cone and Granoflex three-point outside spider. The field is heavy-duty, weighing 8½ pounds.

## FADA REMOTE CONTROL

Fada Radio now has available to the trade a new remote-control unit, which, they state, can be easily attached in a few seconds. This unit consists of an embossed, antique-finished control head equipped with two knobs and a dial. To this control head is attached a single tubular casing approximately ¼ inch in diameter, containing all the cables. At the other end of this pliable cable is another set of knobs. To attach and operate, it is merely necessary to remove the dial knob and volume-control knob from practically any radio set and in their place attach the knobs of the Fada Remote Control.

The control head may be placed in any part of a room or adjoining room up to a distance of 15 feet. The device works two ways—permitting operation at the set as well as at the remote point.

## WESTINGHOUSE POLICE RADIO

A new radio transmitter known as Type EB for municipal police service in cities of 100,000 population and less has just been developed by Westinghouse. It is rated at 50 watts, operates from an ordinary electric light socket, takes but little more power than an ordinary electric iron, and weighing only 223 pounds can

easily be installed on a desk or table in the station house, it is stated. No batteries or special arrangements are necessary except that a conventional antenna must be provided.

A quartz crystal plate, held at constant temperature holds the radiated wave on the assigned frequency. A new type of tube, used as an oscillator in conjunction with the crystal, further stabilizes the wave by providing an electron coupling between the crystal stage and the radio power amplifier. With this electron coupling any variations in the amplifier connected to the antenna are not carried back into the crystal to cause change of frequency.

The radio power amplifier uses two of the new type WL-850 tubes developed by the Westinghouse Lamp Company in Bloomfield and require no biasing voltage. This feature accounts for the absence of a "bias rectifier" previously required.

Simplified controls, permitting a single switch to turn on the set from stand-by to the transmit position is another feature.

A simple push-button is used, when desired, to broadcast a tone signal to call attention to all cruising cars.

The new transmitter is now in production at Westinghouse's Chicopee Falls works and deliveries can soon be made from stock.

## BIRNBACH AERIAL SPRING ADJUSTER

Birnbach Radio Company, Inc., 145 Hudson Street, New York City, have developed a new Spring Aerial Adjuster, No. 765. This adjuster was designed to compensate the additional weight of the doublet type short-wave antenna, and to prevent breakage and contact with high-voltage lines, due to swaying, in any type aerial.

This unit is constructed of a heavy cadmium steel and it has two hooks that interlock with the tension spring, making it nearly impossible for this adjuster to fail or break down in service due to failure of the spring. In addition, porcelain eyes are placed in the hooks at each end.

## CONTINENTAL FLEXO-TERMINAL SUPPRESSORS

Continental Carbon Inc., 13900 Lorain Ave., Cleveland, Ohio, have announced a new auto-radio ignition suppressor which is suitable for installation on any car.

The new S-18 suppressor is less than two inches in length, and has a spark plug



terminal of flexible spring brass that may be bent for straight or angle mounting with respect to the spark plug.



**T**HE Group Subscription Plan for RADIO ENGINEERING enables a group of engineers or department heads to subscribe at one-half the usual yearly rate.

The regular individual rate is \$2.00 a year. In groups of 4 or more, the subscription rate is \$1.00 a year. (In Canada and foreign countries, \$2.00.)

---

The engineering departments of hundreds of manufacturers in the radio and allied industries have used this Group Plan for years, in renewing their subscriptions to RADIO ENGINEERING.

---

Each subscriber should print his name and address clearly and state his occupation—whether an executive, engineer, department head, plant superintendent, or foreman, etc.

**Remember this Group Plan  
when *Your* Subscription Expires**

(Radio Engineering)  
**BRYAN DAVIS PUBLISHING CO., Inc.**  
19 East 47th Street, New York, N. Y.



## LE BOURG AERIAL TOWERS

A. LeBourg, 602 South 11th Street, Gadsden, Alabama, has made available a new type aerial support. These metal Aerial Towers, which are light in weight, may be fastened to any type of roof, without any resulting damage, by means of the loops in the feet of the support. On wood or composition roofs staples may be used to fasten the tower, while for tile or slate roofs, wires running along the ridge from tower to tower and passing through the loops may be used. In case the middle of the tower should sag it is easy to use a third support.

## TOBE CONDENSER ANALYZER

With the advent of electrolytic condensers, radio sets have been increasingly difficult to service; particularly so during the past two years because of circuit designs incorporating the use of multiple and concentrically wound condensers.

Many aids have been available to the Service Man in an assortment of testing devices which check continuity, resistance, voltage, current, and other such electrical characteristics. However, no practical device has been produced to accurately determine the "quality" and efficiency of electrolytic and paper condensers. The Service Man has encountered much difficulty and delay in his work due to the unsatisfactory and sometimes unreliable methods of testing condensers.



The Tobe Deuschmann Corporation continuing its policy of close co-operation with the service field, has spent considerable time in developing a condenser analyzer which satisfies the most exacting requirements. With this instrument practically any commercial paper and electrolytic condenser can be quickly and accurately tested and its quality directly determined. It is stated.

The condenser analyzer detects defective condensers according to the leakage-resistance-voltage method used by the majority of manufacturers in determining the quality of their products. It is an accepted fact that a condenser not having sufficient dielectric leakage-resistance and not capable of withstanding a definite voltage will not operate satisfactorily.

The fundamental principle of the analyzer is to test condensers under normal operating conditions. This is accomplished by means of a specially designed adjustable power supply which is an essential part of the device. The quality of the various condensers is determined by a simple setting of three controls which ad-

just the circuit for the allowable electrical characteristics.

The condition of the condensers is directly indicated as good or defective by a sensitive Neon Glow Tube. This instrument quickly and efficiently locates practically any type of defective condenser without removing the condensers from the radio set.

A complete analysis of the entire condenser installation can be accomplished in a few minutes, thereby improving the ultimate value of the repair job.

The condenser analyzer is furnished complete with instructions and valuable data on condensers and condenser testing.

## ALL-WAVE AERIAL KIT

A new aerial kit, especially arranged for use with all-wave receivers, is announced by the Belden Manufacturing Co., 4689 W. Van Buren St., Chicago, Ill.



The new kit includes two 50-foot coils of 7 x 20 Beldenamel aerial wire, 75 feet of twisted, duplex weatherproofed lead-in wire, two Belden lightning arresters, two lead-in strips, and other material necessary for an efficient aerial installation.

The kit provides a superior antenna system for short-wave reception, effectively reducing pick-up of noises by the lead-in, increasing signal pick-up and functioning equally well on the broadcast band, it is stated.

## NEW FLECHTHEIM CATALOGUE

Flechtheim and Co., Inc., of New York City, have just released their latest catalogue, No. 27, dated 1934-35.

The current effort is a profusely illustrated 8 page catalogue printed in two colors.

The catalogue presents a complete parts replacement line, giving detailed descriptions of all Flechtheim products inclusive of Flechtheim carbon resistors, automobile suppressors, dry electrolytic condensers, paper condensers and paper transmitting condensers.

The catalogue can be obtained without charge by application to A. M. Flechtheim & Co., Inc., 136 Liberty Street, New York City.

## TESTER FOR GIANT TUBES

The Westinghouse Company, at its Radio Division in Chicopee Falls, has just completed a new electrical device for laboratory testing of high-power, radio-transmitting tubes. Engineering tests have been made, and the unit is being shipped to the Westinghouse Lamp Company in Bloomfield, New Jersey, where the tubes are being manufactured. A combination of features makes it possible for this device to test any size radio-transmitting tube

from the smallest to those rated at many kilowatts, it is stated.

The tester is divided into four panels, providing excitation, grid bias, screen-grid bias, and plate voltage. The plate supply and the two bias panels each contain a three-phase, full-wave rectifier. Two of the rectifiers are 1500 volts dc each, and the third rectifier supplies a maximum of 10,000 volts dc. All of the voltages can be varied continuously and evenly from almost zero to the maximum output of the set. With this arrangement, it is possible to obtain almost every operating condition required for the testing of radio tubes.

## READRITE TUBE TESTERS

The Readrite Meter Works, Bluffton, Ohio, recently announced the development of two new tube testers: the No. 421, a counter tube tester for the dealer's counter, and No. 422, a portable tube tester. These testers are so simply designed that anyone, without experience, can operate and understand them, it is said.



These units incorporate a 3½-inch Triplett Precision Meter, which has a shaded two-color scale, that indicates the condition of the tube as either "good" or "poor."

At the left of the upper panel is a bar-knob rheostat used to control line voltage. Another bar knob functions as the selector switch.

A line-voltage control, ac meter is incorporated as well as provision being made for testing cathode and grid leakages and shorts. A simple push button provides two plate-current readings for determining the worth and conductance of all types of old and new tubes.

In addition there are two slots for holding the cord cap when not in use. Also the round metal grid-cap holder holds the grid-cap wire when not in use. The portable model has an oak cover with two latches, removable hinges and strap handle. Its size is 10¾ inches wide, 9¾ inches deep and 6½ inches high.

The Readrite Meter Works will send a folder describing these testers to those interested.

## REPLACEMENT VIBRATORS

The Radiart Corporation, 13229 Shaw Avenue, Cleveland, Ohio, are producing replacement vibrators for the high-voltage units of auto-radio receivers. The vibrator

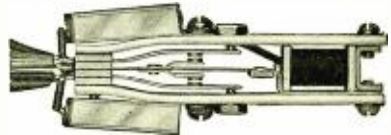

shown in the accompanying illustration, type 3315, is used in the Buick-Olds-Pontiac, and Chevrolet receivers. Replacement vibrator units for other auto-radios are also available.

RECEIVED AT  
 11 EAST 55th STREET  
 PHONE: PLAZA 3-0507

**Postal Telegraph**  
 THE INTERNATIONAL SYSTEM

Commercial Cables  
 All America Cables  
 Mackay Radio

This is a full rate Telegram, Cablegram or Radiogram unless otherwise indicated by signal in the check or in the address.

DL	DAY LETTER
NL	NIGHT LETTER
RM	NIGHT MESSAGE
LD	DEFERRED CABLE
SL	NIGHT CABLE LETTER
WLT	WEEK END CABLE LETTER
	RADIOGRAM

Form 1908 NA3 47 EXPED VIA MACKAYRADIO  
 RADIO LITTLEAMERICA VIA SANFRANCISCO CALIF JUN 4 1934

MCNEIL

BEVERLY HOTEL NEWYORK

FOR BRUSH DEVELOPMENT CO CLEVELAND OHIO QUOTE WE ARE HAPPY TO INFORM YOU THAT BRUSH MICROPHONES ARE BEING USED IN RADIO BROADCASTS FROM THE SECOND BYRD ANTARCTIC EXPEDITION AT LITTLEAMERICA AND ACCORDING TO ENGINEERS EYER AND HUTCHINSON ARE GIVING EXCELLENT RESULTS

UNQUOTE

MURPHY.

JUN 4 719A

**BRUSH Soundcell Microphones** are being widely used where ruggedness and reliability are required.

**THE BRUSH DEVELOPMENT COMPANY**

CORNER PERKINS AND EAST 40th STREET

CLEVELAND, OHIO

**FUSES**

INSTRUMENT Precision—  
 1/100 amp. up  
 RADIO HIGH VOLTAGE  
 AUTO AIRCRAFT  
 Anti-Vibration  
 LITTELFUSE LABS.  
 4505 Ravenswood Ave.  
 CHICAGO, ILL.

Write for New Descriptive Catalog No. 6

We have had years of experience designing and building  
**SPEAKER UNITS and TRUMPETS**

Our Electro-Dynamic Unit has high efficiency at low loads or overloads. Dependable, naturally clear voice at any volume.



Trumpets made in two sizes, 6 ft. and 4 ft. All aluminum.

VOICE OF THE AIR CO.  
 730 PHILLIPS AVE., TOLEDO, O.

**SPEAKER CONE DIAPHRAGMS**

MOULDED SEAMLESS PAPER FIBER  
 USED BY THE LEADERS IN RADIO INDUSTRY  
 OLDEST CONE MANUFACTURER—LOWEST IN PRICE

**UNITED PRESSED PRODUCTS CO.**  
 PRESSED AND MOULDED SHAPES IN PAPER AND FABRIC  
 407 SOUTH ABERDEEN ST. CHICAGO, ILLINOIS

**BLILEY PIEZO-ELECTRIC CRYSTALS**

FOR USE IN RADIO  
 Transmitters - Receivers - Monitors - Standards  
 Supplied to any frequency from 20Kcs to 15,000Kcs.

Send for price list and descriptive circular.

 **BLILEY ELECTRIC CO.**   
 237 Union Station Bldg., Erie, Pa.

**BASES and CAPS** ALL TYPES ALUMINUM — BRASS  
**TUNGSTEN WELDS** ANY COMBINATION Special Strand Wires (O. F. H. C.) Nickel — Tungsten — Moly

Quality Products for Electronic Tubes  
 Send in Your Specifications for Samples and Prices  
 "THE ENGINEERING CO."  
 57-59 BRANFORD STREET NEWARK, N. J.

**When You Renew Your Subscription to RADIO ENGINEERING**

Remember the Group Rate — \$1.00 a year for four or more subscriptions.

Regular Rate—\$2.00 a year in U. S. A.—\$5.00 in foreign countries

**STUPAKOFF INSULATORS**



STUPAKOFF LABORATORIES, INC. PITTSBURGH, PA.

**MACHINES and ACCESSORIES**

FOR MAKING INCANDESCENT LAMPS  
 NEON RADIO TUBES  
 ELECTRODES IN ALL SIZES  
 ELECTRIC SPOT AND BUTT WELDERS  
 ELECTRONIC TUBES  
 NEON LUMINOUS TUBES

WE INVITE YOUR INQUIRIES ON THE ABOVE EQUIPMENT  
**EISLER ENGINEERING CO.**  
 747 SOUTH 13TH STREET NEWARK, N. J.



## HEARING AIDS

FOR CHURCHES  
and AUDITORIUMS



A.C. Operated  
Loud Speakers  
for Remote  
Rooms.  
\$17.50 Each

PAC-7-H Includes Amplifier, Microphone, 6 phones and out-  
let boxes with volume controls. Capacity 50 phones.

PRICE COMPLETE \$150.00

### Sound Systems, Inc.

1311 TERMINAL TOWER CLEVELAND, OHIO

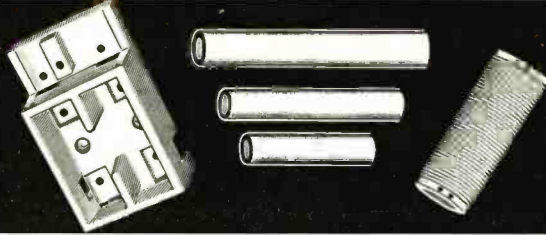

CONSULT COLONIAL for correct electrical porcelain. When  
you are considering some new shape of porcelain insulator or  
a new source of supply, send us your blue-prints, sketches or  
samples. Prompt service on inquiries and orders for any porcelains  
in wet, dry or cast process — glazed or unglazed.

THE COLONIAL INSULATOR CO., Akron, Ohio  
CHICAGO OFFICE—1800 GRACE ST.  
Telephone—Graeland 0486

## APPLIED ACOUSTICS

By  
H. F. OLSON, E.E., Ph.D. and F. MASSA, B.S., M.Sc.  
*Acoustical Research Engineers, RCA-Victor Co., Inc.*

444 Pages 228 Figs. Fabrikoid \$4.50

A modern book on the theory, design, construction, operation and  
analysis of modern acoustical and electro-acoustical apparatus. In-  
cludes analyses of rooms, studios, theatres and operation of loud  
speakers (in cabinets, baffles and horns) and microphones in these  
environments; oscillator and amplifier design, audio-frequency meas-  
urements, magnetic circuit design, acoustical measurements, etc.

### P. BLAKISTON'S SON & CO., INC.

1012 WALNUT STREET, PHILADELPHIA

## • WAXES

## • COMPOUNDS

## • VARNISHES

For Insulation of Condensers

Transformers, coils, power packs, pot heads, sockets,  
wiring devices, wet and dry batteries, etc. Also  
WAX SATURATORS for braided wire and tape.  
WAXES for radio parts. Compounds made to  
your own specifications if you prefer.

### • ZOPHAR MILLS, INC.

FOUNDED 1846 MEMBERS OF N.R.A.  
Court, Lorraine and Creamer Sts., Brooklyn, N. Y.

## LAMINATIONS

for Audio & Power Transformers  
SPECIALIZED METHODS — YEARS OF EXPERIENCE  
Wide Variety of Stock Standard Sizes  
*Dimension and Price Sheets on request*  
We Also Make  
PERMANENT MAGNETS—DIES—TOOLS—  
METAL STAMPINGS  
*Facilities for prompt service*

### Thomas & Skinner Steel Products Co.

1100 to 1120  
E. Twenty-Third St.  
INDIANAPOLIS, IND.

## CANDOHMS

ARMoured WIRE WOUND RESISTORS  
WILL LOWER YOUR COSTS  
OVER EIGHT MILLION IN USE  
MAY WE SAMPLE AND QUOTE

### THE MUTER COMPANY

1255 So. Michigan Ave., Chicago

## INDEX TO ADVERTISERS

<b>A</b>	<b>G</b>	
Allen-Bradley Co. .... 6	Gates Radio & Supply Co. .... 32	Sound Systems, Inc. .... 30
American Electro Metal Corp. .... 32	Goat Radio Tube Parts, Inc. .... 5	Stupakoff Laboratories, Inc. .... 29
<b>B</b>	<b>H</b>	Synthane Corp. .... Back Cover
Blakiston's Son & Co., Inc., P. .... 30	Hotel Lincoln .... 31	<b>T</b>
Biley Electric Co. .... 29	<b>L</b>	Thomas & Skinner Steel Products Co. .... 30
Brush Development Co., The. .... 29	Littelfuse Laboratories. .... 29	<b>U</b>
<b>C</b>	<b>M</b>	United Pressed Products Co. .... 29
Callite Products Co. .... 32	Muter Company, The. .... 30	<b>V</b>
Claro-stat Mfg. Co., Inc. .... 1	<b>R</b>	Voice of the Air Co. .... 29
Colonial Insulator Co., The. .... 30	Racon Elec. Co., Inc. .... 32	<b>W</b>
<b>E</b>	Railway Express Agency, Inc. .... 3	Weston Elec. Inst. Corp. .... 5
Eisler Engineering Co. .... 29	<b>S</b>	White Dental Mfg. Co., The S. S. Third Cover
Engineering Co., The. .... 29	Shakeproof Lock Washer Co. .... 3	<b>Z</b>
		Zophar Mills, Inc. .... 30



# OFFICIAL HOTEL HEADQUARTERS

*for the*



## NATIONAL ELECTRICAL EXPOSITION *September 19 to 29*

MADISON SQUARE GARDEN • NEW YORK

Only four short blocks to the Lincoln Hotel, official headquarters for the exposition, and one of New York's newest and largest hotels.

*See our display at Booths Number 218 and 219... next to the broadcasting studios on Exposition floor*

**\$250**  
SINGLE

**\$350**  
DOUBLE

**TWO ROOM SUITES FROM \$7.00**

1400 outside rooms, each with bath and shower, cabinet radio and servidor...PLUS all the advantages of a **4 STAR HOTEL IN NEW YORK**



**FOR BUSINESS...**One block to Broadway and Times Square, 3 blocks to Fifth Avenue and eight minutes to Wall Street.



**FOR DINING...**Three fine restaurants...the coffeeroom, the main dining room (with dancing) and the Tavern Grill.



**FOR RECREATION...**Sixty-nine theatres within six blocks. Express subway to Polo Grounds and Yankee Stadium.



**FOR QUIET SLEEP...**High above the noisy clatter of the street, our 32 stories of fresh air and sunshine assure you quiet rest.

*Hotel*

JOHN T. WEST  
*Manager*  
FRANK W. KRIDEL  
*Managing Director*



# LINCOLN

44TH TO 45TH STREETS AT 8TH AVENUE • NEW YORK

—ELMET—  
**MOLY**



FOR  
**GRID WIRES**  
**SUPPORT WIRES**  
**ELECTRIC FURNACE  
HEATING ELEMENTS**  
ALSO FOR  
**SCREEN GRIDS--CATHODE COILS  
MANDRELS--CONTACTS, ETC.**

ALL OF THE ABOVE PRODUCTS MAY  
BE HAD IN VARIOUS COMPOUNDS OF  
**MOLYBDENUM-TUNGSTEN**



*Write for Information and Prices*

**American Electro Metal Corp.**  
Lewiston Maine

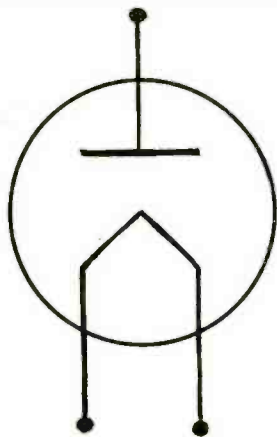

**RECTIFIERS**

GATES has made a special study of practical rectifier problems. We invite your inquiry on rectifiers for filament supply, low voltage speech amplifier supply, microphone pre-amplifier supply, bias supply and high voltage transmitter supply.

**Gates Radio & Supply Co.**  
MANUFACTURING ENGINEERS  
QUINCY, ILL., U. S. A.



**RACON  
P. A. HORNS**

*Include* more than 35 individual types from the standard 3½ ft. Trumpet to the Multiple Unit Aeroplane Horns. This special Unbreakable Trumpet Horn, illustrated, is for use where high-quality is desired but where considerable handling and extreme abuse is present.

All RACON HORNS are made of the patented RACON NON-VIBRATORY ACOUSTIC CLOTH, with cast all-aluminum tone-arms, heavy metal-beaded edge, metal suspension rings and loose-couplings for unit attachment. All RACON HORNS can be supplied in the STORMPROOF type, an exclusive RACON development, guaranteed to withstand the most severe atmospheric and climatic conditions.

*Write  
Dept. R. 8  
for  
complete  
bulletins.*

**RACON ELECTRIC CO. INC.**

52 East 19th St., New York, N. Y.  
London, Eng. Toronto, Can.

**KULGRID WIRE**

... for Grids, round or flat ...

**KULGRID "C"  
TUNGSTEN WELDS**

... for Power Tubes ...

**TUNGSTEN  
MOLYBDENUM**

... Rod-Sheet-Wire ...

**TUNGSTEN CONTACTS**

... all types for all purposes ...

*Write for Literature*

**CALLITE  
PRODUCTS DIVISION**

UNION CITY NEW JERSEY

# Nearly 100% of all Auto Radios are equipped with S. S. WHITE

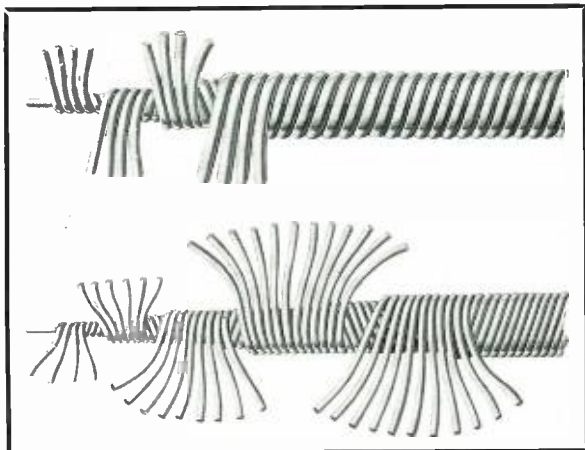

The S. S. WHITE REMOTE CONTROL Shaft should not be confused with the conventional flexible shaft. The difference in construction is illustrated above. REMOTE CONTROL Shaft No. 150L53, shown in the lower illustration, has 5 layers of steel wires. Note the number of wires in each layer—a total of 43 for the complete shaft. This construction was originated by S. S. WHITE for remote control applications.

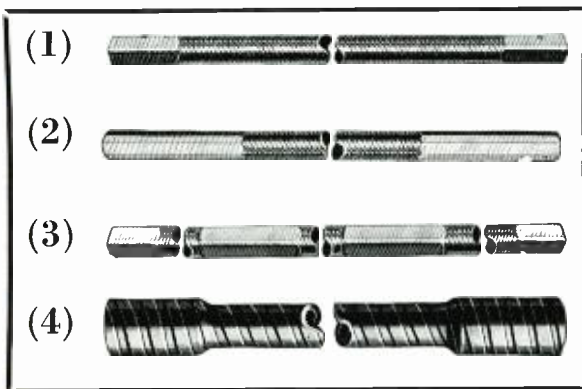

- (1) Shaft with square swaged ends (S.S.W. Patent)
- (2) Shaft with octagonal swaged ends (S.S.W. Patent)
- (3) Shaft with intermediate swages for cutting to length in the field (S.S.W. Patent)
- (4) Casing with enlarged ends (optional) permits attaching large end fittings to the shaft (S.S.W. Patent)

## REMOTE CONTROL FLEXIBLE SHAFT No. 150L53

The reasons back of the overwhelming preference for this shaft are clear cut. The main reason is that it is the flexible shaft which adequately meets the special requirements of remote control of radio. And it meets them because it was specifically developed for the application.

It combines the three essential characteristics: (1) minimum torsional deflection under load; (2) equal deflection when turned in either direction; (3) ample flexibility for free operation when bent in curves of small radius.

The fact is that when properly applied, this shaft provides tuning that is as smooth, effortless and sensitive as a direct connection. This holds true even in long lengths, giving unlimited latitude in the placing of the receiver.

To go with this shaft S. S. WHITE developed the sturdy metallic casing (No. 170A1) only .255" outside diameter, the combination permitting a neat, unobtrusive, wholly satisfactory installation.

### WRITE for SAMPLES

Samples of both shaft and casing will be supplied to manufacturers of radio sets and separate controls on request. No obligation.

### ENGINEERING COOPERATION

Our engineers have a broad auto radio experience. They are prepared to assist in working out the details of any specific application. Put your problems up to us.



**The S. S. WHITE Dental Mfg. Co.**  
**INDUSTRIAL DIVISION**  
152-4 West 42nd St. New York, N. Y.  
FLEXIBLE SHAFTS FOR ALL PURPOSES



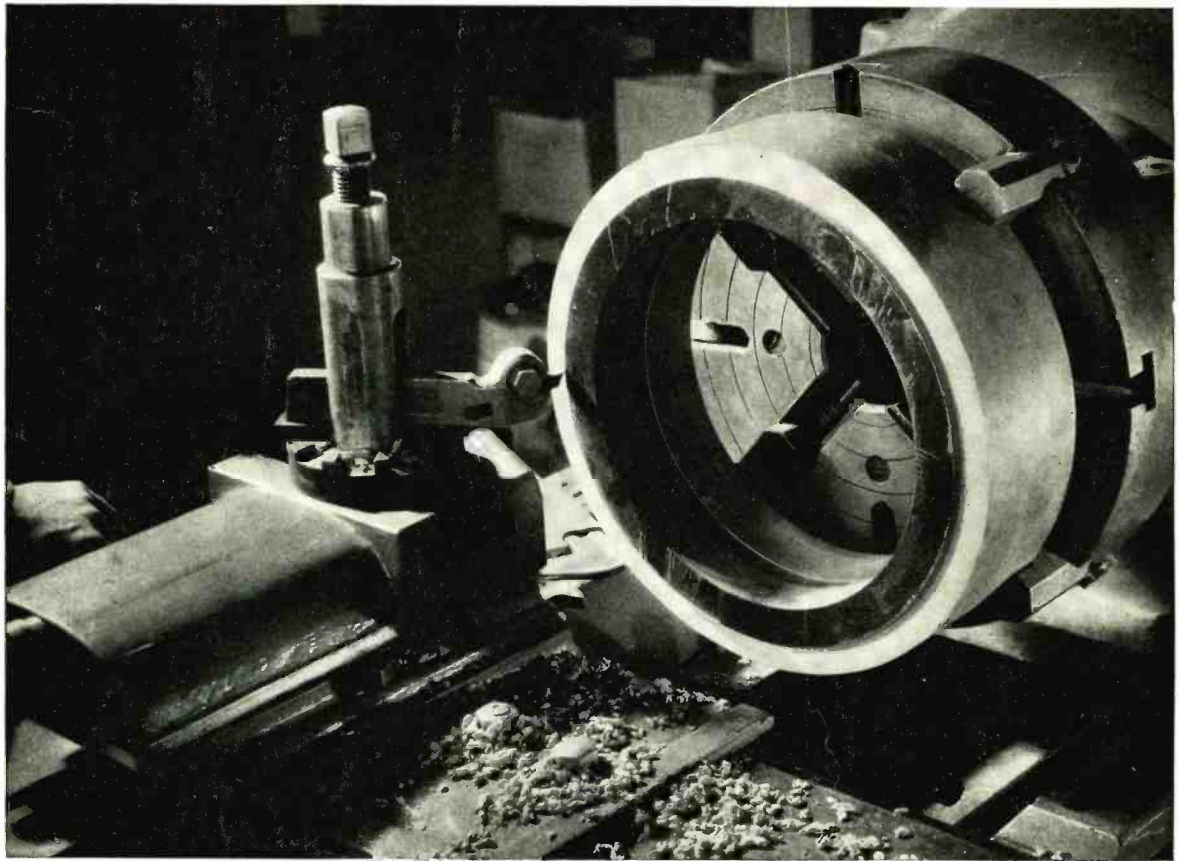

**G**OOD machining qualities, uniform physical and electrical properties are all combined in Synthane laminated bakelite. It is a valuable material for many mechanical and

electrical applications. And it has in back of it Synthane service which assures co-operation in meeting requirements promptly and exactly. Samples for testing sent free on request.

---

**LAMINATED BAKELITE SHEETS · RODS · TUBES  
FABRICATED PARTS · SILENT STABILIZED GEAR MATERIAL**



**SYNTHANE**  
CORPORATION  **OAKS · PENNA**