

JUNE, 1934

# Radio Engineering

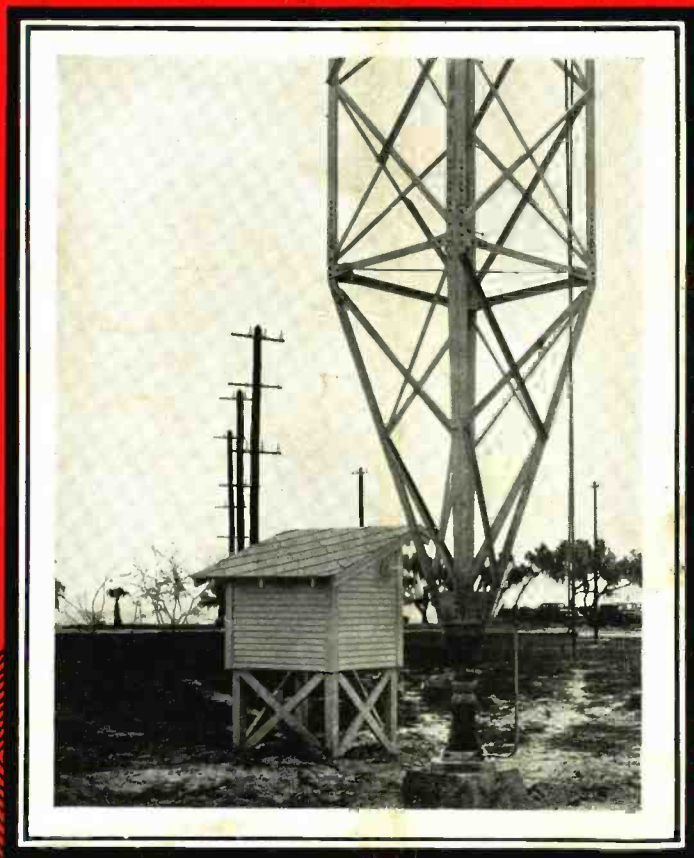
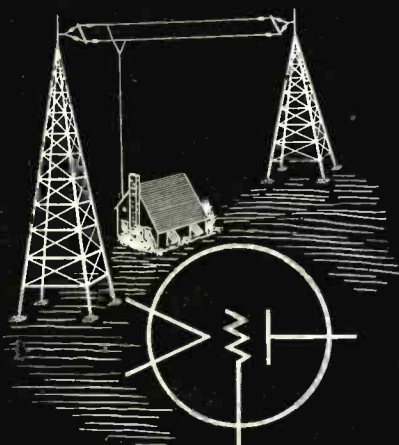

VOL. XIV

NO. 6



The Journal of the  
Radio and Allied Industries

# "Communication and Broadcast Engineering"



**covering the fields of:**

BROADCASTING  
TELEPHONE ENGINEERING  
TELEGRAPH ENGINEERING  
POINT-TO-POINT TRANSMISSION

Aeronautical  
Marine  
Police

CARRIER CURRENT TRANSMISSION  
COMMERCIAL RADIO  
FAC-SIMILE AND TELEVISION

Will be published monthly  
beginning October, 1934

NOTE — The circulation of *Communication and Broadcast Engineering* will be rigidly limited to approximately 5,000 leading executives and engineers connected with broadcasting and radio, wire and cable communication.

**Watch For Further Announcements!**

# Short-Wave Problems Spotlight

## the Superiority of

# SYNTHANE COIL FORMS



SYNTHANE COIL FORMS  
are furnished:



Cut



Cut and punched



Cut and threaded



Cut, threaded and punched



Internally threaded for stud mounting or in standard 18"—24"—36"—48" tubes. COLOR: Natural.

THE extreme selectivity required of short-wave receivers has caused many all-wave radio manufacturers to turn to SYNTHANE for coil forms.

Coil Forms, cut from SYNTHANE laminated bakelite, Grade XX, wrapped tubes, have extremely low moisture absorption, low power factor and high insulation resistance—the three indispensables for sharp tuning. Heat or humidity will not warp them. By the use of special measuring devices diameters are held to close tolerances, assuring uniform inductance.

SYNTHANE short-wave coil forms are made-to-measure; finished to the length, wall thickness and outside diameter to meet specifications.

**SYNTHANE**  
CORPORATION  OAKS · PENNA

**SHEETS · RODS · TUBES · FABRICATED PARTS**

# RADIO ENGINEERING

*Reg. U. S. Patent Office*

*Editor*  
M. L. MUHLEMAN

*Member*  
*Audit Bureau of Circulations*

*Associate Editor*  
RAY D. RETTENMEYER

Vol. XIV

JUNE, 1934

Number 6

## CONTENTS

	PAGE
COVER ILLUSTRATION	
ONE OF THE TWIN VERTICAL RADIATORS AT WFLA	
EDITORIAL .....	4
SHARED CHANNEL BROADCASTING..... <i>By Charles B. Aiken</i>	7
TRACKING PROBLEMS IN ALL-WAVE SUPERHETERODYNES	
<i>By Louis Martin</i>	11
DIRECTIONAL BROADCASTING..... <i>By Raymond M. Wilmotte</i>	12
BOOK REVIEWS.....	14
PRIMARY FREQUENCY STANDARD..... <i>By J. G. Beard</i>	15
DRY ELECTROLYTIC CONDENSERS..... <i>By R. J. Covert</i>	18

## DEPARTMENTS

NOTES AND COMMENT.....	20
A CHRONOLOGICAL HISTORY OF ELECTRICAL COMMUNICATION—TELEGRAPH, TELEPHONE AND RADIO—PART XXV	23
NEWS OF THE INDUSTRY.....	24
NEW PRODUCTS.....	25
INDEX OF ADVERTISERS.....	30

## IMPROVED OUTLOOK

ACCORDING TO *Standard Statistics Co., Inc.*, the profit outlook in the radio industry has improved, largely because of the trend toward diversification of products. Many concerns, it is stated, are now deriving the larger part of revenues from the sale of automobile accessories, electrical refrigerators, etc.

Competition in the home receiver field is still intense. Constant liquidation of distress merchandise is a somewhat unsettling factor, although efforts of the NRA have alleviated this condition to some extent. Following the wave of popularity of the midget sets, most radio concerns are now concentrating on the all-wave receiver, which provides a greater margin of profit, and on the automobile radio, for which a greater volume of sales is expected for 1934 than for the previous year. Demand for these sets has permitted the maintenance of a relatively stable price structure.

BRYAN S. DAVIS  
*President*

JAS. A. WALKER  
*Secretary*

*Published Monthly by the*  
**Bryan Davis Publishing Co., Inc.**  
19 East 47th Street  
New York City

SANFORD R. COWAN  
*Advertising Manager*

A. B. CARLSEN  
*Circulation Manager*

Chicago Office—919 N. Michigan Ave.—L. F. McClure, Mgr.  
Cleveland Office—10515 Wilbur Ave.—J. C. Munn, Mgr.  
San Francisco Office—155 Sansome St.—R. J. Birch, Mgr.

Los Angeles Office—846 S. Broadway—R. J. Birch, Mgr.  
St. Louis Office—505 Star Bldg.—F. J. Wright, Mgr.  
Wellington, New Zealand—Tearo Book Depot.  
Melbourne, Australia—McGill's Agency.

Entered as second class matter August 26, 1931, at the Post Office at New York, N. Y., under Act of March 3, 1879. Yearly subscription rate \$2.00 in United States. \$3.00 in Canada and foreign countries.

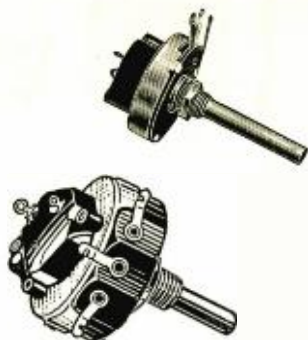
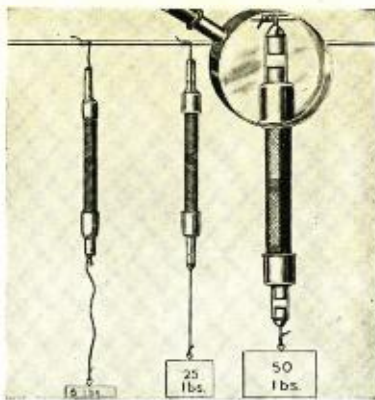

# CLAROSTAT'S NEW RESISTOR and VOLUME CONTROL LINE Will Solve Your Special or Mass Production Problems

## LINE RESISTORS

**EXTERNAL TYPE:** These line reducing resistors are equipped with both male and female plugs in five varying combinations, are especially suitable for the export market and designed to reduce line voltage.

**INTERNAL TYPE:** This line of fixed resistors has been designed especially for use in reducing the voltages of 110 volts and 220 volts DC line, to the values required by the filament circuit of receivers. These new units eliminate the necessity of using protective housings over such resistors. They readily mount into standard tube sockets and operate at lower temperatures due to their efficient design.

## VOLUME CONTROLS

**WIRE WOUND TYPE:** For years leading receiver manufacturers have employed our units because they are manufactured carefully to the specifications set for them and are reliable, compact, rugged and include an ample safety factor. Only the finest quality materials are used. Recent improvements in design and manufacturing facilities permit us to offer better controls than ever before.

**COMPOSITION ELEMENT TYPE:** Our new series of composition element volume and tone control rheostats and potentiometers, embodies an improved and time tried resistance element which is immune to humidity and contact erosion. These controls are available in various resistance gradients.

## FLEXIBLE RESISTORS

**FLEXIBLE RESISTORS:** We have just perfected a new series of flexible resistors of superior quality at prices competitive with carbon resistors. In design they are trim. In accuracy, the commercial tolerance is maintained at  $\pm 10\%$ . In ruggedness and tensile strength, their new design permits them to exceed manufacturers requirements from 250% to 500%. The R.M.A. color code for resistance values is used throughout. Production facilities permit unlimited quantities on short notice.

**METAL CAN RESISTORS:** Our complete line of asbestos covered, enclosed in metal can resistors may be had in straight resistors, tapped resistors and in many other varieties. They are so constructed to mount flush to the chassis; or raised off the chassis to your specifications; or upright mounting position; the entire height not exceeding the height of the radio set's tubes.

*We solicit inquiries on mass production or special resistor problems, for radio, sound, communication or industrial application.*

NEW CONTROL REPLACEMENT GUIDE UPON REQUEST



## CLAROSTAT MFG. CO., Inc.

285 North 6th Street

Brooklyn, N. Y.

*"AD-A-SWITCH" was originated by Clarostat*



# EDITORIAL

---

## PRIORITY

---

SOME YEARS AGO there lived in Greenwich Village—that section of New York City populated by the purveyors of art—a Countess of tender age and pleasing appearance. It was her habit to appear in the streets wearing a large picture hat bedecked with an assortment of vegetables. Because of this mild but rather peculiar weakness, she was commonly referred to as “The Crazy Countess.”

It is well worth noting that the Countess was the acme of immaculateness and wore fresh vegetables each day. No one could remark that she looked ratty, and since her tastes were otherwise above reproach, she was left to her fancy and lived in peace.

A similar case occurred recently, and was reported in the magazine *The New Yorker*. We quote in part:

“On the west side . . . there was seen a young woman in a chic black tailleur. She was walking alone, and didn’t look as though she wanted to be conspicuous. As a matter of fact, she wasn’t; practically nobody seemed to notice that the green boutonniere pinned to her jacket wasn’t mignonette, as it should have been; practically nobody seemed to notice that it was broccoli instead.”

Unquestionably this is the report of a rather clever young lady who is fighting the depression with her head up. The point we wish to emphasize is the statement that mignonette should have been worn.

To most of us, well grooved by custom and made sluggish by habitual actions, it appears not only odd but quite uproarious that anyone should employ edibles for the purpose of personal decoration—yet it cannot be denied that some vegetables have a beauty all their own. The fact that we eat the things appears to add humor to their appearance when used as adornment.

Quite often we refer to “custom” when we really mean “priority.” Should a Prince

meet a Princess wearing a corsage of broccoli and thereupon lean over and take a nibble, quite probably the next day would see the “custom” repeated by every deb and social blade intent on being correct. Any folly becomes the fashion once it has been established by authority. It’s a case of priority.

This same priority plays mean tricks with engineers, as it does with people in all walks of life. But it is particularly mean where exact science is a factor. Someone whose authority appears unquestionable establishes an axiom and from that time on no one thinks of questioning its validity. More often than not these axioms are not established by authority at all, but spring up from the Lord knows where. Thus the most astounding misconceptions become supposed fact merely because they have been let loose in the remarkable grapevine telegraph system we operate.

At one time it was believed that the radio frequencies above 1500 kilocycles were useless for the purpose of communication. No one had tried them but it was supposed that they were useless. It therefore became the custom to believe this; first, because it was convenient to do so; second, because *not* to believe it was to question priority. It was believed at one time that types of iron and steel were unsuited for radio-frequency shielding, due to losses introduced. Today it is being used for this purpose and appears to have distinct advantages. It is still believed by many engineers that no *good* all-wave superheterodyne receiver can be designed without one or two radio-frequency stages preceding the mixer, yet many engineers seem to be questioning this belief.

Customs should not exist in the engineering field. We can continue to frown on vegetables as personal decoration, but we shouldn’t be too rigid in our engineering beliefs. It is only through the disbelief of the correctness or the constancy of axioms that engineering progress is made. Pessimism of a constructive nature is a valuable asset to any engineer. Don’t always be too sure that the other fellow is right; he may be—but he may have heard it from someone else.

**SHAKEPROOF**

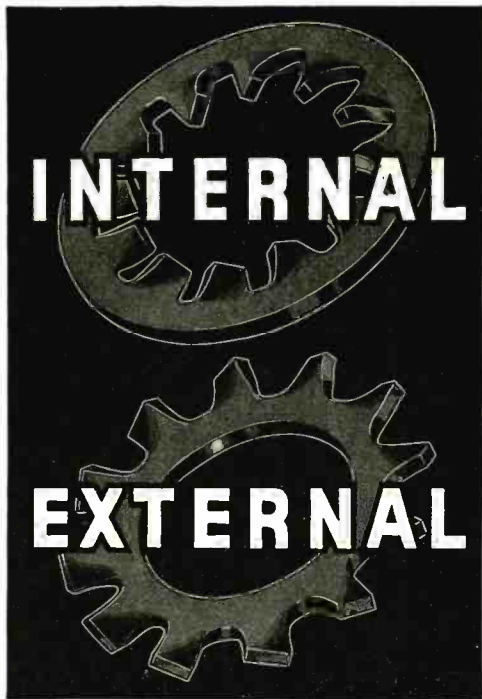

**A TYPE and SIZE FOR Every APPLICATION**

It pays to standardize on Shakeproof for you not only are certain of thorough protection against Vibration—but you can be sure of always getting the size and type of lock washer you need. External or internal—they both give you a perfect lock and are available for your selection in whatever size you require. Here's the sure way to end your worries over locking problems—specify Shakeproof under every nut and screw. Then you'll see your product giving better performance and standing up under any kind of treatment. Dictate a request for testing samples today!

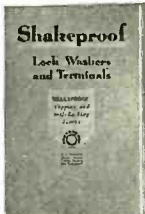

Send today for your free copy of this complete Shakeproof Catalog. Explains thoroughly the many advantages that Shakeproof offers—also shows new patented Shakeproof products.

*"It's the Twisted Teeth that LOCK!"*



**SHAKEPROOF Lock Washer Company**

*Distributors of Shakeproof Products  
Manufactured by Illinois Tool Works*

2509 N. Keeler Ave.

Chicago, Ill.



U. S. Pat. 1,419,564—1,604,122—1,697,954—1,782,387—Other Pat. Pending—Foreign Pat.

**USE the ✓ GOAT CHECK-UP**  
in getting to the bottom of your design and performance problems

In the troubles listed below you will recognize those which are often the most difficult to overcome in all types of radio receivers. Study this list carefully and then check off those which you want to correct.

- Oscillation
- Magnetic Interference
- Electrostatic Interference
- Insecure Shielding
- Difficulties in Replacing Tubes Because of Shielding
- Space Limitations Because of Shielding
- Cost of Shielding
- Sales Appeal Due to Appearance
- Other Factors Which Affect Performance, Assembly or Design



When you have made your check-up, write to Goat engineers, outline your troubles and ask them for suggestions.

Goat does not make a general claim to solve all these troubles under all conditions through the use of GOAT FORM-FITTING TUBE SHIELDS; GOAT SHIELDS have, however, been successful in eliminating all these difficulties in specific cases.

Perhaps GOAT FORM-FITTING TUBE SHIELDS will be the answer to your troubles. Certainly the possibility of a solution warrants your trying them out. We'll gladly send samples and instructions for such a trial.



*If you haven't already received your copy of the new GOAT Engineering Bulletin, fill in the coupon and mail today.*

**GOAT RADIO TUBE PARTS, Inc.**  
314 Dean St., Brooklyn, N. Y.

GOAT RADIO TUBE PARTS, Inc.  
314 Dean St., Brooklyn, N. Y.

Gentlemen:—Kindly send me a copy of your new engineering bulletin covering GOAT FORM-FITTING TUBE SHIELDS.

NAME .....

POSITION .....

COMPANY .....

ADDRESS .....



**1 NOISE TEST**—This test, made in a shielded chamber that eliminates external interference, reveals defects in internal resistor structure that cause noisy resistors. The accurately controlled Allen-Bradley processes result in such uniformity that quiet resistors can be consistently guaranteed.



## 4 ALLEN-BRADLEY TESTS that guarantee resistor uniformity

Uniformity is a vital characteristic of good resistors. Only through uniformity can defective units be eliminated.

Moreover, uniformity of characteristics, such as the changes due to load, humidity, and long use permit designers to develop new receivers with the assurance that all sets delivered from the production line will be consistent in quality and performance, even after long use.

Allen-Bradley Resistors, made under continuous laboratory control, are of such exceptional uniformity that they are the choice of the leading manufacturers of fine receivers. Build quality into your receivers by specifying Allen-Bradley Resistors.

**ALLEN - BRADLEY CO.**  
126 W. Greenfield Ave., Milwaukee, Wis.

**2 LOAD CHARACTERISTIC**—This test determines the effect of load and temperature on Allen-Bradley Resistors. Although resistance changes as high as 10% are tolerated by set manufacturers, Allen-Bradley units change less than 2% on low values and 3% on high values. Individual resistors adhere closely to these group values—erratic behavior is non-existent.

**3 HUMIDITY TEST**—This test, made after the R.M.A. method, determines the effect of moisture. Allen-Bradley limits of permissible resistance change are far below the usual limits, and in addition, Allen-Bradley Resistors vary consistently as a group. Individual resistors do not suffer erratic changes.

**4 LIFE TEST**—Continuous and cycle tests following R.M.A. methods are made at various loads as a check on the uniformity of Allen-Bradley Resistor performance under conditions which occur in radio receivers. In these life tests, Allen-Bradley Resistors demonstrate their stability in long service.





# RADIO ENGINEERING

FOR JUNE, 1934

## Shared Channel Broadcasting

By CHARLES B. AIKEN • BELL TELEPHONE LABORATORIES

THERE ARE AT present a large number of broadcast channels which are shared at night by two or more North American stations, and which are therefore affected, in varying degree, by troublesome interference. The general nature of this interference is all too well known and the ease with which it may be found at many places on the dial of almost any radio receiver is proof of its importance.

### TYPES OF INTERFERENCE

In listening on various shared channels during the evening hours, the observer will notice several types of interference. A heaving sound may be heard which is frequently extremely annoying and which, in some cases, will be much the most prominent form of interference. At other times, or on other channels, undesired speech or music will be the chief indication of the presence of the remote station. Or again, an impairment in the quality of the desired program may be noted. This will appear in some cases as a sort of tremolo and in others as a roughness or harshness. On rare occasions a low-pitched growl or hum may be heard. It is the purpose of this paper to discuss these various forms of interference and to give some quantitative data concerning them, especially the "flutter" effects.

First let us divide the interference into four classes as follows:

1. An audible heterodyne beat-note.
2. Fluttering or heaving effects.
3. Sideband interference.
4. "Wobbling" or roughness of the desired program.

### TYPE ONE

Interference of type 1 was at one time by far the most serious of the four, but since the advent of the fifty-cycle ruling of the Radio Commission, and the consequent widespread use of precise fre-

quency control equipment, audible notes due to the beating of two carriers have become much less important. Many stations now maintain their assigned frequency to within a few cycles, and the beats to which they give rise are not of an audible frequency. A beat having a frequency of 100 cycles would be possible without violation of the Federal regulations if each station deviated from its assignment by the maximum allowable amount and in opposite directions, but such occurrences are rare.

### TYPE TWO

This type depends for its prominence upon the existence of an appreciable noise background in the output of the receiver. This noise may be due to natural or man-made static or to electrical disturbances, such as thermal agitation, in the input stage of the radio set. The rising and falling of this noise at the frequency of the beat between the carriers produces an effect which readily attracts the unfavorable attention of the listener. For a given ratio of the two carriers and a given noise level, the intensity of this effect is greater if the receiver has AVC, or manual gain control and a low-level (square law) detector, than if it has manual control and a linear detector. The reasons for this

dependence of the effect upon the type of detector and upon the sort of gain control will be discussed presently. The flutter is also more prominent with a wide-band receiver than with a narrow one.

A theoretical examination of the nature of flutter interference yields some interesting information which is borne out by experimental studies. Let us consider a radio receiver which embodies manual gain control and assume, for purposes of analysis, that there are impressed upon the detector a single frequency component of noise and two incoming carriers one of which is of considerably smaller amplitude than the other. Let it be further assumed that the difference in frequency between the carriers is only a few cycles per second, less than 100 in any case, and that the noise component differs from the stronger carrier by an audible frequency.

If the receiver is equipped with a square-law detector, the audio-frequency noise output, which is due to the beat between the r-f noise frequency and the strong carrier, will rise and fall as the weak carrier swings alternately into and out of phase with the strong one. The two carriers may be considered as being combined into a single wave of slowly

- Dealing with the experimental studies made on the character and causes of interference noticeable in shared channel broadcasting, such as heterodyning, flutter, sideband interference and wobbling. Valuable data is included on the characteristics of square-law and linear detectors anent to interference.

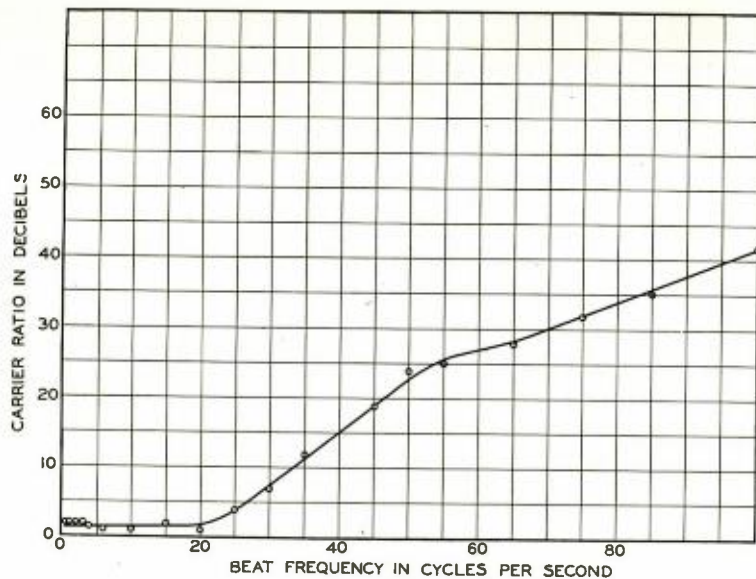

Fig. 1. Carrier ratio at which flutter is just perceptible with a linear detector. Noise equivalent to 9.5 per cent modulation.

varying amplitude, and, since the output of a square-law rectifier is proportional to the product of the carrier and side frequency impressed upon it, it follows that the audible output should vary, or "flutter" up and down, with the amplitude of the total effective carrier. There are many factors which may contribute to making this flutter noticeable, but it seems reasonable to assume that, for a given frequency band width, the most important one should be the percentage variation in the noise level. Or put in another way, the flutter effect should be determined largely by the ratio of that portion of the output noise which varies at the carrier beat frequency to the portion which is of constant level. Experimental studies have shown that this assumption is well founded.

**MATHEMATICAL ANALYSIS**

Proceeding on the foregoing hypothesis, it is a simple matter to show that the ratio of the variable to the steady portions of the output noise is given simply by the ratio of the amplitude of the weak carrier to that of the strong. We shall call this ratio the "flutter factor" and denote it by  $F_Q$ , the subscript indicating the quadratic, or square-law, detector.

$$F_Q = e/E = K, \tag{1}$$

$K$  being the carrier ratio. It is interesting to note that  $F_Q$  is independent of the amplitude of the incoming radio-frequency noise. Of course this can be true only within limits. If the noise output is of such low level as to be entirely inaudible,  $F_Q$  will not only fail to

obey the law expressed by (1) but will cease to have any significance whatever. However, over a wide range of noise levels (1) is valid even when the incoming disturbance has many frequency components.

From a mathematical analysis which was given some time ago\* it is possible to derive a similar expression for the linear detector. The result is:

$$F_L = \frac{Ne}{4E^2} = \frac{kK}{4} \tag{2}$$

In this expression  $N$  is the amplitude of the single component of noise which

we have assumed to be impressed upon the detector, and  $k = N/E$ .

It is evident that the flutter will be more serious with the quadratic than with the square-law detector by the factor  $4/k = 4E/N$ . If reception is to be at all tolerable,  $E$  will be much larger than  $N$  and hence it is evident that the linear rectifier should be very much less affected with flutter interference.

$F_Q$  and  $F_L$  do not tell us the noise levels or the carrier ratios at which the flutter is audible. These depend upon physiological and psychological factors as well as upon the noise field and carrier ratio. Thus the dependence of flutter effect upon band width is connected with the fact that some noise frequencies are more annoying to the observer than are others. But  $F_Q$  and  $F_L$  do show important differences between the two types of detectors, and give useful information as to how the flutter changes with noise intensity and with the relative strengths of the two carriers.

The comparative freedom from flutter effects which has been noted in the case of the linear detector may be regarded as due to the fact that the audio-frequency output of such a detector is independent of carrier amplitude over a wide range. If automatic volume control is used in the receiving set, the amplitude of the carrier wave will be maintained practically constant at the input terminals of the detector. If the effective carrier amplitude impressed upon the antenna undergoes a periodic fluctuation, due to very low frequency heterodyning between the two stations, the gain of the radio-frequency amplifier will undergo cyclic variations in order

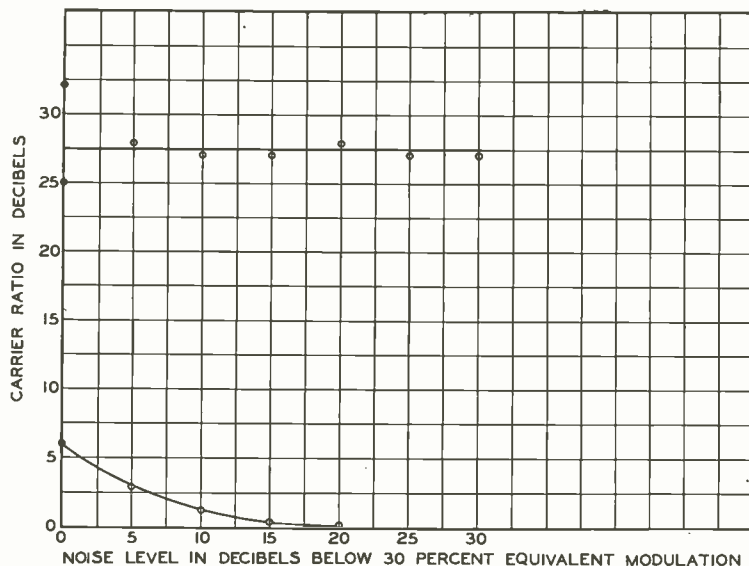

Fig. 2. Carrier ratio for perceptible flutter. Upper curve for a square-law detector and lower curve for a linear detector.

\*"Theory of the Detection of Two Modulated Waves by a Linear Rectifier," C. B. Aiken, Proc. I.R.E., 21, 4, pp. 601-629, April 1933.

to keep the carrier constant at the rectifier. Obviously this will cause a fluctuation in the amplitude of the sidebands, be they due to noise or program.

From this it is evident that, on the one hand, flutter effects in the presence of a noise background will usually be of minor importance if a good linear rectifier is employed in conjunction with a manual volume control; while on the other hand, these effects may become extremely objectionable if automatic volume control is used. Since the latter type of control is in widespread use, the low flutter possibilities of the linear detector cannot be so utilized as to reduce the importance of flutter interference on shared channels.

If the carrier beat frequency is of the order of 10 to 30 cycles, where the ordinary AVC begins to lose its controlling action, some intermediate effect may be expected. The operation will be further complicated by the time delay in the filter included in the AVC circuits, which may have a considerable effect on the flutter.

With other types of detector the gain control will have different effects. The general tendency will be to make the flutter worse than if manual control were used, but exceptions to this are possible. Even with a square-law detector, which already shows so troublesome a flutter, the effect may be made worse at certain beat frequencies.

#### EXPERIMENTAL STUDY OF THE EFFECTS OF A NOISE BACKGROUND

A laboratory investigation has been made which confirms the foregoing theoretical predictions. In this study two unmodulated waves were impressed upon a receiver together with a controllable amount of radio-frequency noise. Both linear and square-law detectors were studied.

Since the modulations of the stations play no appreciable part in determining flutter effects, it was permissible to use unmodulated carriers. Of course the modulation of the stronger station tends to mask the flutter at times, but the interference is determined largely by what happens when the desired modulation is small or zero. Consequently, the quantity which was determined in the experiments was the ratio of unmodulated carriers which produced a just detectable flutter effect.

Thermal noise was furnished by a train of radio-frequency amplifiers which included a calibrated attenuator. With this arrangement it was possible to furnish an accurately known noise level to the input of the receiver.

Fig. 1 shows the results of measurements on a wide-band receiver employing a linear detector and manual gain control. The audio-frequency output band width of this receiver was ap-

proximately 7,000 cycles. The noise level, in this case, was equivalent to 9.5% modulation of the strong carrier. By this is meant that the audio-frequency output of the detector, due to the noise, was the same as that obtained by removing the noise and modulating the strong signal 9.5%.

It is interesting that, for beat frequencies of less than 20 cycles, the carriers must be very nearly equal before any flutter effect whatsoever may be detected. The right-hand portion of the curve is determined by the audibility of the beat-note, and its position will, of course, depend upon the masking effect of the noise background.

The theory has indicated that the flutter frequency portion of the curve should drop with noise level. To check this point a set of observations was made with a fixed carrier-frequency difference of 2 cycles and a variable noise level. The results are indicated in the lower curve of Fig. 2. With a noise level equivalent to 30% modulation, which is an intolerably high level, a carrier ratio of only 2:1 is required to reduce the flutter to a barely detectable amount. At most reasonable levels, the flutter is negligible.

#### THE SQUARE-LAW RECTIFIER

Observations similar to those just discussed were made with a square-law detector. In Fig. 3 the ordinates represent the carrier ratio necessary to reduce the flutter to a just detectable value, while the abscissae represent the beat frequency. The three curves are for different values of the noise level, the figure appended to each curve indicating the number of decibels below 30% equivalent modulation. It will be noted

that at the low beat frequencies a carrier ratio of 24 to 28 db is required to eliminate the flutter. This is in sharp contrast to the results for the linear rectifier which requires a ratio of only 1.5 db to achieve the same result.

The theory has indicated that in the case of the square-law detector the flutter effects, when not masked by the modulation of the strong signal, should be practically independent of noise level. The curves shown in the last figure bear out this prediction quite definitely. Even more definite confirmation is given by the upper curve of Fig. 2 which shows the result of observations taken with a fixed beat frequency of 3 cycles. A comparison of the results for the square law and the linear detectors, which is furnished by this figure, is interesting.

#### INTERFERENCE OF TYPE 3

When the noise level is low or absent, the program of the interfering station will be a serious source of trouble. At higher noise levels this program is to a certain extent masked by the general background. Consequently the relative importance of flutter effects and program interference depends upon the noise level.

To determine which type of interference is most serious, observations were made on the square-law detector with a strong unmodulated carrier and a weak modulated carrier (WABC) at a beat frequency of about 3 cycles. At a given noise level the carrier ratio was determined at which the undesired program was just audible. At the same noise level the carrier ratio for just detectable flutter was also determined, as in the earlier work. These determinations were made for band widths of 7,000 and

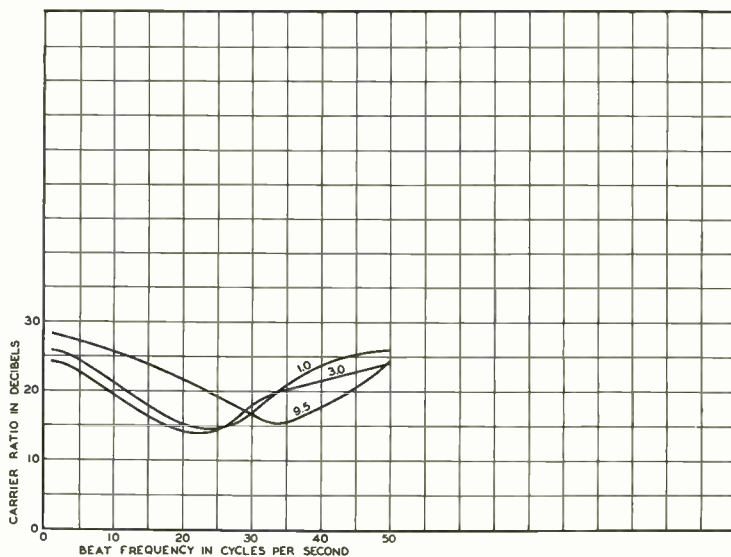

Fig. 3. Carrier ratio for perceptible flutter with a square-law detector. Various noise levels.

of 3,500 cycles. The band width caused no appreciable difference so far as the program interference was concerned, but had a pronounced effect upon the carrier ratio at which the flutter could be detected. The results are shown in Fig. 4. The round dots indicate observations on program interference, the square dots on the flutter effect at 7-kc band width, and the triangular dots on the flutter effect at 3,500-cycle band width. The solid sloping line is the average curve for the program interference.

It is evident that at noise levels below about 5% equivalent modulation the program interference can be detected at lower interfering carrier strengths than can the flutter, when the band width is 3,500 cycles. For the wider band this will be true only below 3%. For quite narrow bands the trend is in the opposite direction.

In obtaining this data points were taken when the interfering program could be heard on peaks of modulation. This meant that for a considerable portion of the time the program was inaudible, and consequently the annoyance caused by it was considerably less than that caused by the continuous flutter. In order to make up for this difference in character between the flutter and program interference, it is necessary to shift the program curve of Fig. 4 downward. Just how far it should be shifted is hard to say, as that will depend upon the character of the interfering program and upon the personal reactions of the observer, but observations have indicated that it should be moved downward at least 7 db. The dashed line indicates the translated curve. From this it is evident that with the narrower band the flutter will be more important at all noise levels above about 2% equivalent modulation. (The measurement of the noise level itself was made with wide band in all cases.) Of course, many listeners would use a still narrower band than this, particularly when listening to programs with a distinct noise

background, and this would lower the flutter effect line. Nevertheless, it is very interesting that at the higher noise levels the flutter may be considerably more important than the program interference.

In high quality areas this would never occur. That is, if the field strength from the desired station were high enough to make the noise level of little consequence, then the interfering station would make its presence known by program interference, and whether or not the carriers were exactly synchronized would make no difference. On the other hand, in outlying areas where a very poor quality of service is the rule rather than the exception, there is no doubt that programs are regularly listened to through a rather heavy noise background. In these regions the flutter may be responsible for much of the more serious interference and if the stations were synchronized this would disappear.

#### INTERFERENCE OF TYPE 4

The presence of the interfering carrier may cause trouble even when it is unmodulated and when the noise level is too low for flutter effects. The heterodyning of the desired carrier may cause a fluctuation in the level of the desired program which is quite unpleasant.

Observations made on this type of interference with a linear detector show that for ordinary speech and for jazz music a carrier ratio of 1 db practically removes perceptible distortion of the desired program. When the music contains many sustained notes, such as occur in a violin solo and even in vocal solos, the cyclic variations in output level are more noticeable, and about 4 db is necessary to reduce the distortion to the detectable limit. This high level of interference is practicable in this case because of the fact that the audio-frequency output of the linear rectifier is very nearly independent of the carrier amplitude.

With the square-law detector a carrier ratio of 10 db produced detectable distortion with almost any type of program on the strong carrier. At a ratio of 16 db distortion could be detected only when the program contained sustained notes. At 18 db it can be noticed in those containing notes which were sustained for a considerable time.

The above observations were made with manual gain control. A set employing automatic volume control may be expected to behave in the same general manner as the square-law detector with manual control.

#### CONCLUSIONS

From the data which have been reported it is possible to describe, in a fairly quantitative manner, the interference which occurs on shared broadcast channels. In order to predict what would happen at a given receiving point we need to know the carrier ratio and the noise level at that point.

If the noise level is negligible, the limiting interference will be due to the undesired program and the carrier ratio which is necessary will be of the order of 40 db, though just what value is required will of course depend upon the standards of excellence which are set up.

If there is a moderate noise level at the receiving point, program interference will still be the limiting factor but it will be masked to a certain extent by the background noise, and consequently a higher level of interfering carrier will be permissible. As the noise level increases, this masking effect will become more pronounced and consequently the program interference will become less important. However, if the interfering carrier is further increased a flutter will appear at a ratio of about 28 db, in the case of a wide-band receiver, at about 24 db for a receiver of 3,500-cycle band width, and at higher levels of interfering carrier with still narrower bands.

At very high noise levels the flutter will be the predominant form of interference, although if the interfering carrier is raised to about 15 db below the desired carrier there may also be distortion of the desired program. This distortion and the flutter effect could be eliminated by synchronization of the carriers of the two stations. This would unquestionably improve the service in certain outlying areas.

These conclusions apply to receivers employing automatic gain control but do not apply to those with a linear rectifier and manual control. In the latter case only the program interference is of importance. However, receivers which have well-designed linear detectors almost invariably have automatic volume control.

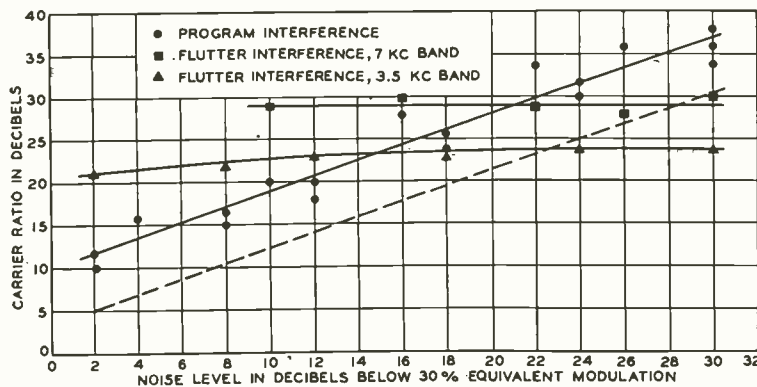

Fig. 4. Program interference and flutter interference as functions of noise level.

# Tracking Problems in All-Wave Superheterodynes

By **LOUIS MARTIN**

Technical Director

SHORT WAVE RADIO MAGAZINE

CONSIDERATIONS OF selectivity and sensitivity have led to the adoption of the superheterodyne as the more or less standard type of circuit for all-wave receivers. While the fundamental idea behind the all-wave super is identical with that behind the standard-band sets, nevertheless the wide frequency range that must be covered imposes severe limitations on circuit design. It is necessary, for instance, to cover the range from 20,000 to 1500 kc in at least three distinct bands using a constant intermediate frequency.

## MATHEMATICAL INTER-RELATIONS

The change from one band to another may be effected either by changing the tuning inductance or the capacitance, and, in some cases, both, although the inductance variation method is the one now in common use. This method gives rise to two different circuits which must be so related that the resonant frequency of one always remains at a constant frequency above the other. The first circuit is the signal circuit and is designated by the subscript *s*, while the second is the oscillator circuit, designated by the subscript *o*. The resonant frequency of both circuits are given by the equations

$$f_s = \frac{K}{\sqrt{L_s C_s}} \text{ and } f_o = \frac{K}{\sqrt{L_o C_o}} \quad (1)$$

in which  $K = \frac{1}{2} \pi$ .

The intermediate frequency,  $f_i$ , then equals

$$f_i = K \left( \frac{1}{\sqrt{L_o C_o}} - \frac{1}{\sqrt{L_s C_s}} \right) \quad (2)$$

provided  $f_o > f_s$ , which almost always obtains in practice.

Now, if both the oscillator and tuning condensers are identical, then  $C_o = C_s = C$ , and

$$\frac{C}{K} f_i = \frac{\sqrt{L_s C} - \sqrt{L_o C}}{\sqrt{L_o L_s}} \quad (3)$$

from which the equation relating the oscillator inductance to the signal tuning inductance is easily determined and equals

$$F_o = \frac{K^2 L_s}{C \cdot f_i^2 \cdot L_s + 2\sqrt{C} \cdot f_i \cdot K\sqrt{L_s} + K^2} \quad (4)$$

Substituting the left-hand equation of (1) in (4), we obtain

$$L_o = \frac{f_s^2 L_s}{(f_s + f_i)^2} = \frac{f_s^2 L_s}{f_o^2} \quad (5)$$

This equation gives the value of the oscillator inductance in terms of the signal circuit inductance and the i-f for a given signal frequency. The only limitation placed upon its use is that  $f_o > f_s$  and  $C_o = C_s$ .

Now, solving Eq. (3) for the intermediate frequency, we obtain

$$f_i = \frac{(\sqrt{L_s} - \sqrt{L_o}) K}{\sqrt{L_o L_s} \sqrt{C}} \quad (6)$$

which is the intermediate frequency used. If this i-f is obtained by making  $C_s = C_o$  at the highest frequency setting in the band, then it is desirable to know the value of the oscillator condenser setting, as the frequency is lowered in that same band, in order to maintain the i-f constant throughout the band. To determine this equation, let  $k = C_o/C_s$ . Then, from Eq. (3)

$$f_i' = \left( \frac{\sqrt{L_s} - \sqrt{L_o k}}{\sqrt{L_o L_s k}} \right) \frac{K}{\sqrt{C_s}} \quad (7)$$

in which  $f_i'$  is the intermediate frequency at any other frequency in the band other than that at maximum frequency. For the i-f to remain constant, then,  $f_i - f_i'$  must equal zero. Therefore, equating (6) and (7) and substituting Eq. (1), we obtain, after solving for  $k$

$$k = \frac{L_s}{\left(1 + \frac{f_i}{f_s}\right)^2 L_o}$$

from which

$$C_o = \frac{C_s L_s}{\left(1 + \frac{f_i}{f_s}\right)^2 L_o} \quad (8)$$

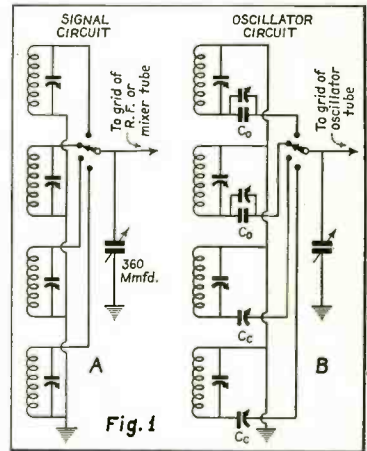

Signal circuit and oscillator circuit of a superheterodyne, showing use of series and shunt padders.

the value of  $C_o$  required to maintain the i-f, at any setting of  $C_s$ .

## WORKING EXAMPLE

These formulas are all that are required for the successful design of the padding circuit of an all-wave receiver. Suppose, for example, that an all-wave receiver is to be designed to cover the range from 20 to .5 megacycles, and let it further be supposed that the range from .5 to 1.5 megacycles is to be covered in a single span, as any standard broadcast receiver. Since a frequency ratio of 3 is demanded, then  $C_{max}/C_{min}$  must be 9. A 360-mmfd variable with a minimum of 40 mmfd will suit our purpose. This same condenser must also be used in the short-wave bands, so that with sufficient overlapping, the lowest-frequency band may cover from 1.5 to 4 megacycles, the intermediate band from 4 to 10 megacycles, and the highest frequency band from about 8 to 20 megacycles. Let us work out the

(Continued on page 22)

- The author has developed formulas with which it is comparatively simple to design the padding circuits of an all-wave superheterodyne receiver. A working example is provided.

# DIRECTIONAL

By  
**RAYMOND  
M.  
WILMOTTE**

DIRECTIVE ANTENNAE are practically as old as radio itself. In the early days of Hertz and Oliver Lodge, when experiments were limited to ultra-high frequencies (to which we have been returning in recent years) the intent was to show the analogy of these waves to light waves, i. e., reflection, refraction, interference, and resonance . . . resonance was the only phenomenon to be added to the list of the phenomena known to optics. All of these experiments by their very nature provided examples of directive antennae.

These directive antennae were soon lost sight of after the experiments of Marconi, which showed the tremendous practical possibilities of long-wave, high-power transmission. Years later, when it was discovered that short waves were just as good, if not better, directive antennae came into their own again. More recently they have entered the field of medium waves or the broadcast frequencies.

## WFLA INSTALLATION

In April, 1932, I erected a directive antennae for station WFLA, in Clear-

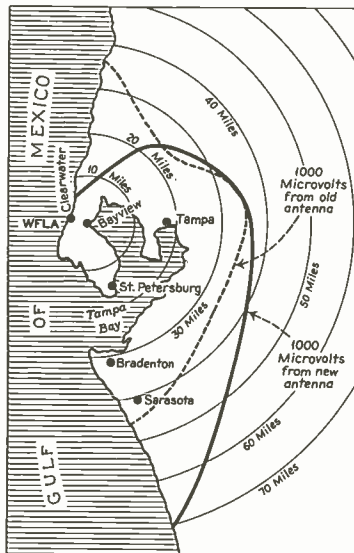

Field strength contours of station WFLA with old and new antenna systems. Coverage is shown only to 1,000 microvolts.



The WFLA twin radiators, at Clearwater, Florida. See the front cover of this issue for a view of one tower base and coupling house.

water, Florida, for the purpose of eliminating the interference this station was causing in the service area of WTMJ, about 1000 miles away. In order to minimize this interference the station had been ordered to reduce its power from 1000 watts to 250 watts. After the erection of the directive antennae, and a series of tests were made on it by the Department of Commerce, the Federal Radio Commission permitted the station to return to its full 1000 watts power.

The directive antennae at WFLA has now been in continuous operation for two years. Since then some other stations have erected similar systems and the Airways Division has installed such systems throughout the country for radio beacons. It may be considered that the application of directive antennae for broadcasting has now had a sufficient practical test, and has been recognized by the Federal Radio Commission for a sufficient period to be considered a satisfactory and proper weapon to solve certain problems of interference and coverage.

The manner in which directive antennae may solve various problems of interference and coverage was described briefly in an early article.<sup>1</sup> In that article, I stated that there were certain unexpected technical difficulties which, fortunately, could be overcome by suitable circuit design. I shall here explain how these difficulties arise and the circuits which may be used to overcome them.

## DOUBLE RADIATORS

Directive antennae consist of a number of radiators spaced from each other at distances comparable with the wavelengths; the radiators must be excited at certain amplitude and phase relation to each other. The radiation pattern depends on, and is controlled by, the

relationship of distance, amplitude and phase between the radiators. In the case of high frequencies and short wavelengths, it is possible to employ a single wire bent upon itself in various ways to take the place of several independent radiators. At lower frequencies and longer wavelengths, this is no longer possible because the distances between the radiators become excessive and the connecting wires too long. It becomes necessary to install several radiators and excite them independently by transmission lines, as shown in Fig. 1.

After deciding on the radiation pattern, the number of radiators, their location, phase, etc., all of which factors are directly connected with the economics of coverage and interference, and after the erection of the radiators and transmission lines, the problem of the best method of coupling such radiators to the transmitter arises. Measuring instruments are essential to the installation and will be important in the operation when the installation is complete. It is, therefore, expeditious to install immediately the measuring instruments that will be used after the station is in operation.

## FIELD-STRENGTH MEASUREMENT

The most direct method of measurement is to install one or more field-strength measuring sets in important directions and connect the measuring instrument of each set by means of a cable to a convenient place in the transmitter building; the measuring sets should be located at a distance not less than one wavelength from the antennae system, nor less than some ten times the extreme distance between the radiators, whichever is the greater, so that errors due to proximity are negligible. A phase-measuring instrument should also be available, since much depends upon the correct phasing between the various

<sup>1</sup>Directive Antennae for Broadcast Stations, Electronics, pp. 362, December, 1932.

# BROADCASTING

- Dealing with the manner in which directive antennae may solve various problems of interference, and data on the coupling circuits for double radiators such as those used at WFLA. Phase distortion is also discussed.

coupling elements. As far as possible, the adjustments should be made at the transmitter end of the transmission lines, so that all adjustments may be made by a single operator guided by meter readings. Adjustments made by communicating with a distant observer at the end of a telephone line are possible, but far from satisfactory.

Fortunately, it is possible to design the circuits so that the voltage at one end of a transmission line is proportional to the voltage at the other end, and is independent of the impedance connected at the end of the line. The main adjustments can then be made with the guidance of the measuring instruments, located inside the transmitter building and connected to the transmission lines. The final adjustments should be made by means of field-strength measuring sets, located at a distance from the transmitter. By this means, any unaccounted effects, due to structures or non-uniformity of the ground, can be accounted for. The readings of the field-strength measuring sets should be correlated with the readings of the meters inside the building. In Fig. 1, for instance, a circuit may be designed so that the voltages at R-1 and R-2, are proportional both in magnitude and phase to the voltages at P-1 and P-2 respectively. If, therefore, suitable instruments are connected at R-1 and R-2, it is possible to know the ratio of the voltages and their phase at the antennae ends of the transmission lines. It is also possible to design the couplings between the antennae and the transmission lines, so that the voltages at A-1 and A-2 are very approximately proportional to those at P-1 and P-2 and, therefore, proportional to those at R-1 and R-2. The instruments at R-1 and R-2 will therefore show with good approximation the ratio of the voltages at the antennae, as well as the phase relation between them.

## COUPLING CIRCUITS

The coupling circuits at B-1 and B-2 should be kept tuned, so that the current in the antennae is at a maximum.

It is not always simple to adjust the circuits at this maximum condition because of the reaction of one antenna on another; this reaction alters the tuning of the antennae so that while one antennae is being adjusted the other becomes mistuned. It is not usually very difficult to obtain simultaneous adjustment for a simple system of two antennae by trial and error. Further difficulty arises when the phase of the antennae is being adjusted, for a change of phase will alter the reaction of the antennae on each other and will put them out of tune. Usually, however, the tuning is not particularly sharp and the practical difficulty is not unsurmountable. If the tuning should become too difficult, it is possible to couple the transmission lines in such a way that the voltage induced by this coupling is equal and opposite to the voltage induced by the direct reaction of one antenna on the other. The phase and amplitude of the antennae can then be adjusted without necessitating any readjustments of the antennae tuning circuits.

In order to obtain the desired result or proportionality between the voltages at R and A, the essential physical condition is that the voltage at R be in

phase with that at A. When this condition is obtained and by whatever means it is obtained, it can be shown that the voltage at R will remain in phase with that at A, and will be proportional to it in magnitude irrespective of the variation of the resistance, or reactance of the antenna, A, due to wind or rain. A simple way of calculating the circuit C-1 is as follows:

We can assume that the antenna termination of the transmission line is a pure reactance equal to the surge impedance,  $Z_0$ , of the line. (If it has not this impedance, it does not matter since the coupling C-1 will have the same effect when it is properly adjusted, whatever may be the terminal impedance of the line.) If the line is of a length "l" the phase shift is  $(2\pi l/\lambda)$ . C-1 must therefore be a circuit which creates a phase shift of  $(-2\pi l/\lambda)$ . The simplest circuit would be a simple inductance "L" of such a value that

$$\tan \left( \frac{2\pi l}{\lambda} \right) = \frac{Z_0}{L\omega}$$

A "T" section is, however, more satisfactory than a simple inductance.

An important feature of this result is that, if the transmission lines are connected at R-1 and R-2 directly to the transmitter, no reasonable changes in the impedance of the radiators, due to weather or other causes, would affect the ratio of the currents flowing in them or the phase relations between them. The voltages at the radiators must, however, remain either in phase or out of phase. No such automatic adjustment of the phase and amplitude relation between the radiators is possible, if it is required to keep the radiators at some other phase relationship to each other.

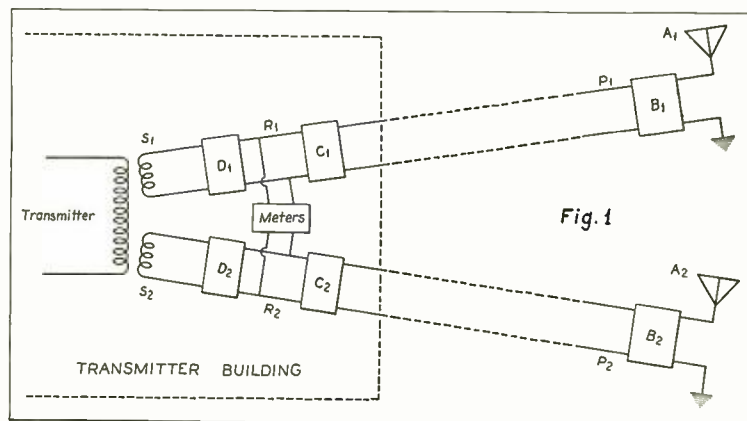

Block diagram of the arrangement of the coupling circuits between the transmitter and the double vertical radiators.

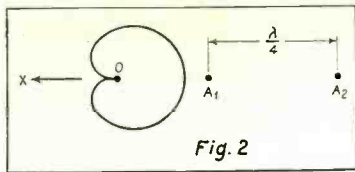

Radiation distribution pattern for WFLA.

The circuit D-1 and D-2 in Fig. 1 are for just this purpose of creating a phase difference between the radiators. When a phase difference is required by the design, all that can be achieved is to design the circuits so that a change in the impedance of either of the radiators produces as small a change as possible in their relative excitation. The best condition is to make the total phase shift between S and A as nearly zero or 180° as possible, and as far from 90° and 270° as possible. For instance, if the radiators are to be excited 90° out of phase, one radiator should be made to lag 45° and the other lead 45°.

An interesting phenomenon is, that physically identical radiators may have different resistance and reactance. The resistance of the reflector radiator at WFLA had some 30% less resistance than its colleague. This difference in the resistance is a factor that has to be considered in designing the coupling circuits B-1 and B-2.

Before terminating this article, I would like to explain a certain phenomenon which has caused some atten-

tion since the station WFLA was erected two years ago. The radiation distribution pattern used at WFLA was a simple cardioid obtained by exciting two radiators, spaced a quarter wavelength apart, in quadrature. The pattern is shown in Fig. 2. It was found that when the adjustment was nearly correct and the signal in the direction "X" reduced to as low a value as possible, there was so much distortion of the signal in or near that direction, that it was almost unintelligible. The cause of this phenomenon is as follows:

The radiation in the direction "X" is weak because the radiation from A-2 in the direction "X" lags by 90° on that from A-1, owing to the extra distance of a quarter wavelength it has to travel, and another 90° due to the phase difference in the excitation, making a total of 180°, so that the two radiations from A-1 and A-2 oppose and cancel each other in the direction "X"; but not in any other direction.

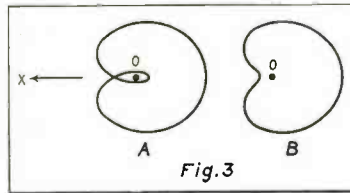

"A" is the distribution pattern for one sideband and "B" the pattern for the other sideband.

This cancellation occurs accurately at one frequency only—that of the carrier, for instance. What happens to the sidebands? The sidebands have different frequencies, so that for them the spacing of the radiators is not accurately a quarter of a wavelength. They will, therefore, produce radiation distribution patterns, such as shown in Fig. 3, A and B. Fig. 3A may be taken as the pattern for one sideband, and Fig. 3B for the other. It is seen that in the direction "X," one sideband may actually be reversed, and will cause enough distortion to render speech unintelligible. As soon as the phase adjustment of the antennae is made less close, the carrier increases in strength, both sidebands become positive, though they may not have the same length, and the amount of distortion rapidly diminishes.

In directions other than "X" the sidebands are so nearly equal in amplitude and phase, that even the most accurate instrument would fail to measure any distortion, and we do not have to worry about the effects on the ear. Here again, suitable design can eliminate the distortion that exists in the directions where the signal falls to very low values.

Further experience may bring to light some more problems. However, the present state of the art seems satisfactory. Of the problems that have come up, most have been solved by this time, directive antennae systems may be counted upon to play their useful part in the field of broadcasting.

## Book Reviews

HIGHER MATHEMATICS FOR ENGINEERS AND PHYSICISTS, by I. S. and E. S. Sokolnikoff, published by the McGraw-Hill Book Co., Inc., New York, N. Y., 6 by 9 inches, 482 pages, cloth covers. Price, \$4.00.

The usual four year course in electrical engineering includes one and one-half years of plane and solid analytic geometry, a year of integral calculus, and, in many cases, a year of differential equations. The problems involved usually stress mechanical and electrical systems, and enable the student to appreciate the mathematical development of transient phenomena in oscillating circuits. Hyperbolic functions are only more or less "mentioned," and geometric applications of partial differential equations are discussed.

Unless special courses in mathematics are taken, the student, upon graduation, is able to solve the numerous stereotyped problems, but is usually incapable of formulating his own ideas in mathematical form if the ideas are along original lines. There is need,

therefore, for a text book which treats the subject of mathematics in a form more detailed than that given in the usual engineering course, and which treats the subject from the viewpoint of the engineer. *Higher Mathematics for Engineers and Physicists* fulfills this need.

The book is divided into fifteen chapters, and includes such important topics as elliptic integrals; infinite series; partial differential equations; Fourier series; multiple, line and improper integrals; ordinary differential equations; vector analysis; and the extremely interesting subject of probability. The series of problems at the end of each chapter and the answers to them form a very important part of the text.

This book does not follow the more or less dry treatments usually used in books on mathematics. The subject matter is closely allied with well-known problems in mechanics and electrical engineering, thus making the introduction to each subject more or less simple. For instance, in the first chapter, the

conventional derivation for simple harmonic motion is given. This derivation is based on the assumption that the angle of displacement,  $\theta$ , can replace the sine of the angle; the usual answer,  $T = 2\pi\sqrt{l/g}$  is obtained.

Now, if the angle is not so small that it can replace the sine or tangent, then the solution is more complex. The authors carry out the solution. The answer involves the term  $\sqrt{1 - k^2 \sin^2 \theta}$ , and the next section of this chapter involves the solution of this type of integral, known as the elliptic integral.

The book is well suited for engineering students, or graduate engineering students desiring a good introduction into the field of pure mathematics. It presupposes, of course, a good working knowledge of the calculus and of elementary differential equations. If perchance, a good review of the usual engineering mathematics is desired, then your reviewer recommends, *Engineering Mathematics*, by Steinmetz, published by McGraw-Hill.

(Continued on page 22)



# Primary Frequency Standard

HAS ACCURACY OF 99.9999 PER CENT.

By **J. G. BEARD**

Radio Engineering Division

WESTINGHOUSE ELECT. & MFG. CO.

FOR CHECKING THE FREQUENCY of radio transmissions, crystal controlled equipment, with an accuracy of one part in a million, is in operation at the government's Constant Frequency Monitoring Station, located at Grand Island, Nebraska.

Few people have ever stopped to realize how small a part in a million really is. Thinking in terms of time, an equal amount would be one second in eleven and one-half days. An equivalent comparison of distance amounts to one inch in fifteen and eight-tenths miles. To make radio-frequency measurements to an accuracy of this degree obviously necessitates the use of a standard whose absolute value and rate are known to an even greater accuracy.

## APPARATUS USED

The apparatus to meet such extremes of accuracy is divided into four major groups.

1. *The frequency standard* is that part of the equipment which generates the primary frequency—the yardstick against which the unknown frequencies are compared.

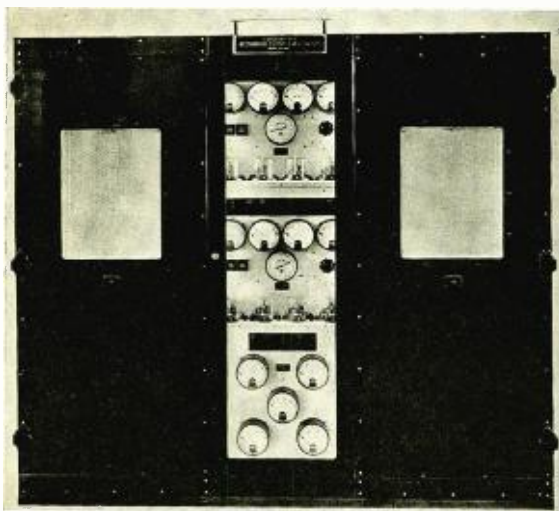

FIG. 1. REFERENCE STANDARD OF FREQUENCY CABINET.

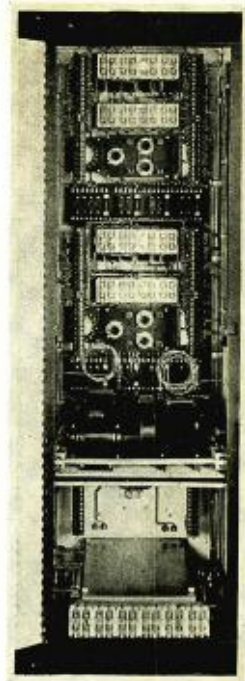

FIG. 4. CONTROL COMPARTMENT, REAR VIEW.

2. *100-kilocycle clock* is applied to that part of the equipment which is used to evaluate the oscillator frequency by comparison with standard time signals.

3. *Measurement rack* is that part of the equipment by means of which a suitable signal of any frequency between ten- and thirty-thousand kilocycles may be evaluated in terms of the standard.

The crystal oscillator equipment has been designed with the specific intention of producing the very highest class of apparatus obtainable. No effort has been spared, either in the form of engineering development and investigation, or in the construction of the component parts to make this apparatus the finest that the present state of the art permits.

This standard of frequency is basically a reference standard rather than a primary source of frequency. Time is the primary standard of frequency. Starting from the time base, means have been provided to determine the absolute frequency of the reference standard as evaluated against time. Time signals received by radio from the U. S. Naval Observatory, at Washington, are compared with the frequency of the reference standard through the final medium of the chronograph. These comparisons between the reference standard and time not only determine the absolute frequency of the reference standard but also provide an accurate means of determining the rate of change in the frequency.

## DETERMINING REFERENCE STANDARD FREQUENCY

An additional means has been provided to accurately determine the frequency of the reference standard in terms of the standard of frequency maintained at the U. S. Bureau of Standards, located at Washington, D. C. The frequency of the reference standard can be adjusted readily to the absolute value established by the radio signals originating from the standard at Washington.

The ability of the equipment to have its frequency adjusted to agree with the value as determined by the Bureau of Standards, enables the instantaneous value of frequency to be known at the time of, and to the same

degree of accuracy, as the standard in Washington. A small discrepancy may be caused sometimes by peculiar forms of fading, and Doppler effects which make an exact match of frequencies by radio difficult, especially at such distances.

The equipment comprising the crystal oscillator has been designed to produce a reliable local source of radio frequency by the aid of which measurements of other radio frequencies can be made to an accuracy of one part in a million. It was further intended that the drift or rate of change in the frequency of the crystal oscillator would not exceed one part in a million for thirty consecutive days. This reference standard was to be the yardstick with which the unknown frequencies were to be compared.

## REFERENCE STANDARD EQUIPMENT

The reference standard (Fig. 1) consists of one large cabinet which is divided into three sections. The two crystal oscillator-amplifier units with their isothermal chambers are located at the ends of the cabinet. The center compartment houses the control and metering equipment. It contains a control panel for each oscillator-amplifier unit and a third panel which supplies power to the other two.

The two oscillator units are arranged to permit operation of one unit entirely independent of the other, thus affording a high degree of reliability. Each oscillator-amplifier circuit is housed under a glass bell jar from which most of the air is exhausted. Two vacuum pumps, one for each unit, are located at the base of the cabinet in the rear of the control panels. They keep the degree of evacuation constant. Mercury manometers serve to start and stop the pumps.

Low humidity is maintained inside each bell jar by a vial containing calcium chloride which absorbs any moisture from the air contained. Constant temperature is provided for the crystal by a mercury thermostat and heater forming a part of the crystal oven.

The bell jar assembly housing the oscillator-amplifier

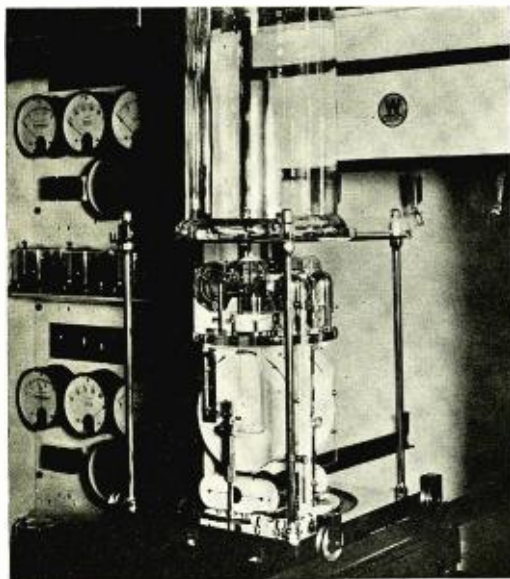

FIG. 2. CRYSTAL OSCILLATOR WITH BELL JAR LIFTED.

circuit is spring-suspended in a large compartment which also is temperature regulated. Heaters are located in the lower part of this compartment and a fan above the heaters draws the air down around the suspended bell jar unit and forces it through the heaters and up the sides of the compartment. A duct system, which extends nearly to the top, controls the direction of the air flow about the suspended unit. Regulation of the temperature at 55 degrees C. is effected by a mercury thermostat. Should the room temperature become low, a second contact in the thermostat, set at 54 degrees C., turns on more heat. Such an arrangement provides better regulation with a lower expenditure of heater power than if only one heater stage were used. Heat-insulating material covers all inner surfaces of the compartment except the glass window, which is provided to permit inspection of the suspended unit. It is made double with a dead air space between the inner and outer glasses.

## ATMOSPHERIC CONTROL

By these several means the conditions affecting the operation of the crystal and its associated circuits are maintained at practically constant values. In order of importance, these conditions are: temperature, humidity and pressure. The air-tightness of the oscillator compartment under the bell jar prevents the entrance of air and so renders it relatively easy for the calcium chloride to absorb the moisture from the small quantity of air entrapped under the jar. Very close regulation of the pressure is maintained by the pump which has only a small amount of leakage to overcome. Especially constant temperature conditions for the crystal is secured by the two-chamber system. The inner or crystal thermostat then has only a narrow range of change for which to compensate and so can regulate the temperature within very close limits.

## PRECAUTIONS

The entire front of the section containing the three control panels is covered by a glass paneled door to prevent accidental operation of any of the frequency-control buttons or other control switches. As a further precaution, a lock has been provided so that access to these panels may be limited to authorized persons. All indicating instruments and thermometers may be observed through the glass doors. Another door in the rear of the cabinet gives access to the fuse blocks and vacuum pumps.

The door which forms the front of each oscillator-amplifier compartment is hinged on one side and is held closed with machine screws spaced around all sides. This construction is used to reduce heat leakage.

All external electrical connections are made from terminal blocks provided inside the center rear compartment of the cabinet.

The foundation of the cabinet consists of a base fabricated from steel channel sections, welded at all joints. The main framework is composed of aluminum angle bars which are joined at the corners by heavy gussets. All fastenings between framework and gussets are made with rivets or by gas welding. Aluminum sheet is used for the outside metallic surfaces.

## ISOTHERMAL COMPARTMENTS

The isothermal compartments which house the crystal units at each end of the cabinet are insulated with balsa wood, three inches in thickness. This is a very light porous wood containing a great number of small trapped

air pockets which offer a high resistance to heat transfer. It thus forms an excellent heat insulator. Doors on the front of the cabinet which allow access to these chambers are also insulated in the same manner. The double glass window in each door, to allow the oscillator-amplifier units to be viewed from the front of the cabinet, obtains its heat insulation from the dead air trapped between the inner and outer glass surfaces, which are separated several inches.

The compartment housing the control panels is located between the two oscillator-amplifier compartments. This makes a symmetrical arrangement of the three units and is the best arrangement for operation. Ready access to the inside of the center compartment is obtained by the door on the rear side of the cabinet. In this space are located fuses, voltage control units, vacuum pump, and filter sections, all arranged for the greatest convenience of inspection and maintenance.

The oscillator-amplifier units are suspended on coiled springs from the top of the heater ducts. Turnbuckles are provided for leveling the units by means of small spirit levels located on each unit.

All parts have been made as accessible as good engineering practice permits.

The output frequencies of the reference standards are 100 kilocycles plus or minus the deviation from this value where each of the two oscillators are intentionally adjusted.

### QUARTZ PLATE CONSTRUCTION

Special care has been given to the quartz plate and to the holder. The plates are cut from the best grade of selected clear, Brazilian quartz crystal. By use of the polariscope, the optical axis is determined accurately and the cutting is laid out in such a way that an "X" or electrical axis of the quartz crystal forms a parallel line to a broad face of the oscillating plate, but is, of course, at right angles to the "X" axis. A plate of quartz cut in this manner from the crystal has then cut from it a circular plate having a hole in its center and concentric with the outside rim. Such a plate is a toroidal figure, having a rectangular cross section. By cutting the oscillating plate in this manner, it is possible to produce a plate having a low temperature-versus-frequency coefficient. This is due to the well-known property of quartz crystals having different and opposite thermo-electric properties in different directions.

The center hole in the quartz plate is tapered slightly from each side so as to form a ridge at the mid-point. This ridge then becomes the point of support for the crystal on the isolantite rod by which it is supported in the holder. Maximum freedom of damping is thus obtained for the crystal. The electrodes, which are adjacent to the broad faces of the crystal but do not touch them, are spaced with pyrex tubing.

Pyrex tubing has been chosen for the electrode spacer because of its low coefficient of expansion and its value as an electrical insulation. The electrodes are made from stainless steel, which has been chosen because of its non-magnetic and non-corrosive properties. Both electrodes are circular in shape. The face of each electrode next to the crystal is lapped flat and to a good polish. One of the pair has an adjustment which allows the air gap between the electrodes and the crystal to be set at the best value.

The crystal holder is contained in a scientifically designed, temperature-regulated oven which is operated at 60 degrees C. within close limits. A thermometer provided to indicate the temperature is calibrated in 0.05 degrees C. divisions.



FIG. 3. CRYSTAL OSCILLATOR UNIT, SHOWING CRYSTAL ISOTHERMAL CHAMBER PARTIALLY OPENED.

Great care has been taken in the selection and manufacture of all parts. As an example, the coils used in all radio-frequency circuits are wound on forms of pyrex tubing which has been specially ground to prevent the wire slipping.

The oscillator plate tuning capacitor has been designed and constructed with heavy plates and isolantite and crystal quartz insulations to secure maximum stability over a long period. It consists of eight sections giving a variation in steps from 70 mmfds to 390 mmfds through a control switch made integral with it. Contacts on this switch are silver plated for security of contact.

Very close control of the pressure in the bell jar is necessary as pressure variation affects the crystal frequency. This control is obtained by the vacuum-pumping system which is individual for each jar. A double closed mercury column manometer controls each pump. The pump starts immediately when the mercury advances enough to break the circuit to the contact, and stops when the circuit is completed. Several contacts are provided on the manometer to permit a choice of the pressure to be maintained.

### FREQUENCY-ADJUSTING CONDENSER

The frequency-adjusting capacitor is constructed with one plate fixed and the other on a fine accurate thread for control of the spacing. The adjustable plate is attached to a small reversible synchronous motor with control in either direction through an external switch on each individual control panel.

Relays which control the heater and vacuum-pump circuits are mounted on the front of the two control panels where they can be easily inspected and adjusted as the need may arise.

A system of periodic inspection and service has been developed which will insure the long-time, uninterrupted operation which will be expected from apparatus of this nature.

# DRY ELECTROLYTIC CONDENSERS

By **R. J. COVERT**

Engineering Department

P. R. MALLORY & CO., INC.

IN THE DESIGN of electrolytic condensers, compactness is not only a most desirable feature toward the size of the finished unit, but mainly toward the capacity and the equivalent series resistance of the rolled unit. Therefore a gauze or similar separator impregnated with an

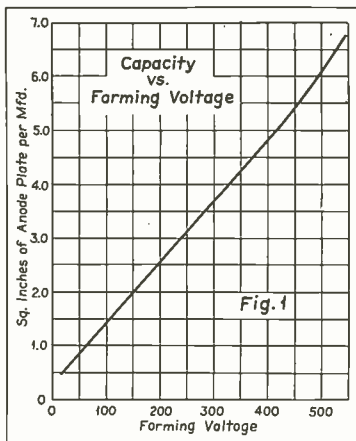

This curve is based on one side of the anode plate alone.

electrolyte is used in order that the two metal electrodes may be placed as close together as practicable.

In one process of manufacture, the separators are placed respectively on the anode and cathode and thoroughly covered with a thin layer of electrolyte, the two plates then being rolled together. Following this the rolled units are heat treated and aged, the time of aging depending upon the voltage rating of the condensers, to a potential slightly in excess of the rated operating voltage. While this aging process tends

to lower the capacity slightly, it does materially reduce the leakage by reforming any minute abrasions on the anode caused by handling during fabrication. And, it should be noted here that it is absolutely necessary that the greatest precaution be exercised in the manufacture and handling of all component parts of electrolytic condensers in order that they may be entirely free from any form of impurities, for the presence of a microscopic amount of an impurity, such as a chloride or a sulphate, will cause very severe corrosion. To protect against this possibility, one manufacturer tests every shipment of material in a chemical laboratory, making approval before acceptance in the store rooms a necessity; and further, all operators on their assembly lines, that handle uncased condensers, are equipped with rubber gloves.

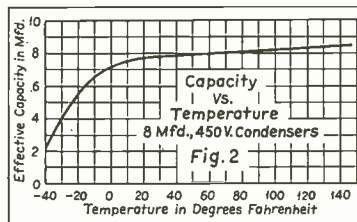

Note the decisive drop in capacity at temperatures below zero. Capacity changes are not permanent.

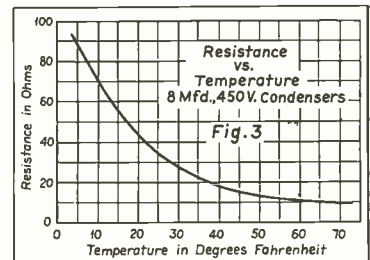

Change in resistance is due to chemical changes in the composition at low temperatures.

## CAPACITY, RESISTANCE, AND LEAKAGE

As we all know capacity varies inversely as the forming voltage (see Fig. 1), which leads us to believe that as the forming voltage is increased the thickness of the dielectric is increased, thereby reducing the capacity per unit area. The curve in Fig. 1 is based on one side of the anode plate alone, although both sides are effective when the condenser is rolled round, for the gained ease in calculations.

Referring to Fig. 2, the temperature-capacity characteristic, it can be seen that the capacity falls off at a reduction in temperature; while Fig. 3 illustrates the increase in resistance due to reduction in temperature. The reason for this lies in the fact that as the temperature is reduced the chemical composition of the electrolyte is changed, thereby bringing about changes in capacity, resistance and leakage. However, an electrolytic condenser returning to its normal operating temperature will also return to its original electrical characteristics, which, of course, is a very desirable and necessary condition.

The leakage of a condenser should never be measured above its rated voltage, for, as we know, this leakage de-

- The accompanying text and curves present a dependable cross-section of the dynamic characteristics of dry electrolytic condensers as applied to receiver and power-supply circuits.

depends upon the extent and completeness of the film, on the nature of the electrolyte, on the thickness of the film, and on the ambient condition under which it operates. Fig. 4 illustrates the change taking place in leakage with a variation of temperature, while Fig. 5 readily shows why the unit should not be operated above its rated working voltage. Therefore, one must keep in mind that the operation of a condenser at too high a temperature will increase the leakage current to such an extent that the unit will burn up and dry out. When such a condition exists, the leakage at normal temperatures, becomes very low, the capacity decreases, and the equivalent series resistance becomes extremely high.

### CONDENSER SELECTION

The variations of impedance due to changes in frequency is clearly shown in Fig. 6. From this we may assume that

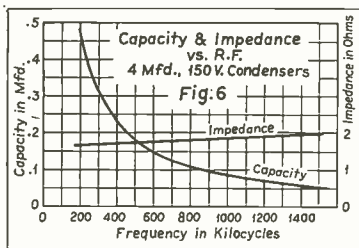

These curves would indicate that electrolytic condensers are satisfactory for use at radio frequencies.

if properly designed an electrolytic condenser may be used in certain r-f circuits.

To select the proper condenser for a particular circuit, we, as well as the designer, must know the capacity, working voltage, peak a-c ripple voltage, surge voltage, ambient temperature and the space available for the unit. This is necessary because, for example, the heating period of the tubes, burned out tubes, removal of one or more tubes, or removal of the speaker plug will cause an excessive voltage, commonly known as the surge voltage, to be applied to the filter condenser—with an improperly

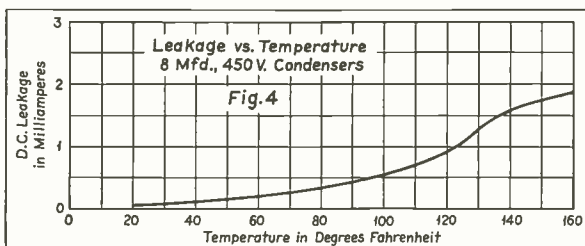

Above: This curve indicates that an electrolytic condenser should be operated at low temperature to prevent high leakage and consequent drying out of the unit. Right: An electrolytic condenser will dry out and burn up if operated above its rated working voltage.

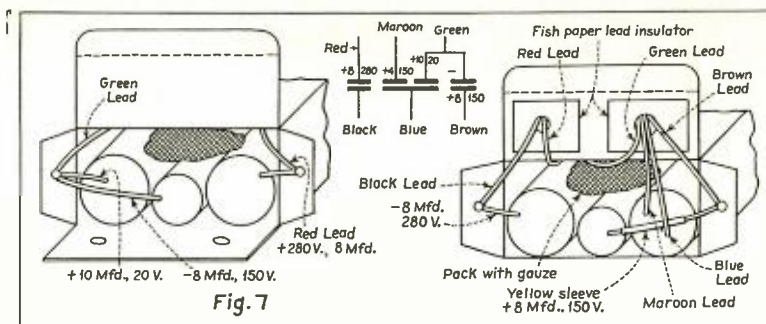

A multiple-unit condenser with aluminum wire lead assembly instead of the flat type aluminum tab connector. The leads may be bunched, and bent in any fashion to make the required connections.

designed condenser the result is obvious.

### NEW DESIGN

In the past dry electrolytic condensers were made with the anode and cathode tab being a component part of the respective foils, and with the old flat type aluminum tab used in conjunction with several units in one carton it became very difficult to assemble them to the terminals, insuring at the same time proper insulation between the tabs or between the tabs and the metal container. Also, as the demand for multiple units increased day by day, it became necessary to form some kind of a tab that would require a minimum amount of space. To offset these problems the aluminum wire tab was developed. This unit makes it possible to bunch the leads, and to bend them in any fashion. In addition, the possibility of shorted sections was reduced. In fact some of the recent designs would be practically impossible were it not for wire lead assemblies. Still another major advantage of the wire lead is its resistance against corrosion at the electrolyte line of the condenser. This latter advantage is due to the fact that for the same cross-sectional area the wire tab exposes only one-eighth the area to attack.

Fig. 7 shows a condenser manufactured with the aluminum wire lead assembly. This, of course, is necessary with so many leads or units in one con-

tainer, and while there is not space here to describe the various types of condensers, types of containers or methods of mounting, it can be said that almost any type of unit may be built providing there is sufficient space within the container for the required volume of condenser assembly needed to attain the proper characteristics of the particular electrical circuit to which the condenser is to be adapted. Versatility of the wire lead assembly is partially gained when the leads are assembled to the tabs and then imbedded in a sealing compound poured into the end of the unit.

A material coming into quite prominent use as a separator is cellophane. The two important features claimed for this product are: increase in breakdown voltages and the ability of the condenser to withstand heavy surges without permanent injury to the condenser, and high capacity per unit volume heretofore unobtainable in the gauze type condenser.

While the radio manufacturers have done a great deal toward the development of the electrolytic condenser by demanding unusual types for their new designs, and while this demand, controlled by the condenser manufacturer's desire to parallel design with paramount quality, has resulted in the production of quality condensers of smaller physical size, there still remains a great deal of research work to be done.

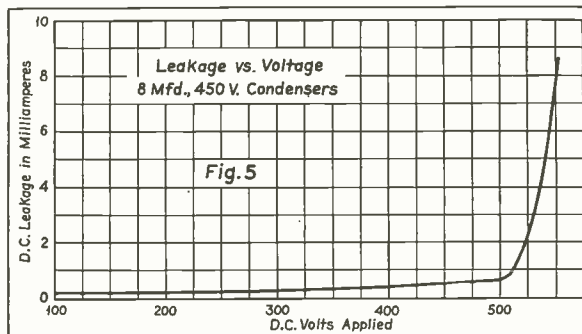

# Design .. NOTES AND

## INSULATING LIQUIDS IMPROVE CONTACT TO COPPER OXIDE

IN THE STUDY of the electrical characteristics of various semi-conductors, including copper oxide, much difficulty has been encountered in securing a good electrical contact to the material. This difficulty has led to results and conclusions which are widely divergent. The main objective of several investigations has been to determine whether or not semi-conductors, in the conduction of current, obey Ohm's law. Obviously, if one investigator secures a contact which has rectifying properties, he will secure a different result and may arrive at a different conclusion than will an investigator who has secured a good non-rectifying contact. Even should they both secure non-rectifying contacts, they will still disagree on the values of the experimentally determined physical constants.

### Electrical Contact

The securing of good electrical contact to copper oxide is particularly difficult. For instance, if soft metal electrodes are pressed against copper oxide, the contact resistance is very high even when pressures up to the crushing strength of the oxide are used. If, however, finely divided carbon is placed between the oxide and the electrodes, this resistance is greatly reduced. The search for other solid materials which act like the carbon has, so far, been futile.

It has been discovered that certain oils and other normally insulating liquids conduct electricity very much like a metal provided the liquids are in the form of a very thin film. This suggests the possibility of using a liquid between the electrodes and the oxide in order to reduce the contact resistance. Such a liquid must not, of course, conduct electrolytically or else reduction of the oxide will occur.

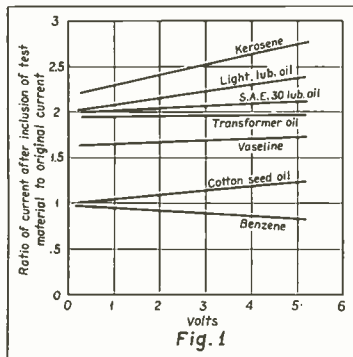

Fig. 1. Contact resistance changes between copper oxide and lead, using different included materials.

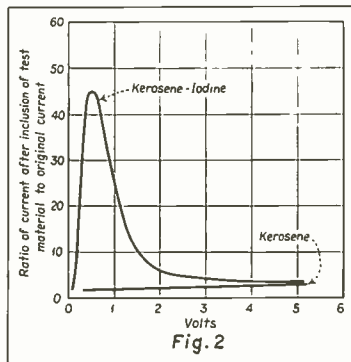

Fig. 2. Change in contact resistance caused by kerosene and kerosene-iodine compared.

In a series of experiments conducted to investigate this possibility, a number of different liquids were used and a corresponding variety of results were obtained. Some of the most interesting and typical results are shown in a manner for easy comparison in Fig. 1.

### Oils Used

It is seen that the best results, from the point of view of contact resistance reduction, were obtained using mineral oils which are normally good insulators. Included in the group is a transformer oil of the class used in high voltage X-ray transformers. A marked improvement is noted in the resistance decrease using this oil. Vegetable oils, of which one typical result is shown, gave slight improvements and hydrocarbons of the order of benzene, aniline, etc., gave results for the most part neutral, but showing an increased resistance in a few cases.

An additional experiment was attempted in which a substance known to have a high electron affinity was dissolved in large proportions in one of the liquids. Kerosene was selected for the experiment because it had shown the best result and the dissolved substance used was iodine. The idea in mind was that the iodine would, in some manner, act as a carrier of electrons across the contact gap. The result, shown in Fig. 2, compared with kerosene alone, justifies the original idea.

### Effectiveness of Iodine

It is seen, from the different shape of the curve, that the action of kerosene and iodine must be different from the action of using kerosene alone. At low voltages, and again at high voltages, the two curves approach each other, indicating that the effectiveness of the iodine is critically dependent on the voltage. This is to be expected if the

contact resistance is to be a function of the movement of the iodine particles. Because of the comparatively high mass and inertia of the iodine, its movement is slow at low voltages. At high voltages the electrons are able to pass across the contact gap without the assistance of the iodine, and at some intermediate voltage the maximum point of conductivity is reached.

### Conclusion

The experiments, while they were crude quantitatively, show conclusively that the inclusion of certain normally insulating liquids between a soft metal electrode and copper oxide reduce the contact resistance. There is no apparent reason why these liquids, or similar ones, should not act in a similar manner for other semi-conductors. This, however, must be determined in future experiments. The further investigation of solutions, such as the iodine and kerosene combination, may lead to some which give a still lower contact resistance.

L. F. Slezak,  
Meter Engineering Division,  
WESTINGHOUSE ELECT. & MFG. CO.

## "ELECTRONIC MACHINE GUN"

"ELECTRONIC BULLETS" spattered on the fluorescent screen of a cathode-ray tube are used to measure the time-current blowing characteristics of instrument fuses in a study now being made. The apparatus consists of a cathode-ray tube



Fig. 1. Photo of the blowing of a 1/4-ampere fuse.

# COMMENT . . . Production

and impulses fed to the grid of the tube by a rotating gear impulse generator. A mechanical analogy is that of a machine gun firing between the rotating propeller blades of an aeroplane, only in this case, the electronic impulses are released between gear teeth. In this simple manner, oscillograms may be timed and recorded with an ordinary camera instead of the usual expensive moving film equipment.

## The Circuit

Referring to the circuit diagram, a large gear (lower right) is rotated close to a polarized electro-magnet by a high-

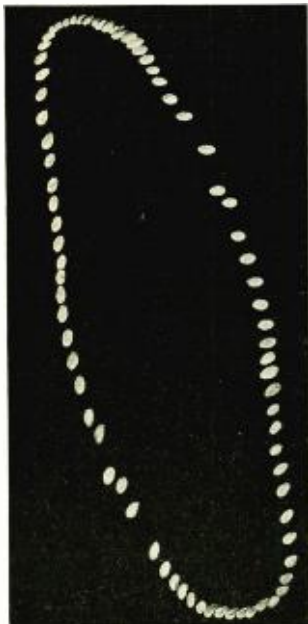

Fig. 2. Photo of the "electronic bullets."

speed synchronous motor. As each gear tooth passes the magnet, an impulse is created which is then amplified by a screen-grid tube. In this way, five thousand impulses per second are produced and applied to the grid of the cathode-ray tube.

With 500 volts on the focusing anode and 2,000 volts on the anode proper, the electron velocities from cathode to screen reach several thousand miles per second, depending a great deal, of course, on the potential of the grid. The circuit constants are so adjusted that during half of each impulse from the timing circuit, the electron beam of the cathode-ray tube is completely shut off. During the other half, it is completely, or nearly so, on, and is delivered to the screen in "shots."

It might seem that the full brilliance

of the screen pattern could not be realized with the beam broken up into shots in this way. In practice, however, it was found that the photographic qualities were in no way impaired, since each "bullet" lights its portion of the screen fully as brilliantly as if the beam traced a continuous line.

In the work of recording transients, (such as blowing a fuse), it is desirable to spread the phenomena over a couple of inches on the screen. This is accomplished by means of the non-recurring sweep circuit shown in the diagram. The condenser, C, is charged to impress a potential on the plates, D2, when the relay is closed. The charge leaks off through a variable resistor, R2, the value of which determines the time of the sweep.

When the fuse is blown, the potential drop across the large variable resistor, R1, is impressed on the plates, D1. The fuse blowing and sweep circuit are begun simultaneously by means of the double-pole relay.

Fig. 1 shows the blowing of a 1/4-ampere fuse at 250 volts d-c. The brilliant point on the extreme left is the initial point of the beam at rest. A small leakage in the sweep circuit draws the beam to the right before the relay button is pressed. As soon as the relay contacts close, the beam shoots up rapidly taking "20 bullets time" to open the circuit and come back to normal again. The wavy appearance on the top of the curve indicates an arc has been formed and would show the fuse is operating at its maximum permissible voltage.

## Fuse Timing

It may be of interest to note that the time required for a fuse to open the circuit drops rapidly as the amperage is decreased. In the amperages of 1/32-ampere and up, it has been possible to determine this characteristic quite well.

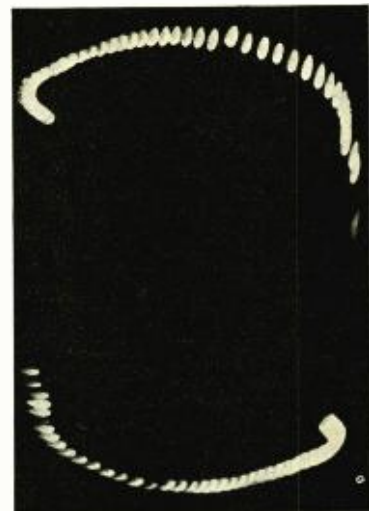

Fig. 3. Photo of the action of a neon lamp on 110 volts a-c.

In the 1/100-ampere size, however, the action seems to take place in less than 1/5000 of a second, and the present timing system, as fast as it is, seems inadequate.

Some very interesting and beautiful patterns of recurring phenomena are obtained when using the above timing method. Fig. 2 is produced by applying 110 volts a-c on plates, D1, with a few volts a-c 90° out of phase on D2 to spread the pattern. The effect of harmonics is shown in several places, and the "bullets" are shown crowded at the ends of the cycle.

Fig. 3 is a snapshot taken of the action of a neon lamp on 110 volts a-c with 110 volts a-c 90° out of phase on plates, D2. The lighting and extinction at each half cycle are readily followed.

E. V. Sundt,

LITTELFUSE LABORATORIES.

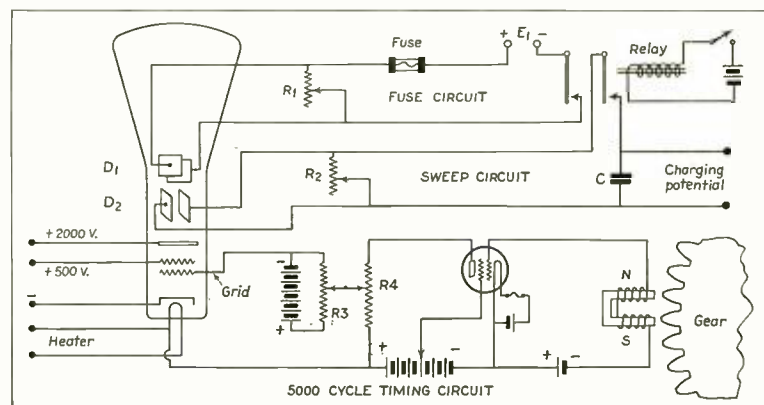

Circuit of the oscillographic equipment employed for obtaining the photographic patterns shown on these pages.

(Continued from page 11)

padding circuit for the intermediate band.

By the use of Eq. (1), the inductance  $L_s$  required with a tuning condenser minimum of 40 mmfd is found to be approximately 6.3  $\mu\text{h}$ . Setting the i-f at 465 kc, Eq. (5) gives the value of  $L_o$ , about 5.8  $\mu\text{h}$  in our case. Now, if no series or shunt condensers are used on the coils, the i-f at the maximum setting of the condensers would be 155 kc, just one-third the desired value.

We know by substitution in Eq. (8) that the required value of the oscillator capacitance is about 302 mmfd in order to maintain the i-f at 465 kc at the maximum settings of the condensers; therefore, a condenser must be inserted in series with  $C_o$  in order to satisfy this condition. The value of the series condenser,  $C_s$ , is determined from the usual law of condensers in series and is

$$C_s = \frac{C_o C_{s \max}}{C_{s \max} - C_o}$$

Substitution in this equation yields 1873 mmfd as the required series capacitance.

#### COMPENSATING CAPACITIES

The conditions considered so far imply that both  $C_o$  and  $C_s$  have the same minimum capacitance and that the inductances have been calculated to yield the desired i-f at the minimum settings. Of course, the distributed capacitance of the coils and the capacitance between leads, shields, etc., destroy the nicely balanced system computed on paper, so that it is expedient to insert small trimmer condensers across each coil, each trimmer having a maximum value of about 15 mmfd. These condensers are then adjusted at the highest frequency in the band for the desired i-f. These series and shunt condensers are shown in the diagrams of Fig. 1.

The effect of the series condenser is to raise the i-f at the low frequencies

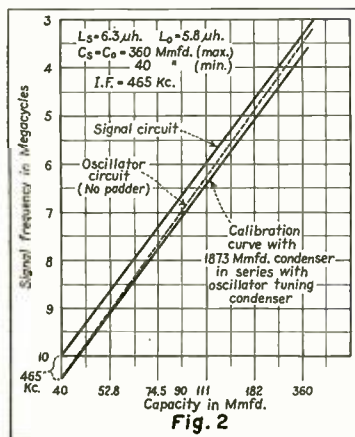

Curves showing the effect of a series condenser.

in the band; the i-f at the high frequencies will remain at nearly the desired i-f since the series condenser inserted is large compared to the minimum value of the tuning condensers. The effect of the series condenser is shown by the set of curves in Fig. 2.

The solid line to the left shows the variation in  $f_s$  with tuning capacitance, and is shown as a straight line for convenience. The dashed line is the curve for  $f_o$  with no series compensating condenser. This line approaches the  $f_s$  line asymptotically. The curve to the extreme right is for  $f_o$  with the 1873-mmfd capacitance inserted. It is substantially parallel to the  $f_s$  line throughout the entire range of the band.

#### SERIES CAPACITY COMPENSATION

Now, manufacturing tolerances of fixed condensers are usually about 10% which, coupled with the stray and distributed capacitances of the circuit, may be sufficient to throw the circuits off balance at the low frequencies. To offset this condition, the careful manufacturer with an eye to precision will use a slightly smaller value of  $C_s$  and compensate by shunting it with a small variable unit. This unit is adjusted to yield the desired i-f at the maximum settings. Thus, every coil in the receiver will require two adjustments, although many manufacturers dispense with one of the adjustments (the one in shunt with  $C_s$ ) on the two highest frequency bands.

## BOOK REVIEWS

(Continued from page 14)

*APPLIED ACOUSTICS*, by H. F. Olson and Frank Massa, published by P. Blakiston's Son & Co., Inc., Philadelphia, Pa., 430 pages, fabrikoid covers. Price, \$4.50.

Rayleigh's "Theory of Sound" still remains the classical reference to practically all the fundamental problems of acoustics. Recently the theory has been extended by Kennelly, Crandall, Lamb, and others. The field of speech and theory has been opened by Fletcher, and the original work of Sabine in architectural acoustics has been materially extended by Watson, Knudsen, Eyring and others. Several excellent treatises on the application of architectural acoustics have recently appeared, while the field of general application of acoustic principles to the solution of problems of acoustic and allied apparatus has remained open until undertaken by the present authors. The need for a practical text on the general application of acoustics has been brought about by the recent rapid advances in the sound technique due to radio, public-address systems, and talking pictures. This book

meets this need in a thorough manner.

While the authors have intended this book as a text for the student of acoustics, it appears that it is liable to be even more valuable as a handy reference book both for the workers in the field of acoustics and for the engineer who has occasion to refer to standard texts in the subject in connection with the design and operation of acoustic and allied apparatus. This book should appeal particularly to those who prefer a word description to a mathematical analysis. After the first two chapters (49 pages), which deal with definitions and some of the fundamentals of dynamical systems, mathematical analysis is dispensed with almost entirely. Even in these chapters derivations and proofs of La Grange's equations, the theory of elastic deformations, the d' Alembertian wave equation and other fundamentals are omitted, but reference is made to other texts which contain such information.

A chapter is devoted to fundamental acoustical measurements and another to apparatus for the acoustical laboratory. Microphones, telephone receivers, and loudspeakers are each allotted separate chapters. These chapters include not only a description of each of the several principles involved in converting sound to electrical impulses, and vice versa, but the application of apparatus based on the various principles of operation is explained in some detail. Fortunately, the publication date of this book has made it possible to include the latest advances in the art. It is unfortunate that more space has not been given to microphonics due to cabinet resonances, which appears to be an ever-present problem in radio receiver design and which has received too little attention in current literature. While some design information is given on microphones and loudspeakers, it would seem that a fuller treatment of this subject might have made this work considerably more valuable. The testing of microphones, telephone receivers, and loudspeakers are allocated separate chapters and are covered in a thorough manner. While some 69 pages are devoted to architectural acoustics, the matter of studio technique might well have been treated more fully. However, the references to current literature on this subject largely make up for this deficiency. The chapters on physiological acoustics and miscellaneous acoustic applications are especially well executed and seem to cover all the ground necessary for any one except specialists in these lines.

*Applied Acoustics* is replete with references, some 120 separate citations being given in footnotes. Actually this bibliography is one of the outstanding features of the book.



# A Chronological History

## of electrical communication

### —telegraph, telephone and radio

This history began with the January 1, 1932, issue of RADIO ENGINEERING. The items are numbered chronologically, beginning at 2000 B.C., and will be continued down to modern times. The history records important dates, discoveries, inventions, necrology and statistics, with numerous contemporary chronological tie-in references to events in associated scientific development. The material was compiled by Donald McNicol.

#### PART XXX

##### 1909 (Continued)

- (1169) John Stone Stone procures American patents Nos. 908,814 and 908,815 covering inventions in wireless telegraphy.
- (1170) Marconi exhibits, in London, his multiple tuner for radio telegraph installations.
- (1171) Henry E. Everding, patent attorney, is sentenced to two years in a penitentiary for participation in fraud incident to the issue of a tungsten lamp patent to John A. Heany, of York, Penna. A patent office examiner, Barton, previously was sentenced to serve three years, on similar charges.
- (1172) The Government, in January, called for bids for the construction of long-distance wireless telegraph stations. The following companies submitted bids: Telefunken Wireless Telegraph Company, of Philadelphia; National Electric Signaling Company, of Pittsburgh; Marconi Wireless Telegraph Company; Massie Wireless Telegraph Company, of Providence, R. I.; The Radio Telephone Company, of New York, and the Stone Telegraph and Telephone Company, of Boston.
- (1173) E. Bellini and A. Tosi, in Italy, describe a new system of directive radio signaling.
- (1174) Up to date forty-five United States patents have been issued for the invention of electrolytic rectifiers.
- (1175) C. M. Senlecq, in France, brings out a method of telegraphing pictures without the use of selenium cells.
- (1176) The sales of the General Electric Company for the year 1908 totaled about \$40,000,000.
- (1177) The Mackay Companies (Commercial Cable Company and Postal Telegraph-Cable Company) for the year ending January 31, reports earnings of \$3,685,761. The Mackay Companies is the largest individual shareholder of stock of the American Telephone & Telegraph Company.
- (1178) The Central and South American Telegraph Company increases its capital stock from \$12,000,000 to \$14,000,000, and the Mexican Telegraph Company from \$3,000,000 to \$5,000,000.
- (1179) H. B. Stone, of Providence, R. I., procures U. S. patent No. 911,774 covering the application of repeating coils to telephone circuits (Application filed November 26, 1907).
- (1180) The Burke Bill for the compulsory use of radio telegraphy on certain classes of vessels is passed by the House of Representatives.
- (1181) In a French electrical journal, L. New describes a system of superposing a high-frequency telegraph circuit on existing wires in use for electric power transmission.
- (1182) The Supreme Court of Illinois renders a decision denying the right of the American Telephone and Telegraph Company to acquire the majority stock of the Kellogg Switchboard and Supply Company of Chicago. The suit has been in the courts eight years and was brought by minority stockholders.
- (1183) G. W. Pickard, of Amesbury, Mass., procures U. S. patents numbers 912,613 and 912,726 covering the invention of crystal detectors for radio signaling.
- (1184) The Wireless Association of America is organized by Hugo Gernsback, New York. (The society merged with a later organization in the year 1913.)
- (1185) The Wireless Institute of New York is organized.
- (1186) On March 4, while the presidential inauguration is under way the city of Washington loses telegraphic and telephonic communication in all directions due to sleet storms.
- (1187) In America there are 10,000 motor-cars and trucks operated by electric motors.
- (1188) The Edison nickel-flake iron storage cell is brought out.
- (1189) 4,164 out of 5,780 central lighting stations in the United States use alternating current for light and power services.
- (1190) There are 3,000 stock ticker instruments installed in offices in New York City using up 50,000 miles of paper tape per year.
- (1191) The printing telegraph system invented by John E. Wright is placed in service on trunk lines of the Postal Telegraph-Cable Company. Five circuits are so operated.
- (1192) The American Telephone and Telegraph Company purchases a controlling interest in the Western Union Telegraph Company, with the object of attempting to derive benefits from joint operation of lines and offices.
- (1193) Stephen D. Field installs quadruplex terminal equipment at both ends of the Key West-Havana cable.
- (1194) Lewis A. Stillwell is elected president of the A. I. E. E.
- (1195) The American Telephone and Telegraph Company handles all of its traffic over all-cable circuits between New York and Philadelphia, New York and New Haven, and Chicago and Milwaukee.
- (1196) The Great Northern Railroad inaugurates (July 10) electric operation of its trains through the Cascade tunnel.
- (1197) The Hydro Electric Power Commission of Ontario, Canada, awards contracts for the building of 300 miles of 110,000-volt transmission line. Energy will be brought from Niagara Falls.
- (1198) The net earnings of the National Carbon Company for the year ending January 31, 1909, were \$980,283.
- (1199) Twenty-five watt and forty-watt tungsten electric lamps are widely introduced commercially.
- (1200) B. Jonas, of Toledo, Ohio, patents a new type of primary cell battery.
- (1201) T. Giara, of Boston, Mass., invents a system of multiplex telegraphy applicable to radio signaling. (U. S. patent No. 914,713.)
- (1202) A United States patent is issued to Werner von Bolton, of Germany, covering the invention of an electric lamp filament of tantalum.
- (1203) J. J. Skidmore, of Boston, patents an automatic, balanced telephone repeater system.
- (1204) J. R. Byrne, of Schenectady, N. Y., brings out a pull-chain switch socket for incandescent electric lamps.

(To be continued)

# NEWS OF THE INDUSTRY

## VETERAN WIRELESS OPERATORS ASSOCIATION NEWS

To the readers of RADIO ENGINEERING, who are not members of the Veteran Wireless Operators Association, we introduce ourselves.

### GREETINGS:

The Veteran Wireless Operators Association was founded in 1925 by a small group of former wirelessmen, all of whom had seen service in the early 1900's as professional wireless operators. From an original membership of less than a score our organization maintained a steady growth until a peak enrollment of 1200 members was reached.

The purposes of the Association, as set forth in our articles of incorporation, are as follows:

(a) To foster and extend an *esprit de corps* among wireless operators.

(b) To afford opportunity for social intercourse, and to promote a fraternal and comradely sentiment between and among its members.

(c) To recognize meritorious service rendered by wireless operators on land, at sea, or in the air, by the erection of memorials and by the bestowal of testimonials, medals, scholarships, or other suitable awards.

(d) To acquaint the public with the work, traditions and ideals of wireless operators and to perform and encourage any other purely fraternal activity or activities adjudged helpful to the wireless profession.

**OFFICERS:** Fred Muller, President, formerly Marine Radio Superintendent, Tropical Radio Telegraph Company, Consulting Radio Engineer, Hillside Avenue, Monsey, New York; George Clark, Vice-President, Museum Director, RCA Victor Company; William J. McGonigle, Secretary, New York Telephone Company, Brooklyn, N. Y.; V. H. C. Eberlin, 2nd, Treasurer, formerly Radio Inspector Tropical Radio Telegraph Company, Chief Radio Officer, S/S. Calamares, United Fruit Company.

**DIRECTORS:** W. S. Fitzpatrick, Chairman, Advertising Manager, RCA Institutes, Inc., New York; A. J. Costigan, Traffic Superintendent, Radiomarine Corporation, New York City; Paul K. Trautwein, President, Mariners Radio Service, New York City; Charles D. Guthrie, Mackay Radio and Telegraph Company, New York City; Thomas M. Stevens, General Superintendent, Radiomarine Corporation of America, San Francisco, Calif.; Charles W. Horn, General Engineer, National Broadcasting Company, New York City; A. A. Isbell, Manager, Commercial Department, RCA Communications, Inc., New York City; L. L. Manley, formerly Service Manager, RCA Victor Company, Camden, N. J.

**MEMORIAL DAY SERVICES**  
May 30th, 1934

At the request of the Veteran Wireless Operators Association, the Naval Com-

munications Service, Coast Guard Communications Service, Radiomarine Corporation of America, Mackay Radio and Telegraph Company, Tropical Radio Telegraph Company and many other commercial radio communications services, observed a silent period of one minute immediately following the noontime signal on Memorial Day in tribute to deceased radiomen. We take this opportunity of publicly expressing our sincere appreciation of their cooperation.

Simultaneous with the silent period observance Memorial services were held at the Wireless Operators Monument in Battery Park, New York City. The Memorial services were presided over by William J. McGonigle who delivered the opening address eulogizing the loyalty and courage of the radio operators who had given their lives in the performance of their duty. An address was prepared especially for the occasion by the Reverend Sidney T. Cooke who officiated in behalf of the Seamen's Church Institute.

The Reverend Cooke concluded his Memorial with a prayer appropriate to the occasion.

The Memorial Services were concluded by the playing of "Taps" by Bugler Kayser, of Fort Jay, New York.

A. F. Wallis, Commercial Representative of Mackay Radio and Telegraph Co.; C. J. Pannill, Executive Vice-President, Radiomarine Corporation; A. J. Costigan, Traffic Superintendent, Radiomarine Corporation, and a group of wireless operators and their friends, approximately three hundred in all, attended the services.

**EDITOR'S NOTE:** *Communications to the Veteran Wireless Operators Association should be addressed to William J. McGonigle, Secretary, 112 Willoughby Ave., Brooklyn, N. Y.*

### THE I. R. E. CONVENTION

The Philadelphia Section of the Institute of Radio Engineers, acting as hosts, may well feel proud of the Ninth Annual Convention of this group which was held at the Benjamin Franklin Hotel, Philadelphia, Pa., on May 28, 29 and 30. With what was probably one of the largest attendances ever held at an I. R. E. Convention, some 670 were registered Monday night and a great many in attendance who were not, and with the entire program working with machine-like precision, the whole affair was a distinct success.

The technical sessions featured such timely subjects as multi-range and high-fidelity receivers, transmitter developments, ionosphere studies, wave filters, cathode-ray tubes, microphones, vacuum tubes, an electronic oscillator, and many others. The present interest in these subjects was definitely shown by the size of the groups that attended each technical session and by the criticalness of this audience. Of particular interest was the

continued emphasis, in practically all the high-fidelity papers, on the fact that cut off of the audio band would probably be around 7,000 rather than 8,000 cycles, in these receivers.

The exhibition of component parts, manufacturing aids, measuring devices and the like, also attracted considerable interest and brought to the attention of those present, the numerous new products that have recently been placed or will be placed on the market. There were, in all, 54 exhibitors.

Of added interest was the informal banquet held on Tuesday evening in the Crystal Ballroom which presented a very interesting program to the unexpectedly large number of guests.

Besides a full program of entertainment for the ladies, two trips of exceptional interest were made available. On Monday evening, a trip through the Franklin Institute proved to be of a great deal of interest and value, while the luncheon and trip through the RCA Victor plant in Camden, N. J., almost stole the show.

In general, the convention proved of great value to all those that attended, and, further, it definitely proved that the radio industry is showing remarkable signs of improvement.

### BRITISH RADIO EXHIBITIONS

**NATIONAL RADIO SHOW**  
Olympia, W. 14. August 15-25. Apply to Secretary, The Radio Manufacturers' Association, Astor House, Aldwych, W. C. 2, England.

**NORTHERN NATIONAL RADIO EXHIBITION**  
September 14-22. Apply to Provincial Exhibitions, Ltd., City Hall, Deansgate, Manchester, England.

**SCOTTISH NATIONAL RADIO EXHIBITION**  
(Incorporating the Music and Gramophone Trades)

October 12-22. Apply to T. Percy Bentley, 6 and 7, Waverly Market, Edinburgh, Scotland.

### BAKELITE "OLD TIMERS" BANQUET

On Wednesday, May 9th, the "Old Timers" of Bakelite Corporation, held the first of an annual series of banquets at Hotel Deauville, Somerville, N. J. Only those who had been with the company more than ten years were eligible to attend. Out of the hundred "old timers" present, a large percentage were celebrating more than twenty years association with the company.

### TUBE SHIELD BULLETIN

A bulletin on form fitting tube shields has just been issued by the Goat Radio Tube Parts, Inc., 314 Dean Street, Brooklyn, N. Y.

This bulletin, besides giving technical data and descriptions of their different type tube shields, also includes information on their performances and construction.

### AIR EXPRESS SETS RECORD

With number of shipments soaring 22% over March and topping April 1933 by a 188% increase, the Air Express Division of Railway Express Agency reported another all-time record for the handling of

(Continued on page 28)

# NEW PRODUCTS

## AIRCRAFT COMMUNICATION RECEIVER

The RCA Victor Model AVR-3 Aircraft Communication Receiver was developed specifically for use in aircraft, and may be used for the reception of radio telephone and any modulated radio service operating in the frequency band of 2,000 to 6,600 kc. These frequencies are covered in two bands, namely, 2,000 to 3,650 kc and 3,650 to 6,600 kc. Ample overlap at each end of the bands is provided.



The receiver is a superheterodyne with a stage of tuned r-f, and a type 85 diode-triode as second detector, AVC, and first a-f amplifier. The output tube is an 89.

Other features of the unit shown in the illustration are: Tuning continuously variable over entire frequency band; requires only small antenna on aircraft; automatic volume control; combined "on-off" switch and volume control; crank type tuning control; indirectly lighted and calibrated dial; twin phone jacks; dynamotor type power unit which derives its primary power supply from the standard aircraft 12-volt storage battery and develops all required plate and bias voltages; an extreme of sensitivity with a minimum background noise; high degree of selectivity; good audio fidelity; a power output of 600 milliwatts; shock mounted and vibration proof construction; and a total current drain of 2.8 amperes at 12 volts for complete operation. The tube filaments and dial lamp require 1.0 ampere and dynamotor power unit 1.8 amperes.

## TRAFFIC CONTROL TRANSMITTER

The RCA Victor Model AVT-1 Airport Radio Traffic Control Transmitter, shown in the accompanying illustration, is especially designed and constructed to meet the requirements of the service encountered in airport traffic control work. The unit permits, among other things, voice communication with all radio-equipped arriving and departing aircraft, thus making possible traffic control by direction and control of landings and take-offs as well as general communication within a 15-mile radius.

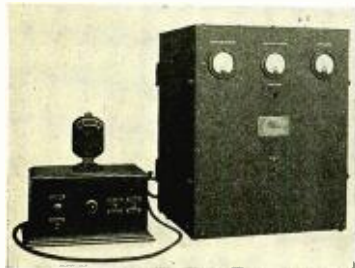

The AVT-1 Transmitter is a crystal controlled, 15-watt, fixed tuned unit, capable of 100% modulation when used with the double-button microphone supplied as part of the equipment. Provision is made for mounting two crystals in the crystal oven, so that, if desired, a spare crystal may always be available, and operation is entirely from 115 volts, 50-60 cycles . . . no batteries being required. However, if the primary voltage differs by more than 5% from the 115 volts under load, corrective measures should be employed.

The transmitter is fixed tuned, as ordered, between 200 and 410 kc, and the r-f section of the transmitter uses an 865 as crystal oscillator, two 865's as power amplifiers, and an 83 rectifier. The a-f section requires the following tubes; one 57 as audio amplifier and oscillator, two 59's as Class B modulators, one 59 as audio amplifier (driver), and an 83 as rectifier.

## AMPERITE RIBBON MICROPHONE

Besides giving faithful conversion of sound to electrical energy, the New Amperite Ribbon Microphone shown in the accompanying illustration is said to be excellent for eliminating acoustic feedback, and contains a number of novel features.

The cavity resonance of the case is eliminated by a screen construction so designed that the sound waves have a free path, the case being heavy enough to withstand a



great deal of abuse. The pole pieces are machined and placed in such a way that high flux density is obtained in the air gap. Although smaller, it is said that the magnets are more powerful than the ones used in former designs, this being made possible by the use of 35% Cobalt Steel. The ribbon is hand hammered to 0.0002 inch.

The output of the microphone is approximately -90 db and has a flat response from 60 to 10,000 cycles (1-db difference).

## IMPROVED 212-D TUBE

Improved mechanical sturdiness obtainable through the unique graphite anode and channel-beam construction, as well as a thoriated tungsten filament, mesh grid and ring seal, serve to produce a new Sylvania type 212-D tube of rigidly maintained characteristics throughout a longer service life, according to the engineers of the Hygrade Sylvania Corporation, Electronics Department, Clifton, N. J.

The graphite anode is further reinforced by the channel-beam construction, resulting in ruggedness; there is little change of

inter-electrode capacities, since the graphite anode cannot warp; the mesh grid is mechanically vibrationless, so that capacity changes with this element are nil; the thoriated tungsten filament is mounted on tension springs which keep this element in perfect alignment under all thermal conditions; the actual temperature between elements, however, is continuously lower than in tubes employing metal plates, because of the high thermal emissivity of graphite; and coolness of these internal elements prevent secondary grid emission and gas, it is further stated.

Connections through the base of the glass envelope are widely spaced and are specially "bead sealed." These base connections . . . plate and grid . . . are not brought through the stem. Stranded wires are placed in bead seals outside the stem and press, so that high insulation value is maintained between these leads. An aluminum base is employed.

All available classes of older 212-D tubes are interchangeable with the four classes of Sylvania 212-D, namely: Class I—110-129 mils.; Class II—129-148 mils.; Class III—148-167 mils.; and Class IV—167-185 mils.

## QUARTZ CRYSTAL HOLDER

The "Ecco" Plug-in Dust Proof Quartz Crystal Holder, manufactured by the Eastern Coil Co., 56 Christopher Avenue, Brooklyn, N. Y., is suited for amateur and broadcast transmitters. It has been designed for use with crystals ranging from one-fifth to six millimeters in thickness (20-600 meters).

The unit is made in two sizes: one to accommodate the average one inch square crystal (Type A), and the other for crystals up to 1½ inches (Type B). Contact to the crystal is made through brass plates ground flat. The bottom brass plate is nickel-plated on its outer side and the top bakelite cover is held in place by four screws. Electrical contact, by means of a copper-braid pigtail, is maintained with the brass plate which rests lightly on the crystal, allowing it to oscillate freely. Standard G. R. tips are used spaced ¼ inch to fit a standard G. R. connector.

## BELDEN LEAD-IN WIRE

A new weatherproofed twisted lead-in wire for short-wave installation, is announced by the Belden Manufacturing Company, 4689 W. Van Buren St., Chicago, Illinois.

The new wire is the same as that provided in the recently announced Belden All-Wave Aerial Kit. It is accurately twisted so that it gives superior service



on aerials that have been specially designed for short-wave service. The lead-in wire consists of 2 stranded rubber insulated conductors with a weatherproofed braid overall. Furnished in 2 numbers—Belden No. 8835, 100 ft. coils and Belden No. 8836, 500 ft. coils.

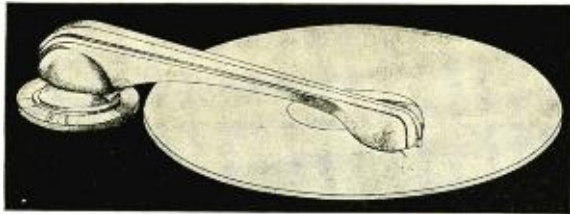

Illustration of the new Amperite crystal pickup of die-cast construction.

#### AMPERITE PICKUP

The Amperite Pickup, manufactured by the Amperite Corporation, 561 Broadway, New York, N. Y., is a non-magnetic device designed so that it may be used with sets having only one stage of audio.

It consists of an oxide crystal with an average resistance of approximately 100,000 ohms, and the output of this unit is +10 db as compared to -15 for the magnetic. The high resistance of the pickup makes it possible to couple it directly to any radio set without making any changes, the operation of the set not being effected. Further, no background noise is developed, it is stated. Proper damping, in addition, makes it possible to eliminate all resonant peaks, and it is said that the response actually rises at the lower frequencies.

The die cast construction eliminates tone arm resonance. Ball bearing pivots give free motion to the arm, resulting in perfect tracking, they state, and long record life is obtained by the low weight on the record. . . . 50 grams.

#### NEW SHURE MICROPHONES

Shure Brothers Company, 215 West Huron Street, Chicago, Ill., have announced three new microphones.

The Model 5B is a two-button full-size microphone weighing 15½ ounces. This chromium plated unit has a maximum current rating of 21 ma. per button and an equivalent internal impedance of 200 ohms. The frame diameter is 3 inches and the frame thickness 11/16 inches.



The Model 3A is a two-button microphone suitable for paging systems, portable public-address, and the like. The maximum current rating for this unit is 10 ma., the equivalent internal impedance is 200 ohms, the frame diameter is 2½ inches, the frame thickness ½ inch, and the net weight 5½ ounces.

A maximum current rating of 10 ma., an equivalent internal impedance of 100 ohms, a frame diameter of 2½ inches, a frame thickness of ½ inch, an overall diameter of 3¼ inches, and a net weight of 5 ounces are the specifications for the single-button Model 2A microphone which was designed to be used on amplifiers that will only accompany a single button unit.

#### CURTIS CONDENSER CATALOGUE

The Curtis Condenser Corporation, 3601 W. 140th St., Cleveland, Ohio, have released a new catalogue covering their complete line of electrochemical condensers. A copy may be had free on request.

#### NEW "DEPENDABLE" SWITCHES

A new line of switches is being produced by the Radio City Products Co., 48 West Broadway, New York, N. Y. These switches, it is stated, fulfill all requirements for a quality product where demands are exacting, and they are unusually rugged in design and construction which safeguards against decrease in efficiency after continued use.

The discs are made of high grade bakelite with a low moisture content, the electrical conductors are made of a special alloy giving high conductivity and a small amount of wear, and the moving arm makes a positive and wiping contact which is self cleaning.



The shaft is entirely insulated from the contact arm, (bakelite shafts being supplied upon order for ultra short-wave use), and the capacity between contacts is low.

These units require only a single hole for mounting (¾-inch bushing), numbered dial plate and knob being included with each switch which is individually boxed. While the switch illustrated here is of the 12-point type, they may be had in ranges from 3- to 12-point in single or multi-gang up to seven gangs.

#### BUD PORTABLE SOUND SYSTEM

The Bud Speaker Company, 1156 Dorr St., Toledo, Ohio, have introduced a new portable sound system which includes as standard equipment a condenser microphone, and which employs speakers with a new type of baffle.

The condenser microphone has a diaphragm of .001 in. duralumin, with a brass back plate. The spacing is adjustable. To the rear of the microphone head is a two-stage resistance coupled pre-amplifier using two type 30 tubes. The output impedance is 200 ohms and the output level is -20 db.

The power supply and power amplifier are mounted in a single case. The power supply employs a type 83 rectifier and the amplifier a type 57, one type 56 and one 2B6 power tube. The power-supply unit also provides the necessary voltages for the condenser microphone.

The speakers are of the permanent magnet dynamic type, with 8 in. faces, and are used in conjunction with a new type of parabolic deflector baffle which is said to reduce feedback to a marked degree.

A special circular describing the Bud Portable Sound System, and other new products, may be had upon request to the manufacturer.

#### "UNIVERSAL" DETECTIVE LISTENING EQUIPMENT

Detective Listening-in Equipment has just been placed on the market by the Universal Microphone Co., Inglewood, Cal., in a specially constructed carrying case. It may be used as a portable outfit, or kept in one location as permanent equipment.

Technically the outfit has two stages of amplification, a volume control, a high and low switch, two pairs of earphones and comes supplied with six microphones of an ultra-sensitive type.

The instrument is said to be practically foolproof. There are no complicated adjustments. Plug in the phones and it is ready to operate. There are 800 feet of lead-in wire which is so small it cannot easily be seen or discovered. The outfit has volume, power and exceptional tonal quality, it is stated.

#### WECO GENERATORS

The Weco Manufacturing Company, Inc., 520 Second Avenue, Seattle, Wash., announce a new alternating-current generator, in which voltage regulation is accomplished automatically within the generator itself without the use of moving parts or resistances. The principle upon which the unit is based may be incorporated in generators of any size or voltage, either single or polyphase, they state.

The generator is a 60-cycle, 110-120-volt, 500-watt (350-watt equipment) unit that is radio shielded and self excited. It requires no batteries and weighs about 60 pounds. It can, they state, be used in the open and under all climatic conditions. A special cooling system is provided.

#### G-E INVERTED CONVERTER

Built from standard direct current motor and generator parts, the General Electric Company has developed a new and inexpensive line of inverted converters, ranging in size from ½ to 20 kv-a, single phase. For use with small machine tools, radio equipment, public-address systems, etc., where only direct current is available, the new inverted converters are available for changing 115 volts d-c to 110 or 220 volts a-c, and 230 volts d-c to 110 or 220 volts a-c.

The field structure of this new equipment serves both windings and is identical with the field construction of standard d-c motors and generators. These two bearing units use duplicate end shields. More compact than a standard motor-generator set, the inverted converters are readily portable, and afford better voltage regulation than is ordinarily available.

#### SHIELDED WEATHERPROOF TUBING

The Shielded Low Capacity Weatherproof Tubing shown in the accompanying illustration is manufactured by the Lenz Electric Manufacturing Company, 1751-57 N. Western Avenue, Chicago, Ill. This



tubing, they state, is excellent for shielding the output of signal generators and, in addition, the small outside diameter permits easy assembly in corner posts of autos as a shield for the antenna lead-in. The inside diameter of this low capacity tubing is 3/16 inch, with an outside diameter of approximately ¼ inch, and it may be obtained in either 50- or 100-foot coils, the respective weights of these coils being 2.0 and 4.0 lbs.

## As "Sterling" is to Silver—



so is the name "GATES" to equipment for Broadcasters—Public Address and Theatre Systems—It guarantees fine engineering—fine design—fine materials—absolute reliability. But 12 years of service to the world's users has taught them that "GATES" means—high quality—less cost—longer life.

*Gates Engineers invite your inquiries on any class of sound equipment.*

**Gates Radio & Supply Co.**  
Manufacturing Engineers  
QUINCY, ILLINOIS

## KULGRID "C" STRAND TUNGSTEN WELDS

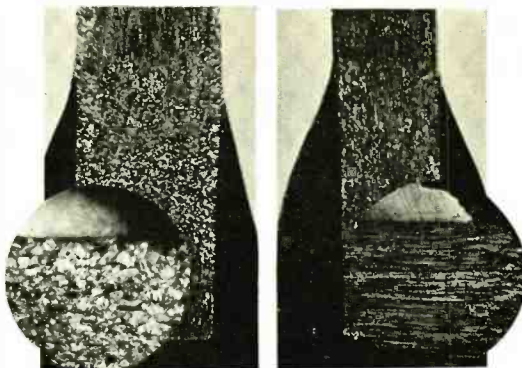

Fig. 1.

Fig. 2.

### Reduce Manufacturing Costs of Electronic and Transmitting Tubes

Note the difference in Tungsten welds when ordinary copper wire (Fig. 1) and Kulgrid "C" Strand (Fig. 2) are used. Copper, while highly conductive, quickly crystallizes under high heat, becomes flaky and brittle and drops off. Kulgrid "C" Strand does not crystallize, remains flexible, maintains its high conductivity and eliminates oxidation or gassiness at the weld and seal.

A 4-page data sheet explaining the properties and characteristics of the four types of Kulgrid Strand will be sent free upon request.

**CALLITE PROD. DIV.**  
UNION CITY, NEW JERSEY

*Dependable Sensational Performance!*

## BUD Laboratory-Built P. A. Equipment



Try **BUD** Sound  
Equipment  
For Five Days  
Absolutely Free!



ELECTRO-DYNAMIC UNITS  
DOUBLE BUTTON CARBON  
MICROPHONES • 4 & 6 FT.  
ALL ALUMINUM TRUMPETS  
FIELD EXCITERS • AIR COLUMN  
HORNS • LOW AND HIGH  
FREQUENCY UNITS FOR WIDE  
RANGE THEATRE USE

We invite careful, critical inspection of our entire line of BUD laboratory-built sound equipment. We suggest that you conduct your own comparative test. We CHALLENGE you to duplicate BUD performance and BUD DEPENDABILITY AT ANY PRICE! Write today for descriptive literature and prices and details of our FREE FIVE DAY TRIAL offer.

**BUD SPEAKER CO.**  
1130 JACKSON ST.  
TOLEDO, OHIO-U.S.A.

—ELMET—

# MOLY



FOR

GRID WIRES

SUPPORT WIRES

ELECTRIC FURNACE  
HEATING ELEMENTS

ALSO FOR

SCREEN GRIDS—CATHODE COILS  
MANDRELS—CONTACTS, ETC.

ALL OF THE ABOVE PRODUCTS MAY  
BE HAD IN VARIOUS COMPOUNDS OF  
**MOLYBDENUM-TUNGSTEN**



Write for Information and Prices

**American Electro Metal Corp.**  
Lewiston Maine

## A. T. R. FULL-WAVE VIBRATORS

The American Television and Radio Co., St. Paul, Minn., have full-wave vibrators of the inverter and self-rectifying inverter types for use in 6- and 32-volt "B" power units.



The full-wave inverter is designed for use with a transformer to deliver a-c current for rectification by means of a tube, such as the 84 type, at a minimum efficiency of 61 percent, and for use with any circuit regardless of whether or not the B- is grounded. It may also be used with just the transformer for supplying current to a-c operated devices.

The self-rectifying inverter is of the full-wave synchronous type, and is designed to deliver high voltage direct current when used with a transformer at a minimum efficiency of 70 percent. It is usually used with circuits having the B- grounded when operated from a common battery supply.

## UNIVERSAL RECORDING DISCS

Universal Microphone Co., Inglewood, Cal., has started to market a new six-inch celluloid disc designed especially for experimental recording purposes.

It will be a blank disc, ungrooved, and when used with a sapphire needle and proper equipment will retain the high-frequencies with the utmost fidelity, they state.

## PORTABLE P-A SYSTEM

The PAC-7 model portable p-a system, a product of Sound Systems, Inc., Cleveland, Ohio, is a complete and practical unit featuring a newly developed crystal microphone that is quiet in operation, can be used in any position, moved while in use without background noise, and does not require energizing current. The loudspeakers, which are of the permanent magnet type requiring but one pair of wires, may be extended several hundred feet without impairing quality. Further, no energizing current is required for the speaker fields.

The PAC-7 amplifier will operate up to 6 permanent magnet speakers at maximum output. The total weight of the unit is 47 pounds. This unit can be used for outside (as well as inside) work with two dynamic units and trumpets. The PAC-7 is a three stage resistance coupled triple push-pull, 7.5-watt output amplifier, with an impedance tap switch to match from one to six 500-ohm lines. The input is high impedance, with two positions, allowing either two crystal microphones

or microphone and crystal phono pickup. Controls consist of an on-off switch, an output impedance tap switch, program selector switch, and volume and tone control.

## CONDENSER MICROPHONES

Several refinements, involving mechanical construction and frequency response characteristics, are present in the current production of Model 40C Condenser Microphones by Shure Brothers Company, 215 West Huron Street, Chicago.

All condensers and resistors are mounted in a catacomb; and are double shielded, protected, and mechanically rigid. The cable to the tube sockets and the output transformer are the only visible elements.

An interesting feature of the new instrument is "valve-control" of barometric compensation to equalize performance under varying air pressures. The range of compensation has been greatly extended, insuring constant performance under widely varying conditions of weather and altitude and improving the frequency characteristic, they state.

Accessibility of amplifier tubes and the four terminals for the adjustment of the output impedance have been retained. They are readily available under the back cover which unlocks with a twist of a tiny chrome lever.

## NEWS OF THE INDUSTRY

(Continued from page 24)

air cargoes over commercial air lines during the month of April. This express matter was flown by contract aviation lines comprising a nation-wide network and including United Air Lines, General Air Lines (formerly Western Air Express), and others, giving a coordinated transcontinental and feeder-line system.

Heaviest gains were reported from metropolitan airports with Chicago registering an increase of 37% over March and jumping ahead of New York which handled the greatest number of shipments on the Railway Express Air system the previous month. Other increases at terminal airport cities were as follows: Toledo, 98%; Tulsa, 80%; Kansas City, 52%; Seattle, 45%; New York, 37%; Dallas, 37%; Los Angeles, 16%; and Cleveland, 16%.

## WESTINGHOUSE APPOINTS NEW SUPERVISOR

Walter C. Evans, Manager of the Chicopee Falls Plant of Westinghouse, announces the appointment of Mr. G. V. Bate as the General Foreman in charge of radio manufacturing. Mr. Bate's duties will include the supervision of all classes of radio production handled at the Chicopee Falls Plant.

## GENERAL CABLE FOLDER

The General Cable Corporation have just issued a folder covering their rubber insulated, braided, non-metallic sheathed Network Cable. The folder covers all the advantages of each particular section of the cable, shows the effects of submersion in oil for an extended period of time, and shows, in addition, a number of diagrams of their products.

The constructional details of General Cable Network Cable may be obtained free upon request.

## INCREASE IN NATIONAL UNION FORCE

Indications that the radio tube industry is participating in the general business upswing were brought to light when National Union Radio Corporation revealed an increase in the number of its factory workers.

Not only are the two National Union factories in Newark, New Jersey, humming with activity during the course of a full five day week, but in addition, a sizable night shift has swung into action, it is stated.

## "UNIVERSAL" CATALOG

Universal Microphone Co., Inglewood, Cal., has issued its fall catalog supplement with nearly a hundred items which the firm has placed on the market since its printed catalog was issued some time ago.

New products include two types of recording machines for 12" to 16" records, 33 $\frac{1}{3}$  and 78 r.p.m.; phonograph pickup and recording head, lead screw device and other items.

The latest development from the Universal factory is a Power Recorder for cutting any type of material and recording of all audible frequencies. The field coil is energized by 6 volts, thus insuring a powerful magnetic field and eliminating lag in cutting. The arm is of rigid aluminum casting and all bearings are the adjustable pivot type which gives free movement without lost motion. The lever adjusted spring sets needle pressure from two to twelve ounces and compensates for slight irregularities in discs or turntables.

The recorder will be marketed in values of 15-50-200 or 400 ohms.

## NBC APPOINTMENTS

Appointment of Walter E. Myers, manager of Station WBZ, Boston, to the post of national sales representative of the National Broadcasting Company in Boston, was announced by Richard C. Patterson, Jr., NBC executive vice-president.

Simultaneously it was announced that J. A. Holman, pioneer radio executive, had been named manager of WBZ.

John H. Bachem, of the Eastern Sales Department, has been made Assistant Eastern Sales Manager under Donald S. Shaw, Eastern Sales Manager.

F. E. Spencer, formerly of NBC's Local Sales, will also assume new duties effective immediately. He will work with Mr. Shaw and Mr. Bachem on the coordination of transcription and local business for the Eastern Sales Department.

James V. McConnell has been assigned to assist Edgar Kobak, Vice-President in Charge of Sales, and Roy C. Witmer, operations head for all NBC sales divisions. Mr. McConnell will function as an operations assistant coordinating the operating activities of all NBC Sales Divisions, and between these divisions and other NBC departments.

## CENCO SCIENTIFIC NEWS

We have just received the first issue of Cenco Scientific News, a publication on educational scientific apparatus, published by the Central Scientific Company, 460 E. Ohio St., Chicago.

This particular issue features "Check Lists of Essential Equipment for the Sciences," and gives, in addition, very interesting descriptions of a number of their products . . . a total of 15 pages of interesting and informative reading.



**T**HE Group Subscription Plan for RADIO ENGINEERING enables a group of engineers or department heads to subscribe at one-half the usual yearly rate.

The regular individual rate is \$2.00 a year. In groups of 4 or more, the subscription rate is \$1.00 a year. (In Canada and foreign countries, \$2.00.)

---

The engineering departments of hundreds of manufacturers in the radio and allied industries have used this Group Plan for years, in renewing their subscriptions to RADIO ENGINEERING.

---

Each subscriber should print his name and address clearly and state his occupation—whether an executive, engineer, department head, plant superintendent, or foreman, etc.

**Remember this Group Plan  
when *Your* Subscription Expires**

(Radio Engineering)  
**BRYAN DAVIS PUBLISHING CO., Inc.**  
19 East 47th Street, New York, N. Y.

**UNIVERSAL — 2-Button Precision LAPEL MICROPHONE**

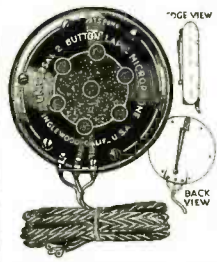

Get full Broadcast quality reproduction with this precision-built, 2-button lapel microphone—Only 3/8 in. thick—Polished Bakelite Housing—Typical Universal ruggedness.

Liberal Discounts to Dealers

UNIVERSAL MICROPHONE CO., Ltd.  
424 WARREN LANE, INGLEWOOD, CALIFORNIA, U. S. A.

**• WAXES**  
**• COMPOUNDS**  
**• VARNISHES**

For Insulation of Condensers

Transformers, coils, power packs, pot heads, sockets, wiring devices, wet and dry batteries, etc. Also WAX SATURATORS for braided wire and tape. WAXES for radio parts. Compounds made to your own specifications if you prefer.

**• ZOPHAR MILLS, Inc.**  
FOUNDED 1846 MEMBERS OF N.R.A.  
Court, Lorraine and Creamer Sts., Brooklyn, N. Y.  
Agents: Ralph B. Clark, 2007 Calumet Ave., Toledo, Ohio  
H. A. B. Snee Co., San Francisco, Seattle, New Orleans

**UNBIASED**

Many unusual troubles and faults not easily disclosed by the set analyser, with full instructions for their remedy, are fully described in this handy, pocket-sized, 180-page book. Compiled from the actual records of many thousands of service calls. Over 500 different receivers treated—contains 50 diagrams.

The author has no connection with any branch of the manufacturing industry. He had no axe of his own to grind when he wrote "Actual Troubles." His daily contacts in the servicing field gave him the foundation for writing this frank, unbiased manual.

**10 Day Free Trial**

A supplement is now being prepared and will be mailed to you (next September) at no additional charge.

**SOLD ON A MONEY-BACK TEN-DAY-FREE-TRIAL GUARANTEE.**

**\$100 POST PAID**

SERVICEMEN'S PUB. CO. 136 E Liberty St., N. Y. C.



IN COLUMBUS, OHIO,  
IT'S THE  
**FORT HAYES HOTEL**

In the center of the business district  
**300 ROOMS EACH WITH BATH \$2.00 Day**  
(Double \$3.00 a day)

PLENTY OF PARKING SPACE — GARAGE  
R. B. BUNSTINE, Manager

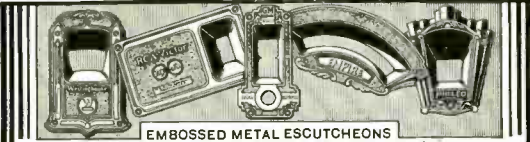

EMBOSSED METAL ESCUTCHEONS OF ALL KINDS. ETCHED PANELS AND SCALES. SMALL METAL STAMPINGS. If it's made of metal consult.

L. F. GRAMMES & SONS, Inc. 350 UNION ST. ALLENTOWN, PA.

**STUPAKOFF INSULATORS**



STUPAKOFF LABORATORIES, INC. PITTSBURGH, PA.

**BASES and CAPS ALL TYPES ALUMINUM — BRASS**      **TUNGSTEN WELDS ANY COMBINATION Special Strand Wire (O. F. H. C.) Nickel — Tungsten — Moly**

**Quality Products for Electronic Tubes**

Send in Your Specifications for Samples and Prices  
**"THE ENGINEERING CO."**

57-59 BRANFORD STREET NEWARK, N. J.

**BLILEY PIEZO-ELECTRIC CRYSTALS**

FOR USE IN RADIO

Transmitters - Receivers - Monitors - Standards  
Supplied to any frequency from 20Kcs to 15,000Kcs.  
Send for price list and descriptive circular.

**BLILEY PIEZO-ELECTRIC CO.**  
237 Union Station Bldg. Erie, Pa.

**INDEX TO ADVERTISERS**

<b>A</b>	<b>G</b>	Shakeproof Lock Washer Co.....	5
Allen-Bradley Co. ....	Gates Radio & Supply Co.....	Sound Systems, Inc.....	31
American Electro Metal Co.....	Goat Radio Tube Parts, Inc.....	Stupakoff Laboratories, Inc.....	30
	Grammes & Sons, Inc., L. F.....	Synthane Corp. ....	1
<b>B</b>	<b>L</b>	<b>T</b>	
Bliley Piezo-Electric Co.....	Littelfuse Laboratories .....	Thomas & Skinner Steel Products Co.....	31
Bruno Laboratories .....	Muter Company, The.....	<b>U</b>	
Bud Speaker Company.....		United Transformer Corp.....	29
	<b>M</b>	Universal Microphone Co. Ltd....	30
<b>C</b>	Racon Elec. Co., Inc.....	University of Wisconsin.....	31
Callite Products Co.....	Fourth Cover	<b>W</b>	
Central Radio Laboratories.....	Railway Express Agency, Inc.....	White Dental Mfg. Co., The S. S. Third Cover	
Clarostat Mfg. Co.....		<b>Z</b>	
	<b>S</b>	Zophar Mills, Inc.....	30
<b>E</b>	Scientific Radio Service.....		
Engineering Co., The.....	Servicemen's Pub. Co.....		





*feature:* UNUSUALLY COMFORTABLE ROOMS. THE FINEST OF FOODS AND RATES STARTING AT \$2.50 SINGLE. \$4.00 DOUBLE

*In Cleveland it's*

**The HOLLENDEN**

1050 ROOMS ALL WITH BATH  
RADIO IN EVERY ROOM

*In Columbus it's*

**The NEIL HOUSE**

650 ROOMS. ALL WITH BATH

*In Akron it's*

**The MAYFLOWER**

450 ROOMS. ALL WITH BATH  
RADIO IN EVERY ROOM

*In Miami Beach it's*

**The FLEETWOOD**

AN EXCLUSIVE WINTER RESORT HOTEL  
OPERATING EUROPEAN PLAN

**PORTABLE ADDRESS SYSTEM  
PERMANENT MAGNET SPEAKERS  
CRYSTAL "MIKE"**

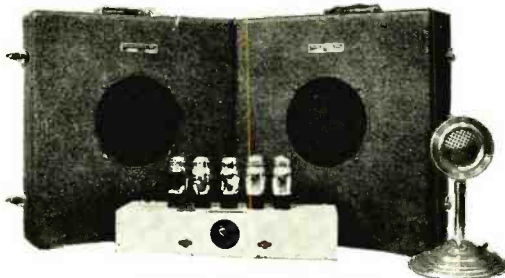

PAC 7 without tubes, \$100  
Compartment in speaker cabinets for amplifier and microphone.

Where dependability and fidelity are necessary, the new Crystal "Mike" equipped portable PAC 7 with permanent magnet speakers answers the need at a new low price. The amplifier will drive up to six speakers at maximum output.

No energizing current needed for loud speakers or microphone.

PAC 3-Amplifier and one dynamic speaker in cabinet, Crystal "Mike"  
Price without tubes, \$75.00

**Sound Systems, Inc.**

1311 TERMINAL TOWER CLEVELAND, OHIO

**ABSOLUTE ACCURACY**

All "Scientific Radio Service Crystals" . . .  
*are accurately ground to an accuracy better than .03% on equipment tested regularly by U. S. Bureau of Standards, Standard Frequency Signals*

Since 1925, owners of Broadcast and Commercial Short Wave stations have found that no chances can be taken in getting the cheaper grade of crystals and that invariably they call on Scientific Radio Service for the Best.

Since 1925, we could be depended upon to make Prompt Shipments. This coupled with a crystal Second to None considering Output and Accuracy of Frequency has earned during these years a reputation which we jealously guard. Therefore, Get the Best.

*Price list sent upon request*

FREE!—Send for Our New Illustrated Booklet—FREE!  
*Superior by Comparison—Prompt Shipments Assured*

**SCIENTIFIC RADIO SERVICE**

*"The Crystal Specialists" Since 1925*

124 JACKSON AVE., UNIVERSITY PARK, HYATTSVILLE, MD.  
Dept. RE-6



**FUSES**

INSTRUMENT  
Precision—  
1/100 amp. up  
RADIO  
HIGH VOLTAGE  
AUTO  
AIRCRAFT  
Anti-Vibration  
LITTELFUSE LABS.  
4505 Ravenswood Ave.  
CHICAGO, ILL.

**University Course in  
RADIO COMMUNICATION**

Open to high school graduates. Complete in 9 months.  
High standard of instruction and equipment. Fall term opens September 14.

**UNIVERSITY OF WISCONSIN**

623 W. State Street Extension Division Milwaukee, Wis.

**LAMINATIONS**

*for Audio & Power Transformers*  
SPECIALIZED METHODS — YEARS OF EXPERIENCE  
Wide Variety of Stock Standard Sizes

*Dimension and Price Sheets on request*

*We Also Make*  
PERMANENT MAGNETS—DIES—TOOLS—  
METAL STAMPINGS

*Facilities for prompt service*

**Thomas & Skinner  
Steel Products Co.**

1100 to 1120  
E. Twenty-Third St.  
INDIANAPOLIS, IND.



**"Don't use all the steam  
for the whistle!"**

We could easily build so gosh-darn much D. C. resistance into our suppressors that you couldn't hear a Tesla coil exploding in your gas tank . . .

But you wouldn't get any power either. It's a case of knowing just the exact ratio of R. F. to D. C. resistance.

. . . and boy—CENTRALABS have the answer. They're sweet for noise suppression . . . and sweet for motor power.

Every Radio Service Man should be a member of the Institute of Radio Service Men

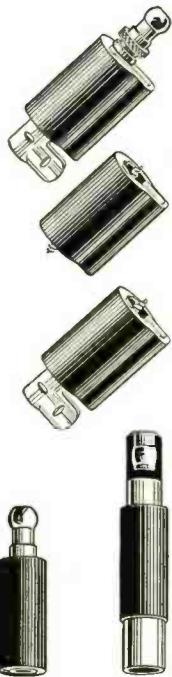

**Centralab**  
Motor Radio Noise Suppressors  
CENTRAL RADIO LABORATORIES  
MILWAUKEE, WISCONSIN



## LABELS that MEAN what they SAY

"RUSH"... "HANDLE WITH CARE"... "KEEP from HEAT and COLD"... "DELIVER IMMEDIATELY on ARRIVAL"... these are a few of the many special labels used by Railway Express to insure speed, safety and careful handling.

And these shipping instructions are not "suggestions" to our 50,000 employees. They are orders... orders that *must* be followed literally.

By giving special care to special shipments, Railway Express has built an enviable reputation for swift, safe handling of all kinds of merchandise. You can trust Railway Express with your emergency shipping problems, as well as for routine service... and know that your goods will arrive quickly and in good condition. Pick-up and delivery service available in all principal cities and towns without extra charge. Telephone the local Railway Express agent for service or rates.

*The best there is in transportation*

SERVING THE NATION FOR 95 YEARS

# RAILWAY EXPRESS

AGENCY, Inc.

NATION-WIDE SERVICE



# Radio TAXICABS



*the big new market for*

## **FLEXIBLE SHAFT controlled sets**

RADIO TAXICABS are a success. The experience of New York City taxi operators who have already equipped their fleets, proves it. They're getting the business. To offset this competition other operators will have to follow suit. And the movement is bound to spread over the country, opening up a vast new market which no Radio Set Manufacturer can afford to overlook.

But to get in on this business, Set Manufacturers must be prepared to offer a flexible shaft controlled set. For this type of set is being, and will invariably be, used in TAXICABS for the same reasons that it is first choice for private cars—flexibility of installation, with controls always at the point of greatest convenience for the user, in this case the passenger.

And the flexible shaft and casing with which the big majority of automobile radios are equipped—the shaft and casing that have made *remote control* of radio a success—naturally are the choice for taxicab radios — S. S. WHITE REMOTE CONTROL FLEXIBLE SHAFT No. 150L53, and FLEXIBLE CASING No. 170A1 — both specially designed for radio application.



**S. S. WHITE**  
FLEXIBLE SHAFT  
No. 150L53  
*and*  
FLEXIBLE CASING  
No. 170A1  
*specially designed for*  
REMOTE CONTROL of RADIO

### **WRITE FOR SAMPLES**

Samples of Shaft No. 150L53 and Casing No. 170A1 will be sent on request to Auto Radio Set Manufacturers and Manufacturers of Separate Remote Controls for auto radios. Full engineering cooperation for working out specific applications freely given. Quotations on specific requirements furnished for the asking.

The S. S. WHITE Dental Mfg. Co.  
Industrial Division

152-4 West 42nd St., New York, N. Y.





RADIAL



TRIPLE-CONNECTOR

# FLASH!

The Racon Electric Company announces a new catalog, describing fully the complete Racon line of electrodynamic units and air-column sound projectors. Nearly 100 different types of loudspeakers are listed, including many new items and important changes in others, to meet the varying requirements of the public address and theatre fields.

You will find in the new catalog a type of high-quality, high-efficiency loudspeaker to meet practically every requirement of sound projection. A copy of the catalog will be mailed on request, if you will write us on your letterhead.

*Racon electrodynamic units and horns are manufactured under 14 exclusive Racon patents.*

**RACON ELECTRIC CO. INC.**

52 EAST 19th STREET, NEW YORK CITY  
LONDON, ENGLAND      TORONTO, CANADA  
*Sales Offices in Principal Cities*



SIX FOOT TRUMPET



AEROPLANE HORN