

MARCH, 1934

Radio Engineering

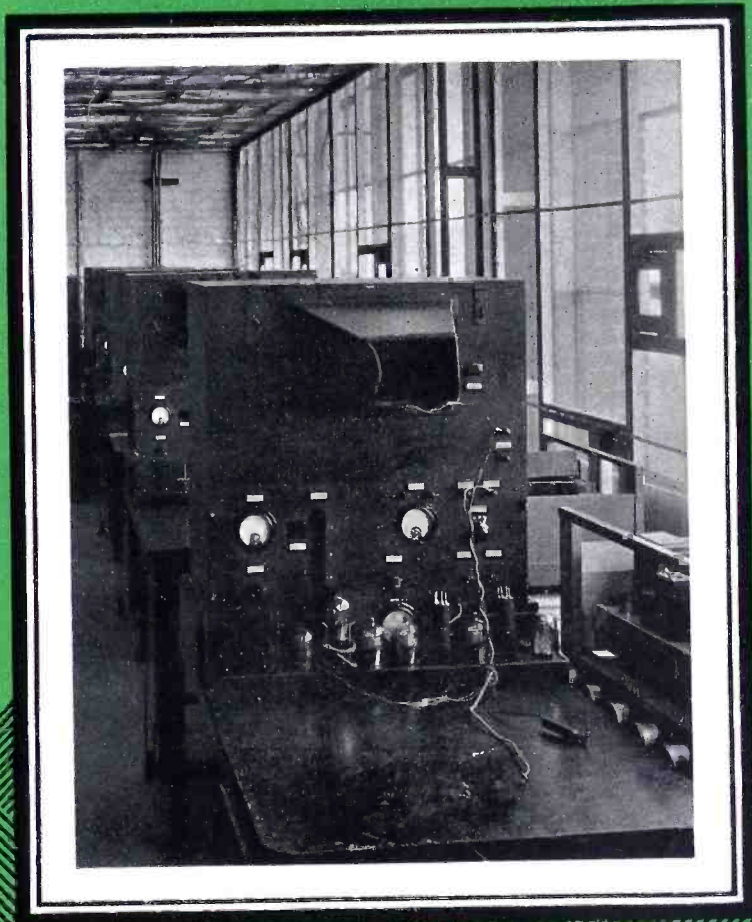

VOL. XIV

NO. 3



The Journal of the
Radio and Allied Industries

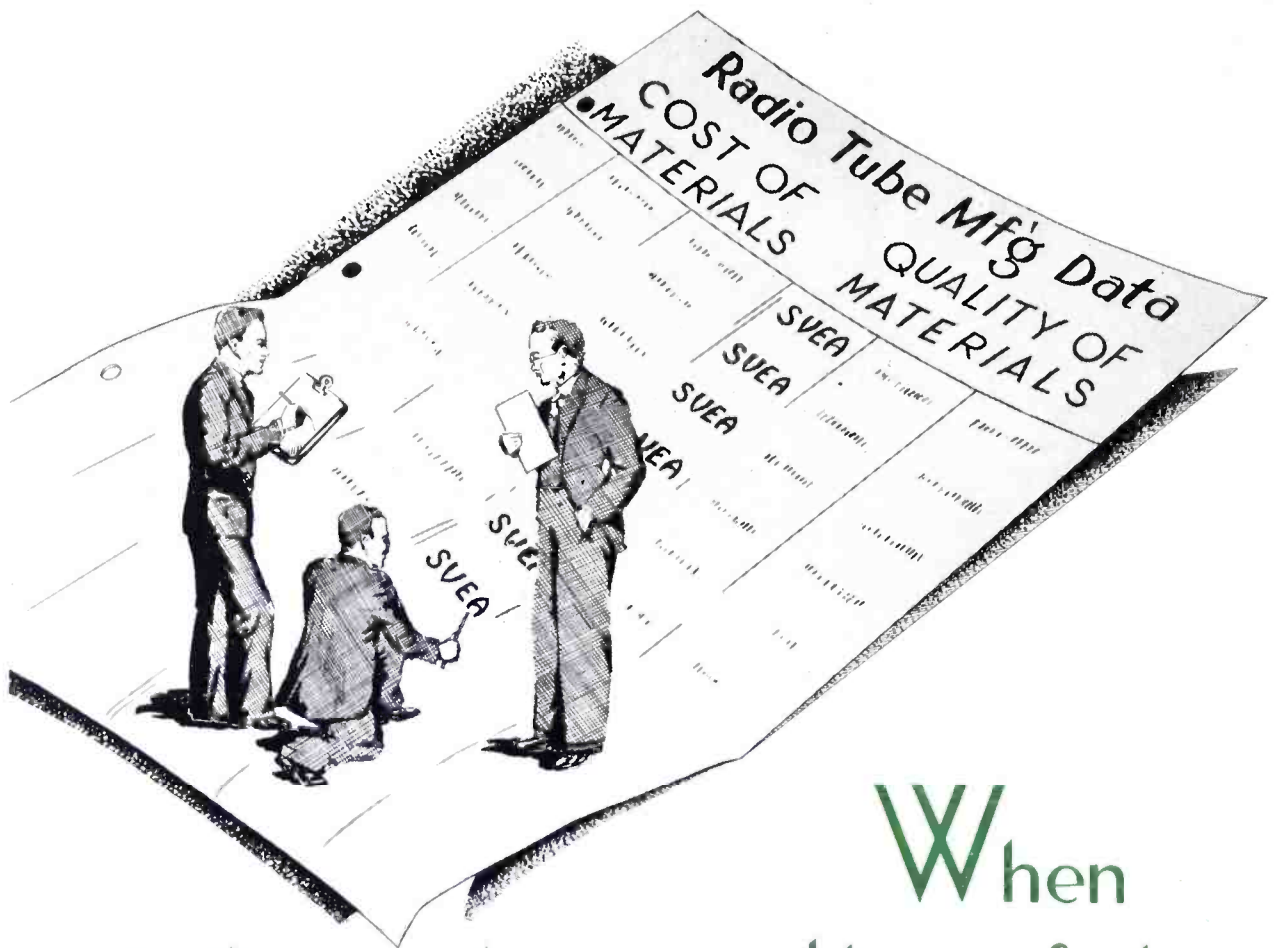

When
production costs and quality are factors

Why not use **SVEA METAL** and begin at once to *improve quality* and *save money*? Cut your metal costs in half, reduce shrinkage and make better tubes! SVEA METAL has been *tested, approved* and *adopted* by tube makers in the front rank. It is

YOUR BEST BET FOR 1934

Swedish Iron &

17 Battery Place



Steel Corporation

New York City



For more than a quarter of a century suppliers of high grade metals to the foremost electrical equipment manufacturers.

RADIO ENGINEERING

Reg. U. S. Patent Office

Editor
M. L. MUHLEMAN

Member
Audit Bureau of Circulations

Associate Editor
RAY D. RETTENMEYER

Vol. XIV

MARCH, 1934

Number 3

CONTENTS

	PAGE
COVER ILLUSTRATION	
STROMBERG-CARLSON OSCILLOGRAPHIC TEST EQUIPMENT	
EDITORIAL	2
MODERN RADIO COMPONENTS.....	5
INTEGRATIVE MANUFACTURING.....By Lee McCanne	10
HIGH-FIDELITY RECEIVERS.....By A. Gerard Hanley	14
PROGRAM FOR JOINT MEETING OF I.R.E. AND I.S.R.U. IN WASHINGTON	15
AUDITORY PERSPECTIVE.....By E. H. Bedell	16
HIGH-FIDELITY TRANSMITTERS.....By J. E. Young	18
AUTO IGNITION INTERFERENCE.....By Ray D. Rettenmeyer	20

DEPARTMENTS

COMMUNICATION AND BROADCAST ENGINEERING <i>A Chronological History of Electrical Communication— Telegraph, Telephone and Radio.....</i>	21
NEW PRODUCTS	22
NEWS OF THE INDUSTRY	28

F. C. C.

FOLLOWING A SPECIAL message from President Roosevelt to Congress on February 26, Senator Dill of Washington, Chairman of the Senate Interstate Commerce Committee, opened hearings March 9 on legislation to establish a Federal Communications Commission, to control communications by wire and radio. A similar bill has been introduced by Chairman Rayburn of the House Committee. Under both bills the present Radio Commission would be abolished and a new communications commission of seven members established, to continue radio and assume wire regulation. The present radio law would be continued, with new amendments proposed. The legislation follows a study of the communications and radio field by a special administration body headed by Secretary of Commerce Roper. The President nominated Representative Anning S. Prall as a member of the present Radio Commission to succeed William D. L. Starbuck, whose term expired February 23.

BRYAN S. DAVIS
President

JAS. A. WALKER
Secretary

Published Monthly by the

Bryan Davis Publishing Co., Inc.
19 East 47th Street
New York City

SANFORD R. COWAN
Advertising Manager

A. B. CARLSEN
Circulation Manager

Chicago Office—919 N. Michigan Ave.—L. F. McClure, Mgr.
Cleveland Office—10515 Wilbur Ave.—J. C. Munn, Mgr.
San Francisco Office—155 Sansome St.—R. J. Birch, Mgr.



Los Angeles Office—846 S. Broadway—R. J. Birch, Mgr.
St. Louis Office—505 Star Bldg.—F. J. Wright, Mgr.
Wellington, New Zealand—Tearo Book Depot.
Melbourne, Australia—McGill's Agency.

Entered as second class matter August 26, 1931, at the Post Office at New York, N. Y., under Act of March 3, 1879. Yearly subscription rate \$2.00 in United States. \$3.00 in Canada and foreign countries.

EDITORIAL

SIGNAL SPRAYING

CHAIN BROADCASTING PROVIDES large circulation for advertisers in a position to foot the bill. Moreover, the chain system permits certain areas to be covered to the exclusion of others, when desired. Again, through the use of relay stations any wave may be tapped for the benefit of the listener who may within a period of a few minutes be shunted from the local studio to Little America or the bottom of the ocean.

The advertiser wishes the greatest coverage for the least amount of money—which is quite natural—or he wishes the program laid down only within a certain specified area where his product may be sold, or where his product sells the best. Above all, the advertiser wishes no waste, either in coverage or money.

There are two forms of waste in present systems of broadcasting. First, waste through coverage of areas either unpopulated or sparsely populated. Second, waste through high unit cost. The first form of waste may best be illustrated by a coastal station pumping energy out over the ocean where it has no value from the viewpoint of the person footing the bill. Or again, a station in the interior pumping half of its energy over a desert and obtaining only fair results in covering one or more densely populated areas with the other half of the energy. The second form of waste may best be illustrated by small stations operating on shared channels whose general overhead covers a complete twenty-four hours, or a small station whose circulation or coverage is much too small to make the business of broadcasting a profitable enterprise, unless the station be subsidized.

If broadcasting is to be viewed as a business enterprise—and so it is—then the matter of cost per potential listener is of some importance. In that event, there are

two items which may contribute a great deal to a reduction of costs and at the same time improve the broadcasting service.

The first important item is station synchronization or common-frequency broadcasting. With such a system, and there are a number available, a number of small stations may operate efficiently on a single channel and thereby either maintain full-time operation in the event of shared channels, or handle syndicated programs for wide coverage. The chances of difficulty are slight since the common-frequency systems are capable of maintaining synchronization within a fraction of a cycle. Mush areas may be eliminated by the use of time-delay correction equipment, though mush areas should not be evident if the stations are fairly close to each other.

Common-frequency broadcasting provides more uniform reception since the combined carriers overlap geographically and therefore not only spray a greater area but provide reinforcement in spots. This form of broadcasting would, of course, release numerous channels now in use. This could be the basis of a redistribution of channels with greater separation to pave the way for high-fidelity transmission and reception, or provide room for more stations.

The second important item is directional broadcasting. Through the use of directional antenna systems, energy now wasted over oceans or unpopulated land areas can be focused where desired, thereby extending the station coverage and improving reception in the areas normally covered. A further advantage in spraying selected territories lies in a reduction in possible interference between stations on adjacent channels. The same advantages would apply were directional broadcasting applied to stations employing a common frequency. The nicest graphic example is a sprinkler system for large lawns.

Special articles on common-frequency broadcasting and directional broadcasting will appear in early issues of RADIO ENGINEERING.

radio engineers do not not guess--



THEY KNOW

There is no room for guess work in a Radio Receiver manufacturing plant. Modern measuring instruments, checking components, plus the trained mind, determine radio receiver performance in advance. The certainty of performance is guaranteed in a measure by the reliability of the components supplier. Clarostat volume controls, pre-tested at the factory, have won the approval of practically every leading receiver manufacturer. Clarostats need no further checking before installation.

For all modern radios

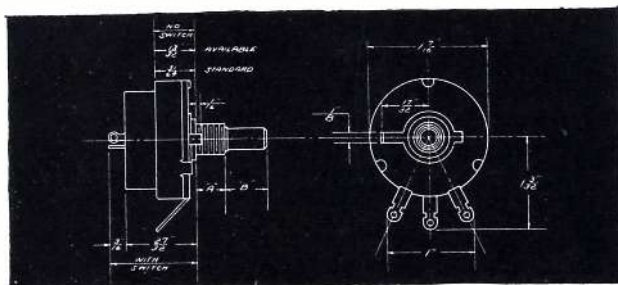

Drawing portrays three separate controls.

- (1) Series 33—without switch—shallow model—depth 13/32".
 - (2) Series 33—without switch—standard model—depth 31/64".
 - (3) Series 133—with power switch depth 27/32".
- Standard dimensions of bushings and shafts are: "A"= $\frac{3}{8}$ " x 32 thd. $\frac{3}{8}$ " long. "B"= $\frac{248}{1000}$ "— $\frac{249}{1000}$ " dia. x $\frac{1}{8}$ " long. Bushing and shaft insulated although available grounded if requested.

CLAROSTAT

Series "33"

While permitting considerable saving in space, this control retains all the reliability and factor of safety found in Clarostat controls. It is available in all usual requirements, both mechanical and electrical. It is in production ready to service the production lines of current demand. WRITE FOR SAMPLES.

We solicit inquiries on mass production or special resistor problems, for radio, sound, communication or industrial application.



NEW CONTROL REPLACEMENT GUIDE UPON REQUEST
CLAROSTAT MFG. CO., Inc.
 285 North 6th Street
 Brooklyn, N. Y.

"AD-A-SWITCH" was originated by Clarostat



HIGH QUALITY—LOW COST ELECTRICAL MEASURING INSTRUMENTS For Audio and Radio Frequency Circuits

We manufacture a complete line of audio and R. F. oscillators, signal generators, vacuum tube voltmeters, distortion measuring apparatus as well as a number of highly valuable individual items which can be employed in the radio industrial and radio service laboratory.

Illustration below shows three of our instruments set up for a distortion test. Technical description of each of these instruments is given below.

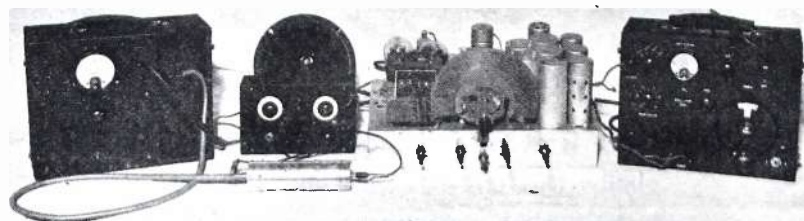

Model 405

Model 902

Receiver

Model 310

Model 405 Vacuum Tube Voltmeter Alternating Current Operated

The type 405 vacuum tube voltmeter is an extremely sensitive direct reading vacuum tube voltmeter moderately priced and designed to have an extremely low internal capacity. The 6A7 tube used in this type of vacuum tube voltmeter is a tube especially designed for the purposes. If operated in a radio set it is a mixer tube. That is, it gives the sum and difference frequencies in the output of the plate circuit of any two frequencies put on the control and mixer grids of the tube. When both frequencies are the same the difference is a pure direct current. By the use of this tube it is possible to construct a vacuum tube voltmeter having extreme sensitivity and stability since it enables us to operate at a normal operating characteristic of the tube. By means of a bridge circuit, of which the plate and cathode of the tube are the unbalanced leg, it is possible to indicate any change in grid voltage on the zero- to 200-microampere meter. In order to reduce all capacities to a minimum the goose neck construction has been used.

The grid of the vacuum tube (which is at the end of the goose neck) is connected directly to the circuit you wish to measure, by means of a lead wire less than 2 inches in length. The vacuum tube itself is thoroughly shielded against any stray fields which would tend to alter the reading.

Model 310 Signal Generator

The Model 310 Signal Generator incorporates every possible need necessary in set testing work. It attenuates down to $\frac{1}{2}$ of 1 microvolt, it is entirely A.C. operated, has a frequency range of 100 to 1500 k.c. Has measured modulation up to 100% with 6% distortion, at 80% modulation distortion is 2.5%. Also it has provision for external modulation, supplies a pure 1000-cycle note for bridge measurements and a variable measured 1000 cycle note with measured attenuation, and is ideally suitable as a source for checking the gain of audio amplifiers. All of this is inclosed in a small shielded container measuring 10" x 12" x 5 $\frac{1}{2}$ " deep. Write for complete data describing this new instrument.

Model 902 Gain Indicator Distortion Analyzer

Model 902 Gain Indicator Distortion Analyzer is a reasonably priced device to indicate the output and the harmonic content of any amplifier or radio set when it is modulated by a pure sine note. It consists of a phase rotating device that is effective at all frequencies in the audible range between 200 and 4000 cycles, and a potentiometer to bring the output voltage amplifier or radio set to the same level as the modulated input. In this way we are able to completely eliminate the fundamental and measure the harmonics generated. The indication of the potentiometer is a measure of the gain of the device under test, and the output of the Model 902 distortion analyzer is the total harmonic output of the device under test. This instrument is designed to be used with the Model 405 vacuum tube voltmeter and the Model 906 Filter system.

Wireless Egert Engineering Inc.
179 VARICK STREET
NEW YORK CITY

RADIO ENGINEERING

FOR MARCH, 1934

MODERN RADIO COMPONENTS

DATA ON THEIR MANUFACTURE, CHARACTERISTICS AND USE

FIXED RESISTORS



THE INTRODUCTION OF automatic circuits in receivers, and the necessity for the more precise operation of tubes, has increased the average number of resistors used in a representative set and likewise called for more rigid tolerances.

The modern composite receiver employs biasing resistors, decoupling resistors, voltage dividers, bleeders, grid and load resistors, voltage-distribution networks, dial-light shunts, filament series and shunt resistors, and resistors as filters in grid circuits and automatic volume control lines.

Since all receiver circuits do not have the same requirements, the resistors used are not all of the same type. Cost must be computed along with the characteristics a resistor must have to fulfill a definite need. More often than not, a saving may be had by giving more than the usual consideration to the engineering features of the circuit and the resistor unit.

MOLDED RESISTORS

There are many effects that must be overcome in the production of a perfect resistor, which, of course, is the goal that all resistor manufacturers seek to achieve. Some of these effects are more damaging than others to the operation of a radio receiver and accordingly must receive greater or less consideration when the problem involves one particular effect against another.

Chief among the many problems in resistor manufacture are the elimination of voltage coefficient, heat coefficient and humidity effects. In order that the radio industry might have standards of comparison, the engineers thereof have collaborated in arranging a series of tests such that the data received by the receiver manufacturers from the resistor

manufacturers can be fairly compared. These tests are known as the R. M. A. Resistor Test Specifications, which are, of course, familiar to everyone in the field.

To repeat, the chief conditions of interest at the present moment are heat coefficient, voltage coefficient and humidity effects. So far as is known, no one has been able to perfect a fixed molded resistor which remains fixed for more than one set of conditions at a time. A given resistor varies in resistance with the variation of the voltage across it, varies with its temperatures and varies with the relative humidity in which it operates. Tests show that any of these effects may be reduced to what appears to be an irreducible minimum without materially affecting the others, but that any attempt to reduce any one beyond that point, results in a change for the worse in the others. In other words, it seems that the safest course for the resistor user is to know what features will cause him the most trouble and buy material which is the best in this respect.

The effect which can most easily be guarded against is the voltage coefficient, inasmuch as it is simple to determine the actual voltage impressed across a resistor in a radio set, and to specify that the resistor purchased be a certain resistance when a definite voltage is impressed across it. If this is done, a resistor may be used which has a comparatively high voltage coefficient but is low in heat coefficient and humidity effects. If this plan is followed, radio reception neither improves nor becomes faulty due to the voltage coefficient of its resistors.

On the other hand, many manufacturers

use resistors of the same capacity and resistance in several parts of the same circuit or in different models under different operating conditions so that in order to eliminate the necessity of stocking several lots of resistors of the same resistance but selected at different voltages, it becomes necessary to buy resistors of low voltage coefficient.

Resistors are now obtainable which show less than 3 percent voltage coefficient between readings taken at 5 volts and at 150 percent rated load. Some makes, while retaining this low voltage coefficient feature, further have less than 5 percent heat coefficient and show less than 15 percent change due to humidity when exposed to 90 percent relative humidity in an ambient temperature of 130° F. The reason for the deviation in the case of the humidity test in ambient temperature from that specified in the R. M. A. code is that people actually exist in such temperatures and humidities—and operate radios.

Manufacturers have been compelled to take back and replace a number of radio receivers which were so affected by the high temperature and humidity that they would not operate a short time after being put into service. It is, therefore, advisable to buy resistors that will remain reasonably constant under the most adverse conditions, particularly if the radio is for export.

The molded resistor has become almost a fixture in radio-receiver design, for there are certain parts of circuits where it fits in admirably. It will give exceptional service under the proper conditions, and will fail only when it is imposed upon.

In modern receiver practice the use of automatic volume control and finely balanced circuits require that the resistor remain within its tolerance under all operating conditions. Where resistors are employed for dividing and delivering specific voltage values to an automatic volume control circuit, the

resistors must have the necessary preciseness for which the circuit calls. It is possible that a poor resistor will produce greater changes in an automatic volume control circuit than that of the signal voltage. The complete failure of the automatic volume control in one receiver was due entirely to the use of a resistor with a very high voltage coefficient as the voltage-dropping device.



Poor composition type resistors create microphonic noise when carrying current. When such resistors are used in circuits followed by high amplification, this noise is plainly audible in the speaker. Although such resistors may not carry any d-c, they may carry very appreciable a-f currents on peak audio swings and in such cases are likely to cause noise modulation of the audio signal. Much of the high residual noise level in some receivers commonly attributed to tubes is in reality due to poor resistors in the tube circuits.

WIRE-WOUND RESISTORS

Although wire-wound resistors were almost entirely absent from receivers of the past few years, they are again coming into common use due to the necessity for power resistors in universal receivers and for operation of receivers on high line voltage. The same type of resistor is also recapturing its place in other sections of receiver circuits where molded resistors cannot properly meet the conditions.

Wire-wound resistors have been greatly improved, and methods of manufacture permit comparatively high values of resistance, with high values of capacity, to be contained in very small areas. A part of the development work must be credited to the wire makers who turn out resistance wire with diameters approximating that of a human hair. Oxidation on the wire serves as an effective insulation and it is therefore possible to make the spacing between turns so minute that it cannot be seen even with the aid of a microscope. Evidence of this spacing and/or oxide insulation can be assured only by a resistance-measuring test in the production line.

Resistors of this type come under three classifications: tubular, rigid strip, and flexible. Winding operations are quite similar for all three types, and each type serves a definite purpose. Little need be said regarding the tubular, vitreous enamel resistors used as voltage dividers, bias resistors in power circuits, etc. As for the rigid and flexible types, the advantages of one over the other are mechanical more than electrical.

The rigid type is more conveniently

tapped, and in many cases the mechanical design of the receiver chassis will call for a resistor which can be effectively mounted in a given position.

The flexible type can often be used as a connection between two components, which in some cases reduces assembly costs. The flexibility and small diameter makes application convenient in limited space.

The rigid strip resistor is more often than not protected rather than insulated against external units. The metal cases may serve as a ground connection. The flexible resistors are insulated from external units by a spaghetti sleeving. If good sleeving is used, the chances of voltage breakdown, or losses, are small. A good spaghetti sleeving will not rupture under mechanical strain. Moreover, if strong, it can be used—and is in most cases—to relieve the resistance wire and the core upon which it is wound, of any physical tension.

In such applications where the wat-

tage dissipation required is excessive for carbon resistors, and yet not sufficiently high to justify vitreous enamel units, the use of wire-wound resistors with some form of protective covering has become very common. In this medium wattage range, and in the higher ranges also, resistor failure is apt to occur if the receiver designer does not keep in mind that resistor ratings are almost invariably given for the resistor suspended in free space. A resistor is essentially a power dissipative device and as such has a maximum temperature rating which is dependent on the unit and type of coating involved. If a resistor is to be operated without proper ventilation, or adjacent to rectifiers or transformers which reach high temperatures, they should not be operated at maximum rating, but should be operated at such rating as will give more than the maximum allowable temperature when such factors as enclosure and adjacent heating are taken into account.

VARIABLE RESISTORS

AS MUCH IMPROVEMENT has been made in variable resistors as in other modern components. Low-ohmage units of high current-carrying capacity are now made with insulated arm shafts permitting one-hole mounting and obviating any insulation precautions which were necessary with the older units when mounted on metal panels. Advancements have also been made in the design of the contact arms and manners of anchoring the resistance wire to the winding base. Wire slippage has been eliminated and the units more readily dissipate heat.

Problems in the design of high-ohmage variable resistors and potentiometers have been more difficult of solution. These problems have been common to both the composition and the wire-wound potentiometers.

One of the main difficulties the supplier has had was the reduction of contact resistance and the development of uniformity in resistance over the arc of rotation. Since a contact has some resistance in the first place, and since oxidation, the accumulation of foreign matter on effective areas, and the wear caused by the rotating contact, all tend to alter the original value, it has been difficult to produce noiseless units.

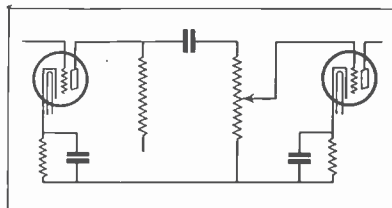

Fig. 1. Circuit of audio level control at the input of the first audio amplifier tube.

Nevertheless, modern design and new manufacturing processes have brought this difficulty down to the point where its effects are almost negligible, when the control is properly used.

The matter of resistance taper and low values of hopoff has also been effectively dealt with. The designer may have about what he wishes, but often the control is used in a circuit carrying current in excess of what the low-resistance arc of the control is capable of handling effectively.



VOLUME CONTROLS

Sets not equipped with AVC normally have the manual volume control in series with the cathode or cathodes of r-f or i-f amplifier. The action of the control is made more effective by employing a lower value of total resistance with greater current-carrying capacity, and bleeding more current through it from the power supply. Or making the single potentiometer serve both as a control of grid bias and as a loss in the antenna circuit.

The minds of the suppliers are somewhat relieved when such a control is used only as a means of varying the bias on the amplifier tubes, for the control is then dissociated from r-f signal circuits and, moreover, is less apt to create microphonic disturbances when at virtual ground potential. However, the same type of potentiometer used as a combination bias and input-signal control can prove to be rather a

noisy affair unless it is absolutely free from contact resistance and maintains its proportionate resistance values. Since the resistance unit carries current, the possibility of noisy contact is increased. These small variations are induced into the antenna circuit and modulate the signal.

Since this form of control is used principally in low-gain receivers, the noise problem is not great. Given the proper resistance-rotation curve, the control is satisfactory. Suppliers usually recommend a double control for receivers with high gain. Since receiver gain bears some ratio to price, the problem solves itself automatically.

Higher priced receivers with automatic volume control quite often retain

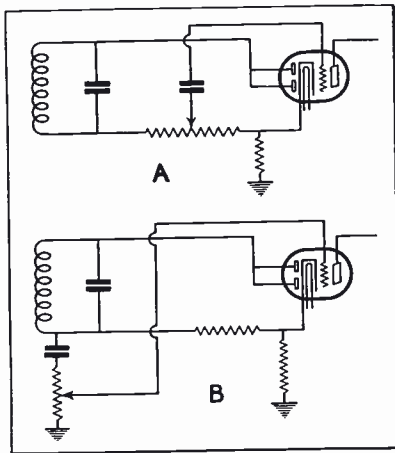

Fig. 2. Two arrangements for a volume control in the output circuit of a diode.

the grid bias variable resistor as a means of controlling sensitivity. Since this variable resistor is placed either in the cathode circuit of an r-f or an i-f tube—and is but seldom used—it offers no particular problem.

The volume control in an AVC receiver is more likely than not in the grid circuit of the first a-f tube. Though the circuit of Fig. 1 bears no evidence of the existence of AVC, it serves the purpose of illustrating the use of a potentiometer as an a-f voltage divider. This has proven to be a highly satisfactory method of controlling the audio level and has the advantage that the resistor unit of the potentiometer does not have to withstand any appreciable load. This gives the supplier considerable leeway in his design.

These potentiometers usually have approximately a logarithmic resistance-rotation curve. This holds so long as the potentiometer acts as a true voltage divider and where no appreciable current is taken off at the contact arm, which is generally the case. The logarithmic resistance-rotation curve gives substantially uniform volume change per degree rotation of the knob. That is, with such a control, the attenuation

in db is directly proportional to knob rotation. Some advantages have been indicated with a resistance-rotation curve where the rate of change of resistance at the low end or maximum attenuation position is somewhat greater than with a logarithmic curve, and where the change of resistance at the high end or low attenuation position is somewhat slower than with a straight logarithmic curve.

Controls such as these are usually designed to have such hopoff resistance values that the ratio of the hopoff resistance to the total resistance is on the order of ten thousand to one, which gives a total attenuation of 80 db. Controls have been used wherein this ratio has been as low as three thousand to one, which gives a total attenuation of approximately 70 db.

It is normal practice to use a tube following the control with as low a grid current as possible. If grid current is high and tube gain high, noise may be apparent when the contact arm is near the top or high-voltage end of the potentiometer, when no signals are being received.

Noise may also develop if the potentiometer is employed as the load resistor for a diode detector, as at A of Fig. 2. The resistor unit is subject to both d-c and a-f currents. The abbreviated diagram B of Fig. 2 shows a separate load resistor. The blocking condenser is placed in series with the volume control potentiometer rather than in series with the lead to the grid of the a-f tube. The resistor is therefore subject to a-f voltages only.

TONE CONTROLS

Variable resistors are extensively employed as tone controls in conjunction with condensers of fixed capacity, the resistor varying the impedance of the condenser to audio frequencies.

The most satisfactory arrangement

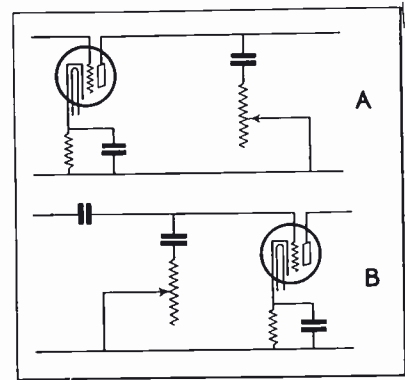

Fig. 3. A: Tone control in plate circuit of audio tube. B: Tone control in grid circuit of audio tube.

from the viewpoint of the engineer is shown at A in Fig. 3. The fixed condenser and variable resistor are connected in series across the a-f line from the output of the first a-f tube. Though the tone-control circuit carries no direct current, the resistor nevertheless has to dissipate a certain amount of a-f power. The situation is not so bad if the tone control is placed in the plate circuit of the first a-f tube, but becomes serious if the control shunts the output circuit of the power stage. In either case, however, it is important that the maximum power dissipation in the variable resistor be determined for the maximum volume setting of the volume control, and the point kept in mind that the maximum dissipation in the tone control resistor will take place at minimum resistance settings.

The most satisfactory circuit arrangement from the viewpoint of many suppliers is shown at B of Fig. 3. Here the tone control shunts the input circuit of the a-f amplifier tube. The power dissipation in this case is negligible and therefore there is little chance of resistor failure.

LOUD SPEAKERS

THE PAST FEW YEARS have brought about a number of improvements in general speaker design of particular value to the set design engineer. Frequency ranges have been extended, and the efficiency of dynamic cone speakers has been increased through the use of improved methods of manufacture and the generous design of the field structures. Sensitivity has also been increased by a reduction in voice-coil clearance, etc.



DYNAMIC CONE SPEAKERS

A reduction in hum has been brought about by the use of neutralizing and bucking coils for such speakers whose

field coils are employed as a part of the filter circuit of the power supply. In this case a-c ripple voltages of from 10 to 25 volts are impressed across the field and tend to produce a distinct hum in the speaker output.

Field winding resistances depend a great deal upon the design of the receiver and power-supply unit. Fields of 7,500 ohms are often recommended for power-pack operation, or where the field functions as a bleeder. For 110-volt d-c receivers a value of 2000 ohms is recommended; for 6-volt storage battery operation 4 and 6 ohms. For automobile radio the suggested field resistance is 4 ohms, and for 110-volt a-c receiver operation where the field is employed as a filter choke, 2500 ohms is usually recommended.

It is normally assumed that for maximum output from triode tubes, the speaker load circuit should have approximately twice the impedance of the power tube or tubes. In practice this load impedance may equal the tube impedance or may run to as much as $3\frac{1}{2}$ times the tube impedance with little change in efficiency. In the case of pentodes, a load impedance one-quarter that of the listed plate resistance is a good average, but it is desirable whenever pentodes are employed to keep the speaker load impedance as nearly constant as possible over the frequency range to be covered. This may be obtained by connecting a filter, made up of a resistance and capacity in series, across the primary winding of the output transformer, as shown in Fig. 4. This combination of resistance and capacity with the inductance of the speaker presents to the tube or tubes a comparatively constant load. When a single pentode is employed, the value of the condenser may be in the vicinity of .015 mfd and the value of the resistor 10,000 ohms. For pentodes in parallel, the capacity of the condenser should be doubled and the value of the resistance halved. A resistor with a comparatively high wattage rating is necessary in either case.

Class B amplifiers present still another matching condition. The load impedance depends on the amount of power desired, the permissible distortion, and the type of driver stage and input transformer. A good average value of load impedance is four times the plate impedance of one of the Class B tubes.

Looking at dynamic cone speakers from the viewpoint of quality reproduction, the supplier is in a position today to offer units with different fidelity characteristics to meet specific requirements. The trend toward increased out-

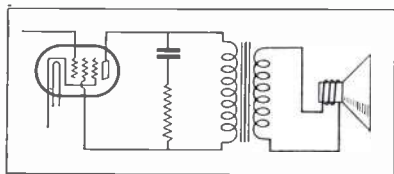

Fig. 4. Filter across output of a pentode power tube for the purpose of providing constant-impedance load.

put power in receivers for the purpose of handling loud passages of music, has also been met by the speaker manufacturers, whose new speakers are more rigidly constructed—with the weight well placed—so that there is little if any chance of rattle or the development of resonant vibration.

As a general rule it is not considered very good practice to employ a dynamic cone speaker for the reproduction of the very high audio frequencies. It is possible, of course, to use a single cone speaker so constructed that it repro-

duces frequencies up to the desired limit, but the beam emitted from such a speaker is very directional, and the directional effect increases in proportion to the frequency, so the listener must sit nearly in front of the speaker to get the desired effect. The use of a small cone speaker to reproduce the high notes may be considered, but the directional effect from this speaker is also a drawback; besides, it is quite a problem to make a small cone speaker so high in efficiency that it does not fall below the efficiency of the large low-frequency cone speaker. The transient distortion is also much worse than in the exponential horn type unless special output circuits are used.

There is one other point that must be taken into consideration; a speaker employing a cone has a tendency toward aggravating the noise condition. Comparatively low noise amplitudes are reinforced by the cone.

TWEETERS

The most perfect combination is a rather large cone speaker capable of reproducing all the low frequencies up to about 1500 cycles or better, and a tweeter or high-frequency speaker capable of extending the range to about 8000 cycles.



There are two types of tweeters supplied; the crystal diaphragm type speaker, with small exponential horn, and the dynamic speaker, with small exponential horn. The crystal type requires no energizing voltage, and may be paralleled with the voice coil of the dynamic cone speaker. Though a filter is not normally used with this type of unit, it is usually necessary to design it around the voice coil of the low-frequency speaker to be used.

The dynamic high-frequency speaker is also of the diaphragm type, and is driven by a very light voice coil having an impedance around 15 ohms. The exponential horns are about six inches long and are made of metal or molded insulating material. The efficiency of these units is several db's above the most efficient cone speaker. The efficiency of these tweeters approaches 50 percent and in practical application it is desira-

CONDENSERS

THE DEMAND FOR smaller units in receivers of the midget and remote-tuning control types has brought about a considerable change in both the design and construction of condensers. In developing smaller units, the suppliers have also managed to include numerous improvements.

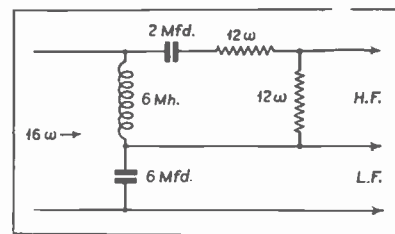

Fig. 5. High- and low-pass filter, with values, to provide cut-off at 3000 cycles at low end.

ble to control the output by the use of a potentiometer across the voice coil. A good value for the potentiometer is 3 to 5 times the impedance of the voice coil.

The desirable characteristic of the tweeter, equipped with a short horn, is that it will diffuse the high frequencies to a far greater extent than the cone speaker. The high-frequency beam from a tweeter, particularly when it is equipped with diffusing blinders, will cover an angle of about 90° with only a few db's decrease in sound pressure.

Suppliers recommend using a filter system in connection with the two speakers in order to permit the low-frequency speaker to carry the whole load up to 1500 cycles or slightly higher, and let the tweeter function from this point up to about 7500 or 8000 cycles. Suppliers feel that it is not desirable to extend the frequency above 8000 cycles when using the dual-speaker arrangement for radio reception, and recommend cutting the system sharply at the desired cutoff, which may, of course, be somewhat below 8000 cycles.

The circuit of a typical high-pass and low-pass filter for use with a low-frequency cone speaker and tweeter is shown in Fig. 5. This particular filter has a cutoff at approximately 3000 cycles for the low-frequency speaker.

Though the use of a filter is recommended, it is practical to use an output transformer with separate secondary windings for the cone and tweeter. A condenser of about 1 mfd should be connected in series with the tweeter voice coil.

The use of a cone and tweeter combination is predicated upon an improvement in receiver design and broadcast transmissions. Results from high-fidelity receivers can be very unsatisfactory.

ELECTROLYTIC CONDENSERS

Electrolytic condensers of both the wet and dry type have been with us for some time. However, it has only been recently that these units have reached the stage of near perfection.

The wet electrolytic still has its place,

though the dry type has become very popular because it is less subject to a change in characteristics. First of all, dry electrolytics of both the can and box types suffer less from climatic conditions. If well sealed, there is very little absorption of moisture and consequent dilution of the electrolyte. Moreover, the dry type is less apt to freeze at low temperatures, and should it freeze it will regain its original characteristics when thawed out.

Suppliers have given much thought to actual production considerations with the result that the designer may obtain condensers of the dry type which will meet his particular needs. Small can type condensers are obtainable for single hole mounting, or with a metal strap mounting where the condenser is to be located under the chassis. The cardboard container types are also obtainable with mounting flanges.

Though electrolytic condensers are now made to fit in small spaces, some thought should be given to their location. High temperatures have a decided effect on the capacity of an electrolytic



condenser, as well as upon its resistance and leakage. If mounted too near to the power transformer, the rectifier tube, or to the power tube or voltage-reducing resistor in a midget receiver, the condenser may be permanently damaged or fail to maintain the value and characteristics listed by the supplier.

Care is also necessary in the use of multi-section electrolytic condensers. An example of a possible difficulty is illustrated in Fig. 6, where there is a 110-volt drop across the filter choke in the negative lead of the power supply. In this case the negative foil A is at a positive potential with respect to the negative foil, B. Under such conditions the leakage will be high and the effect will be the same as if a resistance were shunted across the choke. The effectiveness of the choke is thus reduced. It is necessary, therefore, in a case such as this to employ a multiple-unit condenser with a formed foil for A. The voltage to which the film on the negative foil is formed must be equal to and preferably a bit greater than the voltage between the two negative sections.

VARIABLE CONDENSERS

Variable and adjustable condensers have also come in for some marked improvements. The use of stacked collars in variable condensers, or collars that are an integral part of the shaft, has removed the difficulties brought about

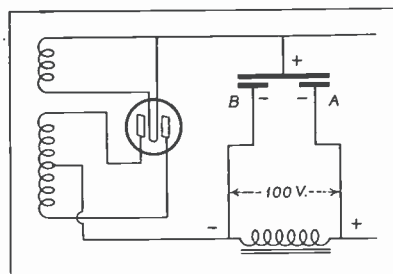

Fig. 6. The voltage difference between foils A and B may cause heavy leakage.

by loose screws, etc. The stacking of plates and the use of shock mountings has also added to the imperviousness of condensers to vibration and the attendant ills.

Trimmer and padder condensers have

COILS

AT THE PRESENT time there seems to be a more or less standardized coil setup in use in the construction of the most reasonably priced receivers. In the tuned r-f, two-gang receivers operating as a-c, d-c sets, the most commonly used coils are impedance-coupled r-f and antenna units employing plain enamel wire secondaries, or where the maximum results are to be gained, a litz two-bank winding. Recently small four-bank secondaries have been employed to save space.

R-F AND OSCILLATOR COILS

Very few attempts seem to be made at shielding the coils in these receivers. Where this is attempted the figure of merit of the coils drops perhaps 10 to 25 percent depending on the size of the



can, due to lower effective inductance and added reflected resistance. This usually necessitates the addition of another stage of r-f amplification. However, the three-gang tuned r-f set has almost become a thing of the past, since at slightly additional cost, a super-heterodyne circuit may be used. Here we find the lowest priced sets employing universal wound antenna and oscillator coils. These coils, when wound on dowels 1/2" in diameter and over so as to keep distributed capacity at a minimum, offer fair comparisons to solenoid coils of the usual form. Where an r-f stage is employed, the antenna and r-f coils are usually solenoid or bank wound and are shielded to provide stability. Oscillator coils for broadcast and long-wave bands may be universal wound. These coils provide excellent uniform translation gains of from 30 to 60, de-

been improved by the use of better insulating materials and more appropriate metals, which have served to reduce materially the power factor, percent change in capacity under severe condi-



tions of temperature and humidity, and change in capacity due to vibration. Improved design has also permitted a considerable reduction in the mutual capacity between condensers mounted on a common insulating base. These advances have materially added to the operating efficiency of i-f transformers, and reduced oscillator drift and alteration in the alignment of r-f stages.

pending upon the type of mixer tube and system of coupling. Due to their apparent advantages the 6A7 and 6F7 tubes are excellent for use with these coils.

INTERMEDIATE TRANSFORMERS

Except in the higher priced sets, the demand has been for small compact



units. This has made the design problem of intermediate transformers extremely limited, in that a coil of high Q calls for a fairly large core. However, as a rule this results in a coil of such diameter that upon insertion into a shield can of small size, the drop in inductance is so marked as to destroy the improvement secured by winding the coil to a better form than when wound on an extremely small one. This has resulted in the use by the suppliers of elaborate types of windings, and trimmer condensers of special design. The latter employ insulation and dielectrics of the highest type available so as to aid in securing an intermediate transformer having a high gain and extreme selectivity.

AUDIO TRANSFORMERS

The demand for high-quality reception has brought about changes in the design of audio transformers. Uniform frequency response has been achieved by the use of special core materials.



Transformer failure has been reduced by the use of wire with improved insulation, and by vacuum-impregnating the windings.

INTEGRATIVE

BY LEE McCANNE

MANAGER, TE-LEK-TOR DIVISION,
STROMBERG-CARLSON TELEPHONE MFG. CO.

- Lateral or vertical manufacturing control—or both? Lateral control is favored by many as the most practical. Mr. McCanne presents the pro's and con's

NOW THAT RADIO has settled down to be a relatively sedate and conservative business, and the wolf at the door has died of starvation, it is appropriate again to discuss radio's future policies and trends.

One problem of vital interest to receiver design engineers, manufacturers and suppliers is the probable division of manufacturing functions and processes under this New Deal era. Who's going to make the parts? Will those who specialize in the fabricating of certain components be able to hold or increase their recent gains, their proportionate share of the business? Or will the manufacturers who assemble these parts tend to absorb their suppliers, to take back the manufacturing functions temporarily allotted to "outsiders"?

Radio's past manufacturing history has been that of any young industry, producing a technical product involving many raw materials. The earliest pioneers were parts manufacturers, catering to private individuals, who assembled the parts in a home workshop. So, too, the first automobiles were home-made assemblies of an engine, a fuel tank, brakes, a chain drive and a horseless carriage. Then increased demand and faster turnover brought forth packaged kits of correlated parts, soon followed by complete assemblies. In many cases these parts and sub-assemblies were all produced in the one plant and specifically designed for the manufacturer's own product.

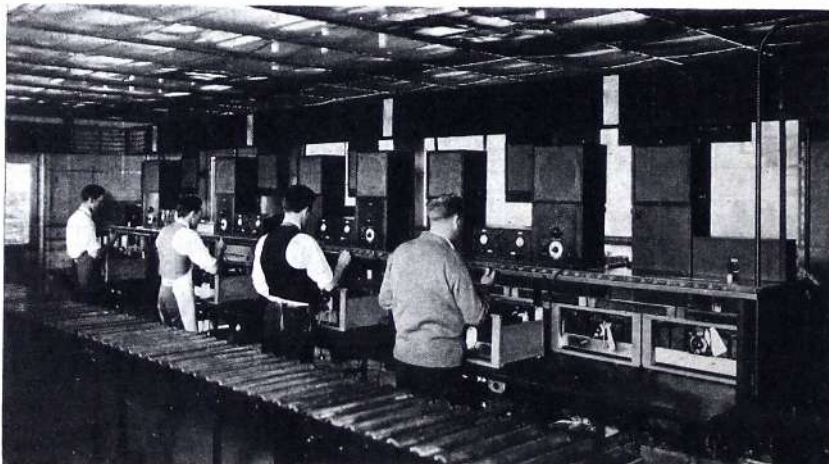

● ALIGNING OF R-F STAGES TO "TRACK THE DIAL" WITH REQUIRED SENSITIVITY . . . STRAIGHT-LINE CALIBRATION ON ROLLER BEARINGS

VERTICAL CONTROL

This vertical control of successive processes is known to economists as "integrative" manufacturing, where one management is responsible for all operations from the initial conversion of raw materials to the final inspection and packing of the finished article. The advantages claimed for it are:

- Closer control over quality and uniformity
- Undivided responsibility
- A surer source of supply
- Parts designed specifically for the product
- One profit to compensate for all operations
- Shorter investment in inventory, due to faster handling and turnover
- Less commercial expense; each part-making department does not have to sell its product, and is sure of at least one user.

LATERAL CONTROL

The opposite of vertical control is lateral control. Under this type of operation, the "manufacturer" establishes a production line to perform the assembly operations and final inspection. He "farms out" the fabrication of his parts to others, or buys from established suppliers. He may or may not duplicate the inspection of parts as received from suppliers, depending upon his aims toward price or quality appeal. He benefits from lateral control as follows:

- Division of risk with his suppliers
- Pooling of tool expense and development costs with competitors
- Production in sufficient quantity to permit economical job lots
- Better patent protection by buying parts from a licensee
- Efficient management and supervision due to specialization
- Increased production capacity with no added investment in plant and special equipment.

MANUFACTURING

Of course, almost no industrial concern is purely vertical or purely lateral in its set-up. There are few blacks and whites, but many shades of grays. Every manufacturer of a composite article must have an assembly line, fed by his own or outside parts suppliers; and nearly all make some of their own parts and sub-assemblies, and buy others.

Many examples can be cited of vertical control in American industries closely akin to radio in the technical nature of their products. Sometimes the vertical control policy is carried beyond the manufacturing functions to include ownership of raw material suppliers and marketing outlets. Thus the Ford Motor Company is famous for its vertical control through ownership of raw material sources and manufacturing subsidiaries, and does much of its own distributing. The Eastman Kodak Company has developed important sources of cellulose compounds through its Tennessee Eastman Corporation, and owns many wholesale and retail stores. The telephone industry is an example of vertical control over manufacturing, selling, servicing and maintenance functions.

AN INTEGRATIVE SET-UP

In radio, perhaps the most striking example of the vertical or integrative manufacturing set-up is that of the Stromberg-Carlson Telephone Mfg. Co.; not that Stromberg-Carlson produces a larger proportion of its component parts than one or two other radio concerns, but because the various departments which perform its manufacturing and distributing functions are all concentrated under one roof. The factory equipment, laboratory and inspection instruments, power plant, distributing office, and personnel relations facilities, including a hospital, a kitchen and dining room, recreation field, factory garage, etc., are in a single one-story building. This company does its own distributing or, in other words, sells directly to dealers, yet the credit and billing departments for handling all U. S. dealer accounts are separated merely by a fire-wall from the radio and loudspeaker factory departments.

To a large degree, this self-sufficiency and preference for company-made parts is a heritage from the telephone industry—still representing 40 per cent of the company's business—and from war-time experiences, when pro-

duction of signalling equipment must go on in spite of coal or material shortages, strikes, accidents or sabotage. Thus, the company power plant has sufficient capacity to supply electricity, compressed air, and exhaust steam for heating a factory more than four times the present size, for which adjacent land is held in reserve and which will be constructed under a program of planned expansion. Coal and water storage facilities would permit operation for more than six weeks without replenishment. A double-track private siding on the main line of the New York Central Railroad and a truck-loading platform permit speedy handling of materials and finished products.

Despite this telephone heritage, however, Stromberg-Carlson's vertical control of radio manufacturing processes is a natural outgrowth of the policies it established early in its radio history for quality control and for price maintenance through the elimination of over-production and dumping. The former called for adequate research, careful design and rigid inspections with a minimum of dependence on human factors. Since the development of proper designs and inspection equipment constitutes the main obstacle to production of many radio parts, the company decided that it might as well make the parts itself; it needed the equipment anyhow. Avoidance of over-production called for rapid materials handling and turnover with a close co-ordination of processes. Frequently the company effects minor changes in receivers in process. Possibly this can more readily be accomplished under a centralized control of all manufacturing divisions, than under circumstances where parts have already been started by an outside supplier under contract.

SOME COMPONENTS PURCHASED

One outstanding exception to this manufacturer's policy of vertical control is that he has never undertaken to produce his own resistors; neither small carbon resistors, nor wire-wound voltage dividers, nor volume controls. Molded plastics and ceramic products are another exception. Tube sockets, tube shields, variable condensers, power transformers, aligning condensers, plugs, jacks, connectors, power supply cords and terminal blocks were formerly manufactured "inside" but are now largely purchased. Vacuum tubes, fuses, fuse

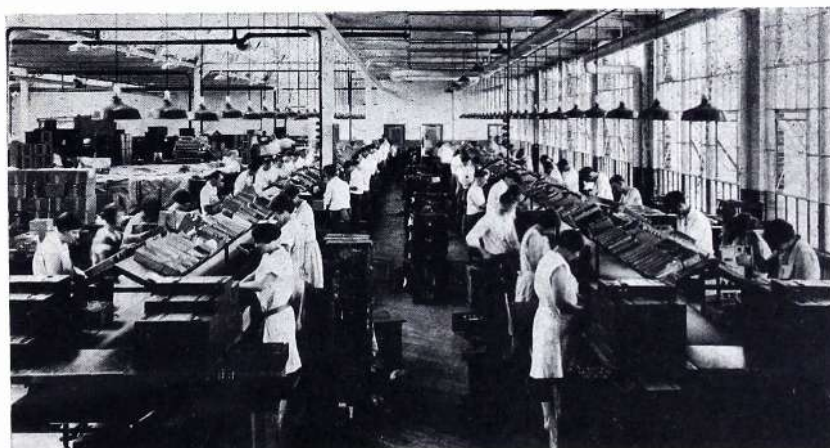

A RADIO CHASSIS ASSEMBLY LINE WHERE THE "LITTLE EVA'S JUST GROW" AS THEY MOVE ALONG FOR MORE PARTS AND DROPS OF SOLDER

blocks, pilot lamps, visual tuning indicators, etc., have always been purchased, but usually according to Stromberg-Carlson's own specifications. Gears, die-castings and motors for automatic record-changing phonographs and for Te-lek-tor remote control mechanisms are purchased. Mica-type r-f by-pass condensers are purchased.

Analyzing this list of purchased items it appears that most of them have fixed dimensions or characteristics not affecting the selectivity, fidelity and overall tone quality to any marked degree. On the other hand, Stromberg-Carlson still manufactures its own loudspeakers, cabinets, audio transformers, r-f and i-f coils, paper-type filter capacitors and other parts which have a definite bearing on demonstrable performance qualities of its product. Indeed, it goes to some lengths which might seem unnecessary. For example, Stromberg-Carlson buys its hook-up wire as bare or tinned or rubber-covered copper. The silk wraps and color-coded cotton serving are applied in its own factory, in order that it may control the quality of insulation and the wax-impregnating process for moisture-proofing. The hook-up wires are then cut to length, formed and braided into a switchboard-type cable, which has been found an important factor in preserving the uniformity of its radio product by preventing feed-backs and stray capacities. The r-f and i-f coils are baked and impregnated in hot wax to seal out moisture. Audio transformer solenoids are immersed in wax compound to prevent electrolysis. Paper-type condensers for filtering or by-pass use are wax impregnated in a vacuum tank after moisture has been extracted.

PRODUCTION ROUTINE

The development of a new radio chassis is the signal for much activity in such a plant. The research workers, aided by outside research laboratories, may be two years or more ahead of production, but the final chassis developments are seldom more than three to six months ahead of the market.

As soon as the desired chassis characteristics are determined, acoustic engineers set to work to develop a loudspeaker for it and to adapt the furniture-designer's proposed line of cabinets for this chassis, to provide the proper acoustic qualities. This is tedious work, involving hours of measurements and days of experimenting in the sound pressure laboratory but it is very important because only by such measurements can the "human factor" be eliminated in the judging of tone.

The sound pressure laboratory comprises a highly

damped room to avoid reflections of sound, a microphone rotating to avoid errors due to "standing wave" effect, instruments for generating pure tones and for measuring the electrical input and sound pressure output of the loudspeaker, and correction factors which, when applied, correct the readings to simulate results as if the measurements had been taken in free space.

TOOLING OPERATIONS

As soon as the chassis design is approved for production, the tool-makers begin to make blanking, perforating and forming tools for chassis bases and all other stamped parts. This is known to be a manufacturer's biggest gamble because, if the receiver does not "take," the tools are worthless, whereas surplus materials and labor can usually be utilized in some other way. Yet the manufacturer seldom charges off his tool costs in the price of his product on the first trial production run. If it so happens that this is the last and only run, the manufacturer faces a severe loss for having brought out that model. Many manufacturers have "gone broke" for this one reason.

Parts from the tools must be washed clean of oil and then spot welded or brazed, rust-proofed or sand-blasted, enameled, lacquered or japanned and baked. Meanwhile, automatic screw machines are turning out screws, bushings, shafts and similar parts, which then are tumbled or nickel-plated and buffed. Many types of screw products are purchased, including hardened self-tapping drive screws, and lock washers.

At the same time, the cabinets are started in the wood-working shop, occupying nearly one-quarter the floor space of the Stromberg-Carlson plant. The raw wood is first seasoned and dried in the company's own kilns. It is then cut to size, shaped, planed, sanded, glued and assembled in presses, in which it remains long enough for the glue to harden. Water-stain is then applied. This is far superior to oil-stains because it penetrates the pores of the wood to give a "depth" to the finish and prevent flaking, and it dries in the air before being coated with lacquer, whereas oil solvents are likely to work through the lacquer and dry as a "bloom." Several coats of lacquer are then applied and the cabinet is hand-rubbed with pumice-stone and oils. Steel wool is used on carved legs and other irregular surfaces.

The loudspeaker assembly is also taking place simultaneously to cabinet production and the preparation of chassis parts. The voice coils are wound by hand.

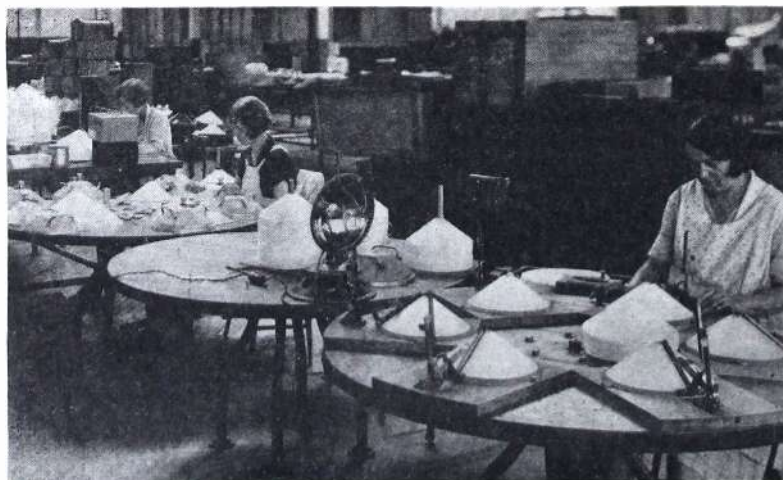

FORMING THE PARCHMENT CONES FOR DYNAMIC SPEAKERS ON REVOLVING TABLES. NOTE THE ELECTRIC HEATER AIMED AT THE TRUSSED CONE

Several layers of wire are separated by rice paper insulation in these voice coils, yet the completed coils are held to exceedingly close limits by means of "go" and "no go" gauges. The voice coils and cones are then assembled. A high-grade leather skiver is used for free-edge suspension; a kid-skin tanned as for organ bellows service, to stand up under vibration without cracking or becoming flabby, and to serve a life-time without hardening.

CALIBRATION AND TESTING

Chassis sub-assemblies are then prepared on lateral benches feeding the chassis production line, which is capable of producing about 600 top-quality radios daily. Special oscillograph instruments draw complete selectivity curves before the aligner's eyes, and five constant-output transmitters feed calibrated attenuators at each inspection position, indicating the sensitivity of each chassis directly in microvolts. A partial view of this production line is shown on the front cover. All inspection positions are completely shielded from outside radio interference. In the past few years, nearly \$40,000 has been invested in radio inspection equipment, to insure a uniform product and minimize the human factors in inspection processes.

After the chassis, with loudspeaker, is assembled in its cabinet, and the tubes to be shipped in that receiver are installed, a final listening test is performed both on broadcast reception and with powerful beat-frequency oscillators, to eliminate any chassis, speaker, or cabinet rattles. Each receiver must pass through one of these final inspection booths to get into the shipping room. It is then immediately packed in its shipping crate or carton.

THE TREND TOWARD LATERAL FUNCTIONS

Many radio manufacturers, however, have lately gone in heavily for the horizontal or lateral distribution of manufacturing functions. One large inducement has been the division of risk with their suppliers. Many furniture companies, for instance, have been forced to stand a share of the loss when orders for cabinets were suddenly cancelled. In this, the radio manufacturer took a stand somewhat akin to the old Standard Oil policy of refusing to invest in ownership of oil wells; they said, in effect: "Let others do the gambling."

Another inducement has undoubtedly led to false conclusions. Many manufacturers have accepted the purchase price as the final cost of an article, without an adequate mark-up in their selling price. They have been fooling themselves in their cost accounting methods of distributing overheads. It cost just as much to sell a purchased transformer as one you have made yourself. It costs just as much to pack and ship and warehouse it. It costs more to handle it than many assembly manufacturers realize.

There are disadvantages to the producer of the parts as well as the manufacturer who assembles them. There is the risk of a sudden and complete loss of his market. His selling efforts are naturally confined to relatively few consumers. It is futile for him to advertise, except in engineering and trade papers, because he cannot sell his product directly to the public. If a competitor should capture an appreciable share of his market, the parts specialist is left high and dry. Sometimes, in such a situation, he is forced into taking over the other manufacturing processes and assembling the completed article, but this has seldom been accomplished successfully in the past. There are numerous examples of loudspeaker or cabinet manufacturers who have endeavored to mar-

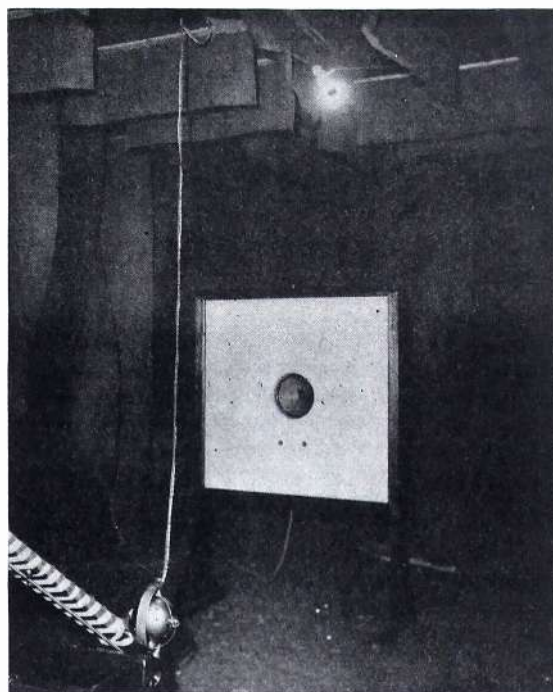

A DYNAMIC SPEAKER UNIT BEING TESTED ON A STANDARD BAFFLE IN THE SOUND PRESSURE LABORATORY. NOTE ROTATING MICROPHONE

ket their own brand of radios, but this usually means not only an uphill struggle to establish the new brand but complete loss of whatever parts business had remained. Purchasers of parts do not willingly buy from a competitor.

THE PARTS MANUFACTURERS

It would be foolish to predict that the large radio manufacturers are going take back unto themselves the fabrication of all parts used in their radios. There are certain items which have benefited tremendously from the standardization and research devoted to them by parts specialists. It is quite likely that integrative manufacturers would never be able to equal their operating efficiency in making tube sockets, fixed resistors, power supply cords, and many other diversified components. The parts manufacturers have built up their production facilities until they, too, can supply all the parts that the world can absorb. It would be economically extravagant to ignore these facilities.

Yet to manufacturers buying these parts, they bring up problems in quality control, price control, and meeting the demand for novel features. Sometimes consumers won't stand for too much standardization. Many purchasers want something "a little different." Standardization tends to lower a top quality product down to a level that can be produced in quantities and at a price satisfactory to the average buyer, whereas price is not an important factor to the quality buyer. Standardization also tends to raise the price of parts to low-price operators above that required for parts to meet their specific needs, in order to make those parts interchangeable to suit the needs of competitors. Specialized manufacturing of parts favors middle-class producers at the expense of the top quality and the low quality producers. The approach of a quality market presents problems to suppliers which they have not had to face in the recent price market.

High-Fidelity RECEIVERS

By A. GERARD HANLEY

PART I

MODERN RADIO RECEIVERS are being built to exceptionally high standards of performance insofar as all characteristics except fidelity are concerned. The sensitivity of the better grade of receivers is usually limited by first-circuit noise, while selectivity is sufficient to permit 10-kc station separation even under very adverse ratios of distant to nearby local station signal strengths. Undesired responses, including image response, are usually less than .001 of the signal response. Again, excellent shielding is the rule rather than the exception, so that the so-called "back door pickup" is of negligible importance.

Power outputs of 15 watts or more are not uncommon and designs are compact and rugged. Many receivers are passed by the National Board of Fire Underwriters, so that receiver failures are not so common. Further, noise outputs are generally quite low, permitting relatively great output volume range. Antenna systems, too, are available to permit the use of well installed antennas without pickup of all the man-made static in the neighborhood. In addition, high-power broadcast stations are becoming more common so that adequate signals are available in nearly every community. Taken all in all the picture is very rosy if fidelity is left out of consideration.

TRANSMISSION BANDS

Moreover, the broadcasters are, in general, doing their part. The better class stations are equipped to radiate an audio band of 8,000 to 10,000 cycles; Radio City is equipped to broadcast an audio band of 15,000 cycles. High-fidelity recordings are regularly broadcast which cover a band of 50 to 8,000 cycles or better, new microphones are being used which are flat to practically 15,000 cycles, wire line networks equalized to 8,000 cycles have been in regular service for some time, and recently a newly developed loudspeaker was described which reproduced with remarkable fidelity frequencies to 8,000 cycles and beyond.

It therefore appears that the broadcast listener is not getting the benefit of the wide audio band that is available and

● The first of a series of articles dealing with the design considerations of receivers having wide acceptance bands. The present article is general and serves as an introduction to the subject

in many instances in use. The growing use of better talkie systems and better maintenance appears to be meeting with popular approval. Since the better systems actually reproduce frequencies of 8,000 cycles and above, it seems that popular demand will shortly force manufacturers to produce receivers of higher fidelity.

ACCEPTABLE BAND WIDTH

There has been considerable discussion, in the past few years, of just what the proper acceptance band of high-fidelity receivers should be, in view of the present 10-kc spacing of broadcast stations. Since the better programs usually appear at night when skywave interference is prevalent, this is, of course, a problem. However, with the present spacing of 50 kc or more for local stations it would appear that high-fidelity receivers offer definite possibilities in areas of high field strengths in which a choice of several stations is available. Sets are already available in which the overall fidelity is essentially flat between 50 and 4,000 cycles—excluding the loudspeaker. It is generally conceded that little is to be gained by extending the frequency range below 50 cycles. As a matter of fact on channels shared by several stations, good low-frequency response may be a decided detriment because of accepting the very low-frequency carrier beats, which might otherwise be inaudible. The response of the ear (see Fig. 1) below 50 cycles drops very rapidly, but in an audio amplifier accepting very low frequency, modulation might occur, which would cause audible responses.

It is generally conceded that before any noteworthy difference in fidelity occurs, the band width must be extended by an octave or more. This does not mean that differences cannot be noticed by switching between two receivers in which the fidelity differs by less than an octave. It does mean, how-

ever, that such small differences in fidelity are not readily noticeable except by direct switching. Such small differences are, therefore, hardly salable quantities. An octave difference in fidelity would, of course, mean an audio bandwidth of 50 to 8,000 cycles.

INTERFERENCE PROBLEMS

Now there are two types of interstation interference likely to be encountered in a broad-band receiver. Probably the most serious of the two is the beat note between the desired and the undesired carriers. The second type of interference is the inverted signal due to the adjacent sideband of the undesired signal and the carrier of the desired signal. Of course, there are numerous other types of interference, such as the beat between the desired side bands and the undesired carrier, but in general these will be small enough to neglect in comparison with the first two.

In receivers of the superheterodyne type, in which the closer selectivity is obtained by means of fixed tuned filters, it is entirely possible to reduce 10-kc beat-note interference to a negligible quantity by use of additional filter elements. The reduction of the second type of interference is, however, not so simple. Fortunately, though, this type of interference is of considerably less importance generally than that due to the carrier beat notes. It cannot be entirely eliminated by good selectivity.

Probably the sole answer is that the wide band can only be used to full advantage under conditions of adequate field strength ratios. It would therefore appear that no material advantage would accrue from any small reduction in band width and that 8,000 cycles is probably as happy a choice, under the circumstances, as any.

FIVE-KC BEAT NOTES

The above discussion is premised on 10-kc station separation and does not

take account of 5-kc beat notes caused by foreign broadcasters spaced midway between the regularly assigned channels. Moreover, no mention has been made of the fact that the noise energy due to static, circuit and tube noises, and the like, increases in direct proportion to increases in receiver band width. It is at once evident that if the receiver is to be generally useful it must have an adjustable acceptance band. A narrow band, of course, is essential for use with distant stations.

POWER OUTPUT OF RECEIVERS

The power output of any radio receiver is, naturally, an open question, and largely a matter of opinion. However, the power capability should be adequate to handle the audio peaks without overloading. This again depends on the conversion efficiency of the loudspeaker.

It seems that 6 watts of electrical energy should be sufficient to fill most requirements. The output rating is, obviously, dependent on the permissible distortion. It has been generally established that for an 8,000-cycle band, some 10 percent of second harmonic, and about 0.7 percent of third harmonic is permissible.* It is probable that this can even be exceeded somewhat on peaks, without serious injury to the program.

DIRECTIVITY OF SPEAKERS

Before a high-fidelity receiver can be fully justified, considerable attention must be given to directivity of the loudspeakers as a function of frequency. In general, loudspeakers that have been used with receivers tend toward marked directivity at high frequencies. No doubt the use of two-unit speakers, one for the high frequency and one for the low frequency range, each employing directly radiating diaphragms, would do much to remedy this situation. As a matter of fact, experimental work indicates that two high-frequency and one low-frequency unit, with the high-frequency units set at a slight bias to each other, will prevent any marked directivity at any frequency. Since the overall effect of high fidelity will depend largely upon the room in which it is used, considerable educational work indicating proper acoustic conditions for the room in which the radio receiver is to be located, needs to be done.

SQUARE-LAW DETECTOR RESPONSE

It is well known that the audio response of a square-law detector depends on the carrier amplitude and the sideband amplitude. This type of detector has two disadvantages. First, the noise arising ahead of and in the detector circuit increases with an increase in car-

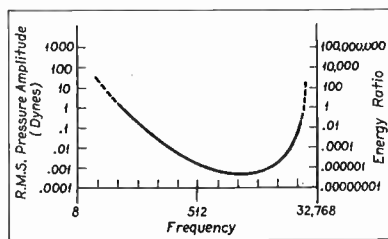

Fig. 1. Curve of the response of the ear to audio frequencies from 8 to around 33,000 cycles. The drop is very rapid below 50 cycles.

rier, and second, the second harmonic of the audio output is a function of percentage modulation. Thus the ratio of second harmonic to the fundamental of the following wave: $E=A \cos wt (1+K \cos pt)$ is after detection in a square-law detector: $K/4$, where K is the percentage modulation. Thus at 100 percent modulation, the amplitude of the second harmonic is equal to 25 percent of the fundamental. In the linear detector, on the other hand, the audio output, and consequently the noise arising in and ahead of the detector, is independent of carrier and proportional

to sideband amplitude (or percent modulation) only. Moreover, theoretically there are no audio harmonics. It is apparent from this that linearity of the detector is essential in a high-fidelity receiver . . . even diodes are parabolic at small inputs. Hence, it seems that high-fidelity signals require a high detector input, which indicates the necessity of AVC.

SQUELCH CIRCUITS

A similar line of reasoning may be followed to show that squelch circuits should be controlled through one or more highly selective circuits in addition to those employed in the i-f amplifier. This device could then be used to insure correct tuning, which would be almost a necessity.

The conclusion is that a high-fidelity receiver requires considerably more care in its operation than present sets. Also, if good results are to be obtained, more fool-proof features are essential than are regularly employed.

*Proceedings I.R.E., May 1932.

PROGRAM FOR JOINT MEETING OF I. R. E. AND I. S. R. U. IN WASHINGTON

THE JOINT MEETING of the Institute of Radio Engineers and the American Section of the International Scientific Radio Union, is to be held April 27, 1934, at the National Academy of Sciences Building, 2101 Constitution Ave., Washington, D. C.

There will be two sessions, beginning at 10 A. M. and 2 P. M. Papers delivered will be limited to twelve minutes each, to allow time for discussion.

The following papers are listed at the time of going to press. While there may be some changes in the final program, the general scope will not be altered.

The development and characteristics of 9 cm. radiation. C. R. Kilgore (Westinghouse Company).

Vacuum tubes for generating frequencies above one hundred megacycles. C. E. Fay and A. L. Samuel (Bell Telephone Laboratories).

Fac-simile radio observations during the 1932 eclipse. E. F. W. Alexander (General Electric Company).

Notes on propagation at a wavelength of 73 centimeters. B. Trevor and R. W. George (Radio Corporation of America).

Some recent work on the ionosphere in Canada. J. T. Henderson (Canadian National Research Council).

Studies of the ionosphere by multi-frequency automatic recording. T. R. Gilliland (Bureau of Standards).

Ionosphere measurements at low alti-

tudes. L. V. Berkner and H. W. Wells (Carnegie Institution of Washington).

High-frequency ammeter. H. M. Turner (Yale University).

The thermal method of measuring the losses in a vacuum tube. F. P. Cowan (Harvard University).

Frequency standard and monitor stations of Canadian Radio Commissions. Col. W. A. Steel (Canadian National Research Council).

A method of measuring noise levels on short-wave telegraph circuits. H. O. Peterson (Radio Corporation of America).

Relative daytime intensities of atmospheric. K. A. Norton (Bureau of Standards).

Developments in automatic sensitivity control. G. E. Pray (Signal Corps Laboratories).

Phase angle of vacuum tube trans-conductance at very high frequencies. F. B. Llewellyn (Bell Telephone Laboratories).

A new method of obtaining the operating characteristics of power oscillators. E. L. Chaffee and C. N. Kimball (Harvard University).

A short-cut method for calculation of harmonic distortion of modulated radio waves. I. E. Mourontseff and H. N. Kozanowski (Westinghouse Company).

Space-charge effects in piezo-electric resonators. W. G. Cady (Wesleyan University).



FIGURE 3. MUSIC DIRECTED OVER THREE CHANNELS

AUDITORY PERSPECTIVE

By E. H. BEDELL, BELL TELEPHONE LABORATORIES

WHEN MUSIC is to be reproduced in auditory perspective before a large audience, there are many requirements that must be met, and much testing and adjusting that must be done, which are not directly related to the basic problem of reproducing the complete frequency and volume ranges. One of the most important group of adjustments is concerned with the acoustics of the halls where the music is being picked up and where it is being reproduced. The importance of the acoustic properties of an auditorium are probably not generally appreciated. Unless they are so bad that they actually spoil a reproduction or an original rendition, their existence is not usually recognized. That they play an important role under all conditions, however, could be inferred from the fact that 90 percent of the sound energy reaching a member of an audience may have been reflected one or more times from the various surfaces in the auditorium.

The acoustic characteristics of a hall are of particular importance when music is to be reproduced in auditory perspective, because the illusion of the actual presence of the orchestra, which it is desired to produce, depends to a large extent on the characteristics of the two halls involved. The system must be set up and adjusted to give the desired illusion under existing conditions, and in general these adjustments will differ for various auditoriums. Imperfect adjustment for the acoustics may destroy the desired illusion and be improperly ascribed to the reproducing system itself.

One of the important factors is the reverberation time of the auditoriums, and as a first step in preparation

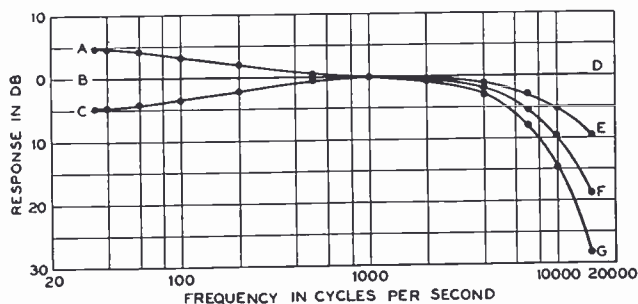

Fig. 2. Quality control networks permit the high- or low-frequency components to be modified as shown above. Thus, A, B and C indicate gain and attenuation at low frequencies.

for the auditory perspective demonstration of April, 1933,* it was necessary to procure the reverberation times under various conditions of both the Academy of Music in Philadelphia, where the music was picked up, and Constitution Hall, where it was reproduced. Although in neither hall were the reverberation times for the various frequencies ideal, in both they were sufficiently satisfactory so that modifications of the halls themselves did not seem required.

ACOUSTIC COLORING

In an ordinary reproduction, not in auditory perspective, one usually has the choice of reproducing the acoustic characteristics of the pick-up hall or studio—and thereby in effect transporting the listener to the pick-up location—or of allowing the acoustics of the place where the music is heard to color the reproduction, which has the effect of transporting the orchestra to the location of the listener. In an auditory perspective reproduction this choice is not possible because the objective is to give the illusion of the actual presence of the orchestra, and this requires that the acoustic coloring of the hall where the reproduction is taking place be represented, and not that of the hall where the music is picked up.

Since the room coloring is due to reflections, the pick-up microphones must therefore be placed near the orchestra if the reverberation effects of the pick-up hall are to be minimized. The perspective effect, obtained from the use of three channels, also requires that the microphones be placed near the orchestra. This close placement of the pick-up microphones, however, is contrary to usual practice for a single channel reproduction. Here it is better to have the microphone at a greater distance from the orchestra, where more of the reverberation effects will be picked up.

ACOUSTIC-STUDY EQUIPMENT

When the microphones are placed close to the orchestra the effects of the acoustic characteristics of the pick-up hall are largely eliminated. The effects of the hall where the music is reproduced, however, have to be carefully studied and preserved. Studies were made in which a heterodyne oscillator, connected to the loud-

*Bell Laboratories Record—May, 1933, p. 254.

The details of the so-called "three-dimensional" sound system recently demonstrated, and the methods and equipment employed for the acoustic study of auditoriums.

speakers through the amplifiers, produced tones of varying frequency which were picked up by a portable microphone connected to an automatic level recorder. The frequency was varied through the range from 35 to 15,000 cycles per second, and continuous curves of microphone response as a function of frequency were obtained for a number of positions in the auditorium. The loudspeakers were placed so that each covered the entire auditorium as nearly as possible, and the curves from the automatic level recorder gave a check on these coverages. They also furnished data for the design of equalizing networks which were associated with the amplifying equipment. In general the audience will not hear the same quality of sound that is given out by the loudspeakers. This is partly due to the effects of reverberation and partly to the fact that the higher frequencies are absorbed more rapidly by the air than are the lower frequencies. The equalizers are designed, therefore, so that the best overall characteristics of the sound will be heard at an average listener position. Correct equalization is thus different for every hall. Since the greater part of the audience in Constitution Hall was well back from the stage, equalization was based on microphone readings taken at some distance from the loudspeakers.

SECONDARY ORCHESTRAL DIRECTION

Besides these various provisions to insure the best quality of music and the truest illusion of the actual presence of the orchestra, tests had indicated that it was possible to produce an aesthetic effect more pleasing than that of the orchestra itself. This was accomplished by control features manipulated by a director seated in the audience. This control position is shown in the photograph of Fig. 1. One of the controls was a volume adjustment which permitted the output of the orchestra to be modified as the director deemed necessary, and allowed a larger range of volume from the loudspeakers than was possible from the orchestra. When the orchestra was playing alone the volume of the three channels was controlled from a single dial. When a soloist was accompanying the orchestra, however, the center channel, connected to a different microphone, was used exclusively by the soloist and was controlled separately. This additional microphone, which could be switched in place of the regular microphone for the center channel, was shielded by a directional baffle so that it responded to energy received from only a very small solid angle. In this way the voice—even during the loudest passages of music—could be kept slightly above the level of the orchestra.

QUALITY CONTROL

In addition to this volume control, a set of quality control networks were provided, which could be switched into or out of the circuit by the keys in the right hand cabinet at the control position. These networks increased or decreased the higher or lower frequency components as shown by the curves of Fig. 2. Similar net-

works were provided for all three channels. When under the control of the director, the employment of these networks may add appreciably to the aesthetic effect of the music.

Besides these volume and quality controls, certain auxiliary circuits were supplied to aid the smoothness of the performance. These are in a cabinet at the left of the control position as shown in the photograph of Fig. 1. An order wire gives communication between all technical operators and the directors position, and a monitor circuit is provided in the reverse direction. The microphone for it is located before the director, as shown in Fig. 3, and loudspeakers are connected in the control rooms and on the stage with the orchestra. These enable the control operators and the orchestra to hear what goes on in the auditorium, and allows the director to speak to the orchestra. Two signal circuits are also employed. One gives the orchestra a "play" or "listen" signal, and the other is a silent signal to the assistant director leading the orchestra, which can be used during the rendition of the music.

CONCLUSION

Because of these various control features, chiefly the volume and quality controls, the reproduction of music in auditory perspective as developed by the Bell System is capable of producing musical effects that are actually superior than those obtainable from any practicable size of orchestra at the present time. The system insures that practically the complete frequency and volume range of the orchestra is reproduced, and in addition a modification and enhancement of the effect is possible under the control of the musical director. It provides facilities which permits the finest musical reproductions to be heard whenever an adequate auditorium and audience is available without the very large expense of actually bringing a first class symphony orchestra to the local auditorium.

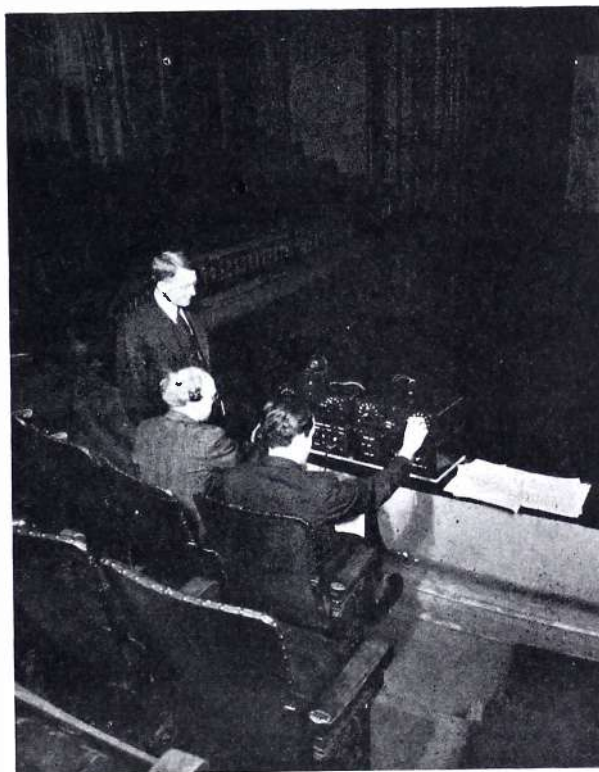

Fig. 1. The point of "secondary orchestral direction," where the transmission characteristics of the three channels may be altered at will.

High-Fidelity TRANSMITTERS

BY J. E. YOUNG

TRANSMITTER ENGINEER
RCA VICTOR CO., INC.

EFFECT OF HIGH-FIDELITY REQUIREMENTS ON TRANSMITTER DESIGN

THE EDUCATION of the public to high-fidelity standards of sound reproduction is slowly being accomplished through extension of the useful audio-frequency range and reduction of distortion in the modern broadcast receiver, as well as through improved methods of recording and reproducing as applied to moving pictures. This education should proceed even more rapidly during the next several years, through the application of systems of automatic tone control to the receiver, thus taking from the listeners' hands the possibility of reducing the program material to an undistinguishable mixture of drum beats and high-frequency chirps. Too often is the tone control on today's receiver set for maximum attenuation of high frequencies and left untouched regardless of the type of program material and the nature of the background noise.

TRANSMISSION FIDELITY

As the frequency range of the receiver is extended, and the distortion reduced, for distortion reduction has proved to be a necessary corollary to extension of the frequency range, the imperfections in present day broadcast transmitters will become increasingly apparent. This is especially true since there are some stations in operation with standards of fidelity rigorously maintained on a high plane. As the receiver is improved and as the public becomes more exacting in its demand for high fidelity the discrepancy between such stations and those not so far in advance of the development of the art as applied to receiver design will become painfully evident. This will probably be especially true of low-power stations, since these stations do not ordinarily have available monitoring and test equipment necessary to check the fidelity of the transmitting equipment. A considerable portion of the listening public derives its entertainment from these same low-power stations and their transmission should therefore be of the highest quality.

In designing the transmitter to complement the high-fidelity receiver it is necessary to anticipate receiver development by several years in order that the transmitter will not be antedated through rapid receiver improvement. There are listed in the following para-

graphs the more important requirements the transmitter must fulfill in order to achieve the necessary advance over receiver development.

The frequency range of most existing transmitters is satisfactory, at least insofar as reproduction of high frequencies is concerned, and low-frequency response is well ahead of present-day receiver design. The average transmitter frequency characteristic is substantially flat from 80 to 7,000 cycles, and many transmitters pass a band of from 30 to 10,000 cycles. Observations made over a period of time indicate that there is little advantage to be secured by reproducing frequencies above 8,000 cycles. It is for this reason advisable to cut off the pass band sharply at 8,000 cycles in order to reduce adjacent channel interference.

HARMONIC DISTORTION

The use of diode detectors and high quality audio amplifiers in modern receivers has resulted in a considerable reduction in receiver non-linearity and no doubt still further reduction will be accomplished in new receiver design. Measurements on existing receivers indicate that 12 to 20 percent distortion is to be expected, while the high-fidelity receiver will generate harmonics not exceeding 3 to 4 percent. This reduction in distortion will emphasize the difference in linearity among the broadcast transmitters. As the public appreciation of finer quality of reproduction increases, a demand for improved quality in those transmitters not up to the high standard maintained by the few will make itself felt. The present limits on distortion may result in a noticeable impairment of quality, depending on the order of the harmonic introduced by the non-linearity, and the type of program material. To anticipate receiver development, transmitter design should not permit non-linearity in the transmitter sufficient to generate harmonics having an arithmetic sum of more than 5 or 6 percent, expressed in terms of the fundamental frequency. This is an equivalent to an R.M.S. sum in the order of 2 to 4 percent, depending on the individual harmonic amplitude.

Since over-modulation results in marked and easily recognizable distortion, means should be provided to limit the percentage of modulation to less

than 100 percent except for very occasional peaks. Such a device may take the form of an automatic limiter, or a visual means of monitoring, which will permit a check of the exact percentage of modulation, regardless of the period of the modulating frequency, or its average amplitude.

Phase distortion is generally conceded to have little objectionable effect in aural reception. It may, however, produce a noticeable distortion where the audio frequency transmitted is composed largely of transients, a condition often met with in certain types of music and speech. It is, therefore, desirable to reduce phase distortion as much as possible.

VOLUME RANGE

Another aspect of high fidelity is the problem of securing a satisfactory volume range. Limitations imposed by present day microphones, telephone lines and transmitters permit a usable volume range of from 25 to 35 db. The necessary compression of, let us say a rendition by a symphony orchestra, to permit its satisfactory transmission over available circuits results in a very noticeable loss of color. The high field strength existing around high-power stations permits the receiver which is properly free of internal disturbance to operate over a much wider volume range. Development of improved microphones and telephone lines permitting a much larger volume range is now under way and should be complemented by a similar development in transmitters. Disturbances on the transmitter carrier due to unsteady anode voltages, axiotron effects, microphonic pickup in tubes, and other causes should be in the order of 60 db down, measured in terms of 100-percent modulation. The peak amplitude of single disturbances should be no more than .1 or .2 of one percent. This added qualification is necessary because certain types of disturbance may have peak values of one or two percent, yet have extremely low R.M.S. values because of the form factor of that particular disturbance.

EXAMPLE OF TRANSMITTER

The large listener field reached by 500- and 1000-watt stations makes high-quality transmission by stations in this power range essential. Recent develop-

ments in transmitting equipment are expressly designed with these points in mind.

As an example, the carrier frequency of the RCA Victor 1-D Transmitter (1 KW) is maintained by quartz crystals, and two crystal units are constantly maintained at the proper operating temperature, within the transmitter. Each crystal oscillator employs one RCA-843 tube. This tube is used because of its reliability and because indirect heating of the cathode prevents hum and frequency modulation. The second radio-frequency stage employs a UX-865 tube. The third stage employs a UV-203A tube and the fourth stage employs two UV-203A tubes in a push-pull circuit. The fifth and last stage employs four UV-204A tubes.

Each radio-frequency stage is tuned by variable condensers. In each stage great precautions have been taken to prevent undesirable couplings and to prevent parasitic oscillations. Each stage receives most of its bias voltage by means of a grid leak but also receives sufficient self-bias so that, in case the crystal excitation is lost, the anodes will not be required to dissipate excessive heat.

The tank coil design in the power amplifier stage has received very careful consideration. Not only is it arranged for maximum efficiency, but an electrostatic shield is provided between the primary and secondary to prevent the coupling of radio-frequency harmonics into the antenna circuit. In addition, a harmonic filter is provided between the power amplifier and the antenna to further attenuate the radio-frequency harmonics.

The first audio-frequency stage employs two RCA-843 tubes in push-pull Class A. The second stage employs two UV-845 tubes in push-pull Class A. The third stage is the modulator stage. It employs two UV-849 tubes operating Class B. The modulator output voltage plate modulates the power amplifier.

CONTROL CIRCUIT

The control circuit is simple and fool-proof. It renders either automatic or manual starting as desired. All controls which are frequently used are located on the front panel. The plate and filament contactors in both the exciter and the amplifier are mounted on rubber shock absorbers. This type of mount-

View of the high-fidelity transmitter, with doors open, showing the location of the components.

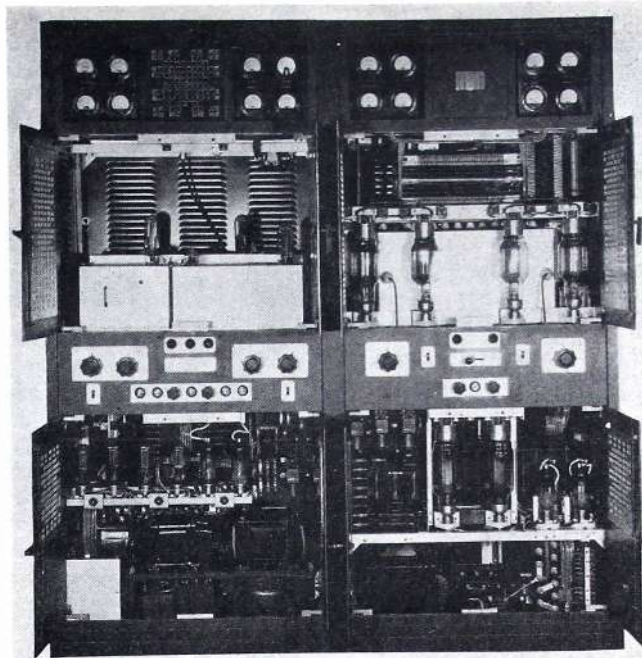

ing prevents the transmission of any vibration due to the operation of the contactors to the frame of the transmitter, minimizing any disturbances on the carrier due to microphonic pick-up. The elimination of the danger of mechanical shock to the tubes contributes to their long life and trouble-free operation. All the tuning controls are located behind small concealed doors. The remote tuning dials connect to the units to be tuned by flexible cables, thus permitting, for the first time, the locating of the units being controlled at the points where they belong electrically, whereas the dials are located where they belong from an artistic and convenience viewpoint.

INDICATING METERS

A total of sixteen meters is provided. It is apparent that operation is always facilitated by a multiplicity of meters. Furthermore, several of the meters can be switched to a number of points in the circuit, thereby making it possible to read every current and voltage of importance in the entire equipment. Tap changing switches have been provided on the front panels to permit compensating for line voltage fluctuations of plus or minus 15 percent. The taps are arranged every 2 percent. This feature is considered very desirable since many 1-KW transmitters are located where the power supply is not standard or fluctuates badly. These tap changing switches can be operated while the transmitter is on the air. It is thus unnecessary to compensate separately the various plate, filament and bias voltages. The operation of the transmitter is, of course, greatly simplified by the

cathode ray modulation indicator and by the high-fidelity loudspeaker.

MONITORING

To adequately monitor the output of this transmitter, a high-fidelity loudspeaker and a percent modulation meter are located in the exciter unit. The monitoring circuits are brought out to terminals and are connected to the 1-KW amplifier when this unit is used. As a further check on the 1-KW amplifier, a cathode ray oscilloscope is mounted in the amplifier frame and coupled to the output tank circuit. The cathode ray oscilloscope permits the operator to check the percentage of modulation at all times and provides a positive indication of over-modulation, regardless of the length of time the over-modulation exists.

The frequency characteristic is substantially flat from 30 to 10,000 cycles. The harmonic distortion has been reduced to several percent with the result that it not only is far below the limits specified by the Federal Radio Commission, but it is also low enough to render satisfactory performance from the most advanced types of laboratory receivers. The carrier hum has been reduced to the level of at least 60 db below the level of 100 percent modulation, which is equivalent to a modulation of less than 0.1 percent. This means that in the program as listened to in a quiet suburban home at average volume, the residual hum remaining, if the program were cut off, would be below the threshold of audibility.

In an accompanying table are tabulated the results of the measurement of the harmonic distortion at 200 cycles in one of the new type 1-D transmitters.

% Modulation	% HARMONIC AMPLITUDE							Arith. Sum.	R.M.S. Sum.
	2nd	3rd	5th	7th	9th	Sum.	Sum.		
100	1.4	0.87	0.8	1.1	..	4.17	2.13		
90	1.1	0.42	1.2	1.0	..	3.72	1.95		
80	0.9	1.25	1.25	0.2	..	3.60	1.99		
60	1.5	1.65	0.45	3.10	2.26		
40	1.2	0.90	0.10	2.20	1.50		
20	1.7	0.40	0.10	2.20	1.75		

Auto Ignition Interference

THE IGNITION SYSTEM of an automobile is quite similar to the circuit of the old spark transmitter. They are, in fact, essentially the same, as can be seen from a comparison of Fig. 1 and Fig. 2.

SPARK TRANSMITTER CIRCUIT

In Fig. 1 is shown an old type spark transmitter which consists, in the main, of a battery, a key, a circuit breaker, a transformer, a spark gap, and an antenna. It operates in the following manner: The closing of the key results in the breaker coil becoming magnetized which, in turn, pulls up the armature and breaks the circuit. The flux in the core immediately begins to decay. This sets up a pulse in the secondary which is proportional to the rate of change of this flux, and a voltage is built up which becomes sufficient to break down the spark gap. The antenna consequently radiates energy.

IGNITION SYSTEM CIRCUIT

Consider the main features of the ignition system of an automobile and note that they are common to the spark transmitter. A typical ignition system is shown in Fig. 2. It consists of a battery, ignition coils which correspond to the transformer in the spark transmitter, a breaker, and the spark plugs which take the place of the spark gap. In Fig. 1, however, the breaker is operated by a coil, like a relay might be, and in the automobile it is motor-driven. We still have, then, transients set up and the resulting radiated energy which is due to the distributed capacitance and inductance in the high-tension leads, over a wide range.

In general, there are four ways of eliminating interference over any given band. First, the electrical circuits may be shielded. If this is properly handled we have a decided advantage in that radiation is prevented at any frequency.

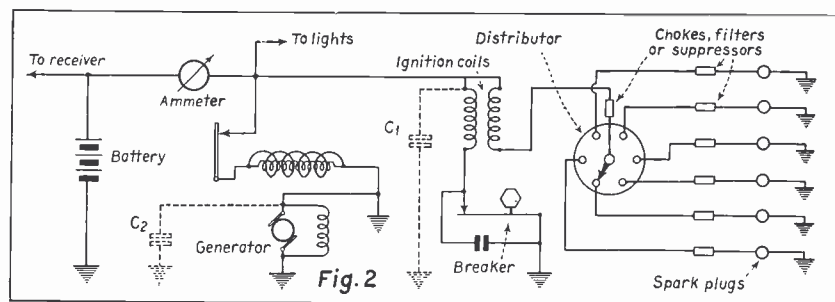

Circuit of an automobile ignition system provided with units for the suppression of interference.

By **R. D. RETTENMEYER**

ASSOCIATE EDITOR

Still another advantage lies in the fact that shielding does not effect the ignition system, which is highly important from the viewpoint of the auto manufacturer. However, care must be taken to keep the capacitance from the high tension leads to the shield as low as possible, and the shielding must be so placed that it will not intermittently short to some part of the car body. This method is quite commonly used in removing interference in aircraft. For automobile use the main disadvantage arises from the high cost of the shielding.

Another method of eliminating ignition interference is the placing of resistance in the high-frequency circuit to damp the oscillations. The value of this resistance must be large enough so that

$R/2L$ is equal to or greater than $1/\sqrt{LC}$.

As a general rule, however, no two cars are alike in their electrical constants and as a result this value is made considerably higher than is usually necessary. It is, also, given a high value—generally around 15,000 ohms—to take care of any ageing effects of the resistor. This method is cheap and it prevents radiation interference at all frequencies. However, these suppressors, as they are called, do reduce the intensity of the spark and thus may reduce the power of the motor.

RESONANT AND ANTI-RESONANT CIRCUITS

A third method is to tune the radiating system below the band on which reception is desired. This can and has been done by using large shielded coils, the coil being shielded to prevent radiation from the coil. This method does

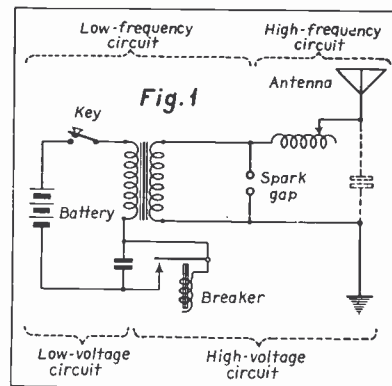

Circuit of a spark transmitter—duplicated by an auto ignition system.

not reduce the spark intensity and may even increase it due to energy stored in the coil; i.e., $\frac{1}{2}LI^2$. The main disadvantages of this system results from the cost and from the fact that it is only effective over a given band.

The last method is the use of an anti-resonant circuit in the high-frequency leads to reduce the efficiency of the radiating system over a given band at which the impedance of the anti-resonant circuit is high. This method is cheap, because only a small coil is required so that it is anti-resonant with its own distributed capacity. The field is thus small and the spark intensity is not reduced. These coils are normally of a 20-millihenry value resonated at about 700 kilocycles. However, radiations above and below the band are not prevented. They are merely reduced.

Most of these suppressors, coils, and the like, are small, and can be placed near the source of the spark. In any case, any suppressor must be close to the source so that radiation will not occur between the spark and suppressor for the leads have distributed capacity and inductance.

THE COMMUNICATION ASPECTS

The decided tendency among some manufacturers is to lean toward the anti-resonant circuit, while other receiver manufacturers favor suppressors. In gaining one advantage, however, they must sacrifice another. Undoubtedly, when the time arrives, and automobile manufacturers consider more seriously the communication aspects of the automobile system, the ignition will be designed so that it can be easily and cheaply shielded. This will not eliminate the use of condensers across the breaker and primary of coil, however, for their main purpose is to eliminate low-tension interference.

With an increased amount of activity on the ultra-short waves, the problem of radiation from automobiles will have to be dealt with. Such interference has already become a serious matter.

COMMUNICATION and BROADCAST ENGINEERING

Published Monthly

A Chronological History

of electrical communication

—telegraph, telephone and radio

This history began with the January 1, 1932, issue of RADIO ENGINEERING. The items are numbered chronologically, beginning at 2000 B.C., and will be continued down to modern times. The history records important dates, discoveries, inventions, necrology and statistics, with numerous contemporary chronological tie-in references to events in associated scientific development. The material was compiled by Donald McNicol.

PART XXVII

- (1067) In the United States 623 cities and towns have electric fire alarm systems and 123 cities have electric police control systems.
- 1904 (1068) The Western Union Telegraph Company announces (March 1) the acceptance of messages for passengers on ships at sea, to be transmitted by wireless telegraphy. Thirty-two Atlantic ships are equipped with wireless apparatus.
- (1069) The Postal Telegraph-Cable Company celebrates in New York (May 24) the sending of the first telegraph message sixty years ago.
- (1070) Officers of the United States Signal Corps complete (August) the laying of the Seattle, Wash., Sitka, Alaska, cable. The cable is 1,071 miles long and was made by an American cable making company. In Alaska there are now 2,128 miles of submarine cable in operation by the Signal Corps.
- (1071) The Lorain Steel Company installs a 6,600-volt electric power plant at its mills.
- (1072) The Cooper Hewitt mercury-vapor electric lamp and mercury-arc rectifier are introduced commercially.
- (1073) Up to this year 620 United States patents have been issued covering inventions of electric meters.
- (1074) Transformers of 2,500 kw. capacity at 60,000 volts are in use in the United States. There are approximately 10,000 transformers in use in this country, ranging from 10,000 to 60,000 volts.
- (1075) John W. Lieb is elected president of the A.I.E.E.
- (1076) The first wireless telegraph act is passed by the British parliament.
- (1077) An International Electrical Congress is held at St. Louis, Mo.
- (1078) The Canadian Pacific Railway Company's telegraphs in Canada include 10,244 miles of pole line; 48,562 miles of wire and 1,143 offices.
- (1079) A telegraphers' fast-sending tournament is held in Madison Square Garden, New York, December 4.
- (1080) H. E. Shreeve, of the Western Electric Company, New York, develops a telephone mechanical repeater which is introduced in service by the American Telephone and Telegraph Company.
- (1081) The Electric Bond and Share Company organized, New York.
- (1082) The flaming arc electric lamp is introduced in the United States.
- 1905 (1083) Mr. Marconi procures patent No. 14,788, in England, covering the invention of the horizontal directional antenna.
- (1084) An electric power transmission system is installed between Minneapolis, Minn., and Taylors Falls, Wisconsin, a distance of forty-one miles. 2,500-volts, 60-cycle, 3-phase current is raised for transmission to 50,000 volts.
- (1085) J. A. Fleming, in England, develops the valve detector for wireless signaling.
- (1086) Schuyler S. Wheeler is elected president of the A. I. E. E.
- (1087) Judge Townsend, in New York, on May 4, renders judgment in favor of the Marconi Company in an action against the De Forest Wireless Telegraph Company for infringement of patents.
- (1088) The Western Association of Electrical Inspectors is organized (June 1) in Chicago.
- (1089) Telegraphers on the Great Northern and Northern Pacific Railroads go on strike, demanding increased wages (July).
- (1090) The Commercial Cable Company lays its fifth transatlantic cable.
- (1091) The use of the telephone in place of the telegraph for dispatching trains on steam railroads is extended on lines in the United States and Canada.
- (1092) The keyboard telegraph Morse transmitter invented by Yetman is introduced in service in railroad and commercial telegraph offices.
- (1093) The Marconi Wireless Telegraph Company begins the construction of a high power station at Clifden, Ireland (October).
- (1094) Up to December 31, the United States patent office has issued 7,154 patents relating to telephone apparatus. Over 800 of these were for transmitters and 500 for receivers.
- 1906 (1095) Lee De Forest, in the United States, is granted a patent (January 18) for a vacuum tube detector for wireless signaling, known as the Audion.
- (1096) A second Radiotelegraphic Conference is held in Berlin, Germany.
- (1097) Mrs. John W. Mackay, jointly with Clarence H. Mackay, New York, present the sum of \$100,000 to the University of California, the income from which is to provide an electrical engineering professorship.
- (1098) The Illuminating Engineering Society is organized, New York, February 10.
- (1099) Earthquake and fire at San Francisco, Calif. (April), destroy telegraph, telephone, electric light and power circuits, causing great damage.
- (1100) The Commercial Pacific cable is extended from the Philippines to China and Japan.
- (1101) Professor Korn, in Europe, exhibits a system of transmitting pictures by wire, employing selenium cells.
- (1102) Great commercial activity throughout the United States creates a large increase in telegraph correspondence.

(To be continued)

NEW PRODUCTS

AEROVOX DRY ELECTROLYTIC CONDENSERS

The Aerovox Type EM, single section, and Type EE, double section, electrolytic can type condensers are recommended for use in small apparatus assemblies, such as the replacing of paper box type condensers in midget sets. They are her-



metically sealed to prevent evaporation of moisture from the electrolyte or absorption of excessive moisture from air, are provided with lug terminals on a molded bakelite top, and are designed for use under temperatures where the life of a paper condenser would be limited. They may be obtained in numerous capacities for various working d-c voltages.

CARDBOARD CONDENSERS

The Type PB, single section, cardboard container bypass condensers are suitable for manufacturing requirements or service work to substitute for paper wound units. They are provided in different capacities for 25, 50, 100, 150, 200, and 300 volts d-c working, and have mounting flanges.

CAN CONDENSERS

The Type MM is a series of small condensers, contained in round aluminum cans one inch in diameter, that are suited as by pass units. They are provided with



an aluminum mounting strip riveted to each can.

The double section units of this series have two terminal lugs mounted on a molded bakelite cover at one end.

The Type EEM, double section, can condensers may be mounted in any position either above or below the chassis by means of a mounting ring. They are completely sealed in one-inch cans and are desirable for use where space does not permit use



of two larger size individual units. The common negative terminal of all units are grounded to the can with two positive lugs on top.

These two types, MM and EEM, may be obtained in various capacities for working voltages of 25, 50, 100, 150, 200, and 300 volts d-c.

HARDWICK, HINDLE TYPE 1642 RHEOSTATS

The type 1642 rheostats, produced by Hardwick, Hindle, Inc., of Newark, N. J., are obtainable in values varying from 1 to 15,000 ohms.

The resistance element of this unit is space-wound upon a toroidal form of elliptical cross section, the wound toroid being covered with vitreous enamel except where contact to conductor is made. Its sliding contact is made between the resistance unit and a brass collector ring through floating dual brushes.

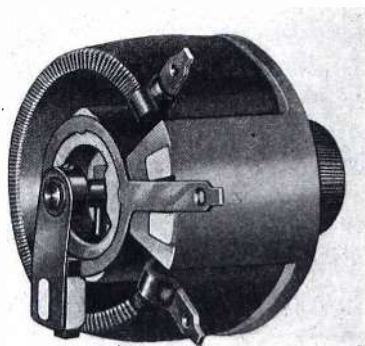

The shaft, mounting, and contact mechanisms are designed so that more than one rheostat may be placed on the same control shaft, and the shaft and mounting brushes are insulated from the electric circuit to facilitate mounting on metal.

Standard rheostats are designed for panels not over 1/4 in. thick, but longer bushings will be provided for thicker panels. Single hole (panel hole either 33/64 or 17/32 in. diameter) mounting is provided with a non-turn feature.

This unit is rated at 100 watts with the total resistance in use. Overloads up to 100 percent will not for short periods in any way injure or shorten its life, it is said.

ELECTRAD FIXED "T" TYPE ATTENUATORS

For fixed attenuation of low-voltage signal lines or for matching in signal level two or more input circuits to a public address system the "T" Type Attenuators are very convenient. Standard values are 5, 10 and 15 decibel attenuation in either 200- or 500- ohm impedance. These attenuation pads are made by connecting 3 wire-wound



resistors of proper value in "T" circuit. They are mounted in a bakelite case which is approximately two inches in diameter and one inch in height.

CORNELL-DUBILIER TRANSMITTING CONDENSERS

The Type TD Cornell-Dubilier transmitting condenser is a small, lightweight, oil-filled unit to incorporate in portable transmitters, and amateur installations.

The Type TD line of condensers is made by a new process of impregnating, using a special oil compound known as "Vegetol." The use of this impregnating medium allows for much smaller physical construction, it is said.

The 1934 Cornell-Dubilier catalog is now available and will be sent on request, if you write directly to the factory at 4377 Bronx Boulevard, New York City.

WESTINGHOUSE ELECTRONIC TIMER

Westinghouse announces the Type HA Electronic Timer which measures out a preset length of time and closes or opens its contacts for that time after the initiating impulse given from a push button, foot treadle, or cam operated switch. The device is used for such operations as the timing of spot and projection welder current flow, X-Ray timing, and other similar applications requiring an easily adjustable and accurately maintained time delay. The time measured out is continuously adjustable from 1/10 second to 45 seconds. It can be applied to any spot or projection welding machine now in service which is equipped with a magnetic main contactor.

The HA Electronic Timer is rugged, as the industrial grid glow tube is designed for sturdiness and long life, and operates the contactor directly without delicate in-

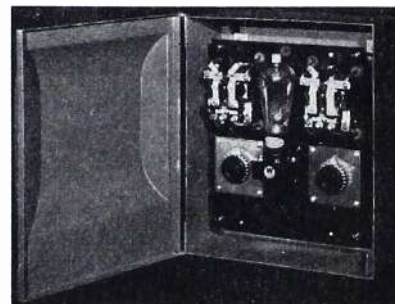

termediate relays. The grid glow tube is free from effects of wide temperature changes.

The timing is variable by means of a coarse and a fine adjustment. The coarse adjustment consists of a tap switch for changing connections to fixed resistors. The fine adjustment is a wire-wound potentiometer. The arrangement used has made long timing periods possible without the use of variable high resistance grid leaks.

For applications requiring high accuracy such as welding, provisions can be made to eliminate the errors inherent in the closure of the contactors. This is done by the use of an auxiliary contact on the main contactor arranged so that the timing is started from the instant the contactor closes instead of when the control switch is closed.

The contactor in the unit has a contact capacity of 10 amperes at 115 volts and 5 amperes at 220 volts alternating current.

PROCTOR PIEZO-ELECTRIC PICKUP

B. A. Proctor Co., Inc., 17 West 60th St., New York, N. Y. have introduced a new piezo-electric pickup unit designed expressly for use in broadcast stations, sound studios, theatres, etc., where a high degree of fidelity is a requirement.

The entire unit, including the tone arm, is solidly built of cast aluminum, machined and finished in instrument black and chromium. By the use of double self-aligning ground cone ball bearings, which take both the radial and thrust strain, freedom of movement of the pickup arm is obtained in both vertical and horizontal directions. The pickup arm is equipped with an adjustable counterweight and calibrated scale indicating in ounces the exact needle pressure on the record.

It is stated by the manufacturer that the crystal elements used in their pickups are individually selected and tested for frequency range and fidelity response.

Though the pickup may be connected direct to input grid, the manufacturers have available a matching transformer with four taps on the primary for compensation of frequency variations, and a secondary tapped to match either a 200- or 500-ohm input.

ROLA PM-8 SPEAKERS

The new Rola PM-8 dynamic loudspeakers embody new features of construction and parts, namely, domed center shield, corrugated diaphragm type centering member, dust proof acoustic filter assembly, high-efficiency magnet core construction.

A domed center shield, placed in the apex of the cone, shields the magnetic air-gap, the vital part of the loudspeaker, against the entrance of magnetic particles and dust. The particle-proof acoustic filter

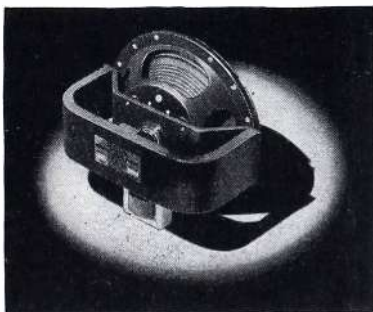

and the corrugated diaphragm type centering member protect the voice coil. Its amplitude, it is stated, remains unrestricted. Precautions are taken at the factory during assembly to produce a unit that is absolutely clean when the air-gap is sealed. It is further stated that a radically new and highly efficient type of magnet core construction and other exclusive features of assembly give greatly increased flux density, and that modern arc-welded construction assures the retention of full magnetic strength and permanence of all parts.

CURTIS DRY ELECTROLYTIC CONDENSERS

A complete line of dry electro-chemical condensers has been announced by the Curtis Condenser Corp., 3601 West 140th St., Cleveland, Ohio.

Standard capacities and peak voltages may be had in condensers housed in impregnated cardboard containers, rectangular metal cases, and round metal containers. Tubular and square section units are also available in small sizes.

The new Brush "Stage" crystal microphone, especially designed to be strung along the stage by the footlights. The surface of the stage acts as a baffle.

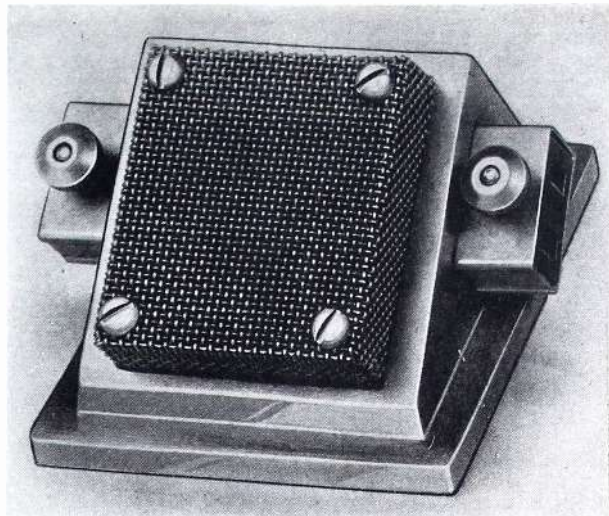

BRUSH "STAGE" MICROPHONE

The Brush Development Co., 3715 Euclid Ave., Cleveland, Ohio, have designed a crystal microphone for use on the stages in theatres, schools, etc. As the illustration infers, the unit is so designed that a number can be strung along the stage by the footlights.

The manufacturer suggests that for large theatres, etc., four to six of the units be used in two groups operating through separate amplifiers and speakers in order to produce a "binaural" type of sound reproduction.

The output level of the microphone is such that it can be used with the ordinary two-stage pre-amplifier and power amplifier, or can be used directly into a high-gain amplifier.

It is stated that inasmuch as this type of microphone is set flat on the floor, it is thus provided with an infinite baffle and, therefore, has an output frequency characteristic much more faithful than it is possible to obtain with other types of units.

NEW DU MONT OSCILLOGRAPH TUBES

The Allen B. DuMont Laboratories, Upper Montclair, New Jersey, have produced two new cathode-ray oscillographs—type 137 with a five-inch tube, and type 138 with a three-inch tube.

The type 137 oscillograph has been developed to enable broadcast stations to determine more accurately and monitor the percentage modulation of the transmitter. In contrast to the meter type instrument it shows the percentage modulation at any given instant rather than showing an average value over approximately one-quarter of a second. This is of considerable importance as it is essential to know the percentage modulation existing on sudden peaks.

The type 138 is useful for many determinations in the laboratory and in the field. It consists of a type 34 three-inch DuMont cathode-ray tube with a high-intensity screen, a power supply which furnishes all the voltages necessary for the operation of the cathode-ray tube, a sinusoidal sweep circuit and the necessary controls.

ACRACON CONDENSERS

The Condenser Corporation of America, manufacturers of Acracron Condensers, have made several changes in their manufacturing process.

All dry electrolytic units have been considerably reduced in size. Besides a greatly increased safety factor from a

surge voltage standpoint, it is now possible to produce units having a power factor loss as low as 1½% and a leakage current of less than 8 to 20 microamperes per mfd at rated voltages of from 25 to 500 volts d-c, they state.

An impervious aluminum oxide film, developed during the past year, improves their initial leakage characteristics after they have been unused for extended periods and also accounts for their improved filtering qualities during initial periods of operation.

The electrolyte in the dry electrolytic units will not dry out under a continuous temperature of 150 degrees Fahrenheit, and it is further stated that the capacity is not greatly affected by sub-zero temperatures. All Acracron units are rated according to their effective capacity at 120 cycles.

ELECTRAD "T" TYPE ATTENUATOR CONTROLS

For volume control in input or output circuits of a public address system, these "T" type attenuators give good service. They are constructed by using a multiple tap-switch of sturdy design with wire-wound resistor elements. Standard sizes are made in impedance values of 200 and 500 ohms with total attenuation of 44 deci-

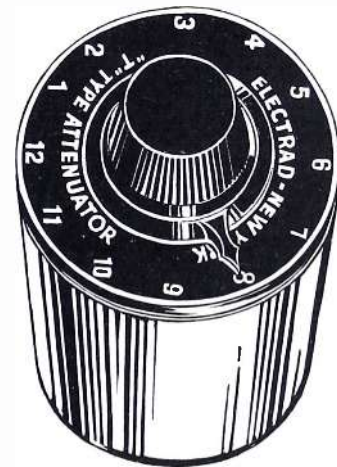

bel. Other than standard impedance or attenuation can, of course, be made to specifications. These attenuators will safely carry 8 watts of signal energy. They are 2½" in diameter and ¾" deep.

"FERROCART" CORE MATERIAL

The new magnetic core material, Ferrocart, which has formerly been available only abroad will soon be available on production in this market. This material comes to this country with a European record of twenty-four licensees among the finest radio set and coil makers in eleven countries, it is stated.

Ferrocart is an iron core material made by a unique process which gives it an extremely high efficiency, favorable permeability, and very low core losses; and it is further claimed that for intermediate-frequency and carrier-frequency coils it is superior to any material thus far offered to the radio trade. Preliminary tests have been made by one of the largest independent radio technical laboratories in the United States.

Offices have been opened in New York City by an American company for the purpose of placing Ferrocart in this market promptly on a production basis and in the proper form and design for direct application in our own types of high-frequency coils.

Full information may be obtained from the new company, the Ferrocart Corporation of America, at 12 E. 41st Street, New York City.

NEW CENTRALAB RADIOHM

The new Centralab Radiohm, manufactured by the Central Radio Laboratories, 900 E. Keefe Ave., Milwaukee, Wis., is a control that is only $1\frac{3}{8}$ inches in diameter but this unit has greater area devoted to the resistor and longer rotation for smooth control than their former controls measuring $1\frac{3}{4}$ inches in diameter. This control retains the patented non-rubbing contact, and it is furnished as a single, twin, or triple control, with or without intermediate resistance tap, with or without a

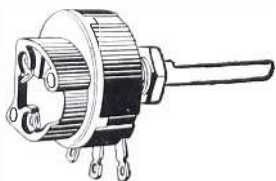

variety of switch combinations including S. P. S. T., S. P. D. T., D. P. S. T., all Underwriters' approved for 250 volt service, or a 10 ampere switch for auto-radio service. This unit has a milled flat shaft $2\frac{1}{4}$ inches long that may be cut to the exact length needed. They may be obtained in sizes up to 3 megohms.

RACON HIGH-FREQUENCY SPEAKER

A new electrodynamic high-frequency loudspeaker has been announced by the Racon Electric Company, Inc. This new unit is designed to cover the frequency band from 3000 to 10,000 cycles. Considerable field work has indicated that for application to existing types of equipment, for broadcast reception and for sound picture work, the upper useful limit of reproduction, based on available sound sources, will not exceed 10,000 cycles, and the unit has, therefore, been designed to function efficiently up to that point. Special units are available, however, for reproduction up to 18,000 cycles.

As supplied standard, a special cast horn is provided as an integral part of the loudspeaker, and the complete assembly

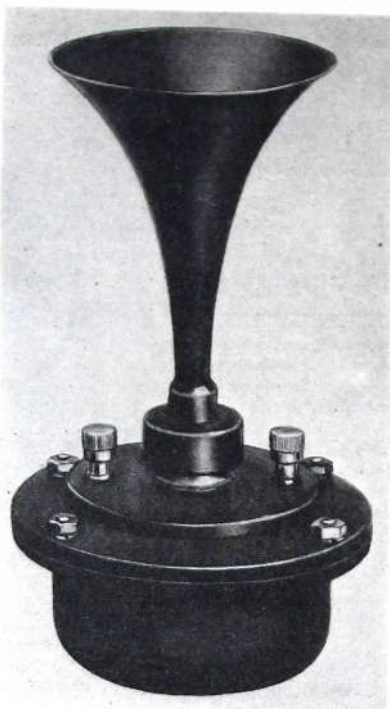

MEISSNER JUNIOR TRIMMER CONDENSERS

The Meissner Manufacturing Co., 2815 West 19th St., Chicago, Ill., have introduced a new style "Junior Trimmer" condenser to fill the need for a small compact condenser to be used as a series or parallel padder in radio-frequency and oscillator circuits, or as a trimmer for intermediate-frequency coils. It is available in either single or double style, the latter having the companion units mounted alongside each other on a common base or on both sides of the small base. The bases on both types are of molded steatite to insure maximum rigidity with minimum loss and as such find ready acceptance for use at ultra-high frequencies.

The standard units may be had in various ranges between the outer limits of 500 mmfd maximum to 3 mmfd minimum. On special request a slightly lower minimum capacity may be furnished but the maximum is necessarily limited to approximately 30 mmfd.

Mounting may be provided by either tapped inserts or studs. The customary oven head screw with slotted end allows for adjustment of capacity from either side of the unit.

The single unit measures $1\frac{3}{16}$ " by $1\frac{1}{32}$ ". The double unit measures $1\frac{1}{8}$ " by $2\frac{1}{8}$ ".

PADDING CONDENSERS

National Company, Inc., Malden, Mass., have introduced two shielded air dielectric padding condensers particularly desirable for use in circuits requiring a high degree of stability and efficiency.

These condensers are no larger than the average padding condenser of the mica

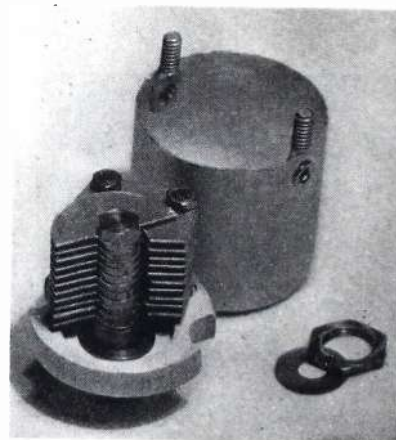

type, and are $1\frac{1}{4}$ " in diameter by $1\frac{1}{4}$ " and $1\frac{1}{2}$ " high respectively.

The insulating base is of isolantite. One-hole mounting is provided. The maximum capacities are 75 and 100 mmfd for types W75 and W100 respectively.

TUNGSTEN CONTACTS FOR "B" ELIMINATORS

The Callite Products Company, of Union City, N. J., has developed a high-quality tungsten contact point having special characteristics and giving long life when used in connection with automobile "B" battery eliminators.

The tungsten has been processed to give a special crystal structure which increases the conductivity of the metal and reduces pitting, thus resulting in long uninterrupted life.

A wide variety of contacts can be selected from stock, or contacts will be furnished in accordance with specifications.

can be quickly and conveniently mounted by means of a bracket.

The loudspeaker may be coupled to the output circuit in several different ways. Where a separate winding is provided, to match the voice coil impedance of 15 ohms, only a blocking condenser to obtain high-pass is required. Where special acoustic conditions are to be met, a dual path filter network is available, and such a system is found extremely useful in large auditoriums and similar locations that may be subject to excessive acoustics feedback and reverberation if indiscriminate projection within the wide-range band is carried out. It has been found desirable to utilize a volume control across the high-frequency unit as the simplest method of balancing the high efficiency of the high-frequency loudspeaker against the comparatively low efficiency of most low-frequency reproducers.

A special type of unit is available for radio receiver manufacturers, that will reproduce the full range of broadcast transmission without overlapping into the noise area encountered at the higher audio frequencies.

KESTER ALUMINUM SOLDER

The Kester Solder Company has announced a flux-filled aluminum solder for commercial use. It is sold in one pound



spools for commercial and industrial use, such as, in radio and electrical manufacturing.

THE DISTRIBUTOR SUPPRESSOR

Erie Resistor Corp., Erie, Pa., has recently added to its line of moulded carbon resistors and suppressors a new type distributor suppressor. This unit has a cap fitting on one end which fits firmly to the distributor cap. It is so designed that there are no exposed metal parts, once the suppressor has been snapped into the distributor head, making it impossible for arcing to take place between it and the spark plug leads. The high tension lead from the spark coil is connected to the



suppressor by a screw recessed in the celite socket.

The unit is compact and ruggedly constructed. A resistance pin $\frac{3}{4}$ " in length, similar to those used in the other styles of the Suppressors, is used in this new design. In spite of its smallness of size, it is stated, repeated tests show that this suppressor changes less than 5% in resistance due in 50,000 miles of use.

NEW SYLVANIA 212-D AND 831A TUBES

A super-power, improved, extra long-life type 212-D amplifier and transmitter tube is now announced by the Electronics Division of the Hygrade Sylvania Corporation, Clifton, N. J. The use of a graphite anode in place of the usual metal plate, together with a thoriated tungsten lead of the usual oxide-coated filament, provides a radically new type 212-D of improved characteristics, it is stated.

The special thoriated tungsten filament overcomes particularly the vacuum instability which is an inevitable result of the use of oxide-coated filament in tubes operating at high plate voltages. The addition of a graphite anode further insures the maintenance of the vacuum due to the proper action of the graphite mass, even when the tube is subjected to overloading. This is characteristic of all Sylvania graphite-anode types, this new tube will stand higher plate voltage and higher plate dissipation with consequent higher output.

NEW 831A TUBE

Under the 831A type designation, there has been announced a new and improved 830 oscillator, amplifier and modulator tube. The new type is provided with a pure tungsten filament in place of the usual thoriated tungsten. More than triple emission is retained while gaining the positive and long-life characteristics of the pure tungsten emitter. The floating anode feature means that the anode is suspended on lava collars to eliminate the corona effect which has been a frequent source of trouble in this type, especially when employed in ultra-high-frequency circuits. As with other Sylvania transmitting, power and large rectifier tubes, type 831A is provided with a one-piece pure graphite anode.

NEW HARDWICK, HINDLE UNITS

The Type M Rheostats, manufactured by Hardwick, Hindle, Inc., Newark, N. J., are of all porcelain and vitreous enamel construction. The resistive element is wound on a flat, mica form, which is embedded within a refractory base and completely embedded in vitreous enamel, so that all area along one edge of the winding is left free of enamel for contact purposes.

The circuit elements are insulated from

all other metal parts, insulation being sufficient for operation at 500 volts in accordance with the A. I. E. E. standards.

Contact between resistive element and a collector ring is secured by a brush contact of the full floating type, giving smooth electrical and mechanical control.

The Type M Rheostat is furnished with a non-turn mounting washer, assuring positive location after assembly. When operated at the nominal rating in free air, the maximum temperature rise will not exceed 250 degrees Centigrade and, while it is not recommended, these rheostats may be operated at 100% overload

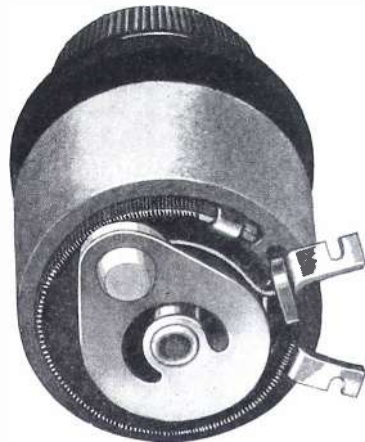

for periods of short duration without impairing their useful life, they state.

The unit shown is rated at 25 watts and may be obtained in values varying from 1 to 10,000 for the total ohmic resistance. The Type M units are supplied in 25- or 50-watt ratings.

TYPE NI RESISTORS

The Type NI resistors embody a new design in vitreous enameled resistor units. They are made by space winding resistance wire of low temperature coefficient of resistivity upon a pure mica strip. This element is then placed in a drawn steel case from which it is insulated, and the case filled with vitreous enamel, sealing it against moisture, air, or mechanical injury. This steel case gives the resistor high heat dissipating properties, it is stated. They may be obtained for several watt ratings and in resistance values ranging from 1 to 30,000 ohms.

ELECTRAD VITREOUS ENAMELED POWER RHEOSTAT

A power rheostat of unique design and rugged construction. The shaft and bushing are insulated and the wire winding is rigidly held in place by vitreous enamel which also covers the refractory base. The contact shoe, of special metal graphite composition, contacts the wire-wound element

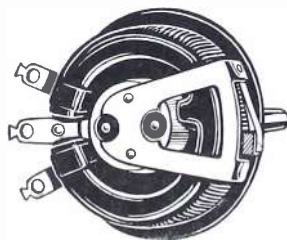

on the outside diameter. The rating is 50 watts with total resistance in circuit and standard resistance values ranging from 1 to 5000 ohms.

MIDGET TRANSFORMERS

Universal Microphone Co., Inglewood, Cal., has started production on a new line of midget transformers with the tiny units weighing but eight ounces.

They are about the size of an average cigar lighter . . . $1\frac{1}{4}$ inches wide; $1\frac{1}{2}$ inches long and $1\frac{1}{2}$ inches high.

Despite their extreme light weight and small size, the midget transformers' efficiency is high because of the special materials used.

Types available include microphone input, interstage coupling, output transformers from various types of tubes to low impedance speaker and tube to line and headphones for small power amplifiers.

TYPE 354 GAMMATRON

Heintz & Kaufman Ltd., 311 California St., San Francisco, Calif., announce the new HK 354 Transmitting Tube, bearing the trade mark "Gammatron." Designed particularly for long, hard service, gas-free operation, high output, and wide adaptability, the manufacturer points out how these are attained: "Construction is distinctively simple and rugged throughout, eliminating the various supports, multiple grids, and insulators heretofore thought unavoidable. There is no plate-supporting collar on the



stem, thereby eliminating that cause of stem breakdown—plate entirely suspended from the envelope dome.

No internal insulators are used in this tube, thus entirely removing this source of gas during service, it is stated. As a further prevention against gassing, both grid and plate elements are made of tantalum, a metal which discharges its own gas within the first few minutes of operation, and thereafter actually aids pumping.

The possibility of heat radiation being impeded is eliminated because no "getter" is used. The thoriated tungsten filament is completely shielded for low plate-to-filament capacity in grounded-grid operation. The envelope is of special Nonex glass.

The rated output of 100 watts can be greatly exceeded in service, with proper handling, it is said.

The characteristics of the 354, which has a plate dissipation of 100 watts, make it adaptable for a wide range of circuits.

SICKLES COIL UNITS

The F. W. Sickles Co. of Springfield, Mass., is presenting a number of novel coil units that will find particular application in compact receivers such as automobile sets. The new i-f units have been introduced, one of them a $1\frac{3}{8}$ " square can unit that can be supplied in cans varying in height from $2\frac{3}{8}$ " to $3\frac{1}{2}$ ", the other a round can $1\frac{3}{8}$ " in diameter. Both of these units are top tuned with the trimming adjustments side by side and employ new type i-f coil windings. Trimmer screws are insulated.

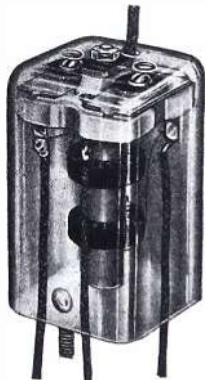

The four-layer bank windings are also being featured. These coils have as high "Qs" as other windings three and four times their size, it is stated. They will find particular merit where compactness and high quality are desired.

Of interest to designers of all-wave sets is a series of very small trimmers having capacity ranges of 3 to 30 mmfd. These are available in single, double, triple, or quadruple combinations. The single is approximately $\frac{1}{2}$ " x $\frac{3}{4}$ " by size.

BRUSH CRYSTAL MIKES

The Brush Crystal Mikes, manufactured by the Brush Development Company, Cleveland, Ohio, are of five types; namely, type G-4S6P, type G-2S2P, type L-2S2P, type H-2S2P, and type D-2S2P. The first letter, indicating the type case used, is followed by a four-letter-numeral combination, indicating the way the individual cells are connected. For example, type G-4S-6P has a type G case and is made up of 24 cells, six of which are in parallel and 4 in series, i. e., 4 in series connected 6 in parallel.

The sound-cell is a small microphone, with about $\frac{1}{4}$ square-inch active surface, working on the piezo-electric principle. These cells are combined to form a single microphone and when they are so handled they form a grille which is enclosed in a metal case.

The following are the stated characteristics:

Response—On open circuit, flat to 6000 cycles, increasing from 6000 to 10,000 cycles by about 4 db.

Output Level—On 25 feet average cable:

—2S2P.....74 db.
—4S6P.....68 db.

Impedance of single sound cell is similar to a capacity of .0033 mfd. They are series-paralleled so that the capacity will never be less than this value. D. C. resistance should be over 5 megohms.

These microphones differ from the usual magnetic devices in that the capacity of leads has very little effect on high-frequency response of the instrument because the sound-cells themselves present a capacity load. From this it will be seen that cable capacity between microphone and amplifier will only lower output, which effect will be the same at all frequencies.

All of these microphones are designed for operation directly into grid of first tube

of the pre-amplifier. A grid leak of about 5 megohms should be used.

A mixer should not be used ahead of the pre-amplifier as it will result in a loss of low response. This is due to the comparatively high impedance of the microphone at low frequencies, which makes it necessary that no resistance lower than 5 megohms should be used in parallel with the microphone if full advantage is to be taken of the fact that the microphone has no low cut-off.

Type D-2S2P is designed for public address work and is said to be quite directional at higher frequencies. Type L-2S2P may be used as a lapel mike and is especially useful where it has to be hidden. Type H-2S2P is designed as a close-speaking hand microphone and is not recommended for music.

THORDARSON "UNIVERSAL-DUPLICATE" REPLACEMENT TRANSFORMERS

Thordarson Electric Manufacturing Company, 500 West Huron St., Chicago, Ill., have announced their new line of replacement power transformers.



The result is in a reduction of the stock necessary for jobbers and Service Men to keep on hand in order to meet requirements, for the Thordarson jobber can now supply a transformer from the eleven new models of the "Universal-Duplicate" line electrically designed to the needs of the receiver.

A Thordarson Replacement Guide has been prepared, listing the proper "Universal-Duplicate" transformer for over 2000 receivers.

GOAT TUBE SHIELDS

The Goat Radio Tube Parts, Inc., 314 Dean Street, Brooklyn, N. Y., who specialize in the mechanical arts, have introduced improved types of the Goat Form-Fitting Shields originally developed for the shielding of tubes in radio receivers and similar equipment.



The salient feature of the Goat tube shield is that it occupies no more space than the tube itself, the shield having the same shape as the tube itself. The shield is in two sections which are firmly held together by a metal collar.

Better shielding and improved appearance, as well as space saving are the features claimed.

NEW CARTER GENEMOTOR

A small rotary type "B" battery eliminator is now being placed on the market by the Carter Motor Company, 361 West Superior St., Chicago. It is $2\frac{7}{8}$ inches wide, 4 inches high, and 5 inches long, and weighs $6\frac{1}{2}$ pounds. Being light in weight and compact it can be placed in either the radio set or the speaker case. The unit is

completely enclosed and shielded and requires no adjustments.

The thrust ball-bearings used do not re-



quire oiling, and permit the unit to operate at high efficiency in any position, it is stated.

The unit consists of a motor generator with a reflex filter circuit and operates from a 6-volt storage battery. The unit delivers up to 350 volts.

When used as an auto "B" battery eliminator it is said that separate filters are not required as the reflex filter system uses the motor field coil for a part of the filter.

The "Pocket" edition is for auto radio, aeroplane transmitters and receivers, farm battery sets, portable sound equipment, and other uses where small size and light weight is necessary.

The new Carter Genemotors can be supplied for both a-c and d-c output up to 500 volts, and also are made to operate from 32-volt farm lighting plants.

ACME VARIABLE VOLTAGE ADJUSTER

The Acme Electric & Manufacturing Co., 1444 Hamilton Ave., Cleveland, Ohio, have placed on the market a new variable voltage adjuster particularly adaptable to radio receivers and generally to any form of electrically-operated equipment attached to an a-c line.

Because of its regulating feature, this transformer may be used both as a step-up or a step-down device. The actual voltage adjustment is accomplished by the knob on the case, as illustrated.

These voltage-adjusting transformers have calibrated a-c voltmeters mounted on the casings and these provide accurate readings of secondary voltage.

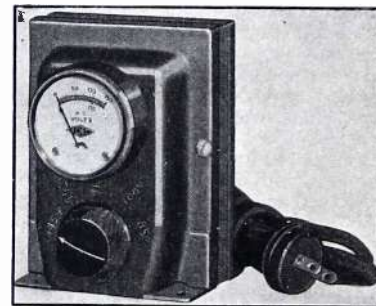

The transformers come in two types, both with a capacity of 100 to 150 volt-amperes, and for operation on a 50-60 cycle line. One type has a voltage range of 85-100-115-130-145 volts, while the other type has a voltage range of 160-180-210-220-240 volts.

Both types come with eight feet of cord and separable plug for primary connection.

For High Fidelity—
SPECIFY ACRACON

Paper Type
By-pass and Filter
Condensers

Wet and Dry Electrolytic
By-pass and Filter
Condensers

Inquiries Invited

Condenser Corporation of America
259 Cornelison Ave. Jersey City, N. J.

—ELMET—

MOLY



FOR

GRID WIRES

SUPPORT WIRES

ELECTRIC FURNACE
HEATING ELEMENTS

ALSO FOR

SCREEN GRIDS--CATHODE COILS
MANDRELS---CONTACTS, ETC.

ALL OF THE ABOVE PRODUCTS MAY
BE HAD IN VARIOUS COMPOUNDS OF
MOLYBDENUM-TUNGSTEN



Write for Information and Prices

American Electro Metal Corp.
Lewiston Maine

Dependable Sensational Performance!

BUD

Laboratory-Built
P. A. Equipment



Try BUD Sound
Equipment
For Five Days
Absolutely Free!

ELECTRO-DYNAMIC UNITS
DOUBLE BUTTON CARBON
MICROPHONES · 4 & 6 FT.
ALL ALUMINUM TRUMPETS
FIELD EXCITERS · AIR COLUMN
HORNS · LOW AND HIGH
FREQUENCY UNITS FOR WIDE
RANGE THEATRE USE

We invite careful, critical inspection of our entire line of BUD laboratory-built sound equipment. We suggest that you conduct your own comparative test. We CHALLENGE you to duplicate BUD performance and BUD DEPENDABILITY AT ANY PRICE! Write today for descriptive literature and prices and details of our FREE FIVE DAY TRIAL offer.



BUD SPEAKER CO.
1125 JACKSON ST.
TOLEDO, OHIO-U.S.A.



SICKLES

ANNOUNCES

NEW I.F.

TRANSFORMERS
TYPE 5000
DOUBLE-TUNED
MIDGET UNITS

- CONDENSER PLATES MOUNTED IN THE SAME PLANE
- FREE FROM ANY MECHANICAL TUNING DIFFICULTIES
- SMALL IN SIZE—1 1/8" SQUARE SHIELD IN HEIGHTS FROM 2 3/8" to 3 7/8"
- BASE OF LATEST DEVELOPMENT IN CERAMIC MATERIAL
- INSULATED ADJUSTING SCREWS
- NEW TYPE WINDING

ECONOMICAL = SIZE — COST

The F. W. Sickles Co.
SPRINGFIELD MASS.

NEWS OF THE INDUSTRY

ADELMAN JOINS CORNELL-DUBILIER

The Cornell-Dubilier Condenser Corporation announces the appointment of Leon L. Adelman as Sales Manager of the Jobbers' Division. Mr. Adelman comes to the Cornell-Dubilier organization after many years of experience among the radio jobbers and in the mail order trade throughout the country. His intimate knowledge of conditions and personalities in the trade equips him to fill admirably the needs of his new position. Among his duties will be the formulation of new sales policies, and close coordination of sales and service to jobbers, and the promotion of the utmost in cooperation between the various departments of the company and its many jobbing outlets.

NEW GENERAL CABLE CATALOG

The General Cable Corp., 420 Lexington Ave., New York, N. Y., have brought out a new catalog covering their complete line of magnet wire. Data is given on enameled, cotton covered, and silk covered wire, and cotton covered rectangular copper magnet wire.

The catalog also includes wire gauge and conversion tables.

EXPRESS SERVICE HAS 95TH BIRTHDAY

Railway Express service in the United States will be ninety-five years old on March 4 and will observe its centennial on the same day in 1939, according to a recent statement of the Railway Express Agency.

The more than 50,000 men and women employed in the various nation-wide operations of that transportation system are now comparing present day conditions with those that prevailed when the "Original Expressman" started the first express company in the country in 1839.

Historical records show that William H. Harnden, conductor on an early day railroad in New England, gave birth to the personal service idea in express transportation, by carrying packages in his carpetbag between business men in New York and Boston.

The Railway Express Agency, now owned by the principal railroads of the country and operating over their 225,000 miles of lines, is the modern outgrowth of Harnden's idea. That company has offices in 23,000 principal cities and towns and handles well over fifty million shipments a year. In the maintenance of its collection and delivery of shipments at many of these points, it maintains a large motor vehicle fleet, comprising some 9,500 units.

BRAND OPENS CHICAGO OFFICE

William Brand & Co., manufacturers of insulating materials, have opened an office in Chicago, under the management of Mr. E. W. Brinson. This new office is located at 189 West Madison St., Room No. 1111, Security Bldg., Chicago.

Mr. Brinson is well known to the electrical industry throughout the middle west, and has recently been connected with the General Household Utilities Co., in Chicago.

Mr. Brinson will carry stock in Chicago.

CORRECTION

In the article, "Output Power and Harmonic Distortion," by D. C. Espley and D. A. Oliver, appearing in the February issue of RADIO ENGINEERING, an omission occurred in the formula for the definition of distortion factor. This will be found on page 12.

The formula should read as follows:

$$\sqrt{I_2^2 + I_3^2 + I_4^2 + \dots} / I_1$$

RADIO SHORT COURSE AT MILWAUKEE EXTENSION

The Annual Radio Short Course which was so popular with a large number of people last season will be repeated this year on March 26, 27 and 28 under the auspices of the Radio Department of the University Extension Division, 623 W. State Street, Milwaukee, Wisconsin, with lecture sessions each morning, afternoon, and evening.

For the nominal registration fee of \$1.00, those enrolled will be entitled to attend all the lectures dealing with many of the most important and latest phases of radio which will be presented by engineers from representative manufacturers. Some of the topics to be presented are: new sets, new circuits, testing equipment and methods, public address systems, television, facsimile, iron clad mercury arc rectifiers, radio applied to aviation, x-rays in industry, and photoelectric cells.

Trips have been arranged to some of the largest electrical plants in the world several of which are located in Milwaukee.

Accommodations for those registering from out of town may be secured at nearby hotels at special rates.

A cordial invitation is extended to the public and especially to those interested in radio.

Complete details may be secured by writing to Mr. Sam Snead, Chairman of the Radio Department, University of Wisconsin Extension Division, 623 W. State Street, Milwaukee, Wisconsin.

LAISE STUDYING FOREIGN MARKET CONDITIONS

Mr. C. A. Laise, President and General Manager of the Callite Products Division of the Eisler Electric Corporation, is now on an extended trip covering the Orient and Continental Europe. Mr. Laise is studying market conditions. At the same time it is announced that the Eisler Electric Corporation have moved their entire manufacturing and office facilities to 538 39th Street, Union City, N. J. from Newark, N. J.

MCGOWAN HAS LARGER SYLVANIA TERRITORY

A new and larger territory including the entire States of Nebraska and Iowa, has been assigned to J. H. McGowan of the Hygrade Sylvania Corporation. Mc-

Gowan, who has been with this organization for some time past, will continue to work out of the sales office in Minneapolis. He is sales representative for both Hygrade lamp bulbs and Sylvania radio tubes.

NEW EXPORT ORGANIZATION

To further the interests of American exporters of electrical appliances to the European continent, Mr. H. E. Van Thijn, of Holland, has arrived from Europe to establish an exporting organization.

Differences in wavelengths, cycles, sockets, etc., as well as important differences in the regulations of regional committees and corporation boards have created difficulties in the merchandising of American electrical manufactures abroad.

The newly created concern will offer its services on both technical and commercial problems of the American exporter. The organization is cooperating with the principal European bureaus of standards. Mr. Van Thijn, a member of the Royal Institute of Engineers in Holland, was formerly connected with the Victor Talking Machine Company of Camden, N. J.

"UNIVERSAL" HOME-RECORDING BOOKLET

Universal Microphone Co., Inglewood, Cal., has issued a supplement to its "Simplified Home Recording" booklet. Supplement of four pages includes a diagram and was written by E. E. Griffin, chief engineer.

The publication describes the use of the Universal recording lead screw in conjunction with the Universal combination pickup and recording head.

AMERTRAN HAS NEW PRESIDENT

At the meeting of the Board of Directors of the American Transformer Company which followed the Annual Meeting of Stockholders on February 27, 1934, Mr. Thomas M. Hunter was elected President of the Company for the ensuing year. The other officers of the Company are Mr. John L. Schermerhorn, vice-president and secretary, Mr. F. B. Fauquier, treasurer, Mr. A. A. Emlen, assistant secretary. The present operating personnel of the Company will continue as in the past.

Mr. Hunter has been associated with the American Transformer Company for 20 years and served as vice-president of the Company from 1929 to 1934. Up to 1933 Mr. Hunter was manager of the Industrial Division of the Company, at which time he was made General Sales Manager.

WHOLESALE P-A BOOKLET

Wholesale Radio Service Co., Inc., 100 Sixth Ave., New York, N. Y., are distributing free a new and valuable booklet, "How to Make Money on Public Address."

The booklet deals with the manner in which to go about getting the public-address business, the types of amplifiers and the equipment to use in various cases, portable and mobile equipment, advertising for business, etc. The booklet also covers the use of amplifier equipment in offices and factories. Well worth having.

OSCILLOGRAPH FOR MODULATION DETERMINATIONS

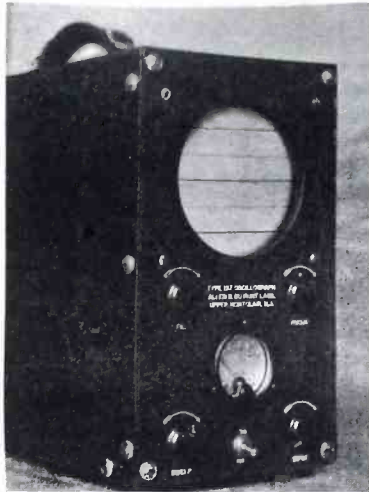

Type 137 Oscillograph
Price \$165.00 Complete

★ The unit consists of type 54 DuMont cathode ray tube with a high intensity screen, a power supply which furnishes the voltages necessary for the operation of the cathode ray tube, a sweep circuit and the necessary controls and binding posts. An engraved glass is mounted in front of the cathode ray tube and marked with suitable lines so that the percentage modulation may readily be observed. The unit is entirely self contained and operates from the A-C line.

*In addition to this unit, a number of other cathode ray oscillographs are available, as well as a complete line of cathode ray tubes.

ALLEN B. DuMONT LABORATORIES
UPPER MONTCLAIR, N. J.

EVERY EXECUTIVE, ENGINEER

and Production Man

Should Have a

FREE COPY

of this

SLEEVING and TUBING BOOKLET



Bentley, Harris Company are pioneers in the manufacture of Varnished Tubing and Saturated Sleeving.

Their modern factory, devoted solely to the production of these products, is capable of turning out millions of feet of Braid, flawless and gauged to meet the most exacting specifications.

B-H Sleeving and Tubing is the highest grade it is possible to make. Inspect actual samples in this new booklet.

● Write for Your Copy Today ●

BENTLEY, HARRIS MFG. COMPANY
CONSHOHOCKEN, PENNA.

CANDOHMS

ARMoured WIRE WOUND RESISTORS

WILL LOWER YOUR COSTS

OVER SEVEN MILLION IN USE
MAY WE SAMPLE AND QUOTE

THE MUTER COMPANY

1255 So. Michigan Ave.

Chicago, Ill.

LAMINATIONS

for Audio & Power Transformers

SPECIALIZED METHODS — YEARS OF EXPERIENCE

Wide Variety of Stock Standard Sizes

Dimension and Price Sheets on request

We Also Make

PERMANENT MAGNETS—DIES—TOOLS—

METAL STAMPINGS

Facilities for prompt service

Thomas & Skinner
Steel Products Co. 1100 to 1120
E. Twenty-Third St.
INDIANAPOLIS, IND.

UNITED

UTC Linear Standard Audio Components in a New High Fidelity A.C. operated Pre-Amplifier for use

with Moving coil
Velocity,
Condenser
and Crystal
type micro-
phones.

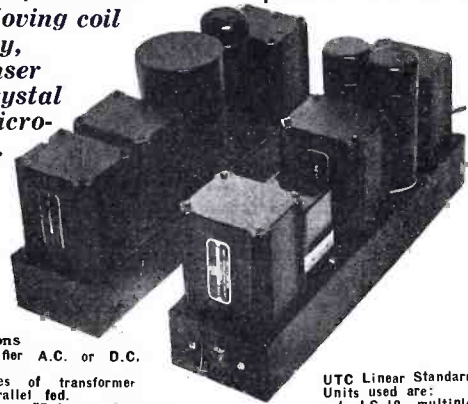

Specifications

Pre-Amplifier A.C. or D.C. operation.

Two stages of transformer Coupling parallel fed.

Uses two type 77 tubes triode connected.

Frequency response linear from 30 to 15,000 cycles.

Input and Output terminations 50, 125, 200, 250, 333 and 500 ohms.

Overall gain 53 D.B.

Power output \pm 7 D.B.

Power Supply uses 84 Indirect heater rectifier.

Voltage output 200 Volts D.C. 6.3 volts A.C.

Filter: Two stage, 400 Henrys, 54 mfd's.

Filter safety factor 100%.

Audio and power sections on individual metal decks for rack or portable case mounting.

UTC Linear Standard Units used are:

1—LS-10 multiple input lines to grid.

1—LS-20 single plate to single grid.

1—LS-50 single plate to multiple lines.

List price \$40.00. Dealers net price \$21.00.

Linear Standard Power Supply units

for above.

2—LS-94 High Inductance filter chokes.

1—LS-180 Power and filament supply transformer.

List price \$30.00. Dealers net price \$18.00.

Pre-Amplifier and Power Supply metal decks completely drilled.

List price each \$5.50.

Dealers net price \$3.30.

UNITED TRANSFORMER CORP.

244-266 CANAL STREET

NEW YORK, N. Y.

NAME PLATES
of Distinction

Etched, Lithographed, Embossed, Hard Enameled, Stamped, Engraved and Cast name plates in all kinds of finishes and metals. The highest quality with the best service.

L. F. GRAMMES & SONS, Inc. 350 Union St. Allentown, Pa.

Autocar

PIEZO ELECTRIC CRYSTALS

All "Scientific Radio Service Crystals" . . .
are accurately ground to an accuracy better than .03% on equipment tested regularly by U. S. Bureau of Standards, Standard Frequency Signals

BROADCAST AND COMMERCIAL BANDS
Broadcast Band Crystals mounted in our Standard Holder and ground to our usual high degree of accuracy now \$35.00 each. Mounted in our NEW Isolantite Monel Metal Crystal Holder \$45.00. Prices for other bands quoted upon application.

AMATEUR BAND
Scientific Radio Service Crystals ground to within FIVE Kilo-Cycles of your specified frequency in either 80 or 160 meter bands \$15.00 each. Mounted in our Standard Holder \$5.00 additional. Accurate calibration with each crystal.

Superior by Comparison—Prompt Shipments Assured

SCIENTIFIC RADIO SERVICE
"The Crystal Specialists" Since 1925

124 JACKSON AVE., UNIVERSITY PARK, HYATTSVILLE, MD.
Dept. RE-3

WAXES
COMPOUNDS
VARNISHES

For Insulation of Condensers

Transformers, coils, power packs, pot heads, sockets, wiring devices, wet and dry batteries, etc. Also WAX SATURATORS for braided wire and tape. WAXES for radio parts. Compounds made to your own specifications if you prefer.

ZOPHAR MILLS, INC.
FOUNDED 1846 MEMBERS OF N.R.A.
Court, Lorraine and Creamer Sts., Brooklyn, N. Y.
Agents: Ralph B. Clark, 2007 Calumet Ave., Toledo, Ohio
H. A. B. Snavo Co., San Francisco, Seattle, New Orleans

For Your Experimental Department

A tube of 500 assorted lugs and terminals — hot tinned for easy soldering.

We are also prepared to handle production stampings.

Write Us for Quotations

Price \$1.00

F. R. ZIERICK MFG. COMPANY
Bronx Lehigh Bldg., 385 Gerard Ave., New York, N. Y.

FUSES

INSTRUMENT Precision—1/100 amp. up
RADIO
HIGH VOLTAGE
AUTO
AIRCRAFT
Anti-Vibration

LITTELFUSE LABS.
4505 Ravenswood Ave.
CHICAGO, ILL.

BLILEY PIEZO-ELECTRIC CRYSTALS
FOR USE IN RADIO

Transmitters - Receivers - Monitors - Standards
Supplied to any frequency from 20Kcs to 15,000Kcs.

Send for price list and descriptive circular.

BLILEY PIEZO-ELECTRIC CO.
237 Union Station Bldg. Erie, Pa.

SPEAKER CONE DIAPHRAGMS
MOULDED SEAMLESS PAPER FIBER
USED BY THE LEADERS IN RADIO INDUSTRY
OLDEST CONE MANUFACTURER—LOWEST IN PRICE

UNITED PRESSED PRODUCTS CO.
PRESSED AND MOULDED SHAPES IN PAPER AND FABRIC
407 SOUTH ABERDEEN ST. CHICAGO, ILLINOIS

STUPAKOFF INSULATORS

STUPAKOFF LABORATORIES, INC. PITTSBURGH, PA.

INDEX TO ADVERTISERS

A	H	T
American Electro Metal Corp. 27	Hygrade Sylvania Corp., The Back Cover	Thomas & Skinner Steel Products Co. 20
B	L	U
Bentley, Harris Mfg. Co. 29	Littelfuse Laboratories 30	United Pressed Products Co. 30
Bliley Piezo-Electric Co. 30	M	United Transformer Corp. 29
Bruno Laboratories 31	Macy Elec. Products Co., Inc. 31	W
Bud Speaker Company 27	Muter Company, The 29	Wireless Egert Engineering, Inc. 4
C	S	Wire Stripper Co., The 31
Callite Products Co. 31	Scientific Radio Service 30	Z
Central Radio Laboratories 32	Shakenproof Lock Washer Co. 32	Zierick Mfg. Co., F. R. 30
Clarostat Mfg. Co. 3	Sickles Co., The F. W. 27	Zophar Mills, Inc. 31
Condenser Corp. of America 27	Stupakoff Labs., Inc. 30	
D	Swedish Iron & Steel Corp., Second Cover	
Du Mont Labs., Allen B. 29		
G		
Gates Radio & Supply Co., Third Cover		
Grammes & Sons, Inc., L. F. 30		



THE Group Subscription Plan for RADIO ENGINEERING enables a group of engineers or department heads to subscribe at one-half the usual yearly rate.

The regular individual rate is \$2.00 a year. In groups of 4 or more, the subscription rate is \$1.00 a year. (In Canada and foreign countries, \$2.00.)

The engineering departments of hundreds of manufacturers in the radio and allied industries have used this Group Plan for years, in renewing their subscriptions to RADIO ENGINEERING.

Each subscriber should print his name and address clearly and state his occupation—whether an executive, engineer, department head, plant superintendent, or foreman, etc.

Remember this Group Plan when *Your* Subscription Expires

(Radio Engineering)
Bryan Davis Publishing Co., Inc.
 19 East 47th Street
 New York, N. Y.

Bruno **HIGH FIDELITY**
 RV3 **VELOCITY MICROPHONE**

1. Frequency response, 30 to 1,400 cycles.
2. Excellent fidelity characteristics.
3. Not subject to humidity changes.
4. Highly directional.
5. Reduces acoustic feedback.
6. Affords higher gain.
7. Ruggedly constructed.

Price in U. S. A. \$55.00

BRUNO LABORATORIES

20-26 WEST 22nd STREET

Pat. Pending
 NEW YORK CITY



CONTACTS TUNGSTEN

For AUTO RADIO APPLICATIONS. Also TUNGSTEN For FILAMENTS, HEATER WIRE, HOOKS, WELDS AND SUPPORTS

KULGRID "C"

For LATERAL GRID SUPPORTS. Also Kulgrid "C" STRANDED FLEXIBLE CABLE—Superb with Tungsten Welds

MOLYBDENUM

For GRIDS, SUPPORTS and Special Purposes

Special Radio Tube Parts

CATHODES, COILS and Special Shapes

CALLITE PRODUCTS COMPANY
 UNION CITY NEW JERSEY

Use MOTOR DRIVEN WIRE STRIPPERS for

Faster, Better Work

Our machines are especially adapted for Radio Coil and Wire Stripping. BRUSH TYPE STRIPPERS remove insulation from coil leads as close to coil as desired.

KNIFE TYPE STRIPPERS remove insulation from all wire ends.

Write today for Bulletin on these and other Insulated Wire Strippers.

THE WIRE STRIPPER CO.

1725 Eastham Ave.

E. Cleveland, Ohio



NEW MACY REPRODUCERS

include new developments in
Horns, Baffles

and

WIDE RANGE SPEAKER UNITS



Powerful Efficient Dependable
 Weatherproof

a complete technical description is given in our free catalog.

Aside from a complete line of standard horns "Macy" will design and manufacture any special purpose horn to meet any requirement.



MACY ENGINEERING CO.

1453 39TH STREET

BROOKLYN, N. Y.



Can Your Product "TAKE IT"?



"It's the Twisted Teeth that Lock"

THE minute your product leaves "home" and starts on its travels to your dealers, it's going to be exposed to a lot of rough handling and punishing vibration. Give it the protection of Shakeproof and then you'll know it will go through without a single connection shaking loose. Put Shakeproof Lock Washers under every nut and screw—the twisted steel teeth of this dependable locking method will bite into both nut and work surfaces and never let go. In fact, the greater the vibration the tighter they lock—and that means better performance and more satisfied customers. Test Shakeproof in your own shop—write for free samples today!

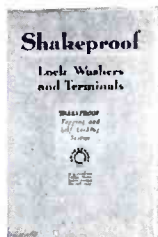

Send today for your free copy of this complete Shakeproof Catalog. Explains thoroughly the many advantages that Shakeproof offers—also shows new patented Shakeproof products.

SHAKEPROOF Lock Washer Company

(Division of Illinois Tool Works)

2509 N. Keeler Ave.

Chicago, Ill.



U. S. Pat. 1,419,564—1,604,122—1,697,954—1,782,387—Other Pat. Pending—Foreign Pat.



"the LONG & SHORT of it"

A longer resistance path means more gradual attenuation, i.e.: a more efficient volume control. The new CENTRAL LAB RADIOHM now available for all replacement jobs is easily twice as efficient as the old style volume control.

The next time you replace a volume control . . . use a CENTRAL LAB RADIOHM and begin to take inventory of the "satisfied customers." . . . You'll find a new satisfaction in this better (yet smaller!) RADIOHM now made in 1 3/8 in. diameter size for the smallest chassis. Change today to RADIOHMS. . . .



RESISTOR "A" in the new RADIOHM has same path across its entire width, giving greater area.



RESISTOR "B" old type. Current concentrates around inner edge, the shortest path.

Your Jobber has the new 1934 VOLUME CONTROL GUIDE. Get it. . . . It's free.

Centralab RADIOHM

Central Radio Laboratories
Milwaukee, Wis.

Progress

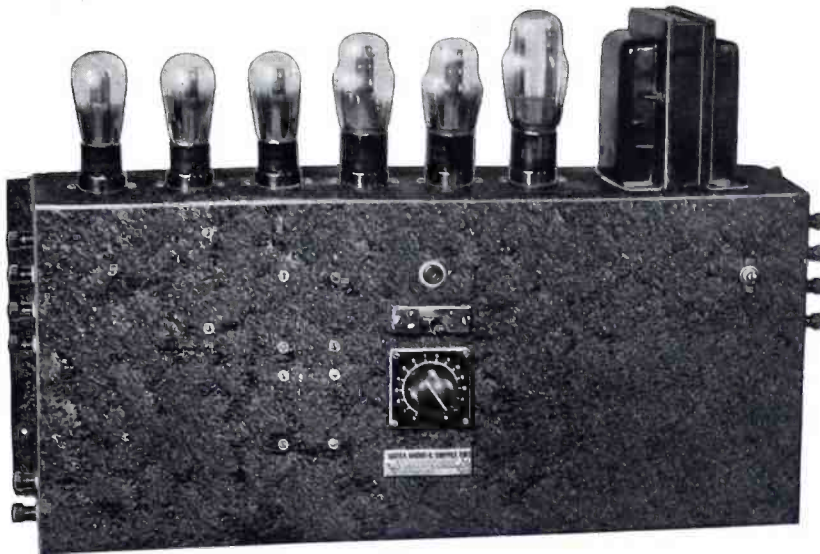

Model 44A—Wide Range Talking Picture Amplifier

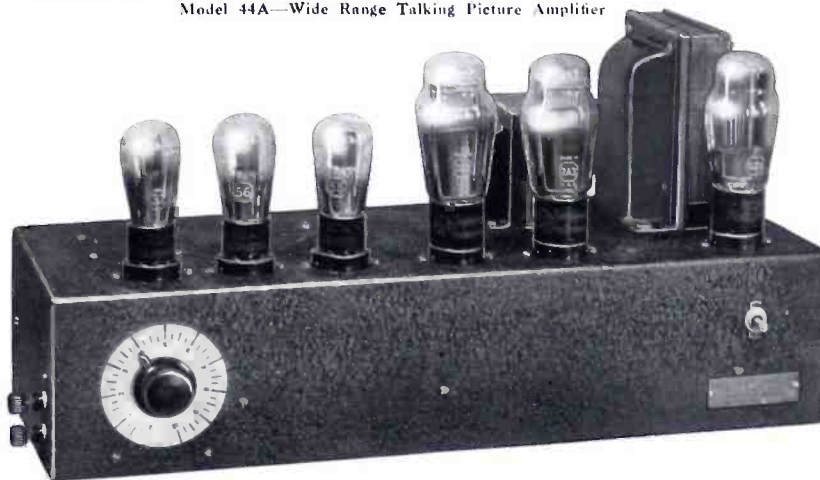

Model 550B—Wide Range Public Address Amplifier



Model A-300—Broadcast Remote Control Amplifier

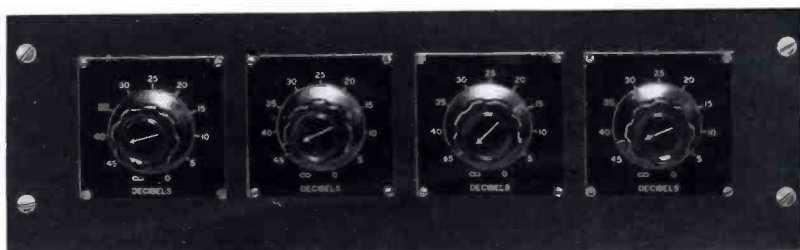

Model 905B—4 Channel Mixer for Dynamic and Velocity Microphones

Progress moves in two directions—Forward and Upward! This has been the course of Gates Engineers for more than 12 years—not only in meeting the demands of the Sound Amplifying and Transmitting Industry, but often anticipating the severest requirements of the rapidly widening field of Theatre, Public Address and Broadcasting demands.

Gates built equipment has been tried, tested and proven the world over since 1922.

You will find Gates quality a step ahead and still somewhat lower in price in the recognized field of sound equipment builders.

GATES

Radio & Supply Co.

*Manufacturing
Engineers*

QUINCY, ILLINOIS
U. S. A.

A REAL 212-D!

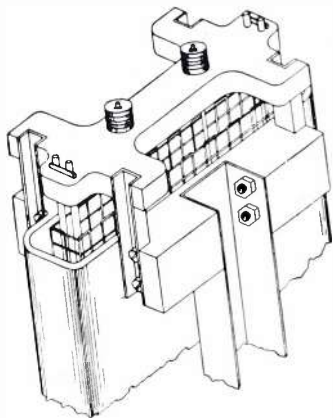

Ruggedly Fine Element Structure

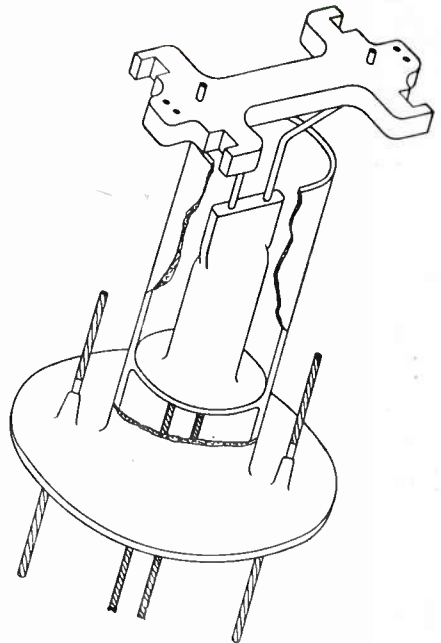

Ring Seal Stem

THE REASONS WHY!

NEW

1. Graphite Anode
2. Thoriated tungsten filament
3. Mesh grid (uniform surface)
4. Channel beam (molybdenum) element supports
5. Ring seal (grid and plate leads bead-sealed through flare—external to the press)

OLD

1. Nickle Anode
2. Oxide coated filament
3. Wound wire grid
4. Flat metal supports
5. Less adequate insulation between high and low voltage elements.

NET RESULTS = LONGER LIFE EXPECTANCY - GREATER STABILITY

This tube is superior for R. F. as well as for modulator service

● Like the many other types of SYLVANIA GRAPHITE ANODE tubes, this greatly improved 212D is receiving a hearty welcome. It is Sylvania's answer to a clamorous demand for a modern tube of this type to cope with present-day broadcast quality standards.

\$75.00

Lower Cost Per Hour Price



HYGRADE SYLVANIA CORPORATION

Hygrade Lamps

ELECTRONICS DEPARTMENT
CLIFTON, NEW JERSEY

Sylvania Tubes

FACTORIES:

SALEM, MASS.

EMPORIUM, PA.

ST. MARYS, PA.

CLIFTON, N. J.

WAREHOUSE STOCKS IN

Portland, Oregon

Atlanta, Georgia

Denver, Col.

Chicago, Ill.

Salem, Mass.

Dallas, Texas

Philadelphia, Pa.

Pittsburgh, Pa.

Los Angeles, Cal.