

FEBRUARY, 1932

Radio Engineering



IN THIS ISSUE



NOTES ON THE FREQUENCY STABILITY OF
QUARTZ PLATES

By L. B. Hallman, Jr.

RADIO BROADCAST FROM FAST BOBSLED

RADIO DESIGN AND THE TREND OF THE
RADIO INDUSTRIES

RADIO COMMUNICATION OF THE
INTERNATIONAL AIRLINES

By H. C. Leuteritz

POLICE RADIO SYSTEM AN EFFICIENT TOOL OF
LAW ENFORCEMENT

By Andrew J. Kavanaugh

TWELFTH YEAR OF SERVICE

The Journal of the
Radio and Allied Industries

ARCTURUS

ANNOUNCES

a line of
**TRANSMITTING TUBES,
 POWER AMPLIFIERS
 and MERCURY VAPOR
 RECTIFIERS**

Arcturus has built into these new products the same superior qualities of construction and performance which have established Arcturus as *the* name for dependability and quality in the receiving tube field.

The two tubes of the series now ready for distribution are Mercury Vapor Rectifier No. E-766 and the heavy duty type Mercury Vapor Rectifier No. E-772.

IMPORTANT POINTS OF SUPERIORITY

- | | |
|---|---|
| 1. Rugged construction. | 3. Uniform output voltage variation over wide range of current drain. |
| 3. Special oxide coated filament - emission is distributed evenly over entire length of filament. | 4. Constant output for hundreds of hours on intermittent life tests. |

Write for details of the new Arcturus Mercury Vapor Rectifier Tubes Nos. E-766 and E-772. Arcturus Radio Tube Company, Newark, New Jersey.



***E-766 (Upper)**

Filament Voltage 2½ Volts
 Filament Current 5 Amperes
 Maximum Peak Inverse Voltage 7500 Volts
 Maximum Peak Plate Current 0.6 Amperes
 Approximate Tube Voltage Drop 12 Volts
 *Interchangeable with '66 types

****E-772 (Lower)**

Filament Voltage 5 Volts
 Filament Current 10 Amperes
 Maximum Peak Inverse Voltage 7500 Volts
 Maximum Peak Plate Current 2½ Amperes
 Approximate Tube Voltage Drop 10 Volts
 **Interchangeable with '72 types

ARCTURUS

**Quality Tubes for Transmitting,
 Receiving and Industrial Uses**

HAVE YOU TRIED

this way of making your product make money?

Too many factors enter into the building of a business to pin losses down to any one of them. But many radio manufacturers, among others, have found this out: that the *right material* can have a lot to do with swinging a losing product into a paying one.

And that is one good reason why Durez, the perfect molding compound, is being put to hundreds of new uses—not only in the radio industry, but in chemical fields, in the electrical world, in automotive, stationery, and even perfumery industries!

One interesting example of Durez' adaptability to the most recent problems is shown right in the illustration. Here is the Super-Thru—made by the Woodruff Company, of Meridian, Miss.—the only "complete lead-in and arrester which meets all requirements covering radio receiving set installations." Durez, as is so often the

case, was selected especially for its high dielectric strength, its ease of molding, and its beauty of finish.

People who "do it with Durez"

The list of Durez users in the radio and allied industries alone reads like a "Who's Who" of business. Stewart-Warner, Delco, Turner Timer, Wagner Motor, Ford, Westinghouse, Telechron, USL Battery, Claude Neon—these are only a handful of hundreds of nationally known manufacturers who find Durez ideally suited to their needs.

These concerns use Durez because it makes a product that will not chip, rust, or corrode—that is molded in one operation without rubbing, stamping, turning, or polishing—that does all these things quickly and inexpensively! . . . Durez

molded parts are strong, light, firm. Studs and inserts can be imbedded in the one molding process. Threads are molded in under closest commercial limits of accuracy.

What are you making that could be made better, more modern and perhaps at less cost, with Durez? We will be glad to show you how Durez fits into the plans of progressive manufacturers.



We do not make the actual pieces, but supply raw material to molders who fill your order. Write for information and free booklet. General Plastics, Inc., 25 Walck Road, North Tonawanda, New York. Also New York, Chicago, San Francisco, and Los Angeles.

THE MAKERS OF DUREZ ARE ALSO THE MAKERS OF DUREZ INSULATING VARNISHES AND LAMINATED STOCK



RADIO ENGINEERING

Reg. U. S. Patent Office

Member, Audit Bureau of Circulations

Western Editor
ULMER G. TURNER

Editor
DONALD McNICOL

Managing Editor
F. WALLEN

Vol. XII

FEBRUARY, 1932

Number 2

Contents

	PAGE
EDITORIAL	4
A CHRONOLOGICAL HISTORY OF ELECTRICAL COMMUNICATION — TELEGRAPH, TELEPHONE AND RADIO, PART II	13
NOTES ON THE FREQUENCY STABILITY OF QUARTZ PLATES	15
<i>By L. B. Hallman, Jr.</i>	
RADIO BROADCAST FROM FAST BOBSLED	20
RADIO DESIGN AND THE TREND OF THE RADIO INDUSTRIES	21
AN EFFICIENT BATTERY-OPERATED RADIO RECEIVER. <i>By Loy E. Barton and L. T. Fowler</i>	23
RADIO COMMUNICATION ON THE INTERNATIONAL AIR-LINES	25
<i>By H. C. Leuteritz</i>	
POLICE RADIO SYSTEM AN EFFICIENT TOOL OF LAW ENFORCEMENT	30
<i>By Asdrew J. Kavanaugh</i>	
THE EVOLUTION OF RESISTORS USED IN RADIO. <i>By H. G. Cisin</i>	33
PORTABLE BEACON TRANSMITTER FOR THE ARMY. . . .	37
TWO SETS OF ELEMENTS IN ONE TUBE <i>By C. F. Stromeyer</i>	39

Departments

NEWS OF THE INDUSTRY	41
NEW DEVELOPMENTS OF THE MONTH	42
INDEX OF ADVERTISERS	50



FLASH!

WHETHER it is due to favoring winds from the plateau of finance reconstruction or to the heartsome aroma from General Dawes' nicotine soaked, underslung pipe, or to President Hoover's statement that the medium sized industries are to have a break—as this closing item of cheer is passed to the waiting hands of an impatient printer, things are stirring. Frozen assets are loosening somewhat; industrial America is recognizing advantages in free wheeling. To judge only from RADIO ENGINEERING's increasing volume of mail from all parts of America, and from abroad, a sort of *tempo allegro* swing has set in which we hope portends blessings shorn of disguise.



BRYAN S. DAVIS
President

JAS. A. WALKER
Secretary

Published Monthly by

Bryan Davis Publishing Co., Inc.
52 Vanderbilt Ave.
New York City

SANFORD R. COWAN
Advertising Manager

J. E. NIELSEN
Circulation Manager

Chicago Office—333 N. Michigan Ave.—Charles H. Farrell, Mgr.
St. Louis Office—505 Star Building—F. J. Wright
Kansas City Office—306 Coca Cola Building—R. W. Mitchell
San Francisco Office—155 Sansome St.—R. J. Birch

Los Angeles Office—846 S. Broadway—R. J. Birch
New Zealand—Tearo Book Depot—Wellington.
Melbourne, Australia—McGill's Agency.

Entered as second class matter August 26, 1931, at the Post Office at New York, N. Y., under Act of March 3, 1879. Yearly subscription rate \$2.00 in United States. \$3.00 in Canada and foreign countries.

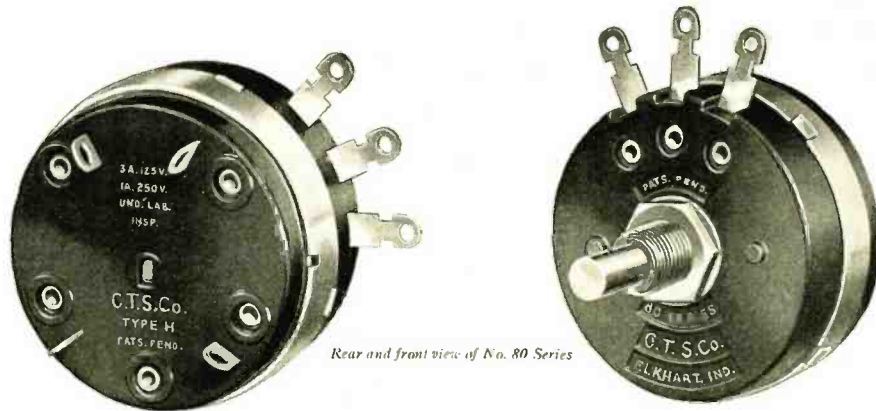

Rear and front view of No. 80 Series

No. 80 Series Volume Control

A 1932 Volume Control in every respect!

Equipped with . . .
D. P. S. T. *low torque*
snap switch or with
S. P. S. T. *low torque*
snap switch, or as
plain Volume Control
without switch

*Contact resistance of these
switches is not only low
but uniform as well, which
makes this unit particularly
adapted for use in
automobile sets.*

YOU can associate these controls directly with the GRID circuit and *there will be no pickup from the power circuit* on account of close association of volume control and A. C. Switch. Switch cam is "COLD." We also furnish the control plain, i. e., without switch combination.

Positioning lugs for preventing rotation of the control on the panel are provided, in accordance with requirements of the Underwriters' Laboratories. Insulated thimble and shaft have been worked out so that capacity between these members and "Live" parts of the control is less than 5 micro mikes. *The breakdown is in excess of 2000 volts.* When desired, we can furnish with shaft and thimble grounded.

Furnished in any desired resistance gradient

You are *not limited* in regard to resistance gradient; *we can furnish in any gradient desired.* Like all of our highest grade controls these No. 80 Series units have sufficient wiping contact to insure keeping down corrosion on the contacting member. Rugged terminal construction makes for rapid assembly. YES! The No. 80 is *quiet in operation!* Write for further details.

CHICAGO TELEPHONE SUPPLY CO.

HERBERT H. FROST, Inc.

SALES DIVISION

General Offices ELKHART, INDIANA and Plant

E d i t o r i a l

FEBRUARY, 1932

RADIO EXPORTS

THE "Buy British" tariff quite naturally resulted in a decline in radio importations into the British Isles from the United States, December as compared with November, 1931. In November 30,683 receivers were imported from America, and in December, 1,940. The drop in tube imports from the United States was from 155,806 to 16,232. Radio accessories dropped fifty per cent, but imports of American reproducers and parts for same showed an increase in December over November notwithstanding the increased duties. The money value of these latter products totals about \$200,000 per month. Possibly the totals for November were above normal because of pre-tariff shipments.

SYNCHRONIZED BROADCASTING

CONSIDERATION of the applications for renewals of licenses for synchronized broadcasting, by the Federal Radio Commission, centers attention upon the degree of success attained by the WEAFTIC hookup and the WJZ-WBAL combination.

While two or three years ago NBC engineers were skeptical as to the practicability of the idea, there is evidence that in the two experimental combinations above referred to definite progress has been made along the desired lines. The possibility of operating numerous stations on identical wavelengths simultaneously is attractive as a solution of certain obvious difficulties of channel congestion.

So far as the WEAFTIC, New York, and the WTIC, Hartford, Conn., hookup is concerned, listeners-in in the WEAFTIC coverage appear to experience little noticeable disturbance, but locally in the Hartford territory, particularly in the direction toward New York, listeners are finding it necessary to be patient with what they characterize as "mushy" reception. WEAFTIC, on 660 kc., employs, presumably, 50 kw. Hartford, with the same power, is synchronized by radio means to the same frequency

as WEAFTIC, the joint operation continuing during one-half of WEAFTIC'S operating time.

It is hoped that the patience of the set owners in the middle ground will hold out until the engineers attain a degree of perfection in synchronizing the two stations which will remove cause for complaint.

TUBE TESTERS FOR SALESMEN

THE phenomenal spread of the use of radio tube testers as an aid in effecting sales of tubes to set owners came about in response to wails from the public that they had no way of knowing whether the dealers and servicemen were giving set owners in difficulty a square deal.

It was a blank puzzle to many set owners why from four to nine tubes should be discovered to be defective when their receivers began to show signs of fatigue. The fact that certain set owners dealing with certain dealers had receiver sensitivity, fidelity and volume restored by the replacement of one, or two, tubes, while other dealers appeared to be unable to restore service unless all tubes were replaced, in time brought about a situation where, due to lack of confidence, tube sales for replacement were not up to what radio engineers knew sales should be for proper performance of sets.

Then came the tube testers equipped with a knowing indicator which in plain view pointed to a good, bad or indifferent register of condition. Now, there is a recurring wave of inquiry on the part of set owners who with their own eyes have seen tube testers sentence tubes to destruction which were performing entirely satisfactorily, and in as many cases tubes given the OK by one type of tester which had been rejected by another type.

If a standardization committee ever had before it a task that called for immediate attention here is one which is already on the front steps.

Donald Mc Nicol
Editor

Wurlitzer Radios don't shake apart in transit..

Self-tapping Screws are used for assembly

Talk to John Bell, Superintendent of the Radio Chassis Department of the Rudolph Wurlitzer Mfg. Company. He can give you plenty of good reasons for using Self-tapping Screws for fastening parts to a radio chassis.

Just consider the advantages which these unique Screws bring in the assembly of the popular Lyric Receivers made by Wurlitzer:

First, Mr. Bell says that the adoption of Self-tapping Screws in place of machine screws has done away with complaints about parts breaking loose during shipment. So secure are the fastenings that it isn't even necessary to use lock washers, which were always used with machine screws. Then, because it is much simpler to use Self-tapping Screws, Wurlitzer assembly costs have been reduced 31 per cent. Ninety per cent of the tapping operations once required are eliminated, saving the cost of taps, extra labor, and rejections caused by stripped threads. Mr. Bell sums up by saying: "We have an all 'round better job for less money."

Production of the latest Wurlitzer receiver is large. However, large production is not necessary to the advantageous use of Self-tapping Screws. An equal unit saving could be effected in a plant producing only a few sets a day. It is important to note also that no special equipment or design changes are required.

Find out what these Screws can save for you. Our Assembly Engineers will tell you, if you attach to the coupon a description of one or more assemblies.



Type "Z" Hardened Self-tapping Sheet Metal Screws
For joining and making fastenings to sheet metal up to six gauge; also aluminum, die castings, Bakelite, etc. Simply turn Screw into drilled, pierced or molded hole. It forms a thread in the material as it is turned in. Can be removed and replaced.

Type "U" Hardened Metallic Drive Screws
This type of Self-tapping Screw is used for making permanent fastenings to iron, brass and aluminum castings, steel, Bakelite, Durez, etc. Just hammer the Screw into a drilled or molded hole. It forms a thread in the material as it is driven.



PARKER-KALON *Hardened* Self-tapping Screws

PAT. IN: U. S. AND FOREIGN COUNTRIES



← 14 Unbiased Reports on Savings.....Scientists Explain Fastening Security →

PARKER-KALON CORPORATION, Dept. L, 190-198 Varick Street, New York, N. Y.

Tell us whether Self-tapping Screws can be used to advantage for assemblies described on attached sheet. Also send booklets on the Security and Economy of assemblies made with Self-tapping Screws.

Name and Company.....

Address.....





UX 864
35 Milliwatts



UV 862, 100 Kilowatts
(The Largest Transmitting
Tube in Production).

Transmitting Radiotrons

are available to fill any socket from Microphone to Antenna.

Uniform quality and long life reflect our vast laboratory facilities and the genius of such men as Langmuir and White.

RCA Transmitting Radiotrons can be imitated but not equalled.

ENGINEERING PRODUCTS DIVISION
RCA Victor Company, Inc.

A Radio Corporation of America Subsidiary

Camden, N. J.

"RADIO HEADQUARTERS"

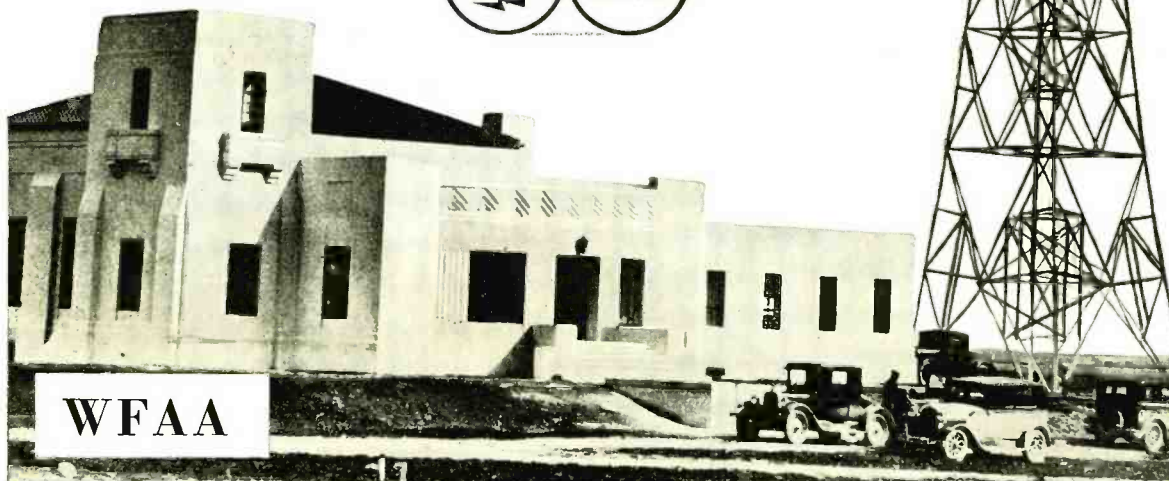

From "RADIO HEADQUARTERS"



Standard Signal Generator TMV-18



"Faradon" Capacitors



Magnetic Pickup and Inertia Tone Arm



Front View



Rear View

Type RL-43 permanent Magnet Dynamic Loudspeaker

A new Permanent-Field Dynamic Loudspeaker for use with up-to-date automobile radio receivers. Requires NO DRAIN ON STORAGE BATTERY for field excitation yet produces same full rich tone previously obtained only with electro-dynamic types. This is extremely important as it is necessary to keep the "A" battery drain for the complete receiver down to a minimum. Acoustically designed non-magnetic case. Rugged construction and double stud mounting to withstand road jar and engine vibration. Dust and dirt proof case provides additional protection. Dimensions 9" outside diameter, by 5 1/4" deep (exclusive of mounting studs).

The RL-43 Loudspeaker Unit is also available for installation in cabinets.

Write us for complete information on this equipment.



INDUSTRIAL PRODUCTS SECTION

RCA Victor Company, Inc.

CAMDEN, N. J.

A Radio Corporation of America Subsidiary



Beat Frequency Oscillator TMV-28



Type RL-36 Midget Electro-Dynamic Loudspeaker



Type RP-67 Automatic Record-Changer (Plays either 78 or 33 1/2 RPM records).

BIG



*things are in store
.....for all who attend*

RMA SIXTH ANNUAL TRADE SHOW EIGHTH ANNUAL CONVENTION

CHICAGO

• STEVENS HOTEL •

RADIO'S BIG ANNUAL CONCLAVE

EXHIBITING ALL NEW LINES AND THE LATEST RADIO AND TELEVISION PRODUCTS.

ELECTRICAL PRODUCTS ALSO IN TRADE SHOW AND MANUFACTURERS' DEMONSTRATION ROOMS.

EVERYBODY IN RADIO (NEARLY 25,000 RADIO TRADESMEN LAST YEAR) ATTENDS THIS ANNUAL NATIONAL RADIO GATHERING, THE BIG INDUSTRY MEETING EACH YEAR.

Better business early in 1932

The RMA event this year is advanced to start sales early. In June, a few weeks after the RMA exhibits of manufacturers' latest products, there will come the big Republican and Democratic national conventions in Chicago to nominate presidential candidates. In June also another heavyweight championship match between Schmeling and Sharkey is scheduled.

GO TO CHICAGO MAY 23, SEE THE LATEST RADIO AND ALSO ELEC-

TRICAL PRODUCTS OF RMA MANUFACTURERS, AND GET IN EARLY ON THE 1932 TRADE.

This is the big and only national industry radio show, sponsored by the RMA and under its management, for RMA members, jobbers and dealers.

All exhibitors required to show current merchandise—no vacant booths.

Electrical products also displayed.

Thirty thousand (30,000) square feet of radio and electrical exhibits in the official hotels—the Stevens and Blackstone.

ADMISSION TO THE TRADE ONLY. PUBLIC NOT ADMITTED.

Reduced railroad rates—special trains—one and one-half fare for round trip to Chicago from everywhere.

Official hotels—Stevens and Blackstone—together on Michigan Avenue. Regular rates. Make your reservations early.

Important and interesting business meetings of industry and allied organizations.

Invitation credentials for the trade show will be mailed about April 15th.

REMEMBER THE DATE—MAY 23—AT CHICAGO.

Official Hotels—

...

Stevens Hotel

Blackstone Hotel

MAY 23-26 1932

RADIO MANUFACTURERS ASSOCIATION

11-WEST 42nd ST. N.Y. CITY • 32 W. RANDOLPH ST. CHICAGO

◆◆◆ LIKE PLACING
A COIL WINDING
DEPARTMENT IN
YOUR OWN PLANT



The experience of leading manufacturers has repeatedly shown that ultimately Inca Coils cost less than those made in their own plants. Then add Inca's unrivaled facilities for manufacturing the wire, winding, testing and inspection of coils, for material control and for meeting fluctuations in production schedules . . . and the advantages of Inca, as a source of supply, are conclusive.



INCA

INCA MANUFACTURING DIVISION OF NATIONAL ELECTRIC PRODUCTS CORP.

Eastern Office:
233 Broadway, New York City

Factory and General Offices:
Fort Wayne, Indiana

Western Office:
2375 E. 27th. St., Los Angeles, Calif.

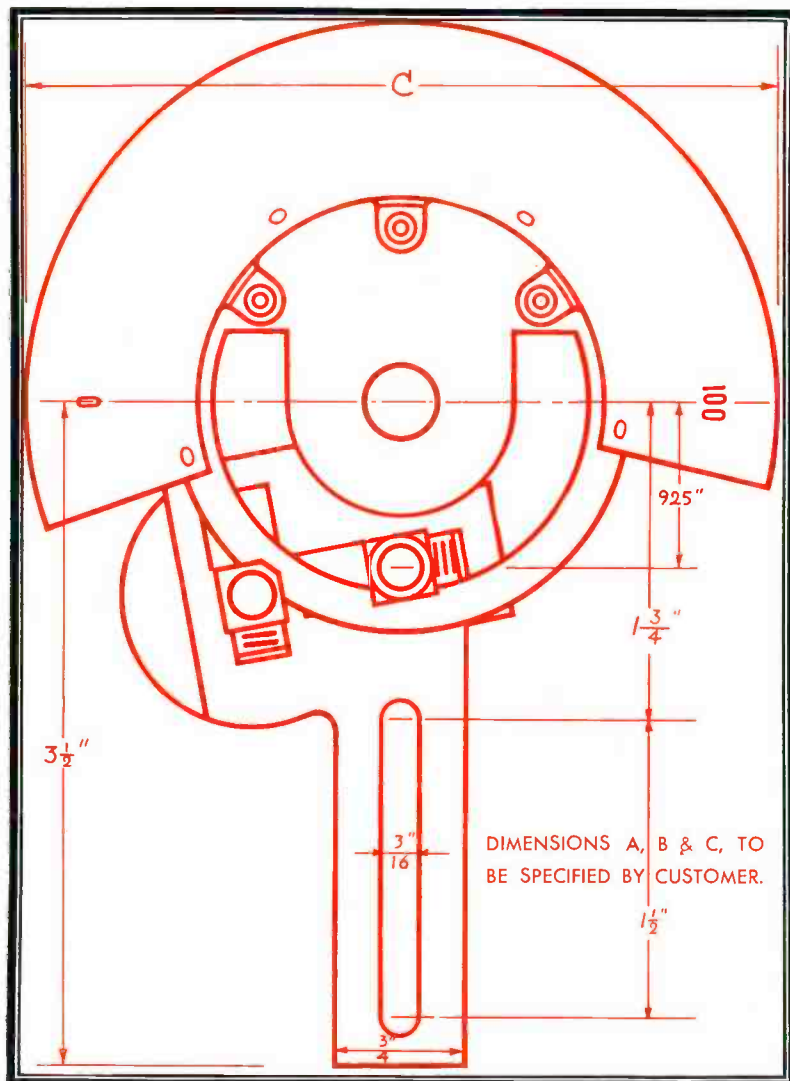

THE 66

DOUBLE REDUCTION
SHORT WAVE WEDGE
DRIVE TUNING UNIT

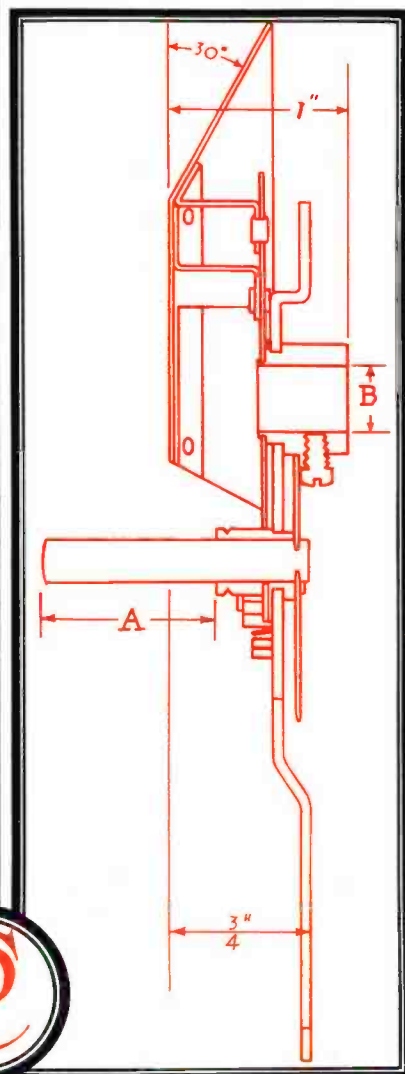

The tuning unit shown above is our new double reduction wedge drive short wave model, with a tuning ratio of 48 turns of the knob to 180 degrees. The style illustrated is our No. 66, on which the scale is angled back 30 degrees. This type of tuning control may be had in a variety of styles including flat fan-type scale, 180 degree full vision scale and other models. Suitable escutcheons are available for all of these variations. This unit is designed for extremely accurate tuning where clear cut separation on a short wave receiver is necessary.

When ordering we must have definite data as follows: Size of condenser shaft; direction of reading (advise whether condenser closes on right or left, do not say "clockwise or counter clockwise"); color of scale, ivory or tan; length of knob shaft (from die casting to end of shaft); trade name required on escutcheon, if any. Slotted mounting bracket will be shipped exactly as shown in drawing unless otherwise specified.

This unit is put up in different forms complete with escutcheon as our No. 66 for retail distribution through high grade parts dealers for amateur or "ham" use.

CROWE
NAME PLATE & MANUFACTURING CO.

1759 GRACE ST.

CHICAGO ILLINOIS



With Apologies TO W. W.

Blessed Event

The C. R. C.s of Beloit, Wisconsin, are blessed eventing. The latest addition to the C. R. C. family is a swellegant new socket which has been tagged No. 500 (that is only half a grand). The fond parents predict it will be the "Twenty Grand" of Socketdom.

Gag

Don't stop me if you have heard this one before. Two scholars on an alcoholiday were standing on the banks of the Potomac and were waxing reminiscent upon the historic memories the spot held for them.

"This," explained one inebriate, "is the very spot upon which George Washington stood when he threw a silver dollar across the Potomac."

"That's nothing," said the second ditto, "I could do that myself."

So—to make a short story shorter—they arranged a wager and the second fellow heaved a silver dollar which landed smack dab in the middle of the river.

He paid off, but alibied, "You know a dollar went a darn sight farther in those days."

Point

The point we are trying to make is that your 1932 dollar will not land smack dab in the middle of the river if you invest it in C. R. C. products. It will reach further today than at any time since the pre-war days. The new "500" series C. R. C. socket is just what the doctor ordered. It is economical, has a superior contact arrangement and rugged construction. Samples of the socket and our new folder entitled "NINE REASONS WHY" will be sent on request.

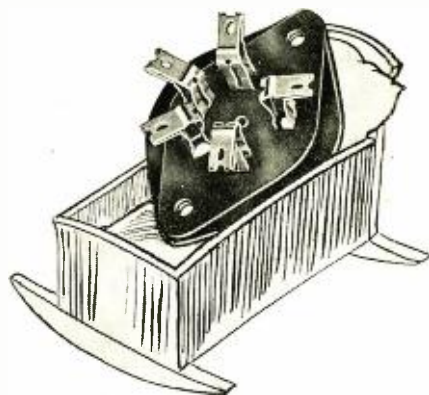

CENTRAL RADIO CORPORATION
Beloit, Wisconsin

Small Parts—But How Essential!

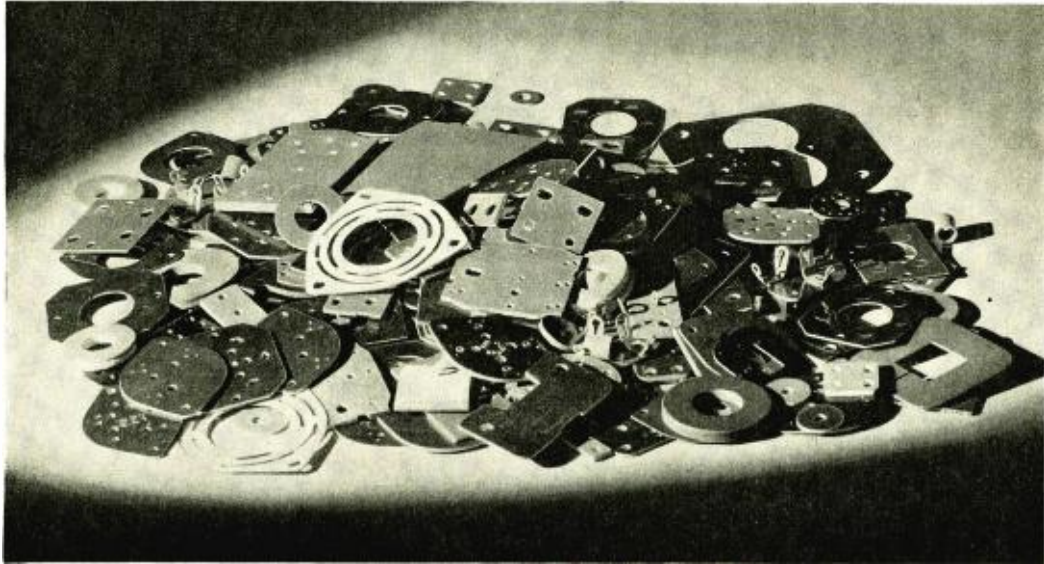

SMALL parts of innumerable sizes and shapes are fabricated from Textolite laminated sheets to meet the demands for better insulation in the radio, electrical, and electronic fields.

Textolite laminated is being used by many of the leading manufacturers in these fields, because they realize that the success of their products depends on the properties of the material used in these apparently insignificant "small parts."

A survey of the results of new applications of Textolite laminated during 1931 revealed an astonishing saving in time, space, and money to the progressive manufacturers who adopted this modern material.

Also—
Textolite molded
Cetec cold-molded

EASTERN FABRICATOR
General Fabricating Co.
37 East 18th Street
New York City

WESTERN FABRICATOR
Electrical Insulation Corp.
308 W. Washington Street
Chicago, Ill.

831-11
JOIN THE "G-E CIRCLE"—SUNDAYS AT 5:30 P. M. E. S. T. ON N. B. C. NETWORK OF 54 STATIONS—WEEK-DAYS (EXCEPT SATURDAY) AT NOON

GENERAL ELECTRIC

PLASTICS DEPARTMENT, MERIDEN, CONNECTICUT

A chronological history of electrical communication

—telegraph, telephone and radio

▲

This history was begun in the January, 1932, issue of RADIO ENGINEERING, and will be continued in successive monthly issues throughout the year. The history is authoritative and will record all important dates, discoveries, inventions, necrology and statistics, with numerous contemporary chronological tie-in references to events in associated scientific developments. The entries will be carried along to our times.

▼

Part II

- 1798 (59) D. F. Salva, in Spain, operates a telegraph between Madrid and Aranguez (26 miles). His experiments date from November 1796. The method employed was similar to that of Reiser.
- (60) Galvani dies. (Born in Italy 1737.)
- 1800 (61) Volta, in Italy, invents the "Voltaic pile," or "Couronne de tasses," in reality a pile of disks, the first known source of electricity as distinguished from static discharges previously employed. One of the first piles consisted of a number of disks of zinc, copper, cloth, piled one on another, Volta was professor of Natural Philosophy at Pavia, Italy.
- (62) Decomposition of water by means of electricity discovered by Nicholson and Carlisle, in England.
- (63) Gas lighting introduced in London, England.
- (64) Abbe Hauy, in France, discovers that a crystal of calcspar pressed between the fingers so as to compress it along the blunt edges of the crystal, becomes electrical. (Piezo effect.)
- 1803 (65) Aldini, nephew of Galvani, of Italy, performs experiments in the transmission of electric signals under the sea near Calais, France.
- 1804 (66) Cruikshank constructs a "trough" arrangement of the *Pile* battery, employing alternate zinc and copper disks.
- 1806 (67) Charles Augustin Coulomb dies. (Born in France 1736.)
- 1807 (68) Soemmering, in Munich, operates a signaling circuit using thirty-five wires. At the receiving end the decomposition of water at the wire terminal of a selected circuit indicated the desired letter.
- (69) Humphrey Davy, in England, decomposes alkalis by means of electricity.
- (70) Fulton propels a boat on the Hudson River by steam power.
- 1810 (71) Davy, in England, exhibits an electric light.
- (72) Gautherot, in France, discovers the principle of the storage cell.
- 1812 (73) Schilling ignites gunpowder by electricity transmitted through a subaqueous conducting wire under the river Neva near St. Petersburg, Russia.
- 1813 (74) John Robert Sharpe, in England, transmits electric signals through seven miles of subaqueous insulated wire.
- (75) Hans Christian Oersted in Denmark, publishes a work on the identity between electrical and chemical forces.
- 1815 (76) Prof. J. S. C. Schweigger, of Halle, Germany, improves Soemmering's telegraph, employing two wires and one decomposing tube.
- (77) William Hyde Wollaston improves the Cruikshank battery by making provision for raising the zinc and copper elements from the acid when the battery is not in use.
- 1816 (78) Francis Ronalds, in England, constructs an experimental telegraph line employing a single needle operated by a friction machine or a Leyden jar source of electricity. At the receiving end a pith-ball electrometer in connection with a clock synchronized with a similar clock at the transmitting end indicated the intended signals. This was the first "dial" telegraph system. A distance of eight miles was covered.
- (79) Gas lighting introduced in Baltimore, Md.
- (80) Dr. John Coxe, of Philadelphia, independently duplicates Soemmering's telegraph experiments.
- (81) Ronalds observes that an electric impulse would probably encounter retardation in a long underground or submarine conductor. (His ideas on the subject could not have been very clear as the effects he observed were in connection with an underground wire but 525 feet in length, and "retardation" as later understood was not successfully investigated until seven years later by Michael Faraday.)
- 1817 (82) Berzelius discovers selenium.
- (83) The Lyceum of Natural History (later the New York Academy of Sciences) organized.
- 1819 (84) The "magic lyre" invented by Charles Wheatstone.
- (85) James Watt dies. (Born in England 1736.)
- (86) The steamship *Savanna* arrives in England from the United States. (May 26.)
- (87) Platinum is discovered in the Ural mountains, Russia.
- 1820 (88) Oersted discovers (July) that a magnetic needle is deflected when situated near a wire charged with a current of electricity.
- (89) De La Rue produces an electric lamp comprised of a coil of platinum inclosed in a glass tube from which the air is exhausted.
- (90) Schweigger and Poggendorff discover that the effect upon a needle is increased by coiling the neighboring conducting wire.
- (91) Arago magnetizes an iron bar inserted within a coil of wire carrying a current.
- (92) Schweigger constructs a galvanometer with which Ampere and La Place, in France, experiment as a receiver of telegraph signals.
- (93) Ampere, in France, announced (September 18) deductions destined to become fundamental principles of electro-dynamics.
- 1822 (94) Seebeck discovers that "If bars of two metals (bismuth and antimony) are soldered at their ends and the junctions brought to different temperatures, an electric current will flow around the circuit—flowing through the junctions in a direction from bismuth to antimony."
- 1823 (95) Michael Faraday, in England, states clearly the effect of retardation to impulses in a long underground or submarine cable.
- 1824 (96) W. Sturgeon, in England, constructs a practical horseshoe electromagnet.
- 1825 (97) The Stockton and Darlington Steam railroad opened for service in England, employing George Stephenson's locomotive.
- (98) The first technical school in the United States (Rensselaer Polytechnic Institute) begins instruction.
- 1826 (99) Daguerre, in France, conducts experiments in photography.
- (100) Sturgeon, in England, discovers that a more constant current is obtainable from a battery when the zinc employed is chemically pure. As a substitute for pure zinc, Sturgeon amalgamated the zinc element with mercury, thereby securing the advantage of pure zinc at small cost.
- 1827 (101) Georg Simon Ohm, of Bavaria, announces definitions of electrical laws, which subsequently bear his name.
- (102) Alessandro Volta dies. (Born in Italy 1745.)
- (To be continued)

SOLID MOLDED RESISTORS

FOR MOTOR CAR RADIO



FOR CONSOLE RADIO

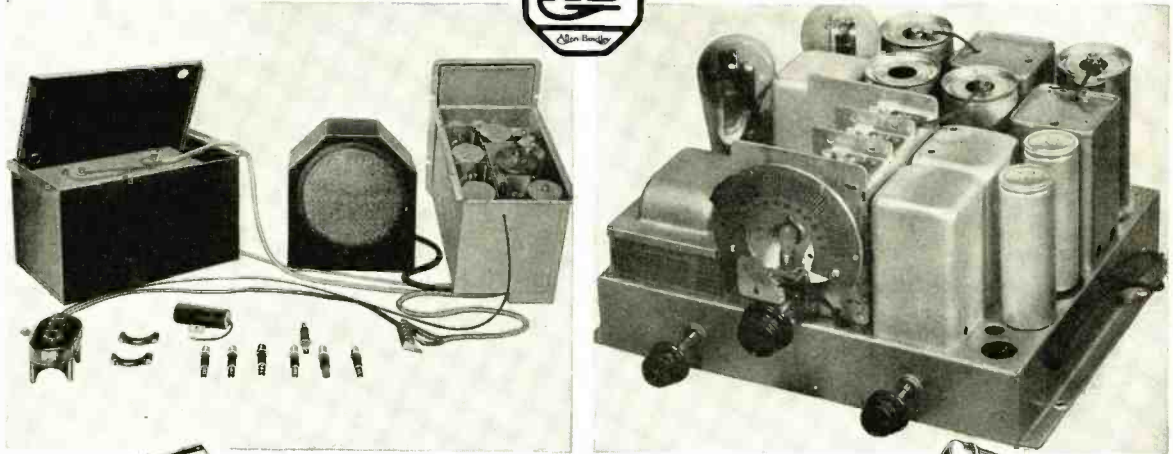

Do Your Sets go "Sour" in Service due to poor Resistors?

The satisfactory operation of your receivers depends to a great extent upon the accuracy of your fixed resistors. Bradleyunit Resistors are used by the world's largest radio manufacturers, because their resistance value is stable under varying conditions of load, temperature, and moisture. They are not subject to wide fluctuation due to long use. Don't risk the reputation of your receiver with poor resistors. Get an Allen-Bradley quotation on your next order.

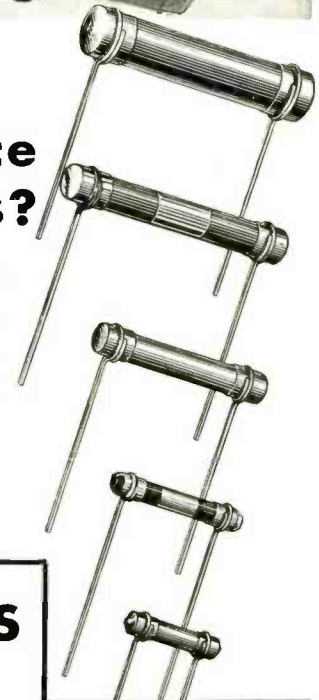

Interference from ignition systems in radio-equipped motor cars is suppressed with Bradley Suppressors. When used with suitable by-pass condensers in ignition circuit, shielded ignition cables are unnecessary.



Type A, Single Bradleyometer



Type AA, Double Bradleyometer

BRADLEYOMETERS

The Bradleyometer is a potentiometer with approximately fifty solid resistance discs interleaved between metal discs.

The total number of discs can be arranged in accordance with any resistance-rotation curve.

One or more Bradleyometers can be arranged to operate with one knob. Mixer controls, T-pad and H-pad attenuators and other complex controls be provided.



Type AAA, Triple Bradleyometer

Bradleyunit Resistors are made in five sizes, with or without leads, and are color coded to meet set manufacturers' specifications. These solid molded resistors are accurately calibrated and have great mechanical strength.

Allen-Bradley Co., 126 W. Greenfield Ave., Milwaukee, Wisconsin

ALLEN-BRADLEY RESISTORS

Produced by the makers of Allen-Bradley Control Apparatus

RADIO ENGINEERING

Production, Administration, Engineering, Servicing

FEBRUARY, 1932

Notes on the frequency stability of quartz plates

By L. B. HALLMAN, JR.*

Effective June 23, 1932, the Federal Radio Commission will require broadcasting stations to maintain transmitting frequencies to within ± 50 cycles of their assigned values. This replaces the present regulation specifying ± 500 cycles

DEVIATION of fifty cycles at an operating frequency of 1,000 kilocycles is only 0.005 per cent. Precision wavemeters obtainable today are accurate to only 0.1 per cent.—hence they are of little value when checking transmitter frequencies under the new regulation. Also, it is clear that factors hitherto considered unimportant will cause frequency variations well outside the 50-cycle limit. This article considers these factors and shows how frequency variations of the quartz crystal controlled transmitter may be minimized.

The importance of the quartz oscillator in constant frequency work can hardly be overestimated. It requires practically no attention, once it is operating properly, and the small size of the crystal makes it easy to mount and locate in constant-temperature chambers. These considerations have caused development work in connection with quartz piezoelectric effects, together with the various modes of vibration of quartz bars and plates to move forward with great momentum. The result is, when one is faced with a problem in this connection, he finds a large number of papers that must be studied before the consensus on a particular question is obtained.

This article summarizes a representative portion of the material published to date on the subject of quartz piezoelectric oscillators, as applied particu-

larly to the broadcast transmitter, and the reader will find in it a brief, concise statement of the amounts that various factors will change frequency. Only the quartz plate and disc will be considered. The bar or rod shape is seldom, if ever, used at broadcasting frequencies.

Consider the simple series circuit consisting of an inductance L , capacitance C , and resistance R . Upon this series combination suppose an alternating e.m.f. of instantaneous value $E_m \cos \omega t$ is impressed—we may express the relation between the e.m.f. and current by the well-known equation: $(LD^2 + RD + 1/C)i = E_m \cos \omega t \dots (1)$ where D represents the differential operator d/dt .

Now in a mechanical system consisting of a vibrating element and applied force, $F_0 \cos \omega t$, we may express the relation between the displacement, x , of the vibrating element and the applied force as follows:

$$(MD^2 + ND + q/x) = F_0 \cos \omega t \dots (2)$$

Comparing (1) and (2) it is seen that the two are identical in form. In the mechanical system we have the mechanical force, $F_0 \cos \omega t$, acting. In the electrical system the force moving the current, i , through the circuit is $E_m \cos \omega t$. Thus it appears that the mechanical displacement, x , acts in the same manner to the mechanical system as the current i , does to the

electrical system. Also, it is reasonable to suppose that, if a system is conceived wherein the electrical and mechanical functions are interchangeable, we may express one in terms of the other. Any substance exhibiting piezoelectric effects acts as such a system. If such a substance is placed in an electric field it will be distorted (strained) mechanically or, conversely, if mechanical force (stress) is applied to a piezoelectric substance it will become charged electrically. In the same manner, if a properly cut quartz plate is placed in an alternating electrical field it will vibrate mechanically and if the frequency of the electrical field is the same as the frequency at which the particular mode of vibration of the plate exhibits mechanical resonance then the amplitude of the vibrations will be many times that at other frequencies. Hence, it is seen that the piezoelectric properties of the quartz serve as a connecting link between the mechanical and electrical oscillations of the plate. Furthermore it is seen that the plate exhibits mechanical resonance at a particular frequency of the alternating electric field. If the current flowing through the quartz plate be measured it will be found to rise sharply at the resonant frequency. Hence, at the resonant frequency both x and i have their maximum amplitudes.

Since the quartz plate may act either as a mechanical or electrical system and since it exhibits the phenomena of series resonance (the current rises to a maximum value at resonance) it seems reasonable to assume that it may be represented, from an electrical standpoint at least, as a series circuit containing inductance, capacitance, and resistance. This has been found to be the case and the values for L , C , and R of the equivalent circuit have been derived by Van Dyke² in terms of the

²Van Dyke, *The Piezoelectric Resonator*, Proc. I. R. E., Vol. 16, No. 6, June, 1928, pp. 742-764.

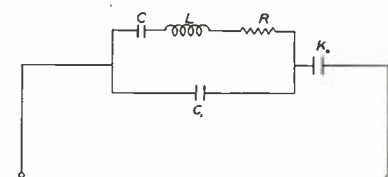

Fig. 1. Equivalent circuit.

¹Benioff, Hugo, *The Operating Frequency of Regenerative Oscillatory Systems*, Proc. I. R. E., Vol. 19, No. 7, July, 1931, pp. 1274-1277.

*Broadcast Station W5FA.

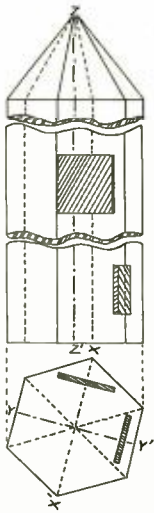

Fig. 2. X and Y cut plates.

piezoelectric constant, certain elastic and mechanical constants, and the dimensions of the crystal. The values found are as follows:

$$\begin{aligned} R &= KN \\ L &= KM \\ C &= 1/Kq \end{aligned}$$

where M , N , and q are constants in (2). The value of K depends on the piezoelectric constant and the dimensions of the quartz crystal. The equivalent circuit is shown in Fig. 1. C_1 is the capacity of the parallel plate condenser formed by the electrodes on the quartz plate and the plate itself as the dielectric. It should be noted in this connection that, in calculating C_1 , the dielectric constant is taken as though the quartz did not exhibit a piezoelectric effect. The value of this constant is $4.6^3 K_0$, K_0 is the capacity formed by the air gaps between the electrodes and the surfaces of the plate. As the dielectric of this condenser is air the dielectric constant to be used in calculating its capacity is, of course, unity. It is evident that the effect of K_0 can be represented by including it in the value of C_1 . Terry⁴ has given the following values of the electrical constants of a quartz plate of length = 3.328 cm., breadth = 2.750 cm., and thickness = 0.6361 cm.:

$$\begin{aligned} L &= 3.656 \text{ h.} \\ R &= 9045.5 \omega. \\ C &= 0.03165 \text{ micromicrofarads} \\ C_1 &= 5.7551 \text{ micromicrofarads.} \end{aligned}$$

The electric field was applied in a direction parallel to the electric axis of the crystal. It might at first appear that, due to the high value of R , the circuit would be poorly selective. It must be further considered, however, that the

value of L is unusually large. The result is that the ratio $R/2fL$, which determines the decrement, is very small; giving a circuit that is much more selective than any that can be built up physically.

Due to the exceptionally small decrement of the equivalent circuit of the quartz plate it will be very effective in holding the frequency of a vacuum tube oscillator to within narrow limits when properly connected. Other things being equal, however, any factors that will change the value of the elastic constants M , N , and q of (2) will change the values of L , R , and C of the equivalent circuit. Thus the resonant frequency of the equivalent circuit will be changed and the frequency of the controlled vacuum tube oscillator will vary. Factors causing the constants M , N , and q to vary are:

1. The cut of the crystal.
2. Its geometrical form.
3. Type of holder.
4. Temperature.

These will be considered separately.

Cut of the Crystal

In Fig. 2 is shown a cross-section and side elevation of the appearance of the quartz crystal as it is formed naturally. Although, in the natural state, its shape may be imperfect it is assumed for the purpose of this article that the crystal has a regular hexagonal cross-section. The shape of the crystal has no definite bearing on its piezoelectric properties⁵. The lines joining diagonally opposite corners of the hexagon ($X - X'$) are known as the electric axes. The lines ($Y - Y'$) making angles of 30° with the electric axes are sometimes called the mechanical axes. The line $Z - Z'$ designates the optic axis. These three axes are very important in describing the various cuts and vibration modes of the quartz plate and are, for convenience, designated respectively, as the X , Y , and Z axes.⁶ The cut of the plate refers to its orientation with respect to the X and Y axes. For example, if the plate is cut from the natural crystal in such a manner that its thickness is parallel to the X -axis it is called an X -cut plate. The Y -cut plate is cut so that its thickness is measured in a direction parallel to the Y -axis. X - and Y -cut plates are shown, in position, in Fig. 2. The particular portion of the cross-section from which the plate is cut has no effect on its characteristics. The important item is its orientation with respect to the principal axes.

The X -cut plate has three principal modes of vibration. The frequency of the first, and most important, is determined by the thickness of the plate (measured along the X -axis). In the perfectly cut X -plate the other dimensions of the crystal have little effect on its resonant frequency. When it is vibrating at this mode the wave traversing the plate is known as an X -wave. The frequency causing the plate to resonate when it is vibrating at the other two modes is determined by axes at right angles to the X -axis and making angles of $-48^\circ 15'$ and $+71^\circ 36'$ with a Z -axis^{7,8}. Fig. 3 shows the location of these axes with respect to the Z -axis. It is interesting to note that they coincide with the directions of the maximum and minimum elasticity moduli of the plate. Vibrations along these two directions may combine in various ways, through elastic reactions within the quartz plate, to give varying modes of vibration whose frequencies may be determined in terms of distances measured in directions at right angles to the electric axis. These vibrations form what are known as Y -waves or Z -waves depending on the axis along whose length, in the crystal, the distance used in determining the resonant frequency is measured. When the plate is vibrating at one of these latter modes, its thickness has little effect on the frequency. Since, in the X -cut quartz plate, the X -wave gives the highest frequency it is this mode that is used at broadcast frequencies.

From what has been said it is evident that there is a quantity having a value such that when it is multiplied by the dimension, in millimeters, of the plate, measured along the axis at which it is vibrating, will give the resonant frequency of the plate expressed, say, in meters. This quantity is known as the

⁷Wright, R. B., and Stuart, D. M., *Some Experimental Studies of the Vibrations of Quartz Plates*, B. S. Jour. of Research, Vol. 7, Sept., 1931, pp. 532-534.

⁸Straubel, H., *Vibration Modes and Temperature Coefficients of Quartz Oscillators*, Zeitsch. f. hochf. Tech., Vol. 38, July, 1931, pp. 14-27.

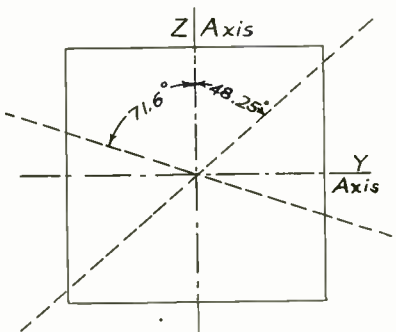

Fig. 3. Location of axes.

³Moulin, *Radio Frequency Measurements*, Second Edition, p. 219.

⁴Terry, Earl M., *Frequency of Quartz Piezoelectric Oscillators*, Proc. I. R. E., Vol. 16, No. 11, Nov. 1928, pp. 1486-1506.

⁵Worthen, Charles E., *Piezoelectric Quartz Plates*, Gen. Radio Exp., Vol. IV, No. 9, Feb., 1930.

⁶Summary of Piezoelectric Crystal Conference Held by U. S. Navy Department, December 3-4, 1929, Proc., I. R. E., Vol. 18, No. 12, Dec., 1930, pp. 2128-2135.

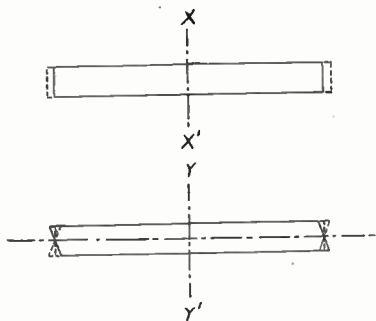

Fig. 4. Diagrammatic representation of vibration.

wave-constant of the plate. It is not, strictly speaking, a constant but will vary for seemingly identical plates. This variation is caused principally by slight variation in the accuracy with which the plate is oriented in respect to its principal axis. The wave-constant of the X-cut plate, when vibrating along its X-axis, has a value of approximately 110 meters-per-millimeter.

The modes of vibration of the Y-cut plate are not well understood. It is practically certain, however, that the mode whose frequency is determined by the thickness of the plate (measured along the Y-axis) is a shear mode. That is, the two faces of the crystal are moving in opposite directions, with the plane midway between them acting as a nodal plane. This is illustrated diagrammatically in Fig. 4. The upper figure shows the vibrations of the X-cut plate while the lower figure illustrates the shear vibrations of the Y-cut plate. The wave-constant of the Y-cut plate when vibrating at this mode is approximately 150 meters-per-millimeter.

The Y-cut plate, as may be expected, has a lower mode of vibration the frequency of which is determined by the length of the plate measured along the X-axis. The wave-constant for this mode is the same as that of the X-cut plate. The Y-cut plate has other modes of vibration but they are not easily analyzed. In fact the wave-constant for the modes discussed is not determined by only one dimension, as is the case of the X-cut plate. For example, the wave-constant for the Y-cut plate when vibrating as illustrated in Fig. 4 (Y-wave) is given as 150 meters-per-millimeter; measured along the Y-axis. This value will be found to vary if either the length or breadth of the plate is changed. In the X-cut plate the separate modes of vibration are independent, to within small limits, of all dimensions other than the one along which it is vibrating. Also, the Y-cut plate has a greater number of parasitic oscillation frequencies than the X-cut plate. In fact the Y-cut plate often has two high frequency modes of vibration

within a kilocycle or so of each other. It appears that the three modes of vibration given for the X-cut plate are fundamental and the various modes of the Y-cut plate are set up by elastic reactions within the plate. (Lack⁹ treats the plate as a system of coupled circuits.)

Geometrical Form

Only two forms are of importance to this discussion: the rectangular and circular plates. Also, we may confine our attention to the high frequency region (X or Y waves) as this is the vibration mode utilized in broadcast work. Within these limits we may say that with a constant thickness the frequency of the X-cut plate is practically independent of its geometrical form. The frequency of the Y-cut plate, however, will be influenced materially by its geometrical form and we cannot expect to change it without materially affecting the frequency.

Type of Holder

The type of holder influences the frequency of the oscillator in that the area of the electrodes will change the capacity C_1 (Fig. 1). In addition, the distance of the electrodes from the crystal (air gap) will change its decrement or alter the capacity K_0 (Fig. 1). Changing the pressure of the electrodes on the surface of the crystal will change both the decrement of the mechanical vibrations of the plate and the capacity K_0 . Beyond a certain position it is probable that variations in the length of the air gap will alter the oscillation frequency only as the capacity, K_0 , is changed.

As would be expected, an increase in the air gap increases the frequency. It has been found¹⁰ that an increase of 0.5 mm. in the length of the air gap increases the frequency 0.075 per cent.

Boella¹¹ has found that frequency variations amounting to as much as 0.003 per cent. may be produced by lightly tapping the quartz holder.

Temperature

Temperature changes will cause frequency changes of varying degrees depending upon the cut and geometrical form of the quartz plate. The temperature coefficient of the X-cut plate is negative (X-wave) and from 20 to 30 parts in a million—depending principally upon the type of crystal holder used and the accuracy with which the plate is cut. When the Y-cut plate is vibrating at its shear mode the tem-

perature coefficient is positive and, approximately, from two to three times that of the X-cut plate. The temperature coefficient of the Y-cut crystal has a wide range of values—it varies with the shape of the plate and is, in addition, a function of the temperature at which the plate is being operated. Under certain conditions it may be zero.

Marrison¹² has described a Y-cut crystal that resembles a miniature doughnut in appearance for which the temperature coefficient is less than one part in a million per degree C. The crystals described were adjusted to a frequency of 100,000 c.p.s. This remarkably low temperature coefficient was obtained by removing the center of a Y-cut disc—leaving a ring-shaped crystal. It was found that removing the central portion gives a much lower temperature coefficient. The coefficient of a disc of the same frequency and having the same outside dimensions as the 100,000 cycle rings is approximately 30 parts in a million per degree C.—more than thirty times that of the ring-shaped crystal. Crystals of this shape, ground for broadcast frequencies, would be very fragile and this probably explains why they have not yet been developed for this purpose.

The general factors influencing the degree of temperature control obtainable with a given assembly have been concisely given by Clapp,¹³ as follows:

1. Degree of insulation of assembly.
2. Rate of application of heat.
3. Distribution of heat.
4. Sensitivity and regularity of operation of thermostats.
5. Position of thermostats.
6. Degree of ripple attenuation.
7. Operating temperature.

¹²Marrison, W. A., *A High Precision Standard of Frequency*, Proc. I. R. E., Vol. 17, No. 7, July, 1929, pp. 1103-1122.

¹³Clapp, J. K., *Temperature Control for Frequency Standards*, Proc. I. R. E., Vol. 18, No. 12, Dec., 1930, pp. 2003-2010.

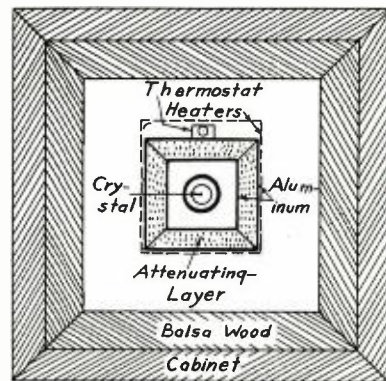

Fig. 5. Diagrammatic view of control temperature.

⁹Lack, F. R., *Observations on Modes of Vibration and Temperature Coefficients of Quartz Plates*, Proc. I. R. E., Vol. 17, No. 7, July, 1929, pp. 1123-1141.

¹⁰Koga, Isaac, *Characteristics of Piezoelectric Quartz Oscillators*, Proc. I. R. E., Vol. 18, No. 11, Nov., 1930, pp. 1935-1970.

¹¹Boella, M., *Performance of Piezoelectric Quartz Oscillators, and the Influence of the Decrement of Quartz on the Frequency of Oscillations*, Proc. I. R. E., Vol. 19, No. 7, July 1931, pp. 1252-1273.

Following Clapp, we will briefly consider each of the foregoing factors.

1. The better the insulation of the walls of the crystal chamber the smaller percentage of time it is necessary to keep the heating elements turned on in order that the temperature remain at a given value. Balsa wood is the most effective insulating material.

2. The rate of application of heat influences to a marked degree the temperature gradient. For most effective control the temperature should be the same at every point in the crystal chamber. If the heat is applied too rapidly there is a definite tendency to produce hot-spots near the heaters.

3. In the ideal case the temperature gradient within the crystal chamber would be zero. This is, of course, impossible if the heat is applied at only one point. We can most nearly attain this ideal by circulating some liquid of constant temperature around the chamber. This, however, presents obvious practical difficulties and the next best thing is to distribute the heating elements uniformly around the walls of the compartment. One simple and efficient assembly is a cubical chamber with the heaters mounted on all six faces. Another type consists of a cylinder with heating elements around the surface and at each end.

4. The amount that the temperature fluctuates around its mean value will depend on the sensitivity and regularity with which the thermostat operates. Two types are commonly used: the bi-metallic and mercury types. Both have their disadvantages. In the bi-metallic type the friction against which the bi-

metallic element operates varies both with the degree of mechanical vibration to which the element is subjected and with the adjusted operating temperature. This makes the operation uncertain. Obviously, the operating temperature of the mercury type varies with the atmospheric pressure. It is the more dependable and more sensitive of the two, however, and should be used in high precision work.

5. It is essential that the thermostat be not placed in the space whose temperature it is to control. The temperature of the space would have to change before the thermostat would operate and this would cause a time lag between the application of current to heaters and the temperature changes in the crystal chamber. To overcome this, the space to be controlled should be enclosed in the necessary distributing and attenuating walls and the thermostat placed outside of these. The best position of the thermostat is in intimate contact with the outer face of the heat distribution wall. The heaters are supported outside of the thermostat.

6. It is necessary to the operation of the thermostat that the temperature should oscillate about a mean value. These oscillations are known as "ripples." It is highly desirable that they be kept as small as possible. Ripples are attenuated with several layers of heat distributing material (aluminum or copper) and attenuating layers (asbestos or felt)—as many of these layers being used as are required to give the desired minimum of ripple.

7. The operating temperature used should effect a compromise between two

opposing factors. The higher the temperature, within limits, the more satisfactory is the thermostat operation and the easier it is to maintain the temperature of the crystal chamber constant against variations of ambient temperature. High temperatures, however, reduce the piezoelectric effect and it is desirable to operate the crystal at as low a temperature as can be maintained by the control assembly. A temperature of around 50° C. has been found to be the most satisfactory.

A control unit that will regulate to within $\pm 0.1^\circ$ C. for room temperatures of 20° C. $\pm 11^\circ$ C. and which illustrates the suggestions just made, is shown diagrammatically in Fig. 5.¹³ Heating units are placed on all six outer faces of the cubical crystal chamber. The same result may be obtained by using a cylindrical shape for this compartment.

Improved Temperature Control

A better temperature regulation may be obtained by using two control units and placing one inside the other. The only temperature variation that the inner unit has to work against then is the variation imposed upon it by the outer unit. Such a compound unit will regulate to within $\pm 0.01^\circ$ C. at 50°. In frequency standards the outer compartment may be made large enough to accommodate the vacuum tube oscillator, isolating amplifier, and associated apparatus. This will keep the temperature of these circuits constant to within, say, $\pm 0.1^\circ$ C. and will minimize frequency variations that might otherwise arise here.

The quartz plate is usually connected either between the grid and filament or between the grid and plate of the vacuum tube. These two circuits are shown in Fig. 6—with the equivalent networks immediately below.

The equivalent circuits in Fig. 6 show that when connected in a vacuum tube circuit the quartz plate does not oscillate at a frequency determined by its elastic and piezoelectric properties alone, but becomes part of a coupled system and the actual resultant frequency is influenced by the degree of coupling of the system and the values of the constants of the entire circuit. It has been shown by Terry⁴ that the circuit constituting the crystal-controlled oscillator is doubly periodic—that is, it may have either one of two frequencies of oscillation at a given adjustment of the circuit. The two cannot exist simultaneously, however. Which frequency will be utilized depends upon the coupling between the crystal and the remainder of the circuit. When the crystal is connected between the grid and filament of the tube we utilize one of these modes of oscillation; the coupling be-

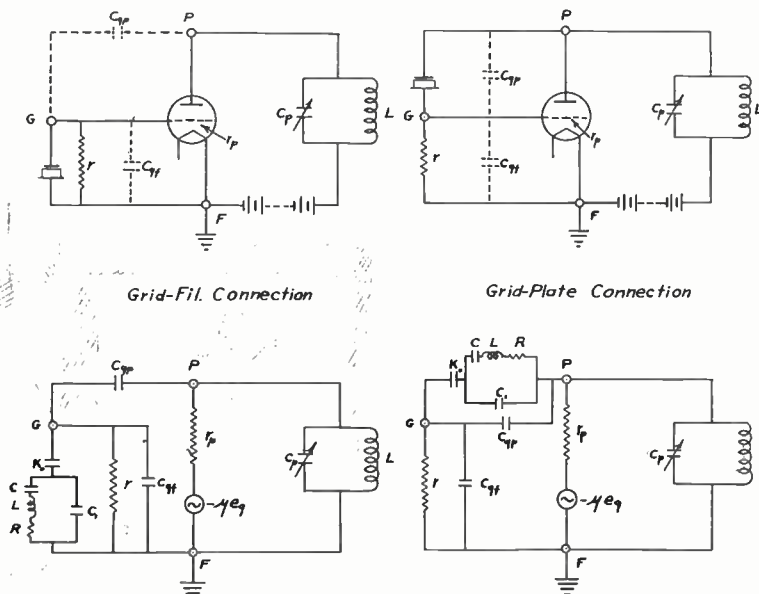

Fig. 6. At top: Circuits with quartz crystal control. At bottom: Equivalent networks.

tween circuits being supplied by the grid-plate capacity of the tube. When the crystal is connected between the grid and plate of the tube we utilize the other possible mode of oscillation. Here the coupling between circuits is supplied by the grid-filament capacity. These two connections, as would be expected, give slightly different frequency characteristics. The frequencies for the two connections may differ by as much as 0.02%. Also, either frequency may be caused to change as much as 0.01% by varying the plate circuit tuning condenser. Neither circuit will oscillate when the plate circuit is tuned to the exact frequency of the equivalent crystal circuit taken separately. The variation of frequency caused by plate circuit tuning is greatest as the natural frequency of the plate circuit is made to approach the natural frequency of the crystal. This is often referred to as the pulling effect of the plate circuit. It is illustrated in Fig. 7.^{3,4}

The effect of increasing the plate circuit resistance by about six-fold (2.1 to 12 ω) is shown by the dashed curve.

Because of the larger coupling capacity, the grid-filament connection gives a greater amplitude of oscillation and a more stable circuit. It is the arrangement usually employed with broadcast transmitters and the data given herewith applies specifically to it.

We will now consider the effect of the more important circuit parameters on the oscillator frequency. The effect of plate circuit tuning, one of the most important, is shown in Fig. 7.

Plate and Filament Voltages

Other things being unchanged, the frequency will be increased by an increase of the internal resistance of the tube (r_p). This may be caused by a decrease of either the plate voltage or the filament current. Koga¹⁰ found that decreasing the plate voltage on a 201-A from 99 to 45 volts and the filament current from 500 to 420 ma. increased the frequency by 0.01 per cent. Small changes had negligible effect.

Grid Leak Resistance

A decrease in r (Fig. 6) decreases, and an increase in r increases, the oscillating frequency. In one instance¹⁰ increasing the grid leak resistance from 15,000 to 105,000 ω increased the frequency by 0.004 per cent.

Grid-Plate Capacity

Changes in the value of the grid-plate capacity of 20 micromicrofarads³ will produce frequency changes of 0.013 per cent.

Grid Filament Capacity

Increasing the grid filament capacity within the oscillation limits of the tube¹⁰ decreases the frequency by 0.006 per

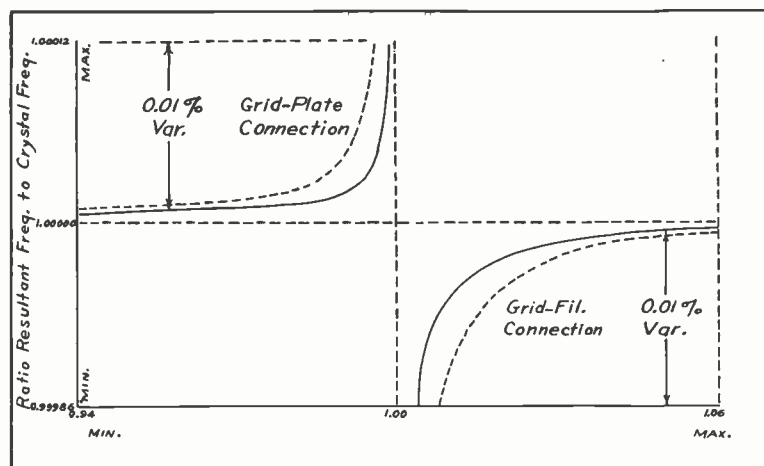

Fig. 7. Effect of plate circuit tuning.

cent. In obtaining this data Koga increased the capacity by shunting the crystal with a variable condenser.

Summarizing the above, it appears that the circuit conditions may influence the frequency of the oscillator by as much as one part in ten thousand. At 1,000 kc. this represents a possible variation of 100 cycles. We conclude, therefore, that such circuit variations as changing tubes, changing the position of the crystal in its holder, and the like, should be checked carefully as to their effect on the transmitter frequency.

Frequently variations caused by circuit parameters that change with the temperature may be minimized by placing the oscillator and its isolating (buffer) amplifier in a temperature controlled chamber. This was explained in the section on temperature control.

Vecchiacchi¹⁴ has found that, by using an oscillatory circuit with a negative resistance, it is possible to obtain a piezo oscillator having a very stable frequency characteristic. This arrangement has been found to be independent of large variations of decrement and equivalent resistance of the piezo-resonator due to changes taking place between the plate and its electrodes. The negative resistance makes it possible to tune the tube circuit to practically the same frequency as the natural frequency of the quartz resonator. A frequency stability of about one part in a million is claimed for this arrangement.

Frequency variations due to changes taking place between the plate and its electrodes may also be minimized by rigidly supporting the plate at points determined by the intersection of the surface of the crystal and a nodal plane. This is easily accomplished with the Y-cut circular plate when it is vibrating

at its shear mode (Fig. 4). Here the plane midway between the two faces of the crystal is not in motion. Hence, it is evident that the crystal may be rigidly supported at any points in this plane. This support practically eliminates changes in the relative position of the plate and its electrodes. To avoid changes in pressure with changes of temperature in such a mounting it is essential that the temperature coefficient of the support should be the same as that of the quartz plate¹⁵.

It should be pointed out here that connecting the crystal oscillator in push-pull reduces the frequency variation caused by variations in the tube constants. This connection also increases the amplitude of the oscillations¹⁰.

In conclusion, amounts that various factors may be expected to influence the oscillator frequency, if no special provision is made, are given below:

Cut of Crystal	Parameter	Variation of Parameter	Variation of Frequency	Change in c.p.s. at 1000 kc.
X-cut.	Temperature	1 deg. C.	-0.003%	30.
Y-cut.	Temperature	1 deg. C.	+0.01%	100.
Either.	Plate Circuit Tuning Cond.	50. %	0.01	100.
Either.	Plate Voltage	50.	0.01	100.
Either.	Grid-Leak	700.	0.004	40.
Either.	Grid-Plate Capacity	20. mmf.	0.013	130.
Either.	Grid-Fil. Capacity	Within Osc. Limits of Tube	0.006	60.
Either.	Air-Gap	0.5 mm.	0.075	750.

¹Note: While plate voltage changed filament current varied 16%.

A study of the above table, together with the discussions given each item, should prove helpful in deciding what degree different variable factors may be expected to influence the transmitting frequency. It is seen that many changes in the circuit constants, previously considered unimportant, become quite important when it is required to keep the transmitting frequency to within +50 c.p.s. of an assigned value.

¹⁵Heaton, Vincent E., and Lapham, E. G., Quartz Plate Mountings and Temperature Control for Piezo-Oscillators, E. S. Journ. Research, Vol. 7, No. 4, October, 1931, pp. 687-688.

¹⁴Vecchiacchi, F. A. Piezoelectric Oscillator With Great Frequency Stability, L'Elettrotec., Vol. 18, 5th Feb., 1931, pp. 79-82.

Radio broadcast from fast bobsled

SPORT enthusiasts in many countries will be also able to listen in by radio and enjoy the main features of the third Olympic winter games to be held at Lake Placid, New York, between February 4 and 13. Extensive hookups are planned by the big broadcasting companies so that listeners-in abroad as well as in this country can follow the progress made by their athletic representatives. A group of expert sport announcers will describe with vivid realism races over the Adirondack ice and snow. It will be the first broadcast of this sort ever made of the Olympic winter games.

More than twenty nations will be represented by the several hundred athletes who will take part in the classic contests at Lake Placid. These contests will be confined to five major winter sports: skiing, speed-skating, figure skating, hockey and bobsled racing.

Half Million Dollar Installation

The committee in charge of the Olympic events has invested more than half a million dollars in constructing

special facilities for the games at Lake Placid. These include a large outdoor stadium, a magnificent arena of brick and concrete, and a one and one-half mile bobsled run down the precipitous slope of Mt. Van Hovenberg—the first route of this kind ever constructed in America. Some 250 miles of ski trails have also been cleared in the Adirondack forests. The arena will be the scene of the figure skating and curling contests, and several of the hockey games which will be staged during the evenings.

The extensive plans for reporting the games by radio to the millions of listeners-in is not only a task involving the big broadcasting companies, including the National Broadcasting Company and the Columbia Broadcasting System, but also the Bell telephone system which will furnish the telephone circuits and facilities connecting the radio equipment at the scene of each contest to the distant broadcasting stations. Also thousands of miles of telephone circuits are required to link these various radio stations over the continent, including

the short-wave ones which will make it possible for many in Europe and other lands to listen in.

For weeks prior to the event the telephone men have been kept busy constructing special lines from the established telephone routes to the scene of the games. The bobsled run, which is about seven miles from Lake Placid, and the ski jump, which is about three miles out of the town, are among the points which will be connected by special lines. The telephone men will also assemble special amplifying equipment for the radio broadcasts and make frequent tests before the actual broadcasting occurs.

Radio From a Bobsled

A particularly interesting event scheduled by the National Broadcasting Company is one in which the announcer will describe the thrills of a bobsled ride. With his special transmitting equipment aboard the sled he will speed down the mountainside and around breath-taking curves at the rate of a mile a minute. A telephone wire along the run will serve as an aerial, harnessing the report by short wave from the sled. Thus the message, possibly including a few gasps for breath from the announcer as the big bob rounds the banked curves almost on its beam-ends will be transmitted afar. Also by means of special telephone circuits along the route the regular reports of the races will be given.

Both the Northern New York Telephone Company, and the Bell System, with which it connects, are cooperating in providing the telephone facilities which will play a vital part not only as an aid to radio broadcasting, but also in supplying adequate means of communication for the thousands of winter sport devotees who will witness the games.

Wherever the spectators assemble for a contest there will be installed loud speaking telephones, whereby all the important announcements concerning the event will be heard clearly by everyone. Additional coin-box telephones will also be installed at many points, including the arena, the stadium and elsewhere, for the convenience of the public.

At this great international winter sports meet there are in attendance champion skating and skiing athletes from all northern European countries. It is expected that records long held will be broken. It is the first event of the kind of such magnitude to be broadcast on national hookups.

The world-wide radio publicity given to the Lake Placid winter sports in connection with the International Olympics this year, will no doubt increase future interest in the attractiveness of that region in the winter.

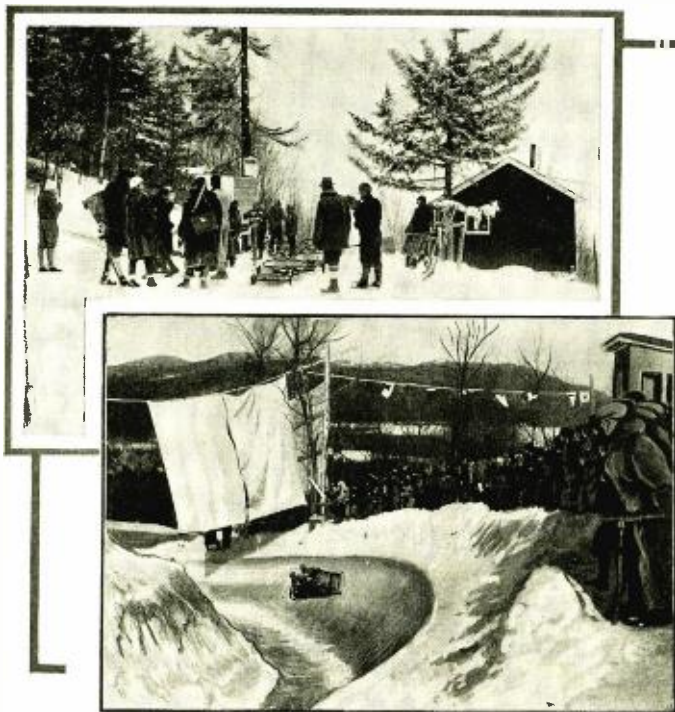

Rounding one of twenty-five curves in the Olympics bobsled run down side of Mt. Van Hovenberg. Above: Lineup at starting house where the runs are checked by telephone.

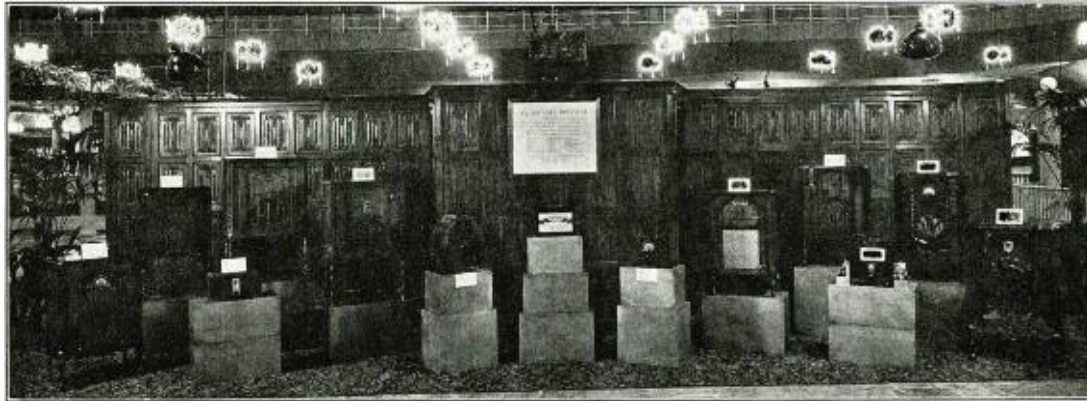

Twenty-one manufacturers are now producing the new type farm radio receiver employing air-cell batteries.

Radio design and the trend of the radio industries

IN much of the general industrial re-adjustment now under way throughout the country one sustained note of suggestion is that as purchasing power improves, buying response will be accelerated first in lines which have new and attractive products for sale.

Manufacturers of radio receivers, vacuum tubes and all of the many accessories used in radio assembly have sensed this situation—in degree varying with the commercial vision exercised by the respective managements. Much of what is going on is taking place beyond the portals of research departments.

Aside from the replacements that will soon be in demand to rehabilitate existing equipment in service during the past three or four years, there are developing useful and profitable fields for new devices and systems. Fields in which the surface has been but loosely grubbed over include those designated as public address, auto radio, police radio, airplane radio, extension of the use of short-wave, or all-wave, receivers for broadcast reception, television, B-eliminators for auto receivers, home talkies, and industrial applications of tube operated or controlled systems. To properly take care of the manufacturing needs of all of these developing utilities should spell profitable activity for all well organized and well managed plants.

Purchasing Power to Increase

As an index of the anticipated revival in purchasing power on the part

of the people at large, a large industrial research organization has just issued a statement which records that for the year 1932 a building program totaling \$3,420,000,000, exclusive of public works, is indicated from extensive statistical returns.

This is an increase of more than half a billion dollars, representing 17.5 per cent, when compared with that of 1931, which, estimated on virtually complete reports, amounted to \$2,909,000,000.

The greatest increase in volume is expected in the central and middle western states. Building construction in this area was well below average during 1931, according to the Association's figures; and a shortage of houses

in suburban sections of cities and in many small towns is expected to increase the building total in that territory by \$200,000,000. Increased volume also is expected in New England, the mid-atlantic and southern states and on the Pacific coast. In the New York area a drop is anticipated in commercial and industrial building, but this should be partially offset by residential construction.







"Residential construction, as usual," the Association said, "will lead all other classifications during 1932. For the first time in four years it is likely to exceed 50 per cent. of the total."

Thus, with aggregate manufacturing plant facilities remaining about as they are as to productive capacity, while other construction experiences a considerable upturn, the prospects for markets for manufactured products naturally improves.

Organized Radio Manufacturers' Plans

The radio industry—manufacturers, jobbers and dealers—is now assured of an early sales stimulus in 1932 from the national presidential campaign.

Plans of the RMA to coordinate its annual convention and trade show next May with the national political campaign and its probable great stimulus to radio sales, the arrangements for the RMA annual industry gathering and trade show, May 23-26, 1932, in Chicago, now will insure three weeks' time for the radio industry to take advantage of politics to make sales. The Republican national convention will be held

NATION'S 1932 BUILDING FORECAST EXCEEDS 1931 by \$500,000,000		
Compiled by the Copper & Brass Research Assn. N.Y.		
	1931	1932 (est.)
Home. Hotel. Apt.. Etc.	 \$1,432 Millions	 \$1,835 Millions
Federal. School. Church. Etc.	 \$842 Millions	 \$962 Millions
Factory. Office. Store. Etc.	 \$635 Millions	 \$623 Millions

Wages to material producers and construction workers will increase purchasing power.

June 13 at Chicago, just three weeks after the RMA trade show, and the Democratic national convention is scheduled around July 1.

The RMA show in Chicago next May will include all available exhibit facilities of the Stevens Hotel, the largest in the world, according to decisions just reached by the RMA show committee and the managing committee of the association's board of directors. Early demands for space in the May, 1932, trade show of the RMA caused the show committee and managing committee to reach a definite decision to use both the large exhibition hall and the grand ballroom of the Stevens Hotel for the official May show. Demonstration, display and entertainment rooms also will be maintained by manufacturers in the Stevens and Blackstone headquarters hotels.

Exhibition privileges in the trade show for RMA members also will be increased, under decision reached by the RMA authorities. It has been decided to permit exhibiting members to display non-radio products of their own manufacture, providing that sixty per cent. of trade show exhibits are devoted to radio displays. This will permit RMA members to show their related

lines which are sold through their regular trade channels.

Plans for joint meetings and other cooperation with the RMA during "radio week" in Chicago next May are being made by the Radio Wholesalers' Association and the National Federation of Radio Associations.

Also cooperating is the Institute of Radio Engineers, which has arranged to hold its spring meeting and display of component radio parts in Pittsburgh, April 7-9, instead of a later date. The I. R. E. meeting will enable radio engineers to make a final survey of all new parts before completing design of receivers to be exhibited at the RMA trade show in Chicago in May.

What Radio Designers Are Doing

Out of the manufacturing establishments where there has been concentration upon the design of radio receivers which will have new appeal and improved performance, comes information of particular betterments. All receivers may not contain all of the improvements developed, but models and types will embody one or several of the features which will make radio receivers of the coming year superior to those heretofore in use.

To list a few of the new things com-

ing along, in terms familiar to engineers, reference is made to oscillograph aligned and sealed receivers; precision selected tubes, sealed-in sockets; panels of airplane fuselage construction; panel key for switching from radio to records; non-glare dials; local-distance switches avoided by employing super-control tubes; triplex audio systems employing screen-grid first audio and push-pull output; bi-resonator r-f. tuning systems; tri-resonator intermediate amplifiers; isolated oscillator tubes; image suppressors for discrimination against cross-talk; detectomatic (duo-diode) detector for proper demodulator action and automatic volume control; tuning meters, and large baffle area cabinets.

Dual Speakers

To meet situations where the best of quality of reception is demanded, the difficulties incident to the use of a single loudspeaker are being corrected by employing two loudspeakers. There are two methods of accomplishing the desired results. One employs a small speaker for the "highs" and a larger speaker for the "lows." Another method is to use two loudspeakers of the same general characteristics, of the same size or different.

New president of I. R. E.

WALTER G. CADY, recently elected president of the Institute of Radio Engineers, was born in Providence, Rhode Island, December 10, 1874. He received the Ph. B. and M. A. degrees from Brown University in 1895-96, and the Ph.D. degree from the University of Berlin in 1900. From 1895 to 1897 Dr. Cady was instructor in mathematics at Brown University. During the period of 1900-02 he was a magnetic observer for the coast and geodetic survey. He left this service in 1902 to become an instructor in physics in Wesleyan University at Middletown, Conn. In 1903 he was promoted to assistant professor and in 1907, professor, and head of the physics department.

Dr. Cady has published various papers on cathode rays, magnetic declinograph, electric arc, electric oscillations, and piezoelectric resonator and oscillator. In 1923 he made the first direct international comparison of frequency standards by comparing a set of his quartz resonators with frequency standards in Italy, France, England, and the United States.

In 1926 he was the recipient of the Morris Liebmann Memorial Prize which was bestowed upon him by the Institute of Radio Engineers for his outstanding work in the development

of piezoelectric oscillators and resonators.

He is a member of the Physical Society, the Optical Society, American

Institute of Electrical Engineers, the American Academy of Arts and Sciences. He became an associate member of the Institute of Radio Engineers in 1914 and a Fellow in 1927. He has been active in Institute affairs, having served on its board of directors and a number of committees during the past several years.



W. G. CADY
President, I. R. E.

BOOK REVIEW

HOW TO PASS U. S. GOVERNMENT RADIO LICENSE EXAMINATIONS. By R. L. Duncan and C. E. Drew. 2d revised edition. 178 pp. Paper covers. John Wiley and Sons, New York, 1932. \$2.00.

This is a new and up-to-date edition of a book that has, during the past ten years, been of great service to radio men aiming to enter the radio telegraph service.

SERVICING SUPERHETERODYNES. By John F. Rider. 161 pp. Radio Treatise Co., 1440 Broadway, New York.

This is one of the most useful radio books published during the year. It is not only an excellent servicing manual but is in fact a text book on the theory and operation of this popular type of radio receiver.

An efficient battery-operated radio receiver

By LOY E. BARTON and L. T. FOWLER*

Herein is described a highly developed, self-powered radio receiver for broadcast reception. Its cost for battery power is less than twice the small cost for current to operate an a-c. receiver

THE early radio receivers consumed relatively high filament power, which was usually supplied by a storage battery. However, the plate power requirements were not great because of the small number of tubes required to operate headsets. The use of regenerative detectors and the small audio power output permitted the use of a one-to-three-tube receiver for what was considered satisfactory reception.

The cost of batteries to operate these one-to-three-tube receivers was not particularly great because of the limited number of tubes and the more or less limited time the receiver was in use each day. However, the public soon demanded multi-tube receivers which would have adequate sensitivity and selectivity and sufficient output power to permit the operation of some form of loudspeaker. These early multitube sets usually consisted of two tuned radio-frequency stages of amplification, a detector, and two audio stages of amplification. The output tube was capable of delivering 10 to 50 milliwatts of audio power. This type of receiver was in use for some time and no doubt many such receivers are still used in communities in which a-c. power is not available. The cost of power for this type of receiver was relatively high and it was necessary to use a 6-volt storage battery for filament supply, which was a more or less continuous source of trouble to keep charged.

The next step in the development of receivers was the development of the dry cell tubes of the type WD-11, UV-199, and UX-120. These tubes permitted the use of dry cells for filament power, but the demand for greater audio power output for greater volume and

fidelity from the loudspeaker was not met satisfactorily by these small, low-power tubes. The result of the demand for higher audio output and greater convenience in supplying the power to the tubes was the development of the present alternating-current tubes and rectifier systems which successfully met the demands of the public where alternating current power was available.

The demand for the a-c. radio receiver left relatively little interest or time for development of the battery-operated set until the spring or summer of 1930. An attempt was made to market a few battery-operated sets prior to this time, but the sales were discouraging because the user of a battery set would not accept a set with considerably inferior performance as compared to the performance of the a-c. set and especially if the cost of operation was several times that of the a-c. set.

With the above facts in mind, the tube companies developed a two-volt

tube and announced to the trade several types of these tubes in the late Spring of 1930. The Eveready 2.5 volt "air cell" battery for lighting the filaments of the new tubes, was announced at about the same time. The new line of tubes was more rugged electrically and mechanically than the early battery tubes. However, after a careful study of a possible tube combination for a receiver to compare favorably with the common a-c. receiver, it was found that the audio power output was relatively small for a comparatively high plate-battery drain.

Class "B" Audio Amplifier

The limitations of the new battery tubes as indicated above made it necessary to resort to other methods of operating the output tubes. The general purpose type two-volt tube, RCA-230, was studied very carefully as a possible tube for use in a class "B" audio output amplifier. This type of amplifier is inherently more efficient than the usual class "A" output amplifier and takes nearly zero plate power when no signal is applied to the output tubes. It was found that this small tube was sufficiently rugged electrically to deliver approximately 1.2 watts of audio power to a loudspeaker. The average plate current to two of these tubes as a class "B" audio output amplifier is about 5 to 8 ma. for peak radio signals at 1.2 to 1.5 watt levels. A signal at this peak level compares very favorably with the average a-c. set. This peak power output was only 5 to 8 ma. average plate current for an average radio program looked very promising as an output amplifier for a battery receiver.

The class "B" audio amplifier is an amplifier with two tubes arranged in a push-pull manner and biased to nearly plate current cutoff. The input transformer in combination with the tube connected to the transformer is such

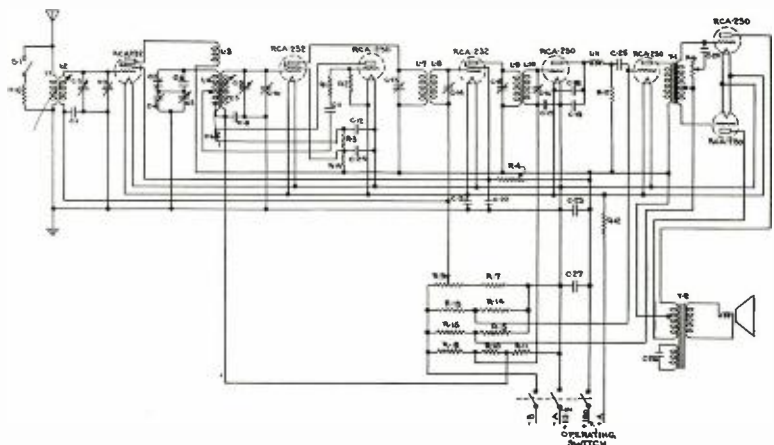

Fig. 1. Schematic diagram RCA-Victor console R-43.

*RCA-Victor Company, Inc., Camden, N. J.

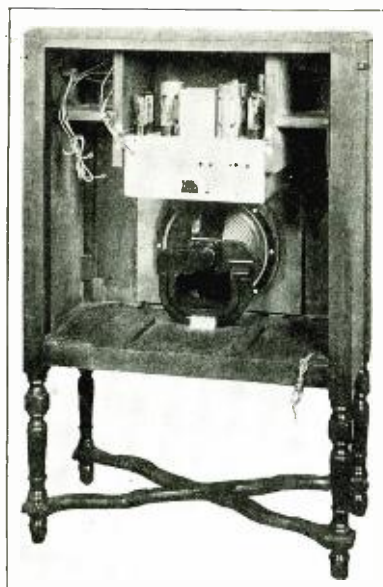

Fig. 2. View of rear of receiver showing mounting of parts.

that the grids of the output tubes may be driven positive without serious distortion of the input wave. The signal on the grids causes one grid to become more negative while the other grid swings in a positive direction. The plate current of the first tube becomes zero soon after the signal starts more negative and the plate current of the other tube increases as its grid swings positive. Therefore, the second tube will supply power for one-half of the primary of the output transformer into the equivalent reflected load in series with the plate for one-half of the input cycle. During the next half-cycle the first tube supplies power to the other half of the primary of the transformer while the second tube is idle. It will be noted that the plate current to each tube on alternate half cycles is opposite in phase so that the voltage in the secondary of the output transformer has the same form as the input wave except for a small amount of distortion that may occur in the driver tube and transformer which supply the signal to the output tubes.

The load resistance for maximum power output for the above amplifier is about 2,000 ohms per plate during the time a particular tube works. However, it was found advisable to use a load resistance of approximately 3,750 ohms per plate as a means of limiting the peak plate current of the tube to a value considered within limits. With the 3,750 ohm load per tube and driven by an RCA-230 through the special input transformer, the peak plate current to each tube is approximately 25 ma. and the peak grid current is 1 to 1.5 ma. for

a positive grid swing of 20 volts. The plate voltage for the above case is 150 volts and the bias is approximately 15 volts. Distortion measurements on the output system indicate that 1.2 to 1.5 watts may be obtained without exceeding 5 or 6 per cent harmonic distortion. The above values of peak plate currents occur at intervals when the instantaneous plate voltage is a minimum, which, no doubt, is the reason these small tubes can deliver the relatively high power without injury to the tube. For a sinusoidal input wave at the above peak value of plate current, the average plate current to the output tubes would be about 16 ma. However, when an average radio signal is being received and the volume control is such that the maximum volume from the set is not appreciably distorted, the average plate current is 5 to 8 ma., depending upon the particular radio signal.

Circuit for the Receiver

Referring to Fig. 1, which is the circuit diagram of the battery receiver as developed, note that the plate supply is obtained from a 157½ volt tap on a 180 volt "B" battery and that bias for the output tubes is taken from one bleeder across the 22½ volt tap at the negative end of the battery. Bias for the remainder of the tubes in the set is obtained from separate bleeders across the same 22½ volt tap. The voltage for volume control is also taken from this end of the battery. The total bleeder current taken by the resistors across the 22½ volts is approximately equal to the current drain on the remainder of the plate battery so that the proper ratio of bias to plate voltage will be maintained as the batteries decrease in voltage due to use. The bleeder is switched on or off, with the filament supply. This system for obtaining bias and the addition of the by-pass condenser C-27 permits satisfactory operation of the receiver over a wide range of "B" battery voltage so that maximum service can be obtained from the batteries. The life of a set of heavy duty "B" batteries and the air cell filament battery is approximately 1,000 hours if the receiver is operated in a normal manner. The above battery life permits 2.5 to 3 hours daily operation of the receiver for a period of approximately one year on one set of batteries. A view of the back of the battery receiver is shown in Fig. 2, which shows the battery compartment and the manner in which the loudspeaker and chassis are mounted.

The receiver uses a superheterodyne circuit consisting of two r-f. tuning circuits associated with one RCA-232 tube, and RCA-230 oscillator, RCA-232 first detector, RCA-232 i-f. amplifier, and 4 RCA-230 tubes, one for the sec-

ond detector, a driver tube, and two tubes for the output amplifier. A local-distance switch is included as indicated on the circuit diagram to provide volume control range in addition to that obtainable by means of the bias adjustment on the r-f. and i-f. tubes for cases where the set is exposed to abnormally high signal strengths, as when near to a strong local station. A tone control indicated as R-6 is provided, which functions in the conventional manner. The filaments are lighted by an Eveready "air cell" 2.5 volt battery with a fixed resistance in series with the filaments to reduce the voltage to 2 volts at the filament terminals. A 2-volt storage cell may be used to supply the filament power if the filament resistor is short circuited or replaced by a fuse. The number of leads to the batteries have been reduced to a minimum and consist of two leads for the filament battery and three leads for the plate and bias supply besides the three-plate battery jumpers.

Loudspeaker

An average electrodynamic speaker field consumes 2 to 5 times as much power as the entire battery set under discussion. Therefore, it is necessary that the loudspeaker for a battery set have a permanent magnet to supply its field. The loudspeaker for the battery set is of the dynamic or moving-coil type. Considerable development and the generous use of special magnet steel to supply the field permits a speaker comparable in sensitivity with the larger electrodynamic speakers and a fidelity practically identical with the larger speakers.

Performance of the Complete Receiver

The combination of the above speaker and the class "B" audio output amplifier permits a volume and fidelity of output which is comparable to good a-c. operated radio receivers. The total filament drain is 480 ma. at 2.5 volts and the total average plate and bias battery drain for approximately maximum undistorted volume on the average radio signal is 12.5 ma., at which point the peak power to the loudspeaker is 1.2 to 1.5 watts. It is interesting to note that the output power of the comparatively small output tubes is more than enough to supply the filament power needed for the entire set. Another interesting feature of the set is that when a peak output of 1.2 watts is obtained at maximum volume on the average radio signal the total average battery power delivered to the entire set is 3.5 watts or an overall efficiency of peak output to average power input of 34

(Concluded on page 38)

Radio communication on the international airlines †

By H. C. LEUTERITZ*

In this important paper is described in detail design of radio equipment and operating problems of the most extensive airways radio communication system in the world

Route Traffic Between Airports

WHERE an organized air route between fixed points is established it is of the utmost importance that an efficient system of communications should exist, in order that messages concerning the departure and arrivals of aircraft, instructions to land at intermediate airports or emergency landing fields, information regarding transport of passengers and goods, and the thousand and one messages which are a part and parcel of an efficient air transport organization may be rapidly and accurately communicated without unnecessary delay.

The Department of Commerce under the Air Commerce Act of 1926 has undertaken to handle part of these details, using wire line facilities where they exist and radio service in other locations. However, the service which is rendered is rather limited in extent so that all the points covered in the above paragraph are not handled by them, particularly on international routes, in which cases the airline operator is necessarily compelled to provide his own facilities.

Experience has shown that the circulation of all meteorological information and all route traffic messages, is best handled by means of radio telegraphic signals.

Meteorological information is usually circulated in the form of code messages, while the normal route traffic messages consist of information concerning number of passengers, letters defining the airplane and such details regarding the aircraft in particular. It is generally agreed that this class of service is more easily dealt with when

using the telegraph code. This insures a permanent record being kept of the actual text of the messages dispatched and received for future reference.

The location of any aircraft on an airway at any particular instant must be available to the flight control officer usually designated as the operations manager. This is most important so that he may keep in close touch with the meteorologist at all times to be in a position whereby he can issue the necessary advice to cancel any flight if in his opinion such flights will jeopardize the safety of the passengers and crew.

Aircraft Communications

Turning to the question of the system to be employed from and to the planes while in flight, it is now accepted that where the pilot of the machine himself has to operate the radio equipment, then the *only* system that can be efficiently operated is radio telephony. The pilot of a modern airplane has so much to occupy his mind while flying the plane and watching the multitudinous "gadgets" which are an integral part of all modern types, that he cannot possibly be expected to concentrate on the reception and writing down of telegraph signals. Consequently the spoken word is essential for such cases.

In the case of large transport planes carrying passengers, it becomes necessary in most cases when employing telephony, to repeat a message two or more times before it is clearly understood. This delay is normally due to static and other contributing noises. This statement is based on experience both here and abroad and on more than one occasion the use of telegraphy copied by an operator aboard the plane has demonstrated that the speed of transmission is greater by use of the telegraph code. On several tests conducted, using both types of communica-

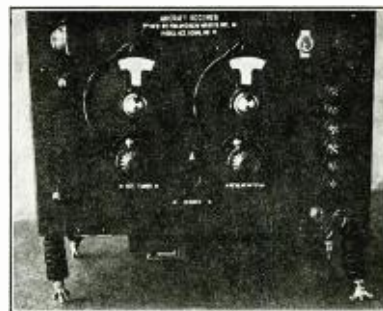

Model ACC aircraft receiver. View of front panel, set closed.

tion, it was possible to deliver a message pertaining to the safety of life and property in one-twelfth the time required by telephony.

In our operations, we not only have to contend with the inherent noise which exists on all aircraft, but the problem of static is decidedly more prevalent and over greater portions of the year in the tropics than elsewhere. This is only natural as the climatic conditions are such as to be conducive to development of electrical storms, etc.

Aircraft communications are carried out in the following manner. The pilot is required to send a message every half hour giving his position on the route. This position uses for its basis given landmarks where same are visible, or a latitude and longitude position when flying over water routes. This report is based on a dead reckoning and is dependent for its accuracy on the experience of the pilot. It is rather surprising to note the accuracy attained by pilots as checked against direction finder bearings. The radio operator, however, is required to contact airport stations every fifteen minutes and maintain a continuous watch so that ground stations and aircraft can contact each other instantly. As an illustration of how this works, a plane on the ramp at Washington heard the Miami station working an airplane in flight between Havana and Key West. When the contact was finished, he called Miami on the same frequency and got an immediate answer to his call and several messages were handled. This was done without any preliminary schedules or advice to the Miami station. This method of operation insures service to all aircraft so that in cases of emergency the situation can be met.

Direction Finding and Radio Beacon Operation

One of the prime uses of radio for aircraft is the possibility it affords of ascertaining the exact position at any instant of an aircraft in flight. While the ordinary methods of navigation can be used with a reasonable amount of

†Presented before the Radio Club of America, January 13, 1932.

*Chief communication engineer, Pan American Airways, Inc.

success in the air, yet certain conditions of weather may be encountered where these methods may not only become almost totally useless, but actually misleading and in some cases dangerous.

For instance, suppose an airplane is flying in bad weather and is suddenly surrounded by thick fog which can neither be flown over or under. It is evident that the ordinary methods of flying by visual observations on the sun, stars or beacons immediately become useless, and reference has to be made to the compass and on dead reckoning. The aircraft compass, as is well known, is liable to be misleading, since under certain conditions it begins to swing, due to the yawing of the aircraft, and owing to the lag due to mechanical inertia, the pilot may over compensate again until the compass card may actually begin to spin. A turn and bank indicator helps here, but no other method of navigation will enable the pilot to determine his exact position except by radio direction finding, as if there is either a wind causing a drift, or an error on the compass, the machine may become many miles off its course, without the pilot having any indication. If the fog belt extends for many miles over the course, it is quite evident that the pilot may become totally lost under such conditions.

Several methods of direction finding for aircraft have been employed to date, viz., (a) Direction finding systems on the ground. (b) Direction finding equipment carried on the plane. (c) Directional transmitter on the ground (radio range system).

A certain amount of discussion has taken place as to which method is preferable, and as a matter of fact there are many pros and cons for each system. Therefore, let us briefly summarize the advantages and disadvantages of each system.

Direction Finding on Aircraft

Advantages. (a) Secrecy; (b) Responsibility for correct position rests with the pilot or navigator on the plane.

Disadvantages. (a) Extra training and work of navigator; (b) Extra weight of apparatus; (c) Wind resistance in the case of a rotatable loop on the plane; (d) Turning of plane in flight when using fixed loops in order to check correct position; (e) Lack of direct contact with ground stations; (f) Lack of check with known ground points; (g) Lack of ground control; (h) Interference from ignition, etc., due to high sensitivity of receiver.

Direction Finding on the Ground

Advantages. (a) Saving of weight of equipment; (b) No extra wind resistance; (c) No extra personnel required; (d) Greater accuracy of bear-

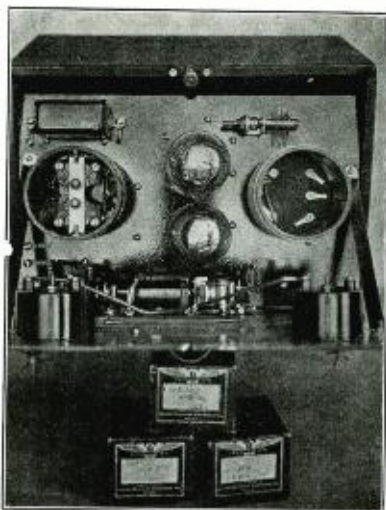

Transmitter.

ings due to absence of noise and ignition interference; (e) Direct contact with ground stations at all times; (f) Direct control by ground stations; (g) Accurate check from ground points; (h) Accurate means provided for keeping aircraft on a predetermined course between airports; (i) Installation cost very low; (j) Air crashes avoided.

Disadvantages. (a) The pilot has to rely on bearings from the ground stations; (b) Slight delay between time of request for position and the time it is received from the ground station. However, this time can be reduced to less than one minute by efficient operation and training of ground crew.

Radio Range

Advantages. (a) Pilot flies a given course; (b) Theoretically any number of planes can follow same course; (c) No extra wind resistance; (d) No extra personnel required.

Disadvantages. (a) Lack of direct contact with ground stations; (b) Lack of direct control by ground stations; (c) Installation costs high; (d) Air crashes are possible between planes following the same course; (e) Responsibility of correct position rests with pilot; (f) Turning of plane in flight in order to check correct position; (g) Confusion of course due to noise and ignition interference; (h) Confusion of course due to other interfering ground transmitters caused by ships, etc.

Although much stress has been laid on the necessity of rapid communication between airports and airplanes in flight, the aid to navigation rendered by directional means is no less important.

Due to the many advantages by the use of direction finders on the ground the Pan-American Airways has adopted this system in preference to all others. A system has been worked out which is

very economical and efficient in operation.

Aircraft Telegraph and Telephone Apparatus

The design and manufacture of aircraft radio equipment is an art in which the radio problems are complicated by the restriction of weight and space. Definite limitations are placed on these two facts and it is only by careful design and arrangement of the circuit parts that it is at all possible to combine compactness with efficiency.

1. The following data is compiled as a result of experience gained in the equipment and operation of radio apparatus on many commercial planes. It is intended to serve as a guide to the technical engineer well acquainted with modern radio practice.

2. Aircraft radio communication has many problems associated with it which do not come into prominence in connection with ground or ship stations. The various systems employed have been developed by no means because they were the simplest and easiest to apply to aircraft communications, but because it is not always economical or practical to carry a radio operator capable of giving his undivided attention to the transmitting and receiving of messages, except on very large passenger machines such as we use in our own services. In the case of single pilot mail or express planes or in the case of limited payload machines and under favorable conditions it is essential to employ telephony, since it forms the only solution to the problem, for it provides a practical means of linking the airplane with the ground or with another machine and can be used by a pilot or navigator without special training.

3. The destructive effect of constant vibration, and the conditions of extreme noise under which telephony has to be carried out, coupled with the fact that in most cases the apparatus is not available for inspection under working conditions except when a test flight is made, constitute the chief difficulties which are experienced. In the new large cabin planes the pilot does not wear a helmet and this further handicaps the use of telephony.

4. The efficiency of the radio installation on an airplane will depend largely on how the initial fitting is carried out, and too much attention and care cannot be given to this subject. Unfortunately provision is not always made in the modern airplane for radio equipment, consequently the disposal of the apparatus (including, as it does, the main set, controls, generator, antenna reels and fairlead) is a matter which often taxes to the utmost the ingenuity of the radio engineer.

In March, 1929, work was started on

the construction of a 200-watt transmitter for airport operation and which utilized one UV-204A tube in an oscillating circuit feeding a doublet antenna.

The plate power supply was furnished by a full-wave rectifier using two UX-866 tubes and delivering from 1,500 to 2,500 volts. The plate voltage transformer was arranged with taps in the primary circuit for voltage control. The entire unit operating from either a 110 or 220 volt, 60 cycle, single phase supply.

These transmitters were later equipped with a wavechange switch to permit operation on two frequencies, and erected at each of the airports along the route for communication both with airplanes in flight and between airports.

In April of 1929 some of the new 100-watt transmitters were delivered and installed aboard aircraft and operated on telephone by pilots. Telephone tests in regular scheduled operation again demonstrated the need for better and more efficient service as the length of time required to deliver messages was considered too great for safe operation. By July 1 these transmitters had all failed from one fault or another and the entire lot were therefore rejected.

On the basis of this experience, complete new aircraft apparatus was designed including both transmitter and receiver.

The aircraft equipment can be divided into the following classification and each part will be considered separately:

- (a) transmitter; (b) power supply;
- (c) receiver; (d) antenna systems.

Aircraft Transmitter

The output of the transmitter is 12 watts cw. telegraph only. The circuit is a standard master oscillator-power amplifier connection employing one 7.5 watt type UX-210 tube as the oscillator and one of the same type tubes as a power amplifier. The amplifier circuit is neutralized and the oscillator circuit is a straight "Hartley." All resistors are of the moulded type to insure reliability.

Plug-in inductances are used so that a quick change of wavelength can be made. The tank circuit capacities are constructed as integral parts of the plug-in coils so that in changing wavelengths, no adjustment is required in the transmitter other than retuning the antenna (by increasing or diminishing its length) for maximum radiation at the new frequency. Standard installations contain plug-in coils for 32, 54, 97, 600 and 900 meters. The latter waves being necessary because of our international flights part of which are

over water. Keying is accomplished by biasing simultaneously both the grid of the master oscillator and the power amplifier.

The set is mounted in an aluminum cabinet with a hinged front panel which tips outward disclosing in full view all of the component parts which are mounted either directly on the front panel or on a sub-panel. The front panel contains three meters; the front panel current meter showing total plate current for both tubes, an r-f. ammeter for antenna current and a zero center ammeter showing the charge and discharge current in the main storage battery. The cabinet dimensions are: width 13 inches, height 9 3/4 inches, depth 8 3/8 inches. A special break-in relay is also incorporated in the cabinet which permits faster communication between the plane and the airport stations. All resistors are of a moulded type and the entire transmitter assembly, including the cabinet, are especially treated with

a coating impervious to heat and moisture. The set is also equipped with an antenna tuning arrangement consisting of a tapped inductance and a variable condenser in order to permit rapid tuning of the fixed antenna on amphibion and boat type aircraft. The radio transmitter complete with coils, vacuum tubes and cabinet weighs 12 pounds.

The filaments of the tubes are fed from a 12-volt aircraft storage battery while the plates are supplied from a small dynamotor rated at 400/12 volts, 70 MA/8-A. No filtering is required.

Aircraft Power Supply

It was at once realized that communication would be necessary in the event of forced landings. To accomplish this, the 12-volt, 65-amp. hour aircraft storage battery was standardized as the source of power instead of a wind-driven generator. With the 8 amp. input into the transmitter dynamotor and

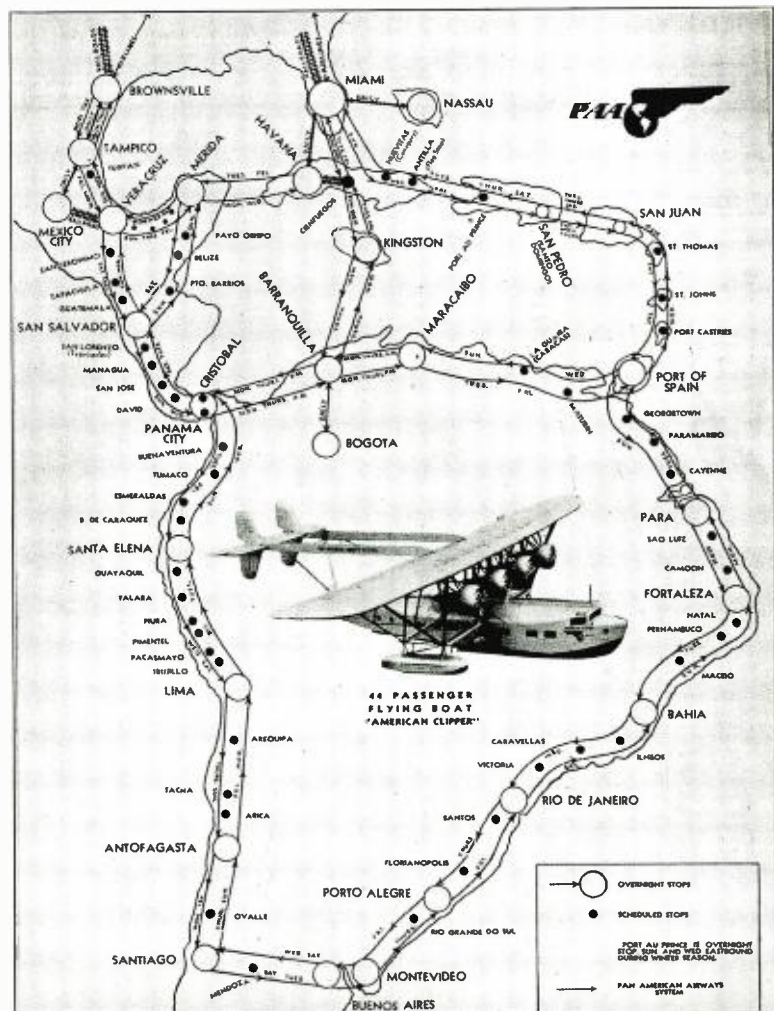

Fig. 1.

the possibility of obtaining bearings on signals for distances up to 400 miles.

The first unit constructed was installed at Kingston, Jamaica, for the purpose of taking bearings on aircraft flying over the largest over-water route in the world. The distance between Kingston, Jamaica and Barranquilla, Colombia, is 540 miles. This location was selected for three reasons. First, for the necessity of navigational aid; second, over water transmission, and third, possibility of making observations on signal propagation over mountains.

The City of Kingston is located on a large sheltered bay and mountains towering 4000 feet encircle the town with the exception of the seaward side. Bearings have been taken on aircraft while they were flying between Kingston and Cienfuegos, Cuba, with the results that the mountains above mentioned were intervening. Observations disclosed that reflection by the mountains affects the aircraft bearings only while the plane is in close to the island of Kingston. On the over-water route, a slight shift in signal minimum is noticed only during sunrise and sunset periods. No extensive night observations have been made, although during the short periods of darkness when bearings were attempted, fairly good results were obtained.

Bearings are taken both while regular transmission is taking place and at other times when particularly requested by the pilot. Eventually this system of D. F. will be installed on board the aircraft, in which case the operator can take his own bearings and plot instantaneous positions. The unit has now reached the stage of development where the apparatus can be installed aboard the aircraft adding only 12 pounds additional weight for the loop and its tuning unit.

In addition to this means of navigation, I wish particularly to call attention to the chart, Fig. 2. This chart

LIST OF STEAMSHIPS ON CRISTOBAL-KINGSTON ROUTE

Date—January 31, 1931

Nr.	Steamship	Company	Knots	D.F.	Sails	Bound For	Radio Call Let.
1	Point Breeze	At.; Refg.	12	Yes	3PM-30th	Philadelphia	KJEI
2	Henderson	U. S. S.	14	...	10PM-30th	H. Roads	NESD
3	Pear Branch	F. & W. Ritson	13	No	4PM-30th	S. Thomas	GDZJ
4	Arizonan	Williams	12	Yes	9PM-30th	New York	WACX
5	Hendon Hall	Inter-Frtg.	13	Yes	3PM-31st	Norfolk	GMZL
6	Albion Star	U. C. S. Ltd.	12	...	Mtd.-30th	Norfolk	G CBD
7	Amapala	S. F. & SS. Co.	14	...	2PM-31st	New Orleans
8	Baracca	U. F. Co.	15	No	12M -31st	Kingston	KEDN
9	Volendam	Holl.-Amer.	16	Yes	3PM-31st	Kingston	PIHP
10	Tela	U. F. Co.	16	No	1PM-31st	Castilla	HRAM
11	Buchanness	W. R. Smith	12	No	7PM-30th	London	GKXY
12	Monique	Cie. Aux.	12	Yes	5PM-30th	Le Havre	FOEG
13	Barrwhin	C. Crom. Co.	13	Yes	6PM-30th	Jamaica	GDYK
14	Queen Maud	E. I. DuPont	12	No	5PM-31st	Baltimore	GKFR
15	Bolivier	Cie. Mar. B.	12	Yes	5PM-31st	S. Thomas	ORVA
16	Serantes	Cie. Nav. V.	12	No	5PM-31st	S. Thomas	EAKT
In-Bound for Cristobal							
					Due*	From	
17	Trojan Star	Amer.-Hawa.	12	No	12M -2nd	Liverpool	GKMV
18	Caledonia	Cunard	16	Yes	9AM-2nd	W. Indies	GFJY
19	Canada	Johnson L.	15	No	7AM-2nd	Stockholm	SDQN
20	Heredia	U. F. Co.	15	Yes	7AM-2nd	New Orleans	KDAH
21	Parrakoola	Tr's.-Atl'c.	13	Yes	9AM-3rd	Europe	SMLA
22	Gisla	Can. Trans.	12	No	9AM-3rd	Philadelphia	LCLD
23	Hakushika Maru	N. Y. K.	13	No	7AM-3rd	New York	JBXD
24	Welsh City	W. R. Smith	13	No	9AM-3rd	U. K.	GKWD
25	Triton	W. W. Line	12	No	7AM-3rd	Baltimore	DDIT

*Approximate.

with its accompanying list shows the number of steamers in this area together with all pertinent data regarding call letters, frequency, where bound for, ship's name, and its approximate position on the day of the flight. These charts are compiled each morning and supplied to the radio operator whose responsibility it is to check these reports while en route. In this way ships are contacted on 600 meters and weather reports obtained while en route in many cases 150 miles before the aircraft arrives at and actually sights the steamer.

It is by careful attention to such details that this route has been flown with the same regularity and safety as any domestic route. Not so long ago one of the aircraft on this route between Colon and Barranquilla sighted some wreckage and persons from the S. S. Baden Baden and prompt means of communication resulted in the rescue of the unfortunates.

Conclusion

The application of radio to aircraft is of special nature and requires considerable thought and planning in order that a suitable network of stations can be erected to serve the particular demands. This must also be done as economically as possible.

It is the policy of the Pan-American Airways to maintain contact with all planes in the vicinity of any particular station at all times, plotting its course and advising the flight office of the location of any one plane on the various routes.

It is demanded that aircraft radio operation be made as reliable as engine operation and is only possible because of rigid inspection before and after each flight.

The system in use is the largest of its kind in the world and an endeavor is being made to make it the most efficient as well.



Canadian telegraph statistics

Gross revenues of all telegraph and cable systems in Canada during 1930, according to a statement recently made public, amounted to \$14,264,997 which is a drop of 12.2 per cent below the 1929 figure of \$16,256,441. Net revenue was \$2,473,706, as compared with \$3,666,077 in 1929. Wire mileage of 371,747 miles, shows an increase of 10,864 miles. Telegrams transmitted, including messages originated at Canadian stations and messages received from the United States and destined to Canadian stations, amounted to 15,558,224—a decrease of 2,471,739 messages from the 1929 total.

Police radio system an efficient tool of law enforcement †

By ANDREW J. KAVANAUGH*

THE radio division of the police department of Rochester, N. Y., since its inception has met all expectations and fully justifies its existence, quickly transmitting pertinent information to the mobile unit and dispatching officers in whatever number necessary to cope with any situation without loss of time. Speed is a very important factor in police work, and any agency which saves time contributes to the protection of citizens and gives them greater assurance of security.

I believe that radio is one of the most important instruments available to the department for crime control, and I believe, too, that its usefulness would be further advanced by two-way communication to replace the one-way system universally used at present. The first officer at the scene, without having to locate a telephone would be able to give timely information directly to other radio cars. This would be particularly valuable in the apprehension of felons where the crime has just been committed and a possibility exists, that the criminal could be picked up from a quick description, by cars on the way to the scene.

Spot Information

An officer sent on a disturbance call may find on arrival that a serious situation has developed; a cutting, murder, gang fight, or something larger than was expected, where assistance might be necessary; to look for criminals, subdue and hold prisoners, call an ambulance, administer first-aid, and perhaps there is no 'phone available for blocks, as often happens in the early morning. Assistance from neighbors or bystanders, in certain districts, is frequently not forthcoming from fear of reprisal. In such an emergency a connection back to radio central would be valuable.

An officer dispatched to an automobile accident finds that a reckless driver has hit another car and injured the occupants. He must call an ambulance, administer first-aid, hold the prisoner, obtain names of witnesses, determine how it happened, clear the usual traffic jam, have the wreck cleaned up, take

the prisoner to the station, and perhaps go to the hospital to learn the extent of the victim's injuries; a little more than was expected from the vague telephone call just received at headquarters. A microphone connection would be handy here.

On an alarm of fire, by means of radio an officer often reaches the scene ahead of fire apparatus. Assistance may be needed to direct traffic, establish fire lines, and in the case of arson, the detective bureau should be notified.

These are a few examples of cases where a two-way radio system would be valuable in saving time. Here is one difficulty occasionally encountered in the operation of the radio system. The officer must stay within hearing distance of his radio, otherwise he may miss a call intended for him. Suppose in cruising he sees someone acting suspiciously in a back yard, or hears a disturbance upstairs in a building. Should he go to a 'phone, which may be a police box several blocks away, to report out of service, or act immediately and run the risk of missing an important radio call? Why not just pick up the microphone and tell the radio dispatcher to take him out of service until he reports back? I believe it is only a matter of time before transmitters for police cars are available, and our radio staff sees no great obstacle to its development.

The present radio transmitter is located on the top floor of the sixth precinct station on Bronson Avenue. This location was selected because of its distance from tall buildings and structures and their attendant absorbing effects, and because the land is somewhat higher here than other parts of the city.

The apparatus is of 200 watts power with provision for an increase to 400 watts feeding into an antenna supported by 100 foot masts.

At the present time we are operating on a frequency of 1,712 kilocycles or 175 meters, in some cases being picked up on broadcast receivers. We have been asked by the Federal Radio Commission to drop to 2,458 kilocycles, or 122 meters. An increase in power will probably be necessary to maintain reliable communication with County and

State police cars, for I have been advised that absorption of radio waves increases rapidly with increase in frequency, hence diminishing the strength of the signal more rapidly with distance.

Four government licensed operators, three on 8-hour shifts and one for relief, having the highest rating in the civil service examination, are on duty at the transmitter. The staff is completed by three service men and the lieutenant in charge.

In addition to the controls in the operating room on Bronson Avenue, a microphone, switch, and signal lights are located at the headquarters telephone exchange, known as Main 59, and connected directly through to the transmitting station. By this means the police telephone operators may put a call directly on the air by throwing a small switch. In order that the telephone operator may not be kept too long from his duty of answering calls, he gives the announcement through the microphone once, or twice if necessary, and the call is heard on a monitor receiver located in the transmitter room, and repeated several times by the radio operator. A green light at the headquarters exchange indicates that the telephone operator may have immediate access to the air. A red one means wait until the radio operator finishes with the last call or test signal. Likewise a red signal light at the transmitter indicates that headquarters is going on the air. The system of control prevents both announcers from using the transmitter at the same time.

Car Directory

To speed dispatching of cars a specially constructed street directory gives the number of cars in the zone in which the street is located. In addition a board with movable blocks representing each radio car is located at both the telephone switchboard and in the radio room. When a car is sent on a call or is out of service for repairs, gas, or on special assignment, the block is moved to the right. When the car reports back in service the block is returned to the left position. The dispatcher can tell at a glance the cars in service in any zone. As a double check a written record is kept at both points, of the movements of all cars and frequent comparisons are made for accuracy. If any question exists, the car is called for a report. Twenty minutes are allowed the officer to report back from a call. If he is not heard from in that time he is called on the radio until a report is received.

Each of the six precincts, with the exception of the smaller first and second precincts, are divided into three zones, a scout car for each zone and a cruiser

†From the Rochester, N. Y., Engineer.
*Chief of Police, Rochester, N. Y.

to cover the entire precinct. In addition there are four detective and auto bureau cars, two for each side of the river.

On a minor complaint a scout car of the zone is dispatched, or if on another call the car in the adjacent zone, or the cruiser will be sent. If the complaint is more serious the scout and cruiser are dispatched together. The cruiser automatically answers all fire calls and major cases, or even a minor complaint if he is in the immediate neighborhood. Should the case be a felony the detective bureau car, inspector's car, and my own would go to the scene, although I do not personally limit myself to felonies, frequently taking in calls to check the functioning of the radio system.

Extreme cases would bring the aforementioned cars, an auto bureau car, and cruisers from the other precincts with extra men picked up on the way.

In the case of an escaping felon a description is broadcast and all police and sheriff cars are on the alert.

Finding missing people, settling family arguments, breaking up traffic jams or ball games in the street, disposing of intoxicated persons, interrupting crap games, preventing suicides, quieting barking dogs in the early morning, burglaries, holdups, fires, are a few of radio assignments. Although the transmitter is operating almost continuously, there are quiet periods, and to give the officer a check on the operation of his receiver fifteen minutes test calls are broadcast. This system allows little excuse for missing a call, although in a very few spots reception is poor, chiefly while passing through certain railroad subways.

Call System

Not all assignments are made over the radio. For reasons of secrecy and detailed work, where speed is no object, the officer is told to call his station. If he goes out on a detail he reports to headquarters exchange, where he is listed out of service both on the telephone exchange and radio room records.

Inasmuch as car dispatching is now controlled from headquarters instead of from the various precincts as formerly, radio receivers have been placed in each station to inform the officer in charge of the movement of his cars.

Police radio cars controlled by WPDR include 22 scout and cruiser, 4 detective and auto bureau, the detective lieutenant, 3 inspector, auto service and radio service, 9 sheriff cars, director, commissioner, city manager and my own car. In addition one State police car of Troop A, East Avon, recently equipped, is using the service. This gives a total of 46 radio equipped cars tuned to the wavelength of WPDR—

Police radio installation at Rochester, N. Y.

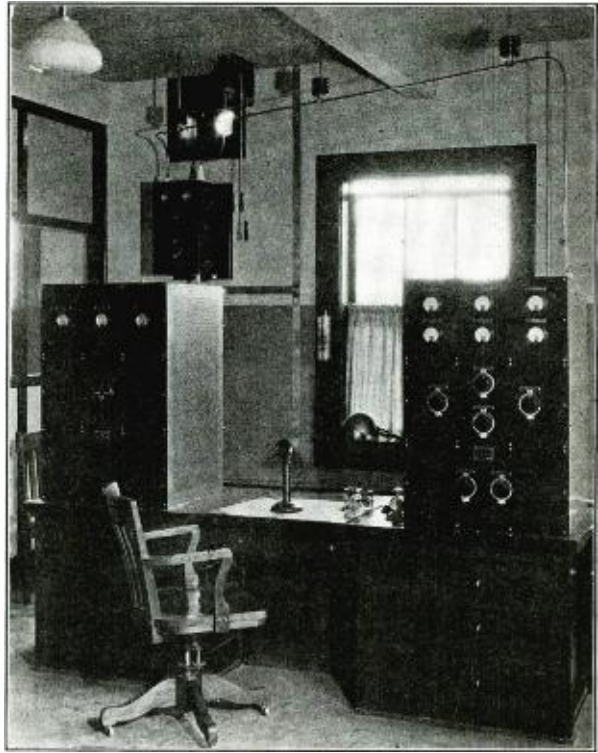

certainly a formidable weapon against crime and a great safety insurance policy for citizens in and around Rochester.

The thoroughness and efficiency of the Rochester police radio system is attested to by the inquiries and visits of officials of other cities. In our own case obstacles had to be overcome and procedure ironed out as in any new device, and other cities contemplating police radio might well consider the variety of problems we experienced in development.

A radio-equipped auto service car is maintained to give emergency service to police cars, tow wrecks, and help the traffic bureau.

A radio-equipped receiver service car can be dispatched to repair a defective police receiver. Major radio repairs are made at No. 6 station where a garage with pit and complete service facilities are available. Three service men on 8 hour shifts keep the radios in order and have testing apparatus and parts necessary to keep the receivers in good condition.

The service department keeps a complete record of each car, receiver, tubes, batteries, and other accessories, to the end that chronic cases of trouble may be definitely cured by suitable alterations.

Battery and tube life under the trying conditions of 24-hour service in police cars is an expensive item. In order to reduce expense and the num-

ber of service calls different makes of accessories are tested in operation to determine the most desirable. Other phases of the receiver installation are checked for more reliable operation.

Vibration and jarring seem to be the root of many trouble cases and a remedy has been found and proven quite successful. The service staff is placing all radio parts excepting the battery wires and antenna in one portable unit placed on the floor of the car in back of the front seat where body motion is least, and eliminating the old trunk and control wire system. The entire radio installation can be removed and a new one installed with no loss of time, as formerly the trouble had to be located and repaired on the spot before the car could be put back in service. Furthermore, the antenna plates are being removed from the running-board and an aerial placed in the roof to give more energy pickup, less trouble, and make the police cars less conspicuous.

The service department is equipping itself for laboratory and development work in order not only to keep up with advances in radio apparatus but to originate desirable extensions of the police radio service.

The swiftness of radio communication has frequently been demonstrated. An out-of-town car coming into the city from the west struck another car and left the scene of the accident, however, not before someone had taken the license

number and telephoned it to headquarters. Shortly after, the car was picked up on the east side as it was about to leave the city.

In another instance a citizen made a complaint to headquarters, was given a telephone connection to the station in his precinct, and a car dispatched to the address. The citizen was still 'phoning when the car arrived, the officer having to wait to be admitted.

A car was reported stolen and a description broadcast immediately. Twenty minutes later it was picked up with three men in Webster, in about the time it would take the car to travel that distance. Shortly before, the deputy sheriff had been sent to Webster on another radio call and was in a position to make the arrest.

Two children were reported missing from home. Through a radio call they

were picked up walking along a highway by sheriff's deputies.

In several cases the timely arrival of police frustrated an attempted suicide. At another time an officer received a call to an address on the street he was patrolling, where a man with a gun was threatening to shoot another man. The time elapsed between receipt of call and arrival at the scene amounted to practically nothing, and more serious complications were prevented. That the nature of the call indicated possible developments was shown by the arrival shortly after of another scout, the cruiser, and a detective bureau car, although they were not mentioned in the call. The cruiser and detective cars automatically answer calls for felonies or attempted felonies, not to mention an inspector, city official, or myself.

Radio often brings the police car to an

ambulance call, or fire, in advance of the ambulance or fire apparatus. In the first case he may administer timely first aid and in the second case he may clear traffic for fire trucks, or may arouse sleeping inhabitants.

When you 'phone in a complaint the police operator at Main 59 throws a switch and speaks into the microphone directing a car to your address. The radio operator at WPDR hearing the call going out on the air disconnects the police operator and repeats several times the call he has just heard. Both the telephone and radio operators make a record of the call, check the car out of service on the record sheet, and move the small block on the board, representing that car, to the right.

The radio, I believe, has brought a new era to police work, and shows promise of even greater use.



Technical papers in recent issues of Radio Engineering

IN the monthly issues of RADIO ENGINEERING, June to December, 1931, the following technical papers were published. A few copies of each issue are still on hand.

July, 1931: The superheterodyne receiver; how chain features are broadcast; a study in radio transmission; vacuum tube life tests; Federal Radio Commission on radio power; short-wave interference with broadcast reception; gain and loss in communication circuits; a new 100-watt radio broadcasting transmitter; a new method of measuring vacuum tube characteristics; tube life measurements; the practical operation of a complete television system; a new modulation tube for television.

August, 1931: Noise generation within radio receivers; using short-wave adapters and converters; vacuum tubes and their applications; WHK introduces refinements into radio transmitting; push-pull arrangements of unusual character; radio power apparatus; standards of performance for commercial television receivers; selective reception in the broadcast frequencies; the design of a complete television system: transmission channels for television: an electrical hair trigger.

September, 1931: Hypersensitive detection systems: an analysis of the series type mixing control; television turns to projection; simplicity extends light-control possibilities: quartz oscillator wave constants; use of a vacuum tube operated relay to control blasting in radio receivers; synchronization of Westinghouse Ra-

dio Stations WBZ and WBZA; new photoelectric lighting control relay.

October, 1931: Factors in the selection of the proper radio power transformers; the tuned-circuit problem in c-w. receivers; radio tube yardsticks; television reception with the superheterodyne; series equivalent of a resistance paralleling a tuned circuit; modern manufacture of radio tubes; the "electric eye"; power keying with ordinary key and telephone relay; miniature radio transmitter for use in upper atmosphere; widening uses of small transformers.

November, 1931: The electric condenser; counteracting acoustic feedback through the tuning condenser; an amplification of a quadrillion times; details of Radio City; a neon

tube a-f. oscillator; attenuation measurements on telephone and telegraph lines; a new television system; broadcast station coverage surveys; grid circuit linear detection; radio reception from distant stations with receiver located close to powerful transmitter; recording characteristics of radio signals and static; modern fabrication of radio receivers and other like assemblies; radio transmitting hazard.

December, 1931: Choosing a s-g. tube; photoelectric relays; design and development of high-power oscillator or amplifier tube UV-862; wireless synchronization; difficulties of small broadcast stations and how to effect remedies; grid controlled vapor rectifiers.



Ship radio for river craft

CHARLES J. PANNILL, executive vice-president of the Radiomarine Corporation of America, has announced the completed installation of what is perhaps the Radiomarine Corporation's most unusual transmitting and receiving station for ship-to-shore radio, being the first high frequency station located on an island point for communication with river craft.

The station is situated at Blue Ash, twenty miles from Cincinnati, Ohio. High frequency transmitters and receivers have been installed on four towing vessels of the Mississippi Valley Barge Line Company, which operates a fleet of barges on the Ohio and Mis-

issippi Rivers between Cincinnati and New Orleans. The service is an innovation in inland waterways communication, as the power boats are the first river craft in the country to use high frequency equipment in keeping contact with their home office.

Radio is employed by the barge company on the rivers so that the home office may direct barges to points where cargo is available. It is used also to prevent unnecessary stops on the river for the purpose of obtaining contact with the home office, and for various other purposes. An increase of this type of radio service is expected.

The evolution of resistors used in radio

By H. G. CISIN

IN the early days of radio, resistors played a comparatively unimportant part. Variable resistors were used chiefly to regulate battery current. A few turns of wire of low resistance and small current-carrying capacity, were wound by hand around a piece of flexible insulating material. Sometimes even cardboard was used for this purpose. The wire was fastened to the insulator at each end and the unit was then bent into circular form and held in place by a "spider." Attached to the central shaft of the spider was a piece of spring steel, which served the purpose of making contact with the wire turns. The shaft was generally rotated by means of a knob.

These early devices were extremely crude, cumbersome and jerky in operation. Usually they were quite inaccurate and generally they were short-lived. However, they served their purpose,



Fig. 1. An early type of variable resistor, used to control filament voltage. Note the lack of protection from dust, dirt and moisture.

until new radio developments brought forth the need for more refined apparatus. The crystal sets of 1921 and 1922 were soon followed by one-tube sets, using a "peanut" tube and energized by dry cells. During this era, headphones sold for \$12 a pair and no one ever worried about volume controls. The main idea was to bring in the signal loud enough for it to be heard distinctly. Soon, larger tubes were introduced with filaments lighted by a storage battery. New circuits then made their appearance with surprising rapidity and before long, sets were being built using three tubes and capable of operating a loudspeaker.

The early types of variable resistors

▲
Improved resistors have been developed to meet the most exacting radio requirements

such as shown in Fig. 1, were no longer of use in coping with the requirements of the new circuits. There was an urgent need for a better variable resistor of perfected mechanical design and of high electrical efficiency. The newly-developed circuits required resistors of high ohmage, able to handle considerable amounts of energy.

With characteristic American ingenuity, resistors were promptly developed to take care of the new condition. Variable resistors were invented, which could be varied from practically zero resistance to 5 megohms, in not quite four turns of the knob. Despite its wide range, this resistor had a current-carrying capacity of over 200 milliamperes. It was small instead of bulky and entirely free from mechanical and electrical handicaps common to previous types of resistors. Instead of employing wire for the resistive material, an early type operated on an entirely different principle. Within a metal shell, a movable piston was moved back and forth by a micrometer screw, turned by the adjusting knob. The piston subjected the resistor material to more or less pressure, so that the resistance of the material varied.

New Receivers

As newer and better circuits were introduced, this variable resistor proved to be adaptable to a wide variety of uses. It was employed for eliminating distortion, for stabilizing tuned radio-frequency receivers, for controlling regeneration, for volume control, for grid leak variation, for power amplifiers, for "B" battery eliminators and in hundreds of other ways too numerous to mention.

It is indeed a tribute to the excellent design of the first units, that this identical compression principle is still in



Fig. 2. A standard compression-type resistor.

use at the present time, despite the revolutionary changes in radio receivers. Modern compression-type variable resistors are available in many different types. A standard model, Fig. 2, is a general variable resistor, used in "B" eliminators, standard radio receivers, low power transmitters, and in connection with television neon lamps. A power model, Fig. 3, is a heavy duty resistor, for radio power units, transmitters and general electrical applications. It is also used as a "C" bias control in auditorium receivers and for certain forms of line voltage controls. The super-power type is employed as a filament and plate control for transmitters, as a speed control for motors up



Fig. 3. Heavy duty compression-type resistor.

to ¼ h.p., as a field rheostat for generators and for line voltage control. Compression-type resistors find a wide field of application for controlling the speed of motion picture projection machines, of home talking picture projectors, etc.

Modern alternating-current receivers using screen-grid tubes, variable-mu tubes and pentodes have given the designers of variable resistors new problems with which to contend. This is especially true as regards volume controls. In the old days, it used to be a simple matter to shunt the secondary of a first stage audio transformer with a variable resistor in order to control volume. Then, the question of distortion was not of such importance. Now, however, there are over twenty-one different methods of volume control, each of which has its particular advantage, depending upon the type of circuit, kind of tubes employed, etc. The problem of tone control is also receiving considerable attention, sometimes calling for special variable resistors.

Wire-wound volume and tone controls of marvelous accuracy and compactness were designed to solve these new problems. The commercial production of these modern high resistance wire-wound controls is a subject of interest. To make these compact variable resistors, it was necessary to design and construct special machines, capable of winding the extremely fine resistance wire at high speed and without short-circuiting of turns.

Factory Progress

The writer was recently privileged to make a tour of inspection through the plant of the Clarostat Manufacturing Company, of Brooklyn, N. Y. and was amazed at the progress which has been made both in machinery and methods, since the old days of hand and lathe winding.

This organization, when confronted with the demand for compact volume controls of high resistance, found that it was impossible to purchase winding machines which could turn out satisfactory work. Research engineers thereupon tackled this difficult job and developed apparatus. Some of the resulting winding machines are almost uncanny in their operation. They handle wire thinner than a human hair, winding it back and forth around straight or tapered bakelite strips. The wire is wound at high speed—several thousand turns per minute—and without breakage. The most marvelous feature of these machines is the fact that they wind the wire with absolute precision. Bare wire is used, sometimes being wound 550 turns to the inch, and still each turn is well insulated from the adjacent one. The writer examined a completed resistance strip under the microscope. The wire on this strip was wound so close that it looked almost like a solid piece of metal to the naked eye. Under the microscope, each turn could be observed exactly parallel to the next one and well separated, with no possibility of short circuiting. Here, in the factory, row upon row of these wonderful machines perform the difficult task automatically, merely requiring an operator to start and stop the mechanism. Incidentally, the wire is not wound loosely, but is so tight that it grips the bakelite strip firmly and cannot be pushed out of place. As a result, there is no appreciable wear, even after 50,000 complete turns of the slider over the edge of the strip.

Process of Manufacture

The assembly of the completed wire-wound strip within the bakelite shell, is also a very interesting process. The three terminal contacts on the shell are riveted in place. The two ends of the



Fig. 4. Wire-wound volume control with enclosed switch.

wire-wound strip are clamped securely to the outer terminals, thus eliminating the use of solder, while insuring an absolutely solid and permanent electrical connection. The slider connects to the center terminal, this connection being made secure by riveting. By means of a novel design, the sliding arm is well insulated from the shaft which carries the knob. The bushing at the base of the shaft is fastened to the outside of the shell by means of a special machine which turns the nut up so tight that it cannot be loosened without breaking the bakelite. These and many other refinements, result in the production of a wire-wound volume control which cannot be excelled in accuracy, compactness, nor in lasting qualities.

In the accompanying illustration, Fig. 4, a typical modern wire-wound volume control is shown. This is one of the P-18 models with built-in 110 volt "on" and "off" switch. The casing is of bakelite with metal and caps. The older type wire-wound volume control used an external toggle-switch. The newer enclosed type has many advantages. By combining volume control and switch in the one casing, it is possible to make the entire unit more compact. Moreover, there is freedom from dust, dirt,



Fig. 5. New dual control coupling arrangement eliminates all chance for lost motion between elements.

and moisture, thus eliminating a prolific source of noise, often present when the mechanism is exposed. Wire-wound volume controls are available in straight-line resistance windings up to 50,000 ohms. For special applications, the windings may be tapered as desired, but the total resistance per unit is then limited to about 30,000 ohms. In these wire-wound units, the movable contacts are designed for smooth, velvety adjustment, with negligible wear and silent operation.

Special wire-wound controls are arranged for constant impedance work. In radio and sound equipment and also in telephone line circuits, either dual or triple unit controls may be required. A recent model dual unit control is illustrated in Fig. 5. Real windings are necessary for constant impedance control, because of the low resistance used and also because all units on one shaft must change uniformly.

Fig. 6 shows the arrangement of a fader. The fader is used principally as a changeover switching device for absolutely quiet, clickless control of two input circuits to a succeeding amplifier. Electrically, the fader consists of a

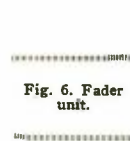

Fig. 6. Fader unit.

potentiometer with a tap in the center of the resistance element.

Wire-wound controls have been developed especially for use in connection with the variable- μ screen-grid tubes. With these tubes, complete control is possible without distortion or cross-talk, by the simple method of controlling the "C" bias of either one or two of the tubes. Because the volume control potentiometer is a part of the voltage divider and must carry considerable current, a wire-wound unit must be used. Engineers have devised a special unit, which consists essentially of a combination of a fixed and a variable resistor. The fixed resistor has a voltage drop of 3 volts. This is always in the circuit and is used so that it is possible to get zero "C" bias. The variable resistor is arranged so that there is a voltage drop of from 30 to 40 volts across it.

Mechanically, the variable and the fixed resistors in the new control, both consist of a single winding on the same bakelite strip. The rotating contact, however, is arranged with a "stop," which prevents it from completing its travel. As a result, a certain definite fixed resistance is always in the circuit.

Although wire-wound volume controls can be used in a number of circuits, certain circuits require special tapers or extra high resistance ranges beyond the possibilities of an all-wire unit.

TELEPHONE REPLACING TELEGRAPH FOR RAILROAD COMMUNICATION

USE of the telephone as a means of regulating the movements of trains daily is increasing, while use of the telegraph is decreasing, according to the American Railway Association.

Reports received from the railroads show that on January 1, 1931, telephones were used for the transmission of train orders over 154,075 miles of road, compared with 99,047 miles which continue the use of the telegraph.

The extent of the increase in the use of the telephone for the transmission of train orders is shown by the fact that on January 1, 1920, the miles of road on which the telephone was used totaled 119,554. On the same date, the telegraph was being used on 134,667 miles of road.

SPEED TRIPLE-TWIN

*a master achievement
from the
Speed Laboratories*

The SPEED "TRIPLE-TWIN," a combination power output and detector tube, far surpasses all recent developments and is comparable in importance only to the invention of the vacuum tube itself.

Its features are outstanding:

- Triple the 245's output and double the 247's without increased plate voltages.
- One "Triple-Twin" supplants complete DETECTOR and AUDIO System.
- Super sensitivity allows elimination of pre-stages in special applications.
- Flat frequency response, 30 to 50,000 cycles. A boon to television.
- Economy in chassis construction.

Complete engineering data available

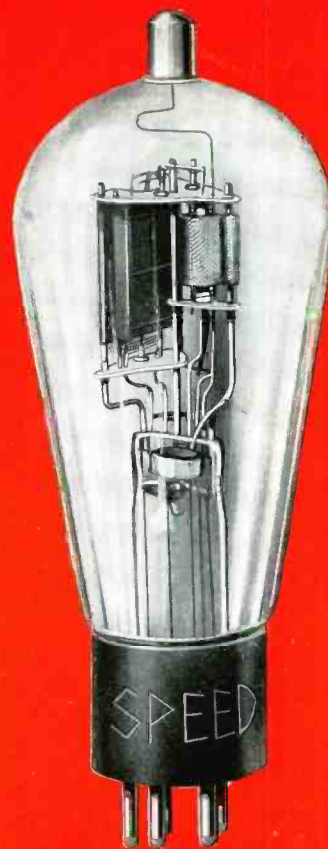

Applications

- Radio Broadcast Receivers
- Special Receivers (Army, Navy, Police, Aircraft)
- Television
- Sound Projectors and Recorders
- Theatre Sound Equipment
- Public Address Systems
- Centralized Radio
- Carrier Current Systems
- Communication Repeater Systems
- Broadcast Transmitters
- Automatic Phonographs
- Industrial Applications

CABLE RADIO TUBE CORP.

**230 North Ninth Street
BROOKLYN, N. Y.**

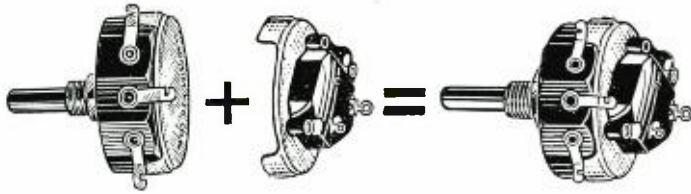

Something New *to think about*

THE AD-A-SWITCH is a new control made up in the general style of the now famous wire wound potentiometer with the added feature that a switch may be slipped on any of them without the use of tools.

THE AD-A-SWITCH arrangement enables one to simplify line-up of his stock of volume controls to a point where duplication of resistance controls carried in stock is no longer necessary. Any AD-A-SWITCH VOLUME CONTROL without switch can be converted instantly into a complete unit with switch by simply replacing the usual dust cap with this special snap-on switch.

THE NEW CIRCULAR HUM-DINGER

New Type MH Circular HUM-DINGERS (midget potentiometers) are designed especially for manufacturers and quantity users. 1 1/8 inch in diameter, they only project 3/16 of an inch behind the panel. Made in all values up to 1000 ohms and with movable arm terminal grounded to or insulated from the frame.



CLAROSTAT MFG. CO. I N C.

285 NORTH 6th STREET

BROOKLYN, N. Y.



CLAROSTAT MFG. CO.
285 N. 6th St., Brooklyn, N. Y.

Gentlemen:

Kindly send your new catalogue to me. There will be no charge.

NAME

ADDRESS



Portable beacon transmitter for the army

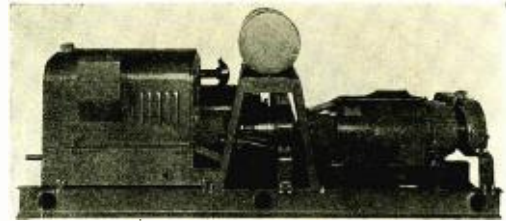

Electrical equipment of a portable beacon for airways.

THE Aeronautical Division of the U. S. Army has purchased a portable visual and aural radio beacon. This beacon is part of the Air Corps' extension experimental program to perfect equipment for safe blind landing.

The portable apparatus will operate in conjunction with the main beacon which will locate the airport to the pilot while the portable unit will locate the runway. The portability of the equipment permits the choice of the best runway for the conditions at the field at the time of the arrival of the plane.

The transmitters, loop assembly and the gas engine generator unit are to be located on one truck, the power plant near the front. The transmitter and the loops will extend from the rear with the position of the loops so that when driving the truck into the wind the position of the radio beam will be right for landing into the wind.

The transmitter is capable of sending out signals for use with either the aural or visual type of beacon receiver. For the aural type, a 720 cycle tone modulation is placed on the carrier. The output to one loop is keyed to send out the letter "A"—and the other loop is keyed to send out the letter "N"—. Other suitable characters may also be used by changing the keying unit. The time relation between the two characters is such that if the plane is on the course the two characters interlock and only a long dash is heard. Position to the right or left of the beam gives a signal in which one of the characters predominates.

On the visual type of transmission, the carrier of one loop is modulated with 65 cycles and the carrier of the other loop modulated with 86 2/3 cycles. If the plane is on the course, the two signal strengths are equal and if the output of the beacon receiver is applied to a reed indicator, both reeds show the same amplitude of vibration. If to one side or the other of the course, the amplitude of vibration of one reed is greater than the other and indicates which side the plane is off the course. In some cases direct reading instru-

ments are used instead of the reed indicator.

The transmitter, rated at 100 watts per loop over a frequency range of 225 to 375 kc., is mounted on a single spring supported frame to protect it against shock during transportation. Tests have indicated that a range of 15 to 25 miles may be expected.

The circuit used is of the master oscillator double intermediate amplifier double power amplifier type with a phase shifter between the master oscillator and the two intermediate amplifiers. The master oscillator may be adjusted to give the desired frequency. The output of the master oscillator is fed into a phase shifter which splits the master oscillator output into two equal parts of the same frequency but displaced 90 degrees time phase from each other. These two outputs in quadrature time phase are individually amplified successively by an intermediate amplifier and a power amplifier. The results are that there are two radio frequency outputs each of the same frequency and same power level but in quadrature time phase.

These two outputs are put on two loops at right angles to each other, giving a rotating field carrier (a carrier having equal signal strength in all directions) and two figure eight stationary sidebands giving a four course beacon. If the phase shifter is shorted out, the two radio frequency outputs are in phase giving a figure eight carrier and a resultant two course beacon. Links are provided on the transmitter for shorting out the phase shifter.

The loops are collapsible and made of treated maple, mycalex insulated. They are mounted very close to the transmitter and are made a part of the power amplifier tank circuits to eliminate need for coupling circuit and additional tuning circuit. This increases the efficiency slightly and simplifies the control. To minimize coupling between the two loops, the leads between loops and transmitter are transposed at intervals.

The complete power supply for the transmitter for either aural or visual type of beacon is obtained from the

gasoline engine generator unit, consisting of an engine and six generators. The engine is 10 h.p., 4 cylinder, 4 cycle, 1800 r.p.m., water cooled, equipped with a mechanical governor for speed control. Coupled to the engine through a Falk spring type flexible coupling is a 500 watt, 110 volt exciter and a 750 watt, 2500 volt plate generator. Just back of the coupling is a link belt chain drive which drives a 300 watt, 110 volt, 1 phase, 65 cycle and a 300 watt, 110 volt, 1 phase, 86 2/3 cycle generators at 1300 r.p.m. At the other end of the coupled generator is another link belt chain drive which drives a 300 watt, 10 volt filament generator and a 400 watt, 110 volt, 1 phase, 720 cycle a-c generator at 3600 r.p.m. These changes in speeds were necessary in order to obtain the proper frequencies.

The approximate weights are: transmitter 350 pounds, engine generator 1100 pounds, and the portable loops 250 pounds.

This equipment was designed and developed by the Westinghouse Electric and Manufacturing Company. In addition this company has developed a universal beacon receiver for use with this type of equipment and is designed to receive signals from an aural type beacon, a visual type beacon, and will also receive telegraphic or telephonic messages.

RADIO EXPORTERS HOLD CONFERENCE

TARIFF reciprocity is favored by radio exporters of the RMA, according to a resolution adopted at a largely attended meeting at the Hotel Astor, New York, January 12. About sixty radio export managers and representatives were in attendance and discussed many problems to develop export trade of association members. Arthur Moss of New York, chairman of the RMA foreign trade committee, arranged the conference and presided. Among those present were A. M. Dettloff, representing the U. S. Department of Commerce, and representatives of American export associations.

RADIO WAVELENGTHS AND THEIR UTILITY

Wavelength	Day Miles	Night Miles
13-21.2 meters	7000	not useful at night
24.4-25.6 meters ..	4000	over 5000
27.3-31.6 meters ..	2500	over 5000
31.6-35.1 meters ..	1500	over 5000
41.2-45 meters	1000	over 5000
48.8-50 meters	600	over 5000
54.5-75 meters	450	2500
75-85.7 meters	300	1000
109-133 meters	150	500
150-200 meters	100	250

The distances are based on observations made with a one kilowatt continuous wave code transmitter and a moderately sensitive receiver.

The advantage of short waves is evident. The advantage of using wavelengths of from 13 to 21.2 meters for daylight work is especially evident.

The long-wave channels are badly overcrowded and new ones are needed. Television, police, amateur phone, commercial and amateur code, and radiophone broadcasting stations are being assigned positions in the short-wave spectrum.

OVERSEAS TELEPHONE SERVICE EXTENDED TO HAWAIIAN ISLANDS

Hawaii and the North American mainland were linked by regular telephone service on December 23. The new service interconnects all Bell and Bell-connecting telephones in the United States, Canada, Cuba and Mexico with those in the principal islands of the archipelago. It marks the first time that the United States and one of its outlying dependencies have been joined by direct voice communication.

A novel type of antenna will be employed at the American radio stations. This is known as the horizontal Double-V, a highly directive antenna. Consisting merely of a pair of wires strung in the form of a diamond from wooden poles, this antenna effectively bridges the 2,500 mile gap between San Francisco and the islands. A maximum power of 60 kilowatts is used in transmitting from this antenna.

San Francisco will be the center for service to and from points in North America. The American transmitting station is at Dixon, Calif., 20 miles southwest of Sacramento and the receiving station at Point Reyes, 35 miles north of San Francisco. These are operated by the Transpacific Communication Co., Ltd., a subsidiary of the A. T. and T. Company. Dixon will transmit to a station at Koko Head, 12 miles from Honolulu and Point Reyes will receive from a station at Kahuku Point, 30 miles from that city. The lat-

ter stations will be operated by the Radio Corporation of America. Through the headquarters of the Mutual Telephone Company of Hawaii in Honolulu the service will embrace all telephones in that company, those on other islands being linked by an inter-island short wave radio system. The cost of a call between San Francisco and Honolulu will be \$21 for the first three minutes and \$7 for each additional minute.

AN EFFICIENT BATTERY OPERATED RECEIVER

(Concluded from page 24)

per cent. If the output is reduced to a rather low volume, the total power input will decrease to perhaps 2.5 watts, which would reduce the efficiency, but at the same time the plate battery drain is less. It is also interesting to note that a pilot lamp was omitted from this receiver because a lamp of sufficient candle power to be of service would require approximately the same power as the combined power required by all the filaments in the receiver. As a matter of comparison of the power efficiency as given above, the efficiency of the average a-c. receiver using two 245 tubes for output is about 3 per cent when calculated in the same manner as above.

The foregoing figures of power requirements are given to indicate how efficiently the small, general purpose 2-volt battery tube performs when operated as a class "B" output amplifier. The other tubes in the set perform equally well when associated with the circuit as shown so that the sensitivity and selectivity of the receiver is in the class with the best a-c. operated receivers. The relatively high power output and the low battery drain from the filament and plate batteries permits a person in localities without a-c. power to get radio receiver performance that compares favorably with that of his city friends at an operating cost that is less than twice the cost for power to operate an a-c. set. The receiver described should be very popular in rural districts and summer cottages where a-c. power is not available and also in the d-c. districts of larger cities. This receiver should also provide exceptional satisfaction to the distance fans who are somewhat removed from man-made interference.

NEW USES OF NICKEL AND NICKEL ALLOYS

Nickel Alloys in Thermionic Valves

A nickel-silicon or nickel-silicon-manganese alloy is found to have the physical and chemical properties required for use in the metallic elements of thermionic valves. Chromium, aluminum and tungsten may also be present in small quantities.—A. J. Mandell—

"Improvements in Alloys for Use as the Metallic Elements in Vacuum Tubes." French Pat. 708616.

Nickel in Thermionic Valves

Electron emission material, consisting of a homogeneous body comprising nickel, titanium, and one or more of the alkaline earth oxides.—Canadian Westinghouse Co., Ltd., assignee of G. P. Halliwell.—*"Thermionic Cathode."* Can. Pat. 313745.

Nickel-Mercury Compounds for Use in Thermionic Valves

Mercury is introduced into electron-discharge tubes in the form of a solid compound of mercury mixed with powdered iron or nickel, which is vaporized with the aid of appropriate reducers.—Allgemeine Elektrizitäts Gesellschaft.—*"Process for the Introduction of Mercury into Electronic Discharge Tubes."* French Pat. 700877.

Manufacture of Nickel-Iron Cores for Power Transformers

Laminated cores are made from nickel-iron alloy sheet (e. g., 46/54 per cent.), cooled and rolled at controlled rates and temperatures, and in non-oxidizing atmospheres.—British Thomson-Houston Co., Ltd., assignee of W. E. Ruder.—*"Improvements in and Relating to Magnetic Material."* Brit. Pat. Appln. 16913 of 1931.

Nickel Alloy Cores for Transformers

Low power transformers, which are claimed to produce and maintain a constant energy independent of the normal fluctuation in supply or primary voltage, are made with cores of materials showing high permeability and low saturation, e. g., Monel metal, nickel-iron alloys or nickel containing small amounts of cobalt, iron, manganese, copper, silicon and carbon.—S. A. Mudge and C. G. Bieber.—*"Transformer."* U. S. Pat. 1806408.

STOCK OF REPLACEMENT PARTS

A useful stock of radio receiver replacement parts includes the following resistor, capacitor and grid leak units:

Fixed capacitors, .0001, .001, .006, .00025, .01, .5, and 1.0 mfd.
Carbon resistors, 500, 700, 800, 1,000 and 2,000 ohms.

Variable wound resistors, 2,000, 5,000, 10,000, 25,000, 50,000 and 100,000 ohms.

Wire wound resistors, 1,000, 2,000, 3,000, 5,000, 7,500 and 10,000 ohms.

Grid leaks, .1, .25, .5, 1.0, 2.0, 3.0, 5.0 and 10 megohms.

Two sets of elements in one tube

By C. F. STROMEYER*

THE Triple-Twin tube and circuit introduce a system for utilizing the positive region of the grid voltage-plate current characteristic as well as the usual negative portion. This method produces a relatively high undistorted power output independent of grid current flow. A further advantage is gained by employing the tube as a combination detector and amplifier.

Efficiency Comparisons

In reviewing efficiency comparisons of output tubes, the ratio of a-c. power to d-c. plate dissipation should not be the only consideration. If the sensitivity of one tube is high enough to eliminate a stage or stages, the effective efficiency becomes greater. Due to the high overall sensitivity of the Triple-Twin, the useful efficiency becomes very appreciable.

The theoretical efficiency of a perfect output tube is fifty per cent. Triodes are slightly less than twenty per cent, chiefly because the input signal is confined to the negative portion of the Eg-Ip characteristic due to grid current limitation. Pentodes should be much better but the auxiliary grid consumes energy and the ratio of the internal impedance to the load is far from unity. This latter condition is necessary to prevent excessive distortion and, consequently, the power transfer is poor. Pentode efficiency ranges between twenty and thirty per cent. The power grid of Triple-Twins operates practically at zero bias which allows the signal to swing equally positive and negative. Their power transfer is excellent as their load for minimum distortion almost equals their internal impedance. They have an efficiency of thirty to forty per cent. These ratings are important in large amplifiers and for d-c. applications.

Fundamental Circuit

The fundamental circuit is given in Fig. 1. The tube contains two sets of three elements; the first set handles the input, and the second, the output. The object of the input section is to always have a high input impedance and output characteristics that will supply the power demanded by the power grid. This section employs an indirectly heated cathode in order to electrically isolate itself from its heater and the output filament. This cathode is internally connected to the output grid.

The input of the first section is similar to usual operation, as this grid does not take current, but it differs in that the

*Chief research engineer, Cable Radio Tube Corp.

By virtue of direct coupling this new tube is reported to be practicable for usual receiver purposes.

cathode is above ground potential. This means that the applied signal voltage is likewise above ground potential. The signal reaches the cathode through a small condenser offering a low impedance to the incoming signal. The grid receives its bias by the d-c. drop in the load impedance of the first section and the IR drop in the resistance. The d-c. return path to this grid is through a resistance. It is significant that the load impedance of the first section exists between cathode and ground and is substantially the combined parallel value of the resistance and the input grid impedance of the second section. The inductance is shunted across this combination but its impedance is high, except at low

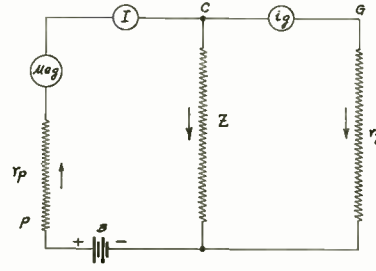

Fig. 2. Equivalent circuit.

frequencies, compared to the other values, and its function is to allow a low d-c. resistance path for grid and plate returns. Its d-c. component also augments the voltage drop but the effect is negligible as the resistance of its winding is small.

Theory of Operation

The simplified equivalent circuit given in Fig. 2 is useful in analyzing the Triple-Twin. (meg and r_p) represent the generator action and internal impedance of the input section. Its grid action is eliminated as it has no bearing on the compensation analysis. The effective load impedance offered by r_c and r_g is represented by Z . r_k is the grid impedance of the second section.

The problem, simply stated, is to find a method of securing a voltage across a varying load which is not affected by the change in load value. It is apparent that when the grid of the second section swings positive, and therefore draws current, its impedance cannot be considered constant, but some function of the positive cycle of the voltage developed between cathode and ground. Consequently, r_k is a varying value which in effect, when combined with Z offers a varying load to the plate characteristics of the input section.

Fig. 4 graphically demonstrates how the changing load reflects on the plate characteristics. This condition is shown only to the left of the operating point. This is because the pulsating voltage developed across Z , with the negative terminal of the plate battery as a reference point, is in

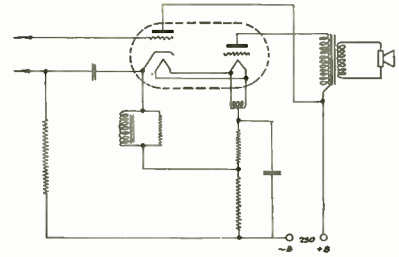

Fig. 1. Fundamental circuit.

phase with the original applied signal. In ordinary circuits where the load exists between plate and B+, the voltage is 180° out of phase with the applied signal. This phase relation in the Triple-Twin circuit is most interesting because, if the two voltages were out of phase, the changing load would exist to the right of the operating point and, therefore, no advantage could be obtained in working into curvature and non-parallelism of the plate characteristics. It is understood that the varying load only exists when the grid is positive. When negative, its impedance is so high that it may be neglected.

From the intersection of the load lines with the curves, a dynamic Eg-Ip curve may be plotted, as in Fig. 3. When the applied sinusoidal signal is negative, the load impedance is constant. The negative half of the current produced by the signal is shown as usual. During the positive half of the cycle, the load is changing, producing a positive peak of current greater than the negative. Now if the tube is designed such that the currents shown in the "equivalent circuit" satisfy this relation $(\Delta I - \Delta I_g) = 0$, there will be no current change through Z caused by the addition of r_k . Consequently, the voltage across Z will be independent of grid current. The arrangement is not a so-called matched device because the current demanded by the grid controls the slope of the positive load line. This line approaches the ordinate and its rate is a function of the magnitude of the positive cycle. It can be justly called a self-compensating device.

The grid current peak is shown as part of a sinusoid. In reality, the non-linear shape of the Eg-Ig characteristic alters this form, but the compensation also nearly assumes this irregular shape. The grid current is in the form of a pulsating half wave as signal frequency. The spreading and curvature of the plate characteristics are in the right direction to establish full grid current compensation. From the foregoing analysis, it is evident that the grid bias is

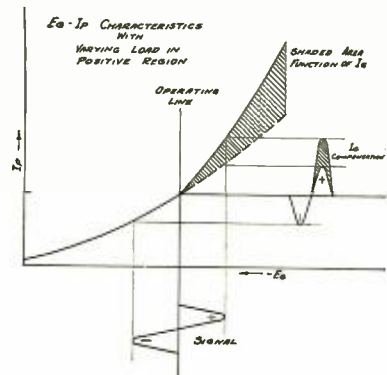

Fig. 3. Eg-Ig curve.

not a function of grid current and therefore remains steady.

Load Impedance

The output of the second section is not entirely the same as a usual power triode. Consideration of the output load impedance involves the curvatures of the output plate characteristics. Near the negative cutoff region the "fanning" is, as usual, appreciable. Near the maximum positive region, they appear the same but just diagonally opposite, as illustrated in Fig. 5.

This latter phenomenon is somewhat complicated, but it is chiefly caused by the crowding effect of the electrons arriving at the grid and the space charge produced by grid secondary electrons. If both curvature and non-parallelism are equal, but one set diagonally opposite and the axis of a load line approximately on zero grid, the extremities may extend equally into these regions. Therefore, the proper load for minimum distortion may be equal to the internal impedance which also permits maximum power transfer. The output and distortion characteristics as a function of load impedance approach an ideal condition. The high frequency power losses caused by increased impedance of the dynamic speaker

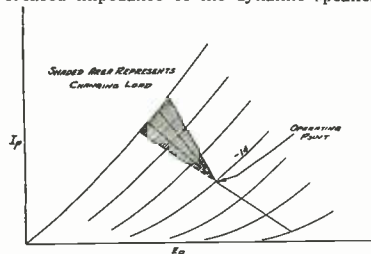

Fig. 4. Typical input plate characteristics.

AUTO RADIO

At the Automobile Show in New York in January a feature which attracted a great deal of attention in certain new car models on display was the RCA-Victor superheterodyne receiver model M-30.

In this receiver automatic volume control is provided to compensate for the variations of input signal intensities to which a radio receiver is so severely subjected in a moving vehicle. The volume may be adjusted to the desired level by manual control and the automatic volume control circuit will maintain this level automatically, subsequent fluctuations in field strength serving to vary the receiver amplification.

The chassis is completely enclosed in a sheet metal housing designed to be quickly removable from the vehicle for servicing. The housing is attached to the mounting bracket by means of two projecting lugs and a simple locking screw. The mounting bracket, however, is securely fastened to the car by the attached studs. A convenient location for this unit, in the majority of automobile installations, will probably be upon the fire wall behind the dashboard. Overall dimensions of the chassis housing are 11¼ inches x 6 inches x 8¾ inches high.

The control unit contains a key-operated power switch for turning the set on and off, the station selector control and the volume control. The unit is designed for convenient clamping to the steering column of the automotive vehicle. The station

selector dial, which is calibrated in frequency, is illuminated to permit easy tuning and to indicate when the set is ready for operation. Tuning of the receiver is effected through the medium of a flexible drive shaft, 30 inches in length, which extends from the control unit for connection to the chassis.

Frequency Response

The fidelity of the Triple-Twin is good. The frequency-impedance characteristic of the coupling choke is not important because of the relatively low shunt resistance. The impedance of the choke is only effective at very low frequencies. Even at the high frequencies used in television, the curve is flat as the distributed capacity of the choke is no appreciable shunt to the resistance.

Power Sensitivity

The power sensitivity is high due to the no-loss effects in direct coupling, and the high gain in both the input and output sections. The effective grid area of the output section may be large, as the plate current is not limited by a strong negative field. This allows high amplification with a low plate impedance. The usual problem when employing high gain tubes, that of eliminating grid to plate coupling, becomes small as the high overall gain is divided between the two sections. For the first section, the value of the by-pass condenser is small. Although the gain in the last section is greater than a power triode, the bias resistance value is less. Consequently, the capacity for effective by-passing can be directly compared with triode operation.

Other Systems

A brief resume of the failure of usual coupling methods to prevent distortion caused by grid current follows:

In resistance and impedance amplifiers, the grid current establishes an IR drop which changes the bias. This alters the

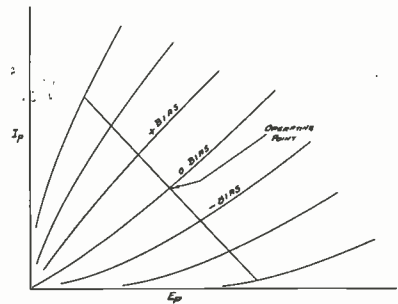

Fig. 5. Typical output plate characteristics.

output characteristic only during that part of the cycle when grid current flows, causing distortion. This varying grid impedance does not reflect a pure changing load to the preceding tube. The system is not the same as in an ordinary impedance-condenser output device, because the reflected load is not altered completely for any one impressed cycle but the change exists during only part of that cycle. The phase shifting of the coupling condenser distorts the wave form and establishes a peculiar path for the currents through the coupling units. The limitations of the circuit, therefore, prevent almost any compensation.

Even if the changing load were reflected on the plate characteristics of the driving tube, the phase relation would be opposite to the Triple-Twin theory. Transformer coupling action is simpler (as the phase relation is satisfactory) but again the bias shifts and the changing load is not fully reflected on the driving tube. This latter effect is due to leakage reactance and the no-load—load characteristic of the transformer.



selector dial, which is calibrated in frequency, is illuminated to permit easy tuning and to indicate when the set is ready for operation. Tuning of the receiver is effected through the medium of a flexible drive shaft, 30 inches in length, which extends from the control unit for connection to the chassis.

The loudspeaker is a recent RCA-Victor development. This unit is known as the permanent field dynamic loudspeaker, employing the same "moving coil" construction common to the conventional electrodynamic type of speaker. The magnetic field, however, is produced by means of a strong permanent magnet which replaces the usual electromagnet.



SENTINEL APPOINTS DUNN ASSISTANT CHIEF ENGINEER

Following the recent appointment of Robert M. Arnold as chief engineer comes the announcement from John T. Beatty, president of the United Air Cleaner Corp., Chicago, manufacturer of Sentinel radio receiving sets, of the appointment of William L. Dunn as assistant chief engineer.

Mr. Dunn brings to the Sentinel organization an extensive experience in radio engineering and the production of commercial equipment. Until recently he was chief engineer of the Sprague Specialties Co., prior to which he was chief engineer of the Colonial Radio Corp. and Charles Freshman, Inc. He received his technical education at the University of Michigan

and the University of North Carolina, following which he took special work in the physics department of Johns Hopkins University, graduating during that period.

The appointment of Mr. Arnold and Mr. Dunn and that of Leonard Tulauskas as research engineer, together with a large staff of assistants, gives the Sentinel organization one of the most capable and well-balanced engineering departments in the radio industry.



APPOINTS SALES REPRESENTATIVES

American Transformer Company, Newark, N. J., has announced the appointment of two district sales representatives. Edgar M. Moore Company, Farmers Bank Building, Pittsburgh, Pa., will handle sales of AmerTran industrial transformers in western Pennsylvania, southern Ohio, and West Virginia. Theodore F. Mueller 3-260 General Motors Building, Detroit, Michigan, will handle sales of all AmerTran products in the entire state of Michigan with the exception of the upper peninsula.



A NEW 3/8 H.P. MOTOR

An advanced type of 110 volt, 50-60 cycle motor for driving turn tables and for recording machines has been brought out by Robert Helmer, 4238 - 160th St., Flushing, L. I., New York.

The new motor has direct drive and no gears; operates without waver, and is accurate to 54 times that of the control frequency.

NEWS OF THE INDUSTRY

HAMMARLUND ACTIVITY

The Hammarlund Mfg. Co., 424 W. 33d Street, New York City, reports unusual activity for this season of the year with extremely large demands for their variable condensers for short-wave and all-wave receivers. Joseph Lush, general manager, reports that over-time shifts are being employed and that there is an increased demand for Hammarlund products.

This line includes the Hammarlund midget condenser for airplane and automobile receivers and short-wave receivers, and the Hammarlund condenser for tuning intermediate transformers made in three ranges, single or double models,—10-70 mmfds.—70-140 mmfds.—140-220 mmfds.

It is stated that data on several new products will be issued by this company within the next few weeks.

SORENG-MANEGOLD MOVES

The Soreng-Manegold Company has established new headquarters at 1901-09 Clyborn Avenue, Lincoln Park, Chicago, Illinois. The company manufactures a line of volume controls, potentiometers and fixed resistors.

ERIE RESISTORS IN ENGLAND

A new plant to manufacture Erie resistors has been established in London, England. This plant is a unit of the Erie Resistor Corporation of Erie, Pa., and production has already begun on the moulded type Erie resistor which has become so well known in the United States and Canada.

The London plant located at Waterloo Road, Cricklewood NW 2 will be in charge of Rod. Weise, managing director.

W. H. Fryling, sales manager of the Erie Resistor Corporation says, "In 1931 we enjoyed the greatest sales volume in history. We are looking forward to even greater business in 1932."

NATIONAL UNION TO WITHDRAW OSCILLATOR OFFER FEBRUARY 15

H. A. Hutchins, general sales manager of the National Union Radio Corporation, has announced that as of February 15, 1932, his company would withdraw their offer of a free oscillator and output meter for retail merchants.

Mr. Hutchins revealed that the terms of the National Union offer made it possible for every radio dealer to possess an oscillator, without incurring any expense. The plan incorporates in its terms a small deposit and the purchase of 150 National Union tubes during the course of one year, after which the deposit is rebated to the dealer in the form of a merchandise credit. At the termination of the contract, the retailer is presented with a bill of sale, giving him full possession of the meter equipment.

It is Hutchins' advice that any dealer who wishes to take advantage of the offer

before its expiration date on February 15, should communicate with the National Union Radio Corporation at its New York offices or with a local National Union distributor.

MARK TIME SWITCHES

Word comes from M. H. Rhodes, Inc., American Industrial Building, Hartford, Conn., that A. B. Ayers has been appointed sales promotion manager of that company.

For the past year the company has been developing and perfecting a special line of Mark-Time switches for radio and elec-



A. B. AYERS

trical appliance manufacturers. The new line, embracing twenty models, is now in volume production and will be merchandised aggressively to the radio trade.

SYNTHANE CORPORATION

S. W. Place, formerly with the Atwater Kent design laboratories, is now connected with the research department of Synthane Corporation, Oaks, Pa., manufacturers of Synthane laminated bakelite, sheets, rods, tubes, fabricated parts and stabilized gears.

Mr. Place has had a wide experience in design of high-frequency circuits. His experience with and knowledge of insulation together with his thorough understanding of the problems of the radio and electrical fields further extends the research facilities of Synthane Corporation that are available to customers and other manufacturers.

The corporation has appointed Industrial

Products Sales Corporation, 7307 Natural Bridge Road, St. Louis, Mo., as sales representatives for St. Louis and the surrounding territory.

Synthane Corporation also maintains representatives in Philadelphia, New York, Cleveland, Chicago, Boston, Detroit, New Orleans, Atlanta, Minneapolis, Los Angeles, San Francisco, Dayton and Pittsburgh.

POWER TRANSFORMER CO.

The Power Transformer Co., 36 East 22d St., New York, N. Y., has moved to the above location from their former location at 145 West 22d St., where they have conducted a successful manufacturing business in coils, resistors and transformers.

DIE CASTING

The Doehler Die Casting Company, 386 4th Ave., New York, has purchased from the National Lead Company all equipment, inventories and good-will of the Newton Die Casting Corporation of New Haven, Conn. Most of the equipment will be moved to the Doehler Plant at Pottstown, Pa., but the Newton customers will be served by any one of the five Doehler plants most conveniently located.

This is the second acquirement of a competitor by Doehler within a short time. The previous one was the die-casting division of the Bohn Aluminum and Brass Corporation.

By the purchase of the Newton Die Casting Corporation, the National Lead Company becomes a substantial Doehler stockholder. The National Lead Company will be represented on the Doehler board of directors.

RECEIVER AND AMPLIFIER ACCESSORIES

One of the most useful bulletins published within a year has just been put out by Electrad, Inc., 175 Varick St., New York. The bulletin gives engineering, manufacturing and service data on volume controls, voltage dividers, vitreous resistors, adjustable resistors, and other devices.

ADDITIONS TO HARDWICK, HINDLE SALES ORGANIZATION

Changes in the sales organization of Hardwick, Hindle, Inc., 215 Emmet St., Newark, N. J., made recently are as follows: Dormand S. Hill and Associates, Michigan-Ohio Bldg., Chicago, Ill., are to act as exclusive sales representatives for the State of Illinois and northern Indiana. Joseph Esherick, who is located in the Otis Bldg., Philadelphia, Penna., has been given eastern portion of Pennsylvania, southern New Jersey and the State of Delaware. On the Pacific Coast, Brad Squires, Inc., who maintain offices at Oakland and Los Angeles, Cal., will handle sales for the entire State of California.



A NEW VARNISH-SATURATED SLEEVING

With reference to the new sleeving brought out by the William Brand Company, 268 Fourth Ave., New York, information from the company reads:

"After three years of experimental work we have perfected this semi-soft varnish-saturated sleeving and are offering it to manufacturers for radio and motor leads and other electrical work where high voltages are not encountered. It replaces untreated sleeving and permits a rigid form of insulation and lead wires, etc., allowing assemblies in places where soft sleeving offers considerable difficulty. It will always remain perfectly round, and retains its resiliency. Does not fray or ravel when cut in smallest lengths.

"This sleeving will withstand 1700 volts breakdown test, which is the highest of any sleeving subjected. It is especially recommended for lead work, sub-panel radio assemblies, and small instrument work."

RESISTOR INSULATION

An innovation in the resistor field has been developed by the Precision Resistor Company of 113-115 Frelinghuysen Ave., Newark, N. J. Their new process of multiple baked enamel insulation used in their Precision type wire-wound, high resistance and porcelain tube high wattage units, has overcome faulty insulation heretofore common with the average resistor unit. Insulation being the vital factor governing the dependability and permanency of resistors, this improved unit, fills a long felt want in the electronic and radio fields



by its assurance of permanent, trouble-free service. It is now possible, with this new multiple insulation, to increase the voltage rating of these units, and still have a large margin of safety. There is a Precision unit for every purpose. Standard units in 1, 2, 5 and 10-watt ratings or to specifications.

TOPHET "A"

Tophet "A" is an essentially iron-free nickel chromium alloy containing 20 per cent chromium. The manufacture of this alloy is carefully controlled at all stages, thereby insuring uniformity of its physical and mechanical properties. It is non-magnetic.

It represents the utmost in efficiency, for heating elements for all purposes. It is especially recommended for use in electric furnaces, toasters, ranges, grills, radiant heaters, and all devices in which the element operates at extreme temperatures

(1400° to 2100° F.) and is exposed to the atmosphere.

While somewhat higher in cost than alloys containing lower percentages of chromium, Tophet "A" will prove as valuable below 1400° as it is above. The fact that it is practically iron-free assures a greatly increased life over any other alloy.

Tophet "A" is supplied with bright finish, and in all sizes of round wire, either bare or covered; also in ribbon form. Coiled wire for elements can be furnished according to manufacturer's specifications.

This wire product is manufactured by the Gilby Wire Co., Newark, N. J.

CINCH OFFERS MIDGET RADIO SOCKET

In keeping with the trend toward compactness and economical cost, the Cinch Manufacturing Corp. is offering a midget radio socket in addition to their regular size socket.

The midget sockets are smaller in size,

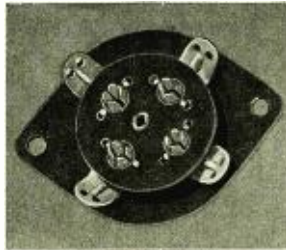

having 1½-inch mounting centers and being 1-7/16 inches wide. A definite saving of space is thus afforded to meet present-day requirements.

Another saving is provided in Cinch radio sockets, both midget and regular size, through the use of 3/64-in. bakelite in addition to the regular 1/16-in. bakelite. The former provides added economy.

Their two designs of contacts have a bearing against each tube prong at eight different points thus insuring positive contact at all times—yet tubes may be inserted or removed with ease and smoothness.

Cinch sockets are furnished in a variety of different styles and sizes and have been adopted as standard equipment on many auto sets where the strain is severe. Samples and details may be obtained by writing the Cinch Manufacturing Corporation, Chicago, Ill.

DISTORTION FACTOR METER

The maximum output level of amplifiers as determined by the introduction of harmonics is now one of the most easily measured characteristics. This has come about as the result of the development by the General Radio Company of a distortion-factor meter which reads total har-

monic content of an impressed wave directly on a potentiometer dial. The method is entirely visual and may be used in a noisy locality. No calibration is required and the manipulation is remarkably simple.

The distortion-factor meter consists of a calibrated potentiometer and a filter is so designed as to cut off sharply above 400 cycles (the test frequency for which the instrument is designed) and has an absolutely flat characteristic from well below the second harmonic to above the 15th harmonic.

In operation the signal being examined is connected to the input and passed through the filter which entirely suppresses the fundamental. The total harmonic content remains and the deflection caused by it on a meter is observed. The filter is then switched out of circuit and a potentiometer adjusted until the output of the instrument for the fundamental is the same as that previously obtained on the harmonics. When equal deflection is obtained the total harmonic content of the wave is read from the potentiometer dial.

CONDENSER MICROPHONE

The Shure Brothers Company, 337 West Madison St., Chicago, with reference to their new condenser microphone, state:

"This instrument is designed to meet the most exacting requirements for high quality radio broadcasting, sound recording, and sound measurement tests. Its outstanding characteristic is its relatively uniform response to all frequencies from 40 to 10,000 cycles. In the special design of



its amplifier are combined the advantages of high output level with extreme wealth of richness in tone quality. Its reproduction is so realistic as to make it difficult for even the trained ear to discern the use of the instrument between the original source of sound and the listening ear."

HIGH AUDIO OUTPUT from small tubes

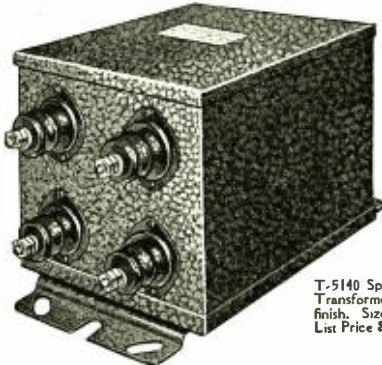

T-5140 Special Plate Supply Transformer—black crackle finish. Size 6 1/4 x 6 3/4 x 10 1/2. List Price \$24.50.

Tube replacement economy and high efficiency justify your immediate investigation of these special and entirely new transformers, designed for use with Class "B" amplifier, using comparatively small tubes. And Thordarson leads again!



T-5100 Special Input Transformer—black lacquered. Size 3 3/4 x 3 3/4 x 3 3/8. List Price \$7.50.

This group consists of plate supply unit, T-5140, for use with 210's. This unit when used as directed has practically a linear output characteristic, which is essential for satisfactory results. For coupling transformers, we offer a special Input T-5100 and a special Output T-5101. Thordarson circuit diagrams S-102 and S-108 should be followed to obtain best results. Sent free on request.

Thordarson Electric Manufacturing Company
500 West Huron Street, Chicago, Illinois



T-5101 Special Output Transformer—black lacquered. Size 3 3/4 x 4 x 4. List Price \$10.00

THORDARSON
Reg. U. S. Pat. Off.
**TRANSFORMER
SPECIALISTS
SINCE 1895 . . .**



new

new SIMPLICITY new ECONOMY

with the **WESTON**

PHOTRONIC RELAYS

Equipment for light sensitive cell applications is reduced, costs cut, installation and maintenance simplified by the new Weston Photronic Cell.

Advanced in design, amazing in performance, it uses no battery, no amplifier. It operates relays directly. Highly sensitive—current output about 1.4 microamperes per foot-candle. No dark current. Instantaneous response. Unlimited life—no deterioration—no readjustments of circuit. No worry, attention or maintenance.

Combined with Weston relays it forms a compact, practical, complete light sensitive unit—known as Weston Photronic Relays. Made in combinations suitable for industrial or experimental applications. Our engineers will be pleased to work with you in developing your Photronic Relay control devices.



Precision type RELAY. Model 30



Sensitive Relay Model 534

WESTON
ELECTRICAL INSTRUMENT CORP.
612 FRELINGHUYSEN AVENUE . . . NEWARK, N. J.

COILS FOR SHORT WAVE RECEIVERS

The F. W. Sickles Company, 300 Main St., Springfield, Mass., have developed several new and interesting coil items for 1932 production. The interest in short wave receivers and converters has resulted in efficient design for i-f. transformers around 450 kc. This unit consists of two Litz wound universal coils tuned by midget compensating condensers, the entire unit being fully shielded.

For the converter manufacturer a tuned output stage, at approximately 1000 kc., increases the gain of the broadcast set intermediate amplifier and also reduces the possibility of interference from locals operating near the intermediate selected for the converter.

Extensive work has also been carried out on converter design and valuable information on this subject is available to set manufacturers.

For broadcast superhets successful design work has been completed for the 5-tube Autodyne receiver. Complete units consisting of antenna coil, band pass, oscillator and i-f. are now available.

INTERMEDIATE-FREQUENCY TRANSFORMER

Because of the trouble and annoyance experienced in receiver sensitivity and selectivity, due, in a great measure, to temperature changes, a unique angle of approach was made by the laboratories of the Radio Coil and Wire Corporation, 847 West Harrison St., Chicago, in designing a new intermediate-frequency transformer unit.

Months of intensive study, research and

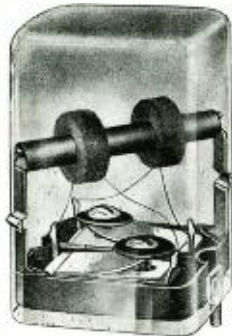

experimenting were spent in designing a unit to withstand extreme changes of temperature and humidity conditions.

Tests of 2,350 various types of coils and windings were made indicating that the use of definite wire spacings and traverses decreased the effective resistance of coils so they would more nearly approach the ideal resonance curve shape.

Final results of this painstaking research and development has resulted in an advanced design of i-f. unit which will stay peaked at 175 kilocycles with a steady, even gain, although subjected to extreme temperature and humidity changes.

It is small in size, ruggedly constructed, easily mounted with positive ground to chassis, accomplished with two hold-down spade bolts. The coils are mounted on a low loss coil form, efficient in selectivity and gain, wide capacity range, easy to adjust, compactly assembled and mounted on a newly developed material known as Learite, enclosed in a satin finished can. Furnished for either upright or inverted mounting.

NEW VOLUME CONTROL

A new volume control of unusual interest to set manufacturers and of special interest to makers of automobile radio receivers is announced by Chicago Telephone Supply Co., Elkhart, Indiana. Known as the No. 80 Series, this new volume control is furnished with or without switch. A switch of the low torque type is used. This may be either S. P. S. T. or D. P. S. T., of approved type. The contact resistance



of these switches is low and remarkably uniform, making this new unit particularly adapted for use in automobile receivers.

An important feature of the design of the No. 80 Series volume controls is that they may be associated directly with the grid circuit with no pickup from the power circuit on account of close association of volume control and a-c. switch. The switch cam is "cold." The insulated thimble and shaft have been designed so that the capacity between these parts and "live" parts of the control is less than 5 mmfds. The breakdown is in excess of 2,000 volts.

The No. 80 Series is quiet in operation. Corrosion of the contacting member is reduced to a minimum due to the special design of the wiping contact, and the ample contacting surface provided. These units have positioning lugs to prevent rotation of the control on the panel, are provided with rugged terminal construction that permits of extremely rapid assembly, and may be obtained in any desired resistance gradient. Further information regarding the No. 80 Series will be supplied promptly by the manufacturer.

TRANSMITTING TUBES BY ARCTURUS

The Arcturus Radio Tube Co., Newark, N. J., has introduced a new line of transmitting tubes, power amplifiers, and mercury vapor rectifiers.

Two tubes now ready are mercury vapor rectifier No. E-766 and a heavy duty type mercury vapor rectifier No. E-772. In these tubes is employed a special oxide coated filament, emission being distributed evenly over the entire length of filament. The output is constant for hundreds of hours on intermittent life tests.

CLAROSTAT AD-A-SWITCH CONTROL

As a further convenience to jobbers and servicemen, Clarostat now has available a new Ad-A-Switch line of volume controls. These controls are made up in the general style and design of the wire-wound potentiometers, and are obtainable in any taper or resistance up to 50,000 ohms. They have the added feature that a switch may be

slipped on any of them without the use of tools.

The Ad-A-Switch arrangement enables one to simplify line-up of stock on volume controls to a point where duplication of resistance on controls carried in stock will no longer be necessary. Any Ad-A-Switch volume control without switch can be converted at will into a complete unit with switch by replacing the usual dust cap with the special snap-on switch.

These switches are the compact bakelite type, built into the metal cover so as to take up very little room. They are Underwriters' approved for 3 amperes, 110 volts.

MIDGET BY-PASS CONDENSERS

The Condenser Corp., of America, Jersey City, N. J., announces a new Acracon midget by-pass condenser. This unit is completely inclosed in an aluminum shell. It is moisture proof and heat proof; the leads are permanently fixed and cannot be dislodged.

DUBILIER MOULDED BAKELITE CAPICITORS

Two new types of moulded bakelite mica capacitors for transmitting and receiving circuit applications are announced by the Dubilier Condenser Corporation, New York City.

The Dubilier type 3 capacitor covers various capacities from .00004 to .004 mfd. The moulded case is oblong shaped with rounded corners and carrying imbedded name plates on top and bottom sides.

The terminals are side strips with holes for mounting and tabs for soldered wire connections. The case measures $1\frac{1}{4} \times \frac{1}{8}$ inches, while the overall length including terminals is $2\frac{3}{8}$ inches.

The Dubilier type 4 capacitor covers various capacities from .00004 to .025 mfd. The moulded case is of radically new design, with integral lugs through which mounting screws may be slipped, for flat mounting. If the capacitor is to be mounted upright, small metal brackets are provided, held in place by rivets slipped



through the integral mounting lugs. The terminals are side strips with holes for mounting tabs for soldered wire connections. Imbedded name plates appear on top and bottom sides. The case measures $1\frac{1}{4} \times 1 \times \frac{1}{8}$ inches. The overall length including terminals is $2\frac{1}{4}$ inches.

DUREZ

General Plastics, Inc., 15 Walck Road, North Tonawanda, N. Y., have issued a new, illustrated booklet showing many radio parts and accessories made up of Durez. The dielectric strength of Durez is 300 to 500 volts per mil.

RADIOTRON BULLETINS

RCA Radiotron Company, Inc., Harrison, N. J., has issued a new series of bulletins showing eight types of Radiotrons with corresponding code markings.

the Genesis of the Fixed Resistor!

On page one of the "Story of Centralab Fixed Resistors" the artist has shown the intricate mixing apparatus which grinds the ceramic material which goes into the manufacture of the Centralab Fixed Resistor. Send for this informative booklet, "A Baptism of Fire," which is free for the asking. It describes in detail how Centralab Fixed Resistors are made . . . and how they differ from the average resistor.

Now in Its 3rd Edition

Send for the new CENTRALAB VOLUME CONTROL GUIDE . . . which tells just what CENTRALAB REPLACEMENT UNIT to use on any and every replacement job. Invaluable to servicemen, and engineers. Priced at 25c.



CENTRAL RADIO
LABORATORIES
MILWAUKEE



CONTINENTAL CARBON RESISTORS AND SUPPRESSORS



Continental Resistors, being made under strict laboratory and factory control, give entire satisfaction in service.

IN SEVEN SIZES

Continental Suppressors are standard with leading makes of automobile radio receivers.



SCREW IN CABLE TYPE SUPPRESSOR

SUPPRESSORS ARE MADE IN THREE TYPES OF TERMINALS

Inquiries invited

CONTINENTAL CARBON Inc.
13900 Lorain Avenue, Cleveland, Ohio.

JENKINS & ADAIR



SPECIAL PURPOSE TUBES
For audio amplifying and control circuits where long life and uniformity are essential.

Send for bulletin.
Prices in U. S. A. and Canada.

J&A 102 tube . ea. \$ 6.00
J&A 205 tube . ea. 6.00
J&A 211E tube . ea. 22.00

Prices are net, f.o.b. Chicago.

Special prices for quantities.

JENKINS & ADAIR, INC.
ENGINEERS
CHICAGO, U. S. A.

Cable Address: JENKADAIR
Phone, Keystone 2130 3333 Belmont Avenue

British Offices: 76 Old Hall Street, Liverpool, England
40 Buckingham Gate, London SW1, England
French Office: 16 Rue de Chateaudun, Asnieres, France
Mexican Office: Av. 5 de Mayo 10, Mexico D. F., Mexico
Indian Office: Queen's Road, Bombay 2
Cuban Office: Calle G. No. 215 Vedado, Havana
Australian Office: 76 William St., Sydney

BREVOLITE

Insulating radio cement

- (1) Excellent Adhesion
- (2) High Dielectric Value
- (3) Non-corrosive

Whether it be mechanical strength you want (for cementing voice coils, speakers, diaphragms, applying felts to bases, etc.) or good insulating properties, color, transparency, body or filling action, slow or fast drying—whatever special requirement you may name—*there is a BREVOLITE Cement that will meet your needs exactly!*

For BREVOLITE is the pioneer radio cement. We have been making a wide variety of cements and liquid insulation since the very beginning of radio. The leading set manufacturers are our customers.

If necessary, we will even develop a special cement for you in our research laboratory. Write us today, telling your exact requirements (if you send a sample part, it will help greatly) and we will submit a suitable cement.

Your inquiry entails no obligation.

BREVOLITE
LACQUER COMPANY

(Also Waukegan Chemical & Lacquer Company)

NORTH CHICAGO, ILLINOIS

SM

PA-22A 50 Watt Quality Amplifier

Gain—78 db
Output—(odb = 6 M.W.)
+ 39 db
Frequency Characteristic—
Flat from 30 to 6,000
c.p.s.
down 6 db at 10,000

Input Impedance—
100,000 ohms

Output Impedance
200 ohms and 500 ohms

Power Supply—
200 watts at 110-125
volts—60 cycles

Size—
21" x 20" x 11 3/4"



Tubes Required—
1—'24, 1—'45, 2—845,
1—'80, 2—866

List Price (less tubes) \$345.00

*Write to Mr. Gray for discounts
and complete details.*

SILVER-MARSHALL, Inc.

6401 West 65th Street

Chicago, U. S. A.

Export Division: 41 Water Street, New York City, U. S. A.

RESINOX

FOR MOLDED PARTS

● Resinox molding compounds produce strong parts, lustrous, free from surface blemishes, and with excellent dielectric properties.

Your molder can offer no stronger assurance of quality than "Made with Resinox."

Our practical technicians are at the service of your molder to assist in the solution of unusual molding problems.

Resinox quality plus Resinox service are your guarantee of complete satisfaction.

RESINOX CORPORATION

A SUBSIDIARY OF COMMERCIAL SOLVENTS CORPORATION
AND CORN PRODUCTS REFINING COMPANY

230 PARK AVENUE

NEW YORK, N. Y.

KELLOGG Condensers..

FILTER » BY-PASS » IGNITION » TELEPHONE » TELEGRAPH
 COILS » TRANSFORMERS » HOOK-UP WIRE *{ All types of braided "Push-back" wire, specially processed for high insulation resistance. }*

Send for No. 66 Radio-Industrial Catalog

Kellogg Switchboard and Supply Company
 1066 West Adams Street . . . CHICAGO, ILLINOIS

DIALS



Lic. Under Pats.
 1713146 & 1744675

General Radio designed the TYPE 502 and TYPE 503 Dials for use on its own laboratory apparatus. The equipment you build deserves them, too.

They are made in a variety of sizes, either with or without a smooth-running slow-motion drive.

WRITE FOR LITERATURE

GENERAL RADIO CO.

CAMBRIDGE A

MASSACHUSETTS



COMPLETE LINE OF GENERAL RADIO

Parts and Electrical Testing Apparatus. Also magnet wire of every description. Large selection of antenna wire in any length up to 5000 feet. Wholesale distributors for every worth while line at lowest wholesale prices.

LOWEST POSSIBLE WHOLESALE PRICES

LEEDS
The Home of RADIO

45 VESEY STREET, NEW YORK CITY

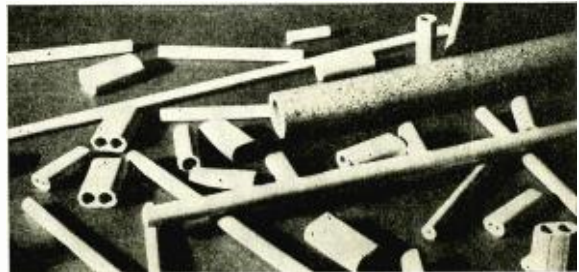

Lowest Thermal Expansion

With a coefficient of thermal expansion of 0.9 to 2.7 from lowest to highest temperatures, Crolite No. 7 establishes a new record. Practically free from dimensional changes due to temperature variations. No internal stresses. Proof against heat shock.

A Ceramic
 Attractive
 In Any Shape
 Rugged



Many Uses
 Good Insulator
 Withstands Heat

And remember, there is a Crolite formula to meet any electrical, high-frequency, thermal, chemical or mechanical requirements.

Write us regarding your severe service problems and we shall gladly supply engineering advice, samples and quotations.

HENRY L. CROWLEY & COMPANY, Inc.

Specialists in Severe Service Materials

1 Central Avenue

:::

West Orange, N. J.

LAMINATIONS

for Audio & Power Transformers

SPECIALIZED METHODS—YEARS OF EXPERIENCE

Wide Variety of Stock Standard Sizes

Dimension and Price Sheets on request

We Also Make

PERMANENT MAGNETS—DIES—TOOLS—

METAL STAMPINGS

Facilities for prompt service



Thomas & Skinner
 Steel Products Co.

1100 to 1120
 E. Twenty-Third St.
 INDIANAPOLIS, IND.

BRASS—BRONZE—COPPER
NICKEL SILVER—ZINC
PHOSPHOR BRONZE

In Gauges .001 and Thicker. 1/16" to 16" Wide

HOT TIN COATED METALS IN COILS AND STRIPS

THE BALTIMORE BRASS CO.
 1206 WICOMICO ST., BALTIMORE, MD.

Recording on Metal

If you are interested in this new and profitable branch of Radio, get your name on our mailing list for our new bulletin describing our Crystal cutting head and complete recorders.

Astatic Microphone Laboratory
 21 Olive Street, Youngstown, O.

NICKEL WIRE CLOTH

for the
RADIO TUBE INDUSTRY

Any mesh woven accurately to your specifications.

"CLEVELAND"

Wire Cloth renowned for its Uniformity, its Superiority, its Durability.

Advise us of your Requirements

The Cleveland Wire Cloth & Manufacturing Co.
 3571 E. 78th Street, CLEVELAND, Ohio

Equip your Midget Radios with

This sound absorption feature will give your set a distinct sales point. Receivers can then be set directly on polished surface without danger of scratches or marks.

Three types: machine screw, wood screw and nail.

Free sample of any type you want



Brawley felt feet

FELT

T. R. BRAWLEY FELT COMPANY, INC.
 279—28th Street, Brooklyn, N. Y.

Low Range FUSES



INSTRUMENT LITTELFUSES
 1/100, 1/32, 1/16, 1/8, 1/4, 3/8, 1/2, 1, 2 amps. for galvanometers, milliammeters, etc.

RADIO FUSES
 1/4 amp. for "B" circuits, also 1, 1 1/2, 2 and 3 amps. for radio manufacturing. Details by return mail.

For Radio Amplifiers and Transmitters
 500, 1,000, 5,000 and 10,000 volt ranges, in 1/16, 1/8, 1/4, 3/8, 1/2, 3/4, 1, 1 1/2, 2 amps.

LITTELFUSE LABORATORIES
 1778 Wilson Ave., Chicago, Ill.

CANDOHMS

WIRE WOUND ARMORED RESISTORS

WILL LOWER YOUR COSTS—May we sample and quote

The Muter Company
 1255 S. Michigan Ave. CHICAGO, ILL.

Miniature copper-oxide RECTIFIERS

Size: 3/4 x 3/4 in. for the construction of a sensitive a.c. voltmeter from a d.c. Milliammeter. (Current Limit 15 M.A.) Price: \$3.00.

LEO TAUSSIG
 1326 GATES AVENUE BROOKLYN, N. Y.

WAXES, COMPOUNDS and VARNISHES

for insulation of condensers

transformers, coils, power packs, pot heads, sockets, wiring devices, wet and dry batteries, etc. . . . WAX SATURATORS for braided wire and tape. WAXES for radio parts. . . . Compounds made to your own specifications if you prefer.

ZOPHAR MILLS, INC.
 Court and Lorraine Streets Founded 1846 Brooklyn, N. Y.

RADIO FILAMENT



Gilgrid Wire and Plate Material Special Alloys for Various Needs

Also Manufacturers of

<i>Gilby Processed</i>	<i>Nickel-Chrome</i>
<i>Carbonized Nickel</i>	<i>Resistance Wire</i>
<i>For Plates</i>	<i>Copper-Nickel</i>
<i>Gilby Patented</i>	<i>Resistance Wire</i>
<i>Selva Mesh</i>	<i>Nickel Wire</i>
	<i>And Sheet</i>

Our engineering department will meet your specifications.

GILBY WIRE COMPANY
 150 RIVERSIDE AVE. NEWARK, NEW JERSEY

CONDENSER PAPER

182 Cornellison Ave. — Mills at — Newark Ave.
 Jersey City, N. J. Elizabeth, N. J.

PETER J. SCHWEITZER, Inc.,
 200 Fifth Ave. New York

NICKEL CUT For Radio Tubes FLAT ENDS

between .070 and .006 dia.
 ±.002"—no burrs—every piece straight
 Capacity 10,000,000 pieces daily

Small metal parts to your blue print. 100 to 675,000 pieces per lb.

Art Wire and Stamping Company
 18-22 Boyden Place, Newark, N. J.



Chateau Crillon
 PHILADELPHIA RITTENHOUSE SQUARE (WEST)

A New Idea in Hotels

If you are going to Philadelphia and are tired of the usual commercial hotel, come to the beautiful, new CHATEAU CRILLON on Rittenhouse Square. Large outside rooms; gleaming, spotless baths; superb decorations; period furniture; famed restaurant with special rates for guests; quick, intelligent service; and, believe it or not, rates to compare with ordinary good commercial hotels! \$4.00 and up.

The MADISON

Overlooking Ocean at Illinois Avenue
 ATLANTIC CITY, N. J.

A HOSTELRY that is in full accord with the charm and traditional hospitality of this famous resort. ¶ Throughout, from its unique, inviting entrance to the spacious ocean view solarium and sun-deck atop, is an atmosphere of cordiality and quiet dignity. ¶ Its furnishings and appointments—authentic period reproductions—are all in the best of taste . . . its cuisine a combination of fresh fare and culinary cleverness . . . its patronage drawn from a class that appreciates the things well done.

Rates for all seasons are most attractive

EUGENE C. FETTER
 Managing Director

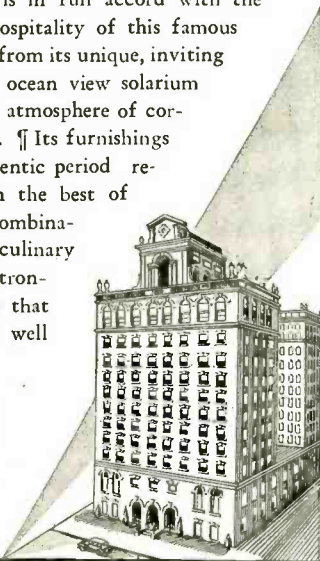

FETTER & HOLLINGER, INC.

Bring your
WIRE & WELD
 problems to
CALLITE

for power tubes and all special applications

TUNGSTEN
 Filament — wire — rod — sheet — coils
 special shapes

MOLYBDENUM
 Wire — sheet — rod
 Special Shapes
WELDS
 Special Tungsten Welds—All Types
REFRACTORY METAL CONTACTS
 —all types—

We can supply the finest quality materials on short notice. Our engineers will co-operate with you

CALLITE PRODUCTS CO., INC.
 UNION CITY NEW JERSEY, U. S. A.

ACME WIRE PRODUCTS

All ACME products are made to recognized commercial standards, including those of:
 Nat'l Electric Mfrs. Assn.
 Radio Manufacturers' Assn.
 Amer. So. for Testing Materials.

Magnet Wire
 (All Insulations)

Parvolt Condensers
 (Filter and By-Pass)
 Also Condensers for Power Factor Correction

Coils, Magnet Wire Wound

Varnished Insulations
 (Cambric, Paper, Silk, Tape)

Aerial Wire
 (Stranded and Solid)
 For over 25 years, suppliers to the largest radio and electrical manufacturers.

THE ACME WIRE CO.
 New Haven, Conn.

DEPENDABLE

QUALITY—UNIFORMITY
SERVICE

ON

WAXES—&—MELTABLE
INSULATING and WEATHER-
PROOFING COMPOUNDS

WAXES—All kinds.

IMPREGNATIONS—Condensers, Coils, Rubber-
Covered and Weather-Proofed Wire, Telephone
and Electrical Cables, Etc.

SEALING COMPOUNDS—Coils, Condensers,
Batteries (Wet & Dry), Pot Heads, Cables, Wir-
ing Devices and Specials.

FINISHING—All grades of Weather Proof and
Rubber-Covered Wire.

SPECIAL COMPOUNDS



35th St. & Maplewood Ave.
Chicago, Ill.

"For over 35 yrs."

ROEBLING

WIRE—Antennae (plain or enameled). Con-
necting and Ground (Rubber covered,
braided or plain).

STRAND—Antennae (plain or en-
ameled) — Double Galvanized.

BUS BAR—Litzendraht-Loop

MAGNET (Cotton or Silk)

WIRE PRODUCTS

JOHN A. ROEBLING'S SONS CO.
Trenton, N. J. *Branches in Principal Cities*

INDEX OF ADVERTISERS

<p>A</p> <p>Acme Wire Co., The..... 51</p> <p>Allen-Bradley Co. 14</p> <p>Arcturus Radio Tube Co....Second Cover</p> <p>Art Wire & Stamping Co..... 48</p> <p>Astatic Microphone Lab..... 48</p>	<p>G</p> <p>Gates Radio & Supply Co..... 51</p> <p>General Electric Co..... 12</p> <p>General Plastics, Inc..... 1</p> <p>General Radio Co..... 47</p> <p>Gilby Wire Co..... 48</p>	<p>N</p> <p>National Electrical Products Corp.... 9</p>
<p>B</p> <p>Bakelite Corp.Back Cover</p> <p>Baltimore Brass Co., The..... 48</p> <p>Brawley Felt Co., Inc., T. R..... 48</p> <p>Brevolite Lacquer Co..... 46</p>	<p>H</p> <p>Haldorson Co., The..... 52</p>	<p>P</p> <p>Parker-Kalon Corp. 5</p>
<p>C</p> <p>Cable Radio Tube Corp..... 35</p> <p>Callite Products Co..... 49</p> <p>Candy & Co. 50</p> <p>Central Radio Corp..... 11</p> <p>Central Radio Laboratories 45</p> <p>Chicago Telephone Supply Co..... 3</p> <p>Clarostat Mfg. Co..... 36</p> <p>Cleveland Wire Cloth & Mfg. Co., The 48</p> <p>Condenser Corp. of America..... 52</p> <p>Continental Carbon, Inc..... 45</p> <p>Crowe Name Plate & Mfg. Co..... 10</p> <p>Crowley & Co., Inc., Henry L..... 47</p>	<p>I</p> <p>Inca Mfg. Division 9</p>	<p>R</p> <p>Radio Manufacturers Ass'n..... 8</p> <p>RCA Victor Company, Inc.....6, 7</p> <p>Resinox Corporation 46</p> <p>Roebbling's Sons Co., John A..... 50</p>
<p>F</p> <p>Frost, Herbert H., Inc 3</p>	<p>J</p> <p>Jenkins & Adair, Inc..... 45</p>	<p>S</p> <p>Schweitzer, Peter J., Inc..... 48</p> <p>Silver-Marshall, Inc. 46</p>
<p>M</p> <p>Muter Company, The..... 48</p>	<p>K</p> <p>Kellogg Switchboard & Supply Co.... 47</p>	<p>T</p> <p>Taussig, Leo 48</p> <p>Thomas & Skinner Steel Products Co. 47</p> <p>Thordarson Elec. Mfg. Co..... 43</p>
<p>L</p> <p>Leeds Radio Co..... 47</p> <p>Litelfuse Labs. 43</p>	<p>W</p> <p>Western Television Corp.....Third Cover</p> <p>Weston Elec. Inst. Corp..... 43</p>	<p>Z</p> <p>Zapon Company 51</p> <p>Zophar Mills, Inc..... 48</p>

THE Group Subscription Plan for RADIO ENGINEERING enables a group of engineers or department heads to subscribe at one-half the usual yearly rate.

The regular individual rate is \$2.00 a year. In groups of 4 or more, the subscription rate is \$1.00 a year. (In Canada and foreign countries \$2.00.)

The engineering departments of hundreds of manufacturers in the radio and allied industries have used this Group Plan for years, in renewing their subscriptions to RADIO ENGINEERING.

Each subscriber should print his name and address clearly and state his occupation—whether an executive, engineer, department head, plant superintendent, or foreman, etc.

Remember this Group Plan when Your Subscription Expires

(Radio Engineering)

Bryan Davis Publishing Co, Inc.
 52 Vanderbilt Avenue
 New York, N. Y.

Los Angeles

Chicago

Cleveland

When you compare results GATES Equipment is the logical choice

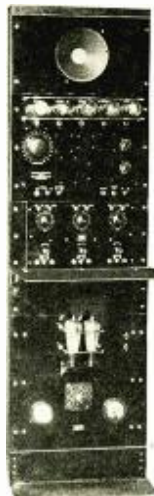

Back of every installation is that conclusion in the field we serve, in—

**Radio Broadcast,
 Sound Recording,
 Public Address,
 Talking Picture,
 Centralized Radio
 Industries**

There is that particular approval of satisfaction in dependability and engineering skill that is daily increasing our wide circle of clientele.

A request on your own business letterhead will bring our catalog.

GATES RADIO & SUPPLY CO.

Manufacturing Engineers

QUINCY, ILL., U. S. A.

How one Radio Cabinet Manufacturer solved a problem!



A RADIO cabinet manufacturer had a chance to bid on a 25,000 cabinet contract. The specifications called for a particularly durable finish. Time was of the utmost importance. Our laboratory backed the customer's problem and Lacquer #5526 was the result. P. S. Our customer got the order. Lacquer #5526 has high solids, is smooth flowing, and rubs down to a satin finish. It is tough, builds exceptionally well, and never "scratches white" when applied over our Sealer #5214. Many thousands of gallons have since been sold to this customer and others—and the price is well within today's highly competitive range. Ask our local representative—a practical furniture man—for a demonstration.

"The Standard of Quality Since 1884"

THE ZAPON COMPANY

A Subsidiary of Atlas Powder Company

Stamford

Connecticut



HALLDORSON PRODUCTION SERVICE

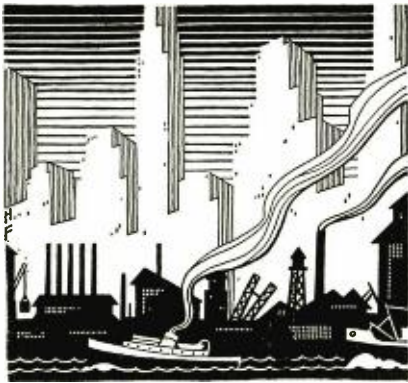

In producing vital assembly parts for set makers, Halldorson recognizes that a radio set is a **SERVICE UNIT** in which *price and performance* control your good-will and sales volume, *in dealing with the Public.*

Hence, in designing and producing parts we consider ours a dual responsibility. First, in contributing to lower cost in every element of design and production. Second, to improve the standard of set performance.

In accomplishing this for you, every advantage is available here—1. Engineering experience; 2. Specialized equipment; 3. Large volume facilities; 4. High quality materials; 5. Centralized location; 6. Low unit cost.

*May we present more definite facts?
Write today!*

THE HALLDORSON COMPANY
4500 RAVENSWOOD AVE. CHICAGO, ILL.

HALLDORSON

✓ POWER TRANSFORMERS

✓ AUDIO TRANSFORMERS

✓ SPEAKER TRANSFORMERS

✓ FILTER AND OUTPUT CHOKES

✓ LAYER WOUND COILS



Announcing the New

ACRACON

MIDGET BY-PASS CONDENSER

WITH the perfection of this new Acracon Midget By-Pass Condenser the use of small tubular condensers becomes practical as all troubles previously characteristic of this type condenser have been eliminated.

Note These Features:

1. Completely enclosed in aluminum shell.
2. Moisture proof.
3. Heat proof. Not damaged by soldering in assembling.
4. Leads permanently fixed. Cannot be dislodged.
5. Container can be grounded to one lead if desired.

Many other points of superiority will be found upon inspection and comparison with other makes.

Write for Sample Today!

CONDENSER CORP.

OF AMERICA

259-271 Cornelison Ave.
JERSEY CITY, N. J.

Factory Representatives In:

Chicago Cincinnati St. Louis San Francisco Los Angeles Toronto

And Other Principal Cities

Now! Television-

- No longer
- an experiment
- but *Practical*
- with the

"JUNIOR WESTERN" Television Transmitter

Radio broadcast engineers who are looking ahead are getting ready for commercial television. They are developing broadcast technique, they are learning the practical phases now, they are establishing themselves and their stations as pioneers in this great new industry.

The "JUNIOR WESTERN" Television Transmitter offers you an opportunity to investigate the full possibilities of Television at amazingly low cost. It will help you build a future for yourself and add to the prestige of your station.

The "JUNIOR WESTERN" TRANSMITTER has the acceptance and approval of many of the leading engineers in this field and furnishes you with the *practical* equipment to study television; if you are an amateur you will be able to broadcast real pictures on the amateur bands.

BROADCAST STATION ENGINEERS

call the "Junior Western" Television Transmitter

PROFESSIONAL EQUIPMENT

The "JUNIOR WESTERN" TRANSMITTER is professional equipment consisting of five integral parts, completely mounted for use: (1) a high powered 1000-watt lamp, (2) a specially developed 45 hole scanning disc, (3) a powerful 900 r.p.m. synchronous motor, (4) an optically fine projection lens, (5) a pickup unit consisting of two 6-inch super-sensitive photo-cells. Complete operating instructions, illustrations and numerous circuit suggestions are included.

The price of the "JUNIOR WESTERN" TELEVISION TRANSMITTER, complete as listed above, ONLY \$250.00. (F.O.B. Chicago, Ill.)

WANT TO BUILD YOUR OWN RECEIVER?

The Western Television Receiving Unit Kit is complete for laboratory or home construction for those who wish to experiment or build their own television receiver. Complete parts included: Scanning disc, motor hanger, glow lamp shield, framer control, wiring harness, lens, bezel, starter control for motor and instruction sheets.

Complete as listed, F.O.B. Chicago, Ill. \$59.50

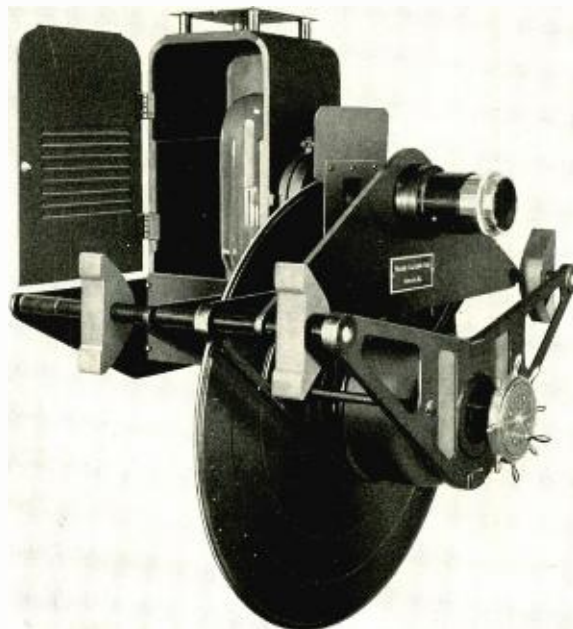

"Junior Western" Television Transmitter complete. Two 6-inch super-sensitive photo cells that go with this equipment are not shown in this photograph

Western Television equipment is now in regular everyday use. Each engineer whose name appears below has made a thorough investigation of the television field and his recommendations have resulted in the placing of orders for Western Television Transmitting equipment. Will you be with them?

Walter J. Lindsay (W9DZ and W9CDN Chicago Daily News) Chief Engineer WMAQ, Chicago Daily News Radio Station, and W9XAP, Chicago Daily News TELEVISION Station.

Carl Meyers (W9DN), Chief Engineer WGN, Chicago Tribune Radio Station whose TELEVISION equipment is about ready for delivery.

Dan Gellerus, Chief Engineer WTML, Milwaukee Journal Radio Station and W9XD Milwaukee Journal TELEVISION Station (W9EVE).

Berthel Berg (W9EXM and W9GHP), Engineer in charge of W9XAO WESTERN TELEVISION CORPORATION Station, Chicago.

Leonard Spencer, Chief Engineer CKAC, La Presse, Montreal, Canada, and VE9EC, La Presse TELEVISION Station.

G. L. Taylor (W9ATU), Chief Engineer, First National TELEVISION School, Fairfax Airport, Kansas City, Kansas.

Broadcasting station engineers and others interested in being "first" in the television broadcasting field should have the "JUNIOR WESTERN." Experimental television work offers the great opportunity of the age. Investigate!

WESTERN TELEVISION CORP.

400 WEST MADISON STREET

CHICAGO, ILLINOIS

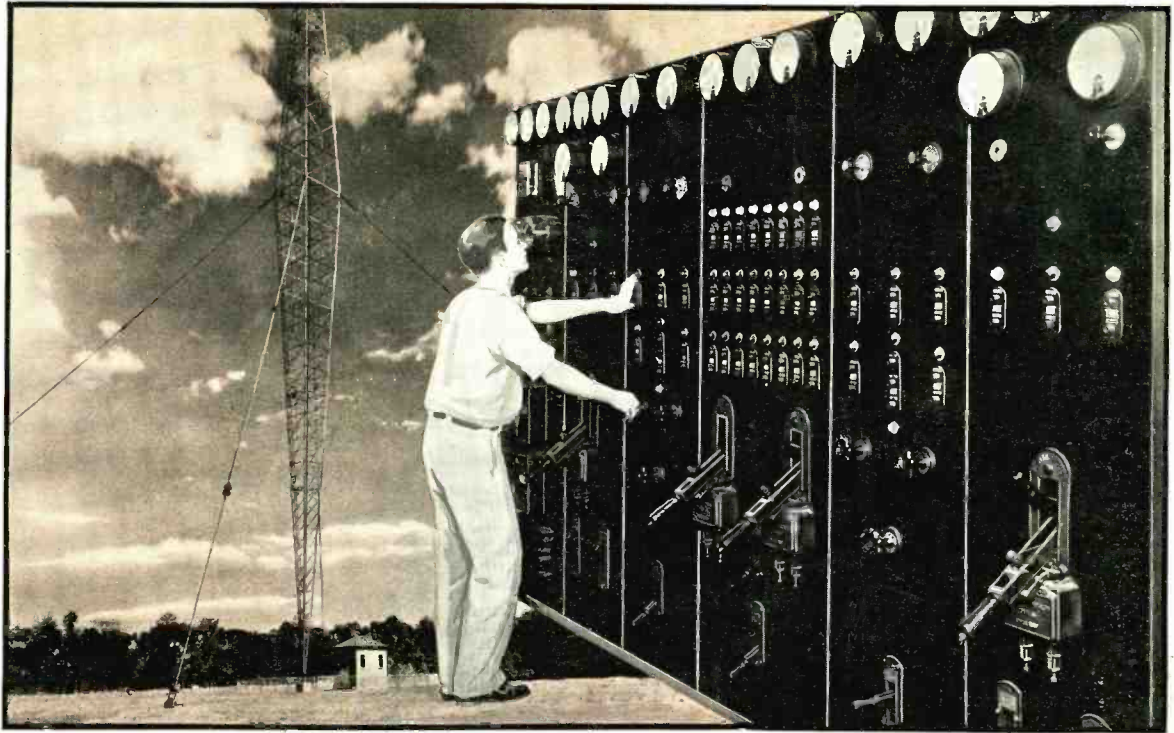

Keeping within the allotted channel requires dependable insulations

Constant demand for new channels in an already overcrowded ether spectrum, has resulted in more stringent legislation concerning wave length control. Broadcasting stations must keep within their allotted channels. This calls for more exacting equipment, and for insulations that will retain their dielectric efficiency constantly over a wide range of operating conditions and in spite of moisture and temperature variations.

Bakelite Materials have long been favored by radio engineers for their dependable insulating qualities. These new and more drastic requirements will find these materials maintaining

their usual preference and rendering their proven dependability in service. And to the manufacturer of broadcasting apparatus, Bakelite Materials offer many economies in production and assembly.

High dielectric and mechanical strength, and resistance to moisture, to oils and to most chemicals are properties which qualify Bakelite Materials for use wherever insulation constancy is required. Whether it be on large transmitters or small receivers, high frequencies or low, Bakelite Molded, Bakelite Laminated or Bakelite Varnish will undoubtedly prove the answer to your insulation problems.

Write for our illustrated booklets "12M, "Bakelite Molded," 12L "Bakelite Laminated" and 12V "Bakelite Varnish". These booklets contain valuable information concerning the properties and uses of Bakelite Materials. There are also many special materials developed to solve particular insulating problems. Do not hesitate to call upon us for information about any of these materials.

BAKELITE CORPORATION, 247 Park Ave., New York ... 635 W. 22nd St., Chicago
BAKELITE CORPORATION OF CANADA, LIMITED, 163 Dufferin Street, Toronto, Ontario

BAKELITE

The registered trade marks shown above distinguish materials manufactured by Bakelite Corporation. Under the capital "B" is the numerical sign for safety, or unlimited quantity. It symbolizes the infinite number of present and future uses of Bakelite Corporation's products.

THE MATERIAL OF A THOUSAND USES

