

Eleventh Year of Service

OCT 31

RADIO ENGINEERING

LABORATORY COPY
Vol. XI OCTOBER, 1931 No. 10

IN THIS ISSUE



FACTORS IN THE SELECTION OF THE PROPER RADIO
POWER TRANSFORMER

By J. A. Comstock

THE TUNED-CIRCUIT PROBLEM IN SHORT-WAVE
RECEIVERS

By A. Binneweg, Jr.

RADIO TUBE YARDSTICKS

By L. G. Lessig

TELEVISION RECEPTION WITH THE SUPERHETERODYNE

By R. William Tanner

SERIES EQUIVALENT OF A RESISTANCE PARALLELING A
TUNED CIRCUIT

By C. H. W. Nason

MODERN MANUFACTURE OF RADIO TUBES

By J. B. Nealey

Sold only by subscription
\$2.00 per year

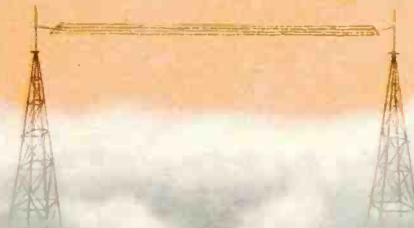

OCT 31

The Journal of the Radio Industry

The Newest '30 Series D.C. TUBES...

with **ARCTURUS** improved features

These tubes are built to the same rigid specifications that make *blue* tubes the decided preference of critical engineers and progressive jobbers and dealers.

The types 136, 137 and 138 are of the heater-cathode construction. This is the construction developed by Arcturus in pioneering the first standard base a.c. tube. Rugged construction that resists shocks and jolts—low current consumption—longer life make these tubes the best yet for automobile sets. They have the usual quick action of all Arcturus Tubes.

The low drain of 130, 131, 132 and 133 types meets the exact needs of battery sets, and their sturdy construction assures efficient portable set performance.

Arcturus Blue Tubes are the standard tube equipment of more manufacturers than any other tube. Most of this year's sets will be equipped with *blue* tubes.

If you have not already done so, write now for your copy of specifications of Arcturus *Blue* Tubes and for complete data on the new d. c. series.

Arcturus Radio Tube Co., Newark, N. J.



The
BLUE
Radio
Tube!



ARCTURUS

"The **TUBE** with the **LIFE-LIKE TONE**"

If you make ELECTRONIC TUBES or if you plan to make them... read these facts about DUREZ!

NO MANUFACTURER of radio bases and parts, no concern which plans to make electronic apparatus and devices, no person who is following closely the new and diverse applications of the electronic tube, can afford to overlook Durez, the perfect molding compound!

For years, Durez has been used successfully in millions of pieces of radio equipment. Tube bases and sockets... panels and condenser sets... variometers and dials... all have worked more silently, smoothly, efficiently with the help of Durez. Now, with chemists and physicists daily uncovering new applications and uses for the revolutionary electronic tube, the possibilities for Durez in this field are greater than they have ever been before!



Durez goes to the molder in powdery, dust-like form. Tremendous pressure is applied. In a matter of seconds, the part comes from the mold, finished!

Parts made from Durez are strong, tough, light

Resistant to acids, moisture, gases, perspiration. Tube bases hold their shape. The high mechanical strength of this amazing material makes very thin sections possible, permitting the extensive use of holes, slots and metal inserts — all cared for in the one molding operation!... Durez will not cold-flow.

Although tooling, polishing and burnishing are unnecessary, the finish on Durez molded parts is always smooth and even. You

can choose from a wide variety of beautiful colors. . . . Each Durez-molded piece is an exact duplication of every other! Precision can be held within closest commercial limits, resulting in definite savings on machining operations.

Let us tell you more about Durez

Durez is continually replacing wood, metal, porcelain, ivory, hard rubber and other materials. Let us show you how it can make your product better, more efficient, more durable. Our engineering staff is ready to give you full information on the practicability of using this extraordinary raw material in your business, or in making something you use. Write for free booklet to General Plastics, Inc., 124 E. Walck Rd., N. Tonawanda, N. Y. Also New York, Chicago, San Francisco, Los Angeles.

THE MAKERS OF DUREZ ARE ALSO THE MAKERS OF DUREZ INSULATING VARNISH



RADIO ENGINEERING

Reg. U. S. Patent Office

Member, Audit Bureau of Circulations

Western Editor
ULMER G. TURNER

Editor
DONALD MCNICOL

Managing Editor
F. WALLEN

Vol. XI

OCTOBER, 1931

Number 10

Contents

	PAGE
EDITORIAL	4
IMPRESSIONS AND EXPRESSIONS, <i>By Austin C. Lescarbours</i>	12
THIRTY MILLION HOMES IN U. S.—TWENTY MILLION FORD CARS PRODUCED—HOW MANY RADIO RE- CEIVERS?	15
FACTORS IN THE SELECTION OF THE PROPER RADIO POWER TRANSFORMER	17
<i>By J. A. Comstock</i>	
MICHAEL FARADAY AND THE TRANSFORMER	19
THE TUNED-CIRCUIT PROBLEM IN SHORT-WAVE RE- CEIVERS	20
<i>By A. Binneweg, Jr.</i>	
RADIO TUBE YARDSTICKS	22
<i>By L. G. Lessig</i>	
TELEVISION RECEPTION WITH THE SUPERHETERODYNE, <i>By R. William Tanner</i>	23
THE GOLD RUSH IS OVER!	26
<i>By Austin C. Lescarbours</i>	
SERIES EQUIVALENT OF A RESISTANCE PARALLELING A TUNED CIRCUIT	28
<i>By C. H. W. Nason</i>	
MODERN MANUFACTURE OF RADIO TUBES <i>By J. B. Nealey</i>	29
THE "ELECTRIC EYE"	31
POWER KEYING WITH ORDINARY KEY AND TELEPHONE RELAY	33
<i>By Herman Kott</i>	
WIDENING USES OF SMALL TRANSFORMERS	36
TRANSFORMER PRODUCTS	38
NEW INVENTIONS	40
NEWS OF THE INDUSTRY	42
NEW DEVELOPMENTS OF THE MONTH	46
INDEX OF ADVERTISERS	58

CROSLY SAYS "PLENTY OF BUSINESS FOR THOSE WHO WORK FOR IT"

POWEL CROSLY, JR., president of Crosley Radio Corporation, Cincinnati, claims that these are normal times and manufacturers have to get after business—not wait for it to come to them.

"It is normal for people to work for what they get," Mr. Crosley remarked. "I believe that when things fall in our laps and business comes without effort, things are abnormal. Therefore, it behooves all of us—those in the radio business in particular—to forget that there was a time when people mobbed radio stores to buy radio apparatus, and, instead, to get out and work for business.

"He who sits and waits for business to come to him will be just 'out of luck' today. Too many people have not learned this lesson. Too many dealers are still sitting around waiting for business to fall in their laps. Hence we have hard times. So let's reorganize our business methods; let's get out after business. He who works hardest will profit most."

BRYAN S. DAVIS
President

JAS. A. WALKER
Secretary

Published Monthly by

Bryan Davis Publishing Co., Inc.
52 Vanderbilt Ave.
New York City

E. M. BACON
Advertising Manager

J. E. NIELSEN
Circulation Manager

Chicago Office—333 N. Michigan Ave.—Charles H. Farrell, Mgr.
St. Louis Office—505 Star Building—F. J. Wright

Kansas City Office—306 Coca Cola Building—R. W. Mitchell
San Francisco Office—155 Sansome St.—R. J. Birch

Los Angeles Office—846 S. Broadway—R. J. Birch

Entered as second class matter August 26, 1931, at the Post Office at New York, N. Y., under Act of March 3, 1879. Yearly subscription rate \$2.00 in United States. \$3.00 in Canada foreign countries.



Little Sticker... Big Story

On the end of every spool of Anaconda Magnet Wire is a sticker. It indicates size, weight, insulation, etc. . . . essential data that prevents errors in your warehouse and winding room. Most important of all, this little sticker bears the name ANACONDA . . . your guarantee that the wire is the quality standard of the industry.

On a complete line of coils, too, the Anaconda name tells the same big story of accuracy and excellence.



ANACONDA WIRE & CABLE COMPANY

GENERAL OFFICES: 25 BROADWAY, NEW YORK

CHICAGO OFFICE: 20 NORTH WACKER DRIVE

Sales Offices in Principal Cities

Magnet Wire Mills at Anderson, Indiana; Muskegon, Michigan; Sycamore, Illinois; and Ansonia, Connecticut

E d i t o r i a l

OCTOBER, 1931

HIGH CLASS BROADCASTING

It is our notion that radio broadcasting is at its best in the National Farm and Home Hour, of the Department of Agriculture at Washington. The chain tieup is national in scope so that the entire country may listen in. The program makeup contains none of the elements commonly referred to as "light entertainment;" by serious thinkers characterized as looseness and waste. Instead, there is a variety of broadcast material which includes musical selections of a high order, expert information of immediate use in regard to farm production and to marketing, and special talks by youthful members of the Four-H clubs located in all sections of the country.

It is an encouraging and inspiring experience to listen to a healthy, serious minded boy in Maine tell how he employs his time in doing something useful; to a boy in Missouri describing how he makes progress in his studies in pig raising, and to a group of girls in New Jersey telling, consecutively, what they preserve, bake or can in order to raise money to pay for club trips to museums and national monuments. The radio tieup makes it possible for each of these youths, widely separated, to listen to all of the talks.

Nothing finer, nothing more helpful, nothing more patriotic is being done in our country by any other agency.

THE TUBE PATENT POOL

THE recent decision of the Supreme Court anent the validity, or lack of it, of the Langmuir patent, the specter of the \$47,500,000 damage suits instituted by various manufacturing units against R. C. A. for alleged violation of the Clayton Anti-trust Act, the R. C. A. suit against the De Forest Radio Company for alleged patent infringement—all this, plus the industrious activity of Oswald F. Schuette, secretary of the Radio Protective Association, and the gentlemanly procedure of the officers of the R. M. A., with respect to an operative patent pool, have brought about worthwhile results.

It is stated authoritatively that the De For-

est Company receives one million dollars in cash and that the twenty other tube companies, parties to the damage suit, are to receive amounts in proportion to their alleged losses.

David Sarnoff, president of R. C. A., stated: "Termination of this large number of suits on terms satisfactory to all parties involved will do much to free the radio industry from litigation with which it has been burdened and impeded for several years and which entailed heavy expense to all concerned."

The end of this throttling ganglia of misunderstandings is a major contribution toward cooperation, particularly desirable now in the radio industry.

THE NEW YORK SHOW

OFFICIALLY it was called the Radio-Electrical World's Fair. The show was well timed to enlist the interest of dealers and the public—September 21-26. Those who feared the show would be poorly attended were agreeably surprised. The daily attendance was considerably in excess of that which might be expected in a period of industrial depression.

The new radio receivers on display showed little of innovation in cabinet housing, but most of them contained features registering progress in circuit and parts design. The new mu-control and pentode tubes have found wide application in receivers.

A six days' exhibition in Madison Square Garden, in these times, is an event in itself. That the show continued for six days to attract large attendance is a tribute to Directors U. J. Herrmann and G. Clayton Irwin, Jr.; Managers J. Chester Johnson and C. W. Glaser; to Arthur Stringer, assistant general manager, and to the other officials who labored diligently to make the exhibit a sales stimulant.

Donald Mc Nicol
Editor

How Crosley saved 20%

... on hard-to-get-at assemblies ... on thin sheet metal assemblies

The Crosley Radio Corporation overlooks no opportunity to lower production costs when it can be done without sacrifice to quality. Here is the way they effected a considerable saving on assemblies, and also obtained better results:

They were using machine screws and nuts and bolts for attaching brackets, transformers, condenser drives and other parts to the chassis, and for mounting the chassis in a cabinet. The location of some of the fastenings made it difficult to start nuts on bolts. On other assemblies they couldn't tap holes for machine screws because the metal was too thin for a satisfactory result. A Crosley engineer obtained samples of Parker-Kalon Hardened Self-tapping



Sheet Metal Screws and after making some preliminary tests was convinced that here was the means of making superior metal assemblies at lower cost. In actual production these Screws effected a saving in labor of from 20% to 30% over former methods.

Self-tapping Screws are used to cut metal assembly costs on practically all well known radio receivers, equipment and accessories. Small as well as large manufacturers save with these Screws. Investigate their advantages. Our Assembly Engineers will tell you whether you can use Self-tapping Screws ... just attach a description of one or more assemblies when you send the coupon for the free booklets shown below.



Type "Z" Hardened Self-tapping Sheet Metal Screws

For joining and making fastenings to sheet metal up to six gauge, also aluminum, die castings, Bakelite, etc. Simply turn Screw into drilled, pierced or molded hole. It forms a thread in the material as it is turned in. Can be removed and replaced.

Type "U" Hardened Metallic Drive Screws

This type of Self-tapping Screw is used for making permanent fastenings to iron, brass and aluminum castings, steel, Bakelite, Durez, etc. Just hammer the Screw into a drilled or molded hole. It forms a thread in the material as it is driven.



PARKER-KALON *Hardened* Self-tapping Screws

PAT. IN U. S. AND FOREIGN COUNTRIES



← 14 Unbiased Reports on Savings.....Scientists Explain Fastening Security →

PARKER-KALON CORPORATION, Dept. L, 190-193 Varick Street, New York, N. Y.

Send me free booklets on the Security and Economy of assemblies made with Self-tapping Screws.

Name and Co.....

Address.....





Leaders in ... naturally in

Vacuum tubes like this one were first used extensively in the transcontinental telephone line, opened in 1915. Western Electric manufactured those tubes. Great improvements have been made since then.



*Peanut Tube—
2½ in. high*



*50 Watt Tube—
8 in. high*



*10 KW Tube—
21 in. high*



Since 1882 Western Electric has been making Bell Telephone apparatus. Out of this half century of pioneering in sound transmission has come equipment for



radio broadcasting,

talking pictures, radio telephone, television—all dependent upon various types of vacuum tube.

...So it is natural that Western Electric leads in the field of electronic equipment. For radio work

there is a full line from the small peanut tube to the huge water cooled power tube. Cathode ray

Western

ELECTRONIC

Distributed by Graybar

Sound Transmission *electronic equipment too!*



Photo-electric Cell





Cathode Ray Oscillograph Tube



Vacuum Thermocouple



Ionization Manometer

oscillograph tubes, photo-electric cells, highly sensitive thermocouples, ionization manometers are special units for laboratory work.  Uniform characteristics, sturdiness and long life are built into all Western Electric tubes—they're made to Bell System  standards of precision and performance. Rely on the natural leader! . . . Send the coupon for further information —better still, write us fully about the kind of electronic equipment in which you are interested.

Electric
EQUIPMENT
Electric Company

GRAYBAR ELECTRIC CO., R E 10-31
 Graybar Building, New York, N. Y.
 Gentlemen: I would like information on the following electronic equipment:

.....

Tubes I am now using are:.....

.....

NAME.....

ADDRESS.....

CITY..... STATE.....

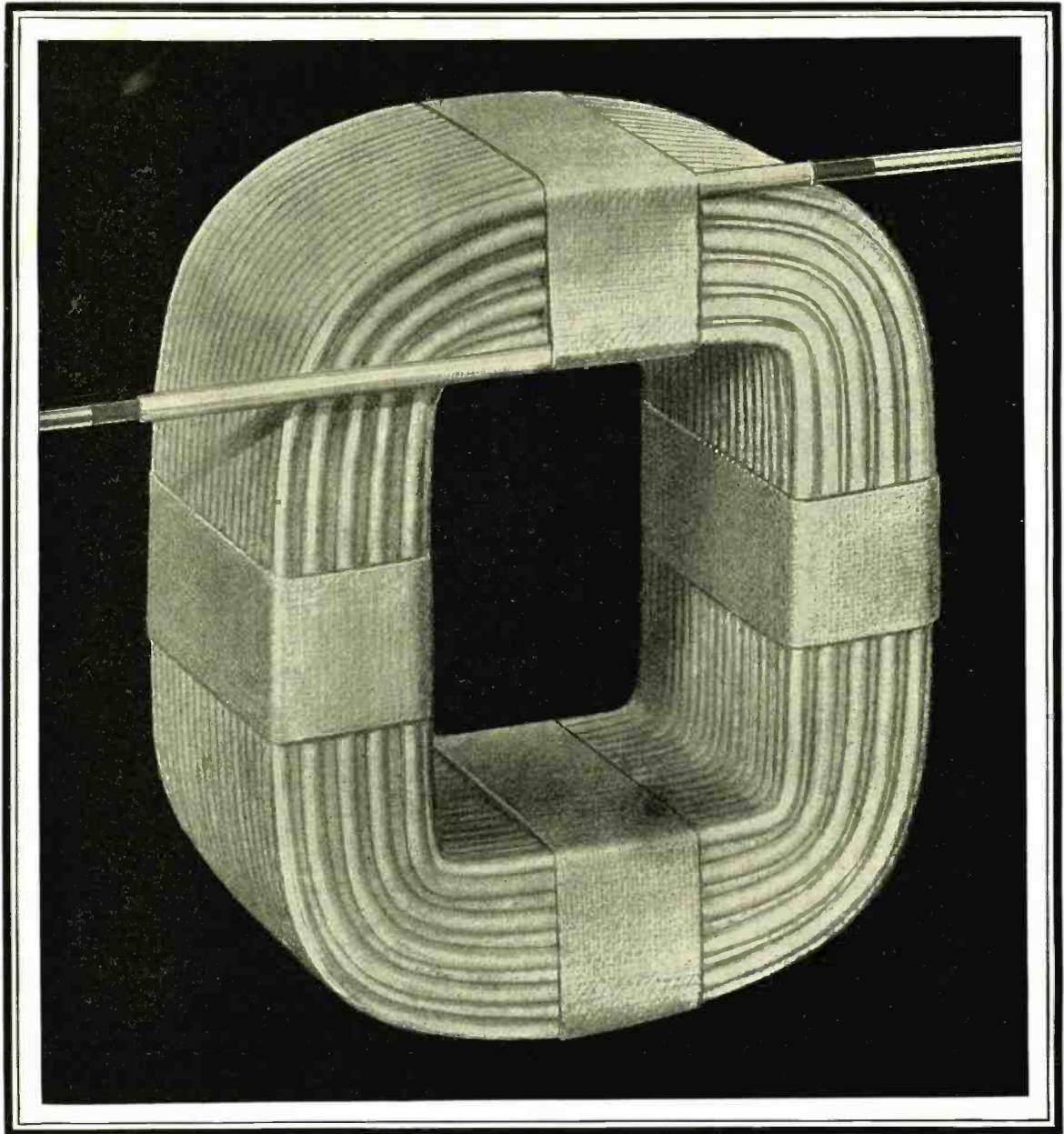

COMMERCIAL RADIO AUTOMOTIVE COILS

High grade magnet wire, made by General Cable; modern manufacturing methods; skilled operators; correct engineering and design . . . such advantages make General Cable Coils more dependable! There is a General Cable Coil of the right size and type for any application you may have.



GENERAL CABLE CORPORATION

EXECUTIVE OFFICES: 420 LEXINGTON AVENUE, NEW YORK CITY

FERRANTI

FLAT RESPONSE CURVES required by broadcast stations and laboratories, and in speech transmission

FERRANTI AUDIO FREQUENCY AND OUTPUT TRANSFORMERS



SPECIAL TRANSFORMER

FERRANTI SPECIAL IMPEDANCE MATCHING TRANSFORMERS

- AF 5M Microphone Transformer to couple 200 ohm two button microphone to tube. Ratio 1-20
- AF 5MX Special Mixing Transformer for coupling several two button microphones as required in mixing panels.
- M L Special Microphone Transformer for coupling two button microphones to lines.
- T L Special Tube to Line Transformer for coupling between tubes and lines.
- L L Special Line to Line Transformer for coupling between lines.
- T S Special Tube to Speaker Transformer for coupling tubes to speakers.
- L T Special Line to Tube Transformer for coupling lines to tubes.
- L S Special Line to Speaker Transformer for coupling lines to speakers.

Many other types can be manufactured as required, such as special output transformers for coupling PENTODE and other types of tubes to speakers, lines, etc., etc.

STANDARD TRANSFORMERS can be shipped immediately from stock.

SPECIAL TRANSFORMERS can be wound and shipped via Insured Parcel Post or Express within four hours after receipt of complete specifications.

Dimensions, width 3 in., depth 2¾ in., height 3¾ in.

Net Weight 2 lbs., 10 oz.

- AF 5 Standard Audio Frequency Transformer for coupling between the plate of one tube and the grid of another. Ratio 1-3.5.
- AF 5c Standard Push-Pull Audio Frequency Transformer for coupling between the plate of one tube and the grids of two tubes in push-pull. Ratio 1-3.5. (Centre tapped secondary)
- AF 5cc Standard Push-Pull Audio Frequency Transformer for coupling two plates push-pull to two grids push-pull. Ratio 1-3.5. (Centre tapped both primary and secondary)
- OP 1c Standard Push-Pull Output Transformer for 2000 ohm tubes such as type 245, 250, etc., used for coupling the output of a radio set or amplifier to a speaker containing its own output transformer. Ratio 1-1. (Centre tapped primary)
- OP 25c Standard Push-Pull Output Transformer for 2000 ohm tubes such as type 245, 250, etc., used for coupling between the output of a radio set or amplifier to the voice coil of an 8 to 16 ohm dynamic speaker. Ratio 25-1. (Centre tapped primary).

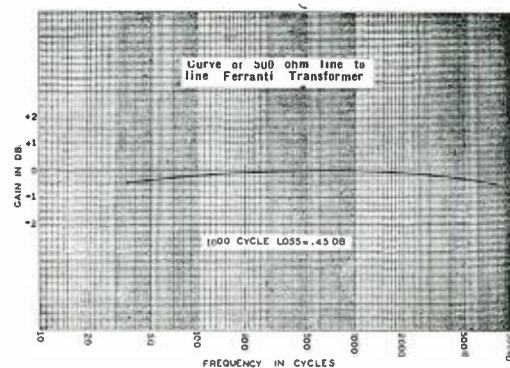

Typical Response Curve

130 West 42nd St.

FERRANTI, INC.

New York, N. Y.



**LOOK BEHIND THE TUBES YOU BUY
AT THE MAKER'S ABILITY TO SERVE YOU**



**BEHIND EVERY HYGRADE
OR SYLVANIA TUBE IS AN
ORGANIZATION WITH
UNSURPASSED FACILITIES
TO SERVE
SET MANUFACTURERS**

GET THESE facts about the maker of the tube — they are vital to your satisfaction.

Experience

It takes a background of years to understand fully the set manufacturer's needs. Hygrade Sylvania has such a background.

Production Facilities

Meeting stiff delivery schedules and effecting mass production economies call for high production facilities. Hygrade Sylvania makes 70,000 tubes a day — one of the world's largest manufacturers.

Engineering Skill

Keeping abreast of the times in tube construction calls for a highly skilled engineering department. Hygrade Sylvania employs a large staff of capable engineers.

Financial Strength

HYGRADE SYLVANIA — soundly financed, conservatively managed — is an outstandingly successful organization. Its stability and promise of future growth insure the buyer of tubes made by Hygrade Sylvania against disappointment, dropping off in quality or failure to deliver.

HYGRADE SYLVANIA CORPORATION

**HYGRADE LAMP DIVISION
SALEM, MASS.**

**SYLVANIA DIVISION
EMPORIUM, PA.**

CAPACITORS

The Dubilier line reflects the latest efforts of William Dubilier, pioneer condenser designer and manufacturer, in collaboration with the Dubilier engineering and production staffs. Startling improvements and refinements have been scored in standard types. Entirely new capacitors have been introduced. Marked economies have been effected in production, without slighting established quality. Thus the largest exclusive manufacturer of condensers or capacitors retains its leadership.

DUBILIER TRANSMITTING CAPACITORS

Backed by twenty years of intensive engineering, these capacitors have been further refined and improved. Simplified production, based on novel engineering, has effected marked economies. An expanded production to meet the demand has set new low prices despite obvious increased values.

DUBILIER ELECTROLYTIC CONDENSERS

Two years of concentrated attention on the many problems of the electrolytic condenser have resulted in products worthy of the label that stamps Dubilier quality, performance and long life. The Dubilier electrolytic condenser line now includes filter and by-pass units for all standard purposes.

DUBILIER TUBULAR PAPER CAPACITORS

Finally, keeping in step with the trend towards utmost economy in radio set production costs, Dubilier engineers have evolved a line of tubular paper capacitors. Compact, neat, wrapped in tough paper jackets, thoroughly impregnated and fitted with pigtailed that cannot pull loose, these Type 706 capacitors, available in a wide range of working voltages and capacities, fulfill the requirements of either the QUALITY builder or the PRICE builder of radio sets.

WRITE for literature covering any of the above as well as the general types of capacitors. And do not hesitate to place your condenser problems before our engineering staff.

DUBILIER CONDENSER CORPORATION

Condenser Specialists since 1910
4377 BRONX BOULEVARD
NEW YORK CITY



Impressions and Expressions

By AUSTIN C. LESCARBOURA

ENGINEERING

IT is one of the anomalies of an industry rich in inconsistencies that its very foundation receives a minimum of consideration. We refer to the engineering end of the radio industry, which is made up of individuals known as radio engineers whose compensation frequently averages lower than factory hands and cub salesmen. And yet radio successes and radio failures may be readily traced to good and bad engineering, largely dictated by fair or unfair compensation.

One company after the other which finds itself in difficulties these days eventually wakes up to the fact that its engineering is at fault. In our own personal experience we know of large corporations that have been all but ruined by poor engineering. Signs of poor engineering are very much in evidence these days. One corporation has a fortune tied up in contracts the terms of which have not been met because of faulty engineering. Another corporation finds itself with a vast amount of production equipment that cannot be used in making the product called for. Still another corporation has lost sales steadily during the past five years, finally to wake up to the fact that its engineering technique is years behind the times. And so it goes.

The foundation of a successful radio business rests on a firm engineering foundation. Such a foundation comprises skilled engineers. Skilled engineers must be kept happy in order to produce their best work. And happiness is very largely spelled by a fat pay envelope. And that fat pay envelope is certain to be met by increased profits resulting from a firm engineering foundation. The vicious circle is readily established and maintained by a wise management.

OVERHEAD

DESPITE the dense smoke screen of the general business depression, we occasionally sense poor management as the main cause of individual difficulties. Indeed, poor management is wrapping itself securely in the smoke screen of business depression, as contrasted with normal times when alibis would be scarce. And the greatest sign of poor management these days is a high overhead which remains unchallenged in the face of insufficient volume of business.

Harking back to the boom days prior to the stock market collapse, we can readily recall the popularity of radio stocks. There were companies that were in the stock-selling business rather than in the business of selling radio merchandise. Such companies were in position to build huge plants, to hire an impressive array of personnel, to conduct startling advertising campaigns, and to undertake elaborate merchandising campaigns. If the company got into the red, it was a simple enough matter to float another stock issue, whereupon enough money would pour into the coffers to navigate for another period of time. With the collapse of the stock market, however, such organizations were stripped of their main source of income—the sale of never-ending issues of stock.

Large and small companies alike, be they corporations, partnerships or individually owned, stock promotions or

otherwise, must face the situation of a lower volume of business by trimming the overhead accordingly. The radio industry must shift into low gear. It cannot maintain its huge productive capacity of other days. Individual companies are carrying too much overhead. Such profits as can be made today are being made by shifting into low gear—reducing the overhead to match orders.

LIGHT-CONTROL

WHILE much romancing has marked the discussions of light-control or photoelectric control in the past, it now begins to look as though the wildest dreams may come true. Heretofore the art has been handicapped by an intricate technique calling for too much equipment and too much investment for the accomplishment of any given task. Today, with the advent of refined selenium cells requiring a minimum of amplification, together with new forms of control tubes and vacuum contacts whereby a very considerable energy may be controlled with a minimum of controlling energy, the entire picture changes.

It is our belief that the next year will see startling strides in the light-control or photoelectric art. Applications now undreamed of will become commonplace. Companies engaged in developing this new art are finding more and more possibilities. Keen interest is being displayed by many industries.

An enormous amount of engineering effort is required for the development of the photoelectric art, and only those companies thoroughly grounded in engineering are going to find a place in this new field.

STUNTS

TO what extent broadcasters keep an ear to the ground, we do not know. It is our present opinion that broadcasters build up program schedules largely around the efforts of their salesmen, or, to put it another way, the preference of program sponsors. As a consequence, radio broadcasting becomes increasingly stereotyped in its character, and decreasingly appealing to its audience.

Whether broadcasters realize the fact or not, their very existence depends on appealing to their audience. While true that sponsors furnish the wherewithal to maintain the broadcasting establishment, there will be no sponsors if there is no audience. During the past few months there appears to be an appalling lack of interest on the part of the erstwhile enthusiastic radio audience. Lack of stunts and the tiresome sameness of programs are responsible for a changing attitude.

Here is something which is vital to the radio industry. After all is said and done, the entire industry is predicated on just one thing: an entertainment service made available to every home. If that entertainment service fails to entertain, the radio industry might as well pack up and quit, except to meet the requirements of communications.

To pep up radio interest and increase sales, broadcasters must give us stunts, thrills, surprises. We are dealing with a jaded public. Nothing short of the most startling stunts ever undertaken by broadcasters will provide a groundwork for radio sales this fall.

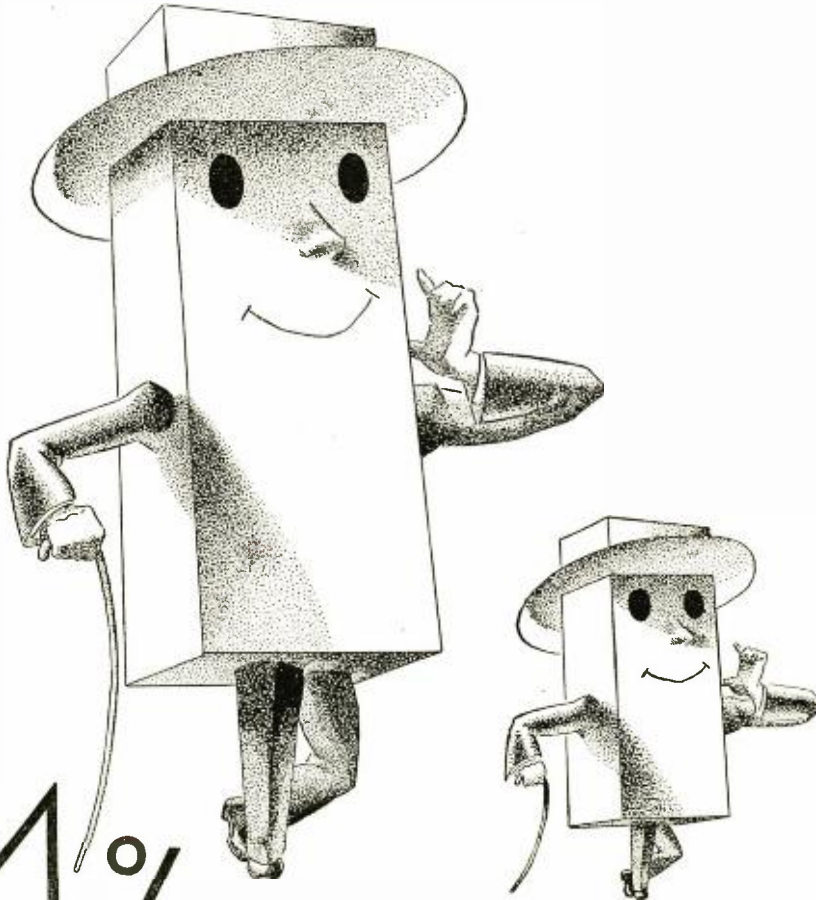

4% POWER FACTOR

THE extraordinary high efficiency of the Elkon non-aqueous electrolytic condenser is well demonstrated by the very low power factor on which it operates. In recent tests it averaged 4%—against 15 and 20, 30 and more percentage power factor of other condensers. It has the highest filtering capacity, low leakage, long life, requires no metal can, and because it is dry* it can be mounted at any convenient angle. Furthermore Elkon has practically the same characteristics as paper condensers—but is *lower in cost and much less bulky* . . . and here's news—all of the above characteristics apply to our new Bi-pass condensers. 73 leading set manufacturers have standardized on Elkon. A request today will bring you your sample tomorrow. Complete information will be sent to all members of your technical staff. Just send their names.

*—water of crystallization, of course—but no *free* water.



ELKON DIVISION OF
P. R. MALLORY & CO., Inc., Indianapolis, Ind.
Sales Offices: New York • Cleveland • Detroit • Chicago • Los Angeles

COST LESS TO BUY AND LESS TO INSTALL

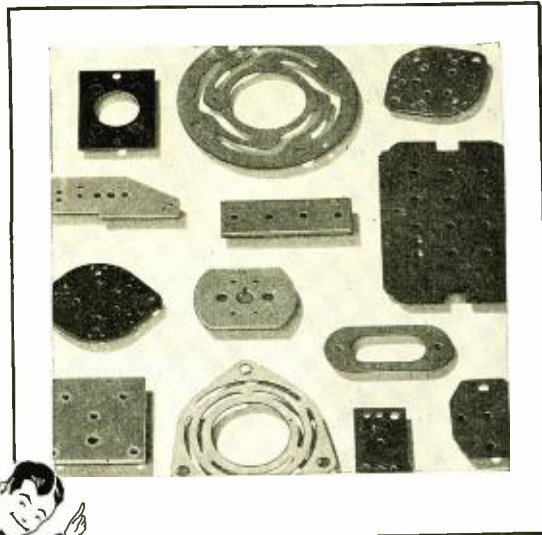

*A few representative pieces
of Textolite laminated pre-
pared for application to
radio receivers*

MEET — the
Radio-frequency
Family of

TEXTOLITE LAMINATED

General Fabricating Co.
37 East 18th Street
New York City

Electrical Insulation Corp.
308 W. Washington St.
Chicago, Ill.

EXHAUSTIVE tests show that in the radio-frequency grade of Textolite laminated the power-factor is so slightly changed by wet or dry conditions that humidity ceases to be a problem. This distinguishing quality, combined with characteristics of easy machinability and mechanical strength, accounts for the use of Textolite in leading radio receivers.

Ask the Textolite specialist at the G-E office in your vicinity, or representatives of the eastern or western fabricators, to outline the properties of this insulating material which make it desirable for application to the set you manufacture.

S H E E T S

R O D S

T U B E S

831-4
GENERAL  **ELECTRIC**

S A L E S A N D E N G I N E E R I N G S E R V I C E I N P R I N C I P A L C I T I E S

Thirty million
homes in U. S.—
Twenty million
Ford cars
produced



Donald McNicol signs register testifying to the production of the twenty millionth Ford car.

—How many radio receivers?

THE possibility of a \$6,000,000,000 radio industry rising out of the current depression and aiding the return of prosperity was presented in an address on August 2 by Dr. Julius Klein, Assistant Secretary of Commerce. Dr. Klein, who spoke over the coast-to-coast network of the Columbia Broadcasting System, pictured the radio industry as expanding rapidly, even in the face of the economic situation.

According to Dr. Klein, approximately 26,000,000 sets are in service around the globe, while figures of the Census Bureau indicate that approximately 10,000,000 homes, one-third of all those in this country, have been equipped for radio reception.

It is probable the radio industry has only half grown, the speaker pointed out and this is a factor which concerns the recovery of business. He said that after each serious depression of modern times, "the opening and development of some particular new field of human occupation for human energy contributed markedly to the restoration of prosperity."

Dr. Klein said radio sets are most irregularly distributed, some states having but 5 or 6 per cent of their homes so equipped, while Rhode Island has 57 per cent and Connecticut almost 55.

The twenty millionth Ford automobile recently turned out at Dearborn represents the extent of production of one company in the automobile field since the industry started. At the present time it is understood that there is one automobile in service for each 1.7 families in the country. A larger percentage of families own automobiles than own vacuum cleaners. As the

Department of Commerce rates homes, there are approximately 30,000,000 of these in the country. A larger percentage of families own radio receivers than own automobiles, but the margin is not large as no doubt will appear in the complete figures of the census.

The factors saturation and obsolescence have an important bearing on the possibility for additional sales of radio receivers in the years ahead.

While saturation is closely related to the general national economic situation it would appear from the statistics before us that there are approximately 15,000,000 unsold radio prospects.

A new slant on the receiver sales situation came to light during the past three months, while an effort was made to estimate the extent of the "return to the farm movement." Inquiry in localities where the home-coming was largest discloses that radio sales have picked up considerably.

If the estimate of 16,000,000 radio receivers sold in the past six years is approximately correct, and it is agreed that obsolescence would require each purchaser during these six years to have had consecutively three receivers, it is at once apparent that there are still in use a very large number of receivers of the first and second vintages.

Replacement of existing obsolescent receivers added to the 15,000,000 unsold homes will constitute a large aggregate of sales to be made when general business conditions improve or become stabilized.

The forecast that the radio industry is but half grown may be found to be true.

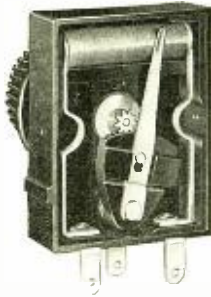

In the Bradleyometer approximately 50 solid resistance disks are interleaved between metal disks forming a resistance column of any desired value. No other resistor offers such flexibility or accuracy.

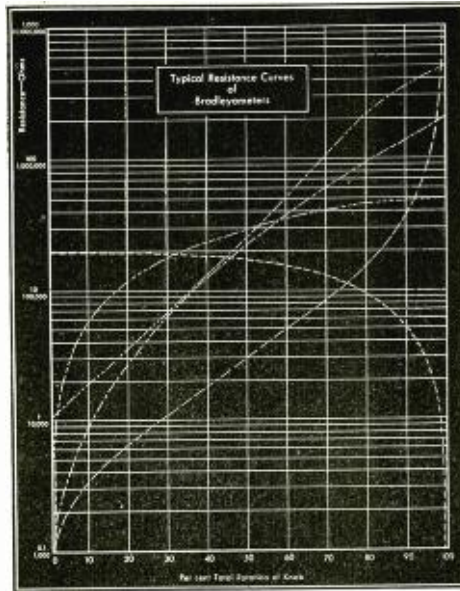

Type A, Single Bradleyometer



Type AA, Double Bradleyometer



Type AAA, Triple Bradleyometer

With Leads



Radio Resistors

Fixed or Variable for any Electronic Circuit

Without Leads



BRADLEYUNIT RESISTORS are made in five sizes, with or without leads. All Bradleyunits are color-coded to meet set manufacturers' specifications. These solid molded resistors are accurately calibrated and have great mechanical strength. They are used by the world's largest radio manufacturers for providing correct C-bias, plate voltage, screen grid voltage and for use as grid leaks.

The Bradleyometer is a stepped potentiometer of most amazing performance. It has astounded radio engineers who were skeptical of its advertised performance. Any type of resistance-rotation curve can be arranged to meet your requirements. Samples will be sent to established manufacturers of electronic apparatus, for test and trial.

Get an Allen-Bradley quotation on your next resistor order.

Allen-Bradley Co.

126 W. Greenfield Ave.

Milwaukee, Wisconsin



ALLEN-BRADLEY RESISTORS
Produced by the makers of Allen-Bradley Control Apparatus

RADIO ENGINEERING

Production, Administration, Engineering, Servicing

OCTOBER, 1931

Factors in the selection of the proper radio power transformer

By J. A. COMSTOCK*

DUE to the radio power transformer being the prime contact between the power supply and the other components of the radio set, it should receive greater consideration, in respect to design and lasting qualities, than has often been given this unit in the past.

Transformer failures are doubtless greater today than failures of any other component, with the possible exception of the filter condenser. Of course, a failure occurring in one of the filter condensers is reflected in the power transformer and often results in the destruction of this unit also. This trouble is becoming less with the improved condensers manufacturers are now turning out.

A brief outline of a suitable type of transformer is set forth below.

The silicon content of the electrical sheet used in the core construction must be of sufficient quantity to defer aging of steel; that is, an increase in core loss with age. This condition occurs only in very low grades of electrical sheet and is greatly accentuated by heat.

The transformer should meet the tolerances set forth by the radio engineer, and in most cases these are in the neighborhood of plus and minus 3% on filament windings and plus and minus 5% on high voltage windings. The transformer should also be capable of withstanding the dielectric tests specified by the Underwriters' Laboratories.

Tests

The transformer that is designed with the correct insulation between

*Chief Engineer, The Acme Electric & Mfg. Company.

layers, etc., using the normal 115-120 volt primary, should withstand an induced voltage test of 340 volts primary at three times normal frequency for a period of at least 5 minutes. This is a very excellent method by which to determine whether or not the transformer will stand up in service over a period of time.

The temperature rise of the transformer windings, determined by resistance method, should not exceed 40 degrees Centigrade rise from an ambient of 25 degrees Centigrade when connected to a full load at normal primary voltage and frequency.

The insulation materials used should withstand a constant temperature of 95 degrees Centigrade without deterioration. This is highly important for export work where 50-cycle installations are made with the standard 60-cycle receiver. The past season has shown a tendency on the part of the radio manufacturer to eliminate the primary tap on the power transformer and design the primary for one voltage only, generally about 120 volts. The secondaries are then designed to deliver, at the tubes, the maximum rated voltage for the particular type of tube used.

This arrangement generally proves quite satisfactory, inasmuch as the greater percentage of house lighting circuits are in the neighborhood of 110-115 volts. The tube filaments are, therefore, operated below the maximum value and result in added tube life. This feature has two distinct advantages; namely, reduction in manufacturing cost by the elimination of the primary tap and of the high-low switch. Also, there is no chance of the operator turning the switch to the low voltage position when

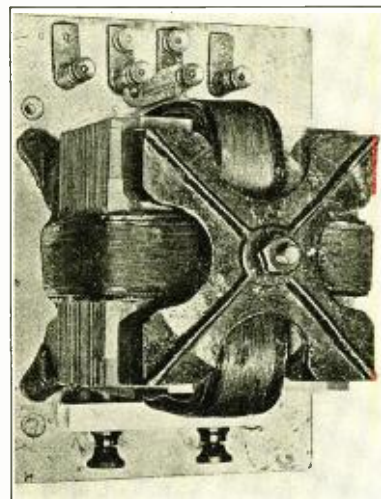

Small transformer constructed by Sir Robert Hadfield in 1903, of silicon steel.

connected to a high voltage supply. The disadvantage of the fixed primary is experienced in localities having very low line voltages.

For satisfactory operation of a receiver, it is particularly necessary that the power transformer have an electrostatic shield properly placed between the primary and the secondary windings. This feature has often been neglected due to a none too clear understanding of the theory of this shield.

A sensitive receiver, when used in connection with a power transformer without an electrostatic shield, will develop a very noticeable modulation hum when tuned to a carrier wave. This condition is very greatly accentuated when tuned to a carrier radiating from a local station.

The modulation hum is set up by the capacity between the primary and secondaries, which results in the secondaries being charged with a static e. m. f. which varies with the applied primary frequency.

This charge thus induced in the secondaries flows to ground and, in so doing, passes through the C bias resistors of the r-f. stages, thereby changing the grid potential of the r-f. tubes, which modulates the impressed carrier.

When tests are conducted some distance from a broadcasting station. This



Enclosed radio transformer.

trouble is not often noticeable, due, no doubt, to a weaker carrier.

Specifications

The radio engineer, in making up specifications, should specify all voltages and currents required on the filament windings and the permissible plus and minus tolerances on same. Confusion is often a result of specifying the a-c. voltage each side of the center tap on the high voltage winding and then specifying the direct current in place of the r. m. s. current, which is the actual value flowing in this winding, and in practically all cases is greater than the direct current.

It is necessary that the transformer design engineer knows the r. m. s. current in order to determine the I²R loss. The actual wattage of this winding is about

$$\frac{\text{total voltage I.}}{2}$$

This is due to the fact that when one plate of the 280 rectifier is on the positive half of the cycle the other plate will be on the negative half of the cycle which, naturally, results in current flowing in but half of the winding at a time. The wattage of this winding is also largely dependent upon the capacity used in the first position of the filter circuit, as this governs phase displacement.

In the foregoing it is shown that the designer must use wire of ample size to carry the r. m. s. current flowing and should not try to arrive at this value by wattage.

The Underwriters allow a maximum temperature rise of 55 degrees on a power transformer, making use of paper, cloth, varnish and other forms of combustible insulation materials. Due to the rather high ambient temperature within the radio cabinet, it is good practice to design the radio power transformer with a temperature rise not exceeding 40 degrees Centigrade

when measured by a change of resistance method as follows:

$$R^1 - (234.5 + T) - 234.5 = \text{the maximum temperature.}$$

Subtract T from this value and this gives the temperature rise.

R = Resistance, cold.

R¹ = Resistance, hot.

T = Room temperature or ambient temperature surrounding the transformer.

In taking the temperature rise, the transformer should be run under load until the heat generated becomes equivalent to the heat radiated. This condition is obtained when the temperature of the transformer fails to rise higher and may be easily checked by a thermometer placed on the core of the unit. It is advisable to allow the unit to run under full load for a period of at least 12 hours—or the above condition may



Open style audio.

be obtained in a much shorter period of time in some cases, depending upon the size of the unit on test.

It is well to keep in mind that a black object is a much better heat radiator than the same object of a white color, due to the increased monochromatic emissive power which may be defined as the ratio of the energy of certain defined wavelengths radiated at definite temperatures to the energy of the same wavelengths radiated by a black body at the same temperatures and under the same conditions. In order to determine to what extent color affects the temperature rise a sample power transformer was made up and encased in a black enamel case. With an ambient temperature of 26 degrees Centigrade the primary resistance was 4 ohms. The transformer was then subjected to a full load run for 24 hours at the end of which time the primary resistance was found to be 4.62 ohms. Therefore, the following temperature rise was obtained:

$$\begin{aligned} 234.5^\circ + 26^\circ &= 260.5^\circ \text{ C.} \\ 4.62 \\ \text{---} \times 260.5 &= 300.87^\circ \text{ C.} \\ 4 \\ 300.87^\circ \text{ C.} - 260.5^\circ &= 40.37^\circ \text{ C. rise.} \end{aligned}$$

The black cases were then removed from the transformer, the black enamel taken off and replaced with white enamel. Another 24-hour run was made under the same ambient temperature and load conditions and the resistance was found to be 4.72 ohms, from which value the following temperature rise was obtained:

$$\begin{aligned} 4.72 \\ \text{---} \times 260.5^\circ &= 307.39^\circ \text{ C.} \\ 4 \\ 307.39^\circ - 260.5^\circ &= 46.89^\circ \text{ C. rise.} \end{aligned}$$

From the foregoing it is plain to see that the transformer, when enclosed in a black enamel case, has a distinct advantage from a temperature rise standpoint over the equivalent transformer when using a light color.

The transformer on which these tests were conducted was a standard transformer used on an average 8-tube radio set. Inasmuch as a 6.52 degree greater temperature rise was experienced with the light colored case, it is well to keep this feature in mind.

The subject of proper insulation materials to be used in power transformers is also a rather comprehensive one and, in the brief space covered by this article, cannot be thoroughly discussed.

Insulation

The selection of wax or varnish for insulation impregnation is also a matter on which engineers differ in opinion and there are many advantages given by the advocates of each side. However, it might be said that thermal conductivity of insulating materials as well as of impregnating compounds plays a very definite part in the temperature rise of the transformers and, therefore, should be given some consideration when transformers are specified.

Varnish has about the same thermal conductivity as wax. Due to the fact that it has a lower rate of penetration than a proper impregnating wax, var-



Closed type power transformer.

nish tends to collect on the paper insulation between the layers and congeal on the surface rather than to impregnate the paper thoroughly and offers greater resistance to the conductivity of heat, due to the poor thermal conductivity of untreated paper.

The dielectric qualities of varnish-treated paper are comparable with those of the impregnated wax paper. Because of the varnish congealing on the surface of the paper the rate of linear thermal conductivity is lower, which results in the transformer having a somewhat higher temperature rise when the coil is varnish-impregnated.

Also, as a rule, proper impregnating wax will more thoroughly impregnate the coil, due to the fact that the viscosity of the hot wax, in liquid state, is somewhat lower than that of most insulating varnishes.

It is advisable, between the first two layers of the high voltage winding and between the last two layers of the high voltage winding of a power transformer, to have twice the layer insulation which is used through the balance of the winding.

A brief explanation is that a transit wave is superimposed on the fundamental frequency and increases the voltage between turns and between the first layers on a high inductance coil. The origin of this transit phenomena may be due to a number of various causes.

It may be said that in designing a transformer, the correct flux density for most practical designs should be in the neighborhood of 10,000 gausses per square centimeter for 60 cycles operation. However, this figure is not a

fixed value and is more or less subject to a considerable increase where high quality core materials are used.

Mechanical vibration of the core is also sometimes the limiting factor of flux density which may be used. Screws placed in the corners of the core or in other positions in the line of flux path will create an eddy current loss in themselves. In some cases this is sufficient to cause overheating of a transformer which, otherwise, would be perfectly good. This condition may be avoided by having the screws placed in the proper positions through the core.

Most line voltages are in the neighborhood of 110-120 volts. In some parts of the country line voltages do run up to 130 and in arriving at the correct flux density the increased line voltage must be kept in mind, as the primary voltage is directly proportional to the

flux density. Therefore, a transformer which is designed with a rather high flux density for a normal line, with an abnormal temperature rise may result in the flux density being increased to the saturation point, which is sure to result in excessive primary current and consequent failure of the transformer. This is generally overlooked by radio receiver engineers.

Copper wire current densities of around 600 to 1,000 circular mills per ampere are also given by some writers as being standard designs, but here again we are confronted with problems of thermal conductivity as well as heat radiation and convection, which are the really determining factors of the final temperature rise.

Any good transformer design is a compromise of the various elements of core density, current density and heat conductivity in its various components.

Step-down transformer.

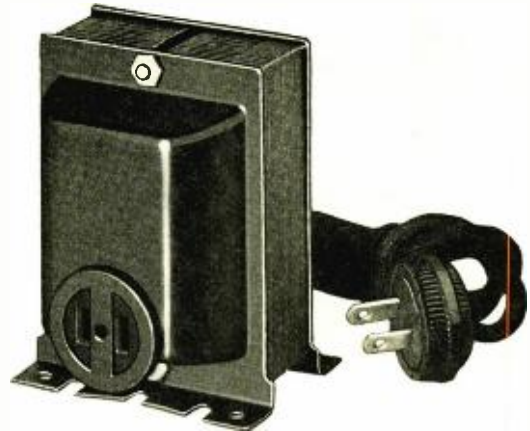

Michael Faraday and the transformer

MICHAEL FARADAY, born in England in 1791, had been a newsboy and a book-binder's apprentice prior to the time he entered the Royal Institution at twenty-two years of age as assistant to Humphrey Davy. During the first ten or twelve years there his duties were largely of a chemical nature, although he managed to keep well abreast of the times in knowledge of what had been accomplished in the study of electricity and magnetism.

Ampere had shown that by means of an electric circuit magnetism could be produced, and following some experiments carried out by Arago, in France, in 1825, Faraday became possessed of the idea that by means of magnetism electricity could be produced. The account of his experimental studies car-

ried on between 1825 and 1831 discloses mainly a long series of failures. Perhaps on more than one occasion throughout these experiments the great truth was thundering for acceptance. The stumbling block was that Faraday had expected magnetism to produce a sustained electrical effect in a wire circuit.

Reasoning that current flowing in a wire has a continuous effect upon a suspended magnetic needle, Faraday's thought was that in some fashion it might be shown that a magnet could in turn create a continuous flow of current in a wire circuit. The generalization known as the principle of conservation of energy was not at that time available as a check upon hypothesis. However, the apparatus Faraday devised to investigate the matter, while

it did not confirm his first notion, served as the instrumentality through which a more momentous truth was uncovered.

The apparatus employed consisted of an iron ring upon which was wound two coils of insulated wire. In present-day terminology we would recognize this as a one-to-one ratio transformer. With a galvanometer connected to the terminal wires of one coil, Faraday passed a current of electricity through the companion coil. We can realize that his feeling at first was one of dismay as the galvanometer needle "kicked" over to one side and then returned to its original position. Although current continued to flow through the coil connected to the battery, the magnetic needle gave no fur-

(Concluded on page 36)

The tuned-circuit problem in short-wave receivers

By A. BINNEWEG, JR.

TUNED circuits for common broadcast receivers are relatively easy to design. One doesn't particularly worry over LC ratios. The problem resolves itself, more or less, into the selection of a suitable size of condenser capacity, and coils to match to cover a range of 1,000 kc. For multi-stage r-f. amplifiers, there is a similar coil and condenser for each stage and a few trimming condensers for lining up the circuits. However, at short waves, the problem is much more difficult.

A short-wave receiver must cover a relatively enormous frequency range. That in itself is quite a problem, considering the tuned circuits. But, the capacity values used in short-wave receivers are comparatively so small that small stray capacities have considerable effect. Even the lengths of wire used in wiring the radio-frequency components of the receiver must be considered. Another difficulty arises from the fact that even the best tubes are not very sensitive at short waves. This makes it necessary to use low-loss tuned circuits and a regenerative detector. A regenerative detector is a foreigner to most broadcast engineers since it has not been used to any extent for several years. So there are a number of difficulties that make short-wave receiver design interesting. The regenerative detector furnishes the most entertainment. Regeneration is necessary for increasing sensitivity and also because short-wave receivers are sold to those who receive code, and oscillation is necessary for code reception.

Even the best of tubes when used at short waves are not very sensitive. Also, it is difficult to line up the r-f. stages of a short-wave receiver; hence, the addition of more r-f. stages means more controls. But an educated public does not care for a large number of controls, so that a relatively few stages

of r-f. may be used. It is clear that if a small number of stages is used, one must design the few stages that are used for maximum efficiency. That introduces other problems. Low-loss coils are not difficult to design, but they should be space-wound in general, and wound on a low-loss form. One manufacturer has developed a special low-loss form material for this purpose. Most of the loss, as is usual in tuned circuits, is in the coils used.

It would perhaps be not difficult to line up the r-f. stages of short-wave radio-frequency amplifiers if it were not for the fact that the frequency range covered by a short-wave receiver is relatively great. A common method for covering this large range is by the use of plug-in coils and a condenser of suitable size, so that the problem of lining up the stages becomes clear. The regenerative detector tuned circuit generally consists of a secondary coil and a fixed tickler coil, the regeneration being controlled by either a capacitive (or "throttle") control, or a resistance in series with the plate supply to the detector. The tickler coil throws things off, in general, since the capacity between the ordinary secondary loads up the detector tuned-circuit making it difficult to line up the detector with the first radio-frequency stage. We do not say that it can not be done, but we do say that it is not easy. The wiring in the detector or r-f. leads, as well as the tube capacities themselves, cause troubles, and the tube capacities vary with different tubes.

Design of the Tuned Circuit

For the reasons given above, let us assume that the receiver design shall consist of a screen-grid detector and one stage of tuned radio-frequency amplification ahead of it. The problem is to design the tuned circuits for detector and radio-frequency stages. If we are inventive we may design a new type of tuning device. However, most of us must be content with either of the following tuning arrangements: A suitable size condenser and a collection of plug-in coils; plug-in coils and plug-in condensers; plug-in tuned circuits;

tuned circuits in conjunction with a rather complicated switching arrangement; a device like the "Aero" tuning unit.

In selecting a suitable size tuning condenser, one will naturally select either a .0001, .00014, or a .00015 (mmfd.) size. These are the common types. The .0001 size makes it easier to tune-in a station, but the range covered is relatively small so that more plug-in coils are needed. However, if the minimum circuit capacities are kept small (this would perhaps not be advisable if one attempted to make a multi-stage r-f. amplifier) only three plug-in coils are necessary to cover the range from approximately 15 to 90 meters. The .00014 size is so close to the .00015 size that it is like splitting hairs, worrying over the difference. These condensers cover larger ranges, but require fewer plug-in coils. With somewhat greater minimum capacities, three plug-in coils will also cover about the same range.

In general, from the point of view of low cost, the use of plug-in coils in conjunction with a suitable condenser will be satisfactory. The saving in cost to the set purchaser means more, usually, than the small inconvenience of changing a few coils. Anyhow, one particular range works best at any given time; for example, the highest frequency range does not give many interesting programs, and is relatively dead at night.

Let us assume that it is desired to design a set of plug-in coils for the tuned circuits of the short-wave receiver. Formulas, although useful, give only approximate results. The coils desired are to be of the popular small diameter tube-base plug-in type. The coils having the approximate final specifications are plugged into the coil sockets and data is taken as to their

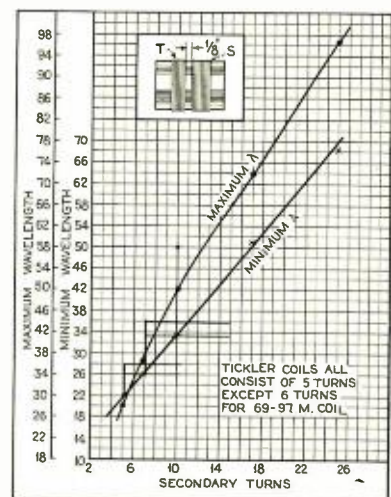

Fig. 1. Design curves for short-wave tube-base coils for 50 mmfd. tuning condenser.

▲
Practical information for receiver design.

ranges. Everything should be exactly as it is to be in the final model, even as to lengths of wires and tubes to be used. Don't make the mistake of running the curves on a set with a bakelite sub-panel and later changing the design to a metal chassis. An interesting fact is that the minimum capacity of a 100 mmfd. midget condenser is the same as a 150 mmfd. In other words, for given conditions they will start tuning from the same point.

The only data of usual interest is the minimum and maximum wavelength to which each coil size tunes with the given condenser. Suppose, for example, that the conditions are as follows:

Known circuit arrangement, known factors of construction, known tuning condenser size, known types of tubes, known coil form, known wire size and spacing of turns and coils.

Using coils near the correct values, take the minimum and maximum wavelengths to which each coil, when plugged into its socket, tunes. From these data and the specifications of the coils, two useful curves can be plotted as shown in Fig. 1. These curves are shown to illustrate the method since the condenser size used is rather small for ordinary use.

The conditions for Fig. 1 are as follows: Small portable receiver using the circuit diagram of Fig. 2. Tuning condenser size, was 50 mmfd. 201-A tubes used. The coil forms consist of ordinary tube bases. The coils "close wound" of No. 30 wire and the secondary and tickler coils separated 1/8-inch on the form. Coils wound to have short, direct leads to the tube-base pins.

Practical Use of Curves

These curves are quite simple to use. Select such ranges for the coils so that no important bands are cut. Also, determine upon an overlap between coils of such an extent that any minor variations in receiver construction will not leave any blank spaces between coils. It is also well to bear in mind that the upper and lower 10 degrees (assuming a 100-degree scale) are not useful for tuning purposes. The lower 10 degrees of an SLC condenser are practically useless because of cramped tuning. This fact is mentioned because common midget condensers are of this type. By using the curves of Fig. 1, the proper number of secondary turns can easily be determined for the desired ranges. Unless it is practical to use fractional turns, select the nearest full number of turns, favoring the greater overlaps, usually. For tube-base coils, it will be found that the tickler turns are almost the same, and they will be the same if, at some frequencies, the tickler coil is given a slightly greater spacing

Fig. 2. Circuit used in obtaining coil data of Fig. 1.

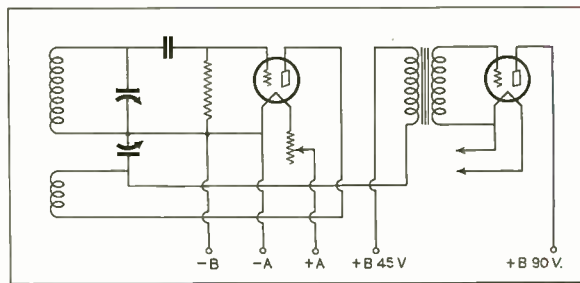

from the secondary than at the lower frequencies.

Coils For R-F. Amplifiers

An untuned r-f. amplifier has certain advantages, but a tuned screen-grid r-f. amplifier gives greater amplification. Plug-in coils are also necessary for tuned r-f. amplifiers.

Due to the broad tuning of the usual short-wave r-f. amplifier, it is not necessary to use the same size condenser as in the detector circuit. For this reason, a condenser as large as a .00035 size can be used. However, the amplification falls off rapidly as the capacity is increased beyond a certain value. If such a large condenser is to

be used, however, fewer coils can be used, and if the same number of coils are used as in the detector circuit, one can design the coils so that a given frequency can be tuned in at a low value of capacity, and a large coil, or a higher value of capacity with the next smaller coil. This is sometimes convenient. In general, it is best to use the same size of coils in the r-f. amplifier as in the secondary coils, whether or not the large size condenser is used in the r-f. stage. Some prefer a smaller condenser so that the circuits approximately line up. Nevertheless, the problem is met for the present, and many improvements are expected for the future.



More than 10,000 commercial operators now licensed

THERE were 10,761 persons licensed to operate commercial radio transmitting apparatus at the close of the fiscal year ending June 30, 1931, according to figures recently obtained from W. D. Terrell, Director of Radio, Radio Division, Department of Commerce. This figure represents an increase of 1,708, or 18 per cent, over the number of licenses outstanding at the close of the previous fiscal year (June 30, 1930).

The licenses were distributed as follows:

Class	1929-30	1930-31
Extra-First commercial...	41	38
First Class commercial...	3481	3481
Second Class Commercial.8019**	5379	5379
Third Class commercial..	None	41
Broadcast Class.....	543	944
Radiotelephone Class....	450	878

**First and Second Class combined.

Radiotelephone Class licenses were issued, representing a gain of 95 per cent.

The number of Extra-First Class commercial licenses decreased by three, or 7.3 per cent. At the present time only .3 of 1 per cent (one out of every 283) of the 10,761 licensed operators holds this class of license.

During the time there was an increase of 1,708 operators, the number of licensed commercial stations decreased by 66. On June 30, 1930, there were 3,984 commercial transmitting stations licensed by the Department of Commerce, divided as follows:

Ship stations.....	2,173
PG coast stations.....	112
Commercial transoceanic.....	165
Broadcasting stations.....	612
Limited commercial.....	331
Experimental and television stations	287

The increase in the number of First and Second Class commercial operators' licenses was only 821, or 10 per cent, while the gain in other classes was much higher. The number of Broadcast licenses increased 401, or 73.8 per cent, while 428 additional

On June 30, 1931, 3,918 commercial station licenses and construction permits were outstanding, with little change in the distribution noted above, representing a decrease of 1.68 per cent from the previous year.—M.R.R., in C. Q., September, 1931.

Radio tube yardsticks

By L. G. LESSIG*

THE progress of civilization has changed the "Jack of All Trades" to a "Master of One." The radio tube is an outstanding example of this change. It is a specialist in its trade. The job for which it is best fitted depends on its grid, plate, and screen (if any) voltages, the distance between electrodes and the area of each, as well as many other factors.

Cathodes and filaments are generally operated "saturated"—that is, at temperatures beyond which there is little benefit from increase in electron emission. It is for this reason that filaments should always be operated at their rated voltage, since this value has been determined as the optimum filament temperature for best tube operation and life. The plate current, however, still depends upon two variable quantities, the grid and plate voltages. In a screen-grid tube the screen voltage must also be considered. The manner in which these variables affect the plate current determines the tube's characteristics, which in turn identify its functions.

Amplification Factor

The ratio between the plate voltage change necessary to produce a certain plate current change and the grid voltage change required to produce the same change in plate current is known as the *amplification factor*. It may be expressed thus:

$$\text{amplification factor} = \frac{\text{plate voltage change to produce a given plate current change}}{\text{grid voltage change to produce the same plate current change,}}$$

$$\text{or } \mu = \frac{dE_p}{dE_g}$$

(d in an equation is a symbol indicating an extremely small change.)

If, for example, the amplification factor of a tube is 6, adding 30 volts to the plate will increase the plate current a certain amount. The same increase, on the other hand, can be effected by add-

ing only 5 volts (positive) to the grid. Conversely, higher negative grid bias voltage will reduce plate current and allow greater plate voltages, within limits. In other words, any voltage placed on the grid of such a tube has the same effect as a voltage in the plate circuit multiplied—or amplified—by the amplification factor of the tube.

The amplification factor for a given tube generally does not vary much under the conditions for which the tube is ordinarily used. It is controlled largely by the mechanical construction of the tube. Amplification factor increases with increasing distance between grid and plate.

Plate Resistance

When a plate current flows between the plate and the filament of a radio tube, a resistance is offered to the flow. The radio vacuum tube in service operates with pulsating and not constant values of grid voltage, plate voltage, or plate current. Such a pulsating current is considered to be a combination of direct current and alternating current. The resistance of the tube to alternating current differs from the resistance to direct current. We will consider here only the resistance offered to the flow of alternating current. It is known as plate impedance, although sometimes expressed as plate resistance. It is the ratio of the change in plate voltage to the change in plate current, and may be expressed in the following relation:

$$\text{Plate resistance} = \frac{\text{change in plate voltage}}{\text{change in plate current}}$$

$$\text{or, } r_p = \frac{dE_p}{dI_p}$$

The plate resistance is a measure of the effect of the plate voltage alone upon the plate current. At low values of plate current in three-electrode tubes, the plate resistance is relatively high.

As the plate voltage is raised, the plate resistance first decreases rapidly, and then more slowly, as the normal operating value is reached. If the applied voltage is very high, the plate resistance may again increase. This critical value indicates that the emission saturation point is being reached; that is, practically the full emission current is flowing. In general, the case is different with screen-grid tubes, since other factors affect the plate resistance.

If the filament emission at high plate voltages limits the plate current, the plate resistance will increase. This decreases the efficiency of a vacuum tube as an amplifier. The available emission of a UX-199 is approximately three times the value of the plate current (2.5 milliamperes) when the negative grid voltage is 4.5 volts and the plate voltage is 90 volts. With no grid bias, the plate current becomes about 5.75 milliamperes, which is close to the value of the emission current. It is at once obvious that a grid bias should be used with all tubes at high plate voltages to prevent excessive plate current and consequent short life.

Plate resistance not only depends upon the dimension and shape of the electrodes of the tube. The best value of plate resistance to be incorporated as a design factor of a tube depends upon the service for which the tube is intended and the power which is available to satisfy the filament and plate current requirements.

Mutual Conductance

Both the plate resistance and the amplification factor of a vacuum tube affect its performance as an amplifier. When comparing the merits of tubes, it is convenient to use a term called *mutual conductance*, which takes both of these factors into consideration. Mutual conductance (also known as transconductance) is the ratio of amplification factor to the plate resistance. (Concluded on page 34)

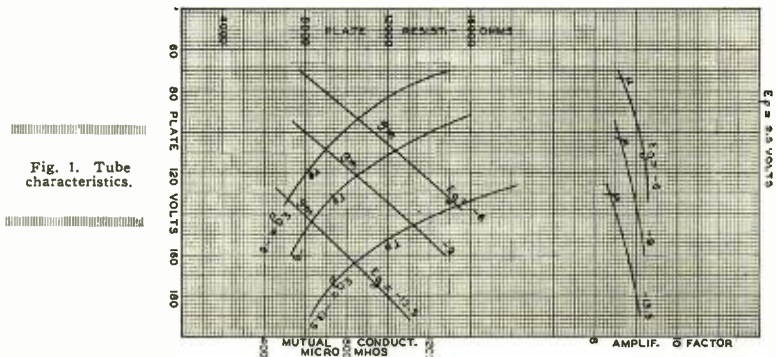

*Commercial Engineering Department, RCA-Radiotron Co., Inc.

Television reception with the superheterodyne

By R. WILLIAM TANNER

HERETOFORE it has been almost impossible to bring in television signals on a superheterodyne with even fair pictorial detail. A number of manufacturers have brought out supers claiming that these receivers will tune in television stations. To be sure, ANY short-wave receiver will do this but the question is: "Will the resulting pictures have good detail?" The answer is: "No, unless the receiver is designed especially for such use." When this is done, it is of little or no value for other services.

The reason for this is easily understood when it is considered that the highest audio-frequency encountered in present-day television practice is slightly higher than 40,000 cycles with 60 line scanning.

It is readily apparent then that a receiver wherein the tuned circuits are capable of passing a band of frequencies 80 kc. wide without sideband clipping, would hardly suffice for broadcast reception considering the fact that broadcast stations are allotted channels 10 kc. apart.

The problems of television superheterodyne design are many and varied. Sensitivity is merely a matter of sufficient number of intermediate-frequency stages. To bring about the condition of 80 kc. selectivity, some drastic work on the tuned circuits is required. Band-pass filters, properly constructed, will, of course, solve this problem, but are not an absolute necessity.

Choice of Intermediate Frequency

The choice of intermediate frequency and the elimination of image frequency interference assume no mean proportions. Also, considerable thought must be expended towards reducing regene-

ration in the i-f. stages and second detector to a negligible quantity.

There are two factors upon which depends how high or how low the intermediate frequency may be. The high limit is determined, not by the gain per stage, because high orders of amplification are possible from 2,000 kc. on down, but by the fact that the second and third harmonics of the intermediate frequency must fall outside of the television band. It has been found that these harmonics will generally appear with sufficient intensity to cause serious interference if allowed to feed back into the first detector. At first thought, it

the intermediate frequency. To eliminate this type of interference, it is essential that the selectivity of the tuned circuits preceding the first detector be sufficient to definitely suppress the unwanted signal.

If the intermediate frequency is too low, excessive selectivity of the first detector tuned circuits will be required which would mean greater complication in the construction as well as increased cost of production.

Image Frequency Interference

Even with the highest possible intermediate frequency, one tuned circuit ahead of the first detector is not sufficient to eliminate image frequency interference. At least two are necessary, the simplest and least expensive arrangement being in the form of a two section band-pass filter. Considerable research with all forms of supers has proven that this band-filter can be adjusted to pass a band much narrower than that required in the i-f. amplifier and still give good pictorial definition. This makes it possible to design the two sections for, let us say, 20 kc. selectivity which would enable the operator to tune out a television station operating on the next channel.

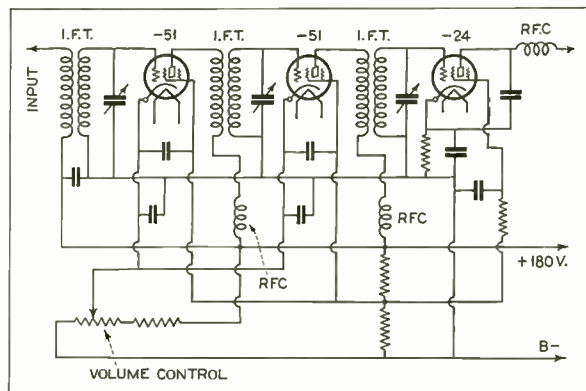

Fig. 1. Intermediate-frequency amplifier.

would seem simple enough to filter out these harmonics appearing in the second detector plate circuit, but, actually this is extremely difficult to accomplish.

The low limit is determined by the problem of image frequency selectivity; that is, of keeping the second signal, which a given oscillator setting will heterodyne to the intermediate frequency, far enough from the desired signal so that great selectivity will not be needed ahead of the first detector.

Image frequency interference, as it is termed today, is the old familiar repeat spot problem. Obviously, there are two oscillator frequencies which will serve to heterodyne a signal to the intermediate frequency, these being separated by twice the intermediate frequency. Also one oscillator setting will serve to heterodyne two signals to

At the present time, the writer has a super in operation which uses regeneration in the first detector as well as a band filter. Here in Michigan it is practically impossible to bring in the east coast 60 hole stations when any of the Chicago 45 hole stations are on the air. Yet with the super just mentioned, by merely increasing first detector regeneration to a point where selectivity is sufficient, the Jenkins stations are brought in with fine detail and with no interference from Chicago. Increasing the regeneration up to the point of oscillation results in the noticeable decrease in pictorial detail but not to the extent that would be thought.

Considering all of the factors mentioned, together with much research work, it would seem that an intermediate frequency somewhere between 400

Engineering details of the design of a superheterodyne receiver suitable for television.

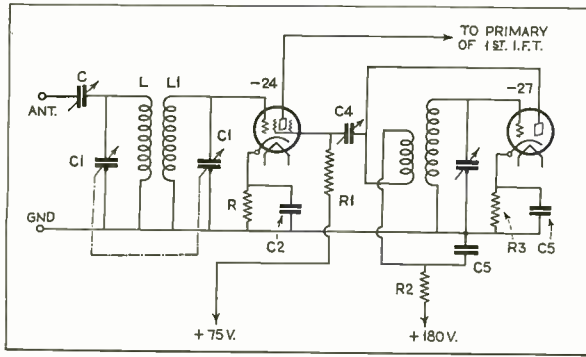

Fig. 2. Showing the use of a band-pass filter in the short-wave end for elimination of image frequency interference.

and 500 kc. would be ideal for a television superheterodyne. Harmonic interference cannot be bothersome and image frequency interference is reduced to a point where it can cause no trouble whatsoever.

The Amplifier

With the problem of intermediate frequency solved, it is an easy matter to design a two or three stage amplifier giving sufficient gain to work over comparatively long distances. It has been found that with more than three tuned stages, it is difficult to construct the amplifier to pass the required 80 kc. band without sideband clipping. Even with only two or three stages, loose coupling in the i-f. transformers must be avoided.

Sufficiently tight coupling cannot be obtained in any manner by employing small diameter winding forms. Neither can concentrated windings, such as honeycomb or layer wound coils, be used since in this case the coupling between primary and secondary would be reduced. Of course, it would be possible to employ tuned trap circuits in place of transformers but this increases the feedback problem and often results in motor-boating.

A diameter of approximately 2 inches is as small as can be used to provide a high degree of coupling. Small wire, 30 to 34 gage enamel, will result in a coil not too large for a compact set. Such transformers can be enclosed within copper or aluminum cans 3 inches to 4 inches in diameter.

By employing shunt capacities such as those used in present-day broadcast supers, the effect of the high degree of coupling in the transformers is partially ruined. Transformers should be worked as close as possible to the fundamental, therefore, the shunt tuning condensers should be between the limits of .00005 to .0001 mfd.

In Fig. 1 is depicted a schematic diagram of an ideal i-f. amplifier for a television superheterodyne. Type '51 variable-mu tubes are used in the i-f. stages and a '24 as a second detector.

Regenerative effects are reduced to minimum by the generous use of by-pass condensers and r-f. chokes.

It will be noticed that a linear or bias type detector is employed which is not in strict accordance with the design of modern television receivers. There is a very good reason for this type of detector as will be explained.

Shielding

It is essential that the i-f. transformers and tubes be completely shielded to eliminate feedback, and generally the plate and grid leads as well. The latter precaution is overlooked in a great many of the modern broadcast and television receivers which results, to a certain degree, in regeneration and, quite frequently, oscillation.

The problem of the second detector plate by-pass and r-f. choke is a rather difficult one. Obviously, the r-f. currents in the plate circuit will not only increase the feedback in the i-f. amplifier but also cause distortion in the audio amplifier unless provided with a low resistance path to ground. At first thought it would seem possible to employ a relatively large capacity from plate to ground. However, if this capacity is much larger than .00015 mfd. some of the higher audio frequencies will not reach the audio amplifier, hence the latent pictorial details will not be present in the picture. A capacity of .00015 mfd. is far too small to by-pass frequencies as low as 400 to

500 kc. But as this cannot be increased, a larger r-f. choke will have to be used. In some cases, two chokes connected in series will be needed.

The short-wave r-f. circuits will be discussed next. The necessity of plug-in coils is eliminated in a receiver designed for television reception since, as stated previously, such a receiver is of little use for other services due to its natural broad tuning qualities. The present television band is from 100 to 150 meters (3,000 to 2,000 kc.) and can be covered with small, compactly wound coils together with low-capacity tuning condensers. A preferred arrangement is shown in Fig. 2.

The band filter coils L and L1 are tuned by means of a two-gang condenser C1. The antenna is coupled to the first section through a capacity C. A screen grid '24 tube is employed as a detector. Bias detection is shown but grid-leak-condenser detection may be employed if desired. The two sections of the band filter should be wound side by side on the same form, the spacing between depending upon the degree of selectivity desired at this point.

The Oscillator

The oscillator is of conventional design, the grid being biased to reduce the plate current. Energy is transferred to the first detector through a small capacity C4 connected from the detector screen grid to oscillator plate. The plate voltage is dropped to the required value by means of the resistor R2 which also functions as a radio-frequency choke, thereby preventing coupling through the B supply.

It would seem rather unreasonable to construct a tuner and i-f. amplifier capable of passing the required band and then employ an audio amplifier which starts to cut off in the vicinity of 7,000 or 8,000 cycles. The usual form of resistance coupled amplifier does this. Low frequencies also suffer when the generally recommended values of grid leak and coupling condensers are employed.

A theoretical discussion of resistance-coupled audio amplifiers is not the pur-

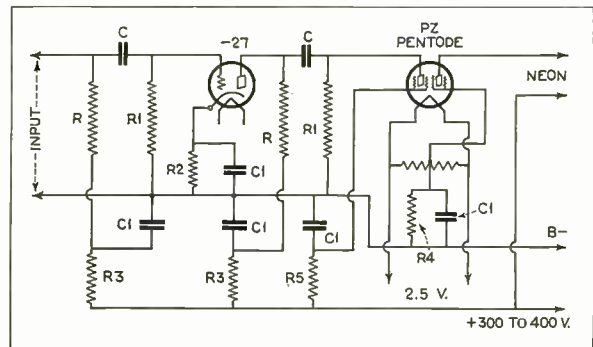

Fig. 3. Circuit of a television audio amplifier using a -27 first, and a pentode power stage.

pose of this article. However, it is well for the television experimenter to understand some of the fundamentals.

The high-frequency limit of an audio amplifier depends almost entirely upon circuit and tube capacities. The former can be reduced to a minimum by keeping the grid and plate leads short and as far away from other leads and metal objects as possible. Tube capacities are a different matter. We cannot alter the characteristics but we can select the type of tube having the lowest grid-filament and plate-filament capacities.

Tubes

The screen-grid tube, contrary to general opinion, is not the best tube for a television audio amplifier. To be sure, the gain is high but the inter-element capacities to ground are also high, particularly from plate to ground through the screen grid. The lumped sum of the tube and circuit capacities as well as the capacity of the coupling condensers in series with the plate resistors, tend to cut off the extremely high frequencies. The direct-coupled amplifier has proven one of the worst offenders since the cutoff starts at about 7,000 cycles. The ideal television audio amplifier would have a flat curve up to about 10,000 cycles with a gradual rise from 10,000 to 40,000, quite unlike broadcast amplifiers. Such an amplifier is not possible without special circuits making for complication and increased cost.

We can choose the "happy medium" by keeping the number of stages as low as possible using the type of tubes having the lowest grid-filament and plate-filament capacities. Then by selecting the proper size coupling resistors and condensers, we can construct a good amplifier.

With three-electrode tubes, the sum of the grid-cathode and plate-cathode capacities is somewhat lower than in the screen-grid types, but in order to obtain good amplification with reasonable plate voltages, the plate resistors should have a value between 20,000 and 25,000 ohms. As the coupling condensers are in series with the plate resistors (with respect to the a-c. circuits) the total shunt capacity is still too high. The meaning of this becomes apparent when it is considered that, in order to offer low reactance to frequencies as low as 15 cycles, the coupling condensers should have a value of at least 4 mfd., depending to a large extent upon the value of the grid resistors.

In television, the frequencies below 100 cycles can be of somewhat lower amplitude than the "highs" with very little effect upon the clearness of the picture, making it possible to employ a coupling condenser of relatively low

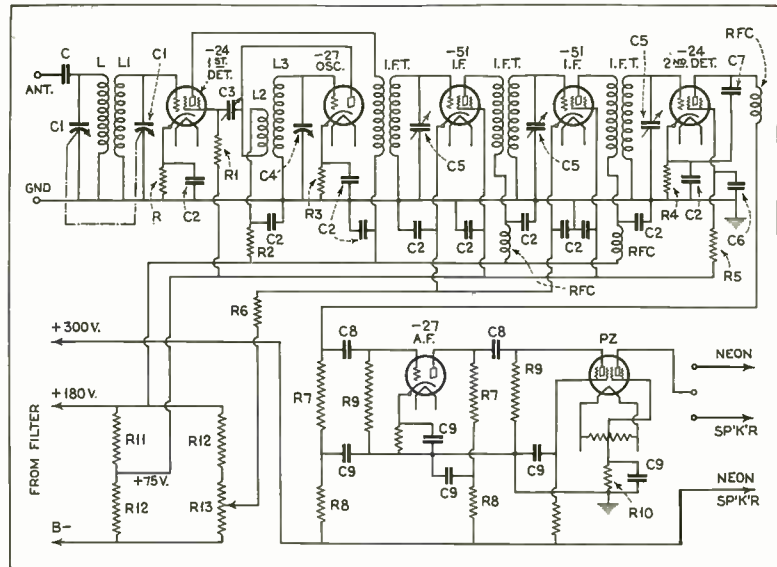

Fig. 4. Complete wiring layout using multi-mu tubes.

- | | | | |
|--------|--|-----|---|
| C | Antenna coupling condenser .000025 mfd. | RFC | Long-wave r-f. chokes. |
| C1 | Two-gang tuning condenser .00015 mfd. | R | First detector bias resistor 10,000 ohms. |
| C2 | .1 mfd. by-pass condensers. | R1 | First detector screen-grid resistor 50,000 ohms. |
| C3 | Oscillator coupling condenser .000025 mfd. | R2 | Oscillator voltage dropping resistor 25,000 ohms. |
| C4 | Oscillator tuning condenser .00015 mfd. | R3 | Oscillator bias resistor 1500 ohms. |
| C5 | I-F. "peaking" condensers .00005 to .0001 mfd. | R4 | 2nd detector bias resistor 50,000 ohms. |
| C6 | Second detector screen-grid by-pass condenser 1 mfd. | R5 | 2nd detector screen-grid resistor 10,000 ohms. |
| C7 | Second detector plate by-pass .00015 mfd. | R6 | I-F. bias resistor 300 ohms. |
| C8 | Audio coupling condensers .1 mfd. | R7 | Plate resistors 100,000 ohms. |
| C9 | Audio by-pass and filter condensers 1 to 4 mfd. | R8 | Filter resistors 25,000 ohms. |
| L, L1 | Short-wave band filter coils. | R9 | Grid resistors 250,000 ohms. |
| L2, L3 | Oscillator coils. | R10 | Bias resistors 400 ohms. |
| IFT | Intermediate-frequency transformers. | R11 | 10,000 ohms. |
| | | R12 | 30,000 ohms. |
| | | R13 | Volume control 10,000 ohms. |

capacity, say .1 mfd. Then by using a rather high value of plate resistor, 100,000 ohms being a good value, and increasing the plate voltage to 300 or 400, we can obtain a fair degree of gain.

When a signal passes through a vacuum tube, it is shifted in phase 180 degrees, which means a complete reversal of the picture through each stage. Obviously, we must employ the correct number of stages to provide a "positive" picture. When the second detector is of the grid-leak type, one reversal takes place here and an odd number of a-f. stages would be necessary. With a bias type of second detector, an even number of a-f. stages would be required since rectification is in the plate circuit and no reversal takes place.

With a bias second detector two or four a-f. stages would be needed. Four would be rather difficult to place in operation due to feedbacks. We may employ only two stages using a '27 first and a pentode power stage. This combination would result in sufficient gain to operate any type of glow-lamp. Fig. 3 shows the circuit of such an

amplifier. R are the plate resistors of approximately 100,000 ohms each and R1 the grid resistors of 250,000 ohms. A-F. filters, resistors R3 and by-pass condensers C1, are connected in both detector and first a-f. plate voltage circuits to prevent motor-boating. The resistor R5 connected in the lead to the space charge grid of the power pentode will depend upon the value of B voltage available but will be within the limits of 10,000 to 20,000 ohms.

Fig. 4 shows the complete circuit of a television superheterodyne. A switch is provided in the output circuit of the power audio stage so that either a speaker or glow-lamp may be used at will.

RADIO DIVIDENDS IN JULY

Dividends paid by radio companies in July amounted to \$1,463,848, according to the Standard Statistics Company, of New York. Total cash dividend payments made by domestic corporations in July were \$516,095,367.

The gold rush is over!

By AUSTIN C. LESCARBOURA

A survey of radio manufacturers with regard to present list prices discloses many interesting opinions and experiences.

WE have just finished checking over the returns on a questionnaire sent to a large group of representative manufacturers in the radio business, and the answers to our questions were, as is usual with questionnaires, much more enlightening in their implications than in their direct statements. In the tabulation of the returns we would say that on the face of these answers the radio industry generally is selling its products from 25 to 50 per cent too cheaply; that list prices must be immediately raised to prevent the industry from going on the rocks; that over-production has caused the debacle, plus dumping; that it is impossible to get the radio manufacturers to adopt any cooperative measures; that it is possible but not probable that standards of set performance might be set up and maintained; and in general, that the solution of the present business problems confronting each manufacturer lies in nearly all manufacturers going back into pants-pressing business, leaving the answerer of the questionnaire free to manufacture at a 100 per cent profit again as he did in the early days.

In detail, all but two of our returns from set manufacturers stated that list prices were too low, with the average percentage at around 30 per cent. While with characteristic caution most of our correspondents decline to be quoted, we may say that the *two* who admit that prices are about right for the present market *are both making money in the present market*. The boys who are losing money are the ones who yell about the low prices. That is only natural. And with the usual radio reasoning they agree that the way to cure their ills is to raise the price. The fact that a list price in radio today means about as much as it does in a clothing store on New York's Grand Street seems to have but little bearing

on the case in their minds. In all the answers that we have received, the only correspondents who mentioned efficient manufacturing and merchandising were the few either not in the set manufacturing business or at present making a profit at low prices. Most of the manufacturers of radios today seem to think that the engineering efforts of the last five years have not yet made it possible to manufacture a good set at a lower price than the inflated lists of the Gold Rush Days. If the answers that we have received to our questions are a fair sample of the individual thinking of the radio trade executives, then it is about time that they stopped wishing for the good old days and began to buckle down to work.

What They Think

In other words, manufacturers who are producing hundreds of thousands of dollars' worth of radio merchandise per year individually answered our questions, designed to bring out any constructive thinking of the individual and said in substance: "We are not able to continue to manufacture radio apparatus at the present prices. We feel that no one else is able to do so either and so we will continue to operate at a loss until enough of our number have been starved out to make the business again profitable. We are sure that our brother manufacturers are such hogs and nincompoops that they could not be brought to any cooperative measures even if those measures could be kept within the Federal Trade Laws. *We believe that the radio business is a dog fight, with 'dog eat dog' as its slogan!*"

That is what they tell us when they say that prices are too low and that there is no help for it. And we would have to agree were it not for the few dissenting answers from those who are themselves manufacturing and selling in the same market, and from those

who are students of radio conditions without being in the manufacture themselves.

Checking over the group which claims that radio is going through a natural evolution—speeded on by the depression, it is true, but by no means caused by it—we find that it is composed of manufacturers who are selling sets at prices well under most of their competitors, and selling them *at a profit*.

Price

The average radio manufacturer has taken to ascribing all his ills to various and sundry of his group who are selling way under the former market price. He is sure that no one can sell at these ruinous prices and still make a profit. He blames his troubles on Over-Production when he should blame it on Over-Capitalization and Over-Equipment. He blames the other fellow for lowering the price by dumping, when he should blame his own poor planning which made his own dumping necessary. Of course, there are gyp sets on the market which are expensive to the consumer at any price, but there are also values on the market today that are better than they have ever been before. That is as true of manufacture in general as it is in radio. Our automobiles, vacuum cleaners, cameras, washing machines, watches, and even our foodstuffs are cheaper today than they have been in the last fifteen years, yet every one seems pained, shocked, grieved, and most unwholesomely surprised when they discover that it is possible to make a good radio set for less than \$150.

Just to see how consistent our answers would be we asked in the same survey whether tube prices were too high and found that it depended to a great extent whose ox was gored. Believe it or not, most tube manufacturers declined to comment on set prices, but set manufacturers were quite ready to

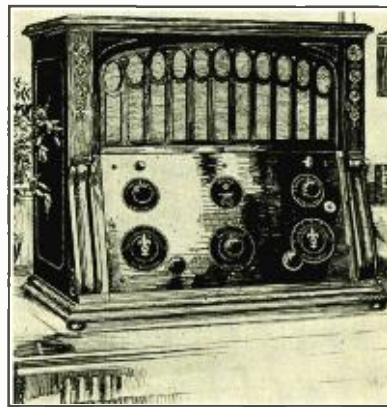

This Radiola-X sold for \$245 plus \$15 for batteries and was good value for its day.

tell what they thought of tube prices. The receiver manufacturers who were the most vociferous about the terrors of low set prices agreed almost to a man that tube prices are about right, although some of our correspondents were honest enough to say that they knew little about tube costs. Among tube men there is quite a split as to whether or not lists are right, there being a general opinion among all concerned and most not concerned that there has been a great deal of "monkey business" in tube prices.

Profit?

There is some divergence of opinion as to whether the radio dealer can sell sets at a profit at present list prices, with the most mature opinions agreeing that free service in the home on cheap sets should be abolished, thus allowing the dealer to treat midgets strictly as package goods. The great trend here shows that the minds of the industry function with regard to the other fellow's pocketbook a great deal better than they function with regard to their own. That the efficient distributors and dealers will be able to make money at present lists and discounts, they agree, but the merchandiser must realize that the easy days are over, and that he will have to do more selling for his money. The same men who are ready and willing to send that advice to the dealer refuse to make it apply to themselves!

One constructive thought has come out of our efforts, which we pass on to the trade along with the many disappointing criticisms that we are here delivering. There seems to be a great willingness among responsible manufacturers to get together and set some standard of performance below which a radio set should not go. That would be a great step in the right direction.

There is no real valid criticism against reducing prices. If there were, most of us would still be living in

hovels, wearing homespun, walking to our destinations, and eating meat only on festive occasions. The history of American progress has been a history of price cutting. The criticism comes when we sacrifice quality for price to such an extent that use is limited and value disappears. We are sold on the principle in this country that quality for the price is the best policy; no one today expects Rolls-Royce performance from a Ford, but we do expect at least Ford performance from a Ford. If some measure of performance for the radio receiver were set up as a minimum, we could at least be assured that the lower prices were genuine reductions rather than cheapening of the product.

What To Do?

This should not be hard to do. Let the leaders of the industry in R. M. A. assembled subscribe to a minimum R. M. A. standard based on sensitivity, selectivity, fidelity, hum, noise level, and life under test; and then let individual companies spend but a small part of their advertising appropriation towards publicizing that standard. If these suggestions were heeded, we would in a short time have every reputable manufacturer who had intentions of remaining in business lined up behind it, and likewise we would soon have the unscrupulous manufacturer out of the business.

This survey has supported the idea that has been growing in our mind for some time, namely, that the run-of-the-mine manufacturer has been spending entirely too much time trying to figure out a way to make his sale price cover the manufacturing cost standards of three years ago, and entirely too little time figuring out a method of making his 1931 costs meet his 1931 price. Some few seem to have fathomed the secret, but all too few.

We might say here in general that,



OPPORTUNITY FOR RADIO AND TELEVISION PARTS MANUFACTURERS

THE recognized success which attended the exhibit of radio parts and accessories at the I. R. E. convention in Chicago, in June, stamped this type of show as a profitable venture for manufacturers.

The custom of holding a Fall, regional meeting of the I. R. E. at Rochester, N. Y., seems to be established. Rochester is a natural geographical center of a large American and Canadian radio manufacturing territory. This year, the Rochester meeting will be held on November 9 and 10, with headquarters at the Sagamore Hotel. Advance registrations for exhibit space already

assure that complete lines of parts will be on display.

November is a good time of year for a technical meeting and a parts exhibit. By that time all concerned have had a good measure of experience with the current year's products and most manufacturers are thinking of the year ahead.

The Rochester meeting of 1931 is almost sure to make radio history.



APPLICATIONS RECEIVED BY THE FEDERAL RADIO COMMISSION

THE records of the Federal Radio Commission show an increase in the number of applications received. In the year 1931 the Commission received 10,030 applications as compared with



A 1931 superheterodyne, using pentode and controlled-mu tubes and tone and static control. This set is in the \$69.50 class, with tubes.

as we have been hammering for some time now, the solution of the radio manufacturer's difficulties lies in engineering and costs. With the inventive and research genius behind the manufacturer, it should follow as the night the day that prices grow gradually less and less as materials grow cheaper, and labor through improved methods grows more efficient. If financing is too full of water, please do not blame your profitless sales on the fellow whose financing is sound. If your overhead is too high, please do not blame the fellow whose overhead is low. If your direct labor cost is too high—but who ever heard of a radio manufacturer whose direct labor cost could be seen with a microscope anyway?

Yes, we've made a survey. And the results have been disappointing in that they have shown very little that can help the industry except in the way of directing attention to the point that seems to be the focus of infection. If you must blame some one for radio's ills, please pick on the right party. Pick on Old Man Progress.

8,543 during the year 1930; and there were 8,628 instruments of authorization issued as compared with 7,655 issued during the previous year.

In addition to the above the Commission received 20,609 applications for amateur radio stations of which 20,204 were granted in 1931.

The figures also show a reduction in the number of radio broadcasting stations. Twenty radio broadcasting stations were deleted, five of which were consolidated with other licensed stations, and two of which were consolidated into one station. Eleven new radio broadcasting stations were authorized to be constructed, making a total of 612 authorized stations as compared with 621 at the end of 1930.

Series equivalent of a resistance paralleling a tuned circuit

By C. H. W. NASON

SELECTIVITY calculations are usually based on the equivalent series resistance of the tuning inductance as obtained by laboratory measurement under operating conditions. While the normal effects of shielding, etc., may readily be simulated in the laboratory setup it is difficult to obtain experimentally the damping effect due to the use of grid circuit detectors. Terman has given (*Dec. 1930 Proceedings I. R. E.*) the method of calculation for the damping due to the detector. These calculations involve the actual value of the grid leak and the rectification efficiency of the tube. Employing the '27 or '24 tubes with a plate voltage of 180 and with the grid return brought to the cathode the equivalent damping effect in parallel with the secondary of the coupling transformer is approximately 150,000 ohms where a grid leak of .25 megohms

is used. For simplicity in calculation of the selectivity of the system it is desirable that we write this in terms of an equivalent series resistance additive to the resistance of the tuning inductance as experimentally obtained.

The circuit arrangement of the detector is shown in Fig. 1A with its equivalent structure as shown in 1B. In order to obtain R' as effective in series with the tuning inductance we must solve the simple relation

$$R'_{eff} = X_c^2/R'$$

Assuming a frequency of 1,000 kc. and a tuning capacitance at that frequency of 300 mmfd., we know that X_c is equal to

$$\frac{1}{2\pi f C}$$

or approximately 500 ohms. Squaring this figure and dividing the result by 150,000, we find that the effective series

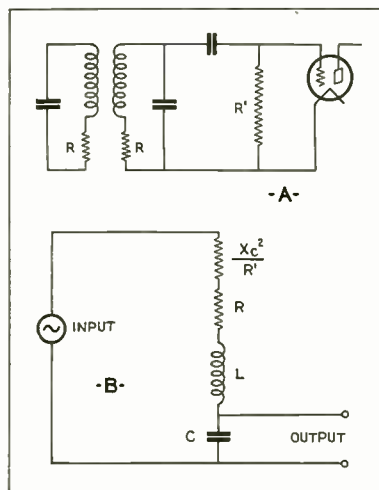

Fig. 1.

resistance is 1.66 ohms. This is not a high figure but may readily upset selectivity calculations if not taken into account. It is particularly important that the detector damping effect be considered in the design of a band selector circuit where the resistance has a marked effect on the spacing of the double resonance peaks.

Note that a value of R'_{eff} must be taken for each frequency at which selectivity calculations are made. The figure of merit for the inductance will then be

$$Q = \frac{\omega L}{R + R'_{eff}}$$

BRIGHAM HEADS RMA ENGINEERING

C. E. BRIGHAM, chief engineer of Kolster Radio, Inc., Newark, N. J., has been appointed director of the engineering division of the Radio Manufacturers' Association.

As the director of the engineering division, he is executive head of the entire engineering work of the RMA. The division includes a safety section, a service section, a standards section with sub-committees on receivers, tubes, acoustic devices, television, amplifiers and cabinets, and an interference section.

In addition, as chief engineer of Kolster Radio, Inc., he is a Fellow, and a member of the board of directors of the Radio Club of America, a member of the Institute of Radio Engineers and on the committee on papers and on standardization of the I. R. E.

From 1917 to 1922 he was a member of the engineering staff of the U. S. Navy radio test shop in Washington, D. C. In 1922 he was appointed chief

research engineer for C. Brandes, Inc., later, the Brandes Laboratories, which became a subsidiary of Kolster. He has continued in service with Brandes and Kolster since the date of appointment in 1922.

ENGINEER REFLECTS DEPENDENCE OF TELEVISION ON RADIO

ASKED what would be the effect of television on present-day radio sets, George Lewis, radio engineer and vice-president of Arcturus Radio Tube Company, Newark, N. J., states that the radio set of today would always be an integral part of television receiving.

"The two systems must be operated simultaneously for satisfactory results," says Mr. Lewis. "One depends on the other in bringing a synchronized television program into the home.

"Commercial broadcasting is transmitted on frequencies between 550 and 1,500 kilocycles and a radio set is necessary to receive the signals in this waveband. Television is sent on fre-

quencies between 2,000 and 2,200 kilocycles, and requires a special circuit or set designed for that waveband.

"True, we may have a compact cabinet combining the two sets, but a radio set today will be an efficient adjunct to the television receiver of the future."

THE FOUR-MILLION RACE

Will Germany beat Britain in the race for the four-millionth receiving license? Although the population of Germany is considerably larger than England's, the license figures remain remarkably close. On July 1 Germany had 3,719,594 registered listeners, while the British total on the same date was 3,756,331.

DIVIDENDS IN AUGUST

Dividends paid by radio companies in August, 1931, amounted to \$1,068,142, according to the Standard Statistics Company, of New York. Total cash dividend payments made by domestic corporations in August were \$211,543,796.

Modern manufacture of radio tubes

By J. B. NEALEY*

ONE of the most interesting and fastest changing phases of radio manufacture is that of the tube and more especially the power tube. These tubes have been brought up to a high state of perfection at the plant and laboratories of the Grigsby Grunow Company, Chicago, Ill., manufacturers of the Majestic radio. In the power tube division of this enormous plant are concentrated a great variety of special machines, tools and equipment, arranged in batteries for mass production. They are so laid out as to attain progressive, straight line production with a minimum of handling between operations, assemblies, tests and inspections.

Nine different types of power tubes are made here but a description of the manufacture of one only will have to suffice in this short article. Taking the process as a whole, working in glass constitutes the major portion of the work. The first step is the blowing of the tubes, and for this machines have been designed and built in which long glass tubes are inserted and the heating, blowing, cutting off and discharge are all performed automatically and continuously.

The machine consists of a heavy metal base holding a vertical shaft which supports and rotates two circular fixtures, one above the other. The lower fixture contains several metal molds just the size and shape of the tubes to be made. As many glass tubes are set on end in these molds and held in the upright position by the upper fixture. The glass tubes are several feet long and a rubber tube is stretched over the top of each and compressed air forced in. The machine then rotates the tube molds through gas jets and as the glass melts, the air forces it out to the shape of the mold and seals one end. The machine then rotates it to a cutter which cuts it off and it is automatically discharged onto a belt conveyor which carries it to an inspector. The glass tube then drops down into the mold again and the process is repeated until the tube is nearly used up.

Inside this tube is a glass flare and stem holding the grid, filaments, etc., and the bottom is flanged so that it can be sealed into the end of the tube. The machine in which this is made is some-

what similar to the one described except that it has no molds nor air under pressure. It will hold 8 glass tubes $\frac{3}{8}$ -inch in diameter, the lower ends of which extend through the bottom fixture. The machine rotates the tubes from one station to another, pausing at each station for a predetermined time period.

Heat in the form of a knife gas flame is applied at the first station and a still hotter flame at the second which heats it to the melting point. At the third station a rotating die rises and forms

Here is an authoritative article dealing with the engineering details of tube manufacture.

the flange on the end of the tube and this is polished at the fourth station. At the fifth the glass tube drops so as to expose a longer portion below the lower fixture and the upper part of this is progressively heated in gas jets at stations 6, 7 and 8. A rotating cutter cuts it off at the last station when it is ejected and it is then inspected.

The Manufacturing Line

This glass flare is now put into another and similar machine where the stem portion is formed. This machine

also has 8 stations and at the first nickel wires are placed in the upper fixture and four copper wires in the lower fixture so that the ends just overlap at a point where the glass then is to be squeezed in to form the stem. The glass flare, a $\frac{1}{4}$ -inch glass tube extending into it, is then put in place at the second station. At stations 3, 4 and 5, one 7 and 13 knife gas flames respectively, play on the small end of the glass flare and wires which they bring to the melting point. The softened end is squeezed together flat at the fifth station so that the wires are welded and then held rigidly in place by the glass.

At the sixth station 5 gas flames play on the flare at a point just below the squeezed portion, a rubber tube is inserted over the end of the small glass tube and air under pressure blows a small hole in the glass flare and the small glass tube is melted in so as to form an air passage. Cracking through sudden chilling is prevented by a single gas flame at each of the last two stations.

This division is equipped to produce 3,750 stems per hour but is now making 7,500 hourly and these are annealed in a gas fired, conveyor type oven to relieve the strains set up during manufacture. The oven is constructed of heavy sheet metal lined with 5 inches of insulating material and is 20 feet long, 2 feet wide and $2\frac{1}{2}$ feet high. The conveyor is made up of two parallel, closed loop chains suspended between sprockets, driver and idler, and to these chains are fastened steel plates which form a solid, moving hearth in the oven. It is driven by motor through a speed reduction gear train so that the speed of the conveyor can be regulated to encompass whatever annealing period is required.

The Gas Oven

Heat is supplied through a separate, induced draft heater, which is fired with a single gas burner. The hot products

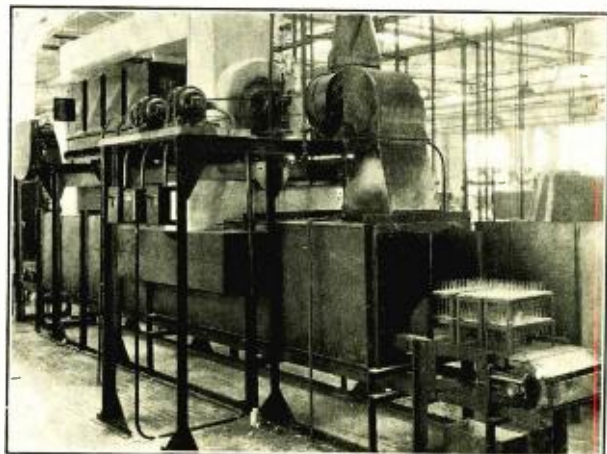

Entering and glass annealing oven for radio vacuum tubes. Two racks of tubes entering oven.

*Engineer, American Gas Association.

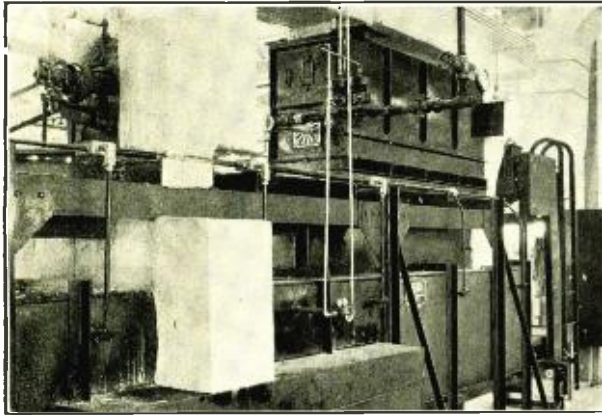

View of glass annealing oven and induced draft heater No. 200.

of combustion are mixed with a portion of fresh air and then forced into the oven through ducts along its side by a motor operated fan with water cooled bearings. An exhaust fan at one end of the oven recirculates much of the hot air passing through the oven, back through the heater, thus raising the efficiency of the unit and reducing the fuel consumption materially. As the exhaust duct is right over the opening at the charging end the air suction forms an air seal which prevents cold air from entering and the hot air from enveloping the operator. The heater, fans and motors are all mounted on a platform above the oven so that the total area occupied by the equipment is only about 60 square feet.

The flares and stems are inserted in racks, each rack holding 50, and the racks are then piled three high and placed on the apron conveyor. The annealing period is divided into two parts, heating from room temperature to 900° F. which requires 12 minutes, and cooling which occupies 24 minutes, a total period of 36 minutes. While this oven was designed for a production of 3,750 stems hourly, the present output is 7,500 and as many as 10,000 per hour have been put through.

Operation is continuous and automatic for the required temperature is maintained with a controlling pyrometer and temperature recorder. The consumption of gas required to anneal 3,750 stems per hour is approximately 600 cubic feet of 530 B.t.u. gas.

The Tube Elements

After the stems have been annealed they pass down various lines of benches and machines, the first operation being the forming of a W shaped filament (cathode) which is spot welded onto the three inside wires of the stem. The grid is spot welded to the two wires next to the outside wires, and the plate is slipped over the two outside wires or rods, while the getter is spot welded to the grid. The bead consists of 7 nickel support wires which are imbedded in a

glass rod 3/16-inch in diameter and 1 inch long. These are spot welded as follows: 2 to the outside grid support rods, 2 to the grid support rods, 2 to the W shaped filament hook supports and one to the back support rod.

The manufacture of the different parts is also very interesting. The grid, for instance, is wound in a converted lath which holds the two support rods in a parallel position while the molybdenum wire (.005 ga.) is wound onto them from spools. The one length thus produced is then cut into 8 parts or 8 complete grids. In this operation the support rods are rotated and the wires are wound on at the rate of 15½ turns per inch. The plate is made from two metal stampings spot welded together.

Filament Coating

A very delicate process is the coating of the nickel wire for the filament with a physical mixture of barium carbonate and strontium carbonate (BaCO₃ and SrCO₃), for just the proper weight must be put on and no more. The wires are unwound from one set of spools and rewound on another, passing through the coating machines and a small furnace, in between. The coating is baked on in the furnaces at 900° F. The getter consists of two stampings from sheet nickel or two cups, one smaller than the other and the smaller with 6 legs that are turned back. The smaller is then inserted in the larger so as to hold the barium magnesium pellet.

The complete assembly consisting of stem, support wires, grid plate, etc., is now inserted in the glass tube and the two sealed together. This is accomplished in a rotating fixture holding 8 bulbs, each bulb being rotated progressively through 6 gas flames, each hotter than the preceding one except the last which is the cutting off flame. In this way the bottom edge of the tube and the outer edge of the flare of the stem are melted and sealed together.

The bulbs are next transferred to the exhausting machine which holds 24

at a time and this process is quite complicated due to the various processes, tests, etc. A rubber tube connected to a vacuum pump through a glass trap and valve in the exhausting line is stretched over the end of the stem. With this arrangement the tube is continually being exhausted as the machine rotates from one position to the other. First the tube is moved into a small oven where it is heated to 950° F. and at the next station it receives a high-frequency electrical bombardment from an induction coil which is dropped around it. The heat thus created drives the gases from the metal and glass pots and they are exhausted together with the air.

Another coil is dropped down opposite the getter in the next position and the bombardment from this explodes the barium magnesium pellet and the barium is distributed as the silver lining to the tube. This absorbs any gases that are formed later thus prolonging the life of the tube. Small gas flames now play on the end of the glass exhaust tube which it melts and seals off.

The bakelite, baked with four hollow legs, is then cemented on with the four lead wires protruding through the legs. The cement is hardened on in an oven at 140° F., the wires cut off flush with the ends of the legs and a drop of solder put on each to form the contact points. Lastly the tube is aged by passing a controlled current of electricity through it.

CANADIAN SUPREME COURT UP- HOLDS DOMINION CONTROL OF RADIO

THE Canadian Supreme Court by a three-two decision states that the control of radio broadcasting in Canada belongs to the Dominion Parliament and not to the Provincial legislatures, according to a telegram dated July 2, from Assistant Commercial Attache Oliver B. North, Ottawa. After lengthy arguments, the Canadian court arrived at its decision, which, however, may not necessarily be final. An appeal from this court to the Privy Council may be made by either side.

The case grew out of the refusal to grant a broadcasting license to a station which was to put on the air a program sponsored by the Quebec Provincial Government. It was argued by provincial proponents that broadcasting for private purposes, especially in cases of small stations whose normal ranges do not extend beyond the provincial borders, should be subject to provincial regulation. On the other hand it was argued from the Dominion that broadcasting, by its very nature, could not be considered a local matter, and that centralized authority is essential to permit instant control when necessary.

The "electric eye"

Many uses for photocells. Dependable insulating materials required.

OVER the longest span bridge in the world, "The Ambassador," between Detroit and Windsor, rumbles the busy commerce of an international highway and a great city, world famous for automobile production. Immigration, internal revenue, the enormously long trucks which carry automobile bodies, from factory to assembly, the new cars being driven slowly to delivery points, make the controlling and recording of commercial and pleasure vehicles, as well as the usual metropolitan traffic on this bridge an unusually complicated problem.

Left to human control, the problem would have called for numerous traffic officers, bookkeepers, and adding machines. The scientific solution, however, was the application of the photoelectric cell or tube, a light sensitive device which opens or closes an electric circuit in response to a sudden change of illumination. One of these tubes is imbedded in each of the ten incoming traffic lanes at the point where the cars stop to pay toll. Directly overhead in the roof of the toll shed is a light source, directed on the photoelectric cell, causing a small current to flow. Every car stopping at the point intercepts the beam of light, and the current



Ambassador Bridge, from Detroit to Windsor, where the task of checking and controlling traffic is being accomplished by means of photoelectric cells and light beams. The system was devised and installed by Benjamin Cooper, a consulting engineer of New York City.

ceases to flow. By this "make and break" circuit effect, the cars are counted, the count is recorded, and signals indicating the density of traffic are flashed to the control and indicator boards in the offices of the chief toll collector and general manager.

Thus has science produced for industry a new servant, the "electric eye," rapid, accurate, untiring, untroubled by any human frailty.

Through the Holland Tunnel, under the Hudson River, moves the heavy interstate traffic between New York and New Jersey. Here is a problem peculiar to tunnels—condition of air must be determined—and again the "electric eye" functions, giving a clue to the density of smoke, vapor, gas, or general humidity.

In a great department store in New York, efficiency engineers have been at work to improve the safety of passenger elevators. This time the "electric eye" provides the automatic control, known as "Safe-T-Ray." Two beams of light are projected across the elevator door opening, and focused respectively on two photoelectric tubes mounted on the opposite side of the car. Normal operation of the doors is permitted when the beams of light are uninterrupted, but when any opaque object intercepts them, the closing action of the doors is instantly prevented.

A public school in New Jersey has an "eyesight conservation room." Here

no human eye, but the infallible "electric eye" is constantly on watch to determine the need of additional light, and to turn on the general illumination.

Miracles, no less, but miracles with a solid scientific foundation. If one of the Indian braves who went single file down Pontiac's Trail along the Detroit



As long as any opaque substance intercepts the "Safe-T-Ray," the elevator doors cannot close.

River could now see bridge, traffic and traffic recorders, he would stoically accept them as part of the white man's incomprehensible magic. But if one of the early Puritan settlers were to return and concentrate on this miracle of doors which will not close, and lights which turn on and off by no visible means, he would find his mind and conscience troubled, and suspect witchcraft or worse.

Now the scientists and engineers who perform these miracles outnumber by far the early Puritans. So too the layman of today—developing some of the Indian's stoicism, has grown quite used to accepting a new miracle of science even before he becomes well acquainted with the last one. Indeed, the developments have so rapidly succeeded one another that the average citizen needs mental seven-league boots to keep abreast of them.

As a symbol of this modern scientific achievement, readily understandable by the general public, a mechanical man, Mr. Vocalite, has been constructed in

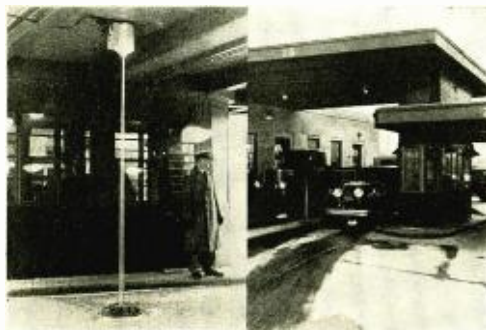

A toll booth showing the source of light mounted overhead directing a beam of light onto the photoelectric cell which is protected by a heavy steel casing.



Bakelite laminated control board of the "electric eye" in the supervisor's office. Lower right—Indicator panel of phenol resinoid. The frequency with which the light goes on and off shows the traffic density of a particular lane

the Westinghouse laboratories. In this robot are concentrated electrical control devices, some already applied to industry, others still in the laboratory stage. Vocal instructions to Mr. Vocalite are transmitted through an ordinary telephone mouthpiece, but there are no electrical connections between transmitter and his mechanical brain. The electrical impulses caused by the spoken orders are carried to the brain over a beam of light; hence the name, "Vocalite," indicating voice and light control.

Mr. Vocalite, at spoken commands rises to his feet, seats himself again, sings, talks, smokes a cigarette. With equal facility, he turns on fans, lights,

vacuum cleaners, and other electrical devices. No primitive race in the beginning of civilization endowed its idols with qualities as great as these given Mr. Vocalite by his creators, but no vague myths of superstition cling around the head of the robot. He is a product of this mechanical, chemical, scientific age, prepared to intrigue the public interest in this great invention of the photoelectric cell, which, in industry, performs duties as diversified as protecting banks against robbery, reading high temperatures inside steel furnaces, sorting yeast cakes on production lines, and classifying colors.

In construction, Mr. Vocalite is also extremely modern. A fitting contrast

to his inert, silent ancestors, built from wood, stone, clay, or crude metals, Mr. Vocalite proudly displays the latest thing in metal alloys upon his person, and his electric heart and mind are insulated from danger by that laboratory product, phenol resinoid, in the form of "Micarta."

The lightning has indeed been harnessed, as was Franklin's dream. Electricity is a servant as dangerous as it is powerful, made safe for service only by non-conducting, insulating materials. Of all the various mediums, Bakelite phenol resinoid is one of the most generally effective organic insulating substances known. No single property is responsible for its extensive use as an insulator. Its service in this field results rather from its combination of properties.

This useful, all purpose phenol resinoid material—as valuable in many another industry as it is in the electrical field—originated a quarter of a century ago. At that time, Dr. L. H. Baekeland, working in his laboratory in Yonkers, New York, solved a problem which had intrigued and baffled many earlier chemists, the combination of phenols and aldehydes to produce synthetic resins—resins which could be controlled, and which could be developed into both liquid and solid materials.



A useful light-control unit

THE light-control relay unit here illustrated has many applications in industrial and experimental operations. It combines a light-operated cell and sensitive relay instrument which has secondary contacts for operating various devices. It is housed in a case 6 by 5 by 3 inches overall.

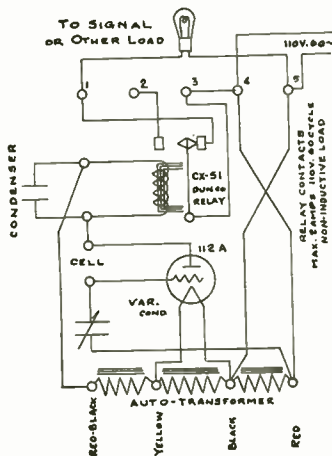

Fig. 1. Typical cell and relay circuit.

with an aluminum finish. This can be given a finish to match any associated fixtures. The unit is equipped so that it may be made to function either on an increase or decrease of light.

The secondary circuit, actuated by the armature contacts of the relay carry a current up to 2 amperes, at 110 volts, 60 cycles. Units can be made up to operate on other voltages, a-c. or d-c.

The cell is of the rugged, selenium type mounted in molded Bakelite body with crystal for protection from dust and moisture.

The life test of this cell shows that it has long life. It can be operated from a 25-watt lamp, without reflector or projector at close range. It may be used to register the number of packages or persons passing a given point.

There are many uses to which these light-cell, relay circuits may be applied. It is predicted that within a few years thousands of operations in industry will be performed automatically by these new devices.

The unit is composed of a newly designed midget relay and associated elements as shown in the diagram, Fig. 1.



Fig. 2. Showing compact assembly of the unit.

New uses are being found almost daily for this inexpensive, automatic device.

The units which can be made up to operate on a-c. may be connected to commercial power supply through ordinary commercial transformers.

The unit here described is manufactured by Struthers Dunn, Inc., 127 N. Juniper Street, Philadelphia, Pa.

Power keying with ordinary key and telephone relay

By HERMAN KOTT*

THE standard telegraph key and telephone type relay may be readily and inexpensively converted into power keying equipment for radio and wire communication purposes, by means of a simple though highly ingenious vacuum contact device now available. The Burgess vacuum contact, originally developed in Germany, is now available in this country for a wide variety of applications, not the least important of which is power keying with the usual low-power equipment.

Briefly, the vacuum contact is an evacuated glass tube containing a pair of copper contact members actuated by the slightest movement of an external glass rod. The device depends for its operation upon the flexing action of glass bellows, transmitting in amplified form the movement of the external glass rod to the contact members in vacuum. The device has been referred to as an electrical hair trigger, for the reason that the slightest movement in the external glass stem is sufficient to control a powerful current. The movement may be as little as .02 inch, which is sufficient to open the contact. A pressure of 6 to 10 ounces is sufficient to operate the device. The contact may be operated at any speed up to 40 breaks per second, with positive, clean-cut makes and breaks, free from sparking

*Engineering Department, Burgess Battery Company.

or arcing as well as chattering or troublesome hangovers. Consequently, clean-cut signals are obtainable at any speed up to the capacity of the vacuum contact. The device is rated to handle 6 amperes continuously or 8 amperes intermittently at 220 volts. A small mica condenser of very low capacity may be shunted across the contact if sparking develops due to an inductive load. In the absence of air or oxygen, the contact cannot corrode. Life tests indicate a life far in excess of that of any equipment with which the device may be employed.

Relay Action

The vacuum contact is virtually a link between delicate controlling energy and powerful controlled energy. As such, it is particularly adaptable to keying circuits in wire or radio communication systems. Applied to the ordinary telegraph key, it converts that key into a flame-proof, easy-operating power key. Applied to the standard telephone type relay, it provides a power relay capable of handling up to 1,300 watts, yet controlled by a few milliamperes of current that may be keyed over an ordinary wire line.

It is left largely to the ingenuity of the individual designer or worker as to how the vacuum contact should be applied to any key. In the case of the standard telegraph key, the photograph Fig. 1 suggests a simple method. It

will be noted that the key frame is fitted with a small brass strip which carries a pair of cartridge fuse clips to hold the vacuum contact. The external glass stem is actuated by a link that connects with the end of the back stop screw of the key. The link has a slot rather than a tightly fitting round hole, so that the glass stem is normally depressed to key the contact open, by the downward thrust of the link. When the key is depressed, the link raises and permits the spring pressure of the contact itself to bring the contact members together, thereby closing the contact. The amount of swing or play of the key lever plays no particular part in the operation of the contact, since the contact closes just as soon as the key is slightly depressed with further movement having no action until the key is released, whereupon the contact opens again. Thus the operator may adjust the front stop screw which replaces the lower contact, for any degree of swing, to suit his particular "fist."

Applied to the standard telephone type relay, the vacuum contact makes possible the handling of power devices by means of an ordinary telephone or telegraph line. The mounting simply provides for the actuation of the vacuum contact stem by the movement of the relay armature.

If desired, the vacuum contact may be operated by a flexible cable or Bowden wire, similar to that employed for camera shutters. This method serves for remote keying a short distance away.

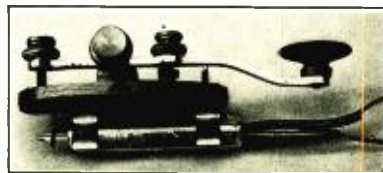

Fig. 1.
Standard telegraph key fitted with Burgess vacuum contact, thereby converting it into a flame-proof power key, capable of keying up to 1300 watts.

▲ ▲ ▲

New Site of Trans-Atlantic Wireless Telephone Station in Scotland

The trans-Atlantic wireless station, which was erected four years ago at Kemback, Fifeshire, Scotland, is to be moved to a new site near Cupar, Fifeshire. The present station was an experimental one and was of a temporary nature. The station was so successful, however, that it has been decided to build a permanent station to handle wireless telephonic communication with the American Continent, and new and improved apparatus is to be installed. It is understood that work on this new station will be begun in two months.

PROGRAM OF I.R.E. ROCHESTER, N. Y., MEETING—NOV. 9-10

THE technical papers to be presented at the Rochester meeting of the Institute of Radio Engineers, November 9 and 10: follows:

"Battery Design Problems of the Air Cell Receiver," by F. T. Bouditch, radio engineer, National Carbon Co.

"European Reception Conditions," W. A. MacDonald, chief engineer, Hazeltine Service Corporation.

"Pentode Circuit Operation," by David Grimes, engineer in charge, R.C.A. Licensee Laboratory.

"Iron-Core-Tuned Inductance in Radio Circuits," by W. J. Polydoroff, director of research, Johnson Laboratories.

"Experimental Visual Broadcasting," by A. B. Chamberlain, chief engineer, Columbia Broadcasting System.

"Advances in Ultra Short-Wave Transmission and Reception," by Eduard Karplus, research engineer, general Radio Co.

"Correlation of Radio Tube and Receiver Designs," by Roger Wise, chief engineer, Hygrade-Sylvania Corp.

"Recent Developments in Amplification and Detection Systems," by P. O. Farnham, development engineer, Radio Frequency Laboratories.

"Use of Suppressor Grids in Radio Tubes," by E. W. Ritter, development engineer, R.C.A. Radiotron Co.

"An Examination of Selectivity," by R. H. Langley, consulting engineer.

RE-BROADCAST OF AMERICAN PROGRAMS SUCCESSFUL IN MANILA

THE Radio Corporation of the Philippines, through its 50,000 watt station, successfully re-broadcasted a four-hour program from San Francisco and New York. In view of this success, the local broadcasting company plans including regular re-broadcasts directly from the United States in its regular programs. A great deal of experimenting has been made by the Radio Corporation of the Philippines and its recent re-broadcast appeared to indicate that the time is not far distant when programs from other parts of the world will be a regular part of the local programs. (*Assistant Trade Commissioner Clarence P. Harper, Manila, Philippine Islands.*)

NEW MACHINE TO INSURE CODING SECURITY

A clever machine which, despite all its inherent complexity, seems to be constructed with admirable mechanical simplicity, is the "Cryptocode." The machine consists of ten brass plates each inscribed with four alphabets in

various orders on their rims, and mounted upon a removable spindle. To use the system, two machines are required, one at each end, with a mutual understanding as to the arrangement of plates and starting arm. The plain message is then broken up into 10-letter units, and written against one of the arms. A reading is taken from any one of the other arms, which is then transmitted by wire. The recipient has only to set up the message he receives against the corresponding arm at his end to reproduce the plain message upon another arm. It is said that:

(a) A 10-letter word may be coded in 12,582,912 ways without altering the relative positions of the discs on the axle.

(b) By interchanging the discs on the axle this number is increased to 45,660,871,065,600.

A small portable machine is designed for the use of troops in the field and commercial travelers, the discs being replaced by steel strips. The American patent number is 1,667,780.

RADIO TUBE YARDSTICKS

(Concluded from page 22)

ance. It is expressed in micromhos as follows:

$$\text{Mutual conductance} = \frac{\text{amplification factor}}{\text{plate resistance}}$$

$$\text{or, } G_m = \frac{\mu}{r_p} \text{ which becomes } \frac{dI_p}{dE_g}$$

Thus, mutual conductance may be expressed as the ratio of a small change in plate current to a change in grid voltage to produce this change in plate current. In comparing tubes of similar types which are to be used for the like purposes, the mutual conductance is the best all around measure of efficiency—but it must not be worked too hard. For instance, the UX-112A has an average mutual conductance of 1,700 micromhos at a plate voltage of 180 volts, and the UX-171A has mutual conductance of about 1,620 micromhos at the same plate voltage. As an amplifier, the UX-171A, however, can supply approximately three times more undistorted output than the UX-112A when sufficient input signal voltage is available and the load is properly adjusted. The tube with the higher mutual conductance and high amplification factor will give greater signal strength in either a radio or an audio-frequency amplifier. On the other hand, the UX-112A makes an excellent detector while the UX-171A is not at all adaptable to such service.

The electrical term, "conductance,"

was selected as the second word of the expression, "mutual conductance," since the path between radio tube input and output circuits is conductive. Because the electrical effect of conductance is the opposite to that of resistance, the unit of resistance, the ohm, was spelled backward to read mho for use as the unit of conductance. "Mutual," in the expression "mutual conductance," is used because tube input and output circuits are in mutual relation.

PUBLIC TELEVISION DEMONSTRATION IN JAPAN

THE first public demonstration of television by a national scientist in Japan was held June 30 in the electrical laboratory attached to the Waseda University, under the direction of Dr. Tadaoki Yamamoto. It met with considerable difficulty at first. The apparatus, which was found quite satisfactory during experiments in the morning, suddenly ceased to function, supposedly due to an abundance of moisture in the air, and the public demonstration was delayed till late in the afternoon. The subject for transmission was a baseball game played on the university grounds about two blocks from the laboratory. The movements of the pitcher were quite plain although the ball could not be seen in motion. The verdict of the umpire was relayed and announced through a loudspeaker synchronized with the movement. Other demonstrations are planned for the near future. (*The Japan Advertiser, Tokyo, Japan.*)

BOOK REVIEW

FOUNDATIONS OF RADIO, by Rudolph L. Duncan, John Wiley & Sons, New York, 240 pp. cloth. Price \$2.50.

Mr. Duncan, who is president of the R. C. A. Institutes, Inc., has written a book for which there has long been a need. This book goes thoroughly into the electricity and magnetism of radio. It is a useful "first book" in the study of radio engineering and as such it is well worth a reading.

TELEVISION — ITS METHODS AND USES, by Edgar Felix, 270 pp., McGraw-Hill Book Co., New York, 1931.

Here is a concise, clear cut explanation and discussion of television today—with an impartial analysis of the problems it faces, its commercial possibilities and its probable future. This is a practical 'book for anyone interested in television.

Miniature radio transmitter for use in upper atmosphere

By S. R. WINTERS

THE world's tiniest radio sending set—small enough to fly in a balloon to a height of eight miles—has been designed by the Signal Corps of the United States Army. The complete outfit, including a dry-cell battery, weighs less than a pound, and on its balloon journey to the upper atmosphere it is given a return ticket to the ground—the transmitter being brought back to earth in a small parachute.

This midget of radio outfits is employed in the unique role of exploring weather conditions in the upper air—tracking the direction and velocity of wind currents. While the radio transmitter is soaring aloft in a hydrogen-filled balloon, two radio receiving sets,



Pilot balloon in which is included a radio sending set for automatically reporting weather conditions at high altitudes.

located on the ground, detect the course of the pilot balloon on its seven-or-eight-mile air journey. This is made possible by use of loop aerials, acting as radio direction-finders, which pick up the signals from the transmitting set in the balloon.

Aiming to lessen the hazards of air travel by an increased knowledge of upper-air conditions, this flying broadcasting station can ride a balloon at night and during foggy weather or other obscure atmospheric conditions. Other methods of plotting wind directions and velocities are less certain during low visibility. The radio signals emanating from the pilot balloon enable the radio observers on the ground to follow the course of the hydro-inflated sphere and, when the latter bursts, a tiny parachute brings the miniature broadcasting station safely back to earth.

Buzzer Used at First

In the original tests, an electric buzzer was used, but this has now been replaced by a vacuum tube as a means of radiating signals from the balloon. A small and short copper wire, trailing the balloon, is the transmitting antenna. A dry-cell battery is the source of power for the transmitter and the supply for any given ascension needs last for only one hour. Obviously, this miniature broadcasting station, operating on a wavelength of 100 meters, is automatic in its functioning—it only being necessary for the ground observer



The radio setup of the Signal Corps for testing radio in pilot balloons and for voice communication with airplanes.

to start it when the balloon begins its eight-mile climb.

This novel method of coaxing weather information from the upper atmosphere by radio having a free ticket on a pilot balloon is an invention of Major William R. Blair, engineer in charge of the research and engineering division of the Signal Corps. His pioneering experiments on the subject were started in 1923, when he was on detail at McCook Field, Dayton, Ohio. At this time, however, the development did not emerge from the table layout stage. Quite recently, the experiments were resumed in a practical fashion at the Fort Monmouth, New Jersey, station of the Signal Corps. The final tests will be staged at Wright Field, in cooperation with the Air Corps of the United States Army.

Second Balloon to Replace Parachute

The concluding experiments will involve an attempt to harness two pilot balloons to one radio transmitter. If this test is successful, when one of the balloons bursts the other would bring the broadcasting set to the ground intact. This would obviate the practice pursued in preliminary trials of sending up a small parachute as the return ticket for the radio transmitter.



Vacuum tubes inside and out

AN engineer of the R. C. A. Radiotron Company gives answers to the questions dealing with the construction of vacuum tubes, as follows:

The "cap" is a tube terminal connection for the control grid at the top of the glass bulb on R. C. A. tubes 222, 224, 232, 235 and 236.

The "brand" on a tube is the identification on the base. This identification usually consists of the manufacturer's

trade name and the tube's type number. "Branding" is the process of marking the base. R. C. A. tubes are permanently branded with a red-hot die.

The "stem" consists of a short glass tube, flared at one end, which is scaled into the neck of the bulb and closed at the other end. The lead wires are sealed into the closed end to carry current to the interior parts of the tube and to act as a support for these interior parts.

The "mount" comprises the "stem" and the complete assembly of tube parts supported by the "stem." A "bead" is a small insulator, for supporting and insulating metal tube parts.

The "getter" is an active material introduced into the glass bulb to maintain a good vacuum. The "getter" in radio tubes is usually an active metal which has an affinity for gas and maintains a good vacuum throughout the life of the tube.

Widening uses of small transformers

THE increase during recent years in the useful applications of small transformers is one of the outstanding evidences of progress in electrical engineering.

There seems no end to the uses to which these power converters may be put. The great variety of transformer units available has required adding many new word combinations to transformer terminology. Transformer engineering has progressed so that only those engineers directly engaged in design, and engineers whose duties require them to keep in close touch with transformer development, are thoroughly conversant with the art.

There was a time, but a few years ago, when a transformer was simply a transformer. Today there are power transformers, filament transformers; transformers known as push-pull input, push-pull output, interstage, adjustable primary, bell ringing, neon sign, signaling, oil burner, magnet operating, ignition, and a dozen other designations.

Audio Transformers

There are in general two distinct classifications into which audio-frequency transformers will fall. Transformers as used today are for voltage or power transfer. A voltage transfer instrument will transmit an alternating voltage with the desired ratio of initial to final magnitudes with a minimum infidelity of waveform, under conditions of very light load. A power transfer instrument will transmit an alternating current at the desired ratio of input to output with a minimum infidelity of waveform, under its rated conditions of loading. There are occasions where one transformer must be designed to function satisfactorily as either a voltage or a power transfer device.

Voltage step-up transformers are normally used between audio-frequency stages. It is important for fidelity of reproduction that the voltage change very little over the range of audible frequencies, and the normal range of applied voltages.

It is generally conceded that frequencies below 30 cycles and above 8,000 do not noticeably affect fidelity by their absence.

What Constitutes a Good Transformer?

This depends upon the use that is to be made of it. For broadcast reception of music, the primary consideration is

quality or faithful reproduction, which requires, assuming an ideal loudspeaker, that the amplification be essentially independent of frequency over some predetermined band, say from 30 to 8,000 cycles. However, with commercial loudspeakers, considerable departure from a flat characteristic is permissible and in some cases even desirable in order to compensate deficiencies in the reproducing unit. For telegraph purposes the primary consideration is intensity or large amplification. The band may be much narrower, say from 800 to 1,200 cycles, for a peaked characteristic is quite desirable in that it may be made to give a louder response to the desired signal and at the same time greatly reduce interference from neighboring channels.

Unfortunately it is not always possible to obtain excellent quality and high amplification from the same transformer. The response characteristic of transformers, however, may be materially modified by design and operating conditions as follows: the amount of iron in the core; the ratio of turns; the actual number of turns in the windings and their position with respect to each other and to the core, that is, whether the windings are interwoven or the primary or secondary is placed next to the core; the total resistance of the plate circuit; the plate voltage and grid bias of the amplifying tube associated with the primary of the transformer; and to some extent, the capacity in parallel with the primary and secondary.

Reliability of Curves

The "amplification characteristic" is a scientific method of stating the efficiency of an audio-frequency transformer, but the amount of reliance that can be placed on a published amplification curve depends on the general reliability of the manufacturer. The curve will show nothing as to the likelihood of the transformer developing a defect after a few months of use, unless the utmost precautions have been taken in its manufacture.

Current and Voltage Transformers

The terms "voltage" and "current," when used to designate types of transformers, refer to electrical design rather than mechanical design. A voltage transformer is essentially a lighting or power transformer of small

capacity used to step down the line voltage for the operation of instruments. The rated output of the transformer is generally made considerably less than the output which could safely be carried without overheating; this limitation of the output is for the purpose of limiting the variation of the ratio of transformation without change of output. The term "potential transformer" has been in use since the beginning of the alternating current art. However, as the word "potential," when used in this sense, is incorrect unless assumed to be a contraction of "potential-difference," and has been used in other senses in scientific work, it is suggested that the expression "voltage transformer" be used instead, as it is not ambiguous.

The ratio of transformation of a voltage transformer is the quotient of the voltage applied to the primary terminals divided by the voltage available at the secondary terminals. The ratio of transformation is a variable quantity, and while it is nearly equal to the quotient of primary turns divided by secondary turns, it should be distinguished from the ratio of turns.

The *current* transformer does not differ in principle from ordinary lighting and power transformers, but it is rather sharply limited as to design, if good results are to be secured. The magnetic induction must be kept low, and the core is preferably of silicon steel. The magnetic circuit should be short and have interlaced joints, if joints are present. The number of ampere-turns should be not less than 300, as a rule. This value refers to the rated maximum current.

MICHAEL FARADAY AND THE TRANSFORMER

(Concluded from page 19)

ther indication of inductive effect. After a short observation Faraday disconnected one of the wires attached to the battery and noticed that now the galvanometer needle again moved away from, and back to, its normal position.

Here at last was the great discovery; the coil of the galvanometer was energized by electric current produced by magnetism. Close upon the heels of this discovery experiments were extended into various avenues, of electrical inquiry but the development which above others served as a step toward radio signaling was that of the induction coil. This instrument, made possible by Faraday's discovery, was destined, in the hands of the experimentalists, to become as revolutionary in its potentialities as was the lever of Archimedes to succeeding generations of mechanics—each discovery presented a key to the multiplication of force.—*From the Engineering Rise in Radio*, by Donald McNicol.

The November issue of
Radio Engineering will feature

▪ **Component Engineering** ▪

Resistances

Electrolytic Condensers

Paper Condensers

Variable Condensers

Tubes, etc.



This November issue will be
out just before the I. R. E. Con-
vention in Rochester, N. Y., Nov.
9-10. Several hundred extra copies
will be available at the Radio Engineering
Booth—Advertising Forms close October 30.



The Paid Circulation of
Radio Engineering is over
9200—A. B. C.

—about 50% greater than the paid
circulation of *any* competing elec-
tronic or radio-industrial journal.

Attend the Rochester I. R. E. Convention—Nov. 9-10

Transformer Products

FERRANTI TRANSFORMERS

Ferranti, Inc., 30 E. 42d St., New York City, have developed a transformer giving a particularly flat response curve over a frequency range from 25 to 8,000 cycles. The superiority of the transformer lies in its ability to transmit efficiently all frequencies required for natural reproduction of speech and music. This result is obtained by a special type of mechanical construction and coil design not used in other transformers. This special construction reduces the magnetic leakage and the self and mutual capacity to a minimum.

The liberal design and high inductance under working conditions, and the high ratio of primary impedance to tube impedance are factors in producing the superior results obtained in amplifiers constructed with Ferranti transformers.

Special impedance matching transformers are now wound to specifications in a particularly short time. Transformers for the exacting requirements of broadcast stations, public-address systems, recording devices, laboratories, speech transmission and other uses where a flat curve over a wide frequency band is required, are obtained by this new type of construction. Impedance matching units are supplied for such cases as microphone step-up, microphone mixing, microphone to line, tube to line, line to line, tube to speaker, line to speaker, line to tube, Pentode to speaker and numerous other conditions.

THORDARSON NEW PRODUCTS

The Thordarson Electric Mfg. Co., 500 W. Huron St., Chicago, have announced some substitutions and additions to their line of audio transformers and chokes. The company's announcement reads:

"The type T-2922 transformer has been discontinued, and in its place we are listing the type T-4304. This is a push-pull input transformer having a ratio of three-to-one and is identical in appearance to the T-2408.

"There are also three new choke coils in stock, all being completely shielded and having screw terminals. Type T-1700 has an inductance of 28.6 henrys and a capacity of 130 milliamperes. Type T-1998 has an inductance of 27.3 henrys and will carry 160 milliamperes. Type T-3646 has an inductance of 10.4 henrys and a capacity of 110 milliamperes.

"In the replacement power transformer, type T-3740, is a new model. This transformer is completely shielded with soldering lugs for sub-panel mounting and will supply 5 heater tubes such as 224s, 2-245 tubes and a 280 rectifier.

"Under the heading of 'Manufacturers' Types' are listed four small units which are sold only in cartons of ten. They are furnished in an open frame mounting with six-inch wire leads. Type T-2999 is a three-to-one audio transformer for general usage. Type T-3391 is a push-pull input transformer with a ratio of three-to-one. Type T-3399 is a push-pull output transformer to couple 171 or 245 tubes to the voice coil of a dynamic speaker. The T-4707 choke has an inductance of 14 henrys and a capacity of 90 milliamperes, and is suitable in many filter circuits, especially where choke input is used.

"The Thordarson T-4843 output transformer is designed to couple the new single power pentode tube to the voice coil of a dynamic speaker. The turn ratio of the transformer is 30 to 1 and the im-

pedance ratio is 900 to 1. The Thordarson T-4831 for push-pull pentodes has a turn ratio of 42.4 to 1, and an impedance ratio of 1,800 to 1.

"These transformers are designed so that the reflected load on the pentode is 8,000 ohms when connected with a speaker whose voice coil has an impedance of 8.9 ohms. Sizes $2\frac{1}{2} \times 2\frac{1}{2} \times 3$ inches. Weight, 2 pounds."

SANGAMO TRANSFORMERS

The Sangamo Electric Company, Springfield, Ill., manufacture a line of interstage transformers. The company's transformers are built in numerous types such as will fit in manufacturers' chassis. The Sangamo company specializes in a high-grade product designed to give the utmost of fidelity to the lowest and highest frequencies commonly used in radio and audio reception. Their transformers are rigidly tested and a faithful response from each transformer must be recorded before shipment.

Typical units are:

Style of mounting—horizontal—one shield. 35-50 watt, 115 volt, 50-60 cycle. Normal h. v. secondary, 300-300. Number of filament windings, 2 or 3. Dimensions outside above mounting: Surface, $3\frac{1}{4} \times 3\frac{1}{4} \times 1\frac{1}{8}$ high. Mounting holes, $4-2\frac{5}{8} \times 3\frac{1}{4}$.

50-60 watt, 115 volt, 50-60 cycle. Same as above except $2\frac{1}{2}$ high.

Style of mounting—vertical—two shields. 50-60 watts, 115 volt, 50-60 cycle. Normal h. v. secondary voltage, 350-350. Number of filament windings, 2 or 3. Dimensions outside, $3 \frac{3}{16} \times 3 \frac{5}{16} \times 4\frac{1}{8}$. Mounting holes, $4-2 \frac{1}{32} \times 2\frac{1}{8}$.

80-96 watt same as above except: Outside dimensions, $3 \frac{7}{16} \times 2 \frac{5}{16} \times 4\frac{1}{8}$. Mounting holes, $4-2\frac{1}{4} \times 2\frac{1}{8}$.

Modifications of the above types are available, including variations in secondary voltages, center taps on various windings, etc. Also larger sizes up to 250 watts, also 25 cycles and 220-volt types.

POLYMET TRANSFORMERS

The Polymet Mfg. Corp., 829 East 134th St., New York, announce three new transformers ready for the market. These are:

TA-733 is a push-pull output transformer designed to operate between two pentode type 247 tubes to a dynamic speaker having a voice coil of 6 to 10 ohms resistance.

TA-734 is a push-pull output transformer designed to operate between two 245 tubes to a dynamic speaker having a voice coil of 6 to 10 ohms.

TA-735 is an output transformer designed to operate from a single pentode 247 tube to a dynamic speaker having a voice coil of from 6 to 10 ohms.

TRANSFORMER DESIGN

In the design of power transformers for radio use, specifications are submitted by radio manufacturers, giving information as to number of windings, voltage desired for a certain amount of current, temperature rise allowed, and approximate size required.

From the above data the designing engineer determines, from previous experience and special conditions, size of core he will use; decides on the grade of silicon steel, flux density at which it will be operated.

A current density is also decided upon,

and from the flux density, number of turns are immediately available through calculation or charts prepared to that effect.

Prepared tables give number of turns per layer of each standard coil, so that the coil may be designed quickly. Insulation is indicated. It is then easy to determine if the coil will or will not fit in the space. The result of this investigation allows design more closely until the correct balance is obtained. A final check is made, when the coil is completed, of the iron and copper losses to determine if the transformer will run at specified temperature rise.

The specification card is turned over to the sample department. When sample is completed it is carefully checked for exciting current, watt losses and voltages under load. Sample is then submitted to the approval of the engineering department of the customer.

Economy has led to small transformers running at higher temperature rise, which requires a better grade of insulation and steel and higher melting waxes for impregnation.

Custom work for radio manufacturers is a specialty of the Standard Transformer Corp., 852 Blackhawk St., Chicago, Ill.

DONGAN PRODUCTS

The Dongan Electric Mfg. Co., 2987 Franklin St., Detroit, Mich., carry a wide line of transformers. These may be listed as follows:

(a) Power supply transformers for furnishing filament current and high voltage supply for radio receivers and audio amplifiers.

(b) Audio-frequency transformers for standard receivers and special applications such as the automobile receiver. These units are made in the various types of straight audio, push-pull input, push-pull output and various types of impedance matching.

(c) Transformers for radio transmitters of both the plate and filament supply. This type of transformer requires that insulation be used which will provide a high factor of safety against any voltage break-down.

High reactance type of transformers. (a) High voltage transformers for operation of neon signs. These may be of the standard low power factor type or of the special high power factor type.

(b) High voltage transformers for oil and gas burner ignition service.

(c) Low voltage transformers for the operation of ultra violet, carbon-arc and the bulb type sun lamps.

Signaling transformers. (a) Small door bell ringing transformers.

(b) Small control transformers.

(c) Signaling transformers.

Toy transformers for operation of small toy motors, etc.

Transformers for special applications.

JEFFERSON

The Jefferson Electric Company, 1599 South LaSalle St., Chicago, Ill., have long been identified with the manufacture of small transformers for various needs. A recent announcement by the company reads:

"The small transformer has always been Jefferson's particular field . . . and in this field it has acquired a worthy and sound reputation built on performance."

MILLIONS FOR BETTER BROADCASTING!



why not a few cents more for
BETTER RECEPTION?

Radio authorities are agreed:—Radio transmission is making tremendous forward strides. Radio reception is lagging behind. Look at the constant improvements in transmission. The use of acoustic panels, of condenser and reflector microphones. The clarification of tone; the reduction of interference, over-lapping, fuzzing, and fading. . . .

It all sounds fine to the radio listener—until his speaker says to him: "Try and get it!"

What Radio Needs

The far-sighted maker of radio sets won't take a chance. He realizes that the industry cannot remain deaf to this challenging demand by better broadcasting for better reception. He knows what the radio public wants—what radio needs.

He knows what Magnavox has done in the past to meet this need. And, being "up" on the latest developments, he knows that the new Magnavox 40 Series Symphonic Speaker represents a great advance, reproducing the full range of voice and music—clear and true—from low G to high C. . . .

A few cents more for better reception—and some wise radio manufacturer is going to solve some mighty troublous problems of "price" competition!

Make no commitments without investigating the New Magnavox 40 Series Symphonic Speaker. A model, with engineering data, will be furnished without obligation.

Magnavox Company Ltd.

Executive and Sales Offices:
155 East Ohio St., Chicago, Ill.

Factories:
Fort Wayne, Ind.



Subsidiaries:
The Magnavox Company
Electro Formation, Inc.
Magnavox (Great Britain) Ltd.
Magnavox (Australia) Ltd.

Magnavox SPEAKERS

THE PRODUCT OF TWENTY YEARS' PIONEER RESEARCH

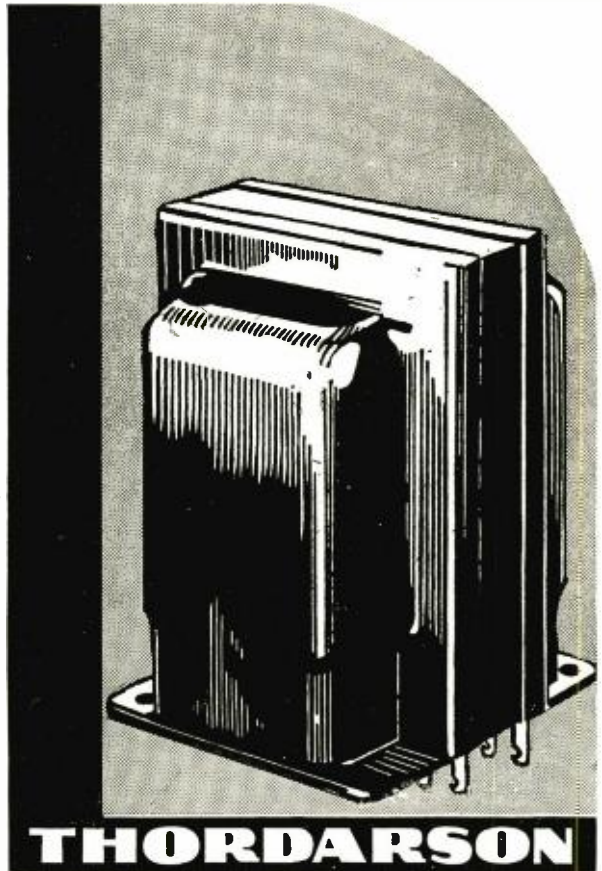

THORDARSON TRANSFORMERS

Keep step with
Engineering trends

Intensive and continuous research and experience keep Thordarson Transformers in step with engineering progress in the radio field . . . and vast purchasing, production and distribution facilities keep their costs low.

Tell us of your requirements and let us make suggestions. Let us show you how Thordarson Transformers—a product of nearly 40 years' leadership in high quality transformer production—can help you sustain your manufacturing profits.

THORDARSON ELECTRIC MANUFACTURING CO.
500 WEST HURON STREET, CHICAGO, ILLINOIS



New Inventions

Cathodes of Electron Discharge Tubes or Thermionic Valves

AN incandescent cathode consists of a core of a highly refractory metal, such as tungsten or molybdenum, at least partly coated with a layer in a meter of lower melting point, preferably nickel, round which is wound a nickel wire coated with an alkaline earth metal or compound. N. V. Philips Gloeilampenfabrieken. British Patent 347,500. Appl. (Holland), October 9, 1929. Appl. (Great Britain), May 16, 1930. Issued: April 30, 1931.

Process for Covering Metallic Particles with an Insulating Layer

DEALS with the insulation with Kieseluhr of magnetic particles, such as permalloy, for cores, etc. used in loading coils. Methods of applying coating. International Standard Electric Corp. German Patent 524,736. Appl. (United States) August 26, 1927. Appl. (Germany) August 10, 1928. Issued: May 11, 1931.

Magnetic Alloys for Telegraphs and Telephones

ALLOYS containing 40-50 iron, 42 or more nickel, with or without silicon, aluminum, chromium and manganese. Similar to British Patent 308,643. W. S. Smith, H. J. Garnett and Holden. German Patent 524,823. Appl. (Great Britain) December 23, 1927. Appl. (Germany) November 21, 1928. Issued: May 13, 1931.

Sealing Device for Vacuum Tubes

AFORM of obturator seal claimed to eliminate leakages. The obturator section is made of nickel or molybdenum. N. V. Philips Gloeilampenfabrieken. French Patent 703,654. Appl. (Holland) November 2, 1929. Appl. (France) October 13, 1930. Issued: May 4 1931.

Cathode Structure

IN a cathode structure, a cylindrical shell of nickel open at each end thereof, a refractory mass within the shell, a heating wire passing through the refractory mass, a protective coating of metal over the shell, such protective coating being more resistant to oxidation than the nickel, and a coating of emitting substance on the outside of the shell over the protective coating. F. S. McCullough. United States Patent 1,814,759. Appl. February 10, 1926. Issued: July 14, 1931.

Neon Flashograph Tube Provides Unique Visual Radio Receiver Tuning

ONE of the newest improvements in radio receivers is the recently invented neon tube, which has special characteristics that make it suitable for a visual tuning device in radio receiving sets. This tube, first introduced by Fada in

the Fada Automatic Flashograph, has a definite advantage of providing accurate visual tuning instead of tuning by ear as in the past, which was proven inaccurate.

As the tuning knob is turned at the approach of a station, a neon tube resonator sends a rising glow of light upwards. When the light has reached its highest point for that station, then that station is sharply and accurately tuned. In a lower indicator a window space is provided for logging favorite stations by call letter on the dial itself.

The general appearance is somewhat similar to a thermometer. Instead of a rising column of fluid there is almost instantly a rising column of red neon light.

As this device is operated by the incoming carrier signal accurate station tuning is assured automatically entirely independent from any volume of the set as the volume control can be turned off and the Flashograph works just the same.

The plate current supplied to the radio tubes changes in value depending upon whether the station is powerful or weak. If the station to which the receiver is tuned is a powerful local the plate current of the radio tubes is of low value. Conversely if the station heard is distant this current reaches a higher value.

As these changes in the current supplied to the radio tubes take place the voltage applied to the plates also changes, but in the opposite direction. That is to say, a powerful station results in more voltage being applied to the plates of the r-f. tubes, whereas a distant station or the absence of a station will cause this voltage to drop in value.

The Flashograph neon resonator tube takes advantage of this situation so that a powerful and worthwhile station, when received, energizes a neon glow tube of an entirely new and novel form. The tube itself is fitted to an automobile lamp base and is one-half an inch in diameter and three and one-half inches long. The two electrodes, one a half inch long and the other three and three-sixteenths inches long, are sealed inside a neon filled glass bulb. When the tube is subjected to a voltage of approximately 170 volts an orange glow surrounds the longer electrode to the half-inch height of the shorter electrode. As the voltage applied to the tubes increases the glow column which surrounds the longer electrode moves toward the end of this electrode. Usually when the voltage reaches 240 volts in value the glow column entirely envelops the longer electrode.

In the actual receiver the neon lamp is mounted vertically behind a celluloid tuning scale and a vertical window through

which the rise and fall of the glow column can be observed. Station signals entering the receiver as the tuning knob is rotated cause the glow column to rise to maximum height and fall again as the exact tuning point is passed. In this way the highest rise of the neon column indicates the exact tuning point for each particular station tuned in.

This method of tuning is much easier to operate than the tuning meter system heretofore used and which was at times confusing.

Improvements in the Carbonizing of Metal Surfaces

CARBONIZATION of nickel, nickel-chromium or Konel grids and plates for use in thermionic valves. The surface is oxidized and the oxidized body is subjected at temperatures of 800°-1,000° C. to a hydrocarbon gas containing a proportion of a vaporized liquid hydrocarbon. C. V. Iredell. (Assigned to Westinghouse Lamp Co.) British Patent 347,267. Appl. (United States) January 25, 1929. Appl. (Great Britain) January 24, 1930. Issued: April 24, 1931.

Improvements in Electric Relays

THE core of the electromagnet producing the electromagnetic force is formed partially or wholly of an iron alloy having a high nickel content (Permalloy). Structural details are given. H. J. J. M. de Regnauld de Bellescize. British Patent 350,487. Appl. (France) December 12, 1928. Appl. (Great Britain) December 12, 1929. Issued: June 12 1931.

Manufacture of Magnetic Alloys

AMETHOD for the heat treatment of substantially carbon-free magnetic alloys, containing mainly iron and nickel, with a nickel content up to 50 per cent, which comprises subjecting the alloys to a heat-treatment at a temperature to anneal completely the alloy, followed after cooling by a second heat-treatment at a lower temperature, which exceeds the magnetic transition temperature of the alloy by at least 100°, but does not exceed 700° C. W. S. Smith, H. J. Garnett and W. F. Randell. Canadian Patent 312,445. Appl. August 20, 1930. Issued: June 23, 1931.

Improvements in Electron Emitting Cathodes

SEPARATE coatings of carbon and of an oxide or a carbonate of an alkali metal or alkaline earth metal are applied to the cathode core, which may be of nickel, nickel-silicon, or platinum. The electrode is heated to a temperature at which chemical interaction between the materials of the coating takes place, to effect an appreciable conversion of such oxide or carbonate to a carbide. Q. R. S. De Vry Corporation. British Patent 351,006. Appl. March 15, 1930. Issued: June 15, 1931.

ELMET Molybdenum Products

and all types of Lead-in Welds

ELMET Two or Three Piece Welds

For Samples and Prices, Write Today to Dept. R-2

AMERICAN ELECTRO METAL CORPORATION
LEWISTON MAINE

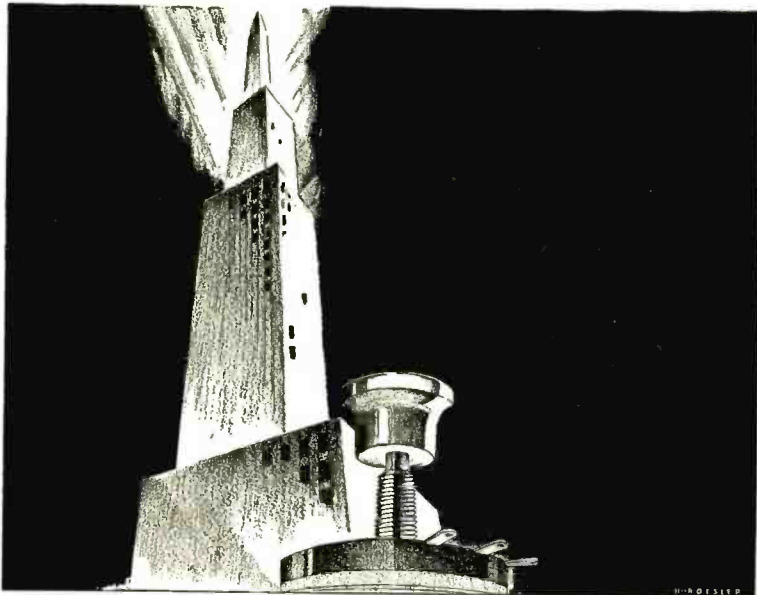

The twenty million volume controls produced by CENTRALAB form a towering monument to skill. Here are twenty million reasons for CENTRALAB'S spectacular rise to fame above the house tops of competitive mediocrity.

Lone experimenters and manufacturers everywhere are offering and producing smoother and more satisfactory reception with CENTRALAB Volume Controls.



MONUMENTS TO SKILL!

Centralab

Central Radio Laboratories
Milwaukee, Wis.

Write for the new CENTRALAB Volume Control with Off and on Switch. Engineers send specification for sample. More convenient than when mounted separately. Save assembly cost . . . saves in first cost.

NEWS OF THE INDUSTRY

TELEVISION PRODUCTS CO. OF AMERICA ENTERS TELEVISION FIELD

The Television Products Company of America, a Delaware corporation, has recently been established to manufacture and merchandise the See-All television kit and the See-All short-wave radio receiver, as well as a complete line of television accessories.

The engineering and designing factor of the corporation is A. Pollak, well known and highly regarded in engineering and manufacturing circles for over 17 years.

Associated with Pollak in Television Products is Ira Greene, a man who needs no introduction to radio and allied trades. Mr. Greene is one of the real pioneers in the radio and electrical industries. He has been affiliated with several successful enterprises in executive capacities of great importance.

KOENITZER PROMOTED BY BELDEN

Russell Koenitzer has been appointed representative in the Detroit-Cleveland territory by Belden. Russ has been with Belden for over seven years in the production, sales service, and advertising divisions. With this experience he has gained a thorough knowledge of Belden products and a wide acquaintance in the automotive, electrical, and radio merchandising fields.

In his new territory he will have complete charge of the Belden complete line of aerial kits, aerial wire, lightning arresters, and other Belden radio wire accessories.



E. F. POTTER

R. C. ELWELL JOINS ARCTURUS

Robert C. Elwell recently joined the sales staff of the Arcturus Radio Tube Company, Newark, N. J.

Mr. Elwell has had extensive experience through his previous connections, having worked for radio dealers and jobbers. This broad experience will stand him in good stead in contacting accounts in his territory.

For three years Mr. Elwell was sales promotion manager of a large radio jobber in the South. Prior to that he was manager of the talking machine and radio departments of a jobbing organization in Ohio for fourteen years, with the exception of a two years' period during which he held a similar position with another wholesaler.

HYGRADE-SYLVANIA PAYS DIVIDEND

Hygrade Sylvania Corp. of Emporium, Pa., declared an initial quarterly dividend of 50 cents a share on the no par common, payable October 1 to holders of record September 10. This is an increase from 40 cents paid previously.

OXFORD-POTTER COMBINATION

Among the interesting events in the radio industry during the past week is the formation of the Oxford Products Company, Incorporated, as a subsidiary of the Potter Company of North Chicago, Illinois. Imperial, Incorporated, of Chicago, Illinois, has been absorbed in this consolidation. This combination links two of the oldest members of the radio industry—E. F. Potter and Frank Reichmann.

The Oxford Products Company will concentrate efforts on the manufacture of loudspeakers and will have a capacity of 5,000 speakers a day. The plant will be located at North Chicago, Illinois.

Mr. Potter is well known among radio men and has concentrated his efforts on the manufacture of condensers of the finest quality. Mr. Reichmann is recognized as one of the earliest manufacturers of loudspeakers in the radio industry.

This new Oxford speaker line includes the popular 6-inch, 8-inch and 10-inch speakers for use with midget and console radios, also 6-inch and 8-inch automobile speakers in pressed metal cases. In addition there is included in the Oxford speaker line 12-inch and 14-inch speakers and a number of models for theatres and public address systems. These speakers are all tested constructions of Mr. Reichmann's plus new developments in this ever changing art.

Although the Imperial, Incorporated, has been manufacturing these speakers under the Oxford trademark, for some time, for a number of the prominent radio set manufacturers, this consolidation will enable this company to greatly expand its operations, making it one of the strongest speaker companies in the radio industry.

WIRE CLOTH

The Newark Wire Cloth Company, Newark, N. J., manufacturers of wire cloth products for all industries, has announced the appointment of F. C. Ryan, as sales manager. Mr. Ryan is a graduate of Lehigh University in chemical engineering. During the war he was connected with the U. S. Bureau of Mines. He will be remembered by many readers as former sales engineer with the New Jersey Zinc Company and later as staff manager with the Johns-Manville Sales Corp.

STENODE CORPORATION OF AMERICA TEMPORARILY SUSPENDS LABORATORY OPERATIONS IN AMERICA

Arrangements having been made for the further development of the Stenode for broadcast receiving purposes by manufacturers under license, and for the development of the system for certain government service, the Stenode Corporation of America is temporarily suspending operations at its Hempstead laboratories.

Negotiations are proceeding with a view to placing the development of the Stenode to telegraphic and cable systems in the hands of telegraphic interests in America.

Pending the re-opening of the laboratories at Hempstead, communications should be addressed to the executive office of the company at their usual address, viz., Hempstead Gardens, Long Island, New York.

Arthur H. Lynch, who has hitherto held the office of vice-president and joint-general manager of the corporation, is now president.



FRANK REICHMANN

RCA Victor Products

for Dependability

A generation of radio research and technical experience helps to perfect every product bearing the RCA Victor name.

LOUDSPEAKERS

Both electro-dynamic and permanent magnetic dynamic types.

MAGNETIC PICKUPS

Either low or high impedance types complete with the new "Inertia" tone arms which give improved frequency response and tracking qualities.

ELECTRIC PHONOGRAPH ASSEMBLIES

Complete motor boards including pick-up, turn-table, motor, automatic stop, etc., ready for mounting directly in your combination cabinet. Also automatic record changing mechanisms.

"FARADON" MICA CAPACITORS

Both transmitting and receiving types, formerly made by the Wireless Specialty Apparatus Company.

RECTOX RECTIFIERS

Dry disc, copper oxide type for loud-speaker field supply.

LABORATORY AND TEST INSTRUMENTS

Precision instruments for the factory, laboratory, classroom, etc.

Equipment and parts supplied to meet your particular requirements. Specialized engineers are available to assure you of correctly designed apparatus.

For complete information, write or call—
Engineering Products Division

RCA Victor Company, Inc.

A Radio Corporation of America Subsidiary

Camden, N. J.



NEW "70" Series

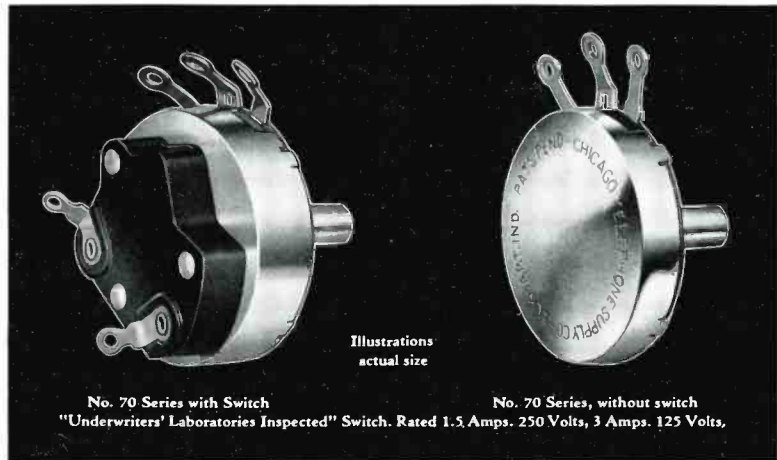

A FEW OF OUR OTHER UNITS (Volume and Tone Controls)



No. 20 Series
Tandem Unit

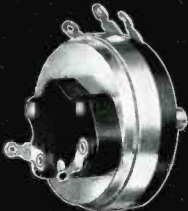

No. 40 Series, with "Underwriters' Laboratories Inspected" Switch. Rated 1.5 Amps. 250 Volts, 3 Amps. 125 Volts.



No. 20 Series
Single Control



No. 20 Series, with "Underwriters' Laboratories Inspected" Switch. Rated 1.5 Amps. 250 Volts, 3 Amps. 125 Volts.

Dominant among Volume and Tone Controls because of superior quality and value

Leadership in any industry usually is founded upon several factors, not the least of which are that the product itself must be of superior quality and of unquestioned value.

Our Volume and Tone Controls have won their position of dominance in the radio industry through sheer merit plus an easily recognized value.

Striking examples of this are to be found in our recently announced "70" Series Composition Element Volume and Tone Controls, and in our No. 20 Series Wire-Wound Units, both of which are outstanding achievements in their respective fields.

Our new "70" Series Controls offer surprising value and high quality in a low-priced unit of the composition element type. Similarly, our No. 20 Series, with its specially designed contact member, provided the first really practical solution of the problem of noise in wire-wound Volume and Tone Controls.

We shall be glad to send full details of the seasoned principles involved in the construction of these controls, and invite inquiries from interested engineers. If you will send us exact specifications, we will, without obligation, submit samples free of charge.

CHICAGO TELEPHONE SUPPLY CO.

HERBERT H. FROST, INC.

SALES DIVISION

General Offices ELKHART, INDIANA and Plant

NATIONAL UNION ELECTS

The Board of Directors of the National Union Radio Corporation at a recent meeting in New York City, elected S. W. Muldowny as chairman of the board and H. R. Peters as president of the organization.

Mr. Muldowny brings to his position a valuable background of large corporation organizational and directional experience. He is connected with Lehman Brothers, International Bankers, and has been a director of the National Union Radio Corporation since its formation in December, 1929. He played a vital part in the merging of the independent tube manufacturers, which were brought together to form the present organization and has spent many months of his time in guiding the National Union policies and developments.

Muldowny succeeds the Honorable Joseph E. Davies of Washington, D. C., who, although he has resigned his position as chairman of the board, remains as a director and member of the executive committee.

H. R. Peters carries with him to the presidential chair a wealth of experience in accounting and general management work. His background includes many years of work as a certified public accountant and later as vice president and general manager of the Waldorf chain of restaurants.

At the time National Union Radio Corporation was organized, Peters was conducting his own public accounting business in Boston, Mass. He was called by Lehman Brothers to the post of treasurer in the newly formed organization. National Union later elected him to the executive vice-presidency, in which capacity he was serving at the time of his recent appointment to the presidency.

WESTINGHOUSE APPOINTS STREAMER MANAGER DIVERSIFIED PRODUCTS DEPT.

J. S. Tritle, vice-president and general manager of the Westinghouse Electric and Manufacturing Company, announces the formation of a diversified products sales department in which is grouped all Westinghouse equipment not specifically aligned with the transportation, the central station and the industrial fields.

His announcement also states that A. C. Streamer, for some years assistant director of sales, has been appointed sales manager of the department.

The major lines segregated under the new department are interior and exterior lighting products; micarta; insulating materials; gearing products; commercial cooking units; and broadcasting and radio material, other than domestic receivers and primarily referred to as radio equipment sold to the government.

Mr. Streamer, native of Boulder, Colorado, graduated from Colorado State University in 1907. After completing the Westinghouse apprenticeship course, he was assigned to the switchboard engineering department. From 1909 to 1913, he was a member of the detail and supply correspondence department where his work was concerned with the illuminating, supply, and switchboard sections. In 1914 and 1915 he held the post of manager of the order section and from 1916 to 1920 he was manager of the switchboard section.

In 1921 he was appointed assistant to the manager of supply sales and in 1926 became assistant director of sales.

Active in association work, he is a member of the American Institute of Electrical Engineers, the National Electrical Manufacturers' Association and the Na-

tional Electric Light Association. For three years he was chairman of the power switchboard and switching equipment section and for five years chairman of the panelboard and switchboard section of the N. E. M. A.

CLOCKS

The Chicago Flexible Shaft Company, Chicago, makers of Sunbeam electric appliances, have recently added to their Sunbeam Eternatime line of electric clocks a group of exceptionally beautiful clocks in marble and onyx.

KESTER SOLDER OPENS NEW CANADIAN PLANT

Kester Solder Company, originators of self-fluxing solder, announce the establishing and opening of a plant at Brantford, Canada, on September 15. The plant will be operated under the name of Kester Solder Company of Canada, Limited.

Seeing the growth of Canadian business caused the Kester Solder Company to establish this new plant. This newest member of Kester plants increases the number to three strategically located manufacturing sources. General offices and plant located at Chicago, the Newark, New Jersey, plant to serve the eastern seaboard and water shipments and now the Brantford plant for Canada.

F. C. Engelhart, president of the Kester Solder Company, commented concerning the Brantford plant, "As with the establishing of our Newark, New Jersey, plant, it is our desire to give our customers the best service possible. Canada could not be efficiently served without a plant located in the Dominion. Our three plants enable us to produce economically and expedite service. Kester leads the field in solder—this new plant still further establishes Kester's reputation for leadership."

"Kester sales are ahead of last year," says J. A. Reitzel, General Sales Manager of Kester.

GATES SELLS COILS

S. O. Lawrence, president of the General Manufacturing Company, 8066 S. Chicago Ave., Chicago, Ill., manufacturers of "Gen-Ral" coils, announces the appointment of Howard Gates as field engineer.

Mr. Gates is well known throughout the radio industry, having for a long time been associated with the Zenith Radio Company.

In his new capacity Mr. Gates will contact radio manufacturers throughout the United States, giving them the benefit of his long experience in the manufacture and design of coils of all types. This engineering consulting service, Mr. Lawrence says, is available to every radio and parts manufacturer in the United States who wishes to take advantage of it.

JORDAN JOINS KEN-RAD

Announcement is made by Richard E. Smiley, general sales manager of The Ken-Rad Corporation, Owensboro, Kentucky, that James D. Jordan has associated himself with The Ken-Rad Corporation as chief engineer of the commercial division.

CLARKE H. METHOT JOINS CABLE RADIO

J. J. Steinharter, president of the Cable Radio Tube Corporation of Brooklyn, N. Y., manufacturers of Speed tubes, has just announced that Clarke H. Methot has been appointed vice-president of the corporation. Mr. Methot will assist Mr.

Steinharter in carrying out sales and merchandising programs on Speed tubes.

For over 29 years Mr. Methot was associated with the Manhattan Electrical Supply Company, resigning as general manager a short time ago. While with Manhattan, Mr. Methot handled the entire distribution and sales policies on the well-known Red Seal dry cells.

After spending a short time at the factory, Mr. Methot will make an extensive tour of all trade centers, in the interest of Speed tubes and other Cable products.

IMPROVEMENT ON SPUD WELDS

New flat end nickel wire sections, to be used in place of spud welds, effecting savings, are announced by the Art Wire and Stamping Co., 16-20 Boyden Place, Newark, N. J. For all cut wire below 3 inches in length the company guarantees accuracies within .001 inch. Manufacturers can reduce their costs by purchasing wire parts, made according to their own blueprints.

TELEGLow LAMP FOR TELEVISION

At the New York Electrical Show, September 21-26, the Sanabria television system was shown daily in actual operation. The lamp used was the Teleglow, manufactured by the Taylor Vacuum Products Company, 1500 N. Ogden Ave., Chicago, Ill.

ARCTURUS ANNOUNCES NEW '30 SERIES D-C. TUBES

After extensive development and life tests conducted over a period of many months, seven new d-c. tubes of the '30 series have been presented by the Arcturus Radio Tube Company, Newark, N. J. These tubes are of two families: the types 130, 131, 132 and 133 which all have a 2.0 volt filament and the types 136, 137 and 138 are rated at 6.3 volts.

The 2.0 volt d-c. tubes have an unusually low drain to meet the exact needs of battery sets. The 130 is a general purpose battery tube which can be used as a detector or amplifier; the 131 is a power amplifier tube for use where economy of plate current is a factor; the 132 is a screen-grid tube and is used as a r-f. amplifier; the 133 is a power amplifier Pentode delivering .650 to .700 watt with a 9.5 volt input.

The 6.0 volt d-c. series are of the heater-cathode construction and are specially designed for use in automobile, motor boat and direct-current sets. Type 136 is a screen-grid tube for use as a r-f. amplifier or detector; type 137 is a general-purpose tube and can be used as either a detector, amplifier or oscillator; type 138 is a power pentode giving a large output with small input voltages. The rugged construction of this series withstands shocks and jolts encountered in portable or mobile battery operated sets.

PENTODE TRANSFORMERS

The American Transformer Company, 178 Emmett St., Newark, N. J., announce three output transformers for use with the new 247 type pentode power tube. These are:

Type 6150—Output from two type 247 pentode tubes to 500 ohms (center tapped primary).

Type—6152—Output from two type 247 pentode tubes to 4,000 ohms (center tapped primary).

Type 6200—Output from two type 247 pentode tubes to 15 ohms (center tapped primary).

NEW DEVELOPMENTS OF THE MONTH

NEWEST LINE RESISTORS FOR D-C. SETS ELIMINATE HEATING TROUBLES

A brand new plug-in type line resistor has been developed by the Clarostat Mfg. Company, of Brooklyn, N. Y., especially for use in d-c. radio receivers. Set manufacturers who have changed over their 110-volt d-c. sets to use the new 6-volt, 0.3 ampere tubes, will find this resistor particularly applicable to their needs.

The new line resistor follows the same general construction which has proved so



efficient in the Clarostat line ballast. It is wound on a sturdy mica frame, and is protected by its perforated metal housing which acts as a ventilating stack, thus rapidly dissipating heat. The unique method of construction tends to keep the line resistor from heating up. This prevents possible injury to nearby components and also precludes disturbing capacity or inductance changes due to overheating. Hence, maximum efficiency of operation is definitely assured.

The Clarostat line resistor may be plugged into a regular two-hole tube-type socket, or it may be obtained with flat prongs, for use in any standard electrical outlet. Line resistors of various values are available to supply the voltage drop required in reducing the standard line potential (110-115 volts, etc.) to the value needed by the tubes, which are all connected in series. The cost of the new Clarostat line resistor compares favorably with the ordinary enamelled resistor and cover, which it now renders obsolete.

CABLE DEVELOPS NEW TUBE FOR TELEVISION EXPERIMENTERS

While the engineers of the Cable Radio Tube Corp., makers of Speed tubes, are working steadily to perfect new types of apparatus for use in the fast developing art of television they have not lost sight of the fact that the art, commercially speaking, has not progressed beyond the familiar scanning disc. For this reason, and in view of the fact that the scanning disc is likely to remain the system most used by amateur experimenters, the Cable engineers have developed a new type of flat-plate neon tube for use in the reception of television signals. The neon discharge tube as used with the scanning disc has long been neglected—experimenters being content with the fact that it “works” without asking “how?” or “why?”

The tube in its usual form consists of two elements sealed within a glass envelope containing some one of the “noble”

gases (neon, argon, helium, for example) at a pressure such that a glow discharge will be formed when a sufficient voltage is applied across the terminals of the tube. One of these electrodes—the positive element or anode—is in the form of a wire loop placed behind the negative electrode (cathode), which is in the form of a flat metallic plate backed with mica so that the glow will form on the front of the plate only.

The mechanism of the discharge is of a rather complex nature and requires that we first realize that a single molecule of the gas may be looked upon as a tiny planetary system made up of a number of electrons (unit negative charges) following fixed orbits about a central nucleus or proton having as many positive charges as there are electrons in the tiny universe of the molecule. When the voltage across the two electrodes is sufficiently high some of the electrons are drawn toward the anode and in their precipitate journey strike other electrons violently, dislodging them from their orbital paths. The gas molecules thus deprived of an electron are in a state of unbalance, for the nucleus has one more positive charge than

rent, there is a lag in its decrease. The magnitude of the lag is termed the de-ionization time. This lag has been found to be due to the fact that a negative charge collects on the wall of the tube. Its effect is to lower the efficiency of the device at signal frequencies having a period less than the de-ionization time.

In the new Cable neon tube the de-ionization lag is conquered by removing its source. The entire wall of the tube with the exception of a small window is covered with a thin metallic coating which acts as the positive element or anode. No negative charge can collect therefore and no slowing up in the action of the tube can occur.

This type of construction presents other advantages in that less current and less output power from the amplifier are required. The tubes are made in one size only, i.e., with a plate area one inch square. This permits the use of any disc size up to twenty inches in diameter. The tube is standard also for those types of commercial scanners employing the scanning drum.

A NEW ANTENNA SUBSTITUTE

The antilli is the name of a new antenna substitute manufactured by the Cole Radio Mfg. Corp., Bloomfield, N. J. It is in the form of a cylinder and gives outdoor antenna distance with an indoor device.

VERTICAL WOOL-PACKED BEARING MOTOR

Bodine Electric Company, 2264 W. Ohio St., Chicago, Illinois, announces that, due to the construction of the end brackets of the new Type N-5 motor, they may be provided in vertical or flange mounted models to meet any specified requirement. Umbrella covers are optional on these in-



there are electrons. Gas molecules thus deprived of an electron are called ions. These are attracted toward the negative electrode, which they strike with great force, giving up their energy in the form of an electromagnetic radiation—light. The color of the light depends upon the gas used and in the case of neon is red. Neon is used for the reason that its efficiency in so far as the light obtained for a given electrical power expended is high.

The intrinsic brilliancy of the light given off depends upon the current flowing through the tube and were this current to be varied the light would vary in accordance with the current. It is thus that the brilliancy of the tube is made to vary in accordance with the television signal.

While the ionization of the gas increases rapidly with the increase of the signal cur-



stallations. These motors are available in ratings of 1/10 and 1/8 h.p. at 1725 r.p.m. and 1/20 and 1/12 h.p. at 1125 r.p.m.

BUILT-IN PROTECTION

CLAROSTAT LINE BALLAST

Don't leave it to your consumers to add voltage compensators to your otherwise well engineered receiver or sound equipment.

When line voltage drops below normal a booster is needed.

When it rises to values unsafe for tubes and components it must be cut to normal.

The Clarostat Line Ballast does BOTH *automatically and instantaneously*.

Guaranteed for one year and actual life tests still in operation show uniform performance for more than 18,000 hours.

Real protection at very little cost.



EXTERNAL PROTECTION



The Clarostat Automatic Line Voltage Regulator—a real protection for the sets already built. Plugs in between receptacle and attachment plug. Automatically changes its own resistance to compensate for line voltages between 110 and 140.

Recommended by many set manufacturers in their Service Manuals.

Free Bulletins Available

Clarostat Mfg. Co., Inc.
285 North 6th Street Brooklyn, N. Y.

CLAROSTAT

TRADE MARK REG. U.S. PAT. OFF.



"SEALEDGED"

REG. U.S. PAT. OFF.

GRID SCREEN

— Patented —

Can't Unravel

Perfect Weave

Smooth Finish.



The photograph at the top is a photomicrograph which shows how the edge of "SEALEDGED" actually looks under a microscope.

"SEALEDGED" is the ideal cloth for pentode and variable-mu tubes. Only the purest nickel wire used: 99 + % pure nickel.

Molybdenum screen is also available for special applications.

Newark Wire Cloth Co.

358-372 Verona Ave.

NEWARK

NEW JERSEY

- Without obligating us in any way please send sample and further particulars concerning "SEALEDGED" Grid Screen.
- Please advise regarding molybdenum screen.
- Please send representative.

Name

Firm

Street

City State.....

SCREEN-GRID CLIP

This new screen-grid clip has been developed by the F. R. Zierick Mfg. Works, 68-72 East 131st Street, New York, N. Y., and is being marketed as their Number 117.

After extensive tests of fitting these on tubes 30,000 times, the clips still held their tension.

These clips are made of brass and are hot tinned to insure easy soldering. They



are meeting the demand for a low priced screen-grid clip, lacking none of the advantages of the higher priced clips.

Samples will be supplied to manufacturers desiring to test them.

FELT FEET FOR MIDGETS

The T. R. Brawley Felt Co., 275—20th St., Brooklyn, N. Y., announces that they have perfected a new felt foot for the midget and table model radios which is electrically insulated so that it can be used to hold a radio chassis into the cabinet and assure against any ground when the radio is set upon a metal radiator cover or other article which may be grounded.

This is done by the use of fibre between the machine screw and metal ferrule used



to hold the foot together; thus, so there is no contact between the metal screw and the metal part of the felt foot.

NEW PHOTOELECTRIC CELL

For many years photoelectric cells have been serving an extremely useful mission in experimental and industrial work in controlling the operation of apparatus and equipment, in controlling various processes and in many counting operations. A number of different types of cell have been available for experimental, commercial and scientific applications, each type, however, had its own inherent limitations in operating performance or had to be used in conjunction with expensive auxiliary equipment.

The development of the Weston photonic cell, with its amazing performance characteristics and its utter simplicity of design marks a sensational advance and fulfills the need for an ideal type of photoelectric cell. Notwithstanding the superiority of this photonic cell, it is exceptionally low in cost as is also its auxiliary apparatus. Its discovery now places photo-cell equipment well within reach of every amateur experimenter.

Electronic in its character, the Weston photonic cell employs a highly light sensitive disc which transforms light energy directly into electrical energy without the use of any auxiliary voltage whatsoever. Its response to light variations is instantaneous and sufficient current is developed to directly operate relays without the use of auxiliary apparatus or any battery. It delivers about one microampere per foot-candle of light intensity. When exposed to direct sunlight the output is approximately 5 milliamperes. The cell resistance varies from about 1500 ohms for 10 foot-candles light intensity to about 300 ohms for 240 foot-candles intensity.

As far as is known, the life of the cell

is practically unlimited and a continuous current flow does not harm it in any way. Since it does not contain any liquid nor require vacuum or gas, there is nothing to get out of order as it is not subject to physical or chemical change and it has a constant output. It can be exposed to direct sunlight without deterioration, has no dark current since its energy is derived directly and only from light; no drifting, hence no circuit adjustments are necessary; no fatigue and it is non-microphonic.

The photonic cell is enclosed in a handsome moulded black Bakelite case fitted at the bottom with two connection prongs which fit into the standard UX radio tube socket. It is rugged in construction and is so simple in design that there is nothing to get out of order. The case is 2¼ inches in diameter and 1 inch in thickness.

CLAROSTAT SPONSORS DUAL VOLUME CONTROLS OF IMPROVED DESIGN

In line with the trend towards increased compactness in the design of radio parts. Clarostat engineers announce an improved type of dual volume and constant impedance controls. These latest additions to the Clarostat line include in their construction all the advantages which have popularized the older model Clarostat dual controls. The new models, however, contain special features which greatly increase their efficiency and utility.

A new coupling arrangement results in a very sturdy unit and eliminates all chance for lost motion between the elements. An electrostatic shield is provided between the two potentiometers. This is often of considerable value in preventing undesired coupling between the two circuits.

The new Clarostat dual controls are much smaller than previous models and



project only 1¼ inch behind the mounting panel. These controls are available with any combination of resistance elements, with standard or reversed taper, either with or without the new built-in 110-volt switch recently announced by the Clarostat Company.

NEW OUTDOOR TYPE NOVALUX PHOTO-ELECTRIC CONTROLLER

A new outdoor type Novalux photoelectric controller has been announced by the General Electric Company. This unit responds to the increase and decrease in daylight intensity and is designed to control street lighting circuits, floodlight installations, electric signs—in fact, any type of outdoor lighting equipment.

The new controller consists of a weather-proof case enclosing a light-sensitive photoelectric "eye," a vacuum tube, contactors and time delay relays. A change in the intensity of the average daylight around the photoelectric tube is picked

up by the tube which controls the grid of the amplifying vacuum tube. The vacuum tube operating on direct current actuates the main contactor through an auxiliary relay. The direct current is obtained from a rectifier and filter mounted on the back of the panel. The photoelectric tube by controlling the grid of the vacuum tube thus indirectly actuates the main contactor. Thermal time delay relays are provided to prevent instantaneous operation in response to the passage of a cloud over the sun, a flash of lightning, a person walking in front of the unit, etc. Operation is positive in that the main contactor will not "flutter" at the critical light intensity.

The unit may be adjusted to close the external circuit at any light intensity between 1 and 10 foot candles, and to open the external circuit at any intensity from 1½ to 4 times that necessary to close the external circuit. Sensitive potentiometers are provided in order to secure close adjustment of the operating light intensity. Adjustments may be made without opening the case.

CATHODE RAY OSCILLOGRAPH

For those users who wish to adapt the cathode-ray oscillograph for mounting on a standard 19-inch (Type 480) relay rack, the General Radio Company, Cambridge, Mass., can supply a suitable drilled panel to which the supporting bracket of the tube mounting may be attached. The bakelite protecting tube then extends through the front of the panel.

When mounted on a relay rack, the tube mounting should be separated by at least 7 inches from the power-supply unit to minimize the effect of stray magnetic fields on the cathode-ray beam.

Three sets of binding posts are provided on the front of the panel to which are attached wires for making connections to the terminals on the tube mounting. Panel, 19x8¾x¼ inches. When assembled, the viewing tube extends 6⅞ inches in front of the panel, other parts extend 13⅞ inches behind it.

PRECISION RESISTANCE BOXES

Herewith is illustrated a standard resistance box for testing and laboratory uses and for communication terminal office purposes.

The coils are from 10,000 ohms to 1 ohm inclusive and non-inductively wound on insulated metal tubes. One-tenth and one-one-hundredth units consist of ribbon bent



back on itself. The resistance wire and ribbon used is double silk covered manganin which has a negligible temperature coefficient. All units are properly aged, treated in bakelite varnish and finally adjusted for accuracy.

This practical and accurate resistance box is manufactured by J. H. Bunnell & Co., 215 Fulton Street, New York.

ACRACON

Electrolytic Condensers

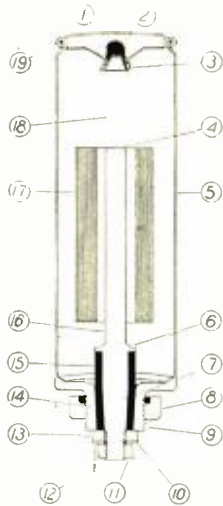

Alone
Offer All
These Features
in
Electrical Design
and
Mechanical Construction

- | | |
|---|--|
| <ol style="list-style-type: none"> 1. Metal cover for protection and appearance. 2. Live rubber nipple. 3. Nipple spun into aluminum shell. Absolutely leak-proof. 4. Anode spiral cold welded into anode, giving rigid construction. 5. One-piece extruded aluminum container. 6. Retaining flange for rubber gasket. 7. Tapered anode stem for snug fit. 8. Large cadmium-plated steel mounting nut, concave to insure tight connection. 9. 3/4" 16-thread neck for mounting. 10. Metal washer. | <ol style="list-style-type: none"> 11. Anode nut. 12. Anode soldering tab. 13. Large size insulating washer. 14. Tapered hole to take tapered anode. 15. Special live rubber insulating gasket, free from impurities. 16. Heavy, rigid anode stem of high purity aluminum. 17. High purity anode, spiral, so wound as to eliminate the necessity of insulating liner between anode and container. 18. Special, high, critical voltage electrolyte, well over anode to insure long life. 19. Leak-proof rolled seam as used in canning industry. |
|---|--|

Acracon Electrolytic units are now available in capacities up to 16 microfarads at either 440 or 475 volt peak in the single anode type.

Follow the leaders of the industry. Specify Acracon Electrolytic Condensers. Also By-Pass, Wax Impregnated, Oil Impregnated, Power and Transmitting types. Write today, enclosing specifications.

**Acracon Features Are Protected by Patents Pending*

Condenser Corp. of America

259-271 Cornelison Ave., Jersey City, N. J.

Factory Representatives In:

CHICAGO ST. LOUIS SAN FRANCISCO
 CINCINNATI LOS ANGELES TORONTO

And Other Principal Cities

“Are the Metals Pure?

• • Well • • you know

the A.S.T.M.!”



“YOU’LL agree, Johnson, that any product which comes up to the Class A Purity Specifications of the American Society for Testing Materials is just about apt to be all right? Well . . . listen to this . . . the highest quality virgin tin and lead alloy in Kester Solder exceeds those specifications!”

Kester is the solder that makes a good set better! Its plastic rosin flux is absolutely safe and sure and will not decompose. It’s non-corrosive and a non-conductor, and even age cannot impair its fluxing value! And what’s more, Kester is as simple as it is safe. The flux is self-contained . . . apply heat, and the right amount flows to the job. Kester saves time, labor, materials . . . cuts expenses and boosts the standards of efficiency and quality. You should use it. Write our Industrial Development Department for the solution to your hardest solder problems. We know all the answers! If you need a more active flux than rosin, explain your needs and let us recommend a special flux. Kester Solder Company, 4224 Wrightwood Ave., Chicago, Illinois. Incorporated 1899.



KESTER

FLUX-CORE SOLDER

Acid-Core • Paste-Core • Rosin-Core

FREE SAMPLE . . . WRITE FOR YOURS NOW!

“Projection Engineering”

The Journal of the “Sound” Industries

Published monthly, and dealing with the manufacture, engineering, service, installation and operation of public address systems, centralized radio, theatre talkies, home talkies. Covering the subjects of design, production, materials, acoustics and the practical problems encountered by field engineers, contractors, installation men and service men.

A.B.C.
PAID
CIRCULATION
OVER 9,000

in the
Electronic
or
**“Sound”
Industries**

A PRESENT MARKET OF PROVEN AVAILABILITY

Public Address
Sound Amplifiers
Sound Recording
Sound Pictures
Home Talkies
Visual Projection
Sound Reproducers
Acoustic Engineering
Automatic Music
Photo Tubes
Amplifier Tubes
Industrial Sound
Applications
Industrial Visual
Applications

Projection Engineering, with a paid A.B.C. Circulation of over 9,000 engineers, executives, technicians, contractors, service and installation men and projectionists, has the largest paid circulation of any publication among the *new*, radio associated, electronic or “sound,” industries.

The editorial staff is headed by Donald McNicol, past president of the I. R. E.

The subscription rate is \$2.00 a year (no newsstand circulation) — \$3.00 for 2 years. (\$3.00 yearly in foreign countries.)

Published by the

Bryan Davis Publishing Co., Inc.
52 Vanderbilt Ave
New York City

Cleveland

Chicago

Los Angeles

CONDENSERS by SPRAGUE PLUS SERVICE by SPRAGUE



- Small Space
- High Capacity
- Single Hole Mounting
- High Voltage
- Self Healing
- One Piece Anode
- Metal Enclosed Vent
- Dull Nickel Con

MOST of the leading radio manufacturers of the country have discovered that they can rely on Sprague Condensers because in efficiency, economy and absolute uniformity Sprague Condensers contribute to the excellence of their own products. And on Sprague Service because at all times our engineering laboratories are ready to cooperate in adapting condensers to the manufacturer's specific requirements. If you are not as yet familiar with either condensers or service we would welcome the opportunity to tell you more about both.

SPRAGUE SPECIALTIES CO.
North Adams, Mass.

SPRAGUE for years has been the chief source of condenser supply to the radio industry. Let us send you full information about Sprague Paper and Electrolytic Condensers, including illustrated booklets, diagrams, etc.



SPRAGUE *Electrolytic & Paper* CONDENSERS

GILBY FILAMENT WIRE



MEANS MAXIMUM LIFE WITH MINIMUM SHRINKAGE

Since the inception of oxide-coated filament, the name GILBY has stood preeminently for all that is BEST in filament wire.

Manufacturers rightfully look upon GILBY as the one TRUE, DEPENDABLE source of supply. They recognize the BEST filament is the CHEAPEST in the long run.

Exhaustive tests prove GILBY FILAMENT has LONGER LIFE with LOWER SHRINKAGE.

REDUCE YOUR COSTS; IMPROVE THE LIFE OF YOUR TUBES BY STANDARDIZING ON—

GILBY FILAMENT WIRE

GILBY WIRE COMPANY

WILBUR B. DRIVER, *President*

NEWARK - - - NEW JERSEY

Manufacturers of

Filament—Grid Materials—Plate Materials—Nickel Wire and Sheet—Nickel Mesh, plain and selvage—Carbonized Nickel Sheet and Mesh—Nickel Chrome Alloys—Nickel Copper Alloys—Manganin

These materials in wire and sheet form, covered with cotton, silk and enamel.

in the pentode



FANSTEEL

pure
molybdenum
wire

It's all *grid* in these new pentode tubes, and the *material* used is a highly determining factor in performance and repeat sales.

Leading manufacturers are virtually agreed on Molybdenum for pentode grids and look to Fansteel as a dependable source of supply.

Fansteel Molybdenum is 99.95% pure. Beginning with ores and basic salts, it is made especially for use in tubes. It is uniform. It is accurate in dimension. It is controllable as to hardness and elongation.

Fansteel Molybdenum Wire forms and welds readily in all standard machines. It is easily degassed and holds its form at exceptionally high temperatures. Its use reduces shrinkage and lowers costs.

Learn how *good* Molybdenum really can be made! Write for samples and try it in your tubes.

tantalum, tungsten
molybdenum
rare metal alloys

FANSTEEL PRODUCTS COMPANY, Inc.

North Chicago, Ill.

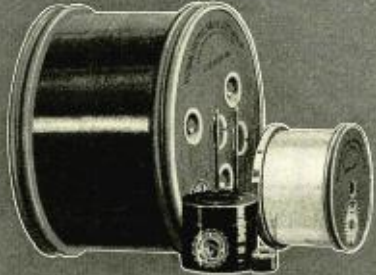

The
PREFERRED
SOURCE OF SUPPLY FOR
MAGNET WIRE & COILS

No electrical or radio product is any better than the magnet wire and coils used in its construction.

Inca products are engineered and manufactured by pioneers in the copper wire industry . . . products reliable in quality and uniformity, and dependable in service.

These are some of the reasons why many of the country's leading manufacturers have adopted Inca as their preferred source of supply.

INCA MANUFACTURING DIVISION
of National Electric Products Corporation
Fort Wayne, Ind.



INCA
SYMBOLIC OF THE
BEST IN COPPER
WIRE PRODUCTS



Astatic Microphone
Type 230

Many features including signal lights and three values of output impedance makes the 230 of outstanding value for Public Address, Recording and Broadcast use.

Bulletin No. 3 on request.

**ASTATIC MICROPHONE
LABORATORY
YOUNGSTOWN, O.**

NEW YORK: R. C. Powell & Co., Inc., 350 Madison Ave.
CHICAGO: Royal Recording & Film Studios, 661 N. Michigan Ave.
ST. LOUIS: Scientific Radio and Television Co., 3619 N. Grand Boulevard.
DALLAS: The Balcom Co., 319 North Bishop St.

GEN - RAL COILS

Reg. U. S. Pat.

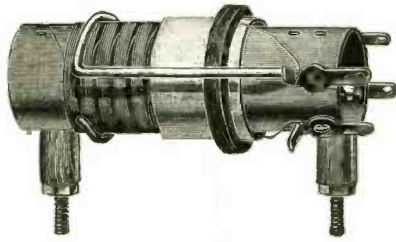

RFB 10 NO. 4000 ANTENNA

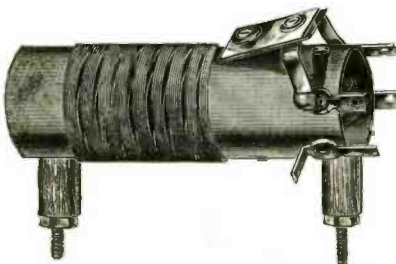

RFB 10 NO. 4000 INTERSTAGE

GENERAL MFG. Co.

8065 SO. CHICAGO AVE., CHICAGO, ILL.

Micro phones

HOME RECORDING » » »
PUBLIC ADDRESS » » » »
STANDARD BROADCAST

**Kellogg Switchboard
and Supply Company**
CHICAGO

M&W Co.
1876

**“Spotting Out”
Lacquer**

Designing a high grade Metal Lacquer for Hardware and Lighting Fixtures requires special technique. By combining many years of experience in this field with modern chemical development and after numberless laboratory and production tests, a New and Superior M & W quality Lacquer is now offered in

S. S. Metal Lacquer No. 49

It gives a light colored, hard, good wearing protective film with good adhesion. It withstands a weather test without discoloring the metal and prevents “spotting out” to a remarkable degree.

Your inquiry is invited.

MAAS & WALDSTEIN CO.
Executive Offices and Plants:
442 Riverside Ave., Newark, N. J.

Chicago Office and Warehouse: 115 W. Washington Blvd.
Los Angeles Office and Warehouse: 2418 Enterprise St.
The border of this advertisement is a photographic reproduction of M & W Prismlac.

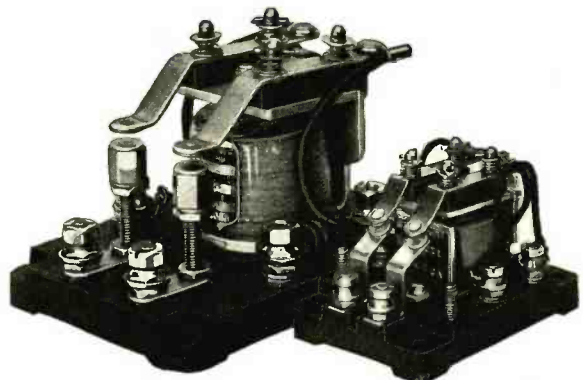

Don't take chances with the relays
• • **DUNCO MIDGETTS** • •
measuring only 1 7/8" x 2 3/4", are now available.

Eight different contact arrangements.
Coils furnished from 60 to 120 volts A.C., 60 cycles, 24 volts D.C. Absolutely free of A.C. hum or chatter.
MIDGETTS have the same tried and proven principles which are responsible for the general acceptance of Dunco heavy duty relays by the world's largest utilities.
Literature and circuit diagrams sent promptly. And remember, if you have a relay problem, put it up to us.

STRUTHERS & DUNNING
127 N. JUNIPER ST. PHILADELPHIA, PA.
DUNCO RELAYS
There is a Dunco Relay to meet your requirements

FORD MICA SERVICE

Accurate Workmanship
Prompt Deliveries

We are prepared to quickly meet your immediate production needs in Tube, Condenser or other radio uses.

Ford Radio & Mica Company

830 Fourth Ave.

Brooklyn, N. Y.

LAMINATIONS

Special shapes to fit individual requirements. Stock shapes of scientifically designed balance for high performance.

QUALITY SERVICE PRICE

LAMINATION MANUFACTURING CO.

Division
Bevin Bros. Mfg. Company
EAST HAMPTON, CONN.

NICKEL CUT For Radio Tubes FLAT ENDS

between .070 and .006 dia.
±.002"—no burrs—every piece straight
Capacity 10,000,000 pieces daily

Small metal parts to your blue print. 100 to 675,000 pieces per lb.

Art Wire and Stamping Company
18-22 Boyden Place, Newark, N. J.



SPOT WELDERS

From .0005 To 3/4"
Combined Thickness

Let us solve your
Spot Welder Problems

EISLER ELECTRIC
760 South 13th Street
NEWARK, N. J.

Baach-International Compound High Vacuum Pumps

We manufacture all sizes of High Vacuum Pumps from 1-200 cu. ft. per min. All pumps tested at 1/2 micron before leaving factory. Write for details.

INTERNATIONAL MACHINE WORKS, Inc.
527-529 Thirty-Second Street, Union City, New Jersey

CLAMP NAILS

For All Mixed Joints

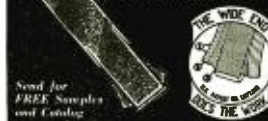

* No need that the owner craftsmen can find machine better. No guarantee that the Master of the Joint has production come ahead to see anything cheaper.

Used in
Welding
Lubrication
Construction
Firearms,
Tables

CLAMP NAIL CO.
3512 Palmer St.
EHR. 358, B.L.

SPECIALS

Electrolytic Condenser
Electrolytic Condenser
R.C.A. Filter Condenser.....
Midget Filter Condenser.....
Midget Filter Condenser.....
Beverly Filter Condenser.....

SERVICE MEN

8 Mfd. Single—475 Volts.....\$.57 Ea.
16 Mfd. Single—475 Volts..... .68 Ea.
7 Mfd. 600 D.C.W.V.95 Ea.
2 Mfd. 450 " (Uncased, Pitched) .36 Ea.
1 Mfd. 450 " (Uncased, Pitched) .25 Ea.
2 Mfd. 600 D.C.W.V.75 Ea.

DEALERS

LABORATORIES

Special Input, P. P. Transformer.....\$.90 Ea.
Choke Coil—30 Henry—120 Mills 1.15 Ea.
John F. Rider's, Trouble Shooters, Manual..... 4.50 Ea.
Victor Push Pull, No. 245 Power Amplifier..... 8.25 Ea.
Replacement Power Transformers for R.C.A.—Victor—Atwater Kent—Majestic—Kolster—Etc.

SPECIALS

W. K. SKIDMORE & CO., 17 WARREN ST., NEW YORK CITY

Get Our List of Other Items

Write for Price List

LYNCH RESISTORS

METALLIZED—PRECISION WIRE WOUND
Using the New Type "K" Filament
Closer tolerances; greater overload capacity;
moisture proof; noiseless.

Write for Latest Catalog RE
LYNCH MFG. CO., Inc., 1775 Bway., N. Y.

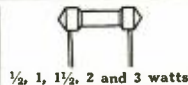

1/2, 1, 1 1/2, 2 and 3 watts



Precision Wire Wound

NEW DEVELOPMENTS Complete Data on All Recent Radio Inventions Now Included in This One Big Guide Book of Radio
Byrd's Antarctic Radio Equipment—Television—Interference Elimination—Short-Wave Apparatus—Broadcasting Equipment—these are only a few of the NEW subjects in the most complete radio handbook ever published.

The RADIO MANUAL

A Handbook for Students, Amateurs, Operators, and Inspectors

Here's the answer to every question about the principles, operation, and maintenance of radio apparatus. A complete radio course in one volume. Prepared by G. E. Sterling, Official Examining Officer, Radio Division, U. S. Dept. of Commerce. 20 big chapters, 369 illustrations.

EXAMINE IT FREE! MAIL THIS COUPON

D. VAN NOSTRAND CO., Inc., 250-4th Ave., N. Y.

Send me the Revised edition of THE RADIO MANUAL for examination. Within ten days after receipt I will either return the volume or send you \$6.00, the price in full. (R.E.10-31)

Name.....
St. and No.....
City and State.....
Business Connection.....



Stampings Pressed Metal for Radio Industry

Steel, Aluminum, Copper, Brass and all Alloys
Send Inquiries and Drawings

METAL SPECIALTY CO. 1533 Riverside Dr.
Cincinnati, Ohio

CONDENSER PAPER

182 Cornhillson Ave. — Mills at — Newark Ave.
Jersey City, N. J. Elizabeth, N. J.

PETER J. SCHWEITZER, Inc.,
200 Fifth Ave. New York

BARE AND TINNED COPPER WIRE

For All Purposes
Fine Sizes Our Specialty
SPARGO WIRE COMPANY
ROME, NEW YORK

Established 1885

ROCHESTER FALL MEETING

Institute of Radio Engineers

1931—November 9th-10th, 1931

Don't Miss This Meeting, which is Sure to Make Radio History.



32 Component Parts Exhibitors.
10 Interesting and Timely Technical Papers by Outstanding Engineers.

Nov. 9th-10th—You can't afford not to attend—Nov. 9th-10th

Headquarters, Sagamore Hotel, Rochester, N. Y.

Write O. L. ANGEVINE, Rochester Engineering Society,
Sagamore Hotel, Rochester, N. Y.—For Reservations

STATEMENT OF THE OWNERSHIP, MANAGEMENT, CIRCULATION, ETC., REQUIRED BY THE ACT OF CONGRESS OF AUGUST 24, 1912, OF RADIO ENGINEERING.

Published monthly at New York, N. Y., for October 1, 1931.

State of New York } ss.
County of New York }

Before me, a Notary Public in and for the State and county aforesaid, personally appeared B. S. Davis, who, having been duly sworn according to law, deposes and says that he is the Business Manager of RADIO ENGINEERING, and that the following is, to the best of his knowledge and belief, a true statement of the ownership, management, etc., of the aforesaid publication for the date shown in the above caption, required by the Act of August 24th, 1912, embodied in section 411, Postal Laws and Regulations, to wit: 1. That the names and addresses of the publisher, editor, managing editor, and business manager are: Publisher, Bryan Davis Publishing Co., Inc., 52 Vanderbilt Avenue, New York, Editor, Donald McNicol, Roselle Park, N. J.; managing editor, F. Walen, Union City, N. J.; Business Manager, B. S. Davis, Scarsdale, N. Y. 2. That the owners are: Bryan Davis Pub. Co., Inc.: B. S. Davis, Scarsdale, N. Y.; Roy T. Atwood, Albany, N. Y.; G. R. Bacon, Douglaston, N. Y.; J. C. Munn, Union City, Pa.; J. A. Walker, Richmond Hill, N. Y.; A. B. Goodenough, New Rochelle, N. Y. 3. That the known bondholders, mortgagees, and other security holders owning or holding 1% or more of the total amount of bonds, mortgages, or other securities are: None. 4. That the two paragraphs next above, giving the names of the owners, stockholders, and security holders, if any, contain not only the list of stockholders and security holders as they appear upon the books of the company but also, in cases where a stockholder or security holder appears upon the books of the company as trustee or in any other fiduciary relation, the name of the person or corporation for whom such trustees is acting, is given; also, that the said two paragraphs contain statements embracing affiant's full knowledge and belief as to the circumstances and conditions under which stockholders and security holders who do not appear upon the books of the company as trustees, hold stock and securities in capacity other than that of a bona fide owner; and this affiant has no reason to believe that any other person, association, or corporation has any interest direct or indirect in the said stock, bonds, or other securities than as so stated by him.

(Signed) B. S. DAVIS, Business Manager.

Sworn to and subscribed before me this 19th day of September, 1931.

(Seal) M. S. OELSNER, Notary Public.

N. Y. County.
New York Co., Clerk's No. 27
New York Co., Registers No. 3-0-10.
Commission expires March 30, 1933.

JENKINS & ADAIR

SPECIAL PURPOSE TUBES

For audio amplifying and control circuits where long life and uniformity are essential.

Send for bulletin.

Prices in U. S. A. and Canada.

J&A 102 tube . . . ea. \$ 6.00
J&A 205 tube . . . ea. 6.00
J&A 211E tube . . . ea. 25.00

Prices are net, f.o.b. Chicago.

Special prices for quantities.



JENKINS & ADAIR, INC.
ENGINEERS
CHICAGO, U. S. A.

Cable Address: JENKADAIR
Phone, Keystone 2130 3333 Belmont Avenue

British Offices: 76 Old Hall Street, Liverpool, England
40 Buckingham Gate, London SW1, England
French Office: 16 Rue de Chateaudun, Asnieres, France
Mexican Office: Av. 5 de Mayo 10, Mexico D. F., Mexico
Indian Office: Queen's Road, Bombay 2

DEPENDABLE
 QUALITY—UNIFORMITY
 SERVICE
 ON
 WAXES—&—MELTABLE
 INSULATING and WEATHER-
 PROOFING COMPOUNDS

WAXES—All kinds.

IMPREGNATIONS—Condensers, Coils, Rubber-Covered and Weather-Proofed Wire, Telephone and Electrical Cables, Etc.

SEALING COMPOUNDS—Coils, Condensers, Batteries (Wet & Dry), Pot Heads, Cables, Wiring Devices and Specials.

FINISHING—All grades of Weather Proof and Rubber-Covered Wire.

SPECIAL COMPOUNDS



35th St. & Maplewood Ave.
 Chicago, Ill.
 "For over 35 yrs."

ROEBLING

WIRE—Antennae (plain or enameled). Connecting and Ground (Rubber covered, braided or plain).

STRAND—Antennae (plain or enameled) — Double Galvanized.

BUS BAR—Litzendraht-Loop

MAGNET (Cotton or Silk)

WIRE
PRODUCTS

JOHN A. ROEBLING'S SONS CO.
 Trenton, N. J. *Branches in Principal Cities*

INDEX OF ADVERTISERS

A				M	
Acme Elec. & Mfg. Co.....	59	Ford Radio Mica Co., Inc.....	56	Maas & Waldstein Co.....	53
Acme Wire Co., The.....	59	Frost, Herbert H., Inc.....	44	Magnavox Co., The.....	39
Ad. Auriema, Inc.....	55			Mallory Co., P. R.....	13
Allen-Bradley Co.....	16	G		Metal Specialty Co., The.....	56
American Electro Metal Corp.....	41	General Cable Corp.....	8		
Amplon Products Corp.....	54	General Electric Co.....	14	N	
Anaconda Wire & Cable Co.....	3	General Mfg. Co.....	53	Newark Wire Cloth Co.....	47
Arcturus Radio Tube Co...Second Cover		General Plastics, Inc.....	1		
Art Wire & Stamping Co.....	56	General Radio Co.....	55	P	
Astatic Microphone Lab.....	52	Gilby Wire Company.....	51	Parker-Kalon Corp.....	5
				Premier Electric Co.....	54
B		H		R	
Bakelite Corp.....	Back Cover	Hygrade Sylvania Co.....	10	RCA Victor Corp., Inc.....	43
Baltimore Brass Co., The.....	54			Roebling's Sons Co., John A.....	58
Brawley Felt Co., Inc., T. R.....	54	I		S	
C		Inea Mfg. Division.....	52	Schweitzer, Peter J., Inc.....	56
Candy & Co.....	58	Institute of Radio Engineers.....	57	Skidmore & Co., W. K.....	56
Central Radio Laboratories.....	41	International Machine Works, Inc.....	56	Spargo Wire Co.....	56
Clamp Nail Co.....	56	J		Sprague Specialties Co.....	51
Clarostat Mfg. Co.....	47	Jenkins & Adair, Inc.....	57	Struthers Dunn, Inc.....	53
Cleveland Wire Cloth & Mfg. Co., The.....	55	Johnson & Johnson.....	59	Summerill Tubing Co., The.....	60
Condenser Corp. of America.....	49	K		T	
Crowe Name Plate & Mfg. Co., Third Cover		Kellogg Switchboard & Supply Co.....	53	Taylor Vacuum Products Co.....	59
D		Kester Solder Co.....	49	Thomas & Skinner Steel Products Co.....	54
Daven Co., The.....	55	L		Thordarson Elec. Mfg. Co.....	39
Dubilier Condenser Corp.....	11	Lamination Mfg. Co.....	56		
E		Lynch Mfg. Co., Inc.....	56	V	
Eisler Electric Corp.....	56	Mc		Van Nostrand Co., D.....	56
Elkon Division.....	13	McGraw-Hill Book Co., Inc.....	54		
Eric Resistor Corp.....	60	W		W	
F				Western Electric.....	6.7
Fansteel Products Co.....	52			Wiley & Sons Co., John.....	55
Ferranti, Inc.....	9				

ACME WIRE PRODUCTS

All ACME products are made to recognized commercial standards, including those of:

- Nat'l Electric Mfrs. Assn.
- Radio Manufacturers' Assn.
- Amer. So. for Testing Materials.

Magnet Wire (All Insulations)

Parvot Condensers

(Filter and By-Pass)
Also Condensers for Power Factor Correction

Coils, Magnet Wire Wound

Varnished Insulations

(Cambric, Paper, Silk, Tape)

Aerial Wire

(Stranded and Solid)

For over 25 years, suppliers to the largest radio and electrical manufacturers.

THE ACME WIRE CO.
New Haven, Conn.

Taylor

MATCHED - TUBES

Tele-Glo

Custom Built for all applications of Vacuum Tubes.

Sound and industrial engineers have found our Technical service an invaluable aid—We offer you service unobtainable elsewhere.

Our Standard Line includes:

- 250 Special (Heavy Duty)
- 281 " " "
- 845 Standard
- 210 Special
- 210 Standard
- 866 Mercury-vapor Rectifier
- 872 " " "
- 875 " " "
- 869 " " "

An exclusive Taylor development. Gas Filled—Hot Cathode Arc Type—Point Source Lamp.

Our Engineers are experienced in this new Art—Television and we invite you to consult with us on your problems.

Industrial laboratories are cordially invited to write us if you have a problem involving light source for high frequency modulation.

TAYLOR VACUUM PRODUCTS CO., Inc.
1500 N. Ogden Ave.
CHICAGO

ACME TRANSFORMERS



Acme Step Down Transformer. 50 to 350 watt sizes available.

Power and Audio Transformers for Radio Manufacturers' use. Prompt quotations given on your specifications.

Send for these new bulletins:

Voltage Step Down Transformers for export shipments, Bulletin No. 121.

Replacement Transformers for service organizations, Bulletin No. 122.



The Acme Electric & Manufacturing Co.
1440 Hamilton Ave. Cleveland, Ohio

JOHNSON'S INDUSTRIAL TAPE

DOES not need a loud-speaker to broadcast its perfection.

Radio engineers all know of and recognize its superiority, its holding properties, lasting adhesion and non-corrosive action. It will outlast any other tape put to similar usage.

Write for free sample and convince yourself of its excellence

JOHNSON & JOHNSON
New Brunswick, N. J.

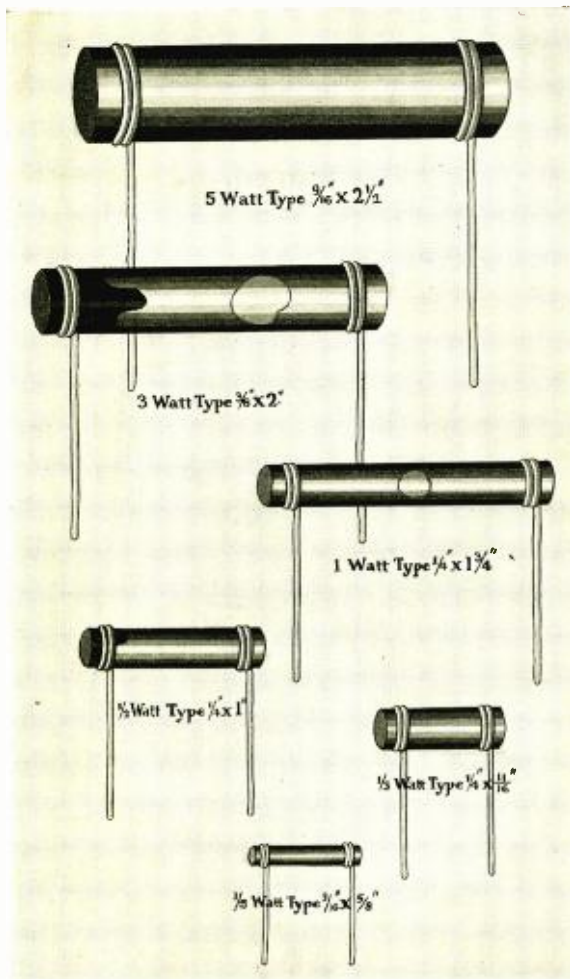

MADE IN SIX SIZES
and in values from 15 ohms
to 10 megohms

ERIE RESISTORS are made in six sizes as shown in the illustration above. They are painted Standard R.M.A. Color Code or to conform with your requirements. R.M.A. Color Code is recommended. The units are made in values from 15 ohms to 10 megohms. Radio engineers have subjected ERIE RESISTORS to every conceivable test and found them within the standards of their specifications. Our records indicate that less than $\frac{1}{2}$ of 1% of ERIE RESISTORS supplied to leading manufacturers were found to be under standard. This truly remarkable showing is indeed proof of careful manufacturing methods and unusual inspection.

MAY WE SEND YOU SAMPLES
AND PRICES?



Factories in Erie, Pa., and Toronto, Canada

READY!

to fill your rush
fall orders for

SUMMERILL SEAMLESS NICKEL TUBING



PROMPT DELIVERIES
any where—any time
—any quantity

The scientific care used in making Summerill Seamless Nickel Tubing is carried through until it reaches you. It is packed in a sturdy box carefully made to insure the contents against all shocks in transport. It assures perfect condition of the tubing when it reaches you.

Radio tube manufacturers can count on Summerill facilities to supply peak production demands. Summerill uniformity, both chemically and mechanically, is again helping to maintain high standards of tube production—and tube performance.

LET US send you a sample for your
engineering and production departments

The Summerill Tubing Co.

founded 1899

Bridgeport

Pennsylvania

Philadelphia District

TUBING by SUMMERILL

• • •

Introducing THE COMPACT "62"

The New Wedge Drive 62 Tuning Unit, complete with escutcheon as shown above, is designed as a low priced unit for midget or console sets in which space is limited. The 62 occupies less space than any of the friction drive units, requiring only one hole, $2\frac{11}{16}$ " in diameter in the panel for mounting. The escutcheon is generous in size, adequately concealing the aperture.

A ratio of 6-1 gives the 62 unusual smoothness and power. The scale is riveted to the back of the es-

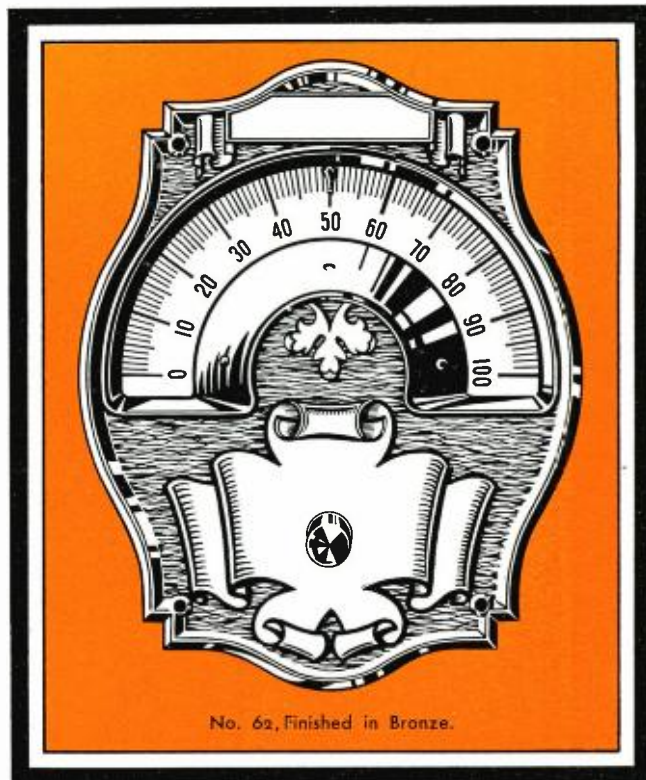

cutcheon and slopes backward at a 25° angle. The pointer is in an overhead position and travels through a 180° arc. This unit, under another number, will soon be available with a travelling light.

The Tuning Meter Escutcheon shown at the left is a stock pattern, for general use.

Write or wire for samples and prices.

C R O W E

NAME PLATE & MANUFACTURING CO.

1737 GRACE ST. CHICAGO ILLINOIS

• • •



Housings of Bakelite Molded, used on the record-changing device of the Stromberg-Carlson Multi-Record Radio.

Large, accurately formed parts, *attractive in design and finish*

An unusual problem of design is presented by the housings of the record-changing device employed by the Stromberg-Carlson Multi-Record Radio. Since the operating mechanism had to be located in a prominent position, it was necessary that these housings disguise the apparatus as well as protect it. This problem was made more difficult by the unusual shape which the housings had to assume.

Bakelite Molded successfully met all of these difficulties. The large irregular-shaped housings of this strong material provide effective protection for the device, and their fine design and attractive walnut finish blend harmoniously with

the rich cabinet. In addition these parts are formed in a single press operation and so accurately that they fit perfectly without machining and are readily interchangeable. Bakelite Molded will not only add to the attractiveness and salability of electronic devices of all kinds, but will frequently contribute to their positive and lasting operation. Its high dielectric and mechanical strength and resistance to moisture make it an excellent insulating material. Do not hesitate to enlist our aid in adapting Bakelite Materials to any of your products. Write for Booklet 38M, "Bakelite Molded", you will find it highly profitable.

Bakelite Engineering Service—We manufacture a wide variety of Bakelite resinoid molding materials, varnishes, lacquers, enamels, cements, and other products. Twenty-one years experience in the development of these materials for electrical and other uses, provides a valuable background for the cooperation offered by our engineers and laboratories.

BAKELITE CORPORATION, 247 Park Avenue, New York.

CHICAGO OFFICE, 635 West Twenty-second Street

BAKELITE CORPORATION OF CANADA, LIMITED, 163 Dufferin Street, Toronto, Ontario

BAKELITE



The registered trade marks shown above distinguish materials manufactured by Bakelite Corporation. Under the capital "B" is the

numerical sign for infinity, or unlimited quantity. It symbolizes the infinite number of present and future uses of Bakelite Corporation's products.

THE MATERIAL OF A THOUSAND USES