

Ninth Year of Service

RADIO ENGINEERING

Vol. IX JUNE 1929 No. 6

IN THIS ISSUE

■■■■■■■

R.M.A. CONVENTION AND TRADE SHOW

(Page Fifty-Seven)

**FREQUENCY DISTORTION IN R.F.
AMPLIFIERS**

(Page Forty-Three)

By Charles J. Hirsch

A NEW METHOD OF TUNING

(Page Forty-Five)

By J. E. Smith

PRODUCTION TESTING OF VACUUM TUBES

(Page Forty-Seven)

By Allen B. DuMont

FIVE-METER WORK

(Page Fifty-Three)

By C. H. West

**RADIO TELEPHONY AS APPLIED TO
AIRCRAFT**

(Page Seventy)

By Robert H. Freeman

■■■■■■■

*Sold only by subscription
\$2.00 per year*



The Journal of the Radio Industry

Let us answer
the question
“Can you make it of
Vulcanized Fibre?”

If you are unacquainted with the physical properties, the machining qualities and the cost of vulcanized fibre applicable to your products, put it up to us to find out.

Our experimental department has shown many a busy manufacturer how the proper application of the right grade of vulcanized fibre will overcome serious production or sales difficulties.

Avail yourself of this service now . . . blue prints or a detailed description of the part and its functions will put us to work at once.

Write today!



**NATIONAL
VULCANIZED
FIBRE**

“the material with a million uses.”
SHEETS : RODS : TUBES : SPECIAL SHAPES



NATIONAL VULCANIZED FIBRE CO., Wilmington, Del., U. S. A.
Offices in Principal Cities

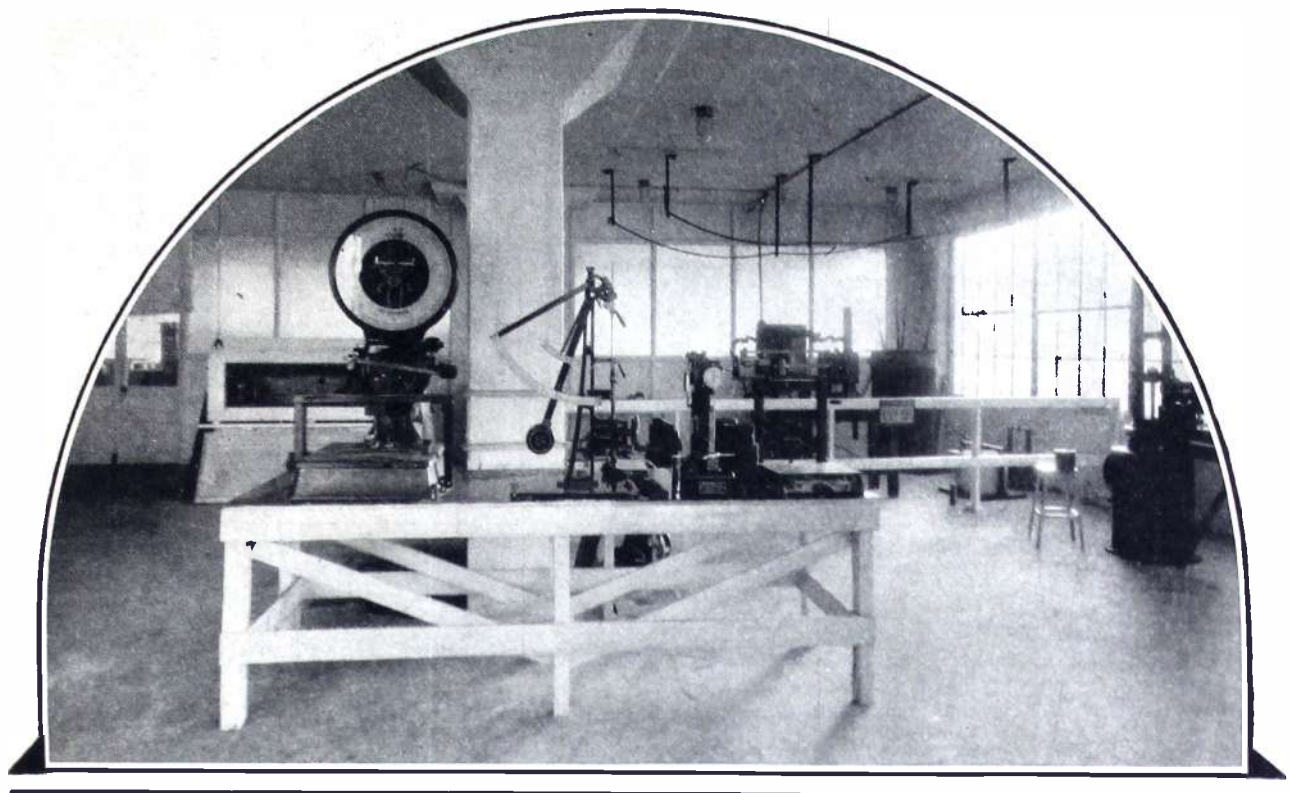

HEADQUARTERS *for* Laminated Insulation!

HERE is some more of the apparatus which is kept busy testing the results of different formulas and different methods of handling . . . as they show up in the physical and electrical properties of Formica.

This steady effort at improvement has been going at Formica for 15 years. And there has been steady improvement . . . with once and a while a big noticeable step forward.

The effort has built the largest plant in its industry; with the largest and most specialized organization making just one product. You can expect quality, uniformity and service from Formica.

Send your blue prints for quotations on your insulating parts.

THE FORMICA INSULATION COMPANY
4654 Spring Grove Avenue Cincinnati, Ohio

FORMICA

RADIO ENGINEERING

Reg. U. S. Patent Office

Applicant, Audit Bureau of Circulations

Editor

M. L. MUHLEMAN

Associate Editor

JOHN F. RIDER

Advisory Editor

DONALD McNICOL

Associate Editor

AUSTIN C. LESCARBOURA

Vol. IX

June, 1929

Number 6

Contents

Frequency Distortion in R-F. Amplifiers, <i>By Charles J. Hirsch</i>	43
A New Method of Tuning..... <i>By J. E. Smith</i>	45
Production Testing of Vacuum Tubes, <i>By Allen B. DuMont</i>	47
Analysis of Papers Employed in Radio Manufacturing, Part III..... <i>By I. L. Gartland</i>	49
Five-Meter Work..... <i>By C. H. West</i>	53
Statements by Executives.....	57
List of R.M.A. Trade Show Exhibitors.....	58
Light-Sensitive Cells, Part IV..... <i>By John Patton Arnold</i>	60
The Problems of Radio Servicing, Part III, <i>By John F. Rider</i>	63
The Engineering Rise in Radio, Part XIII, <i>By Donald McNicol</i>	67

Departments

Commercial Developments: Radio Telephony as Applied to Aircraft, <i>By Robert H. Freeman</i>	70
Book Review	74
News of the Industry.....	76
New Developments of the Month.....	84
Buyers' Directory	110
Index of Advertisers.....	116

The Tariff on Condenser Tissue

By C. C. Colby

Chairman, Legislative Committee, R.M.A.

THE attempt to increase the tariff on condenser tissue, at the request of the paper manufacturers, may bring an acute shortage in this material and seriously affect the radio industry.

Only a few new units, at most five, have been laid down by American manufacturers for the production of this material. There are only three manufacturers of any size producing condenser tissue in this country. The production of these mills is already substantially sold for the year.

With the increased production plans of the radio set manufacturers, the sudden interest in talking motion pictures, both for the theatre and the home; the growth of the electrical phonograph field, the adoption of amplifiers for announcing systems, calling systems, group address systems, centralized radio systems, etc., not to mention television, the increased productive capacity of the American mills will be but a small portion of the increased demand.

Why, therefore, raise the tariff wall against what we must have? The product of the American mills is over-sold; the price of foreign tissue is higher today than that made in this country, and the profit of the American producer is a fair one, even a fat one.

The argument may be advanced that at worst it will mean only an increased cost for tissue. This, however, loses sight of the fact that there is a much increased demand for this material in England and on the Continent, and the importers in this country are already being asked to release commitments in favor of other countries where there is no tariff wall.

Published Monthly by

Bryan Davis Publishing Co., Inc.

Bryan S. Davis,
President.

James A. Walker,
Secretary.

E. M. Bacon,
Advertising Manager.

Publication Office—Lyon Block—Albany, N. Y.

San Francisco Office—318 Kohl Bldg.
Los Angeles Office—New Orpheum Bldg. } Cupit and Birch
846 So. Broadway
Seattle Wash. Office—407 Leary Bldg. }

Entered as second class matter at the post office at Albany, N. Y., January 9, 1925, under the act of March 3, 1879.

52 Vanderbilt Ave.
New York City

Yearly subscription rate \$2.00 in U. S. and Canada; \$3.00 in foreign countries.



Sylvania Announces THE SILENT SLEEVE CATHODE

The pioneering courage and exhaustive experimentation that always have been part of Sylvania development, again bear fruit. This time in the silent sleeve cathode which definitely solves the long baffling problem of crackle and hum in the 227 tube.

The Sylvania 227 now minimizes hum and further increases amplification as a result of the Sylvania designed sleeve which extends over the entire length of the heating element.

The same kind of diligent research and intelligent application of discoveries account for the superior performance found in all types of Sylvania tubes.

We will be glad to send you bulletins showing the characteristics and advantages of all Sylvania tubes.

SYLVANIA PRODUCTS COMPANY
Emporium Pennsylvania

Sylvania

RADIO TUBES

Licensed Under RCA Patents



RE-6 29

W. R. Jones, Sales Engineer
Sylvania Products Co., Emporium, Penn.
Please send me bulletins showing
characteristics of your humless 227.
Also bulletins on the following other
types:

*For further information please use the
coupon—you're WELCOME!*

Name
Company
Position
Address
City and State.....

EDITORIAL

June 1929

DUTY ON CONDENSER TISSUE

IN THE much-discussed revision of the Tariff Act of 1922 now under consideration in Congress there has been included an item in paragraph 1304 which will have a decided influence—and that not a good one—on the radio industry as a whole. This particular point of interest is a proposed increase of duty on condenser tissue.

At the present time the domestic paper mills supply a bit more than two-thirds of the total amount of condenser tissue used in this country. If the foreign mills were to refuse to enter tissue at the increased cost this would create a shortage that doubtless would have a far-reaching effect in the radio industry. If the foreign mills did deliver, shortage in the American product would cause many manufacturers to pay a greatly increased price in order to keep in production.

The consumption of condenser tissue has increased enormously in the past few years. The construction of new mills or the conversion of present mills to the production of this material would require a number of years, considering the highly technical nature of the material, the great difficulties encountered in the control of the various necessary qualities, an organization of specialists, which is almost impossible to secure—as well as the difficulty in securing the proper raw material, a large part of which is imported. Many mills have spent years in an unsuccessful attempt to produce this tissue in qualities which would be acceptable to the chemists and engineers of the various electrical and radio manufacturing companies.

The increase in duty on condenser tissue would mean an increase to the manufacturers of condensers who use imported paper, of approximately three cents per pound on paper .0005 in. in thickness and four cents per pound on .0004 in. tissue.

Now let us look at the subject from another angle. Suppose the owners of the foreign mills decide that they can get a larger profit by shipping their paper to Germany and

France, where, we have it on good authority, there is a similar paper shortage. What would be the result?

It has been found that approximately three million pounds of tissue were imported to the United States last year. If this amount of paper were withdrawn from our market it would mean, in round numbers, that three million radio receivers of the modern electrically-operated type could not be built, as there is about one pound of condenser tissue in a receiver. This situation then would not only be detrimental to the set manufacturer; it would, in turn, affect the manufacturer of every component that is included in a receiver. Such a condition as this would give the radio industry the most serious kind of setback. Likewise, the allied industries would doubtless feel the shortage, as pointed out by Mr. Colby elsewhere in this issue.

Looking at the situation from an unbiased point of view, it seems rather unnecessary for any increase in tariff, as far as giving protection to the domestic manufacturers of condenser tissue. If it were the case that with the existing tariff the foreign paper were much cheaper than the domestic and the market flooded with it, then there would be a different story. But in neither instance is this so—there is but one domestic paper that brings a higher price and as we have stated above, less than a third of the paper used is imported. Up to the present time the very few mills in this country, which can manufacture a suitable tissue, cannot begin to fill the demand.

It seems as though insufficient thought were being devoted to the good of the radio industry as a whole in this particular situation. It is, of course, impossible for Congress to know how an increase or decrease in the existing tariff will affect each industry, but in a case such as this it would seem as if further investigation should be made before the bill is presented in its final form.

M. L. MUHLEMAN, *Editor.*

RADIO - AND THE ORACLE

THE Greeks of old turned to the Delphian Oracle for the solution of their difficulties and a prophecy of future events. Out of this "heart of nature" came the litanies of nations; up with the volcano's tongue of flame arose the canticles of love and woe which guided their actions.

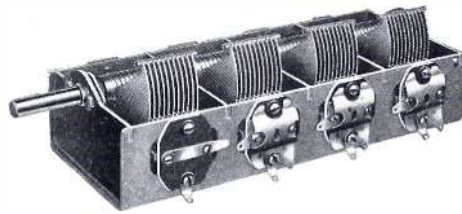
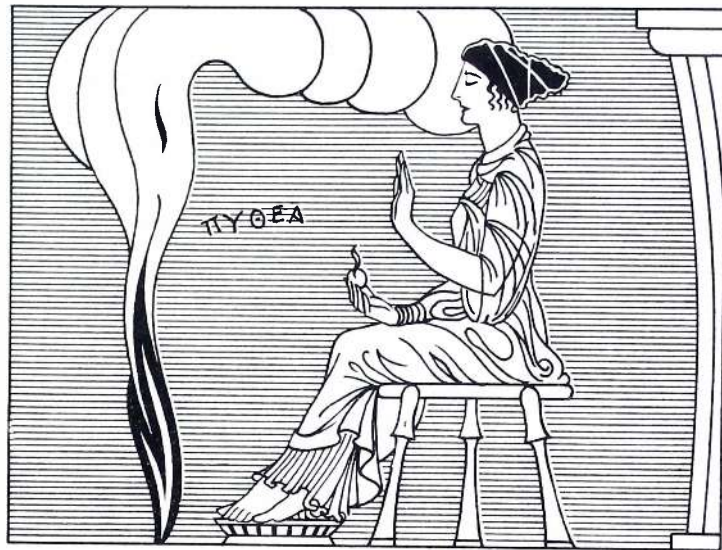

The modern radio manufacturer needs no oracle to tell him that he is operating in a day of new developments. Neither has he need of oracular advice when he goes to buy equipment that will meet the exacting demands of a highly competitive market.

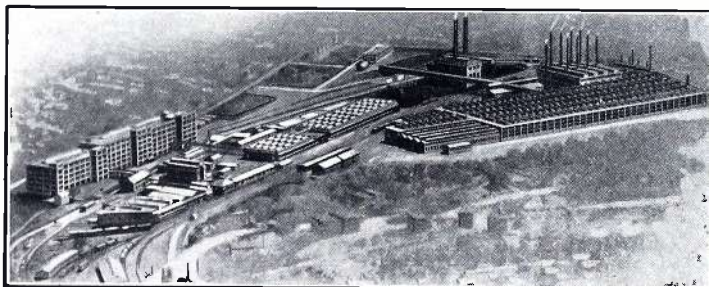

He knows that Scovill Condensers and radio parts are manufactured in accordance with the latest and most efficient scientific developments—he knows that Scovill service insures satisfaction.

Every step in the manufacture of Scovill Condensers is under strict laboratory supervision

SCOVILL

MANUFACTURING COMPANY

WATERBURY, CONNECTICUT

New York Providence Los Angeles Atlanta
 Chicago Cleveland Cincinnati Detroit
 Boston Philadelphia San Francisco
In Europe — The Hague, Holland





Fixed & Tapped
Pyrohm Resistors



Filter Blocks



Moulded
Mica Condensers



Lavite Resistors

AEROVOX

BUILT BETTER
CONDENSERS AND RESISTORS



Grid Leaks

Without A Doubt The Most Complete Line of Condensers & Resistors

No matter what your requirements may be in the fixed condenser and resistor field, you are sure to find an Aerovox unit exactly suited to your needs.

In addition to the large number of stock sizes of condensers and resistors, the Aerovox Wireless Corporation is equipped to supply to manufacturers, at short notice, special types and sizes of filter condensers, filter condenser blocks and resistors in all fixed and tapped combinations.



Filter
Condensers



Bypass
Condensers

AEROVOX WIRELESS CORP.

76 Washington Street, Brooklyn, N. Y.

PRODUCTS THAT ENDURE



Bakelite Case
Condensers



"A" Condensers



Interference
Filters

A COMPLETE CATALOG WILL BE SENT ON REQUEST

SAFEGUARDING *your* RADIO INVESTMENT



THROUGH every phase of radio development, Yaxley Approved Radio Products have, within their own lines, retained an undisputed leadership.

The reason for this is a definite adherence to the highest degree of specialization — concentration on related products for which their engineering and production facilities were best suited.

It is a far cry from the lad in the basement workshop to the big plant making thousands of radio sets a day. But throughout the evolution Yaxley Approved Radio Products have always been the choice of discriminating set builders. They have learned that Yaxley has never made anything that it could not make well.

YAXLEY MFG. CO.
9 S. Clinton Street
Chicago, Ill.

- Volume Controls*
- Rheostats*
- Phone Tip Jacks*
- Fixed Resistances*
- Grid Resistances*
- Socket Assemblies*
- Plugs*
- Jacks*
- Jack Switches*

**TO-DAY
AS IT WAS
IN THE BEGINNING
OF
RADIO**

◆ THE CHOICE IS
YAXLEY
PARTS



Performance - insured

Radio performance can be no better than the performance of each component part.

Your finest engineering efforts are defeated unless each purchased part performs precisely as your specifications require.

The T·C·A standard of quality is your best insurance that these important units, at least, will function as you would have them.

Look us up at the Radio Show and let's talk it over. Booth No. 64D. Demonstrations at Room 516, Stevens Hotel.

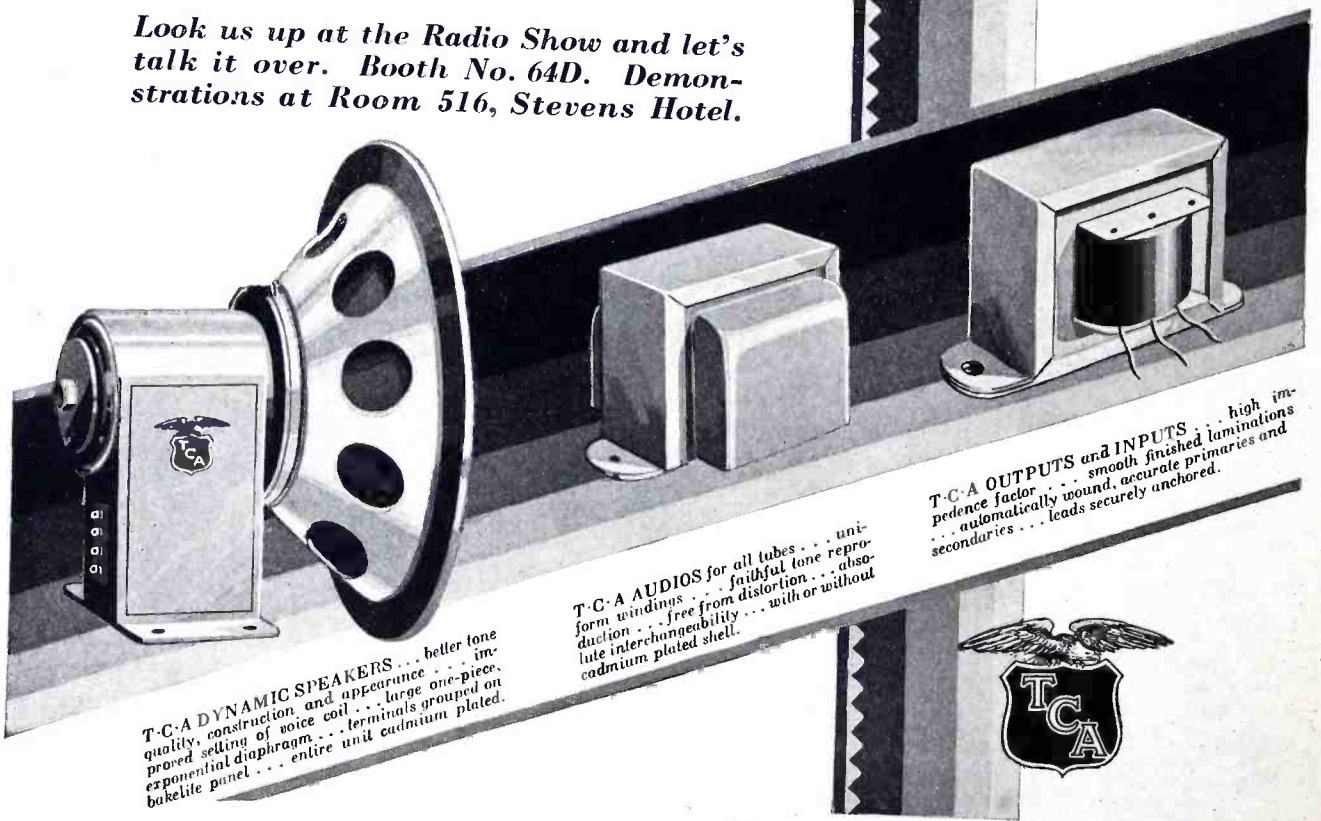

T·C·A DYNAMIC SPEAKERS . . . better tone quality, construction and appearance . . . improved setting of voice coil . . . large one-piece, exponential diaphragm . . . terminals grouped on bakelite panel . . . entire unit cadmium plated.

T·C·A AUDIOS for all tubes . . . uniform windings . . . faithful tone reproduction . . . free from distortion . . . absolute interchangeability . . . with or without cadmium plated shell.

T·C·A OUTPUTS and INPUTS . . . high impedance factor . . . smooth finished laminations . . . automatically wound, accurate primaries and secondaries . . . leads securely anchored.



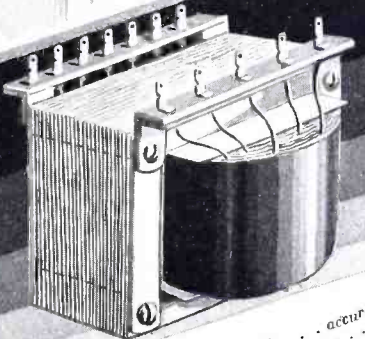
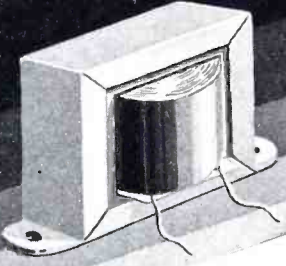
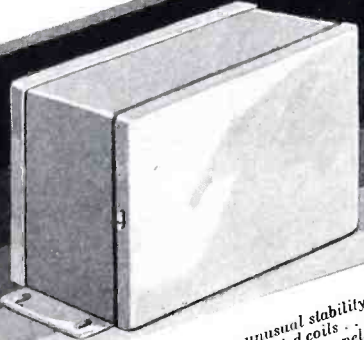
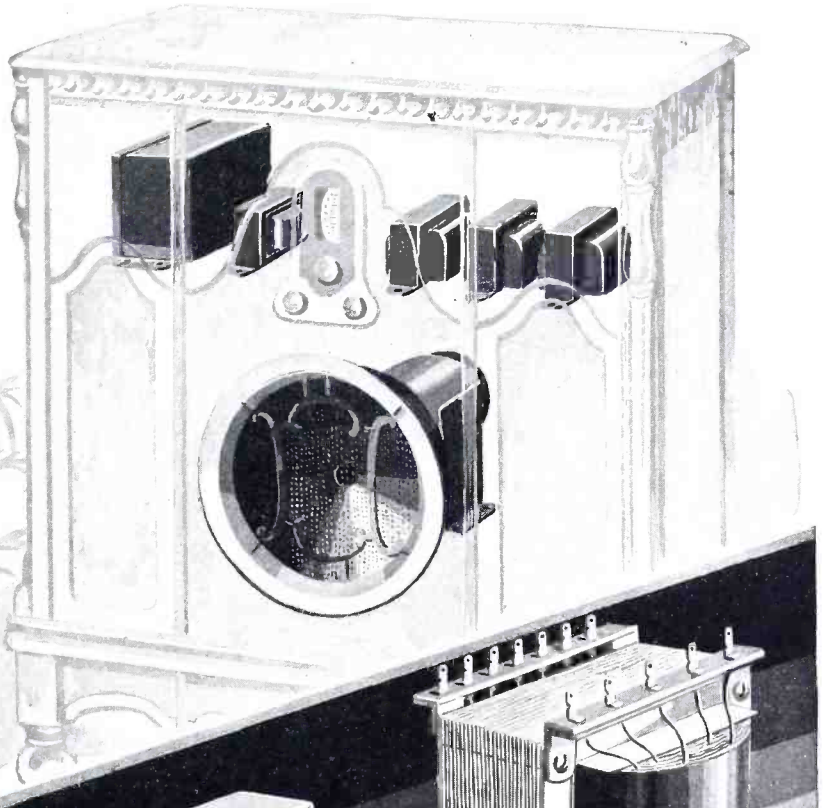

T·C·A POWER PACKS . . . unusual stability and durability . . . vacuum impregnated coils . . . cadmium plated housing with bakelite lug panels . . . furnished complete, semi-mounted, or in separate units.

T·C·A CHOKES . . . single or double coil types . . . precision wound . . . full specified capacity . . . complete range of sizes and resistances.

T·C·A POWER TRANSFORMERS . . . accurate voltages in any desired number or range . . . scientifically designed for quiet and satisfactory performance . . . plainly marked leads, skinned and tinned . . . terminal lug strips as illustrated if desired

Core laminations are all of special soft steel of high magnetic capacity, and separated by a silicate treatment that raises their value. Blanks are clean cut and free from burrs. Cadmium plated shields supplied if desired. All leads securely anchored, and insulated leads thoroughly skinned and tinned for rapid handling and perfect soldering.

Complete data and samples available. T·C·A engineers will gladly assist in your audio and power supply developments.

When you fully understand the policies under which the Transformer Corporation operates, you will concede that our claims for T·C·A products are reasonable and conservative. Specialization, we all know, has its advantages. It makes intensive and critical engineering possible.

It has enabled us to perfect our product to a point where a large demand has developed. We have built millions of units. This volume has encouraged us to build and install special machinery, more accurate and more speedy than human hands. T·C·A Transformers meet the quality requirements of your engineers, as well as the price requirements of your production department.

Transformers and dynamic speakers have much in common from a manufacturing standpoint. So the T·C·A Dynamic was a natural development for this organization.

And the same precision through controlled quantity production that made T·C·A transformers and power packs standard in the country's finest sets, is securing a quality in T·C·A Dynamics that is receiving quick recognition. They are a real contribution to the industry.

TRANSFORMER CORP. OF AMERICA, 2301-2319 South Keeler Avenue, CHICAGO

3 new tubes



from the De Forest laboratories

These 2½ volt De Forest Audions, the latest developments from the De Forest Laboratories, meet the latest circuit requirements.

Audion 424, a 4 element Screen-Grid Heater-type A. C. Amplifier with an amplification factor of 420 is principally employed as a radio frequency amplifier or may be used as a space-charge-grid amplifier.

Audion 427 is a new design of the standard—27 A. C. Heater type tube, which reduces hum, buzz and crackle to a negligible quantity, and reduces heating time to 10 to 15 seconds.

Audion 445 is a new A. C. Power Amplifier, Filament type, which gives maximum volume with Dynamic speakers without blasting or distortion.

AUDION 424
The 2½ Volt A. C. Humless Screen-Grid Detector-Amplifier.

AUDION 427
The 2½ Volt A. C. Humless Heater-Type Detector-Amplifier.

AUDION 445
The 2½ Volt A. C. Power Tube.

Like all De Forest Audions these three tubes are evacuated to 1 micron (less than one fifteenth the air pressure considered satisfactory by other tube manufacturers). They are bombarded in four positions with ample "getter" present after sealing to absorb gases and preserve their remarkable vacuum.

In addition they combine other De Forest features—oxide coated filament, which doubles electronic emission, mica spaced elements, more rigid tolerances, more accurate inspection and longer life.

The more you know about radio tubes the more you will appreciate De Forest Audions and specify them for use in the sets which you design.

DE FOREST RADIO COMPANY
JERSEY CITY, NEW JERSEY

de Forest AUDIONS

"HIGH VACUUM" RADIO TUBES



The MERSHON CONDENSER

has been adopted by many leading radio manufacturers after exhaustive tests, analysis and research. Upon your request, we will be glad to send you a report covering the reasons for the adoption of the Mershon Condenser by several different manufacturers. This experience record will undoubtedly be of assistance to you in studying your own condenser requirements. Address Dept. MW-9.



*The Mershon Condenser is
manufactured exclusively by*

THE AMRAD CORPORATION
MEDFORD HILLSIDE, MASS.

J. E. Hahn, President
Powel Crosley, Jr., Chairman of the Board

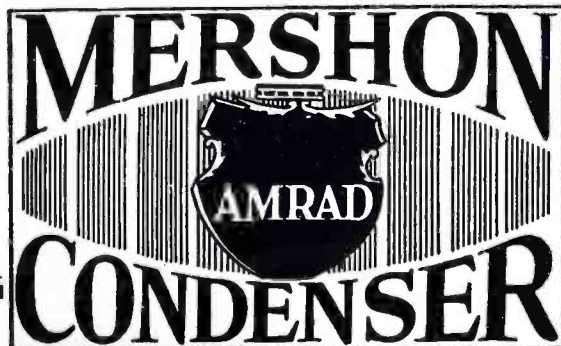

The present Mershon Condenser is a result of over ten years of intensive development. It has many advantages over other types of condensers, some of which are as follows:

1. Self healing in case of puncture.
2. Lower cost per microfarad.
3. One-third as large as paper condensers of the same capacity.
4. Extremely rugged construction.
5. Unaffected by changes in temperature or by moisture.

Peak voltage 400 V. D. C. Operating voltage 300 V. D. C. Copper can is always negative—anodes are always positive. Supplied in a variety of sizes that enable it to be readily employed whatever the requirement may be.

The Mershon Condenser will give years of efficient service and is easily adapted to practically any radio circuit. When connected to a "B" eliminator it prevents "motor-boating."

ZAPON
PYROXYLIN
LACQUERS
For Every
Industrial
~ Purpose ~

*The Acknowledged Standard
of Quality since 1884*

THE ZAPON COMPANY
STAMFORD, CONN.
CHICAGO · CLEVELAND · DETROIT · LOS ANGELES
NEW HAVEN · NEW YORK · OAKLAND
PORTLAND · SAN FRANCISCO
SEATTLE

CROWE Escutcheons

in the Modern Vogue



See Our Exhibit
R. M. A. Trade Show
Booth 134
Stevens Hotel
Chicago
June 3-7

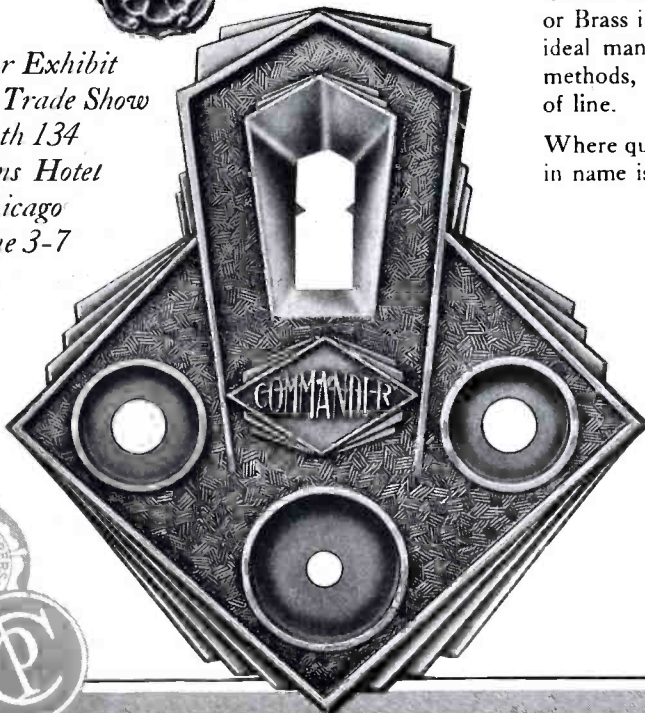

Modern Designs—Distinctive in Character and Symbolizing your own product has been the particular achievement of Crowe for the Radio Manufacturer during the past number of years.

Crowe Escutcheons are made of Bronze, Low Brass or Brass in various finishes and are produced under ideal manufacturing conditions by the latest modern methods, insuring sharpness of detail and definition of line.

Where quantity production is possible and no change in name is contemplated, coin embossed work is advised. The Crowe Art Studios will be glad to submit colored drawings with period designs carried out according to your suggestions.

For small production or when different dealers' names must appear on the escutcheon, we recommend the etched style with formed border and window.

Samples and detailed information on request. Your blue print or drawings will help us in advising you to the best advantage. Our engineering department is at your service.



CROWE NAME PLATE & MANUFACTURING CO., .. 1749 GRACE STREET, CHICAGO

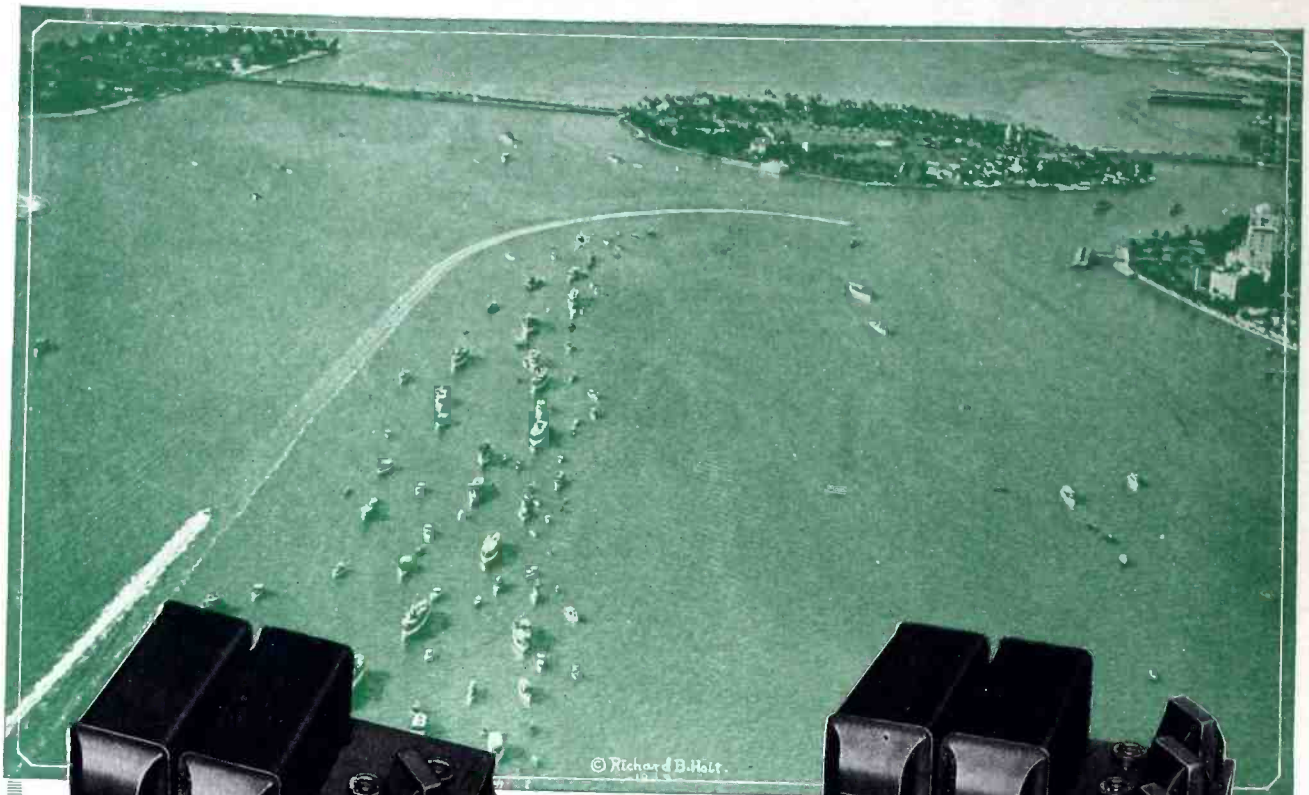

© Richard B. Holt.

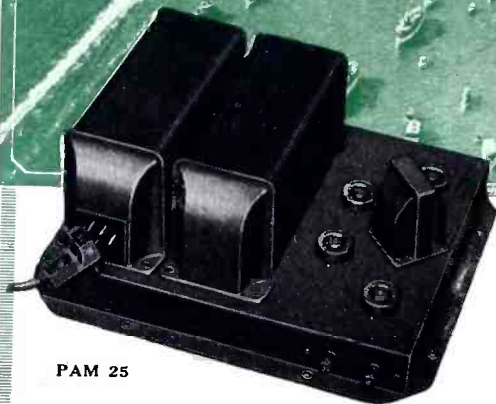

PAM 25

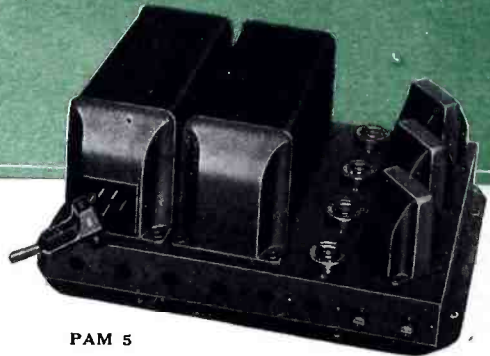

PAM 5

PAM Keeps Pace With the Best

PAMs kept thousands along the shore of Biscayne Bay in constant touch with every phase of the International Boat Race pictured above. The voice of the announcer was easily heard above the roar of the giant motors used by Gar Wood and Seagrave.

Wherever speed kings reign—on track, or ice or sea—in this and other lands, there you will find PAMs which tell the crowds every detail of the contest.

Pictured above are two new PAMs, the PAM-5 which uses one 227, one 280 and two 112s, and is designed to work out of the detector tube of a radio set, a magnetic phonograph pickup, or microphone amplifier. Its output is such that it will feed any number of PAM-25s according to power output required for a particular installation. The PAM-25 uses two 281s and two 250s. When used in conjunction with a PAM-5, it

has a power output of 14 watts. Multiples of this undistorted output can be had by the addition of each PAM-25.

A new 16-page bulletin giving mechanical and electrical characteristics, representative installations, and many new amplifiers will be sent upon receipt of 10¢ in stamps to cover postage. Ask for bulletin No. — when writing.

Samson Electric Co.

MANUFACTURERS SINCE 1892

MEMBER
RMA

Main Office
Canton, Mass.

Factories
Canton and Watertown, Mass.

THE NEW RADIO SET TESTER

See it at the R.M.A. convention

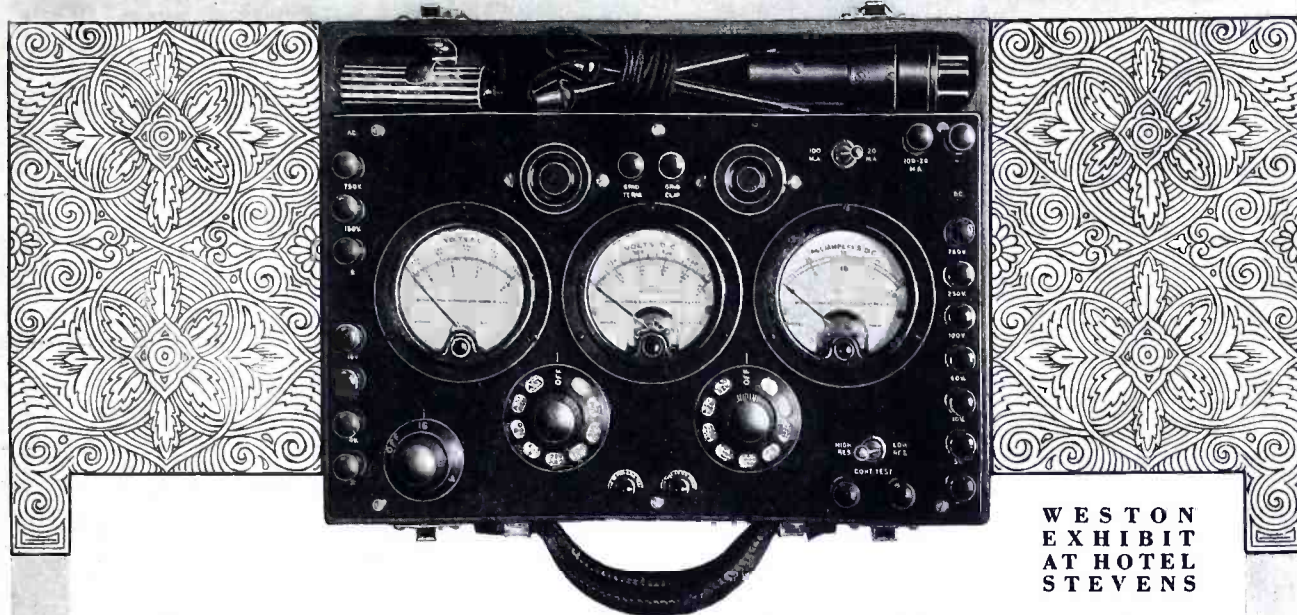

WESTON
EXHIBIT
AT HOTEL
STEVENS

The radio industry is familiar with the Weston Model 537 Radio Set Tester—for A. C. and D. C. receivers. Service men hailed it with great acclaim a year ago, noting its many advantages over the Weston Model 519—for D. C. only.

And NOW—here is another great advance—the Weston Model 547—incorporating many additional features to meet the service testing requirements of radio's latest developments. And there have been many since the last R. M. A. Convention. But with this NEW SET TESTER radio servicing is still further

simplified, even taking into account the number of new tubes, sets and circuits. Space won't permit description here—nor would words alone do this new set tester justice. You must see it for yourself—operate it—try to think up some service problem it can't solve. Try as you will the Model 547 will give you a quick and accurate answer every time. Convenient—complete—light and rugged. Handsome in appearance—and it will yield you handsome profits. It will increase your business and your prestige. **YOU CAN BANK ON IT!**

OUTSTANDING FEATURES OF THE MODEL 547

First of all it is a WESTON—assuring you exquisite workmanship and complete service reliability. It is provided with three instruments—all 3 1/4" diameter and furnished with bakelite cases. Carrying case, removable cover, panel and fittings are also made of sturdy bakelite.

A. C. Voltmeter—750/150/16/8/4 volts. The three lower ranges are brought out to the Tester plug, and all five ranges are brought out to binding posts. 750 volt range is for testing secondaries of power transformers. 16 volt range is to provide for 15 volt A. C. tubes. Operations have been reduced—only one selector switch being necessary.

D. C. Voltmeter—High range increased to 750 volts. Other ranges—250/100/50/10/5—all six ranges brought out to binding posts and Tester plug.

D. C. Milliammeter—Double range—100/20
M. A. provides for lower

readings with better scale characteristics. **Tests**—On A. C. sets the heater voltage and plate current can be read throughout the test while the D. C. voltmeter may be indicating plate bias or cathode voltage.

Self-contained, double-sensitivity continuity test provided. This can also be used for measuring resistance as well as testing for open circuits. Grid test can be made on A. C. or D. C. screen grid tubes—also the '27 tubes when used as a detector—without the use of adapters.

Two sockets on the panel—UY tube adapters eliminated.



SYNTHANE

Laminated Bakelite

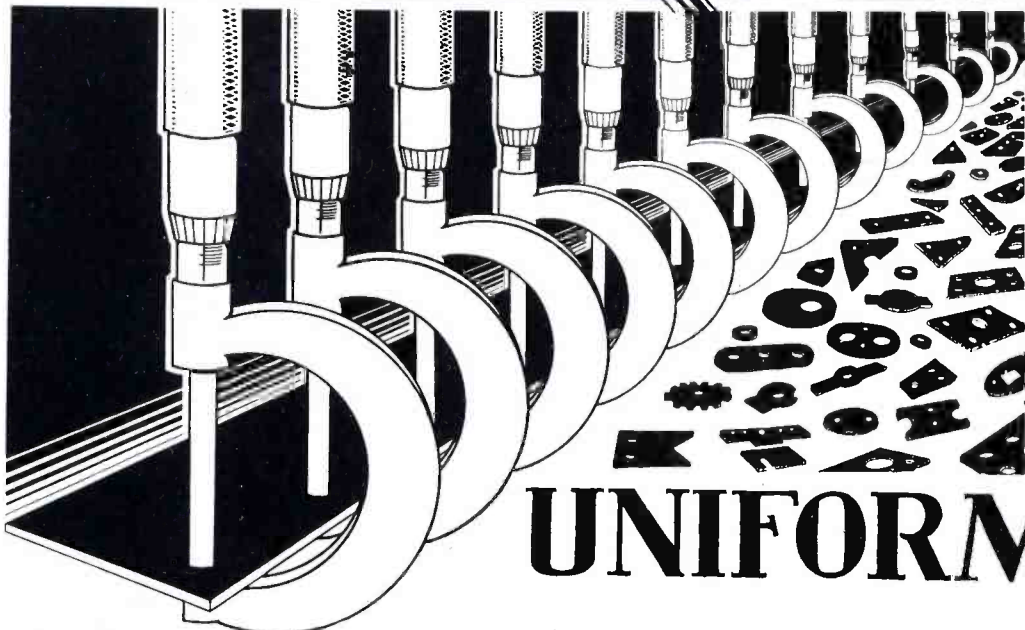

DIMENSIONAL ACCURACY

IN Sheets . . . dimensional accuracy gives you stampings to close tolerances . . . allows you to figure costs more accurately . . . to design tools for the production of more accurate parts . . . to make punch press stamped engravings.

In Specialties . . . dimensional accuracy and strict adherence to blueprints speeds and facilitates assembly in your plant

Synthane Is Uniformly Accurate In Dimensions.

TEST IT YOURSELF



4+ Pts.

- 1 Punching Quality
- 2 High Dielectric Strength
- 3 Low Water Absorption
- 4 Low Surface Leakage

+ UNIFORMITY THROUGHOUT

Sheets, Rods, Tubes, Fabricated Parts

New York, Chicago, Cleveland

RAYTHEON

RAYTHEON has done something more than imitate the design of other tubes. Raytheon has made a very real contribution to radio.

RAYTHEON *was* FIRST

To produce a practical, heavy duty rectifier tube for B-elimination.

And when Raytheon brought out a full line of A.C. and receiving tubes, RAYTHEON was FIRST

To anchor receiving tube elements at the top with mica, increasing rigidity and uniformity of performance.

To produce a long-life, quick-heating tube for A. C. operation.

And RAYTHEON ALONE

Builds a tube of FOUR-PILLAR CONSTRUCTION, cross-anchored top and bottom—a tube so sturdy that its laboratory-tested performance cannot be changed by the shocks and knocks of shipment and handling.

In addition to the many outstanding improvements and patents which can be used by Raytheon *only*, Raytheon will benefit by all R. C. A. tube patents, present and future.

Due to the license granted Raytheon—*jobbers and dealers can sell these high-quality tubes with no danger of legal entanglements or "frozen" stock.*



EVEREADY RAYTHEON

THE NEWEST NAME IN RADIO

NATIONAL CARBON COMPANY, Inc., now controls production and sale of licensed Raytheon Tubes. This combines not only the names, but the facilities of these two companies.

Effective June 1, 1929, Eveready Raytheon Tubes will be produced and merchandised under the control of the great Eveready organization.

Plant enlargements are now under way. Additional equipment is being installed. Production of Eveready Raytheon Tubes will be enormously increased. An adequate supply is assured.

Eveready Raytheon is a large individual division of the National Carbon Company, Inc., and will have all of the usual aggressive Eveready advertising and merchandising activities back of it. Extensive Publicity . . . Broadcasting . . . Advertising.

This means increased opportunities for present Raytheon dealers. Additional franchises will be allotted. There will be full co-operation with the trade.

Plan now to take full advantage of this great new development in the radio tube market. Be sure to order an adequate stock of Eveready Raytheon Tubes.

NATIONAL CARBON COMPANY, Inc., New York
Branches: Atlanta, Chicago, Kansas City, Long Island City, San Francisco

Unit of Union Carbide  and Carbon Corporation



EVEREADY RAYTHEON



EVEREADY Raytheon Tubes will be sold in this package, made in the Eveready colors—red, blue and gray. It brings the prestige of two well-known names together in a striking display.

The change in name will mean even more than a great expansion of production and distribution. In addition to the specialized activities of the famous Raytheon laboratories at Cambridge, Eveready Raytheon will have the benefit of all research and development facilities of the National Carbon Company, Inc.

Eveready Raytheon will continue to lead in radio tube development. As an Eveready Raytheon dealer, the many developments in principle and design which are constantly in progress in the Eveready Raytheon laboratories assure you of radio tubes abreast of the moment . . . ahead of it.

Don't miss this opportunity to profit by all that Eveready Raytheon will have to offer you. Get in touch with your jobber or distributor today.

NATIONAL CARBON COMPANY, Inc., New York

Branches: Atlanta, Chicago, Kansas City, Long Island City, San Francisco

Unit of Union Carbide  and Carbon Corporation





**EVEREADY
RAYTHEON PACKAGE**
*and great new ER 224
Screen Grid Tube*



*Eveready Raytheon Tubes are a
complete line*

ER Rectifier BH	ER 240
ER Rectifier BA	ER 280
ER 201-A	ER 281
ER 200-A	ER 226
ER 112-A	ER 227
ER 171-A	ER 224
ER 210	ER Type A
ER 250	Cartridge Rectifier
ER 245	ER Photo-cell
ER Kino Lamp	

*ER 224 tube with exclusive four-pillar
construction, cross-anchored top and
bottom*

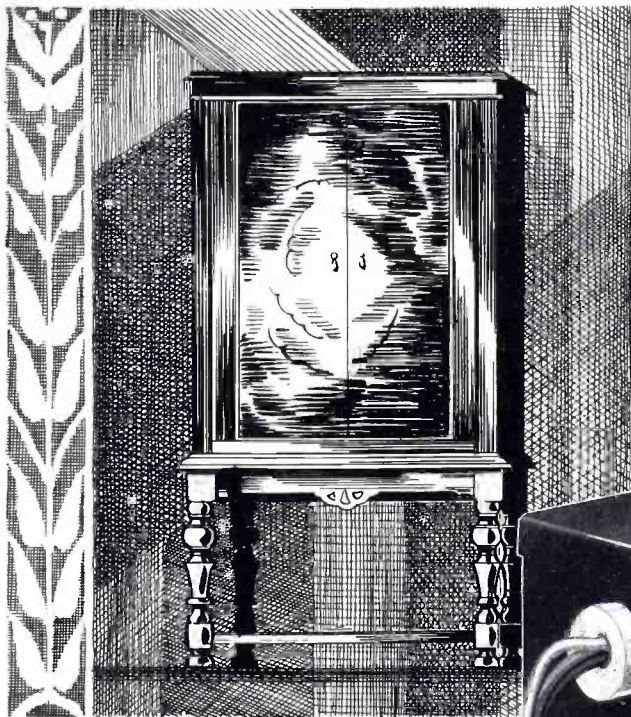

PERFECTED for your new power tube set

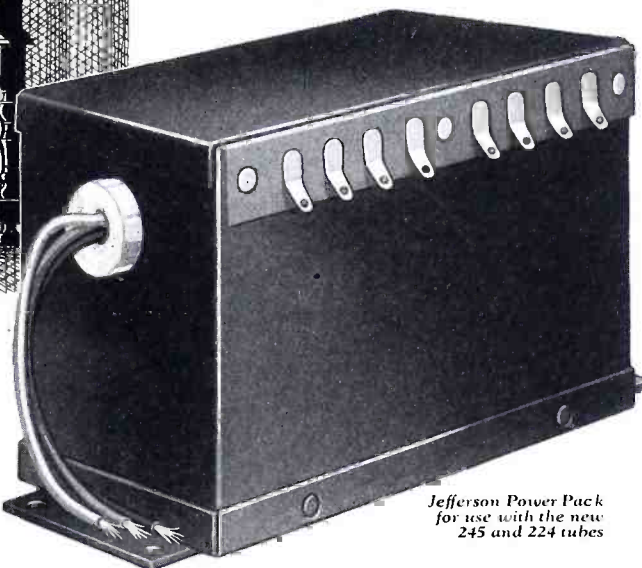

*Jefferson Power Pack
for use with the new
245 and 224 tubes*

Engineering Co-operation

Jefferson engineers, pioneers in the field of transformer development, are ready to assist in solving your transformer and choke problems. In our own modern research laboratories—or working with your engineers—Jefferson engineers can offer valuable aid in the design of your audio and power equipment.

Protection in Peak Periods

The Jefferson world-wide reputation for quality transformers and integrity in trade relations, combined with tremendous production capacity, is your assurance of a reliable source of supply. During last year's peak season, although besieged with outside business, not one of our customers was forced to seek another source of supply. Deliveries were made promptly under all conditions — production schedules protected.

Jefferson Transformers and Chokes

Foreseeing the present trend toward the use of new power tubes in receiving sets, Jefferson engineers have perfected a special transformer—and a wide choice of choke units—for coordinate use with the new 245 power tube and the 224 shield grid tube. Likewise, Jefferson audio transformers have been improved in design to make use of all the potentialities of these new tubes. Complete electrical specifications and quotations will be furnished reliable set manufacturers on request.

JEFFERSON ELECTRIC COMPANY
1592 South Laflin Street Chicago, Illinois

JEFFERSON

AUDIO and POWER TRANSFORMERS and CHOKES

These EBY Products Are Already Half Way On the Set

Their Advanced Designs Reduce Assembly Costs

The Eby Company considers assembly cost as part of the cost of the product to the manufacturer. That's why Eby has specialized in designing products that take only half the time and expense to assemble—that's why Eby products are virtually half way on the set when they are finished at our factory.

Another big feature of Eby products is attractive appearance. Every Eby product is an asset to the finest radio set. And finally, and of equal importance, is Eby service. The Eby Company has been an absolutely dependable supplier of quality products for six years.



Model 6 Socket is new and *much better*. Designed for manufacturers' use exclusively. Popular Eby features have been retained and new ones added.

Five different colors numbered—for identification of tubes.

Long two-sided prongs—for positive contact.

Guide for tube prongs—a famous Eby feature.

Rivet assembly—for economy.

New in performance, new in appearance—and a new low price

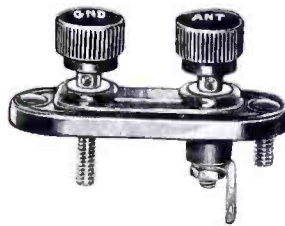

There are three assembly operations on the Combination Antenna and Ground post strips—two nuts to tighten and one soldered connection to make. The ground post is automatically grounded to panel and Antenna post insulated from it. No washers! Furnished with soldering lug and nut assembled on Antenna post



A pair of tip jacks moulded as inserts, in a brown Bakelite strip marked Speaker, Phono or Field. No insulating washers or nuts! Eby type "H"



One nut assembles these two tip jacks moulded as inserts in a brown Bakelite strip. Available marked Speaker, Phono or Field. No insulating washers! Type "S"

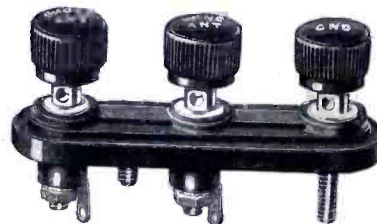

Another product which eliminates assembly operations. The Ground post is automatically grounded and the two Antenna posts insulated with no washers. Quick, easy, economical!



A new and inexpensive connector plug and receptacle. Available with six prongs for connecting set to power supply, with five prongs for push-pull dynamic speaker voice coil and field connections or with four prongs for dynamic speaker voice coil and field connections



Here's another assembly shortcut for manufacturers who want binding posts for Speaker Field connections. One nut to tighten — two soldered connections to make and they are both assembled and insulated. No washers!

The H. H. EBY
4710 Stenton Ave.
Makers of Eby



MFG. CO., Inc.
Philadelphia
Binding Posts

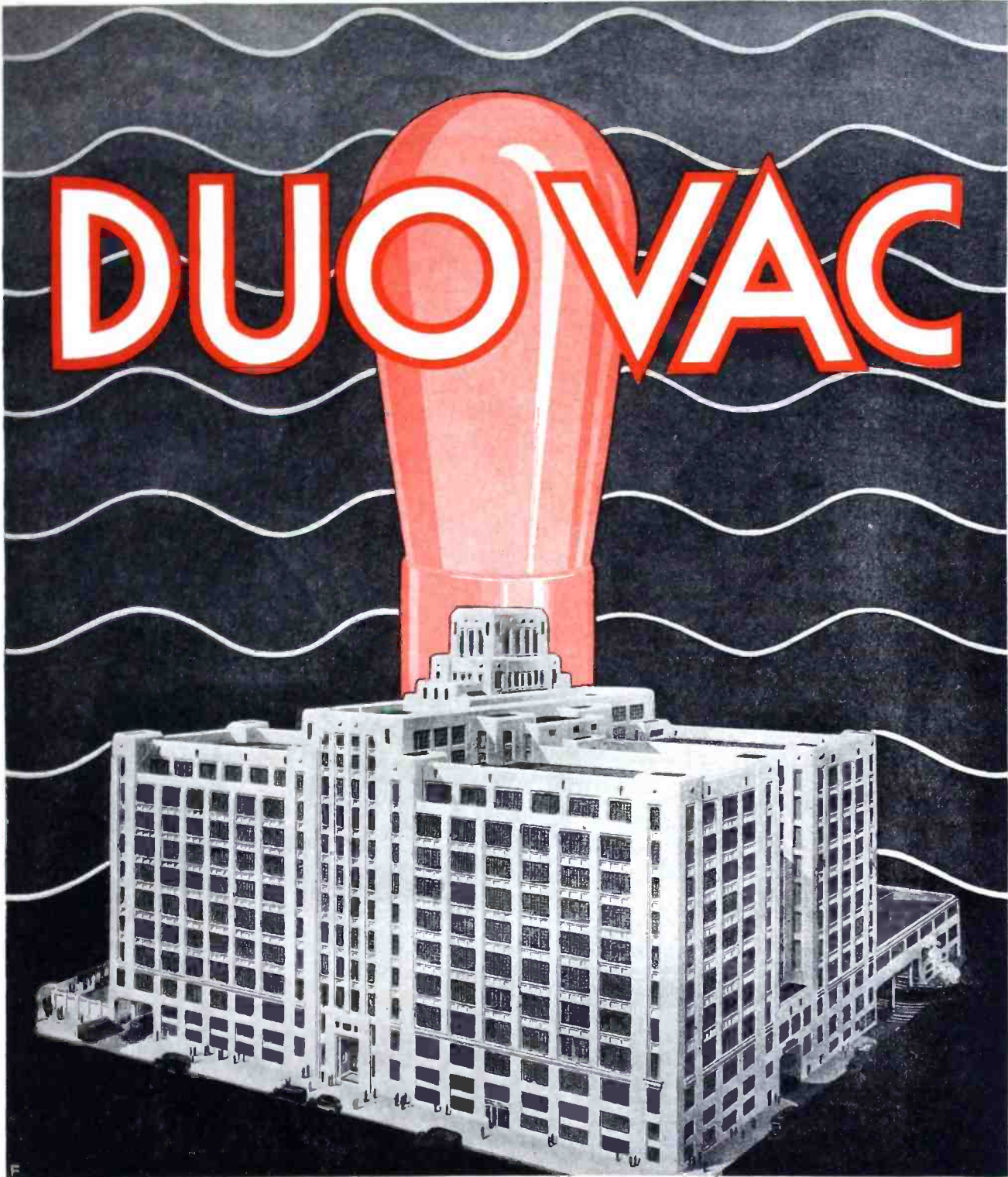

DUOVAC RADIO TUBE CORPORATION'S NEW HOME ··· N. Y. DOCK TRADE FACILITIES BUILDING ··· BROOKLYN ··· NEW YORK

An organization composed of Pioneer Radio Engineers and Executives whose products have achieved fame everywhere, occupies a new plant and presents DUOVAC, a NEW and better tube. DUOVACS are made in the world's FINEST equipped tube factory. Every detail is precisely performed by skilled operators in broad bright daylight with the aid of the newest automatic tube-making machinery.

DUOVAC RADIO TUBE CORPORATION, 360 FURMAN ST., BROOKLYN, N. Y.

OXFORD

Dynamic Speaker

Licensed under Lektophone patents

GOODWILL IS GOOD BUSINESS

Behind and directing everything that the manufacturers of the Oxford Dynamic Speaker are doing is one dominating aim — that is

TO SERVE—

By building the finest radio speakers in the World in large mass production — at the lowest prices consistent with the highest ideals —



OXFORD

definitely stands for

THE FINEST
THE LATEST
THE MOST
DEPENDABLE
IN RADIO
SPEAKERS

Let Speaker Specialists fill your Speaker Requirements. Our spacious new plant provides for the production of thousands of speakers daily.

Oxford Speakers are available, correctly engineered, for the new model chassis of practically all the radio set builders who sell separate radio chassis. Among our thirty-five models we have D. C. speakers now available for chassis of Wells-Gardner, Silver-Marshall, Audiola, Premier, Shamrock, Day-Fan, Minerva, Buckingham, Wexstark, Pierce-Arrow, Sentinel, Liberty, Walbert, Peerless-Pioneer, National, and Krasberg-Gollos.

The Oxford line includes all Dynamic Speakers, such as the Direct Current Models, A. C. Rectified types, tube operated speakers, and theater models.

OXFORD RADIO CORP.

Successors to Joy-Kelsey Corporation

G. A. Joy, President

Roy W. Augustine, Secy. and Treas.

Frank Reichmann, Gen'l Sales Mgr. and Chief Engr.

3200 W. Carroll Ave.

CHICAGO, U. S. A.

SEE OUR EXHIBIT AT THE JUNE TRADE SHOW,
HOTEL STEVENS, BOOTH 41-D, Room 523-A



WHAT'S BEHIND THE KNOB ?

THE volume control on the set you sell may seem like a small thing to you . . . and yet that little unit behind the knob can either make or break the satisfaction of the family to whom you sell a radio.

When they get the set it may work fine, but what will they say after a few months when noise, both mechanical and electrical, develops . . . as well as an unevenness of control. The signals come through in "spurts" and locals are almost impossible to control. What then?

Here's the answer: Be sure the volume control has "Centralab" stamped on the back.

And here is why: Centralab precision controls give a perfect control of all stations smoothly and evenly . . . the exclusive rocking disc construction is insurance against any change in the resistance as well as against the development of mechanical or electrical noise.

THIS shows the exclusive rocking disc construction of Centralab volume control. "R" is the resistance.

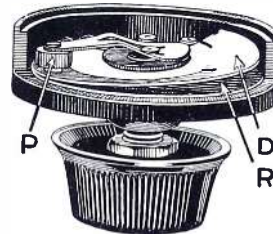

Contact disc "D" has only a rocking action on the resistance. Pressure arm "P" together with shaft and bushing is fully insulated.



This is the action of the usual wire wound control after it has been in use for some time . . . like iron on it so he places a cobblestone pavement.



The tailor uses the same principle as Centralab. He does not want to ruin the garment by placing the iron on it so he places a cloth in between. Centralab controls can not ruin the resistance because the rocking disc is in between the pressure arm and the resistance.

Centralab

CENTRAL RADIO  LABORATORIES

203 KEEFE AVE. :: MILWAUKEE, WIS.



Pointing Out the Features of the New Type B. T. 4 Gang ARMORED CONDENSER

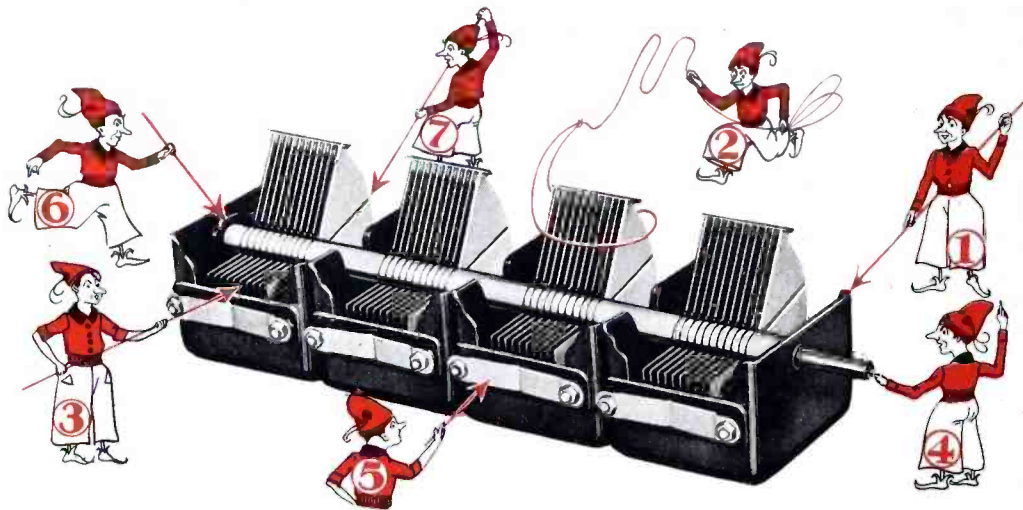

- 1**—Rigid frame made of heavy drawn steel.
- 2**—Rotors and stators are precision spaced and soldered.
- 3**—Accuracy and calibration in ganging is assured by wide spacing between plates.
- 4**—Permanent and perfect alignment of rotors is assured because the removable shaft is independent of bearings.
- 5**—Circuit adjustments are facilitated by the gradual curve on the minimum capacity adjuster.
- 6**—Adjustable smooth acting end thrust and tension fork.
- 7**—The split end rotor plate permits additional adjustment for the entire wave band.

At The Chicago Trade Show

See the United Scientific Laboratory displays, Booth 135, Stevens Hotel, and Room 542-A, Stevens Hotel.

Samples now ready for delivery. Write for prices and full information

UNITED SCIENTIFIC LABORATORIES, INC.
115 Fourth Avenue, New York City

Branch Offices
St. Louis
Chicago
Boston
Minneapolis



Cincinnati
Los Angeles
Philadelphia
San Francisco
London, Ontario

Announcing

TRIAD RADIO TUBES

Achieved at last — the tube perfection for which the radio world has waited! Exhaustive research, a radically new engineering process, greatly advanced laboratory methods, a care in production and testing which has never been known before — from all these has been created an infinitely higher standard in tube quality, a standard which only Triad Tubes offer! Tests have proved their unparalleled clarity of tone, their longer life and their greater sensitivity and volume. ▲▲ Back of every Triad Tube is the personal guarantee of a group of pioneers in the radio industry, whose integrity and resourcefulness has been proved through years of intimate contact with both trade and public. ▲▲ Their product, the result of a conviction that better tubes could be manufactured, now makes possible a greater and more economical enjoyment of radio reception!



GEORGE COBY
President



ELY EGNATOFF
Treasurer



HARRY H. STEINLE
Vice-President and
General Sales Manager



WILLIAM CEPEK
Secretary



"Ask for the tube in the yellow and black triangular box"



See us at the
R. M. A.
Trade Show,
Booth 8,
Exhibit Hall,
Stevens Hotel,
Chicago,
June 3rd.

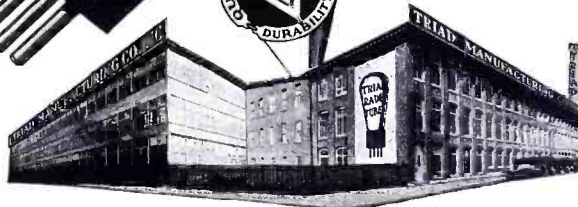

TRIAD MANUFACTURING CO., Inc. ▲ PAWTUCKET, R. I.

Electrostatic Condensers for All Purposes

For Service

Faradon

The Accepted Standard

WIRELESS SPECIALTY APPARATUS CO.

Jamaica Plain, Boston

Est. 1907

MOVING DAY CAME AND WENT...

But POLYMET PRODUCTION Rolled Right Along

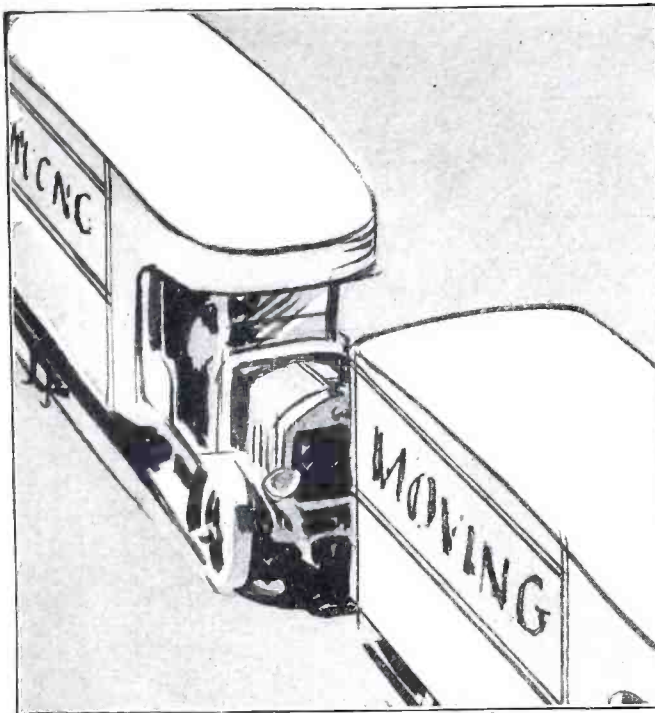

WITH pardonable pride, Polymet points to the successful completion of the Herculean task of maintaining production schedules while the entire Polymet Plant was on the move.

Rather than impair in any detail a reputation for on-time delivery consistently built up over years, Polymet moved unit by unit so that production could flow steadily along.

We are proud of that job, and even prouder that it was a greatly increased business, built on a foundation of consistent Quality, Service and Dependability in Polymet Products, that necessitated our moving at all.

The Polymet factory is now in full operation at the new address printed below. Enormously increased capacity, the very newest in machinery and an augmented technical staff are ready to fill your orders for Quality electric set essentials—on time!

For Coils..Condensers..Resistances..Enameled Wire

POLYMET MANUFACTURING CORP.
839-C E. 134th Street, N. Y. C.

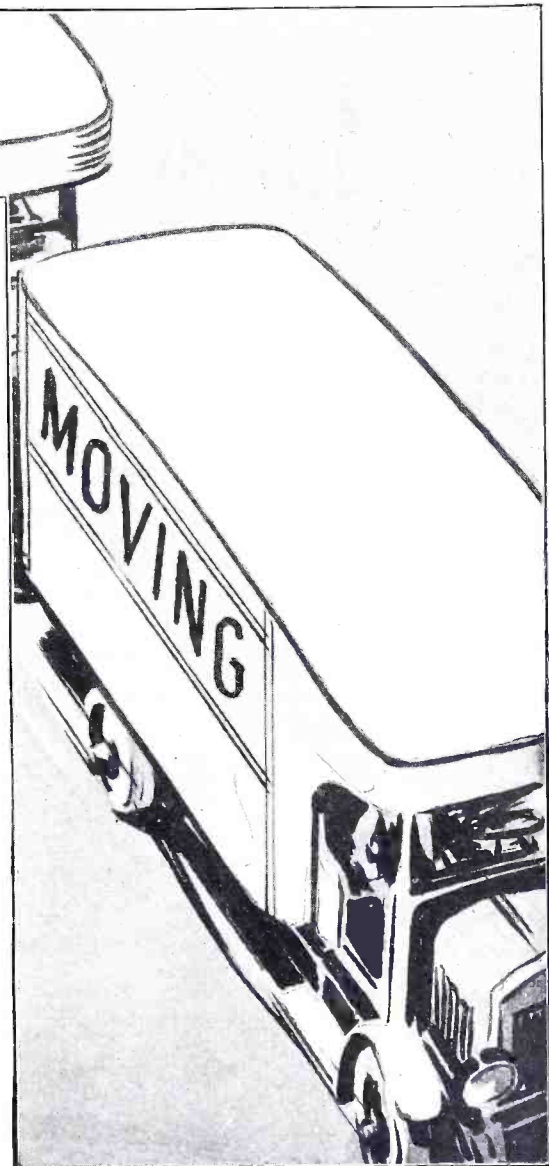

Visit our booth, No. 76, at the R. M. A. Show



POLYMET PRODUCTS



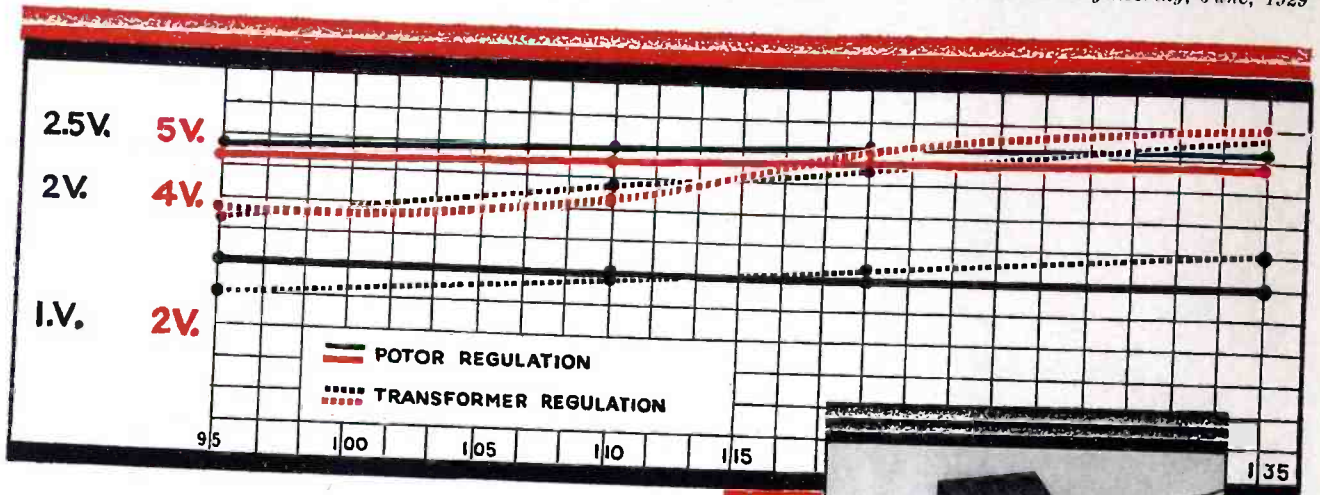

POTOR

A NEW A.C. VOLTAGE REGULATOR

POTOR (Ward Leonard AC Voltage Regulator) replaces, for the manufacturer, the power transformer in any radio receiver. It is made of wire, insulation, and steel—the same components used in transformer construction. POTOR is entirely magnetic in operation. There are, of course, no condensers, resistors, moving parts, or thermally operated units used in, or in connection with, its design.

Any desired degree of regulation may be obtained (manufacturing costs are higher for very close regulation), and POTOR may be designed for any primary voltage range, frequency, and to provide the necessary secondary voltages.

Once the design data has been

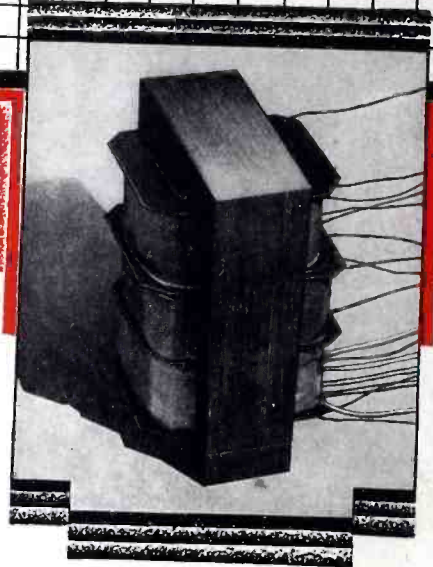

POTOR replaces the transformer in a radio receiver. Illustrated is a typical model.

established, POTOR may be placed in production with no more difficulty than is associated with the manufacture of transformers.

Information on POTOR (Ward Leonard AC Voltage Regulator) will be sent upon request to the Chief Engineers and other executives of radio companies. If you have a specific regulator problem demanding immediate solution, please send us complete data, or preferably, plan to visit our plant yourself. We will show you POTOR

in many applications, and discuss the manufacturing arrangements.



WARD LEONARD ELECTRIC CO.

MOUNT VERNON, N.Y.

Jensen

CONCERT DYNAMIC

by PETER L. JENSEN



JENSEN PATENTS ALLOWED AND PENDING
LICENSED UNDER LEKTOPHONE PATENTS

PETER L. JENSEN has applied entirely new and original principles in the design of this new dynamic. The cone is 10 inches in diameter. The moving coil represents an innovation in design. The sensitivity is greater than that ever attained in any previous dynamic speaker, and the ability to reproduce great volume is exceeded only by the Jensen Auditorium Dynamic.

The Concert Dynamic definitely sets a new standard of excellence. For along with the musical reproduction of bass notes as low as 30 cycles, the higher frequencies are reproduced with extraordinary brilliance. In fact the entire musical scale is reproduced with a brilliance and firmness of quality never acquired before.

There is no need of a "side by side" comparison to appreciate the superiority of this new Jensen Speaker. Wherever it is heard its performance is both

startling and impressive. Many of America's leading radio set manufacturers have acknowledged the superiority of this new dynamic speaker and their engineers in collaboration with Peter L. Jensen have adapted it to their own specific requirements. The trade and public will acknowledge just as readily the marked superiority of radio sets equipped with this new reproducer.

Write for complete information and ask for a frequency response curve of this new speaker.

JENSEN RADIO MANUFACTURING COMPANY
6601 S. Laramie Avenue, Chicago, Illinois 212 Ninth Street, Oakland, California

HEAR DEMONSTRATION AT R. M. A. SHOW, STEVENS HOTEL

NEW, REVOLUTIONARY, A YEAR AHEAD

BEST Theatre PICK-UP

for HOME and THEATRE



Its 5 Advantages:

1. The Best Theatre Pick-up is the largest, heaviest, most powerful Pick-up ever designed.
2. The Best Theatre Pick-up has by far the lightest weight on the record.
3. The Best Theatre Pick-up has less needle noise.
4. The Best Theatre Pick-up will give by far longer record life.
5. The Best Theatre Pick-up has a response curve which follows, almost exactly that of the pick-up selling for over \$200.

COUNTER BALANCED!

The Best Theatre Pick-up, is built like a suspension bridge. So delicately is it balanced, that only a feather weight is placed on the record. When finished playing a record, simply tip the head — it stays — no danger of ruining record or woodwork. Perfect balance does it.

WHEN you examine the Best Theatre Pick-up in your laboratory, when you make your own independent tests, both individual and comparative, you will know that again the designers of the BBL Speaker unit have made the finest product in its field. Samples will be sent to responsible manufacturers.

BEST MANUFACTURING CO.
1200 GROVE ST., IRVINGTON, N. J.

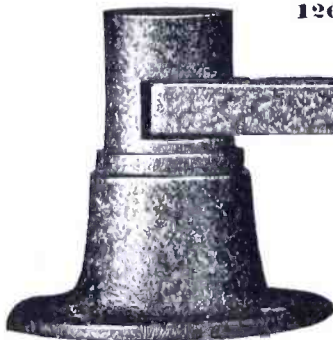

BEST Theatre PICK-UP

for HOME and THEATRE

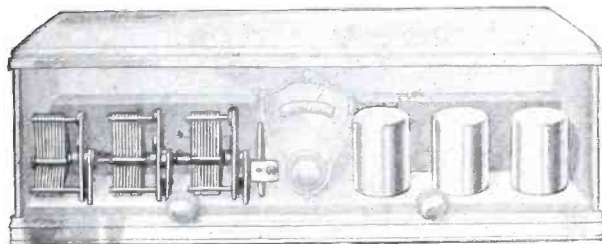

TWO NOTABLE CONTRIBUTIONS TO RADIO DESIGN

Aluminum Condensers

THE perfection of a special Aluminum Radio sheet to meet condenser blade specifications as to gauge and flatness has been very generally welcomed by Radio producers.

A reliable, dependable source of supply of Aluminum condenser blade stock is now available—with variations in thickness within a single sheet of less than .0005" and gauge tolerances from sheet to sheet of $\pm .001$ ".

Aluminum is the logical material for the heavy condenser blades now required in sets that are housed in the same cabinets with powerful loud speakers. Aluminum Blades do not vibrate and produce microphonics.

Aluminum Shielding

SINCE the beginning of 1929, five more prominent manufacturers have adopted Aluminum Shielding. Twenty-seven leading sets are now designed for Aluminum Shielding—an almost universal acceptance.

The reason is evident. Aluminum is highly efficient electrically—especially at radio frequencies. It works easily and well in the shop. It appeals to both purchaser and producer—because it is attractive in appearance, light in weight and non-corrosive.

And Aluminum Shields are economical, from the standpoint of first cost—in production—and in finishing. We solicit your inquiries.

Inquiries are solicited for Aluminum foil, sheet, wire, rod, tubing, stamping, die-castings, sand castings, extruded shapes, screw machine products, strong Aluminum alloys, Aluminum wood grain panels, and magnesium products.

ALUMINUM COMPANY OF AMERICA
2468 Oliver Building, Pittsburgh, Pa.
Offices in 18 Principal American Cities

ALUMINUM
The mark of quality in Radio

LONG LIFE ASSURED



Type B-12
B-L Rectifier.

Type B-402 B-L Rectifier Max. D. C. Rating, 3 Amps. 2 Volts.



Type C-110 B-L
Rectifier Replacement
Unit.

Advancement...

The new Type B-402 B-L Rectifier Unit has caused a decided advancement in the manufacture of dynamic speakers.

An advancement because it permits these economies for the dynamic speaker manufacturer:

Allows a low voltage type of field winding—less turns of larger wire and consequent lower winding and wire costs. Thus a more rugged field winding with a better space factor is assured.

The B-402 is a truly notable addition to the long line of stable, proven and successful B-L Rectifiers.

Write us for complete literature on all B-L Rectifier Units . . . Complete data and engineering service is available at all times.

The B-L Electric Mfg. Co.

(Formerly Mfg. Div. of the Benwood-Linze Co.)

19th & Washington Aves. ' ' St. Louis, Mo.



Type A B-L
Rectifier.



TRADE MARK REG.

DRY...DURABLE...COMPACT...COMPLETE...NOISELESS

The Answer to Your Voltage Control Problem !

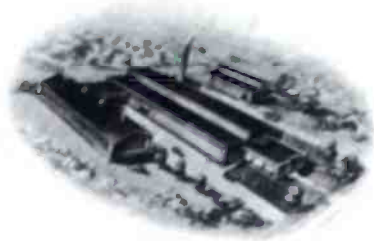

GILBY WIRE COMPANY
WILBUR B. DRIVER, PRESIDENT

SOLE ADDRESS: GILBY WIRE
BERKELEY 5
UNIVERSAL

MANUFACTURERS OF
NICKEL AND NICKEL ALLOYS
RESISTANCE WIRES HEAT AND ACID
BASE & INSULATED RESISTING CASTINGS
FLAT WIRES & STRIP FILAMENT WIRE
SPECIAL ALLOYS

OFFICE AND PLANT 150 RIVERSIDE AVENUE
NEWARK, N. J.

Progressive Radio Mfrs.,
Everywhere.

Gentlemen:

"GILBY BALLAST WIRE"

Varying line voltages are a continuous source of trouble. High voltages shorten the lives of A. C. tubes . . . low voltages necessitate the use of a tapped primary in order to permit the operation of the set. These factors have retarded the successful development of power reception.

In a new development, "GILBY BALLAST METAL", we present a solution.

This is a special NON-CORRODING WIRE which performs at its highest efficiency in air, and it is unique in that it functions most effectively at low operating temperatures, does not disturb the wave form, or introduce harmonics.

An exceptional point in connection with this wire is the fact that a regulation of at least 80% can be obtained with good design.

"GILBY BALLAST METAL" is now being used in large production with highly satisfactory results. It assures good regulation at low cost.

Suitable samples will be sent to you for trial upon your request.

Yours very truly,

GILBY WIRE COMPANY
Wilbur B. Driver
Wilbur B. Driver
President.

WBD/AN



GILBY WIRE COMPANY

WILBUR B. DRIVER, President
NEWARK, NEW JERSEY

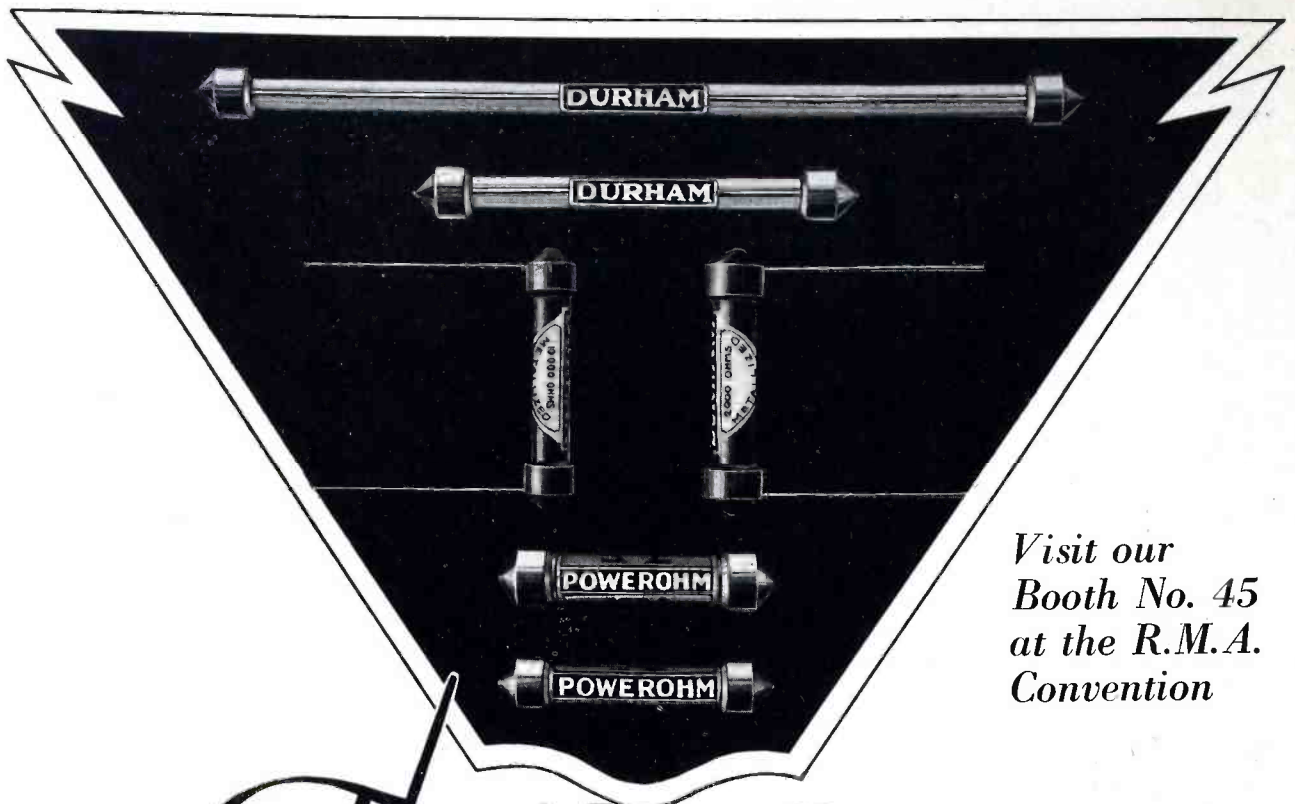

*Visit our
Booth No. 45
at the R.M.A.
Convention*

The New Improved **DURHAM POWEROHMS**

EACH succeeding year, more and more important manufacturers of radio, television and talking movies are standardizing on DURHAMS—the resistances which are dependable, accurate in rating, and can be relied upon for long continued and uninterrupted service.

Supplied in 1 and 2 watt types in standard, pig-tail or special tips; temperature rise at 1 watt is 45°c and at 2 watts 74°c; all types are flash tested at double the rated power load as an extra precaution against electrical or mechanical weaknesses; extremely rugged construction; supplied in all ranges from 500 to 200,000 ohms in power types and from 1 to 100 megohms in resistor types.

Samples for testing gladly sent upon request, together with engineering data sheets. Please state ratings in which you are interested.

DURHAM

METALLIZED

RESISTORS & POWEROHMS

INTERNATIONAL RESISTANCE CO., 206 Chestnut Street, Philadelphia, Pa.

Cunningham RADIO TUBES



Be guided by a name that has meant absolute tube integrity for the past fourteen years. ☞ The name is Cunningham—choice of the American home.

Cunningham Booth No. 5, R M A Trade Show, Congress Hotel, Chicago, June 3-7

E. T. CUNNINGHAM, INC.

NEW YORK

CHICAGO

SAN FRANCISCO

DALLAS

ATLANTA

Manufactured and sold under rights, patents and inventions owned and/or controlled by Radio Corporation of America

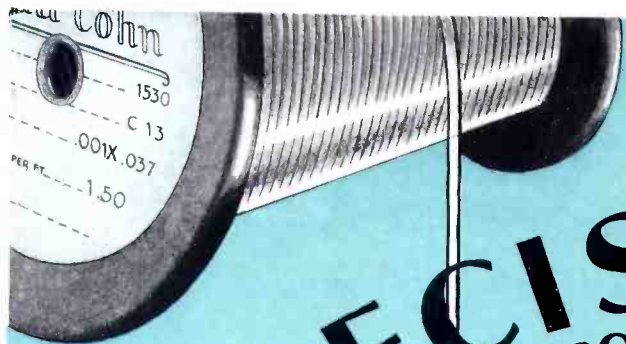

PRECISION FILAMENT RIBBON and WIRE

*It
Hangs
Straight!*

USED BY LEADING

TUBE MANUFACTURERS



Precision Filament is produced by a special process so that it hangs absolutely straight... This quality, in addition to the consistent accuracy, uniform size and resistance, and its clean surface, makes this wire the preference of the foremost tube manufacturers.

PRECISION FILAMENT WIRE
IS A PRODUCT OF

SIGMUND COHN

44 GOLD STREET
NEW YORK

FROST-RADIO VOLUME CONTROLS

supplied in any of these curves as well as special curves to meet your exact requirements

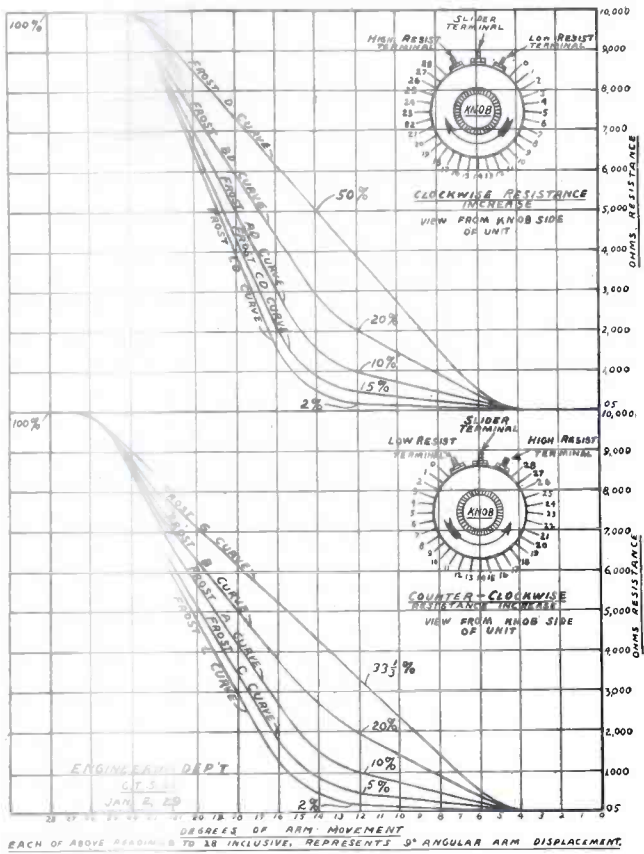

YOU can secure Frost-Radio Volume Controls in any of the curves drawn on the charts shown, as well as in many other curves to suit your needs. You can thus obtain from us any resistance gradient you desire in units from several hundred ohms up to and including a total resistance of several megohms. Frost-Radio Variable Resistors are made in several sizes, in single or tandem construction, and with resistance arranged to increase with either clockwise or counter-clockwise knob rotation. These units are smooth-running, non-inductive, and absolutely unaffected by temperature or humidity changes.

We supply Frost-Radio Volume Controls in the following standard housing dimensions:

Diameter	Depth	Type
1 61/64 in.	39/64 in.	Bakelite
1 7/8 in.	43/64 in.	Metal
1 7/8 in.	3/4 in.	Metal
1 5/8 in.	37/64 in.	Bakelite
1 1/2 in.	43/64 in.	Metal

Tell Us of Your Special Requirements

For other than standard units, please indicate in your request for samples any special dimensions, terminal positions, curve desired, and watt load, and in requesting tandem unit samples state maximum permissible mounting depth. Please note that bushings, threads per inch, shaft lengths and diameters illustrated are standard. Made in two or three terminal type.

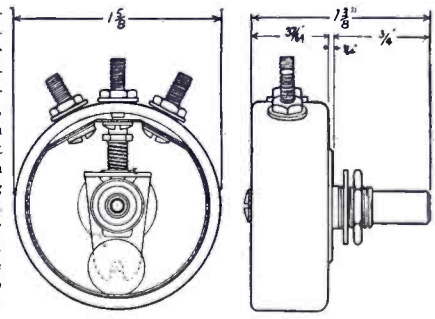
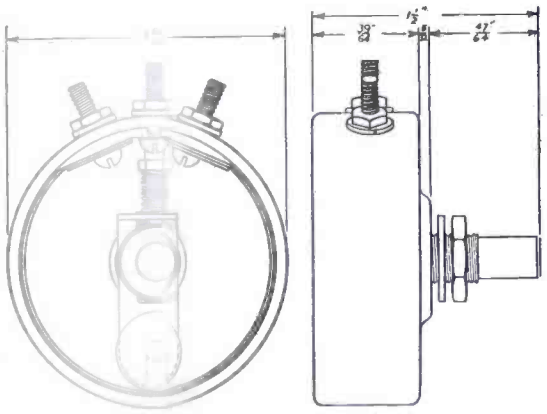

HERBERT H. FROST, Inc. The Largest Manufacturers in the World of High Grade Variable Resistors
 Main Office and Factory: ELKHART, INDIANA 160 North La Salle Street, CHICAGO

TIME

THERE IS STILL TIME TO SECURE OUR QUOTATIONS AND SAMPLE BLOCKS FOR THIS SEASON'S REQUIREMENTS.

OUR OIL CONDENSERS ARE LEADING THE FIELD IN QUALITY AND THE PRICES ARE RIGHT.

DO NOT OVERLOOK THIS OPPORTUNITY. FORWARD YOUR LATEST SPECIFICATIONS TO US AT YOUR EARLIEST CONVENIENCE.

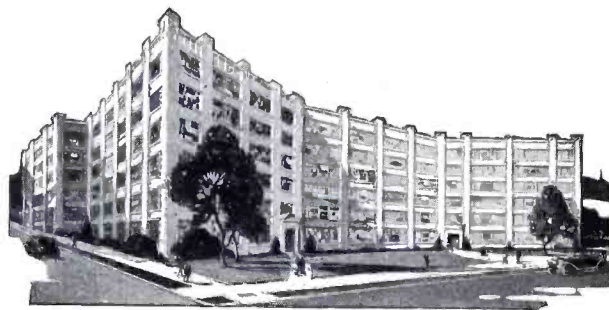

CONDENSER CORPORATION OF AMERICA
259-271 CORNELISON AVE. :- :- JERSEY CITY, N. J.

This New Elkon Rectifier Eliminates the Power Transformer in Dynamic Speakers

This shows the size of one of the rectifier units. Two are required on each speaker.

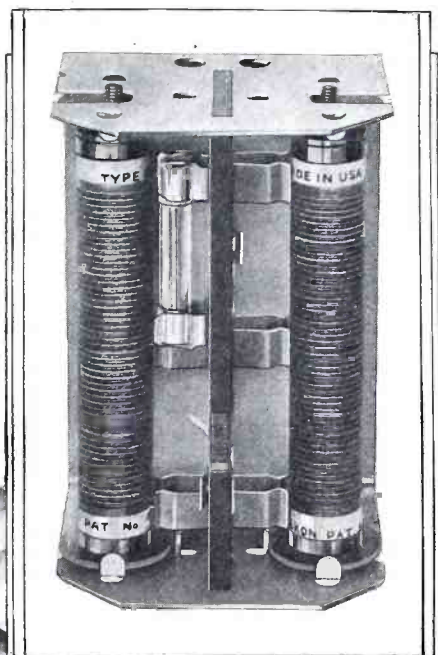

The rectifier units can be easily replaced when necessary as may be seen here.



A GAIN Elkon leads the field. The new Elkon D-30 Power Supply is the outstanding development of the year in rectifiers for dynamic speakers.

This remarkable rectifier operates directly from the AC power line eliminating the Power Transformer and reducing the cost of assembly.

Supplied complete, ready to install, or the rectifier units (two required on each speaker) can be sold separately.

Wonderfully efficient, quiet in operation. The units can be replaced when necessary as easily as a tube is changed in a socket.

If you have not already sent us a sample of your new speaker, do so at once. We will equip it with the new Elkon rectifier and return it to you promptly.



The Elkon D-30 Power Supply complete with cover.

ELKON, Inc.

Division of P. R. Mallory & Co., Inc.

3029 E. Washington St.,
Indianapolis, Ind.

Please send us complete information on your new Elkon D-30 Power Supply for Dynamic Speakers.

Name

Address

ELKON, Inc., Radio Dept. E-61
3029 E. Washington St., Indianapolis, Ind.

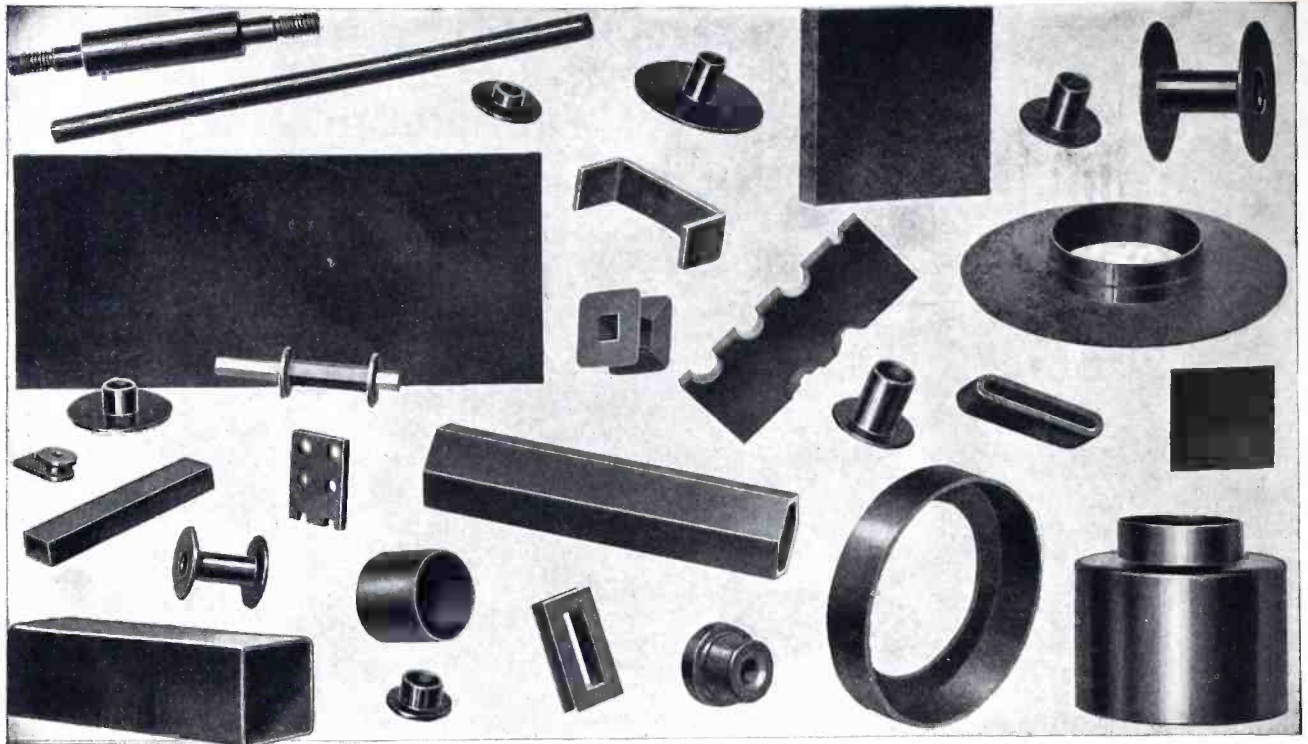

For Complete Satisfaction Specify Textolite Laminated

Textolite laminated gives complete satisfaction to users, not only because of its remarkable combination of qualities, but also because it is made by an organization with facilities and resources to supply all your present and future needs.

It is new to the trade—but it is time-tried in seven years of service. Millions of pounds have been used to replace wood, rubber, fiber, mica, porcelain, and metals in General Electric products.



Its quality is beyond question—the resources of the General Electric research laboratories are enlisted in its manufacture. Modern machinery, supervised by skilled technicians, assures quantity production.

The adaptability of Textolite laminated is amazing. The trade continually finds new uses for it. Complete stocks of rod, tube, and plate are always on hand, and special requirements can be met promptly.

GENERAL ELECTRIC

GENERAL ELECTRIC COMPANY, SCHENECTADY, N. Y., SALES OFFICES IN PRINCIPAL CITIES

885-19

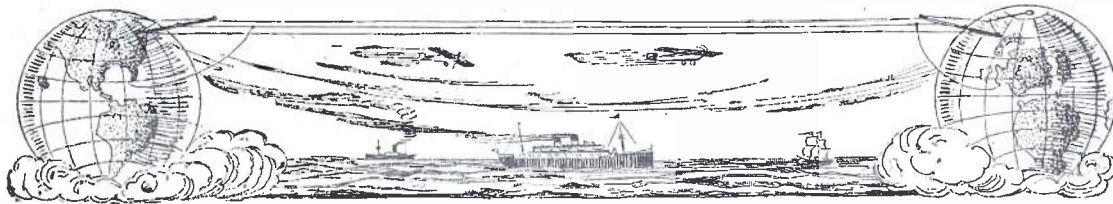

Frequency Distortion in R-F. Amplifiers

Effects of the Shape of the Resonance Curve on the Quality of the Received Signal With Special Attention to Tuned Coupled Circuits

By Charles J. Hirsch, A.B., E.E.

THE effects of the shape and width of the resonance curve of a radio receiver on detection and quality has been much misunderstood. Thus it is quite possible that, in some of the sets using coupled circuits which have been recently advocated, distortion may be increased instead of diminished. It is also possible, under certain conditions, to obtain better quality with a flat-topped resonance curve only 5-kc. wide than with one 10-kc. wide. It is the purpose of this article to discuss the effect of the shape of the resonance curve on the quality and volume of a received signal. This discussion holds only if we make the assumption that the transmitting stations send out waves in the same manner as they do now.

Let us now briefly discuss the high points of modulation and detection, the two being practically the same thing.

If a radio wave of frequency f_0 is modulated by a voice frequency f_1 , the radiated wave is made up, among other things, of the frequencies:

- a. The carrier frequency f_0 .
- b. The upper side frequency equal to $f_0 + f_1$.
- c. The lower side frequency equal to $f_0 - f_1$.

If the carrier is 100% modulated, then the side frequencies are of half the amplitude of the carrier frequency.

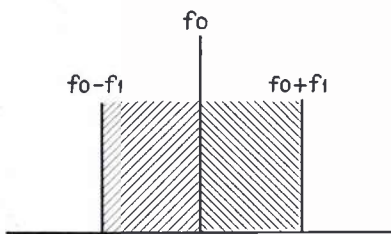

FIG. 1

The received signal is made up of the beats between these three frequencies. We see that the beat between the carrier and each side band has a frequency equal to f_1 , while the beat between the two side frequencies has a frequency equal to $2 f_1$ and is therefore distortion. Low percentage modulation by decreasing the amplitude of the side frequencies, decreases the beats between them more than the beat between the carrier and each side frequency.

If the carrier is 80% modulated, then the side frequencies have an amplitude equal to 40% of the carrier frequency. In other words, the amplitude of the side frequencies is equal to half the percentage modulation of the carrier. (See Fig. 1.)

The modulating then amounts to

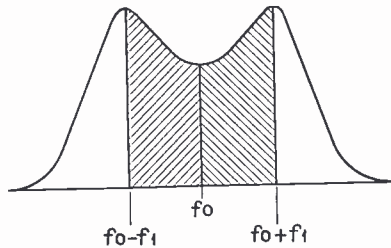

FIG. 2

If the resonance curve has this shape, we see that the side frequencies are accentuated with respect to the carrier. In this manner, the beats between the side frequencies are very marked and distortion is increased.

nothing more than the creation of beats between the high-frequency wave and the low-frequency modulating signal.

Process of Detection

The process of detection is similar to that of modulation. The receiver picks up, in general, three frequencies which are: the carrier and the two side frequencies. When these three frequencies are impressed on the detector, the latter causes beats to take place between them. These beats are:

- a. A beat between the carrier and the upper side frequency. This has the frequency which modulated the carrier at the transmitting station and is therefore what we want.
- b. A beat between the carrier and the lower side frequency. This is identical to "a".

- c. A beat between the two side frequencies. Since the sidebands are separated from the carrier by an amount equal to the desired frequency the two sidebands, occurring one above and the other below the carrier, are separated by twice the desired frequency and therefore cause second-harmonic distortion. However, the

amplitude of the beat between the sidebands varies as the square of the percentage of modulation, while the desired note varies as the first power. This means that for a 100% modulated wave, the second harmonic distorting frequency will be a quarter as strong as the desired note, while if the percentage of modulation is reduced to 10% the second harmonic will only be one-twentieth of the desired note. This shows the advantage of low percentage modulation when good quality is desired.

We see from this that we want to increase the beat between the carrier and each side frequency and that we want to minimize the beat between the side frequencies. With this in mind we can easily see that the ideal resonance curve is not a flat-topped one but one which is flat topped for all the notes that we want to receive and one that would amplify the carrier many times more than the sidebands. Unfortunately, this is impossible so that we must be satisfied with the more easily obtained flat-topped resonance curve.

Carrier and Sideband Amplification

By means of coupled tuned circuits, it is possible to obtain a resonance curve as shown in Fig. 2. Such a

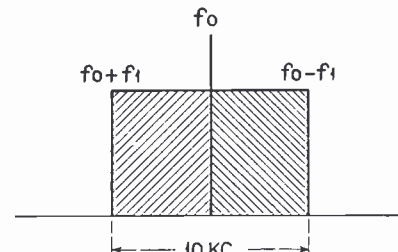
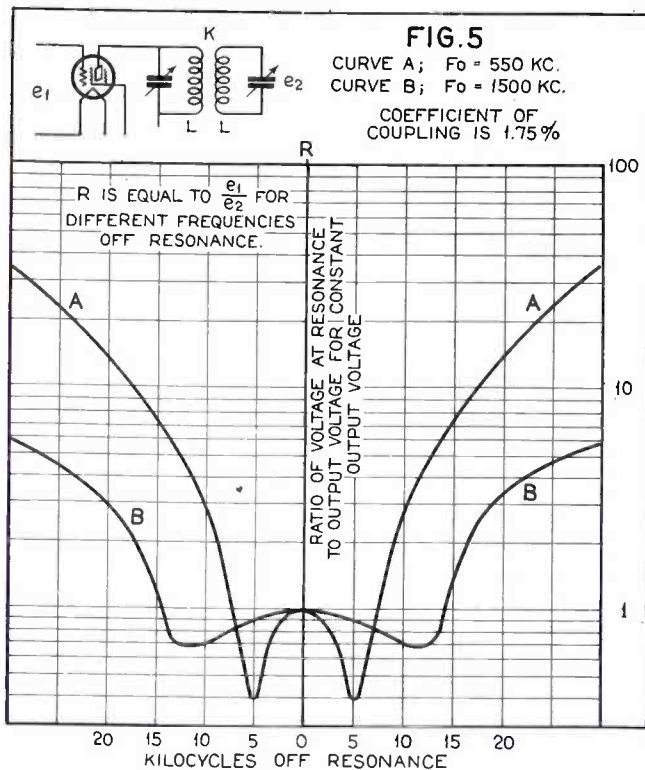

FIG. 3

This is the ideal form for the resonance curve when the present method of tuning is used. The carrier is accentuated with respect to the side frequencies but all these come in equally well over a band of 10 kc. After that there is complete cut-off. The accentuation of the carrier with respect to the side frequencies minimizes the beat between them when compared to the beat between the carrier and each side frequency.



Curves showing the relative voltage required at e_1 to give constant voltage at e_2 for audio frequency differences from the carrier frequency. This plotted to a semi-logarithmic scale to increase the range of the curves. Both curves were calculated for constant coupling.

resonance curve is to be avoided inasmuch as it amplifies the sidebands much more than the carrier. Some calculations were made to determine just how much this would amount to. It was found that with a coil of 150 microhenrys, tuned to 550 kc. and coupled to a similar coil similarly tuned, the two peaks obtained were separated by 10 kc. for 1.75% coupling. However, the carrier in this case was amplified only half as much as a side frequency 5 kc. off resonance. This means that if the transmitted signal is 100% modulated, the second harmonic distorting note will be half as strong as the desired note. However, if two such stages are cascaded, the relative amplification between a note 5 kc. off resonance and the carrier will be as four to one. This means that in this case for a 100% modulated signal, the second harmonic distortion will be as strong as the desired note. This will, of course, give very bad quality. Of course, very few carriers are 100% modulated, but this case was taken to illustrate the point more fully.

The doubly-humped resonance curve given by coupled tuned circuits can, however, by careful matching with an ordinary tuned circuit, be made to give a fairly flat-topped curve. The ordinary tuned circuit discriminates in favor of the carrier as against the sidebands. The coupled tuned circuits discriminate in favor of the sidebands as compared to the carrier. By combining the two, we can obtain a combination characteristic which will be fairly even. This is shown in Fig. 6.

However, another precaution must be taken. Let us suppose that we have carefully matched our circuits so as to give 10 kc. band width at 550 kc. Let

us now find out the characteristic curve at 1500 kc. We then find that the circuit tunes much too broadly. The coefficient of coupling which was correct for a wave of 550 kc. is no longer correct for 1500 kc. In other words, the coefficient of coupling should vary con-

tinuously with the frequency desired, decreasing as frequency increases. This is a point which has been neglected in all popular articles on coupled tuned circuits and manufacturers now sell kits in which the coupling is fixed. While this practice may be justifiable in other respects, we see that it is not correct scientifically.

To have good quality, all frequencies up to 5 kc. should come in equally well. This means that counting the upper and lower sidebands, the resonance curve should be flat-topped for a width of 10 kc. Actually, it is possible to obtain just as good quality with a band width of 5 kc. as with one of 10 kc. This is done by tuning the carrier to either the upper or lower cut-off frequency. This has the effect of cutting off one of the sidebands and, therefore, prevents the beat between the side frequencies. This is shown in Fig. 4. The audible signal then consists only of the beat between the carrier and one sideband.

Advantages of 5-kc. Band

The advantages of a 5-kc. flat-topped resonance curve are:

- a. Better quality because the beats between sidebands are eliminated. This results in the elimination of second-harmonic distortion.
- b. The transmitting station could increase its percentage of modulation, thereby increasing its range without decreasing its quality.
- c. Greater selectivity can be obtained.
- d. If the flat-topped curve is obtained by tuned coupled circuits, then

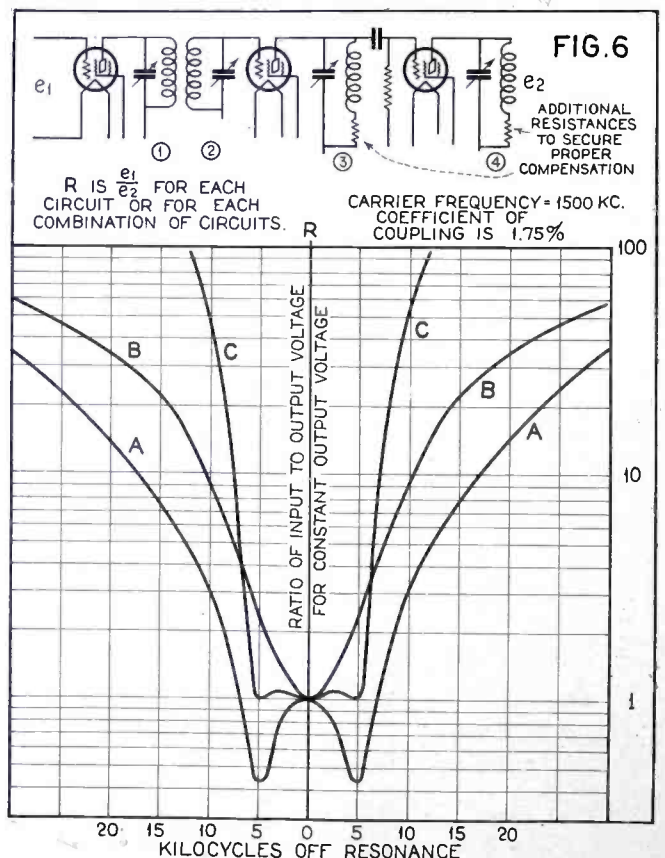

Curve A is the inverted resonance curve of coupled tuned circuits 1 and 2. Curve B is the combined resonance curve of straight tuned plate circuits 3 and 4. Curve C is the combination resonance curve of all four tuned circuits. We see that it is fairly flat topped.

constant coupling will not cause as wide a resonance curve at the high radio frequencies.

e. More efficient circuits can be used.

The disadvantages are:

a. The public is accustomed to tuning to the midpoint of the resonance curve and would probably keep on doing so unless restrained by force or an injunction.

b. The volume would be decreased because we only get the beat between one sideband and the carrier instead of the beats between both sidebands and the carrier.

c. It will not, generally speaking, give better quality than tuning to the edge of the 10-kc. band resonance curve.

d. It is questionable if the public wants the high notes. People are so used to listening to the low notes as an indication of quality that they have probably forgotten there are high notes.

As the ordinary set is tuned in, we hear at first only the high notes, then as we get closer and closer to resonance, the low notes become louder and louder as compared to the high notes until when we are in resonance, the high notes may be mostly lacking. By suitable adjustment of the volume con-

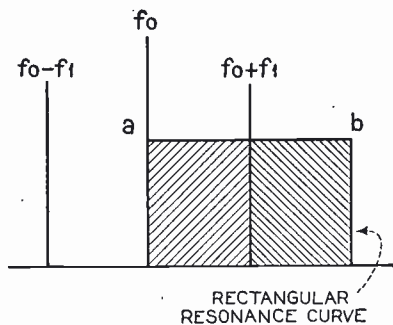

FIG. 4

By tuning the carrier to point "a", the lower sideband is eliminated, while by tuning to point "b", the upper sideband is eliminated. In this manner the beat between the side frequencies is done away and only the desired frequency comes through. It will be seen that this ideal form of resonance curve would also let all audible frequencies up to 5 kc. come through equally well. This would give superior quality to the one obtainable in Fig. 3. The volume will be decreased because the desired frequency is obtained by beating the carrier with only one side frequency instead of two, as in Fig. 3.

control we can then adjust the performance of the receiver to favor either the low or the high frequencies.

It is true that fabulous amplification can be obtained by using the screen-grid tube and feed the output

either into a tuned plate circuit or into a circuit coupled to the plate circuit of the tube. We should not let ourselves be fooled by claims of sensitivity of this type of circuit. If we are only after sensitivity, then it is true that we can get lots of it in this manner, but then sad things happen to the quality. With a coil of 150 microhenrys and 2.75 ohms resistance tuned to 550 kc. and feeding out of the plate of the new 224-type tube, an amplification of 80 per stage can be obtained. However, 5 kc. off resonance is only amplified .345 times as much as the carrier per stage. Therefore, for three stages, the amplification will be 512,000 times and 5 kc. amplification will be only 4.1% of the amplification of the carrier.

By this, I don't mean to condemn the screen-grid tube. It is a good tube and I believe that it is here to stay, but we must be careful before we make extravagant claims for it.

One great advantage of the screen-grid tube is that the elimination of the plate to grid capacity allows us to design circuits with some degree of accuracy. At least now we can figure out a characteristic on paper and on trying it out find something which will be near to what was expected. This was not possible before.

A New Method of Tuning

The Wave-Resonance System of Tuning, Developed by
Major W. R. Blair and Dr. Louis Cohen

By J. E. Smith*

BASED on a fundamentally new principle of tuning, a simple device for use with existing radio receiving sets or for incorporation into future designs of receivers, has been invented by Major William R. Blair, Chief Engineer in charge of Research and Engineering Division, and Dr. Louis Cohen of the Signal Corps Radio Laboratories of the War Department. The mathematical formula of the so-called "circuit tuning by wave resonance" will be outlined by Major William R. Blair, Chief Engineer of the Signal Corps, and Dr. Cohen at the forthcoming annual meeting of the International Union of Scientific Radio-telegraphy.

The instrument by which this new method of tuning is effected consists of a coil of wire, 8 inches long and 2 inches in diameter and containing 400 turns of extremely fine wire, and a thin plate of aluminum, eight inches long and four inches wide. The piece of aluminum is moved at varying distances from the coil of wire as a means of tuning signals from various broadcasting stations. This device, which has a vertical movement instead of revolving about an axis as is true with our present-day variable con-

THE Wave-Resonance Tuning System described in this article is an elaboration on the developments of Major Blair and Dr. Cohen, originally referred to in the May, 1927 issue of RADIO ENGINEERING. Considerable progress has been made since that time.

This system of tuning recalls to memory the Resonance Wave Coil, given wide recognition many years ago.

It is quite possible that Wave-Resonance Tuning can be effectively applied to modern broadcast receivers and assist materially in easing the problem of selectivity vs. distortion.—
Editor.

densers, may be coupled to commercial-built radio receiving sets and thus employed as an extra degree of tuning—insuring much greater selectivity than is now possible with the prevailing method of tuning.

"In the present practice of the radio art," points out Dr. Cohen in introduc-

ing his basically new system, "circuit tuning is accomplished by a proper combination of localized inductances and capacities; the values of the inductance and capacity properly chosen to meet the conditions of any particular problem of design. The phenomena connected with this form of tuning have been studied quite exhaustively by many investigators; every conceivable modification of circuit structure has been subjected to careful analysis, and the results made available in many publications."

Wave-Resonance Tuning

"There is, however, another form of tuning which may be called 'wave resonance' of which comparatively little if any advantage was taken in the radio art, and which will show on investigation to offer possibilities in the accomplishment of results which cannot be very well attained by the older method of tuning. The basic principles of this form of tuning were more or less known to theorists, but the application to the radio art has been negligible."

Wave-resonance tuning may be defined as that condition when a piece of wire or other metallic conductor of distributed inductance and capacity is

* President, National Radio Institute.



Dr. Louis Cohen applying the resonance wave tuning system to a superheterodyne.

subjected to radio waves or electrical oscillations and either the length of the wire or the inductance and capacity per unit length of the conductor are harmoniously adjusted with respect to the wavelength or frequency of the radio wave or electrical oscillations. Or, simply expressed, it means capturing a stationary radio wave on a piece of wire and then picking out the resonant or tuned points. The coil of wire, already referred to, harnesses the radio wave and the thin aluminum plate picks out the signals of the different broadcasting stations.

"This method of tuning," we are told by Dr. Cohen, "offered possibilities for many novel circuit arrangements suitable for various uses in the reception and transmission of radio signals. In the mathematical discussion before the International Union of Scientific Radio-telegraphy, we shall describe circuit systems embodying this method of tuning and demonstrate that a high degree of selectivity is obtainable, and that it offers an effective method for the elimination of interferences. Also, multiplexing, both in the transmission and reception of radio signals, can be readily realized by a circuit system utilizing this method of tuning."

The original but crude method of applying this basically novel system of tuning would be to use a straight, long wire as a wave conductor but, obviously, the required length would be too unwieldy for use with our radio receivers. Therefore, we are reminded by Dr. Cohen, "To make use of wave-resonance tuning in a practical way, a wave-conductor must be made available that will meet the conditions of practical dimensions, and affording convenient means of adjustment for different frequencies. This is realized in the design of a wave-conductor which consists of a solenoidal coil mounted on a metal plate."

"The dimensions of the coils used for the broadcast frequency are 8 inches long and 2 inches in diameter, wound with a suitable number of turns of wire giving the required length of conductor, and at the same time keeping the dimensions within practical

limits. The dimensions of the coil as well as the number of turns may be varied to meet particular requirements of design in the matter of frequency range. By varying the distance separation of the movable plate from the coil, the distributed capacity and, to some extent, the distributed inductance are varied, affording a convenient means for adjustment. In some circuits, the metal plate is grounded and in others ungrounded, depending upon the particular circuit arrangement in which it is used."

Practical Adaptation of System

"The possibility of the adoption of wave-resonance tuning for the reception of radio signals is quite obvious, providing suitable means are introduced for transferring to a receiving device the voltage or current energy from the wave-conductor. This can be accomplished in various ways; it is largely a matter of coupling. The simplest way is to couple a closed circuit, preferably tuned, to the wave-conductor, and the voltage developed

open. The coupling from the primary to the tuned secondary circuit is, obviously, electrostatic. Very good results in the matter of volume and selectivity were obtained with this arrangement."

Elimination of Interference

"Tuning by wave-resonance is well adapted for the elimination of interferences. A wave-conductor connected in series with an antenna can be made to respond resonantly by proper adjustment to signals of a particular frequency, and it should follow from this that it should also function efficiently as an energy absorber of an interfering signal of that particular frequency. That this is actually so was demonstrated experimentally, and accomplished in the following manner. The receiver is connected to the antenna in the usual manner, and a wave-conductor connected to the junction point of antenna and receiver. By the proper adjustment of the wave-conductor to the frequency of any particular interfering signal, a voltage wave is established for that frequency at the junction point of antenna and receiver and, consequently, very little if any signal current of that particular frequency will pass into the receiver."

Multiplex Reception

"The possibility of utilizing wave-resonance tuning for multiplex reception naturally suggests itself. If, as it has been indicated, it is possible to eliminate several interfering signals of different frequencies by the use of several wave-conductors, each adjusted to a frequency of one of the interfering signals, then it should be possible to reverse the process by coupling receivers to the wave-conductors through each of which a signal of one frequency only, for which it is in adjustment, is transmitted to the corresponding receiver. This has been accomplished in a highly satisfactory manner."

"This multiplex method should prove useful for broadcast reception in apartment houses; one large antenna serving as a supply source of the signal energy for all the receivers in the various apartments. It would be simply a matter of extending lead-wires from the antenna to the different apartments, each connecting to a wave-conductor which is coupled to a receiver. A small reduction in signal strength occurs only when all the receivers are operated on the same frequency, and the probability of any large number of receivers operating simultaneously on the same frequency is likely to occur only when receiving from a local station, in which case the energy is more than sufficient, and the reduction in intensity would not even be noticed. For distant stations, if the receiving sets are operated on different frequencies, no appreciable effect is produced on either the tuning or strength of signals by the addition of other receivers connected through wave-conductors."

FORTHCOMING ARTICLES

We have been very fortunate in securing a number of excellent articles that, on the whole, serve well to reflect the general engineering and industrial trend in the radio field. The subjects dealt with hinge around the most recent developments.

Clyde L. Farrar, of the University of Idaho, is to present the results of his work on band-pass tuning, in the July issue. In this same issue there will appear an article on loud-speaker response measurement, by L. G. Bostwick, of the Research Department, Bell Telephone Laboratories.

The long promised articles on sound recording and reproduction, and the governor grid amplifier are in preparation. They are scheduled for an early issue.

across the condenser of the closed circuit applied to the grid-filament of a vacuum tube in the usual way. If desired, additional tuning may be had by the use of a tuned radio-frequency amplifier, and in that case the wave-conductor tuning serves to superimpose another degree of tuning, giving a remarkably high degree of selectivity, and this without any loss in efficiency. In fact, it may be used in connection with any of the well-known types of commercial receivers. In practice, it is found that a sufficient degree of coupling is obtained by placing the wave-conductor close to the receiving set; the coupling is largely electrostatic."

"A better arrangement, however, is to connect the metal plate of the wave-conductor to the receiving set. In this case, the metal plate serves a double purpose; that of adjusting the wave-conductor and as a coupling means. I had the use of a Stromberg-Carlson set in which the primary is untuned; the metal plate of the wave-conductor is connected to one terminal of the primary coil, and the other terminal is

Production Testing of Vacuum Tubes†

Hinging on a Detailed Description of the Circuit and Components of an Automatic Tester Capable of Handling 8,000 Tubes Per Hour

By Allen B. DuMont*

IN THE manufacture of radio tubes, one of the most important operations is the final electrical test to reject all inoperative tubes and those outside of a range which are not satisfactory for set operation. Four or five years ago, when the production of vacuum tubes was just commencing on a large scale, the general procedure of testing was to check each tube individually for the following characteristics:

1. Filament current.
2. Emission.
3. Plate current.
4. Gas current.
5. Electrical leakage.
6. Amplification constant.
7. Plate resistance.
8. Mutual conductance.

As the productions increased, the task became so great that means had to be devised for simplifying this operation. It was found that the tubes could be held within the desired characteristics by checking a few of the essential characteristics of the tube. The limits for these essential tests were determined by target diagrams. The essential characteristics which are now checked on all tubes are:

1. Emission.
2. Plate current.
3. Gas current.
4. Electrical leakage.

The filament current is not ordinarily tested because of the fact that it can be held within very narrow limits by checking the wire before it is used in tubes. Likewise, the amplification constant, plate resistance and mutual conductance are not ordinarily read, because the dimensions of the grids and plates are checked before assembly and a very close check is kept on the centering of the elements. Hence by a proper setting of the emission, plate current and gas limits, the tubes can be maintained within the desired limits for the other characteristics.

The method of testing for these essential characteristics has been to have numerous girls with separate test sets checking every tube and discarding all those outside of limits. As the production gradually increased, the number of test sets necessary became very large. The time required to keep all these sets operating alike, the calibration of meters and the replacing of batteries was a considerable

task. It can be realized that even when extreme care is taken to see that everything is all right, there is a possibility of some time elapsing before a meter off calibration, a wrong battery setting, or a circuit which does not always have perfect contact, is discovered. Likewise, the test girls are liable to make slips occasionally, due to carelessness or fatigue.

Because of these facts, work was started on a machine which would automatically test the tubes and sort them into the following classifications necessary for efficient factory operation:

1. Broken filaments and all types of short circuits.
2. Gassy and low emission tubes as well as any tubes having electrical leakage between the various elements.
3. Tubes outside the specified range for plate current.
4. Good tubes.

By a classification of defects as described above, it is possible for the factory engineers to get back at the source of trouble causing these rejects and make the necessary corrections. At the same time, the good tubes are picked out of the defective tubes and sent to the packers. This machine consists of an electrical control board, connected by means of a cable to the mechanical apparatus which connects

the tubes in succession to the various test circuits. Connected with the mechanical apparatus is the automatic loading device and moving belts which convey the defects and good tubes away from the machine. The loading is accomplished by having a belt divided into sections and timed to move at the same speed as the machine. The bulbs are placed in individual sections on the machine by the divided belt. It is necessary, however, to provide some means to locate the pins and insert them in the socket at each individual section. This is accomplished by rotating the tube by means of a rubber pad until the pin in the base hits a stop. The large and small pins of the tube are now lined up with the socket and the tube is pushed in by means of a metal slide set at an angle and equipped with springs.

The Automatic Tester

The fundamental idea in connection with this tester is that tubes are placed automatically in a socket and by means of a rotating disk, equipped with contact rings and brushes, are successively connected with specially designed electrical circuits to test for the desired characteristics. The circuits are also designed to be set normally to throw out a tube and a good tube releases the relays deenergiz-

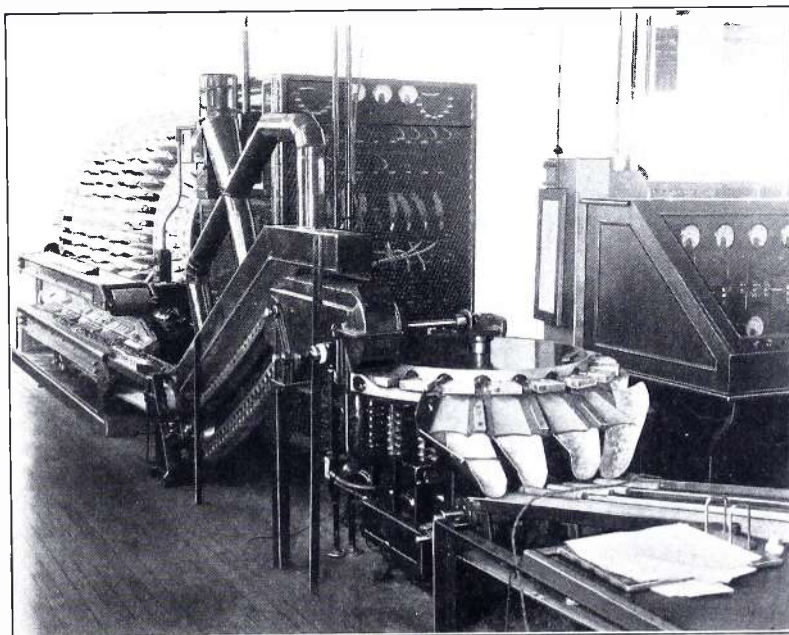

A general view of the automatic tube testing equipment. Note the sorting chutes in the foreground.

† From a paper delivered before the Radio Club of America, November 14, 1928.
* Chief Engineer, DeForest Radio Co.

ing the ejector circuit. The arrangements of the contacts are such that the test circuits are first connected up allowing the meters and relays to come to a fixed position before the ejector circuit is connected in. This serves a double purpose. It makes for greater speed in testing because of the fact that the ejector circuit is not connected in while the meters and relays are becoming stabilized. It also permits the system to be operated with all the circuits set at "danger," as in a railway block signal system.

The ejecting mechanism consists of three solenoids located opposite the various chutes into which the defects are sorted. The tube is ejected by the solenoid moving forward and a cam engages an incline track located on the solenoid, pushing the tube out of the socket. The good tubes must clear the three defect positions and are then pushed out mechanically by means of a fixed incline track operating a cam connected to the tube socket.

The first circuit is designed to eject the following defects:

1. Open filaments.
2. (minus) Filament to plate shorts.
3. (plus) Filament to plate shorts.
4. (minus) Filament to grid shorts.
5. (plus) Filament to grid shorts.
6. Plate to grid shorts.

The essential features of this circuit are: two telephone relays, a protective resistance, and a power control relay which operates the solenoid. When a good tube is in the socket, current flows through these telephone relays and breaks a contact which opens the circuit to the power control relays, thereby allowing the tube to pass this position. If the tube is open-circuited

or short-circuited, no current flows through these relays, and the contact on these relays remains closed, thereby energizing the power control relays which closes a circuit energizing the solenoid which ejects the tube. The protective resistance is simply to prevent the storage battery from being short-circuited when a minus filament to grid short circuit occurs.

The second circuit removes the following defects:

1. Gassy tubes.
2. (minus) Filament to plate leakers.
3. (plus) Filament to plate leakers.
4. Grid to plate leakers.
5. Low emission.

as well as removing

1. (minus) Open filaments.
 2. (minus) Filament to plate shorts.
 3. (plus) Filament to plate shorts.
 4. (minus) Filament to grid shorts.
 5. (plus) Filament to grid shorts.
 6. (minus) Grid to plate shorts.
- as a further check on circuit number one.

The essential parts of this circuit are: a sensitive relay, a milliammeter, a protective relay, and the necessary batteries in the grid circuit. In the plate circuit there is a 500,000-ohm resistance, a microammeter and the necessary batteries. The filament circuit simply consists of the necessary batteries, rheostat, and voltmeter. In connection with the plate circuit there is a one-stage vacuum-tube amplifier, in the plate circuit of which there is a sensitive relay and milliammeter. The two sensitive relays referred to are connected to a power relay which operates a switch connected to the solenoid.

Operation of Tester

The general operation of this circuit is as follows: if the tube to be tested has the required emission, the relay in the grid circuit operates so that the contact arm moves off the bottom contact and does not touch the upper contact. If the emission is below the required value, the arm of the relay does not move off the lower contact. In any one of these cases, if contact is made by this relay, the power control relay is energized, operating the ejector. The protective relay is provided to prevent an excess of current due to a short circuit from damaging the sensitive relay or milliammeter. If the current goes above the value which would cause harm to any one of these instruments, this relay opens and puts a resistance in the circuit which limits the current to the sensitive relay and milliammeter. The gas in the tube is tested in the plate circuit. If there is no ionization present, there will be no current flowing in the plate circuit, and hence the plate current of the amplifier tube will be at its normal value and the relay will be balanced between upper and lower contacts. However, if there is a current of two microamperes or over flowing in the plate circuit, the grid bias of the amplifier tube will be changed by one volt. This causes a change in the plate current of this tube and causes the contact arm to engage the upper contact, closing the power relay, thereby energizing the solenoid.

The reason the sensitive relay in this circuit is balanced between an upper and lower range is that in case the filament of the amplifying tube should burn out, or the grid or plate voltage fail, the contact arm would automatically engage either the upper or lower contact and throw out all the tubes in this particular position. Hence it will be seen that if a tube has the required emission and the gas current is not above the desired limit and has no leakage between the filament to plate, or grid to plate, the tube is allowed to pass by this position. Electrical leakage is determined and taken care of in a similar manner to the gas current.

When the automatic tester was first started the preceding method of testing for gas and leakage was not used. Instead a microammeter was fitted with a shutter and when it moved over a certain amount, light was admitted to a selenium cell which in turn worked a sensitive relay. As a strong light was used it was easy to get a charge of several milliamperes in the cell circuit which worked the sensitive relay. However, it would have been impractical to try to operate a relay between a range of a tenth of a microampere which would have been necessary if this or the preceding method were not used. The cell method was not satisfactory when testing at high speeds because the

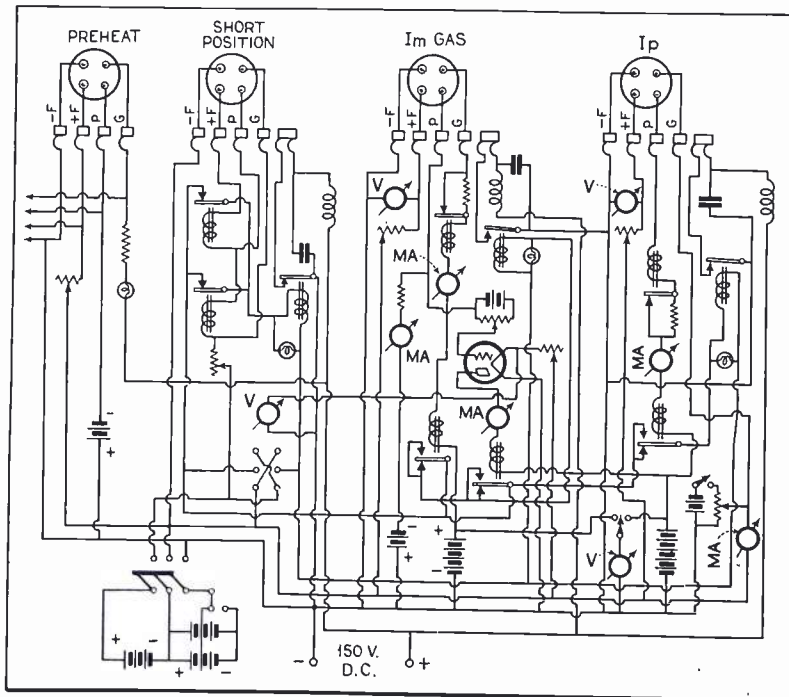

Schematic diagram of the automatic tube tester. Note the special relays.

sensitive microammeter was not sufficiently damped. The present method using a high resistance in the plate circuit, in conjunction with a tube amplifier, permits rapid and certain operation and can be set to throw out tubes within a tenth of a microampere of any desired value.

The third circuit operates to eject the following defects:

1. Low plate current tubes.
2. High plate current tubes.

as well as

1. Open filaments.
2. (minus) Filament to plate shorts.
3. (plus) Filament to plate shorts.

The essential parts of this circuit are a sensitive relay, a milliammeter, a protective relay, the necessary batteries in the plate circuit, and the necessary batteries in the grid circuit together with the power control relay. If the tube has the proper plate current, the sensitive relay in the plate circuit operates so as not to make contact. If, however, the plate current is low, or high, contact will be made in this relay operating the power control relay which operates the solenoid and ejects the tube. It is evident that an open filament will have no plate current and also that

filament plate shorts will operate the sensitive relay.

Miscellaneous Points

One of the problems that came up in conjunction with this machine was to develop a socket which would stand several thousand insertions an hour and last under steady use. The standard commercial sockets were tried and would not last a day and continue to give good contact. After numerous trials a socket having the four contacts set in slides, and the tension to these contacts supplied by an annular rubber ring, was developed which would supply positive contact and last several months without replacement.

Signal lights are provided on this machine to indicate the operation of the various circuits. These lights are simply connected across the line to the power control relay.

The sensitive relays referred to are essentially meters, but instead of having a pointer, they have a contact arm which makes contact between an upper and lower range and may be adjusted to suit the desired conditions. A spring is provided to hold the movable arm to the lower contact. Hence, the contact is normally closed and must

be opened to allow the tube to pass. These relays are special high-torque relays which have been developed for this particular purpose and can be set to work within one-twentieth of a milliamper.

As all the circuits are so designed that a failure in the test apparatus throws all the tubes out at one defective tube to be packed.

This machine will operate satisfactorily at speeds up to 8000 an hour. With this machine no operators are required either to load or unload, and by the old manual testing method, the maximum limit per operator is around 225 per hour.

The same general procedure as outlined can be adapted to various uses such as testing resistances, transformers, condenser units or almost any electrical apparatus. It is evident however that before a machine of this type can be used to any economic advantage the number of units to be tested must run into considerable figures. In many cases this can be overlooked due to the more uniform product which the manufacturer is enabled to turn out.

Analysis of Papers Employed in Radio Manufacturing

III. A Study of Special Papers—Methods of Research, and a Bibliography

By I. L. Gartland

IN Fig. 38 we have a combination of fibres representing the paper used in the cone type loudspeaker. On a close examination of this paper it will be seen that it is extremely bulky. If this paper were made hard and brittle, it would entirely lose its qualities as a cone speaker paper. It will be seen from this microphotograph that the fibres are of the conventional type and are elongated. In this case a brushing

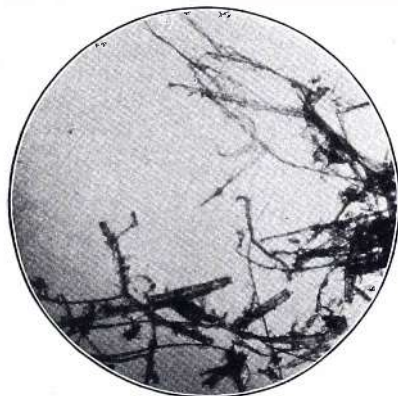

Fig. 38. A brushing effect instead of a chopping action in the beating make this combination of fibres in loudspeaker cone paper conventional and elongated.

effect was used in beating instead of a chopping action. A beater can perform both these actions and the operator at the paper mill is instructed by his chemical control department whether or not to keep the fibres long or short. Cone speaker paper is extremely bulky and "dead"; that is to say, it does not possess the usual tinny sound or the rattle that most papers possess. It is constructed for resonance and the ease with which disintegration was effected indicates that this was the paramount consideration in its making.

Fig. 39 is a microphotograph of the fibres of "Fish" paper. Considerable difficulty will be encountered in the disintegration of these fibres due to the chemical and mechanical hydration of the fibres while in preparation, and it might be found necessary to use small glass beads in the test tube as an aid in disseminating the fibres.

Cone paper and Fish paper are interesting studies when their analyses are executed at the same time, the former possessing soft, pliable and bulky qualities, while the latter is hard and brittle.

There are many other combinations of cellulose that go to make up dielectric and insulating paper. The art of

constructing these papers in the paper mill requires considerable skill in the making and likewise research in the laboratory. It is this combination, with the aid of the consumer which help us develop our products to the highest degree, and without this co-operation there is little hope of obtaining success.

Microscopic Measurements

It is important that a record be

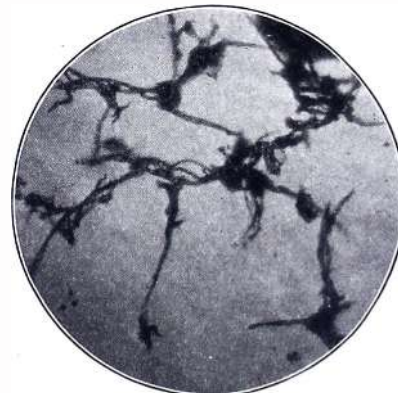

Fig. 39. A microphotograph of the fibres of "Fish" paper.

TABLE OF MAGNIFICATIONS

Tube Length = 160 mm. Projection Distances = 250 mm.

OBJECTIVES	HUYGENIAN OCULARS					CORRECTIONS
	5	6.4	7.5	10	12.5	
(4) 32 mm.	20x	26x	30x	40x	50x	
(10) 16 mm.	50x	64x	75x	100x	125x	
(45) 4 mm.	225x	288x	338x	450x	562x	
(97) 1.9 oil im.	485x	621x	727x	970x	1212x	

Fig. 40.

available of the magnification of the equipment one has to work with and for this purpose a small chart can be made (Fig. 40) to consult as experiments are made.

In order to obtain the relative values of fibres, measurements of these fibres are often required and to accomplish this the following method is used. This method applies also to the measurements of any microscopical objects:

Purchase an ocular micrometer, and stage micrometer the latter being sold in either 1/1000 of an inch calibration or in MM. The MM is preferable because this is more or less the standard unit on both foreign as well as domestic microscopes. There are three types of ocular micrometers most commonly used:

1. A small glass circle, similar to a cover glass, with calibrations thereon (Fig. 41) and inserted in the ocular where the real image is formed.

2. An ocular (usually 7.5x) with a permanent calibrated circular glass therein (Fig. 42).

3. A Filer micrometer (Fig. 43).

Of these three types, the first and second will be found not only convenient but quite accurate for the purpose intended and we will confine ourselves to these.

The value of the Ocular Micrometer varies with the magnification of the real image. The higher the magnification of the objective, the less the ocular

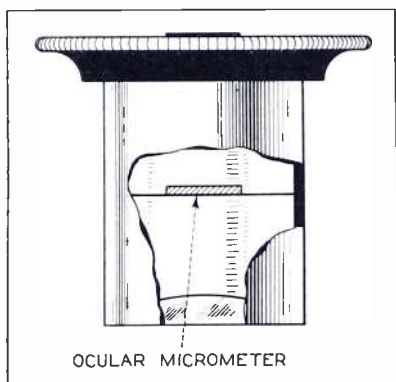

Fig. 41. The position of the ocular micrometer, where the real image is formed, in the eyepiece.

micrometer valuation and the lower the magnification, the greater the valuation. Tube length likewise varies the valuation. To give the ocular micrometer a value, a stage micrometer is used. These are usually calibrated in 0.1 to 0.01 MM, or in from 1/100 to 1/1000 of an inch.

The appearance of the slide micrometer resembles the conventional microscope slide, but in the center of it, and almost invisible to the naked eye, will be found the etchings of the calibrations. The operator is again cautioned to check his illumination

Fig. 42. An ocular micrometer containing a permanent calibrated circular glass. (Courtesy, Bausch & Lomb)



carefully as he will waste considerable time trying to locate these etchings. The following suggestion will assist in finding these lines: A piece of cotton, smeared with ordinary blue writing ink and rubbed across the slide in a lateral direction, will allow the ink to lodge in the etching grooves and aid in finding them. The ocular micrometer is then placed in the tube and the stage micrometer centered and focused until the lines of the stage micrometer are plainly visible. Adjust the position of the stage micrometer until the lines align themselves with those of the ocular micrometer. It will be found that on the first attempt the alignment will resemble Fig. 44. If this is the case, the adjustment of the tube will compensate for this non-alignment and the result should be as illustrated in Fig. 45, which represents a perfect alignment.

It will be noticed that in Fig. 44 the heavy (stage micrometer) lines are slightly to the right of the fine (ocular micrometer) lines.

Assuming that the adjustment is correct and that an MM slide is used, the value of the ocular micrometer can now be determined. A medium power objective should be used first.

By dividing the number of spaces on the stage micrometer by the number on the ocular micrometer, the quotient will equal the value of the ocular micrometer. For instance, if it requires 10 spaces on the ocular micrometer to be included in the divisions of the stage micrometer and the stage micrometer value is 0.1 MM (assuming that 0.1 to .01 MM micrometer is used) each division is $0.1 \div 10 = 0.01$ MM,

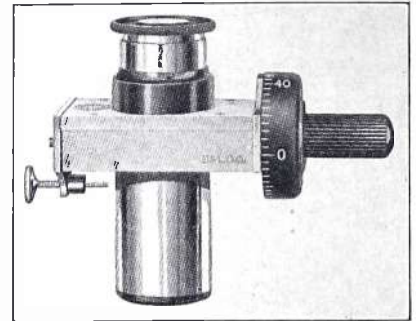

Fig. 43. A Filer micrometer (Courtesy, Bausch & Lomb)

i. e., each division on the ocular micrometer is, therefore, 0.01 MM and any object coming within this division is 0.01 MM in length or breadth.

Any change of objective or change in tube length changes the valuation of the ocular micrometer. It is always well to record the details of the operation to get the value of the ocular micrometer in combination with different objectives. As a guide the following are the important points and might be added to the reference as suggested in Fig. 40:

- (1) Location with mechanical stage (refers to position of etchings).
- (2) Tube length
 - 10 x ocular — 4 MM objective
 - 10 x ocular — 16 MM objective
 - 10 x ocular — 32 MM objective
- (3) Position iris diaphragm.
- (4) Light source.

Do not, however, depend on these as a constant set position each time it is necessary to make measurements. The foregoing should act as a guide and thus save the operator considerable time in finding his values.

If it is found necessary to measure the concavity or convexity of an object one should be careful that at the time of purchase the fine adjustment of the microscope is calibrated so that this measurement can be obtained.

This operation is very simple: Carefully focus until either the lowest, or adversely the highest, point of the object is visible. Read on the fine adjustment the location, then focus up or down until the highest, or adversely the lowest, point is found and again consult the fine adjustment. The number of divisions between the first reading and the last represent either the concavity or convexity of the object.

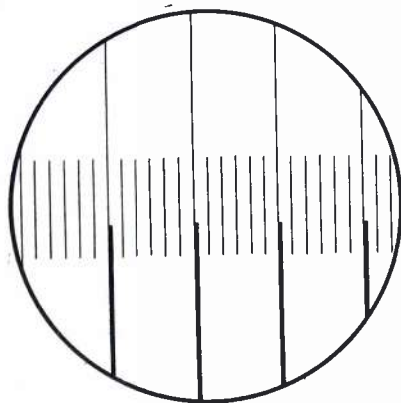

Fig. 44. The stage micrometer lines (heavy) are shown out of alignment with those of the ocular micrometer.

Special Microscopes

Binocular microscopes are becoming more popular, due to the ease with which they can be used with a minimum strain on the eye. In 1851 Professor J. L. Riddell devised the first practical one. Since then vast improvements have been made and the instrument today is capable of producing effects, in some cases, better than the monocular type.

Fig. 46 illustrates the modern instrument. The older models were of the converging tube types, whereas, the more modern are of the parallel type. The more expensive stands manufactured today are interchangeable and either monocular or binocular tubes can be used. It is claimed, among other things, that more detail can be seen by the use of the binocular than the monocular microscope.

Aside from general microscopic analysis, there are special phases of the art for which special apparatus has been constructed. For example, the metallurgical microscope, for the examination of metals, wherein indirect illumination is used because of the opacity of the materials examined. (See Fig. 47). The Brinell Microscope (Fig. 48) is an instrument designed for the purpose of measuring the impressions of the Brinell Ball Test. There is also the Comparison Microscope (Fig. 49), used for comparing (microscopically) any two objects that can be brought within its field. The Abbe Refractometer is of special design, used for obtaining the measurement of refractive indexes and dispersion of fluids, solids and plastic bodies.

For the laboratory of the radio manufactures, however, the conventional Compound Microscope, manufactured by a responsible concern, is recommended. Most of the microscope manufacturers will be of great assistance in choosing the proper instrument, and they should be consulted.

The operator upon whom lies the responsibility of interpreting his examinations for the manufacturing department or research department

should have a method of obtaining his results accurately and speedily.

The procedure can be divided into two distinct classes:

1. Comparative Analysis.
2. Research Analysis.

Comparative analysis is subdivided into

- A. Comparison of qualities.
- B. Control of standard specifications.

The comparison of qualities (A) deals mostly with new materials submitted by the purchasing department to the laboratories as a substitute for those being used.

Control of standard specifications (B) has to do with the checking of raw materials to be used in the product manufactured.

Research analysis (Class 2) has to do with the laboratory's endeavor to find, or create, cheaper and equally good substitutes for materials already being used.

Methods of Research

Microscopic analysis is equally peculiar to certain industries and involves not only chemical and general microscopy, but also metallurgical microscopy. It is impossible to lay down certain rules of procedure, unless the given industry is known. The author has endeavored to suggest, by

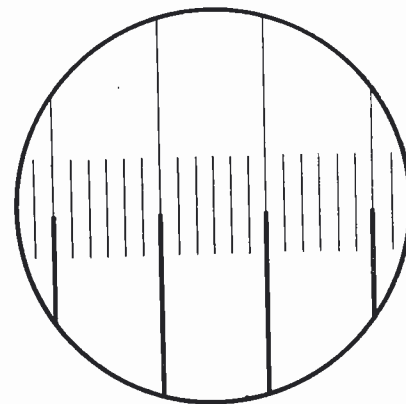
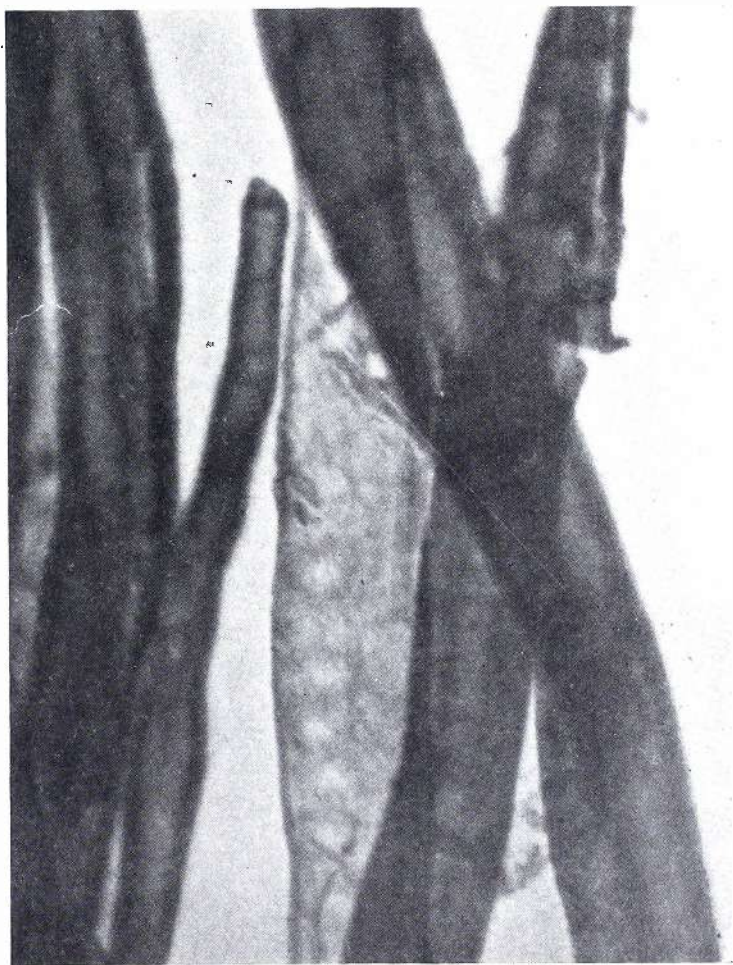

Fig. 45. Here the two sets of lines of the micrometer are shown in perfect alignment, which is the correct adjustment.

touching on the many fields of microscopical analysis, what can be done with the microscope.

Each subject referred to is in itself a study, and text books on these particular branches must be consulted in order to obtain more detailed information.

The ensuing bibliography will cover as much as possible books which might refer directly or indirectly to the subjects covered in this article. In



A microphotograph, executed by the author, that represents Sulphite fibres of the Coniferous group. Magnification 5500X.

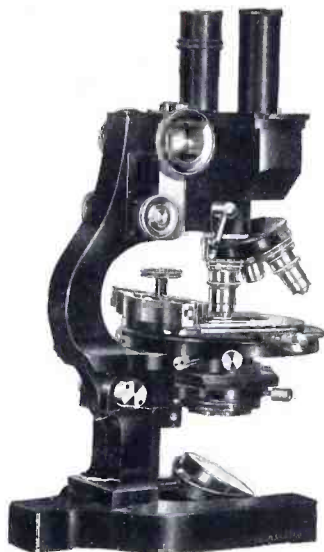

Fig. 46. A modern binocular microscope.
(Courtesy, Bausch & Lomb)

In addition to this the reader might refer to, the Proceedings of the Royal Microscopical Society, London, England; the Microscopical Society of New York, (collaborating with the American Academy of Science), the Index Medicus, and the Wistar Institute Journals.

The Microscopical Society of New York meet usually at the Museum of Natural History, in New York City. This society was organized to promote general interest in this subject, and all branches of it.

Bibliography
(More Recent)

Conrad Beck—"The Microscope." Two editions, 1921 and 1924 (R. & J. Beck Ltd.)
Emile M. Chamot—"Elementary Chemical Microscopy." Two editions. Second pub-

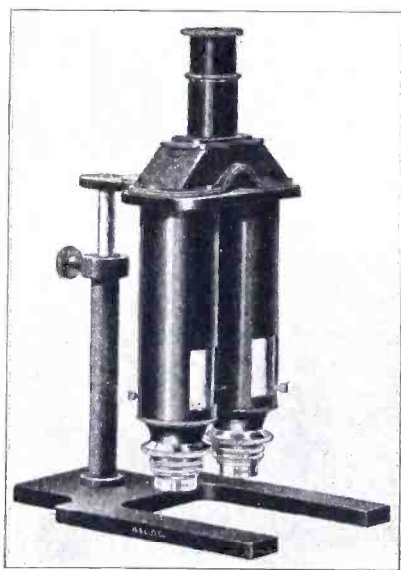

Fig. 49. The Comparison microscope for comparing microscopically any two objects brought within its field.
(Courtesy, Bausch & Lomb)

lished in 1921, and Revised. (John Wiley & Son, N. Y.)
Alfred C. Coles—"Critical Microscopy." (D. Van Nostrand Co. 1922)
M. I. Cross and Martin J. Cole—"Modern Microscopy." Last edition rearranged by Herbert F. Angus. (Chicago Medical Book Co. 1922)
Simon Henry Gage—"The Microscope." Dark-Field Edition (14th) Revised. (The Comstock Publishing Co. 1925-1927.)
B. K. Johnson—"Practical Optics for the Laboratory and Workshop." (Benn Bros., Ltd. London, England.)
J. E. Sears—"Precise Length Measurements." Journal of the Royal Society of Arts. Vol. LXXI Oct. 1923.
W. T. Sedwick and H. W. Tyler—"A Short History of Science." New York, 1917.
James F. C. Southall—"Mirrors, Prisms, and Lenses." (The Macmillan Co., 1923.)

General Bibliography

George Adams—"Micrographia Illustrata." Published for the author, London, 1771.
Roger Bacon—"Opus Majus." (Williams and Norgate, London 1897-1900) Edited by John H. Bridges. Essays—collected and edited by A. G. Little Clarendon Press Oxford England, 1914.
Henry Baker—"Of Microscopes and Observations made thereby." London, 1785.
E. Bausch—"Manipulation of the Microscope." (Bausch & Lomb Optical Co. Rochester, N. Y., 1906.)
L. S. Beale—"How to Work with the Microscope." (Harrison, London, 1880.)
Conrad Beck & Herbert Andrews—"Photographic Lenses." (London, England.)
Conrad Beck—"The Theory of the Microscope." (London, England, 1908.)
Sir David Brewster—"A Treatise on the

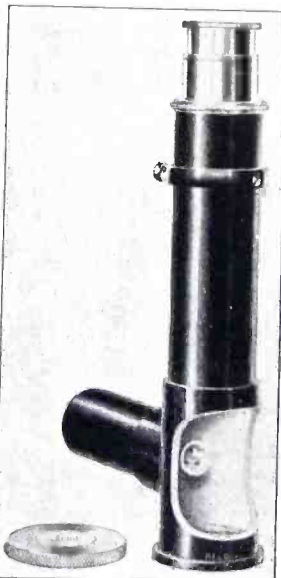

Fig. 48. The Brinell microscope for measuring the impressions of the Brinell Ball Test.
(Courtesy, Bausch & Lomb)

Microscope." (Encyclopedia Britannica, 7th Edition, 1837.)
Carpenter-Dallinger—"The Microscope and its Revelations." (London and Philadelphia, 1901.)
Emile Monnin Chamot—"Elementary Chemical Microscopy." (First Edition) (John Wiley & Sons, New York.)
C. H. Clark—"Practical Methods in Microscopy." (Boston, 1896.)
S. H. and H. P. Gage—"Optic Projection." (Comstock Publishing Co. Ithaca, N. Y.)
J. Hogg—"The Microscope, its History, Construction and Application." (Rutledge, London and New York, 1898.)
Journal of the Royal Microscopical Society. Published by the Society, 1878.
A. B. Lee—"The Microtome's Vademecum." (P. Blakiston's Son & Co. Phila., Penn., 1913.)
"Lenses, their History, Theory and Manufacture." (Bausch & Lomb Optical Co., Rochester, N. Y.)
Sir Isaac Newton—"Optics." (London, England.)
E. L. and Franklin Nichols—"The Elements of Physics." (The MacMillan Co., New York, 1897.)
Joseph Priestley—"The History and Present

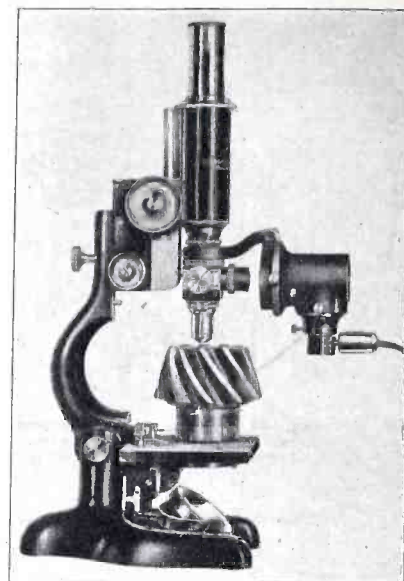

Fig. 47. A metallurgical microscope for examining metals, using direct illumination.
(Courtesy, Bausch & Lomb)

State of Discoveries Relating to Vision, Light and Colours." (London, 1772.)
E. J. Spitta—"Microscopy." (John Murray, London, 1907.)
Transactions of the American Microscopical Society. Published by the Secretary of the Society, N.Y.C., N. Y.
J. Waterhouse—"Transactions of Royal Photographic Society of Great Britain, Vol. XLII, Jan. 31, 1902."
Charles-Edward Amory Winslow—"Elements of Applied Microscopy." (John Wiley & Sons, N.Y., 1905.)
Wistar Institute of Anatomy and Biology—Transactions of this Society, 36th St. & Woodland Ave., Phila. Pa.
Sir. A. E. Wright—"Principles of Microscopy." (The MacMillan Company, N.Y., 1907.)

Bibliography on Paper Manufacture

Cross & Bevan—"Researches on Cellulose." First and Second Edition, 1901-1906.
Cross, Bevan and Sindall, with collaboration of W. N. Bacon—Wood-Pulp and its Uses. (D. Van Nostrand Co., N. Y., 1918.)
Griffin & Little—"Chemistry of Paper Making." (H. Lockwood, 1894, N. Y.)
J. Beveridge—"Paper-Makers Pocket Book." England.
G. Clapperton—"Practical Paper Making." (D. Van Nostrand Co., N. Y.)
Alexander Watt—"The Art of Paper Making." (D. Van Nostrand Co., N. Y.)
Edwin Sutermeister—"Chemistry of Paper Making." (John Wiley & Son, 1920, N. Y.)
H. A. Maddox—"Paper." (Sir Isaac Pitman & Sons, N. Y.)
H. P. Stevens—"The Paper Mill Chemist." (Scott, Greenwood & Son, London, 1919.)
L. E. Andes—"The Treatment of Paper for Special Purposes." (Scott, Greenwood & Son., London, 1907.)
G. S. Witham—"Paper Manufacturing." (New York, 1919.)
R. W. Sindall—"Paper Technology." (Chas. Griffin & Co., London, 1910.)
Technical Association of the Pulp and Paper Industry—Publications of papers by members and Standardization Committees (Division of the American Pulp and Paper Ass'n.), New York City.
Technical Association of the Canadian Pulp and Paper Ass'n.—Publication of papers by members and Standardization Committees. Montreal, P. Q., Canada.
Paper Section, Bureau of Standards, Washington, D. C.

(The End)

Correction: On page 28, May 1929, the titles of the columns of counts in the second column, Mechanical Pulp and Sulphite Pulp should be reversed. The average percentage of the Sulphite Pulp should therefore be 19½%.

Five-Meter Work

Some Theory and Practical Observations on Five-Meter Transmission and Reception, Including Construction Suggestions

By C. H. West*

PROBABLY the greatest set-back encountered in reception of 5-meter signals is the inability to successfully record at all times, and under adverse atmospheric conditions, these feeble impulses, which we know to be penetrable through space and with a velocity equivalent to light.

The inability to successfully receive these impulses is not wholly the fault of equipment, as some very good apparatus has been built in the past and signals recorded at a great distance, but not continually. Signals were generally heard only for a short period of a very long schedule.

From this advanced the famous "skip distance" theory, which is as much to say that signals travel upward until they hit the "Heaviside Layer"; whereupon they are reflected to some remote portion of the earth, in the neighborhood of 5000 miles distant. Also, that failure to successfully record signals at a comparatively short distance seemed to indicate that such was the case.

Theory and Practice

By examining Section B. of the wave chart shown in Fig. 1, it will be noted that the transmitter "T" is radiating a wave 5 meters in length, according to most accurate measurements known at the present time;

* U. S. Marine Hospital No. 21, Stapleton, N. Y.

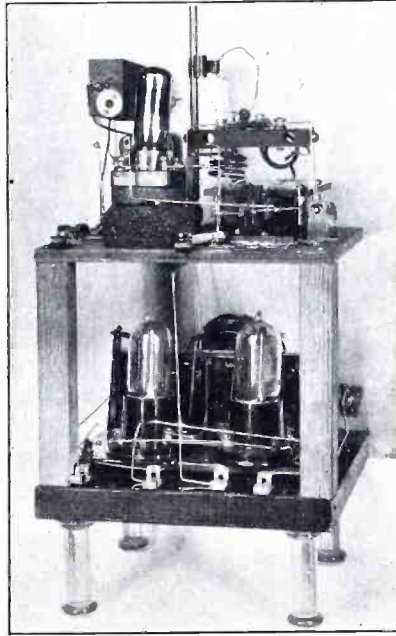

General view of the 5-meter receiver constructed by the author.

Possibly the best demonstration of wave action is not by the "stone and water method", but by the conventional toy balloon. As air is blown into the mouthpiece, the balloon increases in size, but still retains the round shape as the rubber expands. The expansion is equal in all directions, and radio waves radiate into space in all directions and instantly. This can be compared in action to the balloon expanding under air pressure.

As noted on the wave chart, the earth is represented by grouped lines running from 1 to 2. From transmitter "T" to 2 is listed as 5000 miles. One portion of the wave is shown reflecting from the Heaviside Layer; likewise, other portions appear at various points; but it must be remembered that the wave does not go in sections but touches all points to a certain degree, between "T" and the 5000 mile point.

Whether greater signal strength is obtained on the full wave portions (5 meters) along this distance is open to discussion; however, the fact of long distance reception on certain occasions, with inability to record the signal at a few miles, does not necessarily mean there is a "skip distance" in the true sense of the word.

Looking at Section A, Fig. 1, which is based on actual and practical tests conducted by the writer, it will be noticed that two insertions appear on the earth line, in the form of a hill and a mountain. Most every experi-

which is proceeding upward until it strikes the Heaviside Layer. This is represented by various lines running at angles from the transmitter, and represents the action of the wave—which is not by angles, but simply shown that way for illustrative purposes.

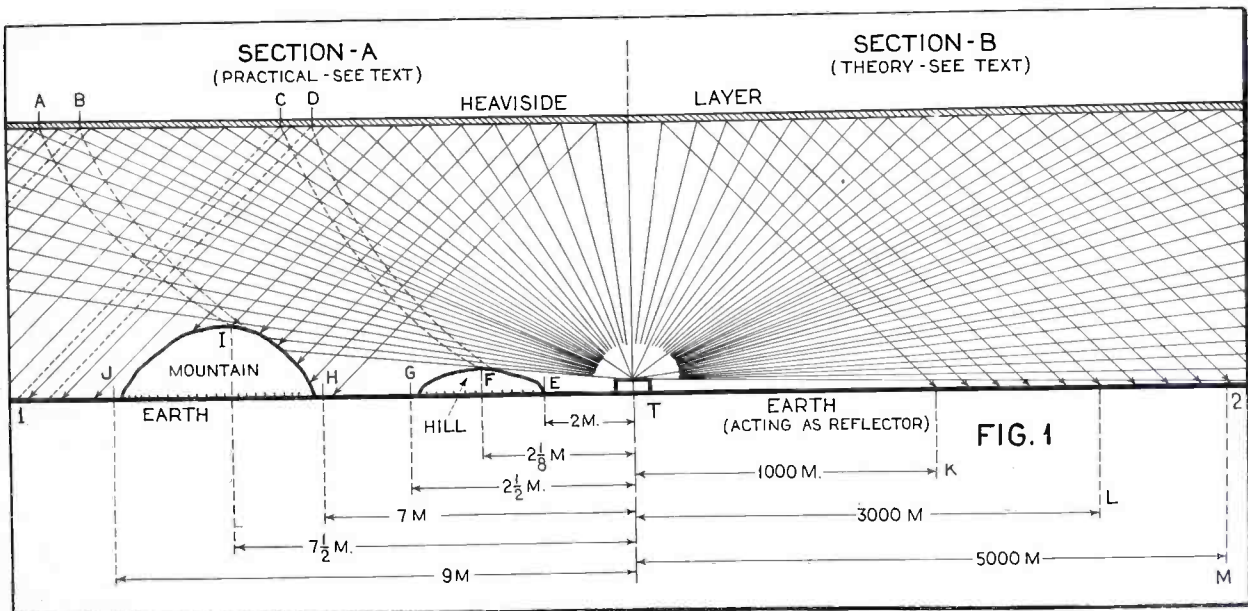

This chart shows the record of reception and the theory of the supposed "skip distance" effect, as recorded by experimenters on this particular band of frequencies. (5 meters).

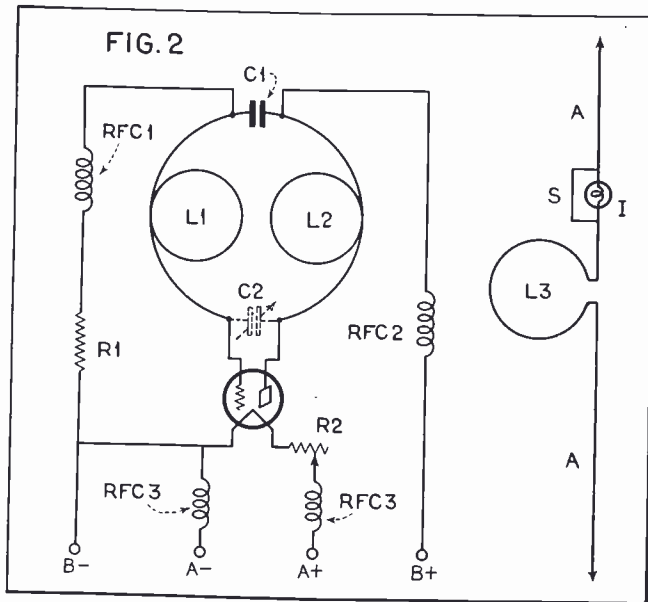

The circuit diagram of the 5-meter transmitter, a photograph of which is shown on the next page. L3 is the inductance in the antenna circuit which is composed of the aerial and the counterpoise, A, A.

menter and engineer engaged in 5-meter research has noticed the peculiarity of being unable to record signals successfully, when located behind a hill or mountain. Likewise, the most advantageous point seemed to be on the highest peak.

This can be best explained by examining the wave action from the horizontal level, and reflection of vertical portions from the Heaviside Layer. It is very evident that the mountainous obstruction is reflecting the horizontal portion of the wave as well as the reflected part from the Heaviside Layer, and it is equally evident that other portions of reflection are going to miss the obstruction.

It is behind these hills and mountains that experimenters have been on the verge of pronouncing 5-meter communication a dismal failure. It has always been assumed that a wave is a wave no matter how it is generated, and if a 5-meter wave is transmitted, this should remain the wave, provided fluctuations of plate and filament power supply are kept at a minimum.

Change in Frequency Noted

We do not care to go exactly contrary to this belief; nevertheless, some recent observations have indicated that maybe our so-called "skip distance" is due to nothing more than the 5-meter transmitter radiating a 5-meter wave, which might be 4.6 meters at many points on the map.

At point "E" on the chart (Fig. 1) signals were recorded nicely at a distance of two miles. By moving the receiver to point "F", at the summit of the hill, signals remained on the same tuning point but with a marked degree of increased audibility.

At point "G" signals became inaudible. The receiver, in these cases, had a very low tuning scale; about 7 centimeters, which required a micrometer action, representing 100 turns, to run

from minimum to maximum on this 7 cm. scale. Points "E" and "F" signals were tuned in at about midway on the tuning control, but at point "G" the signals appeared at the lower minimum, showing the frequency to have changed. This was not due to defects in the oscillator.

At point "H", 7 miles from the transmitter, signals were again heard at about the same tuning portion as for "E" and "F". At the summit of the mountain "I", signals were received, sharp tuned, loud and distinct, and, likewise, at about the same setting as for "E", "F" and "H".

However, at "J" all the coaxing in the world failed to record impulses from the transmitter; and as a final resort, the receiver tuning inductances, being held in wire clips and adjustable, were shortened, thereby decreasing the tuning scale range. Signals were then located at point "J" and at an entirely different setting than previously observed. As stated heretofore, the receiver had a 7 cm. tuning scale, which means that it would actually

tune from, say 5.14 to 5.21 meters. At points "E, F, G, H" and "I" signals were received somewhere within this wave scale; actual measurement by the resonance click method being out of the question due to the broadness of the tuner and hand capacity effects of the frequency meter.

At point "J" the signal was not within this scale, but much lower, and to properly record it, the receiver inductances were subsequently shortened to lower the tuning scale, while the micrometer tuning condenser remained the same and possibly covered approximately the 7 cm. scale, but in the neighborhood of 5.07 to 5.14 meters. The point should not be overlooked that the transmitter remained at a fixed wavelength of about 5.17 meters.

This seemed to indicate that at "G" and "J" the frequency was much higher. The foregoing action could not have been observed had the receiver covered a one-meter tuning scale or even one-half meter, and neither can it be construed to mean that each indentation in the earth's surface—or projection for that matter—is going to change the tuning ratio. After all, the equations of the elements may adjust themselves or give us some fixed rule upon which to work.

However, the fact of long distant reception at 5 meters is vague in detail. Only a few cases have been recorded which *might* be explained to the effect that the wavelength was 5 meters at this point and possibly some other figure at various other distances.

Sunlight Effect

Sunlight has always been a large factor encountered in 5-meter experiments. It has been noticed that daylight reception is far more reliable, remaining so until the setting of the sun, whereupon signals fade badly, become wobbly, and as darkness falls, disappear entirely.

Theory on this particular phase has been advanced on everything from red and green traffic lights to the Aurora

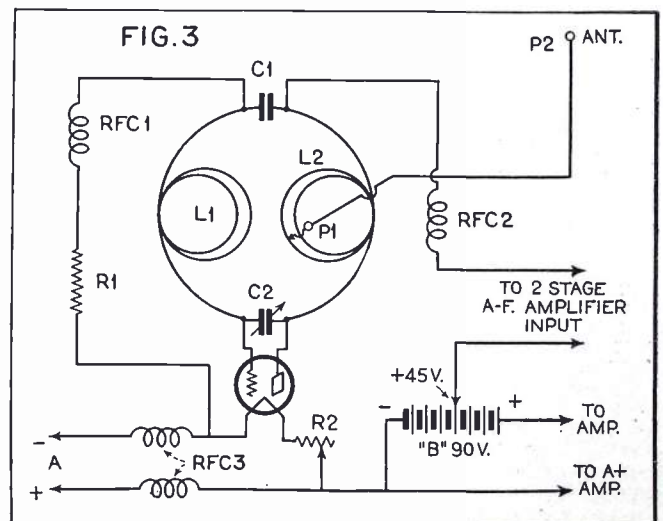

The detector unit of the 5-meter receiver. Note that r-f. chokes are used in the filament, grid and plate circuits. Constructional details are included in the text.

Borealis. Some suggestions have been offered that sun rays tend to aid the natural project from the Heavyside Layer and thus prevent the impulses from wandering off into space beyond the atmospheric layer. On other wavebands, occupied mostly by amateurs, long distance reception remains fairly good at 20 meters during daylight, and 40 meters at night-time.

It has been noted that stations thousands of miles away have been able to record signals and carry on communications, while stations only a comparatively short distance from each other could not communicate reliably, due to bad fading and weak signals, which at that identical moment could be reported strong and steady on the other side of the continent. This is food for thought—and deep thought. Are the signals actually there? Is not some exterior object or element changing the wavelength to some other figure?

It can be remembered by the writer how some years back with a spark transmitter tuned to 200 meters by all the science known at that time, was actually shooting out a wave of 600 meters.

It came to pass that a heavy feeder cable attached by rings to a dead ended steel cable running parallel to the aerial was acting as a loose-coupled helix and re-radiating a wave approximately 600 meters, which was chopping up the commercial work of our older and more experienced brothers to the point of having the writer of this article placed in a quiet location surrounded by stone walls.

Our contention is not that transmitters are emitting a wave contrary to their operators, but there are plenty of other elements not in the form of feeder cables to do it for him, and possibly light plays an important part.

On the other hand, most of our experiments under Section A, were conducted during darkness, and rechecked during daylight. The only noticeable effect was that signals were much stronger during the daytime; the constants, measurements and factors were the same for both factions. This led to the belief that maybe the transmitter was radiating more energy during daylight than darkness.

Experiments on Effect of Light on Waves

A reliable source of plate and filament current was used so that this would be independent from the 60-cycle, 110-volt main lines and their subsequent change during these periods. A wavemeter, equipped with flashlight bulb, was placed in inductive relation to the oscillator and tuned by an extension system until the filament gave forth a glow. This was accomplished during daylight, and as dusk appeared the glow left the flashlight bulb filament. A small

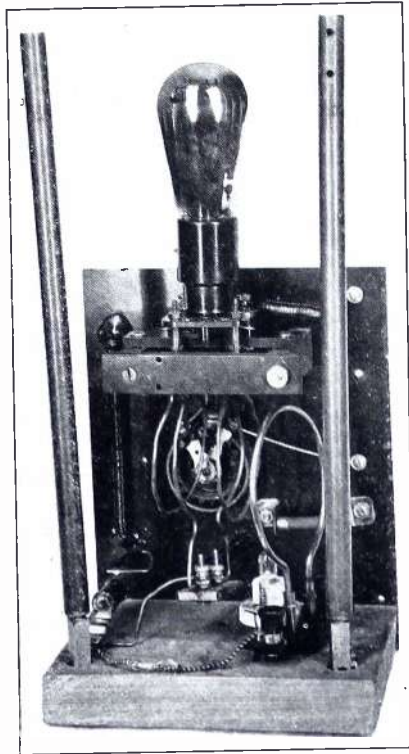

The transmitter for 5-meter operation. The two rods are the aerial and the counterpoise.

movement of the wavemeter towards the oscillator caused the bulb to glow again, only to once more disappear when darkness settled.

These observations were continued and rechecked. The results appear in Fig. 6, which is self explanatory, and indicates that an oscillator at 5 meters does not radiate as much energy during darkness as in bright sunlight. Although the amount of loss is small, close to the oscillator, it might be greater at a long distance.

While a 2-watt loss at the higher wavebands would be hardly noticed, it is doubtful if this same amount of

power at a loss would act favorably from the antenna system of a 5-meter transmitter; which is about a total of 4 feet including aerial and counterpoise, provided the same is operated at the fundamental.

Effect of Artificial Light

To recheck this action of sunlight, a large parabolic light reflector was placed at the rear of the transmitter and equipped with a 300-watt incandescent bulb; which acted as a powerful searchlight, and projected light rays on the oscillator. This caused the resonance bulb on the wavemeter to glow as it originally did during actual sunlight tests. The reflector was then moved to a point in which the wavemeter was between it and the oscillator. The light rays repelled the action of the oscillator; but at this point only.

Powerful artificial light is equal to sunlight so as causing a noticeable change in the output from a transmitter. This was not a new discovery in principle, as the writer noticed during experiments over a year ago, that projected light steadied a signal over a 7 mile range.

The object of this article is merely to acquaint the layman, who is contemplating experimenting at 5 meters, with some facts and theories of which he may not be wholly familiar with. Undoubtedly, many experimenters have dropped the matter in disgust, due to inability to hear signals more than a mile from the radiating source. The persistent ideas on hand regarding "what works on 80 meters ought to on 5" is the main cause.

An 80-meter band receiver will tune nicely from 60 to 90 meters, with a running scale of 30 meters; but a 5-meter receiver will not tune from 3 to 6 meters, which is only a 3 meter tuning scale and equivalent to 300 centimeters, and that represents more kilocycles than the average experi-

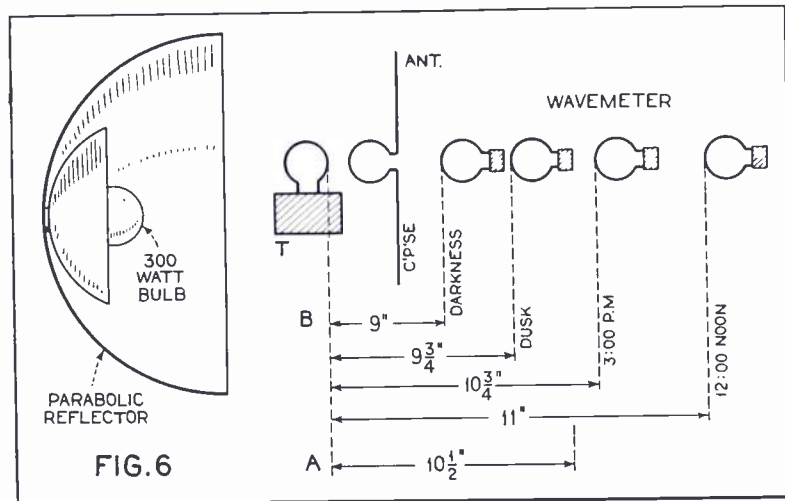

This sketch shows the effect of light and darkness on the strength of the 5-meter wave.

menter has dollars; and after all, isn't our aim to try and segregate just as few of these kilocycles as possible?

Construction Data

Referring to Figs. 2 and 3, schematic diagrams appear for the transmitter and receiver, both operating on the ultra-audion principle. This circuit is a persistent oscillator, provided the desired wave is obtained by use of inductance and very little (if any) capacity. These diagrams are self-explanatory as all constants are given. However, in case of the receiver, this requires a detailed explanation of the tuning control (variable con-

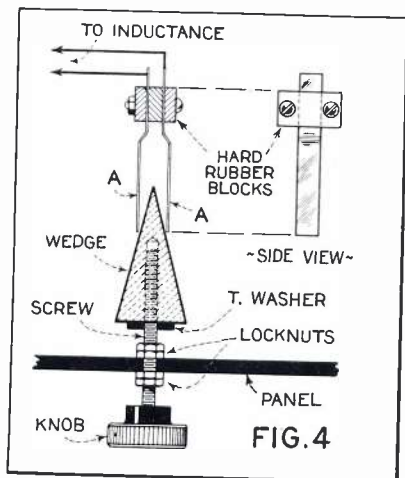

Details of the variable tuning condenser, showing the micro-adjustment of the wedge for varying the capacity between A and A.

denser) and regeneration control (filament rheostat). At a short distance from the transmitter tuning is not critical, but as the distance is increased, likewise will the sharpness of tuning and regenerative feedback. For this reason it is imperative that both these units be well constructed.

The Variable Condenser:

Referring to Fig. 4, A, A are two strips of spring brass 2 inches long and 1/4-to 1/2-inch wide, separated about 1/4-inch at one end by a hard rubber strip; while two outer lengths of equal thickness are bolted together by small machine screws.

The wedge is about 3 1/2-inches long, 1 inch wide, and 1 inch thick at the base. In the end is bored a hole 3 inches long and slightly larger than the control screw used; and on this same end should be fastened a thick, threaded washer, nut, or any threaded bushing, as a screw guide. By inserting a long brass machine screw through the panel and held securely to it by lock-nuts; any action of the control knob will move this wedge horizontally between the two capacity plates A, A.

To prevent the wedge from shaking or wobbling, two flat supports should be placed under and over the plane surface. These should be a close fit.

The wedge will then move horizontally true. It is not necessary that the experimenter use this method of guiding. An upper and lower wooden track-tongue and grooved wedge, or any other method will suffice, as long as the wedge moves horizontally without binding or vibration; which would change the tuning not by the natural method this system intends.

The Rheostat:

This unit, like the tuning control, is vernier or micrometer in action, inasmuch as it provides a very gradual method of adjusting the filament temperature to provide the exact degree of regeneration. It is illustrated in Fig. 5.

Procure a hard wood block and bore a hole 3/8-inch in diameter for a depth of 3 1/2-inches. On a brass machine screw about 10-32 thread affix a control knob, and wind the screw thread full of ordinary resistance wire from an old rheostat (6 or 10 ohm). Insert the screw, with the wire, inside the hole in the block and fasten securely the projecting leads to washers drilled and screwed to the block ends, or by any other convenient method. Carefully withdraw the screw for the first time by turning the knob to the left. The block will now contain a spiral of resistance wire which has the exact pitch and thread as the machine screw. The change of resistance is accomplished by the control screw, which progressively short circuits the resistance spiral.

For the control of a UV-199 tube, an exterior rheostat may be required to aid in adjusting the detector tube filament to the desired degree, but all actual control during reception should be with the vernier rheostat. During local reception, at a short distance of one-half mile, the rheostat seems to have little effect but at long distance it is absolutely essential.

Operation of Receiver

Recent tests at 250 miles brought to light the fact that one-quarter turn of the screw thread dropped the regeneration to a point beyond audibility range. This subsequent reduction of filament current was so small that a sensitive voltmeter would not have recorded the drop.

The most sensitive point of the receiver seems to be where a faint high pitched whistle is heard in the phones. Working slightly clockwise or anti-clockwise from this point, the correct amount of regeneration can be easily obtained where signals are surprisingly loud. The receiver should be a good job. Cushion the detector tube on a rubber bath sponge glued to the tube socket and baseboard. This is important, otherwise exterior vibrations will cause a tube ring that is quite difficult to silence.

Flexible leads of thin copper foil or No. 40 copper wire in spiral 1/16-inch in diameter, and 1/4-inch long should connect the heavier bus-bar leads to the

tube connections. The two inductances should be made of heavy copper wire and arranged to slide within four wire clips, two to each inductance. This is the best method of adjusting the receiver to resonance with the oscillator, and should be accomplished at about one mile or more from the transmitter, and tuning to be worked so the wedge will record the signal at about midway position.

It is surprising to note how any change in the frequency of the transmitter can be easily followed up by the micrometer action of this variable condenser. At a distance of 250 miles during tests, it required five rotations of the tuning knob to completely delete the signal, which corresponded to about a 1/8-inch movement of the wedge, and probably less than a 1/32-inch movement of the two variable plates.

This certainly is a small variable capacity, yet it represents a wide tuning scale at a great distance, while at the short range of one mile, these two plates may be separated from 3/8-to 1-inch without actually tuning the signal completely out.

One very noticeable feature is evident during continued research on the ultra-high frequencies; the human body will tend to run a temperature if any excessive work is being done around the oscillator. However, this need not cause worry, as the individual can refrain from experiment-

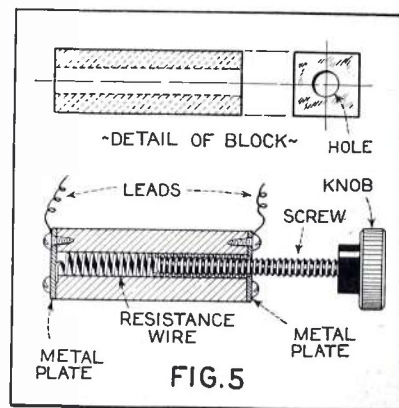

The filament and regeneration micrometer control.

ing for a while. If high power and large output tubes are used, great care should be taken, as high-frequency burns at 56,000 kc. are extremely painful.

Let it be understood, we do not guarantee 5-meter operation or communication, but we do know that with care and understanding this mystery band of frequencies will prove in time as easy as those now in use. We have proved it reliable at 250 miles after four years of research, and intend to increase this distance to 1000 miles or more in the near future and with low power; and possibly by only decreasing further the 7 cm. tuning scale.

At the Turn of the Season

THE radio industry, with the national assemblage at the Fifth Annual Convention and Third Annual Radio Trade Show of the Radio Manufacturers Association, at Chicago, finds itself at the peak of efficient organization as a distinct industrial entity of our country.

"Organization" is the watchword of efficient industries in this new age of commerce. It is not an open sesame to success but it is an imperative necessity to every industry.



HERBERT H. FROST.

The radio industry, through the Radio Manufacturers Association, and through affiliated radio organizations, is at the forefront of industrial organizations.

Six years ago a bare handful of radio manufacturers, these including some of the smaller interests in radio production, had a vision of a radio "industry." In the radio gathering at Chicago this vision is realized.

Every branch of this new but giant industry, whose total national sales are now approaching the billion dollar mark, is now well organized. The Radio Manufacturers Association includes in its ranks virtually every prominent manufacturer of every radio product. The distribution branch of the industry, the Federated Radio Trades Association, the national organization of radio jobbers and dealers, is also efficiently organized, with influential members in every state of the Union. The other side of the radio "Triangle," the National Association of Broadcasters, also has grown shoulder to shoulder during the same period with the organization of radio manufacturers and distributors. And more important, all of these great and influential organizations of radio interest have worked shoulder to shoulder in friendly and harmonious mutual interest. All are soundly financed, strongly supported and form a trinity of organized effort.

This organization of the radio industry was not designed and does not function—far from it—solely for the selfish interests of its members. The ideal of each is primarily public service. The radio public's interest comes first, because the leaders of the radio industrial organizations realize that their success is dependent solely upon the measure of service which they give, first to the public, and second to their members. That the radio public has been well satisfied with this service—broadcasting, the quality and performance of radio products, and the service accorded them by radio distributors—is amply demonstrated, in many ways.

No industry could have grown by leaps and bounds as has the radio industry without, generally speaking, wide public favor and general public satisfaction.

These are achievements of which everyone connected with our new industry can be proud.

Herbert H. Frost

President, R.M.A.

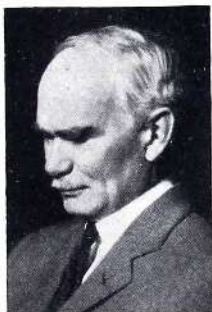

LEE DE FOREST.

had visions of a time, many decades hence, when every home would join in a national forum of space. During those long and arduous years, when I essayed the slow and costly production of audions one by one, at the hands of skilled glassmakers, I dared dream of a time when, perhaps, these intricate devices might be made by machinery to supply the demands of thousands upon thousands of radio enthusiasts. And as early as 1929, my fondest dreams are more than fully realized. Marvelous broadcasting, audions by the millions, a radio audience of tens of millions, a superb radio technique, superphonograph reproduction, talking pictures—it is almost unbelievable, even to one who has worked on

these problems. All I can now do is to wish the radio industry Godspeed in its further efforts.

Lee de Forest

SEVERAL motives inspired the idea of the patent interchange agreement for the radio industry. Probably the prime motive was the unrest caused by the many suits threatened and brought between the various members over the patents that might well become the subject of cross-licensing. A secondary but related motive was the successful operation from an economic viewpoint of the automobile industry for almost fifteen years and of the aircraft industry for a somewhat shorter period under cross-licensing agreements.



LE ROI WILLIAMS.

Le Roi Williams

Chairman, R.M.A. Patent Committee.



H. B. RICHMOND.

discount, but of details regarding factory tests. In many cases, distributors have put in laboratories and technical equipment which exceed the equipment used in many reliable manufacturers' laboratories but a few short years ago.

The thoroughness of engineering design and completeness of service testing assures the consumer of more reliable radio set per dollar of investment than has ever been possible before.

H. B. Richmond

Director, Engineering Division, R.M.A.

THE annual Convention and Trade Show of the Radio Manufacturers Association has become established as the biggest event of the radio industry. This year again it is the big event and this year also is to be the biggest year in business for the radio industry. Everyone senses this. There are a few qualms regarding over-production possibilities but there is little foundation for such fears.

In 1928 the volume of sales of radio products was estimated around \$650,000,000. My estimate for the current year is that it will be close to \$800,000,000 and



BOND P. GEDDES.

possibly approaching the billion dollar mark. Of course, this includes sales of all sorts of radio products and we are constantly developing into new fields and branching new markets for radio manufacturers and distributors.

Without even including new markets, we have unusual replacement markets to supply. Only twelve million, or about one-fourth of the American homes have radio sets of some kind. Modern A-C radio is enjoyed in about only four million homes, as it has been in the market only a little over a year, and every one of the other eight million homes having obsolete radio is a potential market for new modern radio. The public demand for and satisfaction with modern radio is beyond all question.

Bond P. Geddes

Executive Vice President, R.M.A.

AN Association that makes no rules, exacts no promises from its members, admits every radio dealer to its membership, yet regulates and stabilizes the radio business—that is the idea behind the Wisconsin Radio Trade Association.

That the Association has been successful in its stabilization of business is attested by the fact that we have no flagrant price cutters.

Our efforts are not combined to membership alone. When some outsider, not acquainted with our family, begins advertising in a way that is apt to hurt our members and himself we call upon him and talk the situation over and find that he also has ordinary intelligence.

The Wisconsin Radio Trade Association is more, of course than simply a social club. We have our regular activities such as the examination and registration of servicemen, our annual Radio Exposition which provides most of the funds for our year's work; we run co-operative advertising campaigns and publish a monthly trade magazine. We try to do everything possible to make the business of the radio dealers of Wisconsin better and more profitable.

Michael Ert

President, W.R.T.A.



HAROLD J. WRAPPE.

THE past year has been the most successful that the Federated Radio Trade Association has ever had. The Bi-Annual Convention, June 3-8 at the Stevens Hotel in Chicago, marks the third time that the Federated Radio Trade Association has attended a Convention held in conjunction with the Radio Manufacturers Association Trade Show.

The progress the organization has made during the past year is remarkable. The associations affiliated with the Federated have grown from thirteen to twenty-five while the Radio Wholesale Association, affiliated with the Federated, has grown from a nucleus of eleven members to a strong and thriving organization of over 175 prominent wholesalers scattered throughout the country.

We look forward to the coming year as being one of the most successful the radio industry has ever enjoyed with the coming of the screen-grid tube and the many other improvements in loudspeakers and cabinet designs. The merchandise we have to offer to the public represents far greater value for the cost than ever before. The latest improvements and developments have made Radio an established article and an absolute necessity in every home.

Harold J. Wrape

Chairman, F.R.T.A.

List of Third R. M. A.

(Key to List: S—Stevens Hotel)

NAME	BOOTH	ROOM	DELEGATE	NAME	BOOTH	ROOM	DELEGATE
A. C. Dayton Co. 300 E. First St., Chicago, Ill.	S-35	S-923	C. R. Strassner	Connor Furniture Co. New Albany, Ind.	C-B14		
Acme Elec. & Mfg. Co. 1444 Hamilton Ave., Cleveland, Ohio.	S-35	S-553	R. A. Lais	Continental Diamond-Fibre Co. Bridgeport, Pa.	S-9		
Acme Wire Co. New Haven, Conn.	S-42		H. B. Bassett	Continental Radio Corp. 160 Variek St., New York, N. Y.	S-83	S-522	
Adler Mfg. Co. 29th & Chestnut Sts., Louisville, Ky.	B-4-5-6	S-906	Nathan P. Bloom	Cornish Wire Co., Inc. 30 Church St., New York N. Y.	S-130		W. F. Osler, Jr.
Aerial Insulator Co. Green Bay, Wis.	S-33			Crosley Radio Corp. 3401 Colerain Ave., Cincinnati, Ohio.	B-8	B-609	Powel Crosley, Jr.
Aero Products Co. 4611 E. Ravenswood Ave., Chicago, Ill.	S-133		T. H. Brennan	Crowe Name Plate & Mfg. Co. 1749 Grace St., Chicago, Ill.	S-134		Winslow Goodwin
Aerovox Wireless Corp. 70 Washington St., Brooklyn, N. Y.	S-1		S. I. Cole	E. T. Cunningham, Inc. 370 Seventh Ave., New York, N. Y.	C-5	C-H24	M. F. Burns
All-American Mohawk Corp. 4201 Belmont Ave., Chicago, Ill.	S-116-117	S-2001A	E. R. Farny	Day-Fan Electric Co. 1320 Wisconsin Blvd., Dayton, Ohio.	S-53	S-828	Chas. T. Lawson
Allen-Hough Carryola Co. Milwaukee, Wis.	S-50	S-507A		DeForest Radio Co. Central and Franklin Sts., Jersey City, N. J.	B-12	B-4 Art Fl. B-410	C. A. Rice
Allan Manufacturing Co. Harrison, N. J.		S-450A		De Jur-Amesco Corp. 199 Lafayette Sts., New York, N. Y.	S-149		H. DeJur
Aluminum Co. of America 2400 Oliver Bldg., Pittsburgh, Pa.	S-115		Leroy S. Green	Demco Corp. 11 Windsor St., Cambridge, Mass.	S-41 S-21	S-550A S-452A	Tobe Deutschmann
American Bosch Magneto Corp. N. Main St., Springfield, Mass.	B-7	B-815	Morris Metcalf	DeVry Corp. Chicago, Ill.	S-65F	S-509	
American Reproducer Corp. 1200 Summit Ave., Jersey City, N. J.		C-B32	Geo. M. Barcy	Diamond Electric Corp. 780 Frelinghuysen Ave., Newark, N. J.	S-110		F. M. Rosenfeld
Amrad Corporation 205 College Ave., Medford, Mass.	S-97-98	S-620	Albert B. Ayers	Diamond Vacuum Products Co. 4049 Diversey Ave., Chicago, Ill.	S-156		Geo. D. McCabe
P. A. D. Andrea, Inc. Jackson Ave., Long Island City, N. Y.	S-89-90	B-1205		Dongan Electric Mfg. Co. 2987 Franklin St., Detroit, Mich.	S-4		G. J. Soberling
Arbophone Division Co. 321 Main St., Ann Arbor, Mich.	S-130	S-1400	C. K. Verschoor	Ebert Furniture Co. Red Lion, Pa.	S-3	S-524A	
Arco Electrical Corp. 207-13 E. Columbia St., Fort Wayne, Ind.	S-24	S-534A	S. A. Lehman	H. H. Eby Mfg. Co., Inc. 4710 Stenton Ave., Philadelphia, Pa.	S-126	S-2220A	Hugh H. Eby
Arcturus Radio Co. 255 Sherman Ave., Newark, N. J.	S-143		George Lewis	Thomas A. Edison, Inc. West Orange, N. J.	S-529 S-16	C-1177	A. L. Walsh
Aston Cabinet Mfgs. 1223-1229 W. Lake St., Chicago, Ill.	S-136D	S-421A	Gordon L. Aston	The Ekko Co. 111 W. Monroe St., Chicago, Ill.	S-69		T. K. Webster, Jr.
Atwater Kent Mfg. Co. 4700 Wissanickon Ave., Philadelphia, Pa.	C-7	C-F4 S-2201A S-560A	V. W. Collamore	Electrad, Inc. 175 Variek St., New York, N. Y.	S-109		Arthur Moss
Auld Company Columbus, Ohio		C-B36		Electrical Research Laboratories 2500 Cottage Grove Ave., Chicago, Ill.	S-127	S-523	F. Wellman
Audak Co., Inc. 565 Fifth Ave., New York, N. Y.	C-4			Elgin Cabinet Corp. Union and W. Chicago Sts., Elgin, Ill.	S-148	S-444A	H. D. Shoenwald
Nathaniel Baldwin Co. 3474 S. 23rd St., Salt Lake City, Utah.	S-39		L. M. Stohl	Elkon, Inc. 200 Fox Island Road, Port Chester, N. Y.	C-14	C-G6	G. Fred Yeessler
Balkite Co., Chicago, Ill.	S-135D	S-561A		Empire, Ltd. Rockford, Ill.	B-11	B-1019	
Belden Mfg. Co. 2300 S. Western Ave., Chicago, Ill.	S-137		H. W. Clough	Essenbee Radio Devices Co. 2016 W. Lake St., Chicago, Ill.	S-135D		A. I. Blanc
Best Mfg. Co. 1200 Grove St., Irvington, N. J.	S-147	S-539A	G. G. Cromartie	Eureka Talking Machine Corp. Chicago, Ill.	S-158	S-553A	
Birmbush Radio Co. 254 W. 31st St., New York, N. Y.	S-25		Philip A. Birnbach	Exello Products Corp. 4820 W. 16th St., Cicero, Ill.	S-153	S-556	J. L. Axen
Bond Electric Company 259 Cornelison Ave., Jersey City, N. J.		C-B60		Farrand Mfg. Co., Inc. Metropolitan Bldg., Long Island City, N. Y.	S-85	S-509A	George H. Kiley
L. S. Brach Mfg. Corp. 127 Sussex Ave., Newark, N. J.	S-66		Godfrey Gort	John E. Fast & Co. 3982 Barry Ave., Chicago, Ill.	S-27		John E. Fast
Brandes Corp. Newark, N. J.	C-19	C-1102		Federal Furniture Factories 206 Lexington Ave., New York, N. Y.	C-17		David E. Kahn
Bremer-Tully Mfg. Co. 656 Washington Blvd., Chicago, Ill.	S-79	S-1501A	John C. Tully	Federal Radio Corp. 1738 Elmwood Ave., Buffalo, N. Y.	S-108	S-505	L. E. Noble
Brooklyn Metal Stamping Corp. 718-728 Atlantic Ave., Brooklyn, N. Y.	S-54		J. C. Fishel	Robert Findlay Mfg. Co. 1027 Metropolitan Ave., Brooklyn, N. Y.	S-74	S-1020A	Fred Sohward
Brown & Caine, Inc. 2317 Calumet Ave., Chicago, Ill.	S-26		S. H. Feigley	Formica Insulation Co. Cincinnati, Ohio	S-55		D. J. O'Connor
Brunswick-Balke-Collender Co. 623 S. Wabash Ave., Chicago, Ill.	S-142	S-435A B-1005	W. C. Hutchings	Freed-Eisemann Radio Corp. Junius St. and Liberty Ave., Brooklyn, N. Y.	C-1	C-B2-B4	Jos. D. R. Freed
Buckeye Manufacturing Co. Springfield, Ohio.	S-140		C. F. Gedge	French Battery Co. Madison, Wis.	S-64		G. A. Shipley
Buckingham Radio Corp. 440 W. Superior St., Chicago, Ill.	S-95	S-1206A	I. B. Freed	Chas. Freshman Co., Inc. 122 East 42d St., New York, N. Y.	S-80	S-1101A	H. A. Beach
Burgess Battery Co. 111 West Monroe St., Chicago, Ill.	C-10		R. J. Koehr	Herbert H. Frost, Inc. 1128-1224 W. Beardley Ave., Elkhart, Ind.	S-58		F. C. Best
Bush & Lane Piano Co. Holland, Mich.	S-40	S-1106	W. F. Winstrom	General Dry Batteries, Inc. 13100 Athens Ave., Cleveland, Ohio.	C-15		Warner Jones
Cable Radio Tube Corp. 84-90 N. Ninth St., Brooklyn, N. Y.	S-11		J. J. Steinharter	General Instrument Corp. 225 Variek St., New York, N. Y.	S-560		Samuel Cohen
Carter Radio Co. 300 S. Racine Ave., Chicago, Ill.	S-105	S-717	A. J. Carter	General Radio Co. 30 State St., Cambridge, Mass.	S-87		H. B. Richmond
Capelhart Automatic Phonograph Co. Huntington, Ind.	S-37	S-1306		Gilby Wire Co. 150 Riverside Ave., Newark, N. J.	S-10		W. B. Driver
Caswell-Runyan Company Huntington, Ind.	S-65E	S-537	C. A. Backus	Gold Seal Electrical Co., Inc. 250 Park Ave., New York, N. Y.	S-161	S-422A	J. W. Duff
CeCo Mfg. Co., Inc. 702 Eddy St., Providence, R. I.	S-96	S-1802A C-E6-E8	H. H. Steinte	A. H. Grebe & Co., Inc. 70-72 Van Wyck Blvd., Richmond Hill, N. Y.	S-115	B-1505 B-2 Art Fl.	Douglas Rigney
Central Radio Corp. Beloit, Wis.	S-154		W. W. Robinson	Grigsby-Grunow Co. 5891 W. Dickens Ave., Chicago, Ill.	B-3	B-208 B-1 Art Fl. S-2506 S-445A	B. J. Grigsby
Central Radio Laboratories 16 Keefe Ave., Milwaukee, Wis.	S-159		E. R. Stoekle	Gilbranson Co. Hamilton Mfg. Co. Two Rivers, Wis.	S-160 S-17		H. C. Gowran
Champion Radio Works, Inc. Danvers, Mass.		C-B6-8		Herald Company High Frequency Laboratories 28 N. Sheldon St., Chicago, Ill.	S-621A S-43		William Dumke
Chicago Solder Co. 4201 Wrightwood Ave., Chicago, Ill.	S-19		F. C. Engelhart	Holyoke Co. 621 Broadway, New York, N. Y.		S-451A	
Chicago Jefferson Fuse & Elec. Co. 1500 S. Lavin St., Chicago, Ill.	S-30		J. A. Bennan	Howard Radio Co. 4849 N. Crawford Ave., Chicago, Ill.	C-9	C-E4	A. A. Howard
Chillicothe Furniture Co. 1 Cherry St., Chillicothe, Mo.	S-36	S-502A	A. H. Myers				
Clarostat Mfg. Co., Inc. 285-287 N. Sixth St., Brooklyn, N. Y.	S-29		John J. Mucher				
Colonial Radio Corp. East Ave. & 10th St., Long Island City, N. Y.	S-78	S-505A	F. G. Carson				
Columbia Phonograph Co., Inc. 1819 Broadway, New York, N. Y.	B-2	B-5-5 Art Floor	W. C. Fuhri				

Trade Show Exhibitors

B—Blackstone Hotel C—Congress Hotel

NAME	BOOTH	ROOM	DELEGATE	NAME	BOOTH	ROOM	DELEGATE
H. L. Hubbell 59 Market Ave., N. W., Grand Rapids, Mich.	S-7	S-548A	H. L. Hubbell	Raytheon Mfg. Co. Kendall Square Bldg., Cambridge, Mass.	S-101	C-106-118 S-1600	Fred D. Williams
Hygrade Lamp Co. Insuline Corp. of America 78 Cortland St., New York, N. Y.	S-18	S-1306A S-507		Red Lion Cabinet Co. Red Lion, Pa.	C-6	C-F6-F8	J. B. Sehnst
International Resistance Co. 2006 Chestnut St., Philadelphia, Pa.	S-45		Francis E. Ehle	The Rola Co. 4250 Hollis St., Oakland, Calif.	S-71	S 537A	H. S. Tenney
Jensen Radio Mfg. Co. 338 N. Kedzie Ave., Chicago, Ill.	S-125	S-906A	Thos. A. White	Samson Electric Co. 224 Washington St., Canton, Mass.	S-84	S-806	C. C. Galby
Jewell Elec. Instrument Co. 1640 Walnut St., Chicago, Ill.	S-70		J. T. Keeney	Sangamo Electric Co. Springfield, Ill.	S-6		H. L. Kutz
Howard B. Jones 2300 Wabasha Ave., Chicago, Ill.	S-63		Howard B. Jones	Seville Mfg. Co. 99 Mill St., Waterbury, Conn.	S 23		A. Cowperthwaite
Joy-Keley Corp. 542 N. Parkside Ave., Chicago, Ill.	S-41D		R. W. Augustine	Sentinel Mfg. Co. 9705 Cottage Grove Ave., Chicago, Ill.	S-2	S 502	John T. Beatty
Kellogg Switchboard & Supply Co. 1066 W. Adams St., Chicago, Ill.	S-114	S-606A	W. L. Jacoby	Shamrock Mfg. Co. 136 Waverly Ave., Newark, N. J.	S 73	S-820	H. R. Rose
Colin B. Kennedy, Inc. Cypress and Lorens Sts., Highland, Ill.	C-11	S-513A C-112	Colin B. Kennedy	Showers Brothers Co. Tenth and Murton Sts., Bloomington, Ind.	S 136	S 820A	J. L. Woods
The Ken-Rad Corp. Owensboro, Ky.	C-2		A. D. Strathy	Silver-Marshall, Inc. 816 W. Jackson Blvd., Chicago, Ill.	S 122	S-423A	H. C. Bodman
Kersten Radio Equipment, Inc. Kalamazoo, Mich.	S-33D	S-545		Sonatron Tube Co. 108 W. Lake St., Chicago, Ill.	S-91	S 1301A	H. Chirelstein
King Manufacturing Corp. 254 Rano St., Buffalo, N. Y.	S-1101D	S-2220	W. L. Morley	Sonora Phonograph Co., Inc. 50 West 57th St., New York, N. Y.	S-17	S-1901A	Adam Stein
Knoxville Table & Chair Co. Box 1087 Knoxville, Tenn.	S-75	S-1605A	Alvin M. Talley	The Sparks-Wittington Co. Sparks, Mich.	S 101	S-801A	Win. Sparks
The Kodak Elec. & Mfg. Co. 507 E. Pearl St., Cincinnati, Ohio	C-21	C-342	C. E. Ogden	Starr Piano Co. Richmond, Ind.	S 34	S 1166A	
Kolster Radio Corp. 200 Mt. Pleasant Ave., Newark, N. J.	C-18	C-1106	H. H. Froet	Steinle Radio Co. 506 S. Wabash Ave., Chicago, Ill.	S 124	S 901A	F. A. Ahelson
Logan Mfg. Co. Togan, Ohio	S-155			Sterling Mfg. Co. 2831 53 Prospect Ave., Cleveland, Ohio	S 145	S 1124	W. M. Scott
I. A. Lund Corp. 1018 S. Wabash Ave., Chicago, Ill.	S-102	S-453A	I. A. Lund	Stevens Manufacturing Corp. 46-48 E. Houston Sts., New York, N. Y.	S-151	S 511A	John B. Price
The Magnavox Co. 4250 Horton St., Emeryville, Oakland, Cal.	S-102	S-1701A	R. A. O'Connor	Stewart-Warner Speed Corp. 1826 Diversey Parkway, Chicago, Ill.	S 129	S 534	L. E. Parker
Maring Wire Co. Muskegon, Mich.	S-31		H. W. Simpson	St. Johns Table Co. Cadillac, Mich.	C-3	C 111 D2 D1, S 512 S 519	H. M. Petrie
Markel Electric Products, Inc. 145 E. Seneca St., Buffalo, N. Y.	S-60		J. Markel	Storey & Clark Piano Co. 173 N. Michigan Ave., Chicago, Ill.			B. E. Colburn
Master Engineering Co. Chicago, Ill.	S-65D	S-546A		Super-Ball Antenna Co. Green Bay, Wis.	S 57		W. E. Johnson
Matchless Electric Co. Chicago, Ill.	S-453			Superior Calumet Corp. 206 Broadway, New York, N. Y.	S-14	S-1206	
McMillan Radio Corp. 1421 S. Michigan Ave., Chicago, Ill.	S-120	S-556A	Walter Magill	Supreme Instrument Corp. Greenwood, Miss.	S 157	S 139A	
Micarta Fabricators, Inc. 500 S. Peoria St., Chicago, Ill.	S-111		Harry A. Olson	Swan-Haverstick, Inc. Trenton, N. J.	S-20		D. F. Haverstick
Minerva Radio Co. 154 East Erie St., Chicago, Ill.	S-61	S-532A	E. R. Schultz	Sylvania Products Co. Drawer 45, Emporium Pa.	B 10		B. G. Eskone
Leslie F. Muter Co. 8440 S. Chicago Ave., Chicago, Ill.	S-61	S-1406A	Leslie F. Muter	Televoac Corp. 588-12th St., West New York, N. J.	S 146	S-520A	T. P. Vilaghy
National Carbon Co., Inc. 30 E. 42d St., New York, N. Y.	S-100	S-1201A	G. C. Furness	Temple, Inc. 1925 S. Western Ave., Chicago, Ill.	S 132	S 702A	Paul G. Andres
National Co., Inc. 61 Sherman St., Malden, Mass.	S-32	S-517A	James Millen	Thorslason Electric Mfg. Co. 500 W. Huron St., Chicago, Ill.	S 49	S 547	H. P. Manly
National Electrical Products Co. Waukegan, Ill.	S-152		John L. Nelson	Tower Mfg. Corp. 124 Brookline Ave., Boston, Mass.	S 28		Gordon C. Bennett
Maryland Ave. and Beech St., Wilmington, Del.	S-119	S-606 C-1116 S-1623	H. C. Hackett	Transformer Corp. of America 1428-32 Orleans St., Chicago, Ill.	S-44D	S 516	Rosa D. Siragusa
Northern Mfg. Co. 371 Orden St., Newark, N. J.	S-52	S-513	E. A. Tracey	Triad Mfg. Co. Pawtucket, R. I.	S 9	S 2100	
O'Neil Mfg. Corp. 715 Palisade Ave., West New York, N. J.	S-88	S-620A	R. L. O'Neil	Tyrman Electric Corp. 314 W. Superior St., Chicago, Ill.	S-114	S 357A	R. G. Fishel
Operadio Mfg. Co. St. Charles, Ill.	S-79	S-1406	J. McWilliam Stone	Udell Works 28 St. at Barnes Ave., Indianapolis, Ind.	S-72	S-512A	H. T. Griffith
Pacnet Electric Co. 91 Seventh Ave., New York, N. Y.	S-112	S-806A	L. G. Paecnt	United Reproducers Corp. Rochester, N. Y.	S-110 B-9 S-135	S 1100 B 1000 S 512A	David Wald
Perryman Electric Co. 33 W. 60th St., New York, N. Y.	S-82	S-530A	H. B. Foster	United Scientific Lab., Inc. 113 Fourth Ave., New York, N. Y.	S-94	S 602A	Allan G. Mesnick
Philadelphia Storage Battery Co. Ontario and C Sts., Philadelphia, Pa.	S-48	S-539	James M. Skinner	U. S. Radio & Television Corp. 1340 S. Michigan Ave., Chicago, Ill.	S-15		Win. J. Bennett
Philmore Mfg. Co. 106 Seventh Ave., New York, N. Y.	S-51	C-B48	Philip Schwartz	Universal Electric Lamp Co. 26 Treat Place, Newark, N. J.	S-92	S-501A	H. C. Forster
The Pierson Co. Cedar and Pleasant Sts., Rockford, Ill.	C-13		C. W. Pierson	Utah Radio Products Co. 1615 S. Michigan Ave., Chicago, Ill.	S-16	S 129A	W. S. Symington
Pioneer Radio Corp. Piano, Ill.	S-7		E. E. Hannigan	Valley Appliances, Inc. 634 Lexington Ave., Rochester, N. Y.	S-62	S 551A	J. A. Victorson
Platter Cabinet Co. Madison Ave., North Vernon, Ind.	S-76		O. R. Platter	Victorson Radio Co. 2825 Chester Ave., Cleveland, Ohio	C-20	C 1122-1128	H. L. Sommerer
Polymer Manufacturing Corp. 599 Broadway, New York, N. Y.	C-8	C-F22 23	Nat. C. Greene	Victor Talking Machine Co. Front and Cooper Sts., Camden, N. J.		S 557	W. H. Huth
The Pooley Company 1600 Indiana Ave., Philadelphia, Pa.	S-111D	S-545	Ben R. Stauffer	Walbert Mfg. Co. 1000 Fullerton Ave., Chicago, Ill.	B 1	B 506	L. V. Hughes
Potter Mfg. Co. 1950 Sheridan Road, North Chicago, Ill.	S-2	S-502	E. E. Potter	Wasmuth-Goodrich Co. Peru, Ind.	S-150	S 515A	R. T. Blash
Quam Radio Products Co. Chicago, Ill.	C-12	C-1128	A. J. Abrahams	The Webster Co. 850 Blackhawk St., Chicago, Ill.	S-50	S 549	R. Forla
Racon Electric Co., Inc. 18-24 Washington Place, New York, N. Y.		C-B18		Webster Electric Co. Racine, Wis.	S-55	S-1420A	A. S. Wells
Radio Cabinet Co. of Grand Rapids Grand Rapids, Mich.		S-439A		Wells-Gardner Division 1720 N. Robey St., Chicago, Ill.	S-106		Caxton Brown
Radio Cabinet Co. of Rockford Rockford, Ill.		S-1023A	J. L. Ray	Weston Electric Instrument Corp. 614 Frelinghuysen Ave., Newark, N. J.	S-12	S-1805	C. M. Wilcox
Radio Corp. of America 233 Broadway, New York, N. Y.		S-532	B. S. Davis	Wilcox Laboratories Charlotte, Mich.	S-05	S-561	
Radio Engineering Magazine 52 Vanderbilt Ave., New York, N. Y.		C-C6-C8	F. B. Ward	Wright-DeCoster, Inc. St. Paul, Minn.	S-44		
Radio Master Corp. Bay City, Mich.				Yaxley Manufacturing Co. 1103 W. Monroe St., Chicago, Ill.	S-86	C-B22 B25	E. F. McDonald
				Zenith Radio Corp. 3620 Iron St., Chicago, Ill.			

Light-Sensitive Cells

IV. Practical Cells of Various Types

By John Patton Arnold

PREVIOUS discussions have been confined to photoelectric cells of the alkali metal type, although it has been noticed that there are other classes of cells—the photo-conductive and the photo-voltaic. In this concluding article, a few words will be said about these latter devices, and some further data regarding alkali metal cells, which has not been treated elsewhere in this series, will also be given.

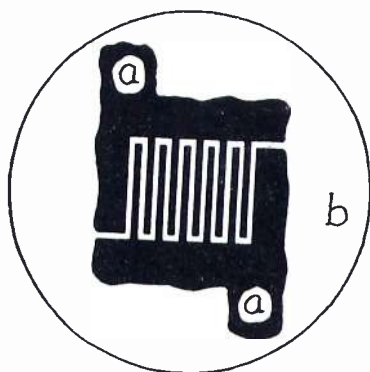

Fig. 15. A sketch of a typical selenium cell-form.

1. Photo-Conductive Cells

Any brief discussion of cells of the photo-conductive class from the practical standpoint must be confined mainly to those employing annealed selenium for the light-sensitive material. It is true that some research has been made in recent years with compounds of antimony, bismuth, copper, lead, molybdenum, silver, thallium, etc., but the results of such investigations have not led to the development of light-sensitive devices which are greatly superior to the selenium cell, excepting possibly the thallium cell to be described below.

The literature in reference to selenium is voluminous, and the reader who wishes to study the subject thoroughly should consult the bibliography compiled by M. F. Doty, "Selenium: A List of References, 1817-1925," published by the New York Public Library, 1927. Of particular interest are the references to its physical and chemical constants, its electrical and optical properties, the cells and their uses, and also the early patents relating to visual communication, sound recording, etc.

Light action in selenium was first reported fully in 1873 by Willoughby Smith who used bars of this element for high resistances. When sunlight fell upon them, it was observed that their conductivity increased. While

useless for the purpose for which they were intended, the curious phenomenon exhibited soon led to the development of the first practical instrument for controlling an electrical current by means of light.

Essentially a selenium cell comprises two metallic electrodes between which annealed selenium is deposited. As the specific electrical resistance of selenium is quite high—30 to 2500 megohms per cubic cm. (Bidwell)—the cells should be so designed that only a short path of relatively large cross-section is traversed by the current flowing between the electrodes when these are connected to a source of potential. Furthermore, the selenium should be spread in a thin film so that a relatively large area, with respect to its volume, is affected by the light. The films should not be thicker than 0.0014 cm., as Brown¹ has shown that this is the effective depth for the penetration of light into the surface of the element. To obtain the greatest ratio between the light-dark current (sensitivity) and to lessen inertia (the lagging of the electrical response behind instantaneous changes of illumination), this latter requirement should always be fulfilled in preparing the cells. At one time it was thought that the heat treatment or annealing process was a very important factor, but Piersol, in a paper referred to later, states that neither the length of time nor the temperature (within certain limits) is at all critical.

Before discussing a few practical cells, it is necessary to point out the materials which are used for their construction. We have three components: the conducting electrodes, the insulating base, and the selenium film. As a number of metals will oxidize at the annealing temperature and combine with the selenium as a selenide, platinum, gold and nickel are the best materials to use, but due to the expense of gold and platinum, such metals or alloys as copper, aluminum, zinc, brass, Constantan, German silver, and also graphite and carbon may be employed. Unfortunately, however, selenium films seem to adhere better to those metals which oxidize than to those which do not. For insulation, quartz, glass, porcelain, slate, mica, soapstone, and bakelite are most satisfactory in preventing leakage currents across the electrodes of the cells. Of the various allotropic forms of selenium, the grey crystalline metallic variety alone has the suitable light-sensitive property, and the object of the annealing process is to convert the

commercial forms of selenium to this variety.

Various cell-forms have been suggested, but perhaps the most satisfactory is the grid arrangement shown in Fig. 15. Here a thin film of metal is deposited either by electrolysis, cathode sputtering, photograving processes, or some similar method. McMahon and Brown² prefer gold and platinum paints consisting of colloidal solutions of the metals in essential oils. The base (b) may be quartz or sand-blasted glass, and the metallic film is divided into two electrically conducting portions, as shown. The selenium film bridges the gaps between the two electrodes or, by the method of the investigators mentioned above, large crystals of selenium are employed. Wires leading to the binding posts of the cell are attached to the electrodes (a, a) by means of Wood's metal. Fig. 16 is a commercial cell of this type.

After a film is deposited on the form, it is then necessary to convert the selenium, usually from an amorphous variety, to its light-sensitive form. Piersol³ describes a process of annealing by means of which "several hundred selenium cells have been made with identical characteristics." He anneals the cells at 180 deg. C. for five minutes. An electric oven is often used for this purpose when accurate temperature control is desired, although a Bunsen burner is satisfactory in most cases.

An even simpler construction than the foregoing has been proposed by Martin⁴ made by heating powdered

² *Jour. Opt. Soc. Am.*, Vol. 11, p. 223; 1925.

³ *Phys. Rev.*, Vol. 30, p. 664; 1927.

⁴ *Jour. Opt. Soc. Am.*, Apr., 1928.

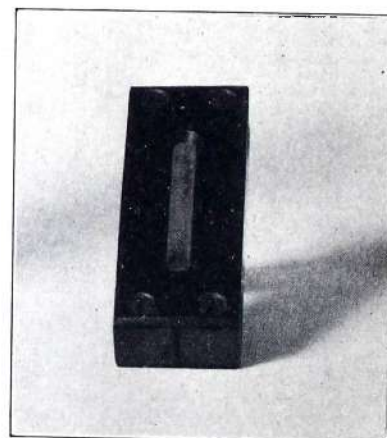

Fig. 16. A commercial selenium cell.

(Courtesy of Samuel Wein)

¹ *Phys. Rev.*, Vol. 34, p. 201; 1912.

vitreous selenium to 216 deg. C. in a test tube and allowing it to cool slowly. By turning the test tube nearly upside down, long threads of selenium can be poured out, their diameters depending on the temperature. Threads about 2 cm. long and 0.1 cm. in diameter were found to be most satisfactory. These threads were annealed and then strapped down on a microscope slide by wires at either end. Cells so constructed are said to have a resistance of about 1/2 megohm.

It is advantageous to place a selenium cell in a vacuum to prevent the absorption of moisture. Ruhmer⁵ suggested this improvement in design. He cut double parallel threads in soapstone or unglazed porcelain tubing and into these grooves wound No. 40 B&S gauge wires, which were secured at one end to the base of an incandescent lamp. The soapstone or porcelain tubing was divided in two pieces in order that wedges could be inserted to take up the expansion of the wires during the annealing of the cell. The bulb was then evacuated. Such cylindrical cells may be placed at the focus of a parabolic reflector and illuminated from all sides.

As to resistance of cells, they may be divided into two classes: (1) high and (2) low resistance cells. The former type have a dark resistance (when they are not illuminated), varying usually from 100,000 to 500,000 ohms, while the low resistance cells from 100,000 to about 10,000 ohms.

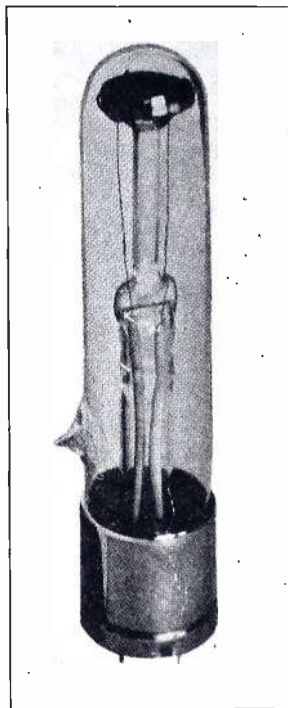

Fig. 17. The Case Thalofide cell, which is particularly sensitive for the infra-red end of the spectrum.

return to the dark resistance value is much slower, varying from several minutes to a number of hours, according to the intensity and duration of the excitation. This fatigue characteristic is more or less noticeable, depending largely on the fulfillment of the conditions of design and construction mentioned in the beginning of this section. However, both the fatigue and lag of cells prevents their satisfactory use for many applications although they can be employed in many cases, especially in places where they are used in connection with a relay for short intervals of illumination with relatively longer rest periods between successive illuminations.

The following facts regarding the care of cells should always be observed:

1. Keep cells cool. The heating effect of passing too large currents through the cell, or from the exposure to intense radiation, will cause the formation of selenides of the metal electrodes. Gold selenide is indicated by the appearance of dark brown spots on the surface of the selenium.
2. Apply the lowest voltages that will give the desired results. The use of high-resistance relays is preferable, or a limiting resistance may be placed in series with the cell for protective purposes. In general, ten milliamperes or more should not pass through the cell, but it is always best to follow the manufacturer's instructions in this matter.
3. Cells should not be exposed to intense light for long intervals of time. The cell becomes fatigued and becomes temporarily (or even permanently) insensitive to light.

4. Keep cells dry. If not sealed in to exclude moisture, they should be kept in a box containing a few pieces of calcium chloride.

5. When not in use, cells should be kept in the dark, but they may be exposed to light regularly, for short periods, to aid in retaining their sensitiveness.

6. If the resistance of a cell drops greatly, it can be raised, at least temporarily, by applying pulsating or alternating currents.

Case⁷ discovered that thallium sulphide is not only sensitive to light, but also has a maximum in the infra-red region of the spectrum and, therefore, such a cell can be controlled by radiations invisible to the human eye. In his earlier work, Case made use of thallium sulphide, but later refers to thallium oxysulphide, having found that the slightly oxidized compound is more active under illumination.

Case fuses the material at about 650 deg. C., the fusing point of the compound, in the presence of air, thus forming thallium oxysulphide. The thickness of the material is usually between 0.3 and 0.5 mm. After fusing, it is immediately and rapidly cooled.

The Case cell (Fig. 17) of this type is called the "Thalofide" cell. The construction consists of a quartz disc, 3/4-inch in diameter, which is coated with a film of lead and this latter is cut in a grid form similar to that shown in Fig. 15. Leads are soldered on after the thallium compound has been applied. The assembly is sealed into an evacuated glass bulb.

The actual light-sensitive surface exposed is about 2 mm. wide and from 10 to 12 mm. long.

The average sensitiveness of these cells is such that the dark resistance is lowered by 50 per cent., in 0.02 foot-candle when the source of light is a tungsten filament. In some of the best cells this drop is obtained in 0.004 foot-candle. The dark resistance of different cells may be anywhere from 5

⁷ *Phys. Rev.*, Vol. 15, p. 289; 1920; *Jour. Opt. Soc. Am.*, Vol. 6, p. 398; 1922.

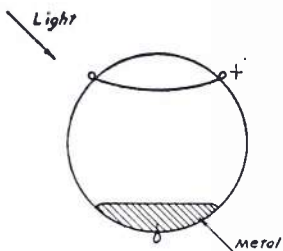

Fig. 18. An early Elster and Geitel potassium hydride cell.

There is very little difference between the two, although high resistance cells often have greater sensitivity. For engineering work, due to various circuit constants as well as ordinary electrical apparatus, cells of fairly low resistance are often to be preferred.

The theory of light action in selenium is explained by Fournier d'Albe,⁸ as due to the ionization of the selenium atoms. The current due to the acting light varies as the square root of the illumination. Selenium is more responsive to light of longer wavelength than any of the photoelectric cells of the alkali metal type, this sensitivity also extending into the infra-red spectrum.

It will be noted that the increased conductivity of selenium under the action of light is fairly rapid, but the

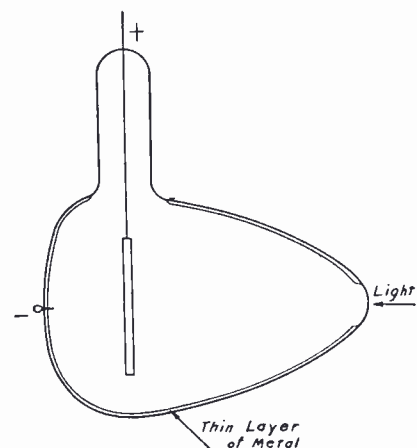

Fig. 19. The alkali metal cell which was designed by Hughes.

⁸ "Das Selen," p. 11; Berlin, 1902.
⁸ "The Moon-Element," Chap. III.

to 50 megohms, depending primarily on the nature of the material used and to the grid spacing. This high resistance could be reduced by making the grid of 100 or more lines per linear inch.

Thallium oxysulphide appears to undergo a slow photo-chemical change without the use of a color filter. This is supplied with the commercial cell.

The thalofide cell responds quickly to the exciting radiation, usually completed after a lapse of 15 seconds. On longer exposures, the galvanometer deflection increases slowly and sometimes irregularly. Although the time—two minutes to obtain maximum response—is shorter than molybdenite,

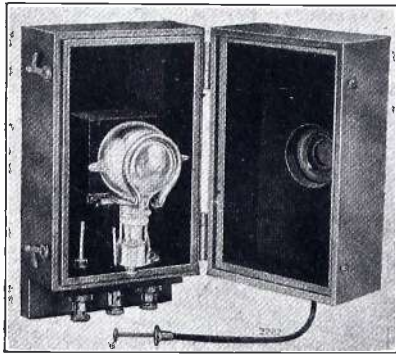

Fig. 20. Mounting for photoelectric cells.
(Courtesy of Cambridge Instrument Co. Inc.)

the thalofide cell behaves somewhat like it, requiring twice as long—about four minutes—for complete recovery. For small deflections, as an exposure of one minute, two minutes for recovery is sufficient.

II. Photoelectric Cells

It has been necessary in the previous articles of this series to compress a great deal of information about alkali-metal cells into a very few pages and, for that reason, some facts concerning the different types of cells that are used for practical work have not yet been mentioned. Allen⁸ has traced their historical development from the early Elster and Geitel alkali hydride cell (Fig. 18) down to all but the more recent types developed in this country. Some of these are of particular interest and will be described here.

Hughes⁹ designed the cell, shown in Fig. 19, which suggests the black-body inclosures used in the study of heat radiation. The pear-shaped flask traps practically all of the light that enters the cell through the window and by progressive reflections from the interior walls produces electronic emission wherever it impinges on the light-sensitive cathode.

Small cells—two, three or four inches in diameter—are usually suitable for all applications except tele-

⁸ "Photo-electricity," Chap. XVII; 1925.
⁹ *Philos. Mag.*, Vol. 35, p. 679; 1913 also his "Report on Photo-electricity," p. 104.

vision. For such communication both large or small cells are used depending on the method of scanning. The two methods are often termed direct and reflection scanning. In the former case, the subject to be transmitted is strongly illuminated and placed before the scanning apparatus; for instance, the conventional Nipkow disc. An image of the subject is thrown on the disc by means of a lens. The photoelectric cell collects the light that falls upon it through the apertures in the disc. This optical system is less efficient than that employed in the reflection method where a small beam of light is made to pass over the subject by the rotation of the scanning disc and large photoelectric cells, like those described in a previous article, collect the diffused light reflected from the subject. The advantages and disadvantages of these systems are fully discussed by Gray and Ives.¹⁰

Various combinations of cells and vacuum tubes in a single device have been proposed. Often these include separate elements for both cell and tube, or a grid element, serving the same function as in the thermionic tube, may merely be inserted between the electrodes. The advantages of such combinations are questionable. Where a filament is employed, the photoelectric cell has a life which terminates when the filament is destroyed, as far as its use in the combination is concerned; otherwise, it has been noted, a cell will greatly outlast a vacuum tube. The heating effect of the filament on the alkali-metal surface may also be harmful. Furthermore, the current-illumination characteristic of a cell is linear from the highest to lowest values. The current-voltage characteristic of a vacuum tube is not linear. This, therefore, limits the wider usefulness of the cell. An assisting grid in a cell may be necessary in certain physical research, but the idea is not new; Lenard in 1902 was probably the first investigator who employed it. There are two very significant patents regarding this structure: Huth, Rosenbaum and Loewe (German Pat. 304,325; Sept. 28, 1917) and Langmuir (U. S. Pat. 1,282,439; Oct. 22, 1918).

Dr. Robert C. Burt, of Pasadena, makes a quartz central-anode cell, but the alkali metal can also be volatilized and deposited on the central electrode so that the cell can be used for stellar photometry as a central-cathode type with a saturation point at about 8 volts.

In working with these cells it is often desirable to mount them as shown in Fig. 20. Here the cell is inclosed in a light-tight wooden case which is fitted with an iris diaphragm and shutter. Thus the size of the light beam that falls on the light-sensitive cathode can be regulated and also the time of exposure may be either "instantaneous" or the shutter con-

¹⁰ *Jour. Opt. Soc. Am.*, Vol. 16, p. 177; 1928; Vol. 17, p. 428; 1928.

trolled by the bulb, as is the case with a photographic camera.

III. Photovoltaic Cells

The literature referring to photovoltaic phenomena is less extensive than that of either the photoelectric or photoconductive effects. Neither has the commercial development of cells of this sort been undertaken to any great extent in spite of the fact that there is no doubt of their practical value.

In regard to the literature on the subject, there seems to be no better introduction to it than the interesting paper of Carl W. Tucker.¹¹ Allen¹² also lists a number of modern references.

Tucker describes the typical photovoltaic cell as follows: "If a photosensitive substance is placed upon two metal electrodes which dip into some solution, the potential difference between these two electrodes, in the dark, may be reduced to zero. But if one of these electrodes is illuminated while the other is darkened, the photochemical changes, which take place on the illuminated surface, may be expected to produce a potential difference between the exposed and darkened electrodes. What the magnitude

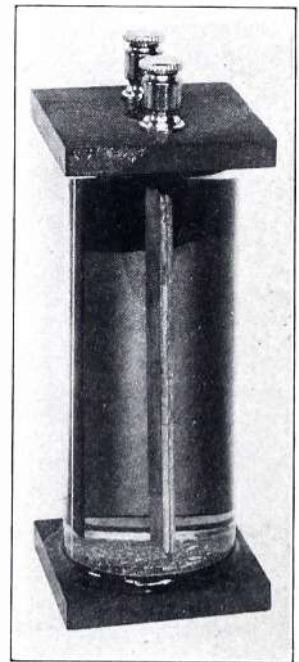

Fig. 21. The Wehn photovoltaic cell.
(Courtesy of Radiovision Corp.)

of this voltage will be and what will be the sign of the charge on the illuminated electrode may be expected to vary with the nature of the photosensitive substance and its light-reaction."

Bequerel¹³ first prepared and named the photovoltaic cell. The

¹¹ "A Study of Photovoltaic Cells" (*Jour. of Phys. Chem.*, Vol. 31, pp. 1357-1380 Sept., 1927).

¹² "Photo-electricity," 2nd, ed., 1925.

¹³ *La Lumière*, II., 121.

photovoltaic effect is also known as the Becquerel effect. This investigator employed silver chloride, bromide, and iodide as the light-sensitive material on plates of silver and platinum, which were immersed in dilute sulphuric acid. Becquerel observed, as Tucker reports, that (1) "the sign of the charge on the illuminate electrode varied with the thickness of the photosensitive material" and that (2) "the observed voltage was inconstant during the illumination and that its value varied with the intensity of the illumination."

Minchin¹⁴ also investigated the silver halides, as well as Wilderman¹⁵. More recently, Case¹⁶ prepared cells of cuprous oxide on copper plates in a solution of 2.5% copper formate

¹⁴ *Phil. Mag.* (5) Vol. 31, p. 207; 1891.

¹⁵ *Z. physik. Chem.*, Vol. 59, pp. 553, 703; 1907.

¹⁶ *Trans. Electrochem. Soc.*, Vol. 31, p. 351; 1917.

and 0.4% formic acid. Thus, as far as investigations in this field have been carried out, it seems that the silver halides or copper oxide are the most satisfactory materials for practical photovoltaic cells.

One of these cells has been developed by Samuel Wein, of New York City. It has a semi-cylindrical copper plate, which is treated chemically, and a lead electrode placed in a bulb containing a colorless solution (Fig. 21). When the copper plate is exposed to diffused sunlight, a current of approximately 0.5 milliampere will pass between the electrodes. Such cells can be charged, just as an ordinary storage battery is charged, and for a time a much larger current flows, although this effect rarely lasts longer than an hour. However, this charging is not at all necessary as the ordinary current output is large in comparison with the photoelectric cells.

The chief advantages of these cells are that they will operate relays di-

rectly, that they do not require external batteries in operation and that they do not exhibit the lag noticed in photoconductive cells. They will also respond to intermittent light comparable to voice frequencies, and hence are suitable for photo-telegraphy and talking motion pictures. The upward frequency is not definitely known—at least, not to the writer—and it is thus uncertain whether they will respond to the wide frequency band required for the production of intelligible television signals. However, they are excellent for every other purpose.

It is also surprising to find that the cells are not subject to progressive fatigue in so far as rough tests can determine. In confirmation of this statement, an experimental cell was observed at intervals over a period of seven or eight months. It does not appear that there has been any diminution of the photocurrent in that time.

(The End)

The Problems of Radio Servicing

III. How General Vacuum Tube Voltage and Current Tests Indicate Specific Faults in the Receiver

By John F. Rider, Associate Editor

TO disseminate radio information pertaining to radio service work is a lengthy procedure. Not necessarily tedious—but lengthy. In view of the fact that a little knowledge is dangerous, we believe that a detailed analysis will serve better than a cursory explanation of the details involved.

We concluded the last installment, relative to the "process of elimination" by stating that the following article will concern radio-frequency amplifiers. We are going to change the routine and delay comment upon this subject until some future date—as there are a few other points we had best cover first.

Service data associated with any part of the radio receiver involves the vacuum tube, since this tube is a part of each system and its operation is controlled by the condition of the various systems, including the power supply units and circuit continuity. Hence, we believe that the first item subsequent to the general discussion contained in the first two installments, should be the vacuum tube. Now, we wish to make clear that we are not attempting an elementary course in vacuum tube design or radio in general. We recognize fully that some of the information contained in these pages is known to some of the readers, but we are also certain that some of the data supposedly known is not fully comprehended. Hence, we move along this line of progress. By discussing

vacuum tubes at this time we eliminate the need for further discussion as we progress through trouble diagnosis and isolation.

We take for granted that the reader is familiar with the structure of the conventional type of three-element vacuum tube, and to a certain extent with the function of the various elements. We will dwell to a certain extent upon the latter in a manner somewhat different than the conventional.

Vacuum Tube Tests

Radio receiver servicing, to be profitable, requires the most rapid form of work consistent with accuracy and the attainment of results. With this in mind, one cannot help but wonder about the most suitable test for a vacuum tube to show its condition and to prophecy its degree of performance. In this connection we must recognize two conditions: first, the tube which is new and second, the tube which has been in use for a period of time.

The average vacuum tube has four important constants: electronic emission, plate impedance, amplification constant (μ) and the mutual conductance. Now, it is quite logical that a rapid test of the vacuum tube need not involve the determination of all of these constants, particularly if the tube is new. The same is true if the tube is removed from a defective receiver. The reason for this is that these constants are governed by one major ele-

ment, the condition of the filament. If the filament is intact and in perfect condition, and if the physical structure of the tube elements has not been altered, the various electrical constants will be as decided upon in the design. If, however, the most vulnerable part of the tube—the filament—has undergone some change, it will influence some of the electrical constants of the tube, since the value of the constant is governed by the number of electrons emitted by the filament. By this we do not wish to imply that the design of the filament governs the constants. What we mean to say is that the electronic emission from the filament exerts a tremendous influence upon the two most important tube characteristics; the plate impedance and the mutual conductance. The amplification constant remains uniform over a very wide range of filament temperature and electronic emissivity. Therefore, as a rapid test, the electronic emission is as good as any, assuming no physical damage to the tube.

As an illustration of the above, the amplification constant of the average 226-type tube remains between 8.2 and 8.4 over a filament potential range from .5 to 1.7 volts, whereas the plate impedance is approximately 43,000 ohms at .75 volt and 8,000 ohms at 1.5 volts—and the mutual conductance is approximately 250 micromhos at .85 volt and 830 micromhos at 1.5 volts on the filament.

Electronic Emission

The importance of satisfactory electronic emission is self-evident. With respect to the test of a tube removed from a receiver, the paramount test is that for electronic emission, bearing in mind that the tube has been in use for a period of time, rendered satisfactory service during that time and that the physical structure of the tube does not undergo a change, unless of course, the tube is subjected to a violent physical shock, which might jar an element loose or break continuity between the wires connected to the tube prongs and the elements. Usage will not alter the plate impedance or the mutual conductance values if the filament emissivity remains constant. With respect to disconnected elements, this condition will be evidenced by certain symptoms and will become evident in a simple plate current test which follows the filament emission test, the latter, however, being the first test made.

We can state without detailed explanation that the most vulnerable part of any vacuum tube, irrespective of type, is the filament. Furthermore, the element which deteriorates most rapidly during operation of the vacuum tube is the filament. In the filament type of a-c. tube, the filament is the source of electrons, exactly as in the case of the d-c. tube. In the cathode type of a-c. tube, the cathode is the source of electrons. Hence, if in the first two instances, the source of electrons undergoes the most rapid change, the same may be considered to be the case in the cathode type of a-c. tube. In addition, we must consider volatilization of the filament in this tube and the production of less heat with which to heat the cathode and also burnout of the filament. Since the operation of the tube is governed by the electronic emission by the electron emitting element, the primary test is that for electronic emission. In the d-c. type of tube employing a thoriated filament, the thorium is burned away and the abundant emission of electrons, due to the thorium, ceases. Since the tube is designed for operation with the thorium in the filament, deactivation of this type of filament will impair the operation of the tube.

The same is true in the case of the filament type of a-c. tube, with the exception, that in this instance, the abundance of electrons is due to an oxide coating upon the filament. After this oxide is burned away, the filament does not emit sufficient electrons for satisfactory operation. In the cathode type of a-c. tube, the cathode is the electron emitter, and if the heat generated by the filament (heater) is insufficient the electronic emission will be insufficient. If, on the other hand, the oxide coating upon the cathode is burned away during operation, the number of electrons emitted will reach a low level where the tube is useless.

Emission Tests

Electronic emission tests must be made under definite prescribed conditions, a requirement which is not fulfilled in everyday practice. These specifications are compiled by the vacuum tube manufacturers. It is true that each individual serviceman can develop his own calibrations for electronic emission, but no matter how it is arranged, definite values must be employed. Every type of vacuum tube has a definite minimum value of electronic emission at certain values of filament and plate potential. This, however, does not signify that all tubes are tested under identical conditions, unless they are of similar type, in which case what has been said does not apply, and all tubes of similar type are tested under identical conditions. Electronic emission in excess of the minimum value is permissible.

The following is the minimum electronic emission value of each tube mentioned and the recommended operating voltages. These values are recommended by E. T. Cunningham, Inc., and are excerpts from their engineering bulletins.

Tube	Fil. Volts	Plate Volts	Minimum Emission (Milli-amperes)
12	1.1	50	6.0
299	3 3	50	5.5
220	3 3	50	13.0
301A	5.0	50	20.0
300A	5.0	50	14.0
340	5.0	50	14.0
112	5 0	50	45.0
112A	(No emission tests)		
371	5.0	50	40.0
310	6 0	100	85.0
350	6 0	250	505.0
326	1 5	50	35.0
327	2 5	50	35.0
313	4.0	100	40.0
316B	6 0	125	85.0
380	5.0	80	100.0
381	6.0	150	200.0

(The plate voltage values mentioned are the voltage applied to the grid and plate connected together as an anode. Although Cunningham designations have been employed, these values are applicable to the UX and to all similar type tubes.)

The practice of judging a tube by the normal plate current, is open to condemnation. The plate current reading alone, gives very little indication of the tube performance as an audio amplifier, a detector or as a radio-frequency amplifier. As a matter of fact, while the plate current is a function of the electronic emission (since the condition of the filament influences the plate reading) filament condition is best determined by an electronic emission test. As a guide to performance as an amplifier, the plate current reading alone will not afford conclusive evidence to the negative or the affirmative, since other items must be taken into consideration. These are

the amplification constant and the mutual conductance. Fortunately, however, as we stated earlier in this text, measurement of these values is unnecessary. The electronic emission test should be the first observation followed by any simple test to show correct operating conditions and continuity of the elements.

Tube voltage specifications must be strictly observed. This applies to all voltages; filament, grid and plate. Frequent mention is made that tube filament life is prolonged by operation below the rated filament potential or temperature. This is true under certain conditions, which, due to the trend in tube filament structure design is applicable to all a-c. receivers. Subnormal filament potential operation of the thoriated tungsten filament prolongs the life of the thorium, that is, the period of operating life, but it alters the molecular structure of the tungsten, making it more brittle and subject to fracture more easily. Excessive filament temperature dissipates the thorium more rapidly and increases volatilization of the tungsten. Hence, such filaments should be operated at normal filament potential and temperature. The same is not true of the oxide coated filaments, where operating life is prolonged by operation below the rated temperature. So much for that at the present time.

Plate Current Tests

In contrast to the electronic emission value when testing a tube, the plate current value is a barometer of circuit conditions when testing receivers with the vacuum tubes in the respective sockets and in the tester socket connected to the receiver. Experience plus the manufacturer's specifications will advise the correct plate current values for various values of plate voltage, as measured with the test set. Correct interpretation of these values expedite isolation of the trouble.

In connection with what is to follow, we wish to make clear that these conditions are not the only ones encountered. Many others will confront the serviceman, but if we remove the haze around a number, the remainder will be viewed in much better light. As we stated, we are concerned with the vacuum tube, and we will consider the items which are associated with the vacuum tube and which manifest some effect upon it.

In view of the fact that receiver installations are of two types, namely, those employing batteries as sources of potential and those employing power devices, such as eliminators, for sources of potential, it is necessary to consider them separately. Let us take the battery source of potential first. The first condition shall be excessive plate current, as indicated upon a set tester or analyzer, when this device is being employed to check a receiver and to locate the defective part. Excessive plate current may be due to several conditions and for purpose of illustra-

tion we show two plate current grid voltage curves in Fig. 1. These curves are for different values of plate voltage and are not the curves of any one specific tube, but are used merely to illustrate the point mentioned. The plate current values are designated upon the ordinate line on the extreme left and the positive and negative values of grid voltage are shown upon the abscissa. These curves are allied with receiver operation and circuit conditions may be applied to these curves for interpretation. If one comprehends this data, much will be gained.

The designations "Ep 90" and "Ep 135" mean that the first curve is representative of a condition when the plate voltage is 90 and the other when the plate voltage is 135. Let us consider the point "0 grid volts" as the starting point for our discussion. The plate current values indicated on the ordinate are the values indicated on the set analyzer plate current meter. According to the curves in Fig. 1, the normal plate current for Ep 90 and 0 grid bias is 10 milliamperes and for Ep 135 and 0 grid bias, the normal plate current is 12.5 milliamperes. It is, therefore, obvious that as the plate voltage is increased, everything else being normal, the plate current increases. Discounting the plate current saturation point governed by the maximum filament emission, it can be said that excessive plate current may be due to excessive plate potential. If we could draw a curve for Ep equal to 200, the plate current with 0 grid bias would be much greater than 12.5 milliamperes.

Now, suppose that we operate with the curve marked Ep 90 and consider the positive and negative grid bias voltages. According to the graph, the negative voltage has a maximum of 20 volts and the positive voltage a maximum of 8 volts. The reason for the inequality is that positive bias is seldom employed. We neglect the small positive bias employed with grid leak-condenser systems of detection, since the bias does not approach the maximum of 8 volts shown. For a plate potential of 90 volts, the usual grid bias is about 4 volts or perhaps a little more. According to the curve, the normal plate current with this plate and grid voltage is about 6.3 milliamperes. We are aware that this value is in excess of the usual value encountered in receivers, but we employ it because it is better for illustration. At 0 grid bias the plate current is 10 milliamperes, an increase of approximately 3.7 milliamperes when the 4 volt grid bias is removed. It is, therefore, evident that the grid bias controls the plate current and if the grid bias is less than normal, the plate current will be more than normal, hence excessive plate current may be due to insufficient grid bias. If we move into the territory occupied by the positive grid bias voltages, we find that with a grid bias of plus 4 volts the plate current is increased to 12.5 milliamperes, (the curvature of the

plate current curve has no significance) and if the normal plate current is supposed to be 6 milliamperes (Ep 90 with 4 volts negative grid bias), it stands to reason that excessive plate current may be due to incorrect polarity of the grid bias—the bias being positive instead of negative.

Referring again to Fig. 1, it is evident that the grid bias controls the value of plate current, when the plate voltage is normal. Also that if the plate voltage is less than normal it is still possible that the plate current should be excessive, as for example—the normal plate current for Ep 135 and 8 volts negative grid bias is 6 milliamperes, the plate current for Ep 90 and 1 volt negative grid bias is 9 milliamperes. Although lacking an illustration, excessive plate current may also be due to excessive filament potential.

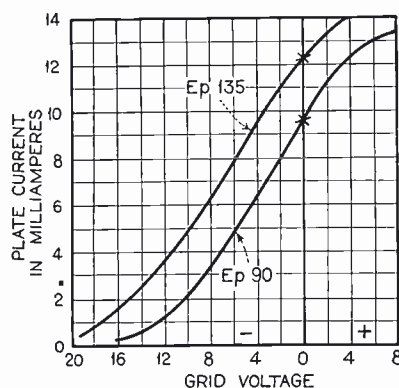

FIG. 1

Representative plate current, grid voltage characteristic curves of a vacuum tube.

With the above in mind and with one exception, it stands to reason that the reverse conditions may cause insufficient plate current. That is to say, insufficient plate potential with normal bias may be the cause for insufficient plate current. Likewise, excessive negative grid bias may be the cause for insufficient plate current, and insufficient filament potential may likewise be the cause for insufficient plate current. The exception we mention is the application of a positive grid bias, which can never cause insufficient plate current, since it will always increase rather than decrease the plate current.

"Floating" and "Positive" Grids

In connection with this discussion of plate current, we must mention another condition before we move on, and this is an unsteady or fluctuating plate current observation. Contrary to the opinion of many, this condition does not indicate a poor contact in the plate circuit. Instead, it is due to an open in the grid circuit, resulting in a "free" or "floating" grid. The fluctuating plate current is an indication that the grid is not at a steady operating potential; the grid intermittently accumulating a heavy negative charge

which reduces the plate current to zero or thereabouts and then losing this charge, again permitting normal plate current, only to again repeat the procedure. The proof that this condition is not due to a poor contact is that the variation is uniform in frequency and is found when the receiver is not passing signals and that the plate voltage is normal and steady at all times, even when the plate current is zero.

Now we refer to Figs. 2 and 3 to illustrate the points mentioned in connection with the curves in Fig. 1 and to bring out a few pertinent details which were not represented and discussed in Fig. 1. In Fig. 2, we view an ordinary stage in an electric receiver, employing an eliminator as the source of plate potential, a-c. tubes and a resistance as the source of grid potential, the potential being due to the passage of the tube plate current through the resistance and the consequent voltage drop. Referring to excessive plate current with normal plate potential we find that a leak between the plate winding of the transformer connected to the plate of the preceding tube and the grid winding of the tube in question will cause the application of a positive potential upon the grid, which will either neutralize the negative grid bias, and cause a positive bias. This condition arises frequently in resistance-capacity audio amplifiers and in some impedance-capacity audio amplifiers, due to a leak through the isolating or coupling capacity as many call this condenser. Other cases have been the radio-frequency transformers where scraping of the insulation permitted contact between the plate and the grid turns, or some other form of short; also a leak between the plate and grid windings of audio-frequency transformers or between the plate and grid leads.

General Voltage Checks

Referring to Fig. 2, we have designated four important sources of potential; V, V1, V2 and V3, each one having a bearing upon the reading observed upon the plate current meter, MA. If the plate current is excessive and the measurement of the plate voltage shows it to be greater than normal, V, V1 and V3 are not involved and examination of V2 is in order. The possible troubles in the source of V2 are two in number. First, the input voltage, and second, the voltage drop across the voltage divider resistance, or an open in the voltage divider resistance. The condition of the voltage divider system is evidenced by the plate voltages applied to the other tubes in the receiver. If voltage is being applied to the detector tube plate and the voltage divider system is of the potentiometer type, it is safe to assume that nothing is wrong with the divider resistance. Even if the resistance usually employed between the detector tap and the B minus is open,

satisfactory operation will be possible, although the output voltage will be higher along the various taps, because the insertion of this resistance increases the current load upon the eliminator.

It is now necessary to consider the operating characteristic of the average B eliminator. If the current load is reduced the output voltage increases and, conversely, if the current load is increased the output voltage decreases. This condition is influenced by the grid

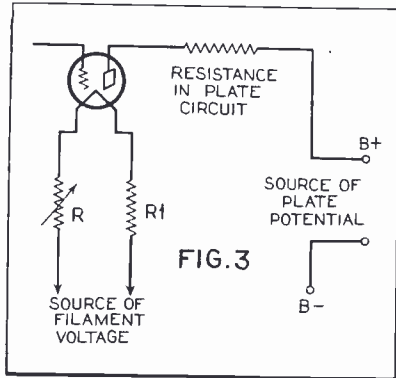

In trouble shooting, it is well to keep in mind that voltage-reducing resistors are often incorporated in the receiver circuit proper.

bias, the output voltage increasing as the negative grid bias is increased, since this action reduces the plate current, hence the current load. In this case, however, the plate current is excessive, and the plate voltage is excessive, hence it is doubtful if it is due to an excessive negative grid bias. If the grid bias were positive, it would cause the increased plate current, but such an increase in plate current load would have a tendency to reduce the output plate voltage. But one conclusion is possible—at some other point in the receiver, the load upon the eliminator has been removed or reduced. Perhaps a plate circuit is open, or if the voltage divider employed in the B eliminator utilizes individual resistances, one of these may be open circuited. In this connection one can eliminate the detector tap, since the current consumption is so small that the removal of this small load will have very little effect upon the system. If the tube under observation is the output tube, it is possible that the lead supplying the other amplifying tubes is open, and vice versa. If the voltage divider system is of the potentiometer type and the tube being tested is one of the amplifying tubes, exclusive of the output tube, an open in the voltage divider system between the amplifying tube tap and the main lead is out of the question, since such a break would open the circuit and plate voltage would not be available for the tube being tested. However an open between the maximum voltage tap and the output tube plate is possible and such a condition would cause the application of excess poten-

tial upon the plate of the tube being tested.

We must also consider another possibility, the lack of function of any voltage reducing resistances in the plate circuit, exclusive of the resistances in the voltage divider system in the eliminator, as in Fig. 3. The tendency towards excessive plate current with excessive plate potential, due to the condition cited, is greater when the C bias resistance is incorporated in the eliminator, rather than in the grid circuit of the tube in question, as shown in Fig. 2. In the latter position, the grid bias increases as the plate voltage and current increase.

Causes of Low Plate Voltage

Insufficient plate voltage and plate current may be due to several conditions in the system. First, a marked reduction in the input voltage feeding the B eliminator. Second, excessive voltage drop in the eliminator rectifying tube, if it is defective. Third, excessive voltage drop in the filter system. Fourth, a shorted condenser across one of the sections of the voltage divider system, which would reduce the total voltage divider resistance across the eliminator output, increase the current flow through this resistance network and consequently increase the load upon the eliminator. This would cause a reduction in the output voltage. Furthermore, if the C bias resistance is located in the eliminator, the action mentioned by causing an increase in current flow, would increase the voltage drop across this resistance and consequently the negative bias applied to the tube. In this discussion we assume that the shorted condenser is not connected across one of the plate voltage taps which supplies plate voltage to the tube under test. The effect of the shorted condenser would become evident upon a plate voltage test throughout the receiver.

With respect to the voltage, V1, in Fig. 2, we must mention a similar resistance located in the B eliminator. In both cases, the resistances are bypassed with condensers. A short in these condensers will short the resistance and eliminate the C bias, thus greatly increasing the plate current and reducing the plate voltage, due to

the operating characteristic of the B eliminator, but the reduction in plate voltage will not equal the increase in plate current. As an example, the normal plate current of a 250 tube operating at 450 volts on the plate, was increased to approximately 135 milliamperes when the C bias of 80 volts was removed because of a shorted bypass condenser, whereas the output voltage of the eliminator, tested at the tube plate, was 420 volts.

With respect to an open in the grid circuit, two conditions may prevail, depending upon the position of the break. If the "open" is located between the grid of the tube socket and the grid end of the unit connected across the grid filament circuit, the "free" grid condition mentioned will be present. On the other hand if the break in the grid circuit is such that the connection between the filament circuit and the B minus is opened, the plate current meter will read zero, since circuit continuity between the plate and the filament has been broken. Such a condition would exist if the grid bias resistance supplying V1, in Fig. 2, were to "open."

The value of the resistance associated with the designation V1 in Fig. 2, governs the value of grid bias applied to this tube. If it is excessive, the negative grid bias is excessive and the reading on the meter, MA will show insufficient plate current. Conversely, if the value of this resistance is less than normal, the reading on meter MA will be greater than normal, showing excessive plate current.

Insufficient or excessive values of V, the filament potential, is governed by the value of V3, the input voltage, when a transformer is used, and the potential value of the battery, if a battery is used. Also upon the values of whatever voltage-reducing resistances may be employed in the circuit, as shown in Fig. 3. If, assuming correct source of potential, these resistances are excessive, the value of V will be less than normal and the reading on the meter, MA will be less than normal. If, on the other hand, the value of these resistances is greater than normal, the value of V will be excessive and the reading MA will be excessive.

(To be continued)

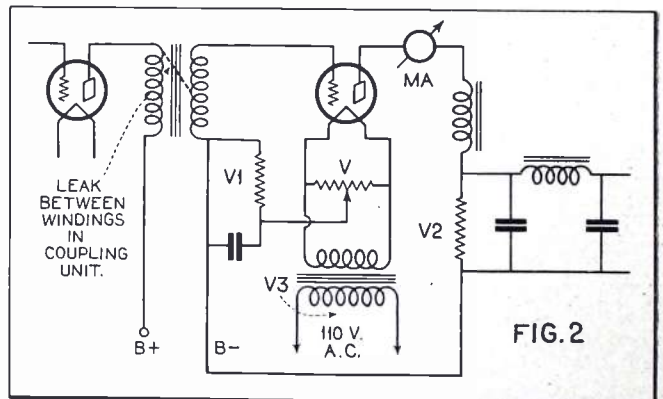

The Engineering Rise in Radio

By Donald McNicol

Fellow A.I.E.E., Fellow I.R.E., Past-President, Institute of Radio Engineers

Part XIII

Advantages of Tube Oscillator

WITH a tube employed as the generator of the oscillations and another tube serving as voice modulator, an end was seen to all previously employed means of setting up radio telephone transmission. The alternating-current transformer, the machine alternator and the arc oscillator were suitable for radio telegraphy, (the arc also for radio telephony), but it was early sensed that the tube had many advantages over other means for the purposes of telephony. Undoubtedly tubes could be made having larger dimensions, suitable for generating large currents, and this is what came to pass with surprising rapidity. Tubes were soon available for the production of radio frequencies at high powers, having grid potentials of 150 volts negative, the plate circuit potentials ranging up to 2,000 volts and higher.

Meissner, in Germany, in 1913. and Round, in England, devised radio telephone transmitting systems in which the three-electrode tube was employed to generate the energy to be radiated from the sending antenna. Round perhaps was first to apply the tube for this purpose. In the early trials the telephone transmitter was connected in the antenna circuit directly. Connected also in the antenna circuit was a glow lamp which gave out full brilliancy when the system had been adjusted to resonance and the oscillatory condition established. With this arrangement it was reported at the time that Round had succeeded in telephoning a distance of fifty miles. Later, the microphone was connected to the grid circuit making possible better control of modulation.

Ingenuous proposals with a view to improvement of transmitting circuits were made by August Hund, Carl Englund, Lloyd Espenschied, John R. Carson, and others, in America. Several of the improvements proposed by these engineers were of fundamental importance, and constituted the bases on which were designed elements of dependable systems of the years following.

The Audion, a Land-Line Telephone Repeater

The acquisition by the dominant telephone interests in America, of the right to use the deForest audion as a repeater, brought the tube into the laboratories of the manufacturing company producing telephone equipment. In this thoroughly equipped electrical laboratory, staffed with competent and

resourceful engineers, beginning in 1912, the audion, its known properties and its possibilities, were subjected to critical examination.

The device was studied from the theoretical standpoint by Dr. G. A. Campbell, whose work on loaded telephone lines, years before, had contributed largely to the success of long distance wire telephony. In the telephone company's laboratory, E. H. Colpitts, H. J. Van der Bijl and others devised improved systems of modulation giving approximately undistorted speech. These latter appeared in 1914.

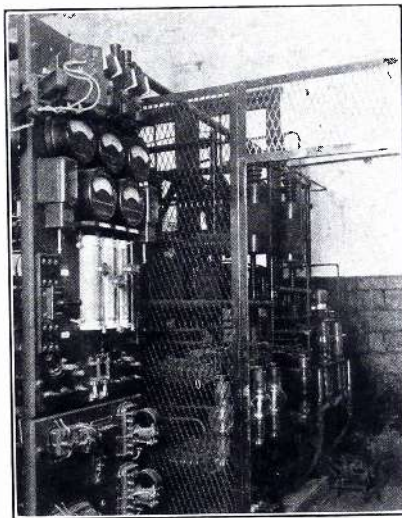

Fig. 18. A portion of the radio telephone equipment employed at Arlington, Va. which successfully transmitted speech to Paris and Honolulu.

With the widespread attack directed upon it beginning in 1912, it was not likely that the audion's secrets would long remain undiscovered. The telephone company's engineers, were at the time interested in perfecting the tube as a repeater for land lines. The development of the tube repeater proceeded so rapidly that the summer of 1914 witnessed its employment in commercial telephone service connecting New York with San Francisco.

A situation which may have had a bearing on the line of research at first followed by the telephone engineers was that as late as the year 1915, the executives of the company had not been alarmingly impressed by the various sallies of enthusiasm proceeding from the laboratories of purely radio organizations.

It may seem justly matter of wonder that this was the situation, but in a pamphlet issued by President T. N. Vail, of the telephone company, in 1915, appear the statements:

"... selection is not secrecy, as any receiver can be adjusted to all lengths and frequencies.

The intensity of these radiations is so great that any large number of sending stations erected near each other would seriously interfere with and confuse each other's outgoing transmission, and even a small number would absolutely destroy the tenuous incoming vibrations, and all could be destroyed by extremely high tension and high frequency radiation in close proximity."

and:

"The great obstacle to dependable usefulness with commercial possibilities—the causes which confine this great achievement to particular undependable uses—are natural conditions as yet and probably forever uncontrollable."

But the great war was on, and soon vast financial resources were to be available for the development of and carrying out of any project which was new and which might contribute toward preparedness for eventualities likely to ensue. The engineers were to have opportunity.

Radiophone Tests of 1915

By means of a tube oscillator radio telephone system the telephone engineers in March 1915 carried on conversation between a station at Montauk Point, New York, and a station at Wilmington, Delaware, a distance of 300 miles. With equipment developed from these tests the engineers, in the fall of 1915, from the Arlington (near Washington) station of the U. S. Navy, successfully transmitted speech to Paris, France, and to Honolulu, Hawaii. (See Fig. 18.)

This somewhat spectacular demonstration of radio telephony attracted attention to the possibilities of the system, and although twelve years were to pass before commercial radio telephony was attempted between America and Europe, there is no doubt that the 1915 demonstrations paved the way for many of the special applications over shorter distances made during the war.

American engineers identified with the radiophone demonstrations here referred to, and with subsequent applications of radio telephony to various needs of war communication, included: F. B. Jewett, E. B. Craft, E. H. Colpitts, Lloyd Espenschied, R. A. Heising, H. W. Nichols, L. M. Clement, A. M. Curtis, H. E. Shreeve, R. V. L. Hartley, H. D. Arnold, N. H. Slaughter, A. A. Oswald and R. H. Wilson.

Improvement in Construction of Tubes

One of the outstanding developments of the war years 1914-1918, was the great improvement made in the design and manufacture of vacuum tubes. The rather fragile tubes in use previously were not suitable for

war operations in which ruggedness and uniformity of performance were essentials. The experience gained by the telephone engineers from 1912 until 1917 in designing tubes suitable for the purposes of the telephone repeater enabled them when the need arose to successfully meet the specifications laid down by the Signal Corps authorities. Dependable and uniform tubes were produced for both reception and transmission, by the various American manufacturers of tubes.

In the first long distance tests (in 1915) there were used tubes with a rating of 25 watts, a complete transmitter requiring 500 tubes in order to radiate approximately 1½ kilowatts of useful power. Before the end of the war tubes of 250 watts rating were being widely used. By 1921, water-cooled tubes of ten kilowatts rating had been produced; in 1923, twenty-kilowatt tubes and a few years later 100-kilowatt tubes were available.

Chronology of Radiophone Demonstrations

Seeking to know the history of radio telephone development it is important to note that the voice was transmitted through space by Fessenden in 1900, and that in the following six or seven years Fessenden, deForest, and others had radio telephone systems in operation, employing the alternator and the arc as generators of electric oscillations.

Throughout the interim 1907-1914, while no end of experimentation was carried on in all parts of the world, little additional progress was made toward perfected radio telephony. Difficulties were, as has been shown, that suitable microphones were not available, and the methods of voice modulation employed were not such that faithful reproduction was obtained in receivers. Also, the arc and the alternator were cumbersome, expensive, and not suited for mobile stations where sources of commercial electric power were not at hand.

The discovery of the oscillating property of the audion very largely corrected this situation, and although war needs only, from 1915 until the end of 1918, were served by the material improvements made, it is perhaps true that during these four years greater actual progress was made than would have taken place in ten or fifteen years of peacetime. A result was that shortly after the close of the war the various nations had in being a great new utility for which it was supposed no peacetime use existed, but which, differing from the torpedoes and hand grenades developed contemporaneously, contained elements which should make of it an agency for good-will, peace and understanding.

Voice Modulation of Carrier Waves

With the tube available for the

generation of electric oscillations, the subject of the transmitter (microphone) and the problem of modulation were presented in a light which made plainer and easier satisfactory solutions.

Methods of modulation which came into use following the intensive developments of the war years included the *absorption* method and the Heising *constant-current* method. By means of the method variously referred to as *diverting*, *detuning* or *absorption* there is effected a reduction in antenna current when the modulator is in operation, to a value below that obtaining when the modulating voice is not applied, an example of which is the employment of a microphone directly in the oscillating circuit, thus varying its resistance. Or, variously, inductively coupled with the oscillating circuit, or by using a three-electrode tube to absorb energy in its plate circuit, the absorption controlled by speech currents impressed on the grid circuit.

The Heising modulator, in principle, variously referred to as non-absorption, constant current or power modulation, is characterized by alternate increase and decrease of radiated energy above and below the value produced normally by the oscillator.

Experimental experience has shown that there are many ways in which the radiated carrier wave of radio telephony may be modulated in order to reproduce at the receiver the voice sounds impressed on the microphone of the transmitter, but the trend of progress in this respect may be understood by referring to a few of the steps successively taken which resulted in improvements, even if these were destined later to give way to still further improvements.

In the radiophone tests from the Naval Station at Arlington, in 1915, previously referred to, the Western Electric Company's engineers who assembled the system employed a method of voice modulation due to Van der Bijl⁷ which operated on the principle of *amplification control*.

In the apparatus a small sized tube operating on a plate potential of 120 volts was used to generate the requisite sustained waves of constant amplitude. The circuit of the telephone was provided with an amplifier so that the signal impressed on the modulator would have an amplitude sufficient to carry the sustained wave over the range of the modulator's control. The radio-frequency current as modulated had an outlet by way of a tuned circuit and passed through two stages of amplification, the last stage delivering energy to the sending antenna.

The first amplifier was made up of from two to twelve tubes connected in parallel, the number depending upon the wavelength intended and upon the

number of power oscillator tubes employed. The power amplifier consisted of from 300 to 550 tubes, tuned circuits being used to pass the radio-frequency wave from the first amplifier to the grids of the power tubes.

A modification of the Van der Bijl system described above consisted of a modulator tube having two grids instead of usual single grid, and having the sustained wave from the oscillator supplied to one grid while the signalling frequency was supplied to the other. It was pointed out by Heising⁷ that the action of the two grids with their individual e.m.f.'s was approximately the same as that when a single grid was employed, with two e.m.f.'s superimposed. The system was known as *double grid* modulation.

Radio transmission systems invented by C. V. Logwood⁸ and by E. H. Colpitts⁹, were based on the principle that the grid of the tube, being a control member, could be used to control the amplitude of the carrier wave by virtue of signal frequencies impressed upon it.

Coming now to the more efficient *constant potential*¹⁰ system of modulation it may be stated that this consists of a signal amplifier tube in series with a radio-frequency amplifier tube. The former, in a sense serving as a modulator tube, varies the power supply to the radio-frequency amplifier, according to signal frequencies impressed on the grid. The latter tube, with constant radio-frequency e.m.f. applied to its grid converts this modulated power into radio-frequency power, resulting in a modulated carrier wave being delivered directly to the sending antenna. In the actual assembly an amplifier tube is connected in series with a frequency changer; one which adds a frequency and not one which multiplies, and may have a natural frequency that of the carrier wave.

It is not necessary to employ a mechanical frequency changer for this purpose as a tube oscillator serves the desired end. The amplifier tube affected by the signal frequencies impressed on the grid, delivers positive and negative speech frequencies in the form of single-phase currents to the frequency changer tube, which tube adds to these a carrier frequency, delivering to the antenna a modulated carrier current.

In closing this chapter it might be well to recapitulate that modulation in radio telephony refers to the variation at an audio frequency of the amplitude of the sustained constant frequency carrier wave, in accordance with the wave shape representing the speech frequencies.

⁷ *Modulation in Radio Telephony*. R. A. Heising. Presented before Inst. Radio Engineers, New York, December 1, 1920.

⁸ U. S. Patent 1,218,195.

⁹ U. S. Patent Reissue No. 14,380.

¹⁰ U. S. Patent 1,137,315.

⁶ U. S. Patent No. 1,350,752.

As pointed out by C. C. Culver¹¹ "in considering any modulation system there is naturally involved the question of the relative importance of the non-signaling amplitude of the carrier current, and the variation taking place in this due to the modulation brought about at the transmitting station. For a given amplitude of non-signaling carrier wave which may reach a receiving station, the response in the telephone receiver is, of course, proportional to the change in the amplitude of the carrier wave, this in turn depending upon the modulation at the transmitting station. However, the actual amplitude of the carrier current is also an important factor. This is evident when we consider the relation of the amplitude of the non-signaling carrier current to the maximum change which can take place in this current. Even though complete modulation obtains, the current amplitude cannot have a minimum value less than zero or a maximum greater than twice the non-signaling value. . . ."

With a view to providing a system of modulation which would not seriously overload the tubes as a result of modulation being applied, and which would permit of a smaller total number of tubes required to effect modulation, Culver and Logwood¹², independently worked out a grid leak method wherein the usual grid leak resistance is replaced by a three-electrode tube, the plate-to-filament resistance of the tube being controlled by means of voice vibrations through a modulation transformer connected to its grid, the control tube functioning as a variable resistance.

CHAPTER 12

Broadcast Radio Telephony
Prior Events

IN the preceding chapter it was recalled that at the close of the Great War the nations found themselves in possession of at least one war department with outstanding potentialities for the establishment and preservation of peace—radio telephony.

Radio telegraphy had, of course, made great gains during the war years. In 1918 authentic statistics for radio telegraph installations showed throughout the world a total of 6,600 stations, of which 720 were coastal stations, 5,700 on ships and 180 inland, and shortly after the close of the war commercial radio telegraph service was established (or resumed) between practically all of the large countries. Transocean radio telegraph service is in competition with the same message service performed by the submarine telegraph cables, and those engaged in carrying on radio telegraph message service had many international relations to adjust, stations to

transform from war needs to commercial needs, and many details of organization and operation which gave them sufficient to think about and to occupy their time.

But what about radio telephony? Obviously, in its embryo state it could not successfully be applied in competition with wire line service where such wire line service was already established. It was not secretive. A great multiplicity of stations (or circuits) could not be satisfactorily operated simultaneously in a given territory. These were considerations which perhaps prompted landline telephone interests to view with little immediate concern the possibility of radio competition.

In the meantime, however, new forces were at work. Where, prior to the war years, radio telephone exploitation had been left to the resources of individual scientists and small radio companies organized for the purpose of raising funds for experimentation and promotion, following the close of the war several of the large electrical manufacturing companies found themselves in possession of patent rights, radio manufacturing facilities and staffs of engineers familiar with the radio art.

For instance, in the fall of 1920, the Westinghouse Electric and Manufacturing Company acquired control of the International Radio Telegraph Company operating five stations on the American Atlantic coast. (All of the private radio telegraph companies taken over on July 31, 1918 for war uses by the government were returned to their owners on February 29, 1920.)

In the year 1919 the General Electric Company acquired control of the American plant and other assets of the Marconi Wireless Telegraph Company, the name of the company being changed to that of The Radio Corporation of America. In August, 1921, the Radio Corporation took over the stations of the International Radio Telegraph Company, owned by the Westinghouse Company, thus leaving in the radio telegraph field as competitors of the Radio Corporation, the Independent Wireless Telegraph Company on the Atlantic Coast and the

Federal Wireless Telegraph Company on the Pacific Coast. With the exception of the Radio Corporation, which operated transocean circuits to various countries, the business of these companies was mainly ship-shore and shore-ship message service.

A situation was here created which does not often have so happy an outcome. The Westinghouse Company's engineers who had radio inclinations quite naturally welcomed the acquisition by their company of the International Company, but when that control later passed to the newly organized Radio Corporation of America, the Westinghouse engineers (as radio engineers) were back where they started at the close of the war—with radio knowledge, radio experience and with certain patent rights.

It does not require a vivid imagination to picture Frank Conrad, M. C. Rypinski and L. W. Chubb, Westinghouse engineers, in conference or individually, speculating with the query: "Well! what now?" These men were all set to go when the race was called off, and each was of the type that gets into a race even if he has to organize a race of his own.

And this is about what took place. Conrad believed that with a radio-telephone transmitter in operation on schedule regularly, sending out music and other entertainment, there was an immediate audience consisting of perhaps a few hundred amateur radio experimenters who should hear the matter transmitted, and if the service was regular and adequately advertised perhaps hundreds of others would supply themselves with radio receivers by means of which the music might be heard. It was his discovery that what had been said agreeably to this notion was evidently true.

As early as October, 1919, Conrad had set up experimental radiophone transmitting equipment at his home at Wilkensburg, Penna. In September, 1920 he gave to the press a notice that on a certain evening he would send out by radio music from a phonograph mounted near the radio transmitter.

(To be continued)

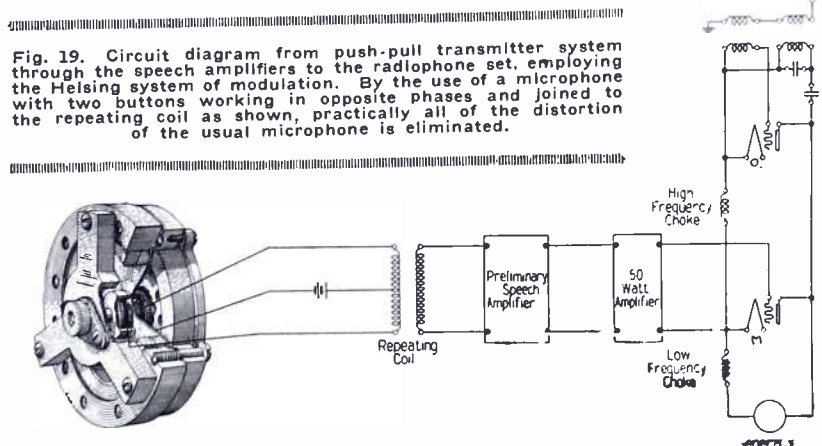

Fig. 19. Circuit diagram from push-pull transmitter system through the speech amplifiers to the radiophone set, employing the Helsing system of modulation. By the use of a microphone with two buttons working in opposite phases and joined to the repeating coil as shown, practically all of the distortion of the usual microphone is eliminated.

¹¹ Proc. Inst. Radio Engineers, October, 1923.

¹² U. S. Patent Application, filed July 2, 1921, No. 1,440,834.



Radio Telephony as Applied to Aircraft

A Description of the Radiophone Equipment Developed by the Communications Department of the Boeing Air Transport System

By Robert H. Freeman*

COMMUNICATION with moving vehicles has long been the dream of man. The railroads recognizing the impossibility of operating fast trains on schedule with any degree of safety to passengers and equipment without having knowledge of the whereabouts of their trains, took up the task of developing some means of communication. Thus, it is after many years of research and development that we now have block systems on all of the first-class railroads and some have gone so far as to install automatic equipment which operates the train independently of the engineer.

With the advent of the airplane and its introduction into the transportation field the same need for control was

* Communications Dept., Boeing Air Transport, Inc.

even more keenly felt than before, as the ships travel at a rate of speed which makes every second count. In the past it has been necessary for the pilot to take off and fly into weather conditions about which he knew nothing, because they were constantly changing. Also, the management was completely out of touch with the craft until it appeared at the terminal field or was forced to return due to bad weather. If the airplane did not appear after a reasonable time had elapsed, a search was organized to comb the country for hundreds of miles to locate the scene of the forced landing.

Airway Requirements

The delay in the air mail delivery and passenger schedule caused by such contingencies could have been avoided

in many cases by communication between the pilot during flight and the ground organization. Unfortunately the plane has no set of rails which it can follow regardless of weather conditions, but has to pick its way through fog, sleet, snow and rain. Thus, it is readily seen that communication with the airplane is of greater importance than with other types of transportation.

With the railroads it was possible to make physical contact with the moving equipment but not so with the airplane. Because of this fact it was necessary to call upon one of the newest branches of science, the radiophone, to fill the needs of this young but rapidly growing means of travel. The development of the radiophone for aircraft work has been of major importance to the entire aeronautical industry, and to the Boeing Air Transport in particular, because it operates over the longest airway, flown regularly, in the world. Planes of the Boeing System now fly over 10,000 miles daily between San Francisco and Chicago and between Seattle and Los Angeles. These are the two longest routes in the United States and offer the most varied flying conditions found anywhere on the continent. The planes must fly from sea level to 12,000 feet and through temperatures ranging from 35 degrees below zero to 135 degrees above, since the routes are over snow-capped mountains and sun-baked deserts.

Realizing that this situation was making itself more apparent, the Boeing System, many months ago made inquiries from manufacturers of radio equipment to ascertain if there was any apparatus available to fulfill its needs. After an exhaustive survey had been made it was found that there was a dearth of information and equipment. It was then that the Boeing System organized a Communications Department for the research and development of the necessary apparatus to accomplish the desired results.

It will be remembered that some

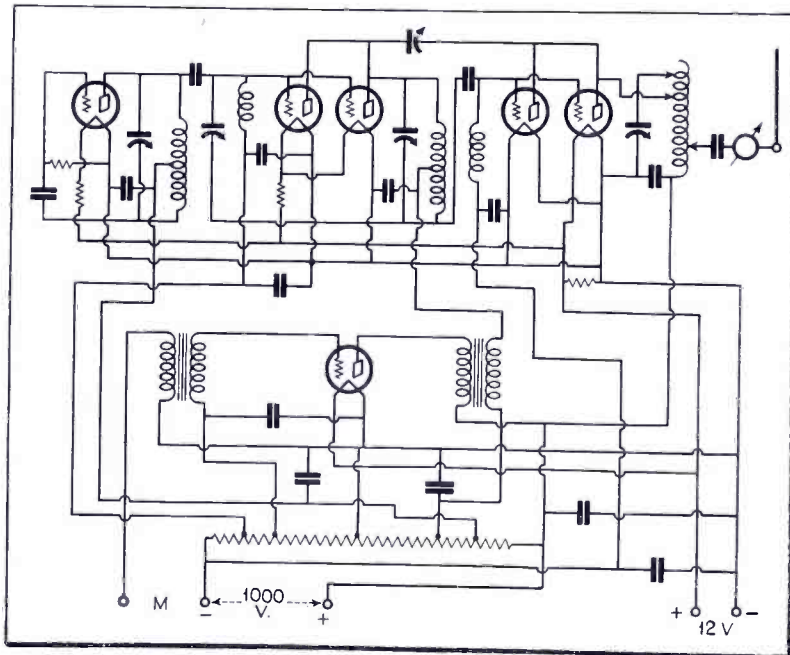

Schematic diagram of the plane transmitter. The modulator is a 50-watt tube, which modulates two 7 1/2-watt oscillators. Two more 50-watt tubes are employed in the amplifier.

work along these lines had been done at the time of the Dole Hawaiian flight, the Southern Cross flight and the present Byrd Antarctic expedition, but also it must be remembered that in all of these cases code was used entirely and then over long distances, hardly ever less than three to four hundred miles. The requirements for this type of communication are far less rigid than those imposed upon the equipment that was to be installed on the Boeing planes. The unusually excellent results with low power on short waves is due almost entirely to the so called sky-wave, but unfortunately this is very unreliable and cannot be counted upon for consistent daily phone communication for distances of one to two hundred miles. Another restriction imposed upon the phone equipment was the barring of all types of trailing wire antennas, for reasons mentioned later on. Then as we all know, the art of communication by means of voice is far more difficult than that of code. Thus it will be seen that this field was hardly touched and a great deal of development work was necessary.

Reduction of Interference

The first problem to be attacked was the reduction of interference caused by ignition noises. The motors in the ships are equipped with two high-tension magnetos which are veritable broadcast stations of highly damped oscillations. It was found that with a receiver of sufficient gain to be of any value in this type of work, that the ignition interference was great enough to paralyze the tubes and block all attempts at reception. Many weary weeks filled with grief and discouraging results, passed before any definite results of a promising nature were secured, but from this work there was developed a "harness" which completely shields all the ignition interference.

During this time many different devices were tried and found wanting in one respect or another. Some were fairly good at one frequency but of no avail at other frequencies. The use of standard braid was tried and found to be very satisfactory, but this was short lived—for as soon as the oil worked down between the strands the contact was poor and the effectiveness of the braid was at an end. The final harness was developed by the Communication Department and it is the only one of which we have knowledge that is entirely successful in completely suppressing the ignition interference below the static level, at high frequencies.

This harness consists of a main ring of aluminum incasing the ignition wires from the point of emergence from the magnetos to the place where the individual wires branch off to their respective cylinders. The individual wires are encased in small aluminum tubes clamped at one end to the main ring, and at the other, connecting to the special spark plugs with a

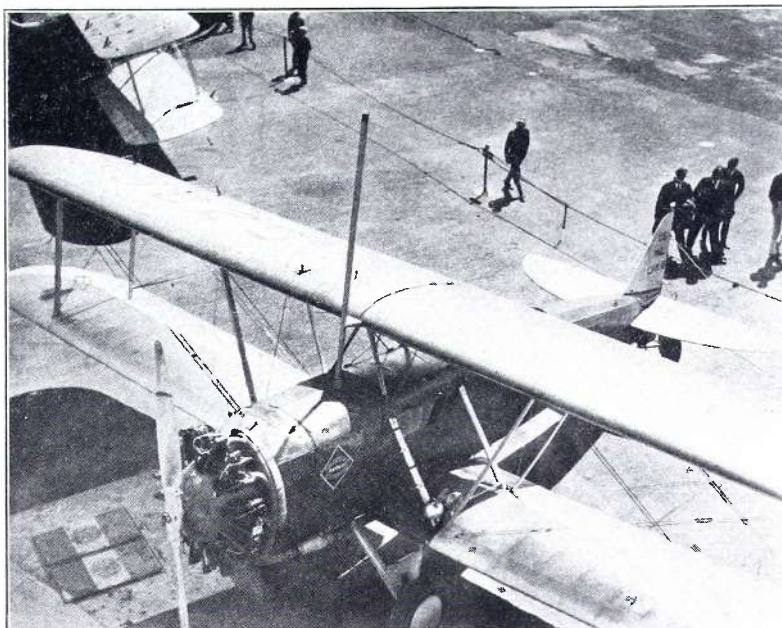

One of the Boeing Transport planes equipped with a streamlined antenna. It can be seen jutting into the air from in front of the upper wing.

short piece of double Belden braid, which is so placed that it is not readily soaked with oil.

The spark plugs offered a very serious obstacle to the complete shielding of the ignition system, as up to the time our work was commenced nothing had been accomplished along this line. The usual shielding stopped an inch or so from the plug and the receivers used then did not have sufficient gain to be greatly bothered with the amount of radiated energy that came from the plugs. Also, at the lower frequencies, used by the Army, Navy and others, this interference was found to be greatly attenuated, but unfortunately these frequencies were not available to us and so it was necessary to use the higher ones where the ratio of interference to static was very much greater, making it necessary to shield even the very shortest section of the ignition system.

Shielded Spark Plugs

At this time the B. G. Corporation undertook to develop a shielded plug but as this required considerable time the Boeing radio test ship was equipped with the usual type of plugs which were then encased in copper cans and attached to the shielding tubes. The main difficulty with this method was the fact that the plugs did not receive sufficient cooling and soon broke down in service. Also, the extra care in servicing the ship was not met with approval by the mechanics. However, this served to carry on the experiments until the first set of shielded plugs arrived.

These plugs, while electrically satisfactory, were mechanically weak and after a short time had to be replaced with new ones. However, they were far superior to the copper can method.

The outer end of the plugs terminated in a long bronze tube lined with mica and containing the terminal at the bottom. The ignition wire fitted into a mica tube which in turn was inserted into the mica-lined bronze tube allowing the end of the wire to come in contact with the terminal of the plug. A bronze cap fitted over the end of the tube and was soldered to the shielding. Later, a superior type was developed in which the mica was replaced with a new form of bakelite and also having an elbow which can be revolved permitting greater ease of attaching the ignition lead.

At the magneto end of the harness it was found necessary to cover the distributor blocks with a machined case, removable for servicing purposes yet fitting so closely that a .010" gauge could not be inserted between the case and the magneto. The magneto is a good shield in itself but it was necessary to plug all the small holes and completely shield the ground and booster wires and the entire booster system. This work was accomplished by one of our engineers whose full time was devoted to this one task. He used a superheterodyne with a gain well over 10⁶. Even after completely quieting a ship in this manner, after a few weeks of service, the ship would again become slightly noisy and usually the trouble would be a broken pigtail or oil soaked cable. However, after trying many types of harnesses it was found that the one referred to would stand up in service longer, accomplish the results better, and require less maintenance than any of the others.

Special "Bonding"

During our work with the shielding of ignition noises it was noticed that

certain other noises, which were very objectional at times, did not come from the ignition system, as they could be heard when the ship was on the ground, with the motor stopped. Upon investigation it developed that these noises were caused by the rubbing together of two metal parts or the sudden change in the potential between the various parts which are included in the ground system. The ship had the standard bonding as required by the Aeronautics Branch of the Department of Commerce, but this was entirely insufficient for radiophone work.

At times the noise assumed tremendous proportions, blocking all attempts at reception. When using the high frequencies, which have been found to be most suitable for airplane communication, it was discovered that so slight a thing as a control pin which had not been bonded across will reduce the intelligibility as much as fifty per cent.

A new type of turnbuckle for the control wires was developed to provide effective bonding for service conditions, and this is now standard equipment on all factory planes. The work of eliminating this source of interference was very discouraging but the results produced were well worth the effort and now we have been able to standardize this bonding for factory use so that all planes now emerging from the Boeing Airplane Company of Seattle are suitable for radio installation without the necessity of additional bonding. Since the advent of the shielded ignition system and the new bonding, it has been possible to obtain more delicate voice reception than has ever been achieved before and it has permitted the reduction in the power of the ground transmitters.

Receiver Requirements

After using in actual service a good many kinds of receivers the following requirements were formulated which cover the situation fairly well. First, the receiver must be capable of locking on the frequency of the ground transmitters. Second, the receiver must have a gain of at least 10³ or approximately 120 db. Third, the volume control must be effective, quiet, and easily operated with gloved hands. Fourth,

the receiver must be rugged but readily replaceable in six minutes.

It might be well to explain why the above requirements were deemed necessary. The locking of the tuning is very essential as the time the pilot needs the weather information, etc., is when he is extremely busy flying the ship and has no time to tune the receiver. The gain must be great enough to cover the distances between the land stations, using an eight-foot mast for the receiving antenna. Due to the cold weather on all the mountain passes from early fall to late spring the pilots wear gloves or mittens and will not remove them to operate the volume control. The receiver must be able to withstand severe shocks so that in case of a forced landing it will not be rendered inoperative. Also it must be easily removed from the ship and another installed while the ship is being "gassed," otherwise it may retard the mail. There are many other considerations which lend their contributing factor but as they are of relatively minor importance they will not be taken up in detail.

The superheterodyne type of receiver was tried and has a good many fine points but could not be used due to the innumerable broadcast harmonics which beat with the oscillator causing the all too familiar squeal. At some time in the future when the broadcasting companies realize that the radiation of harmonics is not necessary nor essential to the proper operation of their stations, the superheterodyne may be used to great advantage. Until that time the tuned radio-frequency type of receiver must be employed. In this case it consists of three screen-grid tubes as radio-frequency amplifiers, a detector, and two stages of audio amplification. The r.f. stages are tuned with a gang condenser which is supplemented with a single plate vernier condenser, so that the final tuning is more readily accomplished. This fine adjustment is remotely controlled from the pilot's cockpit in case the ground stations are not exactly on the same frequency so that the receiver may be shifted slightly for maximum gain. This adjustment covers only a few kilocycles and does not require close setting, which would

be an impossible task with gloved hands.

Receiver Circuit Heavily By-Passed

It was found necessary to filter the plate, C-bias and screen-grid leads of all the radio stages, otherwise undesirable coupling would cause oscillation of one or more of the amplifiers.

The plate supply is derived from batteries, which fact will undoubtedly cause comment as the approved method is to make use of the voltage supplied from the generator which operates the transmitter. This was not done for the reason that in case of a forced landing, due to engine trouble or for some other cause, there would be no plate supply to operate the receiver. This would defeat one of the reasons for equipping the ships with radiophone, as it would be impossible for the pilot to receive the instructions that would inevitably be sent to him in case of such a contingency arising. If the high voltage from the generator were used it would necessitate the addition of a suitable filter and voltage divider which would weigh nearly as much as the batteries and would have none of the advantages. The filaments are heated from the twelve-volt battery which is used for starting, lights, etc., and is part of the regular ship equipment.

Special Headphones

Special headphones are used in connection with the receiver. These are low impedance phones of light weight construction that are very effective in blocking out the engine noises and certainly are much more comfortable to wear than the regular headphones. Each pilot has a pair that is made to conform to his ears so that no discomfort is felt even after six or more hours of use. Even the operators of the ground stations prefer them to the regular headphones. The total weight of the pair of "phonettes" is about three ounces and the receiver, exclusive of the ear plug, is about the size of a dime and three-eighths of an inch in thickness. The gain in these "phonettes" is equal to or greater than that of the usual high impedance phones in spite of their diminutive size.

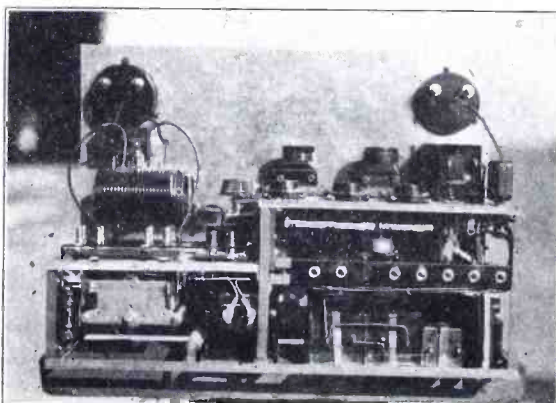

Two general views of one of the plane transmitters. Note the three 50-wattors in the right hand illustration.

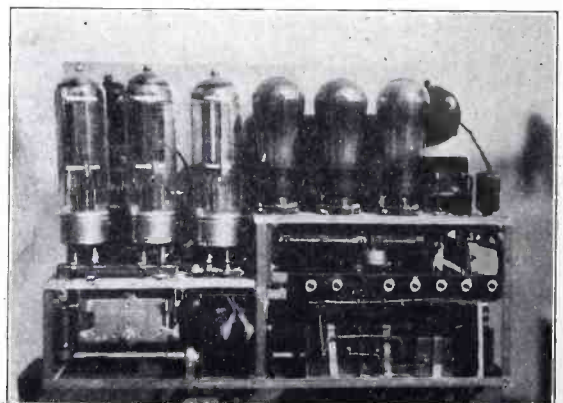

Details of Plane Transmitter

As in the case of the receivers, numerous types of transmitters were used for the preliminary tests, and the following requirements were found to be necessary for the proper operation of the transmitters. First, the frequency must be stable at all times, especially during heavy modulation. Second, the power output must be as great as possible, using as a maximum one-thousand volts and five-hundred milliamperes. Third, the ratio of side-band to carrier must be as large as possible and still keep the speech intelligible. Fourth, the set must be entirely automatic except for the starting and stopping which shall be controlled remotely with a single switch. Fifth, the set must be readily interchangeable so that it may be removed and another inserted in the ship in six minutes.

To fulfill the first condition, a master oscillator and two stages of power amplification were necessary. The modulation was accomplished on the intermediate amplifier so that the frequency of the oscillator would not be changed and also so it would be possible to secure complete or one hundred per cent. modulation of the carrier.

A fifty-watt tube is used to modulate two seven and one-half watt tubes and by the proper use of audio chokes and correct plate voltages, full modulation of the carrier is attained. The modulated radio-frequency energy is then amplified by two fifty-watt tubes, giving a carrier power of fifty watts, and under heavy modulation a peak power of two hundred watts, which is far more effective than one hundred watts, fifty per cent. modulated, as the noise that "rides in" on the carrier is greatly reduced in relation to the sideband.

The transmitter is just a straightforward master oscillator, power amplifier with modulator, as can be ascertained by reference to the pictures and circuit diagram.

Control of Transmitter

The functioning of the transmitter is controlled by a relay operated from the same switch in the pilot's cockpit as the receiver. This unifies the control greatly in that the pilot has only one place to look or feel for when he desires to use the equipment. The power for the filaments and plates is derived from a double voltage generator mounted on the main engine. A special type of control box is used to keep the voltage constant with varying motor speeds. This control consists roughly of a voltage-operated relay and a resistance in the field circuit of the generator. As the voltage rises the relay is opened, inserting the resistance in the field and thus reducing the voltage. This operation normally occurs about sixty to eighty times a second. The ship's storage battery is floated across the low voltage side so



Eddie Allen wearing one of the special microphone mountings that moves with the head, so to speak.

that it may be charged at all times for the starting and lighting loads and also to act as a partial filter for the slight ripple in the generator.

The Microphone

The question of a proper microphone was rather a serious one for quite a while, but it was found that a popular type of mike used by the telephone company would do the trick very nicely. It was discovered that neither the hand type of mounting nor the usual breast type would answer our needs since the pilot needs both hands in bad weather and if he moved his head to one side he would be out of range and a message might be lost. The mounting shown proved to be the answer to our difficulties as it does not allow the pilot to get out of range of the microphone unless he purposely does so by lifting it out of the way. The type of microphone shown in the picture is not the one used at the present time, but it will tend to show the new mounting.

Streamlined Antenna

The subject of antennas was a much discussed and argued question and in the end a good many were tried out and about as many were found wanting in one respect or another. The trailing wire was out of the game since a good many times in the flying of the mail it is necessary to travel very close to the ground to keep under the clouds and thus a wire over fifteen feet long would be a menace to those on the ground as well as the ship.

It would take too long to enumerate the many types tried, so a short description of the final antenna will have to suffice. It consists mainly of a vertical duraluminum streamlined mast about eight feet long, which is self-supporting and mounted at the front edge of the upper wing. This mast is insulated from the ship and is used for both transmitting and receiving. Because of the low doors on some of the hangars it was thought advisable to hinge the mast so that it could

be folded down to allow the ships to be housed.

The type of antenna had some effect upon the frequency that was chosen, but the main consideration was the effectiveness of the frequency. To determine this it was necessary to try many frequencies at varying distances, altitudes, and time of day. This required many hours of flying under all types of weather conditions. As a result it was determined that different frequencies would have to be used for the day and night conditions and thus another limiting factor was placed upon both the transmitter and receiver for now they had to be constructed with a frequency shift that could be operated in a minimum of time.

The ground equipment was not nearly the bugbear that the ship's was but still it was found necessary to watch closely the performance of both the transmitter and receiver. We were enabled to use a good antenna and ground and for this reason it was not necessary to use receivers with as much gain as those in the ships. Two stages of screen-grid, with a detector and two stages of audio amplification were found to be sufficient.

The transmitter on the ground was built along the same lines of design as the ship sets but of course they were not as limited to power. They were somewhat restricted, however, due to economic considerations and the requirements imposed upon us by the Federal Radio Commission. As a result all the intermediate stations are not using more than two hundred and fifty watts and the terminal stations not more than five hundred. However, in all cases the system of one hundred per cent. modulation is employed so as to obtain the most effective signal in comparison to static and other noises.

The writer realizes that he has only hit the high spots in this story but each one of the problems outlined above would furnish material for a complete article. This is presented in the hope that it will give the reader an insight into what has been accomplished along the line of aircraft radio telephony in the past few months by the Boeing Air Transport.

RECTIFIER VOLTAGE

IN designing a B eliminator it is important to keep in mind that the voltage obtained across the input circuit of the filter may run higher than the voltage rating of the power transformer.

As an example, a rectifier circuit employing a CX-380 full-wave rectifier tube, with 350 volts per plate supplied to it by a power transformer, will deliver to the input of the filter circuit (across the first filter condenser) a voltage of almost 350 volts at a current drain of 100 milliamperes. If a voltage of 300 volts per plate is supplied by a transformer, the tube will deliver about 280 volts to the filter at 100 milliamperes.



Book Review



THE RADIO INDUSTRY—The Story of Its Development as Told by Leaders of the Industry. 330 pages. 6x9½ inches. Stiff cloth covers. Illustrated. Published by A. W. Shaw Co., Chicago, Ill. Price \$5.00.

Every industry in the world today has gone through more or less identical evolution. First scientists discovered the principles upon which the fundamentals are based; then another group apply these principles to a specific object. Someone manufactures this object in his backyard, sells it and expands his factory; the product is imitated and improved upon. Then capital becomes interested in the venture—and presto!—we have a new industry.

This sounds very simple, but in the case of the radio industry the evolution has been in progress for centuries. It must be remembered that electricity is the principle upon which radio is founded and the list of discoverers of the axioms of this branch of physics is indeed a long one. Then radio was found to be practical and in 1919, we might say the radio industry got its real start. Of course, prior to this quite a bit of capital was tied up in wireless telegraph stations and the manufacture of apparatus but the statisticians did not have to calculate in hundreds of million dollars, in those days.

If you are interested in following through the past development of radio and its merchandising side, this book will give you facts. It consists of a series of eleven lectures presented before the Graduate School of Business Administration at Harvard University, by men conceded to be leaders in their respective phases of the radio industry.

The first four lectures trace the development of the science from the first discoveries of the principles, to 1917 and from the World War to the present. Then the development of broadcasting, its laws and what it is doing today. Then how broadcasting and the radio industry are being put across to the American people.

As the lectures were generally recruited from the forces of the Radio Corporation of America, this organization has a prominent place throughout the book. Yet this is perhaps justified, because the credit must be given to this and its parent companies for the vast impetus they have given radio here in America. Yet we cannot say that this book is a comprehensive history of the radio industry in the United States. Many others were instrumental in pushing ahead the industry to its present stage of development.

However, if you find romance in business here is a book which you will appreciate. It contains much that is valuable for general information as to just how the whole thing came about. It is well presented on the whole but certain portions proved to be a narcotic.

ELECTRICAL CONDENSERS, Their Construction, Design and Industrial Uses.—By Philip R. Coursey, F. Inst. P., M. I. E. E., Fellow of the Physical Society of London, etc. 637 pages. Illustrated. 5¾x8½ inches. Stiff buckram covers. Published by Isaac Pitman & Sons., 2 W. 45th St., New York City. Price \$10.00.

When an engineer prepares a paper on any one component of a transmitter or receiving set, he almost always calls it "the heart of the set." This is particularly true of those who discourse on vacuum tubes. Now while we do not wish to cast any aspersions on the notable brain child of Fleming and deForest, and concede the great import of tubes in general, yet it should be remembered that there are equally important parts behind the panel.

One of the most important—and it is about two centuries older—is the condenser—and its forms are legion. We think a very nice little debate could be staged as to the relative worth of a vacuum tube or a condenser in broadcast work.

Engineers of today are finding condensers more and more useful and so a book devoted to their history, theory, manufacture, testing and use should prove of great

interest. As is usual the author gives the historical background of the device; the development of the formulae from $C = Q/V$

onward and a clear and simple explanation of what capacity is in electrical work, the properties of different types of condensers, etc.

Chapters IV and V are devoted to the properties, determination of the properties, losses and breakdowns of dielectrics. Chapters VII and VIII are concerned with the capacity of antennae and underground cables and condenser design and calculations, with the measurement of capacity and testing.

Variable condensers are considered thoroughly in Chapters XI and XII. Then a chapter on each of the following dielectrics: air, glass, liquid, paper and mica. Chapters XVIII and XIX are devoted to condensers in high-tension and power work. The last chapter takes up the commercial applications of condensers. An exhaustive bibliography and fair index complete the work.

Condensers today can be accurately calculated, far different from the "cut and try" method of several years ago. The author has included several charts and curves to facilitate such calculations and calculations for circuits.

In short, any engineer that uses electrical condensers in his work or anyone who wishes to get a good working knowledge of the subject, will do well to have this book in his library.

THE RADIO MANUAL.—By George E. Sterling, Radio Inspector, U. S. Department of Commerce. Edited by Robert S. Kruse, formerly technical editor, "QST." 666 pages. Illustrated. 5¾x8 inches. Semi-flexible binding. Published by D. Van Nostrand Co., New York City. Price \$6.00.

One of the most difficult of all handbooks or manuals to compile is one covering the science of radio. Today the theory is constantly having additions made to it by new discoveries and new apparatus. It has been the experience of several publishers that within a comparatively few months after the publication of a book of this type large portions of it were more or less obsolete.

These books have generally dealt with apparatus used by broadcast listeners and it is a hopeless job to be up-to-date on that type of apparatus. Mr. Sterling wisely refrains from mentioning anything whatsoever about broadcast receiving apparatus, except some of the receiving circuits that are more or less fundamental in principle.

The first chapter of the Radio Manual deals with the fundamentals of electricity and magnetism. While it is freely admitted that the electronic theory should be thoroughly understood by those undertaking the design of new apparatus and experimenting in the laboratory, we are willing to wager that the average "hauu," service man or what are you thinks in terms of "A and leads" and not where the electrons are going or coming from. And moreover, if the electronic theory be considered at all, at least let us not lead the groping mind astray.

The author, in describing the electrification of glass and rubber rods by means of rubbing them with silk and wool respectively, says that electrons are rubbed from the glass rod, thus leaving it with less than its normal amount and that electrons are added on the hard rubber rod by rubbing it with wool. On first reading this appears that when glass is rubbed with a piece of silk some of the glass itself is carried off, because electrons are the components of the atoms of the glass. If electrons are removed then the glass undergoes a chemical change, because it is impossible to add or remove an electron to or from an atom without transforming it into another element. The same is also true in respect to the rubber rod. Now this is certainly not the case, for we have yet to hear of glass being changed into some other substance by merely rubbing it with a bit of silk or rubber with a piece of wool.

It is also admitted that the electronic theory is one that is difficult to explain to the uninitiated and it seems as though it would be more feasible to omit it altogether in a text book obviously for operators and service men. If they want this part of the theory let them consult standard physics books where it is set forth clearly and precisely.

The second and third chapters deal with motor generators, storage batteries and charging circuits. Chapter four gives an excellent exposition of the vacuum tube and its applications in various fundamental circuits. The fifth chapter takes up vacuum tube transmitting circuits and the sixth, modulating systems used in broadcasting. Wavemeters, piezo-electric oscillators, wave traps and field strength measuring apparatus are considered in chapter seven. In the next chapters, marine, broadcasting, and spark transmitters are described. Chapter twelve contains data on circuits, sets and the maintenance of commercial apparatus. In the thirteenth chapter marine and aircraft radio beacons are discussed and amateur short-wave apparatus is described in chapter fourteen. The last two chapters are devoted to radio laws and the handling of traffic. In three appendices, U. S. Naval Stations' schedules, automatic alarm apparatus, and kilocycle-meter-conversion tables.

The book should prove of value to the man preparing to pass his operator's license examination and also those who already are brass bouders. It is up-to-the-minute as far as these people are concerned, but for the average man only about the first third of the book would be useful.

The circuits and apparatus are carefully explained and well illustrated. A good index completes the book.

VIBRATION PROBLEMS IN ENGINEERING.—By S. Timoshenko, Professor of Engineering Mechanics, University of Michigan. 351 pages. Illustrated. 6x9¼ inches. Stiff buckram covers. Published by D. Van Nostrand Co., Inc., 8 Warren St., New York City. Price \$4.50.

No matter in what phase of industry the engineer is working he is confronted sometime or other with the matter of vibrations. This is especially true of those designing modern machinery, in which, due to the increase of size and velocity, the analysis of vibration problems is becoming more and more important.

Such problems as the balancing of machines, the torsional vibration of shafts and of geared systems, the vibrating of rotating shafts, the vibrations of foundations, etc., can be thoroughly understood only on the basis of the theory of vibrations. The most efficient design proportions can be found only by a consideration of this theory, so that the operating conditions of a machine will be removed as far as possible from the critical conditions at which heavy vibrations may occur.

This book will be of value to the engineer who is working on problems in which some or any types of vibrations occur. It is not a book for the novice nor for those whose mathematics consist of the recognition of an integral sign when one is met.

The opening chapter contains a discussion of harmonic vibrations of systems with one degree of freedom. The general theory of free and forced vibrations is set forth with the application of this theory to balancing machines and vibration recording instruments.

The second chapter deals with the theory of non-harmonic vibrations of systems with one degree of freedom. In the third chapter systems with several degrees of freedom are considered and in the last chapter is the theory of vibration of elastic bodies.

It is impossible in this space to describe the many phases of different types of machines Prof. Timoshenko considers from the viewpoint of vibrations. Suffice it to say, he applies his theories to problems that the engineer is "up against" and explains his applications clearly and concisely.

There are also brief descriptions of the more important vibration-recording instruments used in experimental investigation.

The book is well indexed.

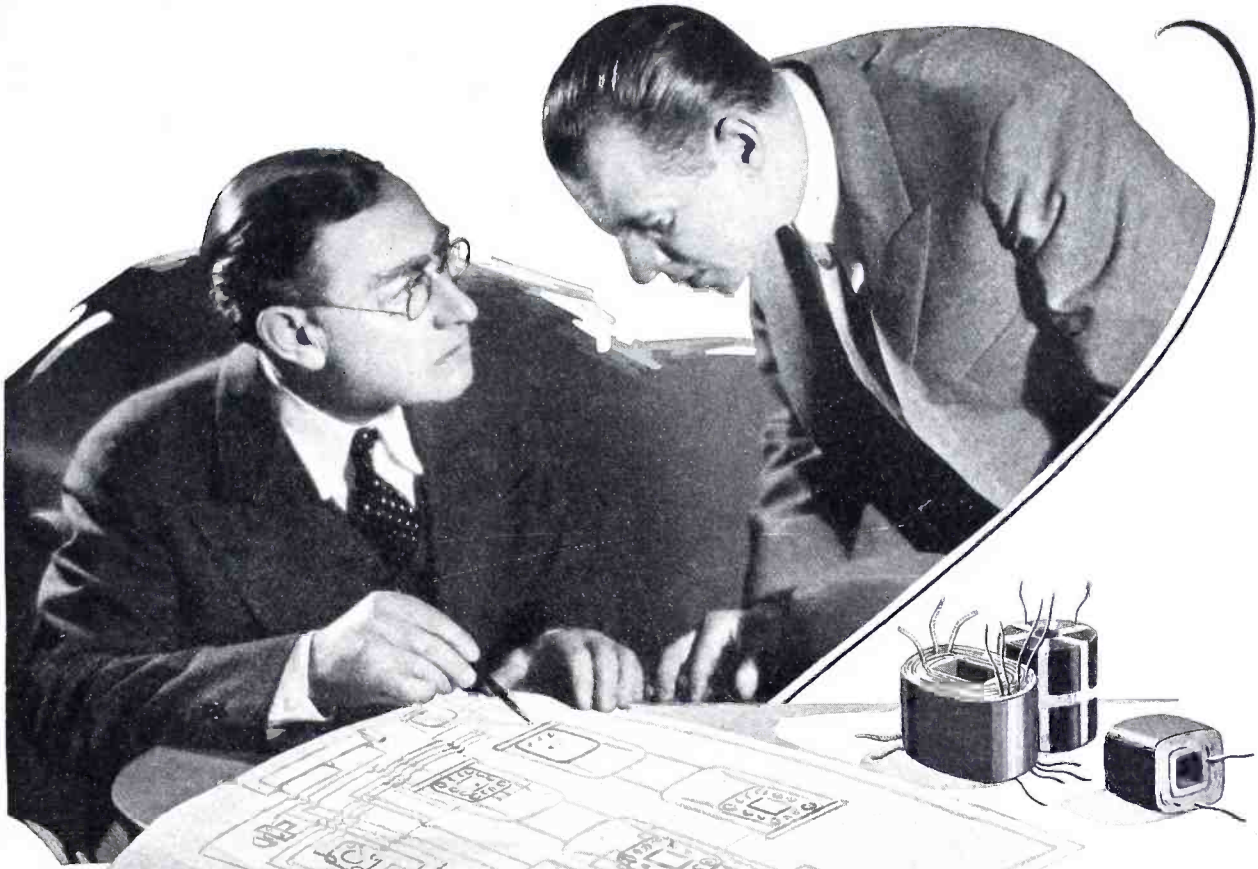

“Here’s where we need Your help”



In this manufacturer’s newest model, Dudlo coils occupy the strategic positions in all audio, power and speaker units. He is taking no chances on slipshod coils again playing havoc with his reputation.

NOT very long ago a prominent radio manufacturer unrolled a blue-print, and turning to the Dudlo sales engineer who stood by his desk, said: “Here’s a job for you fellows at the Dudlo plant. We’ve had a lot of trouble with this power coil. Can’t seem to get it to deliver the proper “B” voltages for these new tubes without overheating. Here’s where we need your help . . . what can you do for us?”

The Dudlo man’s assurance that this manufacturer’s coil troubles would be overcome proved to be fact. Now every radio that leaves the factory is equipped with a specially designed Dudlo power transformer coil, and all former complaints against voltage loss or overheating have automatically ceased.

DUDLO MANUFACTURING COMPANY, FORT WAYNE, IND.
 Division of General Cable Corporation

DUDLO

THE COILS THE THING IN RADIO

NEWS OF THE INDUSTRY

MALLORY & CO. OPENS NEW PLANT

P. R. Mallory & Co., Inc., of which Elkon, Inc., and Knapp Electric, Inc., are divisions, announces the purchase of a new all fire-proof four story building in Indianapolis. The company commenced moving its Radio and Toy divisions into the new plant April 1st. These divisions will be entirely set up and in perfect running order before the other divisions, Elkointe, Fans and Motors.

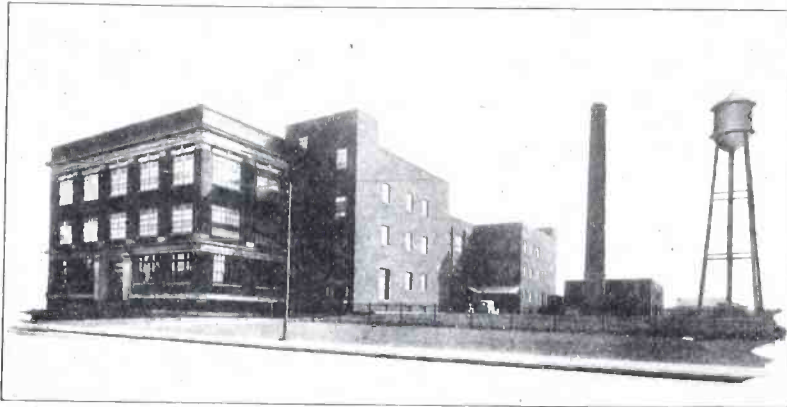

The new Mallory plant in Indianapolis.

Electrical Contacts, and Carboly will be moved.

It is estimated that the entire plant will be in operation by October 1st.

The new plant has about 200,000 square feet of floor space. Is entirely fireproof, completely sprinkled, and is modern in every respect. The power plant is in a separate building which is connected with the main plant by a subway. Railroad sidings are in. The plant is completely enclosed with a fence, and is surrounded by a well kept lawn with flower beds.

The executive offices of P. R. Mallory & Co., Inc., will be continued at 350 Madison Ave., New York, but the main sales offices will be located in Indianapolis.

A New York sales office will be maintained and complete stocks of the radio products of both Knapp and Elkon will be kept so that manufacturers, jobbers and dealers in the East will be able to secure prompt service.

STEINITE ENTERS WORLD MARKETS

The Steinite Radio Company, of Atchison, Kansas, Chicago and Fort Wayne, Indiana, announces that it has added an export department at the Chicago office and is now fully equipped to distribute Steinite sets in all foreign markets.

Mr. A. J. Hutter will head the Steinite Export Department, assisted by a staff of correspondents in Spanish, French, Portuguese and German. Mr. Hutter has been connected with the export trade for many years, and is widely known for his broad knowledge of foreign markets and trade conditions—particularly those in Latin America and Europe.

CARTER RADIO COMPANY MOVES INTO NEW FACTORY

According to a statement issued by A. J. Carter, President of the Carter Radio Company, of 300 South Racine Avenue, Chicago, that organization will move into new and larger quarters on or about May 1, 1929. The need for greater production of parts at reduced cost in meeting the demands of set manufacturers, is given as the reason for the change.

STROMBERG-CARLSON EXPANDS FACILITIES

The big, new Stromberg-Carlson plant in Rochester where both radio receivers and telephone equipment will be manufactured has been completed and is ready for the busiest season in the company's history. Every effort has been exerted to make this structure justify the title, "The Best Telephone and Radio Factory in the World."

crete driveways lead to either end of the platform and the space between the rails of the siding is filled flush with cinders making any part of the loading platform available to trucks.

The type of construction used on this plant is the monitor type. Fifteen monitors, like great inverted troughs with windows on either side, run through the building from east to west, with the supporting trusses within the monitors themselves, covering spans usually of 60 feet, but of 100 feet in one section of the plant. Such construction makes possible a wider space without supporting posts and thus increases clear space in the factory. The reduction in the number of posts makes possible the more efficient placing of machinery and benches. Another advantage of monitor type construction is that it insures perfect light to every part of the working area.

In heating, steam is led to units in the center of each monitor and equitably distributed by means of heating ducts, hung in the tops of the monitors where they do not interfere with the lighting. In the cabinet shop an ingenious filter system removes any dust made by the cabinet machinery, which fails of being exhausted by the usual collector system, before it reaches the heating coils.

One of the outstanding features of the new Stromberg-Carlson plant is the huge radio assembly department with a continuous belt for carrying the completed chassis down to the final testing room. All throughout, whether in plating department, japan department, braider room, or cabinet shop, the latest type of equipment has been installed.

As the company manufactures both telephone and radio equipment, activities common to both fields are grouped together. Many of the machines can be used for either telephone or radio work and most of the employees can be assigned to either field. This insures both labor and machinery being used to the best advantage, for it is possible to transfer men from one field to the other as the necessity arises and thus retain an experienced force. Practically all the work connected with the manufacture of telephones, switchboards, radio receivers, and loudspeakers from the making of parts to their final assembly will be carried on entirely under the roof of this one plant.

The grounds include 28 acres, while the factory building measures 625 by 460 feet overall and covers approximately 360,000 square feet of floor space. The plant is a single building, one story high, divided into four units with a basement under one of them. A private siding enters the property from the adjoining New York Central main line. A shipping and ten feet wide platform of car-door height and receiving runs the full length of the building and can accommodate at one time a dozen freight cars and a fleet of trucks and vans. A spare truck over 750 feet long will take care of any extra cars. Con-



The new Sonatron tube factory located at Chicago.

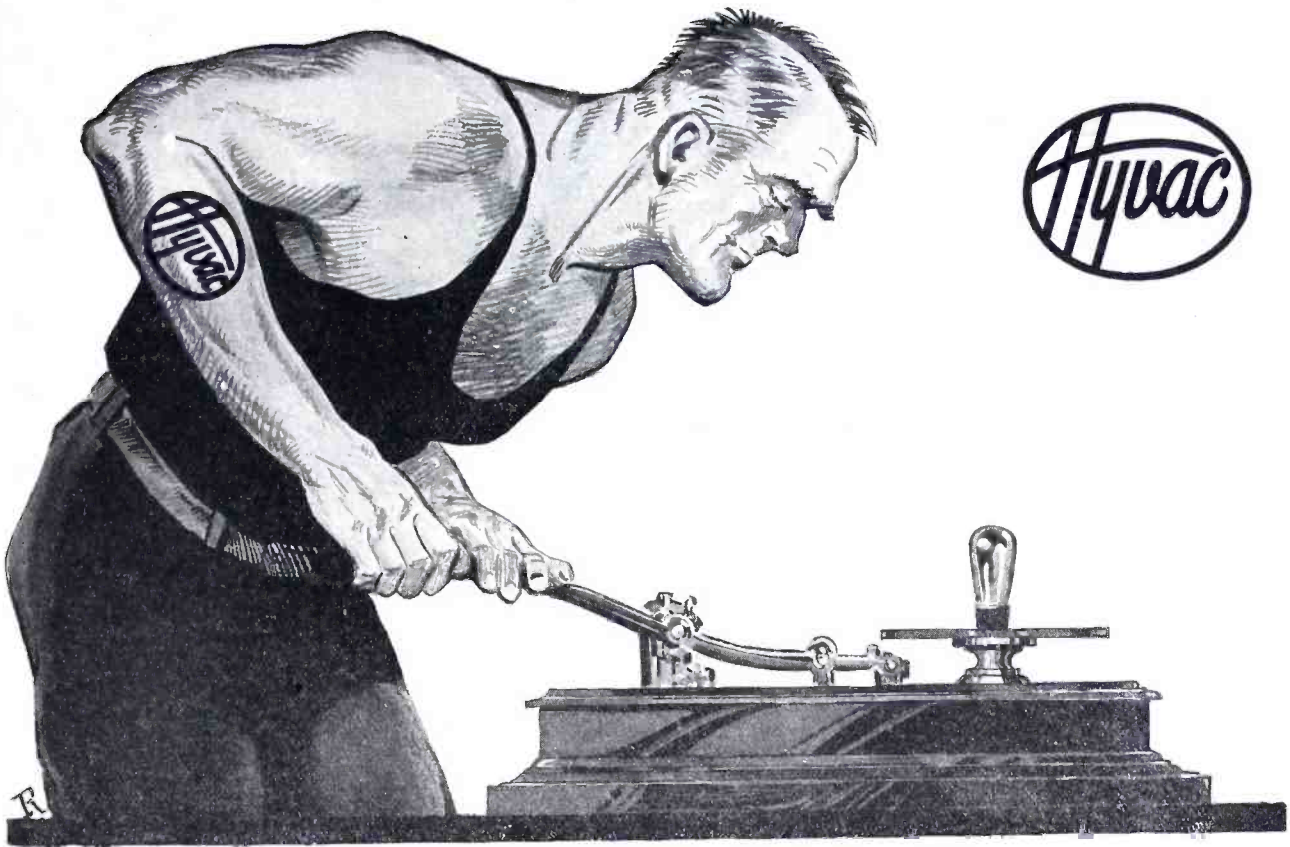

One of the Earliest Known Methods of Securing Vacuum

HYVAC the super-vacuum RADIO TUBE

TREMENDOUS strides have been made in the manner of creating vacuum since the primitive method illustrated above and to this progress the radio tube industry largely owes its present high standard of perfection.

However, the basic principle of tube efficiency, namely "the degree of high vacuum" obtained in a radio tube, remains the same. Modern methods and equipment, combined with the special Hyvac process of exhaust, have made it possible for Hyvac engineers to create radio tubes that set a new standard for crystal-clear reception, humless tone and long life.

To assure your customers the ultimate in radio reception, plus liberal profits for you, stock Hyvac Radio Tubes.

Distributors: Guaranteed exclusive distribution only. Write at once for full information on this outstanding tube proposition in the radio industry.

HYVAC RADIO TUBE CO.

INCORPORATED 1926

38 SPRING STREET

NEWARK, N. J.





The new Erla plant in Chicago; formerly the Cable Piano Co. factory.

ERLA EXPANDS

Purchase of the Chicago plant of the Cable Piano Company by the Electrical Research Laboratories presages large scale expansion in the manufacturing activities of this institution, according to Burton Greene, president.

Cabinets as well as receivers, electro magnetic pickups and dynamic speakers will be manufactured in the new quarters, under the most modern and efficient production methods, using the straight line principle of assembly, materials conveyance, etc.

Real estate acquired measures roughly three acres, with area under roof approximately 300,000 square feet. Land now unoccupied by buildings provides space for tripling present floor space, if needed. Appraised valuation of the property is \$1,500,000.

Equipment for manufacturing 1,500 cabinets daily was taken over as part of the purchase. Including a battery of five dry kilns with a capacity of ten carloads of lumber. Contemplated additions to equipment, together with a rearrangement of the production layout are expected to increase cabinet capacity to a maximum of 2,500 per day, without adding to floor space.

Cable employees previously engaged at the plant in piano manufacture are being retained as a nucleus of the Erla cabinet manufacturing division. Piano standards of workmanship and finish are expected to rule in Erla cabinet manufacture, as a result.

Manufacturing operations now conducted at the Erla plant at 2500 Cottage Grove Ave. and at the Greene-Brown plant at 5100 Ravenswood Ave., will be transferred to the Cable plant as rapidly as possible.

Mass production of the entire new Erla line, including cabinets, is scheduled to be under full headway at the new plant in another thirty days. Meantime production of new Erla models at the present Erla plants is being steadily maintained.

DEJUR-AMSCO ENLARGES CHICAGO OFFICE

The Chicago office of the DeJur-AmSCO Corporation at 77 West Washington Street, has been removed to larger quarters in the Wrigley Building, Chicago. The change was made May 1st. The new telephone number will be Superior 8855. Mr. William E. Burgoyne is the DeJur-AmSCO representative in charge of the Chicago office.

NEW ALL-AMERICAN MOHAWK PLANT

In preparation for the 1929-30 season, the All-American Mohawk Corporation, manufacturer of Lyric radio receivers, has installed new production facilities and methods in its Chicago plant, and will consummate another major step with the official opening of its new cabinet plant in North Tonawanda, N. Y., it is announced by Eugene R. Farny, president. The new plant will supply the corporation with its entire schedule of Lyric consoles.

Officials of the corporation will throw

open the doors of the North Tonawanda plant at the 1929 annual convention of Lyric distributors. The officials will be hosts to between 100 and 125 of their distributor representatives.

The cabinet plant is one of the largest and finest in the country, Mr. Farny said, and will give his corporation the advantage of having all of its consoles manufactured in one place, along with important collateral benefits that accompany centralized control, such as rigid supervision, high quality, economy and like advantages.

Changes of revolutionary importance have been made in the Chicago plant, with the result that approximately 92 per cent. of all parts of the Lyric receiver are now being manufactured under the corporation's own roof. New manufacturing facilities and methods have been installed under the direction of Dr. Whit L. King, factory manager, whose principal task with Lyric has been the reorganization of production processes. Present capacity of the plant has been more than trebled without having to resort to expansion of plant structure.

FORMICA BUILDING NEW PLANT

Construction was begun on May 5th of a new factory addition to the plant of The Formica Insulation Company, Cincinnati, Ohio which would add 25,000 feet of floor space to the plant at a cost of about \$50,000.00.

Demands of the electrical and radio industries for insulating parts has been exceptionally heavy this year, with the result that during March and April the old plant was working 24 hours a day six days a week. As the last half of the year is usually heavier in production than the first half, every effort is being made to get the new building in shape for use before July 1st.

TRANSFORMER CORPORATION IN NEW HOME

Evidence is not lacking that the fast moving radio industry is slated for still higher and better things in the years ahead. Basic conditions in the industry are carefully studied by the radio parts manufacturers whose production program must be laid out a full season earlier than the set manufacturers.

Among the leading parts makers who are effecting major expansion programs, is the Transformer Corporation of America, in Chicago. Their list of customers in the industry will be interested in the announcement that their new home at 2301-2319 So. Keeler Avenue, Chicago, will give them eight times the capacity of their previous location.

They have been among the few transformer and power pack manufacturers who have undertaken the complete manufacture of their products.

Under this one roof will be housed facilities for converting wire, sheet steel and other raw materials into finished, tested transformers, power packs and other radio units. Here will be found a battery of giant presses, some of them running up to fifty-six tons capacity for stamping power-pack containers, and dynamic speaker chassis; rows of automatic punch presses for core laminations; automatic coil winders; "skinning" and tinning machines for finishing leads; ovens and kilns for vacuum impregnating and baking of coils; and on the fourth floor, a spacious and completely equipped daylight laboratory for research and engineering.

Under the able management of Ross D. Siragusa, President and General Manager, T. C. A. has reached a production capacity of 25,000 finished units a day.

The move from the old plant at 1428 Orleans Street was so carefully planned and managed that production was continued without interruption, and all deliveries made on schedule.

B-L ELECTRIC MANUFACTURING CO. FORMED

It was announced by Harold J. Wrape, president of the Benwood-Linze Company of St. Louis, that the manufacturing division of the Benwood-Linze Company has been replaced by the newly formed B-L Electric Manufacturing Company. The B-L Electric Manufacturing Company is a direct subsidiary of the Benwood-Linze Company, formed primarily to facilitate the production of the many B-L Rectifying Elements.

The officers of the B-L Electric Manufacturing Company are announced as: Harold J. Wrape, president; C. Hammechen, secretary and treasurer; C. R. Ogle, vice-president.

NATIONAL-HARRIS WIRE CO. ACQUIRES NEW FIRM

The National-Harris Wire Co., of 195 Verona Ave., Newark, N. J., has taken over additional buildings adjacent to the present plant, for housing the equipment of the Connecticut Wire Co., of Waterbury, Conn., which company they recently acquired.

It is expected that the new plant will also be producing nickel wire, ribbon and tubing by June 15th.



The new home of the Transformer Corp. of America, in Chicago.

A NEW JEWELL 199 Set Analyzer

TESTS SCREEN GRID Sets

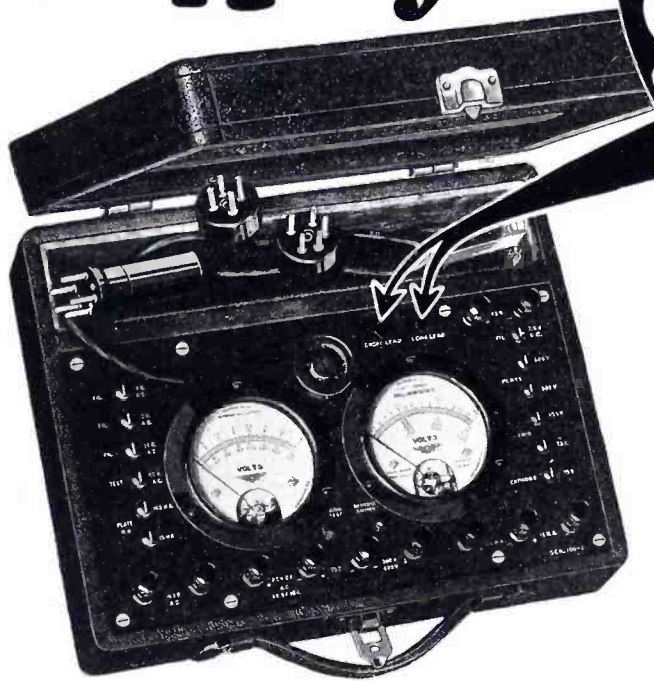

The rapid development of screen grid tubes and the marketing of screen grid receivers by large radio manufacturers demands a set analyzer for testing screen grid sets.

With the keen foresight which has characterized Jewell efforts in the radio service field, Jewell Engineers have already solved this problem. The New Jewell 199 Set Analyzer is equipped to test screen receivers.

Through a remarkable engineering achievement, this valuable feature has been added to the 199 without increasing the selling price. Today you can get a Jewell 199, equipped for testing screen grid receivers, at no extra cost.

THE New Jewell Pattern 199 Set Analyzer answers every requirement of accurate and rapid radio service. It is the same unit which has proved so popular with radio servicemen everywhere, plus the provision for testing screen grid sets.

Equip your servicemen today with Jewell 199's and let them pave the way to satisfied customers and profitable sales by making service calls on radio users. It is the most profitable way to utilize their spare time during the summer months, and is a sure road to accessory sales and leads to new set sales. Sold by radio jobbers everywhere.

MAIL THE COUPON

29 YEARS MAKING GOOD INSTRUMENTS
JEWELL
199 Set Analyzer



Jewell Electrical Instrument Company
1650 Walnut Street, Chicago, Illinois
Of course we want to make our radio servicing more effective. Send your book, "Instructions for Servicing Radio Receivers," and information about the New 199 Set Analyzer for testing screen grid sets.
Name _____
Address _____

ARCTURUS FACTORIES WILL RUN ALL SUMMER

Stockholders of Arcturus Radio Tube Company, at their annual meeting, were informed by President Chester H. Braselton that satisfactory progress is being made in the Company's recently announced expansion program. The Company's plants will run at capacity through the summer months, according to present outlook, he said, and the newly purchased factory in Newark, containing 111,000 square feet of floor space, is expected to begin operations not later than June. Directors were re-elected.

STEP-UP OUTPUT IN NEW JENSEN PLANT

The Jensen Radio Manufacturing company have completed the installation of equipment and machinery in their new plant located in the Clearing Industrial District and production, according to Peter L. Jensen, president, is being stepped up daily.

The new plant, which is the fourth time the company has expanded its manufacturing facilities during the past two years, provides at the present time a daily output in excess of five times the peak production which was reached during the 1928 season with both the old local plant and the factory at Oakland, Cal. With production getting into full swing here, manufacturing on the Pacific Coast is being gradually cut. Ultimately, the Oakland plant is to be used only for warehousing stock to supply the far West trade.

The new factory is of brick and reinforced concrete construction. It is one story in height and of the sky-lighted type. A side track for the load and unloading of freight shipments extends into the building. Arrangements have also been made for the spotting of a car in the building each day for the loading of less than carload shipments which will be picked up each evening and redistributed at the Clearing Station of the Chicago Belt railroad, expediting, according to Jensen's traffic manager, outbound shipments by from ten to twelve hours as compared with the regular truck delivery to the outgoing freight houses.

The progressive manufacturing and assembly lines run through the middle of the building with the stock and parts store rooms to either side, reducing the handling of materials to a minimum and providing the latest and most efficient type of "progressive manufacturing". In their new plant, the Jensen company will produce practically every part entering into their finished product, and will have, according to Mr. Jensen, the largest and most complete plant devoted exclusively to the manufacturing of reproducing equipment in the country.

Plans are already being made to erect another unit practically the same size as the present one and which will join the present building to the south. Business already looked for delivery this year and further anticipated trade demand, will, according to Thomas A. White, general sales manager, necessitate this additional expansion in the company's facilities within a very short time. An option on the neces-

sary ground for this anticipated addition was taken at the time the lease for the present plant was negotiated.

While no definite figure could be obtained at this time it is understood the company is planning on a production for the current radio year of round a half million units. Contracts with a number of the larger radio set manufacturers for Jensen dynamic units, will, according to the schedules which have been placed, necessitate a production of better than 5000 units a day by the first of August.

SYNTHANE IN FULL PRODUCTION

Synthane Corporation, manufacturers of Synthane—a new laminated bakelite product, has swung into full operation at its new plant at Oaks, Montgomery County, Pennsylvania.

The plant was especially built for the manufacture of laminated bakelite, and the entire organization is focused on this one product—in sheets, rods, tubes, and fabricated parts.

Special machinery has been installed throughout and scientifically controlled processes are planned to keep the product uniform in all respects.

Synthane Corporation is represented in the field by J. B. Rittenhouse, 32-40 South Clinton Street, Chicago; H. G. Blauvelt, Tribune Building, New York; and C. E. White and Company, Bulkeley Building, Cleveland.

NEW PLANT FOR SPEED TUBES

A large new tube plant, equipped with the most modern machinery for the production of Speed Radio Tubes is announced by the Cable Radio Tube Corporation of 80-90 North Ninth Street, Brooklyn, N. Y.

Large orders now on hand and demands from the large set manufacturers have necessitated an increase in production facilities to four times that of last year. Capacity of the Cable Radio Tube factories are now 25,000 tubes daily, it is stated.

A stock issue has recently been floated for expansion purposes. This issue is now listed on the New York Curb Market.

POLYMET TAKES OVER STRAND AND STREET WIRE PLANT

Hardly have the reverberations of Polymet's entrance into the coil field by the purchase of the Coilton Electric & Manufacturing Company died away, before the announcement reaches us that the well-known Strand and Sweet Manufacturing Corporation, of Winsted, Conn., makers of fine copper magnet wires, has also been absorbed by Polymet.

This will insure Polymet of a constant supply of magnet wires needed in the manufacture of Poly-Coils, being produced at the recently acquired Coilton plant.

Surplus will be sold to manufacturers in the radio and electrical industries who have been embarrassed by the shortage of fine-sized magnet wires, in which product Strand and Sweet are recognized specialists. Under Polymet management facilities will be improved and capacity further increased.

This rapidly expanding organization now controls three complete manufacturing units, operating at capacity.

NEW SPARTON FACTORY

Continuing its policy of bringing the manufacture of every part that goes into Sparton Equasonne radio sets into one organization, the Sparks-Withington Company, of Jackson, Mich., are equipping an entire new plant for the making of light metal punchings.

In their recently acquired new building on the outskirts of Jackson, machinery is being installed which will be used in the making of a great number of parts for Sparton sets. The new plant will provide space for several hundred additional employees. During the peak of the 1928 season more than 4,000 persons were engaged in the making of Sparton Equasonne sets, and this will be greatly increased during the coming year. The new plant is No. 4 of the Sparton units.

APPOINTMENTS

Federal Radio Corp.

Appointment of R. F. Lovelee to assistant sales manager of the Federal Radio Corporation is another step in Federal's expansion program. Mr. Lovelee's sales and engineering experience fits him most ably for the position.

Ray Lovelee has been a member of the Federal Radio Corporation's staff since its early days in the radio field. He is a University of Michigan graduate, having specialized in electrical engineering. After leaving school he became a student in the laboratory of Western Electric Co. in Chicago, where he remained a year. He joined the Federal company seven years ago and has been for the past two years special representative of the company covering the trade throughout the United States and Canada.

W. Bergman Company, Buffalo, N. Y., one of the largest wholesalers of automotive equipment, hardware and radio apparatus in the Western New York district, has been established as wholesaler of Federal Ortho-sonic radio, according to an announcement from W. E. McAllister, sales manager of the Federal Radio Corporation.

The Bergman Company operates branches in Olean, N. Y. and East Aurora, N. Y., as well as a branch in North Buffalo.

Sanford Motor Supply Co., Inc., Williamsport, Pa., one of the most thoroughly established wholesalers of motor and electrical equipment in the Keystone state, has completed arrangements with Federal whereby it will become wholesaler for Federal Ortho-sonic radio as its exclusive radio line.

Edward Forshay, one of the best known men in the music field is the most recent new member of Federal's sales staff. He will represent Federal Ortho-sonic radio in the Metropolitan Area.

Mr. Forshay has been associated with the music industry for the past twenty years, and most recently was secretary-treasurer of the Milton Piano Co. He was with that company for eight years. Subsequently he was actively engaged in the wholesale and retail trade. He also will be well remembered by members of the trade as representative of the Aeolian Company, which he served for eleven years.

H. A. Sheridan is a new member of the sales staff. He is not, however, new to the Federal company, having been associated with the Buffalo concern for the past two years as production engineer in charge of time study. Subsequently Mr. Sheridan was with the Ordinance department headquarters in Honolulu and with the Holt Tractor Co., of Peoria, Ill. He was also salesman of electrical instruments for W. P. Ambros Co., of Cleveland.

Polymet Manufacturing Corp.

The Polymet Manufacturing Corporation, New York, announces the election of Mr. Otto Heineman to its Board of Directors. Mr. Heineman has been prominent in the phonograph industry in the United States and abroad for 25 years. He is president of the Okeh Phonograph Corporation, New York, president of the General Phonograph Mfg. Corporation, a director in the General Industries Corporation, and other companies. Before coming to this country in 1914, Mr. Heineman was managing director of the Carl Lindstrom A. G., of Berlin, manufacturers of phonographs and records.

Carter Radio Company

Announcement has been made of the appointment of J. H. Kraehenbuhl as general Sales Manager of the Carter Radio Company, Chicago. Mr. Kraehenbuhl was formerly with the Radio Corporation of America.

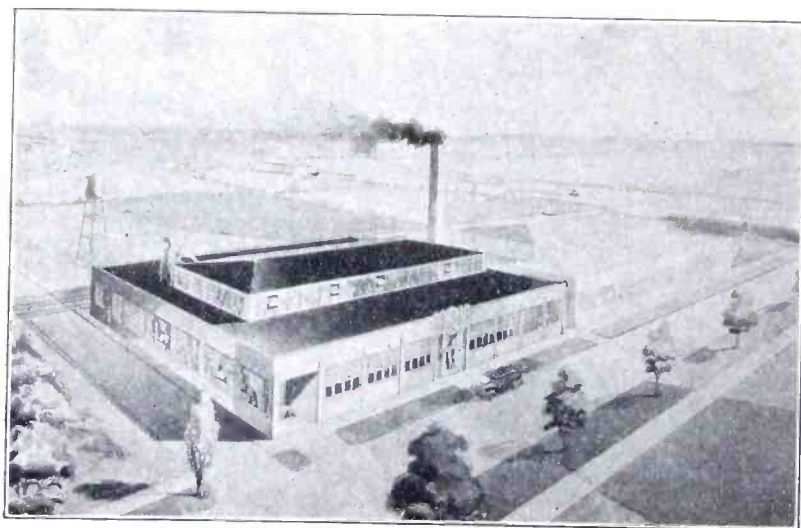

The latest addition to the plants of the Jensen Radio Manufacturing Co., located at Chicago.

**"A Background
of Engineering Merit,"**



**VOGUE
NONPAREIL**

THE increased demand for Vogue Tubes — a demand built upon a background of engineering merit — has made necessary our new modern factory with greatly increased production facilities.

Jobbers, dealers and manufacturers are thus assured of a constant supply of highest quality Vogue Tubes.

Needless to say Vogue Tubes are backed by a 100% guarantee. This fast-selling line is accordingly proving a great profit-maker—due to "A Background of Engineering Merit."

*At the Stevens
Demonstration Room 450-A*

Allan Manufacturing and Electrical Corp.

Harrison
Los Angeles

...

New Jersey
407 E. Pico St.

The Carter Radio Company has just taken over the entire building at 407-415 South Aberdeen Street, Chicago, and in the very near future will have further announcements of new items that will be of great importance to the trade.

Triad Manufacturing Co.

An announcement has recently been made by the Triad Manufacturing Co., Inc., of Pawtucket, R. I., makers of Triad Radio Tubes, to the effect that Mr. V. K. Wilson has been appointed Assistant Sales and Advertising Manager of that organization. Mr. Wilson, well known throughout the trade, has served for a number of years in a similar capacity with the Tower Manufacturing Company, of Boston.

Continental Radio Corp.

The G. S. Means Company, of Fort Wayne and South Bend, Indiana, has been appointed distributor of the "Star-Raider," manufactured by Continental Radio Corporation, Fort Wayne, Indiana.

The main office of G. S. Means Company is located at 427 West Washington Street, in Fort Wayne, and in addition they have sales rooms at 312 East Main Street, and 421 West Washington Street. The South Bend office is located at 315 East Jefferson Street; E. J. Grosh, Manager. Mr. Means is also the General Motor's distributor for this territory. The sixty to seventy G. S. Means salesmen have been turned loose on the sale of Continental's Star-Raider.

Cable Radio Tube Corp.

Martin Zatulove, president of the Martwel Corporation, announced in a recent interview that his company had elected to handle exclusively the Speed Tube, the product of the Cable Radio Tube Corp.

Mr. Zatulove, one time sales director of one of the largest set manufacturing companies in America, is known throughout the radio industry from coast to coast.

Within 48 hours after the completion of arrangements between Mr. Zatulove and the Cable Radio Tube Corp., Mr. Zatulove had made arrangements with Landay Brothers, New York's famous music stores, for the sale of the Speed Tube Line through all the stores of this important outlet.

A.C. Neon Corp.

The Percival K. Frowert Co., Inc., New York advertising agency, has been appointed to direct the advertising of the A. C. Neon Corporation, manufacturer of McCullough radio tubes. A national campaign has been planned.

Controlling interest in the A. C. Neon Corporation, which has its headquarters in New York, was acquired recently by O. W. Ray, a well-known figure in the music and radio industries. He was with the Aeolian Co. for seven years as an executive in charge of the Vocalion Division, Radio Division, Duo-Art Music Division, and the Melodee Music Department.

Kellogg Switchboard & Supply Co.

The Kellogg Switchboard and Supply Company announces the appointment of Mr. Wm. J. Leighner as Works Manager.

Mr. Leighner comes to the Kellogg Company with a background of twenty-six years experience in the electrical manufacturing business. During this time he has been through every phase of production work, from errand boy to Works Manager.

Mr. Leighner's education was along technical lines. After finishing a four year course in engineering at the Westinghouse Technical School, he made a connection in a production capacity with the Westinghouse Electric and Manufacturing Company, with which concern he was associated for many years.

Mr. Fred H. Timperlake, of Chicago, Illinois has just been appointed sales representative for Kellogg of Chicago. He has been assigned to a territory which includes the states of Michigan and Indiana.

Temple Corporation

The Texas Radio & Electric Company of Ft. Worth, Texas with branches in Houston, Dallas and San Antonio, have been appointed exclusive distributors for Temple receivers for the coming season.

A. L. Gossett, head of the Ft. Worth branch has for many years been active in the radio and electrical field and is very well known to the trade in that territory.

H. H. Horn of Los Angeles, California with showrooms at 1629 S. Hill St., has been appointed exclusive Temple distributor for Southern California.

Westinghouse

W. C. Evans, a young veteran of the radio world, has been appointed superintendent of radio operations of the Westinghouse Electric and Manufacturing Company. It has been announced by H. P. Davis, vice-president of the company.

He has been assistant superintendent of radio operations coming to East Pittsburgh from a post with the company in New York and was formerly manager of station KYW in Chicago, a Westinghouse station.

Evans succeeds C. W. Horn, who recently resigned to accept an appointment with the National Broadcasting Company.

At the age of 31, Evans is a radio veteran of 16 years experience. He began his career at the age of 15 as a radio operator on a Great Lakes vessel.

Because of the increasing activities of the Westinghouse Electric and Manufacturing Company in the radio field and in the affairs of various companies allied in radio operations and development, Vice-President H. P. Davis, formerly in charge of Westinghouse manufacturing operations, will devote his entire attention to the radio operations of his company.

This announcement, significant of the expanding importance of radio engineering, manufacture and development, was made



W. C. EVANS,
Radio Division Superintendent,
Westinghouse Elec. & Mfg. Co.

May 1 by A. W. Robertson, chairman of the Board of Directors, to whom Mr. Davis will report.

J. S. Tittle, formerly general manager of the Westinghouse Merchandising Department, with headquarters in Mansfield, Ohio, will assume responsibility and authority for manufacturing operations of the company, according to announcement by F. A. Merrick, vice president and general manager.

Mr. Davis, graduate of the Worcester Polytechnic Institute and an outstanding leader of the electrical industry, is internationally known as the "Father of Radio Broadcasting" for his work in developing radio broadcasting through the establishment of station KDKA, in 1920. He has been associated with the Westinghouse Company since 1891 and has been a vice-president since 1911.

Radio Corporation of America

The appointment of Otto S. Schairer as director of patent development was announced by General J. G. Harbord, president of the Radio Corporation of America.

Mr. Schairer, who is recognized as one of the country's leading experts in patent law, leaves the Westinghouse Electric and Manufacturing Company where he has served as manager of the patent department since 1926.

Harry G. Grover, who was formerly assistant patent attorney was promoted to patent attorney, succeeding Ira J. Adams who resigned to resume private practice.

Arcturus Radio Tube Co.

John L. Stone, recently in charge of sales promotion with the Agar Manufacturing Company, of Whippany, N. J. is now with the Arcturus Radio Tube Company as assistant to the sales manager, L. D. Naylor, according to a recent announcement. Mr. Stone is a graduate of Hamilton College and carries with him to his new association many years of practical sales experience.

Coincident with their general manufacturing and selling expansion, A. S. Van Bochove has joined Arcturus as western sales representative. Mr. Van Bochove, known as "Van" west of the Mississippi, was for five years sales manager of the Jay B. Rhodes Company, manufacturers of oil dispensing equipment.

Allen-Bradley Company

John McC. Price has been appointed district manager in charge of the Chicago office of the Allen-Bradley Company of Milwaukee, Wisconsin. Mr. Price was formerly district manager for the Industrial Controller Company in the same territory. The Chicago office is located at 500 North Dearborn Street, Chicago.

General Amplifier Company

Mr. A. R. Wilson, president of the General Amplifier Company, 27 Commercial Avenue, Cambridge, Massachusetts, has announced the appointment of the Fred G. Smith Company with offices at 1045 Oakdale Avenue, Chicago, Illinois, as Mid-Western Sales Representatives.

Mr. Smith is well-known throughout the electrical and radio trade of the middle west, being one of the "old-timers." His many friends will be interested to hear of his new connection.

Sparks-Withington Co.

The Sparks-Withington Company, Jackson, Michigan, announce the recent appointment of Mr. Frank S. Purviance as district sales representative in the Michigan-Indiana territory becoming effective April 1.

Mr. Purviance was formerly service manager for the company covering Missouri, Kansas, Nebraska, Colorado, and Wyoming. Mr. Purviance has been with the Sparks-Withington Company for the past two years and received a broad radio training for the previous five years during which time he was engaged in retail and wholesale merchandising work, as well as having had broadcasting and service experience.

American Reproducer Corp.

American Reproducer Corporation appoints Mr. David Kahn as distributing Sales Manager for the Metropolitan area on the new Amerovox line.

Mr. Kahn is well known amongst the Radio Jobbers and Dealers throughout this area, having been in close contact with the trade since the birth of the Radio and Phonograph industry. Mr. Kahn started out as an errand boy with a Victor Talking Machine factory distributor and rose from errand boy to General Sales Manager and held that position for eight years. During that time he made the acquaintance of hundreds of Dealers and Jobbers throughout the Metropolitan area, also buyers for chain organizations and department stores.

E. T. Cunningham, Inc.

Important changes in management of their district offices located at San Francisco, Chicago and Cleveland are announced by E. T. Cunningham, Inc.

The new appointments advance E. Lody Sutton, formerly district sales manager of the Chicago territory, to the district managership at San Francisco, succeeding W. E. Darden; F. E. Harding, formerly in charge of the Cleveland office, succeeds Mr. Sutton as district sales manager at Chicago, while F. A. Klingenschmitt, formerly assistant to M. E. Burns, Cunningham sales manager at the New York executive headquarters, becomes district sales manager of the Cleveland territory, with headquarters at Cleveland.

Allen-Bradley Company

The Allen-Bradley Company, Milwaukee, Wisconsin, manufacturers of electric controlling apparatus, announce the establishment of a district office in Atlanta. Messrs. H. Douglas Stier and G. G. Moore will be in charge of the southern office which will be located at 101 Marietta Street, Atlanta, Georgia.

Do it all at once with

DUREZ

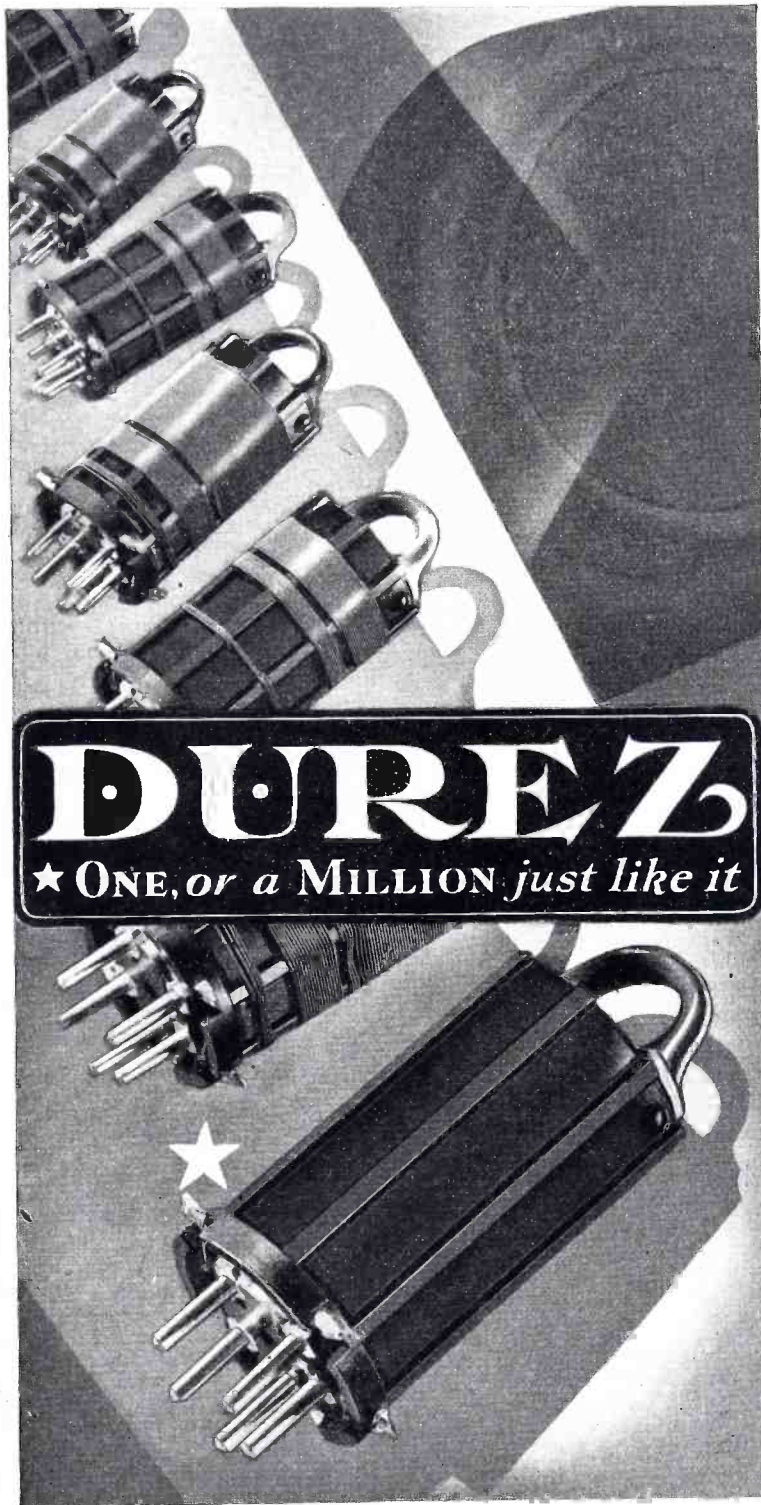

EVERY step saved in manufacturing your product means money. Throughout the radio field, countless operations are being reduced—expenses on time, labor, and material cut down—unnecessary checks abolished—by the use of Durez in place of less easily worked materials!

Look at this interchangeable coil, for instance. It was made of Durez, the perfect molding compound. It came from the die with ribs fashioned, holes made, base immovably molded to the body, the finish lustrous and beautiful! All in one operation! And a hundred, a thousand, a *million* other Durez-modeled coils would look exactly the same!

What do you make? Coil mountings too? Panels, dials, covers, binding posts, tube bases? Are they as tough, as strong, as durable as Durez can make them? Will they resist acid moisture, changes in temperature? Do they come from the mold ready for use—without buffing, burnishing, polishing, or costly tooling? Whatever you manufacture, Durez insures absolute accuracy, reduces rejections to a minimum, and provides a more modern, efficient, and better looking product.

The very fact that there are so many uses for Durez speaks for its marked superiority over other materials. Durez is marvelously strong and tough. It stands all sorts of hard wear and handling, without chipping or breaking. Holes can be drilled and tapped easily—studs can even be imbedded in the molding process. Durez will not corrode. And it is available in all practical colors.

The one way to appreciate fully the physical and dielectric qualities of Durez, the economies it enables, the beauty it offers—is to try it with your own product. Let our laboratory and engineering staff help you. General Plastics, Inc., 65 Walck Road, North Tonawanda, N. Y. Also New York City, Chicago, San Francisco.



Write for this free booklet—*"Do It With Durez."* Contains complete information about Durez—physical and dielectric properties, color ranges, and scores of possible applications.

NEW DEVELOPMENTS OF THE MONTH

THORDARSON R-260 AUDIO TRANSFORMER

The Thordarson Electric Manufacturing Co., of Chicago, are marketing a new type of audio transformer of small dimensions, known as the R-260. Though this transformer measures only 2 by 2 by 2 1/4 inches, it has excellent frequency characteristics. Its fine performance is partly attributable to the Thordarson "DX Metal" core upon which the coils are wound.

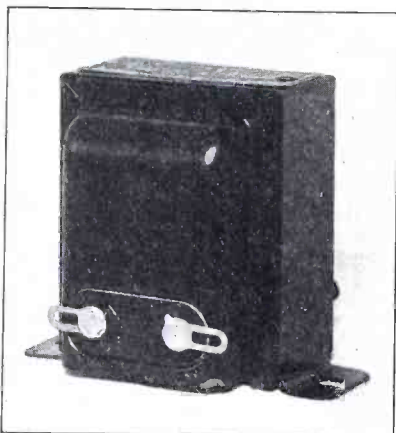

Thordarson R-260 Audio Transformer.

It is claimed that the R-260 transformer is entirely devoid of resonance peaks and provides excellent performance over the entire audible band. The list price of the R-260 transformer is \$7.

NEW WRIGHT-DECOSTER DYNAMIC SPEAKERS

Wright-DeCoster, Inc., St. Paul, Minn., have introduced two new cabinet dynamic speakers—known as Model C and Model B. The latter is shown in the accompanying illustration.

The chassis is of compact construction and employs a ten-inch cone. The apex of this cone is suspended with leather.

The speech coil is wound on a bakelite form, which provides strength without appreciable weight. Each layer of wire in the speech coil is insulated from the next by a sheet of condenser tissue, the voltage breakdown between layers being over 200 volts.

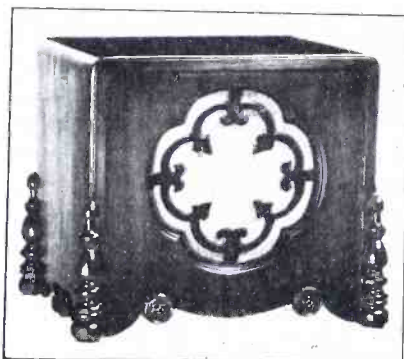

Wright-DeCoster Model B Dynamic Speaker.

The field supply in the a-c. models is obtained from a dry-disc, full-wave, high-a-c. input.

The list price of the chassis is \$72.50. The Model C cabinet reproducer is priced at \$100. The measurements are: width, 16 1/2 inches; depth, 13 inches; height, 37 1/4 inches.

The Model B cabinet reproducer is priced at \$88. The measurements are: width, 16 1/2 inches; depth, 13 inches; height, 15 1/2 inches.

The cabinets are walnut with matched veneer tops. The finish is dark brown shaded walnut, Duco lacquer.

NEW ROLA DYNAMIC SPEAKERS

New models offered by The Rola Company include the Rola electrodynamic units for installation by manufacturer or dealer in cabinet radio sets and electric phonographs, as well as the Rola units in talking picture installations, public-address and school systems. They also include three Rola cabinet loudspeakers for use with table receiving sets.

In its display the Company is presenting for the first time two new Rola electrodynamic units and is also introducing further refinements and improvements in its "J" line of electrodynamic reproducers.

The new Rola electrodynamics have a high output efficiency, obtained by the use of relatively high flux densities in the air gap. High flux densities are obtained without increase of field energizing power, through the use of very short air gap



New Rola "Auditorium" Dynamic Speaker.

distances. The short, precision air-gap is made practical by a highly refined moving coil structure, together with extreme accuracy in the spacing of the pole pieces.

Another improvement is the ventilating of the field winding which minimizes temperature changes. The new Rola ventilated construction eliminates dead-air insulating areas around the windings and results in a substantial reduction in operating temperature.

The removable center-pole nose piece—an exclusive Rola feature which enables easy elimination of any magnetic particles which might enter the air gap—has been retained.

The new "J" series of electrodynamic units with 7 1/2-inch cones and adjustable center pole tip, have been further improved and refined. Chief among the new features is the laminated bakelite spider support, ventilated field coil and more effective slot openings behind the cone.

Included in the "J" series are the Model "J-90" for field excitation from standard

power-pack. The series also includes the Model J-110, a complete electrodynamic unit for light-socket operation with all sets and amplifiers. Other Rola electrodynamic units for manufacturers or dealers are wound to meet any voltage current ratio and for use with any power pack circuit.



New Rola "Concert" Dynamic Speaker.

In addition to the above units the Rola Company also provides the Rola Cabinet Loudspeaker Model 30-J—equipped for light-socket operation with any table receiving set.

The new "C" or Concert Series electrodynamic units are similar in all respects to the "J" types except for their 9-inch cone diameter. This increased cone size gives somewhat greater power capacity and is adapted particularly well to amplifiers using 245 tubes in push-pull combination.

The new "R", or Auditorium electrodynamic unit, has a cone diameter of 12 inches. It possesses a magnetic field structure of great size and power and uses the full output of a type 280 rectifier tube.

Among the Rola electromagnetic loudspeakers are the Rola Model 20 cabinet speaker—attractive in design and of established popularity. The Rola Model 15 equipped with the same unit as the Model 20, furnishes high quality performance at moderate cost. The Rola Model M is the complete electromagnetic unit as installed in the Rola Models 15 and 20.

THE CORWICO VULCAN LIGHTNING ARRESTER

The Corwico Vulcan Lightning Arrester will not only protect the radio set against lightning but will also dissipate accumulated static charges. To accomplish this, materials are used which result in a mini-



Corwico Vulcan Lightning Arrester.



Fixed condenser type 2244 for use in electric (induction) furnaces—capacity (air) 4450 mmf. In castor oil 20900 mmf. May be operated on 140 amperes at 300 KC continuously without overheating.



A type of transmitter that adheres to the high requirements of Cardwell manufacture.



Special Fixed Transmitting condenser, Type 2202 (several capacities, 140 mmf. to 1400 mmf.) Working voltage 30000 volts.



Aircraft Transmitter built in quantity by Cardwell to U. S. Navy Specifications.

VERSATILITY



ALTHOUGH for some years past the name **CARDWELL** has been associated in the Public mind with condensers almost exclusively, this Corporation has successfully handled other engineering and manufacturing problems receiving little or no public attention.



A well equipped laboratory and a modern plant have made possible the direction of the activities of this organization into several channels, more or less allied, keeping faith with our many friends, making new ones and insuring that the products of **CARDWELL** shall continue to be "The Standard of Comparison."



Your proposals are solicited. **CARDWELL** condensers are made for transmitting and receiving, in sizes and types to suit many purposes, from broadcast and commercial use to balancing receiving circuits. Send for literature.



The
ALLEN D. CARDWELL MFG. CORPN.
81 PROSPECT STREET, BROOKLYN, NEW YORK



Type S-1855, Transmitter Condenser. For equipment of over 500 watts power.



Another type—Signal Corps Transmitter built by Cardwell to U. S. Army Specifications.



Type S-1683-11 Transmitter Condenser. Neutralizing or balancing capacity for high power amplifiers.



Illustrating one of the types of Aircraft Receivers manufactured by Cardwell to U. S. Navy Specifications.

imum voltage breakdown and at the same time offer a maximum resistance under all operating conditions.

In every box with a Corwico Vulcan Lightning Arrester is a guarantee in which the Cornish Wire Company agrees to repair or have repaired up to a cost of \$100, any radio receiver, protected by a Corwico Vulcan Lightning Arrester, that has been damaged by lightning.

The Corwico Vulcan Lightning Arrester is approved by the Board of Underwriters and lists for one dollar. It is manufactured by the Cornish Wire Company, 30 Church Street, New York City.

NEW HAMMARLUND CONDENSERS

Three new models of the popular EC-type equalizing and MC-type midget condensers have been brought out for manufacturers by the Hammarlund Manufacturing Company, 424 West 33rd St., N. Y. C.

There are two models of the equalizing type, known as the EC-35-KN3 and the EC-35-KFB. On both models, as on all of this type, the capacity is varied by means of a screw, which runs through a phosphor-bronze spring plate and which controls the distance between this plate and a piece of brass mounted on a bakelite slab. A

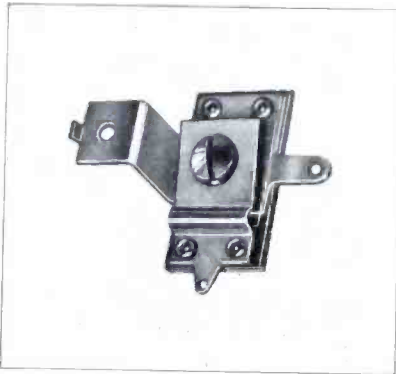

Hammarlund EC-35-KFB Equalizing Condenser.

piece of specially treated mica acts as the dielectric medium.

The EC-35-KN3 contains any number of equalizers mounted on a bakelite strip. The adjusting screw is dead, it being insulated from the spring plate with a bakelized canvas washer. This prevents any variation of capacity when the adjustor is taken away. It can be used for both neutralizing and equalizing and is made in any capacity, e.g., minus 2 mmf. to plus 35 mmf., or minus 20 mmf. to plus 100 mmf.

The EC-35-KFB has a special bracket which enables insertion into a slot in the subpanel, thus aiding its support and simplifying the wiring. It also is made in the same capacities as the EC-35-KN3 and can be used for feedback control, equalizing or as a grid condenser in short-wave



Hammarlund MC-19-G Midget Condenser.

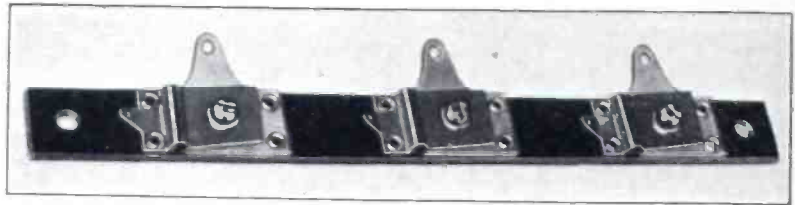

Hammarlund EC-35-KN3 Equalizing Condenser Strip.

receivers. It has a live screw as on all standard models. A wooden adjustor is used to prevent capacity variation.

The midget condenser, MC-19-G is principally designed for antenna tuning with a special base mounting and a long brass shaft for operation from the panel. Its length being made to suit. They are made in capacities from 16 mmf. maximum to 100 mmf. maximum. The plates are cut in straight-line capacity style, they being of brass and soldered to a brass shaft. Bakelite insulation is used. Lock washers are placed underneath all screws. The mounting plate is of chemically treated steel.

The engineering department of the Hammarlund Manufacturing Company will be only too glad to answer any queries as to the use and installation of these in any circuit.

THE "AMERICAN" ELECTRIC DRIVE

The American Safety Table Co., Inc., Eighth and Oley Sts., Reading, Pa., are marketing a newly designed Electric Drive combining a motor and a special safety clutch—that is adaptable to many uses in the radio industry, where electric drive is required.

The salient features of the clutch, which is electrically operated, are: perfect controls of starting and stopping; clutch is directly attached to the motor, which adds greatly to the efficiency in the winding of coils and other winding apparatus used in radio manufacturing; clutch can be en-

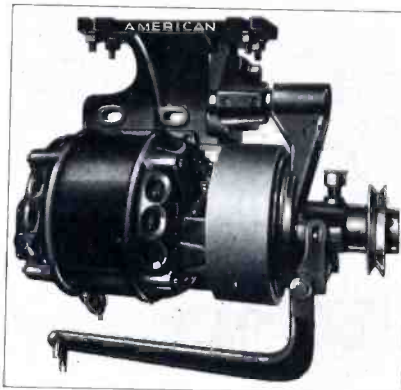

The "American" Electric Drive.

gaged at part speed, then gradually increased to full speed at the will of the operator.

The Electric Drive may be equipped with any make or type of electric motor from 1/8 to 3/4 H.P. capacity in accordance with the requirements of the operation on which it is employed.

The electric drive clutch is all ball-bearing and stops automatically. Lubrication is necessary only twice a year.

WIRE-WOUND VOLUME CONTROL CLAROSTAT

As the result of several years of engineering development on various types of volume control, the Clarostat Manufacturing Company, of Brooklyn, N. Y., now announces a perfected device known as the Wire-Wound Volume Control Clarostat. This device meets the requirements of higher resistance values, together with a positive, non-wearing contact which will insure noiseless operation for many years of constant service.

Basically, the Wire-Wound Volume Control Clarostat comprises a strip wound resistance unit produced by special winding equipment, together with a positive pressure contact-making member which, eliminating

the usual sliding contact, does away with all wear and tear even on the finest wire required for the highest resistance values. The contact-making member comprises a non-turning phosphor-bronze disk, chromium plated, radially slotted in order to be more resilient, freely held between a pair of tilted or eccentrically mounted washers or cams. As the shaft turns the washers or cams, the latter cause the disk to be depressed at one point after another of its circumference, establishing a firm, positive, pressure contact with the winding. This new motion gives to the knob of this device a delightfully smooth, velvety action, quite as well as a noiseless operation. Examina-

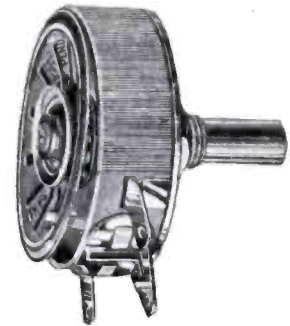

Wire-Wound Volume Control Clarostat.

tion under a powerful microscope shows no appreciable wear even after turning the knob 25,000 times.

The Wire-Wound Volume Control Clarostat may be supplied in any standard resistance range, in potentiometer or three-terminal style, or in rheostat or two-terminal style.

NATIONAL WELD-BUILT CONDENSER

The National Company, of Malden, Mass., are introducing a variable condenser embodying many new and unique features of construction.

Due to the welded construction it is extremely rigid and can thus be supplied in units matched to a high degree of accuracy. It is also furnished with slotted end rotor plates, if desired, for matching to special coils and circuits.

The zero adjusters on these condensers are completely shielded. The plate shape is the well-known National "Equitune." The shaft is removable.

The Weld-Built Condensers can be supplied either in single sections or two, three and four gang units.

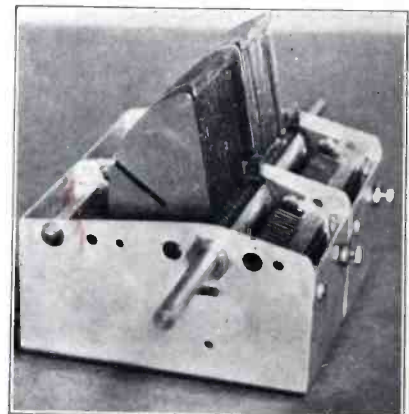

National "Weld-Built" Condenser.

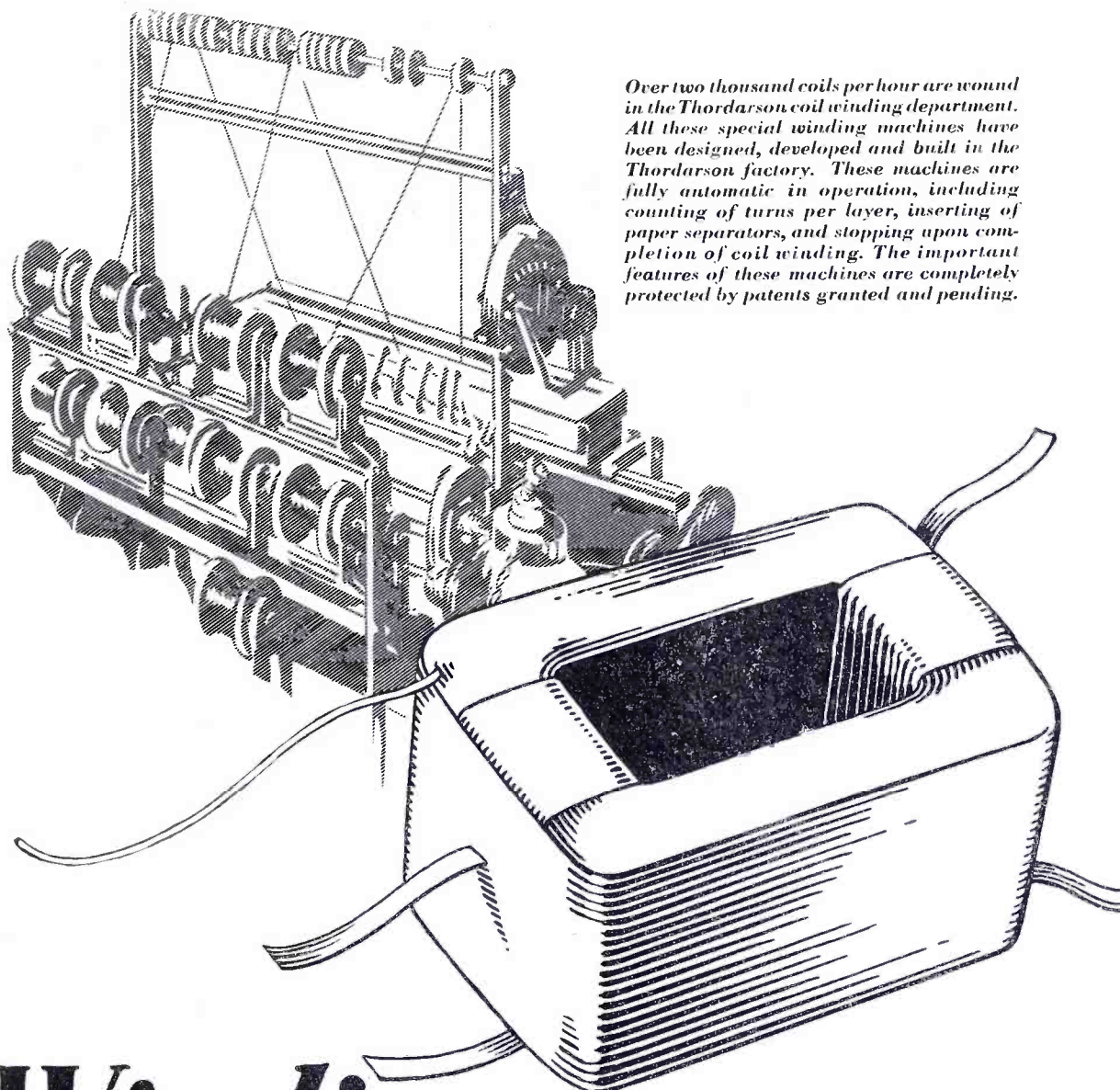

Over two thousand coils per hour are wound in the Thordarson coil winding department. All these special winding machines have been designed, developed and built in the Thordarson factory. These machines are fully automatic in operation, including counting of turns per layer, inserting of paper separators, and stopping upon completion of coil winding. The important features of these machines are completely protected by patents granted and pending.

Windings—

Thordarson coil windings are wound in the Thordarson factory — according to Thordarson designs — on machinery patented, built and owned by Thordarson.

They are combined with other Thordarson built parts to make transformers and chokes that are 100% Thordarson.

THORDARSON

Transformer Specialists Since 1895

THORDARSON ELECTRIC MANUFACTURING CO.
Huron, Kingsbury and Larabee Streets, Chicago, Ill.

NEW BENWOOD-LINZE RECTIFIER

The Benwood-Linze Co., of St. Louis, Mo., is introducing a new type of dry-disc rectifier, as shown in the accompanying

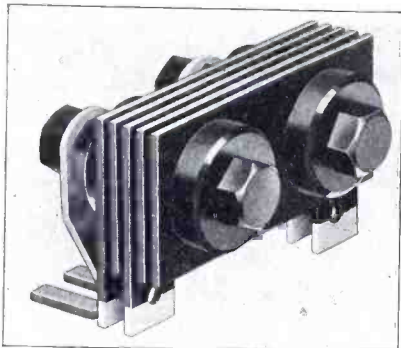

Benwood-Linze Low Voltage Rectifier.

illustration. This rectifier is designed especially for use in dynamic speakers. A similar rectifier has been designed for use in the operation of time clock systems and like appliances.

NATIONAL RAINBOW DIAL

The National Company, of Malden, Mass., have brought out a new type modernistic drum-type dial containing a number of interesting features.

Rather than employing the common direct vision scale, the scale reading is projected, in color, on a small ground glass screen. As the knob is turned, the color of

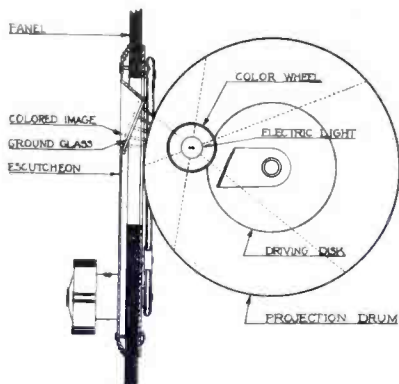

illumination shifts in kaleidoscopic fashion through the entire range of the spectrum. This is accomplished by the use of a special color wheel, geared to the main rotating drum carrying the scale reading. A small light projects both the scale reading and the color on to the small ground glass screen. The accompanying illustrations serve to delineate the arrangement.

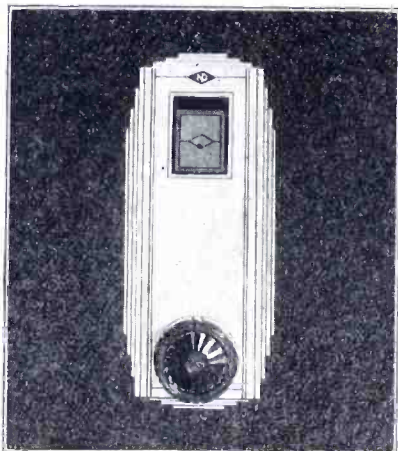

New National Rainbow Dial.

ELECTRAD VOLUME CONTROL AND COVERED RESISTANCES

Electrad, Inc., of 175 Varick St., New York, N. Y., have introduced a new type five-watt, high-resistance volume control embodying a number of excellent features.

The new volume control, illustrated here-with, employs a graphite resistance element fused to an enameled steel plate at high temperature. The resultant resistance element is very hard and not subject to wear or change of resistance value. Due to the smoothness of the enamel deposit, and the high temperature used for fusing, the graphite has a secure anchorage.

The movable contact is of unique construction, in that it is practically "floating," and with its multiple finger design, adapts itself to any possible inequality of surface, thus insuring a smooth, stepless flow of current.

The cover of the unit, as well as the actual base, is made of metal so that heat is rapidly dissipated. The three terminal connections are embedded in bakelite insulation. The contact springs, which make the connections between the resistance and

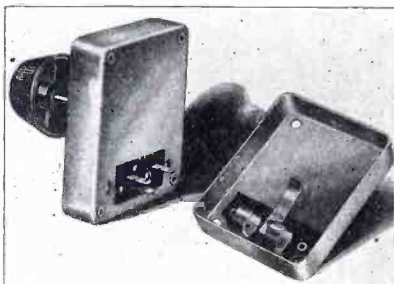

New Electrad Volume Control.

movable contact, and the three terminals, are made of bronze.

The unit, completely assembled, measures 2 3/16 x 2 13/16 x 5/8-inch deep. One hole panel mounting is provided.

The volume control can be made in any desired range, adequately meeting all usual requirements. The resistance curve can be either of uniform resistance variation, or tapered.

The new Electrad Covered Resistance

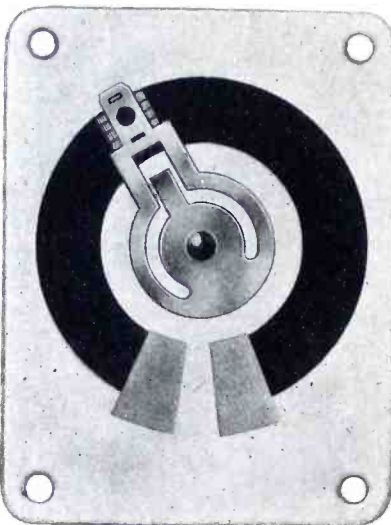

Resistance element and rotating contact of Electrad Volume Control.

Units are of the wire-wound type. A high quality refractory tube, with rapid thermal conductance and low thermal expansion, is used as the base for the resistance wire. The wire is a nickle chromium alloy having a low temperature coefficient of expansion and low thermal expansion. This wire is non-oxidizing below 900 degrees C. and non-corrosive. The black insulating enamel is baked on over the wire at a temperature of only 400 degrees F. Therefore, there is small chance of injury to the resistance wire.

The bands which form the terminal con-

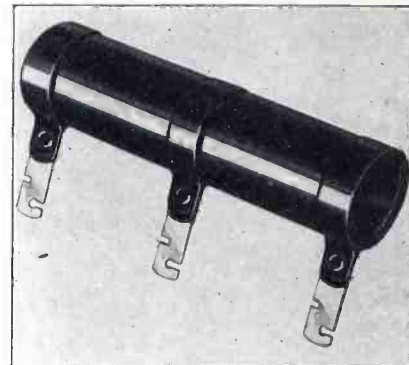

New Electrad Wire-Wound Covered Resistance.

nections on the unit are Monel metal and have approximately the same degree of thermal expansion as the resistance wire. Furthermore, Monel metal is highly resistant to oxidation and is non-corrosive.

These Covered Resistance Units can be obtained in most any resistance value and from 7.5 to 100-watt capacity.

NEW FLECHTHEIM CONDENSER

A new type of high grade paper dielectric filter condenser has been recently developed in the laboratories of the A. M. Flechtheim & Co.

An outstanding feature of the new condenser is its extremely small physical size, it being approximately one-fourth the dimensions of a present standard condenser. It is claimed that the condensers have less than 1 per cent power factor, have negligible dielectric losses and have high value of a minimum of 600 megohms per microfarad resistance. They are very conservatively rated at 1000 volts d-c. (750 v.r.m.s. R.A.C.).

A new process of winding, together with a novel vacuum impregnating method allows an accuracy within 5 per cent of rated capacity, it is stated. The condenser is wound with the acknowledged superior non-inductive method.

NEW U.S.L. ARMORED CONDENSER

The United Scientific Laboratories of 117 Fourth Avenue, New York City, have produced a new armored type B. T. Condenser, to meet the growing demand for precision combined with rigidity.

This new condenser is a compact precision tuning instrument with these exclusive features:

1. Rigid frame made of heavy drawn steel.
2. Rotors and stators are precision spaced and soldered.
3. Accuracy and calibration in ganging is assured by wide spacing between plates.
4. Permanent and perfect alignment of rotors is assured because the removable shaft is independent of bearings.
5. Circuit adjustments are facilitated by the gradual curve on the minimum capacity adjuster.
6. Adjustable smooth acting end thrust and tension fork.
7. The compactness of this condenser makes it convenient for individual shielding work.

These new type B. T. Armored Condensers are made in single, two gang, three gang, and four gang units of .00035 mf. capacity and lower.

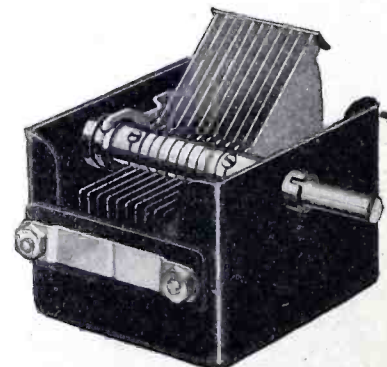

New U.S.L. Armored Condenser.

SPEED

RADIO TUBES

TESTED and APPROVED by Landay Brothers

AND BY THE METROPOLITAN PUBLIC

Thousands of radio fans saw **SPEED RADIO TUBES** tested before their eyes

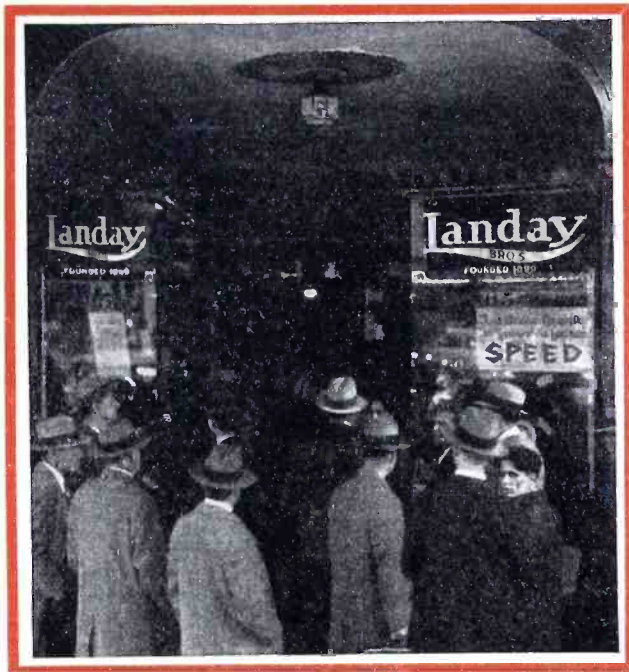

LANDAY BROTHERS, one of the largest radio outlets in the East, tested **SPEED** Tubes, found they were everything we said they were, and then some, and put their o. k. on the **SPEED** Tube Line.

Then Landay showed New York why they chose **SPEED**. All day Saturday,

April 27th, thousands of radio users milled into Landay's to see the laboratory tests on **SPEED** Tubes. "How did it go?" we asked Landay. "It was a great **SPEED** day," they said. (and it certainly looked like it from the sales figures they showed).

But we expected **SPEED'S** success. Every place **SPEED** has gone, it has gone over with a resounding bang. Why not, when the line is right — right in price, right in quality, right all the way through. There's a **SPEED** Tube for every radio and every radio need.

SPEED — short, snappy, easy to remember. A far-flung advertising campaign — Saturday Evening Post, newspapers and fan magazines — will engrave it in every mind — make **SPEED** just another word for Tube. Now's the time to check into the best money-making tube proposition in the field.

SPEED

CABLE RADIO TUBE CORPORATION

(Formerly Cable Supply Co.)

84-90 N. Ninth St., Brooklyn, N. Y.

MAKERS OF RADIO TUBES SINCE 1924



POLYMET SMALL MOLDED CONDENSERS

The Polymet Manufacturing Corporation offers this new mica condenser. Completely surrounded with bakelite, it is rendered entirely impervious to changes of atmospheric condition, dampness, etc.



Polymet Small Molded Condenser.

In addition to the advanced construction features found on all previous Polymet molded condensers, this type incorporates two insulated mounting holes through the bakelite body. It is thus possible to mount this condenser to a metal panel.

Despite its small size ($\frac{1}{4}$ " x $\frac{21}{32}$ " x $\frac{11}{2}$ " this Polymet Condenser comes in all capacities up to .006 mf.

NEW POLYMET VOLUME CONTROLS

The Polymet Manufacturing Corporation has recently produced two unusual volume controls.

One is a metal shell type with a resistance element made of a special compound. Its action is extremely smooth, insures perfect contact at all times, is very durable, has a very low resistance "hop-off", and comes in a very small size (only $\frac{1}{2}$ " outside diameter). This volume control can be made up in any required taper. Polymet engineers recommend this for use when resistances of more than 5,000 ohms are required.

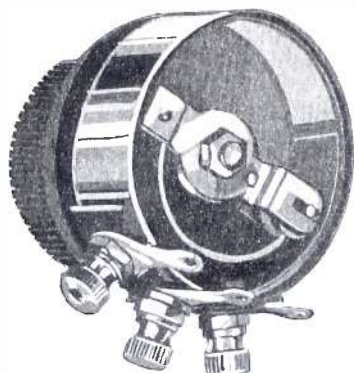

Polymet Metal Shell Type Volume Control.

The second new type of Polymet volume control is a wire-wound type in a bakelite shell. An ingenious contact arrangement provides a firm and uniform, but flexible, contact at all times. It incorporates such essential qualities as positive stop, rigid construction, beautiful finish, and perfect windings incorporating any required taper. This type of Polymet volume control is recommended for use when resistances required are less than 5,000 ohms.

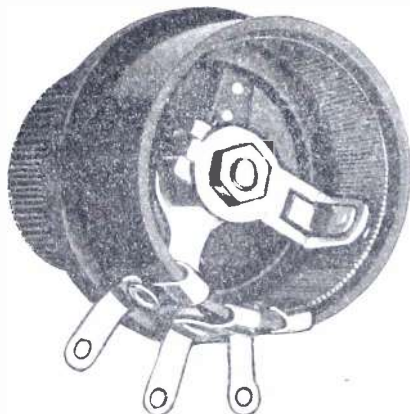

Polymet Wire-Wound Volume Control.

POLYMET BALANCING CONDENSER

A new adjustable condenser, has been produced by the Polymet Manufacturing Corporation. With this type of condenser, adjustments can be made from practically zero capacity up to .0003 mf. by means of

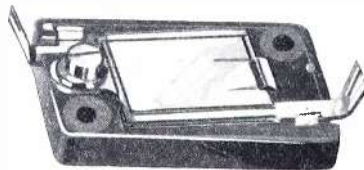

Polymet Balancing Condenser.

a screw placed on the outside of the effective surfaces. The condenser is well-made of metal plates and mica insulators assembled in a nest provided for them in the molded bakelite base. The folded-over edges of the top-plate provide extreme rigidity and uniform capacity.

SUPREME MODEL 400-B DIAGNOMETER

The Supreme Instruments Corporation, of Greenwood, Miss., will have available for delivery some time in June a new model of the Supreme Diagnometer, which will be known as Model 400-B.

This model will not differ fundamentally from their Model 400-A, but there have been incorporated in it certain refinements and slight changes that experience has shown will prove advantageous to the serviceman. The Model 400-A will be continued so that the Model 400-B constitutes an addition to the line.

The Model 400-B is designed particularly to take care of the new receiving sets that will be brought out during the coming season. Many of these sets will use higher voltages so that the range of the voltmeters contained in the instruments has been extended to 750 volts. Multi-scale meters are used with the following scales:

D-C. Voltmeter, 4 scales 0/750/250/100/10
A-C. Voltmeter, 4 scales 0/750/150/16/4.
Milliammeter, 3 scales, 0/125/25 milliamperes 0/2 1/2 amperes. The addition of a scale on this meter will permit closer readings for tube testing and other tests.

DURHAM MF4-2 RESISTORS

The International Resistance Company announces an interesting development in resistors which are supplied to the manufacturing trade, as well as to jobbers and service stations for use in connection with replacements of resistors in power packs and alternating current sets.

The resistance unit is known as their Durham Type MF4-2; a very ruggedly made unit, the thinned wire pigtail leads being simultaneously moulded with the end of the unit, providing a rugged and substantial resistor that is practically indestructible, except under very severe mechanical shock.



Durham MF4-2 Resistor.

Each of the resistors go through an operation, which is unique, consisting of the "blasting" of the resistance unit at twice its normal rating, which in the case of the MF4 unit rated at 1 watt, means a "flash" load for five minutes at 2 watts. The units are supplied to close degrees of accuracy, and show a very low temperature coefficient.

These metallized resistors are supplied by the International Resistance Company in all ranges of from approximately 250 ohms to 10 megohms.

STERLING ALL-PURPOSE TESTER

The Sterling Manufacturing Co., of Cleveland, has announced a new tester added to their line of radio service instruments. It is known as the Type R-522 All-Purpose Tester, because it tells everything the serviceman should know about a-c. and d-c. sets and tubes. It even checks the line voltage so that proper adjustment may be made on the radio set where the line voltage is abnormally high or low.

One feature of the instrument is that through the use of six meters, it is not necessary to have more than two scales on any of the meters. This enables the serviceman to take readings easily and accurately without the possibility of confusing one scale with another. Binding posts are also provided so that the meters may be used as separate instruments.

The Morocco leather-grained case is of the portable type and of small dimensions. The instrument is priced at \$40.50 net to the dealer.

A SET ANALYZER THAT TESTS SCREEN-GRID RECEIVERS

The Jewell Electrical Instrument Company, 1650 Walnut Street, Chicago, announces a new Pattern 199 A-C, D-C, Set Analyzer designed to test the new screen-grid receivers.

This instrument has all the features of the old Jewell 199 Set Analyzer, plus the screen-grid test. It makes every test that will give information regarding the working of a radio set and its accessories. It tests a-c., d-c., and screen-grid tubes, A and B-eliminators, batteries, circuits, grid, plate, and cathode voltages, plate milliamperes, chargers, and line voltage. Silver contact push button switches throughout make rapid, accurate testing convenient.



New Jewell Set Analyzer.

Binding posts make both the a-c. and d-c. instruments available for special testing. All a-c. voltage ranges have a resistance of 1,000 ohms per volt.

This handy set analyzer is furnished in a plywood case with serviceable cover, and equipped with test leads, four and five-prong tube adapters, and line voltage leads. Another feature is the pad of Jewell Analysis Charts, and the Jewell "Instructions for Servicing Radio Receivers," which gives test data on receivers of twenty-five leading radio manufacturers.

STEVENS SP-29 DYNAMIC SPEAKER

The Stevens Manufacturing Corporation, of New York City introduced their new SP-29 Dynamic Speaker.

Among the features of this dynamic speaker is the unique voice coil, utilizing a flat winding of extreme compactness and low impedance for maximum efficiency. The flexible center web is integral with the voice coil support. A special alloy is employed for the pot of the field coil, thereby assuring maximum magnetic flux for minimum bulk and weight. The spacing between pole pieces and voice coil has been reduced to an absolute minimum, providing an efficiency which is immediately noticeable when operating on modest inputs. Three terminals offer a choice of push-pull or single tube amplification, so that a single -71-A, a single -50, or two -71-A tubes or two -10 tubes may be employed in push-pull.

The field coil is energized by rectified a-c. supplied by a tube with a two-section filter. The neat chassis includes all components compactly gathered into a foolproof assembly.

MAGNETS FOR EVERY RADIO NEED

M
A
X
I
M
U
M

E
L
E
C
T
R
I
C
A
L

E
F
F
I
C
I
E
N
C
Y

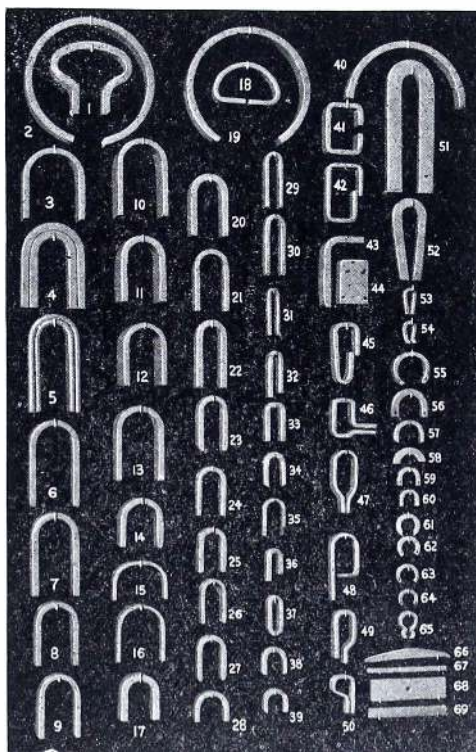

M
E
C
H
A
N
I
C
A
L
L
Y

P
E
R
F
E
C
T

As the pioneer manufacturers of Permanent Magnets of every size and description, we offer you the benefit of many years of research work together with our actual experience in catering to the requirements of the most critical users of quality Magnets in this country.

Since the inception of Radio, special attention has been paid, in our laboratories, to the development of Magnets best suited for use in Speakers.

We are manufacturers of Magnets exclusively and show in the illustration above a few of the many types which we are constantly producing.

If you are in the market, send us your blue prints or sketches for price and delivery. If you have Magnet problems, get in touch with us and let us work out a solution for you.

Indiana Steel Products Company

4545 So. Western Boulevard

Chicago, Ill.

Magnet makers for quarter of a century.

NEW!

for Dynamic Speaker Use

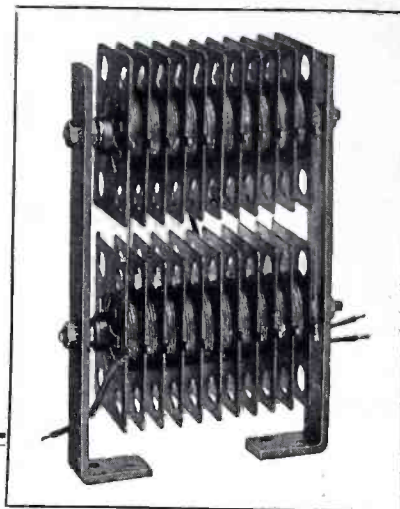

A High Voltage KUPROX Rectifier

FREE!

Our new Engineering Binder, illustrating all standard types of Kuprox Rectifiers for dynamic use, and containing up-to-date engineering information, will be mailed free to any speaker manufacturer, engineer or designer requesting it on his company's letterhead.

Large Industrial Concerns use Copper OXIDE Type Rectifiers Exclusively.

Despite the slightly higher first cost, railroad, telephone, telegraph and similar industrial concerns use only dry plate rectifiers of the Copper OXIDE type—the only dry rectifier that is electronic and not electrolytic in action. Absolute dependability is as important to you as it is to them!

A NEW Kuprox Rectifier for dynamic speaker use, that supplies DC field current direct from 110-volt commercial AC supply, **WITHOUT THE USE OF A TRANSFORMER.** This new rectifier is new only in its application to dynamic speaker operation. Thoroughly tested and proved by more than a year's use in telegraph, railway and commercial fields, and now adapted for dynamic speaker use. Manufactured in two standard sizes, capacities 10 and 15 watts. Samples and complete engineering data to manufacturers on request.

New Low Voltage Designs

Several new types and sizes of low voltage rectifiers have been added to the Kuprox line. Standard capacities 1, 2 or 3 amperes at 2 or 3 volts. These outputs offer a low rectifier and transformer cost and most economical field coil construction. Any desired output can be furnished on special order.

"The Proof of the Pudding"

Not a single manufacturer of dynamic speakers, having adopted Kuprox rectifiers as standard equipment, has ever changed to a competing make. This in face of the fact that 90% of all speaker manufacturers used Kuprox last season! Can you afford to use a less efficient or shorter-lived construction?

THE KODEL ELECTRIC & MANUFACTURING CO.
527 E. PEARL ST. CINCINNATI, OHIO

We look forward to seeing you at BOOTH 29, Stevens Hotel, Chicago

from
Start to Finish in A. C. Sets

For that A-C set you are designing or manufacturing — for good results from start to finish — for absolute minimum of service from the time it is sold until it is discarded in the dim future — for making real merchandise that you, the jobber and the dealer can sell and the public can buy at a profit —

Two items are indispensable and should receive your earnest consideration at this time. No matter what the circuit you employ; no matter what the components; no matter what the list price; please look into these three features for your line of sets:

LINE BALLAST CLAROSTAT

Here is the proper beginning for your A-C set — a constant, safe, and proper input voltage, regardless of line voltage, for insuring satisfactory and economical operation anywhere and everywhere.

No longer need your dealer lose sales in low-voltage areas, where it has heretofore been impossible to give a satisfactory demonstration. The LINE BALLAST CLAROSTAT will automatically raise the applied voltage for satisfactory operation.

And in high-voltage areas, or even when the usual line voltage suddenly takes an upward jump, placing a severe strain on the A-C set tubes, the LINE BALLAST CLAROSTAT automatically reduces the applied voltage to a safe value. It safeguards the tubes and filter condensers, by keeping the secondary voltages within 5 per cent plus or minus, even when the line voltage fluctuates 30 per cent.

But don't confuse this device with other so-called line voltage ballasts. The LINE BALLAST CLAROSTAT is different. It employs an unique ballast wire suspension of mica and angle brass. It is rigid and durable. Stout metal case with ample perforations for dissipating the heat. Standard prongs to plug into standard outlet receptacle or tube socket. Will outlast the usual set in which it is employed. And, best of all, it's troubleproof!

HUM DINGER CLAROSTAT

After providing proper voltages for your A-C tubes, the next consideration is a minimum of hum. With audio systems and loud-speakers made more responsive to the lower frequencies, it becomes essential to eliminate or ameliorate the usual causes of hum. Among these, an accurately determined center tap resistance for the grid return to A-C tubes, known as a hum balancer, is essential.

And that spells HUM-DINGER. Here is a simple, compact, inexpensive device, so sturdy that it will outlast the other components in the set. Essentially a strip resistor, with unique contact that swings over center portion, providing wide balancing range. Contact is adjusted by means of screwdriver engaging with slotted-head shaft recessed in the one-hole mounting bushing. Furnished in any desired resistance value.

Nothing to wear out. Nothing to get out of order. Nothing for the lay hand to tinker with. And offered to you at a surprisingly low price—cheaper than the center-tapped transformer, and easier to assemble and wire.

Wire-wound VOLUME CONTROL CLAROSTAT

The last thing to receive your attention, and usually the first thing to call the service man, is the volume control. Don't take a chance with a questionable volume control! Some of our best radio sets have been ruined by a noisy and unsatisfactory volume control.

The WIRE-WOUND VOLUME CONTROL CLAROSTAT is the product of resistance specialists who spent over a year in studying volume control problems. Hundreds of different models were made and tested. And then came this solution.

This device is provided in any desired resistance value, from 1 to 25,000 ohms. It is compact, wear-proof, simple, easily installed, and trouble-proof. Don't confuse it with those carbonized paper affairs that soon wear out and introduce "static" in the radio reception! Don't confuse it with devices with incomplete wire turns, which depend on carbonized paper or resistance paste for the real resistance! The WIRE-WOUND VOLUME CONTROL CLAROSTAT is a genuine, 100% wire-wound job.

The illustration tells the story. See the unique pressure contact, which makes a positive contact at any point on the wire winding, without rubbing. The wire is never disturbed or displaced. Examination under a powerful microscope shows no appreciable wear after turning the knob 81,000 times. And the smooth, velvety, delightful operation, denotes a new form of contact.

There's a CLAROSTAT for Every Radio Purpose

In addition to the three items just mentioned, there are other Clarostats of every conceivable type, range and size for all radio applications. These devices, already employed in millions of radio assemblies of manufactured, custom-built and home-made variety, have established an enviable reputation in the radio industry. Indeed, the CLAROSTAT is a hallmark of good radio engineering and honest radio manufacturing.

Manufacturers and Designers of A-C Sets

WRITE for engineering data regarding the CLAROSTAT products in which you may be interested. Furthermore, don't hesitate to ask for samples for your inspection and test, addressing us on your firm letterhead. We shall gladly co-operate with you on your resistance problems.

CLAROSTAT MANUFACTURING COMPANY, Inc.

Specialists in Radio Aids

282 North Sixth Street

: :

Brooklyn, N. Y.

CLAROSTAT

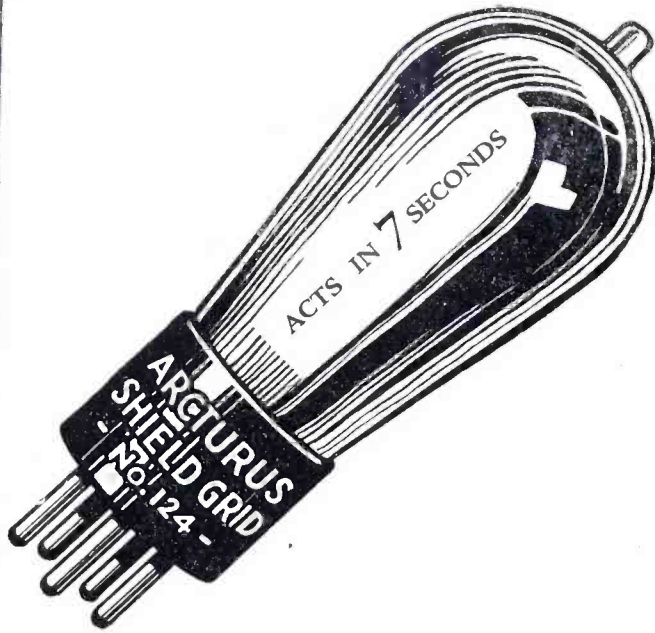

The PIONEER

of the new

A-C Screen-Grid Tube

A YEAR AGO—the Arcturus A-C Screen-Grid Tube was placed with set manufacturers. TODAY—leading set manufacturers use this new Arcturus A-C Screen-Grid Tube as standard equipment.

Arcturus pioneered this latest A-C Radio Tube development and is now building into the No. 124 A-C Screen-Grid Tube a full year's experience. Arcturus Tubes act in 7 seconds, give clearer reception as hum is banished, and they hold the world's record for long life.

Insist on Arcturus *Blue* A-C Tubes in your A-C set. Your dealer has an Arcturus A-C Tube for every socket. Try them today—you'll be amazed at the vast improvement.

ARCTURUS

BLUE ^{A-C} LONG-LIFE TUBES

ARCTURUS RADIO TUBE COMPANY

220 ELIZABETH AVE. ~ NEWARK, NEW JERSEY

IF YOU TAP HOLES—

Why not have the feel of the tap right at your finger tips? A tap is a delicate tool. The Ettco Tapping Attachment taps, delicately—with increased speed—That's the answer.



The Ettco Tapping Attachment

is simple—nothing to adjust—if the tap sticks or hits bottom the Ettco slips—the same action coming out. No clash of a positive clutch—just the smooth action of the patented leather-lined cone clutch.

Sensitive—speedy—satisfactory

No. 1—Tapping Attachment 3/16" in steel, 1/4" in C.I. \$35.00

No. 2—Tapping Attachment 5/16" in steel, 3/8" in C.I. 50.00

No. 3—Tapping Attachment 1/2" in steel, 5/8" in C.I. 80.00

Eastern Tube & Tool Co., Inc.

534 JOHNSON AVE., BROOKLYN, N. Y.

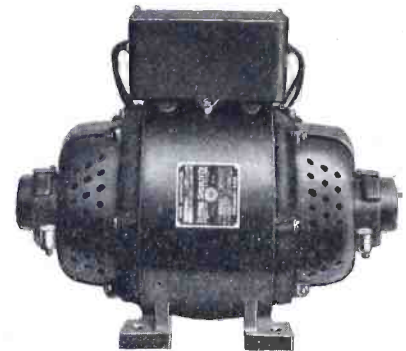

Dynamotor with Filter for Radio Receivers

MACHINES for OPERATING 60-CYCLE A. C. RADIO RECEIVERS, LOUD SPEAKERS and PHONOGRAPHS from DIRECT CURRENT LIGHTING SOCKETS WITHOUT OBJECTIONABLE NOISES OF ANY KIND

The dynamotors and motor generators are suitable for radio receivers and for combination instruments containing phonographs and receivers. Filters are usually required. The dynamotors and motor generators with filters give as good or better results than are obtained from ordinary 60-cycle lighting sockets. They are furnished completely assembled and connected and are very easily installed.

These machines are furnished with wool-packed bearings which require very little attention, and are very quiet running.

ELECTRIC SPECIALTY COMPANY

TRADE "ESCO" MARK

411 South Street

Stamford, Conn.



SERVICE

COILS

QUALITY

AND

TRANSFORMERS

Made to Your Specifications

25 YEARS

of Electrical Manufacturing

Insures Your Receiving

First-Class Design, Construction

and

SERVICE

I. R. NELSON CO.

1 BOND ST., NEWARK, N. J.

ACME WIRE PRODUCTS

Parvolt Filter and By-Pass Condensers

Coils — Magnet Wire Wound

Varnished Insulations

Magnet Wire — All Insulations

All products made to Recognized Commercial Standards, including those of:

National Electric Mfrs. Assn.

Radio Manufacturers' Assn.

American Society for Testing Materials

For 25 years manufacturers and suppliers to the largest and most discriminating users.

THE ACME WIRE CO.

NEW HAVEN, CONN.

Branch Offices

New York

52 Vanderbilt Ave.

Chicago

842 N. Michigan Ave.

Cleveland

Guardian Bldg.

Wooden Skyscrapers -- ?

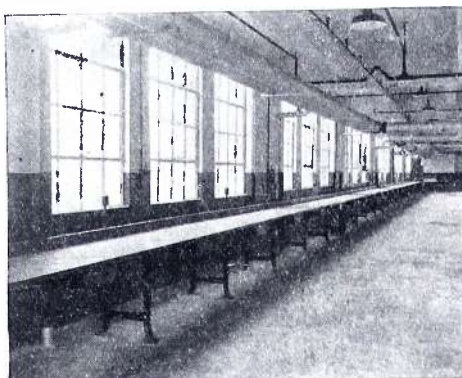

"Hallowell" Steel Work-Bench
(Continuous)

"HALLOWELL"

Steel Benching certainly is a fine example of modern steel construction—strong, rigid, wobble and fireproof and wears as only steel can wear—and by way of contrast, what a sorry figure a wooden skyscraper would make.



Pat'd. and Pat's. Pend'g

"Hallowell" Steel Work-Bench
(Individual)

And those spacious, one-piece steel tops that can't crack and splinter and are so hard and smooth that oil won't soak in are easy to keep clean.

Whether the plant be old or new the time is sure to come when "we will need some benches."

Formerly, they were built to order of wood by carpenters with all the fuss, waste and expense attending such work; but today ready-made, standardized, "HALLOWELL" Steel Benching has taken their place—sold by the foot, or by the mile, as individual or continuous benches and shipped from stock at fixed prices. It's the 20th century way.

We carry 1368 different sizes and combinations of "HALLOWELL" Steel Bench Equipment in stock for immediate shipment.

We also make "HALLOWELL" Steel Work-Tables, Bench-Drawers, Tool Stands and Chairs and Stools.

However, better write our Johnny Martin for particulars and

BULLETIN 386

STANDARD PRESSED
STEEL CO.

Jenkintown, Pa., Box 533

Branches

Boston : Detroit : Chicago : St. Louis

A Special Dept. for Rush Jobs

When a manufacturer wants a resistor built to specifications—he usually wants it in a hurry.

That's why we've installed a special department for just such rush jobs—72 hours after we get your specifications, samples are on their way to you—We even ship by air mail if you desire.

And we don't stop the *rush* with delivery of samples—If satisfactory (and practically all of them are) we can ship quantities in the same quick time. Write to

HARDWICK, HINDLE, INC.

Sales Dept.,
122
Greenwich
Street,
New York



Factory,
215 Emmet
Street,
Newark,
N. J.

RESISTORS

ARMOR GUARANTEED RADIO TUBES

All Standard Types



**ARMSTRONG
ELECTRIC CO.**
187-193 Sylvan Ave.
NEWARK, N. J.

TO HELP YOU SOLVE VACUUM TUBE PROBLEMS



WHEN special circuits or special devices demand a vacuum tube that's different, write or phone the Perryman laboratories for competent engineering counsel.

The Perryman Electric Co., Inc., offer the services of their entire engineering personnel—a most modern and fully equipped laboratory—supervised by George H. Perryman.

This group developed the sturdy Perryman Radio Tube, incorporating the Patented Perryman Bridge and filament tension-spring. Their interests have carried them far into the field of audio amplification, resulting in intensive studies in the development of the talking-movies. Such is the wide and comprehensive experience available to you.

A letter to the laboratories will bring immediate reply.

PERRYMAN
RADIO TUBES

Laboratories and Plant
North Bergen, N. J.

*The Tube
with the
Patented
Bridge
and
Spring*



THE Radio industry has contributed much to the development of Aviation.

Radio Beacons, Radio Altimeters, Receiving and Sending Units, Remote Control—these and other Radio devices have been adapted to aeronautical use by Radio Engineers.

Aviation Engineering, in addition to covering the engineering developments in aircraft—also covers the radio engineering contributions—"the eyes and ears of Aviation."



Aviation
Engineering
IS NOT
Sold on
Newsstands

Bryan Davis Publishing Co.
52 Vanderbilt Ave., N. Y. City

Enter my subscription to AVIATION ENGINEERING for { 1 yr. at \$2.00
2 yrs. at \$3.00

Name.....

Address.....

City..... State.....

Please check classification: Engineer Airport
 Technician Manufacturer

Experienced Engineers Can Now Make Big Money

Installing  the new
PUBLIC ADDRESS EQUIPMENT

Amplion has an exceedingly profitable proposition for engineers who are qualified to enter this new big field of amplification. Write for proposition and latest sound equipment catalog. Build an enduring reputation for yourself in this new field of amplification on Amplion's enduring quality.

AMPLION is the ONE place in America where you can purchase the complete installation or any part of the equipment as desired



Amplion Exponential 10-ft. Air Column Horn

Specially designed to reproduce the human voice and orchestral music in talking picture and group address installations

We Have Ready for Immediate Delivery and Quick Installation

Group Address Equipment of Unsurpassed Dependability, for
Theatres—Hotels—Auditoriums—Hospitals—Clubs—County Fairs

- | | |
|---|-------------------------------------|
| Amplion Giant Dynamic Air Column Units | Amplion Electric Phonograph Pick-up |
| Amplion Exponential 10-ft. Air Column Horns | Amplion Exciters |
| | Amplion Microphones |
| | Microphone Amplifiers |
| | Microphone Transformers |

See Our Exhibit at the Chicago Coliseum June 1 to 9 — or send for catalog

AMPLION CORPORATION OF AMERICA
133 W. 21st St., New York City. Telephone Chelsea 5257



Single Stand

Testing Your Condensers

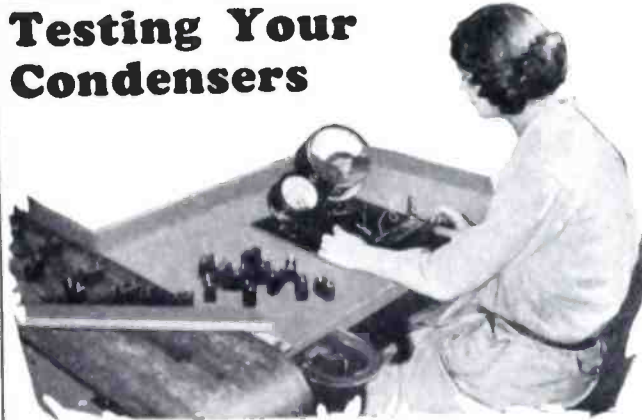

THIS picture from the FAST condenser factory shows the testing equipment at the end of each conveyor belt system. The completed condensers are progressively conveyed by belt system to the testing table, where severe tests are made by expert operators before the product is ready for shipment.

The painstaking care taken in the various processes of production insure to you a uniform quality product throughout. After the testing operation is completed, the condensers are carefully packed in individually marked cartons, ready for shipment to the radio factory.

This is but one of many unit operations to which Fast condensers are subjected in the process of manufacture.

Put your condenser problems up to the FAST Organization of condenser specialists.

JOHN E. FAST & CO

3982 Barry Avenue



Chicago, Illinois

attention service men

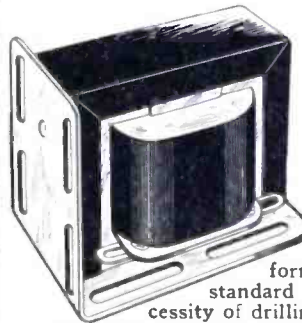

A quality replacement audio transformer for the service man. Possesses the same high degree of performance which characterizes all Thordarson audio units. Provides highest amplification consistent with quality reproduction.

Unique Mounting Feature. The mounting bracket of this transformer is designed to fit all standard mountings without the necessity of drilling additional holes. May be mounted either on end or side or may be used as bracket to support sub-panel.

Remember: Thordarson radio transformers are Supreme in musical performance.

R-100..... List Price \$2.25

THORDARSON ELECTRIC MFG. CO.
Transformer Specialists Since 1895
Huron, Kingsbury & Larrabee Sts.—Chicago

THORDARSON

replacement audio transformer

ATTENTION: MANUFACTURERS

NEW! A Sensational CONDENSER That Will Have Great Bearing in the Radio Industry

HERE ARE THE SPECIFICATIONS:

SAFE CONTINUOUS WORKING VOLTAGE—1000 V. D. C.
(750 r.m.s. R. A. C.)

FLASH TEST (Multitudinous)—1500 V. D. C. (1000 V. A. C.)

BREAKDOWN VOLTAGE—2700 V. D. C.

POWER FACTOR—Less than 1%

CAPACITY—Non-inductive, within 5% of rating

INSULATION RESISTANCE—Over 600 Megohms per MFD.

DIELECTRIC LOSSES—Negligible

BREAKDOWN VOLTAGE, FOIL TO CASE—Over 5000 V.A.C.

PHYSICAL DIMENSIONS—About ¼ present standards

FATIGUE TESTS PROVE UNEXCELLED LONGEVITY

Write at once stating your requirements. Samples and Prices on Application.

A. M. Flechtheim & Co., Inc., 136 Liberty St., New York City, N. Y.



THE CARTER BUILDING

OUR NEW HOME

An invitation is extended to everyone to visit us in our new location at 407-415 South Aberdeen Street, Chicago, Illinois. Here with the largest factory in the world, devoted to the manufacturing of radio parts exclusively and the installation of the most modern labor-saving devices and production methods, we will be able to give you better service than in the past. Watch for important announcements by CARTER in the near future.

CARTER

Radio Company

Now at 407-415 South Aberdeen St., Chicago

Telephone  Monroe 1780

VIRGINIA BEACH

(Over night from New York by boat or rail)

*An
Ideal
Vacation!*

Golf
Tennis
Riding
Fishing
Dancing
Surf Bathing

Write for information and rates
(they're moderate) to

MARTHA WASHINGTON HOTEL
VIRGINIA BEACH, VA.

Fireproof, Brick Construction

The coolest spot on the beach. Invigorating breeze from the Atlantic Ocean on the East and Lake Holly on the West. Quiet, restful, bright, airy outside rooms, parlor suites or apartments, private baths. Superior cuisine. Dining room open all day.

J. WESLEY GARDNER, Manager.



HY-WATT EL-MENCO

EL-MENCO resistors and condensers are being used by practically all the leading manufacturers of radio receiving sets; and have been universally approved by very prominent radio engineers in the country.

"Manufacturers' Specifications Solicited"



Hy-Watt Metallized Resistor



El Menco Molded Bakelite Condenser



El-Menco Grid Leak



Hy-Watt Metallized Resistor



El-Menco Tapped Vitreous Enameled Resistor



El-Menco Vitreous Enameled Resistor

Our engineering staff comprises a group of men who are highly specialized in resistor and condenser construction and design. The high standard of manufacture and the rigid factory tests assure users of EL-MENCO products uniformity and dependability.

ELECTRO MOTIVE ENGINEERING CORP.

127-133 W. 17th St.

"Catalogue Sent Upon Request"

New York City

According to Your Specifications

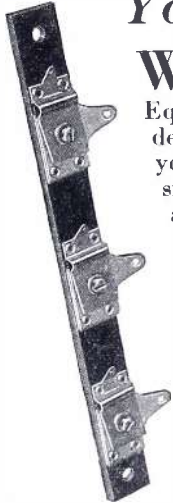

WE are prepared to make special models of the Hammarlund Equalizing and Neutralizing Condensers, either single or in gang, to your specifications. Superbly designed and constructed—compact, accurate, efficient.

Bakelite base; brass stator plate; mica dielectric; phosphor bronze spring plate; convenient adjusting screw and connecting lugs.

The standard models range in capacity value from 2 mmfds. minimum to 70 mmfds. maximum.

Write Dept. RE6 about your needs

HAMMARLUND MFG. CO.

424-438 W. 33rd St. New York, N. Y.

For Better Radio
Hammarlund
PRECISION
PRODUCTS

MANUFACTURERS OF

TUNGSTEN & MOLYBDENUM PRODUCTS

TUNGSTEN ALLOYS

Filament—Wire—Rod—Ribbon—Coils

MOLYBDENUM

Wire—Sheet—Rod

TRIMET

Lead-in Wire

CATHODES AND RADIO WIRE

Coated and Uncoated Ribbon and Wire

REFRACTORY METAL CONTACTS

All Types

CALLITE PRODUCTS CO., INC.,
Union City, N. J.



LEHMAIER, SCHWARTZ & Co., INC.

511 to 541 West Twenty-fifth Street, N. Y. C.
Manufacturers



Visit Our Chicago Office
During the Radio Show
180 North Wacker Drive
Tel. Dearborn 5007

CONDENSER FOLDS

TIN LEAD ALUMINUM COMPOSITION

ESTABLISHED IN 1878, we are proud of the fact that since the inception of paper condensers, we have supplied the major portion of all the foil used in their manufacture; whether these condensers were for RADIO, TELEPHONE, IGNITION OR POWER FACTOR CORRECTION.

"The recognized Standard by which all other Condenser Foil is Judged"

**Copper, Brass, Phosphor Bronze,
Nickel Silver**

Hot Tinned or Plain

We specialize in the manufacture of rolled metals .001 thick and thicker, 1/16" wide and wider, and are now supplying the majority of radio and parts manufacturers.

THE BALTIMORE BRASS COMPANY
1206 Wicomico Street Baltimore, Maryland

Attention—Radio Manufacturers

We are now located in larger quarters, where we have increased facilities for manufacturing METAL STAMPINGS. New presses have been installed enabling us to increase production on METAL CABINETS and CONSOLES.

ALSO MANUFACTURERS OF
Non-tip six-leg steel stepladders. Radiator enclosures and shields. Metal boxes. Eliminator cases. Steel shelvings and partitions. Enameling.

Your inquiries for the coming season are solicited.

New Address

LUNA METAL CRAFT CORP.
38-40 Emerson Place, Brooklyn, N. Y.

FAHNESTOCK

Announces
Clip No. 57
for the
SCREEN-GRID TUBE

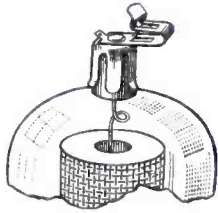

Provision is made for either soldering the wire or using the Fahnestock spring-clip for making connection.

Write for samples and prices

FAHNESTOCK ELECTRIC CO.
Long Island City, N. Y.
"World's Largest Manufacturer of Spring Clip Terminals"



RADIO WIRES



CABLES, HARNESES AND CORDS
MADE TO SPECIFICATION
CORNISH WIRE COMPANY
30 Church St., New York, N. Y.
Makers of Corwico "BRAIDITE" Hook-up Wire



PHOTOELECTRIC CELLS

Television—Talking Pictures—Research

G-M VISITRON cells of the alkali metal hydride type are of highest sensitivity, low dark current, long life, and respond to the smallest changes of light intensity and color. Their high quality and uniform sensitivity make them the choice of leading engineers. Get technical Bulletin P-14 Free.

G-M LABORATORIES INC
1806 Grace St., Chicago, Ill.

WIRE

STRAND—Antennae (plain or enameled)—Double Galvanized.
WIRE—Antennae (plain or enameled). Connecting and Ground (Rubber covered, braided or plain).
BUS BAR—Litzendraht-Loop.
MAGNET (Cotton or Silk).

John A. Roebling's Sons Co., Trenton, N. J.

MOLYBDENUM WIRE

FOR RADIO AND LAMPS
NEON, HELIUM AND ARGON GAS
Highly purified
FLASHLIGHT BULBS
Furnished by
PALATINE INDUSTRIAL CO., Inc., 111-5th Ave., New York

CORE LAMINATIONS

for Audio & Power Transformers — Chokes

Annealed Nickel Alloy.
Hymu (High Permeability) a new grade
Silicon Steel for Audio.

A large variety of standard shapes carried in stock.
Special designs stamped to your order.

Our BOOKLET on LAMINATIONS (sent on request) gives specifications of Stock Standard Shapes, and contains much data of value to the designer—and buyer.

Lamination Stamping Company
764 Windsor Street, Hartford, Conn.

ALHAMBRA

LOUD SPEAKER PAPER

Alhambra Paper gives absolutely uniform resonance and imparts the utmost in tone quality.

Write us about your requirements

THE SEYMOUR CO.,
323 W. 16th St., New York City



Microphones

2-Button Type

For Public Address, etc., list . . . \$25
Standard Broadcast Model, list . . . \$75

Condenser Models for Film and Record Work.
list \$250.00, \$300.00

Also Desk and Floor Stands, Covers, Cords, etc. Miniature
Microphone, Paper Weight, Radiator Ornament, Die Cast.
Bronze finish; prepaid on receipt of \$1.00.

EXPERT MICROPHONE REPAIRS

Dealers everywhere

UNIVERSAL MICROPHONE CO., Inglewood, Calif.

CHICAGO:	NEW YORK:	SAN FRANCISCO:
Fred Garner Co.,	Gotham Eng. & Sales Co.,	C. C. Langevin Co.,
9 S. Clinton St.	50 Church St.	274 Brannon St.

ALL TYPES of LAMINATIONS

for
Audio and Power Transformers—Chokes

IN STOCK FOR IMMEDIATE DELIVERY
EXPERT TOOL AND DIE MAKING

Write for samples and prices. Also quotations on metal stampings.



WILLOR MFG. CORP.

117 Mercer St.,
New York City



CONDENSER

TISSUES

NO Radio set is any better than its weakest link, and the weakest link is very often a filter Condenser. No Condenser is any better than the thin strips of Insulating Tissue which separate the layers of metal foil. A pinhole or a speck of metal in the Condenser Tissue means a breakdown of the Condenser, with the entire set put out of commission.

DEXSTAR Condenser Paper is regarded by Radio experts as being the highest grade Insulating Tissue ever made—the freest from defects, the most uniform in quality, the most lasting under exacting and unusual requirements. DEXSTAR Condenser Tissue is the specialized product of a paper mill which has excelled in Tissue Paper production for three generations.

RADIO designers and builders should have the assurance that Condensers which they use are made with DEXSTAR Condenser Tissues. It is insurance against many radio troubles. The leading Condenser manufacturers are now using DEXSTAR Condenser Tissues exclusively.

C. H. DEXTER & SONS, INC.

Makers of Highest Grade Thin Papers
WINDSOR LOCKS, CONN.

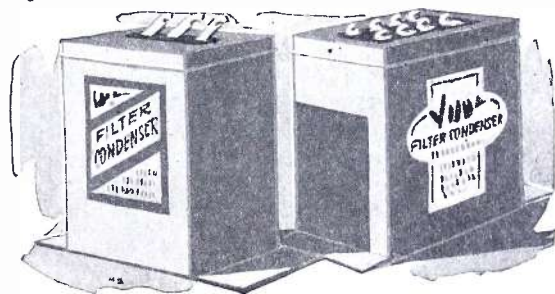

To the Readers and Advertisers in *Radio News, Science and Invention, Amazing Stories, Radio Listeners Guide and Call Book:*

We believe that the June issue of RADIO NEWS speaks for itself. We believe that you will find it to be a vast improvement over any recent issue, and there is a surprise in store for you when the July copies come out. You will find the method of illustration, the typography, the cover, the character of advertising and—what is most important—the editorial material of a far superior quality to any issue of RADIO NEWS ever before published.

The new blood in the Experimenter Publications, Incorporated, has been taken from the leading publishing companies in the country and welded into one cohesive organization which is out to do for the various magazines in this group one of the outstanding jobs in the publishing field. You will find that all of the men heading the various departments in this organization are men of outstanding achievement in their respective fields; and in RADIO NEWS in particular you will find that the editorial, circulation and advertising staffs are made up of men taken from the leading organizations in the field. You will find in RADIO NEWS everything that is worth while that you ever found there before, and in addition, you will find articles describing the application of various radio devices to such new fields as talking movies, public address systems for schools and auditoriums, and so forth, as well as the latest developments in airplane radio.

In connection with the airplane activity in RADIO NEWS, it is a pleasure to tell you that we are cooperating with such organizations as the Guggenheim Fund for the Promotion of Aeronautics, the Radio Aircraft Corporation, the General Electric Company, the Radio Corporation of America, the Bell Laboratories, the U. S. Bureau of Standards and various manufacturing companies whose business it is to provide suitable radio and other scientific equipment for the safeguarding of our aviators.

Since a great many of these devices depend to a very large extent upon the same underlying principles involved in radio itself, it follows naturally that editorial comment of this nature very properly deserves a place in the pages of RADIO NEWS.

Colonel Lindbergh himself has recently said that the success of aviation will to a very large extent depend upon the advances made in scientific radio instruments for use in air navigation.

To provide the necessary space for this additional information on radio as it applies to aviation, we have added sixteen pages to RADIO NEWS. In other words, we are giving our readers just as much radio news as ever and in addition, we are telling them about the latest developments in aviation radio.

The new owners of this business are men with over twenty-five years of successful publishing experience. Ample capital for all purposes has been provided and the business has been moved into quarters more suitable for its purposes.

Summed up—our magazines are in better condition editorially and financially than ever before. They are in experienced hands and both readers and advertisers can look confidently to the future for them to be more readable and more productive. It is our purpose to do everything in our power to be of service to you. We are in a position to aid you because our radio magazines have a larger circulation than any other magazines in the same field. RADIO NEWS, for instance, covers every possible angle of the radio field, and more manufacturers, jobbers, dealers and fans read RADIO NEWS than all the other radio magazines combined.



Publisher.

A General Amplifier for \$85 Using the New 245 Power Tube



Model GA-15
Price (less tubes)—\$85

An efficient two-stage power amplifier operating from the standard 110 to 120 volt, 50 to 60 cycle alternating current line and particularly well adapted for use in small auditoriums or in the home. It employs one 227, two 245 power tubes in push-pull and one 280 rectifier and will deliver fully 4.5 watts of undistorted energy to the reproducer.

The many superior refinements, for which General Amplifiers are known, are incorporated in this device. Absolute tone fidelity at all volumes, reliability and stability are assured.

The facilities of this company are at your service and its engineering staff will be pleased to cooperate with you in problems of power amplification.

Bulletin RE-4 will be sent you on request.

All General Amplifiers are licensed under patents of the Radio Corporation of America and associated companies for Radio Amateur, Experimental and Broadcast Reception.

GENERAL AMPLIFIER COMPANY
27 COMMERCIAL AVE.—CAMBRIDGE, MASS.
Makers of High Grade Power Amplifiers

Dial Headquarters Announces

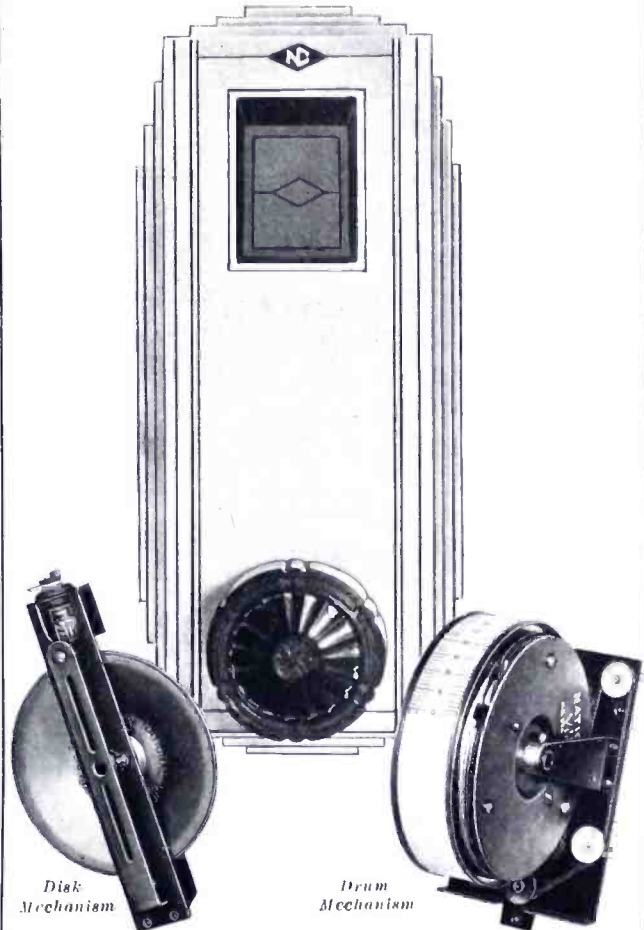

Disk Mechanism

Drum Mechanism

NATIONAL VELVET VERNIER DIALS

Types G & H
and Mechanisms

These new dials bristle with modern and ingenious features for the user's convenience and pleasure. Dial illuminator throws brightly colored image of scale on ground glass screen in dial opening, so that scale reads same from every position. Six rainbow colors change automatically for different parts of the scale. Has beautiful modern escutcheon, brush silver finish. Model G operates disk scale, Model H is drum type,—both using proved National Mechanisms.

National Co. also offers standard Velvet-Vernier Mechanisms for manufacturers' use.

Manufacturers, Jobbers, Set Builders—write or wire for prices.

NATIONAL CO. INC., Malden, Mass.

Est.  1914

You GET More When You BUY More!

When the entire performance and reputation of a receiver often depends on even its smallest parts, why compromise? Standardize on ELECTRAD Voltage Controls and be SURE!

Super-TONATROL
The New
Long-Lived
Five-Watt
VOLUME
CONTROL



U. S. Pats. No.
1034103, 1034104
and Pats. Pend.

U. S. Pats.
No. 1593658,
1034103, 1034-
104 and Pats.
Pending.



The famous ELECTRAD Tonatrol line includes wire-wound volume controls of the Royalty type, in stock ratings that meet all usual receiver requirements. For extra-heavy duty, use the Super-TONATROL. *Tell us your needs.*

ELECTRAD, INC., Dept. RE-6,
175 Varick St., New York.

Let's have the facts about the TONATROL Line, especially Super-TONATROL.

Name

Address

ELECTRAD
INC.

RADIO

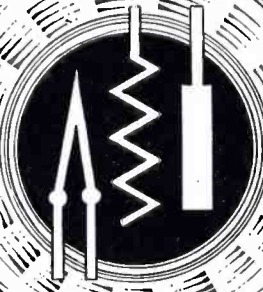

Out on
June
20th

Nothing Else Like It

CIRCUIT diagrams, specifications, prices, characteristics, technical and non-technical data on all new 1930 radio sets, tubes, speakers, transformers, accessories and parts exhibited at the Radio Manufacturers' Show in Chicago, June 4th to 11th. Complete in every detail.

Contents

More than 100 pages of data—ready for mailing to you only a few days after the show closes in Chicago—giving you the whole story on everything that's new in radio. Dozens of circuit diagrams on the very newest factory built sets—shown for the first time at the show. All the new changes in radio frequency circuits, detectors and amplifiers. All the prices of all models, style numbers, specifications etc. Data for service men and dealers. Complete tables of tube characteristics of many makes of vacuum tubes. All the new loud speaker developments, together with prices, sizes, types and characteristics. Data on new audio systems, screen grid tubes, power tubes and rectifiers. New kits and parts for the home builder. Complete story of the show—booth by booth. Summary of the show. Forecast for 1930 radio. All this information is in the JULY issue of RADIO, out on June 20th, only a few days after the show closes. Get the JULY issue—and the five issues that follow—all for only one dollar—just half the regular price. The show issue (JULY) alone sells for 50 cents per copy. The demand will be greater than the supply. ORDER TODAY—send a dollar bill, check or money order and the coupon. \$2.00 worth of information for one dollar—if you act now.

All this for only

Regular
Price
\$2.00

\$1.00

Your money refunded if you are not satisfied.

—SAVE 50%

RE6.

Publishers of "RADIO"
428 Pacific Building, San Francisco, California.
Here is \$1.00 in full payment for a copy of the July SHOW ISSUE of "RADIO" which you will mail me on June 20th and also send me the August, September, October, November and December, 1929 copies of RADIO. It is fully understood that \$1.00 covers the entire cost of this subscription.

Name
Street and No.
City
State

POWER AMPLIFICATION



Type "D"
Price \$145
(without tubes)

- Theatres
- Auditoriums
- Summer Resorts
- Dance Halls
- Factories
- Clubs and Schools

are interested in bringing music or speeches to great crowds of people and should know about

WEBSTER CHICAGO POWER AMPLIFICATION

A WEBSTER power amplifier with a good radio or phonograph reproduces the voice or instrument, thru a series of speakers, with marvelous accuracy. Not a note or a syllable is slurred when WEBSTER amplifiers supply the power. These instruments are designed by engineers skilled in the science of audio amplification, who have had many years of practical experience in this field. The manufacture is done in a plant that has for years specialized in the making of power supplies for radio. The name WEBSTER is a guarantee of accurate design, dependable operation, and superior workmanship. Write for information about our complete line.

POWER Packs, Transformers and Chokes

The WEBSTER line includes complete power packs as well as component pack parts. WEBSTER power transformers and power chokes are standard equipment adopted by the manufacturers of the country's finest radio receivers.



In its Machine and Tool Division Webster manufactures RAULAND SUNSHINE, an ULTRA-VIOLET RAY LAMP of remarkable power. Absolutely harmless and a source of health and happiness for the whole family. A profit-maker for radio, hardware, department, or any retail store. Write for particulars.

WEBSTER CHICAGO

The Webster Co. 850 Blackhawk St., Chicago



Visit BOOTH NO. 150
ROOM 515A
Hotel Stevens

Be sure to see the Webster Remote Control at the Show

ROLA

at the R. M. A. SHOW
Stevens Hotel, Booth 71
and Demonstrating Room 537-A

Introducing

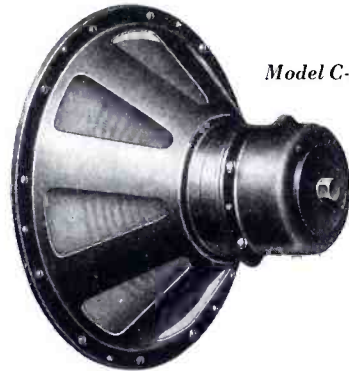

Model C-90-M

New C-90-M Electro-dynamic REPRODUCER

PARTICULARLY of interest to manufacturers at the R.M.A. Show is the new Rola C-90-M electro-dynamic unit. Introducing new high mechanical and electrical safety factors and refinements, this reproducer indicates the attainment of an extraordinary degree of efficiency.

With a 9 inch cone diameter and increased power capacity of the C-90-M is especially well adapted to amplifiers using 245 tubes in push-pull combination—for radio receiving sets, electric phonographs and auditorium installations.

High sensitivity has been obtained by the use of high operating flux density which Rola's short, precision air-gap makes possible *without increase of field energizing power*—a feature extremely desirable where the field current is supplied from the radio power-pack.

Large amplitude of vibration is permitted by an exceptionally free floating spider and leather support. A ventilated field coil minimizes temperature changes which affect the load resistance and tend to cause unwanted variations in the power supply circuit. The exclusive Rola adjustable center pole tip, and the exclusive welded housing-to-shell construction have been retained.

Rola offers the quality radio manufacturer a complete answer to the loudspeaker problem.

The ROLA COMPANY

Cleveland, Ohio
2570 E. Superior Ave.

Oakland, California
Forty-fifth and Hollis Sts.

WANTED Condenser Designer

Company of high standing desires to employ the services of a competent man with or without college training to design condensers and to supervise the manufacture of sample condensers and to otherwise assist in the engineering work connected with condenser manufacture as part of the operating staff of the organization.

Write Box 500

Care RADIO ENGINEERING
52 Vanderbilt Ave.
N. Y. C.

AD. AURIEMA, Inc.
Manufacturer's Export Managers
116 Broad Street, New York, N. Y.

Scientifically equipped to economically export dependable receiving and transmitting radio apparatus

PHOTO-ELECTRIC CELLS THE BURT CELL

Without Fatigue—Highly Sensitive
Absolutely Reproducible—Instantaneous in Response

The BURT-CELL is made by a new method and should not be confused with any other photo-electric cell. By a special process of electrolysis, the photo-electric metal is introduced into a highly evacuated bulb directly through the glass wall of the bulb, giving photo-electric material of absolute purity. The superiority of the BURT-CELL is due to these features, making possible results never before obtainable. Described in Bulletin No. 271.

We also manufacture the STABILIZED OSCILLOSCOPE—the only VISUAL OSCILLOGRAPH having a linear time axis and no inertia—giving an accurate picture of high frequency wave forms.

Write for Bulletin 282.

DR. ROBERT C. BURT
Manufacturing and Consulting Physicist
327 S. Michigan Ave., Pasadena, Calif.

Hear the Aero-Call Short Wave Converter

Factory-Built, Ready to Plug Into Your Present Radio Set

Operates without motor-buzzing, by an auxiliary filter system control, an exclusive feature (patent applied for). This amazing radio instrument now makes it possible to reach 'round the world. Geo. Morecroft of Pa. tuned in England, Holland and Australia on his initial test. Permits you to enjoy programs from coast-to-coast that your regular receiver cannot get. What a thrill it is to plug this into your regular set and instantly be in another world! No change or wiring required.

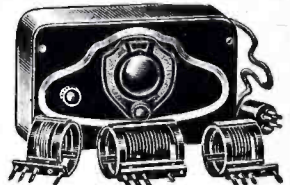

All complete, ready to operate, tubes and coils hidden, no apparatus in sight, except the neat, golden-brown, compact metal cabinet in crackle finish. Size, 9 x 5 1/2 x 2 1/2 in.

The only converter we know of that really works on all sets. Two models—A.C. and D.C. Write for Catalog and literature, or send \$25.00 and name of your dealer. Model A. for A.C. sets \$25.00 Model D. for D.C. sets \$25.00.

At leading dealers and jobbers.



Aero Products, Inc.
4611 E. Ravenswood Ave.,
Dept 769
CHICAGO, ILL.

RELAYS

BREAK IN—6 Volts D.C. and 120 Volts D.C.
STRAIGHT—for Short Wave Transmitters
(1/4 in. or 3/8 in. Contacts)

LEACH RELAY COMPANY

1013 S. Los Angeles St. Los Angeles, Cal.

RADIO MANUFACTURERS

What About Your 1929-30 Publicity?

Are your products getting their share of profitable publicity? We are specialists in radio publicity and have obtained wonderful results for many manufacturers. We have some interesting data available on this subject and shall be glad to mail it to you, without obligation, upon request.

ALLIED ENGINEERING INSTITUTE
Suite 429 — 30 Church Street New York, N. Y.

TESTING OF RADIO APPARATUS

Permeability and Hysteresis Curves of iron samples.

Condensers tested for life, voltage breakdown, leakage, etc.

Input and output curves of socket power devices—Oscillograms.

80th St. at East End Ave. ELECTRICAL TESTING LABORATORIES New York City, N. Y.



Special Test Equipment

for use on the radio manufacturer's production line and in the service laboratory is designed and

built by this company on special order.

Descriptive literature will soon be available. Write for it:

Production tests: *Bulletin B-1*
Service tests: *Bulletin B-2*

GENERAL RADIO COMPANY
30 State Street Cambridge, Massachusetts

New! A Big Improvement in a well-known, standardized **QUALITY** resistance unit. Different and Better.

LYNCH METALLIZED STANDOHM

The "Self-Supporting"



Resistor — with a number of outstanding features:

1. Metallized filament resistance element—universally accepted where the best is standard.
2. Molded end caps, insuring positive mechanical and electrical contact—tapered for insertion in standard cartridge type mounting where interchangeability is desired.
3. Insulated base designed to permit mounting on metal surfaces.
4. Tinned wire leads which can be directly soldered into circuit, becoming integral therewith and proof against noise caused by faulty connections.
5. Special ceramic casing of sturdy construction and maximum heat dissipation.
6. Compact assembly with resultant saving in space requirements.
7. Made in 1.0 Watt and 2.0 Watt types, individually tested and boxed.
8. Moderate in price and efficient in operation.

Order NOW, or write for complete information.

ARTHUR H. LYNCH, Inc., 1775 B'way, New York

Manufacturers of
LYNCH RESISTORS, EQUALIZORS, SUPPRESSORS, MOUNTINGS, RESISTANCE-COUPLED KITS, ETC.

COMPLETE LINE

Immediate Delivery



Write for Bulletin 931

GENERAL RADIO CO. PARTS



45 VESEY STREET, NEW YORK CITY

DeJUR-AMSCO

CONDENSER SERVICE TO

SET MANUFACTURERS

Write for Engineering Data and Working Drawings.

Let us quote on your requirements.

AT THE CHICAGO SHOW

See the DeJur-Amsco complete line of "Bath-Tub" Condensers

Booth 149 Stevens Hotel

DeJUR-AMSCO CORPORATION

Broome and Lafayette Sts., New York City

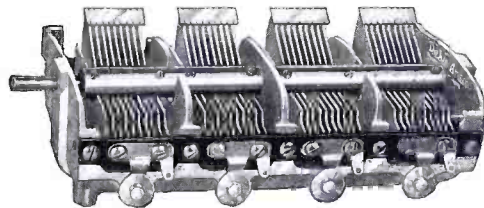

Protected by Patents and Patents Applied For
Single, Double, Triple and Quadruple Types in All Capacities, With or Without Dials.

New!
by the makers of

A. C. Line Voltage Control

For Radio Set Manufacturers

A remarkably convenient and efficient device which automatically handles A. C. line fluctuation over a broad range.
Cost surprisingly low.

AMPERITE

The "SELF-ADJUSTING" Rheostat

For information, write Dept. R.E. 6
RADIALL CO.
50 Franklin St., New York, N. Y.

Read what the New York Sun says!

Edition of May 11, 1929

Book Reviews

THE MATHEMATICS OF RADIO

by John F. Rider. Volume I of "The Service Man's Manual." Radio Treatise Company, New York.

POSSIBLY there are more fans who possess the technical ability to assemble a complicated piece of radio apparatus without knowing the reason for their various steps than are allied with any other hobby or vocation. Radio has grown to be unusually attractive because fine results have been possible without excessive technical knowledge.

Yet there are thousands who have felt the need for at least a ground work in the fundamental mathematics of the more simple problems encountered. Times there are galore for the master of trigonometry and calculus but the vast field lying between the beginner and the professor has remained uncultivated by the author.

That is why this treatise by John Rider will without doubt reach a tremendous number of readers. Knowing the limited time for study available to the man for whom the book was prepared Rider has carefully deleted the mass of preliminary mathematical discussion and has proceeded directly to the formula or result which is vital to the experimenter.

This should not be taken to mean that the Mathematics of Radio is for the beginner. There are few laboratory workers whose memory is so perfect that the possession of this publication would be of no benefit. Aided by an excellent index every page is made available in a minimum of time. Practically every item forming a part of the modern receiver is discussed from a mathematical standpoint. All types of tubes, their characteristics and effects, battery eliminators and power amplifiers are treated in turn, with formulae supplied in such form that only a simple substitution of values must be made.

It is safe to assume that the manual will be a daily aid to every service man in the employ of every service station not to mention the vast army of home builders who have been searching for such a work as this for many moons.

Price \$2.00. Postage extra, 15 cents

128 pages, 8 1/2" x 11", 119 illustrations printed . . . bound in flexible cover . . . This book is sold with a guarantee . . . If you are dissatisfied and you return the book within 5 days after you receive it, your money will be refunded.

Write for descriptive literature

RADIO TREATISE CO.

1440 Broadway

New York City

Use this Coupon

Here is my \$2.15 for the Math. of Radio by John F. Rider.

Name

Address

City State

New Zealand



—a prosperous British country—a popular market for worthy American products.

All New Zealand is "listening-in". Are you selling *your* products there? We will gladly supply you with particulars of the market and people. Write now!

"N. Z. Electrical Journal"

Wellington,

New Zealand

Every Radio Engineer

needs this book—the only work of its kind on Uses, Theory, Design, Construction and Testing of electrical condensers.

ELECTRICAL

Contains also formulae for calculating electro-static capacity, for aerials; charts and curves for calculating design; means and methods of checking calculations by actual measurements.

Cloth bound
Gilt edges
\$10

CONDENSERS

By
Philip R.
Coursey

F. Inst. P.,
M.I.E.E., Chief Engineer,
Dubilier Condenser Co., Ltd.

Invaluable to Engineers,
Students and Research Workers.

514 illustrations, 635 pages

Isaac Pitman & Sons, 2 West 45th St., New York

Please send me.....copies of *Electrical Condensers*
I enclose \$.....

Name

Address

If it's British Radio and Gramophones

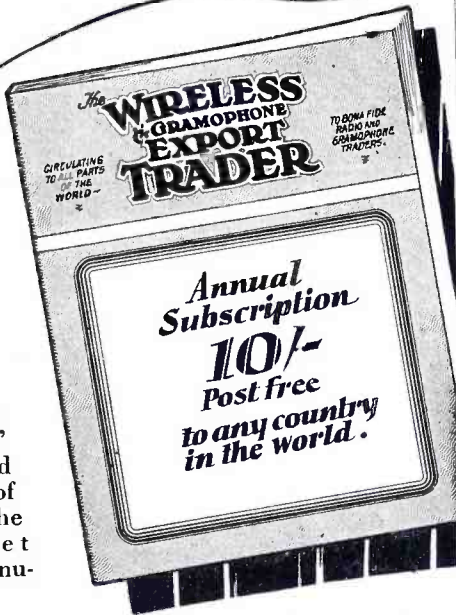

If you are either selling or buying British Radio and Gramophone goods, "The Wireless Export Trader" is your first and finest means of contact with the British Market and British Manufacturers.

IT gives you first hand information as to the trend of the British Radio and Gramophone Trades, the design of receivers and components and the vogue in eliminators, speakers, constructors kits, gramophones and records, with independent tests and expert opinions on their selling values.

"The Wireless Export Trader" is published on the first of the month. Can we mail you a free specimen copy?

Publishers & Proprietors:

The TRADER PUBLISHING Co., Ltd.,
Salisbury Sq., Fleet St.,
London E.C.4., England

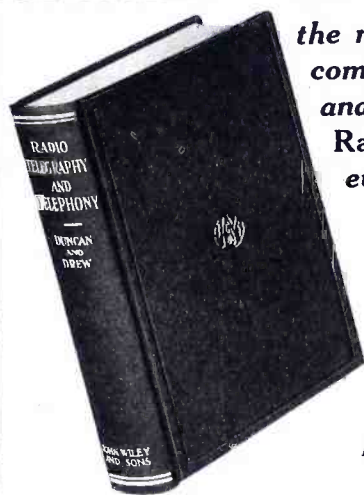

the most complete, comprehensive, and authoritative Radio Handbook ever published!

Published May, 1929

... a practical handbook for Radio Engineers, Operators, Amateurs, Broadcasters, and Students!

Practical Radio Telegraphy and Telephony

By Rudolph L. Duncan

Director, Radio Institute of America

and Charles E. Drew

Instructor in Radio, and in charge of Electrical Division, Radio Institute of America

More than 900 pages of practical information on Ship, Shore, and Broadcast Operating make this Radio Handbook indispensable for the practical radio man. Principles, methods and equipment are described clearly and interestingly and illustrated profusely with more than 450 supplementary and illuminating diagrams and photographs.

This is all brand new 1929 data presented as a result of years of study and research on the part of two of America's foremost teachers of this subject. The book is a product of the School Division of the Radio Corporation of America, and therefore represents the last word on the subject.

Everyone at all interested in this fascinating subject will find his favorite phase of

Radio clearly and fully discussed. Even the casual reader will enjoy this book and discover the answers to a great many radio mysteries about which he has vaguely wondered. This book will greatly increase the enjoyment of your radio and open your eyes to a great field of new and progressive discoveries.

Indispensable to the radio man and extremely interesting to the amateur, this book is also an ideal Wireless Operators' Handbook and a complete text for the student of Wireless Communication.

Never before has such a wealth of practical and usable data been collected in book form for the use of the thousands for whom radio is the most fascinating subject in the world.

Price \$7.50

Send in this coupon at once and examine the book at our expense!

A Wiley Book

FREE EXAMINATION COUPON

John Wiley and Sons, Inc., 440 Fourth Ave, New York
Gentlemen: Kindly send me on ten days' examination Duncan and Drew's "Radio Telegraphy and Telephony."

I agree to remit the price of the book within ten days after its receipt or return it postpaid.

Name
Address
Position or Reference
Subscriber RE-6-29

Buyers Directory of Materials and Apparatus

Readers interested in products not listed in these columns are invited to tell us of their wants, and we will inform the proper manufacturers. Address Readers' Information Bureau.

Addresses of companies listed below, can be found in their advertisement—see index on page 116.

- ADAPTERS:**
Insuline Corp. of Amer.
Lynch, Arthur H., Inc.
- ALUMINUM:**
Aluminum Co. of America
- ALUMINUM FOIL:**
Aluminum Co. of America
Reynolds Metals Co., Inc.
- AMMETERS:**
General Electric Co.
General Radio Co.
Jewell Elec. Inst. Co.
Weston Elec. Instrument Corp.
- AMPLIFIERS, POWER:**
G. M. Laboratories, Inc.
General Amplifier Co.
General Radio Co.
National Co., Inc.
Samson Elec. Co.
- ANTENNAE, LAMP SOCKET:**
Dubilier Condenser Mfg. Co.
Electrad, Inc.
- ARRESTERS, LIGHTNING:**
Jewell Elec. Inst. Co.
Westinghouse Elec. & Mfg. Co.
- BASES, VACUUM TUBE:**
Formica Insulation Co.
General Electric Co.
General Plastics Co.
National Vulcanized Fibre Co.
Synthane Corp.
- BAFFLES:**
Wright-DeCoster, Inc.
- BENCHES, STEEL WORK:**
Standard Pressed Steel Co.
- BINDING POSTS:**
Eby, H. H., Co.
General Radio Co.
- BRACKETS, ANGLE:**
Electrad, Inc.
Insuline Corp. of Amer.
Scovill Mfg. Co.
- BRASS:**
Baltimore Brass Co.
Scovill Mfg. Co.
- BROADCAST STATION EQUIP'T:**
Cardwell, Allen D., Mfg. Co.
General Radio Co.
Nelson, I. R., Co.
- BULBS, PANEL:**
Palatine Industrial Co., Inc.
- BUTTS:**
Scovill Mfg. Co.
- CABINETS, METAL:**
Aluminum Co. of America.
Copper and Brass Research Assn.
- CELLS, PHOTOELECTRIC:**
Burt, Robert C.
G. M. Laboratories, Inc.
Raytheon Mfg. Co.
- CHARGERS:**
Benwood-Linze Co.
Elkon Co.
- CHASSES**
Aluminum Co. of America.
United Scientific Laboratories, Inc.
- CHOKES, AUDIO FREQUENCY:**
American Transformer Co.
General Radio Co.
Jefferson Electric Co.
Silver-Marshall, Inc.
Thordarson Elec. Mfg. Co.
Transformer Co. of Amer.
- CHOKES, RADIO FREQUENCY:**
Cardwell, Allen D., Mfg. Co.
General Radio Co.
Silver-Marshall, Inc.
- CHOKES, B. ELIMINATOR:**
American Transformer Co.
Dongan Elec. Mfg. Co.
General Radio Co.
Jefferson Electric Co.
Nelson, I. R., Co.
Polymet Mfg. Corp.
Silver-Marshall, Inc.
Transformer Co. of Amer.
Valley Appliances, Inc.
- CLAMPS, GROUND:**
Insuline Corp. of Amer.
Fahnestock Elec. Co.
Scovill Mfg. Co.
- CLIPS, SPRING:**
Electrad, Inc.
Fahnestock Elec. Co.
Scovill Mfg. Co.
- COIL FORMS:**
General Radio Co.
Silver-Marshall, Inc.
- COIL WINDING:**
Acme Wire Co.
Dudlo Mfg. Co.
Polymet Mfg. Corp.
Rome Wire Co.
- COILS, CHOKE:**
Acme Wire Co.
Dudlo Mfg. Co.
Jefferson Electric Co.
Nelson, I. R., Co.
Polymet Mfg. Corp.
Rome Wire Co.
- COILS, IMPEDANCE:**
Acme Wire Co.
Dudlo Mfg. Co.
Nelson, I. R., Co.
Polymet Mfg. Corp.
Rome Wire Co.
- COILS, INDUCTANCE:**
Acme Wire Co.
Aero Products Corp.
Cardwell, Allen D., Mfg. Co.
General Radio Co.
Hammarlund Mfg. Co.
National Co., Inc.
Nelson, I. R., Co.
Rome Wire Co.
Silver-Marshall, Inc.
- COILS, MAGNET:**
Acme Wire Co.
Dudlo Mfg. Co.
Nelson, I. R., Co.
Polymet Mfg. Corp.
Rome Wire Co.
- COILS, RETARD:**
Hammarlund Mfg. Co.
- COILS, SHORT WAVE:**
Aero Products Corp.
General Radio Co.
Hammarlund Mfg. Co.
Silver-Marshall, Inc.
- COILS, TRANSFORMER:**
Acme Wire Co.
Dudlo Mfg. Co.
Nelson, I. R., Co.
Polymet Mfg. Corp.
Rome Wire Co.
Valley Appliances, Inc.
- CONDENSER PARTS:**
Aluminum Co. of America
Scovill Mfg. Co.
- CONDENSERS, BY-PASS:**
Acme Wire Co.
Aerovox Wireless Corpn.
Allen-Bradley Co.
Amrad Co.
Condenser Corp. of America.
Concourse Elec. Co.
Dongan Electric Mfg. Co.
Dubilier Condenser Mfg. Co.
Electrad, Inc.
Fast, John E. & Co.
Flechtheim Co.
Polymet Mfg. Corp.
Sangamo Elec. Co.
Wireless Specialty Apparatus Co.
- CONDENSERS, FILTER:**
Acme Wire Co.
Aerovox Wireless Corpn.
Allen-Bradley Co.
Amrad Co.
Concourse Elec. Co.
Condenser Corp. of America.
Dongan Electric Mfg. Co.
Dubilier Condenser Mfg. Co.
Fast, John E. & Co.
Flechtheim Co.
Polymet Mfg. Corp.
Sangamo Elec. Co.
Wireless Specialty Apparatus Co.
- CONDENSERS, FIXED:**
Acme Wire Co.
Aerovox Wireless Corpn.
Allen-Bradley Co.
Amrad Co.
Concourse Elec. Co.
Condenser Corp. of America.
Dongan Electric Mfg. Co.
Dubilier Condenser Mfg. Co.
Electrad, Inc.
Electro-Motive Eng. Co.
Fast, John E. & Co.
Flechtheim Co.
Polymet Mfg. Corp.
Sangamo Elec. Co.
Wireless Specialty Apparatus Co.
- CONDENSERS, MIDGET:**
Cardwell, Allen D. Mfg. Co.
General Radio Co.
Hammarlund Mfg. Co.
National Co., Inc.
Scovill Mfg. Co.
Silver-Marshall, Inc.
United Scientific Laboratories
- CONDENSERS, MULTIPLE:**
Cardwell, Allen D. Mfg. Co.
Hammarlund Mfg. Co.
National Co., Inc.
Scovill Mfg. Co.
United Scientific Laboratories
- CONDENSERS, NEUTRALIZING:**
Polymet Mfg. Corp.
- CONDENSERS TRANS-MITTING:**
Dubilier Condenser Mfg. Co.
- CONDENSERS, VARIABLE TRANSMITTING:**
Cardwell, Allen D. Mfg. Co.
General Radio Co.
Hammarlund Mfg. Co.
National Co., Inc.
- CONDENSERS, VARIABLE:**
Cardwell, Allen D. Mfg. Co.
DeJur-Amsco Co.
Frost, Herbert H., Inc.
General Radio Co.
Hammarlund Mfg. Co.
National Co., Inc.
Scovill Mfg. Co.
Silver-Marshall, Inc.
United Scientific Laboratories
- CONNECTORS:**
Cornish Wire Co.
Scovill Mfg. Co.
- CONTROLS, CURRENT:**
Central Radio Laboratories
DeJur-Amsco Corp.
Insuline Corp. of Amer.
Polymet Mfg. Corp.
Ward Leonard Elec. Co.
- CONTROLS, ILLUMINATED:**
Hammarlund Mfg. Co.
Silver-Marshall, Inc.
- CONTROLS, VOLUME:**
Central Radio Laboratories
Clarostat Co.
Electrad, Inc.
Polymet Mfg. Corp.
- CONVERTERS:**
Cardwell, Allen D., Co.
Electric Specialty Co.
- CONVERTERS, ROTARY:**
Electric Specialty Co.
- COPPER:**
Baltimore Brass Co.
Scovill Mfg. Co.
- CORDS, EXTENSION:**
Acme Wire Co.
Cornish Wire Co.
- CURRENT CONTROLS, AUTOMATIC:**
Radial Co.
- DIALS:**
Crowe Nameplate & Mfg. Co.
Hammarlund Mfg. Co.
National Co., Inc.
Scovill Mfg. Co.
Silver-Marshall, Inc.
United Scientific Laboratories
- DIALS, DRUM:**
Hammarlund Mfg. Co.
National Co., Inc.
Silver-Marshall, Inc.
United Scientific Laboratories
- DIES:**
Luna Metal Craft Co.
Willor Mfg. Corp.
- DYNAMOTORS:**
Electric Specialty Co.
- ENGINEERS, CONSULTING:**
Allied Engineering Institute
- ESCUTCHEONS:**
Crowe Nameplate & Mfg. Co.
Scovill Mfg. Co.
- EXPORT:**
Ad. Auriema, Inc.
- FILAMENTS:**
Cohn, Sigmund
Callite Products Co., Inc.
Gilby Wire Co.
Vacuum Tube Products Co.
- FILAMENT CONTROLS, AUTOMATIC:**
Lynch, Arthur H., Inc.
Polymet Mfg. Corp.
Radial Co.
- FOIL:**
Aluminum Co. of America
Lehmaier, Schwartz & Co.
Reynolds Metals Co., Inc.
- GALVANOMETERS:**
General Electric Co.
General Radio Co.
Jewell Elec. Inst. Co.
- GASES, RARE:**
Palatine Industrial Co., Inc.
- GEARS:**
Chicago Stock Gear Wks.
- GENERATORS:**
Electric Specialty Co.
- GETTER MATERIAL:**
Cohn, Sigmund.
Gilby Wire Co.
- GRID LEAKS:**
Aerovox Wireless Corpn.
Allen-Bradley Co.
DeJur-Amsco Co.
Electrad, Inc.
Electro Motive Eng. Co.
Hardwick, Hindle, Inc.
International Resistance Co.
Lautz Mfg. Co.
Lynch, Arthur H., Inc.
Polymet Mfg. Corp.
Ward Leonard Elec. Co.
- HARNESSES, A-C:**
Cornish Wire Co.
Eby, H. H. Co.
- HEADPHONES:**
Amplion Co. of Amer.
- HINGES:**
Scovill Mfg. Co.
- HORNS:**
Amplion Co. of Amer.
Best Mfg. Co.
Oxford Radio Corp.

MASTER CONDENSER TISSUE AND ALUMINUM FOIL STOCKS

ARE MAINTAINED IN NEW YORK AND CHICAGO

The Old Masters Paper & Pulp Corporation

154 Nassau St.
New York City



22 W. Monroe St.
Chicago

"You can forget the Condensers if they are Dubilier's"

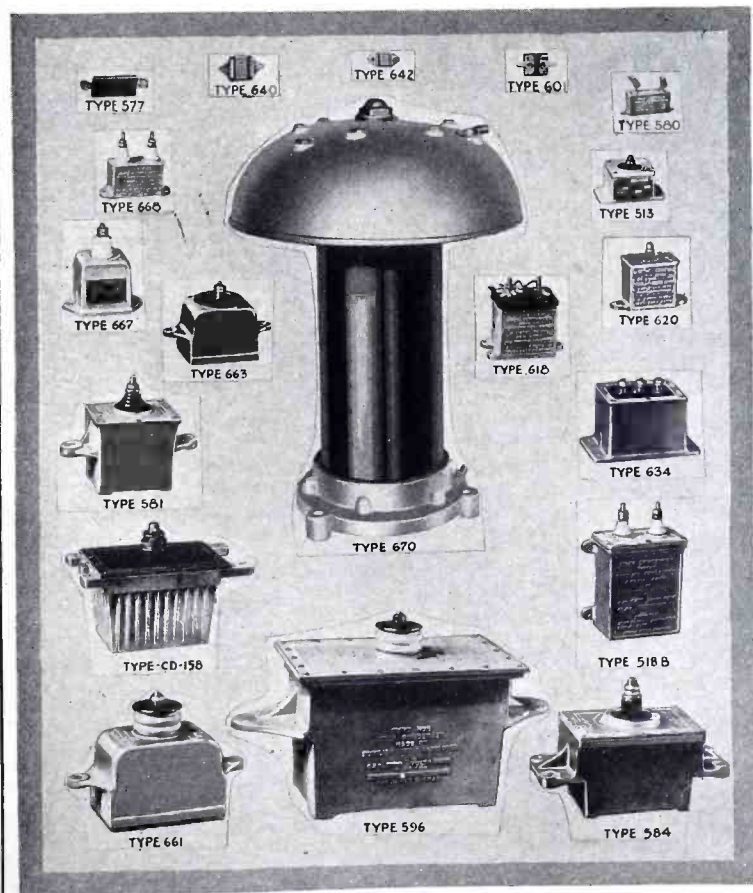

JUST a few of the thousands of types of condensers developed by Dubilier Engineers for radio and industrial purposes.

Ask for Catalog 78



Dubilier
Condenser Corporation

342 MADISON AVE.
NEW YORK, N. Y.

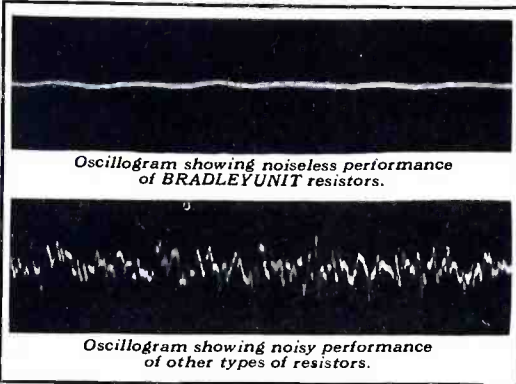

A New Resistor That Assures Noiseless Reproduction

COMPARE the extraordinary quietness of the Bradleyunit Resistor with the noisy performance of other resistors. Many resistors cause disagreeable hissing noises in the loud-speaker. For pure, clear reproduction, use Bradleyunit Solid Molded Resistors. They are unaffected by temperature, moisture or age.

Follow the example of leading set manufacturers by standardizing on Bradleyunits for grid leaks in detector circuits and for resistors in resistance coupled amplifiers. The Bradleyunit is your assurance that noises in the loud-speaker cannot originate in your equipment.

Write today for data and prices

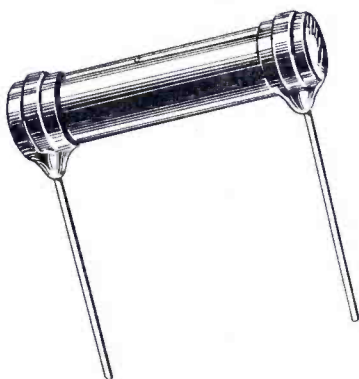

Bradleyunit Resistors are furnished in ratings from 500 ohms to 10 megohms. Equipped with cadmium plated lead wires up to six inches in length. Color coded for quick identification.

ALLEN-BRADLEY CO.
279 Greenfield Avenue Milwaukee, Wis.



- INDUCTANCES, TRANSMITTING:**
Aero Products, Inc.
General Radio Co.
Silver-Marshall, Inc.
- INSTRUMENTS, ELECTRICAL:**
General Electric Co.
Jewell Elec. Inst. Co.
- INSULATION LAMINATED:**
Formica Insulation Co.
General Electric Co.
National Vulcanized Fibre Co.
Synthane Corp.
- INSULATION, MOULDED:**
Bakelite Corp.
Formica Insulation Co.
General Electric Co.
General Plastics Co.
National Vulcanized Fibre Co.
Synthane Corp.
- INSULATION, VARNISHED:**
Acme Wire Co.
- IRON, MAGNETIC:**
Reid, David, Jr.
- JACKS:**
Carter Radio Co.
Eby, H. H., Co.
Electrad, Inc.
General Radio Co.
Yaxley Co.
- JACKS, TIP:**
Carter Radio Co.
Eby, H. H., Co.
Yaxley Co.
- KITS, SHORT WAVE:**
Aero Products, Inc.
Lynch, Arthur H., Inc.
Silver-Marshall, Inc.
- KITS, TELEVISION:**
Insuline Co.
Lynch, Arthur H., Inc.
- KITS, TESTING:**
General Radio Co.
Jewell Elec. Inst. Co.
- KITS, TRANSMITTING:**
Aero Products, Inc.
- LACQUERS:**
Zapon Co., The
- LABORATORIES, TESTING:**
Electrical Testing Labs
- LABORATORIES, ENGINEERING:**
Allied Engineering Institute
- LAMINATIONS:**
Lamination Stamping Co.
Valley Appliances, Inc.
Widor Mfg. Co.
- LAMPS, SOUND RECORDING:**
G. M. Laboratories, Inc.
- LEAD-INS:**
Electrad, Inc.
Insuline Corp. of Amer.
- LOCK WASHERS:**
Shakeproof Lock Washer Co.
- LUGS:**
Scovill Mfg. Co.
Shakeproof Lock Washer Co.
- MACHINERY, TUBE:**
Eisler Eng. Co.
- MACHINES, SPECIAL:**
Willor Mfg. Corp.
- MAGNESIUM:**
Aluminum Co. of America.
- MAGNETS:**
Indiana Steel Products Co.
Reid, David, Jr.
Thomas & Skinner Co.
- MERCURY SWITCHES:**
(See Switches)
- METERS:**
General Electric Co.
Jewell Elec. Inst. Co.
Weston Elec. Instr. Co.
- MICROPHONES:**
Amplion Co. of America
Universal Microphone Co.
- MOLDING MATERIALS:**
Bakelite Corp.
Formica Insulation Co.
General Electric Co.
General Plastics Co.
National Vulcanized Fibre Co.
Synthane Corp.
- MOTORS:**
Electric Specialty Co.
- MOTOR-GENERATORS:**
Electric Specialty Co.
- MOUNTINGS, RESISTANCE:**
DeJur-Amsco Co.
Electrad, Inc.
Lynch, Arthur H., Inc.
Polymet Mfg. Corp.
- NAMEPLATES:**
Crowe Nameplate & Mfg. Co.
Scovill Mfg. Co.
- NICKEL:**
Cohn, Sigmund
- NUTS:**
Shakeproof Lock Washer Co.
- OHMMETERS:**
General Radio Co.
Western Elec. Instru. Co.
- OSCILLOGRAPH:**
Burt, Dr. Rob't C.
General Radio Co.
- OSCILLOSCOPE:**
Burt, Dr. Rob't C.
- PANELS, COMPOSITION:**
Formica Insulation Co.
Insuline Corp. of Amer.
Synthane Corp.
- PANELS, METAL:**
Aluminum Co. of America
Scovill Mfg. Co.
- PAPER, CONDENSER:**
Dexter, C. H. & Sons, Inc.
Old Masters Paper & Pulp Co.
Schweitzer, Peter J., Inc.
- PAPER, CONE SPEAKER:**
Seymour Co.
- PARTS, SCREW MACHINE:**
Standard Pressed Steel Co.
- PHONOGRAPH MOTORS:**
(See Motors)
- PHOSPHOR BRONZE:**
Baltimore Brass Co.
- PHOTOELECTRIC CELLS:**
(See Cells)
- PICK-UPS, PHONOGRAPH:**
Amplion Co. of Amer.
Jensen Co.
Wright DeCoster
- PLATES, OUTLET:**
Carter Radio Co.
Yaxley Co.
- PLATING:**
Valley Appliances, Inc.
- PLUGS:**
Carter Radio Co.
General Radio Co.
Polymet Mfg. Corp.
Yaxley Co.
- POTENTIOMETERS:**
Allen-Bradley Co.
Central Radio Laboratories
DeJur-Amsco Co.
Electrad, Inc.
General Radio Co.
Polymet Mfg. Corp.
United Scientific Laboratories
- POWER UNITS, A-:**
Elkon, Inc.
Jefferson Electric Co.
Kodel Radio Corp.
- POWER UNITS, B-:**
Dongan Elec. Mfg. Co.
General Radio Co.
Jefferson Electric Co.
National Co., Inc.
Silver-Marshall, Inc.
Thordarson Electric Mfg. Co.
Webster Co.
- POWER UNITS, A-B-C:**
Dongan Elec. Mfg. Co.
General Radio Co.
Jefferson Electric Co.
Kodel Radio Corp.
National Co., Inc.
Silver-Marshall, Inc.
Thordarson Electric Mfg. Co.
- POWER UNITS, PARTS FOR:**
Acme Wire Co.
American Transformer Co.
Dongan Elec. Mfg. Co.
General Radio Co.
Jefferson Electric Co.
Kodel Radio Corp.
Lynch, Arthur H., Inc.
National Co., Inc.
Nelson, I. R., Co.
Polymet Mfg. Corp.
Thordarson Electric Mfg. Co.
Transformer Co. of Amer.

- PRESSINGS:**
Scovill Mfg. Co.
- PUNCHINGS:**
Aluminum Co. of America
Luna Metal Craft Co.
Scovill Mfg. Co.
- RECEPTACLES, WALL:** 44
Carter Radio Co.
Yaxley Co.
- RECTIFIERS, DRY:**
Benwood-Linze, Inc.
Elkon, Inc.
Kodel Elec. & Mfg. Co.
- REGULATORS, VOLTAGE:**
Central Radio Laboratories
Clarostat Co.
DeJur-Amsco Co.
Polymet Mfg. Corp.
Radiall Co.
Ward Leonard Elec. Co.
Yaxley Co.
- RELAYS:**
Cardwell, Allen D., Mfg. Co.
Leach Relay Co.
- RESISTANCES, FIXED:**
Aerovox Wireless Corp.
Allen-Bradley Co.
Central Radio Laboratories.
DeJur-Amsco Co.
Electrad, Inc.
Electro-Motive Co.
Frost, Herbert H.
Hardwick, Hindle Inc.
International Resistance Co.
Lautz Mfg. Co.
Lynch, Arthur H., Inc.
Polymet Mfg. Corp.
Ward Leonard Elec. Co.
- RESISTANCES, VARIABLE:**
Allen-Bradley Co.
American Mechanical Labs.
Central Radio Laboratories.
Electrad, Inc.
Electro-Motive Co.
Frost, Herbert H.
Hardwick, Hindle Inc.
International Resistance Co.
Lynch, Arthur H., Inc.
Polymet Mfg. Corp.
Ward Leonard Elec. Co.
- RHEOSTATS:**
Allen-Bradley Co.
Central Radio Laboratories.
DeJur-Amsco Co.
Electrad, Inc.
Electro-Motive Co.
Frost, Herbert H.
General Radio Co.
Polymet Mfg. Corp.
United Scientific Laboratories.
- SCREW MACHINE PRODUCTS:**
Aluminum Co. of America
National Vulcanized Fibre Co.
Scovill Mfg. Co.
Standard Pressed Steel Co.
Synthane Corp.
- SEALING COMPOUNDS:**
Candy & Co.
- SHIELDING, METAL:**
Aluminum Co. of America.
Copper and Brass Research Assn.
Luna Metal Craft Co.
- SHIELDS, TUBE:**
Carter Radio Co.
- SHORT WAVE APPARATUS:**
Cardwell, Allen D., Co.
General Radio Co.
Lynch, Arthur H., Inc.
Silver-Marshall, Inc.
- SOCKETS, TUBE:**
Eby, H. H., Co.
Frost, Herbert H.
General Radio Co.
Lynch, Arthur H., Inc.
Silver-Marshall, Inc.
Yaxley Co.
- SOLDER:**
Chicago Solder Co.
- SOUND CHAMBERS:**
Amplion Corp. of Amer.
Jensen Radio Mfg. Co.
Rola Co., The
Oxford Radio Corp.
- SOUND RECORDING LAMPS**
(See Lamps)
- SPAGHETTI:**
(See Wire, Spaghetti).
- SPEAKERS:**
Amplion Corp. of Amer.
Best Mfg. Co.
Jensen Radio Mfg. Co.
Oxford Radio Corp.
Rola Co., The
Silver-Marshall, Inc.
Transformer Co. of Amer.
Wright-DeCoster, Inc.
- STAMPINGS, METAL:**
Aluminum Co. of America
Luna Metal Craft Co.
Scovill Mfg. Co.
Valley Appliances, Inc.
- STEEL, MAGNETIC:**
See (Iron Magnetic.)
- SPRAYING:**
Valley Appliances, Inc.
- SUBPANELS:**
Formica Ins. Co.
Insuline Corp. of Amer.
General Radio Co.
National Vulcanized Fibre Co.
Westinghouse Elec. & Mfg. Co.
- SWITCHES:**
Electrad, Inc.
Insuline Corp. of Amer.
- SWITCHES, MERCURY:**
G. M. Laboratories, Inc.
- TABLES, STEEL WORK:**
Standard Pressed Steel Co.
- TAPPERS**
Eastern Tube and Tool Co.
- TELEVISION PARTS:**
Allen-Bradley Co.
Clarostat Co., Inc.
Insuline Corp. of Amer.
Lynch, Arthur H., Inc.
- TESTERS, B-ELIMINATOR:**
General Radio Co.
Jewell Electrical Inst. Co.
- TESTERS, TUBE:**
General Radio Co.
Jewell Elec. Inst. Co.
- TESTING INSTRUMENTS:**
General Electric Co.
General Radio Co.
Jewell Elec. Inst. Co.
Weston Elec. Instrument Corp
- TESTING KITS:**
Jewell Elec. Inst. Co.
- TESTING LABORATORIES:**
Electrical Testing Labs.
- TIN COATED METAL:**
Baltimore Brass Co.
- TINFOIL:**
Lehmanier, Schwartz & Co.
Reynolds Metals Co., Inc.
- TOOL STANDS:**
Standard Pressed Steel Co.
- TOOLS:**
Eastern Tube and Tool Co.
Willor Mfg. Corp.
- TRANSFORMERS, AUDIO:**
Dongan Elec. Mfg. Co.
Ferranti, Ltd.
General Radio Co.
Jefferson Electric Co.
National Co., Inc.
Samson Elec. Co.
Sangamo Elec. Co.
Silver-Marshall, Inc.
Thordarson Electric Mfg. Co.
Transformer Co. of America.
Webster Co.
- TRANSFORMERS, B-POWER UNIT:**
Dongan Elec. Mfg. Co.
Ferranti, Ltd.
General Radio Co.
Jefferson Electric Co.
National Co., Inc.
Nelson, I. R., Co.
Samson Elec. Co.
Sangamo Elec. Co.
Silver-Marshall, Inc.
Thordarson Electric Mfg. Co.
Transformer Co. of America.
Webster Co.



RADIO engineers recognize CeCo Tubes as the product of infinitely exacting technical standards. This professional judgment is based on experience with the rare sensitivity, the tone quality, and the power that CeCo's afford throughout their long life.

Leading radio engineers recommend the use of CeCo Tubes in circuits they develop.

An interesting technical discussion of CeCo methods and materials will be sent on request. Ask for the booklet, "Radio Vacuum Tubes."

CeCo Radio Tubes

Listen in on the CeCo Couriers—on the air every Monday evening at 8.30 Eastern Daylight Saving time over the Columbia Broadcasting System.

CeCo Mfg. Co., Inc., Providence, R. I.

Eisler Electric
A. C. Tube
Automatic
Exhaust Machine

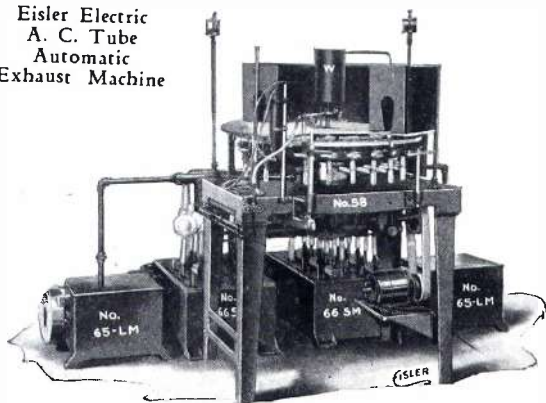

Eisler--the INDEPENDENT RADIO TUBE MANUFACTURERS' STANDARD

WHY do the engineers of the foremost independent Radio Tube Plants specify Eisler Electric equipment?

Because they know that Eisler Automatic Radio Tube Manufacturing Machines are the result of years of research; a thorough knowledge of radio tubes and their requirements. Every machine is built to endure and



Are you prepared
to share the
1929
Increased Tube
demand?

render years of satisfactory service—embodied in each machine are the best quality of materials and the finest workmanship that a human skill can produce.

Certainly there is no better recommendation.

EISLER ELECTRIC CORPORATION

Successors to Eisler Eng. Co., Inc.
760 South Thirteenth St.
NEWARK, N. J.

- TRANSFORMERS, FILAMENT HEATING:**
Dongan Elec. Mfg. Co.
General Radio Co.
Jefferson Electric Co.
Nelson, I. R., Co.
Silver-Marshall, Inc.
Thordarson Electric Mfg. Co.
Transformer Corp. of America.
- TRANSFORMERS, OUTPUT:**
Dongan Elec. Mfg. Co.
Ferranti, Ltd.
General Radio Co.
Jefferson Electric Co.
Nelson, I. R., Co.
Samson Elec. Co.
Sangamo Elec. Co.
Silver-Marshall, Inc.
Thordarson Electric Mfg. Co.
Transformer Corp. of America.
- TRANSFORMERS, POWER:**
Dongan Elec. Mfg. Co.
Ferranti, Ltd.
General Radio Co.
Jefferson Electric Co.
National Co., Inc.
Nelson, I. R., Co.
Polymet Mfg. Co.
Samson Elec. Co.
Silver-Marshall, Inc.
Thordarson Electric Mfg. Co.
Transformer Co. of America.
Webster Co.
- TRANSFORMERS, R. F., TUNED:**
Cardwell, Allen D. Mfg. Co.
Silver-Marshall, Inc.
- TRANSFORMERS, STEP-DOWN:**
Amplion Corp. of Amer.
- TUBE MACHINERY:**
Eisler Eng. Co.
- TUBES, A.C.:**
Allan Mfg. Co.
Arcturus Radio Co.
Armstrong Elec. Co.
Cable Radio Tube Co.
Ceco Mfg. Co.
Cunningham, E. T., Inc.
De Forest Radio Co.
Duval Tube Co.
Hyvac Radio Tube Co.
Perryman Electric Co.
Raytheon Mfg. Co.
Sylvania Products Co.
Triad Mfg. Co.
- TUBES, RECTIFIER:**
Allan Mfg. Co.
Arcturus Radio Co.
Armstrong Elec. Co.
Cable Radio Tube Co.
Ceco Mfg. Co.
Cunningham, E. T., Inc.
Duval Tube Co.
Hyvac Radio Tube Co.
Perryman Electric Co.
Raytheon Mfg. Co.
Sylvania Products Co.
Triad Mfg. Co.
- TUBES, TELEVISION**
See (Cells, Photoelectric.)
- TUBES, VACUUM:**
Allan Mfg. Co.
Arcturus Radio Co.
Armstrong Elec. Co.
Cable Radio Tube Co.
Ceco Mfg. Co.
Cunningham, E. T., Inc.
Duval Tube Co.
Hyvac Radio Tube Co.
De Forest Radio Co.
Perryman Electric Co.
Raytheon Mfg. Co.
Sylvania Products Co.
Triad Mfg. Co.
- UNITS, SPEAKER:**
Amplion Corp.
Best Mfg. Co.
Jensen Radio Mfg. Co.
Rola Co.
Silver-Marshall, Inc.
Temple, Inc.
Transformer Co. of Amer.
Wright DeCoster, Inc.
- VOLTAGE REGULATORS:**
(See Regulators)
- VOLTMETERS, A. C.:**
General Electric Co.
General Radio Co.
Jewell Elec. Inst. Co.
Weston Elec. Instrument Corp.
- VOLTMETERS, D. C.:**
General Electric Co.
General Radio Co.
Jewell Elec. Inst. Co.
Weston Elec. Instrument Corp.
- WASHERS:**
Aluminum Co. of America
Scovill Mfg. Co.
Shakeproof Lock Washer Co.
Synthane Corp.
- WAXES, IMPREGNATING:**
Candy and Co.
- WAXES, INSULATING:**
Candy and Co.
- WAXES, SEALING:**
Candy and Co.
- WIRE, ANTENNA:**
Acme Wire Co.
Cornish Wire Co.
Dudlo Mfg. Corp.
National Vulcanized Fibre Co.
Roebling, J. A., Sons, Co.
Rome Wire Co.
- WIRE, BARE COPPER:**
Cornish Wire Co.
Dudlo Mfg. Corp.
Roebling, J. A., Sons, Co.
Rome Wire Co.
- WIRE, COTTON COVERED:**
Acme Wire Co.
Cornish Wire Co.
Dudlo Mfg. Corp.
Roebling, J. A., Sons Co.
Rome Wire Co.
- WIRE, ENAMELED COPPER:**
Acme Wire Co.
Cornish Wire Co.
Dudlo Mfg. Corp.
Polymet Mfg. Corp.
Roebling, J. A., Sons Co.
Rome Wire Co.
- WIRE, FILAMENT:**
Callite Products Co., Inc.
Cohn, Sigmund
Gilby Wire Co.
Vacuum Tube Products Co.
- WIRE, HOOK-UP:**
Acme Wire Co.
Cornish Wire Co.
Dudlo Mfg. Co.
Roebling, J. A., Sons, Co.
Rome Wire Co.
- WIRE, LITZENDRAHT:**
Cornish Wire Co.
Dudlo Mfg. Corp.
Roebling, J. A., Sons Co.
Rome Wire Co.
- WIRE, MOLYBDENUM:**
Callite Products Co., Inc.
Palatine Industrial Co., Inc.
- WIRE, PIGTAIL:**
Dudlo Mfg. Corp.
Roebling, J. A., Sons Co.
Rome Wire Co.
- WIRE, RESISTANCE**
Gilby Wire Co.
- WIRE, SILK COVERED:**
Acme Wire Co.
Cornish Wire Co.
Dudlo Mfg. Corp.
Roebling, J. A., Sons Co.
Rome Wire Co.
- WIRE, SPAGHETTI:**
Acme Wire Co.
Cornish Wire Co.
Rome Wire Co.
- WIRE, TINNED COPPER:**
Dudlo Mfg. Corp.
Roebling, J. A., Sons, Co.
Rome Wire Co.
- ZINC FOIL:**
Lehmaier, Schwartz & Co.
Reynolds Metals Co., Inc.

PERMANENT MAGNETS—SILICON LAMINATIONS

FOR EVERY PURPOSE

FOR ALL RADIO TRANSFORMERS

SINCE

OUR PRODUCTS ARE GOOD ENOUGH TO CAUSE
LEADING MANUFACTURERS OF THE COUNTRY TO
BUY AND USE THEM SUCCESSFULLY

YOU

WILL PROFIT BY WRITING TO THE

THOMAS & SKINNER STEEL PRODUCTS CO.

1110. E. 23rd ST.

INDIANAPOLIS, IND.

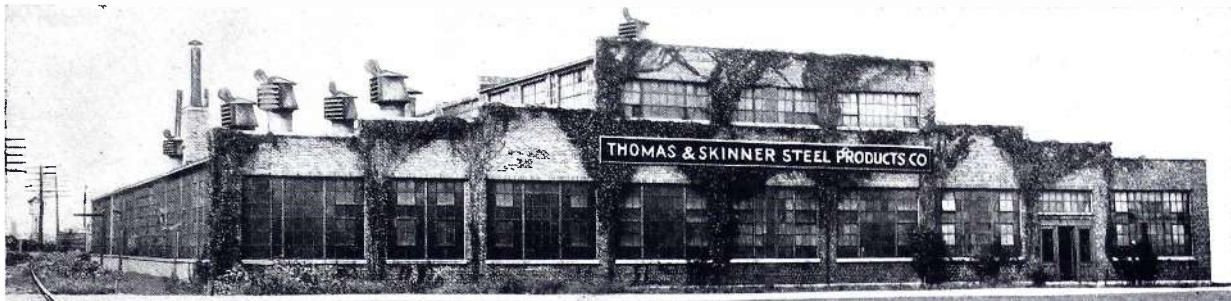

OUR SERVICE

HOLDS OLD CUSTOMERS

ATTRACTS NEW CUSTOMERS

CONDENSER TISSUES

OF UNIFORM QUALITY

Made of the highest grade materials

Mills at { 182 Cornelison Ave., Jersey City, N. J.
 { And Newark Ave., Elizabeth, N. J.

200 Fifth Avenue

PETER J. SCHWEITZER, INC.

New York City

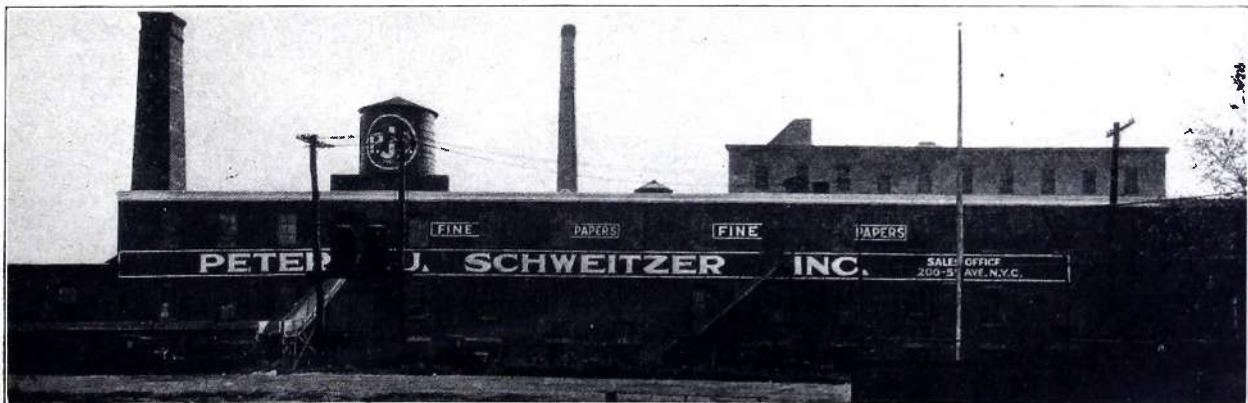

DEPENDABLE

QUALITY — UNIFORMITY
SERVICE

ON
WAXES — & — MELTABLE
INSULATING and WEATHER-
PROOFING COMPOUNDS

WAXES—All kinds.

IMPREGNATIONS—Condensers, Coils, Rubber-
Covered and Weather-Proofed Wire, Telephone
and Electrical Cables, Etc.

SEALING COMPOUNDS—Coils, Condensers,
Batteries (Wet & Dry), Pot Heads, Cables, Wir-
ing Devices and Specials.

FINISHING—All grades of Weather Proof and
Rubber-Covered Wire.

SPECIAL COMPOUNDS



2515 W. 35th St.,
Chicago, Ill.

"For over 35 yrs."

CONCOURSE FILTER BY-PASS CONDENSERS

MADE
ACCURATELY
TO
MANUFACTURERS'
SPECIFICATIONS

Bring your condenser problems to us
and
be assured of a correct solution

CONCOURSE ELECTRIC CO.
294 E. 137th St., New York City

INDEX OF ADVERTISERS

A		E (Cont.)		O	
	PAGE		PAGE		PAGE
Ad Auriema, Inc.	106	Electrad, Inc.	103	Old Masters Paper & Pulp Corp.	111
Acme Wire Co., The	95	Electric Specialty Co.	94	Oxford Radio Corp.	24
Aero Products Co.	106	Electrical Testing Labs.	106	P	
Aerovox Wireless Corp.	6	Electro-Motive Eng. Co.	99	Palatine Industrial Co.	100
Allan Mfg. Co.	81	Elkon, Inc.	41	Perryman Electric Co.	96
Allen-Bradley Co.	112	Experimenter Pub. Co.	102	Pitman, Isaac & Sons	108
Allied Eng. Institute.	106	F		Polymet Mfg. Corp.	29
Aluminum Co. of Amer.	33	Fahnstock Elec. Co.	100	R	
Amphion Corp. of America	97	Fast, John E. & Co.	97	Radiall Co.	107
Amrad Corp.	11	Flechtheim, A. M. & Co.	98	Radio	104
Areturus Radio Tube Co.	94	Formica Insulation Co.	1	Radio Treatise Co.	108
Armstrong Ele. Mfg. Co.	96	Frost, Herbert H., Inc.	39	Raytheon Mfg. Co.	17, 20
B		G		Reynolds Metals Co., Inc.	58
Bakelite Corp.	Back Cover	G-M Laboratories, Inc.	100	Roebings, J. A. Sons Co.	100
Baltimore Brass Co.	100	General Amplifier Co.	103	Rola Co., The	105
B-L Elec. Co.	34	General Elec. Co.	42	S	
Best Mfg. Co.	32	General Plastics	83	Samson Elec. Co.	14
Burt, Dr. Robert C.	106	General Radio Co.	107	Schweitzer, Peter J., Inc.	115
Buyers Directory	110, 112, 113, 114	Gilby Wire Co.	35	Scovill Mfg. Co.	5
C		H		Seymour Co., The	101
Cable Radio Tube Corp.	89	Hammerlund Mfg. Co.	99	Shakeproof Lock Washer Co.	118
Callite Products Co., Inc.	99	Hardwick, Hindle, Inc.	96	Standard Pressed Steel Co.	95
Candy & Co.	116	Hlyvac Radio Tube Co.	77	Sylvania Products Co.	3
Cardwell, Allen D., Mfg. Co.	85	I		Synthane Corp.	16
Carter Radio Co.	98	Indiana Steel Products Co.	91	T	
CeCo Mfg. Co., Inc.	113	International Resistance Co.	36	Thomas & Skinner Steel Prod. Co.	115
Central Radio Laboratories	25	J		Thordarson Electric Mfg. Co.	87, 97
Chicago Solder Co.	118	Jefferson Electric Co.	21	Transformer Co. of America	8, 9
Claroostat Mfg. Co., Inc.	93	Jensen Radio Mfg. Co.	31	Trailer Publishing Co., Ltd.	109
Cohn, Sigmond	38	Jewell Elec. Inst. Co.	79	Triad Mfg. Co., Inc.	27
Concourse Elec. Co.	116	K		U	
Condenser Corp. of Amer.	40	Kodel Radio Corp.	92	United Scientific Labs.	26
Cornish Wire Co.	100	L		Universal Microphone Co.	101
Crowe Nameplate & Mfg. Co.	13	Lamination Stamping Co.	101	W	
Cunningham, E. T., Co.	37	Leach Relay Co.	106	Ward Leonard Elec. Co.	30
D		Leeds Radio Co.	107	Webster Elec. Co.	105
De Forest Radio Co.	10	Lehmaier, Schwartz & Co., Inc.	100	Weston Elec. Instrument Corp.	15
De Jur-Amsco Corp.	107	Luna Tin Mfg. Co.	100	Wiley, John & Sons, Inc.	109
Dexter, C. H. & Sons, Inc.	101	Lynch, Arthur, Inc.	107	Willor Mfg. Co.	101
Dongan Elec. Mfg. Co.	Third Cover	M		Wireless Specialty Apparatus Co.	28
Dubilier Condenser Mfg. Co.	111	Mallery, P. R. & Co., Inc.	41	Y	
Dudlo Mfg. Co.	75	N		Yaxley Mfg. Co.	7
Duovac Radio Tube Corp.	23	National Co.	103	Z	
E		National Vul. Fibre Co.	Second Cover	Zapon Co., The	42
Eastern Tube & Tool Co., Inc.	94	Nelson, I. R., Co.	95		
Eby, H. H., Mfg. Co., Inc.	22	New Zealand Elec. Journal	108		
Bisler Eng. Co.	114				

"ROUND ROBIN"

\$1.

**Group
Subscription
Rate**

(The subscription rate for individual subscribers is \$2.00 a year.)

**To the attention of
CHIEF ENGINEERS
FACTORY EXECUTIVES
PRODUCTION MANAGERS**

"RADIO ENGINEERING" should be interesting and helpful to your personnel. Your copy isn't always available to your assistants.

**WHY NOT START THIS CIRCULATING
AS A ROUND ROBIN?**

BRYAN DAVIS PUBLISHING CO., Inc.,
52 Vanderbilt Ave., N. Y.
Kindly enter the following subscriptions to
RADIO ENGINEERING at \$1.00 a year.
(This subscription rate applies on 4 or more subscriptions)

Name Address Town State

Classification

Name Address Town State

Classification

Name Address Town State

Classification

Name Address Town State

Classification

Name Address Town State

Classification

Name Address Town State

Classification

Name Address Town State

Classification

Will you not cooperate with us by classifying subscriptions sent in as follows:

(M) Manufacturer

(Please check "M" if you are an executive, purchasing agent, production manager, service manager, plant superintendent or foreman.)

(E) Engineer

(T) Technician.

(S) Service Man

(D) Distributor or Dealer

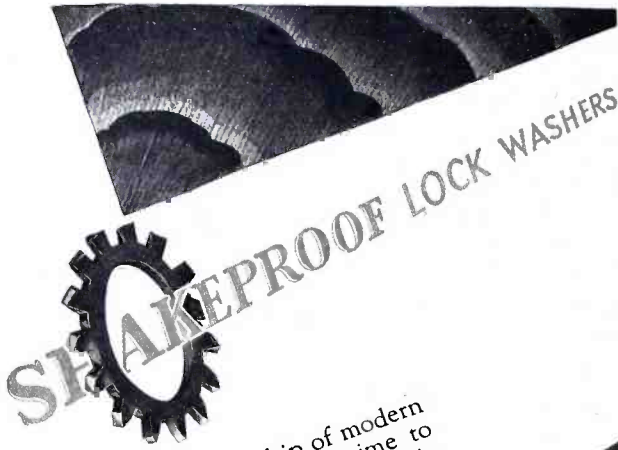

UNDER the whip of modern production — no time to waste — the finest possible job in the shortest possible time — here is where **SHAKEPROOF** is solving the problems of modern industry. A modern washer with teeth that bite into the nut with a grip of steel that only applied force with a wrench can loosen.

SHAKEPROOF Lock Washers are made in a wide variety of types and sizes to fit every need of modern industry. Mail the coupon below for samples and make your own tests. **SHAKEPROOF** can save you time and money and assure a better job on your production line.

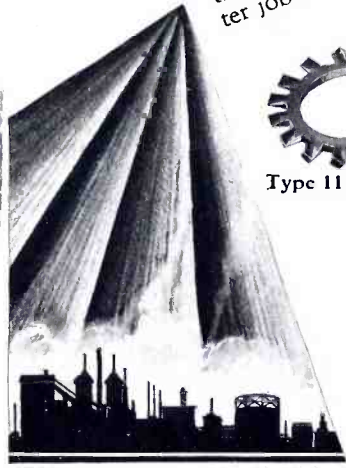

Type 11 External Type 12 Internal



Type 20 Terminal

U. S. PATENTS 1,419,564;
1,604,122; 1,697,954
OTHER PATENTS PENDING
FOREIGN PATENTS

SHAKEPROOF Lock Washer Company

[Division of Illinois Tool Works]

2509 North Keeler Avenue Chicago, Illinois

Free Shop Test Samples

Shakeproof Lock Washer Co., 2509 N. Keeler Ave., Chicago, Ill.

Please send me samples of

- Shakeproof Lock Washers to fit bolt size _____
- Shakeproof Locking Terminals, size _____

Firm Name _____

Address _____ Town _____ State _____

By _____

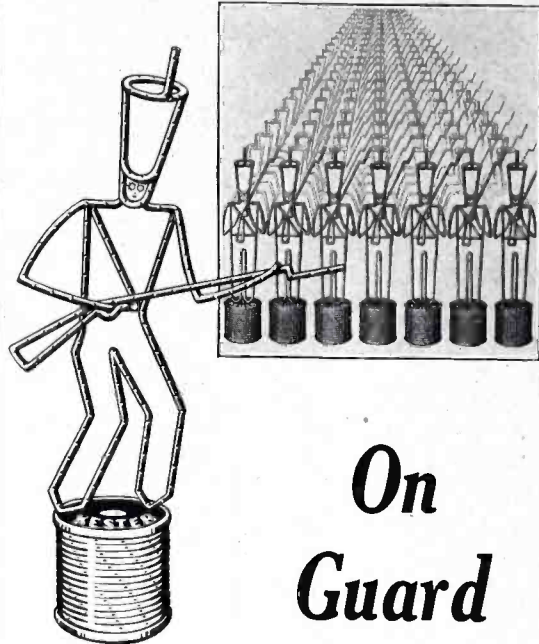

On Guard Between You and High Costs

WHEN costs menace profits—call on the Kester line of Flux-Core Solders. In the Kester line, is a solder for every purpose, with the flux right in the core of the solder—simplifies the operation—saves both time and money.

Behind Kester Solder is our Research and Experimental Department — at your service to help you choose the best flux core solder for your particular operation. Write us today. No obligation.

KESTER SOLDER COMPANY

Formerly CHICAGO SOLDER COMPANY Established 1899
4224 Wrightwood Avenue, Chicago, Ill.

KESTER SOLDER FLUX-CORE



Build Your 1929 Receiver with Approved Parts

A Complete Selection of Audio and Power Parts and Units



No. 994 Power Amplifier Transformer — one of the new types for use with the UX 245 Tubes.

- No. 994 Power Amplifier Transformer\$12.00
- No. 2189 Push Pull Output Transformer\$12.00
- No. 2142 Push Pull Input Transformer\$ 4.50
- No. 3107 Straight Output Transformer\$12.00
- No. 2158 Audio Transformer.....\$ 4.50
Two Secondary Windings (for either No. 2189 or No. 3107) one for Magnetic type and the other for Dynamic type Speaker.
- D-946 Standard Condenser Unit..\$22.50
This Condenser Unit is also designed especially for use with No. 994 Transformer for Power Amplification.
- No. 5554 Double Choke, use in Filter Circuit\$11.00
These Dongan Parts are available now. Equip your receiver with this new amplifier—and enjoy still another of Radio's greatest advancements.
- For Push Pull Radio and Phonograph Amplifier No. 2124 Transformer\$ 6.00

This year a new combination of Power and Tone Reality is available to the average radio owner at somewhat less cost than heretofore possible. This big new market of owners is attained by the introduction of the new UX 245 Tube and the accompanying Dongan Power Parts, all designed to coordinate with the remarkable tube.

A radio receiver built around this power tube and the Dongan Power Parts listed here will satisfy the demands of a fan public for the finest quality of radio reception—at comparatively low cost. Using No. 994 Power Amplifier Transformer, either No. 2189 and No. 2142 or No. 3107 and No. 2158, plus D-946 and No. 5554 the entire cost of Power Parts is \$62.00.

Send check or money order for immediate delivery. Complete information on request.

**See the Dongan Parts Exhibit
at the R.M.A. Show**

Set Manufacturers and Custom Builders are invited to use the services of the Dongan Laboratories in planning their production. Prices quoted on request.

DONGAN ELECTRIC MANUFACTURING COMPANY
2995-3001 Franklin St.,
DETROIT, MICHIGAN

TRANSFORMERS of MERIT for FIFTEEN YEARS

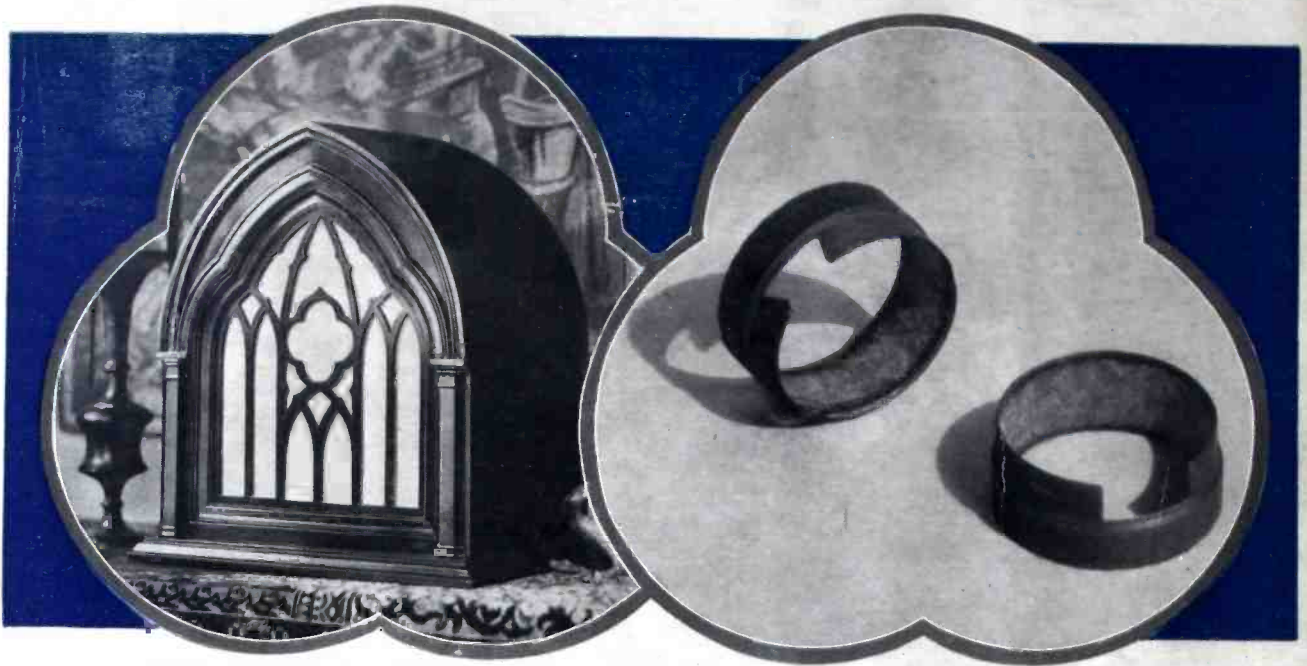

Peerless Dynamic Speaker and Bakelite Laminated Armatures, made by United Reproducers Corp., Rochester, N. Y.

Peerless found Bakelite Laminated superior for Dynamic Speaker Armatures

When other insulation materials proved unsatisfactory for dynamic speaker armatures, Bakelite Laminated was tried and found a complete success. The armature parts are short sections of black Bakelite Laminated tubing, accurately machined to the exact dimensions and form required.

In addition to possessing the excellent electrical properties required in radio reproducing equipment, Bakelite Laminated is exceptionally tough, strong and dur-

able. It will not deteriorate in any climate and does not shrink or swell, nor split or crumble.

Bakelite Laminated has been adopted throughout the radio industry, for the insulation of hundreds of different parts of receivers and speakers, because it is a standardized material possessing definitely known properties.

Sheets, tubes and rods of Bakelite Laminated, in a wide range of sizes, may be purchased under any of the following trade-names:

FIBROc **PHENOLITE** **Spaulding BAKELITE** **FORMICA** **Micarta** **Textolite** **Dilecto**

Write for our Booklet 38L, which describes Bakelite Laminated

BAKELITE CORPORATION

247 Park Avenue, New York, N. Y. Chicago Office: 635 W. 22nd Street
BAKELITE CORP. OF CANADA, LTD. 163 Dufferin St., Toronto, Ontario, Canada

BAKELITE

REGISTERED



U. S. PAT. OFF.

THE MATERIAL OF A THOUSAND USES

"The registered Trade Mark and Symbol shown above may be used only on products made from materials manufactured by Bakelite Corporation. Under the capital 'B' is the numerical sign for infinity, or unlimited quantity. It symbolizes the infinite number of present and future uses of Bakelite Corporation's products."