

RADIO ENGINEERING

The Technical Magazine of the
Radio Trade - Edited by M.B. Sleeper

NOVEMBER, 1926

The Biggest New Thing in Radio

A Brand New Source for Big Sales

Showing how dealers and jobbers can increase business by opening up an entirely new branch of radio development

Circuits That Are Making Money

The dealers technical men must know about these circuits for which construction parts are in big demand

How to Charge for Service on Sets

Detailing the methods by which New York's largest radio store makes service pay in profits and customer satisfaction



20c PER COPY \$2.00 PER YEAR
Sold Only by Subscription

VOLUME VI NUMBER 11
Sixth Year of Publication



*Here's the most
economical "B" battery ever built
for radio*

IN THE production of Heavy-Duty radio "B" batteries Eveready has established a new standard of "B" battery life and economy.

Eveready Heavy-Duty 45-volt "B" Batteries will outlast any Light-Duty 45-volt "B" two to one regardless of the number and kind of tubes used! Moreover, though lasting twice as long, they cost only one-third more!

To cap the climax of "B" battery economy, in Eveready Layerbilt No. 486, Eveready has perfected a Heavy-Duty "B" battery of unequalled endurance and dependability—positively the greatest "B"

battery in service and satisfaction its price can buy.

You can make no mistake in buying Eveready Layerbilt No. 486 for any set using normal voltages (45 to 135 volts).

You will be buying the utmost in dependability of "B"

power—the greatest "B" power operating economy—D. C. (direct current) in its purest form, which insures pure tone quality.

With colder evenings at hand, radio reception is vastly improving. Equip your set now with Eveready Layerbilt No. 486, the greatest "B" battery ever built for radio.

Manufactured and guaranteed by
NATIONAL CARBON CO., INC.
New York San Francisco
Canadian National Carbon Co., Limited
Toronto, Ontario



LEFT—Eveready Layerbilt No. 486.

RIGHT—No. 7111 Eveready Dry Cell Radio "A" Battery. 1½ volts.



EVEREADY

Radio Batteries

—they last longer

Tuesday night means Eveready Hour—9 P. M., Eastern Standard Time, through the following stations:

WEAF—New York	WGB—Buffalo	WGN—Chicago
WJAR—Providence	WOAE—Pittsburgh	WOC—Davenport
WEEI—Boston	WSAI—Cincinnati	WCCO—Minneapolis
WTAG—Worcester	WTAM—Cleveland	WLS—St. Paul
WFI—Philadelphia	WWJ—Detroit	KSD—St. Louis
	WUC—Washington	

many times
better than
in 1921

WITH four times less drain on your "A" batteries than the storage battery tube of five years ago, the filament of a Radiotron UX-201-A throws across to the plate five times as many electrons—a steady stream of tiny electrical charges that carry the song and speech. This is a big increase in efficiency!

And the Radiotron UX-201-A does not burn out—unless you apply a huge, excessive voltage. It does not die gradually, but keeps its efficiency almost to the very end of its life.

These are but a few of the advances in vacuum tube making that have come from the laboratories of RCA and its associates—General Electric and Westinghouse. Unceasing research brings continual improvement in RCA Radiotrons, making possible ever better reception—at lowered cost.

RADIO CORPORATION
OF AMERICA

New York Chicago
San Francisco

to get more
power

put an RCA power Radiotron UX-120, UX-171 or UX-210 in the last audio stage of your set.

to get more
distance

(on a storage battery set)

—put the new special detector Radiotron UX-200-A in the detector socket.

RCA is not only making Radiotrons steadily better—but is further improving reception with these new special Radiotrons. Keep your set up-to-date.

RCA Radiotron

MADE BY THE MAKERS OF THE RADIOLA

EDITORIAL

IT is not within the province of RADIO ENGINEERING to criticize those who differ with the editorial views, but it is not out of order to inquire into the dissenting opinions in the matter of popularizing short wave telephone transmission.

In reply to letters sent to a representative list of men of importance in the industry, a most surprising lack of interest, bordering on antagonism was shown.

Powell Crosley was one who objected to opening up short wave telephone operation to the general public, suggesting that these channels may be needed some day for broadcasting. Zeh Bouck may have reflected the attitude of the A. R. R. L. members who, quitting 200 meters, now have the use of short wave bands. A. J. Carter was unquestionably sincere in voicing no enthusiasm for home made telephone transmitters.

W. A. Ready, Frank Ryder, and Dick Cotton were among those who were willing to approve the idea, and McMurdo Silver went far as to favor it, but all of them seemed vague as to definite possible developments.

Summing up the replies, it is evident that radio manufacturers are so much occupied with current matters that they haven't had the time to enjoy radio's greatest thrill—talking to one's friends on a home made radio telephone.

Meanwhile, the S. S. Kresge stores are doing a record of business in short wave coils and parts. *Radio Mechanics Magazine* is selling more Dataprints for short wave sets than all other designs combined. The few manufacturers of coils for these sets are put to it to handle the increased demand.

What's the answer? Probably, as usual in new radio developments, the public will be allowed to clamor for a season before the manufacturers wake up. While one or two companies might jump in and get some real business, they will wait until all of them start next year, dividing the business to be done into twenty parts instead of two or three parts.

—Unless someone can take off enough time to discover the short wave radio telephone, and find out what it's all about. It is strange, but true, that our stupid public repeatedly demonstrates its ability to learn about new things much faster than our radio experts.

M. B. SLEEPER,
Editor.



RADIO ENGINEERING

The Technical Magazine of the Radio Trade

Edited by M. B. SLEEPER

Managing Editor, HOLLIS de NEEFE

Vol. VI.

NOVEMBER 1926

No. 11

Sixth Year of Publication

CONTENTS

Biggest New Thing in Radio.....	439
<i>By M. B. Sleeper</i>	
Possible Territory for Eliminator Sales...	440
How to Charge for Service.....	442
<i>By Hollis de Neefe</i>	
Two Specials for Fall Business.....	443
Quantity Production of Radio Coils.....	444
Making Money.....	446
Notes on the Infradyne.....	447
171 or 210 Amplifier Tube.....	448
<i>By C. E. Burke</i>	
High Voltage Fixed Condensers.....	450
Suggestions for Super Circuits.....	452
Short Waves and Radio Laws.....	454
Reports of the R. M. A. Committees.....	456
The Radio Manufacturers.....	460
Advertisers' Index.....	478

In the December Issue

December RADIO ENGINEERING will be of too-much-to-miss importance to those who realize that, in this business, time is the essence of money, because December will have two absolutely new developments to disclose—a Raytheon B battery eliminator with voltage regulation to compensate for variations in the A. C. supply circuit, and an A and B eliminator, using tube rectification—not the Tungar—which delivers sufficient current to operate any ordinary number of 0.25-amp. tubes.

RADIO ENGINEERING

Published monthly by RADIO ENGINEERING MAGAZINE, Inc. Publication office, Lyon Block, Albany, New York. Editorial and General offices, Radio Hill, Poughkeepsie, N. Y. Printed in U. S. A. Yearly subscription \$2.00 in U. S. and Canada; ten shillings in foreign countries. Entered as second class matter at the postoffice at Albany, New York, January 9, 1925, under the act of March 3, 1879. New York advertising office, B. S. Davis, 52 Vanderbilt Ave. Chicago advertising office, E. H. Moran, 307 N. Michigan Ave.

Cardwell Condensers

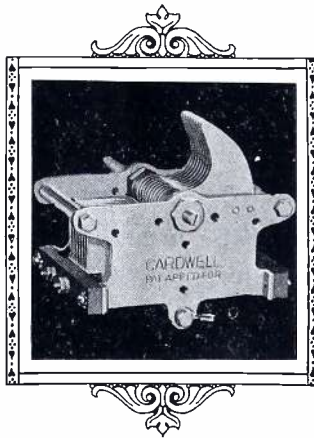

The Type "C" has a tuning characteristic which approaches straight frequency at minimum and straight wavelength at maximum. Priced from \$4.00 up.

The Type "C" Cardwell Condenser is almost the universal selection of Radio Engineers and Editors who want the best. Mr. John B. Brennan used them in the New Radio Broadcast "Lab" circuit. . . . Mr. E. M. Sargent recommends the 317-C as the only condenser for the "Infra-dyne" The "A. C. Varion," which you can build to work direct from the lighting fixtures, uses the 217-C. . . . For Short Wave Reception, Cardwell Condensers have always been accepted as the only practical instrument.

"THE STANDARD OF COMPARISON"

Write for 36 page illustrated booklet
Allen D. Cardwell Mfg. Corporation
81 Prospect Street, Brooklyn, N. Y.

Here We Go!—

**Brand New Dope in Radio Mechanics for January that Will Sell Out the Entire Edition.—
Arrange For Your Copy Now, For you Can't
Afford To Miss It.**

—1—
**Constant
Voltage
Raytheon
Elimina-
tor**

Constant voltage Raytheon R-171 compact eliminator, supplying B voltage for the set and A, B, C for a 171 Power Tube.—Built around a new Thordarson development, this is the first Raytheon circuit designed to compensate for voltage changes in the A. C. supply.

—2—
**Raytheon
Elimina-
tor and
Quality
Ampli-
fier**

Glenn Browning designs a combination Raytheon eliminator and quality amplifier. Using National units, he has produced a device of which he says—"This is what I use for my set." Most of us know that when G. H. Browning does something it's well worth while investigating.

—3—
**1/4 Amp.
A Bat-
tery
Elimina-
tor and B
Supply**

Absolutely new!—An A and B device which we're keeping a secret until the January Radio Mechanics is out—something we developed at Radio Hill, into which is built John Grabar's technical knowledge, Hollis de Neefe's practical experience, and M. B. Sleeper's skill in mechanical design.

—4—
**2-Tube
Short
Wave
Receiving
Set**

The prettiest little two-tube short wave set you ever saw—extra low in cost—extra high in performance. Using General Radio parts, it is so designed that it has only one tuning condenser. Interchangeable coils cover short and broadcast waves.

**What
About
Xmas
Presents
?**

You know that there's no Christmas present for a Radio fan like a year's subscription to Radio Mechanics—and there's big stuff coming, such as the "TC on A. C." Ask us for special Christmas cards to send to those for whom you subscribe.

RADIO MECHANICS, INC.
Radio Hill, Poughkeepsie, N. Y.
Enclosed are \$1.00 for which enter my subscription
for 1 year and send me FREE Dataprints
No. as soon as they are ready.
Name
Street
City
State

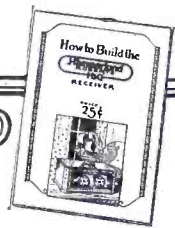
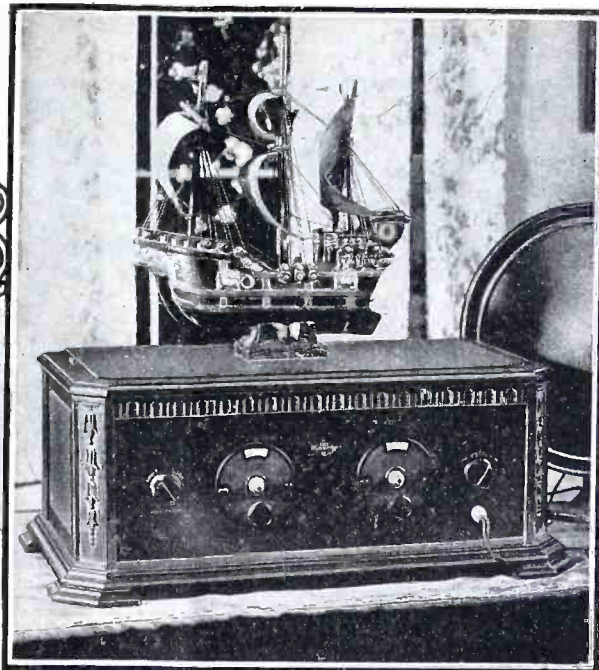

**"How To Build It"
Book**

Complete instructions for assembling, wiring and operating the Hammarlund-Roberts Hi-Q Receiver. Prepared under the direction of the Engineers.

25c

\$63.05

**Complete Parts
(less cabinet)**

Automatic Variable Coupling, same control operates tuning condenser and primary coil coupling simultaneously, gives maximum and equal amplification and selectivity over entire tuning range.

Stage Shielding—prevents coupling between stages, eliminating oscillation and increasing selectivity. Clarifies reception.

Hi-Q Foundation Unit



Includes drilled and engraved Micarta Panel, drilled Micarta sub-panel, two complete shields, extension shaft, two equalizers, fixed resistance, hardware, wire, nuts and screws.

\$10.50

Associate Manufacturers

Carter Radio Co.
Martin-Copeland Co.
Radiall Company
Samson Electric Co.
Sangamo Electric Co.
Benjamin Electric Mfg. Co.
Eby Manufacturing Co.
Hammarlund Mfg. Co.
Durham Resistors
Westinghouse Micarta

Hammarlund-Roberts Performance Means A New Measure For All Radio

THE Hammarlund-Roberts Hi-Q is an outstanding example of scientific radio engineering. No ordinary standards of tone, selectivity or volume, can be applied to this new receiver.

In designing this Hi-Q Receiver, the Hammarlund-Roberts Board of Engineers representing twelve nationally known manufacturers, had at their disposal the finest experimental laboratories—and no handicap in building to establish specifications or to a set price.

This concentration of the leaders in the perfection of one radio Receiver has developed entirely new features that produce results unknown to the average radio man. Automatic variable coupling gives maximum and equal amplification and selectivity over the entire tuning range. Stage shielding eliminates coupling between stages, prevents oscillation and increases selectivity. Two dial control simplifies tuning.

ANYONE CAN BUILD THE HAMMARLUND-ROBERTS Hi-Q

All the research, the selection of parts, the exact placing of units, has been worked out in advance for you. And you have a receiver that will equal an eight tube set—simplicity of design and operation hitherto unthought of—all at less than half the price you would pay for a factory made set of anywhere near equal efficiency.



*High ratio of reactance to resistance. High ratio—Great selectivity—Loud signals.

Hammarlund-Roberts • 1182-G Broadway : New York

tone reality need not be expensive

You don't need an expensive set to get faithful reproduction. Resistance coupling gives even amplification of all tones. And it has the added advantage of costing little, and consuming less "B" battery current.

Micadon 640 A is the Dubilier resistance coupling unit. It is a fixed condenser of the famous Micadon type, designed and patented by Dubilier to provide unvarying capac-

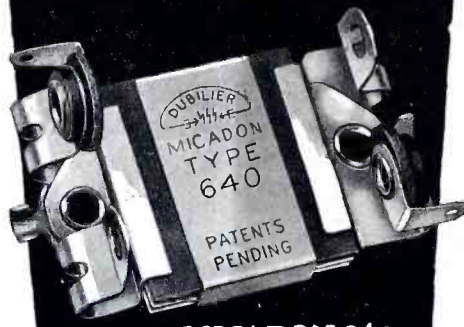

MICADON 640A
Capacities:
.006 to .02 mfd's
Price:
\$1.00 to \$1.95



METALEAK
15,000 ohms to
200,000 ohms
75¢ each
25 meg to 5 meg
50¢ each

ity with the lowest dielectric loss—so essential for the true reproduction of sound.

Used with the silent Dubilier Metaleak, Micadon 640 A will give you the foundation for an amplifier unit with all the tone quality found in the best radio sets.

Send 10c for our booklet showing fourteen ways to improve your set with simple applications of fixed condensers.

Dubilier

CONDENSER AND RADIO CORPORATION

4377 Bronx Blvd., New York, N. Y.

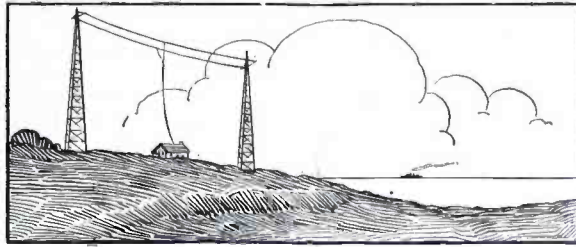

BIGGEST NEW THING IN RADIO

Every technical man can get behind this newly created demand and make sales grow where sales never grew before—By M. B. Sleeper

SOMETHING new to sell means more sales, and this 1927 season is just ripe to start off an entirely new branch of radio sales that no one has tackled—that is, the radio telephone transmitter. Put up in a package for the public and labelled, "The Home Broadcasting

doesn't mean a thing. He wants telephone today just as he wanted telephone four years ago.

Last year some of the experimenters' magazines attempted to interest their readers in short wave telegraph transmitters, but if they had just consulted a few of the technical men, they

would have been advised to use the space for something else, because a sending set with a key attached to it has an infectious popularity on a par with the measles.

However, all the short wave promotion has not been wasted. No, indeed! That's what has put everyone on his toes, ready to jump the minute he can hear something without having to learn a new language. So the public has been prepared for short waves—it's just up to the dealers to line up for cashing in this season.



A radio telephone transmitter for use in talking between airplane and earth—designed by the National Company, Cambridge, Mass.

Is the Radio Phone Practical?

Short waves have definitely established their ability to cover tremendous distances on the tiniest amount of power. The transmission contest staged by the Jewell Electrical Instrument Company was won with a 199 tube transmitter! Radio waves don't care whether they are modulated at dot-dash intervals or at voice frequencies. The short wave, low-power phone set is as practical as broadcasting itself. If you don't think so, just listen in and find out. Then give your customers a chance to try it—but that's getting ahead of the story.

What put across radio broadcasting in the first place? It was the idea

Station," it is the real wow for making the cash register jingle.

Why the 1927 Season?

Thanks to the A. R. R. L, we really know something about short wave transmission and reception—at least enough so that short waves have become safe for public consumption.

We are now at the point where lots of people have bought, or are ready to buy, short wave coils and other equipment for reception, but, with an avalanche of sales ready to descend upon the alert dealer, it is all poised waiting for the answer to the question—"What can I hear on short waves?"

Well, you can't honestly promise the B. C. L. much more than code signals—which he wouldn't spend a nickel to hear. The fact that telegraph signals can be picked up from all over the world on a twenty-five-dollar set

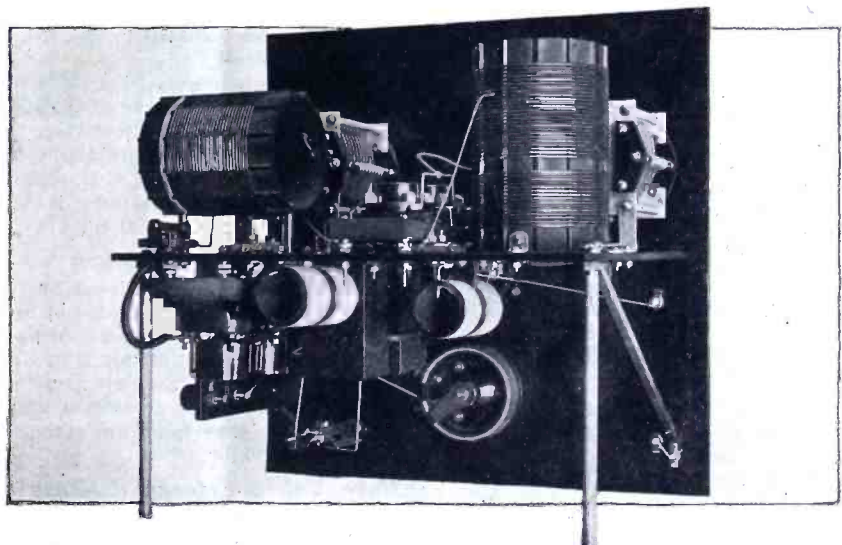

This is not a difficult project, tho it is more elaborate than is necessary for home use in radio telephone transmission

that people thought it couldn't be possible, but they wanted to listen in just to make sure.

Let it be known that John Jones is talking to John Smith by radio telephone, and every nut in the town will join the stampede to get in on the conversation—because no one can believe that Mr. Smith and Mr. Jones can do such a thing. But if it can be done, an American public has simply got to do it.

Start 'Em—They'll Do the Rest

The dealers' problem is a simple one. It consists of starting the radio telephone idea, and then letting the people know about it. Use a little imagination. Get a simple B battery operated transmitter in operation, and set up a short wave receiver a couple miles away. Try it out so that you know it's O. K. Then get the local newspaper reporter and a few of your good customers on hand for a demonstration.

That will get you a front-page story in the newspaper. Then make it a habit to ask your customers casually, "Did you hear me talking to Mr. _____ last night?"

Excitement? Activity? And remember that the first dealer in town to do it will get the reputation and the business.

All Standard Parts

New things which require extra investment introduce an element of risk, but the short wave phone set can be

made of standard parts. Every dealer has in stock all the parts required, except for the microphone, and possibly the hot-wire ammeter.

Everything else, coils, A. F. transformers, jacks, switches, condensers, tubes, batteries, dials, panels—all can be found in any standard stock.

The wonderful thing about short wave transmitters and receivers is that his customers haven't got the equivalents already constructed. When a new circuit comes along, it's a question as to whether a man has something just as good already.

But no one has a telephone transmitter. He's got to buy one. He's got to add something to what he now has—sales growing where sales aren't growing now. That's what makes money.

How to Do It

Every dealer's technical man knows enough about short waves and circuits to put up a phone transmitter, and will jump at the chance to start something new. Designs are now available for tried and tested outfits which can be depended upon to give good results. RADIO ENGINEERING is ready to give 24-hour service in answering questions from dealers concerning any phase of short wave phone transmission, and offers its entire facilities without charge to those who want to cash in on this new line.

It's so easy to do it. It's just a question of getting started, and to be the first to start.

matter of eliminating artificial static, what about approaching them on the matter of eliminating voltage fluctuations in the light supply lines?

There may be an economic reason for permitting the voltage to vary, and since we pay for watts consumed and not current drawn, we get our money's worth at any potential. On the other hand, there is an economic reason for making it feasible to use eliminators, since they are an additional load which encouraged, will reach worth while proportions.

Probably the central stations will be willing to help out in this difficulty if their attention is drawn to the importance of constant voltage, for this affects many more consumers than are troubled thru the air by leaky lines.

Meanwhile, knowing that practically the entire field of prospective eliminator purchasers have homes equipped with 110 to 120 volts, work on maintaining constant output voltages from eliminator circuits is very much in order.

874 Tube for Raytheon Circuits

This is a subject on which little has been accomplished except by R. C. A. Their devices are equipped with regulator tubes in both the input and output circuits. The 876 tube is put across the A. C. line, before the primary of the power transformer. This is to hold down the voltage delivered to the primary when it goes up above normal. Then, across the 90-volt tap at the output there is the 874 tube to keep the voltage constant. This is accomplished by putting more than 90 volts on the 90-volt tap, so that the 874 can cut it down by its varying resistance which changes with the potential applied to it.

Radio dealers whose customers have not obtained satisfactory results from Raytheon tube kits will find assistance in an article to appear in RADIO MECHANICS for January, showing the first application of the UX 874 tube to a Raytheon outfit. The R-171 Compact Eliminator, built around the new Thor-darson unit, is of special interest because it is so designed that the voltage regulator circuit is built into the device, but with no additional expense except for the tube itself. Therefore, the eliminator can be put in operation without the regulator, and the 874 tube inserted later if the output is not sufficiently constant.

Voltage on the Last Tube

No attempt has been made to control the high voltage going to the plate of the 171 or 210 amplifier tube because that is not as critical as for the R. F. and first A. F. tubes, variations in which are multiplied by succeeding stages.

Moreover, the adjustment of the last tube is not critical, while constant voltage is often essential on R. F. tubes, particularly if they are kept from oscillating by regulation in the plate circuits thru a variable high resistance.

Possible Territory for Eliminator Sales

With a chart showing the line supply voltage available in the United States

WHERE can B battery eliminators be sold? Wherever there is A. C. current of 110 to 120 volts. This is an obvious answer to an important question. The market lies in territories which provide the correct line voltages—and to a large number of consumers.

To give a quantitative answer to this matter of sales distribution on eliminators, the accompanying table, compiled from data collected thru the central power stations, is presented.

It shows that only nine states have 500,000 or more prospective customers. They are:

Massachusetts	Illinois
New York	Michigan
New Jersey	Wisconsin
Pennsylvania	California
Ohio	

It shows that twenty states have less than 100,000 prospects. On the other

hand 74% of the possible users of B eliminators are included in the list of nine states above.

This table also shows whether or not it is worth while to make eliminators to operate on voltages other than the standard range of 110 to 120 volts. Less than 7% of the total A. C. current supplied thruout the country is less than 110 or more than 120 volts.

D. C. Supply Devices

One special fact is disclosed by the table. In the concentrated area of New York there are 355,100 homes that have 120 volts D. C. Most of this is in New York City. That is the only territory which justifies sales promotion effort on anything other than the standard type of eliminator.

Have You a Constant Voltage in Your Home?

Now that the central stations have got to the point of cooperating in the

This Chart Shows the Available Voltage for Light Socket Operation of Radio Equipment

Total Number of Domestic Lighting Customers	Number of Domestic Lighting Customers Using Alternating Current (By Voltages)										Number of Domestic Lighting Customers Using Direct Current (By Voltages)				
	Voltage														
	100	104	105	108	110-115	118-120	125-127	220	110	115	120	125	220	225	
United States.....	14,532,930	2,480	92,170	21,220	196,930	9,436,657	1,745,550	1,680	388,500	26,980	8,680	366,970	1,060	21,670	150
New England.....	1,318,700	760	67,300	1,470	187,700	1,140,450	109,740	720	3,500	450	1,780	1,210	280	260
Middle Atlantic.....	3,461,300	760	22,570	187,700	187,700	2,514,000	395,280	770	240	230	1,670	355,100	80	6,880	150
South Atlantic.....	966,700	30	1,130	18,490	9,230	762,430	179,840	80	191,240	3,440	4,350	7,660	700	11,080
East North Central.....	3,829,600	1,260	1,050	18,490	9,230	3,183,960	405,730	80	880	9,650	4,350	1,540	1,870
West North Central.....	1,565,850	1,260	1,050	18,490	9,230	1,338,620	190,850	80	1,080	2,100	760	1,540	1,480
East South Central.....	498,500	430	720	720	720	488,970	119,830	110	4,110	2,100	760	100
West South Central.....	861,650	430	720	720	720	730,220	119,830	110	4,450	2,500	130
Mountain.....	464,330	443,900	33,140	181,000	160
Pacific.....	1,566,300	1,056,340	328,800
New England:															
Maine.....	152,000	109,760	41,200	1,040
New Hampshire.....	63,200	28,060	33,130
Vermont.....	59,600	59,600
Massachusetts.....	686,000	640,420	35,410	170
Rhode Island.....	95,500	80,220
Connecticut.....	262,400	234,800
Middle Atlantic:															
New York.....	1,554,800	760	1,470	187,700	187,700	830,600	366,780	720	2,280	130	1,780	355,100	280	150
New Jersey.....	689,000	655,490	28,500	1,220	320	110
Pennsylvania.....	1,247,500	1,027,910
South Atlantic:															
Delaware.....	93,300	23,300
Maryland.....	167,700	32,640	147,290
District of Columbia.....	167,000	65,000
Virginia.....	197,200	119,100	8,100
West Virginia.....	65,300	93,060	2,230
North Carolina.....	137,700	137,700
South Carolina.....	71,600	47,880	380	770
Georgia.....	133,700	132,910	470
Florida.....	132,200	110,830	21,370
East North Central:															
Ohio.....	1,012,000	1,002,020	3,530	1,170	670	770	80	2,710
Indiana.....	435,000	367,980	36,650	460	270	1,680
Illinois.....	1,300,000	1,106,290	1,700	189,530	1,230	670	580	970
Michigan.....	723,000	665,220	196,670	800	800	1,520
Wisconsin.....	359,600	594,460	164,090	80	470	230	7,000
West North Central:															
Minnesota.....	395,000	312,200	77,200	470	900	4,700
Iowa.....	278,250	271,360	980	790	3,250	850	750
Missouri.....	427,900	320,690	105,280	600	400	600	70	740
North Dakota.....	33,200	3,890	3,890	5,620	940	170	640	2,020
South Dakota.....	48,600	19,360	180	2,800	160	150
Nebraska.....	136,300	45,810	180	3,200	390	310	2,320
Kansas.....	246,600	127,530	2,000	80	410	780	1,570	560
East South Central:															
Kentucky.....	163,600	160,350	1,100	1,100
Tennessee.....	179,000	176,380	1,080	1,540
Alabama.....	111,400	108,560	340	2,500	770
Mississippi.....	44,500	43,680	50
West South Central:															
Arkansas.....	92,300	90,380	1,600	320
Louisiana.....	88,050	40,420	53,050	3,980	180	470
Oklahoma.....	180,800	177,840	66,780	1,710	320	710	690
Texas.....	490,500	421,690	410
Mountain:															
Montana.....	62,950	56,640	5,830	330	90	60
Idaho.....	50,800	47,430	3,220	110	40
Wyoming.....	27,400	26,410	950	40
Colorado.....	160,800	144,440	1,740
New Mexico.....	20,400	18,070	1,350
Arizona.....	30,650	30,650
Utah.....	107,800	105,730	2,070
Nevada.....	13,630	13,630
Pacific:															
Washington.....	266,500	90,370	175,970	160
Oregon.....	146,300	140,720
California.....	1,134,600	951,890	22,110

How to Charge for Service

This system of guarantees and charges makes service pay a profit, and insures customer satisfaction—By Hollis de Neefe

MANY dealers have declared that the service department is the separator which skims the cream of profit from their business. It will be interesting for these men to note just how some of the larger companies are meeting and overcoming this difficulty.

Mr. Howard Cervantes, service manager of Haynes-Griffin Radio Service, Inc., has prepared a conditions of sale and guarantee form which covers every situation encountered during and subsequent to the sale of a new set and its associated equipment.

At the very top of this form is a sentence which states:

This guarantee is valid only on radio sets installed and used in metropolitan New York and immediate suburbs.

Then follows in large black type this notice:

CONDITIONS OF SALE:

This Guarantee Tells You What You Are Entitled to from Haynes-Griffin.

In order to avoid misunderstanding, salesmen are required to call the attention of the radio purchaser to the following conditions of sale and guarantee.

The attached coupon to be signed by the customer is merely our salesman's receipt that he has furnished you with a copy of this guarantee.

The purchaser of a new set can never claim that he was promised some special concession, because the contract states exactly the terms of the company, and his attention is called to all the clauses by the large and prominent notice. Following the conditions of sale notice is clause 1 of the contract, which reads:

1. You are entitled to

ONE WEEK'S FREE TRIAL on the receiving set and accessories selected. Within one week after purchase, the set may be returned to us either for cash refund, credit or replacement by some other set, at your option. This trial privilege applies to all sets, regardless of make or price. Obviously, however, it is impossible for us to allow credit or refund on any charges made by us for labor covering installation by us, or for material used in erecting an aerial. This is the sole exception to our unqualified offer of one week's free trial.

Haynes-Griffin has prepared a chart

of New York City and vicinity. Upon this chart is drawn a line enclosing a certain area, of which their store is the approximate center. Within this area they make a uniform installation charge of ten dollars. Outside of this district the charge is fifteen dollars.

Now, by reference to clause 1 of the contract, it is plainly seen that the dealer makes no refund on any of his charges made for installation, labor, or material used in constructing an aerial. The purchaser will not take so long to make up his mind as to which set he desires in his home, if each change of installation costs him ten or fifteen dollars. This clause in the contract is certainly a most commendable one, for it strikes directly at the roots of one of the greatest evils so long connected with the retailing of radio receivers.

In connection with the above, it is interesting to note that the customer can save the initial installation charge, if he desires to deliver and install the set himself. In such a case, however, he is not entitled to the thirty days' free service, which applies only on such sets as were originally installed by the dealer's own service department. (Clause 3 covers this.) This protects the dealer against unreasonable claims and demands arising from circumstances beyond his control, such as faulty installations made by the purchaser himself.

Clause 2 of the contract reads as follows:

2. Following the period of One Week's Free Trial we continue to guarantee radio sets furnished by us to be free from defects in material and workmanship.

If any defects develop within the set manufacturer's guarantee period, provided the merchandise has not been tampered with, we agree to repair the set satisfactorily or at our option to replace it with another of the same make.

Clause 2 is largely self-explanatory, but it should be especially noticed that the dealer does not guarantee a certain set for a period exceeding that covered by the manufacturer's guarantee. It is advisable that the purchaser be furnished with a copy of the guarantee issued by the manufacturer whose set he buys, in order that any misunderstanding of this clause be avoided.

Clause 3 tells the purchaser exactly what free service he is entitled to:

3. For thirty days following purchase, our service department is at your disposal *without charge*.

Upon request an experienced radio repair man will call at your home to correct any defects which become manifest, or make such adjustments as are sometimes necessary, due to peculiar local receiving conditions. This *Free Service* at your home does not include service on breakage or defects due to carelessness or abuse of the set or accessories by the customer.

The above mentioned Free Service for thirty days is extended, of course, only on such sets as were originally installed by our own service department.

By reference to the above, it will be noted that the purchaser can not demand free service on the set or accessories, if such service is necessary because of his mistreatment of this equipment. For instance, if a man damaged his receiving tubes because he overloaded the filaments with excessive voltage, he could not expect the service man to call and install new ones free of charge.

Clause 4 deals specifically with service calls and inspections made after the expiration of the thirty days' free service period:

4. All service calls or inspection made at your own home after thirty days from purchase are charged for at the rate of \$2.00 per hour, including traveling time.

We are unable to make any exceptions to this rule regardless of circumstances, and all guarantees furnished by us are subject to this provision. Replacements or repairs necessary under our general guarantee as outlined in Paragraph Two are made free only on the basis that the material in question is brought to the store from which purchased, and not called for or delivered by us.

The dealer will not be bothered by so many unnecessary calls for service when a charge is made for each call. Many people are apt to be unreasonable in their demands when their wishes are granted without charge. Undoubtedly most dealers have had unpleasant experiences of this sort.

Appended to the bottom of the four clauses already enumerated are the following footnotes:

Tubes and Batteries

Equipment such as tubes and batteries furnished by us are of standard make and tested quality. Owing to the fact that the life of the very best of such equipment is uncertain and also because we have no means of determining the amount or kind of usage such equipment receives in the hands of the purchaser, we do not guarantee the life of either

vacuum tubes or batteries. When our service department is called upon to replace batteries or other accessories in the home of a customer a cash charge is made for the new material as well as the services of our radio repair man, as outlined in Paragraph Four.

Distant Stations

We do not guarantee the reception of distant stations on any radio receiver, regardless of make or price. The securing of distant stations depends upon elements beyond our control, such as weather conditions, location of the radio and the skill and patience of the operator.

Traveling Expenses

In districts outside of Greater New York, or wherever we do not maintain a regular delivery service, we are obliged to make an additional charge covering traveling expenses on all service calls regardless of circumstances, including the original installation and on calls necessitated by defects in the material furnished or in the character of our own workmanship.

The above items are inserted so that no misunderstanding will exist in the mind of the purchaser as to the obligation of the dealer where the performance and life of the set and accessories are concerned. These items furnish quite a contrast to the wild claims made by less reputable concerns as to "coast to coast reception," and similar extravagant statements.

Below the items last named is a notice which states:

IMPORTANT: No salesman or employee of Haynes-Griffin Radio Service, Inc., is authorized to change or add to the conditions of sale as above enumerated in any particular. No promises of additional service or further guarantee of performance on the part of the merchandise sold over and above those enumerated in this guarantee are authorized or agreed to by us.

At the very bottom of the form, and readily detachable by means of the perforated edge, is a coupon which is to be filled out by both customer and salesman:—

Date

Receipt is hereby acknowledged of a copy of the Conditions of Sale and Guarantee covering the radio set this day purchased by me from Haynes-Griffin Radio Service, Inc.

.....

Customer's Signature
Make of Receiver

.....

Serial No.
Salesman

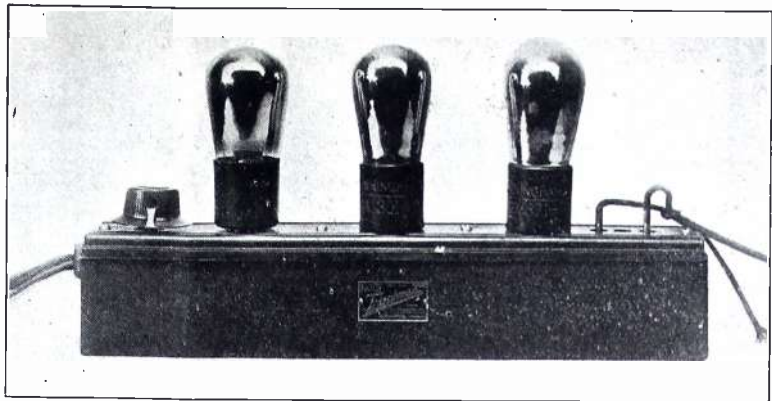

Here is a Truphonic amplifier in unit form, to be built into a set or added to a complete outfit that needs A. F. improvement

Two Specials for Fall Business

The Alden Truphonic line and Sangamo's series of high voltage condensers are attracting much attention

THE wide spread utilization of battery eliminators for operating power tubes has created a demand for condensers that will stand up under high voltages. Sangamo Electric is placing on the market a line of condensers and condenser blocks which is especially designed for eliminator work. Below are pictured one of their B blocks and two of the high test filter condensers. The block is well designed, being both electrically and mechanically of sturdy construction. It consists of two 4-mfd., one 2-mfd. and four 1-mfd. capacities. This particular block was designed to operate in conjunction with the Varion eliminator.

Sangamo manufacturers two types of condensers called series A and series B. Series A condensers are guaranteed for continuous operation at 250 volts A. C. and 400 volts D. C. Each one of these condensers is tested before leaving the factory at 400 volts A. C. and 750 volts D. C. They come in various sizes, ranging from .1 mfd. to 4 mfd. For eliminators providing exceptionally high voltages—as for example, the plate supply for a 210—

series B is recommended. Condensers of this type will not break down under continuous operation at 500 volts A. C. or 1,000 volts D. C. To insure this ability to stand up, they are first subjected to a thorough test at 800 volts A. C. and 1,500 volts D. C. This is an ample margin of safety to take care of surges and no-load conditions in the eliminator.

The Alden company has put out an audio amplifier of entirely new and radical design. It is based upon a method of amplification designed by H. P. Donle. As the above illustration shows, the outfit is very compact and fits very easily into any set. It comprises three stages of audio with an output unit to prevent the high plate voltages from injuring the loudspeaker. This power amplifier should be attached directly after the detector tube.

The Truphonic employs the catacomb style of assembly. The catacomb is of lacquered steel and houses the three coupling units and the output unit. On top is a moulded Bakelite strip for the sockets. In addition this holds a rheostat and three pin jacks.



Sangamo is certainly out for business on high-voltage condensers that will stand up under overload conditions, both mechanically and electrically



Fig. 1. The machinery and method employed for winding plain coils or tubing

Quantity Production of Radio Coils

As it is done by the Twin Coupler Company, the largest producers of coils in the world

LOCATED in Poughkeepsie, N. Y., is the Twin Coupler factory, the largest radio coil-winding plant in the world. Little known to the general public, or even the trade, they turn out a production running into millions of coils per year. This quantity is divided between sales to set and kit manufacturers, and to the chain stores. In types, the coils include practically everything which is in big demand, from little spider webs to coils wound by the yard, on celluloid, and sold by the inch.

Fig. 1 shows the method by which coils are wound on tubing. The long bench is fitted with rows of machines, such as the one shown, on both sides. These are operated by individual countershafting run from a long shaft under the bench at the center.

The machines themselves are very simple, for so dexterous do the operators become that no guiding mechanism

is required, yet, in thousands of coils, there is no effective variation in the number of turns in a given space.

Coils of all types are wound on a piece-work basis. At the start, it seemed preferable to pay the operators on an hourly basis, but the change to piecework was accomplished without upsetting the quality of the work produced, and at the same time wages were increased and costs reduced.

Basket-Weave Coils

One of the most interesting machines used in this work is that on which basket-weave coils are wound. Anyone who has attempted this kind of coil on a home made fixture knows that such a process is out of the question when shipments running into hundreds a day must be made. However, very few radio men have any idea as to the method employed commercially.

Figs. 2 and 4 tell the story. Two

girls comprise a basket-weave team—one to operate the winding machine, and the other to sew the coils and remove the winding fixture.

The fixture, held by a draw-in chuck to the head of the machine, revolves at quite a high rate of speed. The fixture on the bed of the machine carries a cam, rotated thru gears, at a rate depending upon the number of pins in the winding fixture. Bearing on the cam is an arm, normally held against the cam by a long coiled spring at the rear.

Wire is fed in thru guides from a spool at the right, as in Fig. 4. It passes thru a polished hole in the arm bearing on the cam. Now, as the winding fixture turns, the cam makes the wire-guiding arm move up between two sets of pins on the fixture, and down between the next two. The arm is kept clear of the pins by the tube thru which the wire is fed. As the winding progresses, the operator moves the little knob on the arm bearing along its shaft.

When the coil is complete, the operator may add a turn, or take off one, to get the right number as indicated by the counter, releases the fixture by turning the hand wheel, and passes the coil and fixture to her team-mate.

The second girl then puts the end of the fixture thru a hole in the bench, to hold it in place, and sews the coil with string. This binding string can be seen in some of the coils shown in Fig. 3. That process completed, she pushes out the fixture with the aid of a small bench arbor press.

It may seem that the insulation is given rather rough treatment. However, short-circuited turns are practically unknown. This is largely due to the fact that the wire has first a coating of enamel, then a layer of cotton, and, on the outside, a layer of silk insulation. Such a covering has been found to withstand the roughest treatment without cutting thru to the wire.

Other Coil Winding Machines

The machinery described is only one of the many interesting devices used in speeding up the production of radio coils. Since patents have issued on the basket-weave machine, this information has been released to RADIO ENGINEERING. Other equipment, however, on which the patent situation has not been completed, cannot be shown, we are sorry to say.

At least, the information presented indicates the high development reached in this separate and special branch of radio manufacture. In addition to the process described are those involved in the production of skeleton-tube coils, the "celluloid coils," and other special types developed by individual set manufacturers, for which the Twin Coupler Company has built high-speed winding equipment.

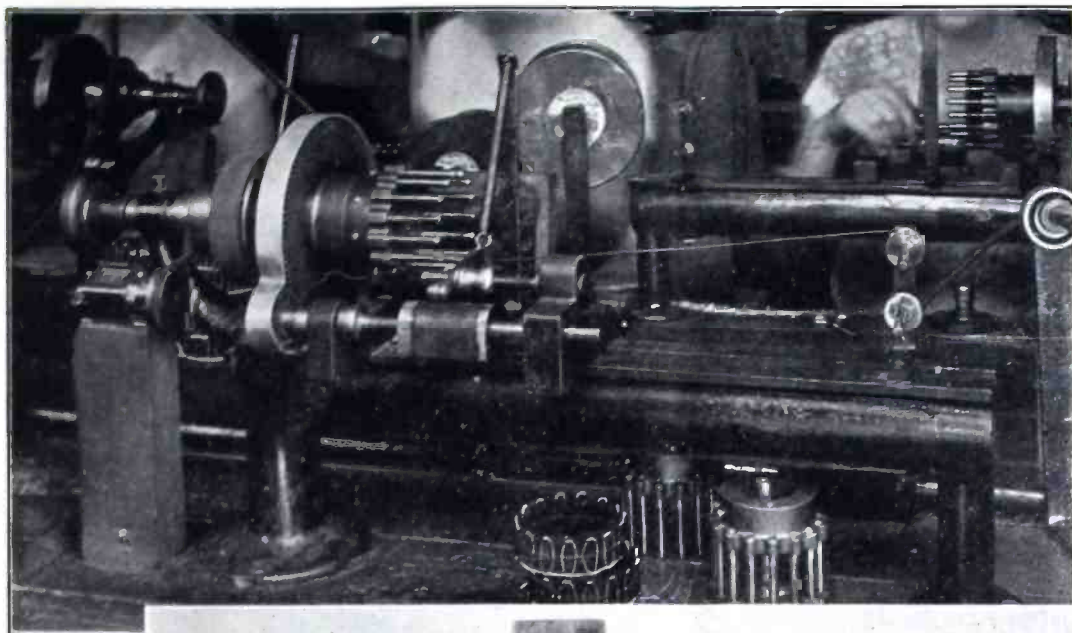

Fig. 2. Close-up of the machine for weaving the wire in and out around the pins. Note that the cam which actuates the wire-guide is operated by a gear attached to the main spindle. The form on which the wire is wound is held by a draw-in chuck, operated by the hand wheel on the left end of the spindle.

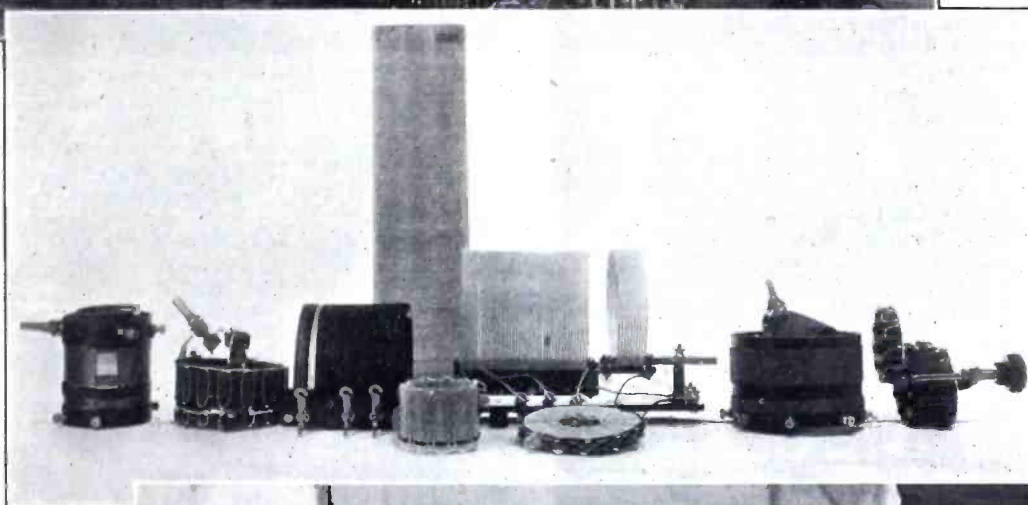

Fig. 3. Above: Types of coils from the Twin Coupler factory. They include basket-weave, spider web, and plain coils on tubing, as well as those wound on thin celluloid.



Fig. 4. Below: A basket-weave team. The girl on the left operates the winding machine, while the other sews the coils with thread and removes the winding fixture.

Making Money

Ideas for dealers and jobbers who are on their toes to capitalize on new demands

WELL, here we are again, and with some more hot stuff for this month. By this time, you probably know that we give here the advance dope on what is to appear in *Radio Mechanics*. By the way, have you seen a copy of this magazine yet? If not, you had better get one, for you have been losing out on some real radio articles. *Radio Mechanics* is full of interesting reading for every member of the family.

For instance, if you want to tie up with a real new outfit; if you want to beat the other fellow to it, look in the December number of *Radio Mechanics* for

The Biggest New Thing in Radio

Yes, and when we say that we mean it. To come to the point at once, the December Number of *Radio Mechanics* contains a feature article on a combination short wave receiver and telephone transmitter. No, you won't have to mortgage the old homestead in order to buy the parts for one. Far from it! In fact, one of the features of the outfit is that you can build your own Junior Broadcaster for less than a good five tube kit will cost you. And it operates from B batteries!

Have you ever talked—and by talked we mean speech and not code—to your friend by radio? No? Well, you have been losing out on the biggest kick you ever got out of anything. Think of it! You can sit down at your own little broadcasting station and call up your friends on the other side of the city; or, if the weather is with you, a hundred or more miles away. No toll charges with this outfit either.

The Junior Broadcaster is simplicity itself. Just a few minutes spent studying the schematic diagram will give you a good idea of the circuit, and you'll be all set to go. The parts needed are remarkably few. Two Karas variable condensers and a set of short wave Aero coils form the heart of the outfit, which is built in sub paneled style for the benefit of the fellow who wants things neat, as well as efficient. Two Benjamin sockets are mounted with their springs under the sub panel, so that all of the wiring can be done from underneath. The modulation transformer and 30 KC choke are made by Acme, and the RF choke is a No. 85 Samson.

A General Radio hot wire ammeter is mounted on the front panel, and shows the amount of energy put into the antenna. Amperites control the filaments of the oscillator and the modulator, and all battery connections are made to Eby binding posts. The sub panel is mounted on Radion

brackets, and a Carter jack and Yaxley switch complete the parts list.

Judging by the interest that has been aroused by our laboratory model in Poughkeepsie, we know that the dealer who starts pushing this transmitter will be all set for a lot of new business that he couldn't reach before.

The Hi-Q Kit

Did you stock the Hammarlund-Roberts kit last year? If so, undoubtedly you enjoyed a nice volume of business on it. Well, the kit that proved to be so popular last year will be even more so, with this year's added refinements.

Radio Mechanics for December has a complete construction article on the assembly of this kit, and each feature is described in detail. Speaking of features, the new Hi-Q has so many new ones, and such good ones they are, too, that we hardly know which one to describe first.

The circuit consists of two stages of tuned RF, which are equalized by the well known Roberts method. The second RF and detector stages are completely shielded, and the condensers which tune these circuits are mounted on one shaft.

The new Hammarlund Auto Couple coils are used with condensers of the same make. The primaries of these coils are varied as the condensers are varied, so that full efficiency coupling is maintained at each wave length setting.

One of the best features of the Hi-Q kit is that no special parts are required, except the Foundation Unit, which includes the drilled and engraved front panel. That is, it is not necessary for the dealer to stock a lot of special parts which can be used in no other circuit.

The Varion B and C Eliminator

Radio Mechanics for December contains a construction article on the Varion B and C battery eliminator. This is one of the first outfits especially designed to use the new Raytheon BH tube. Two variable C taps are provided, either or both of which will supply up to 45 volts of bias voltage. This feature is a most desirable one, for it obviates the necessity of buying a 45 volt B battery for use on the grid of the popular 171 power tube.

The Varion uses the Amertran power transformer and chokes, and a Sangamo condenser block. Ward Leonard resistances provide the various output B voltages, and the two bias controls are Centralab heavy duty potentiometers. The entire assembly is mounted in a metal box, upon which is fixed an insulated strip for the Eby binding posts.

Trinity Dealers

Bill and Bud were called on an installation job for a Trinity Five receiver, and had some interesting experiences with power tubes in this set. There has been considerable controversy concerning the use of the 112 and 171 power tubes, and Bill writes in detail concerning their use and results in the Trinity set.

These boys know their stuff when it comes to setting up a receiver, and the Trinity dealers can get some good pointers from Bill's article and photograph of the completed job. You know, it is not nearly so difficult to sell a set, if you can give the prospect an idea of how the receiver will look when installed in his own home.

A Radio Bug Factory

A new field is opening up in radio. Many of the more progressive schools of the country are using radio receivers and associated apparatus to teach the practical applications of physics and to give the pupils more tangible evidence of the workings of electricity.

There is a page of pictures in the December number of *Radio Mechanics*, which shows what one of the New York schools is doing in this connection. The idea is a most commendable one from an educational standpoint, and its effects will be noticed far more than the average dealer imagines.

Teaching radio in the schools will do much toward removing ignorance and misunderstanding of this wonderful discovery of our scientific age, and will thereby serve to stimulate the demand for radio sets and parts.

Quality Condensers

There are any number of filter and by-pass condensers on the market, but all of them are bulky and difficult to dispose of in a receiving set. Tobe has realized this drawback and, as a result, has designed the Tinytobe. These are midgets in size but giants in performance. This seems to be the first design put out offering especially high voltage rating in small capacities. With the advent of B eliminators and power tubes, there are high voltages used, which subject by-pass condensers to a considerable strain. Often the common garden variety will blow with just about a hundred volts applied.

The Tinytobes have all the qualifications of their bigger brothers. They are tested at 1,000 volts and guaranteed for continuous operation up to 500 volts. They look like small cans in an aluminum casing. The dielectric used is paper, with exceptionally strong—electrically speaking—foil for the conducting medium.

These condensers are manufactured in a number of sizes, varying from .0001 mfd. to .01 mfd. The price range is 35c for the .0001 mfd. up 55c for a .01 mfd. condenser.

The Sangamo condensers should be mentioned in this connection. Their small sizes are well known to the trade and justly deserve the popularity which they have achieved.

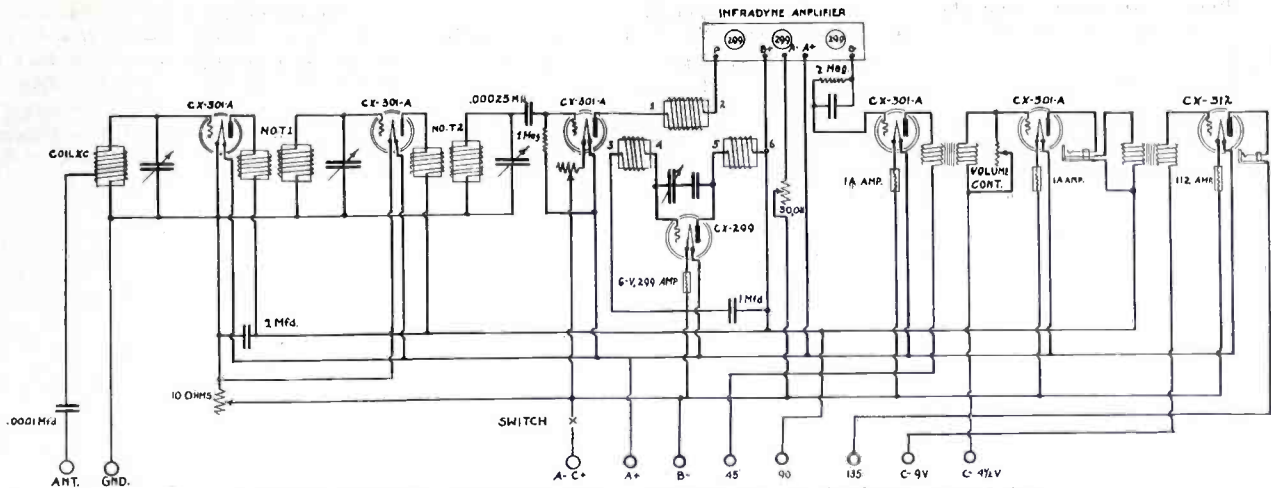

Complete schematic of the Infradyne. Additional circuit details are given below

Notes on the Infradyne

Here is the fundamental data on E. M. Sargent's high frequency intermediate set

THE Infradyne is a radical departure from any circuit so far developed. It incorporates so many unusual features which will arouse the fans' curiosity, that the technical men had best prepare themselves with a fund of information concerning this receiver. Particularly, it is advisable that they familiarize themselves with the theory, as well as the practical aspects, of its operation.

Most everyone is familiar with the operation and the theory of the super-heterodyne, and how its local oscillator beats with the incoming wave so as to produce a new low frequency signal which is amplified through the intermediate stages. It is not so well known, however, that when a radio frequency current is mixed in the first detector with the frequency generated by the local oscillator, that a sum frequency is also produced. This sum frequency is the frequency of the incoming signal plus the frequency of the oscillator.

Those who were familiar with this presence of the sum frequency disregarded it altogether, for it was considered impossible to amplify such short waves efficiently in a fixed amplifier, or in a combination of tuned circuits. The Infradyne, however, utilizes a recently discovered means whereby practically the same degree of amplification can be obtained at any frequency.

One of the characteristics of the super-heterodyne, and one which has been the most criticised feature of the circuit, is the presence of repeat points on the oscillator dial. In congested broadcasting centers it is often found that when the oscillator is tuned so as to produce the required heterodyne with the incoming signal

of a certain station, it will also heterodyne another station, whose frequency differs from that of the one being received by the frequency of the intermediate amplifier. This trait of the super-heterodyne can be rendered non-troublesome only by the careful selection of the frequency of the intermediate amplifier, or by making the input circuit to the first detector sufficiently sharp so that unwanted waves cannot enter.

It is evident that the Infradyne, using the sum frequency, completely obviates this trouble, for a station can be tuned in at only one point on the oscillator dial. Further, since the frequency of the fixed amplifier is so high, any tube noises which might prove troublesome at lower frequencies are not amplified, and the receiver is very quiet in operation.

Aside from the novel use of fixed high frequency amplification, the Infradyne circuit, as shown in the schematic diagram, possesses other unusual features. It is interesting to note the function performed by each of the ten tubes used in this receiver.

The incoming signal proceeds at its original wavelength, through two stages of tuned R. F. amplification, and into a first detector, which uses the conventional grid leak and condenser combination for accomplishing rectification. Toroid coils, or similar inductances which have a small external field, are used in this section of the receiver. The grid circuits of the first three tubes, which are of the 201-A type, are tuned in unison by a triple gang condenser, each section of which is 0.00035 mfd. capacity. It should be noticed that the grid leak is in shunt to the grid and positive filament, instead of in parallel with

the grid condenser. This connection is necessary because the gang condenser has a common rotor, which is connected to the negative filament. Although none are shown, it is preferable that small trimmer condensers be used in shunt to the tuning condensers on the R. F. stages, in order that complete electrical balance can be obtained, and exact resonance of the three circuits procured at any setting of the triple gang condenser dial.

The output of the first detector goes through a coil which is in inductively coupled to the grid and plate coils of the 199 oscillator tube. It is here that the frequency coming from the first detector is added to the frequency generated by the oscillator, and the sum of the two is fed into the input of the Infradyne amplifier, to be further intensified by three stages of amplification at 3,200,000 cycles. The 199 tubes are used in the Infradyne amplifier, since they are more suitable for this form of amplification at the extremely high frequency employed.

The output of the Infradyne amplifier feeds into the grid circuit of the second detector tube. A 201-A is used at this point, because the original signal has by now been so intensified that considerable handling capacity is required. The rest of the circuit consists of a standard two-stage, transformer coupled audio amplifier, in which volume is controlled by a variable high resistance which shunts the secondary of the first audio transformer.

Certain changes must be made in the construction of the Infradyne for the action is different from that which takes place in the ordinary super-heterodyne. The triple gang condenser must have a capacity increase in a direction opposite to that of the oscillator condenser, and the condenser used to tune the oscillator must rotate through 360 degrees, if it is desired to have the two dials read alike for a given station. This peculiarity of the circuit is due to the use of the sum frequency.

Following is the list of parts for the Infradyne, as specified by E. M. Sargent, sponsor of the circuit:

- 1 Remler Infradyne amplifier.
- 1 Continental triple vernier condenser.
- 1 Remler .00035 condenser.
- 1 Tapped inductance.
- 1. Gen. Radio No. 301 30 ohm rheostat.
- 1 Set No. 33 Thorola Doughnuts.
- 2 National Type B CCW dials.
- 7. Benjamin UX sockets.
- 1. 112 amperite.
- 2 1-A amperites.
- 1 6V-199 amperite.
- 1 30 ohm U. S. L. rheostat.
- 1 10 ohm U. S. L. rheostat.
- 1 Centralab 50,000 ohm radiohm.
- 3 2-in. rheostat dials.
- 1 Yaxley filament switch.
- 1 single closed Electrad jack.

- 1 single open jack.
- 1 Jewell No. 135 0-5 D. C. voltmeter.
- 1 Electrad grid leak mounting.
- 1 Electrad fixed condenser mounting.
- 1 1-megohm Electrad fused metallic leak or Arthur H. Lynch fixed resistor.
- 1 2-megohm Electrad fused metallic leak or Arthur H. Lynch fixed resistor.
- 1 Electrad .0001 mfd. condenser.
- 2 Electrad 1 mfd. condensers.
- 2 Sangamo .0005 condensers, 1 with clips.
- 1 Electrad .00025 condenser.
- 9 Eby binding posts.
- 1 Formica walnut panel 3/16 x 7 x 30.
- 1 Redwood baseboard 3/4 x 10 x 34.
- 2 Amertran de luxe transformers.

out the distortion resulting when 201A tubes are forced. The undistorted output is more than ten times that of the 201A. Its low output resistance makes it particularly well suited for working into a low impedance cone. When the input is sufficient to work it to its capacity, the power delivered is ample for home use.

In order to obtain results equivalent to those delivered by the 213 rectifier, two 216B rectifiers must be used to supply the high voltage required by the 210 tubes. A transformer secondary voltage of nearly 1000 volts is also required. It is felt that a unit of these proportions is an extravagant and possibly a dangerous one for home use. These considerations have led the engineers of the General Radio Company to build their power units around the 171 tube.

171 or 210 Amplifier Tube?

*Specifying conditions under which the 171 or 210 gives the better results—By C. T. Burke**

As there are two tubes available for use in the last audio stage where considerable power is desired with perfect quality, some question has arisen as to which of these tubes should be used in a given case.

The plate characteristics of these tubes (UX-171 and UX-210) or (CX-371 and CX-310) are as follows:

UX 171

Grid Volts	Plate Volts	Output Resistance	Maximum* Undistorted Output (Milliwatts)	Amplification Factor
16½	90	2500	130	3
27	135	2200	330	3
40	180	2000	700	3

UX 210

Grid Volts	Plate Volts	Output Resistance	Maximum* Undistorted Output (Milliwatts)	Amplification Factor
4.5	90	9200	18	7.5
9	135	8000	65	7.5
10.5	157.5	7400	90	7.5
18	250	EFJJ	340	7.5
27	350	5100	925	7.6
35	425	5000	1540	7.7

*Proper bias assumed.

Considering first the output resistance, it will be seen that it is lower for the 171 for all conditions of plate voltage. A low output resistance increases the energy transferred from the tube to the speaker, and in part compensates for the low amplification factor of this tube. The low resistance also results in a greater energy transfer at low frequencies, where loudspeakers are inefficient.

The input voltage which may be applied to a tube without causing grid distortion is fairly well indicated by the grid bias voltage. An inspection of the table will show that the 171 permits a greater input at 180 volts than does the 210 at 425 volts, and more than twice as much as the latter tube at 180 volts plate.

Considering next "maximum undistorted output," it is seen that the 171 will deliver about twice the power at

180 volts that the 210 will at 250 volts plate. At 425 volts the 210 will deliver somewhat more than twice the power than the 171 delivers at its maximum plate voltage.

The amplification factor of the 210 is greater at all voltages.

From the above data it is possible to deduce a few rules for the use of these two tubes.

Where the plate voltage available is less than 200, the 171 tube should invariably be used.

Where it is desired to obtain the greatest possible volume, as might be the case in a hall or large assembly room, the 210 tube should be used with 425 volts on its plate.

The 171 tube is the ideal type for use when it is desired to obtain the proper volume for a living room with-

B Power Compact

THORDARSON has just announced a new Power Compact, which marks a distinct step ahead in the design of foundation units for B eliminators and power amplifiers. This device will undoubtedly have wide appeal to the constructor of power units, because of its extreme compactness, simplicity, and ease of assembly.

The Power Compact contains in one small, metal case a power supply transformer, a center-tapped filament supply winding for the power tube, two buffer condensers connected across each half of the power transformer secondary, and two filter choke coils. It is made in two types; R-171 for the Raytheon BH rectifier and UX 171 power amplifier; and R-210, designed for the UX 216-B rectifier and the UX 210 power amplifier.

The type R-171 has but six external connections, in addition to the twisted leads by which it is connected to the lighting mains.

The exact electrical center of the filament supply winding is obtained by a unique method. It is common practice to tap a continuous winding, but an entirely different arrangement is used in the Power Compact. Two individual and perfectly balanced coils are wound side by side, and the center of the winding is taken from the common lead of these two coils. Those who have built power amplifiers can readily appreciate just how important it is to have a perfectly balanced grid return in order that all AC hum can be completely obliterated.

In addition to the Power Compact R-171, there are but a few additional parts necessary to construct a complete power amplifier and B supply. Two Clarostats, 10,000-ohm and 2250-ohm fixed resistances, a standard condenser block designed for use with the Raytheon BH, two tube sockets, a Thordarson R-200 input audio transformer, and an R-196 choke to put in the output circuit with a 4-mfd. fixed condenser complete the assembly.

*Engineering Dept., General Radio Co.

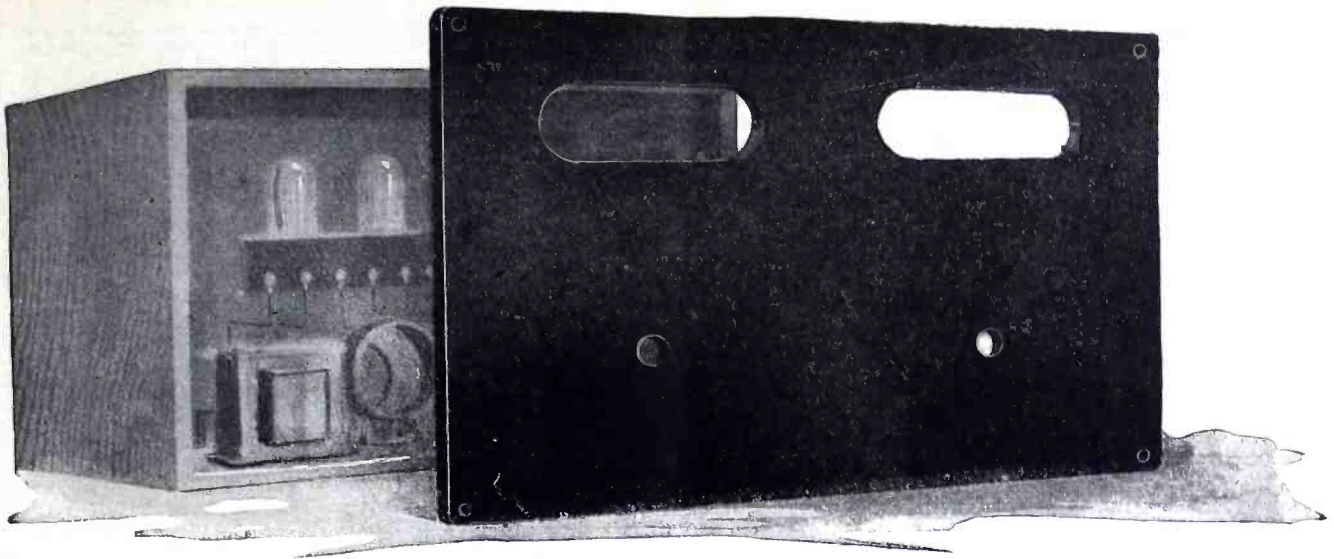

Add to Your Set

Permanent Beauty

MICARTA—the panel material of permanent beauty—is warp-proof, moisture-proof, oil-proof, heat-proof, *time*-proof.

In the permanent beauty of Micarta you have the choice of three finishes—ebony, walnut, and mahogany. Ebony is a plain black finish with satiny luster. Walnut and mahogany are natural wood finishes to match the cabinet work. Any of these may be decorated, to your specifications.

Beauty helps to sell radio sets. Permanent beauty keeps them sold and builds up an endless chain of good-will for your product.

Micarta panels, fabricated and decorated to your specifications, can be obtained from:

Micarta Fabricators, Inc.
309 Canal St. 500 South Peoria St.
New York, N. Y. Chicago, Ill.

MICARTA
REG. U. S. PAT. OFF.

*The
Permanent
Panel Material*



Westinghouse Electric & Manufacturing Company
East Pittsburgh Pennsylvania

Sales Offices in All Principal Cities of
the United States and Foreign Countries

Westinghouse

X90102

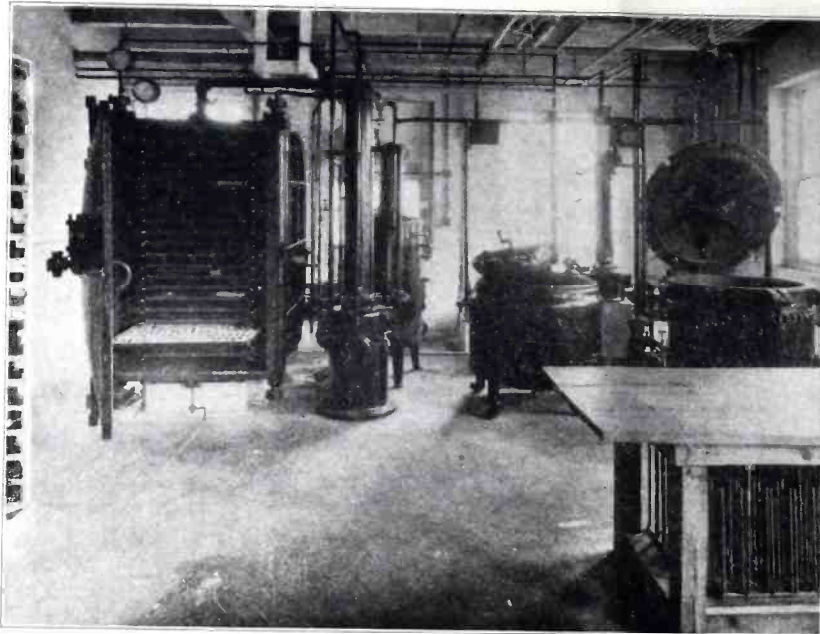

Fig. 4. The heart of the condenser plant. The quality of the product will depend largely upon the treatment in the impregnator and dryer

Fig. 2. A side-view of the winding machine, exposing the reels of alternate paper and foil



ing mandrel contains a revolution counter which can be seen on the right. The windings themselves have the appearance of an oblong. After they are removed from the mandrel they are pressed together slightly to permit stacking.

Fig. 2 shows the winding machine with the reel-box cover opened. These reels are set on spindles which in turn rest on ball bearings. Guides are provided which exert a uniform pressure and keep foil and paper in exact alignment. This alignment is secured by adjusting handles on the outside of the reel box, as shown in Fig. 3. The small studded projections are for adjusting the guides which are also set on ball bearings.

Whether a condenser will stand up under high voltages or not will depend to a large extent upon the care with which it is handled in the impregnator and the dryer. Fig. 4 shows the impregnator and tanks on the right with the vacuum dryer on the left. The latter has associated with it a number of auxiliary machines such as a steam boiler to provide heat and a vacuum pump to draw away the moisture laden

High Voltage Condensers

These pictures, taken in the Muter factory, show some of the processes of making fixed condensers

THE popularity of B eliminators has caused a tremendous increase in the demand for filter and by-pass condensers. As a result a number of manufacturers have installed equipment for the production of this type of condenser. In anticipation for this demand, the Leslie F. Muter Co. has installed what we be-

lieve to be one of the most efficient and best equipped plants for the production of filter condensers.

lieve to be one of the most efficient and best equipped plants for the production of filter condensers. To insure a uniform product of high quality, the plant has been designed by experts to take advantage of all known devices and processes. Even

the location and construction of the building has been carefully considered, a fact often neglected. The factory housing the Muter plant was carefully sealed in order to prevent dust and other foreign matter entering the premises.

One of the most important devices is the winding machine. A picture of the machine is shown in Fig. 1. It is completely enclosed and is operated by a direct current motor whose speed can be controlled very readily. The wind-

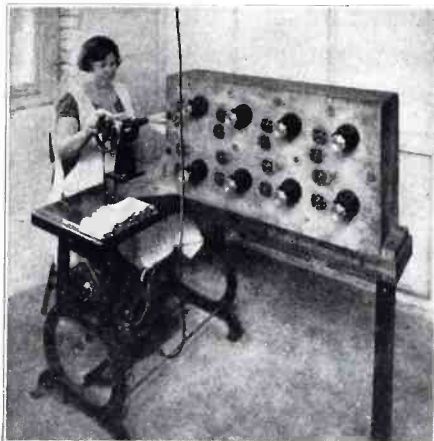

Fig. 3. Another view of the winding machine showing the handles for aligning the spindles and the guides



Fig. 1. A special winding machine was designed to keep all foreign matter from the paper and foil

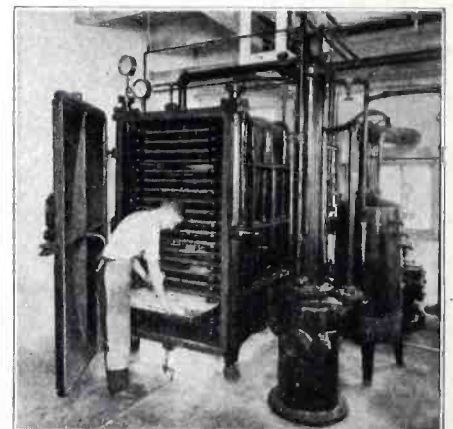

Fig. 5. Placing a tray of condensers into the dryer. Notice the auxiliary equipment needed

air as fast as it is released. The impregnation system consists of the impregnation chamber, the liquor tank for heating the paraffin, a condenser, which is a mechanical device for reducing atmospheric pressure, and a combination vacuum pump.

lieve to be one of the most efficient and best equipped plants for the production of filter condensers.

To insure a uniform product of high quality, the plant has been designed by experts to take advantage of all known devices and processes. Even

Equamatic
System Licensed
Under King
Patents
Pending

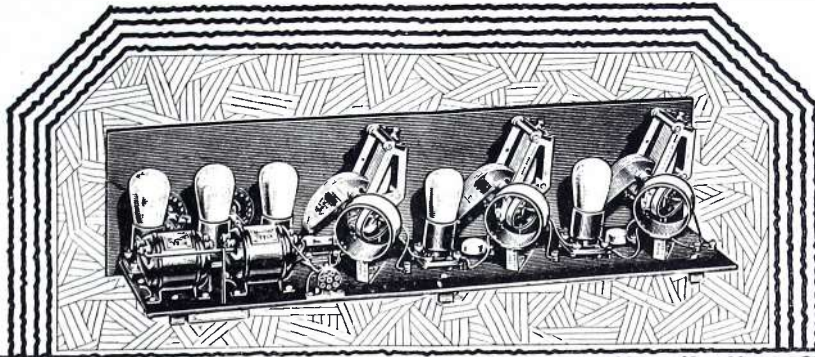

The Karas Equamatic Five Tube Sensation!

The Circuit that has Changed the Meaning of Tuned Radio Frequency

The Karas Equamatic System of tuning has completely changed all previous conception of five tube performance. With this new automatic system of tuning all five tubes operate at their highest efficiency, not at certain wave lengths, but at all dial settings from 200 to 600 meters. The result is a volume, tone quality and sensitivity that has never been approached by any other five tube circuit.

This greatly increased efficiency is brought about by maintaining a CONSTANT EQUAL TRANSFER OF ENERGY at the practical maximum between the primary and secondary coils. Radio engineers have been trying for years to find a satisfactory method of doing this. Now the problem has been solved in the Karas Equamatic System by a very simple, mechanical method.

How the System Operates

The radio frequency transformers used in the Karas Equamatic System differ radically from all previous types. In the Karas Equamatic coil the primary is entirely separate from the secondary and is mounted on the extended shaft of the condenser so that it turns with the condenser dial. The secondary is mounted on the sub-panel by means of a sliding standard so that it can be pushed toward the primary or away from it to get the proper degree of coupling.

Perfect Coupling at ALL Wave Lengths

When all three sets of coils have been adjusted the coupling is AUTOMATICALLY varied at exactly the proper rate to keep the tubes operating just below the oscillation point on ALL wave lengths. There is no extra control. The set is merely tuned in the ordinary manner.

New Sharpness and Selectivity

There is no overlapping of electromagnetic and electrostatic fields to cause broadening or distorting effects. As a result the circuits in the Karas Equamatic Five Tube Sensation tune with amazing sharpness. Stations snap in and out with remarkable precision.

The signals are as pure, clear and natural as those of a crystal receiver. The volume can only be compared with that of a seven tube set and in addition there is the sensitivity and range of a regenerative circuit.

The Karas Equamatic is Easy to Build

You can build this powerful, clear toned receiver in a surprisingly short time with complete assurance that you will get even better results than we claim.

Packed with every set of Karas Equamatic Coils is a complete manual of simple diagrams and instructions showing where to place every part and how to make each connection. This manual also completely illustrates and describes the principle and operation of the system. To build the Karas Equamatic Five Tube Sensation you will need the Karas parts listed on the coupon, plus other standard parts easily secured.

Order from Your Dealer or Direct

Karas Equamatic parts are carried in stock by reliable dealers in most cities. If your dealer happens to be out of stock, order direct from us by using the coupon at the right. SEND NO MONEY. Just pay the postman the price of the Karas parts, plus a few cents postage.

Essential Parts of the Karas Equamatic Sensation

Karas Equamatic Inductance Coils are packed three in a carton, and come to you with complete manual of simple diagrams and instructions, all necessary nuts, screws and binding posts, ready for mounting in your receiver. Price, set of three coils...\$12.00



Karas Special 17-Plate Orthometric Condensers, three of which are used in the Equamatic Receiver, have special extended shafts upon which to mount the primary coils of the Inductances. Price, ea. \$7.00

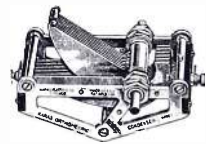

Karas Harmonik Audio Frequency Amplifying Transformers are essential to the tone quality success of the Equamatic Receiver. Two of these are used for the two stages of Audio frequency amplification. Price, each\$7.00



Karas Equamatic Retard Coils, two of which are used, were designed especially for the Equamatic System. Price, each\$1.00

Karas Equamatic Sub-Panel Brackets. To insure the necessary exact positions of primary and secondary coils these brackets are essential. Price, set of three.....70c

Karas Micrometric Dial. It has a 63 to 1 vernier and tunes to 1/1000 of an inch. Price.....\$3.50

KARAS ELECTRIC COMPANY

Association Building

CHICAGO

Radio Engineering, November, 1926

KARAS ELECTRIC CO., 1098 Association Bldg., Chicago, Illinois

Please send me a set of 3 Equamatic Inductance Coils, \$12.00; 3 special Orthometric Condensers with extended shafts, \$7.00 each; 3 Micrometric Vernier Dials, \$3.50 each; 2 Harmonik Audio Transformers, \$7.00 each; 2 Equamatic Retard Coils, \$1.00 each; and 3 sub-panel brackets, 70c, for which I will pay postman \$60.20, plus postage, upon delivery. It is understood that I have the privilege of returning any of this apparatus for full refund any time within 30 days if it does not prove entirely satisfactory.

Name

Address

City State

(If cash accompanies order we will ship postpaid)

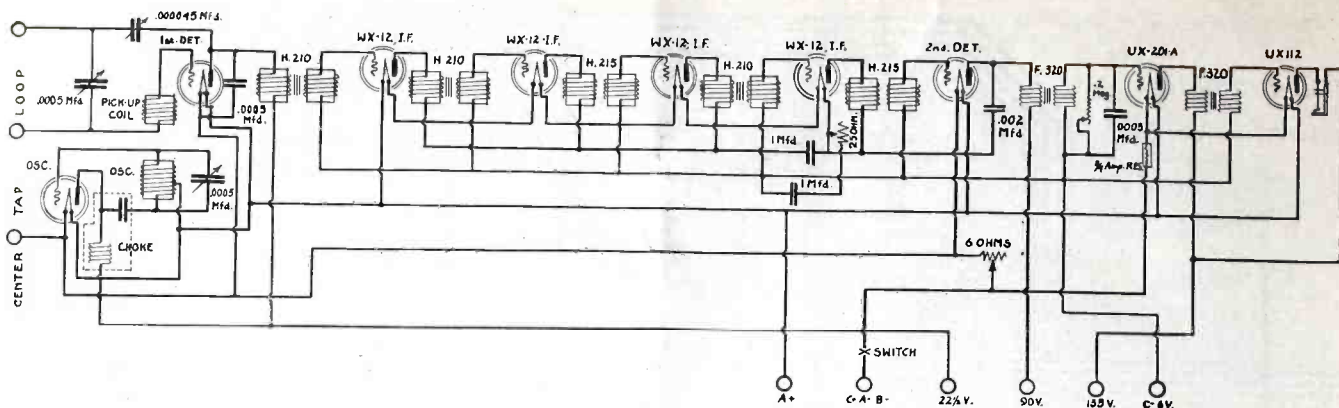

This outfit tested at Radio Hill in conjunction with a Duro loop, shows tremendous pick-up, with operating characteristics unusually satisfactory

Super Circuit Suggestions

Showing the use of H.F.L. units to give better results with less Battery Consumption

FOR the man who wants absolutely the last word in snappy appearance, simplicity of construction, and efficient performance, we have constructed, in our laboratory, a most unusual super-heterodyne, using the circuit shown in the schematic diagram. It is probably safe to say that few sets which have appeared heretofore however incorporated as many novel, desirable, and extremely important features. It eradicates, at one stroke, all the difficulties commonly encountered with the super circuit, and the criticisms which have been directed at these receivers can not be applied to this particular set.

In this receiver, every tube, with the exception of the oscillator and the first detector, operates with its grid negatively biased by a C battery Aside from the great saving in B battery current which is thereby effected, it will be interesting to note here the other advantages of this arrangement.

As is well known, most super-heterodynes of conventional design use a potentiometer to control the tendency toward oscillation which ordinarily is present in the intermediate amplifying tubes. This arrangement, in addition to being very wasteful of B batteries and a common source of frightful howls from the speaker, presents a further disadvantage which is not so commonly considered.

When the potentiometer is pushed to the negative side in order to obtain the utmost sensitivity and selectivity, the intermediate amplifying tubes are in a highly regenerative condition. As a result, the band of frequencies which is allowed to pass through the intermediate stages, is narrowed down to such a point that the higher frequencies are cut off, and the music received is entirely lacking in the harmonics and overtones that make broadcast reception enjoyable.

In this receiver, WX 12 tubes are used for the intermediate amplifiers,

and since they have much less of a tendency to oscillate than 201-A's in this part of the circuit, the receiver is very quiet and stable in operation. A further advantage of this arrangement is that the WX 12 tubes can be wired in series, which cuts down the amperage consumed from the A battery. This obviates the necessity for a high resistance to reduce the voltage of the storage battery to a value sufficiently low for the filaments of these tubes.

The remarkable sensitivity of the receiver is not obtained by the use of excessive regeneration, but by four stages of intermediate frequency amplification. Three of these stages use iron core transformers, while the fourth is an air core transformer, in addition to the air core filter coil which is customarily used in the standard super-heterodyne circuit.

Since the iron core transformers amplify a very broad band, and the air core coils are peaked within one per cent of each other, great amplification and selectivity are obtained with a complete absence of the hissing noise which is so common to some supers.

Because the circuit arrangement is somewhat different from that usually employed, a short explanation of the schematic diagram will be of interest. The pickup coil of the oscillator is in the grid lead to the first detector, as is customary. Some regeneration is used in the first detector circuit, provided by the Chelton Midget condenser, of .00045 mfd. capacity. This can be considered as a neutralizing condenser, for it will be found that one setting of this will suffice to prevent oscillation at any wave in the broadcast band. The use of this condenser, however, sharpens the tuning of the loop circuit considerably and adds to the directional properties of the loop as well as the sensitivity of the entire receiver.

In the model described, we used throughout the transformer and coils

made by the High Frequency Laboratories, and which are known as the H.F.L. Units. We used the type H 210 for the iron core intermediate stages, number H 215 for the filters, L 425 for the choke unit, L 430 for the oscillator, and the F 320 audio transformers. Using these parts, the entire set was wired with 20 feet of wire, which is less than is used in many three-tube sets.

The average length of the connections made is less than two inches, and the average length of the high potential leads is less than half an inch. Such an arrangement is conducive to efficiency, and tends to minimize stray capacities and closed loops caused by long leads.

Tuning is done with two Remler .0005 mfd. condensers. These condensers are particularly suitable for a circuit of this type, for two reasons. The stations are spread out over the full 360 degrees, and tuning is rendered less critical because more dial space is afforded a given signal. This is a decided advantage in such an extremely selective circuit.

Amsco floating tube sockets are used. In such a sensitive receiver, it is important that the microphonic noises caused by vibration of the tube elements should be eliminated, and this is best accomplished by the use of cushioned sockets.

Amperites control the filaments of the audio tubes, and Frost rheostats are used for the detectors and oscillator, and the intermediates. Battery connections are made through a Yaxley battery cable, and the loop and loud speaker tips are plugged into Yaxley jacks. Tobe 1 mfd. condensers are used across the C battery and the 90 volt section of the B battery, and Dubilier fixed condensers contribute small capacities at the desired points. Benjamin brackets support the sub panel, and a Centralab 200,000-ohm Radiohm is used across the secondary of the first audio transformer as a volume control. A Culver-Stearns filament switch completes the assembly.

A Duro loop is recommended for this set, as it has the right inductance to make the two condenser dials work together.



800 Ohms Per Volt—



Pattern No. 116
B-eliminator Voltmeter

is the internal resistance of the Jewell Pattern, No. 116 voltmeter developed for B Eliminator testing. It requires but one and one-fourth milliamperes for full deflection on the high scale. Its double range and very low current draw makes the instrument particularly valuable in adjusting the various voltage taps of B-eliminators. It will show the true voltage available, which cannot be obtained with the ordinary voltmeter.

The instrument can also be used for general laboratory test purposes where accurate voltages are required.

Send for our special Form No. 1018 which fully describes this quality instrument.

JEWELL ELECTRICAL INSTRUMENT CO.

1650 Walnut St. - - Chicago

"26 Years Making Good Instruments"

AERO COIL

SUPER-SENSITIVE INDUCTANCE UNITS

The most important factors in perfect set performance!

Aero coils are the **PERFECT** supersensitive inductance units! Due to their special patented construction, high frequency resistance is reduced to a minimum. Hence Aero Coils are capable of greater volume, and are sensitive to all the radio frequencies, thereby correcting the real cause of distortion, impossible to correct with other types of coils. But more! No dope is used. So if you are interested in better performance from any set, be sure to build with Aero Coils.

TUNED RADIO FREQUENCY KIT

The Aero Coil Tuned Radio Frequency Kit illustrated here will positively improve the performance of any receiver. Patented Aero Coil construction eliminates radio frequency losses and brings tremendous improvement to volume, tone and selectivity.



Kit consists of three matched units. The antenna coupler has variable primary. Uses .00035 condenser. 8 page color circuit, layout and instruction sheet for building the supersensitive 5 tube Aero-Dyne receiver packed with each kit. Extra copies, 75c each.
Price\$12.00

LOW WAVE TUNER KIT

Completely interchangeable. Adapted by experts and amateurs. Range 15 to 130 meters. Includes three coils and base mounting, covering U. S. bands, 20, 40 and 80 meters. You can increase the range of this short wave tuner by securing coils No. 4 and 5. Combined range of 15 to 550 meters. Both interchangeable coils fit same base supplied with short wave kit and use the same condensers. Coil No. 4 price \$4.00; Coil No. 5 price \$4.00.
Price\$12.50

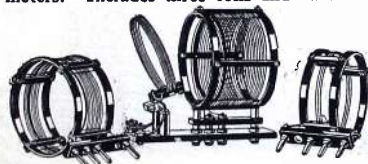

Aero Interchangeable Coils No. 4 and 5



Increase range of your short wave tuner by securing coil No. 4 and coil No. 5, combined range 125 to 550 meters. Both interchangeable coils fit the same Aero base supplied with the short wave kit, and use the same condensers.

Coil No. 4—Range 125 to 250 meters..... \$4.00
Coil No. 5—Range 235 to 550 meters..... \$4.00

Other Supersensitive AERO Inductance Coils

There is an Aero Coil for every inductance requirement. In addition to those described here we make the following coils: Aero 3 Circuit Tuner, \$6.50. Aero Radio Frequency Regenerative Kit, \$10.00. Aero Low-Loss Antenna Coupler, \$4.50. Aero Oscillator (for Superhetrodynes), \$5.50. Aero Wave Trap Unit, \$4.00.

You can get any or all of these coils from your nearest dealer. See him TODAY.

AERO PRODUCTS, Inc.

1772 Wilson Ave., Dept. 17, Chicago, Ill.

Pacific Coast Representatives
HENDER-SELTZER

1111 Wall St., Los Angeles, Calif.
377 Brannan St., San Francisco, Calif.

Short Waves and Radio Laws

*The present U. S. radio regulations and their application to short wave telephone transmitters**

THERE is a most surprising lack of familiarity, among the trade, concerning the license situation as it relates to the operation of short wave telephone and telegraph transmitters.

Some have the idea that there is an almost insurmountable barrier raised by the radio laws, while others are skeptical about being able to use transmitters at all.

This is foolish and most unfortunate, for anything that retards the development of short wave activity holds back sales, too. The situation is exactly this:

The present laws provide that transmitting apparatus is exempt from license if it is only for "transmission of radiograms exclusively between points in the same State, if the effect of such transmission does not extend beyond the State (so as to interfere with radio communication of other States), or if the effect of such transmission does not interfere with the reception of radiograms from beyond the State (so as to interfere with the interstate radio communication of that State)."

The biggest short wave business to be done is in the sale of standard ap-

paratus to be used for B battery operated short wave telephone transmitters. Such outfits, on phone, have a very limited range—10 to 20 miles—and are most unlikely to interfere with any interstate communication, particularly because of the enormous number of wave channels available in a very limited band. It can be assumed that such stations do not interfere unless, in congested areas, interference is reported. This, mind you, applies to telephone transmitters, and not to low-power telegraph stations, which reach out regularly for hundreds of miles.

If, however, a station license is required, it is a simple matter to obtain it, and the operator's license which is then necessary, as every licensed station must be operated by a licensed operator.

An operator's license is necessary before a station license can be obtained. Application should be made by letter to the District Radio Inspector. Letters should be addressed

Radio Inspector,
Customs House,
(City)

They are located in the following cities:

Boston, Mass.

New York City
Baltimore, Md.
Savannah, Ga.
New Orleans, La.
San Francisco, Cal.
Seattle, Wash.
Detroit, Mich.
Chicago, Ill.

If it is not possible for you to take an examination, the Radio Inspector may issue a second grade amateur license. The examination for first grade includes questions which will show that you are familiar with your equipment, that you understand the necessary parts of the International Convention and the U. S. communication laws, and that you can receive code signals at the rate of 10 words per minute—5 letters to a word. This is so that you can recognize distress signals, altho they will hardly be encountered at short waves.

So, if it is necessary to have station and operator's licenses—what of it. Certainly any man who has brains enough to understand radio to start off with has sufficient ability to pass an operator's exam, and any man who has the stick-to-itiveness to dope out some of the common circuits can get up to 10 words a minute with surprisingly little practice.

* For a copy of these laws and complete information about operator's and station licenses send 15c in cash or money order—not stamps—for "Radio Communication Laws of the United States" to the Government Printing Office, Washington, D. C.

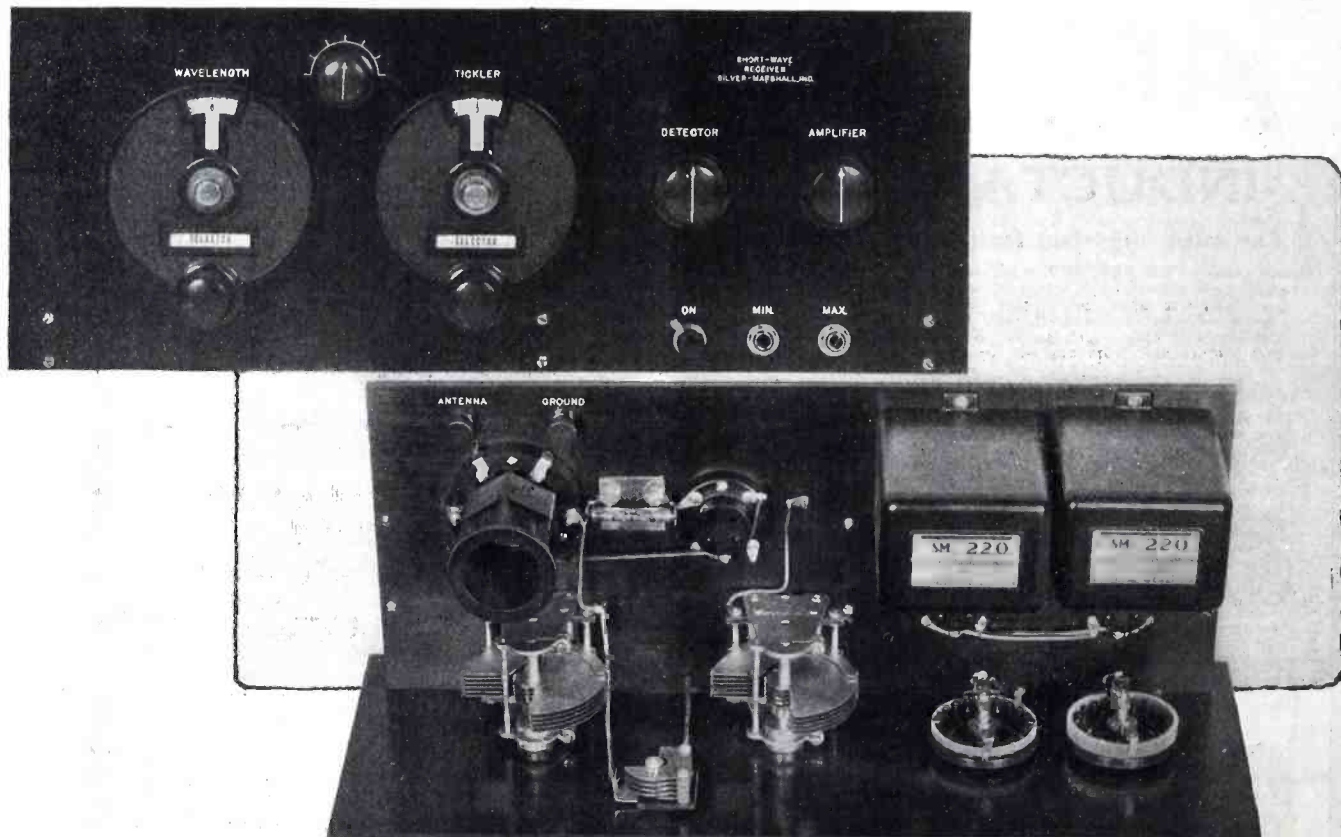

McMurdo Silver's design for a short wave receiver. The circuit is similar to that of the Hush-Hush II, shown in Radio Mechanics for October, 1926



*Bakelite Veri Chrome panel
in black and gold.*

*Ornamental window dial
of Bakelite Molded by
Brooklyn Metal Stamping
Co.*

Consider the decorative possibilities of Bakelite

Radio sets today must meet the demands of the critical eye as well as the critical ear. As a sales factor, beauty has come to be equal to performance.

The utility value of Bakelite in radio is universally recognized, but its art possibilities, which have a definite sales value, afford an opportunity for limitless development.

Pictorial decorations by talented artists may be faithfully and permanently reproduced on Bakelite panels. Every line and curve of the

most ornate design for radio parts may be duplicated in Bakelite molded.

When using Bakelite the radio manufacturer is not limited to a single color, but may select from the various shades available one that will harmonize perfectly with the style of cabinet used.

Our engineers and research laboratories welcome opportunities to cooperate with manufacturers in obtaining the maximum benefit from the use of Bakelite. Our Booklet 38 may also offer suggestions.

BAKELITE CORPORATION

247 Park Ave., New York, N.Y. Chicago office, 636 W. 22nd St.

BAKELITE CORPORATION OF CANADA, LTD., 163 Dufferin St., Toronto, Ont.

BAKELITE

REGISTERED

U. S. PAT. OFF



THE MATERIAL OF A THOUSAND USES

"The registered Trade Mark and Symbol shown above may be used only on products made from materials manufactured by Bakelite Corporation. Under the capital 'B' is the numerical sign for infinity, or unlimited quantity. It symbolizes the infinite number of present and future uses of Bakelite Corporation's products."

Reports from the R. M. A.

Indicating the effective work which the Radio Manufacturers' Association is doing

VACUUM TUBES

It is the purpose of these specifications to provide a guide relating to the accepted American practices in testing and inspecting vacuum tubes for use in radio receiving equipments.

Radio manufacturers have received numerous reports stating that their equipment is rendering very unsatisfactory service when the owner uses tubes produced by those having limited knowledge and experience in manufacturing accessories of this type.

Investigation has indicated that the merchandising units of the radio industry, in many instances, have little or no information upon which to base their views of the desirability or performance efficiency of vacuum tubes.

The Radio Manufacturers' Association appreciates the adverse reaction that is developed against every branch of the industry when a radio receiver operates at any but its maximum efficiency; that inefficient, defective, and in some instances, inoperative tubes are being marketed; and believe that a brief relating to recommended practices for vacuum tubes will unquestionably tend to curtail the continued use of tubes whose life and performance are questionable.

Also appreciating that the vacuum tube is in a state of development and that rigid specifications would tend to hamper or retard future progress in the production of a more efficient device, these specifications, prepared as a tentative guide, will receive annual revision.

NOMENCLATURE

Properties of the Filament

Filament Potential (Ef). That potential applied to the filament terminal of the vacuum tubes.

Filament Current (If). The current supplied to the filament when the normal or specified potential is applied.

This current being measured at the filament terminals leading to the (+) positive terminal of the filament or "A" battery.

Note: This connection is chosen in order to minimize the error introduced by the plate current being added to that of the filament.

Filament Electron Emission (Ip). The maximum space or plate current obtainable in a vacuum tube operated at its rated filament input with all elements except the filament connected together at the same potential.

The plate potential should be of such a magnitude that an increase will

not appreciably increase this space or plate current.

Filament Life (t). The number of continuous hours a tube will operate with normal potential supplied to its elements with a maximum change in major characteristics of X%.

TUBE CHARACTERISTICS

Major Characteristics. The major characteristics of a vacuum tube are specified as follows:

- (1) Amplification factor
- (2) Output impedance.

Amplification Factor. The ratio of the change in plate potential to the change in grid potential which produces the same effect on the space current.

Output Impedance. A value equal to the change in plate potential divided by the corresponding change in the plate current.

Grid Filament Capacity. The electrostatic capacity between the grid and filament systems of a tube.

Note: In this definition it is assumed that the filament is inactive.

Grid Plate Capacity. The electrostatic capacity between the grid and plate systems of a tube.

Note: In inter-element capacity measurements it is assumed that the value represents the total capacity as introduced between the elements and the conductors leading to the external terminals of the tube.

Power Input to Filament. The product of the normal filament current (If) and the normal filament potential (Ef).

Filament Efficiency. The current in milliamperes in the plate circuit divided by the power input to the filament.

Note: It is assumed that the tube is arranged to prevent grid current to be added to that of the plate.

Filament Saturation Current. The minimum filament current required to produce plate current saturation.

Note: Plate current saturation is defined as the point at which a further increase in filament current will not materially increase the plate current.

Properties of the Plate

Plate Potential. The potential measured between the plate and negative filament terminal of the tube.

Plate Current. The current in the plate circuit where the tube is operated at normal filament and plate potential.

Note: The potential applied to the plate to be that recommended by the manufacturer and the grid to be main-

tained at the potential of the (-) negative end of the filament.

Plate Saturation Potential. The minimum plate potential required to produce current saturation at normal filament input.

Properties of the Grid

Grid Potential. The potential as measured between the grid and the (-) negative end of the filament.

Grid Current. The current produced in the grid circuit when the tube is operated at its normal filament and plate characteristics.

Note: In accepted practice the grid current of a tube should be a minimum except when the tube is intended for use as a detector.

Discussion

It was the recommendation of the meeting that the definitions should be reviewed by a Special Committee in order that this work would not conflict with that prepared by the Standardization Committee of the Institute of Radio Engineers. It was appreciated, however, that the recommended practices of the Vacuum Tube Committee were primarily designed for us by those having limited technical training, therefore, the language throughout the report should be selected for the layman.

Recommended Tolerances

Figure of Merit Factor. While our electron tubes are operated by grid voltage, they are used as power amplifiers and should be so rated.

Rather than utilize the expression "mutual conductance" as a measure of the performance of a tube, this expression is recommended:

$$Fm = \frac{M}{R_p}$$

Where M is the voltage amplification and Rp the A. C. plate resistance when operated at normal Ep and Ef.

At the present state of the art it is the feeling of the Radio Manufacturers' Association that an absolute value of figure of merit should not be stated.

It is accepted that this factor is a direct measure of the efficiency of the tube as an amplifier, hence it should be of primary importance in the selection of tubes.

Discussion

This subject received considerable discussion wherein those in attendance believed that a single factor would represent the figure of merit of a particular type tube, one of the voltage operated type, however, this factor would impose a penalty upon a power output tube.

Therefore, it was recommended that the Special Committee attempt to formulate a figure of merit factor applicable to tubes designed for specific purposes. It was the feeling that three factors should be sufficient to care for the various types of tubes found on the market at present.

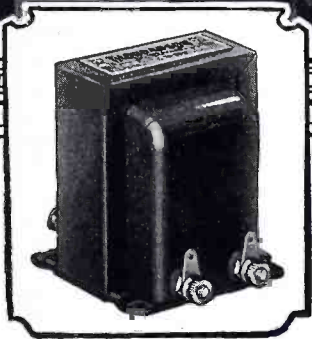

THORDARSON

R-200
AMPLIFYING TRANSFORMER

Supreme in
MUSICAL PERFORMANCE!

THE secret of good reception lies not in attempted correction of the deficiencies of poor broadcasting, but in faithfully reproducing the programs of the better stations.

Thordarson transformers employ neither a "rising" or a "falling" characteristic for corrective purposes. They are designed to give, as nearly as possible, equal attention to all notes.

The majority of leading quality receivers are equipped with Thordarson transformers—a substantial evidence of the musical supremacy of Thordarson amplification.

THORDARSON ELECTRIC MANUFACTURING CO.
Transformer Specialists Since 1895
WORLD'S OLDEST AND LARGEST EXCLUSIVE TRANSFORMER MAKERS
Huron and Kingsbury Streets — Chicago, Ill. U.S.A. 3445



Output Impedance

In the Radio industry, various types of transformers and aural devices or loud speakers are encountered, each of which may have a different value of impedance.

It is appreciated that the impedance of such devices is not an absolute value, but dependent upon frequency and as all audible frequencies are imposed, this value cannot be a constant.

When the impedance of a tube is stated, the Radio Manufacturers' Association recommended that this value be written (plus or minus) tolerance of X%.

Discussion

It was the feeling that absolute values and tolerances should be specified by the designer of radio receivers. Manufacturers can produce tubes having any particular impedance and are in a position to hold this impedance within very narrow margins.

Regret was voiced by the inability of the tube manufacturer to obtain scientific information from the receiving set producer covering their requirements for this particular characteristic.

It was recommended that this committee undertake to gather from members of the Radio Manufacturers' Association, who are radio set manufacturers, data relating to the variation in plate impedance permissible without materially reducing the performance of the device in which the tube is used.

The committee, in collecting this information, should impress the set manufacturer with the fact that extremely precise values can only be maintained at additional production expense, therefore, a survey should be made of tolerances experienced under the present methods of production, and that the manufacturer of receiving sets carefully consider existing tolerances before making a decision which would require more precise values at a probable increase in list price.

Note: The question has been raised—should this term "Output Impedance" be termed "Internal Plate Impedance"?

Amplification Factor

As the amplification factor of a tube is dependent upon the geometry, variations in this factor may be used as a direct measure of the accuracy with which the elements are manufactured and assembled. Therefore, it is recommended that the amplification factor of a tube have a tolerance of only X% from the mean value specified by the producer.

Inter-Element Capacity

The rapidly increasing rise of receivers designed to neutralize the inter-element capacity of the tube make it desirable that limits be imposed upon this capacity.

The Radio Manufacturers' Association recommends that tubes intended for use in such receivers have:

1. A definite capacity between
 - (a) Plate and grid of X mmf.
 - (b) Grid and filament of y mmf.
2. That the capacities vary less than X% from these specified values.

Tube Life

The Radio Manufacturers' Association recommends that vacuum tubes for use in radio receiving equipment have a normal life of at least 1,000 hours.

Standardization of Measurements

The Vacuum Tube Committee considered that a report covering the Radio Manufacturers' Association recommended practices would not be complete without containing a section relating to standard practices followed in determining the most important characteristics of vacuum tubes.

It was understood that The Institute of Radio Engineers had appointed a Special Committee to standardize conditions of measurements of this type, therefore, it was recommended that the Radio Manufacturers' Association Vacuum Tube Committee confer with The Institute of Radio Engineers and the officials of the Radio Laboratory of the Bureau of Standards before definite recommendations are contained in a report.

The most urgent measurements to be standardized are:

1. Filament current.
2. Filament potential.
3. Amplification constant.
4. Plate impedance.
5. Inter-element capacity.

Future Activities

A copy of this report is being addressed to the Chairman of the Technical Committee requesting that the Vacuum Tube Committee continue with its activities and that the recommendations of the open meeting at Atlantic City be referred to a Special Committee of selected members who are qualified to bring about a solution to the problems presented in this report.

CONDENSERS AND DIALS

The committee on standard dimensions for Condenser Shafts, Rheostat Shafts, bushing for Dials, Knobs for same, recommend the following:

Condenser Shafts .250 plus or minus .001.

Bushings in Dials and Knobs for above shafts .253 plus or minus .001.

Rheostat Shafts .250 plus or minus .002.

Bushings for Dials and Knobs for Rheostat Shafts, .254 plus or minus .002.

These recommendations were adopted after considerable discussion by your committee, which consists of

Messrs. Kurz, Carter, Karas, Stoekle, Alden and Parker.

There were other things discussed relative to certain dimensions but your committee was authorized only to work on standards for dimensions of the shafts and the bushings.

C. A. KURZ, *Chairman*.

SOCKETS

From ten points of Radio Socket make-up and assembly submitted and considered by the Socket Committee, three details of construction have been received with favor and are hereby submitted to the Standards Committee:

1. Socket bases shall be of hard rubber or its equivalent, of Bakelite or its equivalent when sockets are mounded.

2. Terminal markings: Terminal markings shall be permanent, distinct and in accordance with present or prevailing tube terminal arrangements, i. e., G, P, +, — or G, P, + F, — F or prevailing standard markings.

3. Opening of receptacle type sockets shall be of sufficient size to accommodate various present style tubes or future designs and sizes.

We felt we should report to you our findings as we have been able to develop them thus far but it is the opinion of your committee in view of the rapid change now taking place in socket design that the subject should be more thoroughly and conclusively covered in a later report.

C. B. HARLOW, *Chairman*.

INSTRUMENTS

Pin jacks on panels of radio sets adapted for reading filament voltage shall be of such dimensions as to take the standard telephone tip; shall be spaced 1-3/16 inch center to center on a horizontal line; shall have the right hand jack positive, looking at the panel of the set; and shall have a clear space around them 2-1/4 inches in diameter, the jacks being located on a horizontal line 3/8 inch below the center of such clear space.

The above is the apparent standard used by the Radio Corporation on Radiolas 25 and 28. Instruments have been placed on the market equipped with prods for this particular spacing and are now well distributed in the hands of dealers and jobbers.

It would seem wise to standardize on these dimensions before other manufacturers have similar ideas and put jacks on their panels with different spaces. As far as your committee can see, other dimensions will be of no advantage whatever and will only serve to increase the different kinds of meters which must be made, jobbed and stocked.

JOHN H. MILLER, *Chairman*.

Fans want them

to add the "professional touch" the note of style to home built sets!

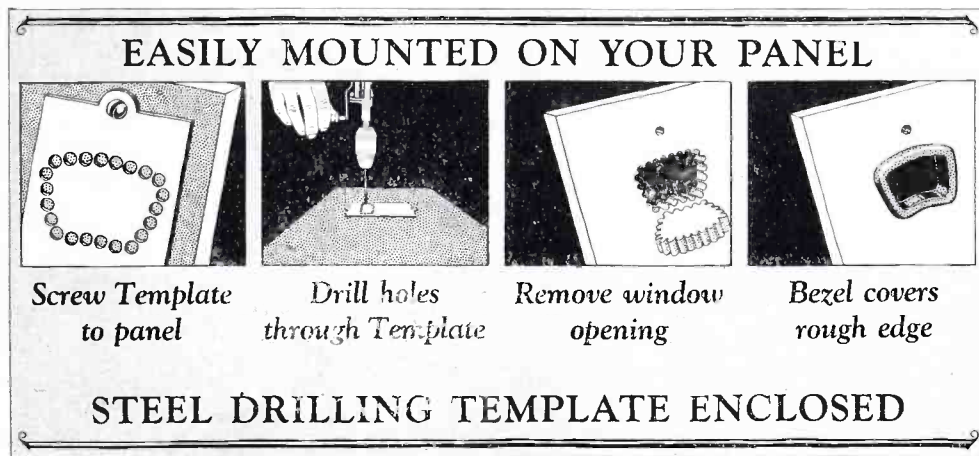

This new label—printed in striking blue and yellow—now comes pasted on every MAR-CO control carton. It pictures the 4 simple steps in panel drilling, for mounting the control. To show these pictures to a fan... is to remove his last resistance to buying the one tuning control that returns you the most profit!

Easy to install and to sell

At the New York, Boston, and Chicago radio shows—the MAR-CO control display was a big center of interest. Qualified observers reported "more interest among set-builders in the MAR-CO control than in any other instrument exhibited".

Its illuminated back-panel scale is the one thing fans everywhere want. It makes a home-built set look "professional".

But, because of this, it also looks difficult to mount—which is NOT the case. For the template supplied makes panel drilling so easy—you simply CAN'T go wrong. And in order to SHOW just how easy the mounting is—MAR-CO is now pasting the label shown above on every carton... and reproducing the pictures in color page advertisements in ten radio magazines.

Now, therefore, the wise parts dealer will

feature MAR-CO controls. They give you a bigger profit than any other tuning control. They are specified equipment in a score of this season's most important circuits. And they are continuously featured by the most powerful advertising schedule in the parts field.

The sooner you put a display of MAR-CO controls in your window... the sooner your parts profits will grow. MARTIN-COPELAND COMPANY, Providence, R. I. Branch Offices and Representatives in principal cities.

MAR-CO illuminated controls list at \$3.50, including Bezel, Template and MAZDA lamp. Replacement lamps, 20c. Scales read either 0 to 100, or 100 to 0. Lamp runs off "A" battery, draining only .1 ampere. Controls fit all standard condensers, including double and triple models.

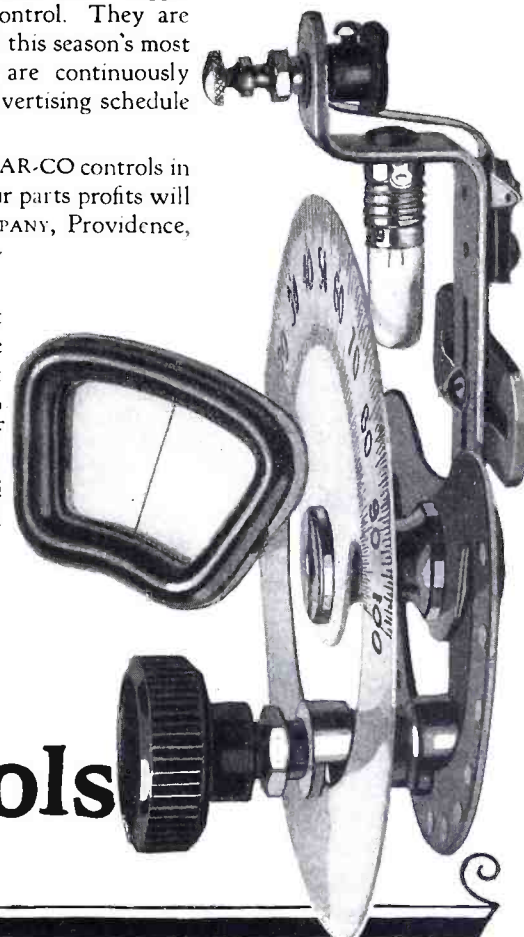

MAR-CO

Illuminated Controls

The Radio Manufacturers

Current news about the activities and plans of the radio manufacturers and concerns which make things used by the industry

Clarostat

THE American Mechanical Laboratories, Inc., 285 N. Sixth St., Brooklyn, have just released a new model of Clarostat. This unit is considerably more compact than its well known predecessor, but retains all of the desirable features that have made this device so popular.



The new Clarostat is very compact

The Clarostat is particularly well suited for output voltage control on B eliminators, but can be used in many other ways. The resistance range is practically zero to over five million ohms, and is controlled gradually. The list price is \$2.25.

Stevens

Stevens and Co., Inc., 46 E Houston St., New York City, is making a new line of cone speakers. In these models, known as the Conoidal, the shape of the cone is considerably different from that of the conventional type.

The Stevens cones are made for both wall and table mounting.



One of the new Stevens cone speaker models

Eby

The H. H. Eby Mfg. Co., 4710 Stenton Ave., Philadelphia, is packing sets of Eby binding posts in small boxes. These boxes are marked on the cover with the name of the circuit for which the binding posts are packed. Many popular circuits, such as the Hammarlund-Roberts Hi-Q, Browning-Drake, etc., are represented, and each box contains the requisite number of posts.

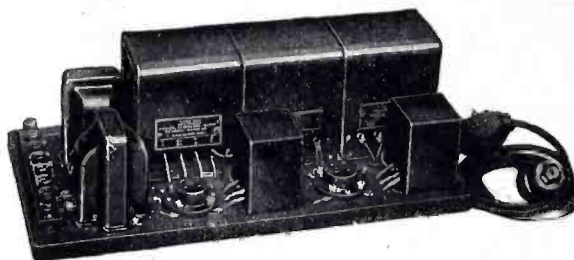

The General Radio B eliminator and power amplifier kit, completely assembled

Balkite

The Fansteel Products Co., Inc., North Chicago, Ill., has added several refinements to the Balkite charger and B Power units. The Balkite Combination comprises a charger and B eliminator in one unit. When connected to a storage battery, this unit supplies A and B power to the set and is controlled by the filament switch on the receiver.

Bruno

The Bruno Radio Corporation of New York City has released a device known as the Unitune. This is a piece of apparatus which is designed to afford one hand control of two or more tuning condensers. One model consists of two condensers, upon each of which is mounted a coil. This outfit serves as the foundation unit for the popular circuit which combines a stage of tuned radio frequency and a regenerative detector.

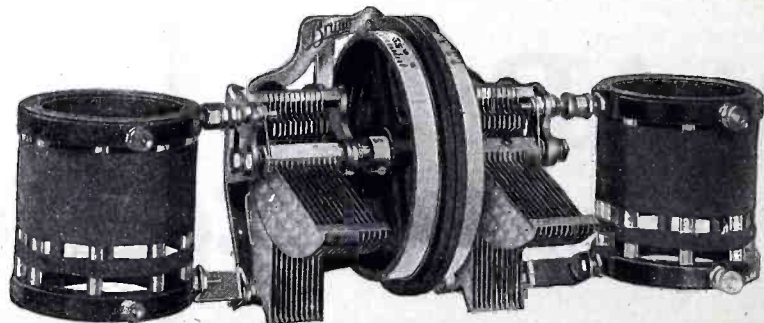

The Bruno Unitune and coils provide one hand control for a stage of tuned radio frequency and a regenerative detector

General Radio

The General Radio Company, Cambridge, Mass., has several new items. The 285-D audio amplifying transformer made by this company has a primary impedance designed to match the impedance of the special detector tubes, type UX 200-A.

General Radio is also marketing complete kits for those who desire to make their own B eliminators and power amplifiers. These kits are made in two types; one uses the Raytheon BH tube for a rectifier, and the other has a type 213 Rectron for this purpose. Both models are designed to furnish A, B and C voltage to a type 171 amplifying tube, and also supply the B voltage to the entire receiver.

You may have wondered why a Radio Set using the NATIONAL BROWNING - DRAKE TRANSFORMERS perform so exceptionally well

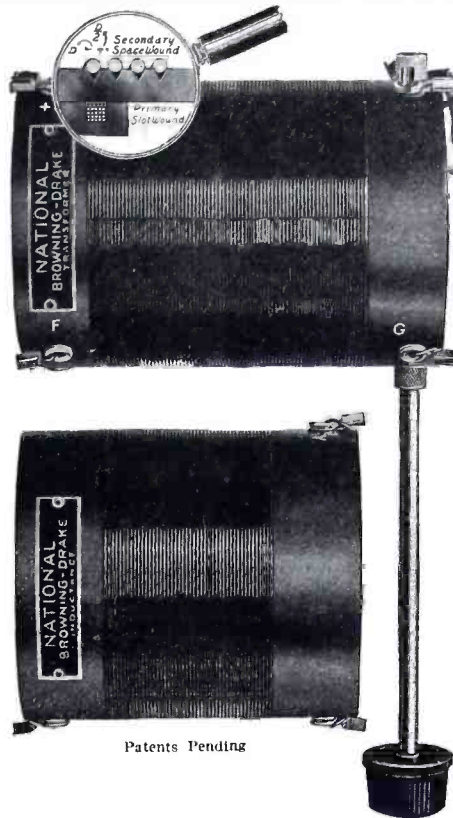

Patents Pending

There are
2
reasons
for this

1. SLOT-wound Primary
2. SPACE-wound Secondary

These are the 2 reasons why the NATIONAL BROWNING - DRAKE TRANSFORMERS are so sensitive and selective. They were developed mathematically by Glenn H. Browning and F. H. Drake after a year of research at Harvard University and are made under Glenn H. Browning's supervision.

The NATIONAL TUNING-UNITS comprise these five coils and the NATIONAL "Equicycle" condensers (plates developed by Prof. R. F. Field of Harvard University, and Carl A. Hellman of Washington, D. C.)—and the unexcelled NATIONAL VELVET VERNIER DIALS, Type A, Type B, as shown, or Type C, the ILLUMINATED DIAL.

*Price B D-1 B, \$10.25 B D-2 B, \$14.75
Inductance Coil and Transformers, separate.. \$8.50*

NATIONAL Radio set essentials may be easily assembled into a modern receiving set—sensitive, selective, easy to operate and easy to listen to. Send for Bulletin 116 P. K.

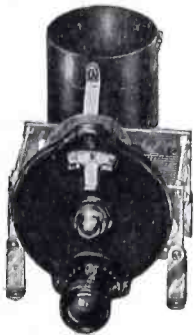

B D - 1 B

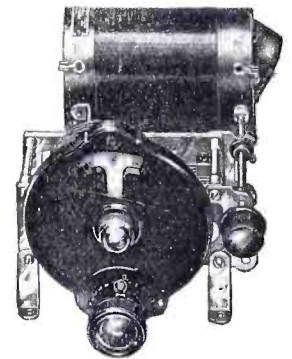

B D - 2 B

BE SURE YOU GET THE GENUINE
NATIONAL

RADIO PRODUCTS

NATIONAL CO., INC., Engineers & Manufacturers; W. A. READY, Pres., 110 Brookline St., Cambridge, Mass.
Makers of Browning-Drake Coils and Transformers, Equicycle & Equimeter Condensers, Impedafomers and other Radio Products.

English-Whitman

English-Whitman Products, Incorporated, 120 Broadway, New York City, has announced a coneless and hornless loud speaker. This speaker uses a double compound unit, and incorporates a different principle in construction and action.

The same company is the maker of



PATENT PENDING

The New English-Whitman speaker, which employs a double compound driving unit.

the Tun-A-Loop, which is of radically different construction from loops of conventional design. The inductance of this loop is adjustable to the inductance value of the coil which it replaces.



The Vesta tube is made in all standard sizes.

Vesta

The Vesta Battery Corporation, 2100 Indiana Avenue, Chicago, Illinois, is manufacturing a new trickle charger of the electrolytic type, which is designed for charging 6-volt storage batteries from 110-volt, 60-cycle A. C. This unit, as shown, measures 4¾ in. by 8½ in. The list price is \$10.00.



The Vesta trickle charger for 6-volt A batteries.

This company is also making an A Power Unit, consisting of a 25 or 50-ampere hour, 6 volt storage battery, combined with the above trickle charger. The battery and trickle charger are built into the same glass case and a hydrometer is built into the battery. The 25-ampere-hour type lists at \$25.00, and the 50-ampere-hour type lists at \$27.50.

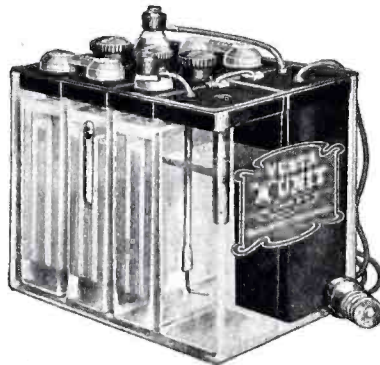

The Vesta A power unit contains a storage battery, trickle charger, and hydrometer in one glass case.

Wireless Radio Corporation

The Wireless Radio Corporation, Varick Avenue and Harrison Place, Brooklyn, New York is making a new Straight Line Separation variable condenser. This condenser is a combination of S.L.F. on the lower wave lengths, and S.L.W. on the higher ones. It is made with aluminum or brass plates in capacities of .00025, .00035, and .0005 mfd.



A new cone speaker by Utah, which weighs only 3½ lbs.

Utah

The Utah Radio Products Company, 1421 S. Michigan Avenue, Chicago, has announced a new cone speaker of the free edge type.

The model shown is 17½ in. high, and weighs only 3½ lbs. The list price is \$16.00.



(Quarter Size)

The Carter wall plate for aerial and ground installations.

Carter

The Carter Company, 300 S. Racine Avenue, Chicago, is making wall outlets which facilitate the wiring of the home for radio. The two models shown can be adapted easily to existing installations.



(Quarter Size)

The Carter wall plate which incorporates a jack for the loudspeaker and a volume control.

Mr. Radio Engineer

- To—Simplify set operation.
- To—Solve all tube control problems.
- To—Avoid the possibility of distortion in reception.
- To—Decrease servicing need.
- To—Lower production costs.

COMMUNICATE—with an organization that has specialized in filament control ever since Radio was born.

Radiall Company

50 Franklin St., New York, N. Y.

Makers of



Bradley-Amplifier

Resistance-Coupled PERFECT AUDIO AMPLIFIER

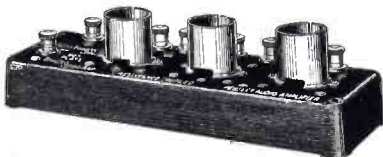

Provides audio amplification with minimum distortion. Bradleyunit molded resistors used in the Bradley - Amplifier do not vary with age and are not affected

by atmospheric conditions. Can be used to replace transformer amplifiers in standard radio sets with decided increase in tone quality.

288 Greenfield Avenue

Allen-Bradley Co.
Electric Controlling Apparatus

Milwaukee Wis.

Radio Dealers and Jobbers—

Don't miss the December issue of RADIO MECHANICS, containing the first article on building the new

—JUNIOR BROADCASTER—

There is big business in standard parts for building B battery operated radio telephone transmitters. GET YOURS.

Radio Mechanics goes on sale all over the country on the 15th of the month.

SM

630

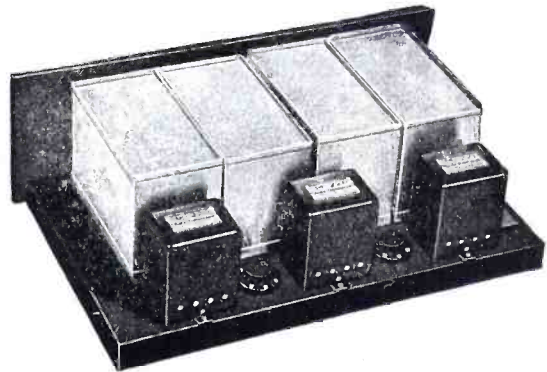

SHIELDED SIX

Endorsed and approved by Radio Broadcast, Citizen Radio Call Book and many other prominent publication and newspapers.

The Shielded Six is one of the highest types of broadcast receivers. It embodies complete shielding of all radio frequency and detector circuits. The quality of reproduction is real — true to the ear.

Behind the Shielded Six is competent engineering. It is sensitive. Day in and day out it will get distance — on the speaker. It is selective. Local stations in the most crowded areas separate completely — yet there are but two dials to tune.

These features — its all-metal chassis and panel, its ease of assembly, and many others — put it in the small class of ultra fine factory built sets, priced at several times the Six's cost.

The S-M 630 Shielded Six Kit — including all specified, matched and measured parts to build this remarkable receiver — price \$95.00.

The 633 Essential Kit — contains 4 condensers, 4 R. F. transformers, 4 coil sockets, 4 stage shields and the link motion — all laboratory matched — price \$45.00.

Clear and complete instructions, prepared by S-M engineers, go with each kit — or will be mailed separately for 50c.

220 and 221 AUDIO TRANSFORMERS



S-M 220 — the big, husky audio transformer you hear in the finest sets — the only transformer with the rising low note characteristic that means real quality — not only on paper — but when you hear it. It is a power job — yet this finest of audio amplifying devices is sold, with a guarantee for but \$6.00.

The S-M 221 is an output transformer that will bring out the low notes on your present set. It should be used between the last audio tube and the loud speaker — it eliminates strong signals without distortion, \$6.00.

All prices 10% higher west of the Rockies.

SILVER-MARSHALL, Inc.
854 W. JACKSON BLDG.
CHICAGO, U. S. A.

Duro

The Duro Metal Products Company, 2651 N. Kildare Avenue, Chicago, is the maker of the Quali-tone loop illustrated. A unique feature of this loop is the thumbscrew adjustment by which the wires can be tightened.

This company also makes complete loud speakers and phonograph units. The loud speakers are made in four models, with a list price range of from \$7.50 to \$25.00.

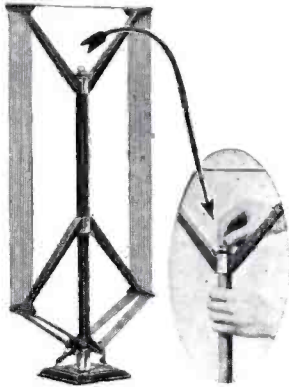

The Quali-tone loop has an adjustment to keep the wires taut.

Polymet

The Polymet Manufacturing Corporation, 599 Broadway, New York City, is making a full line of fixed, by-pass, and filter condensers, including a block of filter condensers in one case for B battery eliminator circuits.

In addition to the above, this company manufactures resistance amplifier kits, phone plugs, rheostats, resistors, and the Poly Claro Plug, which takes the place of the regular loud speaker plug and controls the volume.



The Poly Claro Plug controls volume.



The Polymet resistance coupled amplifier can be added to any set.

Amsco

Amsco Products, Inc., Broome and Lafayette Streets, New York City, has announced the Amsco Floating Socket. As illustrated, this socket consists of a floating spring arrangement, enclosed in a mottled green bakelite base. The socket is of the UX type, and the wiping contacts are of phosphor bronze. The list price is \$1.00.



The New Amsco spring mounted floating socket.

In addition to its line of Amsco Grid Gates, resistance couplers, single variable condensers, etc., this company is making ganged condensers for single control circuits. One model is shown, and many others are made in various sizes, number of gangs, and capacities.

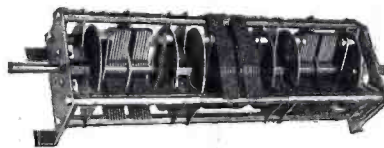

An Amsco gang condenser for tuning multi-stage radio frequency circuits with one control.

Liberty

The Liberty Transformer Company, 123 North Sangamon Street, Chicago, has just announced a new Liberty audio transformer of 2 to 1 ratio. This transformer is particularly de-



Liberty audio transformer for sub-panel mounting.

signed for the set manufacturer. The model illustrated is shown with mounting brackets adapted to facilitate sub panel mounting and wiring.

Martin-Copeland

The Martin-Copeland Company, Providence, Rhode Island, has recently marketed the new Marco Illuminated Tuning Control. This control mounts behind the panel, with the exception of the tuning knob. The figures are read through an adjustable bezel, for which a drilling template is furnished. The small bulb which furnishes the light for this control is concealed behind the panel, and an auxiliary switch is included in the assembly so that this light can be turned off separately, if desired. The list price is \$3.50.

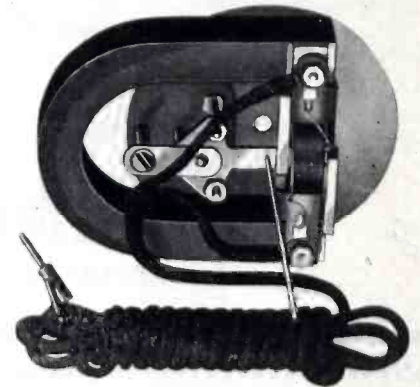

The Best actuating unit designed for cone speakers.

Best

The Best Manufacturing Company, 1200 Grove Street, Irvington, New Jersey, is making a complete line of loud speaker units, including a balanced armature unit, specially designed for cone speakers. This company makes special designs to specification.

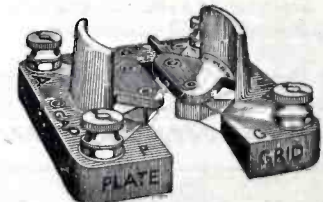

The Airgap socket has no insulating material between the grid and plate binding post.

Airgap

The Airgap Products Company, 9 Campbell Street, Newark, N. J., is the manufacturer of the Airgap Socket. This socket is designed to reduce the dielectric loss between grid and plate by means of an air space at this point instead of the conventional insulation. The list price of this socket is \$.75.

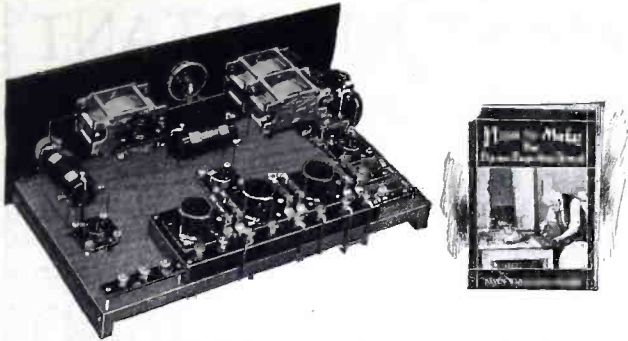

"Birds-eye" view of the new two-dial hook-up of the Daven Bass Note Circuit. Easy to assemble. The last word in tone quality. Book of clear instructions for building this set 25c at dealers, 30c by mail.

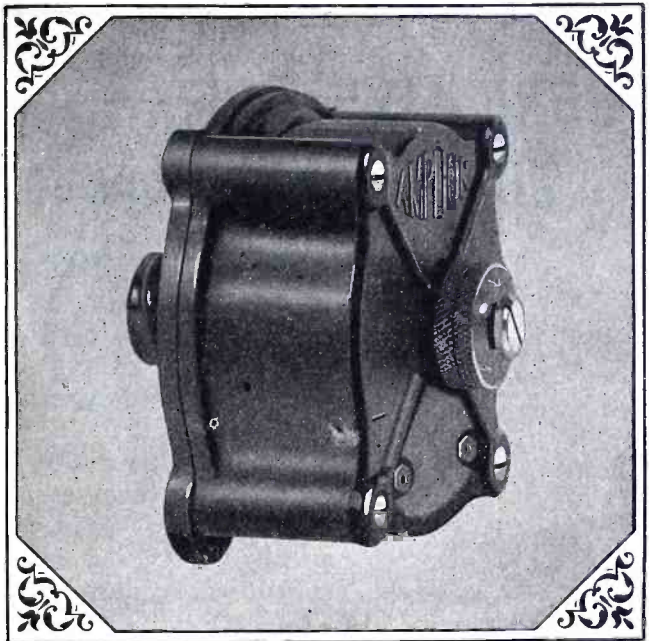

Amplion quality a strong trade asset!

EVERY Amplion unit represents a genuine and exceptional "Value for Money" proposition.

"The House of Graham" has a 40 years' reputation for high-grade products sold at fair prices. Every Amplion unit justifies and maintains this reputation.

Amplion is unreservedly guaranteed. It is nationally advertised. It is well known by consumers and throughout the Trade as a quality product.

Put the pedigreed Amplion units in your Radio Sets. They will help you sell more sets—they insure constant consumer satisfaction.

A letter indicating your interest will secure immediate co-operation from Amplion engineers.

THE AMPLION CORPORATION OF AMERICA
Suite W, 280 Madison Avenue, New York City
THE AMPLION CORPORATION OF CANADA Ltd., Toronto, Ontario



And Now—
the BASS NOTE CIRCUIT
in a
2-Dial Hook-up

CLEARER than ever—even more selective—and always that crystal purity of tone—from highest soprano down to deepest, richest bass. The same astonishing Daven Bass-Note Circuit—with new refinements.

For instance, two tuning dials only—instead of the usually accepted three. An R. F. choke coil that prevents the radio waves from entering the audio amplifier. A special compensating condenser that increases selectivity, especially in long-distance tuning. And a brand new layout, requiring less base space and a smaller, neater panel.

Read "How to Build the Bass Note Circuit"

A brand new booklet that tells in simple, clear way how to assemble a Daven Bass Note Receiver. A wiring diagram of an altogether new type shows quickly how to put the parts together. 25c at any Daven Dealer's—30c by mail.

DAVEN
BASS NOTE CIRCUIT



**New 8th Edition
Daven Manual**

explains Daven Amplification in full detail, and shows how to apply it to any type of set. 25c at dealers, 30c by mail.

"The Sine of Merit"
DAVEN RADIO CORPORATION
TRADE MARK *"Resistor Specialists"* REGISTERED
202 SUMMIT STREET, NEWARK, N. J.
Daven Catalog Free on Request

SURE—Polymet is THE Condenser House!

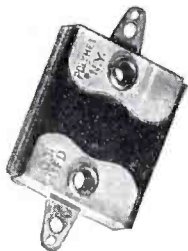

Poly Fixed Mica
Condenser



By-Pass Type

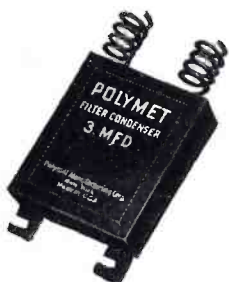

Filter Type

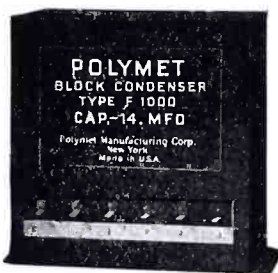

Raytheon Circuit Condensers

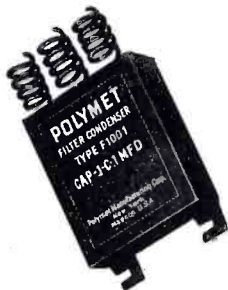

On the impersonal, brass-tacks basis of comparative performance rating, Polymet Condensers rank FIRST! 125 manufacturers of high quality receivers and power units specify Polymet as standard equipment—an overwhelming, unprecedented endorsement of the quality ideals that are built into each Polymet Product.

We will be delighted to send you complete details regarding the various types and capacities of Polymet Condensers; prices, discounts and all other information. Why not write today?

Polymet Manufacturing Corporation
599—Broadway,
New York City

*"World's Largest Manufacturers
of Radio Essentials"*

POLYMET PRODUCTS

MOST IMPORTANT
ISSUE OF THE
YEAR—DECEMBER
RADIO ENGINEER-
ING. ——— BRAND
NEW DATA ON
A AND B ELIM-
INATORS ———
NEVER SHOWN
BEFORE ———
DON'T LET YOUR-
SELF MISS IT.



59*

\$2.25

B eliminator manufacturers
use or recommend

CLAROSTAT

**And the roll is growing*

CLAROSTAT covers every resistor need. It is designed for the precision control of modulation, regeneration, oscillation, grid action, plate voltage and general laboratory practice.

"The Gateway to Better Radio"

Is a 32-page Radio Manual that no radio fan should be without. It covers every phase of radio and all the latest developments. It tells you how to eliminate distortion, how to improve your volume and tone; how to build the latest popular receivers and all types of battery eliminators. Extremely well written and profusely illustrated, it is worth many times its price (25c) to you. May we send you a copy?

American Mechanical Labs., Inc., Dept.
R.E., 285 No. 6th Street, Brooklyn, N.Y.

The Type 405 GENERAL RADIO—RAYTHEON PLATE SUPPLY

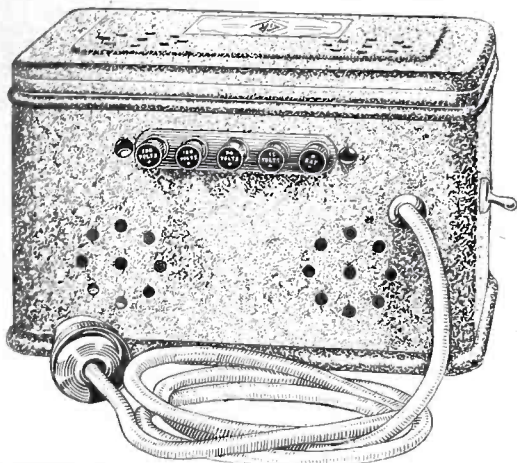

Price \$46 Complete with Raytheon Tube

Improved quality of reception, free from anxiety caused by steadily deteriorating "B" batteries, is now possible through the use of a General Radio—Raytheon Plate supply.

This unit operates on 110 volt (60 cycle) A. C. and provides voltages of 45, 90, 130 and 200.

Voltages are readily adaptable to all popular makes and circuits of radio receivers by means of fixed resistances which are tightly sealed from dust and moisture, thus eliminating bothersome and noisy tendencies of variable resistance voltage controls.

The voltage drops at the various taps per milliamper load as follows:

Tap	Open Circuit	Rate of Drop per Milliampere
45	55	2.35 volts
90	132	3.50 "
130	205	3.00 "
200	260	1.80 "

The unit is contained in a metal case with attractive black crystalline finish, and has a conveniently located A. C. switch.

Type 405 Plate Supply, with BH Raytheon Tube. . . \$46.00

Ask your dealer to show and demonstrate this unit to you or write for our booklet containing complete information.

GENERAL RADIO CO., Cambridge, Mass.

GENERAL RADIO PARTS AND ACCESSORIES

WATCH
THE JANUARY
ISSUE
FOR
M. B. SLEEPER'S
NEW
SYSTEM
OF
SHIELDING
APPLICABLE
TO ALL
RADIO SETS

ANOTHER NEW CARTER

PRODUCT

"MIDGET"
Rheostat
with
Filament
Switch

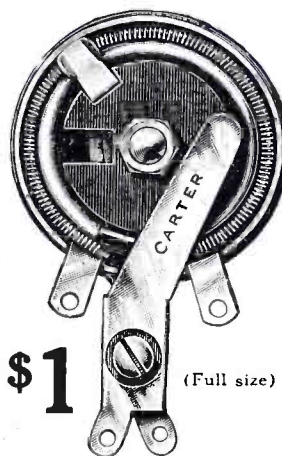

\$1 (Full size)

First and ONLY self-cooling all-metal frame rheostat with filament switch.

Springs are actuated by a cam which closes filament circuit as soon as knob is turned from "Off" position. Separate filament switch eliminated. Operation simplified. Space conserved.

2; 3; 6; 10; 15; 20; 25; 30; 40; 50; 75 Ohms.

In Canada: Carter Radio Co., Limited, Toronto

At
Your
Dealers



R.M.A.

How Good is Insulation?

INSULATION is a relative term descriptive of a dielectric designed to prevent loss of current by leakage. All so-called molded insulations look more-or-less alike. But their dielectric characteristics vary widely. RADION stands supreme in its field. All electrical tests empha-

size that fact. Whatever insulating parts you employ in the circuit which may be made by moulding, stamping or machining can probably be made better out of RADION. We welcome investigations and comparisons and are glad to submit samples and prices.

New Crackle Surface Finish now available on ACE QUALITY HARD RUBBER PANELS

You will be interested in the new Crackle Surface—a decided departure in Ace Quality Hard Rubber Panels. It closely resembles high grade leather and



will distinctly dress up the set. Now ready in stock panel sizes or cut-to-order in quantity.

Jobbers and Dealers
write for
Samples and Prices

AMERICAN HARD RUBBER COMPANY
11 Mercer Street New York, N. Y.

When you think
of perfect electrical contact
—as being permanent—
think of the

Lastite

it locks!



The Standard, tubular Soldering Terminal
for making radio circuits mechanically strong

A refinement that saves time and material

Manufactured by

William Stevens Co.

27 Hammatt Road, Roslindale Mass.

VOLTRON

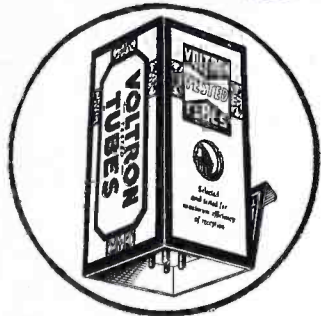
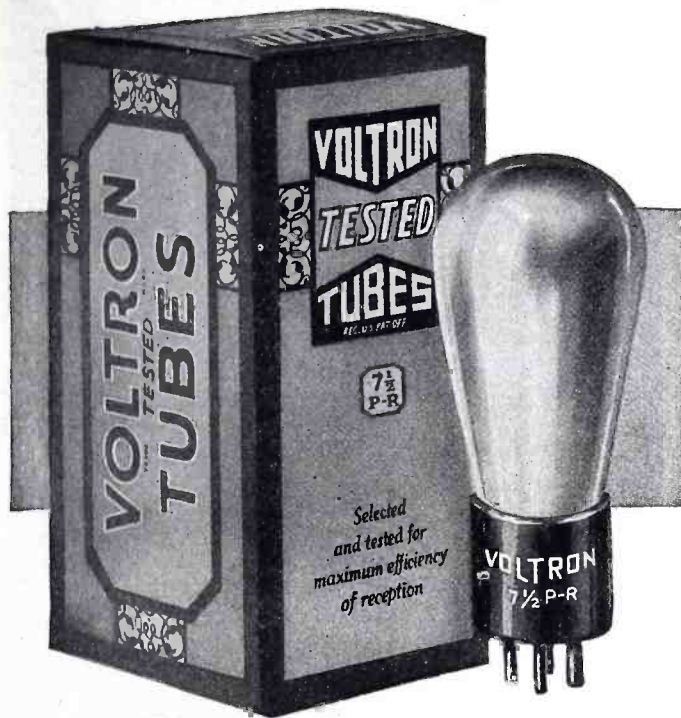

7 1/2 P-R

For the last Audio Frequency Stage

Filament Voltage 7.5
 Filament Current 1.25
 Plate Voltage 425.

This tube will increase your volume 100% without sacrificing quality.

MAC LAREN
MANUFACTURING Co. INC.
 26 Park Place
 NEW YORK CITY

SANGAMO

Mica Condensers in intermediate sizes



IMPROVE
 TONE
 RANGE
 AND
 VOLUME

IT is accuracy, not luck, that makes one receiver sweeter and more powerful than another that is almost its twin. Especially condenser accuracy, for the closer you come to absolute accuracy at these critical parts, the more wonderful your receiver will be. The cost of accurate condensers is small—the effect is immense.

Now you can get Sangamo Mica Condensers in capacities in between the usual stock sizes, so you can build with greater accuracy than ever before. They are guaranteed to be accurate, and they always stay accurate, being solidly molded in bakelite. Neither heat, cold, moisture, pressure nor acid fumes will affect their capacity, because bakelite seals the delicate parts against all outside influences.

Capacities in microfarads and prices

0.00004	0.001	} 50c.
0.00005	0.0012	
0.00006	0.0015	
0.00007	0.00175	
0.00008	0.002	
0.0001	0.0025	} 60c.
0.00012	0.003	
0.00015		
0.000175	0.0035	
0.0002	0.004	
0.00025	0.005	} 70c.
0.0003		
0.00035	0.006	85c.
0.0004	0.007	90c.
0.0005	0.0075	95c.
0.0006	0.008	\$1.00
0.0007	0.01	1.15
0.0008	0.015	1.25

With Resistor clips, 10c extra

Also Sangamo By-Pass Condensers

1/10 mfd. 80c. 1/2 mfd. 90c.
 1/4 mfd. 80c. 1 mfd. \$1.25

Sangamo Electric Company

6332-1

Springfield, Illinois

RADIO DIVISION, 50 Church Street, New York

SALES OFFICES—PRINCIPAL CITIES

For Canada—Sangamo Electric Co. of Canada, Ltd., Toronto.
 For Europe—British Sangamo Co., Ponders End, Middlesex, Eng.
 For Far East—Ashida Engineering Co., Osaka, Japan



"
They add
to Radios
Charm"

Your
tuning skill
is utilized 100% by
Samson Vernier Dials

When tuning with Samson Vernier Dials your hand moves in the **same** direction as the condenser and dial so if you have gained tuning skill with ordinary dials there is nothing to unlearn.

And this skill is **increased** by Samson Vernier Dials delightful smoothness of action which is independent of condenser wear; by their vernier action which eliminates nervous tension; and by their split degree scale next to a hairline for accurate reading.

The remarkable durability of these dials is due to a sturdy accurate construction which practically does away with the need for wear adjustment that is provided.

Each dial is suitable for either clockwise or counter clockwise instruments.

Samson Vernier Dials are not a new experiment. Their principle of construction has been proved in use and they are fully protected by patents.

Our book "Audio Amplification"—already accepted as a manual of audio design by many radio engineers—contains much original information of greatest practical value to those interested in bettering the quality of their reproduction. Sent upon receipt of 25c.

Samson Electric Company

Manufacturers Since 1882

Main Office:
Canton, Mass.



Sales Offices in
Thirty Cities



AEROVOX

"Built Better"

**FIXED
CONDENSERS**
are Specified in

LC - 27

Diamond of the Air
To be announced soon(?)
Raytheon "B" Eliminator
Ultradync
To be announced soon(?)

by L. M. Cockaday

" Herman Bernard
" John Rider
" Raytheon Mfg. Co.
" R. E. Lacault
" R. E. Lacault

AEROVOX fixed condensers have been approved
by M. I. T. and Yale Universities.

AEROVOX WIRELESS CORP.
489-491-493 Broome Street
New York

A BATTERY ELIMI-
NATOR ALL STAN-
DARD PARTS —
DOES NOT USE
TUNGAR TUBE OR
TRICKLE CHARGER
—ADVANCE DATA
DECEMBER RADIO
ENGINEERING —
CONSTRUCTION
ARTICLE, JANUARY
RADIO MECHANICS

new



Heavy-Duty RADIOHM

Radio engineers are enthusiastic about this new Centralab Heavy-duty Radiohm. No wonder! It won't heat up excessively with load of three watts—stands up permanently under that load. Withstands a ground test of 1500 volts without breaking down. Has same mechanical features as Centralab Standard Radiohms, thus insuring *permanence of resistance; smooth, noiseless adjustment; unusually long life.* PLUS these advantages:

- 1—Full resistance variation with a single turn of the knob.
- 2—Resistance value remains permanent as adjusted. (No carbon particles or discs.)
- 3—Resistance value remains same for any knob setting, regardless of how many times the knob may be adjusted.
- 4—Furnished in resistances of 600, 2,000, 10,000 and 50,000 ohms.
- 5—Also finished in three terminal potentiometer type for "C" bias control in eliminator circuits. Write for full information, prices and discounts.

CENTRAL RADIO LABORATORIES,
25 Keefe Ave. Milwaukee, Wis.

Centralab

Centralab variable resistances are standard equipment on 69 makes of radio sets.

Announcing

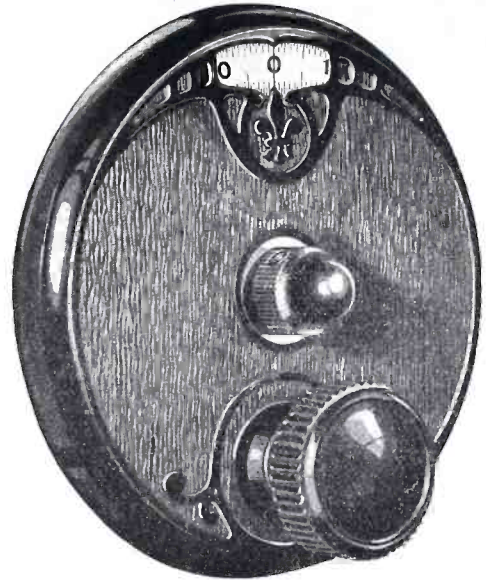

The EBY SHIELDED DIAL

A complete metallic shield forms the back of the new Eby Dial and reduces body capacity. When you take your hand off this dial your set **stays** tuned to the station you had when your hand was on it.

Its hairline accuracy is secured by an anti-backlash friction drive and non-microphonic construction, assuring smooth, silent, sensitive performance.

Operates any Type Condenser Clockwise and Counterclockwise Action

The Eby Shielded Dial operates any type of condenser on the market today whether it turns clockwise or counterclockwise. One additional hole is all that is necessary for mounting.

The dial housing is black Bakelite with a black oxidized metal adjusting screw. It adds to the appearance and performance of any set. Price \$2.50.

Manufactured under patent of Nov. 17, 1925 by

THE H. H. EBY MFG. CO.

4710 Stenton Ave., Phila., Pa.

Makers of Eby Binding Posts and Sockets



H.F.L. Transformers

The Highest Standard of Radio

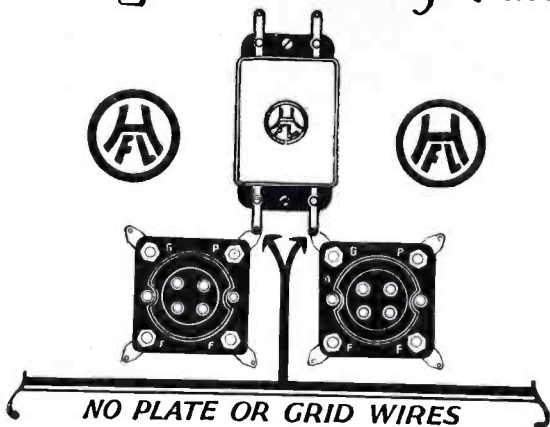

For Perfect Reception

H. F. L. Transformers have been endorsed and approved by the leading radio authorities as the finest instruments obtainable. Regardless of broadcast conditions these improved transformers guarantee selection of radio programs at choice. They combine tremendous power with an unexcelled purity of tone and amplify the weakest signals to full loud speaker volume. H. F. L. Transformers operate with all types of standard tubes. They are unsurpassed for quality, clarity and volume—affording well-nigh perfect reception.

H. 210 Iron core transformer Price \$8.00
 F. 320 Audio frequency transformer with an exceptionally high amplification factor. Each unit carries laboratory calibration, incomparable faithfulness of Range 32,000 to 42,000 cycles, tone. These units are the result of an entirely new principle in transformer construction. Price \$8.00
 H. 215 Air core transformer Price \$8.00
 L. 425 Radio Frequency Choke tuned stage, designed to amplify signals at a maximum efficiency Unit. Price \$5.50
 L. 430 Low Loss Radio Frequency Transformer. Price \$5.50

Get H. F. L. Units at any reliable wholesaler

High Frequency Laboratories

131-B N. WELLS ST., CHICAGO

Sheet Copper for Shielding

Shielding

Prevents aerial radiation and feedback.

Insulates against interference from adjoining circuits.

Improves efficiency, selectivity and tone quality.

USE SHEET COPPER because it combines low resistance with easy working qualities.

COPPER & BRASS
 RESEARCH ASSOCIATION
 25 Broadway — New York



Accurate Primary Coupling at Every Condenser Setting with the

New Hammarlund "AUTO-COUPLE"

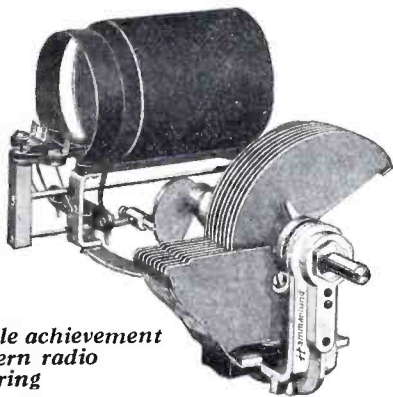

A notable achievement in modern radio engineering

THE "Auto-Couple"—Hammarlund's latest contribution to radio—has been specified by the designer-engineers for the new Hammarlund-Roberts "Hi-Q" Receiver. It may be used also with equal efficiency in other tuned radio frequency circuits.

It is a scientifically correct arrangement of Space-Wound Coil, "Midline" Condenser and Aluminum Shield which encloses the complete assembly including a tube and its socket. It gives automatic, graduated primary coupling at every broadcast wave-length, assuring maximum transfer of energy and minimizing unwelcome oscillations on the shorter waves.

The "Auto-Couple" assembly is accurately and strongly built and rigorously tested. For the convenience of set-builders coils, condensers and shields are also sold separately. Condensers which may be used with the "Auto-Couple" are the Hammarlund "Midline" or "S-F-L" .00035 (17 plate) or any other make of condenser having a back extension shaft.

Hammarlund Space-Wound Coils may be had for use in neutrodyne and other tuned radio frequency circuits—also for any regenerative circuit requiring a tickler feed-back. Their superiority is universally recognized by leading engineers and advanced amateurs.

Most good radio stores sell Hammarlund Precision Products—if yours doesn't, write us direct. Descriptive folder on request.

HAMMARLUND MANUFACTURING CO.
424-438 West 33d Street, New York

For Better Radio
Hammarlund
PRECISION
PRODUCTS



Bradleyohm-E

PERFECT VARIABLE RESISTOR

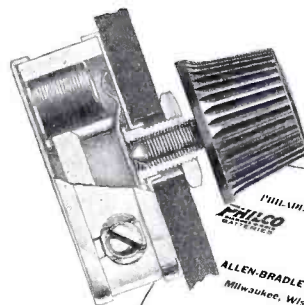

Endorsed by
PHILCO

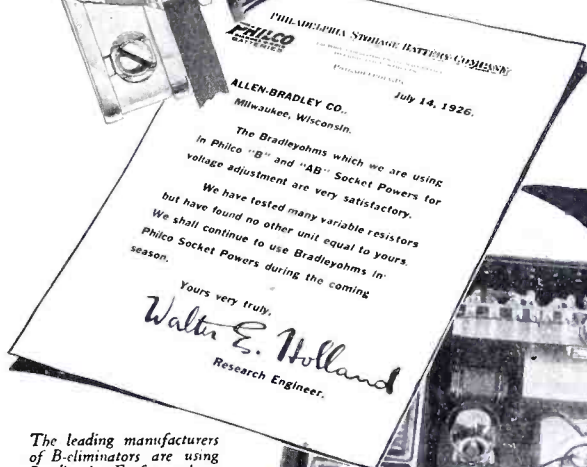

The leading manufacturers of B-eliminators are using Bradleyohm-E for voltage control. The number of Bradleyohms in each B-eliminator varies from one to three depending upon the type of eliminator. In all cases, the Bradleyohm-E is the choice of the experienced radio engineer.

EVER since radio broadcasting began, Allen-Bradley Radio Devices have met the demand for silent, stepless current control. Today, Bradleyohm-E, perfect variable resistor, is not only adopted as standard equipment by manufacturers of B-eliminators, but is recommended almost universally by radio engineers and



For a fixed resistance unit, Bradleyohm-A offers unusual advantages. It is a solid, molded resistor with silver-plated terminal caps that can be soldered without injuring the resistor. Since the Bradleyohm-A contains no glass in its construction and does not depend upon hermetic sealing for accuracy, it is unaffected by temperature, moisture or age.



Bradleyohm-E
PERFECT VARIABLE RESISTOR

Bradleyohm-E and Bradleyohm-A can be obtained from your radio dealer in several ratings. Insist on Allen-Bradley Radio Devices for lasting satisfaction.

ALLEN-BRADLEY CO.

MILWAUKEE



288 Greenfield Avenue

WISCONSIN

PIERCE

AIRO

Complete Assembly for a SIX TUBE RESISTANCE-COUPLED SINGLE DIAL RECEIVER

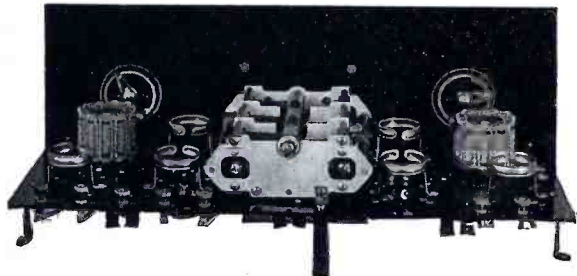

Front and Interior Panel View

Scientifically Perfected and Built

Install the Pierce-Airo Complete Assembly in your own models and save time and expense of manufacturing. It is a mechanically and electrically perfect product. Pierce-Airo fits all standard cabinets and consoles now on the market. It meets the season's demand for simplicity of operation and pure tone by scientifically combining single dial control and resistance-coupled amplification. No live dealer can afford to overlook this unusual opportunity to sell Pierce-Airo Complete Assembly. Let us quote on your requirements TO-DAY.

Pierce-Airo Complete Assembly with a 7 x 18 Processed Bakelite Panel, Ready for Wiring . . .

\$42.50

Write TO-DAY for Proposition

UNITED SCIENTIFIC LABORATORIES, Inc.
82 Fourth Avenue, New York City

Branch Offices

Boston
Chicago
St. Louis



Branch Offices

Minneapolis
San Francisco
Los Angeles

TEE DEE RECHARGEABLE "B" BATTERIES ALKALINE

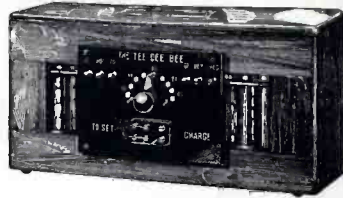

The TEE DEE "B" battery provides a permanent, dependable and foolproof source of plate current for any set. Gives greater satisfaction with much lower initial and maintenance costs than most B Eliminators. Stays sold resulting in satisfied customers and a larger net profits to the dealer.

List Prices—90 Volt, \$20; 135 Volt, \$30
90 volt as shown and 135 volt with special models for charging on 32 volt systems.

Incased in a beautiful cabinet with polished, hard rubber panel and nicked switches. This battery is a thoroughly high grade job throughout and must be seen and used to be fully appreciated.

Mr. Dealer: For bigger profits during the coming season, get our proposition at once and push this battery in your city.

Price either type 60c



UV Type



UX Universal Type

Super Sockets

MANUFACTURERS! SET BUILDERS! You will find SUPER-SOCKETS ideal for that new set. They provide positive one piece contacts from wiring to tubes and are specially adapted for concealed wiring beneath a sub panel, imparting a neat appearance to your set, and cutting assembly costs. Special models for manufacturers at attractive prices. MANUFACTURERS! JOBBERS! DEALERS! Write for discounts.

Radio Electric Co.

Makers of UNITROLA

West Winfield, N. Y.

—For POWER SUPPLY!

MANUFACTURERS AND JOBBERS

who want complete eliminators made up under their own name—who need special eliminator parts made to specification

Communicate, now, with

SHORE ELECTRIC CO.

64 University Place

New York City

See That Screw

A screw-driver adjusts an X-L in crowded places



X-L VARIO DENSER

RESULTS in easier tuning more distance, volume and clarity—greater stability. Indorsed by leading authorities. Model "N" slight turn obtains correct tube oscillation on all tuned radio frequency circuits. Neutrodyne, Roberts two tube, Browning-Drake, McMurdo Silver's Knockout, etc., capacity range 1.8 to 20 micro-microfarads. Price \$1.00
Model "G" with grid clips obtains the proper grid capacity on Cockaday circuits, filter and intermediate frequency tuning in heterodyne and positive grid bias in all sets. Capacity range Model G-1 .00002 to .0001 M F D. Model G-5 .0001 to .0005 M F D. Model G-10 .0003 to .001 M F D. Details on request. Price \$1.50
X-L Push Post. Push it down with your thumb, insert wire, remove pressure and wire is firmly held. Releases instantly. Price 15c.
Seven Push Post Panel permanently marked in white on black insulating panel. In box including soldering lugs, raising bushings and screws for mounting, etc. Price \$1.50



X-L RADIO LABORATORIES 2423 Lincoln Ave., CHICAGO, ILL.

They Buy by the Name

When the Product is Well
Named and Well Known

ALL BENJAMIN RADIO PRODUCTS ARE
OF THE SAME HIGH STANDARD AS THE
FAR-FAMED CLE-RA-TONE SOCKETS

EVERYDAY consistent good performance in radio operation is backing up the widespread national advertising of Benjamin Radio Products. Thus by increasing thousands of set users and builders the name and fame of these radio products are being spread.

Cle-Ra-Tone Spring-Supported, Shock-Absorbing Sockets



Stop Tube Noises—Anti-Microphonic. The Greatest aid to non-noisy operation. One-piece suspension spring and contact member. Positive tube to terminal connection.

Improved Tuned Radio Frequency Transformers



Better in all important features and characteristics. Space wound. Basket weave. Cylindrical. Highest practical air dielectric. Gives wonderful sharpness in tuning, better volume and purer tone.

2 1/4-in. Diameter Transformer Compact. Especially desirable for crowded assembly. Eliminates interfering "pickup."

3-in. Diameter Transformer Capacity coupling reduced to lowest degree. For use with .00035 Mfd. Condensers.

Straight Line Frequency Condensers



No crowding of stations. The broadcast range is spread evenly over the dial. Stations come in without interference, and tuning is much easier. Adjustable turning tension. Finished in dull silver. Made in three sizes:

.00025 Mfd. .00035 Mfd. .0005 Mfd.

"Lekeless" Transformers



Uniform high inductance, low distributed capacity and low resistance. The external field is so slight that it permits placing coils close together without appreciable interaction.

Brackets



An aid to simplification in set construction. Supports sub-panel, with room underneath for accessories and wiring. Plain and adjustable.

Battery Switch



Quick, positive, clean-cut make and break. When it's "in" it's "off," eliminating danger of wasteful use of battery.

Rewards for Radio Reasoners

Awards for novel and original hook-ups, modifications of existing circuits; trade-names; slogans.

Write our nearest office for full details

Benjamin Electric Mfg. Co.

New York 120-128 S. Sangamon St. San Francisco
247 W. 17th St. Chicago 448 Bryant Street
Manufactured in Canada by the Benjamin Electric Mfg. Co.
of Canada, Ltd., Toronto, Ontario

Radio Time is Here!



Don't Wait!

Put up your Beldenamel Aerial —this week!



DO you know that a clean, bright aerial wire gets louder volume and longer distance than a corroded, soot-covered aerial? The corroded, tarnished surface of a bare copper aerial wire interferes very seriously with the flow of radio frequency currents from the antenna to the set. That is why the shiny, smooth wires of a Beldenamel Aerial are protected with baked enamel.

If you install a Beldenamel Aerial, now, you will be through with aerial troubles for years to come. Smoke, fumes, and weather cannot affect the Beldenamel coating on a Beldenamel Aerial. That is why so many old, bare copper aeriels are being replaced with Beldenamel Aeriels.

Ask your nearest dealer to show you a Beldenamel Aerial. It is sold in a distinctive striped black-and-orange carton that protects you against substitutes.

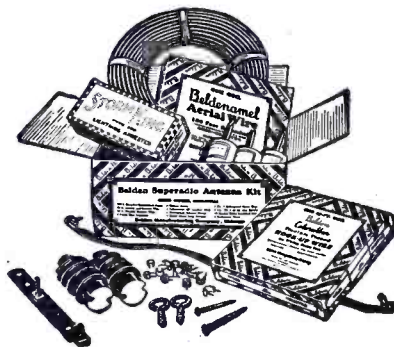

The Belden Superadio Antenna Kit contains a Beldenamel Aerial and quality parts to build an aerial and ground of lasting efficiency.

BELDEN MANUFACTURING COMPANY
2302-A South Western Avenue Chicago, Illinois

AMSCO

FOR EXCELLENCE

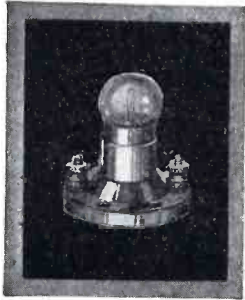

FILATROL

The AMSCO Filatrol is an automatic filament control that *really* takes the place of manually adjusted rheostats in the average circuit. Its unique design, a departure from conventional form, gives unfailing efficiency, and unmatched compactness. Guaranteed.

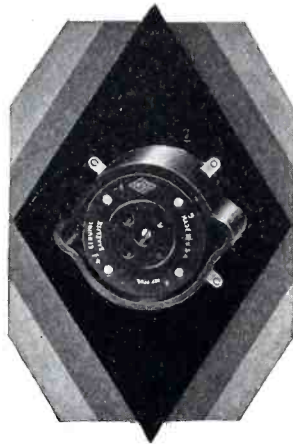

FLOATING SOCKET

Rugged and substantial, this socket is extraordinarily tiny—and "it floats!" All types of tubes fit with the click that accompanies positive wipe contact. The tubes almost literally float on air, practically isolated from the base or panel. Microphonic noises, mechanical feed back and audio vibration are effectively eliminated. An imperative choice for the sensitive set—or the set with built-in loud speaker. It's guaranteed.

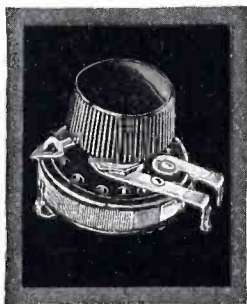

TOM THUMB RHEOSTAT

A true midget for saving space front and back of the panel. Needless bulk is eliminated by AMSCO design. Air cooled construction—Bakelite base and knob with indicator arrow. Sold under the usual AMSCO guarantee.



AMSCO PRODUCTS, Inc.
Broome & Lafayette Sts., N. Y. C.

Makers of Allocating Condensers,
Metaloid Grid Gates and Resistors
and other Engineered Radio Parts.



When you see

TOBE

Trade-Mark

on your condensers, B Blocks, resistors or vacuum grid-leaks, you see a guarantee of quality and worth.

Tobe Deutschmann Co.

Engineers and Manufacturers of Technical Apparatus
CAMBRIDGE, MASS.

WIRE

STRAND—Antennae (plain or enameled)—Double Galvanized.

WIRE—Antennae (plain or enameled) Connecting and Ground (Rubber) covered, braided or plain.

BUS BAR—Litzendraht-Loop.

MAGNET (Cotton or Silk).

John A. Roebling Son's Co.

Trenton, N. J.

D. K. BULLENS CO.

Stock Magnets for Loud Speakers

Permanent Magnets to Blue Print

Pottstown, Pennsylvania

Bradleyometer

THE PERFECT POTENTIOMETER

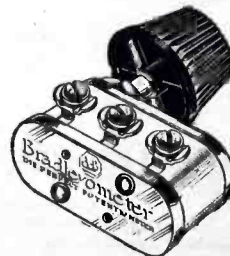

Uses graphite disc resistors which are noiseless and not affected by atmospheric conditions. Metal parts are nickel plated. One hole mounting. Finish and knob match Bradleystat. Made in 200 and 400 ohm ratings.

Allen-Bradley Co.

Electric Controlling Apparatus

288 Greenfield Ave., Milwaukee, Wis.

The Bradleyometer is
noninductive

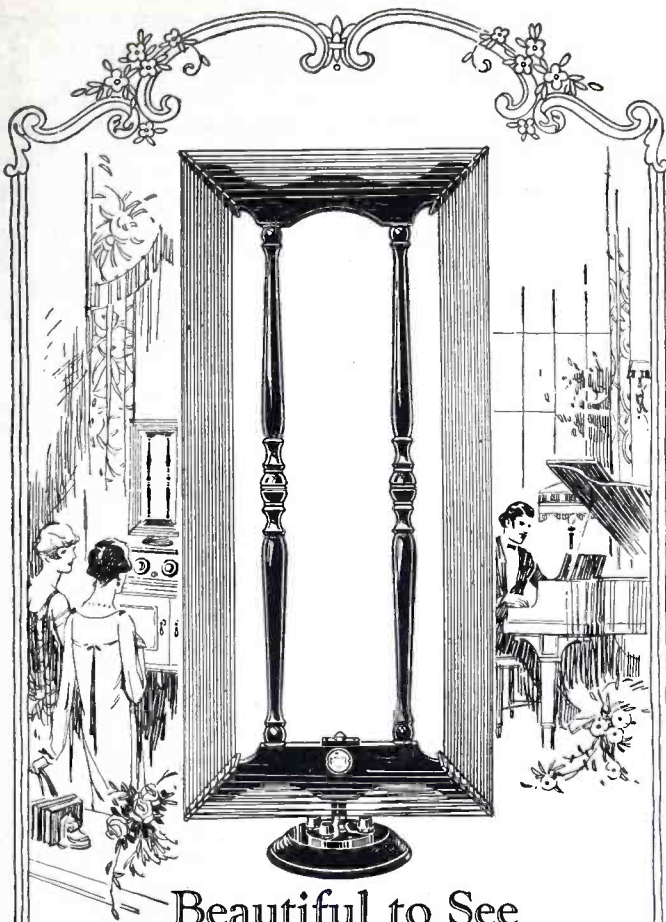

Beautiful to See Delightful to Hear

If you have not seen the Bodine DeLuxe Loop, you have a new thrill in store. The perfect symmetry and exquisite proportions of this beautiful loop harmonize with the most attractive home surroundings. Its remarkable efficiency combined with an overall size of but 12 x 26" is a pleasant surprise. The Bodine DeLuxe Loop is a decided aid to tuning in congested areas. By tuning out interfering stations and reducing static it improves tone quality. Ideal for loop sets. Write for circular telling how to secure the closer tuning and better tone quality provided by the Bodine DeLuxe Loop with aerial sets. See a Bodine DeLuxe Loop at your nearest radio store.

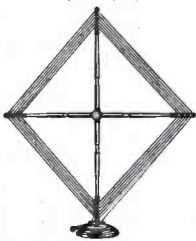

Bodine Folding Loop

The basket weave method of winding the Bodine Folding Loop provides unusual selectivity, longer distance and greater volume. The winding of fine stranded copper wires inside a silk braid is very efficient and designed to avoid stretching. Hinges of the English Mahogany frames are neatly concealed. Satin-silver dial makes logging easy. Bodine Folding Loop is 24" square, but when folded fits box 3 1/2 x 6 x 18". Ideal for camping. Very attractive for home use. See a Bodine Folding Loop at your dealer's store.

Bodine Twin-Eight R. F. Transformers

This specially designed coil has been widely adopted by set manufacturers because of its unusual efficiency. The Bodine Twin-Eight method of winding provides greater amplification than is possible with any type of toroidal or doughnut coil with less interference with other parts of the set. Very compact, making assembly of set easy. Improves any tuned radio frequency hookup. Price \$2.00 each. Set of 3 matched coils \$6.00.

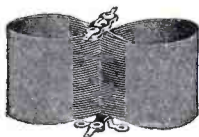

Write for free wiring diagram of the Bodine Twin-Eight Receiver which utilizes these unusual coils.

BODINE ELECTRIC COMPANY,
2266 West Ohio Street,
Chicago, Illinois
Kindly mail FREE circular describing:
Bodine Radio Loop.
How to use a loop with aerial receiver.
How to build the Bodine Twin-Eight Receiver.

Mail
the
Coupon

Name _____

Address _____

Range of Human Voice

CYCLES

CONCERTONE AMPLIFICATION CURVE

RANGE OF PIANO SCALE

JEFFERSON
Concertone
TRANSFORMER

The very nearly straight "curve" of the new Jefferson "Concertone" Sealed audio frequency transformer assures full amplification of all notes—from the lowest to the highest audible to human ears.

Ideal for Power Tubes

CORE and windings which are sufficiently large and heavily insulated, permit Jefferson "Concertones" to be safely and continuously used with power tubes.

JEFFERSON TRANSFORMERS



Jefferson No. 358 Filter Chokes are particularly adapted for use in the output circuit because of their extremely low D.C. resistance and their ample current carrying capacity.

Jefferson Electric Mfg. Co.
Largest manufacturers of small transformers
542 SO. GREEN ST. CHICAGO, ILL. U.S.A.



Chosen by EXPERTS

GLENN H. BROWNING, Laurence M. Cockaday, Gerald M. Best and many other eminent radio designers use the Lynch Metallized Resistor in their experimental circuits and receivers. These men know radio; they have laboratory and testing equipment with which quickly to make accurate comparisons. There could be no better proof of the true merit of the Lynch Metallized Resistor than the endorsement of these experts.

Comprising a concentrated metallized deposit one-thousandth of an inch thick upon a rigid core, sealed forever within a glass tube, the Lynch Metallized Resistor gives *conductive*, non-arcing resistance that remains silent, accurate!

Dealers—Write us!

ARTHUR H. LYNCH, Inc.
Fisk Bldg., Broadway & 57th Street
New York, N.Y.

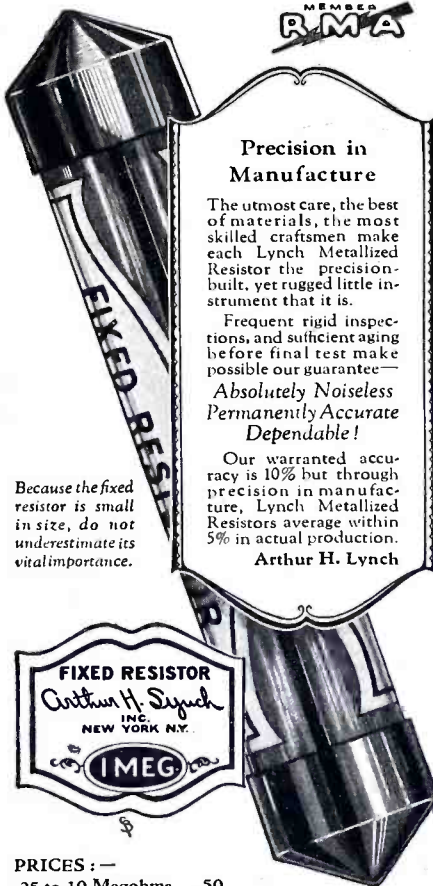

PRICES:—
.25 to 10 Megohms .50
above .01 to .24 " .75
.001 to .01 " \$1.00
Single Mounting .35
Double " .50

Lynch Metallized Resistors cost no more than the ordinary kind. If your dealer cannot supply you it will be well worth your while to wait for the mail—we ship post-paid, at once.

LYNCH METALLIZED

FIXED RESISTORS

FREE!

Get the first 3 issues of **RADIO MECHANICS** free.

Fill in below.
The Names of three Radio Dealers who would be interested in reading **RADIO ENGINEERING**.

We'll send them each a copy.

Then we'll send you the first three Issues of **RADIO MECHANICS** free.

If you don't want to tear up this copy use a separate sheet of paper.

Send each of these Dealers a copy of **RADIO ENGINEERING**.

Name

Street

City State

Name

Street

City State

Name

Street

City State

Send me the first three issues of **RADIO MECHANICS**

Name

Street

City State

M. B. SLEEPER, INC.
Radio Hill
Poughkeepsie,
New York.

INDEX OF ADVERTISERS

	PAGE
A	
Aero Products, Inc.....	453
Aerovox Wireless Corp.....	470
Allen Bradley Co.....	463, 473, 476
American Hard Rubber Co.....	468
American Mechanical Labs.....	466
American Transformer Co. Back Cover	
Amplion Corp. of America.....	465
Amsco Products	476
B	
Bakelite Corp.....	455
Belden Mfg. Co.....	475
Benjamin Electric Mfg. Co.....	475
Bodine Electric Co.....	477
Bullens, D. K.....	476
C	
Cardwell, Allen D., Mfg. Corp... ..	435
Carter Radio Co.....	467
Central Radio Labs.....	471
Chicago Solder Co.....	472
Copper & Brass Research Assoc..	472
D	
Dongan Elec. Mfg. Co.	
Inside Back Cover	
Daven Radio Corp.....	485
Dubilier Cond. & Radio Corp....	438
Duro Metal Products Co.....	479
E	
Eby, H. H., Mfg. Co.....	471
Electrad, Inc.....	479
F	
Ferranti, Inc.	480
G	
General Radio Co.....	467
H	
Hammarlund Mfg. Co.....	473
Hammarlund-Roberts	437
High Frequency Labs.....	472
J	
Jefferson Electric Co.....	477
Jewell Elec'l Inst. Co.....	453
K	
Karas Elec. Co.....	451
L	
Lynch, Arthur H.....	478
M	
MacLaren Mfg Co., Inc.....	469
Martin Copeland Co.....	459
N	
National Carbon Co.	
Inside Front Cover	
National Company	461
P	
Polymet Mfg. Corp.....	466
R	
Radiall Co.	463
Radio Corp. of America.....	433
Radio Electric Co.....	474
Roebbling, J. A. Son's Co.....	476
S	
Samson Electric Co.....	470
Sangamo Electric Co.....	469
Shore Electric Co.....	474
Silver Marshall	463
Spartan Elec. Corp.....	479
William Stevens Co.....	468
T	
Thordarson Electric Co.....	457
Tobe Deutschmann	476
U	
United Scientific Labs.....	474
W	
Westinghouse Elect. & Mfg. Co.	449
X	
X-L Radio Laboratories.....	474

it takes you less

than one second



to end microphonic howling for once and all! That's when you slip one of these live rubber "howl absorbers" over the offending tube

Mc DONALD HOWL ARRESTER

remember this name! You can get it for every size tube. Just ask your dealer, or write

Sole Selling Agents for the U. S. A.
SPARTAN ELECTRIC CORP
350 West 34th Street, New York City
Manufactured in the U. S. A. by
Scientific Products Canada, Ltd.

Price 75 cents each
"It Stops that howl"

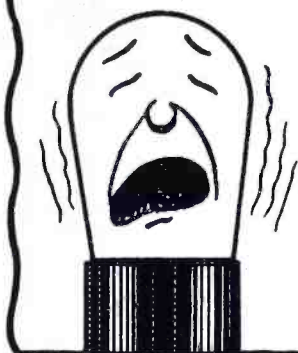

Quali-Tone

TROUBADOUR

Just as the amorous nobles of old Spain, France and Italy charmed a continent with their hauntingly beautiful music and poetry—so has the marvelous reproduction of the TROUBADOUR impressed itself upon the Radio World of today. It is Music and Song and Poetry unaltered, undistorted—true. Distinctively artistic in design, body finished in rich walnut brown, base and faces in dull black Morocco leather finish. Troubadour's weight of 11 pounds is absolute assurance against vibration, while Quali-Tone's advanced construction results in a new quality of reproduction—that amazes listeners by its depth, resonance and purity. Height, 16½ inches. Diameter 13½ inches. Depth 5½ inches.



\$30

New Drum Type

8000 Miles on the Quali-Tone Loop

The Quali-Tone Loop pictured here holds two World's Records for distant reception, having brought in stations 8000 miles away. Write for verification of these records. Exclusive Thumbscrew Adjustment keeps wires taut always. Guaranteed to improve the performance of any receiver. Price\$10

SEND for literature describing Quali-Tone's complete line, which includes the Junior Speaker—\$7.50. Quali-Tone No. 2 Speaker—\$10. Quali-Tone No. 3—\$15. Quali-Tone No. 4—\$25 and Quali-Tone Radio Units at \$3 and \$7.50.

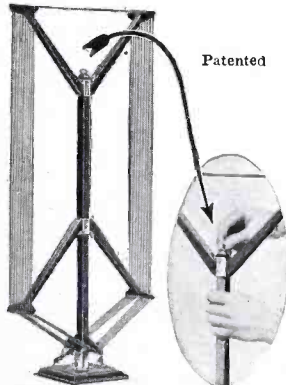

Patented

DEALERS & JOBBERS

Duro Metal Products Co.
2659 N. Kildare Ave. Chicago

DEALERS
Write for
Discounts
JOBBERs

ELECTRAD

ELECTRAD Certified Jacks

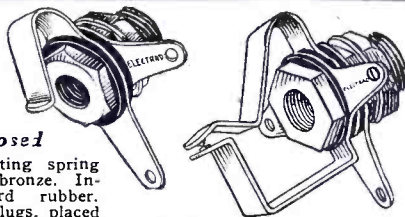

Open and Closed

POSITIVE acting spring of phosphor bronze. Insulation of hard rubber. Tinned soldering lugs, placed to make good connections easy. Sterling silver contact points. Requires less than 1" behind panel. Certified and guaranteed electrically and mechanically. List, open 25c, closed 35c. In Canada, open 35c, closed 50c.

ELECTRAD

CERTIFIED SWITCHES

When they're on, they're 100 per cent on; when they're off, they're 100 per cent off. Solid brass construction. Tinned soldering lugs, placed to make good connections easy. Neat design, genuine Bakelite knob. Require less than 1" behind panel. List 40c—in Canada 60c.

Write for details of our square dealer proposition that helps you sell and protects your profits.

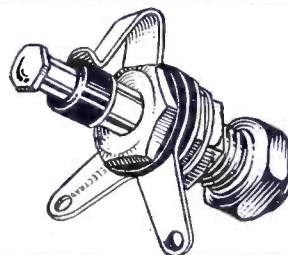

Write for information on the Electrad 500,000-ohm compensator for perfect control of tone and volume. 428 Broadway, New York City.



ELECTRAD

FERRANTI

*supreme
- yes, but why?*

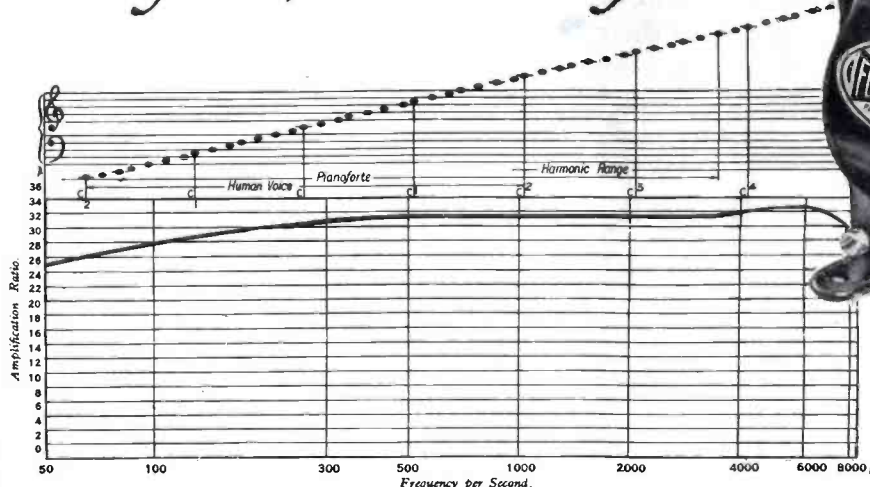

Audio Frequency
Transformer
A. F. 3 \$12

This graph is drawn on the musical scale — the only accurate way of showing the full value of each tone which your set receives. Note that the evenness and fullness of amplification extends throughout the range of the organ, the cello, and the human voice. The unattainably perfect curve would be a straight line. Note how much nearer than any other transformer the Ferranti approaches this characteristic of perfection. That is why it is called "nearly perfect."

FERRANTI TRANSFORMERS

Ferranti Transformers are the result of research conducted to produce a transformer of low self-capacity and high amplification ratio with flat curve over a frequency range of 50 to 8000 cycles.

The Ferranti Transformer is at present manufactured in England by Ferranti Limited, engineers and electrical manufacturers with forty years' experience in the design and manufacture of high grade electrical equipment. Extensive experience in the winding of coils of fine wire for electrical instruments and meters has paved the way to the production of this nearly perfect transformer.

Ten tests are made on each transformer after assembly to establish its condition.

The amplification ratio of each transformer is tested with a tube. All transformers which do not come within five per cent of the accepted standard are rejected.

All transformers are tested at 1000 volts between primary and secondary and between primary and secondary and ground.

Ferranti Transformers, even under the extreme climatic conditions of the Tropics, have been found to stand up to the most severe conditions of service.

Use the Ferranti after the new detector tubes, and before new amplifier tubes, and you will have efficiency that cannot be approached by the old-time transformers and tubes.

To convince yourself, *put a Ferranti in one of your sets*, taking care to observe the installation directions and *note the difference*. Facts speak clearly and loudly as to the supremacy of Ferranti when put to the acid test.

We are trading through bona fide wholesalers with a minimum quantity shipment of 12 transformers. We are preparing to supply two transformers and two only to any retailer who sends cash with order and the name of his jobber. If you should be a dealer or jobber and are interested in handling Ferranti Transformers, please write immediately and we shall supply you with information in regard to discounts and general company policy.

No Better Transformer Is Available At Any Price

FERRANTI, INC.

130 West 42nd Street

New York, N. Y.

THE NEARLY PERFECT TRANSFORMER

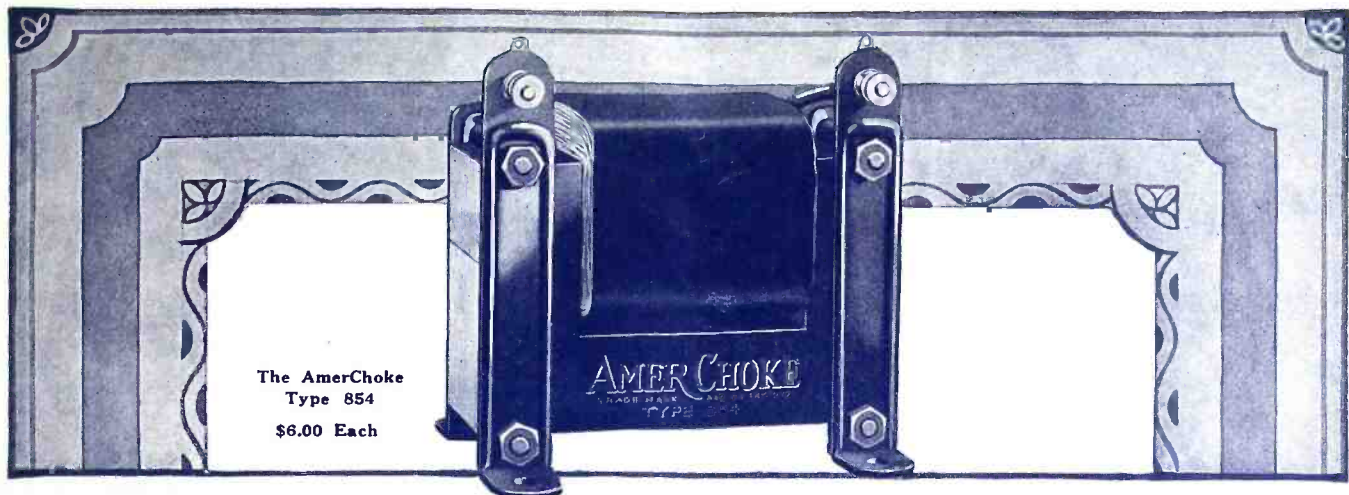

The AmerChoke
Type 854
\$6.00 Each

AMERTRAN RADIO PRODUCTS

A Reliable Choke for Filter Circuits

The AmerChoke Type 854 is a choke coil or impedance designed primarily for use in filter circuits. As an output impedance with a fixed condenser it forms an ideal filter for the loudspeaker, insuring tone quality equal to the average output transformer. And it will be more economical. For filter circuits in "B" Eliminators, the AmerChoke will give perfect results due to its scientific design and generous proportions.

To obtain even, quiet current supply use the AmerChoke and the AmerTran Power Transformer (described at the left) in the construction of your power amplifier.

The AmerChoke type 854 has a no-load inductance of approximately 100 henrys at 60 cycles with average close butt joints. Magnetic saturation from direct current is prevented by two butt joints in the iron core. The AmerChoke shipping weight is about 5 pounds and the price \$6.00 each F.O.B. Newark, N. J., or at any Authorized AmerTran Dealers.

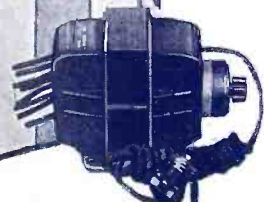

The AmerTran Power Transformer Type PF-52

Type PF-52 is intended for use in the best power supply developments. It will convert the standard 110 volt, 60 cycle alternating house lighting current to a higher voltage for the plate and low voltage for filament supply.
\$18.00 each.

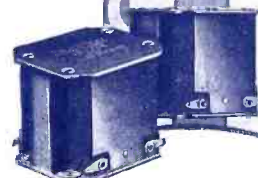

The AmerTran De Luxe Audio Transformer

This new transformer sets an entirely new standard of audio amplification. It makes possible a transformer coupled amplifier that excels all other forms of amplifiers. Made in two types for first and second stages.
Price \$10.00 each.

AMERICAN TRANSFORMER COMPANY

178 Emmett Street, Newark, N. J.

"Transformer Builders for Over Twenty-five Years"

Other AmerTran Products

AmerTran Resistor Type 400—\$7.50. AmerTran Heater Transformer Type H-28 (for A. C. Tubes) \$10.00.

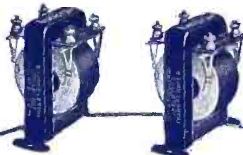

AmerTran Types AF-7 and AF-6 AmerTran Audio Transformers, types AF-7 and AF-6, have been considered for years among the leaders in audio amplification. These popular and efficient models are made in two types—AF-7 (ratio 3½:1)—AF-6 (ratio 5:1)
\$5.00 each.

We shall be very glad to send you upon request a copy of our booklet "Improving the Audio Amplifier" together with other interesting constructional data.



Approved Parts

FOR

Eliminators Power Amplifiers

Dongan's dominant position in the radio field today is due to the jealously guarded standard of construction and a willingness to pioneer unflinchingly in any new idea that is proved practical. Typical of Dongan's leadership is Dongan's present position in Eliminator and Power Amplifier design.

Dongan has perfected transformers and chokes of several types which are used widely with UX, RCA and Raytheon Tubes for both Eliminator and Power Amplifiers.



No. 1582 B-Power Unit

For the Raytheon Tube

Gives quiet, smooth B-Power supply. 1 Transformer and 2 chokes built into compact black crystalized case.

List \$11.00

Manufacturers

For a reliable source of supply on the latest designs Dongan offers quantity production on all approved types. For special requirements our engineering department is at your service.

Power Amplifiers For Home Use

Use Dongan No. 2567 transformer half wave with UX 216 B-tube used in conjunction with UX Power Amplifier tube No. 210.

List \$10.00

Dongan transformers available for all standard types of power Amplifier tubes.



Type H-Audio Transformer

A Super-Transformer for present wave length conditions. Unusual power and smoothness.

List \$4.50



No. 2568 ABC Power Unit

Designed for use with Raytheon BH tube. Eliminates all batteries. Built into sturdy good-looking black metal case.

List \$17.50

Fans

Order these and other Dongan parts from your dealer or send to the factory for complete information on constructing eliminator and power amplifier units.

DONGAN ELECTRIC MANUFACTURING COMPANY

2995-3001 Franklin St.,
DETROIT, MICHIGAN

TRANSFORMERS of MERIT for FIFTEEN YEARS