

RADIO ENGINEERING

The Technical Magazine of the
Radio Trade—*Edited by M.B. Sleeper*

A. C. Power Supply Issue

APRIL, 1926

Working Data on A. C. Supply Devices

Specially prepared for Designers and Engineers who are working on power supply equipment to be used in receiving sets for full production

Dealers' Checking Charts for Radio Sets

Checking Charts show the repair man the exact location of faults in standard types of receivers—or if the trouble is in the accessories and not in the set at all

Improved Design for the Universal Set

Showing new mechanical design suggestions for the Universal Receiver which are also applicable to other types of receiving sets and laboratory equipment

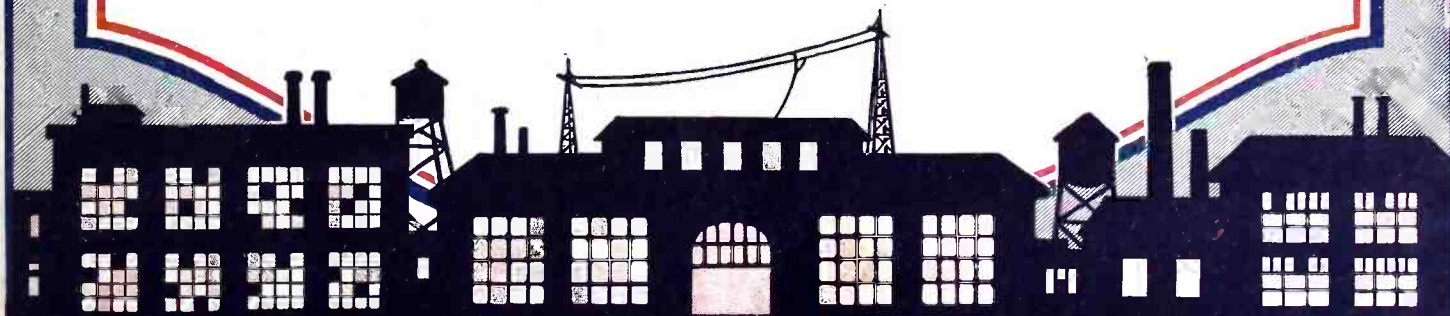

20c PER COPY \$2.00 PER YEAR
Sold Only by Subscription

VOLUME VI NUMBER 4
Sixth Year of Publication



*"Your radio is always top notch.
What do you do to keep it so full
of pep?"*

KEEPING your "B" batteries full of pep, without frequent renewals, is simply a matter of using the right size Evereadys for your particular set with a "C" battery*.

The rule which determines the right size "B" batteries to use is so simple no one can make a mistake, and once learned it definitely settles the question of "B" battery service and economy.

On 1 to 3 tubes — Use Eveready No. 772.

On 4 or more tubes — Use the Heavy Duty "B" Batteries, either No. 770, or the even longer-lived Eveready Layerbilt No. 486.

On all but single tube sets — Use a "C" battery.

When following these rules, No. 772, on 1 to 3 tube sets, will last for a year or more, and Heavy Duties on sets of 4 or more tubes, for 8 months or longer.

These life figures are based on the established fact that the average year-round use of a set is 2 hours a day.

A pair of Eveready No. 772's for a 5-tube set

instead of 2 Eveready No. 770's or 2 Eveready Layerbilts No. 486—looks at first glance like an economy because of lower first cost. But in a few months the 772's will be exhausted and have to be replaced. After the same length of time the Eveready No. 770's or the Eveready Layerbilts No. 486 will still be good for many more months of service.

We have prepared for your individual use a new booklet, "Choosing and Using the Right Radio Batteries," which we will be glad to send you upon request. This booklet also tells about the proper battery equipment for use with the new power tubes.

*NOTE: In addition to the increased life which an Eveready "C" Battery gives to your "B" batteries, it will add a quality of reception unobtainable without it.

Manufactured and guaranteed by
NATIONAL CARBON CO., Inc.
New York San Francisco
Canadian National Carbon Co., Limited
Toronto, Ontario



LEFT—No. 486.
for 4, 5 or more
tubes. \$5.50.



RIGHT—Eveready Dry Cell Radio "A" Battery, 1½ volts.

EVEREADY

Radio Batteries

—they last longer

Tuesday night means Eveready Hour—9 P. M., Eastern Standard Time, through the following stations:

| | |
|----------------------------------|------------------|
| WEAF—New York | WSAI—Cincinnati |
| WJAR—Providence | WEAR—Cleveland |
| WEET—Boston | WWJ—Detroit |
| WTAG—Worcester | WGN—Chicago |
| WFI—Philadelphia | WOC—Davenport |
| WGR—Buffalo | WCCO—Minneapolis |
| WCAE—Pittsburgh | St. Paul |
| KSD—St. Louis | |
| Pacific Coast, Eveready Program, | |
| KGO—San Francisco, 8 to 9 P. M. | |

Radiotron UX-199
the same tube but with the
new standard base.

Radiotron UV-199
dry cell tube for both de-
tection and amplification.



Low in cost to run

*I*T'S the special filament of an RCA Radiotron UV-199 (or UX-199) that makes it cost so little to run. This tube draws so little current that for a limited time it can even be operated from flashlight batteries—for your portable sets! It never needs more than inexpensive dry batteries—and it uses them up slowly.

The thoriated filament of this tube is specially treated, so that there is always a layer of thorium a single atom deep on the filament-surface. And electrons leap from the thorium at a stupendous rate—conveying the music and the speech.

Because this type of filament gives off more electrons at less heat—it lasts longer, and it uses less battery current. And because this type of filament was developed in the great research laboratories that contribute to RCA, you will find it in every genuine RCA Radiotron UV-199 and UX-199. Another good reason for being careful to find the RCA mark on the base when you buy!

RADIO CORPORATION OF AMERICA
New York Chicago San Francisco

RCA Radiotron

MADE BY THE MAKERS OF RADIOLAS

EDITORIAL

ALTHO it may seem early in the year to talk about next fall's business, developments in that direction have progressed already to a point which call for discussion.

Practically all the established manufacturers have completed the designs for their fall models, leaving only small details to be settled, and the determination of supply sources. Many are already making tools and dies, purchasing machinery, and reorganizing production equipment.

This is of great importance to jobbers and dealers, for it promises that deliveries will keep pace with demand. It promises protection to the consumers, also, against obsolescence, for plans made so far in advance will not permit sudden changes in circuits and models.

These new sets will not be shown officially until the first of June, but it is not too early to discuss some of the outstanding design features.

For one thing, prices are going up and down. That is, good cheap sets will be slightly lower in price, while strictly high class sets will cost more.

The changes which will bring lower prices are mainly due to improved methods in manufacturing and merchandising. Few scientific developments are to be found in them, but they will be better built, and for that reason more satisfactory to the consumers and more profitable to the dealers.

Last season, increased prices were justified principally by the elaborate cabinets which housed ordinary sets. Next fall, the value will be in the apparatus itself.

When you see the new receivers, you will feel that the manufacturers have learned more from last season than in any other year since broadcasting started. Problem after problem has been solved—little ones, big ones, relating to ruggedness, quality, appearance, operation—all to make radio safe for the old folks who can't understand, the in-betweens who don't want to understand, and the young ones who haven't learned.

Die-castings, molded bakelite units, bearings ground and lapped, welded joints, and cabled wiring are much in evidence, where before they were novelties. Shielding is making tuning sharper and eliminating noises. Condensers are ganged together, so accurately made that single control gives tuning as it should be. Loop antennas are coming back. R.F. and A.F. circuits are liberally by-passed with high-capacity condensers. Sifter circuits keep the D.C. from the loud speaker. All good sets have meters to show the condition of the A and B batteries. Even the least of them have tip jacks for plugging in an external meter.

Most sets above the average price range will operate from 110 volts. Details of the most advanced developments along this line cannot be disclosed yet, tho it can be said that amazingly simple methods for A.C. operation are now in use.

All things considered, in spite of present conditions which are disturbing, the radio trade can well afford to sit tight and do its best with what is now available, confident that the industry is at last well entrenched by scientific development.

M. B. SLEEPER, *Editor.*

RADIO ENGINEERING

The Technical Magazine of the Radio Trade

Edited by M. B. SLEEPER

Vol. VI.

APRIL, 1926

No. 4

Sixth Year of Publication

CONTENTS

| | |
|--|-----|
| Quality Amplification—How to Get It..... | 151 |
| <i>By J. L. Schermerhorn</i> | |
| Making the Hammarlund-Roberts Non-Regenerative | 152 |
| I. and M. Data on the Operadio..... | 153 |
| Our Idea of the Universal..... | 154 |
| <i>By M. B. Sleeper</i> | |
| New Trends in Set Design..... | 156 |
| <i>By McMurdo Silver</i> | |
| 5-N-1 Super-Range Receiver..... | 158 |
| <i>By S. W. Nichols</i> | |
| Radio Set or Machine?..... | 160 |
| <i>By R. A. Sayres</i> | |
| A. C. Power Supply Equipment..... | 161 |
| How Loud Speaker Troubles Are Overcome | 176 |
| <i>By C. E. Brigham</i> | |

In the May Issue

May will be devoted particularly to materials, supplies, and equipment for manufacturers who are now ready to place orders, for fall delivery, and who are gearing up their factories for fall production. There will also be a construction article on a short wave B battery operated phone transmitter, and new data on the Perlesz gang condensers and the Howard loop operated neutrodyne.

In the June Issue

June will be a special Associated Manufacturers of Electrical Supplies Convention number. The radio section of the A.M.E.S. has been doing some remarkable work for the radio industry, altho very little has been published concerning its activities. In June, however, we hope to present the details of some of the achievements of the A.M.E.S. radio section.

RADIO ENGINEERING

Published monthly by M. B. SLEEPER, Inc., Publication office, Lyon Block, Albany, New York. Editorial and General offices, 52 Vanderbilt Ave., New York, N. Y. Printed in U. S. A. Yearly subscription \$2.00 in U. S. and Canada; ten shillings in foreign countries. Entered as second class matter at the postoffice at Albany, New York, January 9, 1925, under the act of March 3, 1879.
Bryan S. Davis, Advertising Manager; E. H. Moran, Western Representative, 307 N. Michigan Blvd., Chicago, Ill.

Cardwell

Old Friends

With New Faces

are far more dependable than strangers.

The logical plate shape of a rotary variable condenser is semicircular, and to use these plates to the proper advantage, neither rotor nor stator should be cut away to any extent.

Cardwell Taper Plate Type "E" condensers have the old familiar plate shape, but have a straight frequency tuning characteristic.

Authorities agree that these condensers are the finest instruments ever produced. Mr. Arthur H. Lynch, Editor of "Radio Broadcast," selected them as ideal for use in the "Aristocrat" and other receivers. Mr. Gerald M. Best, Editor of "Radio," uses them in his new "Super."

The Type "C" approaches straight frequency at minimum but gives more separation at maximum.

They are priced the same—the .0005 mfd. capacity lists at \$5.00, and others, proportionately.

The Allen D. Cardwell Mfg. Corp.

81 PROSPECT STREET
BROOKLYN, N. Y.

5c. in stamps brings this booklet on the Best Super-Heterodyne.

If your dealer can't supply you, order direct. Write for illustrated catalogue and handbook.

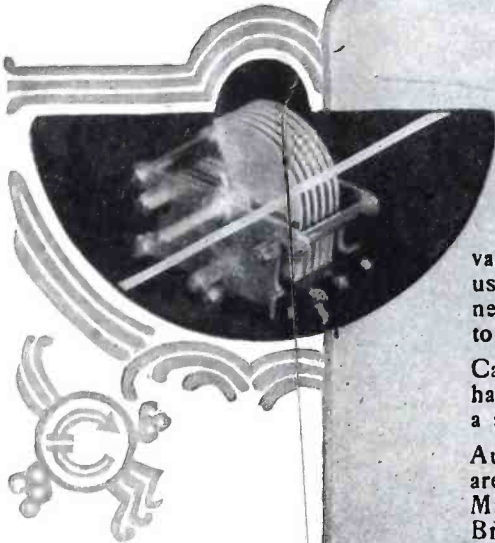

The Taper Plate Type "E" with straight frequency tuning characteristics

The Type "C" has a modified straight wave length tuning curve

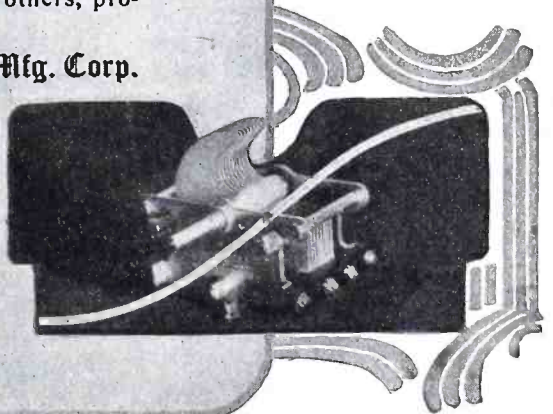

Condensers

"THE STANDARD OF COMPARISON"

The **UNIVERSAL**

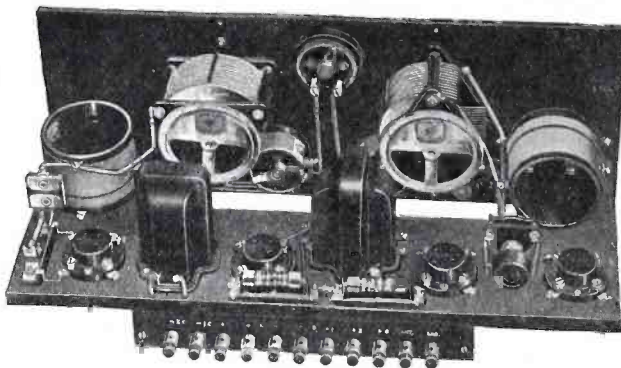

Exemplifying All the Refinements of Modern Receiver Design



FREE to Set-builders

Ask your dealer for free booklet containing diagrams, templates, list of parts, and complete instructions for building the "UNIVERSAL." If he is unable to supply information and parts write to Dept. "UNIVERSAL," General Radio Co., Cambridge 39, Mass.

The Radio Broadcast "UNIVERSAL" has been designed by Arthur H. Lynch to include every popular improvement of receiver design that is practicable for home construction.

The experiences and skill of Radio Engineers, Radio Editors, and amateur set-builders throughout the United States are summarized in this receiver.

While the circuit itself is not new in principle, it is slightly different in its application, and embodies the latest refinements of the radio art.

From a standpoint of performance, simplicity, and economy of construction and operation, the "UNIVERSAL" is unrivaled.

To the set-builder who expects real results from his set we give our assurance that he will get them from properly built "UNIVERSAL."

The General Radio Company has endeavored to make it possible for the experimenter to obtain its products with a minimum of effort. A careful selection of distributors and dealers has been made. They are best fitted to serve you. If, however, you are unable to obtain our products in your particular locality they will be delivered to you, prepaid, direct from the factory upon receipt of list price.

Write for our latest parts catalog 924-E.

GENERAL RADIO CO., Cambridge 39, Mass.

GENERAL RADIO

INSTRUMENTS

Behind the Panels of Better Built Sets

THE *Dependable* B-POWER

Constant-B

Replaces Your "B" Batteries Permanently

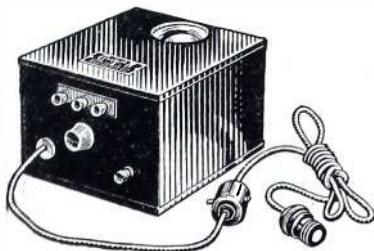

After installing the All-American "Constant-B" you need only snap the electric switch to have permanent and constant plate power for your radio, direct from the light socket. With it there is no ruinous acid, no hum—nothing but the pure, full tone that is only possible when the "B" voltage is *constantly* up to standard.

The complete factory-made "Constant-B" as illustrated above, is now obtainable from All-American jobbers and dealers. Descriptive folder will be sent on request.

Price **\$45** COMPLETE WITH RAYTHEON TUBE

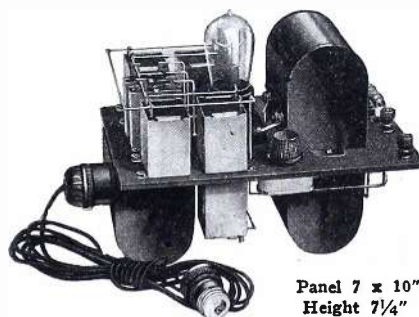

Panel 7 x 10"
Height 7/4"

For those who prefer to assemble the "Constant-B" from separate parts, the following items are also obtainable.

- B-Power Choke; inductance full 50 henries, in stout metal shield. Type R-8.....\$4.50
- B-Power Transformer with separable plug (short-circuit-proof). Type R-7.....\$6.00
- Tube Socket; the popular All-American bakelite socket is ideal for this purpose. Type R-25 75¢
- Raytheon Tube, each.....\$6.00

Send for bulletin B-82, giving detailed directions with full-size templates for building the above illustrated B-Power unit.

ALL-AMERICAN RADIO CORPORATION, 4217 W. Belmont Ave., Chicago, U. S. A.

E. N. RAULAND, President

Pioneers in the Industry

Sales Offices in

Boston New York Philadelphia Washington Atlanta Pittsburgh Buffalo Detroit
Chicago Minneapolis St. Louis Denver Boise Los Angeles San Francisco Seattle

OWNING AND OPERATING STATION WENR—266 METERS

ALL-AMERICAN

Radio Built for the Years to Come



Use Type 719 across the transformer secondary.

Circuit diagram for Raytheon plate supply.

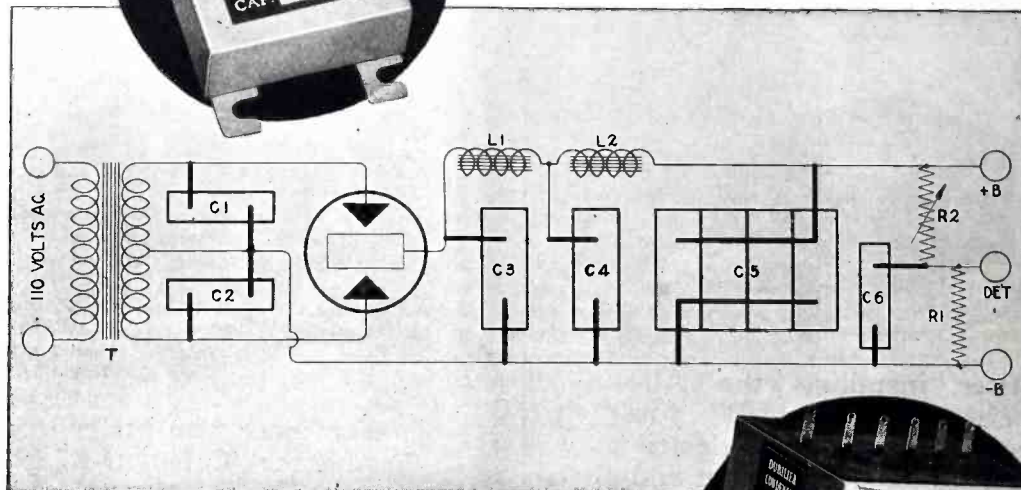

Type 720 contains the entire filter system conveniently tapped and marked.

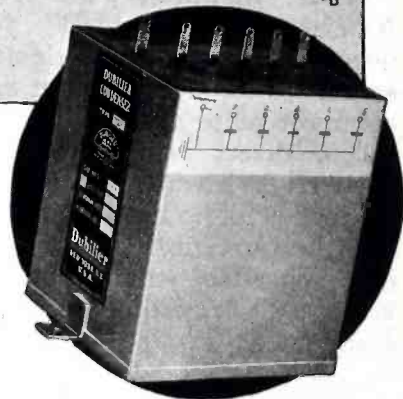

Your Filter Condensers Must be Right!

One of the most popular types of home-built "B" battery eliminators uses the Raytheon tube as a rectifier.

As in every other type of plate supply unit, lasting satisfaction and safe operation depend on the kind of filter condensers used. Due to the high voltages impressed on the filter circuit by the input transformer, only condensers especially designed for this work will give permanent service. Ordinary By-pass condensers should not be used in filter circuits.

Dubilier Filter Condensers, Types 719 and 720 contain all capacities necessary for constructing a Raytheon plate supply unit. These condensers were specifically designed for this circuit.

You can't build right unless your parts are right!

Insist on getting DUBILIER Filter Condensers. If your dealer cannot supply you write directly to

Dubilier

CONDENSER AND RADIO CORPORATION

4377 Bronx Boulevard, New York, N. Y.

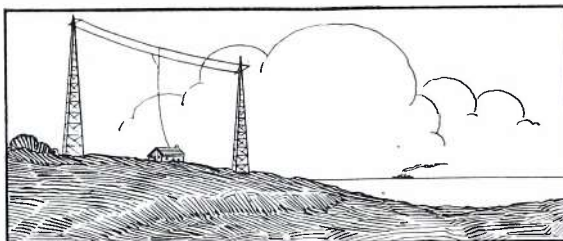

QUALITY AMPLIFICATION

*Tricks we have learned in the laboratory about amplification, translated into terms applicable to all types of radio sets—By J. L. Schermerhorn**

THE individual radio set builder is, in one respect, in an envious position compared to the professional radio engineer, who must prepare his designs within the scope or limitations of the patent licenses held by the manufacturing company with whom he is employed. Very often the professional radio engineer is limited at the start by a pre-established sales price. The set builder knows no such limitations. He builds for himself or his clients the best set his knowledge permits, regardless of patents.

There are actually only about five fundamentally different tuning circuits—the simple variometer or coupler, regenerative, tuned radio frequency, reflex, and super-heterodyne. All others are modifications or combinations of these, and while they differ only in details, many of these details are very important. Why do you suppose it is that one man purchases a quantity of good parts and builds a set which gives excellent results, and on the strength of this another man buys the same parts for the same circuit and his set is a failure? The reason is simple. He thought he would do better by making a panel layout to look like a million dollars, and arrange the parts and wiring back of the panel to suit the front appearance.

The first man carefully studied the arrangement of the parts back of the panel so as to obtain the shortest possible grid and plate connections, which he placed far apart and at some distance from all other leads, and at the same time located the tuning coils in the different stages so that they would not couple, and he did not place solid metal or condenser plates within or across the open ends of the coils. He bunched together within the set, close to the parts to which they were attached, all of the insulated battery leads and formed them into one compact cable all the way through the set and out to the batteries. The second man gained in the appearance of his set by using that nice, shiny, stiff bus wire and zig-zagged it through

his set until it looked like an airplane view of the streets of London. If he had been less concerned with the front appearance of the set and more concerned with the parts back of the panel, it is possible that his set would have been just as good as the other. To obtain the best in any receiving circuit there are two alternatives. One is to make a Chinese copy of a perfect working model—the other is to exercise your brain a little and allow it to soak in a few of the principles of the operation of vacuum tubes. Obviously, the latter is the better course to follow.

Regardless of whether a tube is used as a radio frequency amplifier or an audio amplifier, the flow of electrons is from the heated filament to the plate, out through the coupling device, and directly back to the filament in the shortest possible path. In the radio frequency tube, radio frequency current should flow directly from the plate to the coil and back to the filament through a fixed condenser. It is the coil which is functioned as an inductance and the condenser as a capacity and not the wires which make the connections to these parts. These connecting wires should, therefore, be short and direct and with as few bends as possible. Much radio fre-

J. L. SCHERMERHORN, altho well known in the inner circle of radio engineers, has been too busy doing things to spend time telling about them. It is a privilege, therefore, to present these very practical and useful notes on amplifiers in general and the combination power amplifier and B-eliminator in particular.

What Mr. Schermerhorn says about A. F. and R. F. amplifiers is the boiled-down experience of years of laboratory work on this subject, and, when you stop to think about it, it is easy to understand why he is so absolutely right in criticizing the usual methods employed in amplifier assemblies.

quency energy is lost in sharp, right angle bends.

In the audio amplifier the audio frequency must also flow in the shortest possible path from the plate of the tube to the primary of the audio transformer and then directly back through a large fixed condenser to the filament of this same tube, keeping the connections as short as possible because some of the audio frequencies reach several thousand cycles. It is even more essential that the connections between the grid terminal of the audio transformer and the grid of the tube be as short as possible and that a fixed condenser should be connected directly between the filament terminal of the audio transformer and the filament of the tube. Whether R.F. or A.F., the incoming circuit is from the filament through the coil to the grid, and the outgoing circuit from the plate to the next coil and back to the filament, and fixed condensers are necessary to complete the A.C. path and at the same time prevent short-circuiting the D.C. circuit.

At this point it may be well to stress the fact that the D.C. circuit for both A and B is intended only to maintain a source of D.C. potential, and the connections to the batteries or B eliminator should not be a path for R.F. or A.F. currents. It is, therefore, advisable to bunch all these battery connections together in the form of a cable, immediately after they leave the parts to which they are connected in the set, in order that they may in no way become the carriers of A.C. currents by forming inductive loops or acting as capacity coupling devices as they often do when spread out over a set.

While there may be as many as five fundamental tuning circuits, there are only two distinctly different kinds of audio interstage coupling devices, namely, transformer coupling and resistance or impedance coupling. Resistance coupling is essentially similar to impedance coupling. There are now available audio transformers of frequency characteristics which our tests show are better than it is possible to obtain with resistance or impedance coupling. Recent improve-

*Chief Engineer, American Transformer Co.

ments in loud speakers have made it possible to distinguish this difference. An impedance or a resistance amplifier cannot be perfect, due to limitations which are briefly as follows:

If the fixed condensers are not sufficiently large, the bass notes are missing. If they are large enough to pass the bass notes, they tend to introduce a time lag in the circuit. These conditions fix a definite limit for preventing the absolutely uniform amplification of all the audio frequencies. An audio transformer has recently been developed in which the amplification at 50 cycles is more than 80% of the average amplification at all other audible frequencies.

Uniform bass note amplification is accompanied by an energy component which increases rapidly toward the lower frequencies. This is not revealed by the voltage amplification curve, nor is it evidenced by great volume. It requires energy to make a musical instrument produce a deep bass note so that it sounds natural to the human ear. It requires a similar amount of energy applied to the loud speaker to make it reproduce that which the bass instrument has given to the microphone. The energy amplification increases approximately as the square of the voltage amplification, and since the last audio tube is the neck of the bottle, it should be evident that where low frequency notes are to be reproduced naturally, the last audio tube should be a power tube operating at its maximum plate voltage with the proper amount of negative grid bias.

The power tubes and improved audio transformers which are now available are among the chief contributing factors toward the wonderful advances recently made in quality reproduction. These tubes require, however, plate voltages and plate currents higher than can be economically produced with B batteries and greater than can be supplied with the average B eliminator now on the market. Standard parts are now available for the construction of high voltage B eliminators of the power amplifier type which not only supply the high plate voltages for the other tubes in a receiver. The filament of the last power tube can

be heated with 60-cycle alternating current, without causing an appreciable hum, or excessive drain on the A batteries used for the other tubes in the receiver. The power transformer supplies the filament current for both the rectifying tube and the power amplifying tube, as well as the plate supply for the entire receiver.

A great deal of distortion in most receivers is due to tube overloading which is caused by strong signals producing grid voltage swings either so that the positive peaks are cut off, or that the negative peaks reach a point where little or no plate current flows. Either of these conditions produces imperfect modulation of plate voltage with resultant discord and rattle in the loud speaker. Overloading occurs generally in the last tube because the grid voltage on this tube is greatest. If the UX-210 power tube is used in the last stage, it is well worth while to place a D.C. milliammeter with a 50-milliamperere scale in series with the D.C. line, and adjust the bias on this tube until the needle does not move with the strongest signal. It will be found that the lower the plate voltage, the more difficult it becomes to make this adjustment. Following is a complete list of the parts and their constants:

- C₁=2 MF. 1,000 V. Test
- C₂=4 MF. 1,000 V. Test
- C₃=2 MF. 1,000 V. Test
- C₄=4 MF. 1,000 V. Test
- C₅=1 MF. Low voltage
- PF52=AmerTran power transformer Type PF-52
- AFT-1=AmerTran DeLuxe 1st stage
- AFT-2=AmerTran DeLuxe 2nd stage
- L₁=AmerChoke, type 854
- L₂=200 turn air core R. F. choke
- L₃=Audio freq. choke
- M=D. C. milliammeter 50 MA.
- R₁=8,000 to 9,000-Ohm resistance, Ward Leonard
- R₂=7,500-Ohm resistance, W. L.
- R₃=5,000-6,000 ohm resistance, W. L.
- R₄=20,000 to 25,000-Ohm resistance, W. L.
- R₅=50,000 Ohm variable, Central Lab. or Clarostat.
- R₆=Federal No. 25 1,700-ohm for bias on UX-210.
- R₇=0.1 to 1-Meg. variable leak, Central Lab., or Clarostat

Making the Hammarlund-Roberts Non-Regenerative

SINCE the publication of the KB-8 data in the March issue of RADIO ENGINEERING, we have had a number of requests from those who have built Hammarlund-Roberts receiving sets, asking if they, too, can be changed around so as to be non-oscillating.

Fortunately, the Hammarlund-Roberts design lends itself very readily to this change. First, the tickler coil should be removed from the tuning unit. In the official Hammarlund-Roberts data, the terminals are marked 6 and 7 on the schematic and picture wiring diagrams. Then a wire should be run directly from P, on the detector socket, to the P post on the first A. F. transformer. For experimental purposes, the tickler can be disconnected and turned at right angles to the secondary winding, although results are slightly improved if the tickler is taken out of the field of the secondary. Then the gridleak on the detector should be changed to one of 5.0 megohms. The potential on the +B detector binding post should be reduced to 22 volts. As a last step, you will probably find it necessary to disconnect the 0.002 mfd. fixed condenser which goes from the P post of the first A. F. transformer to the positive side of the filament.

Then, substitute a Donle detector tube for the 201-A tube.

For those experimentally inclined, it will be interesting to disconnect the first A. F. transformer and put in its place a resistance coupling unit. The terminal markings on a resisto-coupler correspond with those on the A. F. transformer, and the wire should be connected to the resisto-coupler which is the same as if it were a transformer.

In experiments we have made, the non-regenerative Hammarlund-Roberts set is just as sensitive on ordinary weak signals, although you may find that for extremely faint stations there is an advantage in regeneration. Anything that comes in with good quality when the set is hooked up for regeneration will come in as loud and with still better quality when it has been changed over.

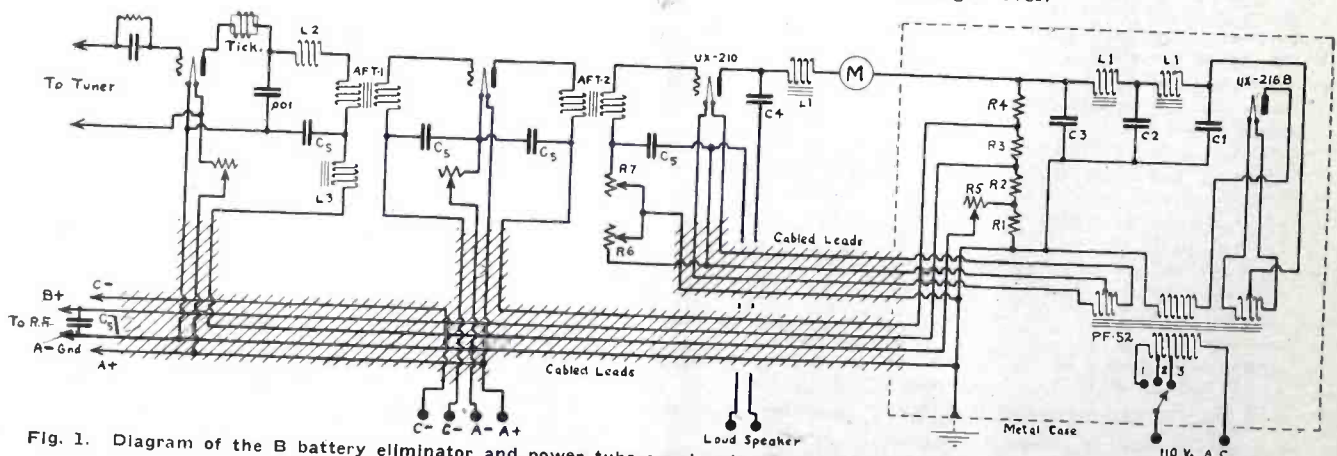

Fig. 1. Diagram of the B battery eliminator and power tube supply circuit. Leads at the left go to the balance of the set.

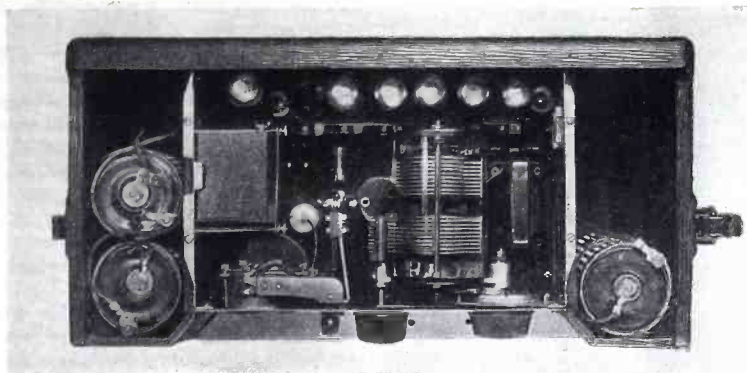

Fig. 1. The instrument compartment. As a UX-120 is used, no tube is inserted in the left hand socket of the gang.

I. and M. Data on the Operadio

Things the installation and maintenance man should know about servicing the Operadio portable receiver.

SEVERAL years of specializing on the manufacture of portable radio equipment has enabled the Operadio Company to eliminate practically all of the difficulties which have arisen when the sets have been operated by reasonably intelligent people, but there are always some folks who can do what shouldn't be done or undo what has been done correctly. The installation and maintenance man, therefore, needs some general data about the Operadio in order to check up on things which interfere with the proper operation of the set. The design of the portable and console types is the same, so that what applies to one applies to both.

The greatest source of trouble is due to the UV-199 tube. Many B.C.L.'s buy tubes without having them tested or buy very cheap tubes which deteriorate quickly. The set is made so that a UX-120 or CX-220 tube can be used in the separate left hand socket. In that case, no 199 is put into the left hand socket of the gang unit. This is shown in Fig. 1. When the power tube is employed, a small size 22½-volt battery should be used for the C battery. That is directly in front of the power tube. With a 199 for the last tube, however, a 4½-volt biasing battery should be employed.

With the correct C battery in place, turn the voltage control so that the A voltage on the lower scale of the meter reads 3.25. Have the B batteries connected and the loop plugged in. Set the volume control at 0 and rotate the tuning control from 0 to 100, at the same time tapping the spring contact on the loop post inside the set with your finger. No popping noise should be heard at any point of the tuning control setting. If the popping noise is heard, the tubes in the center pair of sockets in the gang unit should be changed. It may be necessary to reduce the voltage to 3.

A popping noise should be heard when the loop contact spring is touched with the finger when the volume control is set at 5, and the loop parallel or at right angles to the front of the set. If a noise is not heard at first, turn the loop 180 degrees from its original setting. This noise should come in at any point on the tuning control dial. If it is not heard, try it shifting the second and third tubes in from the right of the socket gang.

When the set howls just at the click point as the volume control is advanced, this can be eliminated by adjusting the choke condenser, the small circular condenser located on the

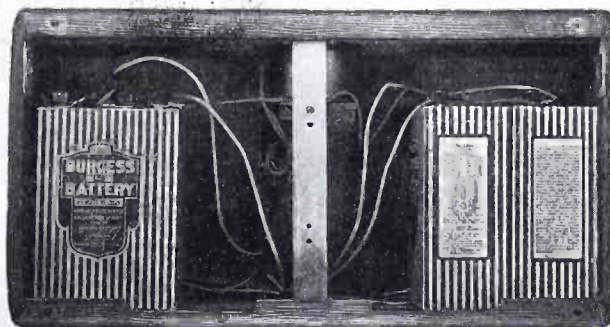

Fig. 2. B batteries are carried in the compartment in the bottom of the set. Colored leads indicate the proper connections.

Bakelite panel just behind the loop mounting. Turn the center screw to the right a quarter of a turn at a time until this howling stops. Do not turn it any more than is absolutely necessary. After the set has been in operation a short time it may be found that the screw could be turned back to the howl. This screw should be kept turned as far to the left as possible.

The loud-soft switch on the front

panel is very important because, by operating the set with the switch in the soft position as much as possible, the B battery consumption is greatly reduced. Practically all local stations can be brought in with the switch at the soft setting.

The voltmeter provided on the Operadio set is a great convenience to the installation and maintenance man. When a trouble call comes in, the owner should be asked the readings of the voltmeter for the A and B batteries. If the voltmeter doesn't show at least 3 for the A batteries, the set requires new dry cells. The B battery reading should show 65 volts. A variety of battery combinations can be employed, but for ordinary use at least 65 volts is necessary.

Once in a while a B.C.L. incidentally crosses the wires and blows the B battery fuse. The fuse is located directly behind the voltmeter jack, and is mounted on the Bakelite panel. If the B battery fuse is blown, there will be no B reading on the voltmeter. Spare fuses are mounted on the right hand side of the top compartment, right near the right hand tube. It is essential to use an Operadio fuse, for they are designed to pass 0.175 ampere. Substituting a dry current fuse may cause the owner to blow out all his tubes in case he makes a mistake.

Occasionally, through carelessness in inserting the loop, the wiping contact on the loop mounting becomes loose. That generally causes a scratching noise when the loop is rotated. Examine this point to see that a perfect connection is made at all positions.

These elementary instructions, plus the information given in the Operadio handbook on connecting the A and B batteries is practically all the infor-

mation required by the installation and maintenance man. Because of the design of this set, if the fault cannot be located readily, the set should be sent to the nearest Operadio service station. It is difficult to take the tuning unit out of the cabinet, and it is quite likely that the set will be more seriously injured, for the circuit is not easy to follow through without considerable experience on this type of receiver.



In the first place, there is a decided tendency toward compact construction, and the designer's ability is frequently tested by the necessity for maintaining high electrical efficiency while grouping the instruments into a limited amount of space.

Since the design was not to be strictly orthodox, we selected an odd-size front panel, 10 ins. high by 12 ins. long, of 3/16-in. Celoron. The reason for this will be developed as the design is discussed.

It is an axiom of good design practice that a radio set should be as attractive in appearance as it is efficient in operation. The foundation of attractiveness is symmetry of design. Just as an artist distributes weight and mass in a painting, this same practice must be followed in arranging the parts of a radio receiving set.

It is generally easy enough to group instruments together, but that brings up the matter of leads, which so materially effect the results of the completed outfit.

You will notice many times, perhaps without realizing that you feel it, that poorly constructed sets have blank spaces here and heavy masses there, placed with no relation to the finished design.

On the other hand, it is perfectly

Our Idea of the Universal

Using the parts originally specified for the General Radio Universal set, this new design was developed—By M. B. Sleeper

TO the radio man who has some understanding of the fundamentals of apparatus design, there is as much interest and enjoyment in the mechanics of radio equipment as in the actual operation of the apparatus.

The General Radio Universal receiver, because of the combination of instruments and the circuit employed, offered an excellent problem in mechanical design, and from that angle we tackled the set in the Radio Engineering laboratory. The parts used, except for some of the hardware and the panels, are identical to those

specified in the original design. The result, however, as you will see from the accompanying illustrations, is very different.

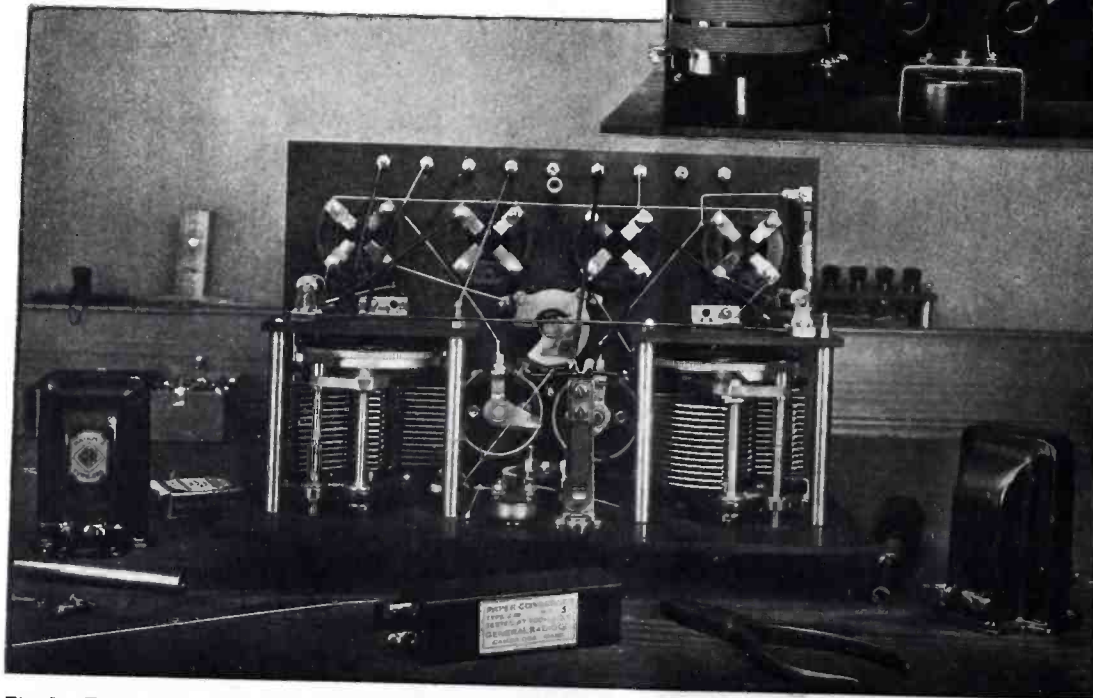
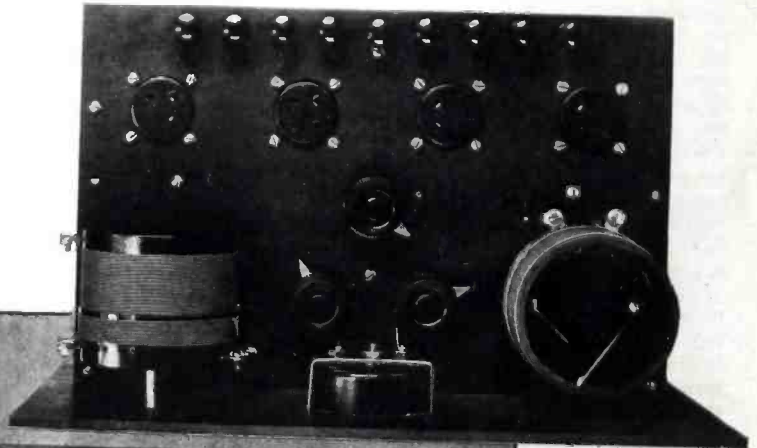

Fig. 1. The bottom of the set, with the transformers removed showing the sockets, rheostats, and neutralizing condenser. Insert—Top of the tube panel

possible, except in unusual circumstances, to break up such disproportionate distribution, and make the parts look as if they are all knit together.

Figs. 1 and 2 show our design for the Universal receiver, laid out in accordance to the foregoing discussion. On some sets, the equipment lends itself to the use of a long panel with the instruments on a narrow tube panel close to the back of the front panel. That was true on the Brown-Drake Five. Again, on such a set as the KB-8, a long panel is employed but, by breaking up the R. F. and A. F. amplifying sections, an effect of compactness is obtained even tho a total depth of 7 ins. is employed.

The Universal receiver, on the other hand, was a little different. That was due to the fact, perhaps, that the tuning inductances are small in size, compared to the variable condensers, and the A. F. transformers are large. Consequently, it was not possible to relate these instruments, together with the auxiliary parts, into a symmetrical arrangement at the back of a long panel.

That accounts for our choice of a 10 by 12-in. front panel, with a tube panel 7 by 11 ins. It is not always

possible to use a tube panel 7 ins. wide, yet on this set, as you will see from the top and bottom views, it worked out very nicely.

On the upper side of the tube panel, there is a neat row of binding posts at the rear, then the appearance of complication which might have been introduced by mounting the sockets on the top of the panel was precluded by setting them underneath. That left just a comfortable amount of space to be broken up by the rheostat and neutralizing condenser knobs, the two tuning coils, and the Dongan filament voltmeter.

The arrangement employed for the sockets is still another illustration of the flexibility of design made possible by the Little Lastite terminals. You have probably noticed the variety of ways that they have been worked into various designs shown in *RADIO ENGINEERING*. In the case of the sockets, we simply removed the screws which were provided as terminals for the contact springs, put the screws thru the panel and the sockets, and into Lastites underneath.

The coils are mounted on standard coil mounting pillars 11/16-in. long by 5/16-in. in diameter, threaded 6-32 clear through. One coil is mounted

on the front panel, while the other is secured to the tube panel. The cross bar at the end of the General Radio coil form is very convenient for this purpose.

The rheostats and neutralizing condenser were put inside on the tube panel at the suggestion of Mr. Gawler, of the General Radio Company. These controls are not critical, and may as well be put out of the way where there is no temptation to play with them.

When you consider the arrangement of the variable condensers and the A. F. transformers, you can readily appreciate what was said about the distribution of mass. It was necessary to have the variable condensers close to the inductance coils, and to have the A. F. transformers directly adjacent to the sockets. At the same time, because of the depth of the tube panel, it was not practical to rely only on small angle brackets to fasten the tube panel to the front panel. All these factors were taken care of by using two vertical sub panels 3 1/2 by 4 ins., of 3/16-in. Celoron. Fig. 1 shows how the panels were fastened so that they would be perfectly firm and at the same time brace the horizontal tube panel. Each small panel was fastened at the top to the under side of the tube panel by an angle bracket, while two panel support pillars, 3 3/8-ins. long by 3/8-in. in diameter, threaded 6-32 at each end, brace the small panel to the front panel.

That left room enough for the variable condensers, and made the sub-panels available for mounting the Amperettes and the heavy transformers.

Of course, luck plays a more or less important part in the small details. Often times a splendid assembly has

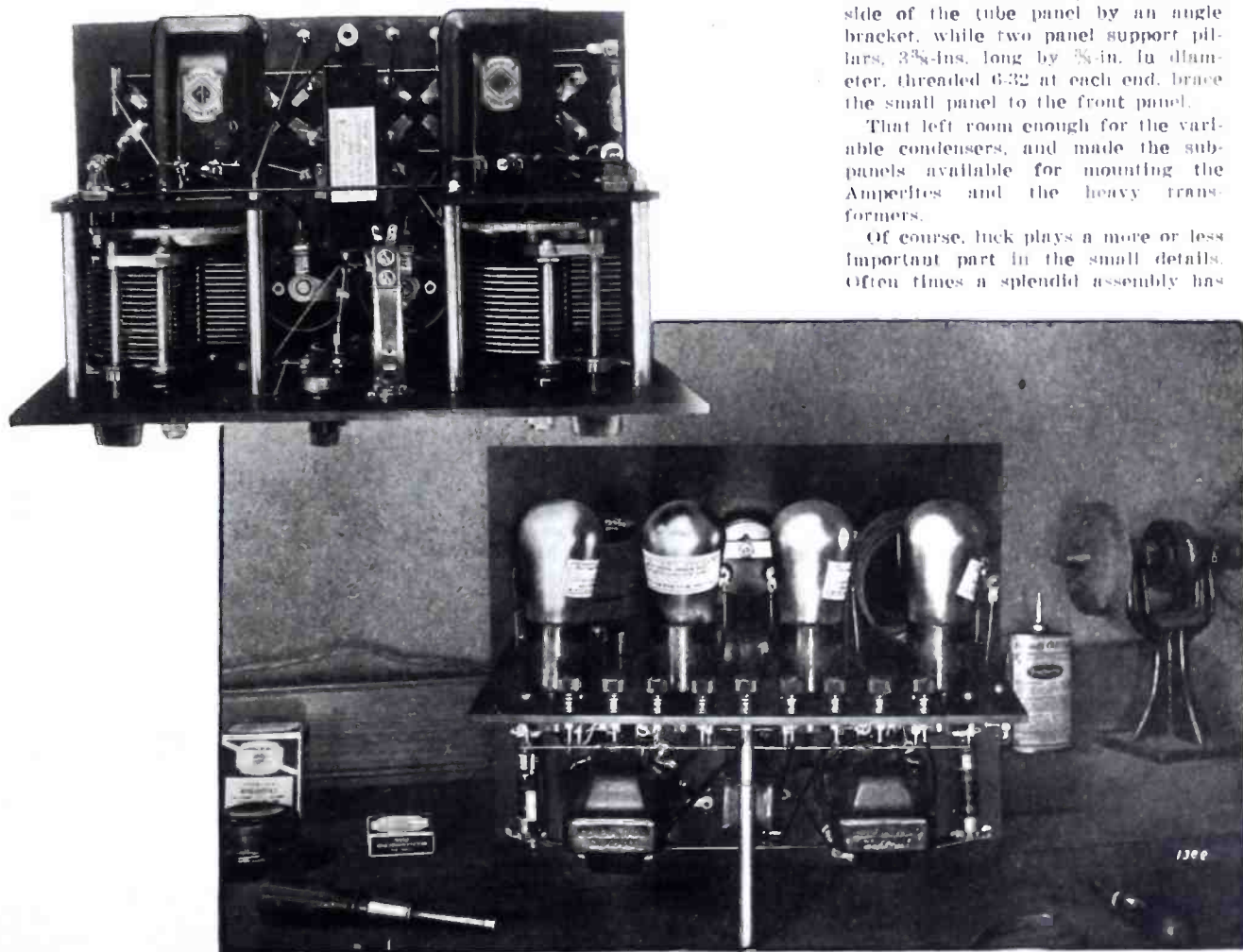

Fig. 2. Rear of the Universal set. Note the impression of balance in the location of the parts. Insert—Transformers in place on the sub-panels

to be rejected because of complications in the wiring, or difficulties introduced in putting the parts together. We are very fortunate not to encounter such trouble on this set, for, if the parts are put together in proper sequence, there is no interference.

We did change one thing. Instead of having both of the vernier control knobs on the condensers at the same side of the main dials, we simply took off one vernier and turned it 180 degrees. That meant drilling a couple extra holes in the front end plate, but that was easy enough to do. The reason was simply to give a symmetrical appearance to the front panel.

As an experiment, we removed the graduated wheels from two Pacent Microverns, and put them on the variable condensers in place of the dials. They were so attractive in appearance that you may like to try this stunt on some of your own equipment. The wheels are just right to clear the vernier shafts on the condensers.

This left the Royalty resistance, Carter jack and switch, and the voltmeter as the only parts on the front. A little engraving put on the finishing touches.

It was our intention to purchase two drawer-pulls of the type which are made to carry small cards. Then we were going to cut off the handles and fasten the card frames on the front of the panel above the condenser wheels. That would provide two places for recording dial settings on the most popular stations. At the last minute, however, we found that the drawer-pulls we could get were too small for this purpose, and they were omitted.

The final test of a design is the operation of a set. Here again luck may be a factor, for the most carefully planned assembly sometimes goes wrong on small things which cannot be predetermined. As it turned out, fortune was with us, for the set operated in a most commendable manner. The variable resistance method of preventing oscillation was smooth and in every way satisfactory. In volume and sensitiveness, too, it seemed as if we had even better results than we had anticipated from the enthusiastic reports of those who build the set according to the original design.

The next time you design a set of your own, keep some of these things in mind. The experienced designer takes them into account unconsciously as he works, but the novice can very definitely improve the appearance of his work by spending a little time and thought on the arrangement of his apparatus instead of working only for the results obtained after the instruments have been put together hurriedly.

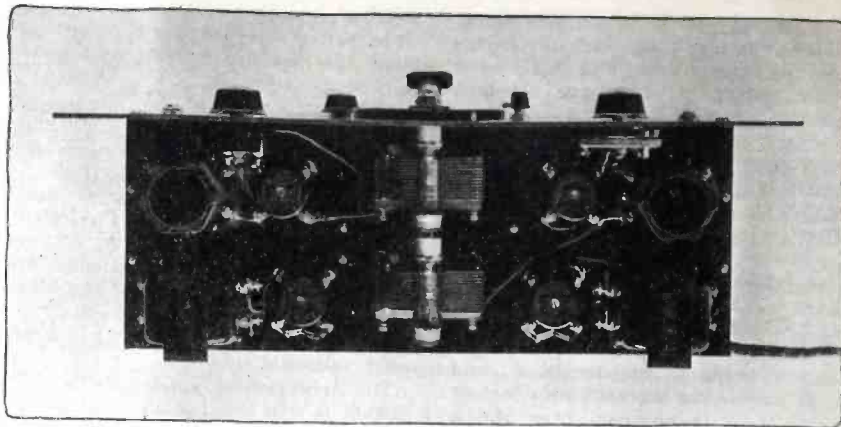

Fig. 1. This arrangement makes the coils accessible for changing, and permits the variable condensers to be synchronized while the set is in operation

New Trends in Set Design

This construction kit introduces features which will become increasingly popular, for they are basically sound

—By *McMurdo Silver* *

THE S-C single control receiver has been received by set builders with tremendous enthusiasm, and it has been very interesting to look into the reason for the high rating of acceptance which has been accorded it.

All manufacturers as well as the dealers and jobbers have been puzzled to find some things about which they were not enthusiastic taken up quickly by the public, while others have had a very cool reception when they promised much in volume of sales.

In almost every case, if the sale of a set or a kit is carefully analyzed, it will be found that the general public react quickly and strongly to good engineering practice, even tho they are not sufficiently familiar with the radio part to analyze their attitude.

It was with this very important merchandising factor in mind that the S-C receiver was developed.

It is an easy matter to make an outfit which will meet competition in range, volume, and sharpness. Super-sensitiveness can be attained without excessive cost, but it has been demonstrated time after time that real engineering built into a set can put it beyond the competition of its price or performance class.

Take the connection cable, for example, which is used for wiring the S-C receiver. The average set builder responds quickly to this idea as a novelty, yet at the same time he recognizes it, perhaps unconsciously, as a genuinely sound piece of engineering.

Then, having used this method of wiring the first time, he will insist upon it in the next set he builds. Very quickly, the connection cable will be translated into complete receiving sets, for the set builder exerts a tremendous word-of-mouth influence through the

entire industry. It has been found time and again that the set builder is the spokesman for the buyers of complete radio sets.

Concerns manufacturing equipment or kits for the set builder are, consequently, usually ahead of the complete set manufacturers in new developments, for they are in closer touch with this group who set the pace for the buyers of complete outfits.

Radio frequently repeats itself. Time was when almost all inductances were of the Honeycomb type because, by plugging in coils of different sizes, a wide band of frequencies could be covered. Then came the single-band receivers, covering perhaps 200 to 500 meters. Now new developments are bringing back plug-in coils, but of a very different design, for low losses are demanded in present-day coils.

Short wave transmission is receiving a tremendous amount of attention since we have outgrown the idea that reception was not possible below 100 meters. The reception of signals from stations 2,000 or 3,000 miles away has become so ordinary that the DX fans are now requiring a practically unlimited range, made possible by the use of very short waves.

European broadcast stations, operating on 1,600 meters, are being received in the United States.

To cover these two fields, we have gone back to plug-in coils, but of a design which has far lower losses than the old Honeycomb coils.

Here again the set builders are setting the pace, and a review of models for the coming season shows that complete set manufacturers are preparing to meet this special requirement which, very soon, the B. O. L.'s will take up from their set builder friends.

The type of coil used in the S-C set is fitted with six contacts, around the bottom of the coil frame, which en-

* Pres. Silver-Marshall, Inc.

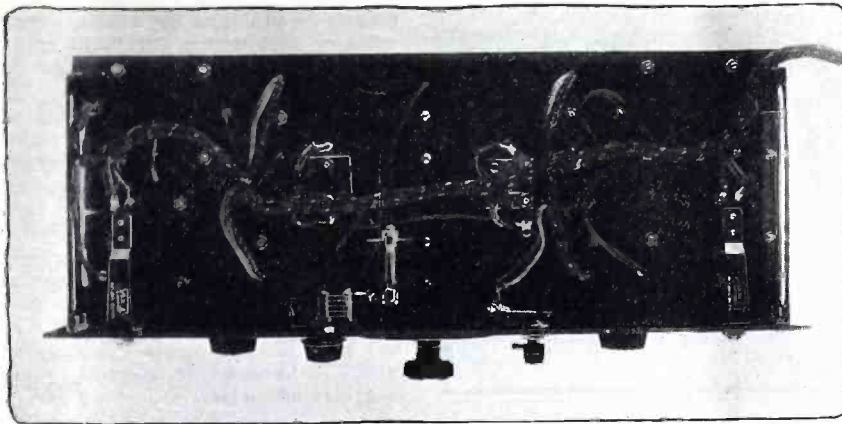

Fig. 2. The pre-formed cable, with its varicolored wires, simplifies connections and provides continuous conductors, straight thru to the batteries

gage with springs set into a Bakelite ring that serves as a mounting and at the same time carries the terminals.

This outfit is probably the first to be equipped with sockets for UX tubes only. We find that the set builders much prefer the UX base. It may appear that this choice is due to the novelty of the mounting method, but, at the same time, it must be admitted that it is better engineering than the UV type.

When single control methods were first introduced, everyone tried it, and practically everyone gave it up for a bad job. The obvious reason was that, being different, it was not as easy as the old method, but now we find that those who failed gave up too easily, for single control is thoroughly practical. It is just a matter of maintaining closer limits in the condenser design, in the coils, and in the wiring. Only experience at trying was necessary to show that coils can be maintained so closely as to be interchangeable. Variable condensers are somewhat more difficult to handle, yet,

confronted by the necessity for doing so, methods have been developed for keeping them uniform.

Because of the particular purpose of this set, an auxiliary condenser is used to take up slight variations, for the average set builder has not the facilities of the manufacturer for setting the condensers when the outfit is put together.

The window-dial is the forerunner of a style which will be popular in all types of sets. This will, undoubtedly, develop into an arrangement built into the panel. Possibly it will take the form of an indicator unit such as we find on automobile dashboards.

There is still much difference of opinion concerning A. F. amplifying methods. We analyzed the present demand carefully before deciding upon the big Thordarson transformers, and selected them as being entirely safe, for, when all is said and done, considering both quality and volume, the permanence and dependability of a high grade transformer has a great deal in its favor.

By checking over these factors it is easy to understand, then, the success of the S-C receiver as a merchandising proposition, and it will be interesting to watch for future developments to bear out the prediction that design trends illustrated in this outfit will be built into many of the complete sets brought out for the fall season.

New Shape For Condenser Plates

An original idea in variable condenser design is presented by the Allen D. Cardwell Company, Brooklyn, New York. These condensers give a straight line frequency characteristic. This is obtained without the use of irregularly shaped plates. Instead, the fixed and variable plates are thicker at one end than at the other.

When the variable plates are turned in, the thin end meets the thin end of the stator, giving a wide spacing. When the plates are turned 180 degrees, the thin end of the rotor gets around to the thick end of the stator, where the spacing is very small, and the thick end of the rotor is within the thin end of the stator.

In other words, the S.L.F. characteristic is obtained by varying the separation between the plates during the rotation, instead of varying the radius which is intermeshed.

The advantage of this design lies chiefly in the economy of space. Moreover, these plates should prove to be very rugged, and should withstand much hard use.

The Cardwell Company is also building a modified S.L.W. condenser, designed for approximately S.L.F. tuning at the low capacity, and additional station separation at maximum.

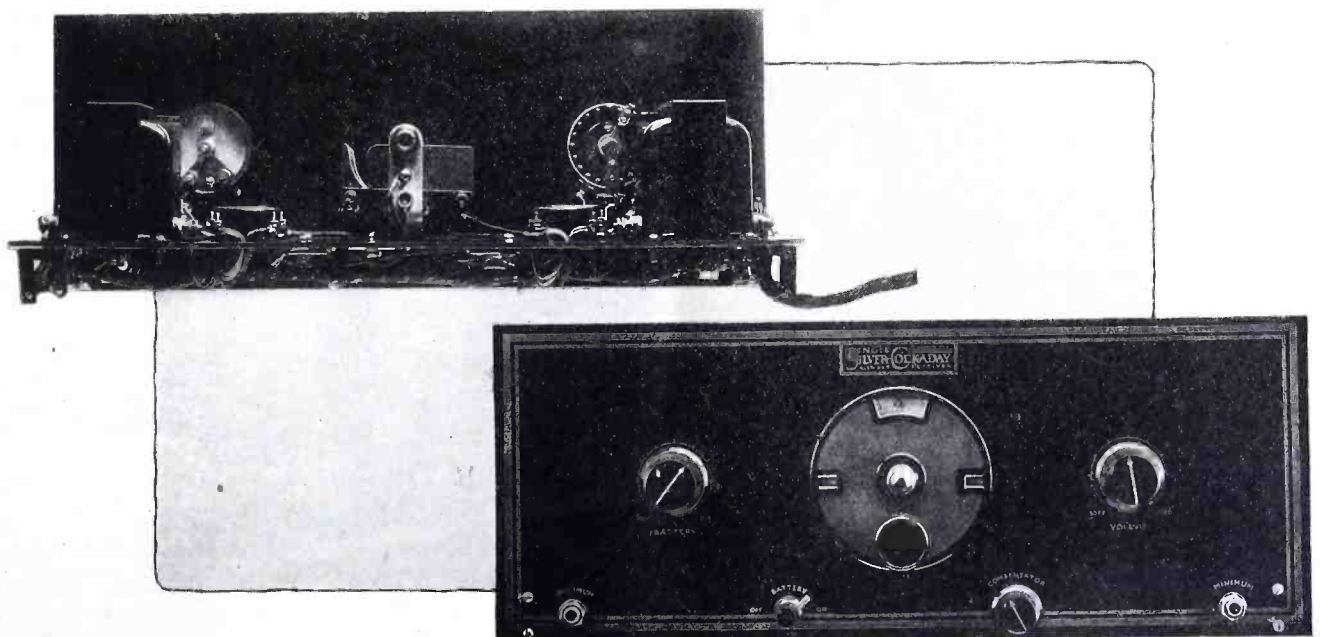

Fig. 3. Rear and front views of the S-C receiver, illustrating the tube panel system of assembly and the layout of the main and auxiliary controls. The panel is of decorated Bakelite

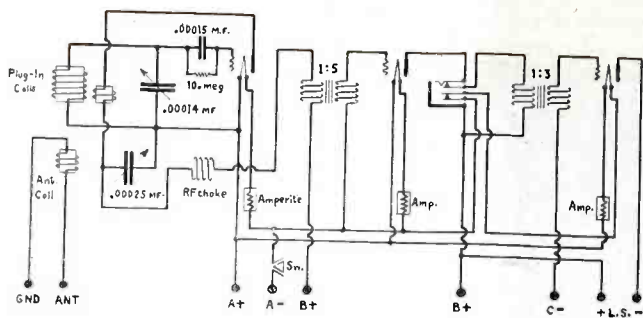

Fig. 1. A simple circuit for a set which has a practically unlimited receiving range

5-N-1 Super-Range Set

5,000 to 10,000 miles is the range of this short wave receiver. It tunes over five frequency bands, covering 16 to 550 meters

—By S. W. Nichols *

NOT so long ago, the man who claimed that he heard a broadcasting station two or three thousand miles away was put into the class of the golfer who makes a hole in one, but to-day anything short of five thousand miles has become local reception.

With the advent of short wave transmitters and receivers, the possible range of radio sets has been increased to one-half the circumference of the globe. An entirely new field of interest has been opened up by short wave equipment. Set builders are finding new applications for their experience, DX fans among the B.C.L.'s are learning the code, and a furor of activity exists which rivals the days of the first broadcasting.

It is fortunate that the short-wave band is being put into use, for there is frequency space for a tremendous number of stations. Moreover, transmission on the low waves is so effective that every radio service on the

* With the assistance of F. J. Marco.

air is hastening to make use of it.

There are things going on between 10 and 200 meters of interest to everyone. Special broadcasting and re-broadcasting is being done. It is possible, when the interference at longer waves is too bad or the static too severe, to go down to short waves and escape both. There are two-way phone stations, with interesting conversations to listen in on, and code stations too numerous to count.

For the man who is learning the code, short-wave transmitters offer the best possible practice. There are automatic transmitters, sending at all speeds, which constitute a code school in themselves.

From 10 to 200 meters is a frequency band of 28,000 K.C., while from 200 meters to the highest in use, there are only 1,400 K.C. That is, the low wave band provides twenty times the number of channels that exist from 200 meters up.

At the RADIO ENGINEERING laboratory we have been working for a long time on short-wave sets. There are

many new problems involved in short-wave receiver design, for slight variations which are not noticeable on equipment for the higher waves will change the inductance or capacity of the circuit enough to tune a transmitting station out entirely. Moreover, insulation becomes an increasingly important factor. Just as high frequency currents travel on the outer surface of the wires, instead of permeating them, high frequency currents travel on the outside of insulation. Insulators which are perfect at 60 cycles are absolutely valueless at 30,000 K.C., corresponding to a wavelength of 10 meters.

Variable condensers, coils, grid condensers, gridleaks, and sockets display characteristics, at short waves, of which they were never suspected before. Noises are experienced from microscopic accumulations of moisture on any of the parts. The set must be kept absolutely free from dust, particularly in the form of carbon from smoke.

The accompanying illustrations show the design of the set on which, at the laboratory, we have picked up stations all over the United States, Europe, South America, Hawaiian Islands, and as far away as Africa. These results make us wish the world were larger so that we could reach out to even greater distances. Stations four or five thousand miles away come in with such volume that the headphones cannot be used on the second amplifier.

Anyone who is only familiar with equipment for covering the broadcast band cannot realize the thrill and excitement of hearing two experimenters down in South America talk to each other. Here, at last, is equipment for the man who wants to pick up genuine DX himself, rather than listen dubiously to the claims of others.

The set is very simple in design, for no radio frequency amplification is necessary, and almost anything in the world can be heard with the tele-

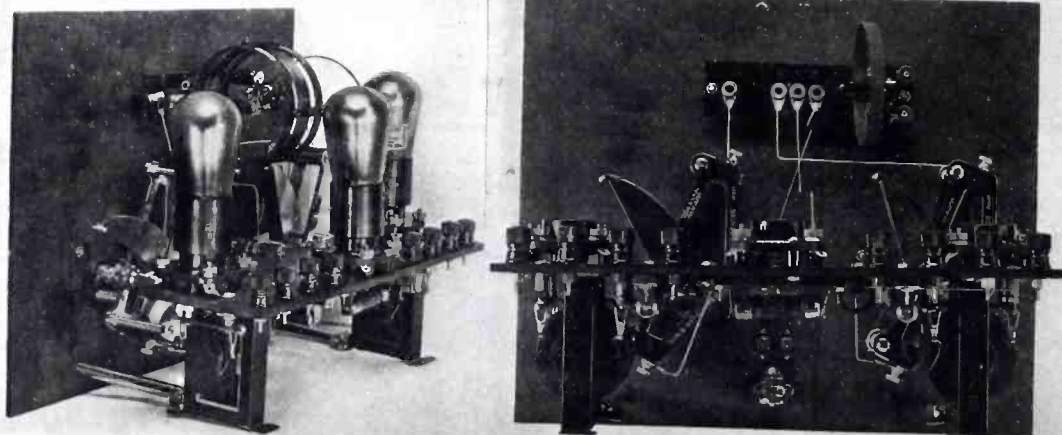

Fig. 2. Left, the finished set, ready to be wired up. Right, the rear of the set before it was completely wired. Notice the mounting for the plug-in coils

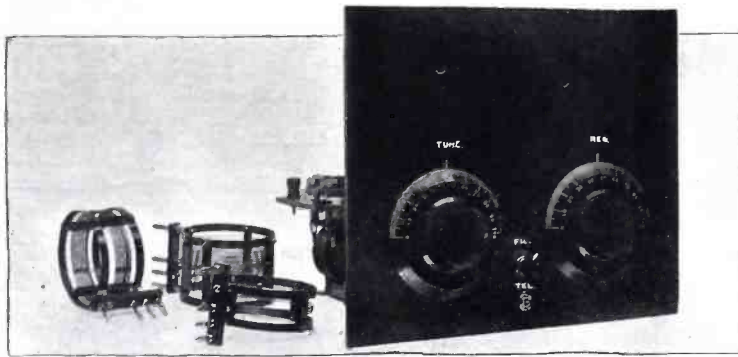

Fig. 3. Here are the three secondary-tickler inductance units for the three short wave bands

phones plugged in on the first A.F. stage. Stations within a thousand miles come in too loud for the telephones on the second stage. For that reason, as you will see from the wiring diagram in Fig. 1, the filaments are arranged so that, when the switch is turned on, all tubes are lighted if the loud speaker is connected to the tip jacks in the second stage. With the telephones plugged into the first stage, however, the filament of the last tube goes out. No readjustment of rheostats is required, for each tube is provided with a 1A Amperite.

The tuning circuit consists of an Aero Products inductance unit which has a built-in adjustable primary or antenna coil, and jacks for plugging in any one of five different secondary-tickler units. Fig. 2 shows the secondary-tickler-unit in place, at the left, and on the right, the mounting without the removable coils.

This tuner is designed to take care of the special requirements of short wave reception. Bare wire, held by threaded Bakelite strips, is used for the secondary. That keeps the capacity of the coil down to a minimum and eliminates solid dielectric within the field. In addition, the framework gives plenty of mechanical strength, so that the coil units can be handled easily. Inside the secondary is a small tickler. That does not require adjustment, for regeneration is controlled by the 0.00025 mfd. feedback condenser. The wavelength is regulated by a 0.00014 condenser. Both are of the Karas low-loss, S.L.F. design.

Both the grid condenser and grid-leak must be chosen with great care, for they are liable to be a source of disturbing noises. The values specified are 0.00015 mfd. for the condenser and 10.0 megohms for the leak.

Benjamin sockets were selected because they have low losses at high frequencies, they provide spring suspension, and will take either UV or UX tubes.

In the A.F. circuit Amertran transformers were employed, the first with a high ratio winding and the second with a low ratio winding.

Since this first set was built, we have been comparing notes with Karas Electric and Aero Products to determine what changes could be made to

still further improve the operation of the set.

Building a short wave receiver is a different job from making a 200 to 600 meter outfit, because the parts cannot be put together in an offhand manner. If that is done, difficulty is always experienced from noises and body capacity defects. Sometimes a little carelessness in wiring is responsible for the strangest detuning. If a wire vibrates, it may change the capacity in the circuit enough to tune out a station altogether.

We now have a final design which is ready in blue print form. As a further check, the design has been submitted to F. J. Marco, of Chicago, who has done a tremendous amount of work on short wave receivers. Much of this has been in a consulting capacity for radio manufacturers. Mr. Marco has gone over the design thoroughly, and every set of prints bears his O.K. and signature.

The data prints give the complete parts list with the constants and manufacturers' names, panel patterns, picture and schematic wiring diagrams, step-by-step assembly instructions and terminal checking list. This makes up all the information that a set builder requires. All the drawings are full size, so that they can be copied exactly in putting the set together.

The operation of the set is a very simple matter. First the wave-length range must be decided upon. The

regular set of Aero coils covers three bands, 15 to 33 meters, 30 to 63 meters and 60 to 130 meters. This is with the 7-plate Karas condenser. Calibration curves which have been made show that coil A, with the variable condenser specified and a 201-A tube, tunes to 3,500 K.C. at 39 divisions to 4,000 K.C. at 57.5 divisions on a 100-division scale. That covers the 80-meter band. Coil B runs from 7,000 K.C. at 47.5 divisions to 8,000 K.C. at 70 divisions. This is the 40-meter band. Coil C runs from 14,000 K.C. at 45 divisions to 16,000 K.C. at 72.5 divisions, for the 20-meter band.

If you want to plot the curve for these condensers, locate the two points given for each coil and extend a straight line above and below it. The curve drops down slightly at the low capacity.

A particularly nice feature about this set is that it can be used for broadcast reception, as well. Two more coils are available which, with the same variable condensers, tune from 200 to 400 meters and 350 to 600 meters.

Therefore, with this outfit, which we have designated as the 5-N-1 receiver, the entire range of experimental and broadcast reception can be brought in.

In the final design of the short wave receiver, embodying the improvements recommended by Aero and Karas, as well as by F. J. Marco, a 7 by 18-in. front panel was used, with a 3½-in. tube panel. Exactly the same parts and circuit are employed. The principal difference is that the inductance unit is mounted on the tube panel. That is to keep it well away from the front in order to eliminate hand capacity effects. That is a very important problem in short wave receiver design. The introduction of only a few micro-microfarads, from hand capacity will cut out a station.

National velvet vernier dials are provided for the condensers. The condensers are set back on coil mounting pillars, and the shafts cut off to accommodate the fastening from the dial which must be adjusted with a set screw at the rear of the panel.

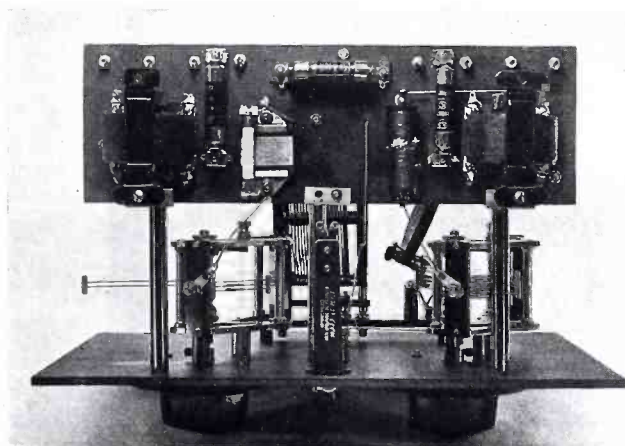

Fig. 4. Looking at the set from the bottom, you can see the arrangement used to reduce the length of the leads

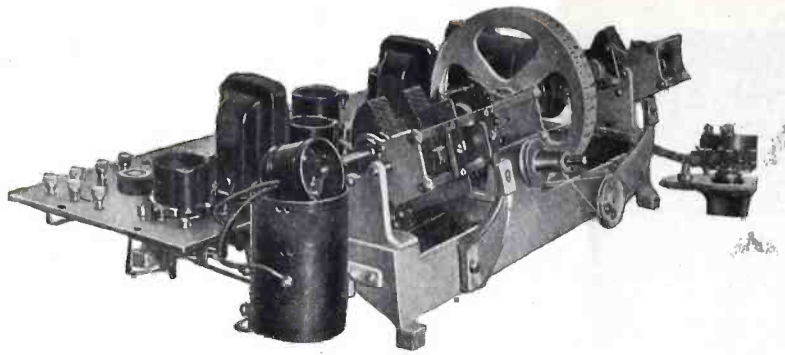

Fig. 1. A real radio machine, designed to be put together quickly and to stay put forever

Radio Set or Machine?

*A marvelous advance from our first sets is represented by the machinery of the modern radio receiver — By R. A. Sayres **

ANYONE who thinks he has reason to find fault with the speed at which radio has been developed in the laboratories, and these developments applied to commercial practice in the model shop, drafting room, and test room should look over the radio magazines and catalogs of a few years back. Then, the beautifully designed radio set was nothing more than an orderly arrangement of units, probably utterly unrelated in their electrical dimensions, fastened to a board or the top of a table.

The obvious weaknesses in assemblies of that sort are now corrected in the modern equipment, and in the process of achieving the proper relationship of electrical dimensions, mechanical features are now to be found in sets which, only a little while ago, were entirely unknown.

While it is unquestionably true that the public has been put to much inconvenience because of the weaknesses and failings of various types of radio sets, it is no less true that manufacturers have been forced to do things they never anticipated in order to pro-

tect their reputations from the dreadful things which the B.C.L.'s have done to radio outfits. Manufacturers have been forced to make their equipment so rugged and simple and fool-proof that it is almost impossible for

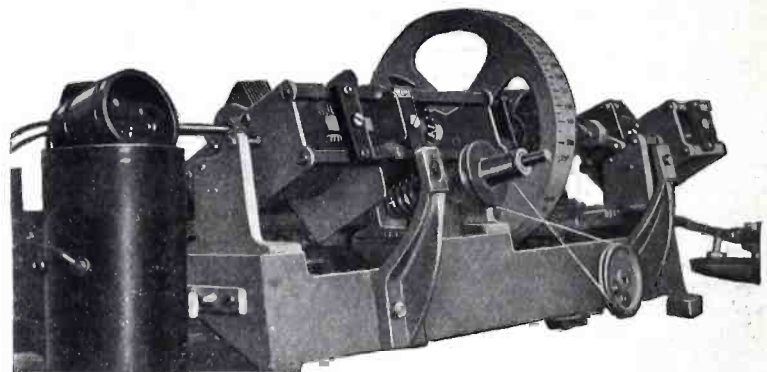

Fig. 2. Close-up view of the die-cast chassis and the variable condenser mounting with the non-slip reduction gear

the uninformed to make mistakes which put the sets out of commission. As is the way of the public, the manufacturer is always blamed for selling anything which can be put out of commission by mishandling.

This explains the unusual construction of the Ferguson Model Eight. From the accompanying illustrations it is clear that the design has been made so rugged that it is proof against any kind of abuse, and we have found that the apparent complexity of the parts which can be seen if the set is opened up is a splendid deterrent to those who might be attempted to meddle.

The entire set is carried on a rigid aluminum frame which we refer to as the chassis. As it is die-cast, dimensions can be held to a thousandth of an inch. Thus it is possible to assemble the set with a minimum of hand work. The chassis provides a direct mounting for the three tuning condensers, the 60 to 1 reduction mechanism, and one inductance unit. A mounting is also provided for the Bakelite tube panel. That has the sockets, transformer, and coils, as well as the incidental items.

Unlike the earlier designs, this set is not carried by the front panel. Experience showed that to be an unsatisfactory method, because it put so much strain on the wood screws which held the front panel to the cabinet, and provided no rigidity for the wiring.

The metal chassis design, on the

other hand, is mounted on the bottom of the cabinet and, by virtue of the metal frame work, no vibration is imparted to the connecting wires. Packing experts found that the continual vibration during transit, between parts which were not fastened firmly together, put just enough strain on the soldered joints that they gave way repeatedly. In the preliminary tests on this design, sample sets were built and shipped to various parts of the country where they were not only subjected to the hazards of transportation but where they were affected by various climatic conditions. Through it all, however, the sets came through with flying colors, and in not one case did the roughest handling or the most severe conditions affect the operation of the set.

In our work along this line we have come to think of receivers as radio machines, for, as equipment is designed in a mechanical unit, it does become machinery, in contrast to the assemblies of the past.

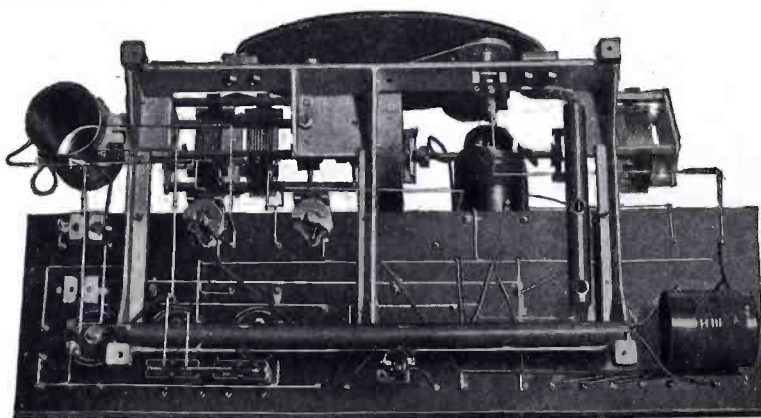
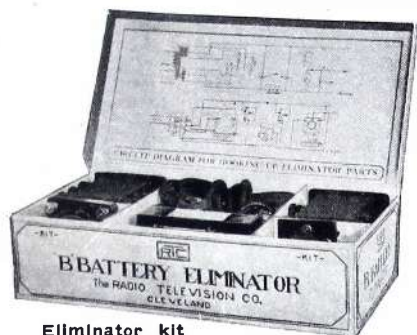

Fig. 3. All the weight of the parts is carried on the chassis which, in turn, rests on the bottom of the cabinet, where it is fastened

*J. B. Ferguson, Inc.

A. C. Supply Equipment

Notes about the manufacturers of parts and complete devices for A. C. current and voltage supply.



Eliminator kit for set builders

Radio Television

THE Radio Television Company, 9410 St. Catherine Avenue, Cleveland, Ohio, is manufacturing a complete line of equipment for power supply circuits. These items include transformers of various types, chokes, low-current fuses down to .09 ampere, and 50,000-ohm. variable resistances for use across supply lines of 100 to 500 volts. They are also making a battery eliminator kit and complete eliminators.

Very shortly, the R.T.C. eliminator for A, B, and C supply will be on the market.

The R.T.C. system is very interesting, for no reactance is employed, but instead a very high resistance which can be of the conventional design or in the form of a vacuum tube, the resistance of which is regulated by adjusting the filament temperature.

American Mechanical Laboratories

American Mechanical Laboratories, Inc., 285 No. 6th Street, Brooklyn, New York, is supplying the Clarostat to manufacturers of power supply equipment, for use as a detector voltage regulator.



The Clarostat for voltage control

The resistance of the Clarostat can be varied from practically zero to 5 megohms, with a maximum carrying

Radio Engineering, April, 1926

capacity of 22 watts. A threaded pressure control, allowing very fine adjustment, is employed to compress a mixture of highly pulverized graphite mixed with pulverized mica. The mica particles serve as tiny springs to spread apart the graphite dust when pressure is released.

Tobe Deutschmann

Tobe Deutschmann Company, Cornhill, Boston, Mass., is producing a condenser block designed particularly for the Raytheon eliminator circuit. The case contains two 2 mfd. and one

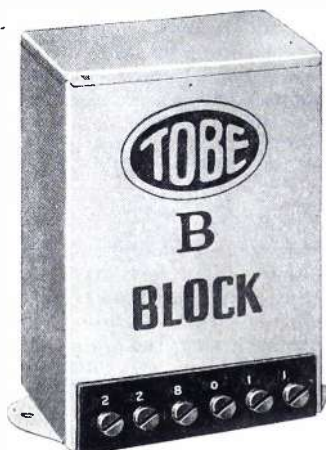

Condenser bank for B eliminator

8 mfd. condensers. This company recommends the mounting of the two 0.1 mfd. condensers in separate cases.

In addition, Tobe condensers for voltages up to 750 made in capacities of 0.1 to 5.0 mfd., and are guaranteed accurate to 5 per cent of their capacity rating.

Acme Electric

Acme Electric and Mfg. Company, 1444 Hamilton Avenue, Cleveland, Ohio, has a tube rectifier type of B power supply. Built for 110 to 120 volts, 60 cycles, it has terminals for the detector voltage and one amplifier tube voltage. Both are controlled simultaneously by a knob at the front of the metal cabinet.

Dubilier

Dubilier Condenser and Radio Corp., Bronx Blvd., New York City, is continuing the production of their Super-Ducon. It is now fitted with a special 2-filament bulb, giving full wave rectification. Various minor improvements have been made, but in outward appearance it has not been changed.

Dubilier also manufactures a D.C. resistance unit with a filter circuit.

Perryman

Perryman Electric Company, North Bergen, N. J., is making two rectifier tubes, one for half wave rectification and one for the full wave circuit. Both types use 4.5 to 5.5 volts on the filaments.



Micamold resistors are sealed in Bakelite

A thoriated filament is employed to give high emission. The design of the elements is such as to give an extremely low voltage drop between plate and filament, in order to give a maximum D.C. voltage.

Thordarson

Thordarson Electric Mfg. Company, Chicago, Ill., has developed a complete line of transformers and chokes for battery eliminators. They have a special group of units for the Raytheon tube circuit. In addition, they are making other types to manufacturers' specifications.

Micamold Radio

The Micamold Radio Corp., Flushing, Ave., Brooklyn, New York, is already making deliveries on their new low-resistance elements. These range from 2,500 to 50,000 ohm. Micamold resistors are of the standard gridleak size, but made with the resistance element imbedded in molded Bakelite. Regular tapered terminals are provided at each end, also molded into the Bakelite. Thus they are permanently protected against moisture. Each resistor is guaranteed within 5 per cent of its rated value.

These units are in addition to the Micamold gridleaks which run up to 10 megohms.



Acme Electric eliminator device

Gould

The Gould Storage Battery Company, New York City, is almost ready to announce improvements which are to be incorporated in the Gould Uni-Power. This is a combination storage battery and rectifier, contained in a very attractive case which covers all the elements. A special switch is provided so that, when the set is shut off, the battery is automatically put on charge.

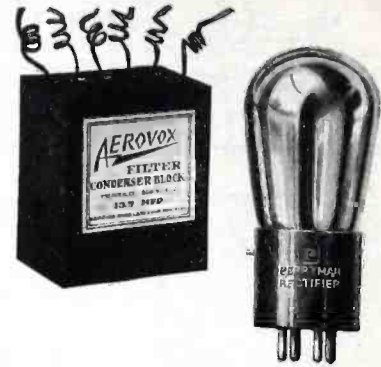

Grigsby-Grunow-Hinds and Davy eliminators, for A. C. operation. At the right, the Aerovox condenser block and the Perryman rectifier tube

Acme Apparatus

Acme Apparatus Company, Cambridge, Mass., is another of the Raytheon tube group. By very clever mechanical design, the Acme eliminator has been reduced in size to approximately the dimensions of a vertical 45-volt B battery.

Two voltages are provided on the Acme unit, one for the detector and one for the amplifier tubes. The former is adjustable by means of a variable resistance.

Acme is also producing a set of chokes and transformers for set builders. The standard Raytheon circuit is employed.

Allen-Bradley

Allen-Bradley Company, Milwaukee, Wis., has developed fixed and variable resistors for power supply devices. There is a variety of applications for the resistors in obtaining voltage drops, while the variable type is also used either in series or in parallel for detector voltage adjustment.

General Radio

General Radio Company, Cambridge, Mass., has a complete line of transformers and chokes for power supply circuits, particularly adapted to use with the Raytheon tube. Their business on these parts is largely through retail distribution channels to set builders, altho some of the manufacturers also are building General Radio units into their equipment.

Davy

Davy Electrical Corp., Brooklyn, N. Y., has completed the development of their A power unit, a device which handles from four to six 0.25 ampere vacuum tubes. Rectification is accomplished by two Rectigon tubes which, as they are operated, their rated output should last almost indefinitely.

The details of the Davy system are not yet available, but the circuit employed does not require condensers of any kind. Moreover, there are no

liquids or moving parts. The A eliminator is designed for standard circuits of 110 to 120 volts, 60 cycles.

All-American

The All-American Radio Corp., Chicago, Ill., has been making transformers and chokes for the Raytheon circuit. Now they are preparing to market a B battery eliminator. This unit, also, is designed for the Raytheon rectifier.

Polymet

The Polymet Manufacturing Corp., 599 Broadway, New York City, has installed equipment for large scale production on by-pass condensers. Polymet is guaranteeing their condensers against breakdown at voltages of 8,000 to 1,000. The capacities cover the usual range required in eliminator circuits.

Radio Pep

Pep Manufacturing Company, Inc., 33 W. 42nd St., New York City, is producing an electrolytic B eliminator fitted with eight cells instead of the four-cell construction ordinarily employed, in order to produce 135 volts under heavy load.

Operating from 110 volts 60 cycles, Radio Pep is supplied with binding posts for 45, 67, 90, and 135 volts. There are no parts to require renewal, altho a little distilled water must be put in the cells once or twice a year.

E. B. Lund

E. B. Lund Company, 74 Broadway, New York City, is importing a very complete line of condensers from Germany. These include condensers up to 10 mfd., constructed to withstand up to 1,000 volts A.C. or 1,300 volts D.C. A variety of mounting methods and connecting lugs are available.

Epom

The Epom Corporation, 114 East 47th Street, New York City, has a very interesting development in B eliminators. They are making a special type designed and adjusted at the factory for the Atwater-Kent Model 20 sets.

There are simply three binding posts on the eliminator to run to the receiver, and a cord for plugging into the A.C. line.

This is in addition to the regular Epom eliminator which has been on the market for some time. The Epom tube has no filament. It is of the double-plate design, built to handle both halves of the cycle.

Aerovox

Aerovox Wireless Corporation, Broome Street, New York City, has apparently solved a problem which has been encountered by most eliminator manufacturers, namely, that of making high resistance units of fairly high current carrying capacity.

The Aerovox type is wire-wound, and provides a resistance of 2,500 ohms. per inch of length. The units are so designed that they can be fastened together, and taps brought off as required. The diameter varies according to the current carrying capacity required. As they are now de-

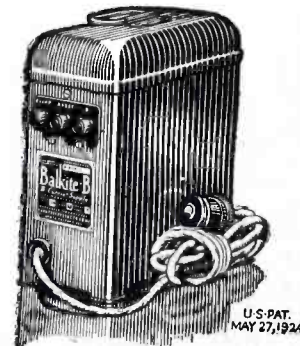

Small Balkite chemical eliminator

signed, they can handle up to 0.25 ampere.

Aerovox is also building two types of filter condensers of standard values. The smaller has an A.C. working voltage of 150 or 250 on D.C., with an A.C. flash test of 550 or 800 volts D.C. The larger type is built to withstand 300 volts A.C. or 500 D.C. and a flash test of 1,500 A.C. or 2,000 D.C. Flexible wires are used for the terminals.

BRANDES will welcome the opportunity of cooperating with set manufacturers to create speakers adapted to the particular needs of their receiving sets. Brandes are experts in radio acoustics.

They have well-equipped laboratories manned by a large and efficient staff.



Brandes

*Experts in radio acoustics
since 1908*

15 to 550 Meters

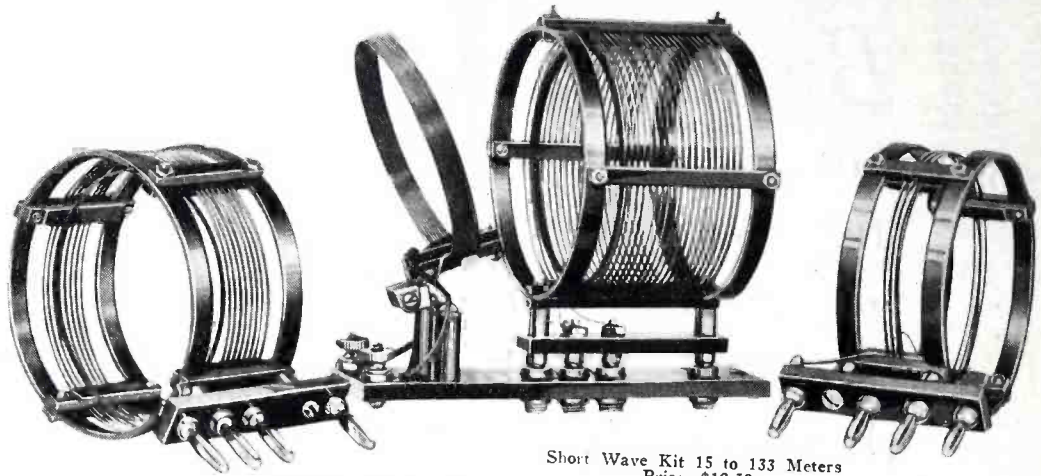

Short Wave Kit 15 to 133 Meters
Price \$12.50

Coils here illustrated cover wave band 15-35 and 30-65 and 60-133. The other two coils which cover bands 125-250 and 235-550 are illustrated to the left.

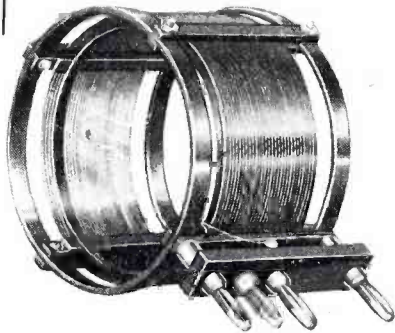

Aero Coil No. 4 for wave band 125-250 meters. Price \$4.00. (Fits mounting base in kit.)

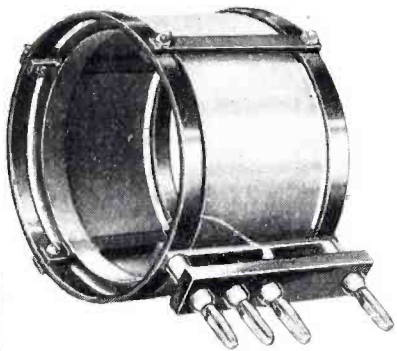

Aero Coil No. 5 for wave band 235-550 meters. Price \$4.00. (Fits mounting base in kit.)

OTHER Aero Coils for B C L Band

| | |
|------------------------------------|---------|
| TRF-120—Tuned R. F. Kit—3 units.. | \$12.00 |
| RFR-110—R. F. Regen. Kit—2 units.. | 11.00 |
| CT-80—3 Circuit Tuner..... | 8.00 |
| OS-55—Oscillator | 5.50 |
| AX-45—Antenna Coupler | 4.50 |
| WT-40—Wave Trap Unit..... | 4.00 |

Capetown, South Africa—7500 Miles, was received in the Radio Engineering Laboratories in New York—on a new wonder set which uses these coils—described in this issue.

Here is the ultimate in "universal" receivers — made ideal for short wave work by the perfect adaptation of the famous Aero Coil.

The receiver illustrated in this magazine, in the New York laboratory of Radio Engineering magazine has been copying amateur stations 5000 to 7500 miles away. An amateur at Cape Town, South Africa was brought in with extreme volume on a loud speaker by this amazingly efficient receiver.

The operating principle of this new set is inductively coupled feed back to the antenna, controlled by variable capacity coupling. The receiver is very easy to control and works very smoothly and quietly in any band from 15 to 500 meters.

The Perfect Inductances

The antennae primary.

Aero Products, Inc., Dept. 14,
1768-72 Wilson Ave., Chicago

though variable is permanently mounted. Only the grid coil is interchangeable — and change from one wave band to another is accomplished by merely plugging in the proper coil.

Coil Specifications

The inductances are the patented Aero Coils. The wire is bare copper, for the short wave work—each turn uniformly air spaced from the next—but rigidly supported in the strong, skeleton bakelite patented Aero Coil frame.

Order Direct If Your Dealer Is Not Stocked

Accept no substitutes for these perfected, accurate inductances. If your dealer is not yet stocked with this plug-in Kit, order direct from us.

AERO PLUG IN COILS

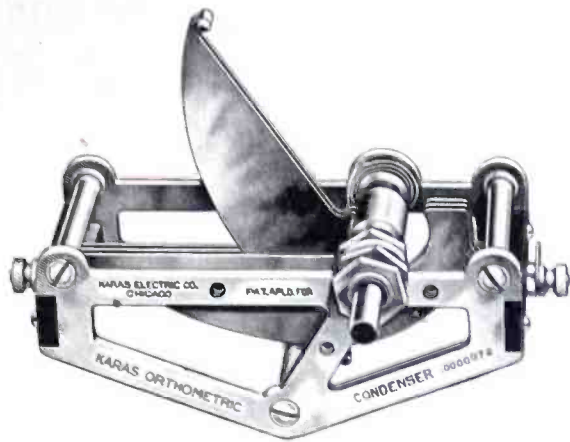

The KARAS Orthometric Straight - Frequency - Line Condenser

*Ideal for both Short Wave
and Broadcast Receivers*

The Condenser Recommended for the 5-N-1 Short Wave Set

Karas has taken the lead in developing condensers to meet the exacting requirements of Short Wave work. Karas builds the only 140 mmfd. condenser on the market. The Karas Orthometric 7 plate and 11 plate condensers are recommended for the new 5 N1 short wave set described by Mr. Sleeper in this issue of Radio Engineering.

How many short wave experimenters appreciate the extremely exacting condenser requirements of a short wave set? How many realize that many condensers, satisfactorily adapted to the broadcast range, will prove quite worthless in short wave reception?

At 10 to 40 meters, radio energy performs many queer tricks. The dielectric MUST neither leak or absorb energy. It must be highly efficient as a dielectric, and be placed well without the effective electro-static field. The plates must hold the charge without variation. All these things are well accomplished in the design and construction of Karas Orthometric short wave condensers. They are as nearly perfect both electrically and mechanically as it is possible to build condensers.

The accurate straight-frequency-line characteristics of Karas Orthometrics are vitally important in short wave work. Think of it! There are as many channels of 10 kilocycle separation between 50 and 60 meters as there are between 200 and 500 meters.

Order Through Dealer, or Direct on This Coupon

Karas Condensers in the 23, 17 and 11 plate sizes are generally sold by good Radio Parts Dealers in most cities. They are sold subject to our regular 30 day guarantee of "Satisfaction or your Money Back." Due to the scattered demand for condensers built for short wave work, the 5 and 7 plate sizes are not so widely stocked by dealers. Orders will be filled direct, or may be placed through your dealer and his jobber. If you prefer to order direct, use this coupon. Send no money. Just pay the postman the price plus a few cents postage.

KARAS ELECTRIC CO.,

Manufacturing Plant: N. Rockwell St.
Offices: 1064 Association Bldg.,
Chicago, Ill.

Mechanical accuracy is vital. Slight variations in plate spacing that might be immaterial in broadcast work would upset frequency control at the tremendously high frequencies with which the short wave set has to deal. The spring pig tail connections on the 5 and 7 plate condensers are insulated to prevent contact noises at extremely high frequencies.

Karas Orthometric Condensers are mechanical masterpieces. They go far beyond the standards of accuracy heretofore considered necessary in condenser construction.

You will probably want one or two stages of audio in your short wave receiver. You cannot beat Karas Harmonik Transformers. Include one or two transformers with your order. They are \$7.00 each.

Specifications of Karas Orthometric Short Wave Condensers

Price \$6.50 each.

| | |
|----------|-------------------------|
| 5 plate | Max. Cap. .0001 mfd. |
| | Min. Cap. .00001 mfd. |
| 7 plate | Max. Cap. .00014 mfd. |
| | Min. Cap. .0000108 mfd. |
| 11 plate | Max. Cap. .00025 mfd. |
| | Min. Cap. .0000115 mfd. |

Also—

Karas Orthometric Condensers for Broadcast Receivers

23 plate .0005 mfd. price \$7.50

17 plate .00035 mfd. price 6.75

Karas Harmonik Transformers, price \$7.00

Karas Electric Co.,
1064 Association Bldg., Chicago.

Please send me Karas Harmonik Transformers and Karas Orthometric Condensers, sizes as checked below. I will pay the postman the price plus postage upon delivery. It is understood that I have the privilege of returning these condensers and transformers for full refund any time within 30 days if they do not prove entirely satisfactory.

..... 5 plate; 7 plate; 11 plate;
..... 17 plate; 23 plate

Name
Address

If you send cash with orders we'll ship condensers and transformers postpaid.

MR. CHIEF ENGINEER:—You can specify quality and service, and save both time and space in assembly

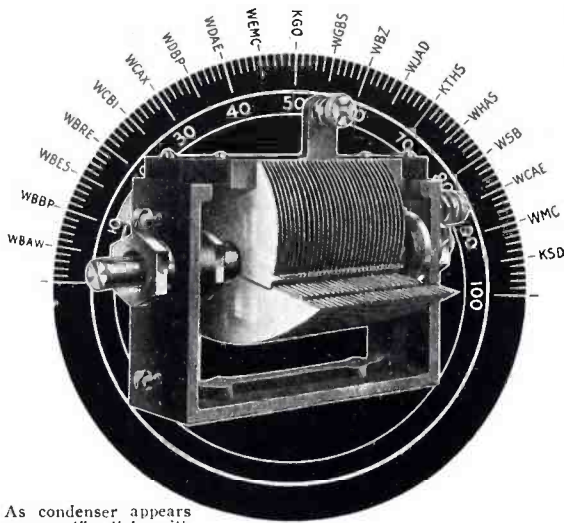

As condenser appears on a 4" dial with shield removed.

Manufacturers have already placed orders for 1926 season, so indicate your requirements at an early date.

Samson
Uniform Frequency
Condensers

give supreme service because of steel shaft and bronze bearings—heavy ribbed die cast frame—large phosphor bronze contact spring—short rigid locked and soldered brass plates—stiff metallic shield—and gold plated stator and rotor plates to prevent corrosion. They are capable of being mounted in three positions and are half to a third the size of others.

Losses lower than laboratory standard condensers and guaranteed accuracy within plus or minus one per cent of their rated capacity are other features covered in an attractive leaflet by our consulting engineer. Send for it.

SAMSON ELECTRIC COMPANY

Manufacturers Since 1882



Canton, Mass.

Sales Representative in 30 American Cities

DEALERS— Blueprints Sell Parts

SHORT WAVE sets will keep up summer business because there's practically no static interference. Sell the new 5-N-1 short wave Dataprints, and keep your customers busy building these sets.

THE 5-N-1 design is endorsed by Karas Electric and Aero Products, and every Dataprint bears the signature and O.K. of F. S. Marco, consulting engineer and short wave expert.

5,000 to 10,000 Miles with 3 Tubes.

5-N-1 Dataprints, with panel patterns, picture wiring diagram, schematic, parts list, all instructions, postpaid.....\$1.00

K-B-8 Dataprints, non-regenerative Browning-Drake\$1.00

RX-1 Dataprints, the famous 4-tube set built for the Donle tube.....\$1.25

Dealers—50% in Lots of 6 or More.

M. B. Sleeper, Inc., Technical
Publisher

A-52 Vanderbilt Ave.

New York City

DONLE DETECTOR TUBES

*Specially Adapted to the Development
of Non-Regenerative Circuits*

MANUFACTURERS of complete receiving sets will find that the increased sensitiveness of the DONLE DETECTOR TUBE makes the use of regeneration unnecessary. This has been demonstrated in the conversion of the KB-8 Browning-Drake circuit, in which no regeneration is employed, without loss of sensitiveness, thru the use of the Donle tube.

DEALERS can improve the operation of all sets by using the DONLE TUBE. Grid return must go to the positive side of the detector socket. 22 volts on the plate, 5 volts, ¼ ampere for the filament.

DONLE DETECTOR \$5.00

6 tubes or more, 30% discount. Cash must accompany all orders. All shipments insured.

C. J. BROWN

AUTHORIZED DISTRIBUTOR

17 West 51st Street

New York City

AMERTRAN

TRADE MARK REG. U.S. PAT. OFF.

DE LUXE

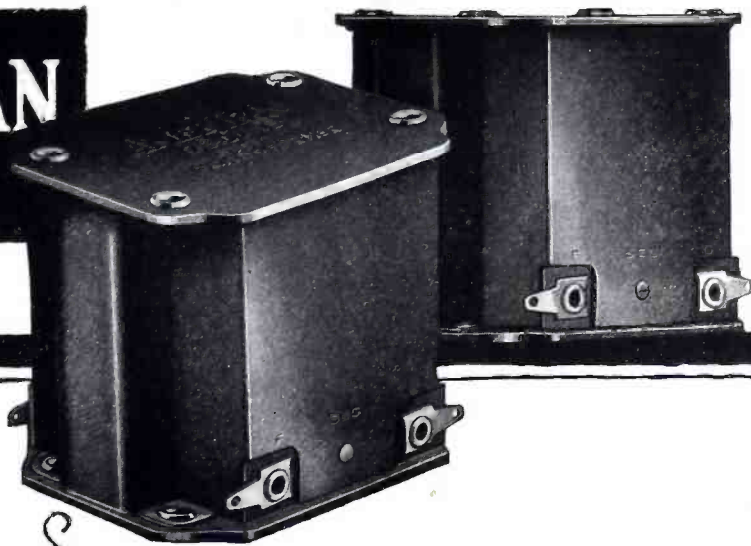

AMERTRAN
Types AF-7 and AF-6

AmerTran audio transformers Types AF-7 and AF-6 have been considered for years among the leaders in audio amplification. These popular and efficient models may now be purchased at a considerable saving in cost. Types AF-7 (ratio 3:1)—AF-6 (ratio 5:1) . . . \$5.00 each

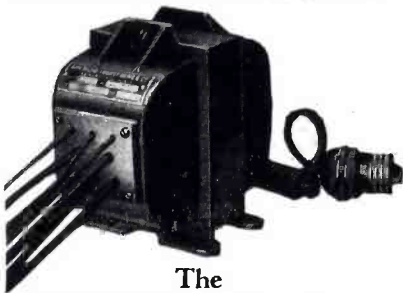

The
AMERTRAN Power Transformer

Type PF-52, 65 VA—60 cycles
110/118/125—525—8/4-8/4

Type PF-52 is intended for use in converting the standard 110 volt, 60 cycle alternating house lighting current to a higher voltage for the plate and low voltages for filament supply. It can be depended upon to give good results when used in connection with the different tubes now available, and as designed with the usual margin of safety.

AmerTran Power Transformer type PF-45 is another transformer of the AC power type, similar to type PF-52 except that it has a plate winding for 450 volts AC and is without a metal ground shield between the primary and secondary winding. Price, Type PF-52, \$18.00—Type PF-45, \$15.00

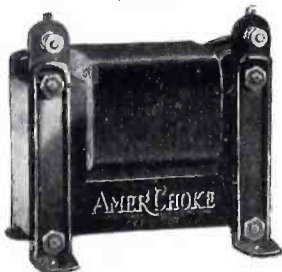

The New AMERCHOKE
Type 854

Type 854 is a scientifically designed impedance or choke coil of general utility, designed primarily for use in filter circuits. As an output impedance for by-passing direct current from the loudspeaker it is just as efficient and more economical than an output transformer. When used with a 1 mfd. (or greater) fixed condenser, the tone quality equals that of the best output transformer. DC saturation is prevented by two adjustable butt joints in the core. \$6.00 each

A New Standard of Excellence

For more than twenty-five years, the American Transformer Company has specialized in the manufacture of transformers. The transformers used by Marconi in his first trans-Atlantic tests in 1904 were made by this Company. Since that time the engineering staff has directed a large share of its resources toward the development of transformers for radio use. In 1921 the AmerTran Audio Transformer set a definite standard of excellence in its field.

The last five years have seen radio develop rapidly. Better tubes, broadcasting and acoustical apparatus have brought these phases of reproduction nearer to perfection than ordinary transformer, impedance or resistance audio amplification.

When the new AmerTran DeLuxe Audio Transformer was recently introduced it put the "audio side" ahead of broadcasting facilities and reproducing instruments. Faithful amplification with natural quality thus, has again established AmerTran as the mark of a "new standard of excellence." Combined with the new tubes, cone speakers, and clear signals from the detector tube, the AmerTran DeLuxe will reproduce natural volume over the entire audible range. The AmerTran DeLuxe is made in two types, one for the first stage and one for the second stage, and plainly marked as such. Price, either type, \$10.00.

And now, as Radio Reception is further simplified and refined, the American Transformer Company offers another major contribution. The AmerTran Power Transformer and the AmerChoke make it possible and economical to use the new 7½ volt power tubes in the last audio stage. The filament of this tube is lighted direct from this transformer. The Power Transformer also has a filament supply winding for the rectifying tube and supplies sufficient plate current, after rectification, for the operation of the set.

For use in building, experimenting and manufacturing—these new AmerTran Radio Products assure dependability and satisfaction—and furnish the most advanced construction in practical radio.

Write for descriptive booklet entitled "Improving the Audio Amplifier."

American Transformer Company

178 Emmet Street, Newark, N. J.

"Transformer builders for over twenty-five years."

SOLD ONLY AT
AUTHORIZED AMERTRAN DEALERS

SM

S-C

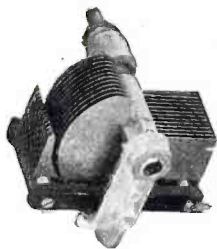

Type 316 Condenser, .00035 Mfd. for single or gang control. Brass plates, die cast frame. Price, \$5.75.



Type 801 Universal Vernier Dial, Ratio 14.5:1. Fits any standard condenser right or left, 180 or 360° movement. Price, \$2.50.



Interchangeable Coils for any wavelength. Standard Sizes, \$2.50. Type 515 Coil Socket, \$1.00.



Type 510 All-Bakelite Socket for UX Tubes, 50c.

IT IS NOT remarkable that McMurdo Silver, Laurence M. Cockaday and the engineers of seven important manufacturers should choose S-M parts wherever possible for the S-C receiver.

That was a foregone conclusion, for they knew that S-M equipment was dependable — to the last detail, *right*.

That is why, in practically every successful receiver design of past and present seasons you will invariably find S-M apparatus — depended upon, and *dependable*.

See — Handle these and other S-M Parts at your dealers. Find out for yourself exactly why they are being chosen by experts and engineers, and endorsed by leading radio authorities.

Silver-Marshall, Inc.
108 S. Wabash Ave.
Chicago

Type 340 Compensating Condenser, .000025 Mfd. with knob, \$1.50.

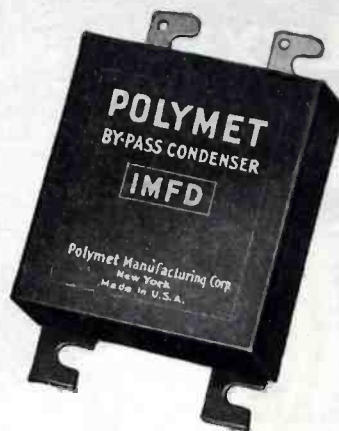
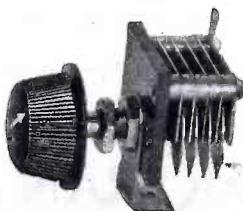

By-Pass Condensers By Polymet!

Polymet's latest product. Manufactured with the latest, improved apparatus. Special impregnation process assures maximum durability and long life, and absolutely prevents leakage. High breakdown test; 800-1000 volts. The most efficient and satisfactory on the market. Prices 60c to \$3.50.

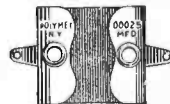

Poly Fixed Condensers

Specified in S. C. Circuit

Highest quality materials and housed in genuine Bakelite. Each condenser is individually tested and capacities stamped are guaranteed to be accurate. Selected by U. S. manufacturers as standard equipment. Prices 25c to \$1.00.



Poly Grid Leaks

Specified in S. C. Circuit

Resistance is absolutely controlled. Each unit is individually tested and reading marked guaranteed dependable. Selected for their quality by manufacturers of receiving sets. 1/4 to 10 megohms—25c.

Polymet Manufacturing Corp.

599 Broadway

New York City

POLYMET PRODUCTS

Send for this New Hookup

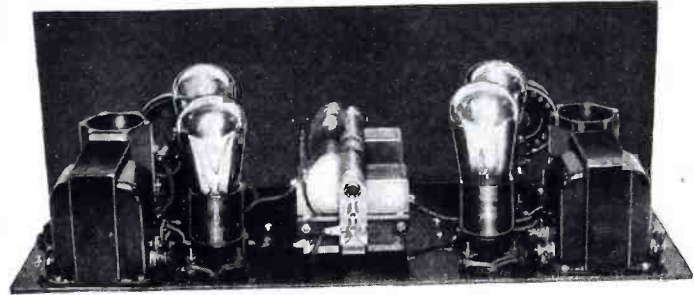

Four Tube Receiver

The outstanding radio receiver development of the season, in which is combined the genius of two of the most successful and distinguished radio engineers, assisted by the engineering and laboratory staffs of seven prominent radio manufacturers. The receiver for the home builder that will represent for several seasons to come a far greater value than any other design available. Send for the book. Read how to obtain the following

Startling New Features

SINGLE CONTROL—But one tuning or station selector control.
SELECTIVITY—In a residential district of New York City, within a few hundred yards of powerful stations, thirty-five stations were heard between 9 and 10 p. m. on the loud-speaker. KFI, in Los Angeles, was heard with ample volume to fill two rooms. Tests in Chicago brought in either coast with ample speaker volume, and indicated that a consistent range of 1,000 to 2,500 miles might be expected.
QUALITY—Two new-type Thordarson power amplifying transformers possessing a substantially flat frequency characteristic over the range of 40 to 6,000 cycles, give a quality of reproduction so perfect that comparison by the best trained human ear with other types of amplifiers will not reveal any superior type.
VOLUME—In all cases the volume will exceed that obtainable from other four-tube receivers, and in practically all cases equal or exceed that obtainable from standard five and six-tube receivers.
UNLIMITED WAVE-LENGTH RANGE—Through the use of interchangeable coils, the wave-length range is practically unlimited.
WIRING AND ASSEMBLY—All wiring is carried in a special harness. Since each wire is exactly the right length, and has a special color, it is impossible to go wrong in wiring. No soldering is needed unless preferred by the builder. Only a screwdriver and a pair of pliers necessary to assemble this set in less than two hours.
Over-all design, rugged and solid. Adapted to practically any standard cabinet, any standard tube, any battery or eliminator source of supply, outdoor antenna or loop. While the parts are the best that the leading laboratories of the country afford, the set can be built at an extremely low cost. Full description of the receiver was published in the March issue of Popular Radio.
 Get the hand book at your nearest Radio Dealer or clip the coupon and send with 25 cents TODAY.
 Address



The S-C
Merchandising
Company

245 S. Wabash Avenue, Chicago

Gentlemen: Please find enclosed 25c, for which send me hand book of the new S-C Receiver.

No choicer group of radio products has ever been embodied in a single radio receiver. Not only are these manufacturers nationally known and accepted as the leaders in radio design and construction, but they have developed for the S-C receiver many new features which will create a new standard in reception throughout the radio world.

Represented Manufacturers:

Belden Mfg. Co.
S-C Wiring Harness

Central Radio Laboratories
Centralab Resistance

Polymet Mfg. Corporation
Fixed Condensers, Leak and Leak Clips

Poster & Co.
Drilled and Processed Front Panel and Drilled Sub-Panel

Silver-Marshall, Inc.
Variable Condensers, Coil Sockets, Coils, Tube Sockets, Vernier Dial, Mounting Brackets

Thordarson Electric Mfg. Co.
R 200 Power Transformers

Yaxley Mfg. Co.
Rheostat, Jacks, Switch

The S-C Merchandising
Company
245 S. Wabash Ave.
Chicago

NAME

ADDRESS

POSTER

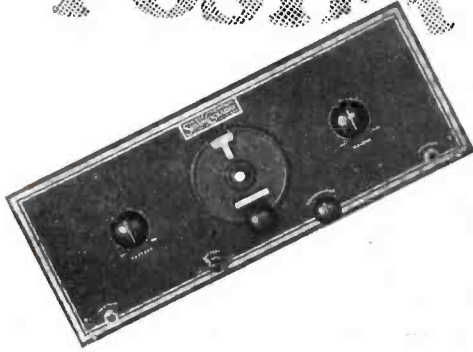

Behind Every Good Panel

is the Poster Guarantee of material, workmanship, price and speed. Our years of experience have equipped us to turn out large quantities on short notice. Our special processes insure quality work and prompt shipments. Wire or write for prices and other information.

SILVER COCKADAY

SELECTS
PANELS by POSTER

ANOTHER success has been achieved by the oldest and largest house of its kind in the country—Poster & Company. Poster's Perfect Panels have been selected as standard equipment for the Silver Cockaday.

We point with pride to this acknowledgment of the supremacy of Poster's Perfect Panels. Our facilities and complete equipment are ready to serve you in an equally satisfactory manner. Branches in both New York and Chicago. Submit specifications and sample to our nearest factory, and be assured of prompt information and delivery.

Poster & Co., Inc.

26-B Barclay St., New York
721 Fulton St., Chicago



Modernize Your Radio Set!

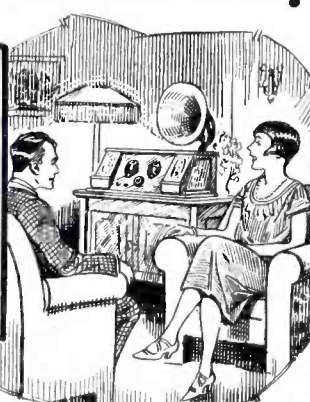
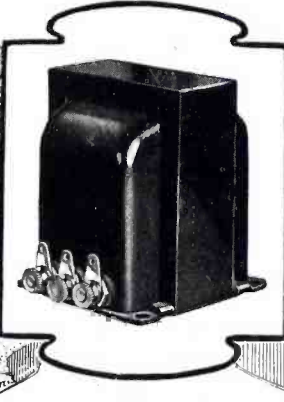

Are you still using primitive methods of amplification? Why not make your receiver an up-to-date model by installing Autoformer amplification—the ultimate in reproductive equipment?

The Autoformer, a step up impedance amplifier, reproduces with full volume those bass notes lost in ordinary transformer amplifiers.

The Autoformer provides the unrestrained flow

of distortionless music. It records everything from the slightest shading to the greatest extreme of volume, intensity, and timbre.

Better volume control.
More volume on distant stations.
Full bass note amplification.
Greater clarity on all signals.

THORDARSON

Autoformer

Trade-Mark Registered

All Frequency Amplifier

Price \$5.00

Write for free descriptive circular

OTHER THORDARSON TRANSFORMERS

B-200 Amplifying Transformer
Standard Amplifying Transformers
Power Amplifying Transformer
Interstage Power Transformer

B-Eliminator Transformer
B-Eliminator Chokes
Battery Charging Transformers
Transmission Equipment

THORDARSON ELECTRIC MANUFACTURING CO.
Transformer specialists since 1895
WORLD'S OLDEST AND LARGEST EXCLUSIVE TRANSFORMER MAKERS
Chicago, U.S.A.



AEROVOX

FIXED CONDENSERS

"Built to be Better"

AEROVOX WIRELESS CORP.

489, 491, 493 Broome St.,
New York City

Branch Offices:

CHICAGO, Ill.,
53 W. Jackson Blvd.
CINCINNATI, Ohio,
304 Palace Theatre Bldg.

BOSTON, Mass.,
104 Portland St.
LOS ANGELES, Cal.,
324 No. San Pedro St.

UNION RADIO TIP JACKS

Are Specified and
Must Be Used in the
HAMMARLUND-ROBERTS RECEIVER

Retail
Price

25c.

a pair

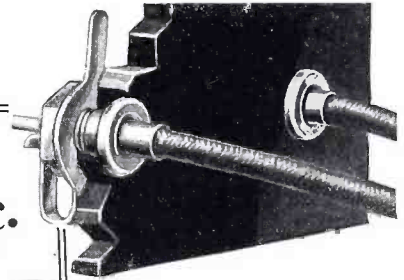

Fans everywhere are building the popular Hammarlund-Roberts Receiver. When they buy this circuit—they must buy Union Radio Tip Jacks, because they are specified by the engineers and designers of this Receiver. Panels are drilled for, and will accommodate only Union Radio Tip Jacks.

Set builders appreciate the advantages of these Tip Jacks and their marked improvement over binding posts. They lock securely on the panel and assure a positive, temporary or permanent connection and will not work loose. Soldering lug is provided for permanent fastening. **ALL PARTS ARE HEAVILY NICKEL PLATED.**

They Are Used as Standard Equipment in Many of the Best Sets on the Market

Firmly grip all wires from No. 11 to No. 24 B & S gauge. Three sizes for all panels. **TYPE A (Standard)**—for 3/16" to 1/4" panels. **TYPE B (Special)** for panels, cabinet walls and partitions from 5/16" to 1/2" thick. **TYPE C (Special)** for panels up to 1/8" thick. Packed in "self-selling" counter cartons of 1/12, 1/2 and 1 gross pairs. Also in boxes of 5 pairs for the Hammarlund-Roberts Set.

Other Guaranteed Union Radio Parts

VERNIER DIAL ADJUSTERS—In demand by fans for finer tuning. Permits instant adjustment of the dials. Retail price 60c.



IDENTIFICATION TAGS—There is a ready sale at all times for these labels. Made of hard, red fibre ovals. Prevent shorting battery, or blowing tubes. Marked with proper identifications of battery connections such as A-, B-, B67, B90, etc. Two holes, will take any wire up to 1/8". Packed 100 to a box of one designation only. Retail price \$1.00. Also in set of nine. Retail price 10c.

To All Branches of the Trade

Send for literature 'N' and samples of our reasonably priced Guaranteed Radio Products. Get details of our attractive proposition.

UNION RADIO CORPORATION
124 ~ SUSSEX ~ AVENUE ~ NEWARK ~ N.J.
NEW YORK OFFICE ~ 116 ~ WEST ~ 32ND ~ STREET

Oh boy
KESTER
Rosin core
Radio SOLDER

Safe & Safe and Simple
APPROVED BY RADIO ENGINEERS
A GENUINE SOLDER
CHICAGO SOLDER COMPANY
4224 Wrightwood Av., Chicago, U.S.A.

Originators and World's Largest Makers
of the famous Self-Fluxing Solder
OUR DEALER CAN SUPPLY YOU

When Your Friends Ask For Advice

Every radio engineer is constantly besieged by his friends for advice as to the kind of a radio set he recommends. Goodness knows it is enough for a man to take care of the radio problems of his business without having to service all the sets in the neighborhood.

Here's a Suggestion

When someone asks you about a low-price set that will give good results—above all, perfect quality—just tell him to send \$32.50 to DURRANT RADIO for an RX-1 kit. So complete are the instructions, and so carefully designed are the parts that they can be assembled by any novice. Start your friend on the RX-1 and he will never worry you with his troubles.

Complete KB-8 Kit

DURRANT can supply the complete KB-8 kit, with drilled and decorated Celoron panels, all parts as originally specified.

Price postpaid.....\$59.50

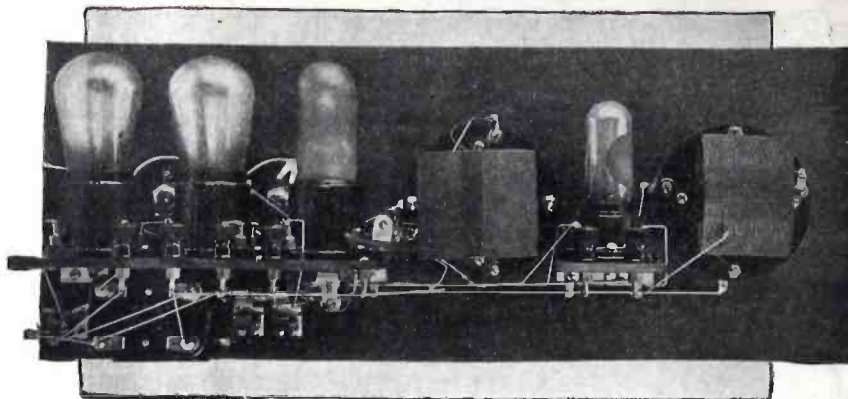

RX-1 IS BETTER THAN EVER

With the New Donle Detector Tube

Keen critics of radio reception say that no other set, at any price, gives reproduction equal to RX-1 results. Certainly no set within its price class offers the 100% quality parts with which the RX-1 is equipped.

And now, with the new Donle detector tubes available, to replace the Sodian, even better results can be obtained.

\$37.50 is the price of the complete RX-1 kit, including drilled and engraved Celoron panels, and a tested Donle detector tube. Add 10c for insurance, DURRANT pays the postage.

DURRANT RADIO, Limited

T-52 Vanderbilt Avenue, New York City



The Donle Bristol Detector Type B-6

A supersensitive detector which can be used in any standard receiving circuit and which will greatly improve the quality of all signals and the volume of weak signals.

Manufactured and sold by
THE DONLE-BRISTOL CORPORATION
Meriden, Connecticut

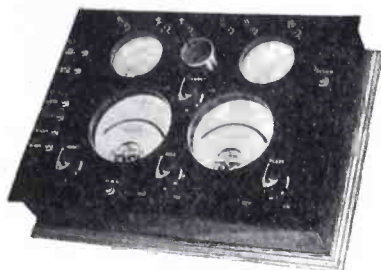

PATTERN NO. 130

“NEW”—

DIRECT READING VACUUM TUBE TEST-SET

☐ *“Almost Human”*—is what one radio engineer said when he saw one of these new sets demonstrated.

☐ Mutual conductance, plate resistance and amplification constant taken rapidly and accurately absolutely without calculation.

☐ Every radio engineer should send for Special Circular No. 726.

Jewell Electrical Instrument Co.

1650 Walnut St. - Chicago

26 Years Making Good Instruments.



Crowe Metal Panels

for

BROWNING-DRAKE KB-8

are now in preparation and will be available through leading distributors and radio dealers. Carefully packed in individual containers, with insulation and instruction sheet, completely drilled, ready for use.

Inquiries Invited from Responsible Jobbing Houses

ADDRESS

CROWE NAME PLATE & MFG. CO.
1749 Grace Street :: Chicago

NATIONAL

ANNOUNCING BD-3B

— a new National Tuning Unit embodying the wonderful

BROWNING-DRAKE TRANSFORMER

and an innovation in condenser design

NATIONAL EQUICYCLE CONDENSER

The novel shape of the plates spaces the station groups at equal intervals of 10 kilocycles in a true straight frequency line.

The useful range of rotation has been increased from 180° to 270°. This has been accomplished without the use of gears, cams or levers, thereby eliminating consequent lost motion.

This unit possesses the same electrical efficiency and mechanical stability that have always characterized NATIONAL DX Condensers.

BD-3B Tuning Unit Price \$12.75

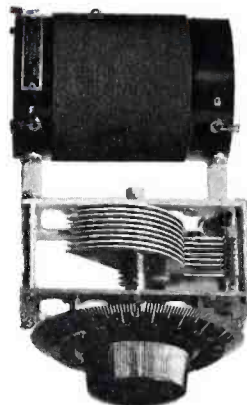

National Tuning Unit BD-3B
Send for Bulletin 110

These National Tuning Units Give Supreme Satisfaction

BD-1 A

Patents pending

BD-2 A

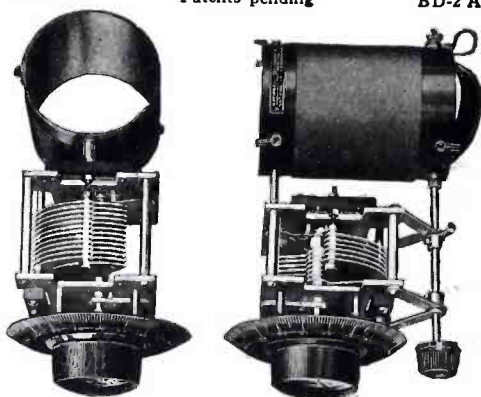

These time-tested units include the (genuine) BROWNING-DRAKE Transformer and the NATIONAL EQUI-METER (straight line wave length) Condensers and also the NATIONAL Velvet Vernier Dials. How well they excel in receiving range and volume is well known. They are the acknowledged standard; their efficiency proved.

NATIONAL Tuning Units are now made in the following types:

BD-1A—Includes the NATIONAL EQUI-METER (straight line wave length) Condenser and the (genuine) BROWNING-DRAKE Inductance Coil with the NATIONAL Velvet Vernier Dial. Price \$9.25.

BD-2A—Includes the NATIONAL EQUI-METER (straight line wave length) Condenser and the (genuine) BROWNING-DRAKE Inductance Coil with the NATIONAL Velvet Vernier Dial. Price \$12.75.

BD-1B—Includes the NATIONAL EQUICYCLE and the (genuine) BROWNING-DRAKE Inductance Coil with the NATIONAL Velvet Vernier Dial. Price \$10.25.

BD-2B—Includes the NATIONAL EQUICYCLE Condenser and the (genuine) BROWNING-DRAKE Transformer with the NATIONAL Velvet Vernier Dial. Price \$13.75.
BD-3B—Includes the NATIONAL EQUICYCLE Condenser and the (genuine) BROWNING-DRAKE Transformer, without tertiary coil, and NATIONAL Velvet Vernier Dial. Price \$12.25.
Prices quoted are for Type A Velvet Vernier Dials. If so specified, Type B Dials will be supplied without extra charge.

RADIO PRODUCTS

NATIONAL IMPEDAFORMER (Patents pending)

— radio's most recent contribution to faithful tone reproduction

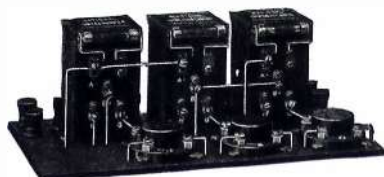

The illustration shows the assembly of three Impedaformers as they would appear in a set

With these units an impedance coupled audio amplification system can be constructed which will truthfully and uniformly reproduce in all its richness and purity each and every note sent out by broadcasting stations. The tone quality is superb and the volume is greater than with resistance coupled amplification. This is accomplished with no more B battery voltage than is

usually used on a transformer system and with a minimum of storage battery consumption. Made in two types: Type A embodies National Choke Coil only. Price \$4. Type B contains Choke Coil with grid condenser and grid leak, combined in a single unit. Price \$5.50. Connections are the same as for an ordinary audio transformer.

NEW TYPE B VARIABLE

National Velvet Vernier Dial

*Variable
Ratio*

*Velvet
Smoothness*

Ornamental

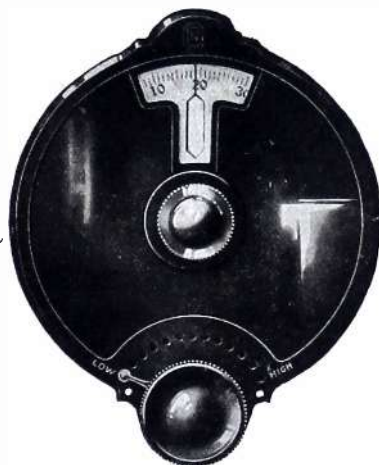

*Positive
Control*

*Easily
Mounted*

Gearless

(Patents pending)

A modified application of our "Velvet Vernier" mechanism. Easily mounted on the 1/4-in. shaft of any standard type of variable condenser. Replaces plain dials on any receiver where sharper tuning is desired.

Reduces to any ratio from 6-1 to 86-1. This aids greatly in the separation of stations operating on the lower wave lengths. Moulded from black bakelite in ornamental design with perfectly uniform graduations.

| Specifications | PRICE LIST | |
|--------------------------------|---------------|-------------|
| | Nickel finish | Gold finish |
| Clockwise 200-1 (360°) | \$2.50 | \$3.00 |
| Counter-Clockwise 1-200 (360°) | 2.50 | 3.00 |

NATIONAL COMPANY, INC.

W. A. READY, President
110 Brookline St. Cambridge, Mass.

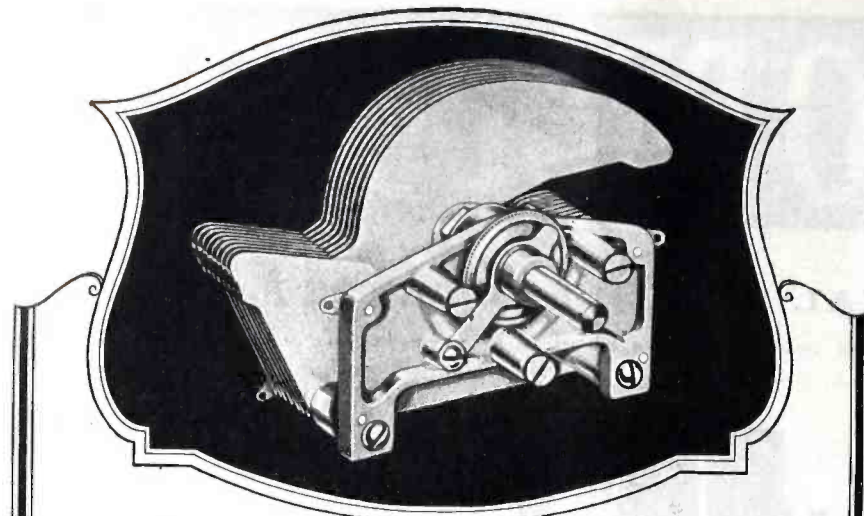

The Benjamin A REAL Straight-Line Frequency Condenser

The key to finer radio. Easier tuning—better selling. Backed by generous national advertising. Logs evenly over the sweep of the dial in exact ratio with the broadcasting frequency steps. Eliminates bunching

of stations and increases selectivity and sensitivity. No body capacity effects and no absorption losses. A beautiful instrument in unpolished silver plate, made with the precision of a watch, to last a lifetime.

Cle-Ra-Tone "Push" Type Radio Socket

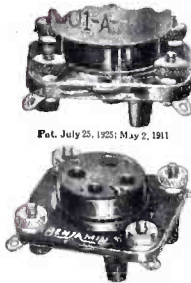

Pat. July 25, 1925; May 2, 1931

The Benjamin Radio Socket of many distinctive and individual features. The suspension spring and contact member are made in one piece, eliminating high resistance joints. Side wiping contacts insure perfect electrical connection to the tube prongs. Tube noises are stopped by preventing transmission of outside vibrations into microphonic disturbances. For standard UX tubes.

Send for full information on Benjamin Super Radio Parts for Better Radio Sets

The Benjamin "Lekeless" Transformer

A few of the characteristics which make this a "Lekeless" transformer are: [1] A closed field which prevents power leakage and feed-back, making neutralization easy. [2] A minimum amount of supporting insulation lowers power loss. [3] Extremely low distributed capacity, low resistance and high inductance. Each turn of wire placed with perfect mechanical accuracy, resulting in uniformly high inductance and low losses.

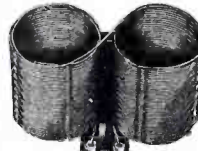

Patents Pending

Benjamin Electric Mfg. Co.

120-128 So. Sangamon Street, Chicago

New York: 247 West 17th Street

San Francisco: 448 Bryant Street

Manufactured in Canada by the Benjamin Electric Manufacturing Company, of Canada, Ltd., Toronto, Ontario

How Loud Speaker Troubles Are Overcome

—By C. E. BRIGHAM*

THE advent of the console type radio receiving set with speakers built in, has been very rapid over the past six months and bids fair to become one of the chief problems for immediate development.

The rapid development of the frequency range of speakers has increased the problems of the power supply unit manufacture, for most of the "ripples" occur in the lower frequency range and are perceptibly audible in the new speakers. When they are put in the same cabinet with the set, magnetic couplings due to current supply devices, or audio or radio frequency

*Chief Engineer, Brandes Products Corp.

couplings due to proximity of the speaker to the transformer, or vibration known as "acoustical feed backs," which shake the tube filaments and plates—all cause disturbing noises in the speaker.

The development of speakers along the line of sensitivity and ability to take volume, has also increased the problems of putting them in a console type set.

People who buy radios are often the same people who buy automobiles. Very seldom do they ever think of driving their auto at sixty miles an hour, but they like to know that their car will approximate that speed. And so with their radio set; seldom do they want to give the speaker the full power of the set, but they like to know that both the set and speaker will stand the full power without rattling or without setting up acoustical feed backs.

Being acoustical experts, we have been asked by a number of manufacturers to study the problems of putting speakers in their sets, and we have developed some very interesting things.

For instance, one manufacturer wished to place the speaker at the end of the cabinet directly in line with both the condensers and the tubes. Due to its location, the speaker, when the power was turned on, vibrated the entire wooden cabinet including the panel board, and caused howling. The condensers were rigidly mounted to the panel board and to a supporting frame from the bottom of the cabinet.

Exhaustive study developed the fact that it was not necessary to put the tubes on spring sockets, nor to interfere greatly with the manufacturer's production design. Very simple changes in the method of mounting the set to the base board and the panel board, completely removed every trace of howl, irrespective of the amount of volume.

In another circuit which is extremely delicate we discovered two ways to answer the problem. One was to change the position of the speaker, and the other to spring mount the tube sockets and weight the tubes. These cases both deal with acoustical feed backs.

Magnetic couplings may some times be the cause of a receiving set howling due to a loud speaker being enclosed in the same cabinet as the receiving set. Such conditions are noticed when a loud speaker is so placed in a cabinet that it is necessary to run the output leads of a loud speaker to the other extreme end of the cabinet, thus causing magnetic coupling between the loud speaker cord and the receiving set. Also, due to the proximity of the cord, this may cause capacity coupling as well as magnetic coupling.

When power cones are used in which it is necessary to use a power amplifier, stray magnetic fields either from the powerful electromagnets which are used with the loud speaker or stray fields set up by the alternating current coils may feed back to the receiving set causing a bad howling.

Speaker development has not yet reached its maximum, and the further development of speakers is bound to introduce entirely new problems when we endeavor to put the set and the battery eliminators and the speaker—the complete radio—into one cabinet, and have all working at maximum efficiency.

It is an easy matter to put a speaker in a console cabinet, and by cutting down efficiency of the set or the speaker, get fairly good results without howling. But when all units are brought to maximum efficiency, this problem of feed backs and couplings of one sort or another, requires individual study by experts with experience in looking at the problem from many angles and solving it under most adverse and varied conditions.

ELECTROCON

A AND B

ELIMINATOR

For 110-126 Volts, 60 Cycles

THIS is the first A and B eliminator which can operate up to 7 UV201-A's in parallel—absolutely no changes are required in the set.

No chemicals, no moving parts—nothing to wear out. Covered by a 6-months guarantee against electrical and mechanical defects.

Also provides 22, 45, 90, and 135 volts B supply. At 135 volts 40 mils can be drawn, sufficient for any 7-tube set. Rectifier unit, 6 x 11 x 8 ins. Filter unit, 9 x 15 x 9 ins.

Complete A and B eliminator with full instructions, \$85

Except 2 rectifier tubes, which cost \$4.00 each

PARTICULARLY ADAPTED TO RX-1 AND KB-8 SETS

for SET BUILDERS—

To increase volume, range, and selectivity of any receiver, put on a Penetrola. DURRANT has tested the Penetrola and recommends it especially for the RX-1, KB-8, all neutrodyne, 3-circuit tuners, and S-C set.

Complete kit, with instructions, \$15

Panels for 5-N-1 short wave receiver, as OK'd by F. J. Marco.

Celeron, drilled and engraved, \$4.50

DONLE TUBES

Immediate delivery from stock—Donle detector tubes increase the volume and quality of all tuned R. F. and neutrodyne sets. Used in the Hammarlund-Roberts to stop oscillation, \$5.00.

(Add 10c for insurance)

Durrant Radio, Ltd.
T-52 Vanderbilt Avenue,
New York City

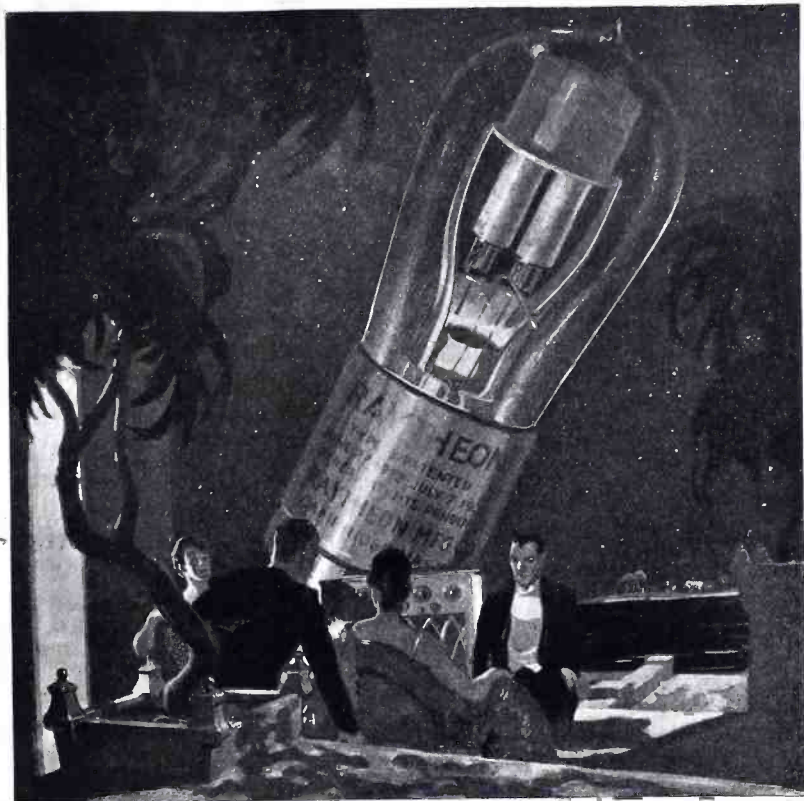

RAYTHEON

The tube that perfects the B-eliminator

RAYTHEON is more than the name of a new type rectifier. It is the symbol of a research laboratory, the mark of an organization of engineers. Radio manufacturers, radio editors and radio dealers appreciate the value of *Full Wave Rectification, No Filament, No Chemicals, Ample Voltage* and a *Sixty Milliampere* output. Price six dollars.

RAYTHEON B-eliminators or specially designed parts for home-built units are made and sold by these and other well-known manufacturers:

Acme Apparatus Co.

All-American Radio Corp.

Dongan Electric Mfg. Co.

General Radio Co.

Jefferson Electric Mfg. Co.

Mayolian Radio Corp.

Modern Electric Mfg. Co.

Thordarson Electric Mfg. Co.

Tobe Deutschmann Co.

Webster Co.

RAYTHEON MANUFACTURING COMPANY
Cambridge, Massachusetts

"Distance without Distortion"

PERRYMAN RECTIFIERS

Perryman rectifier tubes are the only tubes that meet the requirements of *all* present "B" eliminators. Not only are they made with bases that fit the two styles of tube sockets but their current output is big enough to supply "B" current to the largest receiving sets without straining the tubes.

Because Thorium is the most active electron-emitting metal known, because it operates at low temperatures, because the Perryman filament is a Thorium content filament—Perryman rectifier tubes will stand the gaff of eliminator service.

Made in half-wave and full-wave types with both styles of base for every rectifier use. *Order samples from your jobber.*



Perryman Rectifiers have an extremely low voltage drop between plate and filament. The filament depends entirely upon Thorium for its activity.

P. R. 196 is a full-wave rectifier employing 4½ volts on the filament.

P. R. 213 is a full-wave rectifier employing 5 volts on the filament.

P. R. 216A is a half-wave rectifier employing 5 volts on the filament.

P. R. 216B is a half-wave rectifier employing 7½ volts on the filament.

Perryman Rectifiers are made in two styles of base, to fit practically all eliminators.

\$6.00 List

PERRYMAN ELECTRIC CO., INC.
LABORATORIES AND PLANT NORTH BERGEN, N. J. SALES AND EXECUTIVE OFFICES 33 W. 60th ST., N. Y. C.

CLAROSTAT

has been approved and adopted by a host of nationally known battery eliminator manufacturers —because CLAROSTAT has no equal for voltage control in "B" Battery Eliminators.

— only CLAROSTAT gives you a range from practically zero to 5,000,000 ohms and a carrying capacity unequalled by any variable resistor.



CLAROSTAT is mechanically and electrically sound and will make possible absolutely noiseless operation.

Special types for "A" and "B" Battery Eliminators for manufacturers.

American Mechanical Laboratories, Inc.
285 North Sixth St., Brooklyn, N. Y.



For Perfect Tone and Volume Control USE ELECTRAD ROYALTY 500,000-Ohm Compensator

THE remarkable results secured by the use of this perfected device are due to the fact that it controls the output without any distortion or noise, so that pure music is received. Note these six important features of design and construction:

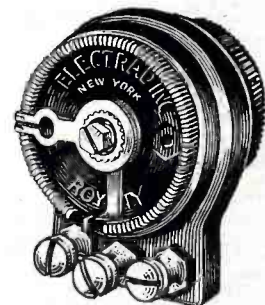

- 1—Resistance element is not exposed to any mechanical operation.
 - 2—Electrical contact is made positive by a metallic arm on the wire-wound strip.
 - 3—The same resistance is always obtained at the same point.
 - 4—The resistance value is under control in the process of manufacture and does not change in use.
 - 5—The entire range of resistance is covered with less than a single turn of the knob.
 - 6—There is no mechanical binding and the shaft is turned over the entire range with a perfectly smooth operation.
- Made in various types for various purposes. Prices \$1.50 to \$2.00; in Canada, \$2.10 to \$3.00. Write for circular.



Write for information and hook-up on the Electrad 500,000-ohm Compensator for perfect control of tone and volume 428 Broadway, New York City.

ELECTRAD, Inc.



DURHAM

Metallized High Resistors



Now Standard

Practically all electrical research and commercial laboratories, nearly every high grade manufacturer and many of the "how to build" writers — are using the permanent, noiseless and accurate qualities of DURHAM's in their finest work.

| | Plain | Pigtail |
|------------------|-------|---------|
| Over ½ meg..... | 40¢ | 60¢ |
| Under ½ meg..... | 60¢ | 75¢ |

Manufacturers—write for discounts.

INTERNATIONAL RESISTANCE CO.

Perry Building

Philadelphia

screw-machine products —brass

For plugs, jacks, clips, condenser and transformer parts, etc., BRASS assures economy in quantity production. It also gives the right electrical conductivity and the mechanical accuracy essential to proper operation of radio sets and parts.

**COPPER & BRASS
RESEARCH ASSOCIATION**
25 Broadway, New York

RADION

means receiving set efficiency

Rewards in the competitive race for manufacturing supremacy are going to those manufacturers whose apparatus delivers broadcasting with greatest clearness and volume.

Insulation plays so important a part in protecting the circuit against leaks and losses that many manufacturers have found it desirable to use RADION for moulded parts where dependable insulation is needed. They know and use "The Supreme Insulation."

**AMERICA HARD RUBBER
COMPANY**

Dept. M N 12

11 Mercer Street, New York City

RADION

The Supreme Insulation

"Tune in" the Lost notes with **DAVEN**

AMPLIFICATION

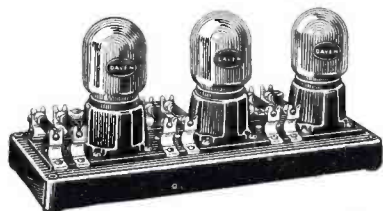

YOU will never know the meaning of full note reception until you have improved your radio set with Daven Amplification.

It brings to you such perfect natural-toned reception you feel as though you could reach out and touch the artist.

Simple to install—accurate in tone reproduction — inexpensive — and above all, it insures you against the fear of your radio set becoming obsolete!

Go to your Authorized Daven Service Dealer. He is competent to make the installation.

OTHER DAVEN ACCESSORIES

| | |
|-----------------|-------------------|
| Amplifier Tubes | Resisto Couplers |
| Power Tubes | Leakandensers |
| DRF Coils | Resistors |
| Amplifier Kits | Ballast Resistors |
| | Mountings |

"The Sine of Merit"

DAVEN RADIO CORPORATION

Resistor Specialists

Reg. U. S. Pat. Off.

Newark

New Jersey

USE THIS FREE COUPON

DAVEN RADIO CORPORATION
155 Summit St., Newark, New Jersey

Please send me the following on Resistance Coupled Amplification.

Check the one you prefer.

Resistor Manual
25c. is enclosed

Complete Catalogue
(free)

Name _____

Address _____

FOR DEALERS: Send your letterhead or card, or this coupon and we will have our nearest distributor communicate with you.

QUALITY, RELIABILITY, TONE
Have Made the
AMPLION
A Standard Unit



When you buy the famous Amplion Manufacturers' Unit for your console set.

We decide for you:—

Its *DESIGN* which is the result of 35 years of experience.
Its *QUALITY* which is the best that can be produced.
Its *RELIABILITY* which is absolute and guaranteed by a great world-wide organization.

BUT You tell us:—

The pitch or fundamental frequency you require to tune with your set.
The impedance you require to get the utmost efficiency from your amplifier.
Your Engineers and ours get together to enable our MU-67 Unit to demonstrate to the public all the tone value and volume of which your set is capable. It is only by this cooperation that 100% efficiency can be obtained. By this means the individual character can be carried from aerial to air column.
Have you heard Amplion high and low pitch units which together cover the whole of the musical range?

THE AMPLION CORPORATION OF AMERICA

Executive Offices:
Suite W. 280 Madison Avenue, New York City
Chicago Branch: 27-29 No. Morgan St.
In Canada: Burndep't of Canada, Ltd., Toronto

To-day
-in every
good set!



100% Value
From Each Tube

What's the use of buying good tubes if you don't get their full value? Individual, automatic tube control is the answer. Amperite alone gives it. That's why it is specified in every popular construction set. Offers precision regulation—automatically. No hand rheostats to regulate. Eliminates all errors of human judgment. A special type for every style and strength of tube. Price \$1.10.

Write for free hook-ups

Radiall Company

Dept. RE4, 50 Franklin St., N. Y. City

AMPERITE

REG. U.S. PAT. OFF.

The "SELF-ADJUSTING" Rheostat

Don't Forget

The customer's viewpoint. The discriminate buyer wants simplicity, safety, and convenience. There is nothing more desirable than a plug socket connection between the batteries and the radio. Samples of the Jones Multi-Plug will be forwarded without cost to sales executives and engineers of reliable radio manufacturers.

SIMPLIFY AND SATISFY WITH

Jones
MULTI-PLUG
 THE STANDARD SET CONNECTOR

HOWARD B. JONES

618 So. Canal St. :: Chicago

De JUR \$10 AMPLIFIER



Distortionless Amplification

Equipped throughout with De Jur quality parts. Genuine Bakelite sockets which will take standard or new UX tubes. De Jur grid leaks with soldered caps used as resistors. Genuine Bakelite panel mounted in mahogany case which sets into any type set. No bus bars used in wiring. All metal strip connections are riveted. No screws, nuts or bolts to get loose. The only Amplifier insuring permanent, positive contact throughout.

A BIG SELLER

Here is one of the biggest values in radio to meet the big demand for R. C. Amplifiers. Backed by the known De Jur guarantee. Write for full particulars and discounts.

DE JUR PRODUCTS CO.

199 Lafayette St., N. Y. C.



8 out of 10 Manufacturers Use Eby Binding Posts

The chances are that the receivers you are selling in your store are equipped with EBY Binding Posts. 80% of the leading radio manufacturers have chosen EBY on performance.

Your customers all know EBY and your jobber has all of the 27 different markings.



LIST
 PRICE
 15c

And Now There's Another Eby Leader

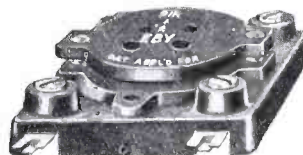

LIST
 PRICE
 60c

The new Eby Quality Socket insures a positive wiping contact at all times. Its ingenious design allows the tube to "float" when in service, thereby reducing microphonic noises and protecting the tube against damage. It also permits interchangeability and other features of the new UX and CX tubes.

If your jobber can't accommodate you—Write to us

H. H. EBY MFG. COMPANY

4710 Stenton Avenue
 Philadelphia, Pa.

| Cabinets | Machinery | Patents |
|---|--|---|
| JORDAN CABINET CORPORATION Tel. Sunset 4453 Brooklyn, N. Y. | RADIO PRODUCTION CO. <i>Coil Winding Machines</i> Tel. Canal 0474 212 Center St. New York | PATENTS <i>Write for free book</i> MUNN & CO. <i>Associated since 1846 with the Scientific American</i> 648 Woolworth Bldg., New York City 537 Scientific American Bldg., Washington, D. C. 1326 Tower Building, Chicago, Ill. 638 Hobart Bldg., San Francisco, Cal. 549 Van Nuys Bldg., Los Angeles, Cal. |
| Compounds, Battery | BRANCH TOOL CO. <i>Engraving Machines</i> Forestdale Rhode Island | Screw Machine Products |
| MITCHELL-RAND CO. <i>Dept. R. E.</i> 18 Vesey St New York City Mfrs. of Spaghetti Tubing | EISLER ENGINEERING CO. <i>Tube Machinery</i> Newark New Jersey | WM. STEINEN & CO. Tel. Market 9077 297 Washington St., Newark, N. J. Screw Machine Products and Springs |
| Castings, Die | Magnets, Permanent | Buyers and Sellers of SURPLUS MATERIALS |
| MARF MACHINERY and DIE CASTING CO. 149 41st St. Brooklyn, N. Y. Tel. Sunset 9108 | D. K. BULLENS CO. <i>Hot Forged Radio Magnets</i> Pottstown Pennsylvania | SLAP RADIO CO. 16 Hudson St. New York City Tel. Whitehall 5712 |
| Hardware | Packing Materials | Wire |
| F. R. ZIERICK MACHINE WORKS 6 East Howard St., New York City <i>Terminals—Lugs—Ground Clamps— Socket Springs—Socket Shells—Bus Bar Strips—Angles—Brass and Copper Specialties. Metal Stampings by the thousand or million</i> Tel. Canal 0079-1279 | PEQUOT MFG. CO. <i>Specialist in Radio Packing Materials</i> Long Island City New York | Antenna Magnet Litz Lead in Flexible Silk Bus Bar Annunciator Loop Aerial Guy Detector CORNISH WIRE CO. 30 Church St. New York City |
| Insulation, Moulded | Panels, Composition | JAS. GOLDMARK CO. <i>Magnet Loop Aerial All Insulations Litz Stranded Flexible Leads (Cotton or Silk Covered) Flexible Rubber Covered for Wiring Sole Manufacturers of WIRIT</i> 83 Warren St. New York City |
| INSULATING CO. OF AMERICA (Radio Panel & Parts Co.) <i>Insuline and Bakelite Panels Plain, Drilled and Engraved Sub-Panels Etch-O-Gravure and Other Methods of Panel Decorations</i> Insuline Bldg. 59 Warren St. New York, N. Y. Branches in Principal Cities | POSTER & CO., INC. <i>Drilling, Engraving, Decorating Genuine Bakelite</i> New York Chicago 28 Barclay St. 721 Fulton St. | Panels, Metal |
| Lacquers | CROVE NAMEPLATE & MFG. COMPANY <i>Quality Etched Metal Panels and Nameplates</i> 1749 Grace St. Chicago, Ill. | STRAND—Antennae (plain or enameled)—Double Galvanized. WIRE—Antennae (plain or enameled) Connecting and Ground (Rubber covered, braided or plain. BUS BAR—Litzendraht-Loop MAGNET (Cotton or Silk). JOHN A. ROEBLING SON'S CO. Trenton, N. J. |
| EGYPTIAN LAQUER COMPANY <i>Dpt. R. E.</i> 90 West St. New York City | | |

PATENT SERVICE
FOR THE MANUFACTURER —
We have retained experienced patent lawyers to create patent situations around the manufacturer's products.
FOR THE INVENTOR —
We aid and assist in the development of his inventions and represent him in negotiations with manufacturers. In meritorious cases we finance the work.
RADIO PATENTS CORP.
INC. 1917
247 Park Ave. New York City.

"ACRACON"
— a New Name in Electrical Condensers —

- Acracon is built to the special operating requirements of "A" and "B" Battery elimination.
- Current waste is reduced to minimum due to the high dielectric resistance and improved method of impregnation.
- Method of winding layers eliminates inductive effects.
- Contact to each layer of foil provides lower R. F. resistance.
- Every unit tested at 1000 D. C. volts for a minimum period of 5 minutes.
- Compact construction — Perfect Performance, for use in either set construction or current-tapped devices. Units also built to special manufacturing specifications.

Manufactured and Sold By
The Condenser Corp. of America
25 Waverly Place New York, N. Y.



Pioneers—Now Leaders

Since B-Eliminators first attracted the eager experimenters Dongan has pioneered in the building of transformers and chokes. Our 15 years experience in the production of transformers gave us a big impetus. Our forward-looking engineers told us B-Eliminators would predominate eventually.

Dongan has worked with Raytheon in the perfection of Raytheon B-Eliminators. Dongan B-Power Units are one of the most important factors in the operation and performance of Raytheon B-Eliminators.

Today we are supplying the leading manufacturers of Eliminators with Dongan B-Power Units. No matter what type you build we can supply you—mounted or unmounted types.

TRANSFORMERS



LIST
\$7.00

Manufactured for 25, 40, 50 and 60 cycles.

- 509 Full wave for Raytheon Tubes.
 - 537 Full wave for R.C.A. UX 213 Tubes.
 - 537 Full wave for Cunningham CX 313 Tubes.
 - 538 Half wave for R.C.A. UX 216B Tubes.
 - 538 Half wave for Cunningham CX 316B Tubes.
 - 561 For R.C.A. UX 216B Tubes, or
 - 561 For Cunningham CX 316B Tubes
- To be used with Power Amplifier Units.

Set Manufacturers Planning 1926 Production

AUDIO TRANSFORMERS of Dongan design have been standard equipment in leading sets for three years. When designing your new sets for the 1926 season take advantage of our new, improved audio transformers. Arrange for sample orders now.

CHOKES



- 514 20 Henry \$5.00 List. (Our specifications of 539 Output Choke is adapted for bridging across loud speaker.)
- Raytheon Tubes \$6.00 List.

Fans--

Build Your Own B-Eliminators

You can do it easily with Dongan B-Power Units—simply constructed and inexpensive. You'll be happily surprised at the wonderful results you'll get, with your set.

If Your Dealer Cannot Supply You Send Money Order Direct

DONGAN ELECTRIC MANUFACTURING CO.
2996-3001 Franklin St., Detroit, Mich.



WALBERT



Adaptable

The Penetrola—with all its advantages—188 times the energy—perfect selectivity—interference elimination—is instantly available for any receiver—adaptable to almost any reception condition—always representing a vastly improved quality of reception.

“Bloopers” operators or sufferers—add a Penetrola for increased range and selectivity.

Descriptive literature on the Penetrola—its uses and advantages sent upon request.

WALBERT MANUFACTURING CO.
925 Wrightwood Ave., Chicago

PENETROLA