

# RADIO ENGINEERING

*A Magazine of Technical Accuracy  
for the Radio Engineer, Dealer, and Manufacturer*

*Edited by M.B. SLEEPER*

## DX REFLEX

The most dependable long distance, one-control set for loop or antenna

Some startling data on the effect of losses in radio tuning circuits

Construction of a two-step audio frequency amplifier

Crystallizing lacquer--the handsomest finish for radio parts

20c a Copy--In England, 1/-

OCTOBER, 1924

Vol. 4

No. 9



THIS BATTERY WILL MATERIALLY REDUCE YOUR OPERATING COSTS ON HEAVY CURRENT SETS

**NEW!**

Eveready Heavy Duty "B" Battery. 45 volts. Three Fahnestock Clips. Length, 8 3/8 inches; width, 4 7/8 inches; height, 7 3/8 inches; weight, 13 3/4 pounds.

New low price, \$4.75

## New Heavy Duty 45-volt "B" Battery No. 770

### Extra large cells—extra long service

For maximum "B" Battery economy, use this *New Eveready Heavy Duty 45-volt "B" Battery*, in the following general cases:

- 1—On all receiving sets operating at 90 volts or more, having four tubes without a "C" Battery, and all sets having five or more tubes, with or without a "C" Battery.
- 2—On all power amplifiers.
- 3—On all sets that pull heavy currents from the "B" Battery.

Under the above conditions, the *New Eveready Heavy Duty 45-volt "B" Battery* will give much longer service than the 45-volt "B" Battery of usual size.

If your receiving equipment falls under any of the above classifications, you can make a big saving in "B" Battery costs by using this *New Eveready Heavy Duty 45-volt "B" Battery No. 770*. Buy it and you get the biggest battery value on the market to-day!

Manufactured and guaranteed by  
**NATIONAL CARBON COMPANY, INC.**  
 Headquarters for Radio Battery Information  
 New York—San Francisco

Canadian National Carbon Co., Limited, Toronto, Ontario

**EVEREADY**  
**Radio Batteries**  
*—they last longer*

No. 7111  
 Eveready Radio  
 "A" Dry Cell  
 Specially  
 manufactured for  
 use with dry cell  
 tubes



Eveready 6-volt Storage  
 "A" Battery

No. 766  
 Eveready "B"  
 22 1/2 volts. Six  
 Fahnestock Spring  
 Clip Connectors



No. 772  
 Vertical 45-volt, large  
 size "B" Battery

No. 771  
 Eveready "C" Battery  
 Clarifies tone and  
 prolongs "B" Battery life



No. 764  
 Vertical 22 1/2-volt  
 "B" Battery

# FRESHMAN MASTERPIECE

## It's Easy to Build

a five tube radio frequency receiver when  
you use the Freshman Masterpiece Kit

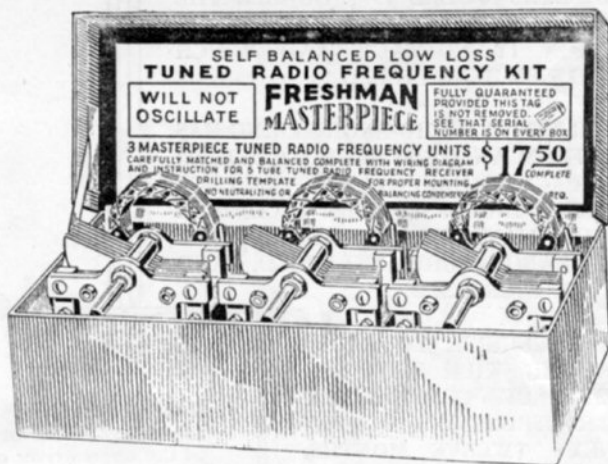

## No Neutralizing or Balancing Condensers Required

when you build with this kit to produce a radio frequency receiver that will bring in even the most distant stations with the volume and clarity of locals. So selective that stations can be brought in day after day at the same dial settings. A set that will be the equal, if not the superior, to any 5 tube receiver on the market, and what's more, it's the easiest set in the world to operate.

Kit consists of 3 Masterpiece Tuned Radio Frequency Units carefully matched and balanced. Complete with wiring diagram and instructions for building any 5 tube tuned radio frequency receiver and also drilling template for proper mounting .....

# \$17.50

Each and every Freshman Masterpiece Coil bears a serial number and Trademark—our guarantee of electrical and mechanical perfection. Every genuine Freshman Coil is made of specially insulated wire to prevent short-circuiting, so often caused by inferior coils. For your protection demand only the genuine.

At your dealers, otherwise send purchase price  
and you will be supplied without further charge.

CHAS. FRESHMAN CO., INC., 106 Seventh Ave., New York

**T**HE PROGRESS OF RADIO ENGINEERING IS UNIQUE AMONG RADIO PUBLICATIONS. IT IS THE ONLY RADIO MAGAZINE WHICH, BECAUSE OF THE PARTICULAR EXCELLENCE OF ITS CONTENTS, CAN BE SOLD AT A PRICE WHICH COVERS ITS MANUFACTURING COST.

STILL, RADIO ENGINEERS, DESIGNERS, AND SET BUILDERS WOULD PAY DOUBLE THE PRICE TO GET THE SPECIAL KIND OF INFORMATION IT CONTAINS—AND WHICH IS FOUND NOWHERE ELSE.

BY SHEER MERIT, RADIO ENGINEERING HAS GROWN FROM AN EIGHT-PAGE FOLDER TO A SIXTY-PAGE MAGAZINE. KEEPING PACE WITH THIS INCREASE, THE TECHNICAL FACILITIES HAVE BEEN EXPANDED, THE DARIEN LABORATORY ENLARGED, AND THE STAFF INCREASED.

EVERY SUBSCRIBER TO RADIO ENGINEERING WILL FIND THE MAGAZINE OF CONTINUALLY GREATER USEFULNESS DURING THE NEXT TWELVE MONTHS, MAINTAINING A GREATER RATE OF PROGRESS, EVEN, THAN WAS ACHIEVED IN THE PAST YEAR.

THERE ARE BIG THINGS AHEAD TO KEEP EVERY RADIO MAN ON THE ALERT.

## SAVED—

Your pet tube, or perhaps all of them, may be blown out by a slip of the screw driver or an error in connections—Protect them from harm with a KANT-BLO!

## Free Vacuum Tube Insurance

To every radio man who sends in a year's subscription to Radio Engineering, new, renewal, or extension, a binding post type Kant-blo will be sent *free*. The Kant-blo will save you many times the subscription cost if it protects your tubes from *only one* short circuit.—Send \$2.00 with your name and address clearly printed to the Tube Insurance Department. You will receive your Kant-blo immediately, and your subscription or extension for RADIO ENGINEERING will be entered for one year.

**M. B. SLEEPER, Inc.** TECHNICAL PUBLISHER

A-52 Vanderbilt Avenue

New York City

Radio Engineering, October, 1924. Vol. No. 4, No. 9. Published monthly by M. B. Sleeper, Inc., 52 Vanderbilt Ave., N. Y. C. Printed in U. S. A. Yearly subscription \$2.00 in U. S. and Canada; ten shillings in foreign countries. Entered as second class matter June 15, 1924, at the post office at New York, New York, under the act of March 3, 1879. Additional entry at Albany, New York.

# Another step ahead!

## ULTRADYNE *The Improved* SUPER-HETERODYNE MODEL L-2

### "Modulation System"-Plus Regeneration

**T**HE new Ultradyne, Model L-2 surpasses all conceptions of sensitivity and selectivity—represents the peak of Super-Heterodyne engineering skill.

To the "Modulation System" which has previously made the Ultradyne famous, regeneration is added in Model L-2. The result is ultra-sensitivity, never before thought possible. The Regeneration of infinitely weak signals produces tremendous amplification.

Selectivity is so high and amplification so strong that distant stations can be tuned in through local stations and put on the loud speaker.

This use of regeneration is the latest development of R. E. Lacault, A.M.I.R.E., Consulting Engineer of this Company, and formerly Radio Research Engineer with the French Signal Corps Laboratories, since his perfection of the "Modulation System" which is used exclusively in the Ultradyne Receiver.

The Model L-2 Ultradyne compels so complete a revolution in all previous ideas of Super-Heterodyne performance, that you can only comprehend its unusual selectivity, sensitivity, volume and range by operating this wonderful receiver.

*Write for descriptive circular.*

**PHENIX RADIO CORP., 7 Beekman Street, New York**



Send for 32-page illustrated book giving latest authentic information on drilling, wiring, assembling, and tuning the Model L-2 Ultradyne Receiver.

**50c**

### ULTRADYNE KIT

Consists of one low loss Tuning Coil, one low loss Oscillator Coil, one special low loss Coupler, one type "A" Ultraformer, three type "B" Ultraformers, four matched fixed Condensers.

The Ultraformers are new improved long wave frequency transformers, especially designed by R. E. Lacault, Consulting Engineer of this Company and inventor of the Ultradyne.

To protect the public, Mr. Lacault's personal monogram seal (R.E.L.) is placed on all genuine Ultraformers.

Ultraformers are guaranteed so long as this seal remains unbroken.



**\$30**

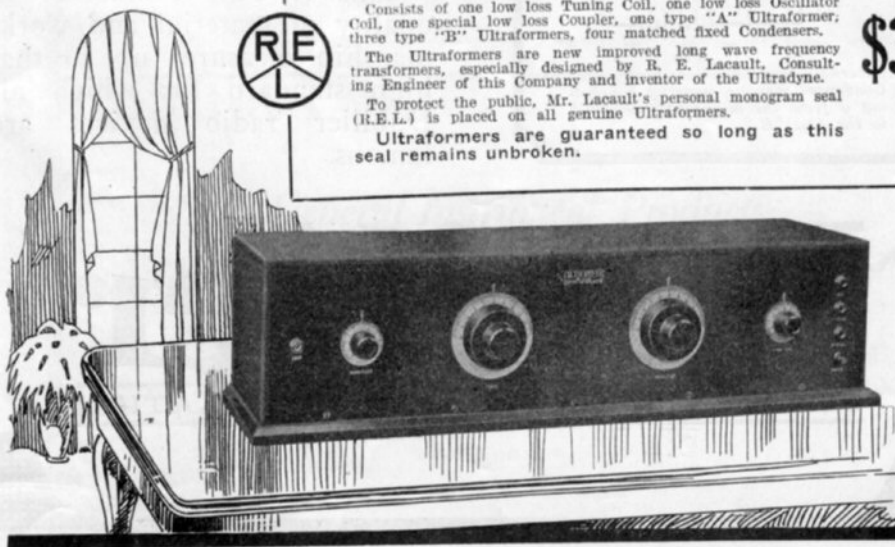

# The BY-PASS CONDENSER

## Improves Reception

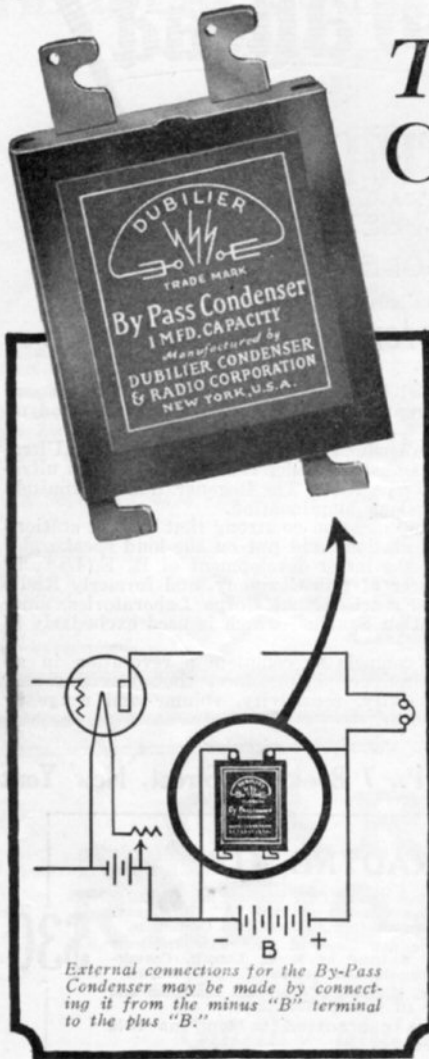

You will get the program clearer if you install a Dubilier large capacity By-Pass Condenser in your radio set. Just locate it as the diagram indicates. The result is that the minute fluctuations of the "B" battery are smoothed out into a steady, even flow of current, devoid of all noises.

The result is astonishing! Signal strength is increased—tones purer—volume smoother. The whole program comes in far truer and pleasanter than ever before.

This By-Pass Condenser in quality of material and workmanship measures up to that high standard for which all Dubilier radio devices are famous.

# Dubilier

CONDENSER AND RADIO CORPORATION

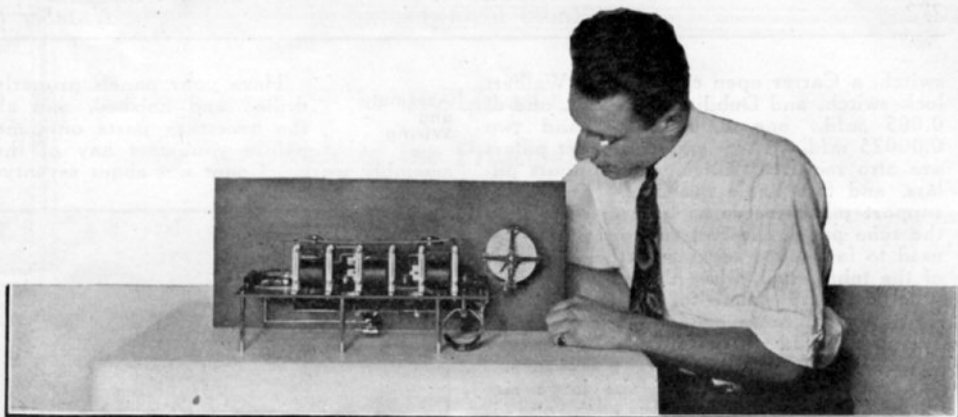

## A DX Set That Always Works

On antenna or loop, this set will out-perform most 4-tube receivers, and equal any of them. Built into an attractive cabinet, it is ideal for the home. A special diagram is given showing the connections for operating on the Run-A-Radio.

**W**HAT do you say to the man who asks you for advice as to the best kind of a radio set to make for use in his home, a set that will work either on a loop or antenna, that is attractive in appearance, and is sufficiently simple to operate so that his wife or children can handle it? This being a question often asked, we have tried to answer it in the design of the four-tube reflex set, type 6500.

The circuit is not new. In fact, it is old enough to have been thoroughly tried and tested by many set builders. With the refinements worked out in the design presented here, we consider it the safest four-tube outfit for the inexperienced constructor, and the most satisfactory for the inexperienced operator. There are no tricks or kinks about the assembly, nor opportunities for those trying faults which, in many circuits, frequently develop and often-times successfully resist correction.

If this set is built into a good looking cabinet, preferably one which will hold the batteries or battery substitute device, it makes an equipment of which any one may well be proud, and a set which will come surprisingly near the average super-heterodyne in the results produced.

As you will see from the front view, Fig 1, the panel carries one tuning condenser, a potentiometer, and rheostat. The tuning is done entirely with the large dial. For local reception, it is not neces-

sary to use the potentiometer altho it helps to bring up faint signals. A rheostat is provided on the last tube, to regulate the volume. When the set is to be operated at full volume the rheostat requires no adjustment whatever. Amperites, mounted underneath the first three sockets, maintain the current at its correct value during the operating life of the A battery, as they increase in resistance when the battery is freshly charged or decrease as the voltage drops to the point of full discharge.

Underneath the tube panel are the sockets and R.F. transformers, while the A.F. transformers are put on the top so as to make the leads short. At the left hand end of the panel you will see a small knob controlling an anti-capacity switch by which the circuit can be changed for operation on a loop or antenna and ground.

Formica panels carry the various parts. The front panel measures 10 by 24 ins. and the tube panel 7 by 16 ins., both 3/16-in. thick. The instruments themselves comprise a Bruno 0.0005 mfd. condenser, a 30-ohm Pacent rheostat and a 375-ohm potentiometer, four Bestone sockets, three 1A Amperites, an Eastern Coil pickle-bottle coupler for the tuning inductance, seven binding posts of the Eby or Marshall-Gerken type with non-removable tops, Acme R2, R3, and R4 R.F. transformers, three Acme A.F. transformers, a Rusonite fixed crystal detector, Harco single-pole double throw anti-capacity

Arrangement  
of the Type  
6500 Set

switch, a Carter open circuit jack, Walbert lock switch, and Dubilier Micadons, one of 0.005 mfd., one 0.002 mfd., and two 0.00025 mfd. Three panel support pillars are also required, sixteen coil support pillars, and two angle brackets. The panel support pillars serve as braces to hold up the tube panel, the coil support pillars are used to fasten the sockets to the underside of the tube panel, while the angle brackets hold the tube panel to the front panel. For controls, there are one 4-inch. Accuratune dial and two plain 2-in. Accuratune dials.

Because of the large size of the panels, each one is shown in two sections. Figs. 4 and 5 are one-half scale drawings of the two halves of the front panel while Figs. 7 and 8 show the halves of the tube panel at one-half scale.

To determine the locations of the holes, measure the distances from the center of the panel to the left or right, and from the bottom of the panel up to the crossed lines which mark the centers. This method is more accurate than measuring from the ends of the panels since the panels may not have been cut with absolute accuracy. Use the smoother, straighter edge for the bottom.

If you are not sufficiently skillful to work from the half-scale drawings, full-size blue prints can be obtained which you can put directly on the panel and punch through with a Starrett automatic center punch.

The finish of the panel is a matter of choice. However, since the surface of Formica has a high gloss, the panel can be polished or, for a dull appearance, rubbed down with No. 0 sandpaper and oil.

Sizes for the holes are given only when they are to be made with other than a No. 18 drill.

Have your panels properly drilled and finished, and all the necessary parts on hand before you start any of the assembly work. Count out about seventy-

Assembly  
and  
Wiring

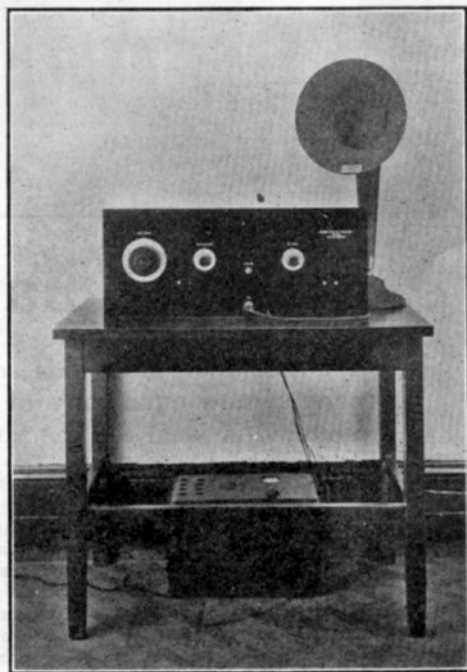

Fig. 1. A complete installation, with a Run-A-Radio replacing the batteries.

five lugs and fill each one with solder before they are put on to any of the instruments. That will help you to make the wiring neat and will prevent damage to any of the parts from overheating while the wires are being soldered to the lugs.

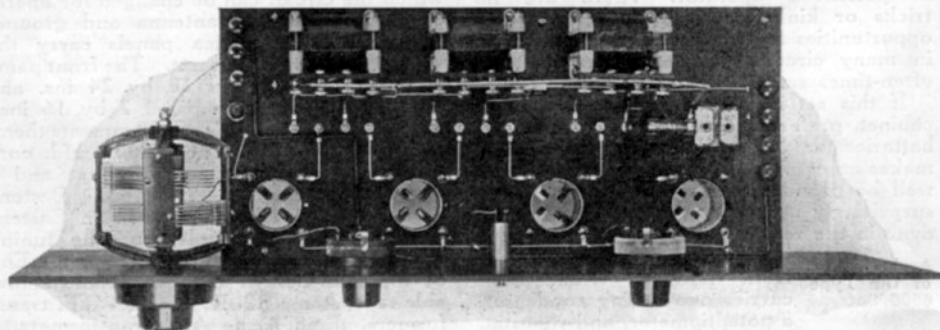

Fig. 2. The A.F. transformers are put on top so as to make the leads as short as possible.



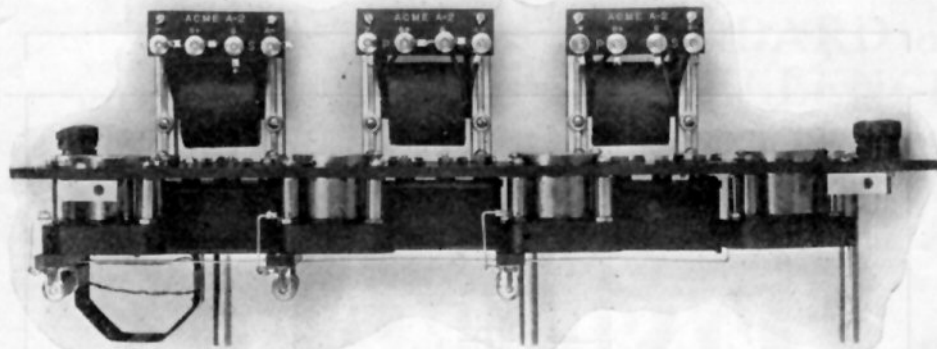

Fig. 3. Looking at the front of the tube panel before it is mounted on the front panel.

Use a good iron, well tinned, and maintained at a heat sufficient to make the solder flow freely. Either Kester rosin core solder or plain soft solder with Nokorode paste is recommended. Apply enough heat to the rosin core solder to make it flow freely. Otherwise you may have a "rosin joint". If you use paste, put on the smallest amount possible. Use Wirit for wiring the set.

Follow through the assembly exactly as the steps are laid out in the instructions following. Read each step through before you start on it, for there are special instructions which will help you.

1. Remove the thumb nuts from the binding posts on the sockets and put, in their places, coil mounting pillars. Referring to the picture wiring diagram, Fig. 6, put lugs under the pillars on the socket binding post screws for connections 2, 4, and 6. Fasten the Amperite mountings underneath the three right hand sockets. You can see the arrangement in Figs. 3 and 9. Use 1-in. 6-32 R.H. screws and nuts, clipping off the extra lengths of the screws. Mount the sockets underneath the tube panel with the terminals in the positions shown in Fig. 6. Use  $\frac{1}{2}$ -in. 6-32 R.H. screws. One lug is required under the head of each screw except on the G post of the right hand socket which takes two. Note also that a lug must be put between the pillar and the underside of the panel on the P terminal of the left hand socket, connection 62. Remove the thumb nuts from the terminals on the R.F. transformers and mount the transformers underneath the tube panel, fastening them by putting 6-32 nuts on the screws on the top of the panel. Each of these terminals takes one lug except the G binding post on the R4 transformer at the left. Break off the fibre base from the Rusonite fixed detector mounting, and fasten one of the clips under the nut on the G terminal of

the R4 transformer. Flatten out the lips of a lug and solder it to the under side of a 0.002 mfd. Micadon. Arrange it so that the eye of the lug will fit under the nut on the  $\frac{1}{2}$ -in. 6-32 R.H. screw which secures the left hand clip of the fixed crystal detector. A lug must be put on this screw also for making connection 47.

2. Connect 1 to 2, 3 to 4, 5 to 6, and 7 to 8. Wire 7 to 8 should also be soldered at 9 and 10. Connect 11 to 12, 13 to 14, 15 to 16, 17 to 18, and 19 to 20. Do not allow yourself to become confused by the dotted lines. They indicate wires run on the underside of the panel while the wires above the panel are shown by full lines.

3. Mount the binding posts on the tube panel, putting the lugs in place. Be sure that the holes for the wires point outward.

4. Connect 21 to 22 and solder this wire at 23 and 24.

5. Mount the audio frequency transformers, using  $\frac{1}{2}$ -in. 6-32 R.H. screws and nuts.

6. Connect 25 to 26. This is from the B+ to the A- binding post on the right hand transformer. Connect 27 to 28. This runs from the B+ post on the center transformer to the B+ post on the left hand transformer. Connect 29 to 30. 30 is the G post. Connect 31 to 32, and 33 to 34. Connect 35 to 36. 35 is the G post. Connect 37 to 38. 37 is the A- post on the center transformer and 38 the A- post on the left hand transformer. Connect 39 to 40, and 41 to 42. 41 is one of two lugs on the B+ post. This wire drops from the transformer down to the panel and along the panel to the hole where it passes underneath and goes to the lug on the binding post. Connect 43 to 44, first putting a piece of MR varnished tubing on this wire. 43 is the G post. Connect 45 to 46.

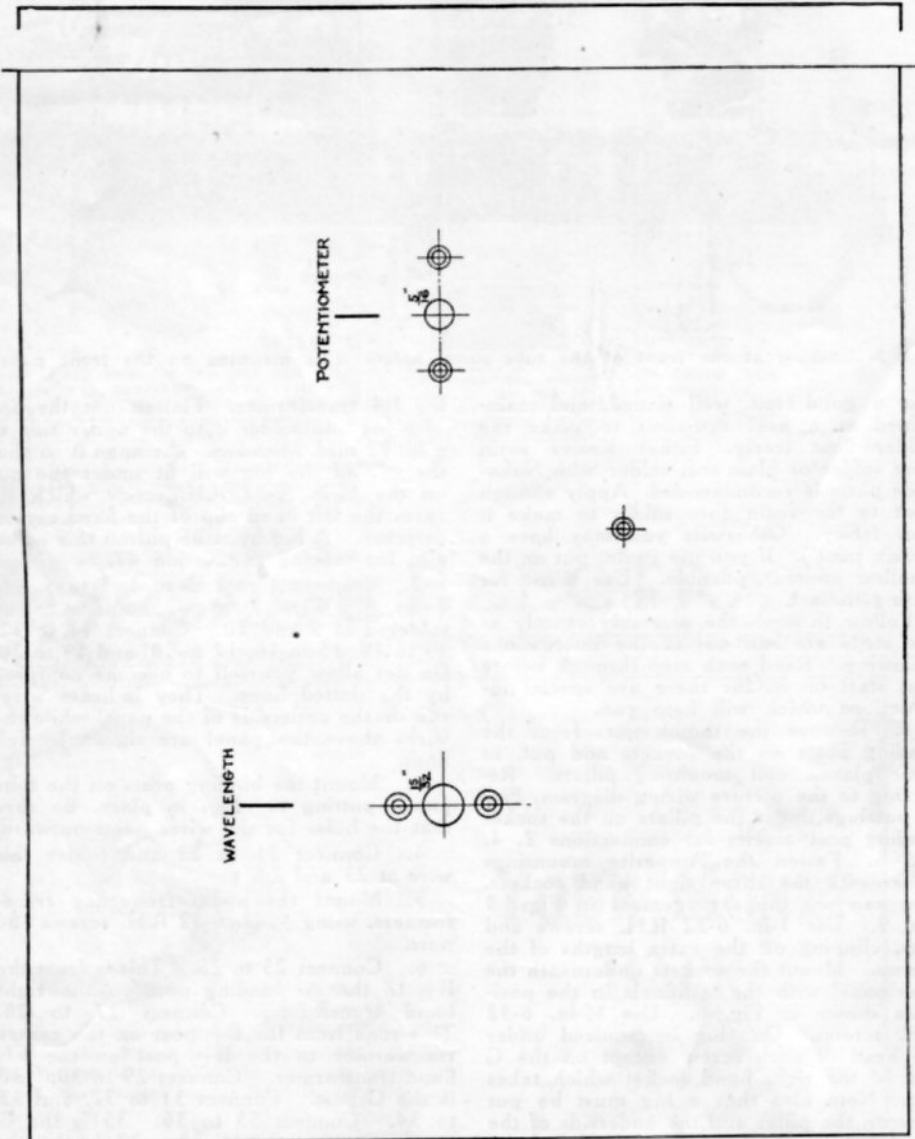

Material:  $\frac{3}{16}$  Formica Holes: No 18 drill unless otherwise specified

Des. by:	RADIO ENGINEERING	
Dr. by:	A.G.	4 TUBE REFLEX RECEIVER TYPE 6500
Ch. by:	<i>[Signature]</i>	
In Chg:	<i>[Signature]</i>	Left Half of front Panel
Limits:	Job: 7770	Sept. 15, 1934
Scale: Full Size	Dr. 10-24-2	Sheet: 2 5

Fig. 4. One-half scale drawing of the left end of the front panel.

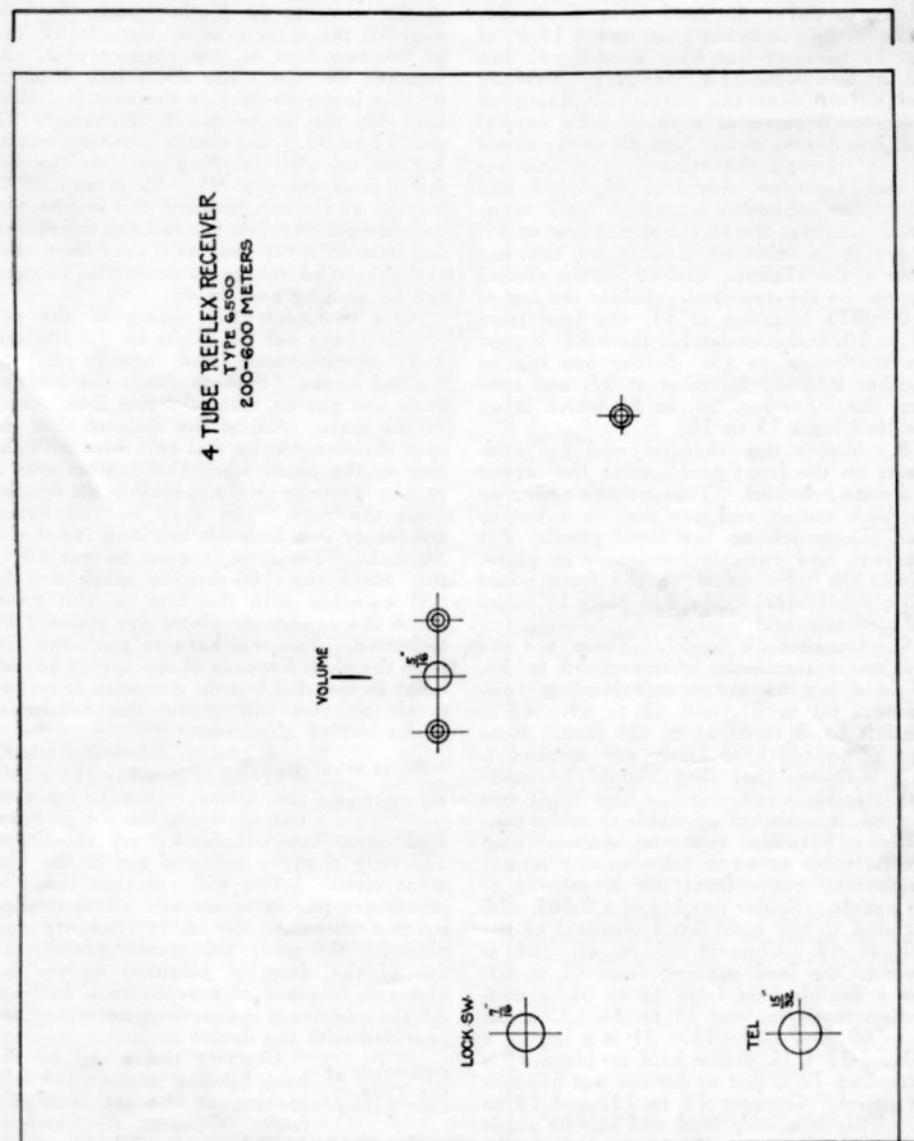

Material:  $\frac{3}{16}$  Formica      Note: No 15 drill unless otherwise specified

Des. by:	RADIO ENGINEERING		
Dr. by:	A. G.		
Ch. by:	G. W.		
In Chg.:	PL No.:	Right Half of Front Panel	
Limits:	Job:	7776	Sept. 15, 1924
Scale: Full Size	Dr.:	10-24-3	Sheet 3 5

Fig. 5. One-half scale drawing of the right end of the front panel.

7. Measure off a length of varnished tubing to cover the lead from 47 to 48. Remove the insulation from about 15 ft. of No. 24 wire, or use bare wire if you can get it, and wind this wire very carefully and tightly over the varnished tubing so that it will serve as a shield. Be careful that you do not in any way allow the shield to cut through the tubing. Put this armored insulation over lead 47 to 48 and solder the connections. 48 is the P terminal. Connect the shield at one end to 49, where it is soldered directly on the end plate of the Micadon, and at 50, the second lug on the B+ terminal. Solder the lug of a 0.00025 Micadon at 51, the lead from 29 to 30, and connect 52, the other lug on the condenser, to 53. Solder one lug on another 0.00025 Micadon at 37, and connect the other lug, 54, to 55 which is on the lead from 35 to 36.

8. Mount the rheostat and potentiometer on the front panel, using the screws and nuts provided. Take off the collar on the lock switch and use that as a nut to hold the switch on the front panel. Put the jack and variable condenser in place. Mount the tube panel on the front panel using angle brackets held in place by  $\frac{1}{2}$ -in. 6-32 screws and nuts.

9. Connect 56 to 57. These are the two stator terminals. Connect 58 to 59. 59 is a lug on the center binding post. Connect 60 to 61, and 62 to 63. 63 is the left hand terminal of the jack. Note that some of these leads are marked f. This indicates that they should be made with flexible conductor. Altho Wirit can be used, it is always advisable to make connections between separate panels with flexible cable so as to take up any strains which may come from the movement of the panels. Solder one lug of a 0.005 mfd. Micadon to the right hand terminal of the jack at 64. Connect 65 to 66. 66 is made to the lead running from 62 to 63. Run a flexible lead from 64 to 67, a connection made to lead 33 to 34. Connect 68 to 69, and 70 to 71. 71 is a lug on a  $\frac{1}{2}$ -in. 6-32 R.H. screw held in place by a nut. Lug 72 is put under the nut beneath the panel. Connect 72 to 73, and 74 to 75. This is a long lead and can be made with solid wire covered with varnished tubing. Note that the wire passes through a hole and connects to the binding post, under the panel. Connect 76 to 77, 78 to 79, and 79 to 80. This last lead, covered with varnished tubing, runs along the tube panel and through a hole to the binding post beneath the panel. Connect 81 to 82.

10. Mount the pickle bottle coil under the tube panel, using  $\frac{1}{2}$ -in. 6-32 R.H. screws. Put the anti-capacity switch in place.

11. Connect 83, the secondary lead, to

84, the primary lead, at 85, and run one of the wires to the binding post, 86. Connect 87, the other primary lead, to 59, one of the two lugs on the binding post, and connect 88, the other secondary lead, to 89, the lower contact on the switch. Connect 90, the upper switch contact, to 91, and 92 to 93. Connect 94, the remaining lug on the A— binding post on the left A.F. transformer, to 95. 95 is on lead 49 to 50, and when making this connection care should be taken not to keep the soldering iron on it too long as it may burn thru the varnished tubing underneath. Connect the C- binding post to 46.

This completes the wiring of the set.

12. Take out the shafts on the rheostat and potentiometer and break off the molded knobs. Smooth down the knurled ends and put on them the two 2-in. Accuratune dials. Adjust the dials so that the zero division on the dial coincides with the line on the panel when the contact arm is at the extreme right, looking at the set from the rear. The shaft on the Bruno condenser is a little bit too long for the 4-in. dial. Therefore, it must be cut off to fit. Have the 100-division mark on the dial coincide with the line on the panel when the condenser plates are entirely interleaved. You will have to push the dial onto the shaft because of the spring adjustment in the dial but do not push it on too much or you will throw the condenser plates out of alignment.

A special schematic wiring diagram is given to show how the filaments are to be connected when the set is operated on a Run-A-Radio battery substitute. The only changes required are in the filament circuit. You will see that the filaments are put in series and all controlled by one rheostat. No Amperites are employed. Moreover, this system permits the use of the drop in potential across the filaments in place of a separate C battery. All the additional instructions necessary are provided with the device itself.

Connect the aerial to the back binding post on the left, the Type 6500 Reflex looking at the set from the front. Connect the ground to the middle binding post. The loop used may be any of the good types now on the market. A Ritter or General Radio loop is recommended. Connect the outside lead to the middle binding post with the ground lead. Connect the inside lead to the front binding post. Care should be taken to keep the loop leads as short and as far away from each other and the operator as possible.

Connect a 6-volt storage A battery to the two front binding posts on the right, looking at the set from the front. The

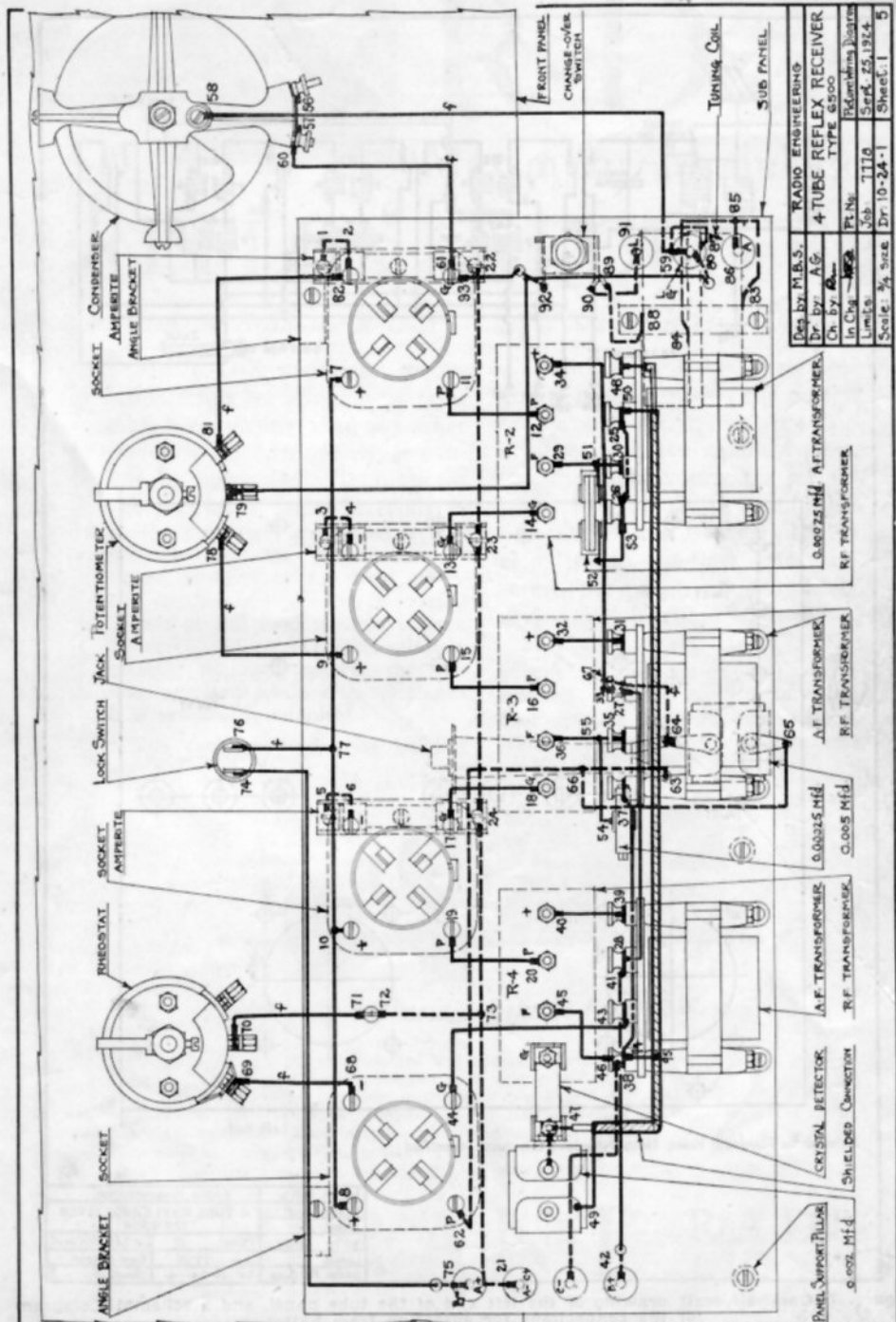

Fig. 6. Picture wiring diagram. The tube panel is tipped down to show the parts mounted on it.

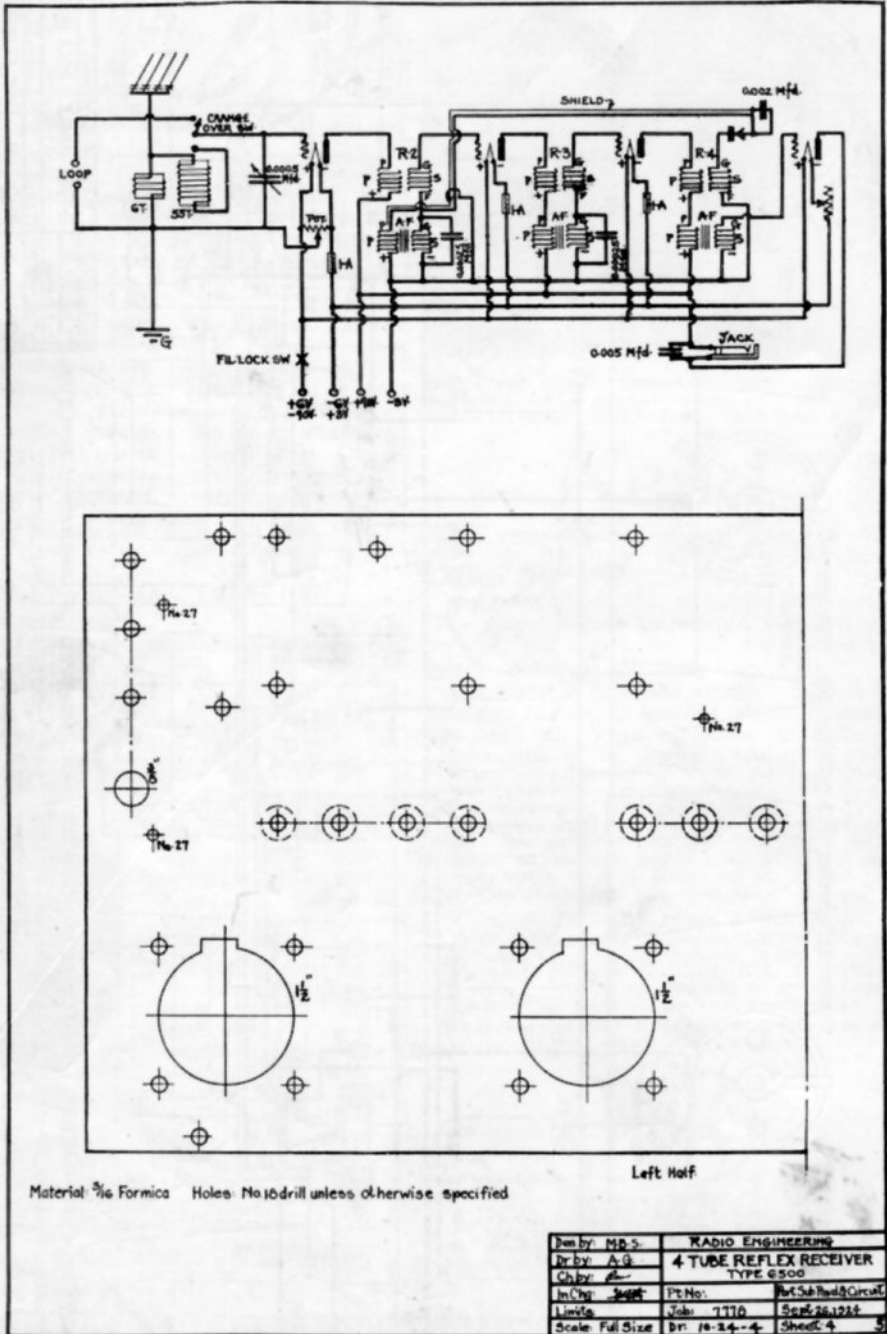

Figure 7. One-half scale drawing of the left end of the tube panel, and a schematic diagram of the connections for operating from batteries.

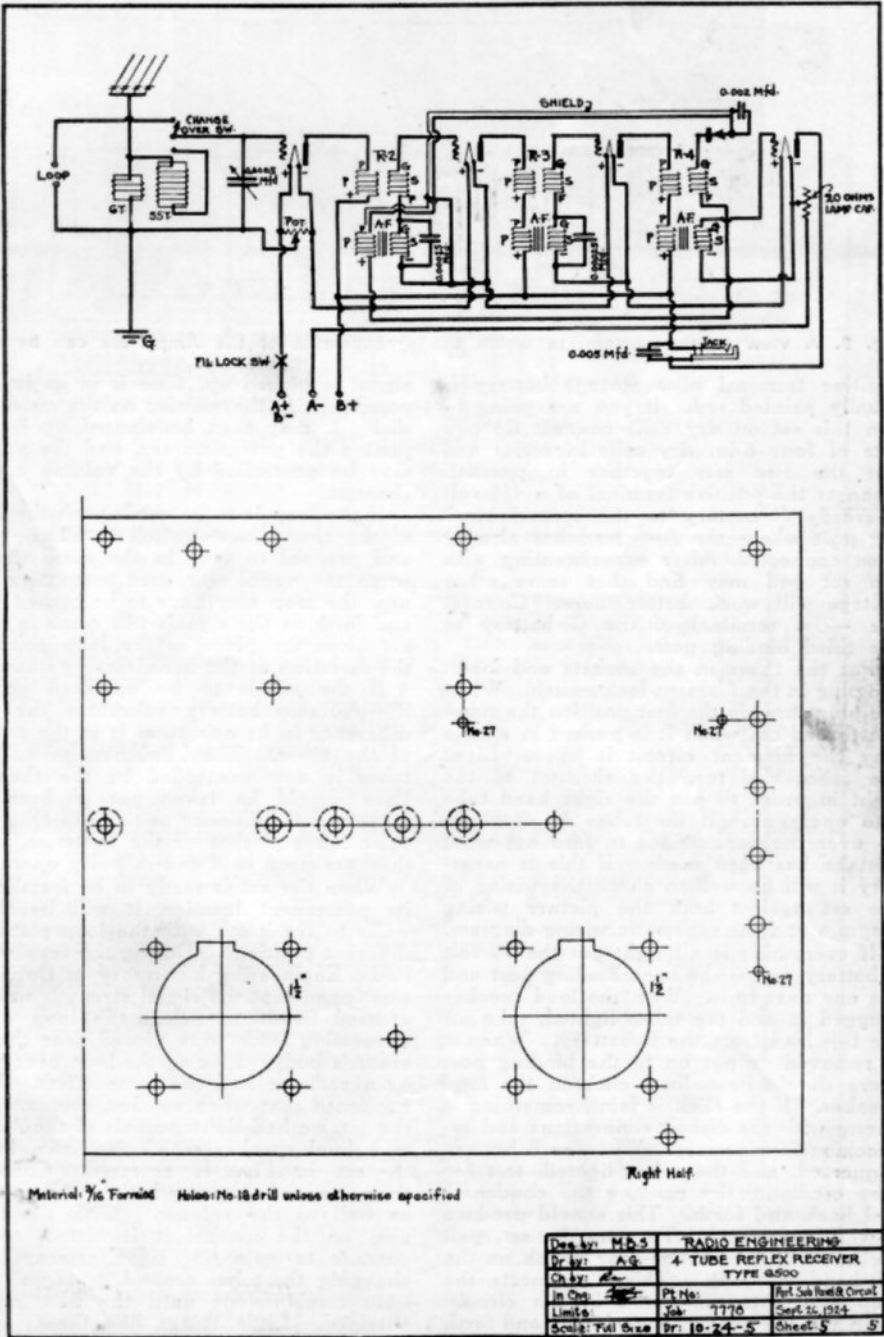

Fig. 8. One-half scale drawing of the right end of the tube panel and a schematic diagram of the connections for operating from a Run-A-Radio.

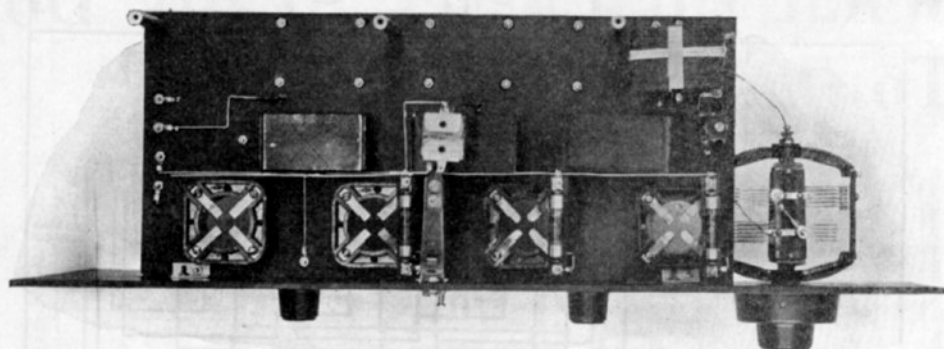

Fig. 9. A view of the bottom, in which the arrangement of the Amperites can be seen.

positive terminal of a storage battery is usually painted red. If you are going to run this set on dry cells connect up two sets of four 6-in. dry cells in series and put the two sets together in parallel. Connect the positive terminal of a  $4\frac{1}{2}$ -volt Eveready C battery to the second binding post where the A— lead has already been connected. After experimenting with the set you may find that some other voltage will work better here. Connect the —3v. terminal of the C battery to the third binding post.

Put the tubes in the sockets and insert the plug in the filament lock switch. When the plug stops in the first position the tubes are turned on, when it is pushed in all the way the filament circuit is open. Light the tubes and turn the rheostat to the right in order to put the right hand tube into operation. If the tubes do not light go over the connections to find out what mistake has been made. If this is necessary it will be well to check the wiring of the set against both the picture wiring diagram and the schematic wiring diagram.

If everything is all right put the 90-volt B battery across the back binding post and the one next to it. With the loud speaker plugged in and the tubes lighted, take off the B+ lead from the B battery. When it is removed or put on to the binding post there should be a loud click in the loud speaker. If the click is faint, something is wrong with the circuit connections and rechecking is necessary. With the B battery connected, and the tubes lighted, test for tube oscillation by running the condenser dial back and forth. This should produce a whistling sound. To tune the set, pull the knob of the change-over switch on the left-hand side, up. This disconnects the loop and puts the aerial in the circuit. Then run the condenser dial back and forth between zero and about 75, keeping the potentiometer dial at about half position. Signals will be picked up near the points where a low whistle is produced. When a

signal is picked up, tune it in as loud as possible with the vernier on the condenser dial. It may then be cleared up by adjusting the potentiometer, and the volume may be controlled by the volume control rheostat.

If the loop is to be used, push the knob of the change-over switch in all the way, and proceed to tune in the same way as when the aerial was used, excepting that now the loop may have to be turned back and forth as the signals will come in loudest when the plane of the loop points in the direction of the broadcasting station.

If the set is to be operated on the Run-A-Radio battery substitute the only difference in its operation is in the control of the tubes. The brightness of all four tubes is now controlled by the rheostat. Care should be taken not to burn the tubes at full brilliancy as this shortens both their life and that of the batteries, when they are used, and causes noisy operation.

When the set is ready to be installed in its permanent location it will be worth while to try it out with the loop placed in different positions. During the tests at the Radio Engineering laboratory at Darien, it was found that the signal strength was decreased materially when the loop or its connecting leads were placed near the operator's body. Placing the loop near walls or a radiator had the same effect. It so happened that when we first connected up the set, we had the terminals of the Ackerman loud speaker which is shown beside the set in Fig. 1, reversed. Changing these around improved the tone quality as well as the volume. With the tubes now on the market it is almost always possible to gain in signal strength by changing the tubes around, trying all possible combinations until the best one is obtained. Little things like these, which take only a few minutes to try out on any set, are often times the means of bringing in stations which were never heard on the set before.



# What Do Losses Really Do To Tuning Circuits?

With all that has been published concerning high efficiency inductances and condensers, no one has presented any actual data to demonstrate that losses, high or low, affect the sharpness of tuning or the strength of the signals. Here is the story of efficient coils and variable condensers, told in terms of tuning and signal strength.

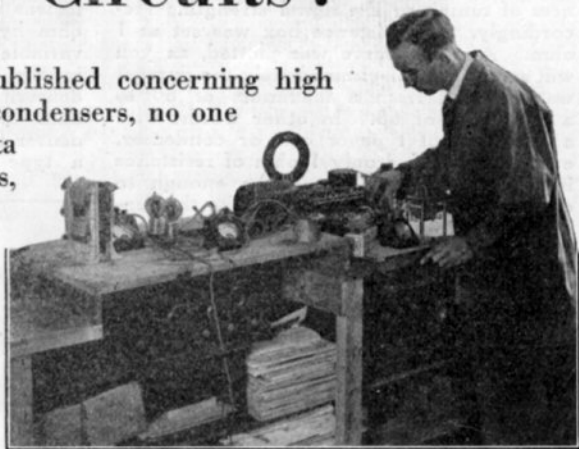

**D**URING the past three or four years there has been considerable discussion concerning losses in radio receiving circuits but, strangely enough, what has been said and written has hardly amounted to more than expressions of opinion. Even when Mr. Allen Cardwell set the ball rolling by his series of articles on the design of variable condensers, following which there has been a most surprising response in new types of low-loss condensers, he told only a part of the story. Mr. Kruse, of QST, has written a great deal about the elimination of losses but he has contributed very little of a quantitative nature.

After all, we are only interested in eliminating losses which will improve the results as indicated by the telephones or loud speaker or the adjustment of tuning dials. If losses do not affect the operation of our sets, we might as well have them as to do away with them. Therefore, not knowing positively that the losses made any difference, the discussion about them has been purely academic and interesting without being particularly useful.

Through the courtesy of the General Instrument Company, whose testing laboratory was put at our disposal, we set out to determine whether or not it is worth while to attempt to increase the efficiency of tuning circuits by cutting down the losses in coils and in condensers. The accompanying photographs show how the tests were made, and the curves illustrate the data which we collected.

In Fig. 1 you will see the set-up for measuring the effect of losses, or resistance, in a simple tuning circuit, made up

of a variable condenser and coil. This might be the secondary of an ordinary tuner or one of the stages in a neutrodyne or tuned R.F. receiver. A low-loss condenser was connected with a pickle bottle coil. In series with the coil and condenser a General Radio resistance box and Weston thermal ammeter were inserted. The resistance box was connected so that various amounts of resistance might be added to the tuning circuit, and the ammeter was used to show the amount of current flowing through the circuit. The pickle bottle coil was loosely coupled to the inductance in an oscillator circuit.

In this set-up, the oscillator corresponded to a transmitting station or the output of a vacuum tube. The pickle bottle coil picked up energy from the transmitter since it was inductively coupled to the oscillator. The ammeter indicated the current flowing through the circuit, corresponding to a pair of telephone receivers which would indicate the signal strength. With the oscillator adjusted for a particular wave length, say 400 meters, when the tuning condenser connected to the pickle bottle coil was rotated the current in the circuit gradually increased to maximum, when it was adjusted right at 400 meters, and then dropped down again, as is the case when tuning in a transmitting station.

To see how sharply tuned this circuit was, the condenser dial was slowly turned, one or two degrees, at a time, and the reading of the ammeter taken. In Fig. 2, you will see that, starting from zero current picked up by the test circuit, the current gradually increased and dropped off again. This curve is quite sharp, for no

resistance was cut in at the resistance box.

Then we wanted to see if losses amounting to a few ohms would affect the sharpness of tuning or the signal strength. Accordingly, the resistance box was set at 1 ohm. Another curve was plotted, as you will see in Fig. 2. Immediately the current was reduced from a maximum of 80 to a maximum of 68. In other words, with a less efficient type of coil or condenser, even tho it added only 1 ohm of resistance in the circuit, that would be enough to cut down the signals and to make the tuning broader. Increasing the resistance to 5 ohms brought the maximum current down to 38. 10 ohms added by the resistance box reduced the current by seventy-five per cent, while 25 ohms made the tuning so broad that such a circuit would be useless for tuning.

Actually, the effect of a small amount of additional resistance in the circuit is much more pronounced than the curves show because the thermal ammeter introduced as much resistance, at 400 meters, as the losses in the coil and the condenser combined. Therefore, an added resistance of 1 ohm increased the total resistance of the circuit by only ten per cent, since at 400 meters, the resistance of the coil, condenser, and thermal ammeter was 10 ohms.

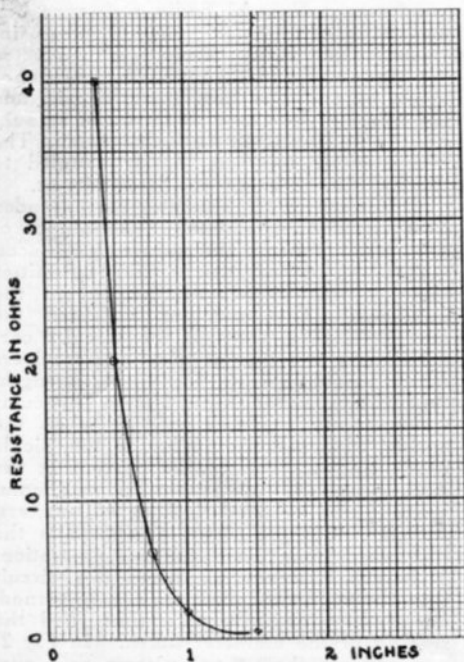

Fig. 5. Increased resistance introduced by a variable condenser at the end of the coil. The horizontal scale shows the separation between the end of the winding and the condenser end plate when the shaft of the condenser was in line with the axis of the coil.

Yet this ten per cent increase reduced the signal strength from 80 to 68.

Next we asked ourselves whether or not it was easy to increase the resistance 1 ohm by the use of an inefficient coil or variable condenser. Measuring the loss in the General Instrument low-loss condenser, we found that it amounted to 0.02 ohm at 400 meters while a good condenser fitted with solid bakelite end plates, a type much more efficient than many

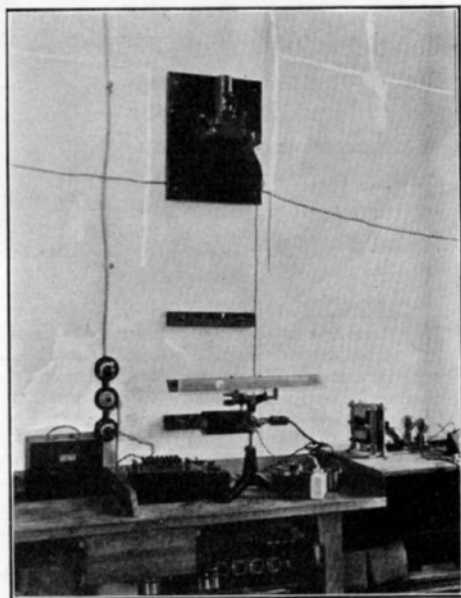

Fig. 3. A Leeds-Northrup reflecting galvanometer for measuring insulation leakage.

now on the market, had a resistance of 3 ohms. This loss, through the use of a poor condenser, brought the maximum current from 80 down to 50, making the curve almost as broad as that shown in Fig. 2 for 5 ohms resistance. There you have a definite demonstration of the value of low-loss condensers as indicated by the sharper tuning and greater signal strength when the most efficient type is employed.

For several months we have urged the elimination of tubing in favor of the use of the pickle bottle type of coil. To find out whether or not the tubing made any difference in the resistance of the coil, we laid two little strips, of the size employed for mounting the pickle bottle coils, inside the winding in their usual position. At 400 meters the resistance was increased by 0.5 ohm. Of course, the volume of insulating material was much less than that in a regular tube. If an equivalent volume had been put inside the coil, the losses would probably have mounted to at least

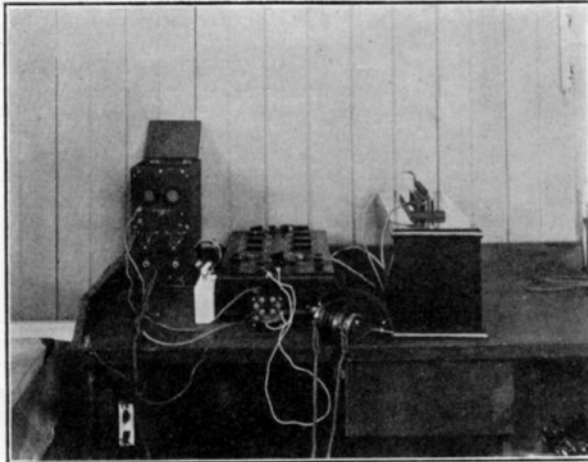

Fig. 4. At the center is a General Radio decade bridge, with a Leeds-Northrup standard at the right. The bridge is used for measuring D. C. resistance, inductance, or capacity. An alternating current is supplied by an A. F. oscillator mounted beneath the table. Note that a telephone transformer is used instead of connecting directly to the measuring circuit.

2 ohms. That would make the circuit a little more broad than is indicated by the 1-ohm curve in Fig. 2.

Much has been written about metal parts mounted near inductances. We wanted to find out if they really affected the resistance of a circuit. A variable condenser was held in various positions outside the coil, from 2 or 3 ins. away up to a point where the condenser almost

touched the outside of the winding. As long as the condenser was not at the end of the coil it did not affect the resistance at all. However, the moment the condenser was brought near the open end, the resistance went up very quickly. In Fig. 1 you will see the arrangement for the test from which we plotted the curve in Fig. 5. The condenser, with metal end

(Continued on page 314.)

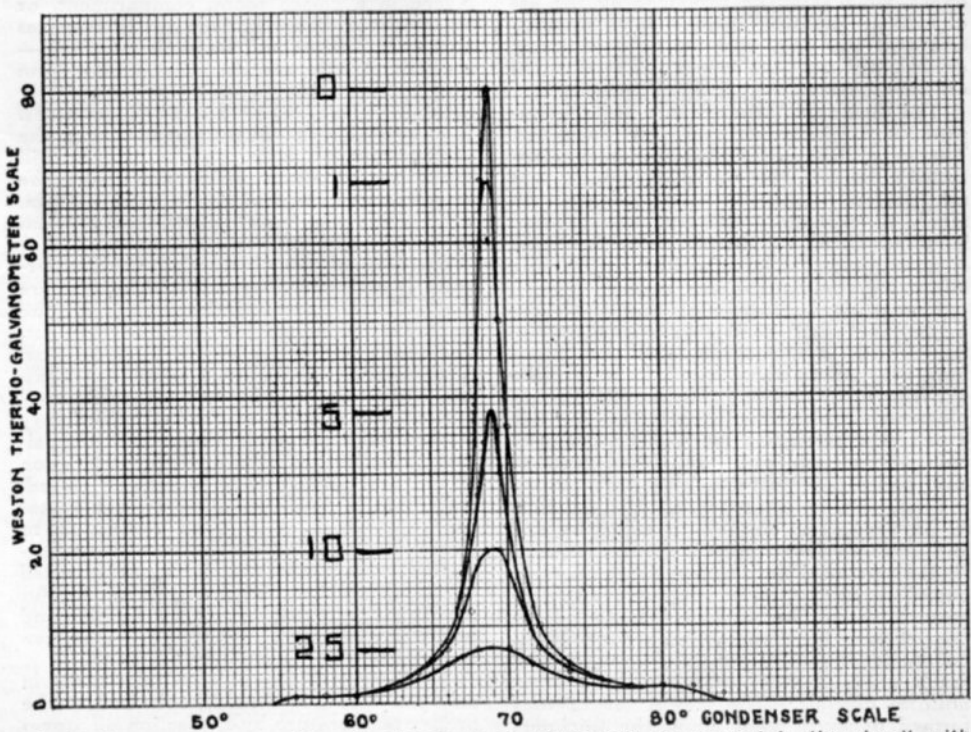
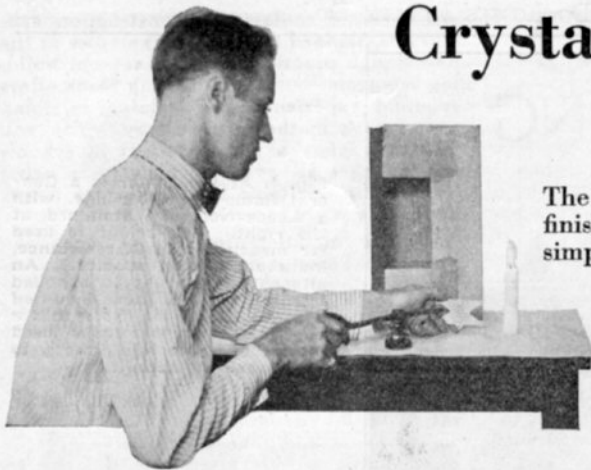

Fig. 2. Resonance curves show the sharpness of tuning and the current in the circuit with various amounts of resistance.

# Crystallizing Lacquer



The use of this most attractive finish is described, as well as a simple set-up for experimenting with it. You have seen the crystallized finish on some radio instruments—this article tells how it is obtained.

**A**MONG the hundreds of things in radio which the engineer, experimenter, and designer of radio apparatus sees and admires frequently, but does not know much about, is the crystallized lacquer finish which is appearing on more and more of the high class radio products being put on the market. This condition of ignorance of a comparatively simple and cheap process seems to be due more to lack of available information on the subject than anything else. The crystallized effect, which may be produced by the use of Hilo crystallizing lacquer, is very attractive and pleasing, with its softly glinting crystals giving an effect like that of crackled glassware.

The finish is permanent and weather-proof and withstands wear and hard use. The crystallized effect gives a very satisfactory finish on surfaces which are not perfectly smooth,—iron castings, die moulded castings, ordinary steel sheets, moulded fibre, woodwork, and glassware. It saves undercoat labor as its wrinkles hide minor imperfections in any surface.

One great advantage of this finish lies in the fact that good results can be obtained without any special skill, or apparatus other than that found in any radio experimenter's home. The necessary implements required for a successful job are a can of crystallizing lacquer, an ordinary paint brush, an oven or closed wooden box, and a thermometer.

First, the article to which the finish is to be applied is cleaned so as to be dry and perfectly free from oil, grease, or dust. If the material is porous, like fibre or paper, a primary coat of some colorless varnish should be applied first to fill up the pores. The crystallizing lacquer should be applied quickly, and left alone, as too much brushing may cause streaks of non-uniform crystals. The size of the crystals formed depends solely upon the thickness of the coat of lacquer applied; the heavier

the coating, the larger the crystals will be. For smaller crystals the lacquer may be thinned with turpentine. For factory production work the lacquer should be applied by spraying, as more uniform results are thus obtained due to the more perfect control over the thickness of the coating. The lacquer should not be applied in direct sunlight as this interferes with crystallization.

As soon as the articles are coated with the crystallizing lacquer, they should be placed in a closed room, compartment, or oven—the ordinary kitchen gas oven serves unusually well as will be explained later—and left at a temperature not higher than 110° F. until the crystals are completely formed. This takes about 45 minutes. The crystallizing takes place during the early stages of drying. The lacquer will crystallize at room temperature but the action is quicker and much more certain, and the crystals more uniform and perfect, at around 100° F.

Best results are obtained if the temperature is maintained by artificial heat where the gases of combustion mingle with the air, thus reducing the oxygen content. The room or oven should be kept dark or, if necessary, lighted by a small gas light. No fresh air should be admitted until crystallizing is complete, and if an ordinary kitchen baking oven is used as the crystallizing chamber, all vents for the admission of air, and all dampers, should be closed. One method, which is more or less makeshift but which gives good results, is to cover the articles which have been lacquered, with a glass bell jar or an inverted box, making it as airtight as possible. An ordinary wax candle may be lighted and placed inside so as to burn up the oxygen in the air, thus aiding crystallization.

If the crystallization is to take place in an open room, it should be heated to the proper temperature by Perfection oil stoves

*(Concluded on page 302)*

# RADIO ENGINEERING

M. B. SLEEPER, Editor

F. A. SKELTON, Managing Editor

Published monthly by  
M. B. SLEEPER, Inc.

Editorial and General Offices  
A-52 Vanderbilt Ave., New York, N. Y.

Chicago Advertising Office  
Morley Company, 157 E. Ontario Street.

---

Twenty cents per copy in the United States and Canada; in foreign countries one shilling. Two dollars per year, twelve numbers in the United States and Canada; ten shillings in foreign countries.

Copyright 1924 by M. B. Sleeper, Inc.

---

Vol. IV      OCTOBER, 1924      No. 9

---

## EDITORIAL

**H**OWEVER good a thing may be, its value is limited to the use which is made of it. This applies equally to an invention or a magazine article. Because, with the thousands of subscriptions and the increased newsstand circulation starting with this issue, so many new readers will see Radio Engineering for the first time, an explanation concerning the monthly construction articles may increase their value by showing new ways to make use of them.

When the construction articles are being planned, the circuit, the controls, the tubes, batteries, range, volume, cost, and the mechanical design are as carefully considered as in any manufacturing plant. Each outfit is designed to fit into a particular set class, to meet a particular sort of requirements. Then it is worked out mechanically so that it can be assembled with the simple equipment found in most set-builders' home shops. Finally, instructions and drawings are prepared to furnish "success insurance" to the constructor. However, as you will see, this is only a part of the scope of the construction articles.

The set-builder, making an outfit for himself or to sell to a customer, can be sure that, following the instructions and using the same or equivalent parts, the completed outfit will be successful, that there will be no waste of time or materials. As for the appearance of the finished set—there is the opportunity for original thinking. It can be put into a simple box, a phonograph cabinet, or one of the new types of special radio tables, with or without a built-in loud speaker.

Remembering that the set-builders of a few years back are the manufacturers and

engineers of to-day, the construction articles are planned to provide examples of the best design practice. For that reason, building sets from Radio Engineering plans offers splendid experience and training in doing radio work in the correct way. You will find that many a radio student in schools and colleges all over the country is being brought up on Radio Engineering as a text book of design.

To the manufacturer, the construction articles are useful as sources of new ideas. Have you ever noticed that ideas often suggest ideas, even tho they are totally different? That's the way for a manufacturer to use these articles, and that purpose is always borne in mind in their preparation.

Some magazines do not favor the publication of new designs each month, but prefer to show additions or variations of the same outfit month after month because, otherwise, their readers would complain that they couldn't decide what outfit to build. Radio Engineering, however, does not admit that there is such a thing as THE BEST SET or THE BEST CIRCUIT for thousands of people whose requirements and means vary so widely. Nor does Radio Engineering believe that new devices or better methods should not be shown for fear of making present devices and methods become obsolete too quickly. Even when radio apparatus has become as standard as electrical equipment, there will be countless developments ahead.

Then, as now, Radio Engineering will employ expert designers to originate and to gather from manufacturers new ideas for the construction articles, for the work of this publication is, first and foremost, to lead the way in the practical and conservative advance of radio construction.

In this issue is the announcement of a Registry of installation and maintenance men. A new undertaking, the publication of this Registry was prompted by repeated requests, "Can you tell me of anyone in my town who will look out for my tubes and batteries?" or "Is there a reader of your Magazine in my city who knows how an antenna should be erected to give good results?" Then a manufacturer who sells many construction kits by mail asked how he could get hold of men to whom he could refer customers when they got in trouble.

Our answer is the I and M Registry. If you can handle this work, for which the standard charge is a dollar and a half per hour, not including travelling time within city limits, get your name on the Registry. Since this is a reader service, the charge for listing is made as small as possible. If it brings you only one job a month it will be profitable to you and, if you really go after the work, you may be able to turn a small start into a real business.

M. B. SLEEPER, Editor.

# How to Build the Haynes Audio Amplifier

Assembly data on the amplifier which is designed particularly for the Haynes tuner although it can be used on any receiving set.

EVERY man who builds a one-tube receiver sooner or later wants to add a 2-step audio frequency amplifier. There are many different designs which can be employed, of which one is generally as good as another providing that the transformers are correctly built, for they form the keystone of the instrument.

The A. F. amplifier described here is designed for use with the Haynes tuner, in that the binding posts have been arranged for short inter-panel connections. However, it is equally good on any type of tuner.

The panel on which the instruments are mounted covers 7 by 10 inches, 3/16 inches thick. The material is black Formica. On the front are rheostats for regulating the tubes and three jacks into which the phones can be plugged for detector, first stage, or second stage. Behind the panel, are the A. F. transformers mounted at right angles to eliminate inductive effects, and the two sockets.

Complete parts required are:—2 30-ohm Haynes-Griffin rheostats, 2 Haynes-Griffin Panel Mounting sockets, 1 open circuit and two double circuit Haynes-Griffin jacks, 2 Haynes-Griffin A. F. transformers (Type 91), and 6 binding posts. All the parts are mounted on the front panel, obviating the necessity for a special type panel.

The rear view of the amplifier is shown in Fig. 5, with a half scale drawing of the front panel in Fig. 4.

The exact connections for the amplifier are shown in Fig. 6, the picture wiring diagram. You will see that the connections are numbered to correspond with the following step-by-step assembly instructions. You will save yourself time if you will go through the work in the order indicated.

No. 1 Mount the binding posts on the front panel and put the rheostats in place, making sure that the terminals are toward the bottom of the panel. Lugs should be

put on the screws as the parts are mounted. Have them point in the directions indicated by the heavy lines in Fig. 6.

No. 2 Connect 1 to 2 and 3 to 4. 4 is the right-hand terminal on the right-hand rheostat. Mount the three telephone jacks, putting the open circuit jack looking to the left looking at the panel from the rear. Connect 5 to 6. Keep this wire close to the panel and run it along the open circuit jack next to the frame. Cover the wire with M-R varnished tubing between points 5 and 7. Connect 7 to 8. 8 is the terminal on the centre jack to the metal frame. Connect 9 to 10. 10 is the top contact on the right-hand jack. Cover this wire with M-R tubing. Connect 11 to 12. 12 is the contact next to the frame. Cover this wire with M-R tubing.

No. 3 Put the lower transformer in place temporarily.

No. 4 Connect 4 to 13, the right-hand terminal of the left-hand rheostat.

No. 5 Remove the transformer. Mount the two sockets using the screws provided.

No. 6 Connect 14 to 15 and 16 to 17. 14 and 16 are the front left-hand terminals of the sockets and 15 and 17 are the left-hand terminals of the rheostats. Connect 18 to 19 and solder this wire at 20 where it passes the front right-hand terminal of the right-hand socket. Connect 21 to 22. 21 is the rear left-hand socket terminal and 22 the top terminal on the centre jack. Connect 23 to 24.

No. 7 Mount the lower socket making sure that the primary terminals are down and the secondary terminals up.

No. 8 Connect 25 to 26. 25 is the B post on the transformer and 26 the second contact down on the left-hand jack. Connect 27 to 28. 27 is the B terminal and 28 the second contact up on the left-hand jack. Connect 29 to 30, and 31 to 13. The last connection is to a second lug on 13.

No. 9 Mount the upper transformer with the primary terminals to the right and secondary terminals to the left. Connect 32 to 31, 33 to 34, 35 to 36, and 37 to 38,

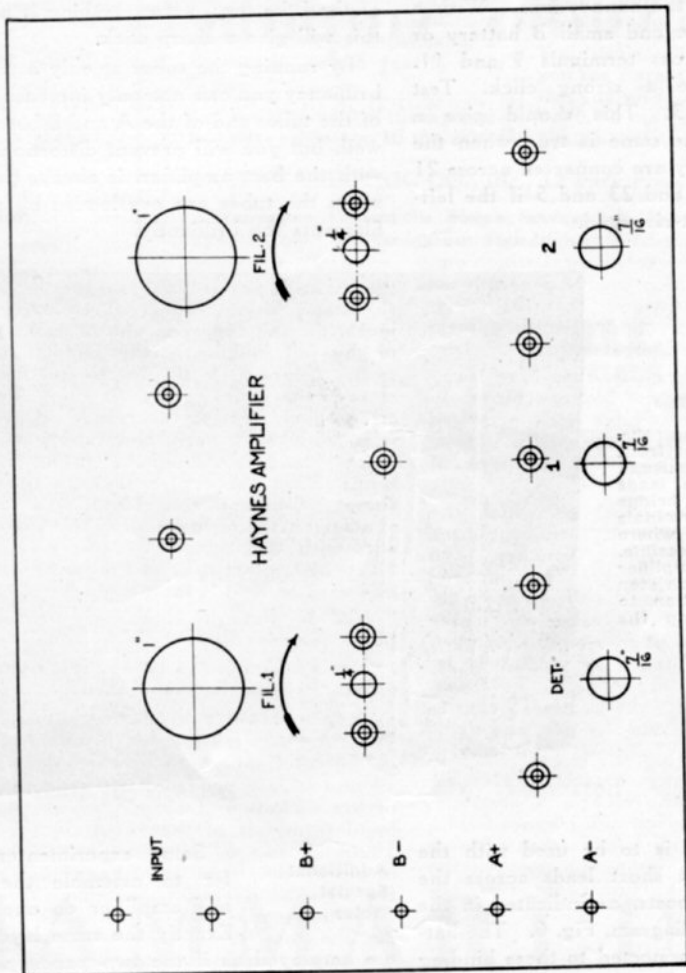

Material:  $\frac{3}{16}$  Ferrica Holes: No 10 drill unless otherwise specified

Des by	A. J. H.	RADIO ENGINEERING
Dr. by	A. G.	HAYNES-2 STAGE
Ch. by	R.	AUDIO FREQUENCY AMPLIFIER
In. Ctg.	15 2 2	Front Panel
Pr. No.		
Lim. Cts.	Job: 7770	Aug 20, 1924
Scale	Full Size	Dr. 10-24-1 Sheet 3

Fig. 4. Front panel of the Haynes amplifier, drawn to exactly one-half scale.

36 is the second contact up on the centre jack and 38 the second contact down.

This completes the wiring of the amplifier.

Testing  
and  
Operating

When the wiring has been finished, it is well to make sure that there are no errors in the connections. With a pair of telephones and small B battery or dry cell, test across terminals 9 and 11. This should give a strong click. Test across 30 and 3. This should give a strong click. The same is true when the phones and battery are connected across 21 and 5, 34 and 3 and 23 and 5 if the left-hand jack is short-circuited.

nect the minus lead from the B battery to the bottom terminal of the Kant-blo and run a wire from the metal ends of the Kant-blo to the (minus) B battery on the set.

To make a final test on the jacks, insert the telephone plug in each jack and, while the plug is in place, remove the plus lead of the B battery. If everything is all right, this will give a sharp click.

By running the tubes at only a moderate brilliancy you can not only increase the life of the tubes and of the A and B batteries as well, but you will prevent distortion which, with the best amplifier, is always produced when the tubes are overloaded by running filaments too brilliantly.

Fig. 5. Mounting the transformers on the front panel is rather unusual, but it makes the leads very short, and brings the transformer terminals out in the open where they are easily accessible. As you put the amplifier together, check each step with this illustration to avoid errors during the assembly.

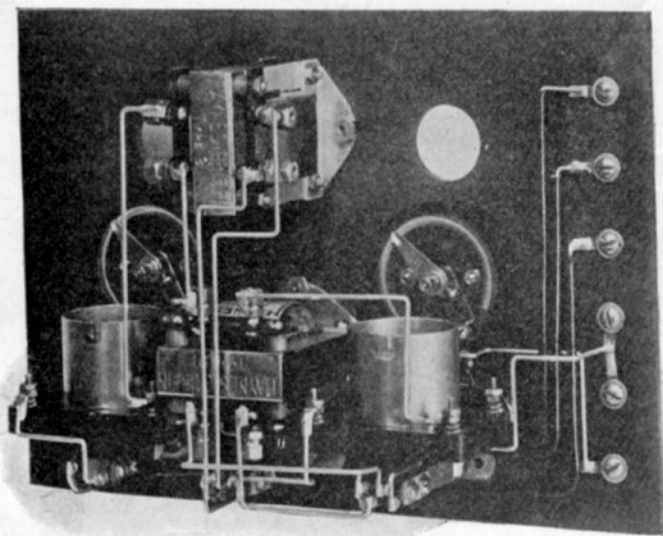

If the amplifier is to be used with the Haynes tuner put short leads across the adjacent binding posts, as indicated in the schematic wiring diagram, Fig. 6. The batteries should be connected to these binding posts also. The tubes should light as soon as the rheostats are turned up. Do not connect the B battery to the amplifier, however, until you have tested to see that the filaments light properly for, if there is a short circuit the tubes may be blown out.

If you want to use a Kant-blo tube protector without mounting it on the set itself, make a little bracket for it near the place where you connect your B batteries. Con-

Additional  
Special  
Notes

Some experimenters prefer to assemble the tuner and amplifier on one panel.

Exactly the same layout can be employed as if the two panels were to end to end and made into one. The binding posts can be mounted on a terminal panel strip supported on pillars at the rear of the front panel. If this is done, carry out the wiring as shown in the schematic diagram Fig. 6 just as if the dotted line connections were put in solidly. You will not need a double set of binding posts however, but just leads off from the points where the binding posts are indicated, to the binding posts on the terminal strip.



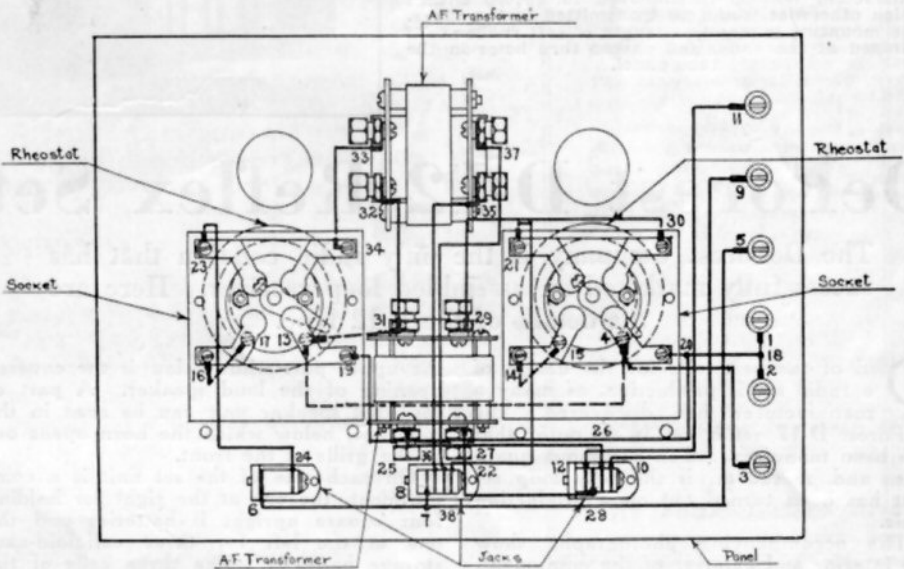
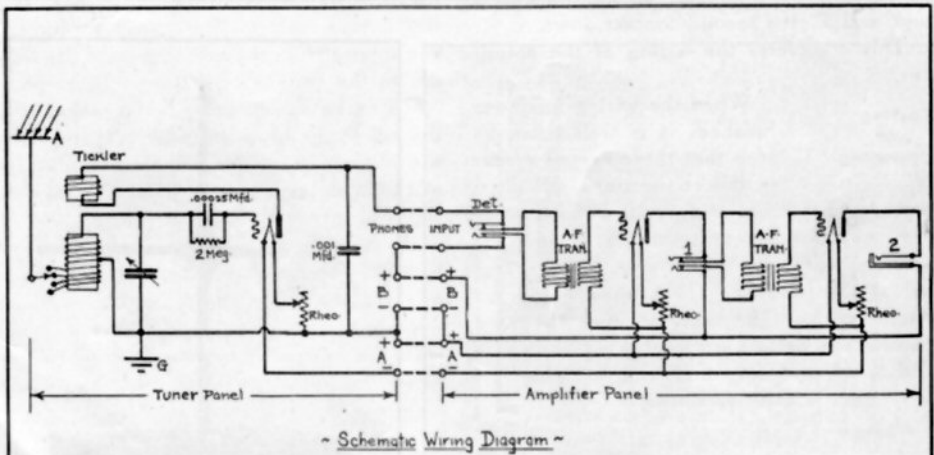

Des. by A. J. H.	RADIO ENGINEERING	
Dr. by A. G.	HAYNES 2 STAGE	
Ch. by F. C.	AUDIO FREQUENCY AMPLIFIER	
In. Chg. - G. F. S.	Pl. No.	Wiring Diagrams
Lim. In.	Job 7716	August 21, 1924
Scale:	Dr 10-24-2.	Sheet 4

Fig. 6. Picture wiring diagram, illustrating the connections as they are actually made, and a schematic of the complete outfit.

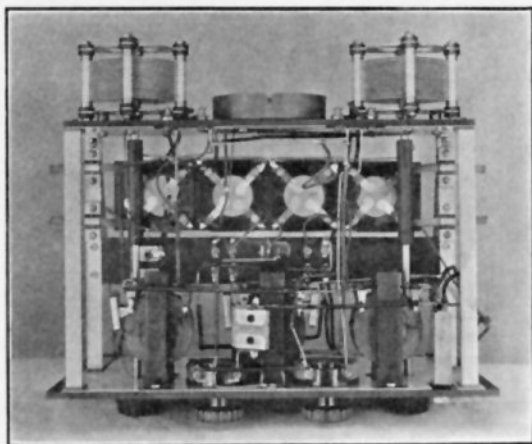

A view of the under side of the tuning and amplifying unit, removed from the cabinet. Note the long condenser shafts, broken by Formica tubes to prevent hand capacity effects. Both front and sub panels are shielded by sheet aluminum. A simple and very satisfactory method is employed to absorb shocks which otherwise would be transmitted to the tubes. The mounting is merely a length of soft rubber cord clamped at the ends, and passed thru holes in the tube panel.

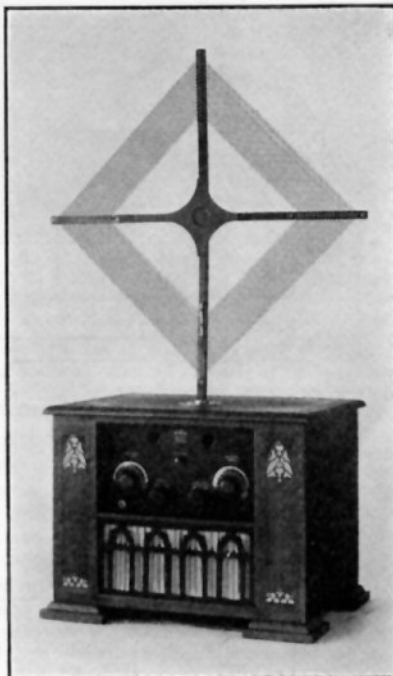

## DeForest D-12 Reflex Set

The DeForest Company is the only radio concern that has successfully marketed an assembled loop receiver. Here are the details of the D-12 type.

ONE of the best tests for the design of a radio set is production, as many a manufacturer has discovered. The DeForest D-12 reflex set is an outfit that has been manufactured in enormous quantities and, moreover, is the only loop set that has been turned out on a production basis.

The accompanying photographs show the interior and exterior of the equipment. The loop, wound with tautflex cable on a wooden frame, is of the collapsible type, and can be taken apart by removing eight thumb nuts from screws in the molded bakelite center support. At the bottom of the lower wooden strip is a plug by means of which connections are made to a jack mounted in the cabinet. This is shown in the inside top view.

The cabinet is of wood covered with leather on which an attractive design is embossed. The receiving set unit fits into

the upper part while below is the covered opening of the loud speaker. A part of the loud speaker unit can be seen in the top view, below which the horn opens out to the grille at the front.

On each side of the set unit is a compartment, the one at the right for holding four square upright B batteries and the one at the left for three celluloid-case storage batteries. The three cells of the battery are fastened together, making it a solid unit. This is probably the only storage battery outfit which carries both the A and B batteries.

The radio instruments are mounted entirely on the front panel. To support them, there are three brass strips on each side, two horizontal and one sloping upward, as you can see from the photographs. The horizontal strips are secured to the rear panel, and are braced by the sloping strips. In addition, the upper

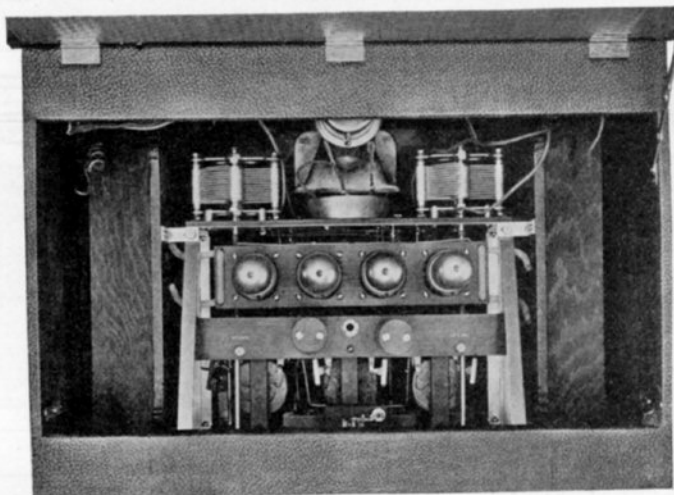

Three celluloid-case storage cells, fastened together as a unit, fit in the left hand compartment, and four 22-volt vertical B batteries in the other space, making the set entirely self-contained.

strips carry the narrow panel which takes the radio frequency transformer connections, the loop jack and the antenna and ground binding posts. The latter connections are employed only when unusual circumstances require an antenna. Ordinarily no connections are made to them as the loop is sufficient.

One of the simplest, and at the same time most satisfactory tube mountings is used in this set. The sockets are on a bakelite strip at the corners of which are holes for the flexible rubber cords. The ends of the rubber are held by clamps on the upper supporting strips. Then the rubber is passed up one hole and down the other through the end of the socket strip. Unlike other sets, this outfit is arranged for plug-in R. F. transformers. Three transformers are furnished with the set, and one of two combinations plugged in, depending upon the wavelength range required. The transformer contact pins are laid out in such a way that it is impossible to reverse the connections.

To absolutely prevent hand capacity effects, the front and sub panels are both shielded and the condenser shafts put on bakelite extensions, insulating the shafts of the condensers from the shafts to which the dials are fastened. There is no danger of introducing losses in this receiver by the shielding since the only tuning inductance, the loop, is outside the set itself.

The circuit of the D-12 is similar to conventional diagrams for four-tube reflex receivers. There are three stages of radio frequency amplification and three stages of audio, with a crystal detector. The first tube is used as a straight radio amplifier and the last tube as a straight audio with the two intermediate tubes reflexed.

This has come to be a standard design, particularly since the revived popularity of the crystal detector.

A most ingenious arrangement is employed for adjusting the crystal. At the center of the front panel is a small knob. Turning this around raises and lowers the cat whisker. An additional adjustment is given by moving the knob sidewise, which changes the cat whisker accordingly. If sensitive spots are not found within the arc thus covered, the pivot can be moved, making the entire surface of the crystal accessible. In actual operation, once a sensitive spot has been found, it is an easy matter to locate it subsequently even though the crystal itself cannot be seen.

In addition to the rheostat and potentiometer, which need not be changed once the set has been adjusted, there are the tuning dials. The condenser at the right controls the wavelength of the loop circuit while the left hand condenser tunes the output or secondary of a tuned radio frequency transformer. The latter is fitted into a copper shield, similar in shape to the cover of a baking powder can. This is mounted at the rear of the sub panel, between the two variable condensers. Practically all the tuning is done with the loop condenser with the other to sharpen the adjustment and to bring the signals up to maximum audibility. Only when extremely faint signals are being brought in is it necessary to change the setting of the potentiometer.

The sharpness of the two controls, assisted by the directional effect of the loop makes it possible, when operating the outfit in the heart of New York City, to tune in WEAf, WJZ, WJY, and WNYC one at a time even though they are all going at once.

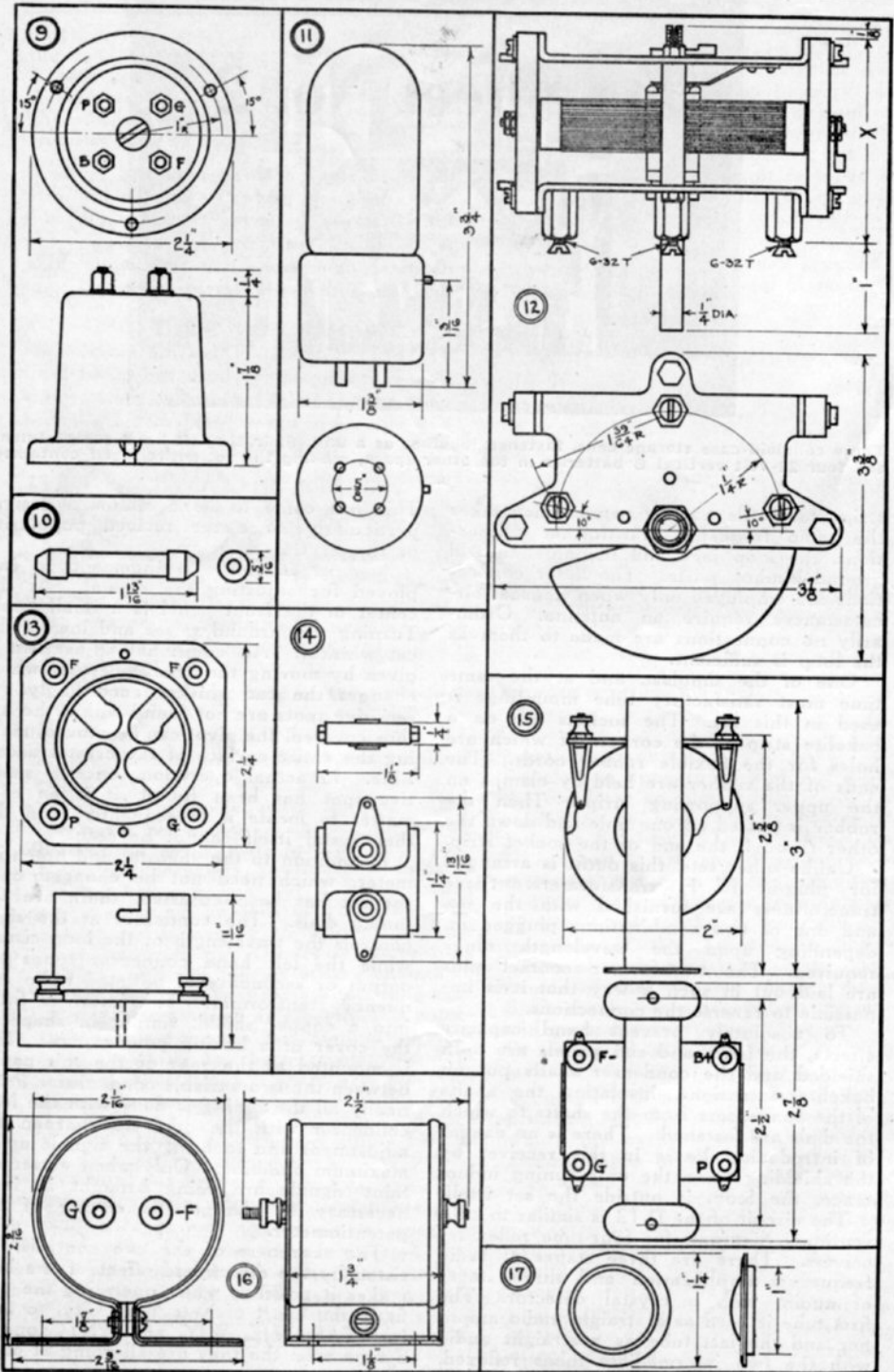

## Data Sheet No. 2

9. B. M. S. RADIO FREQUENCY TRANSFORMER. This transformer is mounted in a molded Bakelite case, equipped with terminals at the top and mounting holes around the flange at the bottom. It is designed for use with a vacuum tube or a crystal detector.

10. DAVEN RESISTANCE. These units are made with resistances of 2,500 ohms to 10 megohms, mounted in cartridges of the same size. This range covers both coupling resistances for resistance coupled amplifiers and grid leaks.

11. SODION D-21 TUBE. The new Sodion tube is designed to fit a standard socket such as are used with the UV 201-A tubes. This detector does not require a controlling potentiometer. It can be used in any type of circuit in place of a UV 201-A as it has the same filament characteristics.

12. CARDWELL CONDENSER. Dimensions are given for the parts which do not change in the different sizes. The distance marked X varies in the different sizes as follows: 0.00025 mfd.,  $2\frac{1}{2}$  in., 0.0003 mfd.,  $2\frac{3}{4}$  in., 0.00035 mfd.,  $2\frac{3}{4}$  in., 0.0005 mfd.,  $2\frac{3}{4}$  in., 0.001 mfd.,  $3\frac{7}{8}$  in. These condensers are designed for receiving circuits. The 0.0045 mfd. transmitting condenser measures  $5\frac{3}{4}$  in.

13. MARSHALL-GERKEN SOCKET. A molded Bakelite base is employed on this socket, with a tube of brass, nickled and polished. The mounting holes take 6-32 screws.

14. DUBILIER MICADON. Dimensions are given for the standard Dubilier micadon fitted with soldering lugs. This type is built in capacities ranging from 0.0001 mfd. to 0.006 mfd. Condensers fitted with special lugs and mountings are of the same dimensions.

15. AMERTRAN A. F. TRANSFORMER. Transformers of this type are available in two ratios, 1 to 5 and 1 to  $3\frac{1}{2}$ . The high ratio is employed in amplifiers of one or two stages. The low ratio is frequently used in the second stage and in

the third stage if three steps are required. Some designers prefer to use the low ratio for all stages, believing that less distortion is produced with the lower ratio. Mechanical dimensions are practically identical on both types of transformers.

16. RICHARDSON INPUT AND I. F. TRANSFORMERS. The same external design is employed for both the tuned input and intermediate frequency transformers. The case is of brass, nickled and polished, while the end plates are of hard rubber.

17. SHEFFIELD GLASS LENS BEZEL. This glass bezel is made in two parts, a ring which is forced into the panel and a ring carrying the glass lens which is pressed into the ring from the front of the panel. Glass is frequently preferred rather than wire screening because it is easier to see through than wire screening and, being solid, it prevents dust from getting through into the instruments.

NOTE: The drawings on the opposite page are of exactly one-half scale so that dimensions not given can be readily scaled off.

Each month there will be described on these pages new products of particular merit and standard items which are very widely used in various kinds of equipment. With this data available, experimenters and designers can determine without delay whether or not parts they want to use will fit into equipment which they are planning, without waiting to actually buy the parts and take off the dimensions.

This information will be found of great value and it is suggested that the data sheets be torn out from the magazine or the issues kept so that the working data will be available at all times.

Full size blue prints of the drawings can be obtained from the blue print department of Radio Engineering at a price of twenty-five cents each. It may be more convenient to work directly from the full size drawings rather than from those made at one-half scale. Moreover, the blue prints can be filed away for ready reference.

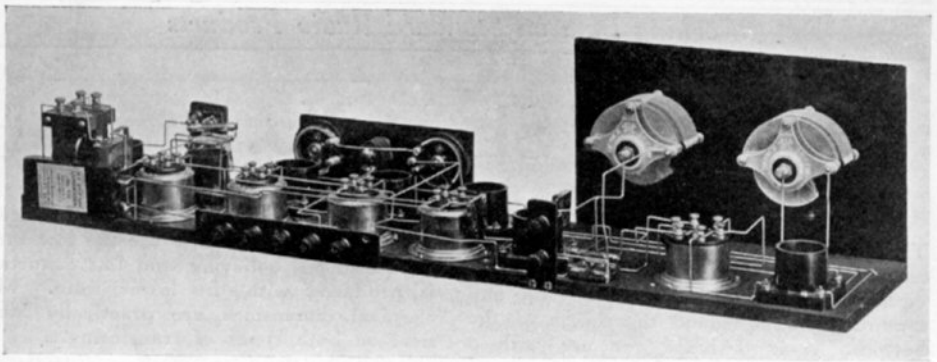

## A Laboratory Layout Adapted For Station or Portable Use

A special feature of this receiving set is the oscillator coupler, a complete non-adjustable unit similar in appearance to the I. F. Transformers.

**T**HE layout for this super-heterodyne receiver was chosen because its arrangement will suggest a number of uses in portable receiving sets or the more elaborate cabinet type equipment. Temporary panels were fitted to the base board for testing purposes. This outfit is built around the combination of the Brooklyn Metal Stamping oscillator coupler, input transformer, and intermediate frequency transformers.

**Outline Of the Circuit** This receiving set, operating on a loop antenna, employs seven tubes, the last one for a single step of audio frequency amplification. Another step can be added, of course, but ordinarily super-heterodyne receivers require only one step of A. F. amplification. In the point of controls, this is one of the simplest sets to handle for, in addition to the usual tuning condensers for the loop and oscillator, there is just one rheostat and the potentiometer which controls the voltage on the three intermediate frequency amplifying tubes. UV201-A tubes are recommended throughout altho, if the A battery current is not too greatly limited, UV200 tubes can be used for both detectors. In the former case only 1.75 amperes are drawn from the current sup-

ply while, with UV200 detectors, the current is 3.25 amperes.

The oscillator coupler is very convenient to use since it is made up into such a compact unit. The coupling, being fixed, requires no additional adjustment, and the entire instrument is shielded by the metal case so that there is no chance of induction between it and other parts of the circuit.

**Parts Employed In the Set** The tuning condensers are of the Haynes-Griffin type, equipped with an additional plate for vernier adjustment. Dubilier Micadons are used for the fixed condensers excepting the 0.5 mfd. type which is of Federal Telephone manufacture. Electrad or Daven gridleaks are used. The Osc-coupler which makes up the oscillator coil unit, the input transformer, and the three intermediate frequency transformers are manufactured by the Brooklyn Metal Stamping Company, while the audio transformer is the new Federal type. Both the rheostat and the potentiometer are from the Amsco company. The sockets may be of any good design such as the Bestone or Kellogg types. A Cutler-Hammer switch is employed to open the filament circuit when the set is not in use. Eby binding posts are provided for the terminals.

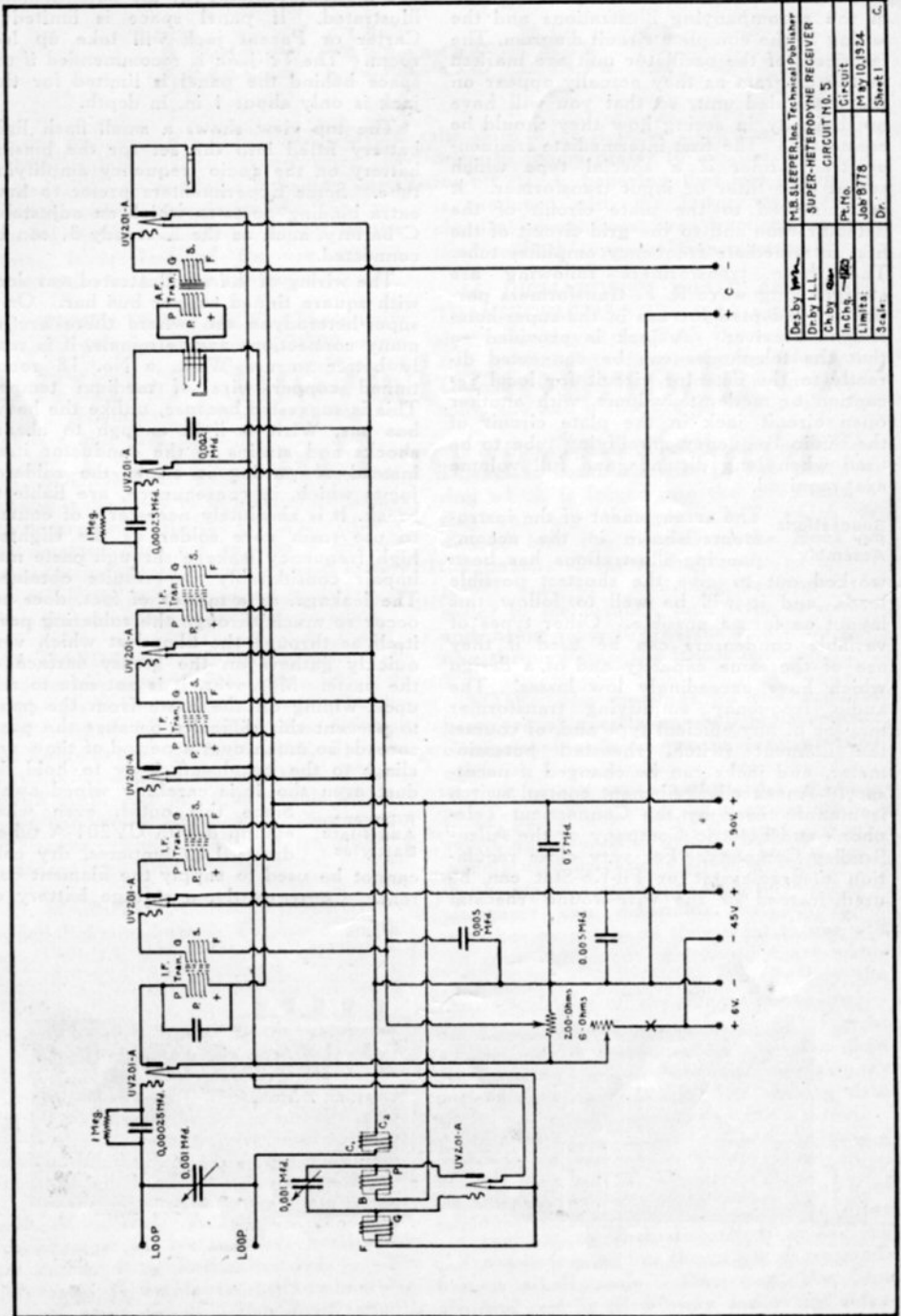

Des. by	H.B. SLEEPER, Inc. Technical Publications
Dr. by	I.L.L.
Ch. by	Geo.
In Chg.	W.D.
Limits:	Job 8775
Dr.	M. B. V. 10, 1924
Sheet:	Sheet 1

Wiring diagram of the super-heterodyne set for use with the Brooklyn Metal Stamping transformers and coupler.

The details of the assembly are shown in the accompanying illustrations and the wiring in the complete circuit diagram. The terminals of the oscillator unit are marked in the diagram as they actually appear on the assembled unit, so that you will have no difficulty in seeing how they should be connected. The first intermediate frequency transformer is a special type which serves as a filter or input transformer. It is connected to the plate circuit of the detector tube and to the grid circuit of the first intermediate frequency amplifier tube. The three transformers following are straight long wave R. F. transformers particularly adapted for use in the super-heterodyne receiver. A jack is provided so that the telephones can be connected directly to the detector circuit for local reception or moderate volume, with another open circuit jack in the plate circuit of the audio frequency amplifying tube to be used when long distance and full volume are required.

**Suggestions For Assembly** The arrangement of the instruments shown in the accompanying illustrations has been worked out to give the shortest possible leads, and it will be well to follow this layout as far as possible. Other types of variable condensers can be used if they are of the same capacity and of a design which have exceedingly low losses. The audio frequency amplifying transformer may be of any efficient type and, of course, the filament switch, rheostat, potentiometer, and jacks can be changed if necessary. An excellent filament control switch is manufactured by the Connecticut Telephone and Electric Company or the Allen-Bradley Company. For very close regulation a Bradleystat or Fil-Ko-Stat can be used instead of the wire-wound rheostat

and a Bradleyometer for the potentiometer illustrated. If panel space is limited a Carter or Pacent jack will take up less room. The Tri-jack is recommended if the space behind the panel is limited for this jack is only about 1 in. in depth.

The top view shows a small flash light battery fitted into the set for the biasing battery on the audio frequency amplifying tube. Some Experimenters prefer to have extra binding posts to which an adjustable C battery, such as the Eveready 3, can be connected.

The wiring of the set illustrated was done with square tinned copper bus bar. On a super-heterodyne set, where there are so many connections and terminals, it is really better to use Wirit, a No. 18 round tinned copper wire of medium temper. This is suggested because, unlike the heavy bus bar, Wirit is light enough to absorb shocks and strains in the conductor itself instead of putting it on to the soldered joints which, in consequence, are liable to break. It is absolutely necessary, of course, to use rosin core solder as the slightest high frequency leakage through paste may impair considerably the results obtained. The leakage, as a matter of fact, does not occur so much through the soldering paste itself as through the film dust which very quickly gathers on the greasy surface of the paste. Moreover, it is not safe to rely upon wiping off the paste from the panel to prevent this difficulty because the paste spreads so much over a period of time, and clings to the panel sufficiently to hold the dust even tho it is carefully wiped away.

**Filament And Plate Batteries** Since this outfit, even when equipped with UV201-A tubes, draws 1.75 amperes, dry cells cannot be used to supply the filament current. Consequently, a storage battery or

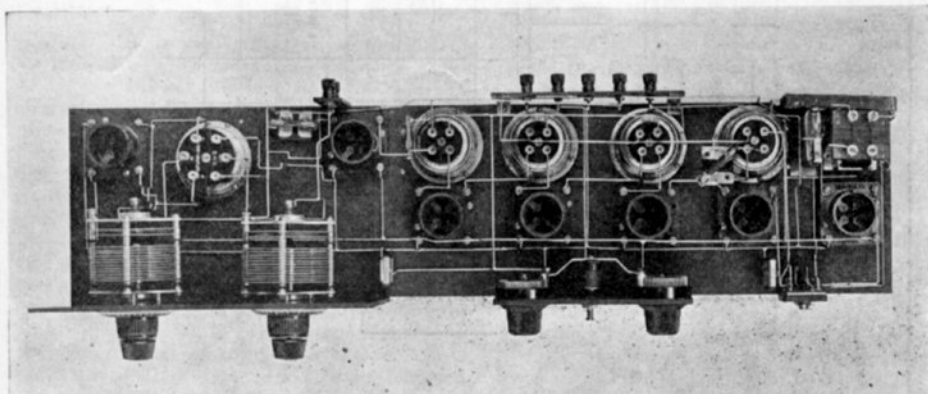

Top view of the Brooklyn Metal Stamping Company's layout in which the arrangement of the various parts is shown.





**DV-3**  
**Tube for Dry Batteries**  
Filament potential 3 volts.  
Filament consumption 6/100  
of an ampere.

**DV-2**  
**Tube for Storage Batteries**  
Filament potential 4½ volts.  
Filament consumption 25/100  
of an ampere.



## The tube that revolutionized radio

**I**N 1905 Dr. Lee De Forest discovered the principle of the vacuum tube. This discovery revolutionized radio transmission and reception.

Ever since then De Forest Tubes have been inseparably linked with radio progress and performance. Today, as in the past, they are unsurpassed for giving volume and clarity of tone—for reproducing the full beauty of sound. They are non-microphonic and can be used in all standard circuits.

De Forest Tubes consume little current and are made to give unusually long service. They are endorsed by leading radio authorities.

*The De Forest DV-2* is designed

for use with storage batteries and is a particularly powerful tube for power amplifier work. Its average mutual conductance is 720 ohms; its amplification constant (or Mu) is 7.2; its plate impedance 10,000 ohms.

*The De Forest DV-3* is for use with dry batteries and is both radio and audio frequency amplifier and a fair detector. Average mutual conductance 460; average amplification constant 6; plate impedance 13,000 ohms.

De Forest Tubes are made by the De Forest Company, makers of De Forest Radiophone, Loud Speakers and other radio parts. The name De Forest is a guarantee against all defects in material and workmanship.

DE FOREST RADIO COMPANY, Jersey City, N. J.

# DE FOREST AUDIONS

battery substitute device is necessary. In the case of country homes equipped with 32-volt lighting systems the set can be run directly from the 32-volt line if a 20-ohm rheostat is employed in place of the 6-ohm rheostat specified. The rheostat, however, must be capable of carrying the load of 1.75 amperes.

For B batteries, binding posts are provided to take one 45-volt battery which is connected to the first and second detectors, and for two other 45-volt batteries which, with the first one, apply 135 volts

For reception on a regular antenna and ground, the terminals marked LOOP should be connected to the secondary of a Fikit or fixed coupler, and the primary of the device to the antenna and ground. For all ordinary reception, however, the loop will produce sufficient volume but in the country or when the outfit is to be operated under the disadvantages of portable use it may be advisable to provide for antenna and ground operation.

For reception on regular antenna and ground the Brooklyn Metal Stamping Cor-

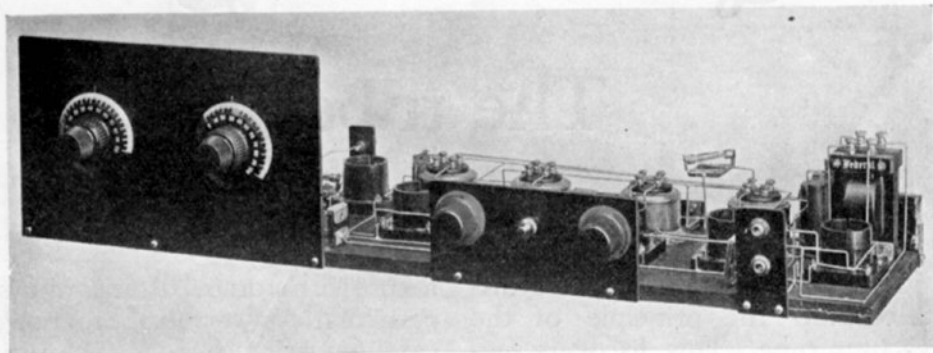

Looking at the super-heterodyne receiver from the rear.

on the plates of the oscillator and amplifier tubes.

Experimenters frequently inquire if they can use 110-volt D. C. current for super-heterodyne sets. This can be done provided the necessary resistance is inserted in the 110-volt line but a filter device, made up of choke coils and high capacity condensers is needed to smooth out the commutator hum. Otherwise there is a residual noise in the set strong enough to drown out the reception. Alternating current cannot be used at all with the potentiometer and center tap method of connecting, which has been recommended in various publications. There are, however, battery substitute devices, working from 110 volts A. C. or D. C., which do give smooth current and voltage supply for the A, B, and C batteries.

This set is designed for operation with a loop. Since a 0.001 mfd. variable condenser is specified for the loop tuning circuit a small loop can be employed. A large loop, such as the Ritter or R. C. A. types, will make the wavelength very high unless the tuning condenser is of a 0.0005 mfd. capacity. Then the set will cover a range of 200 to 600 meters.

poration manufactures a fixed antenna Coupler, in appearance and size similar to the oscillator coupler. This coupler is intended to be used with a double circuit jack or Tri-Jack. The terminals on the set marked LOOP should be connected to the plate end of a double circuit jack—and the antenna coupler terminals S1 and S2 connected to the P tran and B Tran terminals of the Tri-Jack or the inner blades of a double circuit jack. The terminals of the antenna coupler ANT and GND should be connected to the antenna and ground respectively. The loop should be connected to a plug for insertion in the jack.

For all ordinary reception the loop will produce sufficient volume, but in places where the outfit is to be operated under disadvantages in the country or portable use, a small antenna is preferable.

Adding another stage of audio frequency will often result in the elimination of noises which are picked up when the set is critically adjusted to the point where the very weakest static is heard. Reducing the critical adjustment to silence these noises and adding the extra audio frequency stage will often result in clearer reproduction and easier adjustment.

# Fit for a King

Britain's greatest engineers in designing receiving equipment for his Majesty, KING GEORGE V, choose *Resistance Coupled Amplification*. None other would do.



## RESISTANCE COUPLED *The Aristocrat of Amplifiers*

The Concert Halls and the Chambers of *Buckingham Palace* that in years gone by have resounded with the sweetest of melody and voices, will find the new notes that art and science have spun across the skies no less sweet. The RESISTANCE COUPLED AMPLIFIER will render the harmony of distant players as no other system could—even as if the receiver were not, and musicians flung their symphony directly against the portieres of the palace.

The DAVEN RADIO CORPORATION is the pioneer in the manufacture of RESISTANCE COUPLED AMPLIFIERS—the royal Amplifier—specializing in complete sets, parts, and construction kits. The story of auditive perfect amplification is told in the Daven "RESISTOR MANUAL," by Zeh Bouck. This manual contains the how-to-make-it data on Resistance Coupled Amplifiers. At all first class dealers. **Price 15 cents.**

## The Daven Super-Amplifier Unit

*The Super-Amplifier Unit illustrated of molded bakelite in which sockets and all necessary essentials are inserted is the most compact amplifier unit on the market. It is the simplest method of adding Resistance Coupled Amplification to any receiver.*

*Recommended to those who desire the advantages of Resistance Coupled Amplification, but who have hesitated in consideration of the perplexities of obtaining and assembling the proper unit. All connections invisible beneath the base.*

**At Your Dealers**

DAVEN RADIO CORPORATION  
NEWARK "Resistor Specialists" NEW JERSEY

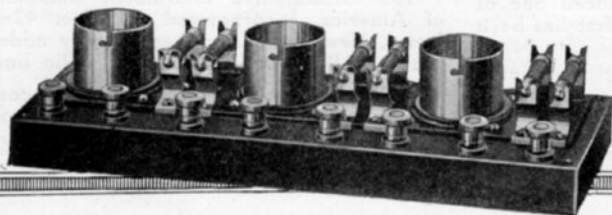

DAVEN RADIO

## About the Manufacturers



**T**HE story of the development of Formica is told by the illustration of the Formica factory, a plant with over 100,000 sq. ft. of floor space, grown from a little shop, in 1913, of 1800 sq. ft. The entire production of this factory is devoted to sheets, tubes, rods, special shapes, and machined parts.

It is rather surprising to see the advertisements of the Gilbert-Keator Corporation as radio distributors. Most everyone thought of Charles Gilbert and Randall Keator as being an inseparable part of the De Forest organization. They are distributing the De Forest, Thompson, Brandes, Dubilier, Timmons, Ray-O-Vac, Pacent, Acme, Jewett, Balkite, Run-A-Radio, French, Carter, and the Neidich lines.

The Gilfillan Company is the first concern on the Pacific coast to manufacture a Neutrodyne under the Hazeltine license. The first announcements of the outfit, a most attractive set, state that these outfits are being made in Kansas City, Los Angeles and New York City.

Since the idea of mounting binding posts on an elevated strip was shown in Radio Engineering for August, 1923, this arrangement has become increasingly popular. Terminal mounting units of this sort are now being manufactured by the Bel-Tone Radio Company.

The Atwater-Kent Company is at last manufacturing radio sets in regular cabinets. It is surprising that the enormous radio business of that company has been built up on the base panel design, since it is so totally different from standard practice.

Speaking of apparatus that is radio but doesn't look it, the designers of the new Magnavox receiver have produced one of the most attractive disguisers that has been brought out so far.

Since Stevens & Company discovered that tools were used in radio construction, several other concerns have brought out special devices for assembling instruments. The Bridgeport Hardware Mfg. Corpora-

tion has just announced a very complete and interesting line.

If you want a loud speaker that really gives volume and that can be almost hidden behind a teacup, be sure to see the Reflectone made by Rice and Hochster of New York City.

The new Eismann 6D receiver, beside being an excellent radio outfit, is one of the best examples of the attractiveness that can be given a radio set by the use of crystallizing lacquer.

Of the various methods employed for spacing stator plates on variable condensers the U. S. Tool Company has one of the cleverest. The plates are stamped out in a long strip and folded back and forth to build up the stator group. Thus the plates are formed from one continuous piece of metal.

The first company to specialize in the manufacture of sponge rubber cushions for shock absorbers on sockets and tube panels is the Miller Rubber Company in Akron, Ohio.

The Liberty Electric Corporation has recently purchased a factory of 35,000 sq. ft. at Stamford, Connecticut. It is understood that this concern has been awarded a very large contract for the manufacture of super-heterodyne sets for the United States government.

In order to take care of increasing demand, the Hammarlund Manufacturing Company, formerly located at 144 West 18th Street, New York City, has removed to larger quarters at 424 West 33rd Street, New York City. The facilities in their new home are such as to enable them to increase their production considerably.

The Consolidated Instrument Company of America, Incorporated, 41 East 42nd Street, New York City, has recently added the Cico Bakelite jack to their radio line.

A Bakelite frame eliminates metal construction. The overall dimensions are small. Special phosphor bronze springs are used throughout.

# 30 leading set manufacturers indorse PACENT quality

## PACENT Radio Essentials

Adapters  
Improved Audioformer  
Audioformers  
Auto Plug  
Bal-con  
Coil Plug  
Coil Plug Receptacle  
Condensers  
Detector Stand  
Duojack  
Duo Plug  
Duo Lateral Coils  
Headsets, Everytone  
Jacks  
Jack Set  
Loops  
Loop Plug  
Loop Jack  
Multi Jack  
Plugs  
Potentiometers  
Rheostats  
Resistances, Cartridge  
Sockets  
Twin Adapter, etc., etc.



The foremost radio set manufacturers in the United States and Canada are using Pacent Radio Essentials as Standard Equipment. Only a high standard of quality which is dependable at all times, could justify this choice.

Let the judgment of these manufacturers guide you in the selec-

tion of your radio equipment. You can build a better set than your neighbor if you use better parts. "Don't improvise—Pacentize" is the slogan for radio results.

Your dealer will be glad to show you the Pacent Radio Essentials that you need for the next set you build. Write for complete catalog No. 10.

PACENT ELECTRIC CO., Inc., 22 Park Place, New York City

Washington Minneapolis Boston San Francisco Jacksonville Chicago  
Birmingham Philadelphia St. Louis

## Pacent RADIO ESSENTIALS

**"DON'T IMPROVISE — PACENTIZE"**

*"Just Be Sure It's a Hammarlund"*

- 1 Lowest losses (too small to measure)
- 2 Micrometer Vernier
- 3 Soldered brass plates
- 4 Rotor grounded to frame
- 5 Adjustable cone bearings
- 6 Double wiping contacts
- 7 Takes any size dial

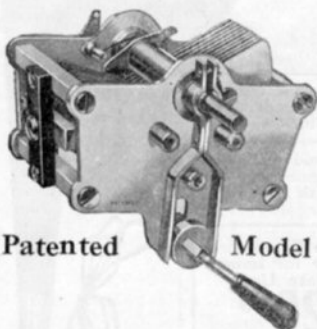

Patented Model "C"

# HAMMARLUND VERNIER VARIABLE CONDENSER

*Increases Your Range and Volume*

**ELIMINATES INTERFERENCE**

*Write for New and Interesting Folder*

HAMMARLUND MFG. CO., 424-438 West 33rd Street, NEW YORK

THE NEW

# Ackerman ARISTOCRAT

The SUPER-HET of Loud Speakers

MODEL 25

An improved Loud Speaker made by loud speaker specialists.

Will operate on any set of three tube capacity up to the eight tube super heterodyne.

Guaranteed to reproduce voice and music in perfect mellow tone, with plenty of volume.

No extra batteries required.

25" high. 11" bell.



Three finishes: Black, Olive Green or Brown Crystalline.

With gold plated ferrule connecting fibre horn with base.

Price Complete  
Ready for Immediate Use

**\$20.00**

If your Dealer cannot supply you, send us cash with order or we will be glad to ship same to you C. O. D. and you can pay postman on delivery. In ordering specify finish.

**Ackerman Brothers Company,**  
INCORPORATED

Department RE-10

301 West 4th Street

New York

Order an "Ackerman Aristocrat" and get the best that's in your set

## CRYSTALLIZING LACQUER

(Continued from page 284)

having their wicks turned up almost to the smoking point, or by gas heaters. In either case, the heater serves the double purpose of heating the room and fouling or reducing the oxygen content of the air. No ventilation should be allowed during the process.

After the crystals have formed, the lacquer may be air-dried, or if a very hard finish is desired it may be baked. The black lacquer may be baked at any temperature the equipment can reach or that the coated article can stand. It will harden in two hours at 250° F. and in one hour at 350° F. The clear lacquer should be baked at not over 150° F. because of the tendency to turn yellow at higher temperatures. It will harden in four hours at 150° F.

Hilo crystallizing lacquer is made in black and clear. Any desired color can be obtained, however, by first applying a coat of enamel of this color. When this has dried hard, the clear crystallizing lacquer is applied over it. The color shows plainly through the clear lacquer, producing a crystallized effect in that color. Crystallizing lacquer can be applied over any other finish, amyl acetate lacquer, enamel, shellac, or japan. Transfers, striping and stencilled designs show plainly through the clear lacquer.

Very attractive metallic crystallized finishes can be obtained very easily by altering the process slightly. Among these are bronze, gold, silver, and copper. Immediately after the clear crystallizing lacquer has been applied and crystallized, but before it is thoroughly dry, the metallic powder of whichever kind is desired, is blown on to the lacquer, covering it and forming a uniform coating. This scheme, however, is not very well adapted to manufacturing methods as there are only a few moments at most between the full crystallization of the lacquer and the drying. In addition, the blowing of the powder on to the work entails a large percentage of loss due to its flying around. A more practical method is to wait until the lacquer is dry, and then apply the metallic powder mixed in an ordinary bronzing solution, with a brush. This distributes the metallic powder evenly over the surface.

The crystallized lacquer finish is comparatively new and many and varied uses are being found for it every day. It is predicted that this finish will become more and more popular among experimenters and manufacturers as its possibilities are realized, for it is not only attractive and permanent, but it is less expensive than nickel plating.

## Specify RASLA for Reflex!

Write for the Rasla Reflex Construction Bulletins with full size layouts. They're FREE!

**R**EFLEX experts built the RASLA Fixed Detector and the RASLA CR Transformer. Much research work was done before they were placed on the market. That is why these RASLA reflex products will mean success for you.



RASLA Type CR Transformer is the only radio frequency transformer designed especially to link a vacuum tube and a crystal detector.



The RASLA Fixed Detector is a permanently fixed, super-sensitive crystal detector that will give splendid results in reflex and other circuits. Everyone is a good one.

DAVIDSON RADIO CORP.  
222 Fulton St., New York

**RASLA**

**TRANSFORMER ~ FIXED DETECTOR**



OSCILLO COUPLER

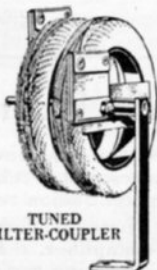

TUNED FILTER-COUPLER



RECEPTRAD  
R&R  
PRODUCTS

## RECEPTRAD

### Super-Heterodyne

**R**ECEPTRAD Parts for the Super-heterodyne, Ultradyne, and other circuits requiring long wave radio frequency amplification are unequalled in quality and performance. They make real "DX" possible without outdoor antennae.

All good dealers sell these—

Oscillo Coupler (SW21).....	\$6.00
Tuned Filter Coupler (H34).....	7.50
RF 1716 Transformers (3 required), each.....	6.50
Audio Transformer (ATX).....	5.75
Audio Transformer (AT3).....	5.75
By Pass Condensers 1MF (G1000) (2 required), each.....	1.50
Antenna Coupler.....	6.00
Greiff Super-Het Manual (complete with photos and diagrams).....	1.50

**FREE**—Blueprint No. 8 of the Greiff 8 tube super-het if you mention your dealers name and address.

**RADIO RECEPTOR CO.**

59 Bank St. New York City

## Standardized Parts List

The materials used to make up the set described in this issue were supplied by the following companies. The manufacturers whose names appear below will be glad to send you bulletins describing other products which they make. Please mention RADIO ENGINEERING when you write them.

### PARTS FOR THE TYPE 6500 4 TUBE REFLEX RECEIVER

Type	Name	Price
	Acme Apparatus Company, Cambridge, Mass.	
R-2	1—R.F. Transformer .....	\$5.00
R-3	1—R.F. Transformer .....	5.00
R-4	1—R.F. Transformer .....	5.00
A-2	3—A.F. Transformers .....	15.00
	Bruno Radio Corporation 300 Water St., New York City	
	1—22 plate Ultra Vario condenser .....	5.50
	Carter Radio Company, G-209 So. State St., Chicago, Ill.	
101	1—Open circuit jack.....	.70
	Cornish Wire Co., R-30 Church St., New York City, N. Y.	
1	1/4-lb. spool No. 24 Bare Copper wire .....	.25
	Dubilier Condenser & Radio Corp., A-48 W. 4th St., New York, N. Y.	
601	2—.00025 mfd. Micadons ...	.70
601	1—.002 mfd. Micadon ...	.40
601	1—.005 mfd. Micadon.....	.40
	Eastern Coil Corp., 22 Warren St., New York, N. Y.	
	1—Pickle Bottle coupling coil.	2.00
	H. H. Eby Mfg. Co., X-40 S. 7th St., Philadelphia, Pa.	
	Ensign Set of 7 binding posts	1.40
	James Goldmark Co., B-83 Warren St., New York, N. Y.	
W	1-1/2 lb. spool of Wrlt.....	.90
	Harco Products Co., 25 Church St., New York City, N. Y.	
	1—Harco S.P.D.T. anti-capacity switch .....	1.00
	Henry Hyman & Co., Inc., 76-Y Broadway, New York, N. Y.	
724	4—Standard base sockets.....	3.00
	Mitchell-Rand Mfg. Co., 18-F Vesey St., New York City, N. Y.	
7	4—Lengths special No. 7 varnished tubing .....	.60
	Mydar Radio Co., 9-E Campbell St., Newark, N. J.	
	1—Accuratune 4 in. vernier dial	3.50
	2—Accuratune 2 in. plain dials	1.50
	Pacent Electric Co., A-22 Park Place, New York City, N. Y.	
85	1—30 ohm rheostat.....	1.00
88	1—375 ohm potentiometer...	1.25
	Poster & Company 26-R Barclay Street, New York City	
	1—10 x 24 x 3-16 in. Formica panel .....	7.20
	1—7 x 16 x 3-16 in. Formica panel .....	3.36
	Radiall Company 320 W. 42nd St., New York City	
1A	3—Amperites for UV 201-A tubes .....	3.30
	Ritter Radio Corp., 232-R Canal St., New York City	
	1—Ritter Portable Loop ....	6.50
	Rusonite Products Corp., 15 Park Row, New York City, N. Y.	
	1—Rusonite Fixed Detector..	1.00
	Walbert Manufacturing Co., 931 Wrightwood Ave., Chicago, Ill.	
	1—Walbert Filament Lock Switch	.50
	MISCELLANEOUS PARTS	
58	4-pkgs. of 25 soldering lugs..	.80
185	2—left hand nickeled angle brackets .....	.20
14	16—Coil mounting pillars....	1.28
151	3—nickeled panel supports...	.90
62	1-pkg. of 10-1/2 in.-6-32 F. H. nickeled screws .....	.12
63	4-pkgs. of 10-1/2 in.-6-32 R.H. nickeled screws .....	.48
143	1-pkg. of 10-1 in.-6-32 R.H. nickeled screws .....	.14
49	4-pkgs. of 10-6-32 nickeled nuts .....	.32
	Complete Set of Parts	\$80.20

## Back Issues of Radio Engineering

If you have missed any issues of RADIO and MODEL ENGINEERING for this year, check over the following list and order those that you did not get so as to make your file complete.

January—Tuska Superdyne, 4-tube Monotrol, oscillating wavemeter.

February—7-tube super-heterodyne set, Cockaday Receiver.

March-April—Portable tuned R. F. set using UV-199 tubes, Harkness circuit for Diode or crystal detector.

May—Improved Rasla reflex, the most successful 1-tube receiver ever built, 100-meter Sodian receiver.

June—Sodian reflex set using UV-201—A amplifier, the Bestone V-60, tuning filter for cutting out interference.

July—Resistance coupled amplifier, Tools for the radio model shop, Crystals that oscillate.

These copies will be sent promptly upon receipt of your order accompanied by a money order or postage stamps.



# KESTER *Radio* SOLDER



**Oh boy!** it sure is  
**Safe & Simple**

Here's the solder that contains the flux recommended by radio engineers! The pure rosin core inside of Kester Radio Solder is a natural flux and can leave no harmful chemical or electrical action on delicate parts or joints. It requires only heat.

In developing radio frequency, it was found that all fluxes, except rosin, spatter, fume and run over delicate parts and joints. This causes leakage and makes the best insulation as poor as a grid leak!

Solder with Kester Radio Solder. You will have no need to go over and wipe away surplus flux. Leave what rosin may remain — it is a good insulator!

There you have it: Kester Radio Solder is a safe and simple solder with which your set can be quickly, neatly, safely and substantially soldered. Get a handy can of Kester from your dealer.

**CHICAGO SOLDER COMPANY**  
4224 Wrightwood Ave.  
Chicago—U. S. A.

# TURN-IT ADJUSTABLE GRID LEAK

*Changes the Range of  
Resistance to Suit the  
Strength of Reception.*

Constructed along entirely new lines which avoid all use of graphite or carbon and the microphonic noises generally attending the use of these materials Turn-It greatly increases the volume, secures greater distance and reduces noises in your set.

A Turn-It gives constant and undiminished satisfaction. There is nothing to wear out.

Absolutely guaranteed.

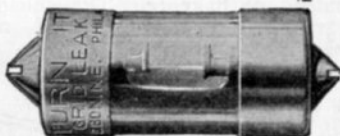

Turn-It Grid Leak is Only \$1  
At Your Dealers or Direct from Us  
**TURN-IT RADIO SALES, Inc.**  
30 Church St., N. Y.

*New!*

Scientifically correct  
and guaranteed!



**hand calibrated**

Unless grid potential is correct, in coming signals will be blocked. You can set Fil-Ko-Leak for a specified resistance and adjust

for best results! Hand calibrated and doubly checked over the operating range for all tubes

1-4 to 5 megohms. Unconditionally guaranteed for service and accuracy — not affected by atmospheric conditions or wear. Markings are read through panel

peep-hole. Table mounting bracket furnished.

2.00

In Canada  
\$2.75

**FIL-KO-LEAK**  
SCIENTIFICALLY CORRECT  
VARIABLE GRID LEAK

—with battery switch



And at no extra cost! Fil-Ko-Stat gives perfect control of any type tube in any hook-up — maximum signal strength — longer tube and battery life. Stops tube noise. Brings in DX stations you never heard before. Switch attaches to regular "Stat" mounting screws.

2.00

In Canada  
\$2.75

**FIL-KO-STAT**  
SCIENTIFICALLY CORRECT  
RADIO RHEOSTAT

—with \$100 guarantee



1.50

In Canada  
\$2.05

**FIL-KO-LIGHTNING  
ARRESTER**  
SCIENTIFICALLY CORRECT  
RADIO LIGHTNING ARRESTER



MADE AND GUARANTEED BY  
**DX INSTRUMENT CO.**

HARRISBURG, PA.

Send 2c stamp for booklet "Improved Reception Through Scientific Tube Tuning" and learn how to get the most out of your radio receiver.

Geared 80-1 Ratio

RADIO MAP OF THE U.S.

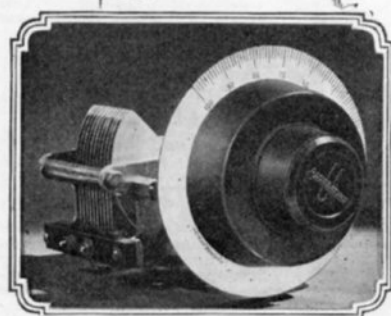

## Tune in "Hard-to-Get" Stations

"I LOGGED 48 stations in one evening with your Accuratune Dial. Twenty-nine of these I had never gotten before with ordinary dials on my set."

Accuratunes are actual micrometer tuning controls, geared 80-1 ratio for hair splitting adjustment. Those "hard-to-get" stations you ordinarily run past are brought in, clear and distinct, with perfect ease.

Accuratune micrometer controls give greater efficiency than any vernier condenser, vernier attachments or any other tuning device. Indispensable on all Super-Heterodynes. Fit all standard condenser shafts. Flush panel mounting.

Price \$3.50. At your dealers—otherwise send purchase price and you will be supplied postpaid.

*Write for descriptive circular*

### MYDAR RADIO COMPANY

Pioneer Manufacturers of Quality Vernier Devices  
9E CAMPBELL ST. NEWARK, N. J.  
Radio Ltd., Montreal, Canadian Representatives.

# ACCURATUNE

80-1

MICROMETER CONTROLS

# B.M.S.

## HET-TRI-FORMERS and OSCILLATOR COUPLER

B. M. S. HET-TRI-FORMERS and the B. B. M. S. OSCILLATOR COUPLER make super-heterodynes deliver the very last ounce of energy and reach out after the very distant stations. The "super" is truly at its best with B. M. S. transformers.

The set consists of four HET-TRI-FORMERS and one OSCILLATOR COUPLER. The binding post panels are moulded of bakelite. The shielded cases are highly nickel plated and polished. Ask your dealer!

FREE—Write us for the complete descriptive booklet

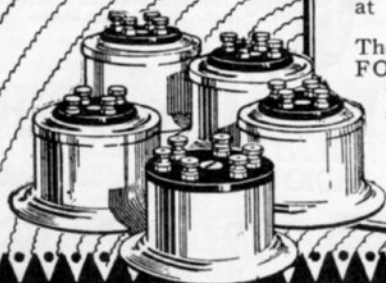

\$ 25 Per Set

BROOKLYN METAL STAMPING Corp.  
718 Atlantic Avenue, Brooklyn N.Y.

ANT +    SPEAKER +    SPEAKER -    A BAT +

LONG ANT    A BAT -

SHORT ANT    B BAT +

LOOP    B BAT -

PHONE    C BAT +

**Tops Don't Come Off**    C BAT -

**25 Different Markings**    B AMP +

H. H. EBY Mfg. Co.    B DET +

Phila., Pa.

A+ BAT B-    +    -

*A Complete*  
**CONSTRUCTION and  
 REPAIR SERVICE**

*offering you*

Technical accuracy, expert workmanship, attractive prices and prompt shipment to all parts of the world.

**We build anything from a one-tube set to an 8-tube Super-Heterodyne—from our high grade parts or yours**

*"Radio Engineering's"  
 Models a Specialty*

Put your building, repairing and testing problems up to us.

*Correspondence invited.*

H. E. ERICKSON, A. M. I. R. E.,  
 VICE-PRESIDENT.

**BROADCAST SERVICE COMPANY**  
ONE UNION SQUARE, NEW YORK CITY

*"Old timers in Radio."*

**I<sup>a</sup><sub>n</sub>d M -**

"I and M" is an expression which will be used by thousands and thousands of people during the coming year. "Call up the I and M man," they will say when the radio set goes wrong, or "who is the I and M man?" when they buy a new set.

- Are you qualified to erect antennas and install radio sets?*
- Can you test A and B batteries and locate faulty tubes?*
- Do you understand how to operate and adjust equipment?*
- Will you do this work at the standard rate of \$1.50 per hour?*

An I and M man handles only installation, operation and tube and battery testing. He does no internal repair work of any kind. If there is something wrong inside the set, he tells the owner to take it back to the dealer or manufacturer. He does nothing which will in any way void the manufacturers guarantee. A star will be put after the name of each man who sends in six letters from set owners, attesting that he has handled their I and M work in a satisfactory manner. The registry will appear each month in Radio Engineering.

**WITH** the November issue of Radio Engineering we shall start an indexed Registry of I and M men, so that owners of radio sets who are not familiar with radio sets can find in the Registry the name of the nearest I and M man. Each name will appear as below:

Ill., Chicago—**HAROLD MANSFIELD\***  
 10 South Michigan Blvd. Tel. Wor. 2271

Moreover, these names will be available to manufacturers who can use I and M men to handle SOS calls from customers who are in trouble.

**HOW TO GET  
 YOUR NAME IN  
 THE REGISTRY**

*Send your name, address, and phone number, clearly written, to the I and M Dept. The listing charge is 50c for 1 month, \$2.00 for 6 months, \$3.00 for 12 months.*

Coming!

# Microloss

Condensers

See November issue

## M. B. SLEEPER

### Recommends—

222 Radio Circuit Designs, a splendid book of hook-ups, 252 pages, 284 illustrations .....\$1.00

Radio Engineering Principles, most useful of text books, for the student and Experimenter .....\$3.50

How to Retail Radio, an idea book for the radio dealer who is planning ahead for his fall business.....\$2.00

ABC of Vacuum Tubes, an understandable explanation of the audion, filled with diagrams and pictures.....\$1.00

Radio Telephony for Amateurs, Ballentine's book, by an amateur and for them .....\$2.00

These books are selected particularly for spare time reading. They will be sent promptly, postpaid, well packed.

M. B. SLEEPER, Inc.

Technical Publisher

52 Vanderbilt Avenue, New York.

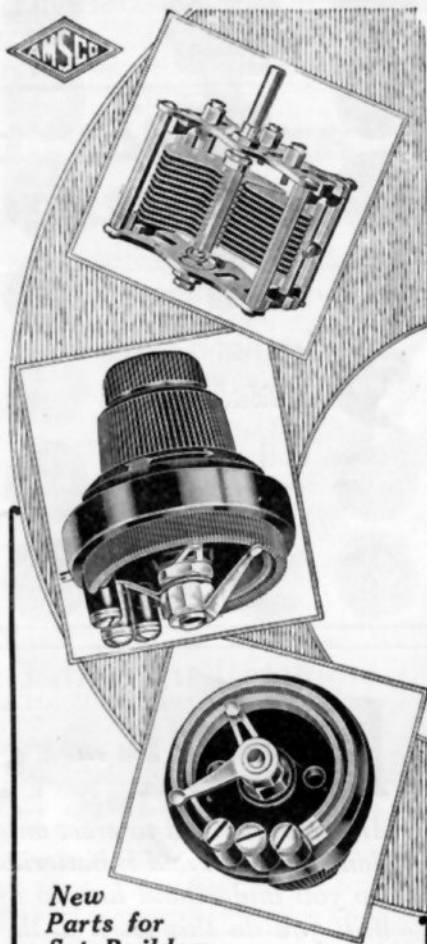

### New Parts for Set Builders

#### Amsco Low Loss Condenser

Designed especially for perfection in set building. A laboratory instrument.

#### Amsco "Dublwundr"

Combination rheostat and Potentiometer. Selected by L. M. Cockaday for use in his improved Four Circuit Tuner, as described in the October Popular Radio.

#### Amsco Double Rheostat—

Designed to take the place of two Rheostats. Saves panel space and wiring.

Ask for wiring diagrams and literature. They're Free.

**AMSCO PRODUCTS, INC.,**  
416 Broome St., New York City

# Haynes-Griffin

RADIO SERVICE, Inc.

145 W. 45th St.,  
New York

MAIL ORDER  
DEPARTMENTS

111 S. Clark St.,  
Chicago

## Parts for the HAYNES Two-stage Amplifier

Exactly as described by M. B. Sleeper in this issue of "Radio Engineering." Parts may be purchased separately or in combination, at the prices shown below. Send your order to our nearest store.

2 Haynes-Griffin Audio Transformers, Type 91, at \$5.50 each.....	\$11.00	1 Haynes-Griffin Single Circuit Jack, No. 101.....	.60
2 Haynes-Griffin Panel Mounting Sockets at \$1.00 each.....	2.00	6 Hard Rubber Binding Posts at 5c each.....	.30
1 7x10" Hard Rubber Panel, drilled for mounting all specified material	2.00	Miscellaneous material, consisting of	
2 Haynes-Griffin 6 or 30 ohm Rheostats (according to type of tube used) at 75c each.....	1.50	4 lengths of bus bar at 3c each,	
2 Haynes-Griffin Double Circuit Jacks, No 103, at 80c each.....	1.60	3 lengths of spaghetti at 7c each,	
		24 lugs at 5c per dozen, 4-6-32 x	
		1/2 machine screws and nuts at 1c	
		each, 1 foot rosin core solder.....	.50

Complete Parts with Drilled Panel . . \$19.50

## FREE! A Brand New Radio Catalog Every Month

Thousands of fans living in the New York and Chicago districts depend upon our stores in these cities to keep them informed of the newest radio developments.

They know that Mr. Haynes and his assistants test every new set, circuit and part as it appears. Then, if the apparatus is efficient and if it fills a real need, it is immediately offered to our retail customers.

Now, no matter where you live, you can enjoy the benefits of this up-to-the-minute radio service. Once a month, we issue a catalog called "Radio Dispatch." It is edited personally by A. J. Haynes, Associate, Institute Radio Engineers, and every edition contains entirely new material.

It brings you the best of what's new in radio every thirty days. And it tells you how to obtain the newest apparatus as quickly as though you lived next door to the country's largest radio store.

It's free. No subscription, no obligation. Use the coupon now.

Address Our Nearest Store

HAYNES-GRIFFIN RADIO SERVICE, Inc.

145 W. 45th St., New York 111 S. Clark St., Chicago

\*\*\*\*\* Radio Dispatch \*\*\*\*\*  
The Last Word In Radio Development  
Published Monthly by Haynes-Griffin Radio Service, Inc.  
41 W. 43d St., New York, 111 S. Clark St., Chicago



Here is a new publication for R- experimenters. A. J. Haynes Radio fans how they can with the latest developments in Radio Engineering.

E-11

R- experimenters how they can with the latest developments in Radio Engineering.

HAYNES-GRIFFIN RADIO SERVICE, Inc.  
145 W. 45th St.  
New York City  
111 So. Clark St.  
Chicago

I want to keep in touch with every new radio development. Send me "Radio Dispatch" every month.

Name.....

Address.....

R-D-X R-D-X R-D-X R-D-X R-D-X

R-D-X R-D-X

## R-D-X Radio Frequency Coupler

The R-D-X radio frequency control coupler can be used in any circuit, reflex, regenerative, or radio frequency, where a primary, secondary, and coupling coil is required. Designed for 200 to 600 meters with a 0.0005 mfd. condenser.

Price .....\$3.75

## R-D-X R. F. Transformer

The R-D-X radio frequency transformer is independent of wave length, non-oscillating, and highly efficient. It can be used also as a tuned R. F. transformer or in neutrodyne circuits, for 200 to 600 meters, with a 0.0005 mfd. condenser.

Price .....\$2.00

### EASTERN COIL CORP.

*All Types of Coils Wound for  
the Trade*

22 Warren Street, N. Y. C.

R-D-X R-D-X



TRADE MARK  
WIND MARK

\$5.50  
Vernier  
\$1 Extra

Pat.  
Pend.

# "Bruno" <sup>3</sup> in <sub>1</sub>

22 Plate  
Ultra Vario Condenser

A balanced precision instrument  
scientifically designed with  
3 capacities  
.0005      .00025      .000125

**Bruno Radio Corporation**  
NEW YORK

## Amplify the MODERN way!

**B**EFORE starting to build your radio set, remember that upon the audio transformers depends the quality of reproduction and consequently the pleasure which you will derive. With this in mind, choose MODERN Transformers and be safe!

Insist upon MODERN Transformers. They are made in three types—the Ten to One, the Push-Pull, and the Four to One.

*Send for the Book of MODERN Hook-ups.  
We will gladly mail it to you FREE!*

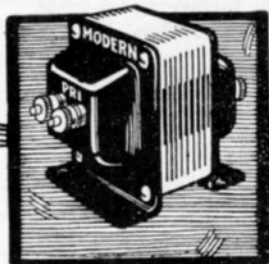

**B.L. SALES CO.**  
218 Fulton St.  
New York

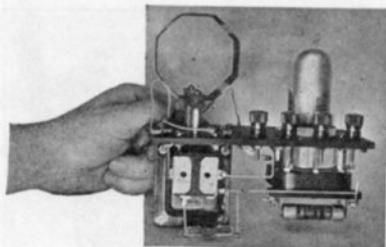

# R-D-X

Maximum Modulation

## REFLEX RECEIVER

### *How to Build the R-D-X*

The R-D-X maximum modulation reflex set brings in stations with more volume than any other one-tube set. In quality, it cannot be surpassed. It tunes as sharply as a super-heterodyne, cutting thru local stations as if they did not exist. The R-D-X was designed particularly for local reception, to bring in stations up to 10 miles distant at full loud speaker volume. However, under favorable circumstances, the loud speaker range is much greater, while with telephones it is practically unlimited.

You can't go wrong by building the R-D-X.

### *What the R-D-X Does*

Putting an R-D-X set together is so easy that the merest novice can do it, and it's fun because, with the simplest tools, you can make yourself a set superior to many factory-built outfits. The construction kit is complete to the last post and screw, the panels are accurately drilled and machine engraved.

All parts are from well-known, reputable manufacturers — Paragon, Formica, Dubilier, Eastern Coil, Bestone, Radiall, Modern, Rasla, Kurz-Kasch, Eby—names which guarantee 100% performance.

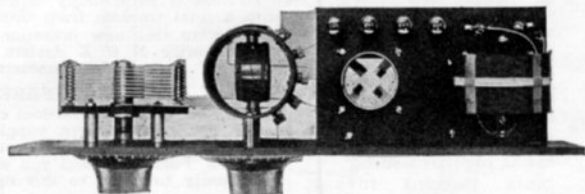

### *Looking at the Inside of the R-D-X Reflex Set*

Complete set of parts, with drilled and engraved Formica panels, all ready to assemble, shipped in a strong packing case. Full, illustrated assembly instructions are provided, prepared in such a clear, understandable way that you cannot make mistakes. Each part is guaranteed to be in perfect working order. Price, postage prepaid .....

Note: Full size blueprints and instructions only, \$1.00

# \$ 25

# DURRANT RADIO Limited

C-52 Vanderbilt Avenue

New York City

## Eliminate Soldering

with this new

# RADIO TOOL

GET away from the mess of soldering. Use the Rance Radio Pliers with its specially designed pins. This new feature forms wire ends into perfect loops that fit accurately over standard binding posts, and make cleaner, better connections. Sets wired in this efficient way look neater and work better. Electrical and radio experimenters find these pliers indispensable in their workshops.



The Rance Combination Pliers made to our specifications by KRAEUTER, maker of fine tools. Nickel dreadnought steel. For a lifetime of hard use. Price \$2.50.

Descriptive Folder R 5 gladly sent free on request. Or send us \$2.50 for your pair of the Rance Combination Pliers. Complete instructions with each pair.

Dealers and distributors will be interested in our sales plan

### RANCE CORPORATION

41 E. 42nd Street

New York

## What Is Your "B" Battery Cost?



The Trans-B-former was designed and developed by the Kellogg Switchboard and Supply Company and fulfills every requirement for furnishing plate current for both detector and amplifier of your receiving set. It is neatly arranged in a heavy, quarter-sawed, oak cabinet, with glass cover. The binding posts are clearly marked with the voltage output. Positive in operation and one of the biggest advances in radio today.

At your Dealers, \$50.00

Use—Is The Test



**KELLOGG SWITCHBOARD & SUPPLY COMPANY**

1066 W. Adams St. Chicago, Ill.

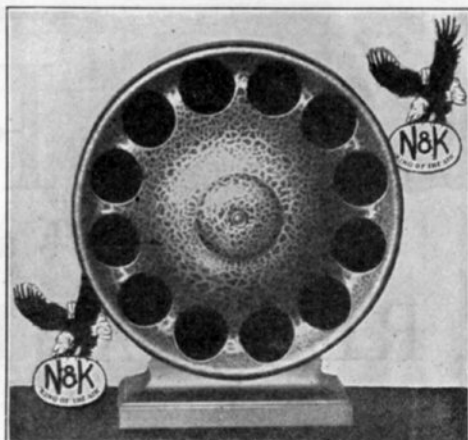

Made of a new lightweight material which eliminates rattling and rasping. Requires no batteries. Operates on all ordinary plate voltages. 14 in. high. Write for Free Descriptive Folder.

## New!

AS revolutionary—in principle, in design, in tone quality—as the now famous N & K Imported Phones.

Its principle is that of *sound reflection*. The sound waves issue from the speaker in their full roundness, and are carried to every corner of the room.

Its shape is new and artistic. And it is made in handsome finishes which harmonize with all types of home decoration.

Its material is new. Burtex, a scientific product, which, unlike vibrant wood or metal, prevents counter-vibrations, thus eliminating unpleasant twanging, rasping, rattling sounds.

Its tone is surprisingly distinct, mellow, natural, with a total freedom from distortion.

Listen to this new invention on your own set. We authorize N & K dealers to put it into the homes of responsible customers on

### FIVE DAYS' FREE TRIAL

Price, complete with six-foot cord, \$27.50. If your dealer has not yet been supplied, notify the Th. Goldschmidt Corporation, Dept. K10, 15 William St., New York City, and you will be given prompt opportunity to listen to this new Loudspeaker.

Made by the makers of N & K Imported Phones, price \$8.50, and the N & K Imported Phono Unit, \$7.50.



## Imported LOUDSPEAKER TYPE W

DEALERS:—If your jobber cannot supply you, write for name of N & K authorized Distributor.

TH. GOLDSCHMIDT CORPORATION  
Dept. K10, 15 William St., New York; 41 Common St., Montreal





Don't underestimate the value of **TIGHT CONNECTIONS!** The best built set in the world won't operate right if it leaks.

You'll never be troubled with leaky connections when Stevens Spintite Wrenches are on the job. These handy little tools spin the nuts down tight, with vise-like pressure, making joints that are as solid as if soldered. No chance of losing the most delicate electrical impulse.

Spintites—get into the cramped places where pliers are useless—no fumbling and fussing. Anyone who likes good tools will appreciate Spintites—they're *real tools*, made of tempered steel, in one piece; ruggedly built for long wear.

Set of Spintites for Round Nuts, in 3 most popular sizes, \$1.00  
 Set of Spintites for Hex Nuts, in 3 most popular sizes \$1.00  
 Set of Spintites in 7 sizes for all Hex Nuts, on stand \$3.50

*Spintites are made in every size and style*

Stevens Panel Cutters (see A) for cutting peek or socket holes in rubber or bakelite panels.  $\frac{3}{4}$ " size, 75c.  $1\frac{1}{2}$ " size, 85c.  $1\frac{1}{2}$ " size, \$1. Set of 3, \$2.50.

Stevens Combined Drill and Countersink (see B). Drills and countersinks in one operation. Price, 35c.

*Write us for Booklet 24 today, describing complete line of radio tools. If your dealer can't supply Stevens tools order from us direct.*

Stevens & Company  
 375 Broadway New York

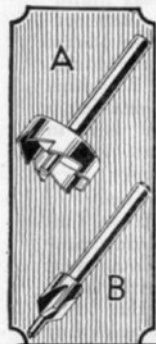

# The "KNOCKOUT" Tool Kit

FOR ALL RADIO CONSTRUCTION

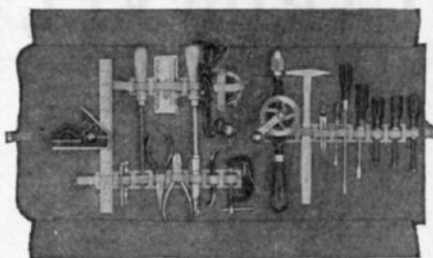

★ RADIO BROADCAST

DOUBLEDAY, PAGE & CO.  
 GARDEN CITY, NEW YORK



Mr. Wm. H. Siebert,  
 Hammacher, Schlemmer & Co.,  
 4th Ave. & 13th St.,  
 New York City.

Dear Mr. Siebert:

Your radio kit arrived this morning. Saturday is a short day with us and I do wish you could have held off the delivery until Monday. The kit just threw a monkey-wrench in the machinery and I doubt that any of my gang will be able to compose themselves for the rest of the morning.

They have been trying the automatic center punch on all kinds of panel material and are greatly enthused over it. I'm afraid some of our panels may be a little the worse for the wear. Three requests have been made to take the kit home and the only way to settle the dispute is to take it home myself. You may be sure that the kit will never be returned to you so you may as well send the bill along.

In the future, when you have such a pleasant surprise for us, please see that it arrives at some time other than Saturday morning.

Very truly yours,

*Arthur H. Seyditz*  
 Editor

AHL:H

## "GNOME BRAND" TOOL KITS

Just what you need to build the type 6500 Triflex Receiver and all other sets and equipment

RADIO KIT No. 1—22 TOOLS. \$16.00 each (as illustrated)  
 RADIO KIT No. 3—16 TOOLS. \$8.00 each

Tools may be purchased individually if desired. Also Carpenters' Tools in sets for home and general use.

Send for circular No. 282

HAMMACHER, SCHLEMMER & CO., Inc.  
 NEW YORK Since 1848 4th AVE. & 13th ST.

# CARDWELL

Low Loss, Grounded Rotor

## CONDENSER

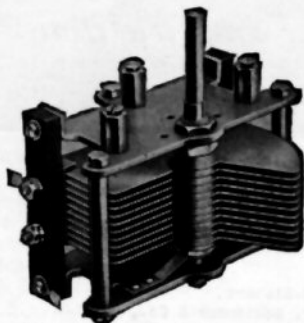

Cardwell is the original Low Loss, rotor grounded condenser. It is a significant fact that of all the various kinds of radio apparatus on the market to-day the CARDWELL CONDENSER is the ONLY unit which is recognized by engineers and technical Editors of National prominence as the ONE best.

*A Postcard brings you an Education on Condensers.*

Allen D. Cardwell Mfg. Corp.  
81 Prospect St. Brooklyn, N. Y.

## WHAT DO LOSSES REALLY DO?

*(Continued from page 282)*

plates, was set up so that the shaft was in line with the axis of the coil. When the end plate was 3/8-in. from the end of the coil, the resistance added by the condenser was 40 ohms. This went down to 2 ohms with the condenser 1 in. away from the winding. Moving the condenser to one side or the other reduced the resistance slightly until it was out of line with the outside of the coil. Then the loss disappeared entirely.

This shows clearly that a condenser and coil, mounted like an ordinary neutrodyne or tuned R. F. unit does not have any effect upon the signal strength or tuning. However, when the condenser is put at the end of the coil, as is the case with a condenser mounted on a panel beside a coil arranged so that the axis is horizontal, the tuning is made broader and the signal strength reduced.

Another test was made on the coil and condenser. Here the resistance of the pickle bottle coil and low-loss condenser was measured at wave-lengths ranging from 140 to 500 meters. We know in a general way that losses show up more at low wavelengths. This test showed in actual ohms of resistance just how true that is. At 500 meters the resistance was 4.6 ohms while at 140 meters the resistance was 26.5 ohms, an increase of approximately five hundred percent. Consequently, it is far more important to guard against losses below 200 meters than above 400 meters.

Some interesting information is contained in a letter received from the engineering department of the Wireless Manufacturing Company—"We were much surprised at the high resistance of the basket weave coil. Removed from its mounting, the resistance was 4 ohms against 2.5 ohms for a pickle bottle coil or 4.2 ohms for a coil wound on a tube. All the coils in these tests were of 150,000 c.m.s. inductance."

The competition in the efficiency of radio equipment has become so keen that manufacturers who have not already provided themselves with proper equipment for testing accurately the products which they make will very soon find that they are working entirely in the dark and they are very liable to discover that claims they have been making are not met by their equipment when it is actually put into use. The instruments needed for the important measurements are not expensive nor is their use so complicated that a trained engineer is required to operate them.

ALL  
EXHIBIT SPACE  
IN THE

**THIRD ANNUAL  
CHICAGO  
RADIO SHOW**

**SOLD**

**JAMES F. KERR**  
General Manager

127 No. Dearborn St. Chicago, Ill.

Improve  
your set  
with an  
AmerTran

Send for  
Circular  
No. 1005

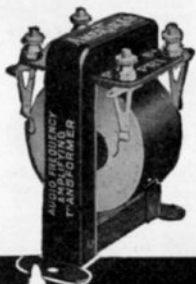

## STANDARD of EXCELLENCE

for audio  
amplification

# AMERTRAN

TRADE MARK REG. U.S. PAT. OFF.

The AmerTran is now made in two types: AmerTran AF-6 (turn ratio 5), is for use in the first stage; AmerTran AF-7 (turn ratio  $3\frac{1}{2}$ ) is the

companion transformer for use in further stages of amplification. Ask your Electrical Dealer; or sent carriage charges collect. Price, each type, \$7.

American Transformer Co., 173 Emmet St., Newark, N. J.  
*Designers and builders of radio transformers for over 23 years*

## From Loop to Loud Speaker

Wherever your radio set requires insulation, use Bakelite.

This remarkable material has all the properties essential to good insulation—and what is more—it is permanent. Heat, cold and moisture do

not affect Bakelite and it does not deteriorate with age.

Bakelite has the endorsement of a vast number of radio set builders and is used as standard insulation by all the leading radio manufacturers.

Send for our Booklet I.

### Send for our Radio Map

The Bakelite Radio Map lists the call letters, wave length and location of every broadcasting station in the world. Enclose 10 cents to cover the cost and we will send you this map. Address Map Department.

**BAKELITE CORPORATION**  
247 Park Avenue, New York, N. Y.  
Chicago Office: 636 West 22nd Street

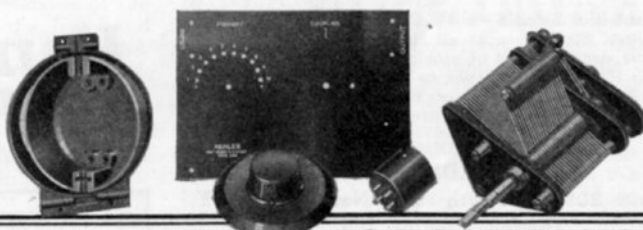

THE MATERIAL OF A THOUSAND USES

# Ingenious

## The "SELF ADJUSTING" Rheostat



Write for FREE Hook-ups

**\$1.10** everywhere

AMPERITE controls perfectly and automatically the current flow from battery to tube. No Rheostat knobs on panel to turn. No ammeter needed. No worry. One AMPERITE for each tube inside the set regulates current on thermo-electric principle. Simplifies wiring and operation. Facilitates tuning. Proven in use. Adopted by 50 set manufacturers. Be sure your set is equipped with AMPERITE.

RADIALL COMPANY  
Dept. RE-1, 50 Franklin St., New York

# AMPERITE

"means right amperes"

CERTIFIED LEAKS. Absolutely accurately calibrated, permanent fixed resistance units from 1/4 to 10 megohms. Price 50c.



VARIOHM, a variable grid leak will give you exactly the correct grid resistance. Any resistance from 1/4 to 30 megohms. Once set is permanent. Price 75c.



USE THE AUDIOHM for clarity and volume control. Put one across the secondary of your transformer. Price \$1.50 with adjustable bracket.

## GET DISTANCE CLARITY VOLUME

Stop the leaks, stop the distortions in your set that are preventing you from getting distant stations clear and loud. A money back guarantee that any set will be improved by Electrad products.

Electrad products on sale at most all reliable radio stores. Sold direct if your dealer cannot supply you. Money back guarantee.



LEAD-IN. Don't ruin your window frames or sills. Use an Electric Lead-In. Guaranteed 3000 volt test. Insulation not skimmed. Fits under closed windows. Can be bent any shape. Fahenstock clips. Soldered connections.

# ELECTRAD Inc.

Dept. 3 F 428 Broadway, New York

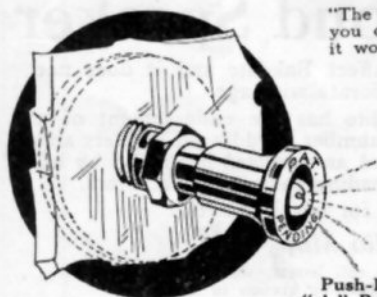

Push-Pull "A" Battery Switch Style

"The Kant-Blo Switch on our Super-Heterodyne does all that you claim for it. If we had installed this signal long ago it would have paid for itself hundreds of times."

(Copy of letter on request)

"Be Sure it Has a Kant-Blo When You Buy a Radio"

# YOUR MONEY BACK

If you blow a tube when your radio set is equipped with a

# Kant-Blo SIGNAL

"Lights on any Short Circuit"

Only one Kant-Blo needed to protect any number or any kind of radio tube

The Kant-Blo Signal is easily installed. Simply takes the place of either the ordinary push-pull "A" Battery Switch or one "B" Battery Binding Post now on set.

Kant-Blo Signals—both Binding Post Style and Switch Style—are at all the best radio stores. If your dealer is out of stock send us \$2 for a Kant-Blo Binding Post Style, or \$3 for the Switch Style, and we will ship any number of KANT-BLOS direct to you, charges prepaid.

Sole Distributors

APEX RADIO COMPANY

Suite 208, 503 Fifth Ave., New York, N. Y.  
Telephone Murray Hill 3520

Manufactured by Gano Kramer Co., Inc., New York

HAROLD BOLSTER,  
on behalf of the Principal Radio Manufacturers and Dealers of America

Presents—

This greatest  
radio show  
ever held  
will be  
*profit-sharing*  
*with*  
*exhibitors*

**THIRD ANNUAL**



**NATIONAL  
RADIO  
EXPOSITION**  
GRAND CENTRAL  
PALACE  
NOV. 3rd. to 9th. 1924

Special  
Election  
Week  
Program  
Features

Main and  
Mezzanine  
Floors

"The World and  
his Girl will  
be there"

**NEW YORK CITY**

Featuring, *in advance*, the  
most striking develop-  
ments in the Radio art  
and the Radio industry  
for the coming year

—Receiving Set Models  
for 1925

—Phonograph Radio  
Combinations for 1925

—Improved Equipment  
for 1925

American Radio Exposition Company

Director: HAROLD BOLSTER  
522 FIFTH AVENUE

General Manager: J. C. JOHNSON  
NEW YORK

Telephone: Vanderbilt 0068

"The Knobs Can't Come Off"

15c  
each



15c  
each

New  
Improved  
Model

12  
Styles  
Engraved

## "Read'em" Binding Posts

Samples of this quality terminal sent to manufacturers upon request.

The Marshall-Gerken Co.  
184 Ontario St., Dept. 184, Toledo, O.

# RUSONITE PRODUCTS

Price  
50c

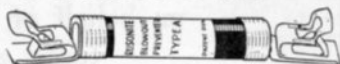

RUSONITE Blowout Preventer—Prevents tube blowouts, wire damage, excessive voltage or short-circuit risks. Indestructible.



Price  
\$1.00

RUSONITE Fixed Detector—The test of detector value—Results. Try the RUSONITE in your reflex and experimental work.

Price  
50c  
up



.001  
m.f.d.  
to  
.006  
m.f.d.

RUSONITE Fixed Mica Condenser—Moulded and hermetically sealed—Capacity absolutely constant. No losses of any kind. Accuracy predominant. Write for literature.

RUSONITE PRODUCTS CORP.  
15 Park Row New York, N.Y.

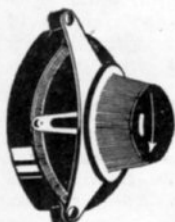

Cico Bakelite  
Rheostat

One point mounting  
Binding post connections. Vernier or plain  
types 6-10-20-30 ohms.  
Absolutely uniform resistance. Plain, \$1.35.  
Vernier, \$1.50.

# CICO

RADIO PRODUCTS are  
**UNQUALIFIEDLY GUARANTEED**  
against all defects

Look for the distinctive GREEN CICO BOX

Consolidated Instrument Co. of America  
41 East 42nd St., New York



Cico 2-Way Plug

Two sets of headphones or loudspeaker and one set of phones may be connected simultaneously. Fits all standard jacks. Takes all types of tips. Price 40c.

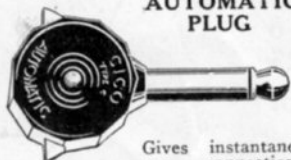

CICO  
AUTOMATIC  
PLUG

Gives instantaneous connection. A slight pressure on the wings with thumb and index finger releases tips for change. Bakelite body. Metal parts nickel-plated. Takes all tips. Price 75c.

CICO BAKELITE JACK

Something entirely new. An improved new principle. Moulded completely from bakelite. No metal in frame construction. Short springs of special phosphor bronze which is non-corrosive. No soldering. Sterling silver contact points assure perfect contacts. Scientifically perfect in every detail. Unusual in design and value. Something well worth all the pride you will take in it.

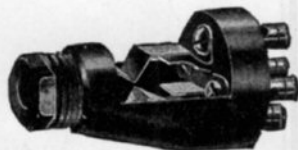

No. 30—Single circuit open \$.80  
No. 31—Single circuit closed .85  
No. 32—Double circuit . . . .90  
No. 33—"A" Battery Switch .90

# RHEOSTAT TYPE 40

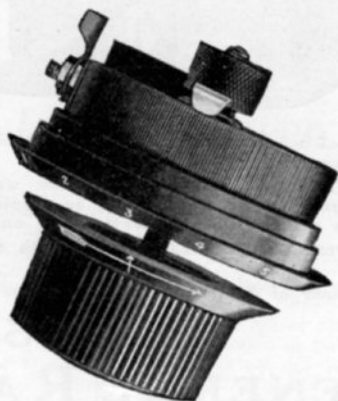

Embodying many new and original features. Solid Bakelite, of course. See it at your dealer.

We beg the public's indulgence in our effort to supply them with our NOLOSS Pyrex and Isolantite insulated variable condensers.

We are increasing our production facilities four-fold and hope to be in a position to supply the current demand by November 15th.

*General Instrument Products  
cost a little more but are worth infinitely more*

BOOKLET UPON REQUEST

**GENERAL INSTRUMENT CORPORATION**

MANUFACTURERS OF LABORATORY EQUIPMENT

423 BROOME STREET

NEW YORK, U. S. A.

# THE IDEAL 30 K.C. TRANSFORMER

Type  
271



M. F.  
Transformer

The successful operation of a Superheterodyne depends largely upon the efficiency of its medium frequency transformers.

The GENERAL RADIO TYPE 271 M. F. Transformer was designed *specifically for amplification of medium frequencies*, and is not merely an adaptation of a radio or an audio frequency transformer. It is shielded both electrostatically and electromagnetically.

The working range is from 7,000 to 12,500 meters with a peak frequency of 10,000 meters.

In Superheterodyne sets four of these transformers may be used with excellent results.



"Quality"  
Easily Recognized

Price \$5.00

**GENERAL RADIO Co.**  
CAMBRIDGE, MASS.

# CARTER RADIO PARTS

*Everywhere Preferred for  
Quality and Workmanship*

ASK "OLD-TIMERS" IN RADIO: THEY KNOW

PLUGS  
RHEOSTATS

JACKS  
RECEPTACLE JACKS

JACK SWITCHES  
NAME PLATES

*Insist on the Original*

Write for  
Complete  
Catalogue

**Carter Radio Co.**  
209 S. STATE STREET  
CHICAGO

Any Dealer  
Can  
Supply



Members of  
R. M. A. and  
N. R. T. A.

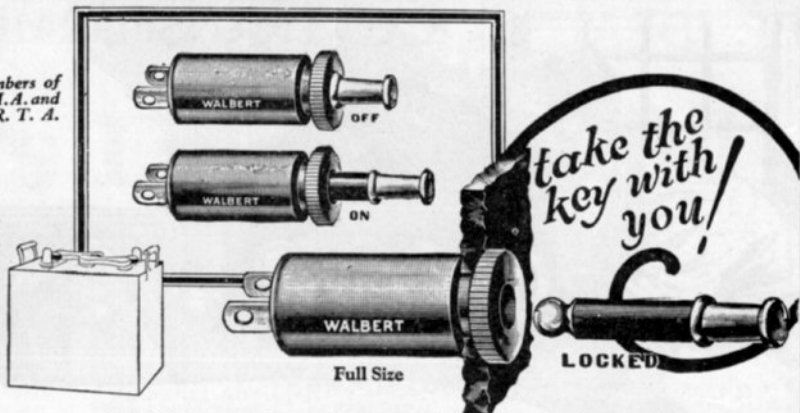

# PROTECTION

for tubes and batteries



The Walbert Safety Rim Socket is guaranteed *not* to break at the slot. Special heavy bakelite design decreases interelement capacity thereby utilizing all available grid voltage for producing signals. (New tubes have bakelite bases for same reason.) Soldering lug and double-spring contact integral.

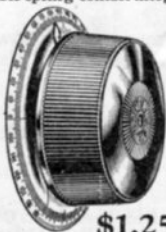

Stations unheard before are tuned-in readily with the UNIVERNIER, the original geared tuning dial. Gives 12-to-1 (micro-selective) control of any instrument. (A lower ratio is inefficient; a higher cumbersome and needless.) New "dished" dial and heavier mechanism. Positive vernier - No slippage! Pointer rigid with shaft.

## WALBERT FILAMENT LOCK SWITCH

Safeguards Tubes and Batteries

**Y**OU don't need to worry any more about someone meddling with your radio set while you are away. Simply remove the key (smaller than standard plug) from the Walbert Filament Lock Switch and take it with you just as you'd take the ignition key from an auto. Your tubes and batteries will be fully protected.

Put this combination filament control switch and safeguard on your set today. Attach it in a few minutes. It's very compact—takes little room on panel or behind it. Sturdy interior phosphor bronze springs assure positive contact. Shell and key handle insulated from circuit. Costs no more than an ordinary battery switch.

### WALBERT FILAMENT LOCK SWITCH 50c

At your dealer or sent postpaid on receipt of 50c.  
(Please mention dealer's name.)

Jobbers and Dealers: Write for Discounts.  
THE WALBERT MANUFACTURING CO.  
931 Wrightwood Avenue Chicago, Illinois

## WALBERT

Parts with a Purpose

Send 2c for UNIVERNIER Log-book.

ALL WALBERT PRODUCTS PROTECTED BY PATENTS OR PATENTS PENDING, U. S. AND FOREIGN

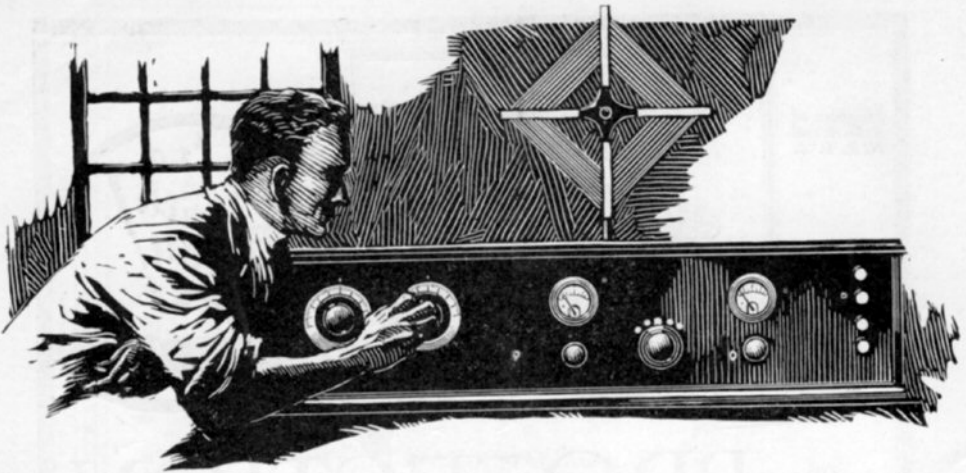

## Mechanical Quality and Insulation Value!

THE mechanical qualities of Formica have as much to do with the preference of the 125 leading independent radio manufacturers for Formica, as its high dielectric strength.

These makers want to know that their panels are not going to sag and curl, and that the screws and binding posts will not loosen up because the material is so elastic it flows out under pressure.

They build for permanence. They want fine finish—and lasting finish. They want a material that will work well in their factories. And they get it all in Formica!

This year there will be scores of sets that carry a Formica front panel, Formica base panel, Formica terminal strips, Formica transformer cases, Formica jack washers—and many other parts. That stops losses and gets more distance and volume.

Be sure to use a Formica base panel in your Neutrodyne or Super-heterodyne.

Dealers: The standing of Formica as radio insulation is well known by most amateurs and they want it. It is a satisfactory line that moves in good volume.

**THE FORMICA INSULATION COMPANY**  
4653 Spring Grove Avenue, Cincinnati, Ohio

### Sales Offices

50 Church St., New York, N. Y.  
422 First Ave., Pittsburgh, Pa.  
1142 Granite Bldg., Rochester, N. Y.  
419 Ohio Bldg., Toledo, Ohio  
1210 Arch St., Philadelphia, Pa.  
1026 Second Ave., S. Minneapolis, Minn.

585 Mission St., San Francisco, California  
Whitney Central Bldg., New Orleans, La.  
516 Caxton Bldg., Cleveland, Ohio  
9 S. Clinton St., Chicago, Ill.  
708 Title Bldg., Baltimore, Md.  
47 King St., Toronto, Ontario

---

# FORMICA

Made from Anhydrous Bakelite Resins  
**SHEETS TUBES RODS**

---

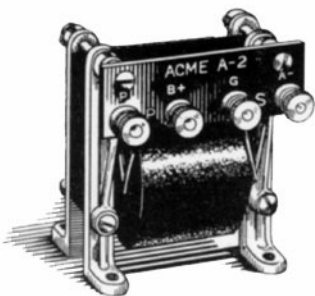

After distance,  
what do  
you want?

## *Amplification without distortion*

OF COURSE, you want to hear the distant stations but you want these loud and clear so a whole room full of people can understand.

And when you listen to a fine musical program from your local station it certainly is fascinating to get all the notes, all the words, and to be able to close your eyes and just be content.

If you use Acme Transformers in the set you build and insist on their use in the set you buy, you are giving your loudspeaker a chance to reproduce the singer's voice, the violin's notes, the orchestra or lecture, loud and clear, without distortion.

Send 10 cents today for 36-page book "Amplification without Distortion," containing many practical wiring diagrams and many hints for getting the best out of your set.

ACME APPARATUS COMPANY  
*Transformer and Radio Engineers and Manufacturers*  
Dept. R. M. 10 Cambridge, Mass.

# **ACME** *~for amplification*

---

---

# "The Best That Money Can Buy"



"DEVEAU GOLD SEAL" HEAD SETS are electrically and mechanically,—as well as from a radio standpoint,—as perfect as the highest-priced Head Set on the market,—and yet, with all their perfection, they retail at only \$6.00 for 2200 Ohm and \$8.00 for 3200 Ohm.

The trade mark "DEVEAU" has stood for the highest quality in telephone apparatus for thirty years,—a guarantee that every known advantage in design and manufacturing has been taken into careful consideration.

Magnets are extra-heavy one-piece units; cups are of aluminum to keep down the weight but unlike other Head Sets, every exposed metal part of the set is finished in genuine 24-karat gold,—under a protective lacquer so that the finish will last for years; the terminals of each unit are concealed,—no contact possible with user's hands.

"DEVEAU GOLD SEAL" HEAD SETS are like a piece of fine jewelry in appearance, but with all the radio niceties that the most advanced radio enthusiast can desire. DEVEAU Units exactly match each other in

tone,—each has maximum sensitivity and perfection of tone quality.

The patent design of headgear is far ahead of any Head Set on the Market,—affording as it does, instant fitting to ears and head without "re-harnessing" and without binding or pressure—the latter an admitted nuisance with all other makes of Head Sets.

Caps are of genuine Bakelite—of scientific design, and comfortable to the ear; the Bakelite never loses its jet-black lustre or highly polished surface.

"DEVEAU GOLD SEAL" HEAD SETS are never found in the cut-rate market—they are only sold to jobbers who appreciate their value.

"DEVEAU GOLD SEAL" HEAD SETS are guaranteed to be electrically and mechanically perfect—our Guarantee protects every purchaser.

Order through your regular jobber or write direct for the names of authorized Distributors throughout the country.

Send for descriptive Bulletin of Deveau Radio Apparatus and Micrometer Adjustable Air-Gap Radio Loud Speakers.

## STANLEY & PATTERSON

27 WARREN STREET

23 MURRAY STREET

NEW YORK CITY, U. S. A.