

RADIO & MODEL ENGINEERING

*A Magazine for the Experimenter
who builds his own Equipment.*

Edited by M.B. SLEEPER

RADIO FREQUENCY NUMBER

AUTHORIZED CONSTRUCTION
DATA FOR THE HAZELTINE
NEUTRODYNE RECEIVING SET.

NEW TYPE TUNED RADIO
FREQUENCY REFLEX RE-
CEIVER, USING NON-OSCILLAT-
ING CIRCUIT.

DESIGN AND CONSTRUCTION
OF A MODEL MARINE EN-
GINE, DOUBLE ACTING SLIDE
VALVE TYPE.

September-October 1923

10¢ a Copy - In England, Sixpence

Vol. 3 No. 7

The "B" Battery is the Life of Your Radio Set

THIS IS NUMBER ONE OF A SERIES

THE only function of your Radio set is to produce sound-waves—those mechanical disturbances in the air caused by some rapidly vibrating body. So far as the Radio set itself is concerned the actual source of the sound is the "B" Battery. It is not an exaggeration to say that the "B" battery is the "life of your Radio"; for the set itself is simply a device to reproduce sounds, and the sounds all have their origin in the "B" Battery.

The "B" Battery is simply a box full of electrical energy; harnessed for you by experts. Without the Radio wave the flow of energy from the "B" battery is smooth, steady and *silent*. It is the final aim and purpose of all the many parts which go to make up a Radio receiving set, to convert the otherwise steady flow of electrical energy from the "B" Battery, into a rippling, vibrating, throbbing, audible current.

As the sound-waves—whether caused by the human voice in talking or singing, or by musical instruments—are modulated up and down—now high—now low; so does the current from the strongly vital "B" Battery follow the modulations and the variations, so that the original message, in all its delicacy of tone and vibration, comes clear and distinct through your Radio set.

Not a mere adjunct to the pleasure-giving quality of your Radio set is the "B" Battery—instead, it is the vital, life-giving part—the very heart of your Radio set.

Do not slight this vital part—give your Radio set the advantage of the best—use Eveready "B" Batteries.

Note: This is No. 1 of a series of informative advertisements which will appear in this magazine. They are designed to help Radio users get the most out of their Batteries and Radio sets. If you have any battery problem, write to G. C. Furness, Manager Radio Division, National Carbon Co., Inc., Long Island City, N. Y.



The New Metal Case Eveready "B" Battery (No. 766)

"The Life of Your Radio"

The same popular 22½ volt Eveready "B" Battery in a new, handsome, durable, waterproof, metal container. Eveready quality throughout. At all dealers, \$3.00.

The "B" Battery is the vital part of any radio receiving set. Eveready Batteries—especially made for Radio—serve better, last longer and give better results.

Manufactured and guaranteed by

NATIONAL CARBON COMPANY, Inc.
Long Island City, N. Y.

EVEREADY

Radio Batteries

—they last longer



When they ask you what to buy, say

“SLEEPER MONOTROL”

The First Radio Broadcast Receiving Set Licensed under the Grimes Inverse Duplex Inventions

MONOTROL means **one tuning control**. The voices of the air, the music, the messages of great men and women, reports of the World Series, the intercollegiate football games, all yours for the choosing, on a radio set with just one tuning control.

Monotrol means no outside wires, no aerial and no ground connections, (no landlord to bother with).

Monotrol means simplicity and beauty, a sweetness of tone, a clarity and faithfulness of reproduction that will make radio mean happiness this fall and winter and all the seasons to come.

Monotrol 3

Monotrol 3, the set illustrated, using three tubes, designed for local reception on a loud speaker, list price without accessories \$115.00.

Monotrol 4

Monotrol 4, identical in outward appearance, but with four tubes, for long distance on a loud speaker, list price without accessories, \$125.00.

SLEEPER RADIO CORP.
F-88 Park Place New York City



Only Dubilier Micadon Type 601 Will Do in a Neutrodyne Set

BECAUSE success with the Neutrodyne circuit depends on balanced capacities only Dubilier Micadon type 601 will do.

For Dubilier Micadon type 601 is a fixed condenser of guaranteed **permanent** capacity—like all Dubilier fixed condensers.

The features that insure permanence of capacity are patented and are therefore not to be found in other fixed condensers.

Price, 35 cents to 75 cents each, depending on capacity (.0001 to .006 mfd.)

This is Dubilier
Micadon Type
601, about nat-
ural size.

*At all
Good Dealers!*

DUBILIER CONDENSER & RADIO CORP.

48-50 West Fourth Street, New York City

DUBILIER DEVICES



The Hazeltine Neutrodyne

A much discussed set on which little construction data has been available

THE Hazeltine Neutrodyne Receiver has caught the interest of Experimenters not only because it is a non-regenerative receiver of greater sensitiveness than most regenerative sets, but, it may be suspected, because of the novel appearance of the angle-mounted coils which catch the curiosity of the constructor. The theory involved in the Neutrodyne circuit, and an account of methods by which tube and circuit capacities are neutralized were presented by Prof. Hazeltine in a paper read last spring before the Radio Club of America, and later published in QST Magazine. This theoretical data is applied in the following details for the construction of a Neutrodyne type receiving set.

The Neutrodyne Circuit

The Neutrodyne circuit is essentially a two-step tuned radio frequency amplifier and detector, to which a step of audio reflex can be added and one or two straight audio frequency steps. The plate circuits of the first and second radio frequency amplifiers are connected to primary coils consisting of a few turns of wire on a tube about 3 ins. in diameter. Each secondary is wound on a slightly larger tube with a greater number of turns and tuned to the wavelength of the incoming signals by a variable condenser. Fig. 1 shows the rear view of the completed set with the transformers mounted on their condensers. More details are shown in Fig. 2, the top view. Another transformer, identical in design to those just described, is used for the primary and secondary of the loose coupler. No tuning is provided for the primary but the secondary is controlled by a variable condenser. Because of the comparatively large inductance used in the primaries of the transformers, the tubes tend to oscillate. To prevent that, neutralizing condensers are connected as shown in Fig. 3. Oscillations are made possible by the capacity of the tube and its respective primary transformer winding. When, how-

ever, the tube capacity is neutralized, oscillations cannot take place.

In the set described here the detector plate circuit is connected to the primary of an audio frequency transformer, the secondary of which is inserted in the grid circuit of the first radio frequency amplifier. Thus one step of audio frequency amplification is provided without the use of an extra tube. The telephones are connected in the plate circuit of the first tube, altho a plain audio frequency amplifier can be inserted at that point if still louder signals are required.

The Type 5200 Receiver

Altho the Neutrodyne is a splendid all around outfit, it is particularly good for those who are situated in the immediate vicinity of a broadcasting station, since the tuning is so sharp that practically any interference can be cut out. For example, a few blocks from WEAf, operating at 492 meters, WIP, at 504 meters can be brought in without any interference with the other stations. The disadvantage of this sharp tuning can be overcome by logging stations as they are heard for, even on different antennas, the calibration of the dials is not affected. This feature will appeal to those who are forced to sit up late at night until local broadcasting stops before they can get through to distant stations.

Construction Work Required

Altho the transformers can be wound at home, it will be found more satisfactory to buy the complete tuning units, for they must be built in exactly the correct way to produce maximum results from the set. These are sold in sets of three with two neutralizing condensers, ready to be assembled in the set. If they are purchased ready made, only the panel drilling, assembly, and wiring remains. As is true of all sets using R. F. amplification, the wiring must be done neatly and the picture wiring diagram, Fig. 4, followed with great care so as not to introduce additional capacities

which will cause trouble in making the adjustments. The front panel is of standard dimensions, 7 x 18 ins., so that it can be obtained at your local radio store. Cabinets of this size are also available almost everywhere. A depth of 7 ins. from the back of the panel is necessary to accommodate the base panel which measures 7 x 10 ins. With the exception of binding posts for the antenna and ground and for connection to a loud speaker the terminals are at the rear on a small panel supported by two polished nickel brass pillars. The wires can be brought in through small holes drilled in the back of the cabinet.

Two brass pillars are required to support the terminal panel. They can be purchased complete, or can be cut from $\frac{3}{8}$ -in. rod, 3- $\frac{3}{8}$ ins. long, threaded 8-32 at each end.

Filament Control Circuit

An entirely new method is used for the filament circuit. In arranging the front panel, there seemed to be no convenient location for a second rheostat to control the two amplifiers, nor could a plain on-and-off switch be fitted in without destroying the symmetrical appearance of the panel. As is so often the case, the problem was solved by getting at it from an entirely different angle.

It is not good practice to put 6 volts on UV201-A tubes. Consequently, we wanted to work out a switching arrangement that would keep a small resistance in the amplifier filament circuits, and that would be operated with the detector rheostat knob. You will see in Fig. 3 that there is an auxiliary contact on the rheostat. This is also shown in Fig. 4. The contact is made of No. 30 spring brass, $\frac{1}{4}$ -in. wide and $\frac{3}{4}$ -in. long. One end is fastened under the terminal screw, while the other is bent to

make firm contact with the resistance winding. Just at the end, it is bent up so that the contact arm can be slipped under it.

When the contact arm is turned around to light the detector tube, the extra contact closes the amplifier circuit thru a small part of the resistance. This can be seen in Fig. 2. In the off position of the contact arm, however, the detector circuit is open, and the contact arm lifts the spring from the winding and opens the amplifier filament circuit. Before you finally solder the connection 26, Fig. 4, to the winding you must have the set ready for operation and determine the proper point by test.

Standardized Parts Require

The three tuning units, the neutralizing condensers, and the rheostat, are of Fada manufacture. Dubilier micadons are recommended where fixed condenser are required. It is important to use a Pacent jack because it is just short enough to fit in front of the socket. The sockets and audio frequency transformer are of Sleeper Radio make. Eby binding posts are used for the terminals. Both the front and the base panels are of Formica. It is possible, of course, to substitute other parts, altho it is safer and more satisfactory to follow the details entirely.

Laying Out the Panels

Figs. 5 and 6 show the layout of the front panel, the left hand half in Fig. 5 and the right hand in Fig. 6. The arrangement of the base panel is illustrated in Fig. 3. A drawing of the terminal panel is also shown in Fig. 5. Since these drawings are exactly one-half size, dimensions can be measured on the drawings, doubled, and laid out on the panels. This work must be done carefully, using a combination

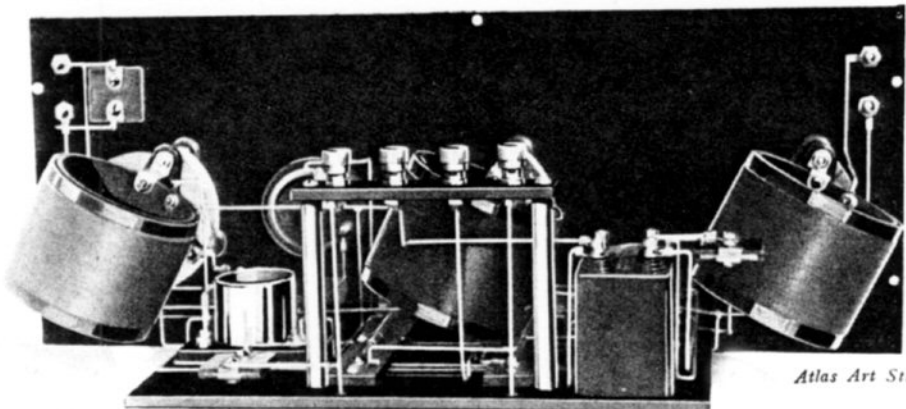
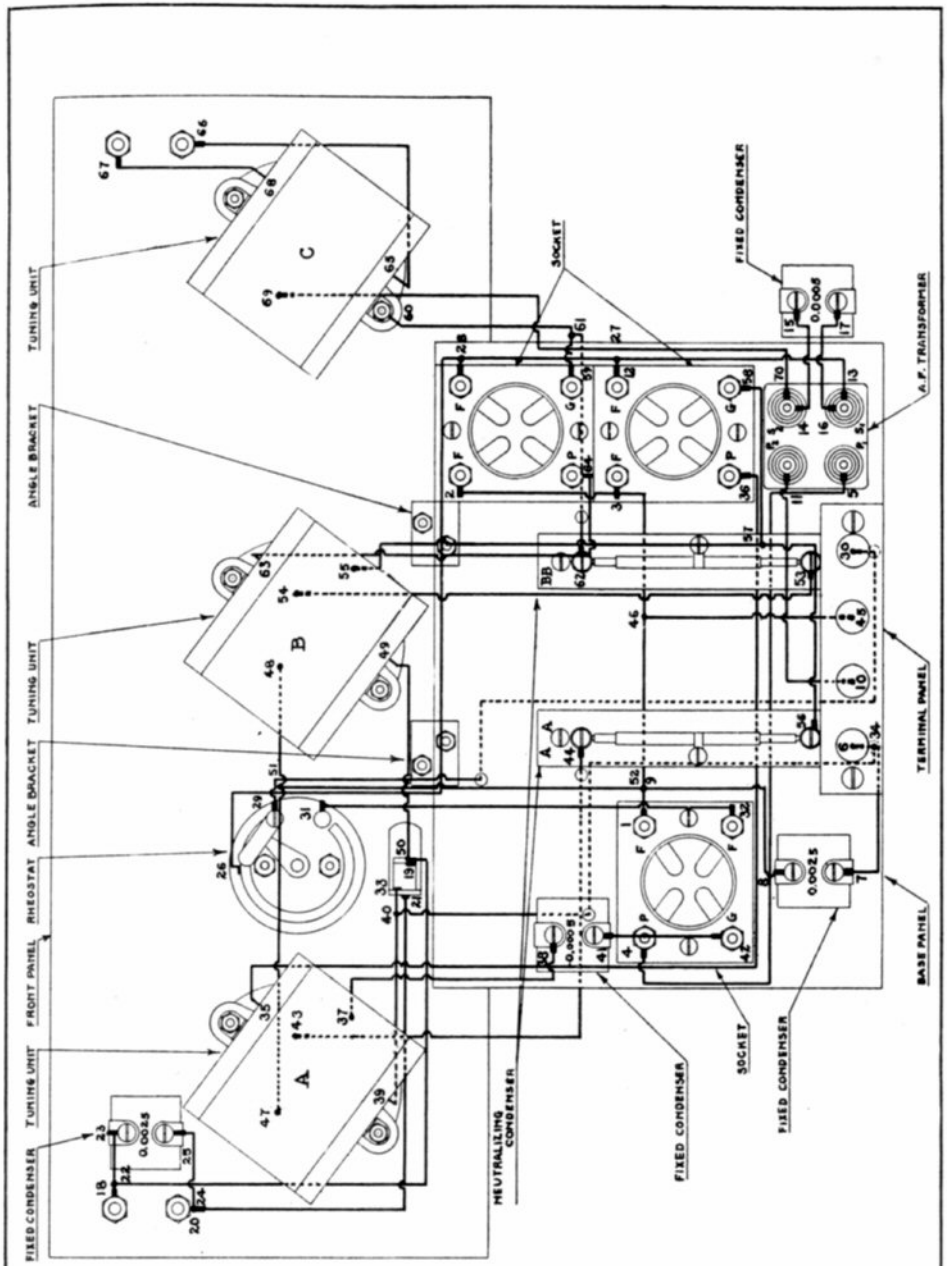

Fig. 1. In this view the wires running under the neutralizing condensers can be seen. No peep holes were provided, partly because there was no convenient place for them, and partly because the light from UV 201-A tube is hardly visible



Drs. by M.R.S.	RADIO and MODEL ENGINEERING		
Dr. by I.L.L.	3-TUBE NEUTRODYNE SET		
Ch. by	TYPE 5200		
Limit: <i>ACB</i>	Pt. No.	Picture Wiring Diagram	
Scale:	Job 1777	Sept. 22, 1923	
	Dr. 123	Sheet 4	4

Fig. 4. Imagine that the front panel has been tipped back on a plane with the base panel. Then the wiring would appear exactly as it is in this illustration

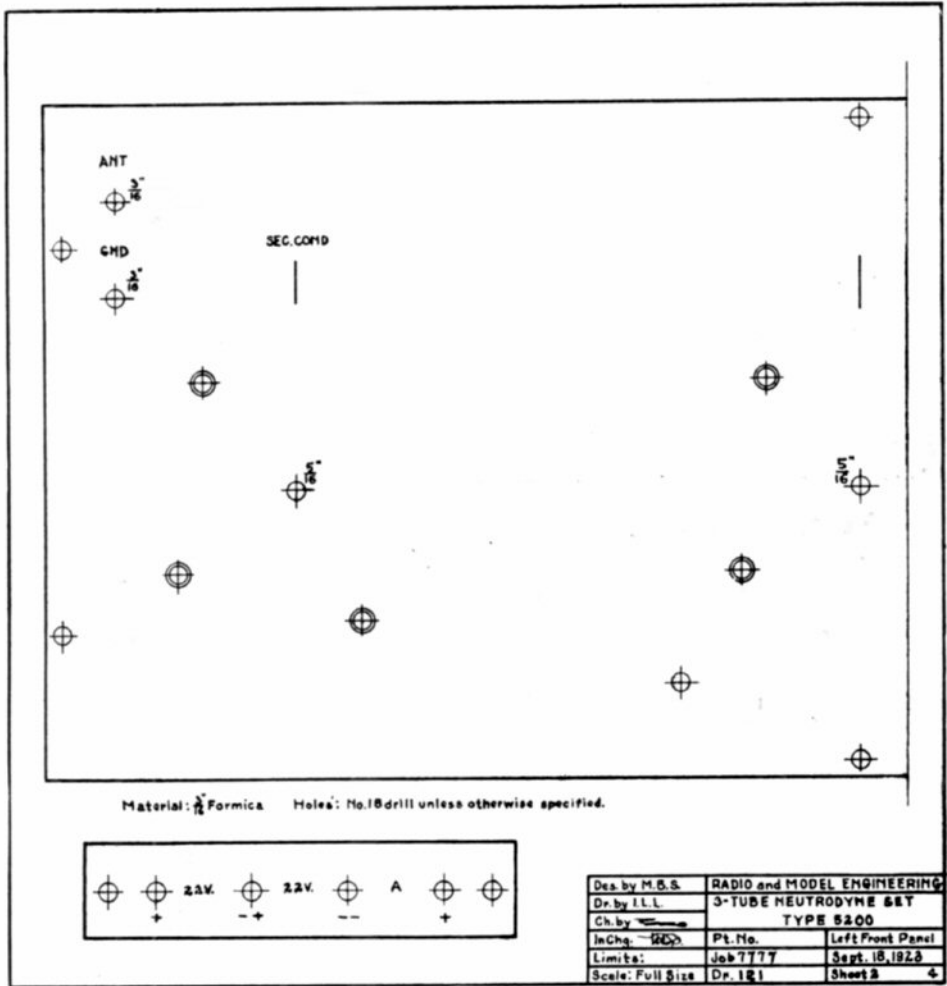

Fig. 5. Left hand half of the front panel, and the terminal panel, shown at one-half scale. All dimensions taken from this drawing should be doubled

square, dividers, and scribe. You can do this layout work on the front of the panel if you make the marks short and light. Some Experimenters find this the safest method because they occasionally make mistakes in reversing the positions of the holes when they are laid out on the back of the panel.

All holes not otherwise marked should be made with a No. 18 drill. Concentric circles indicate countersinking for flat head screws.

The small terminal panel, altho not standard in size, can be cut out from a little scrap of Formica which you will have around the shop.

Assembly and Wiring

To prevent the introduction of additional capacities which would be hard to balance out, the wiring shown in Fig. 4 should be carefully followed. To simplify the connections and to reduce their length several special arrangements have been used which make it necessary to follow step-by-step, the assembly and wiring instructions. For example, the neutralizing condensers are raised from the base panel by putting nuts on the fastening screws under the condenser bases to allow wires to be run beneath them. Therefore, these condensers cannot be mounted until the wires beneath have been put in place.

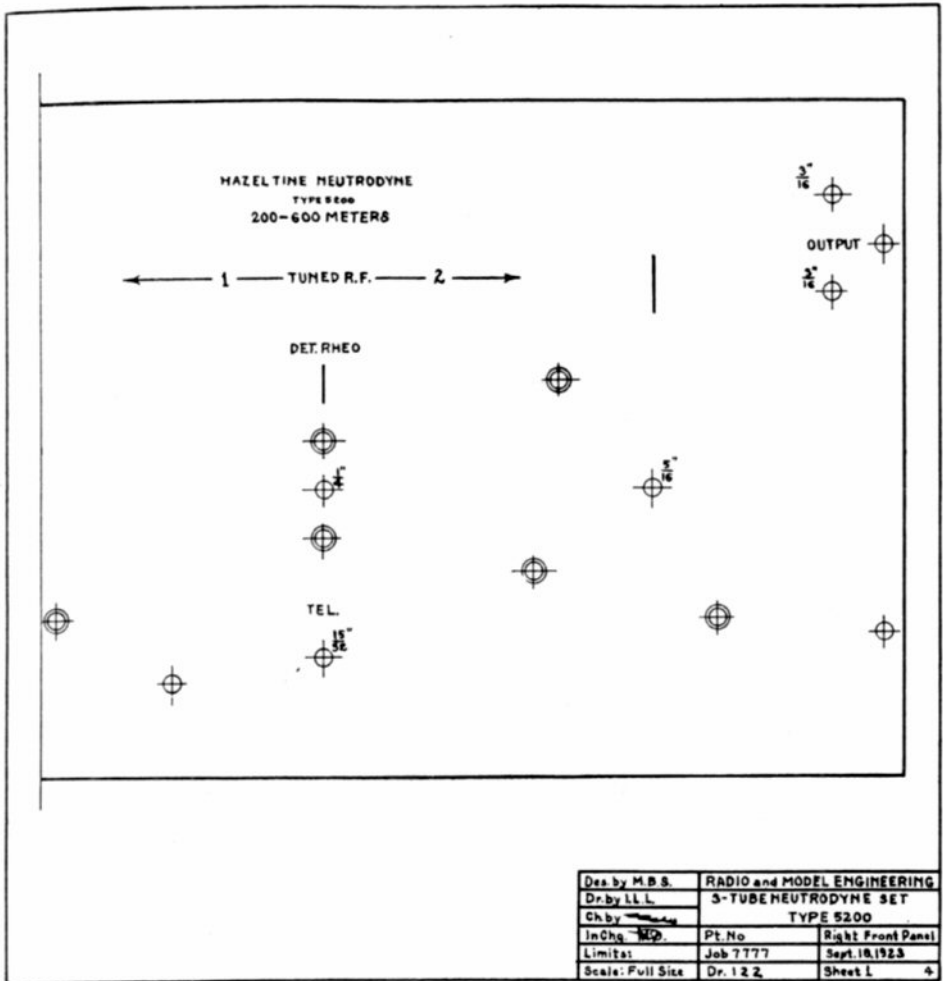

Fig. 6. If your panel is not exactly square use the straightest edge for the bottom, scratch a line across the center and measure from the line to left and right

As you mount each part put on the soldering lugs as indicated by the heavy lines in Fig. 4. It is much easier to tighten them before the part is fastened down than afterward. When you buy lugs make sure that they are actually tinned and not simply dip nickelled. Dipped nickeling does not help materially in making the soldered joints but if the lugs are actually tinned the solder flows more freely. Use an electric soldering iron, preferably the American Beauty type.

1. Mount the sockets on the base panel with the terminals in the position indicated.

2. Connect 1 to 2, and also solder this wire to terminal 3 by which it passes. Run

this wire close to the base panel as it goes under the neutralizing condensers.

3. Mount the audio frequency transformer.

4. Connect 4 to 5. This wire must also be close to the base panel.

5. Mount the binding posts on the terminal panel, making sure that the holes point at right angles to the length of the panel.

6. Fasten the terminal panel to the supporting pillars with $\frac{1}{2}$ -in. 8-32 R. H. screws and use the same size screws to hold the pillars to the base panel.

7. Connect 6 to 7, 8 to 9, and 10 to 11. This last wire runs directly out from the

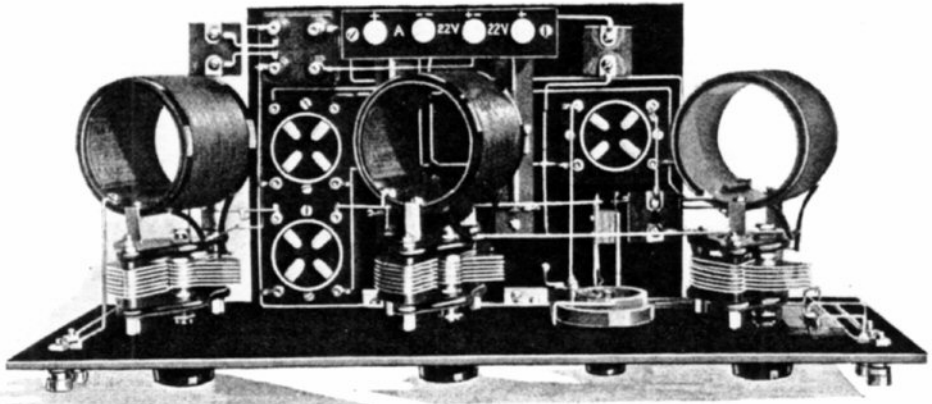

Atlas Art Studio

Fig. 2. This shows clearly the arrangement of all the parts. The tandem sockets at the left are for the amplifier tubes, and the one at the right is for the detector

transformer P2 terminal parallel to the base panel. Connect 12 to 13, 14 to 15, and 16 to 17. Soldering lugs should be fastened to the micadons with $\frac{3}{8}$ -in. 6-32 R. H. screws and nuts.

8. Mount the open circuit jack, binding posts, and rheostat on the front panel.

9. Mount the front panel on the base panel by means of 1-in. right hand and left hand nickelled angle brackets, using $\frac{3}{8}$ -in. 6-32 R. H. screws and nuts.

10. Connect 18 to 19, and 20 to 21. Connection 21 is made to the frame of the jack so as to keep the wire close to the panel. Connect 22 to 23, 24 to 25, 26 to 27, and solder this last wire to 28 by which it passes. Connect 29 to 30. This wire goes down through a hole just below terminal 30 and runs under the panel and up through another hole right near the left hand angle bracket and on to the rheostat. Connect 31 to 32 and 33 to 34. This wire goes through a hole in the base panel just below terminal 6 and comes out through a hole under the grid condenser, then on to the frame contact of the jack.

11. Mount tuning unit A using $\frac{1}{4}$ -in. 8-32 F. H. screws. These holes should be countersunk rather deeply so that the screws will go into the condenser supports a little more than $\frac{1}{16}$ -in.

12. Connect 35 to 36. Keep this wire close to the base panel. Connect 37 to 38, 39 to 40, and 41 to 42. Terminal 35 is the upper inside lug on the primary coil; 37 is on the middle condenser support rod; 39 is the lower inside primary terminal.

13. Mount neutralizing condenser AA, using $\frac{3}{4}$ -in. 6-32 R. H. screws and nuts. Put a nut on each screw under the condenser base so as to hold it above the wires which pass underneath.

14. Connect 43 to 44. 43 is the tap on the outside secondary winding. It goes under the base panel and up through a hole in the base panel next to terminal 44. Connect 45 to 46.

15. Mount tuning unit B.

16. Connect 47 to 48. 47 is the connection to the rotary plates of unit A and 48 is the connection from the rotary plates of unit B. Connect 49 to 50. 49 is the lower inside primary terminal. Connect 51 to 52. 51 is a connection to the wire running between 47 to 48.

17. Mount neutralizing condenser BB in the same way that the other was mounted.

18. Connect 53 to 54. 54 is the tap on the outside secondary winding. Connect 55 to 56. 55 is a soldering lug on the middle condenser support rod. Connect 57 to 58.

19. Mount tuning unit C.

20. Connect 59 to 60. 60 is a soldering lug fastened to the lower strip which holds the coils to the variable condenser. Connect 61 to 62. This wire goes from 62 through a hole in the base panel and out to connection 61. Connect 63 to 64. 63 is the upper inside primary terminal on tuning unit B. Connect 65 to 66. 65 is the lower inside primary terminal of tuning unit C. Connect 67 to 68. 68 is the upper inside primary terminal. Connect 69 to 70. 69 is the terminal from the rotary condenser plates.

21. Put the dials on the three variable condensers so that the 100-division line on the dial coincides with the line on the panel when the plates are totally interleaved. If you replace the Fada knob on the rheostat with the dial shown, have the dial at zero when the rheostat is in the off position.

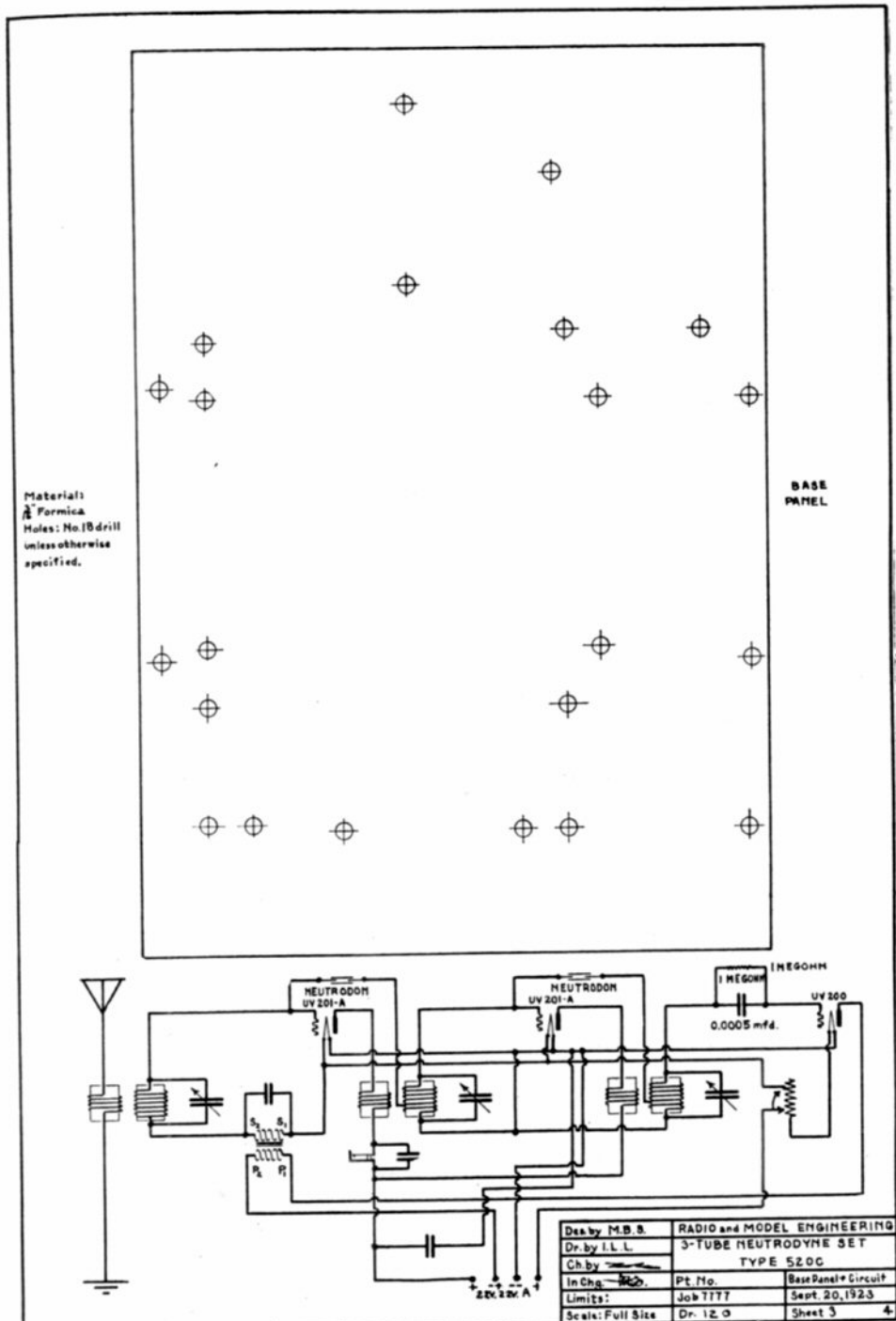

Fig. 3. One-half scale drawing of the base panel. Do not forget the extra holes thru which the connecting wires pass. Here is also a schematic diagram of the set

When the set is assembled, connect the batteries, put UV201-A tubes in the tandem sockets and UV200 detector tube in the separate socket. The first job is to adjust the tubes on the neutralizing condensers.

Connect a 0.00025 mfd. variable condenser across a coil wound with 55 turns of No. 24 S.S.C. wire (No. 22 S.W.G.), wound on a tube 3 ins. in diameter. Across the coil connect a buzzer, dry cell, and switch. From one end of the coil run a wire to the antenna binding post of the set and

center and right hand condensers until they all check.

A short signal-wire antenna gives the best results with this set. It is not necessary to use more than one wire. Loop antennas are not recommended, for if the set is to be used where an outdoor antenna is impractical, a short indoor antenna can be used.

Because of the sharpness of tuning, it may help you, when first operating the Neutrodyne, to have the following tables of approximate settings for the three variable condensers:

Fig. 7. You must be very careful about the location of the screws which hold the variable condensers, so as to reproduce the angle exactly. Otherwise there will be coupling between the coils

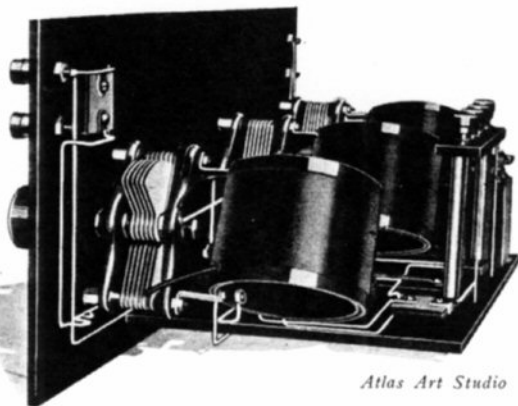

Atlas Art Studio

connect the ground binding post of the set to the earth. Adjust the rheostat so that the detector lights with normal brilliancy and, with the testing circuit condenser at about 20 degrees, adjust the 3 tuning condensers on the set until signals come in at maximum intensity. All three dials will be found to have approximately the same setting. Then remove the first amplifier tube from the socket. This is the one next to the panel. Readjust the condenser dials until signals are again at maximum intensity. Put a small piece of paper over one of the filament contact pins of the tube you removed and put it back in the socket again. The filament will not light but the grid and plate will be connected. Signals will still come in at the phones. Adjust the neutralizing condenser next to the A. F. transformer until the signals are at minimum intensity. Repeat this operation with the second amplifier tube after putting the first tube in operation again, and adjust the other neutralizing condenser until signals are again at lowest strength.

In operating the Neutrodyne you will find that, over the wavelength range, there may be some fixed difference in the condenser settings. If you want to make the dials read more nearly the same number of divisions move the dials on the shafts of the

WNAC	270m.	17 degrees
KDKA	326m.	26 degrees
WDAP	360m.	32 degrees
PWX	400m.	43 degrees
WGM	429m.	48 degrees
KFI	469m.	58 degrees
WEAF	492m.	67 degrees
KSD	546m.	87 degrees

For ordinary tuning to pick up anything that may be in the air, the dials must be rotated very slowly, only a few degrees at a time. The transformer tuning condensers should be moved together at about the same settings. Then the secondary condenser is tuned back and forth, a little above and below the settings of the other two dials. This is done because the secondary condenser tuning is slightly sharper than the others.

A set employing ordinary R. F. amplification is usually adjusted by means of the potentiometer, so that the circuit oscillates. Then broadcasting stations are picked up by the beat notes. This cannot be done, however, with the Neutrodyne, if the capacities are properly neutralized, as the receiver does not produce oscillations to heterodyne with the waves radiated by the transmitter.

RADIO & MODEL ENGINEERING

Published monthly by
M. B. SLEEPER, Inc.
A-88 Park Place, New York City

Ten cents per copy in the United States and Canada; in foreign countries six pence. One dollar per year, twelve numbers in the United States and Canada; five shillings in foreign countries.

Radio and Model Engineering is mailed to subscribers at the end of the month, and appears in the radio stores on that date.

Copyright 1923 by M. B. Sleeper

EDITORIAL

MOST everyone who comes into our editorial office says, "It must be great to be able to put in all your time at experimental work. It seems as if the few evenings I can spend in my shop is no time at all."

As a matter of fact, it is mighty agreeable work, preparing articles for R and M, getting around for lunch with this man or spending an afternoon with that one who has some new ideas, or going thru a factory to see what is going on. However, along toward the end of August, this work, like any too steadily pursued, did seem to drag a bit. With twice as many pages as a year ago, challenging problems became merely the labor of filling pages. Enthusiasm was no longer spontaneous. Even the typewriters' click dropped to a monotone, and the rustle of opened letters sounded as if the paper had succumbed to New York's devastating heat.

But what a change has come with September. The two-hours-for-lunch club as suddenly disbanded. The man who, a month ago, idly asked, "Doing anything?" is seen hurrying on his way. If he stops to talk it is of new plans, fall models now ready, distributors appointed, or contracts closed. The radio center of the whole world, bounded by Warren Street, Broadway, Fulton Street, and West Broadway, of which Park Place is the main thoroughfare, is fairly radiating radio activity. True to form this year, business started promptly after Labor Day.

And in our office, too, things have taken on a new aspect. Subscriptions are rolling in, renewals from old subscribers, book orders, and a flood of letters bearing ques-

tions answerable and otherwise. The roll of airplane motors, passing up and down over the Hudson River, on which the laboratory windows open, is neither distracting nor diverting. They are not heard, so deeply engrossing has the Magazine work become once more. The ZR1, flying low over our building, might have passed unnoticed if her radio signals had not caused interference.

I hope that you, too, are again feeling the call of the shop and laboratory, the urge to build, the desire to create—to do new things. Manufacturers, the torn between open alliance with the Experimenter and the B. C. L., have come to a fair understanding of that something about radio which puts it above amateur photography, home mechanics, and hammered brass, which brings us back to it more eagerly each fall. And this discovery accounts for the conviction of manufacturers that radio, in the laboratory or living room, has come to stay.

Do you want proof of their conviction? Most striking is a series of beautiful illustrations showing the use of radio in the home, each accompanied by a story of the possibilities of radio entertainment, which is appearing in the Saturday Evening Post, under the name of the National Carbon Company. This series, costing thousands of dollars, is really an advertisement of radio itself, and not of Eveready batteries, for you will search to find even the company name. To the man who knows how big things are done in a big way, this is definite recognition of the permanence of radio by which its future is assured.

More than that, it is assurance to the radio engineers who are giving their utmost, too often at great personal sacrifice, to the manufacturers, who are depending upon the years to come to bring returns on their technical organization and special manufacturing equipment, and the dealers or distributors, who are risking huge investments in quickly changing radio apparatus, that, after all, their pioneer work has laid a foundation on solid ground from which a great and useful industry will develop.

Next month, in response to many requests, we shall have an article on a Grimes circuit set, operating on an antenna and ground, equipped with three tubes, of which two are for the radio and audio amplifiers, and one for the detector. Practically all the Grimes circuit data has been on loop sets, probably because it is the best type for loop receiving, but it is equally efficient in a set correctly designed for an out-of-door or in-door antenna and ground.

M. B. SLEEPER,
Editor.

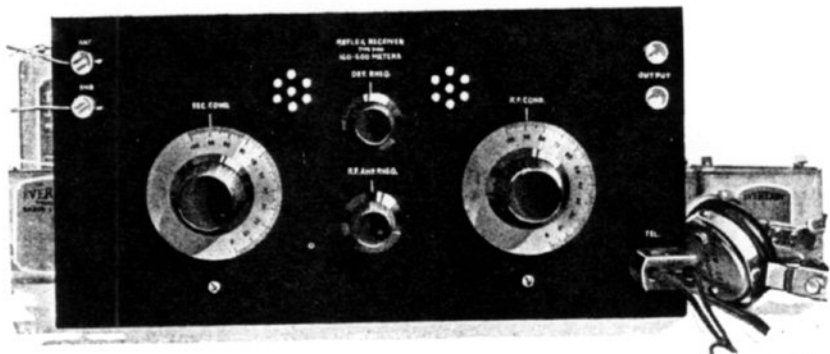

Atlas Art Studio

Tuned Radio Reflex Set

A 100% receiving set in which tuned radio frequency holds up the efficiency over the entire wavelength range, and makes the tuning sharper

MORE and more tuned radio frequency is coming into popularity. Up to the present time very little has been published on the subject, altho development work is in progress in several of the commercial laboratories. As a matter of fact, tuned radio frequency is not new, for, as is true of a number of things which are now being put to practical use, the theory is long known, but the useful application is recent.

The type
5100
Receiver

Originally, tuned R. F. amplification was applied to regenerative receivers. In addition to the fine tuning required for a set of that type, additional complications were introduced because the tuned amplifying transformers caused the amplifier tubes to oscillate. You know how hard it is to tune a set which is oscillating to a broadcasting station. With the original tuned R. F. amplifiers the tuning difficulties seemed to multiply with the square of the number of steps. Consequently, more than one step was not practical.

The more recent system of tuned R. F. amplification, disclosed here for the first time, employs transformers which do not cause the tubes to oscillate. For some reason it was assumed that the primary of such a transformer required such a large inductance as to make the tube oscillate. Recent experiments have shown conclusively that an efficient R. F. transformer can be made with a primary winding of only a few turns, so few that the circuit composed of the filament-plate capacity and the primary coil is non-resonant at the wavelengths on which the set is operated.

In the type 5100 receiver there is a fixed coupler for the antenna and secondary circuits, tuned by a 21-plate condenser. The secondary circuit is connected to a UV201-A tube which serves as an R. F. amplifier. In the lead to the filament is the secondary of an A. F. transformer, by means of which the A. F. current from the detector plate is lead back to the grid of the first tube. Consequently, the phones are inserted in the plate circuit of the first tube. In series with the phones is the primary of another fixed coupler, the secondary of which is also tuned by a 21-plate condenser, and lead across to the grid and filament of a UV200 detector. The detector plate, in which A. F. current flows, goes to the primary of the A. F. transformer and on to the B battery.

You will notice that provision is made for a C battery to put a small negative charge on the detector grid. The voltage may be $1\frac{1}{2}$ or 3. For this purpose an Eveready type 771 battery is recommended. It was found that this improved the speech quality and made the tuning a little sharper.

This set is referred to as Operates at Full Efficiency 100% for the reason that with the fixed coupler used as a tuned R. F. transformer, the set always works at maximum efficiency, while the untuned transformer is most efficient near the center of its curve, and is less efficient at wavelengths lower or higher. In other words, this type of set is as efficient as when the best R. F. transformer is used, operated at the transformer peak, and more efficient at higher or lower wavelengths.

Altho UV201-A and UV200 tubes give

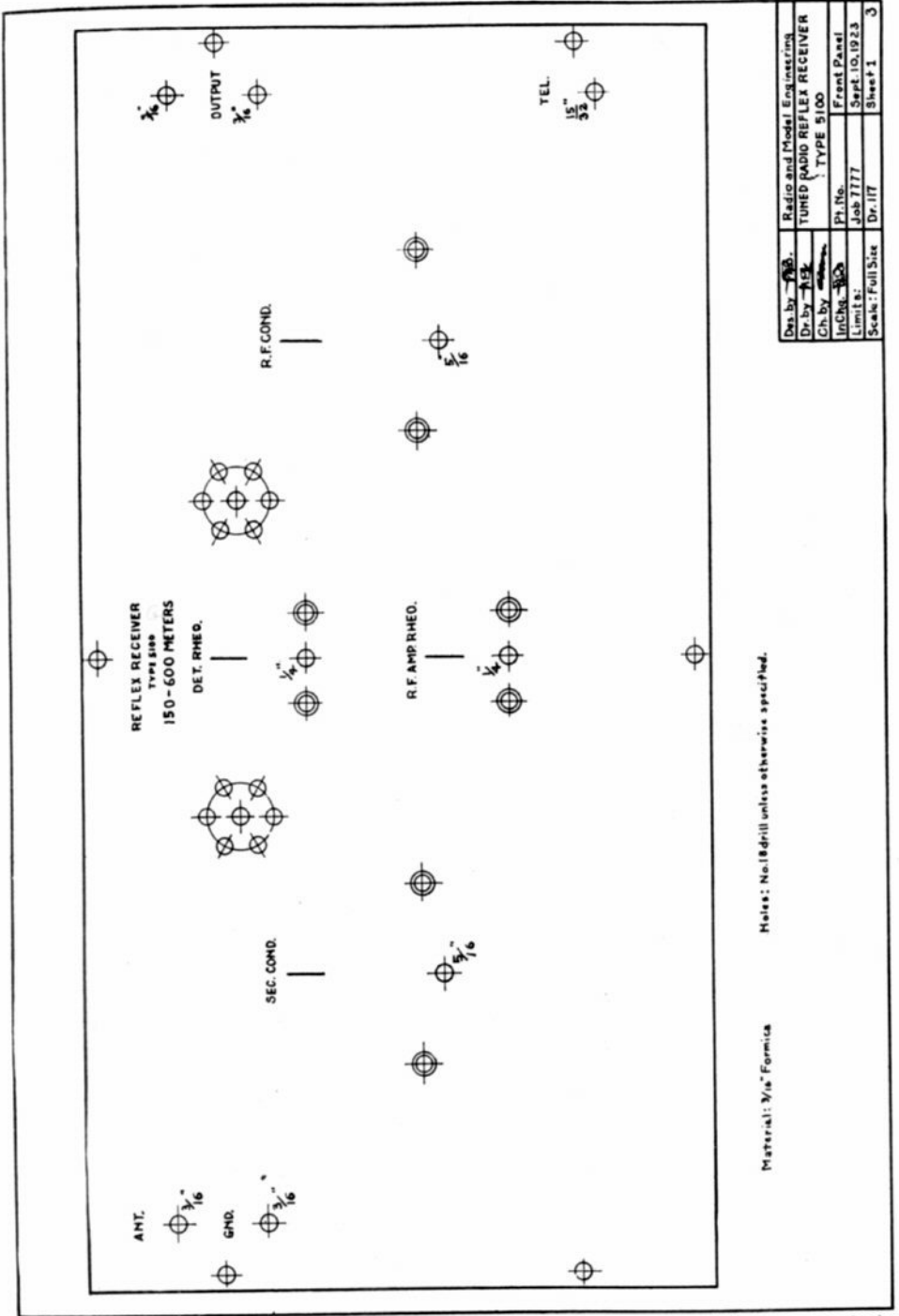

Des. by: W.B.	Radio and Model Engineering
Dr. by: W.B.	TUNED RADIO REFLEX RECEIVER
Ch. by: W.B.	TYPE 5100
Inst. No. W.B.	Pl. No.
Limit to: W.B.	Job 1777
Scale: Full Size	Dr. 177
	Sheet 1
	Sheet 3

Fig. 1. The front panel at one-half scale. Dimensions are not shown, as they are confusing to many Experimenters, but the distance to centers can be measured on the drawings and easily



Fig. 2. The perfect symmetry of this design makes this set particularly attractive in appearance. After all, a really successful set must look the part

Atlas Art Studio

the best results, any of the low current tubes can be employed with excellent results.

By altering some of the details, similar parts from reliable manufacturers can be substituted, altho results equal to those obtained in the original set cannot be definitely assured. The 8-ohm rheostats are the 153-A Fada type, the jack, a Pacent open circuit type 61. For the grid condenser, a Micadon of 0.0005 mfd. is used, provided with a leak by putting India drafting ink across the terminals.

The fixed couplers and A. F. transformer are of Sleeper Radio manufacture. Panels are, of course, of Formica, 3/16-in. thick and of standard dimensions, 7 by 14 and 7 by 10 ins. If you use UV201-A and UV200 tubes a storage battery is most satisfactory, but with two UV201-A's, two sets of four Eveready 6-in. dry cells, in parallel, gives a reliable current source, or with two UV199's two or three of the new Eveready 771 batteries, in parallel, are satisfactory and convenient.

For terminals, Eby Sergeant S. S. binding posts are shown, altho many Experimenters prefer the Ensign type, with the non-removable bakelite tops and bases.

In Figs. 1 and 4 there are one-half scale drawings of the front, base, and terminal panels. The latter is not of standard size, but it can be cut from a scrap piece of Formica. Before you do any work on your panels, test the edges and corners to make sure that they are straight and square. To locate the holes accurately, you must measure the distances on the drawings, double them, and lay them out on the panels with a combination square and scribe. It is important, therefore, to

have the edges true, for, otherwise, the square will not produce right angles.

Be sure to start each hole with a center punch mark, to prevent the drill from running off to one side. Clearance holes are indicated for the shafts, so that they will not bind.

Assembly and Wiring

In the picture wiring diagram, Fig. 5, the connections are numbered in the sequence in which they should be made.

As a matter of fact, this sequence was not followed in wiring the original set, for the steps could be planned only after it was finished. However, it is far easier to follow the step-by-step instructions than to proceed by the cut and try method. Most important of all, have every part ready for assembling before you start that work. Soldering lugs are indicated by heavy lines. You will save yourself much trouble if you put on the lugs on each part and have them pointing in the correct direction before you fasten in place.

1. Mount the binding posts on the front panel. Watch the holes in the binding posts so that you will have them properly directed.

2. Mount the rheostats on the front panel. The Fada knobs can be used, or they can be replaced by the indicating knobs shown, to match the dial knobs.

3. Connect 1 to 2. Use square tinned copper bus bar for the wiring, as it is easy to solder and gives an excellent appearance. Put on each joint just the tiniest bit of Nok-orode soldering paste. Have your iron well tinned and hot enough to make the solder flow smoothly.

4. Mount the sockets on the base panel.

5. Mount the A. F. transformer.

6. Connect 3 to 4.

7. Mount the binding posts on the terminal panel.

8. Fasten the terminal support pillars to the base panel with 1/2-in. 8-32 R. H.

Laying Out the Panels

screws, and use the same size screws to secure the terminal panel to the pillars.

9. Connect 5 to 6, 7 to 8, 9 to 10, 11 to 12, and 13 to 14.

10. Mount both fixed couplers. Check the positions of the terminals, and be sure that you have put on the extra lugs required.

11. Connect 15 to 16 and 17 to 18.

12. Mount the base panel to the front panel, using standard 1-in. right hand and left hand angle brackets with $\frac{3}{8}$ -in. 6-32 R. H. screws and nuts. Do not give the screws their final tightening.

13. Connect 19 to 20, 21 to 22, 23 to 24, 25 to 26, 27 to 28, and 29 to 30.

14. Mount the telephone jack, putting all three washers, furnished with the Patent type, at the front of the panel.

15. Connect 31 to 32, 33 to 34, 35 to 36, and 37 to 38.

16. Mount the R. F. condenser. You will have to force it in place, as there is not quite enough room until it is in position. Be sure that the lugs are on the terminals.

17. Connect 39 to 40, 41 to 42, 43 to 44, 45 to 46.

18. Mount the secondary condenser.

19. Connect 47 to 48, 49 to 50, and 51 to 52.

20. Tighten the screws holding the angle brackets to the front and rear panels.

This completes the assembly and wiring of the set.

Testing and Operating When you are ready to try out the set, connect the batteries, as shown in Fig. 4. Be sure to put on the A battery and test the filament circuit before you con-

nect the B batteries. With UV201-A and UV200 tubes, put 45 to 135 volts on the amplifier and 16 to 22½ volts on the detector. In case you use UV201-A's or UV199's for both tubes, experiment a little to see what detector voltage gives the best results. Binding posts are provided at the right hand end of the panel for telephones or a loud speaker, or either one can be plugged in at the jack. An A. F. amplifier can also be connected to the output posts if very loud signals are required. The antenna may be of one wire as long as is convenient, ranging from 35 to 300 ft. A good water pipe ground is needed.

Light the filaments to moderate brilliancy and tune in with the condensers, keeping them at about the same number of divisions on the dials. You will find that they follow along at practically the same settings. If there is a fairly even difference over the entire range, one dial can be moved back that many degrees, so that they will be exactly the same. The dials can be calibrated for various broadcasting stations, and this calibration will not change even though the antenna is altered. In fact, on a set of this type, you need not fear that your antenna will be too long. If you are not satisfied with the signal strength, increase the length of your antenna, but do not use more than one wire.

Experiments made with UV199 tubes show that, while they can be used with the 8-ohm rheostats specified, an audio frequency howl is liable to develop when a 4½-volt battery is used on the filaments. Consequently it is better to make up a 30-ohm resistance and put it permanently in

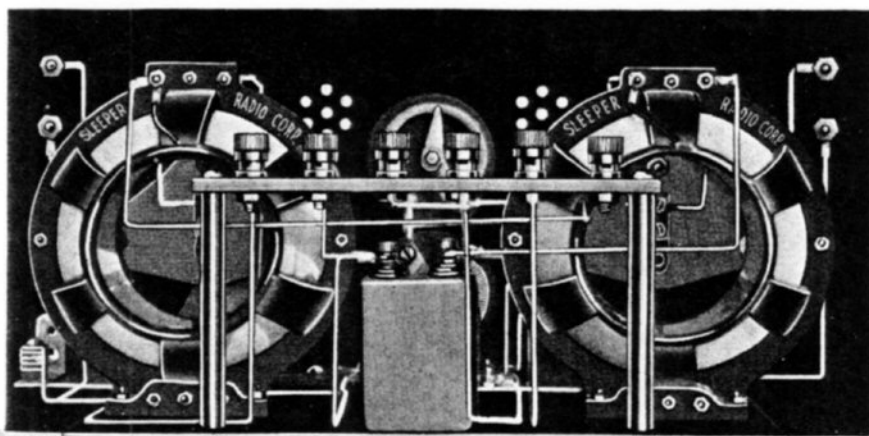

Atlas Art Studio

Fig. 3. The rear view shows the arrangement of the fixed coupler, the A. F. transformer, and the terminal panel. Raising the binding-posts in this way makes them easy to reach when the set is in the cabinet

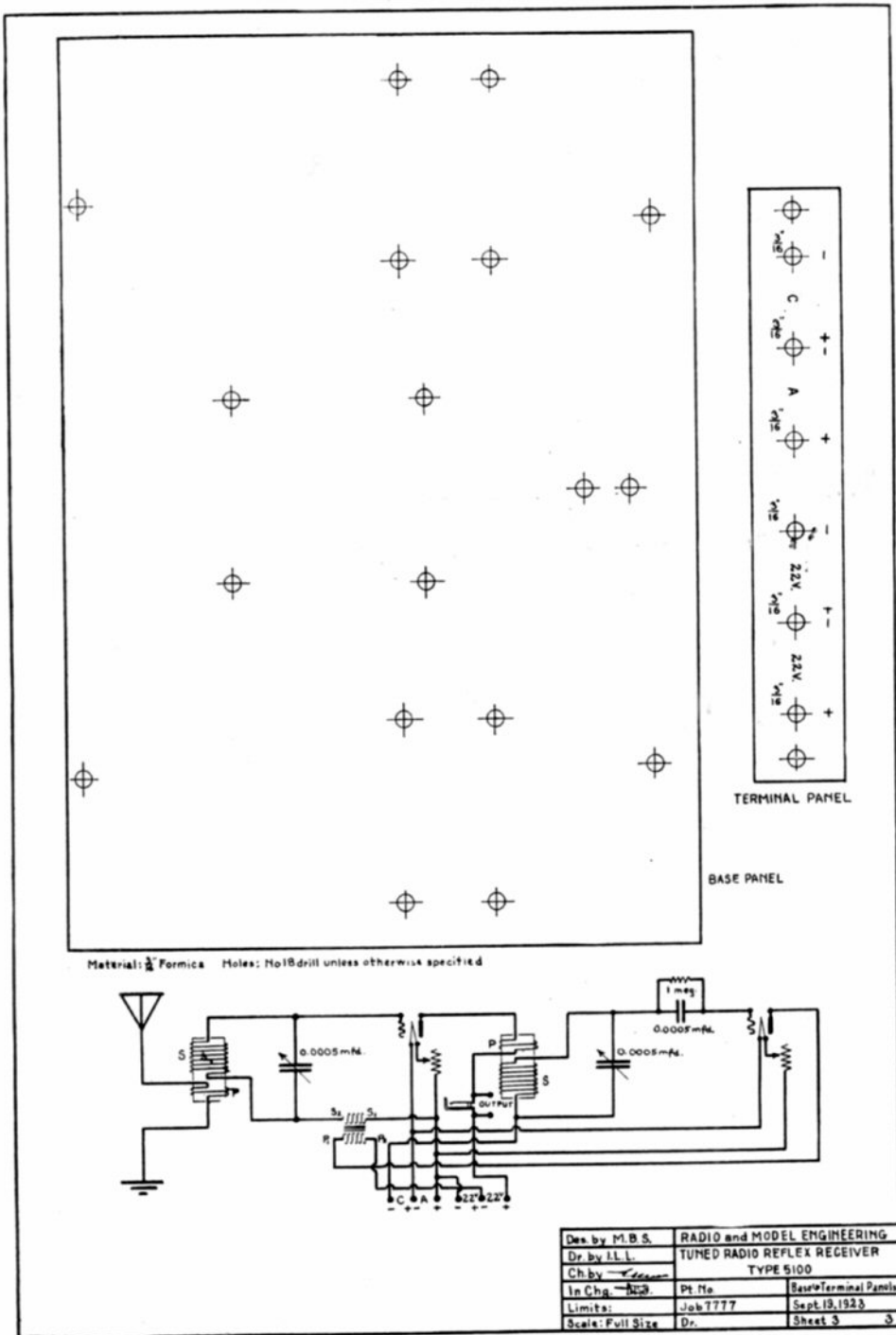
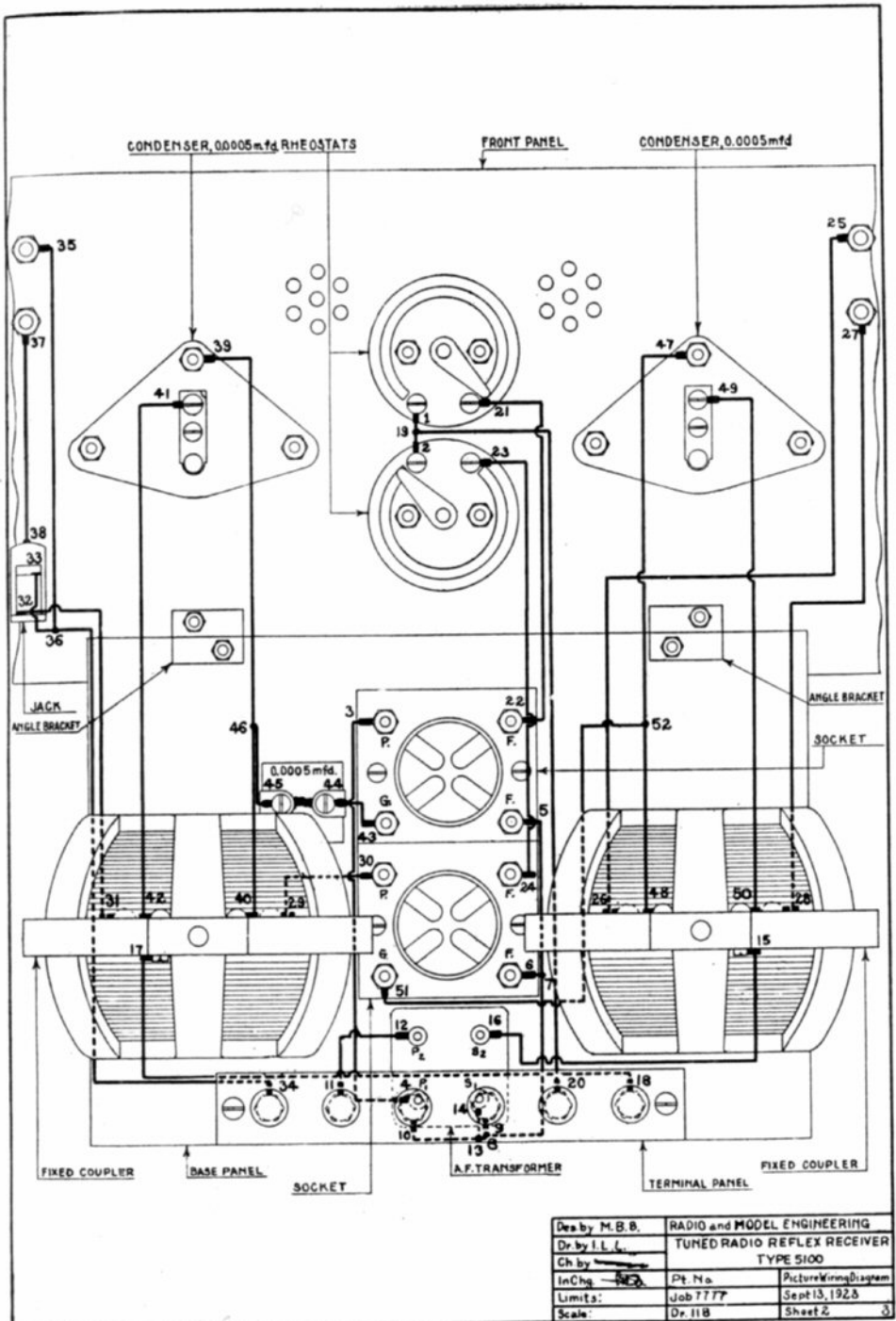

Fig. 4. Here are the the base and terminal panels at one-half scale. A schematic wiring diagram is also given to show the circuit system



Des by	M. B. B.	RADIO and MODEL ENGINEERING	
Dr. by	J. L. C.	TUNED RADIO REFLEX RECEIVER	
Ch. by		TYPE 5100	
In Chg.	W. C.	Pt. No.	Picture Wiring Diagram
Limits:	Job 7777	Sept 13, 1928	
Scale	Dr. 118	Sheet 2	

Fig. 5. This picture wiring diagram shows the connections as they were actually arranged. The base panel has been tipped down, but the terminal panel is in its natural position

one of the A battery leads, or to change to the type 156-A Fada rheostat, which has a resistance of 60 ohms. The former arrangement is preferable because it allows either type of tube to be used. If the 30-ohm resistance is made up with an adjustable contact collar, sufficiently close regulation can be obtained, for the UV199's are not critical.

Several sets of this type were built by Experimenters while the outfit shown here was being worked out in our laboratory. All reported exceedingly good results, particularly with regard to the quality of the

the type 3100 two-step amplifier.* The amplifier can be connected as a separate unit, or made right into the set by using a panel 24 ins. long.

Our laboratory model was so successful that one of our men took it home to use for entertainment. He put it in a cabinet 10½ ins. deep inside, with a vertical strip of wood 2 ins. wide nailed and glued 7 ins. from the front. In the remaining space, behind the strip, there is just room enough for two Eveready 771 batteries, used as A batteries for UV199 tubes, and two 763 batteries of 22½ volts each. This makes

Fig. 6. In this end view other construction details can be seen. There is just room for the variable condenser in front of the fixed coupler. Therefore, it is necessary to spring it in place, as the fixed coupler must be mounted first

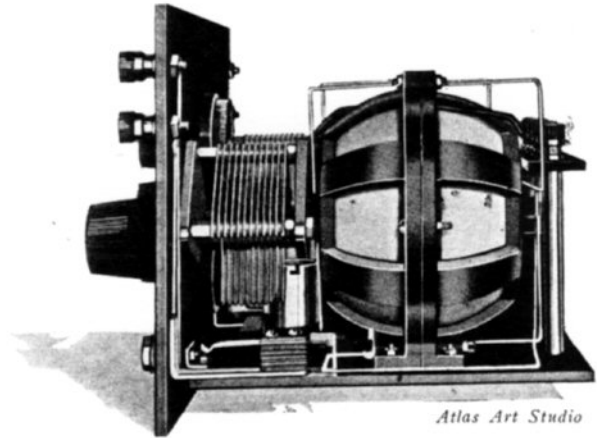

Atlas Art Studio

signals, with best volume when a UV201-A was used for the amplifier and a UV200 for the detector.

If you want louder signals than can be obtained from this set as it is, you can add

a most attractive receiving set, particularly as no leads are required except those to the telephones or loud speaker.

*Described in *Six Successful Radio Sets*, by M. B. Sleeper, Price 50c.

The following numbers of *Radio and Model Engineering* can still be supplied. The months and feature articles are listed below. Take this opportunity to complete your files. Price 11c each.

- | | | | |
|------------|---|----------------|---|
| June 1921, | Design of loose couplers. | Mar. 1923, | 150 to 700-meter regenerative set—Sleeper circuit set. |
| Oct. 1921, | Radio frequency amplifier. | Vol. 3, No. 3. | One-tube reflex using crystal detector—one-step tuned radio frequency amplifier for regenerative sets. |
| Dec. 1921, | Rectifier for short wave transmitter. | Vol. 3, No. 4. | Simplified Reinartz set, only two tuning controls—Use of the fixed coupler—Receiver with two-step radio frequency amplifier and detector. |
| May 1922, | Regenerative set with detector and 2-step. | Vol. 3, No. 5. | Special receiving set designed for the WT501 tube—Standard radio design practice, Part 1—The Duo-trol set. Design of radio filters. |
| Aug. 1922, | 2-step amplifier—Laboratory oscillator. | | |
| Oct. 1922, | Loop receiver—Wavelength inductance, capacity tables. | | |
| Nov. 1922, | 2-tube telegraph or telephone transmitter—Inductance tables. | | |
| Jan. 1923, | Non-regenerating receiving set with detector and 2-step amplifier—Super range receiver. | | |

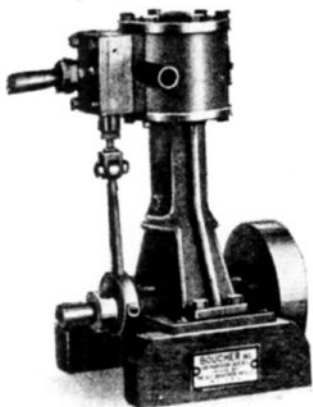

Double Acting Slide Valve Engine

A scale reproduction of a marine engine. It is suitable for operating small boats or mechanical devices, when run from steam or compressed air

GIVEN those who are not mechanically inclined find themselves fascinated by the put-put of a model steam engine, and unable to resist the temptation to turn the valve to make the engine speed up or slow down. While to those who are skillful with tools, and love to make things, that steady purr, particularly to the constructor, is most traducing music. His eyes shine, he turns the flame a little brighter under the boiler, and presses his finger on the fly wheel to test the power.

Until recently this privilege was only for those who could design their own engines, make the patterns and castings, and do the rather complicated machining and turning. This called for a fairly complete experimental shop, or made it necessary to have that work done in a regular, and very expensive, machine shop. This situation accounts for the delay in fulfilling the name Radio and Model Engineering. Now that machined parts are available for building engines, boats, and various scale models, however, we can proceed with model work, knowing that this hobby, so widely enjoyed in England, is at last open to everyone in America.

Description of the Engine The double acting slide valve engine illustrated here is of $\frac{3}{4}$ -in. bore and $\frac{5}{8}$ -in. stroke. Parts are available, however, for a smaller size, $\frac{5}{18}$ -in. bore and $\frac{1}{2}$ -in. stroke, and a larger type, 1-in. by $\frac{3}{4}$ -in. The same instructions are applicable to all three designs. They are designed to operate on steam or compressed air up to 100 pounds.

Fig. 1 shows the completed engine mounted on blocks for testing. Further details of the construction are disclosed in Fig. 2. Every feature of a heavy duty engine you will find in this miniature reproduction, with all parts carefully scaled as to size to produce a most realistic appearance. Altho a model engine, it is in no

way a toy, nor can it be compared with the flimsy tin and lead engines which have nothing to recommend them beyond their nickel finish.

If you are not familiar with steam engines you may be puzzled to hear this model described as "double acting". In a single acting engine steam is admitted above the piston so that it is forced down; then the momentum of the fly wheel carries it up again ready for the next downward impulse. The double acting type does not put as much reliance on the fly wheel for, when steam from above has pushed the piston down, steam is admitted from below to push it up again.

Parts and Materials Assembling the engine from machined castings is a simple matter, requiring only the use of the wrench supplied with the set of parts. All surfaces of the castings are finished where finish is needed, the cylinder and bearings ground, and the holes threaded. The little bolts, with their hexagonal heads, are just like those on big engines. Packing is provided for at seven points,—on the cylinder, the steam chest, the piston, and the valve and piston rod glands.

Bearing surfaces are so arranged that steel works against brass, thus providing long wear and minimum friction. The crankshaft is turned from a solid block of steel. While this is more expensive than if it were made in separate pieces, fastened together, the solid construction assures perfect and permanent alignment.

Assembly of the Engine Fig. 3 illustrates the four sections into which the engine can be separated for purpose of assembly. The assembly instructions must be followed carefully so that the parts will go together in proper sequence. This is important, particularly in tightening the nuts, for otherwise you

may not be able to get at them with the wrench.

1. The first section shown in Fig. 3, at the left, comprises the eccentric, fitted in the eccentric rod and held in place by two short brass bolts with hexagonal heads, the valve head and rod on which is carried the valve, held in place by the valve nut, and the steam chest into which the valve rod gland is screwed.

2. Fit the eccentric in the eccentric rod and tighten down the two brass bolts which hold the eccentric in place. It should turn without binding. Then secure the U-shaped valve head on the upper end of the eccentric, inserting the $\frac{3}{8}$ -in. bolt, which is threaded only at the end, for the bearing pin, and tighten on a nut. The head and eccentric rod should move freely on the pin. Put the short threaded rod in the valve head.

3. From the sheet of paper supplied make two gaskets to fit the steam chest. Cut out the inside, too.

4. Make a tiny ring of the valve packing supplied and put it carefully in the steam chest where the valve rod goes. Turn the packing gland a little way in and insert the valve rod. Tighten the gland until the valve rod moves slowly but smoothly.

5. Put the valve in the steam chest. You will see, when you do that, that it fits one way but not the other. In the horizontal slot in the valve put the valve nut, and screw the valve rod into the nut.

6. To test the fit, put one of the gaskets you cut out on a piece of glass, put the steam chest on the gasket, and see if, then, the valve bears smoothly on the glass. Lay these parts aside temporarily.

7. Screw the exhaust pipe into the cylinder, and set it aside.

8. The column carries a gland and packing to prevent the steam from escaping around the piston rod. Fit a ring of the rope packing in the gland, and turn the gland in part way. The column is ready then for later assembly.

9. Put the fly wheel on the short end of the crank shaft, with the counter weight opposite the connecting rod bearing.

10. Remove the cap from the connecting rod, fit it on the crankshaft, and replace the cap bolts. The marked side of the cap and of the connecting rod should be together.

11. Fit the cross head to the connecting rod, holding it in place with the larger smooth shank bolt, and securing the bolt with the large nut.

12. Thread the piston rod into the cross head. This completes the fourth unit.

13. You are now ready to assemble the separate units. Put the piston rod in the gland at the top of the column, and slide

the cross head in place. Secure the column to the base with four $\frac{1}{4}$ -in. bolts.

14. Put the piston on the piston rod, and clamp it with a nut. The piston should go up just high enough that it does not pass the top of the cylinder. This distance can be gauged by putting the cylinder on the column and turning the crankshaft to the up position. The top of the piston must be just below the top of the cylinder. Tighten the packing gland so as to give a snug fit on the piston rod.

15. Cut off a length of packing just long enough to fit in the groove around the

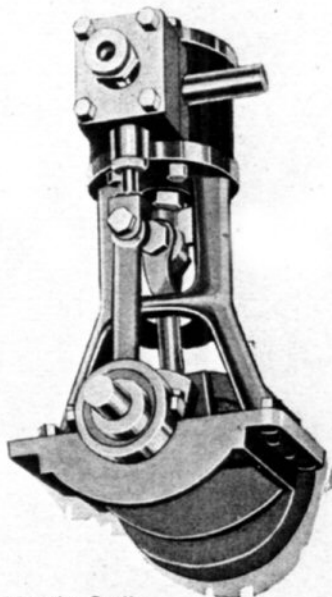

Atlas Art Studio

Fig. 2. A detailed view of the marine engine, showing the arrangement of the eccentric and valve

piston. Also cut out paper packing to go between the cylinder and column. Holding the piston packing in place, slide on the cylinder, put the packing on the column, and bolt the cylinder to the column with four short bolts.

16. Cut out packing to go between the cylinder head also. Bend the sheet iron jacket around the cylinder, and hold it until the cylinder head is bolted down. Be sure that it fits into the grooves in the cylinder head and in the column. The two bolts adjacent to the steam chest are short ones, as are also the two opposite. In the two remaining holes 1 $\frac{3}{16}$ -in. bolts are used, threading into the column.

17. Try the bearings now, to make sure that they run without excess friction. It is easier to remedy mistakes at this point than later on. There is bound to be a certain

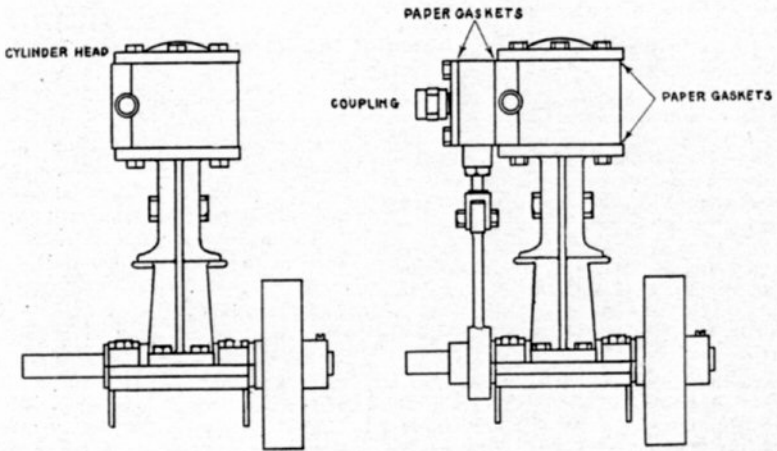
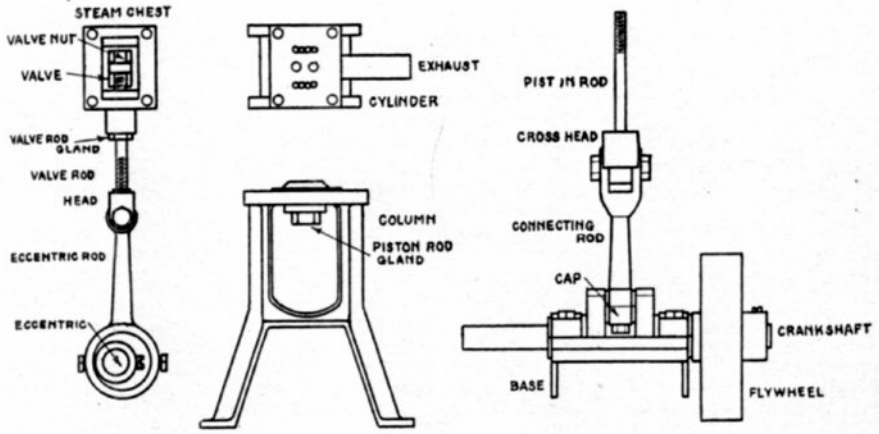

Des. by M.B.S.	RADIO and MODEL ENGINEERING	
Dr. by L.L.L.	DOUBLE ACTING SLIDE VALVE ENGINE	
Ch. by <i>W.M.</i>	TYPE D61	
In Chg. <i>W.M.</i>	Pt. No.	Assembly Steps
Limit: <i>W.M.</i>	Job 7777	Sept. 3, 1923
Scale: Full Size	Dr. 119	Sheet 1

Fig. 3. The four units into which the engine can be divided, above, and the partly and fully completed engine below

stiffness, but that will wear off with use.

18. Secure the eccentric to the shaft by means of the set screw provided. When the piston is in the up position the eccentric should be half-way up.

19. With the steam chest in place, see if the valve, when the eccentric is in the center position, is half-way between the holes in the face of the cylinder. If it is not, turn steam chest around, screwing the nut farther on or off the valve rod, until the valve is exactly between the holes.

20. Put the paper packing in place between the steam chest and cylinder, and the other packing between the steam chest cover and steam chest. Tighten down the cover with the bolts provided.

21. Test the valve for extra friction against the steam chest. If it is too tight, put on another paper packing, or, if too loose, use one of thinner paper. Be very careful about all the points at which packing is required, for efficiency is so easily

lost at these points just as is the case with a big engine.

22. Fit the pipe coupling on the steam chest cover. This completes the engine.

Use of
the D61
Engine

Complete details of boilers to operate this engine will be given later, as well as designs for boats which it can operate.

However, you may want to try it out first on compressed air, or run it from a valve on a steam radiator. This can be done easily by attaching to the coupling on the steam chest a short length of heavy-wall rubber tubing.

If you want to operate electrical or mechanical devices, it is advisable to use a round leather or spring belt. In that case, have a V-shaped groove cut around the fly wheel, to keep the belt in place. The power of this engine will surprise you, for it can do as much work as a large electric battery motor.

THE MODEL DEPARTMENT

Plans for model articles are being worked out for coming issues, covering the various phases of model engineering

MODEL construction is such a diversified field, and includes so many different branches of engineering that it is not an easy task to plan ahead for articles in R and M. Moreover, there is no model press in this country as there is in England, where several magazines, devoted exclusively to the subject, are published. Many books are available there but, unfortunately English design practice is so different from ours that their data helps us very little.

Consequently, our work in R and M is truly that of pioneers. To proceed in the most helpful manner, we have divided model building into four classes: Working models of engines, boilers, and fittings; model power and sailing boats; model railroads; and exhibition models. The last class may include any of the first three. Exhibition models may actually operate, or they may not.

Of these divisions, model railroads is so involved that we shall wait on this until a larger amount of space can be given to this department. We are most fortunate to have the cooperation of Mr. H. E. Boucher in the preparation of model articles. For years his factory, the only one of the kind

in the country, has been building scale reproductions of battleships, sailing craft, steamships, railroads, steam engines and boilers, public buildings, industrial plants, and all kinds of mechanical equipment.

The beauty of scale reproductions is the accuracy of details. Specific data adaptable to model work is extremely hard to obtain. With the assistance of Mr. Boucher, however, we can proceed with full confidence in correctness of the designs presented, while you may be sure that the articles will be the best that can be obtained for you.

The articles will be written around models actually constructed in the R and M laboratory, so that we can first experience and solve the problems which you would actually encounter too. This is very important in model building because of the large amount of hand work required which can be ruined by a single slip due to inadequate instructions. Some of the special features, such as painting and finishing, hull carving, and similar things will be treated separately, as they enter into the construction of many different models. Later on, the articles will appear in book form, similar to the reprint books on radio equipment.

Standardized Parts List

The materials used to make up the sets described in this issue were supplied by the following companies. The manufacturers whose names appear below will be glad to send you bulletins describing other products which they make. Please mention R & M when you write them.

PARTS FOR THE TYPE 5200 NEUTRODYNE

Type	Name	Price
	F. A. D. Andrea, Inc. 1581-S Jerome Ave., New York City	
163-A	3—Tuning units	\$22.50
153-A	1—8-ohm rheostat	1.00
164-A	2—Neutralizing condensers	2.50
	Dubilier Condenser & Radio Corp. A-48 W. 4th St., New York City	
601	2—0.0005 mfd. Micadons	.70
601	2—0.0025 mfd. Micadons	.80
	H. H. Eby Mfg. Co. X-701 Chestnut St., Philadelphia, Pa.	
55	8—Sergeant binding posts	1.60
	Pacnet Electric Co. A-22 Park Place, New York City	
61	1—Open circuit jack	.60
	Kurtz-Kash Co. Dayton, Ohio	
A-218	3—3 $\frac{3}{8}$ -in. tapered knobs and dials	3.60
A-212	1—2-in. tapered knob and dial	.60
	Sleeper Radio Corp. 88-F Park Place, New York City	
A-14	1—A. F. transformer	5.00
A-1-X	3—Audion sockets	2.40
	Miscellaneous Parts	
155	1—Formica panel 7 x 18 x $\frac{3}{8}$ in.	3.14
153	1—Formica panel 7 x 10 x $\frac{3}{8}$ in.	1.81
58	3—Pkg. 25 small tinned lugs	.60
47	8—2-ft. lengths square tinned bus bar	.40
185	1—Angle bracket, left hand	.10
22	1—Angle bracket, right hand	.10
72	1—Pkg. 10 $\frac{1}{2}$ -in. 8-32 R. H. polished nickeled screws	.14
141	1—Pkg. 10 $\frac{3}{8}$ -in. 6-32 R. H. polished nickeled screws	.12
188	1—Pkg. 10 $\frac{3}{4}$ -in. 6-32 R. H. polished nickeled screws	.14
131	2—Terminal panel supports, polished nickel	.60
49	2—Pkg. 10 6-32 nickeled nuts	.16

PARTS FOR THE TYPE 5100 TUNED RADIO REFLEX SET

	F. A. D. Andrea, Inc. 1581-S Jerome Ave., New York City	
153-A	2—8-ohm rheostats	2.00
	Dubilier Condenser X Radio Corp. A-48 W. 4th St., New York City	
601	1—0.0005 mfd. Micadon	.35

	H. H. Eby Mfg. Co. X-701 Chestnut St., Philadelphia, Pa.	
55	10—Sergeant binding posts	2.00

	Pacnet Electric Co. A-22 Park Place, New York City	
61	1—Open circuit jack	.60

	Kurtz-Kash Company Dayton, Ohio	
A-213	2—3-in. knobs and dials	1.50
A-88	2—Indicating knobs	.60

	Sleeper Radio Corp. 88-F Park Place, New York City	
A-209	2—Fixed couplers	8.00
A-14	1—A. F. transformer	5.00
A-1-X	2—Sockets	1.60
A-16	2—21-plate variable condensers	7.00

Miscellaneous Parts		
154	1—Formica panel, 7 x 14 x $\frac{3}{8}$ ins.	2.46
153	1—Formica panel, 7 x 10 x $\frac{3}{8}$ ins.	1.81
58	2—Pkg. 25 tinned soldering lugs	.40
47	6—2-ft. lengths square tinned bus bar	.30
185	1—Angle bracket, left hand	.10
22	1—Angle bracket, right hand	.10
72	1—Pkg. 10 $\frac{1}{2}$ -in. 8-32 R. H. polished nickeled screws	.14
141	1—Pkg. 10 $\frac{3}{8}$ -in. 6-32 R. H. polished nickeled screws	.12
188	1—Pkg. 10 $\frac{3}{4}$ -in. 6-32 R. H. polished nickeled screws	.14
131	2—Terminal panel supports, polished nickel	.60
49	2—Pkg. 10 6-32 nickeled nuts	.16

Auxiliary Equipment

	Stanley and Patterson West and Hubert Sts., New York City	
843	Deveau Gold Seal Phones, 2,200 ohms	6.00

	Pacnet Electric Co. A-22 Park Place, New York City	
40	Telephone plug	.50

	National Carbon Co. Long Island City, N. Y.	
767	45-volt variable B battery	5.00
6850	6-volt, 90-ampere-hour storage battery	18.00
771	4 $\frac{1}{2}$ -volt tapped battery	.70

	Radio Corporation of America	
UV-201	Amplifier tube, 6 volts, 1.2 ampere	6.50
UV201A	Amplifier tube, 6 volts, $\frac{1}{4}$ -ampere	6.50
WD-11	Detector-amplifier tube, 1 $\frac{1}{2}$ volts, $\frac{1}{4}$ ampere	6.50

Blue Prints

5100	Tuned radio reflex receiver, set of three full-size blue prints	.75
5200	Neutrodine receiver, set of four full size blue prints	1.00

Bound Volumes of Radio and Model Engineering

For the last three months we have been trying to get together complete files of Radio and Model Engineering. We've succeeded in assembling thirty-eight sets from April, 1922 to May, 1923. Because these volumes are so limited in number we have had them bound in full leather, embossed in gold in a style used for private libraries and book collections.

Each volume is numbered and will be inscribed to the purchaser and autographed by M. B. Sleeper, as a presentation copy. As an

aid in your radio work, and a record of radio apparatus design you will find this book very much worth having. There are 256 pages, with nearly 200 illustrations.

Orders for the bound volumes will be filled as received. Remittances which come in after the thirty-eight copies have been sold will be sent back by return mail. The price is five dollars.

Send your order to Radio and Model Engineering, A-88 Park Place, New York City.

Radio Design and Construction for Experimenters

By *M. B. SLEEPER*

THERE are a few books which every Experimenter always keeps within arm's reach in his laboratory, those which are not only interesting but continually useful.

Such a book is Radio Design and Construction. It is a construction of design information and construction data that makes you say when you see it—"Just the dope I want!"

The first part is devoted to coils, condensers and data for tuning circuits. There are no mathematical formulas, but simple tables from which you can determine the size of condenser and coil needed for tuning over any wave length range, how to take off taps at the proper points, how to tell the correct number of turns, the length, diameter and size of wire for a coil of a given inductance. There are six photographs showing each step in making banked windings.

You will find yourself referring to these chapters time after time, getting from them quickly and accurately the data you need. And the chapters on construction are particularly well chosen, too.

Complete construction data, picture wiring diagrams, half-size panel patterns and step-by-step instructions are given for a two-control, three-circuit regenerative set, tuning from 150 to 1,000 meters, of the type using two variometers and a fixed coupler; a three-tube Hazeltine Neutrodyne set for broadcast reception, designed with one reflex step of audio frequency amplification; and a two-tube tuned radio reflex set, for 200 to 600 meters, which can be operated with dry cell tubes of any type.

Add Radio Design and Construction to your radio library and you will find it most used of all your books.

**ASK YOUR LOCAL RADIO DEALER FOR THIS BOOK
AND ALSO GET FROM HIM A COPY OF REFLEX AND
RADIO FREQUENCY**

The Price of these books is 50c each. By mail 4c extra

M. B. SLEEPER, Inc.
TECHNICAL PUBLISHER
A-88 Park Place New York City

THINK OF DURRANT AS YOUR NEW YORK STOCK ROOM, FROM WHICH YOU CAN DRAW ON. ORDER THE SUPPLIES YOU NEED FOR YOUR WORK.

REMEMBER, IF YOU WANT YOUR STOCK CLERK TO FILL YOUR ORDERS ACCURATELY, THAT YOU MUST WRITE OUT YOUR ORDER CAREFULLY, GIVING TYPE NUMBERS, NAMES, AND PRICES.

REMEMBER THAT YOUR NEW YORK STOCK ROOM CARRIES ONLY SUPPLIES CALLED FOR IN THE STANDARD PARTS LISTS IN R & M. COILS ARE NOT WOUND, NOR ARE PANELS DRILLED OR ENGRAVED.

PRINT YOUR NAME AND ADDRESS CLEARLY. IF POSSIBLE, REMIT BY MONEY ORDER. AN EXCHANGE CHARGE OF TEN CENTS MUST BE ADDED TO OUT-OF-TOWN CHECKS. ADD TEN CENTS FOR INSURANCE.

Get-It-to-Me-Quickly Mail Service

And remember that DURRANT can send you your supplies more quickly than the manufacturer who makes them, for DURRANT carries in stock at all times the supplies called for in the Standard Parts Lists in Radio and Model Engineering.

D U R R A N T

AS NEAR AS YOUR MAIL BOX
A-36 EAST 49th STREET NEW YORK CITY

MINIATURE MARINE ENGINES

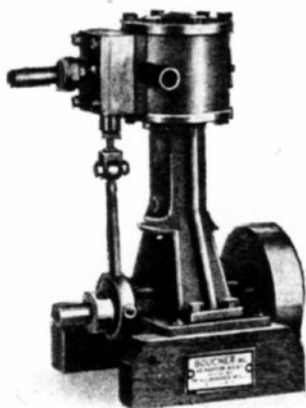

DOUBLE ACTING SLIDE VALVE MARINE ENGINE
Type D 61

Our construction sets of this engine can be made without a lathe. The type illustrated above is one of many of our miniature engines.

Not Toys—but Working Scale Models
'For the man or boy who loves to make things'

This type of engine is in general use in many branches of engineering. These models designed after the big ones with minor changes which are necessary—assure good working miniatures. Suitable for boats up to 42 inches long.

They will run at high speed on steam pressure up to 100 lbs.

SPECIFICATIONS

Engine Type No.	D-51	D-61	D-81
Bore	5/8"	3/4"	1"
Stroke	1/2"	5/8"	3/4"
Height above base	3/4"	3-9/16"	4 1/8"
Diameter of fly-wheel	1 1/2"	1 3/4"	2"
Width	2"	2 3/8"	2 3/4"
Length	2 3/8"	3"	3 1/4"
Weight	10 oz.	16 oz.	24 oz.
Price, complete, ready to run	\$28.00	\$30.00	\$34.00
Machine casting set	\$18.00	\$19.00	\$20.00

OTHER CONSTRUCTION SETS

of Power-Boats, Sail Boats, Hulls for Tugs, Liners—ready for you to make, or completed blue prints and instructions with all sets.

BOUCHER, Inc.

415 Madison Ave.

New York, N. Y.

SEND FOR FREE CATALOGUE

Radio and Model Engineering Library

These six books were written for the practical Experimenter who wants dependable information on the construction of sets incorporating the best commercial practice, yet so designed that they can be built of standard parts in the average Experimenter's kitchen table workshop.

No. 1. Design of Modern Radio Sets: Fourth Edition. Special features are the 150 to 2600-meter set and the long wave receiver. 20 Halftone illustrations, 12 scale drawings,.....Price 50c.

No. 2. Design of Modern Radio Sets: Describes the simpler types of equipment for beginners in radio construction. A particularly valuable chapter is that in laying out panels, 23 halftones, 15 drawings,.....Price 50c.

No. 3. 101 Receiving Circuits: Second edition. Circuits for every known type of radio set, with full description of their use and purpose. The newest hook-up book, showing 113 circuits,.....Price 50c.

No. 4. Six Successful Radio Sets: Showing the favorites of Experimenters, on which reports have been received from almost every country in the world. Full construction data, 25 halftones, 15 scale drawings,.....Price 50c.

No. 5. Reflex and Radio Frequency: The only book giving full data on the Grimes Inverse Duplex. Also describes reflex and radio frequency sets of latest types, 22 halftones, 19 scale drawings,.....Price 50c.

No. 6. Radio Design and Construction: Tables for the dimensions of coils and size of condensers for any wavelength. Construction of Neurodyne, Reflex, and other new sets, 12 halftones, 12 scale drawings,.....Price 50c.

IF YOUR DEALER CANNOT SUPPLY THESE BOOKS, ORDER BY MAIL, ADDING 4c FOR POSTAGE.

SPECIAL OFFER: ANY FIVE OF THESE BOOKS WILL BE SENT POSTPAID FOR \$2.00.

M. B. SLEEPER, INC., A-88 PARK PLACE, NEW YORK CITY

Now You Can Build Your Own HAZELTINE NEUTRODYNE Circuit Radio Receiver



The FADA set of special "Neutrodyne" parts pictured above and the 32 page book "How to Build Hazeltine Neutrodyne Circuit Radio Receivers" make this marvelous new receiver available for all.

The FADA-Hazeltine parts sell for \$25.00, including the book. The book alone is 50 cents.

It's the first authentic construction "dope" on neutrodyne sets. Your copy can be mailed immediately.

F. A. D. ANDREA, INC. 1581-S Jerome Ave., New York City

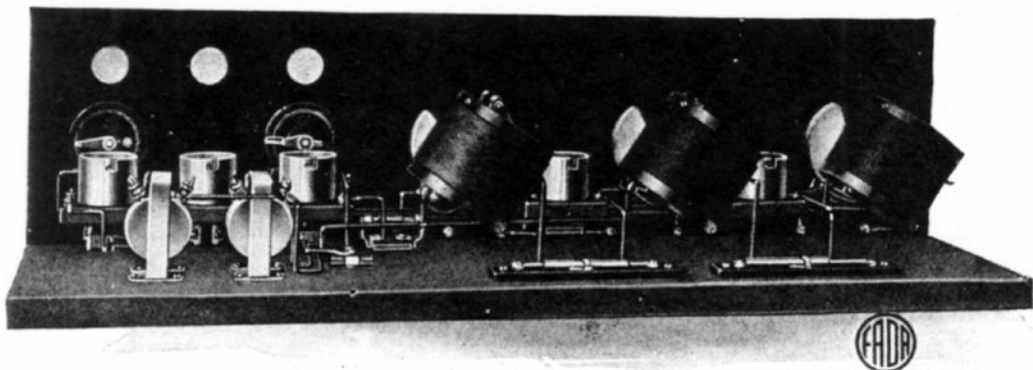

Showing the rear view of a five-tube Neutrodyne circuit radio receiver constructed according to information in the booklet "How to Build Hazeltine Neutrodyne Circuit Radio Receivers."

IF YOU ARE

- Building your own set
- Puzzled by some problems
- thinking of buying an outfit
- interested in radio adventures
- interested in radio personalities
- interested in good radio illustrations
- interested in radio news and developments —*then*

RADIO BROADCAST

is the magazine for you!



Radio Broadcast has gained 200,000 readers in a year. Every issue contains splendid photographic illustrations and drawings. There are articles for beginners, stories of adventure and the regular departments: "Progress of Radio in Foreign Lands", "New Equipment", "Questions and Answers" and many others.

Tear Off Along This Line.

SEND IN THIS COUPON NOW AND GET 5 ISSUES FOR \$1.00

Doubleday, Page & Co.
Garden City, N. Y.

Please send me the next five issues of RADIO BROADCAST for the special price of \$1.00, which I enclose.

Name

Address

(Regular Price—\$3.00 a Year)

EASILY SOLVED!

When Lefax RADIO HANDBOOK is your Guide

KEPT UP-TO-DATE BY
NEW PAGES SENT MONTHLY



Whatever problem confronts you—whatever question comes up in your mind—concerning Radio—you will always find the answer or the solution in the Lefax RADIO HANDBOOK—and the New Pages sent monthly. "My radio library contains over seventy volumes—almost everything published on radio during the past twelve years" wrote I. A. Warren, E. E., 1016 Ainslee St., Chicago, Ill., "and I have found your book the best, most useful, general all-round work so far."

THE ONE BEST BOOK ON RADIO

Lefax Radio Handbook written in every day language, is most complete and authoritative book on the subject. Is loose-leaf and kept up-to-date by 48 new pages each month. Imitation Morocco leather cover. For sale at all good radio dealers.

PRICE IN U. S. A. \$5.00

LEFAX, Inc. 149 S. 9th St., Phila., Pa.

Written by Dr. J. H. Dellinger, and Mr. L. E. Whittemore, the two chiefs of the U. S. Bureau of Standards radio Laboratory.

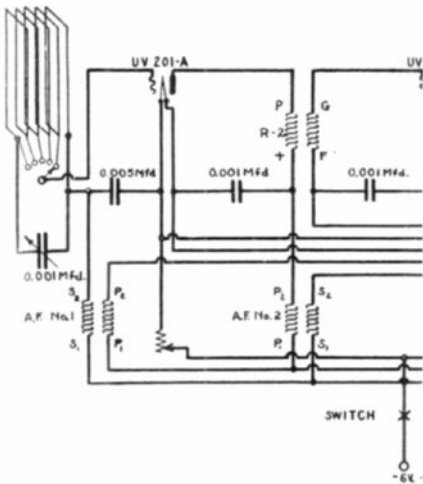

Specify the A-14 Sleeper Audio Transformer *Because—*

Altho the resonance curve of an audio frequency transformer is important, a transformer may have a perfect curve and yet be useless or worthless. The Sleeper transformer has a curve equal to any other type and is superior to any other in these features:

← It is smaller than any other shell type transformer. Consequently it lends itself to good mechanical design. It is easily mounted by two screws at the bottom of the case.

← It is the only moisture-proof transformer. The sealed bakelite case is strong, rugged, and exceptionally neat in appearance. The terminals, with their insulating bushings, are conveniently located for short connections.

← It is so shielded that, when two A-14 transformers are placed side by side, there is no inter-transformer howling. Such a combination of features is found in no other transformer.

SPECIFY the A-14—Price \$5.00

SLEEPER RADIO CORP.

88-F Park Place
New York City, N. Y.

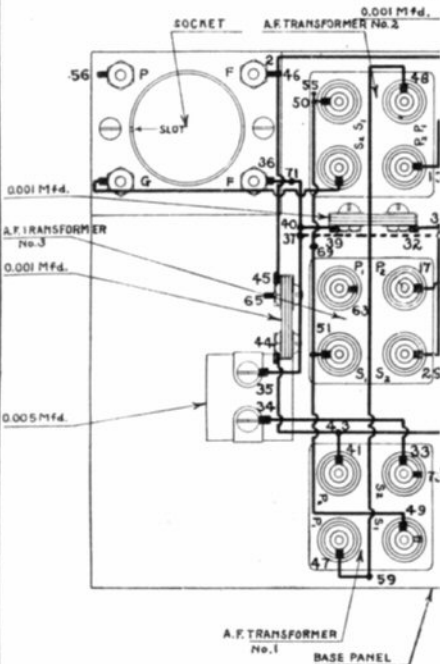

This Authoritative Information is Released by Permission of the Sleeper Radio Corporation, Licensed under the Grimes Inverse Duplex Inventions.

Des. by M. B. S.	RADIO and MODEL ENGINEERING	
Dr. by I. L. L.	4-TUBE GRIMES INVERSE DUPLEX	
Ch. by	TYPE 5000	
In Chg. → E. S.	Pt. No.	Picture Wiring
Limbs:	Job T177	July 26, 1923
Scale: 0.8"=1.0"	Dr. 109	Sheet 1 of 4

"The Best That Money Can Buy"



"Gold Seal" Head Sets

2200 Ohms

\$8.00

3200 Ohms

\$10.50

"DEVEAU GOLD SEAL" HEAD SETS are electrically and mechanically,—as well as from a radio standpoint,—as perfect as the highest-priced Head Set on the market,—yet, with all their perfection, they retail at only \$8.00 for 2200 Ohm and \$10.50 for 3200 Ohm.

The trade mark "DEVEAU" has stood for the highest quality in telephone apparatus for thirty years,—a guarantee that every known advantage in design and manufacturing has been taken into careful consideration.

Magnets are extra-heavy one-piece units; cups are of aluminum to keep down the weight but unlike other Head Sets, every exposed metal part of the set is finished in genuine 24-karat gold,—under a protective lacquer so that the finish will last for years; the terminals of each unit are concealed,—no contact possible with users' hands.

"DEVEAU GOLD SEAL" HEAD SETS are like a piece of fine jewelry in appearance, but with all the radio niceties that the most advanced radio enthusiast can desire. DEVEAU Units exactly match each other in tone,—each has maximum sensitivity and perfection of tone quality.

The patented design of headgear is far ahead of any Head Set on the market,—affording as it does, instant fitting to ears and head without "re-harnessing" and without binding or pressure,—the latter an admitted nuisance with all other makes of Head Sets.

Cups are of genuine Bakelite,—of scientific design, and comfortable to the ear; the bakelite never loses its jet-black lustre or highly polished surface.

"DEVEAU GOLD SEAL" HEAD SETS are never found in the cut-rate market,—they are only sold to Jobbers who appreciate their value.

"DEVEAU GOLD SEAL" HEAD SETS are guaranteed to be electrically and mechanically perfect,—our Guarantee protects every purchaser.

Order through your regular Jobber or write direct for the names of authorized Distributors throughout the country.

Send for descriptive Bulletin of Deveau Radio Apparatus and Micrometer Adjustable Air-Gap Radio Loud-Speakers.

STANLEY & PATTERSON

250 WEST STREET

Downtown Stores { 27 WARREN ST.
23 MURRAY ST.

NEW YORK, U. S. A.