

1993

Radio
Electronics

ELECTRONICS EXPERIMENTERS handbook™



SOLID-STATE
TESLA COIL

- Build A Simple FM Transmitter
- All About Voltage Doublers
- Build A Speaker Protector
- Color Bar Generator



● MAGNETIC FIELD METER

- Add Music On Hold To Virtually Any Telephone
- How To Get 120-Volt AC Power From 12 Volts DC
- Build An Electronic Compass
- Semiconductor Memory Technology
- New Audio Formats are Coming!
- Build An Electronic Fuse
- Experiments In Voice Recognition
- All About Cable TV's Infamous Bullet



● BUILD THE HYPER CLOCK

● KEEP TABS ON YOUR ELECTRICITY USAGE

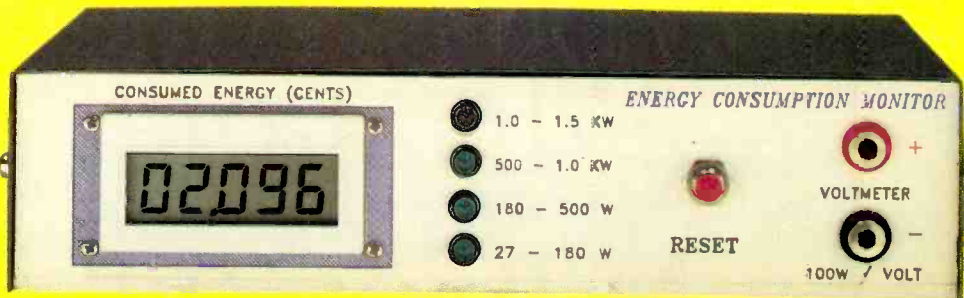

\$3.95 U.S.
\$4.50 CAN

48 HOUR SHIPPING

ELENCO & HITACHI & B+K PRODUCTS AT DISCOUNT PRICES

TO ORDER
CALL TOLL FREE
1-800-292-7711
1-800-445-3201 (Can.)

ELENCO OSCILLOSCOPES



S-1325 25MHz \$349
Dual Trace Oscilloscope

S-1340 40MHz \$495
Dual Trace Oscilloscope

S-1360 60MHz
Dual Trace, Delayed Sweep
\$775

- Automatic beam finder
- Built-in component tester
- 1mV sensitivity
- Dual time base

B+K OSCILLOSCOPES

2120 - 20MHz Dual Trace	\$395
2125 - 20MHz Delayed Sweep	\$539
1541B - 40MHz Dual Trace	\$749
2160 - 60MHz Dual Trace, Delayed Sweep, Dual Time Base	\$949
2190 - 100MHz Three Trace Dual Time Base, Delayed Sweep	\$1,395
2522 - 20MHz / 10MS/s Storage	\$869
1442 - 20MHz Portable	\$1,229
1443 - 40MHz Battery / AC operated with Cursor & Readouts	\$1,439

1.0GHz PORTABLE SPECTRUM ANALYZER

Model 2610 \$2,595.95

- AC/DC operation (battery included)
- 70dB dynamic range
- Resolution bandwidth of 10kHz
- 50Ω and 75Ω input impedance (switch selectable)
- Fixed bandwidth setting for viewing TV signals
- Field calibratable with internally generated 100MHz, 80dB signal

Hitachi Compact Series Scopes

V-212 - 20MHz Dual Trace	\$409
V-525 - 50MHz, Cursors	\$975
V-523 - 50MHz, Delayed Sweep	\$949
V-522 - 50MHz, DC Offset	\$849
V-422 - 40MHz, DC Offset	\$749
V-222 - 20MHz, DC Offset	\$625
V-660 - 60MHz, Dual Trace	\$1,095
V-665A - 60MHz, DT, w/cursor	\$1,325
V-1060 - 100MHz, Dual Trace	\$1,375
V-1065A - 100MHz, DT, w/cursor	\$1,649
V-1085 - 100MHz, QT, w/cursor	\$1,995
V-1100A - 100MHz, Quad Trace	\$2,195
V-1150 - 150MHz, Quad Trace	\$2,695

Hitachi RSO Series

RSO's feature; roll mode, averaging, save memory, smoothing, interpolation, pretriggering, cursor measurements.

VC-6023 - 20MHz, 20MS/s	\$1,650
VC-6024 - 50MHz, 20MS/s	\$1,950
VC-6025A - 50MHz, 20MS/s	\$2,350
VC-6045A - 100MHz, 40MS/s	Call
VC-6145 - 100MHz, 100MS/s	Call

Digital Capacitance Meter

CM-1550B

\$58.95

- 9 Ranges
- .1pf-20,000ufd
- 5% basic accy.
- Zero control w/ Case
- Big 1" Display



Digital LCR Meter

LC-1801

\$125

- Measures:
- Coils 1uH-200H
- Caps .1pf-200uf
- Res .01-20M



Big 1" Display

Multimeter with Capacitance & Transistor Tester

\$55 CM-1500B

- Reads Volts, Ohms
- Current, Capacitors,
- Transistors and
- Diodes / with case



FLUKE MULTIMETERS

(All Models Available Call)

Scopemeters		70 Series	
Model 93	\$1,095.00	Model 701I	\$65.00
Model 95	\$1,395.00	Model 771I	\$145.00
Model 97	\$1,695.00	Model 791I	\$169.00
10 Series		80 Series	
Model 10	\$62.95	Model 87	\$289.00
Model 12	\$79.95		

Quad Power Supply XP-580

\$69.95

- 2-20V @ 2A
- 12V @ 1A
- 5V @ 3A
- 5V @ .5A



Fully regulated and short circuit protected

Triple Power Supply XP-620

Assembled \$75

Kit \$50

- 2 to 15V @ 1A,
- 2 to -15V @ 1A
- (or 4 to 30V @ 1A)
- and 5V @ 3A



All the desired features for doing experiments.
Features short circuit protection, all supplies

AM/FM Transistor Radio Kit with Training Course

Model AM/FM 108

\$27.95

- 14 Transistors • 5 Diodes
- Makes a great school project

True RMS 4 1/2 Digit Multimeter M-700T

\$135

- 05% DC Accuracy
- 1% Resistance with Freq. Counter
- Data Hold



Sweep/Function Generator with Freq. Counter

\$259

Elenco Model GF-8026

- Sine, Square, Triangle, Pulse, Ramp
- .2 to 2MHz, Freq Counter .1-10MHz
- Internal Linear & Logic Sweep



Function Generator Blox

#9600

\$28.95

- Provides sine, triangle, square wave from 1Hz to 1MHz
- AM or FM capability

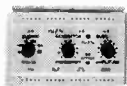

Kit

\$26.95

XK-500 Digital / Analog Trainer

A complete mini-lab for building, testing, prototyping analog and digital circuits Elenco's Digital/Analog Trainer is specially designed for school projects, with 5 built-in power supplies. Includes a function generator with continuously variable, sine, triangular, square wave forms. All power supplies are regulated and protected against shorts.

Power Supplies

- Variable Power Supply
- +1.25 to 20VDC @ 5 Amp (+1.25 to 15VDC @ 1 Amp)
- -1.25 to -20VDC @ 5 Amp (-1.25 to -15VDC @ 1 Amp)
- +12VDC @ 1 Amp
- -12VDC @ 1 Amp
- +5VDC @ 1 Amp
- 30VAC Center Tapped @ 15VAC at 1 Amp

Analog - Section

- Function Generator Sine, Triangular, Square wave forms
- Frequency adjustable in five ranges from 1 to 100KHz
- Fine frequency adjust
- Amplitude adjust
- DC offset
- Modulation FM-AM

Digital - Section

- Eight data switches
- Two no bounce logic switches
- 8 LED readouts TTL buffered
- Clock frequency 1 to 100KHz
- Clock amplitude 5VPP square wave

Breadboards

- 2 breadboards, each contain: 840 tie points (total 1,680)



\$159.95

Assembled

\$129.95 Kit

Learn to Build and Program Computers with this Kit

Includes: All Parts, Assembly and Lesson Manual

Model

MM-8000

\$129.00

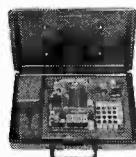

Starting from scratch you build a complete system. Our Micro-Master trainer teaches you to write into RAMs, ROMs and run a 8085 microprocessor, which uses similar machine language as IBM PC.

Elenco Wide Band Signal Generators



SG-9000 \$129

RF Freq 100K-450MHz AM Modulation of 1KHz Variable RF output

SG-9500 w/ Digital Display & 150 MHz built-in Counter \$249

WE WILL NOT BE UNDERSOLD

UPS SHIPPING: 48 STATES 5%

IL RES 7.5% TAX (\$3 min \$10 max)

PROBES INCL ALL SCOPES & METERS

C&S SALES INC.

1245 ROSEWOOD, DEERFIELD, IL 60015

FAX: 708-520-0085 • (708) 541-0710



15 DAY MONEY BACK GUARANTEE

FULL FACTORY WARRANTY

WRITE FOR FREE CATALOG

PRICES SUBJECT TO CHANGE

1993 **ELECTRONICS** **EXPERIMENTER'S** *handbook*

SPEAKER PROTECTOR

This simple circuit will protect your stereo speakers in the event of amplifier failure.

BY RICHARD H. BOBBELIT

It's a fact that most stereo systems have a built-in speaker protection circuit. However, if the amplifier fails, the speaker can be damaged. This simple circuit will protect your speakers in the event of amplifier failure.

The circuit is simple and easy to build. It consists of a diode, a resistor, and a capacitor. The diode is connected in series with the speaker. The resistor and capacitor are connected in parallel with the speaker. This circuit will protect the speaker from damage in the event of amplifier failure.

79

WILL "BEASTIE" SPEAKER CABLES IMPROVE YOUR AUDIO?

Are expensive speaker cables really worth the money? This article tells how we found out for sure!

BY RICHARD H. BOBBELIT

Speaker cables are an important part of any stereo system. However, many people believe that expensive speaker cables will improve their audio. This article tells how we found out for sure!

We tested several different types of speaker cables, including expensive "beastie" cables. The results were surprising. We found that the expensive cables did not improve the audio quality. In fact, they made it worse!

90

BUILD THIS THD ANALYZER

How good is your amplifier? Our inexpensive THD analyzer will let you know.

JOHN F. HAZEL

This simple circuit will measure the Total Harmonic Distortion (THD) of your amplifier. It is easy to build and use. The results will tell you how good your amplifier is.

The circuit consists of a diode, a resistor, and a capacitor. The diode is connected in series with the amplifier output. The resistor and capacitor are connected in parallel with the output. This circuit will measure the THD of the amplifier.

67

GREAT PROJECTS

- 35 SOLID STATE TESLA COIL
- 59 ENERGY CONSUMPTION MONITOR
- 73 SIMPLE FM TRANSMITTER
- 79 SPEAKER PROTECTOR
- 84 MUSIC ON HOLD
- 95 BUILD THE HYPER CLOCK
- 104 LINE POWER FROM 12 VOLTS
- 109 BUILD THIS MAGNETIC FIELD METER
- 115 BUILD AN ELECTRONIC COMPASS
- 123 RS-232 TERMINAL/MONITOR

TECHNOLOGY

- 4 FUEL CELLS
- 19 EXPERIMENTS IN VOICE RECOGNITION
- 42 SEMICONDUCTOR MEMORY
- 65 CABLE TV'S INFAMOUS BULLET
- 75 AUDIO FORMAT CONFUSION
- 90 WILL BEASTY CABLES IMPROVE YOUR AUDIO?
- 119 VOLTAGE DOUBLERS

TEST EQUIPMENT AND SERVICE

- 27 DIRECT DIGITAL SYNTHESIZER
- 51 COLOR BAR GENERATOR
- 107 HOT TROUBLESHOOTING TIPS
- 48 ELECTRONIC FUSE
- 67 THD ANALYZER

AND MUCH MORE

- 130 AD SALES OFFICES
- 130 ADVERTISING INDEX
- 2 EDITORIAL
- 98 FREE INFORMATION CARD

BUILD THIS MAGNETIC FIELD METER

Determine your exposure to low-frequency magnetic fields with our easy-to-build portable ELF gaussmeter.

HOWARD MITT

This simple circuit will measure the strength of low-frequency magnetic fields. It is easy to build and use. The results will tell you how much exposure you have to magnetic fields.

The circuit consists of a coil of wire and a sensitive meter. The coil is connected to the meter. This circuit will measure the strength of the magnetic field.

109

AUDIO FORMAT CONFUSION

Two new digital audio formats—Sony's Mini Disc and Philips' Digital Compact Cassette—promise to battle each other as they create consumer confusion.

BRUCE G. FORTIN

The audio industry is in a state of confusion. Two new digital audio formats are being introduced: Sony's Mini Disc and Philips' Digital Compact Cassette. These two formats are expected to battle each other as they create consumer confusion.

Both formats offer high-quality digital audio. However, they are not compatible with each other. This means that consumers will have to choose between the two formats.

75

DIGITAL SINEWAVE SYNTHESIZER

Build the direct digital synthesizer and generate low-distortion sine waves digitally.

BY PHILIP D. BOOP

This simple circuit will generate low-distortion sine waves digitally. It is easy to build and use. The results will tell you how good your synthesizer is.

The circuit consists of a microcontroller and a DAC. The microcontroller generates a digital sine wave. The DAC converts the digital signal to an analog signal. This circuit will generate a low-distortion sine wave.

27

EDITORIAL

Learning electronics can be fun!

Welcome to the 1992 edition of the Radio-Electronics Experimenters Handbook! In buying this issue, you've taken the first step in what could be a rewarding experience for the education you'll gain and the fun you'll have. We've picked our favorite stories that have appeared in Radio-Electronics Magazine over the last year or so. We've printing them here as 128 pages jam-packed with great projects and the latest technology.

We've done our part. Now it's up to you. Have you always been fascinated by high-voltage sparks? Then build our Tesla coil and learn how it works. Bothered by high electric utility bills? Then build our energy consumption monitor and keep track of how much individual appliances consume. Concerned about low-frequency magnetic radiation? Build our magnetic-field monitor and find out if you need to take action.

For the serious experimenter, we show how to build a direct digital sinewave synthesizer. Our THD analyzer lets you see just how good your audio equipment is.

For the technology buff, we look at Sony's Mini Disc and Philips' Digital Compact Cassette. We explain how fuel cells — perhaps the energy source of the future — work. And we see how cable TV fired their infamous "bullet."

So before you pop that videocassette into your VCR for another evening in front of the tube, think of what you might be missing. Building electronic projects is a lot of fun. And you'll learn something, too!

—THE EDITORS

1993 **ELECTRONICS EXPERIMENTER'S handbook**

Hugo Gernsback (1884-1967) founder

Larry Steckler, EHF, CET,
editor-in-chief and publisher

EDITORIAL DEPARTMENT

Brian C. Fenton, editor

Marc Spiwak, associate editor

Neil Sclater, assistant editor

Teri Scaduto, assistant editor

Jeffrey K. Holtzman
computer editor

Robert A. Young, assistant editor

Robert Grossblatt, circuits editor

Larry Klein, audio editor

David Lachenbruch
contributing editor

Don Lancaster
contributing editor

Kathy Terenzi, editorial assistant

Andre Duzant, technical illustrator

Injae Lee, assistant illustrator

PRODUCTION DEPARTMENT

Ruby M. Yee, production director

Karen Tucker, advertising production

Marcella Amoroso, production traffic

CIRCULATION DEPARTMENT

Jacqueline P. Cheeseboro,
circulation director

Wendy Alanko,
circulation analyst

Theresa Lombardo,
circulation assistant

Typography by Mates Graphics

Cover photo by Diversified Photo
Services

**Advertising Sales Offices listed
on page 130.**

**Gernsback Publications, Inc.,
500-B Bi-County Blvd., Farm-
ingdale, NY 11735. 516-293-3000**

As a service to readers, *Radio-Electronics Electronics Experimenter's Handbook* publishes available plans or information relating to newsworthy products, techniques and scientific and technological developments. Because of possible variances in the quality and condition of materials and workmanship used by readers, we disclaim any responsibility for the safe and proper functioning of reader-built projects based upon or from plans or information published in this magazine.

Since some of the equipment and circuitry described in *Radio-Electronics Electronics Experimenter's Handbook* may relate to or be covered by U.S. patents, we disclaim any liability for the infringement of such patents by the making, using, or selling of any such equipment or circuitry, and suggests that anyone interested in such projects consult a patent attorney.

Radio-Electronics Electronics Experimenter's Handbook is published annually by Gernsback Publications Inc. All rights reserved. Printed in U.S.A. Single copy price \$3.95, Canada \$4.50. Canadian GST Registration No. R125166280. ©Copyright Gernsback Publications Inc., 1992.



3765 \$29.95



2800P \$16.95 Softcover



9370-XX \$38.60 Counts as 2

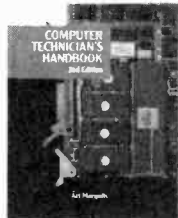

3279-XX \$36.95 Counts as 2



2883P \$18.95 Softcover



3107P \$18.95 Softcover

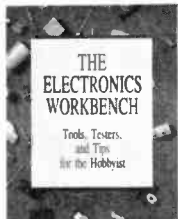

3672P \$18.95 Softcover



3671 \$29.95



2613P \$17.95 Softcover

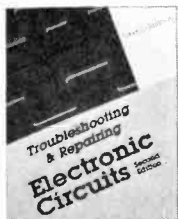

3258 \$28.95



2925P \$10.95 Softcover

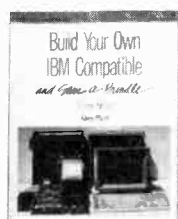

3804P \$19.95 Softcover

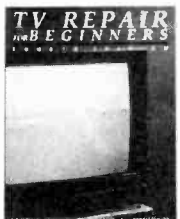

3627P \$19.95 Softcover

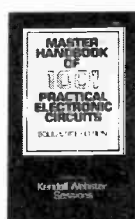

2980P \$19.95 Softcover

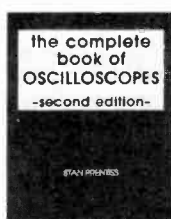

3825 \$26.95

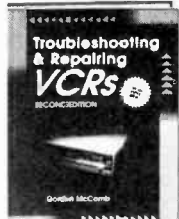

3777 XX \$32.95 Counts as 2

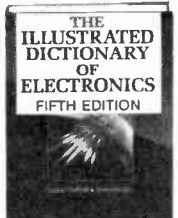

3345P \$26.95 Softcover



2867P \$18.95 Softcover

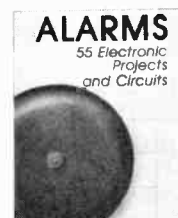

2996P \$14.95 Softcover

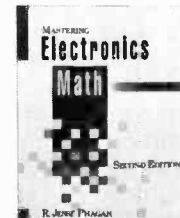

3589 \$27.95



3632P \$10.95 Softcover



3438-XX \$39.95 Counts as 2



1938-XXX \$60.00 Counts as 3

Select any 5 books

for only \$4.95

(values up to \$143.75)

when you join the Electronics Book ClubSM

As a member of the Electronics Book Club . . .

. . . you'll enjoy receiving Club bulletins every 3-4 weeks containing exciting offers on the latest books in the field at savings of up to 50% off of regular publishers' prices. If you want the Main Selection do nothing and it will be shipped automatically. If you want another book, or no book at all, simply return the reply form to us by the date specified. You'll have at least 10 days to decide. Your only obligation is to purchase 3 more books during the next 12 months, after which you may cancel your membership at any time.

(Publishers' Prices Shown) ©1992 EBC

Your most complete and comprehensive source for the finest electronics books

If coupon is missing, write to: Electronics Book Club, Blue Ridge Summit, PA 17294-0810

ELECTRONICS BOOK CLUBSM

Blue Ridge Summit, PA 17294-0810

YES! Please send me the books listed below, billing me for just \$4.95 plus shipping/handling & tax. Enroll me as a member of the **Electronics Book Club** according to the terms outlined in this ad. If not satisfied, I may return the books within 10 days without obligation and have my membership cancelled. A shipping/handling charge & tax will be added to all orders.

--	--	--	--	--	--	--	--	--	--

If you select a book that counts as 2 choices, write the book number in one box and XX in the next. If you select a Counts as 3 choice, write the book number in one box and XXX in the next 2 boxes.

Name _____

Address _____

City/State _____

Zip _____ Phone _____

Valid for new members only, subject to acceptance by EBC. Canada must remit in U.S. funds. Applicants outside the U.S. and Canada will receive special ordering instructions. All books are hardcover unless otherwise noted. FEX992



ELECTRICAL POWER SUBSYSTEM

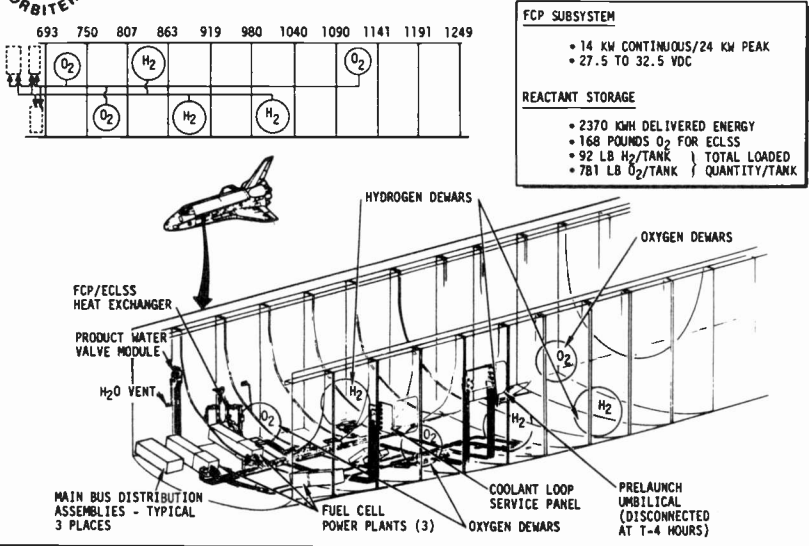

FUEL CELLS

Could fuel cells be the ideal energy source of tomorrow?

RALPH HUBSCHER

FUEL CELLS COULD POTENTIALLY BE the most efficient and environmentally clean source of power ever developed. Fuel cells are an attractive alternative to conventional power generation because they are highly efficient, and produce drinking water as an added by-product. What more could you ask for in an energy source? The principle of fuel cell operation was discovered by Sir William Grove in 1839. He found that electricity could be generated by supplying hydrogen and oxygen to two separate electrodes immersed in sulfuric acid. For more than a century, however, fuel cells remained a mere curiosity.

The theory of fuel cell operation defied commercial applications for so long because of technical and financial obstacles. It wasn't until the 1960's, during the growth of the space program, that there was a renewed interest in developing fuel cell technology into a viable energy alternative to standard power generation.

There are two important concerns in conventional power generation: efficiency and pollution. Most of the power in the world is generated from heat engines using the heat from combustion of fossil fuels. Mechanical systems involve many energy conversion steps, and their efficiencies are limited by the laws of thermodynamics. That results in considerable power losses.

converts potential chemical energy of fuel into electricity. It operates at a constant-temperature during the electrochemical process, therefore it's efficiency is not limited by thermodynamic laws governing heat engines.

Pollution is a result of combustion, industrial processing, and vehicle exhaust. Those pollutants consist of unburned fuel, partially burned fuel, carbon, carbon monoxide, carbon dioxide, dust, sulfur dioxide, nitrous oxides and so on. Waste heat from power plants warms up the rivers, causing havoc to the natural balance of fish and wildlife. And we all know of the devastating effects of acid rain, which results from man-made emissions of sulfur and nitrogen in the air. The by-product of a fuel-cell reaction, however, is water. Who would object to that?

Fuel-cell chemistry

Fuel cells operate by converting the potential energy of certain chemical reactions directly into electrical current in a flameless, catalyzed reaction. Some types of fuel cells work very well at room temperature.

A basic fuel cell consists of an anode (+) and cathode (-) separated by a conducting electrolyte such as a solution of potassium hydroxide. A fuel, such as hydrogen gas, or hydrazine, is introduced to the negative electrode

WARNING! This article deals with and involves subject matter and the use of materials and substances that may be hazardous to health and life. Do not attempt to implement or use the information contained in this article unless you are experienced and skilled with respect to such subject matter, materials and substances. Neither the publisher nor the author make any representations as to the accuracy of the information contained herein and disclaim any liability for damages or injuries, whether caused by or resulting from inaccuracies of the information, misinterpretations of the directions, misapplication of the information or otherwise.

where it is oxidized, releasing electrons to the load. Oxidation is the process of removing one or more electrons from an ion or molecule. In fuel cells, hydrogen ions are formed at the electrode by electrochemical oxidation of the fuel. If the fuel is hydrogen, hydrogen ions are created by the following ionization reaction:

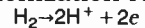

Oxygen, air, or hydrogen peroxide (a source of oxygen) is fed to the cathode, where it is reduced, whereby the O₂ oxygen molecule splits apart. Ionic conduction completes the circuit through the electrolyte. Hydrogen and oxygen react to form water, as this chemical equation shows:

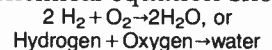

If hydrazine is oxidized, additional nitrogen is formed which is a normal constituent of air, and also safe:

GET THE LATEST ADVANCES IN ELECTRONICS

WITH A SUBSCRIPTION TO

Electronics

Radio Combined with
Electronics[®]

NOW

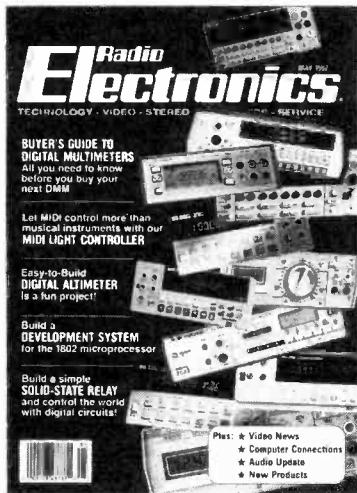
[®]

Electronics Now gives you exciting articles like:

- Buyer's Guide to Digital Oscilloscopes
- Build A Scanner Converter
- Single-Chip Voice Recorder
- Build A MIDI Interface for your PC
- Troubleshoot Microprocessor Circuits
- Build A High-Power Amplifier for your Car
- Add Music On Hold to your Phone
- All About Binaural Recording
- VGA-to-NTSC Converter

ENJOY THE WORLD OF ELECTRONICS EACH MONTH!

Subscribe to the best electronics magazine—the one that brings you the latest high-tech construction projects, feature articles on new technology, practical troubleshooting techniques, circuit design fundamentals, and much more.

Electronics Now looks to the future and shows you what new video, audio and computer products are on the horizon. What's more you'll find helpful, monthly departments such as Video News, Equipment Reports, Hardware Hacker, Audio Update, Drawing Board, Computer Connections, New Products, and more. All designed to give you instruction, tips, and fun.



FOR FASTER SERVICE CALL TODAY

1-800-999-7139

DON'T DELAY SUBSCRIBE TODAY!

Just fill out the order card in this magazine and mail it in today.

5XP37

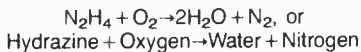

You may be tempted to say that if hydrogen is such a "clean" fuel, we can just burn hydrogen in air and get pure water as the combustion product plus power. Burning hydrogen would indeed be a considerable improvement over burning coal, oil, or gasoline. However, when air is burned, a large amount of nitrogen is drawn into the combustion chamber and heated to roughly 1000°C. At that temperature, it partially reacts with oxygen and forms oxides of nitrogen. So, even though the reaction product of the main reaction is pure drinking water, the side reaction spoils it all by making the resulting water unsuitable to drink. If hydrogen and oxygen react in a fuel cell at room temperature, that problem is eliminated.

Space-age power

The desirable characteristics of fuel cells led to the development of various systems ranging in size from 5-watt portable units, to the kilowatt (kW) power level for military applications, on up to large stationary plants delivering megawatts of power. The lower-power fuel cells were designed primarily for the space program and front-line military use where ease of operation, low maintenance, and low noise are important.

Fuel cells are used solely for power generation of space crafts because of one chief advantage: when power is required for more than a few hours, the battery weight per kilowatt-hour as a function of its operational life is far superior to that of conventional battery cells. A relatively light-weight fuel cell can have a lifespan of five to ten times that of a primary battery.

Fuel cells built between 1960 and 1970 for the Gemini and Apollo space missions and in 1980 for the Space Shuttle Orbiter are among the most successful fuel cells to date. They were needed because of their chief advantages over batteries—weight and lifespan. Those fuel cells used cryogenic reactants of hydrogen and oxygen.

Some space-craft power generation systems use solid polymer

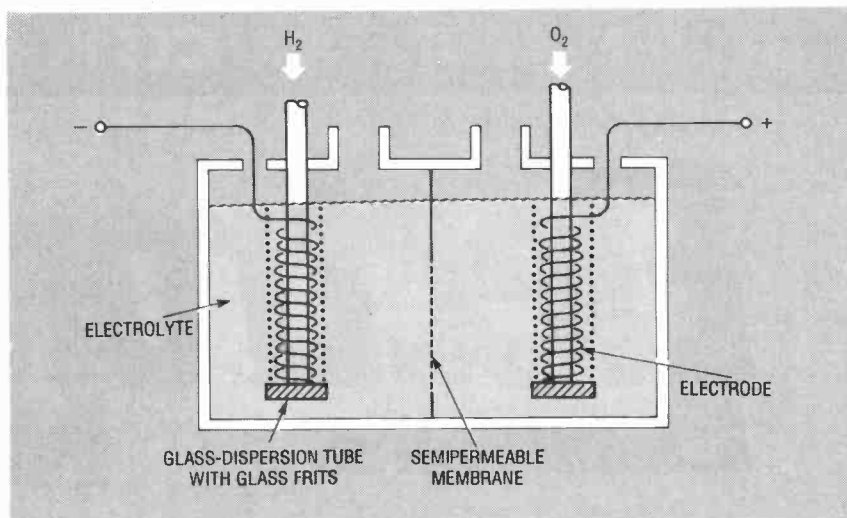

FIG. 1—THE AUTHOR'S FUEL CELL uses two adjoining chambers separated by a semipermeable membrane. The chambers are filled with an electrolyte. Hydrogen is directed to one electrode, oxygen to the other.

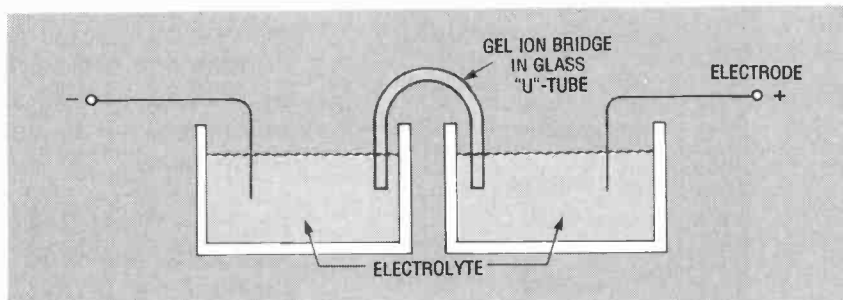

FIG. 2—IONS TRAVEL ALONG a gel-on bridge in a glass tube placed in the electrolyte solution.

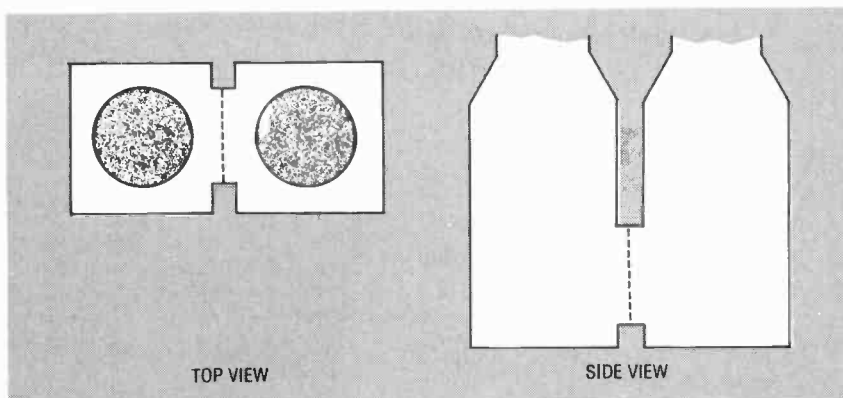

FIG. 3—THE CONTAINER used for the fuel cell consists of square-based 250-ml polyethylene bottles with holes cut in their sides. A round piece of fine glass was cemented in with sealing wax and an additional layer of beeswax.

electrolyte (SPE) technology in the construction of their fuel cells. That type of fuel-cell assembly consists of an ion-exchange membrane-electrode system with gas distribution, current collection, heat removal, and water management. Many of those assemblies are bolted together between end plates to form an SPE stack assembly.

The Gemini system used three 1-kW SPE fuel-cell stacks. The Apollo system used a larger 1.5-kW fuel-cell stack based on a concentrated 45% potassium-hydroxide electrolyte. The Apollo power plant was designed to operate for over 400 hours. The fuel cell in Apollo 8 lasted for 440 hours, the system produced 292 kWh of power, and 100 liters of water.

Your choice for only \$9.95

when you join the Electronics Engineers' Book Club

Your source for . . .

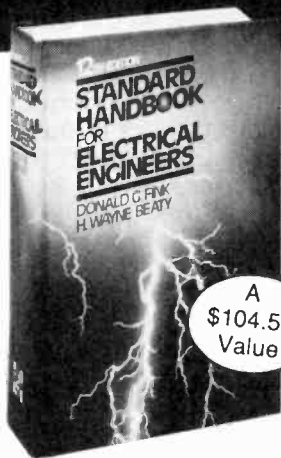

A
\$104.50
Value

STANDARD HANDBOOK FOR ELECTRICAL ENGINEERS, 12th Ed.

Edited by Donald G. Fink and H. Wayne Beaty

- the essential on-the-job reference for Electrical Engineers
 - latest information on rapidly changing areas such as nuclear power and high-voltage transmission systems
 - all the essentials including circuits, telecommunications, power distribution and electrical standards
 - Written and compiled by 115 recognized experts
- 2,248 pp., 1,863 illus. and tables
Order #020975

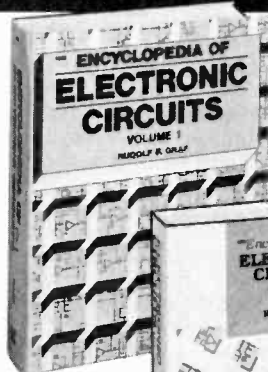

A
\$120.00
Value

THE ENCYCLOPEDIA OF ELECTRONIC CIRCUITS —Volumes 1 & 2

by R.F. Graf

These comprehensive sourcebooks put over 1,900 of the latest and most useful circuit designs at your fingertips. The format, generously illustrated and cross-referenced, is organized for quick access to 108 distinct categories.

Volume 1—768 pp., 1762 illus.

Volume 2—744 pp., 728 illus.

Order #585785

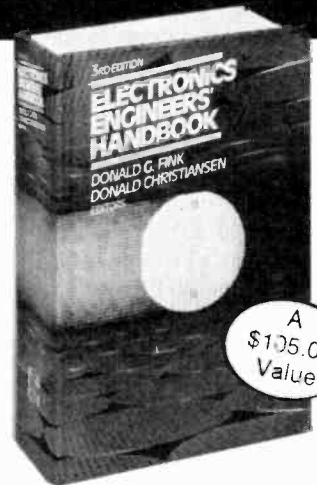

A
\$105.00
Value

ELECTRONICS ENGINEERS' HANDBOOK, 3rd Ed.

by Donald G. Fink and Donald Christiansen

This fully revised and updated edition of the standard desktop reference shows you how to use the latest design and cost-cutting solutions at work in the industry today. You'll find a wealth of new material on electronic systems design, computer systems and digital recording, telecommunications, process control, laser technology, and CAD of electronic circuits.

2,258 pp., 1,800 illus.

Order #9255H

As a member of the Electronics Engineers' Book Club . . .

. . . you'll enjoy receiving Club bulletins every 3-4 weeks containing exciting offers on the latest books in the field at savings of up to 50% off of regular publishers' prices. If you want the Main Selection do nothing and it will be shipped automatically. If you want another book, or no book at all, simply return the reply form to us by the date specified. You'll have at least 10 days to decide. Your only obligation is to purchase 3 more books during the next 2 years, after which you may cancel your membership at any time.

A shipping/handling charge and sales tax will be added to all orders. All books are hardcover. (Publishers' Prices Shown) ©1992 EEBC

If coupon is missing, write to:

Electronics Engineers' Book Club, Blue Ridge Summit, PA 17294-0860

ELECTRONICS ENGINEERS' BOOK CLUB

Blue Ridge Summit, PA 17294-0860

YES! Please rush me the book(s) indicated below for just \$9.95 plus shipping/handling & tax. Enroll me as a member according to the terms outlined in this ad. If not satisfied, I may return the book(s) within ten days without obligation. A shipping/handling charge and sales tax will be added to all orders.

- Standard Handbook for Electrical Engineers, 12th Ed. #020975
- Encyclopedia of Electronic Circuits, Volumes 1 & 2 #585785
- Electronics Engineers' Handbook, 3rd Ed. #9255

Name _____

Address _____

City/State _____

Zip _____

Phone _____

Valid for new members only, subject to acceptance by EEBC. Canada must remit in U.S. funds. Applicants outside the U.S. and Canada will receive special ordering instructions.

RPIFX992

The Space Shuttle system was more advanced in design than either the Gemini or Apollo fuel cells. The Space Shuttle fuel cells are 20 kilograms lighter and deliver six to eight times as much power. Each fuel cell power plant consists of a power section where the chemical reaction occurs, and a compact accessory section connected to the power section, which controls and monitors the power section's performance. The three fuel-cell power plants are coupled to the hydrogen and oxygen reactant subsystem and the power distribution subsystem. The fuel cells generate heat and water as by-products of electrical power generation. The excess heat is directed to Freon coolant loops, and the water to a potable water storage subsystem.

Some power specifications of each fuel-cell power plant are:

- 2 kilowatts at 32.5 VDC.
- 12 kilowatts at 27.5 VDC.
- 7 kilowatts continuous power.
- 12 kilowatts peak.
- All three fuel cell power plants are capable of supplying a maximum continuous output of 21,000 watts with 15 minute peaks of 36,000 watts.

Some experimental fuel cells have been considered for use with vehicles. The major prohibiting factor in their use is the difficulty in reliably containing hydrogen gas, and the possibility of an explosion. Also, special fuels such as hydrogen, methanol, and hydrazine are more expensive than hydrocarbon fuels.

Many advanced fuel-cell designs have been developed for power utility applications, but because of the typical problems of fuel storage and cost effectiveness, they have not been widely used.

An experimental fuel cell

The author was able to build a successful experimental fuel cell by the technique described below. We must, however, issue this word of caution: This product should *NOT* be built or experimented with in any way except under the direct supervision of someone who is highly qualified in the fields of chemistry or chemical engineering. Some chemicals and gaseous by-products in a fuel cell could be toxic and/or explosive! All dangerous

CHEMICALS USED IN FUEL CELLS

- **Hydrogen**—A colorless and odorless gas which is sold compressed in steel bottles. Small lab-size bottles are available together with simple low-priced reducing valves. Hydrogen is not poisonous, but extremely flammable and forms explosive mixtures with air.
- **Oxygen**—Also is sold in compressed form in lab-sized bottles. It is not toxic but must be kept from fire or flame since it will support combustion and can make a four alarm fire out of a glowing match.
- **Hydrazine**—Anyone not used to working with dangerous chemicals should not handle this compound. It is carcinogenic and should be dispensed in a hood only. Hydrazine should be handled with rubber gloves.
- **Hydrogen peroxide 30%**—Most everyone knows this chemical as a 3% solution for bleaching or wound treatment. The 30% concentration will bleach the skin and is dangerous when swallowed. Handle with rubber gloves.
- **Sulfuric acid**—It is poisonous when swallowed. It can blind you if splashed in the eye. It will burn holes in your clothes. A solution in water should be prepared by slowly pouring small amounts into plenty of cold water while stirring with a glass rod. Handle with rubber gloves.
- **Potassium hydroxide solution 30%**—Potassium hydroxide is a strong base and is poisonous. 300 grams are dissolved in 900 milliliters of cold water. Let it stand and cool off. Store in a plastic bottle with cap. Handle with gloves, it can damage the skin.
- **Palladium dichloride**—Dark brown crystals soluble in water. Moderately poisonous when swallowed. Dissolve 2 grams in 100 milliliters of water.

chemicals are listed in the sidebar. You must be familiar with proper handling and disposal of any chemicals used.

The author's experimental fuel cell uses two adjoining chambers separated by a membrane, as shown in Fig. 1. An electrode with catalytic properties is placed into each chamber. Both chambers are filled with a liquid electrolyte. One electrode is then purged with hydrogen gas, the other with oxygen or air, and a voltmeter is connected across the electrodes.

In order to be able to build a fuel cell you should be familiar

with semipermeable membranes and catalysts. Semipermeable means that only some ions can pass through it but other matter is retained. In actual applications, separation of ions is not perfect, and some leakage usually occurs, and is permissible. Total blockage on the other hand would inhibit a reaction. The following materials could be used as semipermeable membranes:

- Unglazed discs of baked clay (an old clay flower pot).
- Fine glass frits (the partly fused mixture of sand and fluxes which glass is made of).
- Cellophane.
- Wet plaster.
- Moist, or hardened cement.
- Zinc oxide or zinc chloride cement.
- Certain types of plastic foam.
- Silicic acid gel, prepared by slowly acidifying sodium silicate solution.
- Gelatin saturated with salt.

Clay, cement or plaster discs should be as thin as possible. The gels should be used to build ion bridges according to Fig. 2. Glass frits can be bought at lab supply houses and are best for this use. If glass frits are used, the gases move upward, and stay in the proper place. Any fair separation will do. The author used two square polyethylene bottles and a large fine glass frit which was glued into holes cut in the sides of the bottles (Fig. 3).

In order to get hydrogen and oxygen to react at room temperature they must be coaxed a little. Without the proper catalyst, nothing at all happens.

A catalyst is a compound that hastens reactions without actually taking part in the reaction. If you set up a H_2/O_2 fuel cell with sulfuric acid and carbon electrodes for instance, there will be no electrical energy generated. If platinum- or palladium-coated carbon electrodes are used, the reaction gets going. Union Carbide has used this method and supply such electrodes.

The method the author used to plate carbon was to wrap platinum wire and a platinum net around the carbon rods, which works very well. An easy and low-priced way of producing a large surface of palladium is to coat nickel netting with palladium. That can be done by immersing a

With NRI hands-on training, you can experience the rewards of a career in computer programming

**NEW!
386sx
mini-tower
computer!**



Now you can get the practical training and experience you need to succeed in computer programming, today's top-growth computer career field.

NRI at-home training gives you real-world programming skills in four of today's hottest computer languages: BASIC, Pascal, C, and COBOL. You get hands-on training that now includes a powerful 386sx/20 MHz mini-tower computer, modem, and programming software ... all yours to train with and keep! Best of all, NRI gives you the programming know-how you need to succeed on the job, in a new career, or in a business of your own.

Job opportunities for the skilled computer programmer will increase by 71.7 percent over the next 10 years according to Bureau of Labor Statistics forecasts. And now, with NRI training, you can be one of the increasing number of computer programmers using their skills to build a top-paying career — even a business of their own — in this professionally and financially rewarding high-tech field.

▼ The only programming course that includes a powerful 386sx-based computer system and programming software you keep

Right from the start, NRI training gets you actively involved in the challenge of real-world programming. You learn how to create the kinds of full-featured, powerful programs today's employers and clients demand.

And, unlike any other school, NRI lets you experience first-hand the power of an IBM PC/AT-compatible, 386sx-based computer system, complete with modem, a full megabyte of RAM, disk drive, and monitor — all yours to train with and keep!

Plus you explore the extraordinary capabilities of not one or two but four in-demand computer languages. You learn to design, code, run, debug, and document programs in BASIC, Pascal, C, and COBOL. In the process you become uniquely prepared for the wide variety of programming opportunities available today.

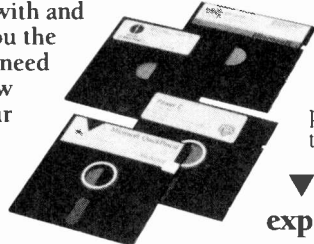

▼ No previous experience necessary

Immediately, you start getting the money-making job skills you need to secure a future in computer programming — no matter what your background. NRI's unique Discovery Learning Method guides you swiftly from computer novice to computer professional with step-by-step lessons covering program design techniques used every day by successful PC programmers.

You'll find no heavy textbooks to plow through. No night classes to attend. Instead, NRI's at-home, step-by-step training covers all the bases, guiding you

from the important fundamentals to real-world methods and techniques. Backed up throughout your course by your experienced NRI instructor, you quickly gain the skills you need to handle a wide variety of programming tasks with confidence. You even use your modem to "talk" to your instructor, meet other NRI students, and download programs through NRI's exclusive programmers network, PRONET.

▼ Send today for your FREE catalog

Now you can experience the professional and financial rewards of a career in computer programming. See how NRI at-home training gives you the know-how, the computer, and the software you need to get started in this top-paying field. Send today for your FREE catalog!

If the coupon is missing, write to us as the NRI School of Computer Programming, McGraw-Hill Continuing Education Center, 4401 Connecticut Avenue, NW, Washington, DC 20008.

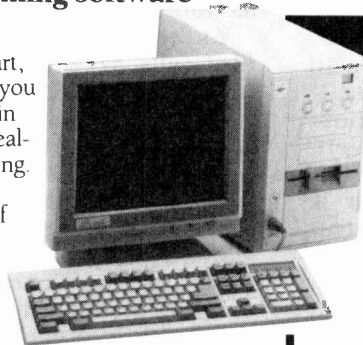

SEND FOR YOUR FREE NRI CATALOG TODAY!

NRI Schools

McGraw-Hill Continuing Education Center
4401 Connecticut Avenue, NW, Washington, DC 20008



Check one free catalog only

- | | |
|------------------------------------------------------|----------------------------------------------------------|
| <input type="checkbox"/> Computer Programming | <input type="checkbox"/> Programming in C++ with Windows |
| <input type="checkbox"/> Microcomputer Servicing | <input type="checkbox"/> Desktop Publishing & Design |
| <input type="checkbox"/> PC Applications Specialist | <input type="checkbox"/> Bookkeeping and Accounting |

Name _____ Age _____
(please print)

Address _____

City _____ State _____ Zip _____

Accredited Member, National Home Study Council

9-092

nickel net in a 2% solution of palladium dichloride over night. The coating looks black. Palladium coated nickel acts like pure palladium. The author had a supply of platinum on hand or he would have used the approach just mentioned.

The amount of palladium dichlorides you need costs about \$20.00. Platinum, palladium, silver, nickel (especially Raney nickel) have been used as catalysts in different fuel cells. Platinum-group metals work so well because they have an affinity to hydrogen and will pick up consid-

erable amounts of it for storage in their crystal lattices. A platinum electrode saturated with hydrogen, therefore, is practically an electrode of solidified hydrogen. The pure metal is too expensive, so palladized nickel, platinumized carbon or Raney nickel on a carrier matrix are the first choice.

drogen to disperse. Rotameters were used to check gas flow. They can be replaced by bubble indicators if you prefer. Gas flow was 10-20 liters per hour (l/h) but can be varied. Oxygen flow should be about 1/2 that of hydrogen flow. The reaction is sluggish at the beginning as hydrogen has to saturate the platinum metal surface.

An indication of about 10 mV may occur for several minutes, which will then rise. There may be steps in this rise, therefore it may be necessary to put a little drain on the system by using a

resistor that react at room temperature are shown in Table 1. The fuel cell can also be used as a one-shot unit for liquid fuel, namely hydrazine, and 30% hydrogen peroxide. Both compounds are rocket fuels but can be controlled very well. They are, however, highly toxic and poisonous. Because hydrazine is known to be a carcinogen, one should not work with it unless you are familiar with handling very poisonous substances. Hydrogen peroxide at 30% concentration will bleach your hands and should also be handled very carefully.

TABLE 1
FUEL-CELL COMPONENTS THAT REACT AT ROOM TEMPERATURE

Fuel	Oxidant	Electrode Material	Electrolyte	Catalyst	Recorded Voltage (mV)
hydrogen 20 l/h	oxygen 10 l/h	carbon	5% sulfuric acid	none	No reaction
hydrogen 20 l/h	oxygen 10 l/h	carbon/platinum	5% sulfuric acid	platinum	533
hydrogen 20 l/h	air 40 l/h	carbon/platinum	5% sulfuric acid	platinum	469
hydrogen 20 l/h	oxygen 10 l/h	platinum	30% potassium hydroxide	platinum	988
hydrogen 20 l/h	oxygen 10 l/h	palladium on nickel	30% potassium hydroxide	palladium	*
2 ml 24% hydrazine hydrate	10 drops 30% hydrogen peroxide	palladium on nickel	30% potassium hydroxide	palladium	*

*This reaction was not tried by the author, but works according to literature on the subject.

erable amounts of it for storage in their crystal lattices. A platinum electrode saturated with hydrogen, therefore, is practically an electrode of solidified hydrogen. The pure metal is too expensive, so palladized nickel, platinumized carbon or Raney nickel on a carrier matrix are the first choice.

Impinger-type glass tubes with frits or aquarium-type dispersion tubes are used as gas inlet tubes. The electrodes are wound around the tube in a coil. Copper wire leads are connected. The electrolyte is a 30% potassium hydroxide solution. Oxygen and hydrogen can be bought in small laboratory bottles with reasonably priced lab-reduction valves.

Hydrogen can also be produced from zinc and diluted hydrochloric acid. That leaves you with a solution of zinc chloride which is hazardous to the environment and must be disposed of in a manner prescribed by law.

The entire experiment was conducted in the open air in order to allow the flammable hy-

drogen to disperse. Rotameters were used to check gas flow. They can be replaced by bubble indicators if you prefer. Gas flow was 10-20 liters per hour (l/h) but can be varied. Oxygen flow should be about 1/2 that of hydrogen flow. The reaction is sluggish at the beginning as hydrogen has to saturate the platinum metal surface.

An indication of about 10 mV may occur for several minutes, which will then rise. There may be steps in this rise, therefore it may be necessary to put a little drain on the system by using a 100-ohm resistor connected across the 2 chambers. It can be removed again after a few minutes. That helps overcome polarization effects. The author measured 998 mV after about 10 minutes. To compensate for the slow start, the cell will generate a voltage for some time after the hydrogen is turned off.

After you finish, the potassium hydroxide solution should be poured into a well-capped plastic bottle. It can be used over again, but it will accumulate carbonate which makes it less effective. Some prefer diluted sulfuric acid for the same purpose because it keeps longer. Air can, in most cases, be substituted for oxygen. The amount must be raised, however, since only 1/2 of air is oxygen. Hydrogen peroxide can be used in place of oxygen but it dilutes the electrolyte.

Fuel cells have been run with "steam reformed" methyl alcohol. At 200°C, methyl alcohol reacts with water to form hydrogen and carbon dioxide as shown in the following equation:

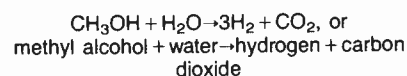

At temperatures higher than room temperature many other reactions are possible. Some of them allow a separation and collection of the water formed.

You're probably wondering why fuel cells are not more widely used. The first big drawback is cost, which is always a primary consideration in power generation. Hydrogen is an expensive fuel compared to other types of fuels, and the storage of hydrogen is still a problem. Perhaps in the future, we'll use solar energy on a large scale to decompose water into hydrogen and oxygen, which can then be stored. When energy is needed, the two gases can be recombined to water in a fuel cell.

AMAZING ELECTRONIC PRODUCTS and KITS

NEW CONCEPT! Mystery Levitating Device



Remember War of the Worlds? Objects float in air and move to the touch. Defies gravity, amazing gift, conversation piece, magic trick or great science project.
ANT1K Easy to Assemble Kit / Plans \$19.50

Combination Solid State Tesla Coil & Variable 100,000VDC Generator



Operates 12-19 VDC for Field Use or 115 VAC For Laboratory Use

Experiments Using Tesla Coil:

- Plasma in a Jar/Tornado, Furnace
- Kirlian Photography
- Wireless Energy Transmission
- Induction Fields • Pyrotechnic Effects
- Corona and Brush Discharge
- Energizer for Neon Plasma Tubes

Experiments Using Hi Volts DC:

- Plasma Blaster Driller/Cutter
- Anti-Gravity/Force Fields
- Ion Reaction Motors
- Lightning Generation
- High Ion Source
- Ozone For Air Purification
- Electrification of People & Objects
- Particle Accelerators/Atom Smashing
- High Energy Capacity Charging

HVM7 Plans Complete System \$15.00
HVM7K Complete System Kit/Plans \$174.50
TCL4K Tesla Coil Only Kit/Plans \$99.50
115/19AC Wall Adapter for 115AC \$15.50

Table Top Tesla Coil

Spectacular - A Real Attention Getter!
• 250,000 Volts! • 7-10' Sparks!
Energy even passes through windows. Great for science projects, displays, advertising.

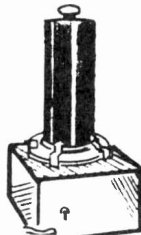

Highly spectacular devices produces visible, audible bolts of lightning appearing to flash in the air. Causes certain materials to burn from within and glow, lights bulbs without wires, produces induction fields, St Elmo's fire corona. Clearly demonstrates high frequency high voltages yet terminal may be touched by user during operation with a metal object. 115VAC operation only.
BTC3 Plans ..\$15.00 BTC3K Kit/Plans \$299.50
BTC30 Assembled and Tested \$399.50

Plasma Fire Saber



Produces the spectacular effect that captured the fantasy of millions of movie fans. Visible plasma field is controlled by grip pressure and adjusts saber length. Active energy field produces weird & bizarre effects. Excellent for special effects. Specify photon blue, neon red, phasor green, or starfire purple.
PFS2 Plans ... \$8.00 PFS2K Kit/Plans \$49.50
Special Offer PFS20 Assembled reg \$89.50 \$59.50

Solar Power Devices

Build a fence shocker, solar motor, light, bug zapper, batt charger, etc. SOL1 4", 2 Amp Cell w/Plans .. \$8.50
SOL2 6x12", 14 V Cell w/Plans \$7.50

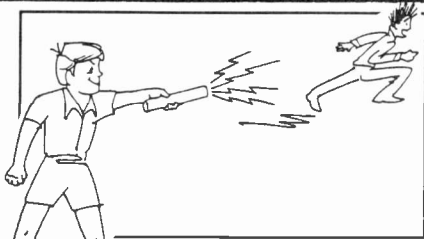

Shocker Force Field / Vehicle Electrifier

- Neat little device allows you to make hand and shock balls, shock wands and electrify objects, charge capacitors. Great pay back for those wise guys who have wronged you!
SHK1KM Easy To Assemble Electronic Kit . \$24.50

100,000V Intimidator / Shock Wand Module

Build an electrical device that is affective up to 20 feet. May be enclosed for handheld, portable field or laboratory applications.
ITM2KM Easy to Assemble Electronic Kit ... \$49.50
ITM2 Plans Only; Credit-able to Kit \$10.00

Ion Ray Gun - Projects charged ions that induce shocks in people & objects without any connection! Great science project as well as a high tech party prank.
IOG3 Plans \$10.00 IOG3K Kit/Plans \$69.50

Invisible Pain Field Generator

Shirt pocket size electronic device produces time variant complex shock waves of intense directional acoustic energy capable of warding off aggressive animals, etc.
IPG7 Plans \$8.00 IPG7K Kit / Plans \$49.50
IPG70 Assembled \$74.50



Homing / Tracking Transmitter

Beeper device, 3 mile range.
HOD1 Plans \$10.00 HOD1K Kit/Plans \$49.50

Listen Thru Walls, Floors

Highly sensitive stethoscope mike.
STETH1 Plans ... \$8.00 STETH1K Kit/Plans \$44.50

3 Mile FM Wireless

Mike - Subminiature!
Crystal clear, ultra-sensitive pickup transmits voices and sounds to FM radio. Excellent security system, warns of intrusion. Become your neighborhood disk jockey! Monitor children and invalids.
FMV1 Plans \$7.00 FMV1K Kit/Plans . \$39.50

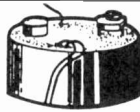

Telephone Transmitter - 3 Miles!

Automatically transmits both sides of a telephone conversation to an FM radio. • Tunable Frequency
• Undetectable on Phone • Easy to Build & Use
• Up to 3 Mile Range • Only transmits during phone use
VWPM7 Plans ... \$7.00 VWPM7K Kit/Plans \$39.50

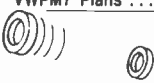

ElectroMagnetic Coil Gun

Projects a metal object over a considerable distance. Become part of and perhaps contribute to this exciting new concept of weaponry.
EML2 Plans \$8.00 EML2K Kit/Plans \$99.50

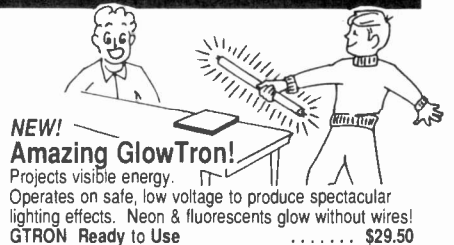
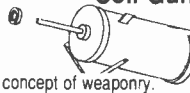

NEW! Amazing GlowTron!

Projects visible energy. Operates on safe, low voltage to produce spectacular lighting effects. Neon & fluorescents glow without wires!
GTRON Ready to Use \$29.50



TV & FM Jocker / Jammer - Shirt pocket device allows you to totally control and remotely disrupt TV or radio reception. Great gag to play on family or friends. Discretion required.
EJK1KM Easy to Assemble Electronic Kit . \$19.50

Visible Beam Laser

High brightness red HeNe laser visible for miles. Produce your own light show! Projects a beam of red lite clearly visible under most circumstances. Can be used to intimidate by projection of a red dot on target subject. Also may be used to "listen in" utilizing our laser window bounce method #LLIS1 below. Easy to Build Modules Produce A Working Visible Laser:
LAS1KM Kit w/1mw Laser Tube, Class II . \$69.50
LAS3KM Kit w/2.5mw Laser Tube, Class IIIA \$99.50

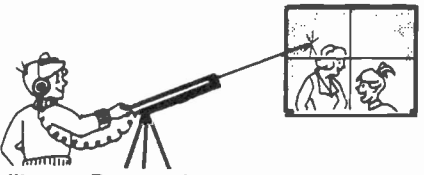

"Laser Bounce" Listener System

allows you to hear sounds from an area via a lite beam reflected from a window or other similar object. System uses our ready-to-use LATR1 Laser Terminator gun site as the transmitter. The receiver section is supplied as an easy-to-build kit, including our cushioned HS10 headsets. Order # LLIS20 System, includes our LATR1 Ready-to-Use Laser Gun Site, LLR1K Special Receiver Kit, and HS10 Headset, all for only \$299.50

5mw Visible Red Pocket Laser

Utilizes our touch power control!
VRL3KMX Kit / Plans \$119.50

See In The Dark Viewing

Device uses invisible infrared illumination for seeing in total darkness. Excellent for low cost night vision, along with observing lasers and other IR sources. Functional unit, many useful applications.
SD5 Plans \$10.00
SD5K Kit / Tube / Plans \$299.50
GPV10 Ready to Use Viewer \$499.50
6032A Tube / Plans to build your own ... \$99.50

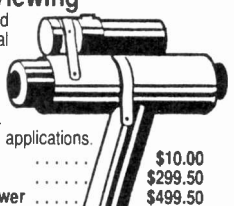

INFORMATION UNLIMITED

Dept REH12, Box 716, Amherst, NH 03031
Phone: 603-673-4730 FAX 603-672-5406
MC, VISA, COD, Checks Accepted. Please Add \$5.00 Shipping & Handling

Catalog

with many more items
FREE with Order,
Or Send \$1 P&H



Order by Mail,
or by 24 Hour
Orders-Only Phone:
800-221-1705

f your home or office has more than one telephone extension, you've probably had the unpleasant experience of picking up the phone only to find it already in use. You may get an angry response from the person on the other end. If a modem is in use, you'll be greeted by the obnoxious squall of two computers exchanging bits. Such an interruption usually means a lost connection, or the corruption of a file being transferred.

A solution to that problem is the Phone Sentry—an inexpensive, simple, reliable indicator that warns you when a phone extension is in use. The Phone Sentry is easy to build and install in one evening, and presents no load to the phone line. It's small, inconspicuous, and costs only \$5 a copy.

How it works

To understand how the Phone Sentry works, you need to understand how the telephone system works—or, at least, how the local subscriber loop works, since that's the part that enters into your house.

The telephone line is held at about 45 volts DC by the local switching office when it's hung up. When a telephone is taken off its hook, a 1K load brings the line down to 6 volts DC. The line stays at 6 volts DC until you hang up, then it returns to 45 volts DC and is disconnected.

The Phone Sentry operates by monitoring the telephone line voltage and switching on a flashing LED whenever the voltage drops below 20 volts. The Phone Sentry can be placed anywhere on a phone line, not just on an extension in use.

Circuit operation

The Phone Sentry circuit is deceptively simple, yet elegant in design. At the heart of the circuit is IC1, a CMOS CD4093B quad NAND gate Schmitt trigger.

Ordinary CMOS gates switch midway between the voltage of the positive and negative supplies. For a circuit powered from 5 volts, this point (called 0.5 V+) is 2.5 volts. When the input voltage rises past or falls below that point, the output will switch. Normally, that's a desirable characteristic, and is one of

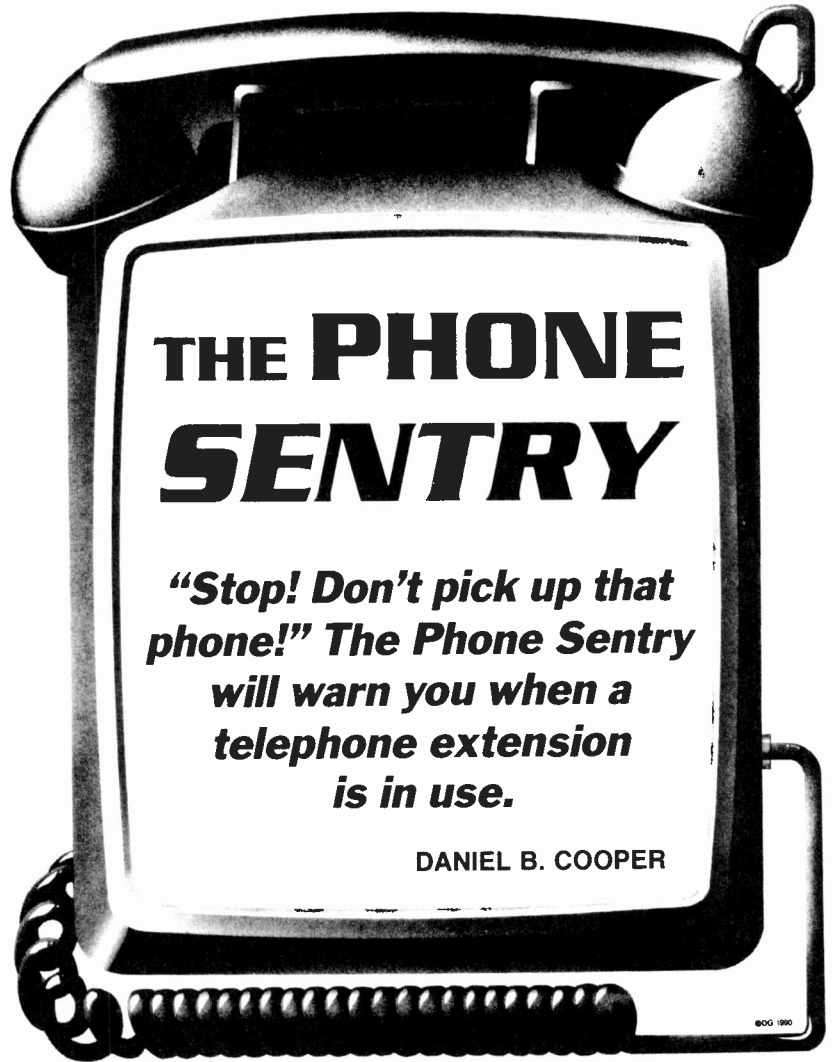

CMOS's good points. However, when a CMOS input is presented with a slowly changing or noisy input, the symmetrical switching characteristic can cause the circuit to jitter or oscillate as the input nears the 0.5 +V point.

The Schmitt trigger input handles noisy environments by separating the rising and falling voltage-switching points. A Schmitt trigger input will react to a rising input voltage only when it passes a threshold that is higher than 50% of the supply voltage, usually about 70%, or 0.7 +V. A falling input voltage will cause a change only when it falls below a much lower threshold of about 30% of the supply, or 0.3 +V. An input voltage between those two thresholds will have no effect until it rises above 0.7 +V, or falls below 0.3 +V.

The region between the 70% and 30% switching levels is

called the hysteresis gap, or dead band. Hysteresis permits a Schmitt trigger input to respond very cleanly to noisy or irregular input signals. It also permits some fancy tricks, such as one-gate oscillators. It is the latter capability for which a Schmitt NAND gate is used in the Phone Sentry.

Figure 1 shows a block diagram of the Phone Sentry. The four gates of the CD4093B are used as three separate elements. One Schmitt-trigger NAND gate acts as an input comparator to monitor a phone line. It in turn gates another NAND gate used as an oscillator, which drives a high-current buffer for LED1.

The schematic of the Phone Sentry is shown in Fig. 2, with its circuit waveforms at critical locations shown in Fig. 3. Bridge rectifier D1-D4 eliminates any phone-line polarity problems. It also removes the 80-volt peak-to-

The Importance Of Setting Standards.



Without standardization in electronics, television wouldn't be seen, radio wouldn't be heard, computers wouldn't share information.

Fortunately the Electronic Industries Association (EIA) has been setting electronics standards since 1924 for everything from early tube radios to today's cellular telephones and stereo TV's.

Standards create *markets and jobs*. Today EIA, an internationally accredited standards making body, is helping to make HDTV a reality by working with the federal government and other industry organizations, to develop a timely, uniquely American transmission standard. For home automation,

EIA also is close to completing a standard which will permit all home electronic products to communicate with each other.

Our more than 1,000 member companies are manufacturers representing every facet of the American electronics industry—from defense to consumer products.

EIA is proud of the contributions it has made through its standards making process toward the growth and vitality of the U.S. electronics industries.

Setting the standard for more than 66 years.



ELECTRONIC INDUSTRIES ASSOCIATION

1722 Eye Street, N.W., Suite 300, Washington, D.C. 20006

peak ring signal, which could damage the Phone Sentry or make LED1 flicker.

The output of the bridge rectifier is divided down by R1-R2, with 27% of the input voltage reaching IC1-a. 27% represents the voltage divider of the $[R2/(R1 + R2)]$ ratio, which equals $[1 \text{ megohm}/(1 \text{ megohm} + 2.7 \text{ megohm})] = 0.27$

The bridge always presents two of the four diodes as a phone-line load, D1-D4 or D2-D3, dropping the line voltage down by 0.7 volts DC each, or 1.4 volts total. Since the input impedances of pins 12 and 13 of IC1-a are almost infinite, they draw no current. What appears across R1 and R2 in series should be about

$$45 \text{ V} - 1.4 \text{ V} = 43.6 \text{ V.}$$

The voltage at pins 12 and 13 with the phone hung up is therefore

$$43.6 \text{ V} \times 0.27 = 11.78 \text{ V,}$$

which is 2.78 volts above the 9-volt DC supply. The IC, however, is protected from overcurrent burnout by R1 and internal diodes. When an extension is in use, the 6 volts on the line goes down to

$$(6 \text{ V} - 1.4 \text{ V}) \times 0.27 = 1.24 \text{ V.}$$

Capacitor C1 filters out small spikes that can be generated during the ringing cycle, protecting the IC and eliminating any residual tendency of the LED to flicker.

Because the comparator is a Schmitt NAND gate, its output (pin 11) will be low whenever the input voltage is above about 6.3 volts (70% of 9 volts), and high whenever the input drops below about 2.7 volts (30% of 9 volts). Those switching values fit perfectly with the 11.78 and 1.24 volts generated from the phone line by the rectifier and divider. The output will be low when all phones are on-hook, and high when any phone is picked up, or a modem is connected to the line.

The LED could be driven directly by IC1-a, but B1 would be drained in about 10 hours because LED1 draws 10 milliamps when lit. To extend battery life to at least 100 hours, IC1-b, the low 5% duty-cycle oscillator, is gated by IC1-a, driving LED1 and giving a bright flash with much lower current drain.

The output of the comparator is used to gate an oscillator on and off. That oscillator consists

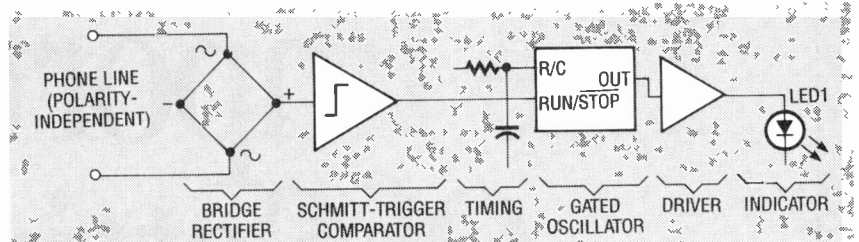

FIG. 1—BLOCK DIAGRAM OF THE PHONE SENTRY. The rectified phone-line voltage drives a comparator, whose output gates a low duty-cycle oscillator. The oscillator drives a CMOS buffer/driver. The period and duty cycle of the oscillator are controlled by timing components R3, R4, and C2.

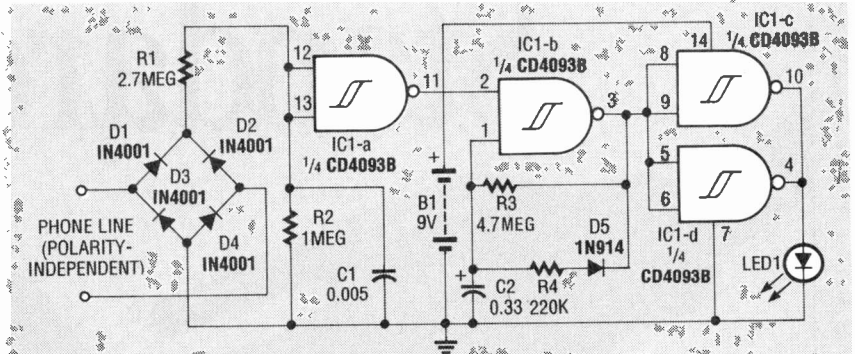
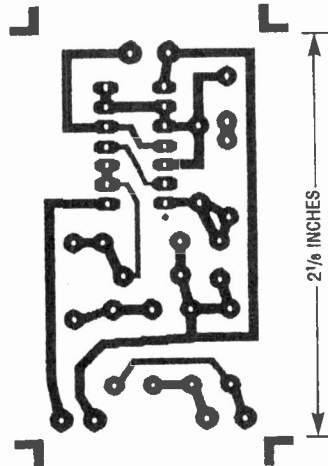

FIG. 2—SCHEMATIC OF THE PHONE SENTRY, using a CD4093B quad NAND-gate Schmitt trigger. The green (tip) and red (ring) phone-line wires are polarity-independent due to D1-D4. Input comparator IC1-a gates IC1-b, a single-gate oscillator, which drives IC1-c and -d, used in tandem as a high-current buffer/driver.



THE PC-BOARD FOIL PATTERN FOR the Phone Sentry.

of a second Schmitt NAND gate (IC1-b), R3, R4, C2, and D5. When pin 2 of IC1 is held low by the comparator, the output of the gate is held high. That output is used to charge timing capacitor, C2, through timing resistor R3. The junction of components R3 and C2 is connected to pin 1. With the output held high, the charge on C2 will rise to the level of the supply voltage.

When a phone is picked up and the loop voltage drops, the comparator's output goes high and the oscillator is enabled. Since

PARTS LIST

All resistors are 1/4-watt, 5%.

R1—2.7 megohms

R2—1 megohm

R3—4.7 megohms

R4—220,000 ohms

Capacitors

C1—0.005 μF, 100 volts, disc or monolithic

C2—0.33 μF, 16 volts, tantalum or electrolytic

Semiconductors

D1-D4—1N4001 diode

D5—1N4148 diode

IC1—CD4093B quad Schmitt trigger NAND-gate

LED1—light-emitting diode, any size or color

Miscellaneous: 9-volt alkaline battery with clip, PC board (see foil pattern), 22-AWG wire, plastic case (optional), LED mounting clip (optional), modular plug-to-bare wire phone cable (optional), two-way phone jack duplexer, 14-pin DIP IC socket.

both inputs are now high, the output switches low. The charge of C2 is drained, partly through R3, but more quickly through R4 and D5. When the voltage at pin 1 drops below the Schmitt input's lower threshold, the output of the gate switches high, and the capacitor begins charging again through R3. When the capacitor voltage reaches the Schmitt's upper threshold, the output switch-

FROM **\$19⁹⁵**
Standard

→ **\$199⁹⁵**
High Performance

**GREAT
VALUE!**

Standard Features - Models 100, 150, 200 & 400

- AC & DC VOLTAGES ● DC CURRENT ● RESISTANCE
- CONTINUITY TESTER - Buzzer ● DIODE TEST ● 3 1/2 Digit LCD
- LOW BATTERY INDICATOR ● ACCURACY +/- 0.5% RDG

The Ultimate Meter
TRUE RMS - LCR - Hz - dBm

**Kelvin Meters backed by a
2 Yr Warranty - Parts & Labor**

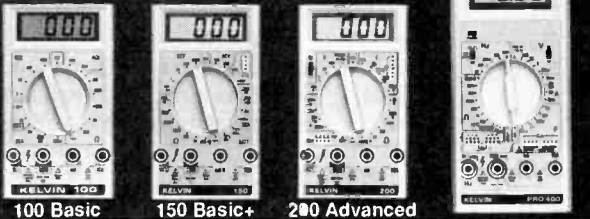

- | | | | |
|---------------------------|--------------------------------|------------------------------------------------|------------------------------------------------------------------------------------------------------------------------|
| 100 Basic | 150 Basic+ | 200 Advanced | PRO 400 |
| BATTERY TEST | TRANSISTOR hFE
BATTERY TEST | TRANSISTOR hFE
CAPACITANCE
AC/DC CURRENT | 20MHz FREQ
COUNTER
AC/DC CURRENT
CAPACITANCE
LOGIC TEST
TRANSISTOR hFE
LED TEST -
VERIFY GOOD/BAD |
| KELVIN
990087 | KELVIN
990090 | KELVIN
990091 | KELVIN
990092 |
| \$19⁹⁵ | \$29⁹⁵ | \$39⁹⁵ | \$69⁹⁵ |

Protective Cases

For Models 100, 150, 200 \$4.⁹⁵ (990088)
Case For Model Pro 400 \$9.⁹⁵ (990094)

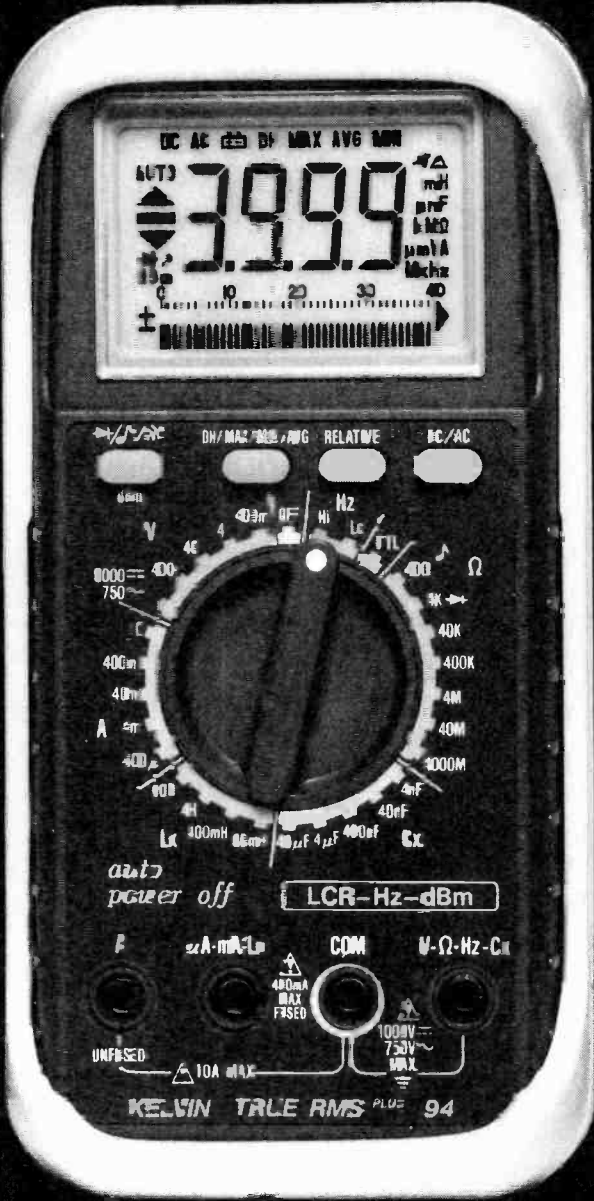

Model 92 PERFORMANCE PLUS **Model 93 DIAGNOSTIC PLUS** **Model 95 ENGINE ANALYZER PLUS**

Standard Features - Models 92, 93, 94 & 95

- DC/AC VOLTMETERS ● AC/DC CURRENT ● OHM METER
- FREQUENCY COUNTER to 4 MHz ● AUDIBLE CONTINUITY TESTER
- DIODE TESTER ● MAX/MIN AVERAGE MEMORY RECORD
- RELATIVE MODE ● 10A HIGH-ENERGY FUSE PROTECTION
- DATA HOLD ● AUTO SLEEP & AUTO POWER OFF

PERFORMANCE PLUS Complete with above **Standard Features** plus WATER RESISTANT (92 & 94 Models only), 2 YEAR WARRANTY, YELLOW HOLSTER, PROBES, BATTERY, FUSE, STAND
Model 92 # 990109
\$119⁹⁵

DIAGNOSTIC PLUS Complete with **Standard & Model 92 Features** plus LOGIC PROBE, CAPACITANCE TESTER, TRANSISTOR TESTER, TEMPERATURE TESTER & K-TYPE PROBE, HIGH VOLTAGE WARNING BUZZER
Model 93 # 990110
\$149⁹⁵

ENGINE ANALYZER PLUS Complete with **Standard & Model 92 Features** plus TEMPERATURE, TACHOMETER & DWELL ANGLE TESTER, DUTY CYCLE, 10 MEGA OHM IMPEDANCE, ANALOG BAR GRAPH, K-TYPE TEMP PROBE, ALLIGATOR CLIP TEST LEADS, INDUCTIVE PICKUP CLIP, 6' TEST LEADS & CARRY CASE
Model 95 # 990112
\$199⁹⁵

KELVIN

10 HUB DRIVE
MELVILLE, NY
11747

M/C & VISA

(800) 645-9212
(516) 756-1750

Established 1945
(516) 756-1763/FAX

12 INSTRUMENTS IN ONE - DC VOLTMETER, AC VOLTMETER, OHMMETER, AC CURRENT, DC CURRENT, DIODE TESTER, AUDIBLE CONTINUITY TESTER, dBm, FREQ COUNTER, CAPACITANCE METER, INDUCTANCE METER, LOGIC PROBE

0.1% ACCURACY on DC Voltages Water Resistant

\$199⁹⁵ MODEL 94 #990111

COMES COMPLETE WITH YELLOW HOLSTER, PROBES, BATTERY, FUSE, STAND

Freq Counter to 20 MHz

10 MEGA OHM IMPEDANCE
RELATIVE MODE / DATA HOLD
MAX/MIN AVERAGE MEMORY RECORD
10A HIGH-ENERGY FUSE PROTECTION
AUTO SLEEP & AUTO POWER OFF w/lt Bypass

Cases for 90 Series Meters

Regular Padded Zippered ... \$9.⁹⁵ (#990116)
Deluxe Padded Zippered \$14.⁹⁵ (#990115)

This meter is designed in accordance with relevant safety requirements as specified in IEC-343, UL-1244 and VDE-0411.

charge to the lower threshold the first time. Therefore, the first flash of the LED is longer and brighter than those that follow. That's a nice touch, because all of the Phone Sentries in the house will give an initial bright flash when a phone is first picked up to answer a call.

Construction and installation

The Phone Sentry can be assembled on either a PC board, shown here, or on perforated construction board of similar size. The PC board is about the size of B1, so housing the unit is simple, and its construction is straightforward. Figure 4 shows the parts placement diagram; use a socket for IC1, and install it using proper anti-static handling techniques.

The Phone Sentry is small, with several installation options. Once you decide how to mount it, you can select how to wire both the phone line and LED1. If you put the Phone Sentry inside an extension or a wall-mount jack, then solder a foot of 22-AWG wire to each input terminal.

If you use a small case for plugging into a wall socket, solder the green (tip) and red (ring) wires of a modular plug-to-bare-wire phone cord, and clip the yellow and black wires. You may want to solder LED1 directly to the PC board, or mount it in a visible location with two 6-inch pieces of stiff wire.

You can mount both the PC board and B1 in a standard desk phone. Open the phone and secure both the PC board and battery clip to the baseplate with double-sided foam tape. Drill a small hole in the dialing button escutcheon, and use silicone sealant or an LED clip to mount LED1. Connect the two input wires to the tip and ring wires, insert B1, replace the cover, and plug the phone back in.

If there's no space for the Phone Sentry and B1, use a small plastic box on the side of the phone for the PC board, B1, and LED1, and pass the tip and ring wires through a hole in the box and phone case to the connecting points inside the phone. For a wall phone, mount the same case near the wall jack and run the wiring into the wall jack, so it's independent of the phone. **R-E**

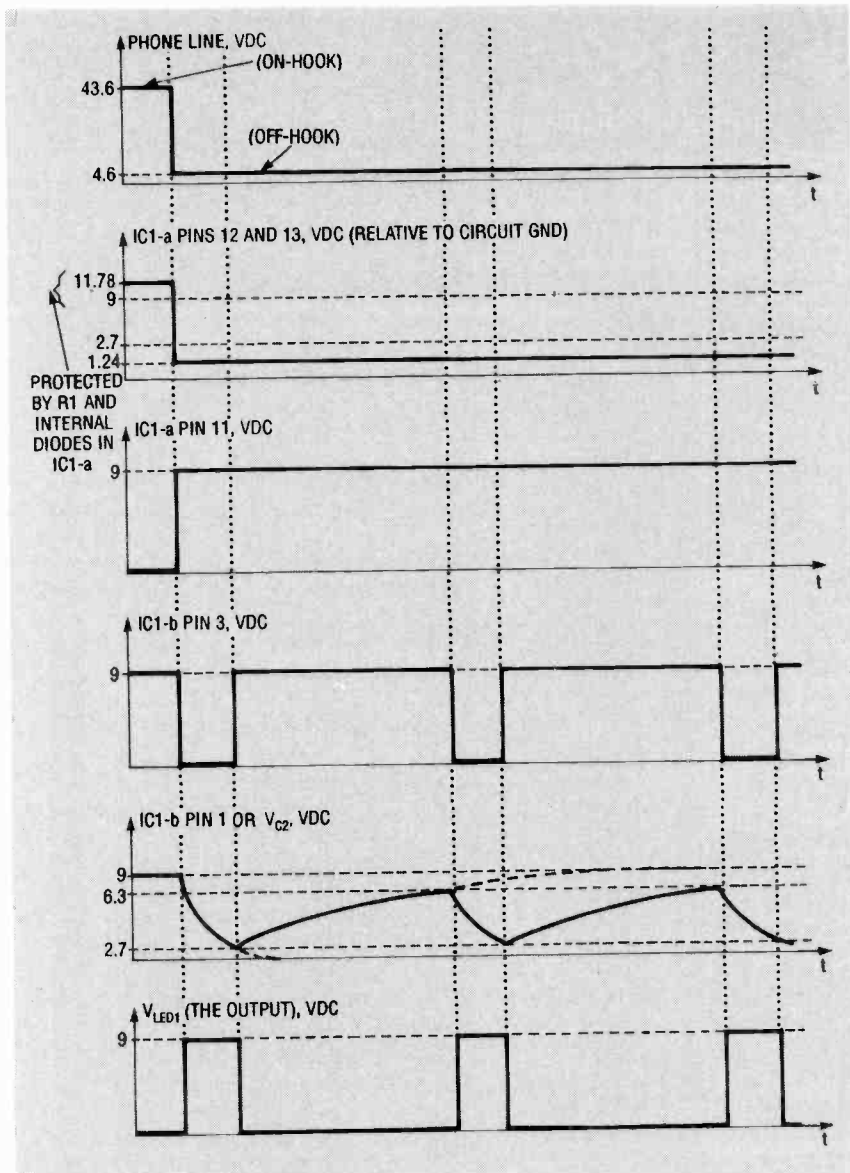

FIG. 3—CIRCUIT WAVEFORMS OF THE Phone Sentry. Shown are the voltages on the phone line, pins 12 and 13 of IC1-a, pin 11 of IC1-a, pin 3 of IC1-b, pin 1 of IC1-b (the voltage across C2), and across LED1.

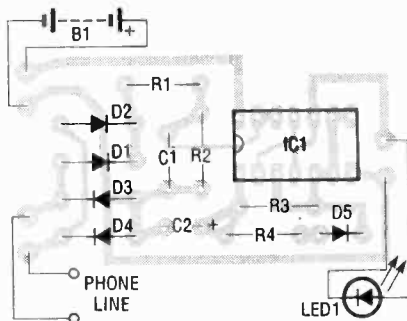

FIG. 4—THE PARTS PLACEMENT DIAGRAM of the Phone Sentry. You can mount LED1 in several ways, depending on how you mount the PC board.

going back on-hook.

The output of the oscillator (pin 3) is inverted and used to drive the indicator LED. When the oscillator's output is high, the output of the driver (pins 10 and 4) is low, and the LED is off. When the oscillator output is low, the driver output is high, and the LED is on. Since the capacitor discharge time (oscillator output low) is much shorter than the charge time (oscillator output high), the LED is on much less time than it is off, resulting in a very low duty cycle, and low battery drain.

Because the capacitor starts each cycle charged much higher than the Schmitt input's upper threshold, it takes longer to dis-

es low again and the process repeats until the gating input is again brought low by the phone

Here are two simple projects that will allow you to control things using up to eight voice commands.

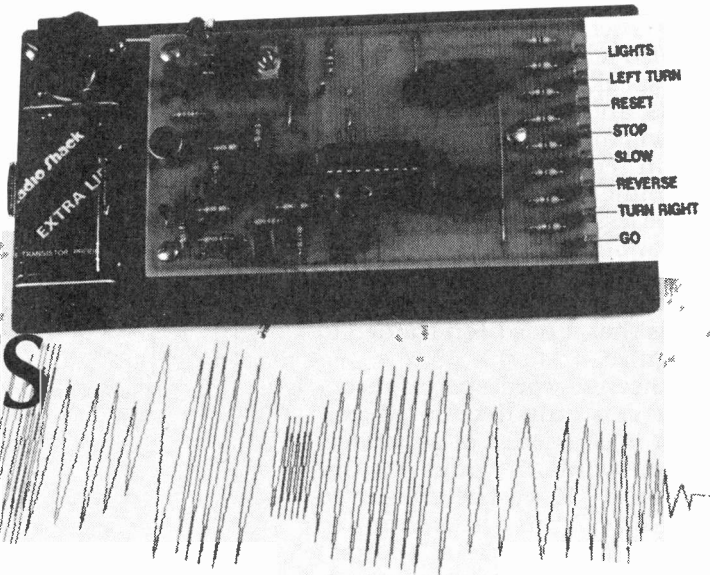

EXPERIMENTS IN VOICE RECOGNITION

DANIEL B. COOPER

SOME OF THE MOST FASCINATING things that electronics experimenters can do are those that seem impossible. Remote control and voice synthesis are two areas of experimentation that were once nearly impossible for hobbyists and amateurs to work with, but integrated circuits have brought both within the reach of even novice tinkerers. Another area that has always been very difficult to work with is voice recognition. And now there is a new IC which brings simple speech-recognition technology within the reach of novice experimenters.

Most voice-recognition projects and experiments have used personal computers as the backbone of the recognition device. A number of voice-recognition expansion cards for both Apple and IBM-compatible computers are available, but they're relatively costly and require the computer in order to be usable. The voice-recognition IC, the VCP200 speaker-independent word recognizer, is a stand-alone device that provides all of the essential elements for speech recognition in a single 20-pin package.

The project

There are a number of applications, both serious and fun, useful and merely entertaining,

for the VCP200. Rather than limit this interesting device to a single-purpose project, we are presenting two separate projects: one is suitable for experimentation—and also makes a nifty science-fair project—and the other is less ideal for experimentation but better for actual use in an application of one sort or another. A variety of adjustments and interfacing techniques will be discussed, and some flexible interface and driver circuits will be presented. None of the parts, with the exception of the VCP200 itself, are exotic or costly, and most are probably in your junk box or parts collection.

The experimenter's version is a self-contained device with a microphone and eight indicator LED's. The addition of a power supply is all that's needed. The project will recognize eight words and short phrases from almost any speaker, and light the corresponding LED in response. Outputs are provided for driving other circuits or devices.

The "working" version of the circuit eliminates the indicator LED's and their driver IC's, and uses a much smaller PC board. However, it retains the eight outputs and all other circuitry, and is therefore more suitable for building into a motorized model or other project.

Voice recognition

The basic elements of voice or speech recognition have been known for a number of years. Human speech consists of phonemes, which are the smallest individual units of sound that make up words and sentences. The "ah" sound in "father," the "t" sound in "top," and the "rr" sound in "radio" are all examples of phonemes. Any word in a particular language can be created by stringing together the proper sequence of phonemes and spaces of silence. Not all languages use the same phoneme sets; English, for example, lacks a glottal stop and the click found in many African languages.

Electronic voice recognition consists of analyzing the arrangement of phonemes in a spoken sequence and matching them against stored patterns or templates to determine the word or phrase. There are many variations in the actual processes used for each of the three steps: storing the patterns, analysis, and matching. However, the basic techniques used for voice recognition can be loosely grouped into four categories.

In speaker-dependent voice recognition, the intended user of the recognition device "trains" it by carefully pronouncing the list of recognized words, several

times each. The system creates detailed templates, or patterns of that speaker pronouncing those words, and stores them. The system will have a very high success rate in recognizing that speaker pronouncing those words, but it will be less able (if at all) to recognize another speaker saying the same words—and, of course, it will only recognize those specific words that it has been trained to recognize.

A discrete-word speech recognizer can only decode speech when it is a series of separately spoken words. It could not understand "Move the cursor to field one," but the sequence "Goto" (pause) "Field" (pause) "One" would be understood. Speaker-dependent discrete-word recognition systems are the most common types in use.

A speaker-dependent connected-word recognition device must be trained to recognize each different speaker's pronunciation. However, more powerful analysis capabilities allow decoding of words strung together in a long phrase or sentence. This type of recognizer could decode "Move the cursor to field one," but is typically costly and complex. The success rates are also typically lower than for speaker-dependent discrete-word recognition systems.

A much more difficult process is to decode the speech of a variety of speakers. No two people pronounce words in quite the same way. When analyzed electronically and graphically, variations, even with very similar-sounding speakers, are quite

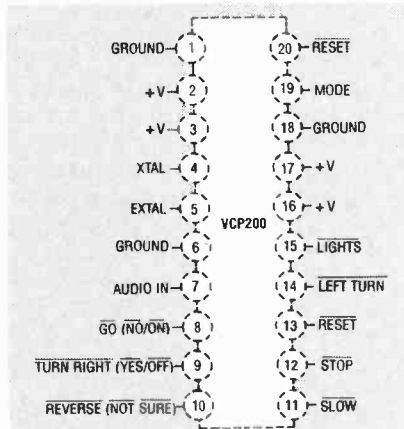

FIG. 1—THE PINOUT OF THE VCP200. The output pins 8, 9, and 10 respond to different words or phrases, depending on the operating mode selected.

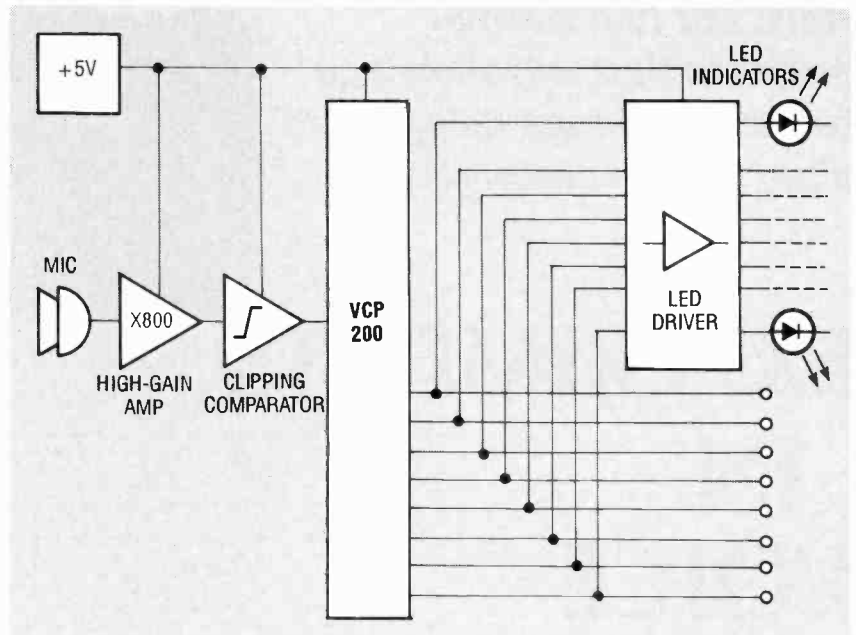

FIG. 2—BLOCK DIAGRAM of the voice-recognition circuit. The VCP200 contains almost all of the required circuitry, and needs only a power supply, microphone, and high-gain amplifier with clipping comparator output for operation. The LED indicators and their drivers are optional.

marked. That natural variation makes it very difficult for a system to recognize, with a high success rate, the same words spoken by different people.

Speaker-independent voice recognition follows the principle that all speakers have certain similarities in their pronunciation. For example, nearly all

speakers pronounce the word "stop" with the following similarities: an initial sibilant ('sss'), a short plosive ('t'), a soft vowel ('ah'), and a final plosive ('p'). By matching selected phonemes and allowing for variation in the matching algorithm, the same words can be identified and decoded from a variety of speakers.

PARTS LIST

All resistors are ¼-watt, 5%

- R1—2200 ohms
- R2—1000 ohms
- R3—10,000 ohms
- R4, R7—470,000 ohms
- R5—11,000 ohms
- R6, R8—5600 ohms
- R9—4700 ohms
- R10—10 megohms
- R11—100,000 ohms
- R12—19—470 ohms

Capacitors

- C1—0.22 μ F, 16-volts, tantalum
- C2, C3, C12—0.01 μ F disc
- C3—39 pF disc
- C5—4.7 pF disc
- C6—C8—0.1 μ F disc
- C9, C10—27 pF disc
- C11—10 μ F, 16-volt tantalum

Semiconductors

- D1—D8—red light-emitting diode (optional, see text)
- IC1—LM324A quad op-amp
- IC2—LM7805T 5-volt, 1.5-amp voltage regulator

IC3—VCP200 speaker-independent word recognizer

IC4, IC5—CD4011B quad NAND gate (optional, see text)

Other components

- JU1—switch or jumper (see text)
- MIC1—electret microphone
- XTAL1—10 MHz crystal

Miscellaneous: PC board (See text), bus wire, SPST power switch, SPDT mode switch, normally open pushbutton reset switch, 9-volt battery or 8–15 volt DC power supply, 9-volt battery clip, three 14-pin IC sockets, one 20-pin IC socket, mounting screws and standoffs, 4-40 \times 3/8-inch screw and nut, hookup wire, solder, aluminum sheet for heatsink.

Note: The VCP200 may be available from Radio Shack (it has been discontinued but many stores still stock them) as part number 276-1308, or from VCPI, 1 Willings Place, Monterey, CA 93940, for \$14.95 postpaid.

The drawbacks to speaker-independent systems are that the number of separately recognizable words is limited, the recognition success rate is generally lower than that of speaker-dependent systems, and the system can be easily fooled by similar words. For example, "swap," "stat," "spat," "spot," and "spit" all have phoneme patterns that are similar to "stop." Most speaker-independent word recognition systems will be unable to distinguish between those words.

Most dedicated voice- or word-recognition systems are speaker-independent discrete-word types. Although they have some severe limitations, they excel at simple voice-control tasks involving a few carefully chosen words and phrases. The VCP200 is a speaker-independent discrete-word recognizer.

The dream of designers, control engineers, and science-fiction writers is a system that can recognize normal, connected speech from a wide variety of speakers. Despite much effort, no such system yet exists. The first successful "natural speech" recognizer will almost certainly demand the resources of a dedicated supercomputer to handle the massive analysis and computational steps required. However, keep in mind that speech synthesis, now achieved with single dedicated IC's, also once required a full-sized computer.

The VCP200

The VCP200 speaker-independent word recognizer, from Voice Control Products, Inc. (VCPI), is a mask-programmed Motorola 6804 microprocessor. The 6804 is a 20-pin device that implements most of the standard 6800-series instruction set and capabilities, and contains one kilobyte of onboard ROM. Although an EPROM version is available for user development, production devices such as the VCP200 use a ROM that is mask-programmed at the time of manufacture with the appropriate data and control information. That approach, used for many computationally-based special-purpose devices, is a viable alternative to designing a costly single-purpose chip from scratch.

The VCP200's ROM contains a

phoneme analysis and matching program using a proprietary algorithm. The algorithm analyzes a modified voice input signal and matches it against a selection of stored word-recognition templates to identify twelve different words and short phrases: Yes, No, On, Off, Lights, Left Turn, Reset, Stop, Slow Reverse, Turn Right, and Go.

The chip is switchable between On/Off and Command modes. In the On/Off mode, it recognizes only the two word pairs On/Off and Yes/No. In the Command mode, it recognizes the other eight words and phrases. A separate output for each word is provided, which is latched low when the word is successfully recognized. If the VCP200 cannot find a close match among its word templates, all eight outputs are left high.

The VCP200 is virtually a stand-alone device, requiring only a 10-MHz crystal and four passive components for operation. The only outside circuitry that is required is a special input amplifier, built from a common op-amp, that delivers a sharply clipped and amplified voice signal. That quasi-digital signal can be easily analyzed by the microprocessor.

The VCP200's biggest disadvantage is the limited and non-expandable word list. However, considering that the chip is inexpensive and easy to use, that limitation shouldn't bother anyone who is interested in exploring voice-recognition technology without making a heavy investment of time or money.

Unfortunately for experimenters, VCPI regards the VCP200's program and word-recognition algorithm as proprietary information. Few details are available, and VCPI's literature and documentation discusses the technology only in general terms. An interesting exercise for the advanced experimenter would be attempting to work out the essential elements of the algorithm, using standard reference information on voice recognition, digital analysis of analog signals, and pattern matching.

The pinout of the VCP200 is shown in Fig. 1. The chip is powered from a single-ended 5-volt supply, which connects to

pins 3, 6, and 1, and must provide about 15 milliamps. Its oscillator crystal connects to pins 4 and 5, each of which must also be tied to ground via 27-pF capacitors to complete and stabilize the oscillator tank circuit.

Pins 2, 16, 17, and 18 of the VCP200 are not used in a standard application. They are special-purpose control pins that are usually tied to +V or ground, and are connected that way on our PC board. Generally, these pins may be ignored, as they are normally used to set the VCP200 into various test and special-application modes that are not useful to the experimenter.

The reset input, pin 20, is held high for normal operation and brought low for a reset. A simple resistor-capacitor pair connected to this pin will cause a power-on reset. The VCP200 can be manually reset by strobing the pin low at any time, by holding it low, you can safely disable the chip's operation.

Pin 19 is the operation-mode select input. When this pin is high, the chip is set to the Yes/No mode, and only Yes/Off (pin 9), No/On (pin 8), and Not Sure (pin 10), which indicates a recognition failure, are active. When pin 19 is low, the VCP200 is placed in the Command mode, and all eight outputs are active, with each corresponding to a different recognized word or phrase.

The VCP200's audio input, pin 7, requires an input signal that is either quiescent, or swings past the digital logic thresholds. That requirement translates into a highly amplified, sharply clipped signal that is "shut off" when it is not of sufficient amplitude. Such a signal is easy to achieve with a standard op-amp, as we'll see.

Finally, pins 8 through 15 are the VCP200's outputs. During or after a reset (pin 20 brought or held low), all eight outputs are held high. When the chip successfully recognizes a word or phrase in Command mode, the corresponding output will be latched low until the next recognition attempt occurs. If the VCP200 fails to find a match to an input signal, all eight outputs will remain high. In the Yes/No mode, during or after a reset, pins 8, 9, and 10 (as well as the five unused outputs, pins 11-15)

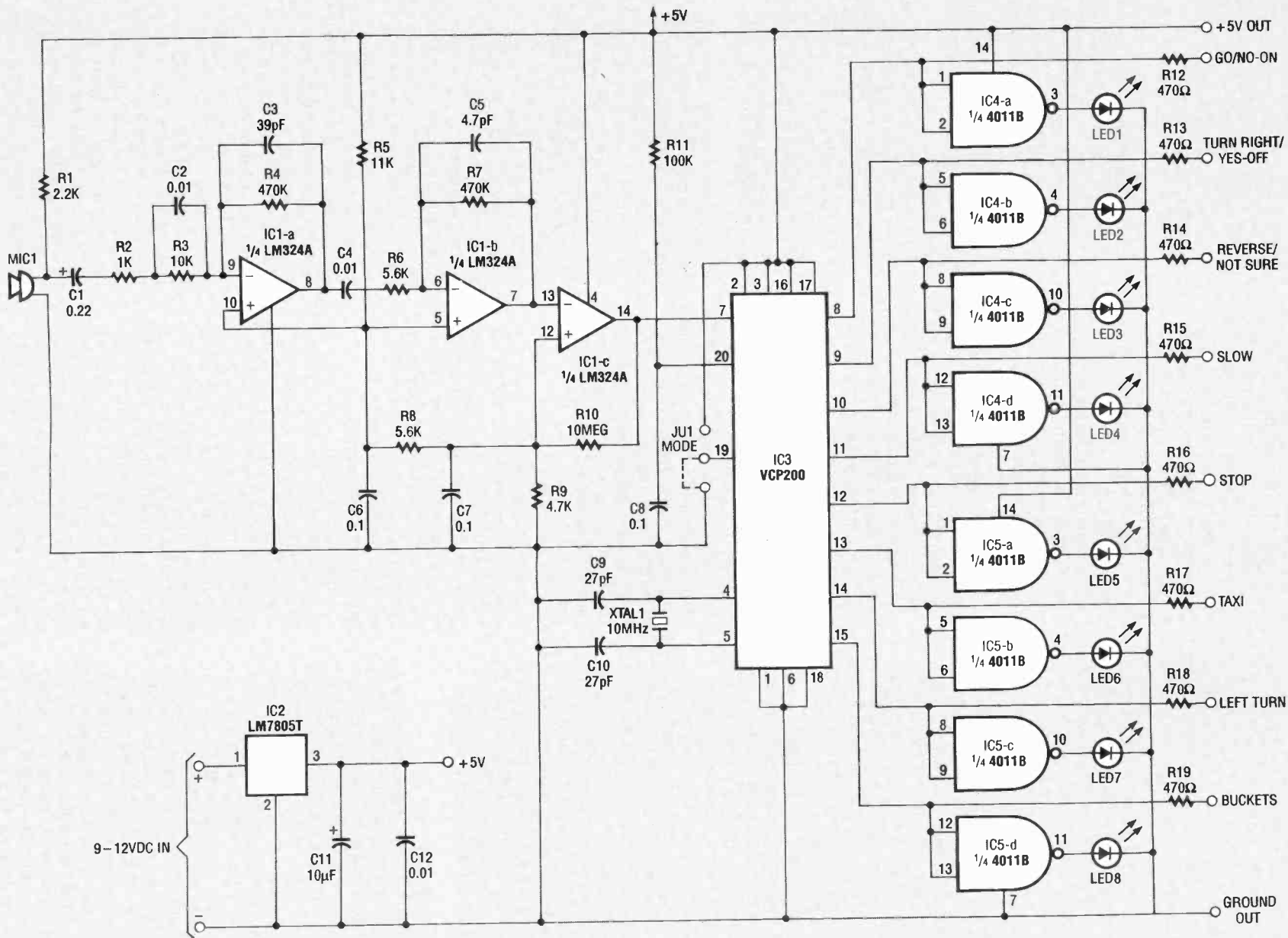

FIG. 3—COMPLETE SCHEMATIC of the voice-recognition circuit. The jumper JU1 may be replaced with an SPDT switch to control the operating mode. Either way will work, but the switch is easier to use.

will be high. Some recognition failures in the Yes/No mode can also cause all three active outputs to go high.

The circuit

As said earlier, there are two versions of the circuit. A block diagram of the experimenter's version is shown in Fig. 2. The circuit contains a power supply, an input amplifier and comparator, the VCP200, and output drivers. The power supply is quite conventional, using IC2, an LM7805T 5-volt regulator.

The input amplifier is not a conventional design; the output signal, if it were connected to a speaker, would be quite distorted and unlistenable. The purpose of the two-stage amplifier, with its overall gain of about 800, is to increase the microphone signal to a useful level. The output is then passed to a comparator that keeps the final output signal ei-

ther quiescent (flat-line) or switching between the supply limits—a quasi-digital signal. The output of the amplifier is passed to the VCP200's audio input, where the signal can then be analyzed.

The VCP200's eight outputs are made available, via current-limiting resistors, so that external interface circuits may be added to control motors, solenoids, and other active elements. Eight LED's are added to give a quick and easy indication of the circuit's response. The LED's are driven by CMOS buffers, which isolate the LED's from the outputs, preventing either the indicators or any outlying circuits from interfering with each other.

Figure 3 shows the complete schematic for the experimenter's version of the voice-recognition project. Note that the schematic of the working version would be exactly the same, except for the

omission of LED's 1–8 and IC4 and IC5.

Power for the voltage regulator, IC2, can be from 7.5 to 15 volts. Since the circuit draws only about 22 milliamps peak, a 9-volt battery is a good choice. Capacitors C10 and C11 filter and stabilize the regulator's output.

The signal from the electret microphone, MIC1, is coupled to the LM324A op-amp, IC1, through C1. The amplifier uses IC1-a and IC1-b to form a two-stage device that amplifies the microphone signals with a gain of 500–800. That transforms the weak input signal (under 5 mV) to a signal that swings from one output limit to the other, often with considerable clipping.

The amplifier has a restricted bandwidth, with a more or less flat response from about 500 Hz to 9 kHz. Signals under 300 Hz and over 15 kHz are sharply attenuated. That covers the

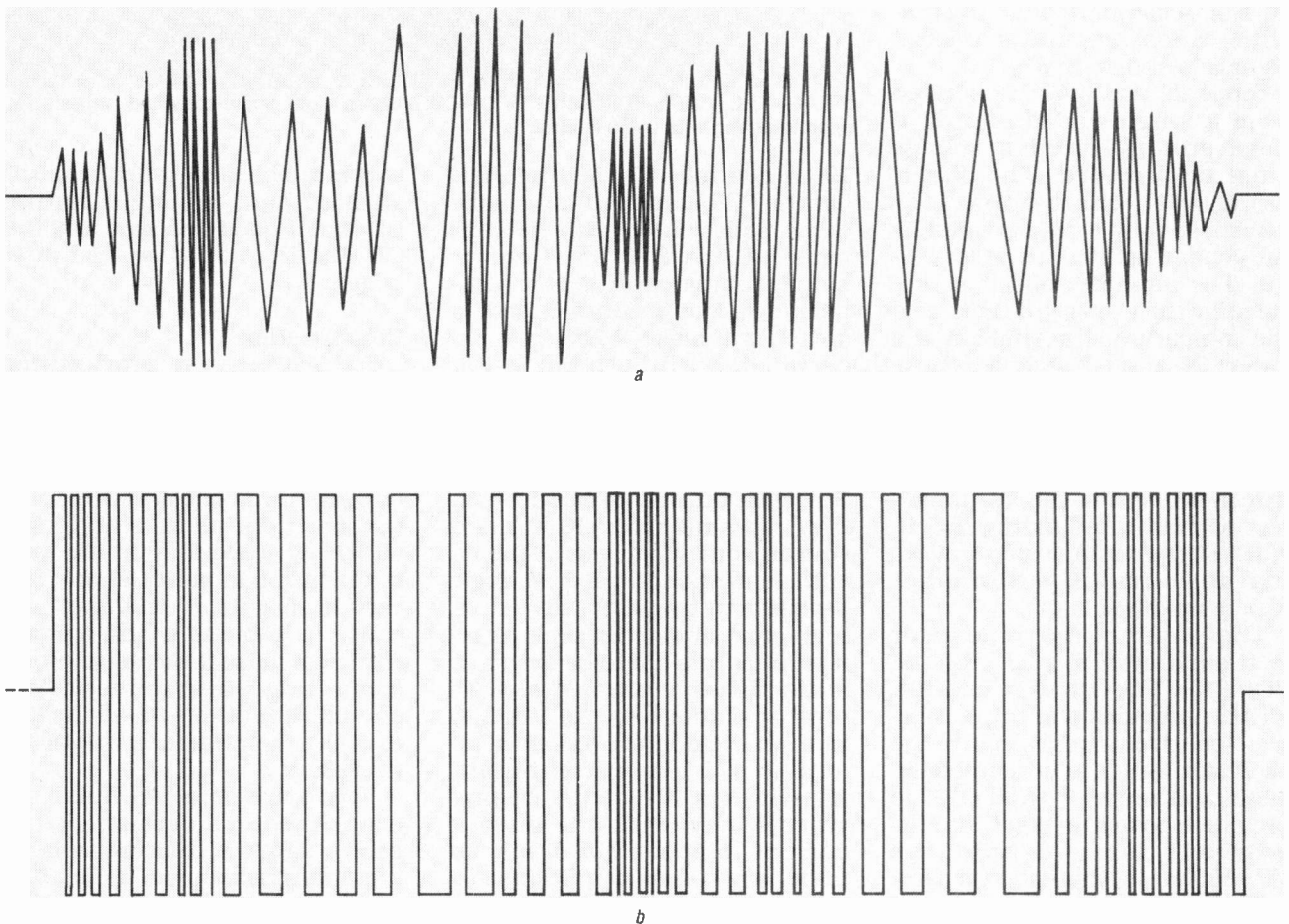

FIG. 4—AMPLIFIER (a) AND COMPARATOR (b) output waveforms. The comparator converts the amplifier signal into a clipped, quasi-digital 4-volt p-p signal only when the amplitude of the amplifier's signal exceeds the comparator threshold.

VCP200's input range of 300 to 5500 Hz, with some additional headroom for the easily-lost higher frequencies. The amplifier's characteristics are important, because the quality of the input signal largely determines how well the voice recognizer will work.

To keep the VCP200's input quiet, unless a signal of sufficient strength is present, and to ensure a sharply clipped signal, the output of the amplifier is passed to a comparator, IC1-c. (The fourth op-amp on the LM324A, IC1-d is not used, and its pins are left unconnected.) The comparator's output remains steady unless the input signal swings past its threshold. Input signals of less than 2.5 volts peak-to-peak will be ignored. However, all signals stronger than that will cause the comparator's output to swing from limit to limit, or about 4 volts peak-to-peak, which is within one-half volt of each supply rail. A comparison of the amplifier and comparator output signals is shown in Fig. 4.

Since the LM324A is operated from a single-ended supply, a "false ground" or offset voltage must be provided. The offset, along with the comparator threshold voltage, is provided by the voltage divider string R5-R8-R9. The amplifier offset is provided by the upper junction, and the comparator threshold by the lower; C6 and C7 stabilize those voltages. That design forces the center voltage of the op-amp's output signal to be separated by a volt or so from the comparator's threshold, and is the key to correct operation. Adjusting the divider string is one of the ways that the circuit's performance can be modified.

The output of the comparator is then routed to pin 7 of the VCP200. The 10-MHz crystal, XTAL1, provides the chip's master clock frequencies, with the oscillator tank circuit completed and stabilized by C9 and C10. To provide a power-on reset, the RC pair R11 and C8 hold the VCP200's reset input low for a few milliseconds after power comes on. As C8 charges through R11, the reset pin is brought high, resetting the VCP200.

The VCP200's mode input, pin

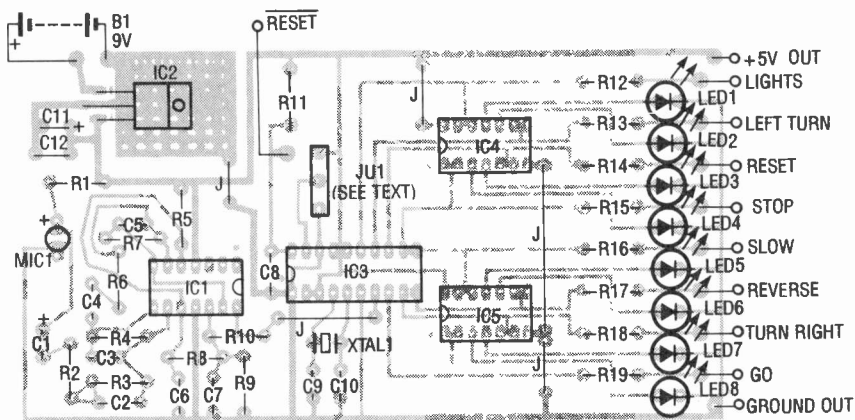

FIG. 5—THE COMPONENT LAYOUT for the experimenter's version. The "working" version parts layout is the same except for the smaller PC board that omits the LED's and their drivers IC4 and IC5.

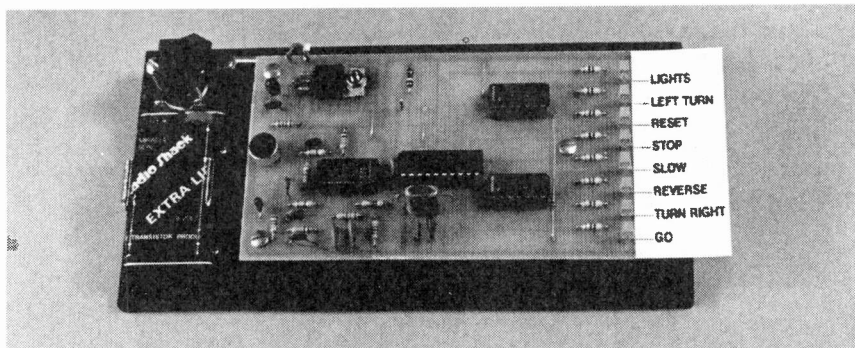

FIG. 6—THE VOICE-RECOGNITION CIRCUIT offers eight voice-activated outputs for experimenting with voice control.

19, is controlled by setting JU1. On the PC board, JU1 is actually three pads which may be connected to an SPDT switch, or simply jumpered. However, jumpering is not recommended; a switch will make it easier to experiment with both operation modes.

The eight outputs, pins 8 through 15, are left open for the experimenter to use as necessary. Since the outputs are active-low, they can sink about 10 mA and source somewhat less. That is sufficient enough to drive logic devices and transistor drivers. If high-current devices such as relays or motors are to be driven, a buffer/driver must be used. To prevent damage to the VCP200 from an accidental overload of an output, 470-ohm current-limiting resistors (R12-R19) are provided. They limit the output current to about 9.5 mA, even under worst-case conditions.

The eight LED indicators, LED1-LED8, are driven from CMOS drivers IC4 and IC5, which are CD4011B quad NAND gates. However, several other

common chips could be substituted here, among them the CD4001B quad NOR gate and the CD4093B quad NAND Schmitt trigger.

Construction

Foil patterns are provided for both versions. Although a PC board is recommended, perforated construction board and point-to-point wiring could also be used. If you use point-to-point construction, be sure and keep all wiring, especially in the area of the input amplifier, short. The very high gain of the amp will cause it to pick up and amplify electrical noise if excessively long connecting wires are used. You should use sockets for all the IC's to make them easier to replace if necessary.

If you are going to build the experimenter's version of the project, follow the parts-placement diagram shown in Fig. 5. If you are going to build the smaller "working" version, simply use the smaller foil pattern; parts placement is the same as the larger version, except that the

LED's and their drivers, IC4 and IC5, are left out. On both, keep the wire jumpers and resistors close to the board. Insert the disc capacitors so that their bodies are seated against the board, but don't chip the dielectric material. Be careful to observe the polarity on the two electrolytic capacitors, C1 and C11.

The voltage regulator, IC2, requires special mounting. The middle lead should be bent about 0.1 inch farther from the body than the two side leads, and all three bends should be made so that the regulator's mounting hole lines up with the hole in the board (see the photo in Fig. 6 for details.) If you are going to be using the project by itself, with no outlying devices powered from the board, no heatsink is needed for the regulator. If you are going to be powering other devices from the regulator that will increase the load to more than 100 milliamps, a heatsink should be added to the regulator. A flat aluminum stock heatsink can be bent into a shallow "U" shape and installed under the regulator. Because there is no space for a large heatsink, the current drawn from the regulator should be limited to no more than 250 mA even when using as large a heatsink as possible.

For most experimenters, mounting MIC1 directly to the board will be adequate. In some cases, though, it may be better to mount the microphone remotely. In that case, light-gauge shielded cable should be used to connect the microphone to the board. Electret microphones are polarized, so be sure the positive terminal is connected to the pad that leads to C1 and R1.

If you like, the eight LED indicators can be mounted remotely with a length of ribbon cable. If you mount them on the board, be sure to position them all at an even height. How you finish the remaining steps depends on how you want to use the board. For display and experimentation, you'll want the input and outputs of the circuit easily accessible with test points. Otherwise you can hardwire driver circuits and the like directly to the board.

In the prototype, the PC board and power switch are mounted to

Command	Pronunciation	Comments
Yes	yeSSS	Both of these words should be longer than "No", or "On," with emphasis on the final sibilant.
Off	awFFF	
No	no	These words should be kept very short. You'll find that almost any short, sharp sound will be interpreted as one of these words.
On	on	
Go	go	
Lights	LytSSS	
Left Turn	LeFFFT Turn	Emphasize F and the two T's, and separate words clearly.
Reset	rESSSeTT	A difficult word for the VCP200 to recognize. Emphasize the first E, S, and final T.
Stop	SSSTawPP	Emphasize T and P. Keep short, but longer than "Go".
Slow	SSSlöh	Emphasize S and vowel.
Reverse	rEverSSS	Another difficult word for the VCP200. Emphasize first E and final sibilant, but do not separate syllables.
Turn Right	Turn-ryT	Emphasize T's and slur words together slightly.

a thick plastic base using spacers and screws, and the battery clip is secured by smaller screws. Although the prototype has no reset switch and is strapped into the Command mode, you can easily add the controls. Just use a slightly larger mounting base and mount the switches in the same manner. If you are using the working version, and will be using it as a part of a complete project or more complex setup, use your judgment as to mounting the board.

Testing

When you have the board (either style) finished, leave the IC's out of their sockets and connect the power terminals to 9–15 volts DC. Then check for +5 volts DC at pin 3 of the regulator, pin 4 of IC1, pin 2 or 3 of IC3, and (with the experimenter's unit only) pin 14 of IC4 and IC5.

Disconnect power, insert IC1, and then connect power again. Check for an AC voltage at pin 7 of IC1. It should vary with the level of sound up to about 2 volts peak. Check the voltage at pin 14 of IC1. When the sound level is high enough, a 2-volt signal should be present. If the comparator is functioning correctly, pin 14 should switch between no signal and a 2-volt AC signal,

with nothing in between. If you're using an oscilloscope, look for a 0–4 volt signal at pin 7, and a 0 or 4 volt clipped signal at pin 14.

Once the board has passed these tests, remove the power and insert the rest of the IC's. When you reconnect power, all LED's should remain off, or if you're using a board without the indicators, all of the outputs should be high. Say "Go." The appropriate LED should light (or the output will go low). Try the other phrases to make other LED's light. Don't worry if the circuit doesn't seem to respond well—it takes a little practice to speak the words and phrases clearly enough for the VCP200 to understand. Table 1 explains how to pronounce the words so that the VCP200 will understand them.

Modifications

The gain of the amplifier may be adjusted by changing the value of R4, R7, or both. Adjusting R7 is preferred. The higher the resistor values, the higher the gain of the amplifier. Lowering the gain will lessen the circuit's sensitivity to background noise, but will require the operator to speak rather loudly and directly into the microphone. Raising the

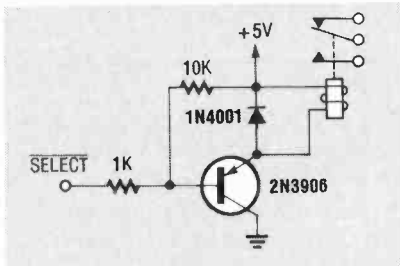

FIG. 7—BASIC POWER DRIVER CIRCUIT for interfacing the project to motors, lamps, or other high-current devices. The relay must have a 5-volt coil, but can have any arrangement of contacts suitable for the application.

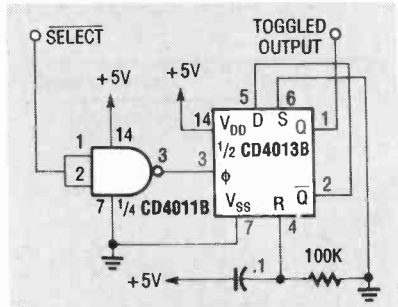

FIG. 8—TOGGLED, LATCHING interface circuit. The output switches states on successive occurrences of the associated voice command.

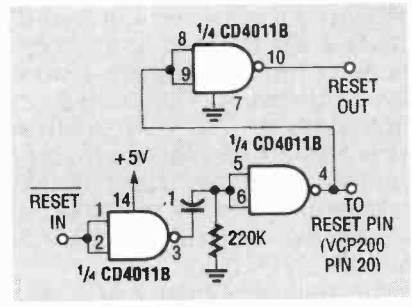

FIG. 9—THIS CONTROL CIRCUIT allows the project to be latched into forward or reverse motion while permitting other voice commands to be processed.

gain will allow softer speaking from a greater distance, but at the expense of greater sensitivity to noise.

The frequency response of the amplifier is about 300 to 9000 Hz. Since the VCP200 responds to frequencies from 300 to 5500 Hz, reducing the upper cutoff point of the amplifier to 6000 or 7000 Hz would probably make it less sensitive to noise. If you are familiar with op-amp circuit design, a good way to improve the project would be with a high-precision bandpass amplifier. It should have a nearly flat response from 500 to 6000 Hz, with a sharp rolloff (third-order or better) at each end. The flatter the bandpass response and the sharper the cutoff points, the better the overall performance is likely to be. Higher frequencies are more sharply attenuated by distance and may need extra boost (actually less cut) in order for the VCP200 to successfully decode them.

The comparator threshold is set by the lower output of the resistor divider string R5-R8-R9. Since the artificial ground level or offset voltage of the amplifier is set by the upper output of the same string, some care is needed when adjusting either voltage so as not to disturb the other. The amplifier offset should be kept as close to +0.5 volts (or 2.5 volts) as possible, to ensure proper amplifier operation (i.e., balanced clipping of the signal). Thus, the series value of R8 and R9 should always be the same as that of R5.

If the comparator threshold is very close to the amplifier offset, very low-level sounds will be "digitized" by the comparator and make their way to the VCP200's input. That would permit better

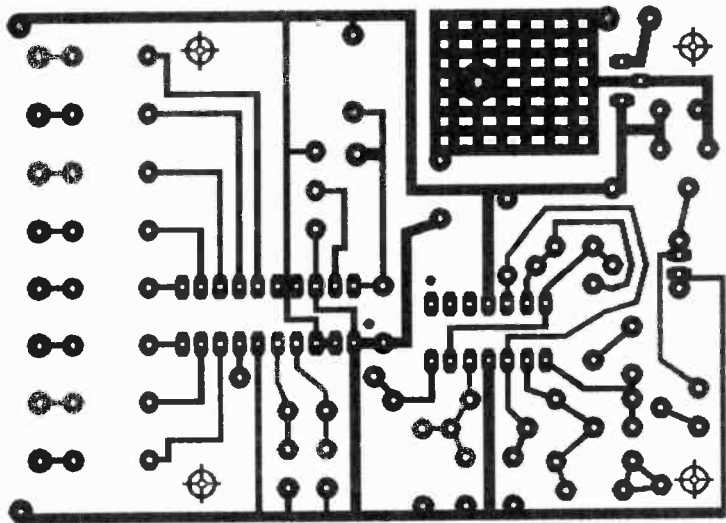

HERE'S THE FOIL PATTERN for the experimenter's version of the circuit, which includes the indicator LED's.

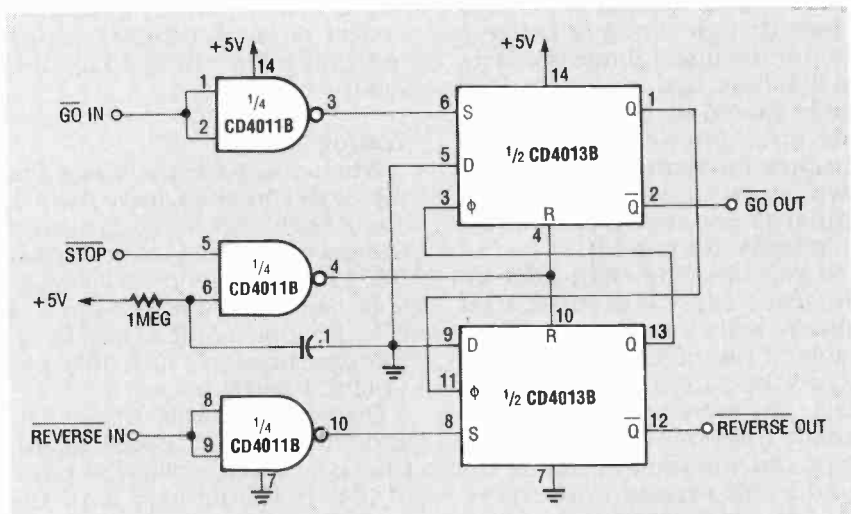
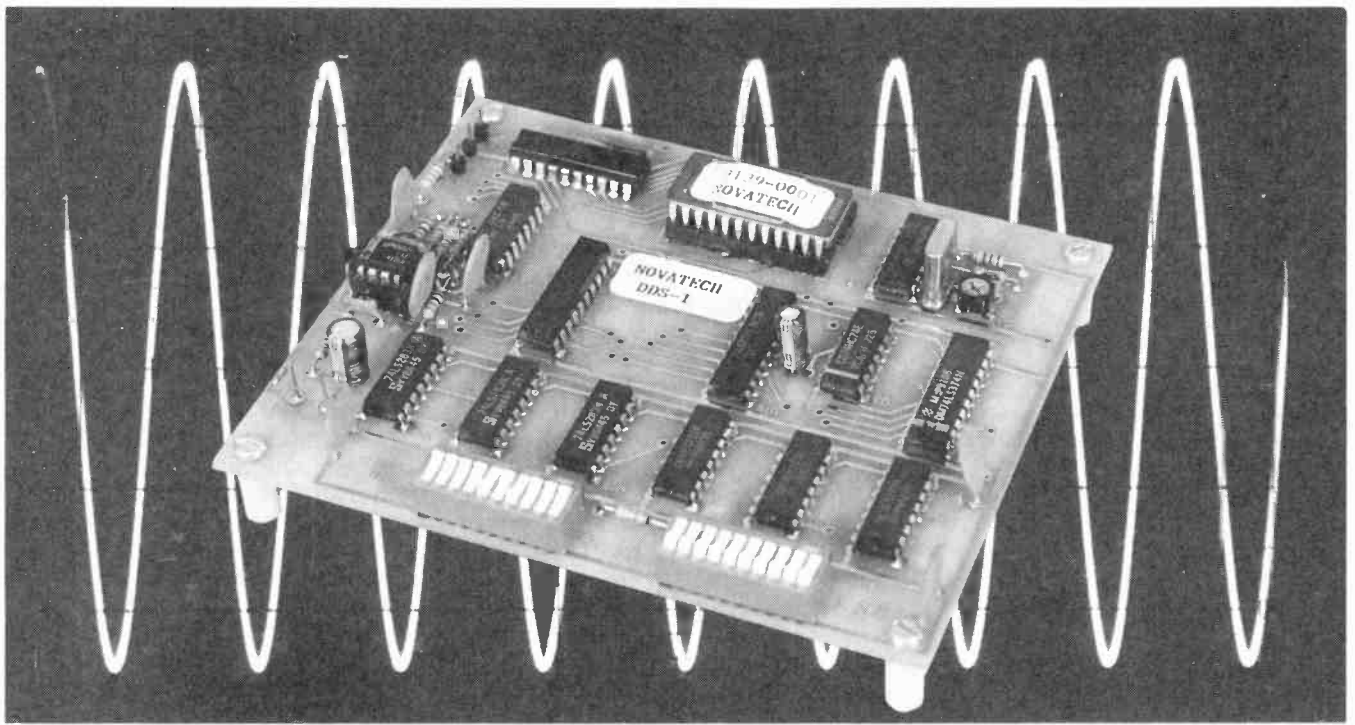

FIG. 10—A "SUICIDE" RESET CIRCUIT permits the voice-recognition circuit to be reset via voice command.

operation over distance or with softly-speaking users, but would make the unit prone to interference from noise. If the comparator threshold is set further

from the amplifier offset, noise will be rejected but louder speech or shorter-range operation will be required. For extensive experi-

continued on page 57



STEVEN D. SWIFT

DIGITAL SINEWAVE SYNTHESIZER

***Build this direct digital synthesizer,
and generate low-distortion sine waves digitally.***

HOW OFTEN HAVE YOU WISHED YOU had one of those fancy frequency generators that let you set your frequency accurately without having to fiddle with the uncalibrated tuning knob? Without a high-quality frequency counter and without nearly infinite patience, it is impossible to keep your audio oscillator on frequency without constant tweaking. If you eliminate the expensive extras, while retaining resolution and stability, you'll end up with the synthesizer project presented in this article.

While this synthesizer doesn't have the features of some very expensive products, it does provide 1-Hz resolution at over 500 kHz with crystal-controlled precision, all for less than \$70. Once you add a suitable enclosure and power supply, you'll have a digital

frequency synthesizer small enough to fit on even the messiest workbench. And it's perfect for providing that odd-ball frequency that your new project needs.

Direct digital synthesis

As the name implies, direct digital synthesis (DDS) is a method of frequency generation that uses digital methods rather than the traditional analog oscillator, phase-locked loop, or bank of crystals. The availability of fast digital circuits and D/A converters make this technology available to the average electronics enthusiast.

A review of trigonometry is important to the understanding of DDS before delving into the details of the electronics. Figure 1 shows a circle with a radius

whose length is arbitrarily set to one. The radial line labelled R is allowed to rotate about the circle through an angle P, which will be referred to as the phase. Drawing a horizontal line from the tip of R until it intersects with the vertical axis defines the length S shown in the figure. As the radius, R, is allowed to make a complete rotation around the circle, the length of S takes on all values between +1 and -1, while P varies from 0 to 360 degrees. The length S is precisely the sine function of P, $\sin(P)$, shown in Fig. 2-a.

If, rather than allowing R to rotate smoothly around the circle, we make 8 equal steps around the circle, then the values of S form the stepwise approximation shown in Fig. 2-b. As the number of steps are increased, the ap-

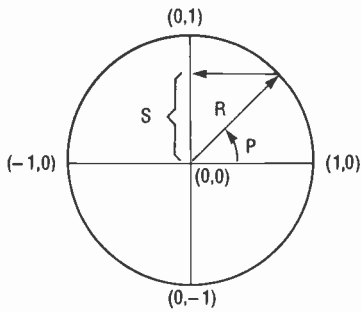

FIG. 1—THIS CIRCLE HAS A RADIUS whose length is arbitrarily set to one. As R rotates around the circle, S takes on all values between +1 and -1.

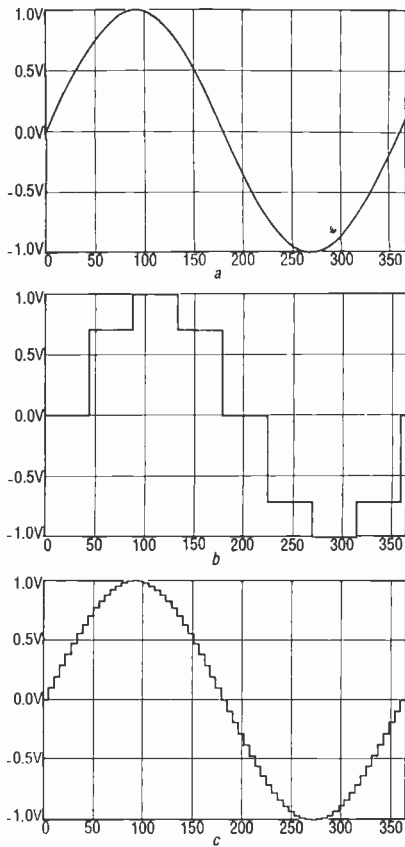

FIG. 2—THE LENGTH S, AS R ROTATES, is the sine function of P (a). If we make 8 equal steps around the circle, then we get the stepwise approximation shown in b. If we make 64 steps, the approximation becomes closer to the actual sine function (c).

proximation becomes closer to the actual sine function, with Fig. 2-c showing the approximation for 64 steps. In practice, analog filtering is used to smooth out the steps, as we'll see in a minute.

From this simplified discussion, a method for generating a varying frequency can be derived. Assume that each step occurs at a precisely determined

instant, then by varying the step size the number of steps around the circle can be varied. The fewer the steps, the faster the complete circle is covered, hence the higher the frequency of the sine-wave approximation. Note that fewer steps means a coarser approximation to the actual sine function, with the output eventually reducing to a square wave, which points out one of the limits of this technique. All we need now is a circuit that will synchronize the variable-phase steps to a precision clock.

Figure 3-a shows a block diagram of the system. The block labelled Phase Accumulator repetitively adds the value set by the Step Size Programmer to the sum performing the function of stepping the radius (R) about the circle in equal phase increments. The phase accumulator behaves like a simple counter, except that

rather than incrementing its output by one on each clock pulse, the output advances by the value set by the step size programmer on each clock pulse. The block labelled SIN(P) converts the value stored in the phase accumulator to a sine amplitude approximation. The step size programmer is simply a bank of DIP switches, the phase accumulator is a series of cascaded 4-bit adders, and the SIN(P) block is a sine look-up table contained in an EPROM.

The digital data present at the output of the SIN(P) block must be converted to an analog voltage in order to be useful. A method for doing this is shown in Fig. 3-b, which consists of a D/A converter, filter, and output amplifier. The filter helps to smooth out the jagged steps in the sine approximation, while the output amplifier buffers the output of the D/A converter. In the actual

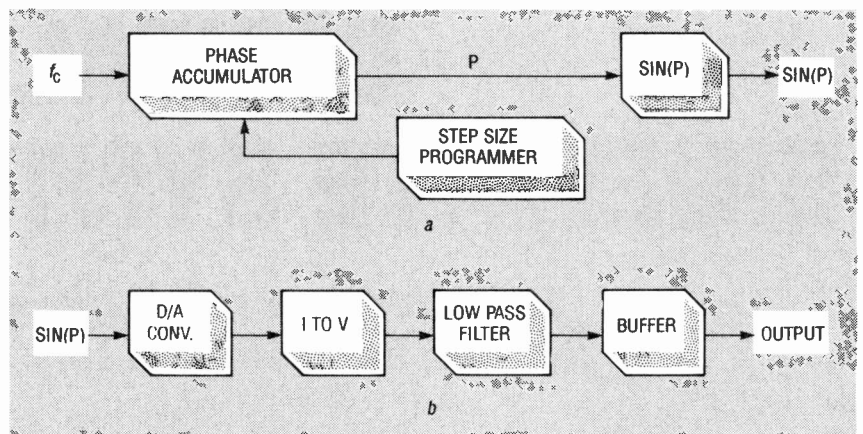

FIG. 3—BLOCK DIAGRAM of the phase accumulator and phase-to-sine converter (a), and the block diagram of the digital-to-analog converter and output stage (b).

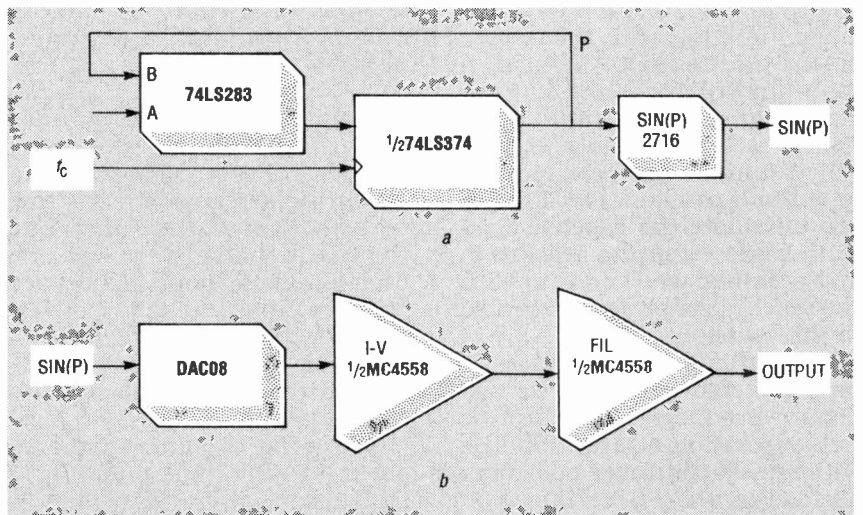

FIG. 4—PARTIAL SCHEMATIC of the phase accumulator (a) and the converter and output stage (b).

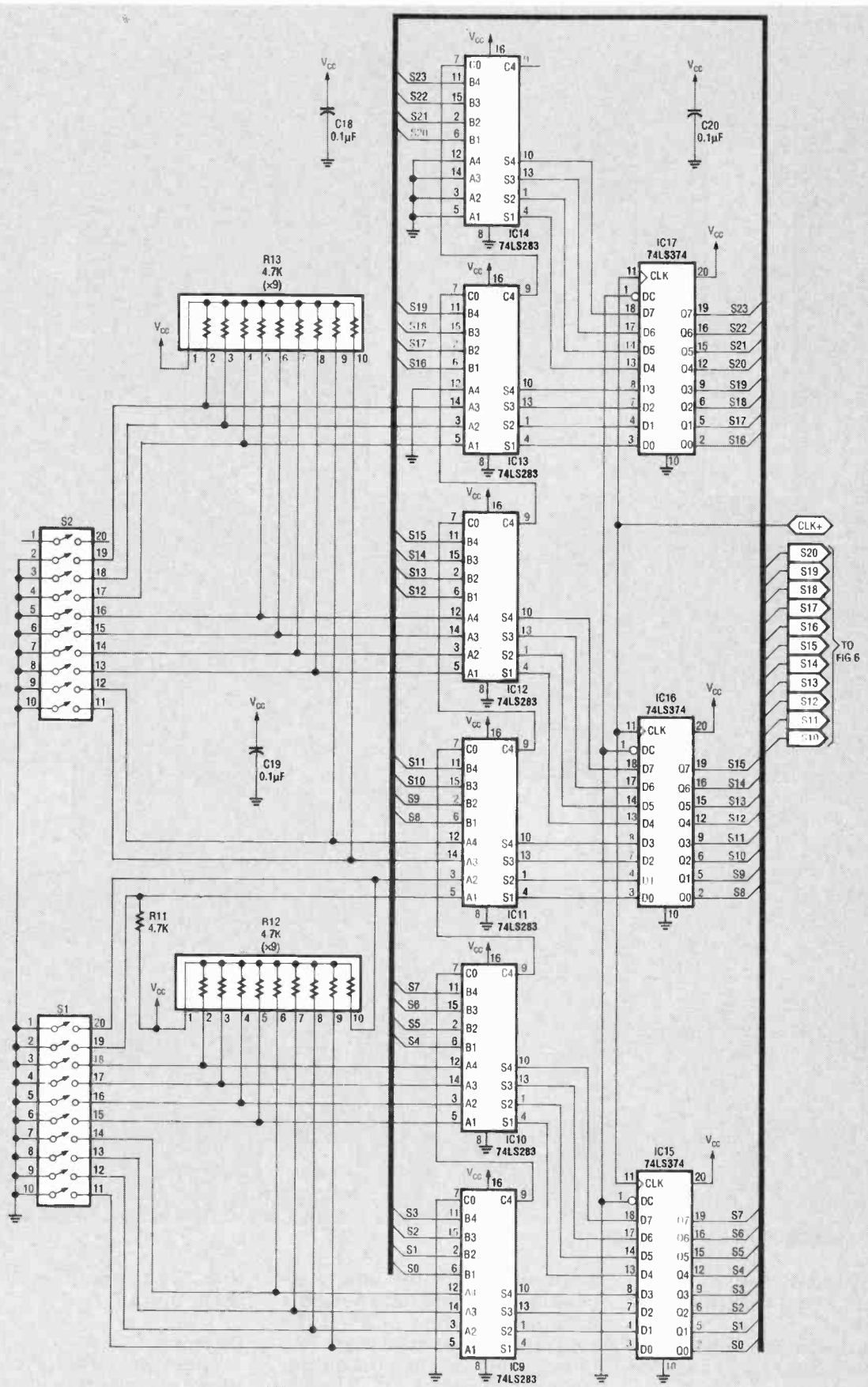
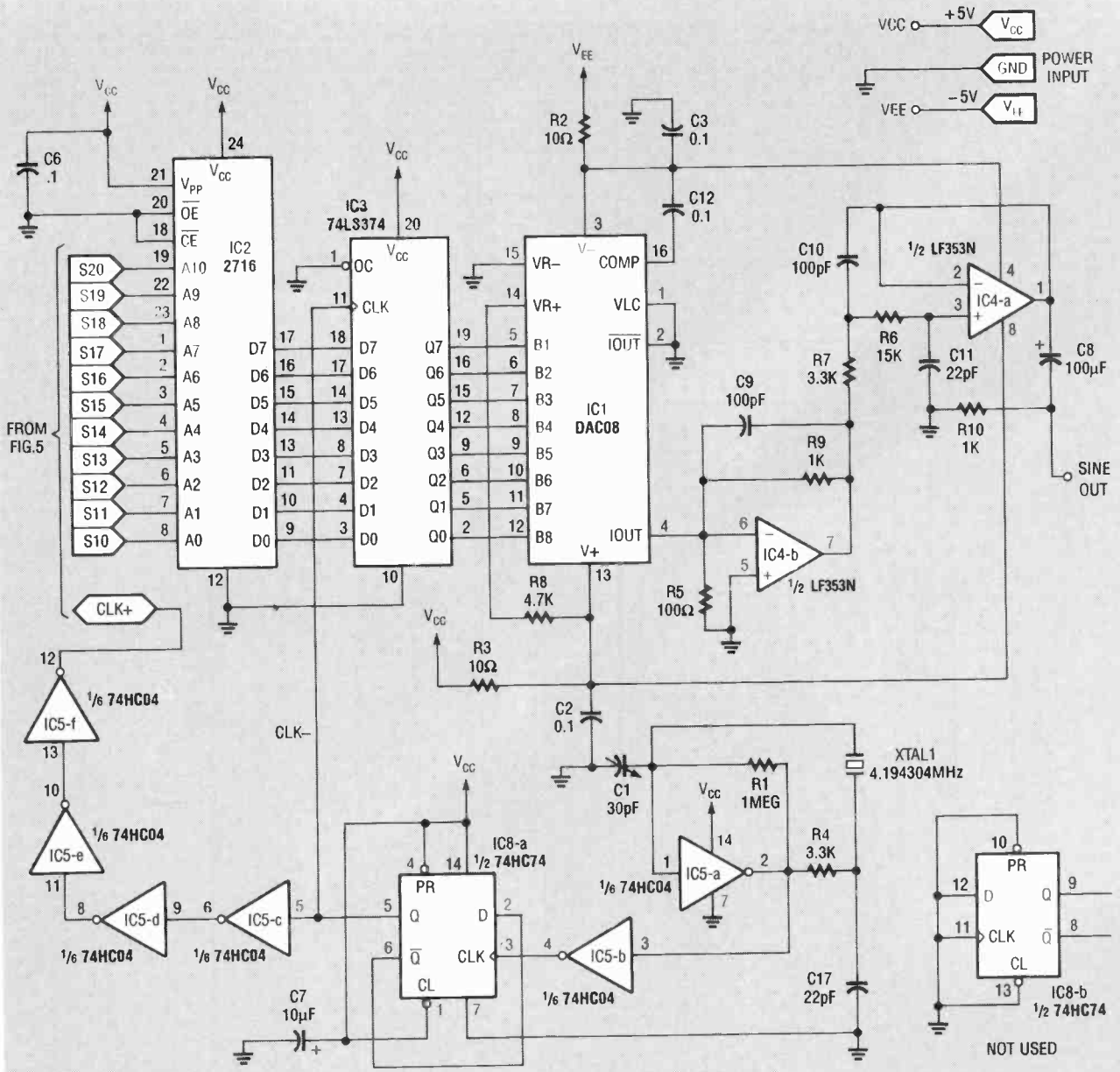

FIG. 5—HERE'S THE COMPLETE SCHEMATIC for the phase-accumulator circuitry.



OPTIONAL POWER SUPPLY

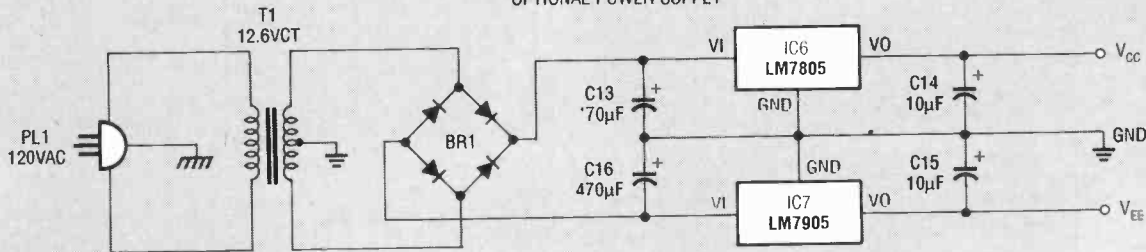

FIG. 6—THE SCHEMATIC for the analog section.

implementation, the buffering and the filtering functions are combined.

The frequency resolution of a DDS system is set by the master clock frequency, f_c , and the number of bits, N , in the phase

accumulator. For the binary accumulator that we have here, the resolution is then $f_c/2^N$. If the step size programmer is set to a binary value, M , then the output frequency is $M \times f_c/2^N$. The design presented here keeps M less

than $N/4$ to minimize distortion at the output.

Circuitry

There are several manufacturers of complete integrated circuits that can perform the digital

portion of the block diagram, but these parts are expensive and not readily available. Figure 4-a shows a partial schematic of the phase accumulator using components that are inexpensive and easy to get.

The complete phase accumulator consists of six 74LS283 4-bit adders, with their outputs latched by three 74LS374 octal D flip-flops. The outputs of the 74LS374's are fed back to the B inputs of the 74LS283, which forces the sum stored in the latches to be added to the value set by the switches on the A inputs. Since the 74LS374 stores data only at the positive edge of its clock input, the fact that the data presented to its inputs will be changing shortly after the clock causes no errors. The delay through the latch and adder guarantee glitch-free operation. At each clock pulse a new sum is present at the output of the latch. The output of each adder then stabilizes with the new sum allowing the cycle to repeat continuously. This sum represents the value P in the theoretical discussion, while the value set by the DIP switch represents the size of each phase step.

The sine-wave lookup table is contained within a single 2716 EPROM providing phase-to-amplitude conversion. Although 24 bits are available in the phase accumulator as implemented here, only 21 bits are used to maintain compatibility with readily available crystals. For those who wish to program their own EPROM, both a hex dump of the contents of the EPROM and an S-Record formatted hex dump for use with PROM programmers can be downloaded from the R-E BBS (516-293-2283, 1200, 2400, 8N1) in a file named DIGSYN.HEX. A programmed EPROM is available from the source shown in the parts list.

The data in the EPROM represents the values generated by the mathematical function $127.5(\sin(2\pi P/2048 - \pi/2))$ truncated to 8-bits, with P taking on values from 0 to 2047, that is, the addresses of the EPROM. The formula offsets the sine function so that its value ranges from 0 to 255 as P ranges from 0 to 2047 and avoids negative values which would complicate the next stage.

That matches the function to the 2716 EPROM with its 11-bit address space and with its 8-bit output range. A C-program used to generate the values in the table is shown in Listing 1. Since the EPROM has only 11 address lines, only 11 lines from the accumulator are used in this application. The 8 bits at the output of the EPROM are a digital representation of the amplitude of the sine wave and must be converted to an analog voltage before being filtered and buffered.

Since simplicity and low-cost were design goals, the output of the EPROM is latched by another 74LS374, which allows the full clock period for the EPROM output to settle, permitting the use of inexpensive slow EPROM's. The latch also guarantees a glitch-free input to the D/A converter section.

Figure 4-b shows the D/A converter circuitry. The D/A conversion is accomplished using a DAC08 8-bit D/A converter (an MC1408 can be substituted with some loss in performance). The output of the converter is a cur-

rent proportional to the digital value present on its 8-bit parallel input. The current is set by R8 to a maximum of 1.06 mA. The digital word presented to the D/A varies from 0 to 255, forcing the current output to vary from 0 to $(255/256) \times 1.06$ mA. The current is then fed to op-amp IC4-b which converts it to a voltage that varies from 0 to approximately 1.0 volt. The complete schematic for the phase accumulator circuit is shown in Fig. 5, and the schematic for the analog section is shown in Fig. 6.

First-order filtering is accomplished by C9 in this conversion stage. Op-amp IC4-a provides additional filtering to further smooth out the steps in the sine approximation. The output of this two-pole filter is AC-coupled to the output connection. Figure 7 shows the relative response of the filtering provided in the output stage. The corner frequency of the filter is set by the formula

$$f_o = 1/(2\pi\sqrt{R7 \times C10 \times R6 \times C11})$$

which, for the values shown, is equal to 482 kHz. A high-speed

LISTING 1

```

/* This program calculates the value of the sine function
   offset so that the 4th and 1st quadrants cause a code
   from 0 to 255. Code is generated to fill a 2048 byte prom
   (2716 or equivalent) for a full circle of 2*pi radians.
   Other size memory may be used by changing the value of
   bytes in the declaration table. */

#include <stdio.h>
#include <math.h>

main()
{
    double p=0; /* phase input to sin fcn */
    double S=0; /* output value of true sin fcn */
    int s; /* amplitude truncated to 8 bits */
    double sin(); /* true sin fcn */
    double pi=3.141592654;
    int addr=0; /* address of EPROM */
    int bytes=2048; /* size of EPROM in bytes */

    printf(" 0 1 2 3 4 5 6 7 8");
    printf(" 9 a b c d e f \n");
    while (addr < bytes)
    {
        if (addr % 16 == 0)
            printf("\n%4x ", addr);
        p = 2.0*pi*((double) addr)/((double) bytes);
        S = 127.5*(1.0+sin(p - pi/2.0)); /* gives 0 at -90 deg */
        s = (int) S; /* convert to an integer */
        if (S < ((double) s) >= 0.5) /* rounds if necessary */
            s++;
        printf("%2x", s);
        addr++; /* increment address */
    }
}

```

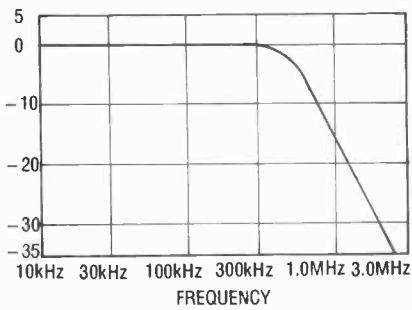

FIG. 7—THE RELATIVE RESPONSE of the filtering in the output stage. The corner frequency is equal to 482 kHz. A high-speed op-amp is required to effectively filter the waveform.

op-amp is required in this stage to filter the waveform effectively. The 4558 op-amp we used is a good compromise between performance and cost.

The clock for all functions is provided by a crystal oscillator running at 4.194304 MHz, which happens to be exactly the 22nd power of two. The clock is divided by two to provide the phase-accumulator clock and EPROM latch clock. Additional inverters are used as delay elements to ensure that the latches are clocked at precisely the right instant to prevent glitches. With the clock and timing as such, EPROM's with access times as slow as 475 ns can be used.

With 21 bits of the phase accumulator used and a clock frequency of $4.194304/2$ MHz (f_c), the output resolution is precisely 1 Hz. Since 19 bits are presented as the input to the phase accumulator by the DIP switch, the maximum output frequency is:

$$2^{19} \times f_c / 2^{21} = f_c / 4 = 524.288 \text{ kHz}$$

While a DDS system can approach $f_c/2$, $f_c/4$ was chosen as a maximum to limit the total distortion in the output waveform. The top frequency is actually 1 Hz less than that because the maximum setting is $2^{19} - 1$ for a 19-bit binary input. The filter rolloff shown in Fig. 7 attenuates clock-related distortion by over 30 to 1.

Construction

A double-sided PC board is available from the source shown in the parts list, and we've also provided the foil patterns in case you want to make your own board. If you're using the PC board, follow the parts-place-

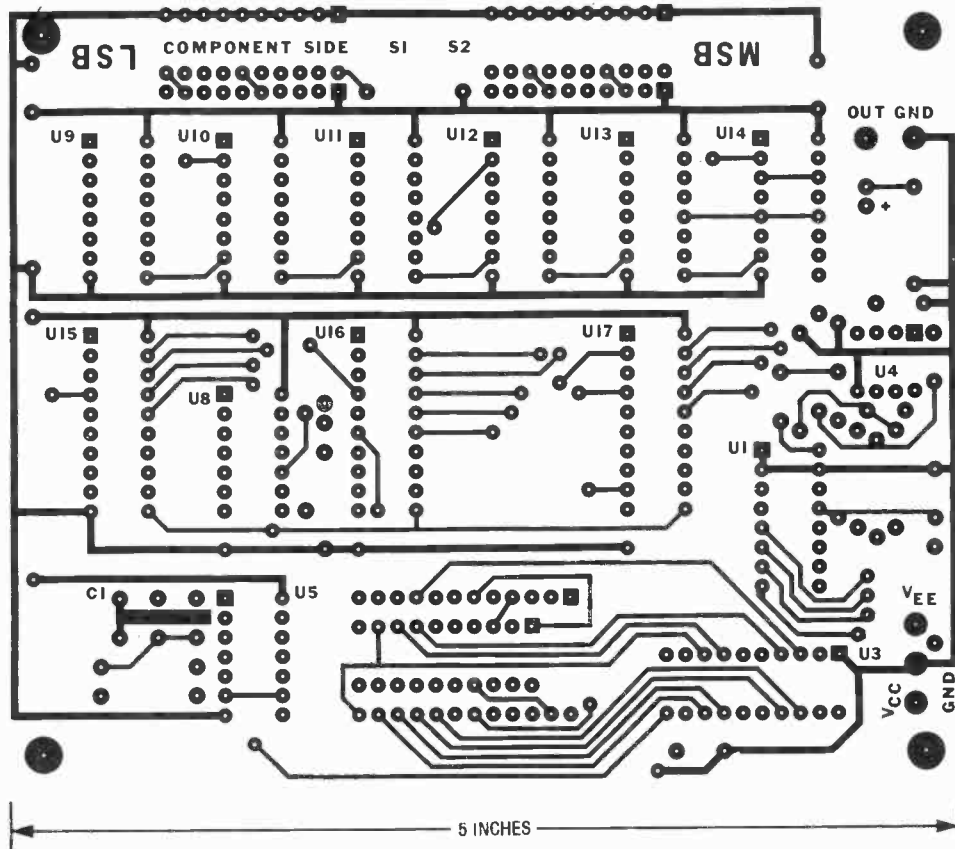

FOIL PATTERN for the component side of the digital synthesizer.

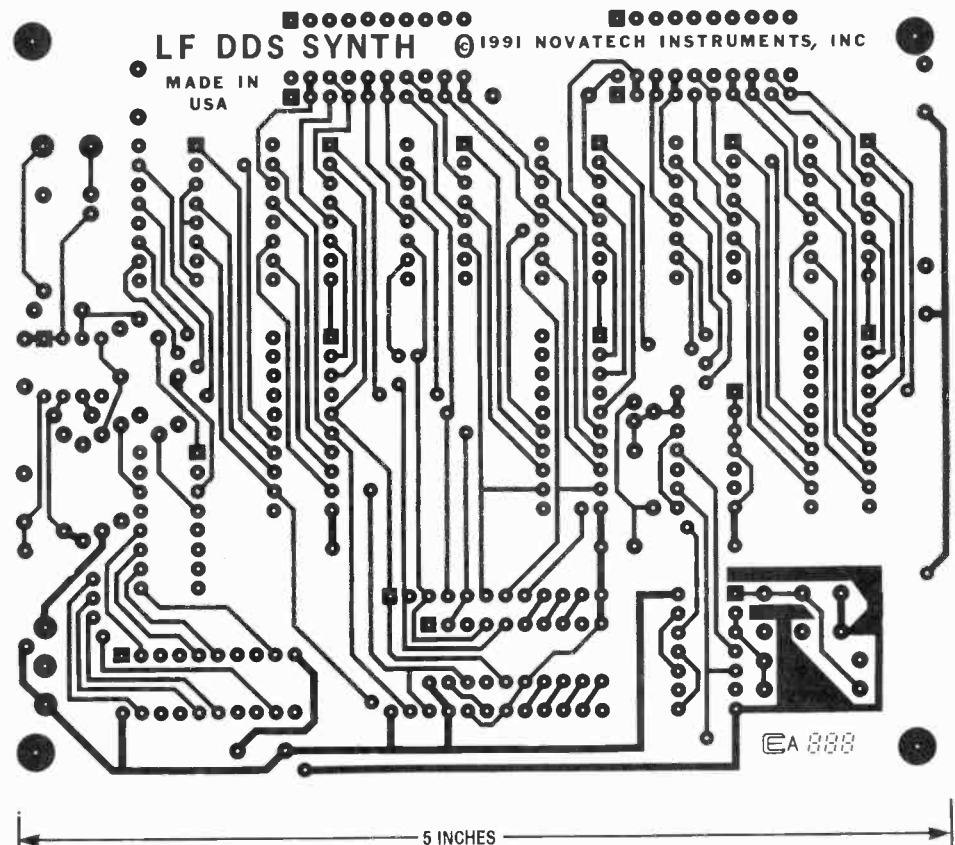

FOIL PATTERN for the solder side of the digital synthesizer.

ment diagram shown in Fig. 8. Note that IC5 and IC8 are high-

speed CMOS and must therefore be handled carefully to prevent

PARTS LIST

All resistors are 1/4-watt, 5%.

R1—1 megohm
 R2, R3—10 ohms
 R4, R7—3300 ohms
 R5—100 ohms
 R6—15,000 ohms
 R8, R11—4700 ohms
 R9, R10—1000 ohms
 R12, R13—4700 ohms × 9, 10-pin SIP resistor

Capacitors

C1—5–30 pF trimmer
 C2, C3, C6, C12, C18–C20—0.1 μF, ceramic disc
 C4, C5—not used
 C7, C14, C15—10 μF, 35 volts, electrolytic
 C8—100 μF, 16 volts, electrolytic
 C9, C10—100 pF, ceramic disc
 C11, C17—22 pF, ceramic disc
 C13, C16—470 μF, 16 volts, electrolytic (optional for power supply)

Semiconductors

IC1—DAC08CN 8-bit D/A converter
 IC2—2716 2K × 8-bit EPROM
 IC3, IC15–IC17—DM74LS374N octal latch
 IC4—LF353N dual op-amp
 IC5—MM74HC04N hex CMOS inverter
 IC6—LM7805 +5-volt regulator (optional for power supply)
 IC7—LM7905 –5-volt regulator (optional for power supply)
 IC8—MM74HC74AN dual D-type CMOS flip-flop
 IC9–IC14—DM74LS283N 4-bit adder
 BR1—1-amp bridge rectifier (optional for power supply)

Other components

XTAL1—4.194304 MHz crystal
 S1, S2—10-position DIP switch
 PL1—AC line cord (optional for power supply)
 T1—120VAC/12.6VAC transformer (optional for power supply)

Miscellaneous: PC board, solder, case, mounting hardware, etc.

Note: The following items are available from NOVATECH INSTRUMENTS, INC., 1530 Eastlake Ave. E, Suite 303, Seattle, WA 98102 (206) 328-6902:

- Complete kit of parts (except a case and the optional power-supply parts)—\$69.95
- Please add \$5.00 shipping and handling. Washington State residents must add 8.2% sales tax.

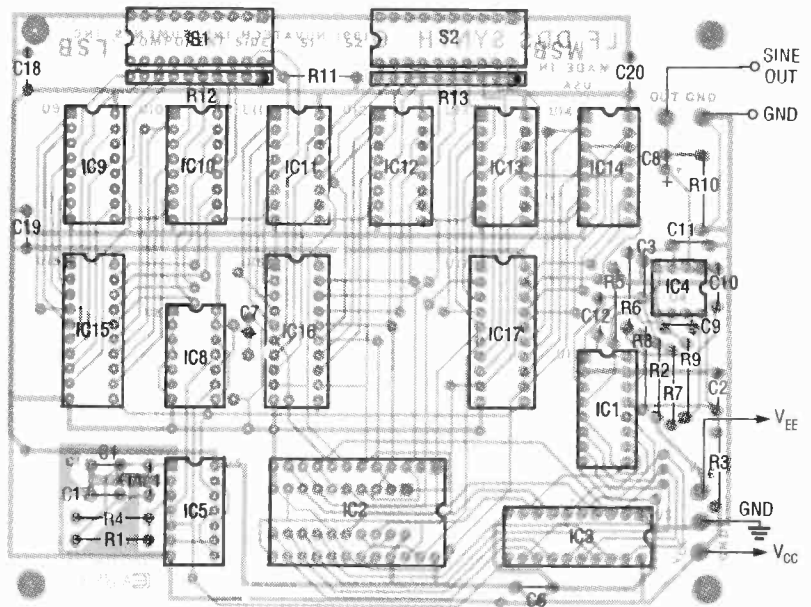

FIG. 8—PARTS-PLACEMENT DIAGRAM. Follow this diagram if you're using a PC board. The smaller IC outline beneath IC2 is for experimenting with a faster EPROM such as a 74S472 (see test).

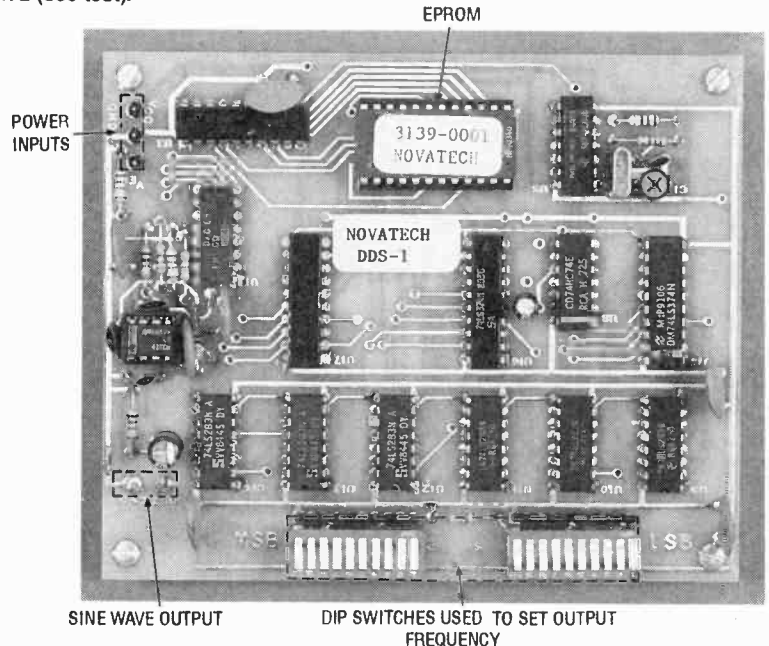

FIG. 9—THE COMPLETED UNIT. This compact PC board can easily be installed in almost any kind of project case.

damaging them. Use a grounded-tip soldering iron (if you've got access to one) and ground yourself before picking up the board or an IC. Space for the optional power supply (shown in Fig. 6) is not provided on the PC board, but it can be made on any kind of board. The power-supply circuit is not critical, but be careful due to the line voltages present. Figure 9 shows the completed unit.

Since the majority of the circuit is digital, simple wiring techniques can be used. The author's original prototype was

built using wire-wrap methods for the digital section and point-to-point for the analog section. If you're wire-wrapping the circuit, some care must be applied to the analog section to prevent digital switching noise from getting into the output. The ground returns for all of the analog section must connect to the power supply separately from the digital section and the analog bypass capacitors must be connected as close as possible to the analog integrated circuits. The oscillator, consisting of IC5-a, R1, R4, C1 and

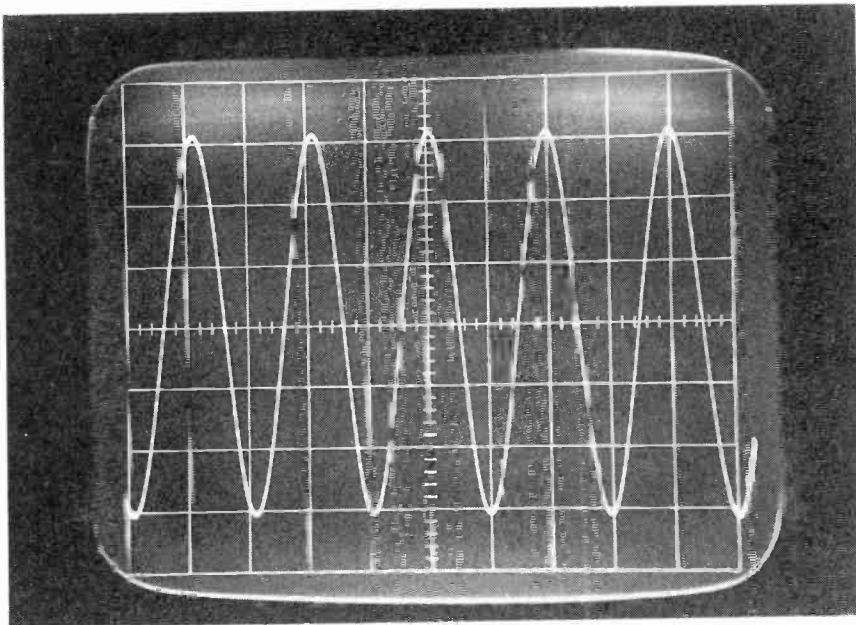

FIG. 10—OUTPUT OF THE AUTHOR'S PROTOTYPE at 100 kHz (5 μ s/div. horizontal, 0.2V/div. vertical)

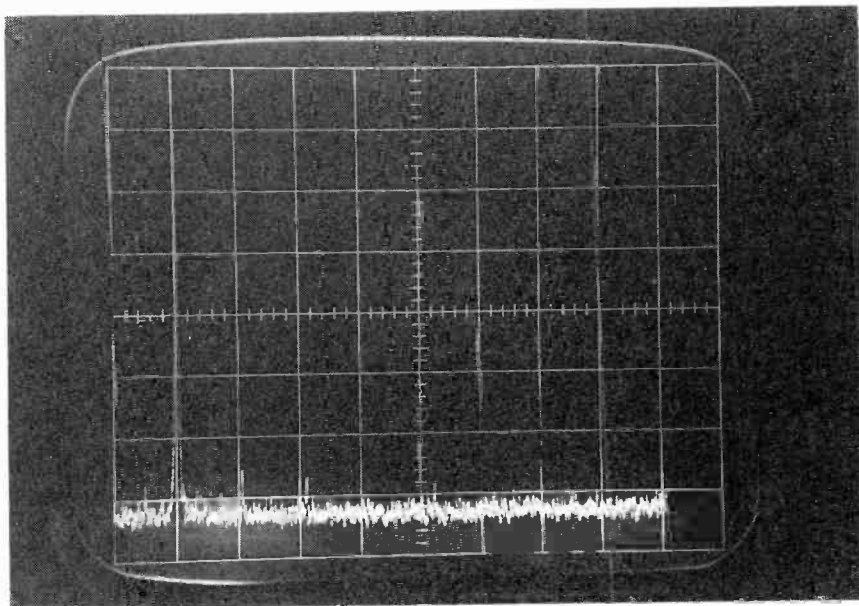

FIG. 11—SPECTRUM ANALYZER PHOTOGRAPH of the 100-kHz output. (100 kHz/div. horizontal, 10dB/div. vertical, 500 kHz center frequency, 10 kHz resolution bandwidth)

TABLE 1—SPECIFICATIONS

Frequency Range:	1 Hz to 524.287 kHz
Resolution:	1 Hz over complete range
Accuracy:	Depends on crystal, typ. 0.005%
Output:	Low distortion sine wave
Output amplitude:	Approx. 1 volt peak-to-peak, decreases at top end
Power requirements:	+5V at approx. 250 mA -5V at approx. 50 mA

XTAL1, must be tightly wired. The author's original prototype had the discrete components soldered directly to the wirewrap-socket pins of IC5. A board with an existing ground plane is ideal for wire-wrap construction.

Operation

Before turning on the power, carefully inspect the board for shorts, solder bridges, wiring errors, etc. Set the DIP switch to any non-zero value. If you have a frequency counter available, con-

nect it to pin 5 of IC8-a. If you don't have a counter, adjust C1 to mid-range; with the crystal specified, your error should be no more than about 0.02%. Apply power and, using an insulated adjustment tool, adjust C1 to exactly 2.097152 MHz if you have a counter connected. With an oscilloscope connected to the output, vary the DIP switch setting; you will see the frequency change. For higher and higher frequencies the distortion will increase with the maximum distortion at the highest setting.

The frequency output is equal to the binary value set by the DIP switches, with a logical 1 corresponding to an "off" position. For a switch setting of 001,1000,0110,1010,0000 (100 kHz), the author's prototype gave the waveform shown in Fig. 10. A spectrum-analyzer display of the 100-kHz output is shown in Fig. 11. Note that the harmonics are at least 40 dB down, corresponding to about 1% distortion. Varying the least-significant DIP switch will change the frequency output by 1 Hz. Since the frequency is set by the DIP switch and the accuracy of the crystal oscillator, the output will be the same even after a power-down, power-up cycle. Table 1 summarizes the specifications for the completed digital synthesizer.

Experiments

If the digital parts are changed from 74LS to 74F, the EPROM changed to a bipolar PROM (such as a 74S472 which is accommodated on the circuit board), and the clock oscillator replaced by a faster one, the output frequency can be increased at the expense of resolution. The author has successfully operated the circuit up to a 5.0-MHz output frequency, providing 10 Hz resolution. The circuit is simple and compact enough that several units can be built to provide fixed calibration frequencies needed on your bench. High-speed CMOS logic may be substituted for the low-power TTL devices for lower-power operation. If you decide to change to CMOS, IC3 must be a 74HCT374 as the output of the EPROM is TTL-compatible. Advanced CMOS, 74AC or 74ACT, should not be used because of noise induced by its fast edge rates.

R-E

Our solid-state Tesla coil can produce

sparks as long as 8 inches with a peak

output of about 100,000 volts.

SOLID STATE

TESLA COIL

DUANE A BYLUND

Tesla coils have been around for almost 100 years and, with the exception of vacuum-tube driven coils, not much has changed from the way Nikola Tesla invented them. This article describes a new type of Tesla coil; a true solid-state Tesla coil. One thing that makes our Tesla coil unusual is that the coupling to the secondary coil is by a direct electrical connection rather than by magnetic fields. Direct coupling is not new to Tesla coils but it is seldom seen.

The solid-state Tesla coil is by no means as spectacular as capacitive-discharge Tesla coils but it gives just as good, or better, performance as a vacuum-tube Tesla coil. Sparks as long as 8 inches are possible with a power-line consumption of 2 amps at 120 volts (see Fig. 1), and the output reaches a peak of about 100,000 volts. Although the average power input to the device is around 250 to 300 watts, the peak input power to the Tesla secondary coil is about 800 watts. The Tesla coil is an excellent teaching tool, as many interesting things may be learned with the aid of this device.

Circuit description

The schematic for the solid-state Tesla coil is shown in Fig. 2. The secondary of the Tesla coil, when directly driven by a solid-state driver, appears like a series RLC circuit. That's due to the self-capacitance of the coil with respect to ground. The capacitance is normally very small with the inductance being fairly large. At the resonant frequency, the inductive reactance cancels the capacitive reactance. The effective impedance is limited by such losses as the DC resistance of the coil, AC skin effect of

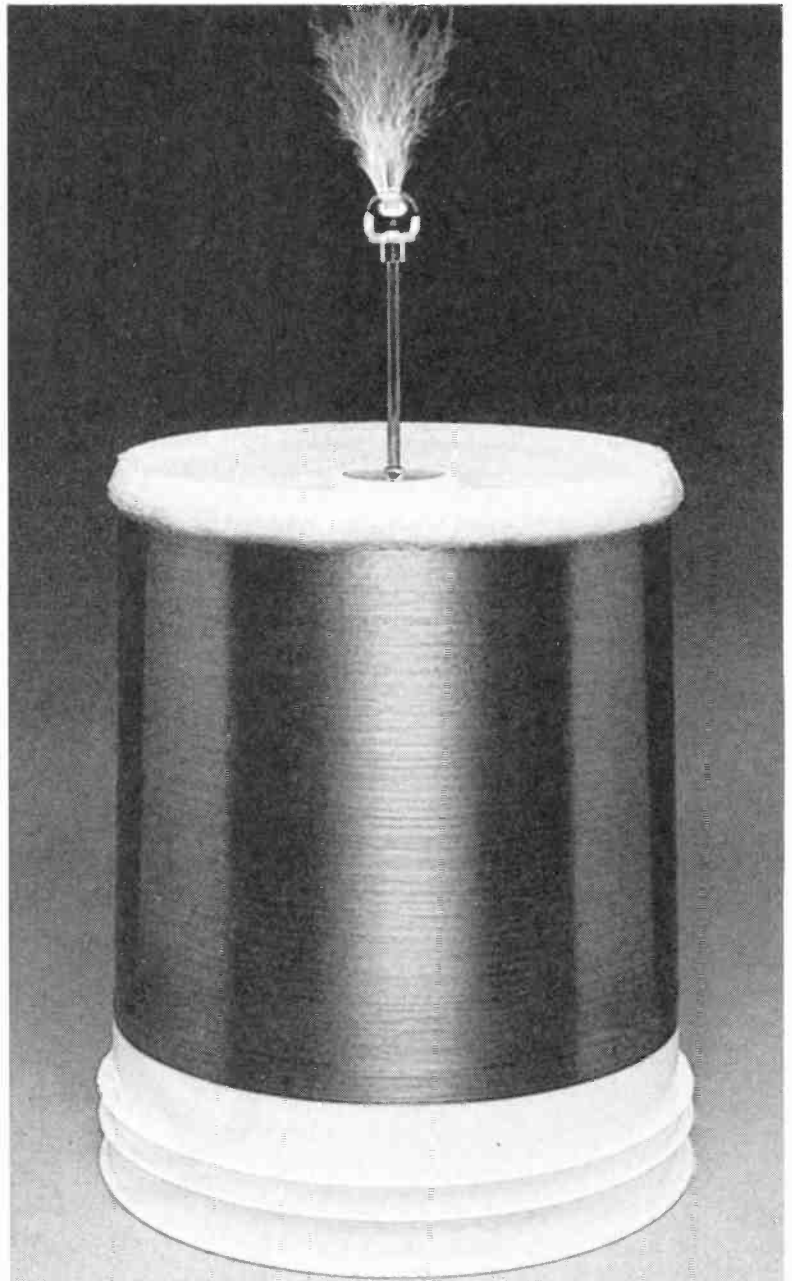

the wire, eddy currents induced in nearby objects by the field of the coil, and so on.

Series RLC circuits have relatively low impedances when operated at the resonant frequency. The coil used in this project, when operated at its resonant frequency, looks like a 450-ohm resistive load to the solid-state driver. Series RLC circuits produce high voltages on the inductor and capacitor at the resonant frequency. The high voltage is due to a high current flowing through a high reactance (remember that the inductance is large and the capacitance is small, creating large reactances in each component at a given frequency). That is what produces the corona discharge at the end of the secondary coil.

The heart of the driver is IC1, the SG3524 pulse-width modulator. The duty cycle is fixed at about 45% for best efficiency. The frequency is controlled by the resistance on pin 6 and the capacitance on pin 7. With the values shown, the frequency has a range from 200 to 240 kHz. A flip-flop inside the chip divides that by 2 so that the effective output of the driver has a range from 100 to 120 kHz.

The outputs on pins 12 and 13 are 180 degrees out of phase with

Warning!! This article deals with and involves subject matter and the use of materials and substances that may be hazardous to health and life. Do not attempt to implement or use the information contained herein, unless you are experienced and skilled with respect to such subject matter, materials, and substances. Neither the publisher nor the author make any representation as for the completeness or accuracy of the information contained herein, and disclaim any liability for damages or injuries, whether caused by or arising from the lack of completeness, inaccuracies of the information, misrepresentations of the directions, misapplication of the information, or otherwise.

each other, and drive the gates of MOSFET's Q1 and Q2, which, in turn, drive the primary of transformer T1. Transformer T1 drives the bases of switching-transistors Q3 and Q4. The components in the base circuitry are used to increase the switching speed of the transistors. Transistors Q3 and Q4 switch the line voltage across the primary of T2, which increases the voltage and drives the end of the secondary coil directly. Note that the line voltage delivered to T2 is half-wave rectified by D1. That is important to the operation of the Tesla coil because a pulsating voltage is needed to produce the best effects.

When the device is plugged into a wall receptacle it will be in its standby mode. That is, the 21-volt power supply will be operational and the FET's will be driving the primary of T1. The standby mode produces enough power to "tune" the driver to the coil's resonant frequency before

full power is applied. (Remember that the resonant frequency can be affected by nearby objects.) The current supplied to the secondary coil is indicated by LED1. Tuning is accomplished by adjusting the frequency via R1 and observing LED1. When resonance is achieved, the secondary coil will have a low impedance which will produce maximum current, lighting the LED. Diodes D3-D6 limit the forward and reverse voltages on LED1 when in the high-power mode. (Note that you must use an LED that lights at 1.5 volts—some LED's, including most green ones, need 2.1 volts or higher.

When the device is switched into the operating mode (or the high-power mode), half-wave line-voltage pulses will be applied to the primary of T2. As the half-wave voltage increases, the current in the secondary coil increases and the energy stored in the inductance and capacitance of the secondary coil will increase. During this time there is no corona from the secondary coil (if the coil is constructed as shown in this article). Sometime before the half-wave line voltage reaches its peak, the corona will appear on the secondary coil, which will dissipate the stored energy very quickly. During the remainder of the half-wave line voltage, the coil will produce corona but the energy level will not be as great as the initial discharge. The coil will produce sixty individual corona discharges every second, although you'll see a continuous discharge.

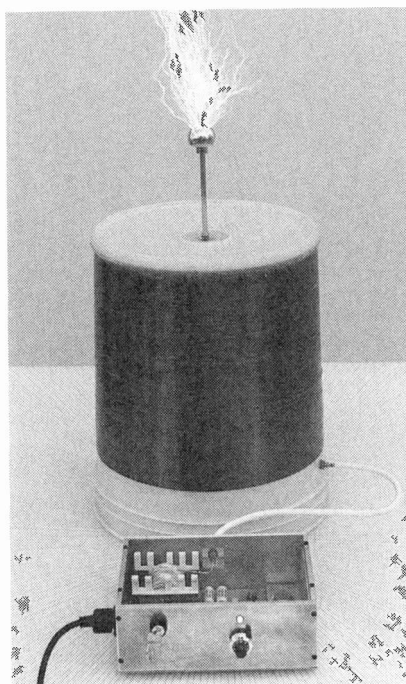
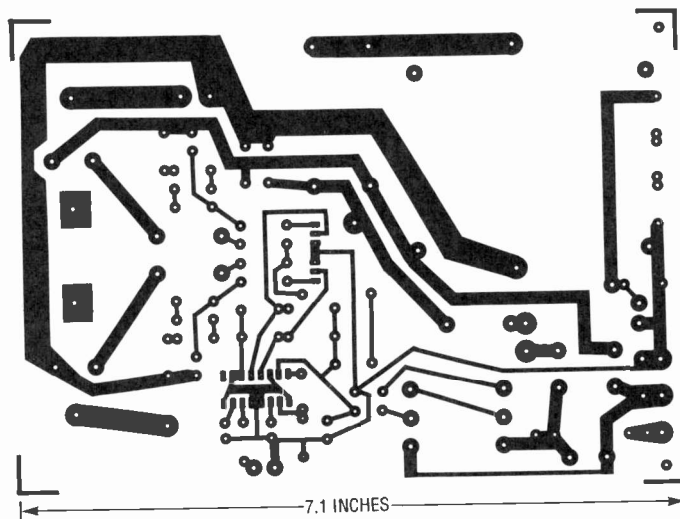

FIG. 1—THE SOLID-STATE TESLA COIL can produce sparks as long as 8 inches. The output reaches a peak of about 100,000 volts.



USE THIS FOIL PATTERN, shown half-size, to etch your own PC board.

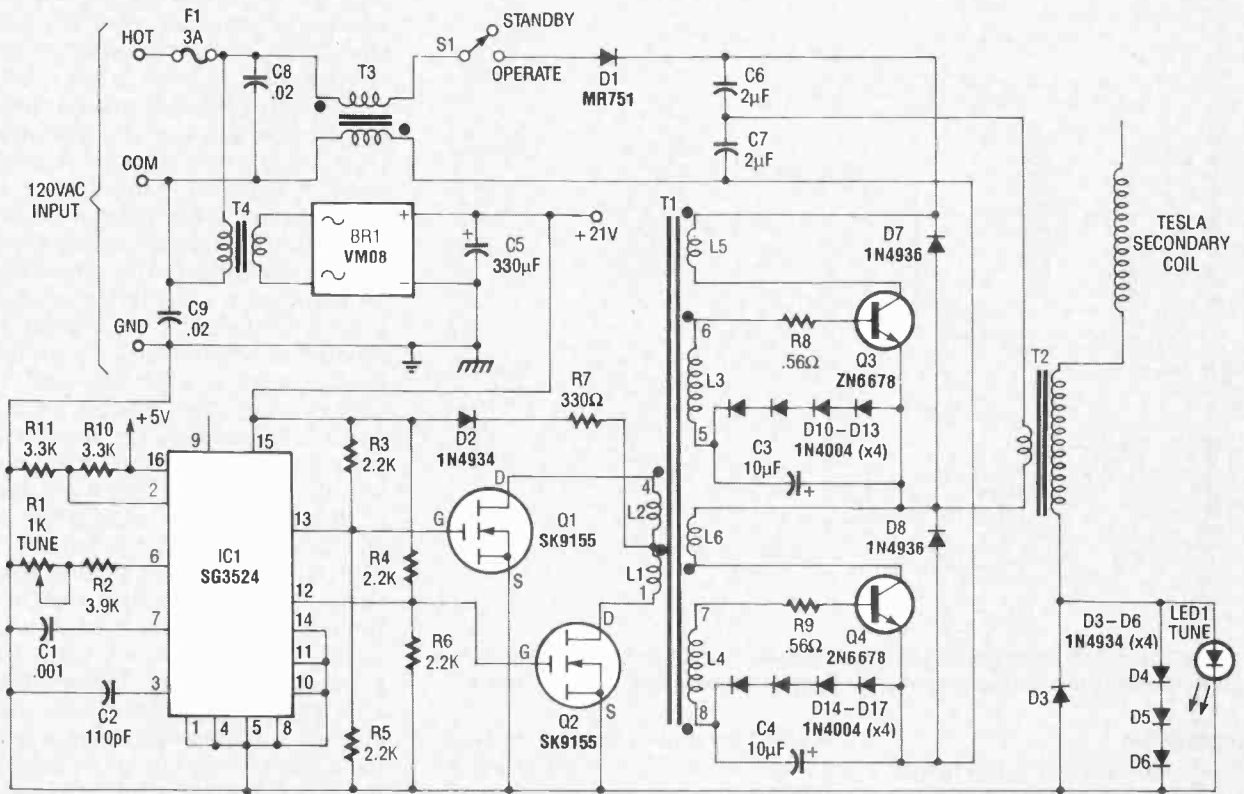

FIG. 2—SCHEMATIC FOR THE SOLID-STATE TESLA COIL. The secondary of the Tesla coil appears like a series RLC circuit due to the self-capacitance of the coil with respect to ground.

PARTS LIST

All resistors are ¼-watt, 5%, unless otherwise indicated.

- R1—1000 ohms, 10-turn potentiometer
- R2—3900 ohms
- R3, R4—2200 ohms, ½ watt
- R5, R6—2200 ohms
- R7—330 ohms, 1 watt
- R8, R9—0.56 ohms, 2 watts, flameproof
- R10, R11—3300 ohms

Capacitors

- C1—0.001 µF, 50 volts, 5%, polyester
- C2—110 pF, 50 volts, polyester
- C3, C4—10 µF, 35 volts, tantalum
- C5—330 µF, 35 volts, electrolytic
- C6, C7—2 µF, 200 volts, nonpolar film-type
- C8, C9—0.02 µF, 1000 volts, ceramic disc

Semiconductors

- IC1—SG3524 pulse-width modulator
- D1—MR751 diode
- D2—D6—1N4934 diode
- D7, D8—1N4936 diode
- D9—not used
- D10—D17—1N4004 diode
- Q1, Q2—SK9155 power MOSFET

Q3, Q4—2N6678 or SK9140 NPN transistor

LED1—red LED. See text

Other components

- F1—3-amp, 250-volt, fast-blow fuse
- BR1—VM08 bridge rectifier, Varo
- T1—hand-made transformer (the core is TDK # PC30EER25.5-Z and the bobbin is TDK # BEER-25.5-118CP)
- T2—hand-made transformer (the core is TDK # PC30EC70-Z and the bobbin is TDK # BEC-70-5116)
- T3—hand-made transformer (the core is TDK # PC30EER25.5-Z and the bobbin is TDK # BEER-25.5-118CP)
- T4—115VAC/15VAC center-tapped transformer (Triad F-132P)
- S1—SPST key switch

Miscellaneous: enclosure, aluminum angle bracket, high-voltage wire (to connect main unit to Tesla secondary), 30-gauge magnet wire for Tesla secondary and L1 and L2, 24-gauge magnet wire for L3 and L4, 18-gauge stranded hook-up wire for L5 and L6, 15-gauge mag-

net wire for T2 primary, 26-gauge hook-up wire for T2 secondary, 18-gauge magnet wire for both windings of T3, brass rod, discharge ball, hardware, AC linecord, etc.

Note: The following items are available from Corona Coil, PO Box 474, Riverton, UT 84065 (801-254-7653):

- Core, bobbin, and wire for T1, T2, and T3—\$30.00
- Set of T1, T2, and T3 (assembled)—\$50.00
- Tesla secondary coil—\$35.00
- PC board—\$15.00
- Aluminum angle bracket (heatsink and PC-board mount)—\$5.00

Please add 10% S&H for all items.

A 124-page book by the author, *Modern Tesla Coil Theory*, is available for \$19.95 plus \$2.50 shipping from the Tesla Book Co., PO Box 12187, Tulla Vesta, CA 91912 (619-437-8515).

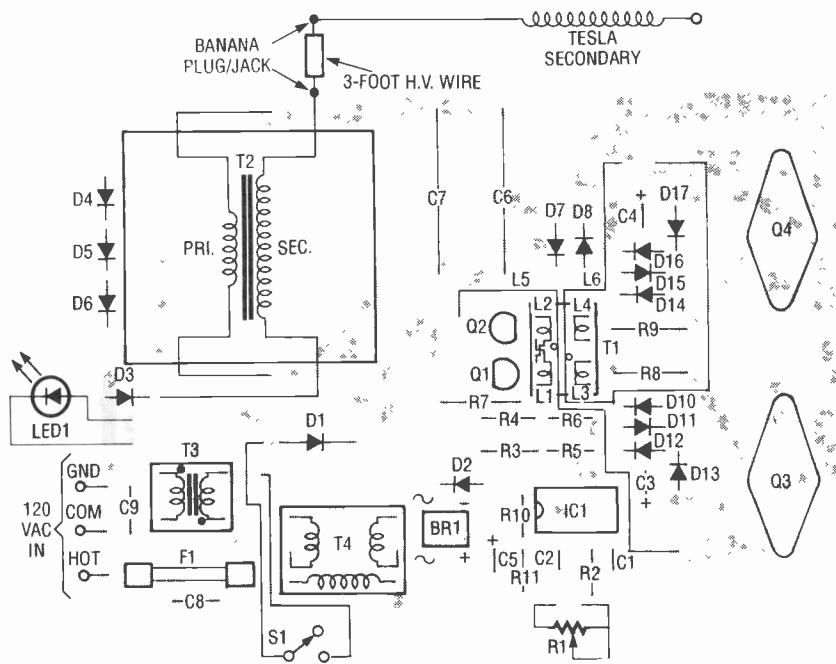

FIG. 3—PARTS-PLACEMENT DIAGRAM. It's best to play it safe and use the PC board for this project; we've provided the foil pattern if you would like to etch your own board.

Construction

Most of the construction is fairly simple if the printed circuit board is used. A parts-placement diagram is shown in Fig. 3, and we've provided the foil pattern if you would like to etch your own board. Figure 4 shows the completed prototype board housed in its aluminum enclosure.

The most difficult item to construct will be the Tesla secondary coil, followed by T1 and T2. The

secondary coil may take an hour or so to make if you prepare ahead of time. Preparation includes making some device that will easily rotate the coil form while winding the wire. The author used a small lathe and it took about 15 minutes of actual winding time and 30 minutes to get set up.

Do not deviate at all from the following parameters of the secondary coil! Any deviation will

change the characteristics of the coil and it may not operate with the driver unless modifications in the driver are made. Any change in physical dimensions or wire size will alter the resonant frequency and effective impedance of the coil. Any change to the discharge electrode will effect the maximum energy obtainable.

The coil form for the secondary winding is a standard 5-gallon plastic container 10 inches in diameter at the bottom, 12 inches in diameter at the top, and 14 inches long. The bottom of the container becomes the top of the coil. To make winding easier you should drill a hole about an inch in diameter through the center of the bottom of the container. A similar hole should be drilled through a removable lid and then the complete coil form can be rotated easily on a dowel. Start the secondary winding 1 inch from the small-diameter end and close-wind 30-gauge magnet wire for a total length of 10 inches. It does not matter what direction the wire is wound in.

When winding the original coil for this article, shellac was used to lubricate the wire as it was wound and also to act as a sealant afterwards. It was difficult to wind the coil because the coil form was very slick and had a slight taper to it and, as a result, the wire kept slipping. It may be easier to spray the container with adhesive before winding the wire to make it stay in place. A couple of coats of shellac should be applied to the finished winding. You also must put 3 or 4 beads of silicone sealant around the end of the winding at the top of the coil to keep corona discharges away from the area. If corona discharges appear along the coil at the top it will limit the maximum energy and destroy the coil form.

The discharge ball, or electrode, is a brass-plated metal doorknob, 1-inch in diameter, that can be found in hardware stores (see Fig. 5). The ball is mounted on a 4-inch brass rod; you can drill and tap the ends of the brass rod with a 6-32 tap (or whatever matches the threading on the doorknob) to make mounting easier. The brass rod is connected to the coil form by two pieces of plastic, one on each side of the coil form, over the 1/2-inch

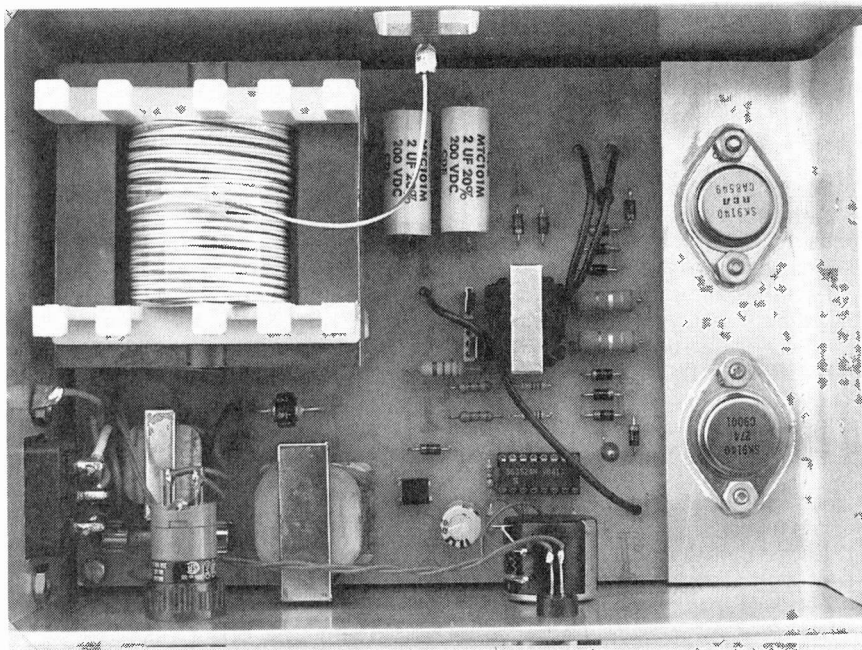

FIG. 4—HERE'S THE AUTHOR'S COMPLETED PROTOTYPE housed in its aluminum enclosure. It's important that the case be properly grounded.

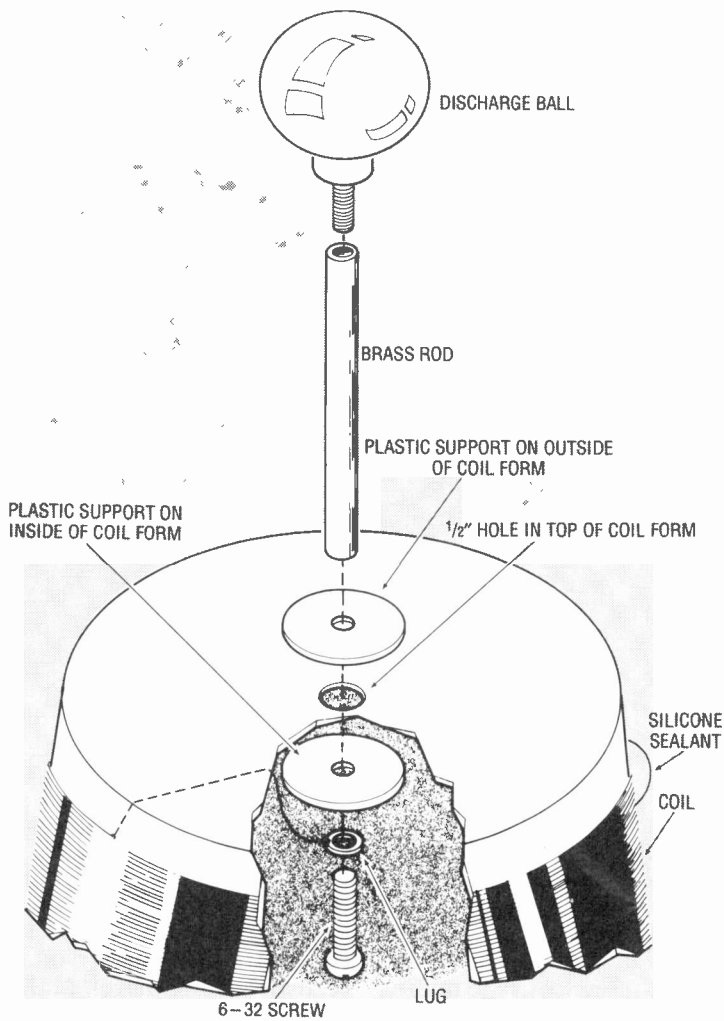

FIG. 5—THE DISCHARGE BALL is a brass-plated metal doorknob, 1-inch in diameter. The ball is mounted on a 4-inch brass rod that's been tapped to make mounting the ball easier.

hole. A 6-32 screw passes through the pieces of plastic and into the brass rod to hold the assembly together. The wire is soldered to a lug held in place by the 6-32 screw.

A banana jack is used to make connections at the bottom of the coil. Locate the jack about $\frac{3}{4}$ -inch from the edge of the wire on the coil. Silicone should be used to insulate the connections between the magnet wire and the brass rod and banana jack. The finished coil, when built exactly as we've shown, will have a resonant frequency of about 110 kHz.

Transformer T1 is made with a ferrite core and bobbin from TDK (see the parts list). Coils L1 and L2 are wound first with 30-gauge magnet wire, 16 turns each, making one layer on the bobbin. The two windings are bifilar

wound, as shown in Fig. 6-a; L1 starts on pin 3 and L2 starts on pin 4. Wind both in a counterclockwise direction while looking at the top of the bobbin. Terminate L1 on pin 1 and terminate L2 on pin 2. Put a layer of cellophane tape on top of the winding to insulate it from L3 and L4.

Coils L3 and L4 are made with 5 turns each of 24-gauge magnet wire and are also bifilar wound, on top of L1 and L2, and in the same direction. Coil L3 starts on pin 6 and L4 starts on pin 8. Terminate L3 on pin 5 and terminate L4 on pin 7. This completes the transformer until it is mounted on the PC board.

Put the two core halves through the bobbin and put tape around them to hold them in place. As shown in Fig. 6, L5 and

L6 are wound after the transformer is mounted on the board; L5 and L6 are wound with 18-gauge stranded hook-up wire with one turn each. Solder the collector (Q4) end of L6 to the PC board. Go one turn in a counterclockwise direction around the core of T1 and then terminate the other end of L6 at the primary of T2. Solder the collector (Q3) end of L5 to the PC board and go in a clockwise direction around the core of T1 for one turn, terminating the winding at the cathode of D1.

Transformer T2 is also made from a ferrite core and bobbin from TDK (again, see the parts list). The primary is 10 turns of 15-gauge magnet wire, although a smaller gauge, say 18, can probably be used. It does not matter what direction the wire is wound in but the turns should be equally spaced across one layer of the bobbin. Put several layers of cellophane tape on top of the primary to insulate it from the secondary and to provide a smooth surface on which to wind the secondary. The secondary is made with 280 turns (the exact number is not critical) of 26-gauge hook-up wire. The direction is unimportant. You can use magnet wire if you desire but you should put cellophane tape between each layer. The low-voltage end of the secondary is the one that is the closest to the primary winding. When the windings are complete, put the core halves through the bobbin and hold them in place with tape wrapped around them.

Transformer T3 is made with the same core and bobbin as T1. Both windings are bifilar with 18-gauge magnet wire for as many turns as possible. The start of both windings are polarized as indicated by a dot in the schematic diagram (Fig. 2). The pins on the bobbin are not used and should therefore be cut off, and the 18-gauge wires are then soldered directly to the PC board as indicated.

An aluminum angle bracket is used when mounting switching-transistors Q3 and Q4. The bracket provides the physical support between the PC board and enclosure and also provides good heat sinking for the transistors. The transistors should

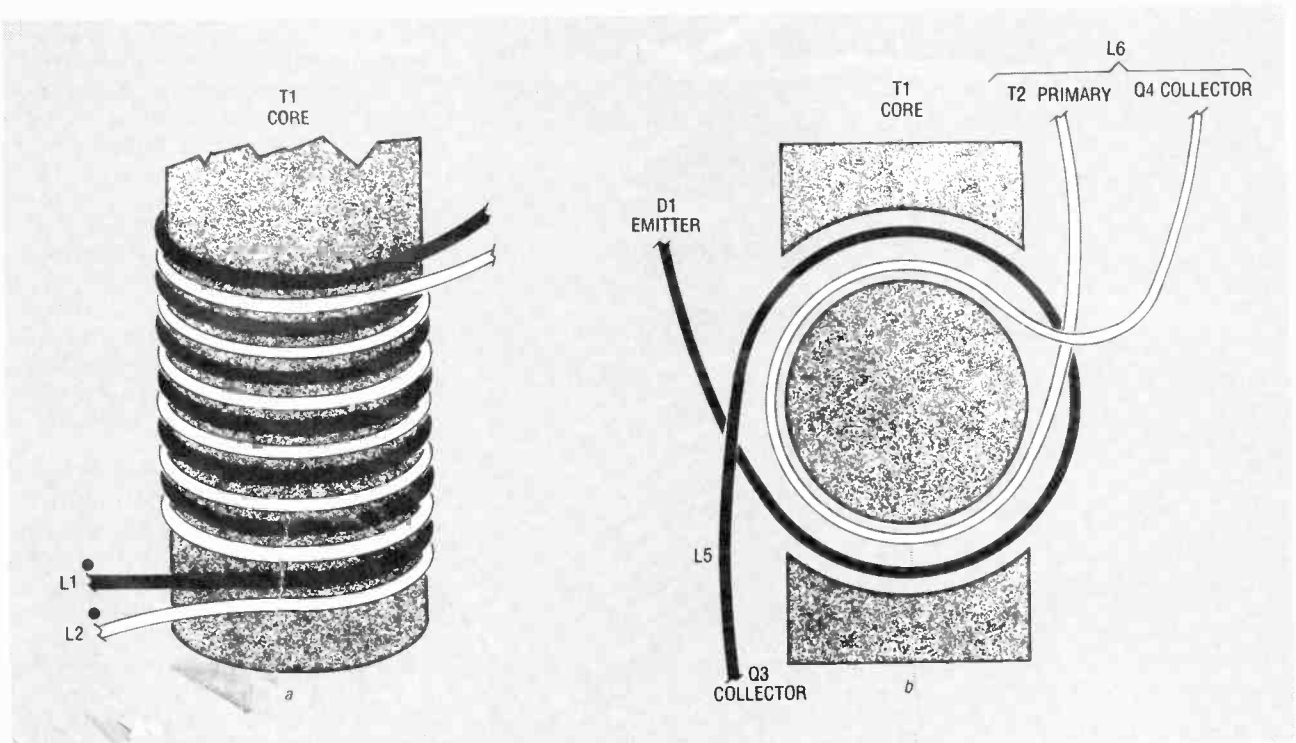

FIG. 6—TRANSFORMER T1 IS MADE by winding coils L1 and L2 first (a). After putting a layer of cellophane tape on top of the first windings, coils L3 and L4 are wound on top of L1 and L2. Coils L5 and L6 are wound after the transformer is mounted on the board (b). See text for detailed instructions.

be insulated from the aluminum; insulating hardware is normally included when you purchase the transistors. Use the PC board as a template for drilling holes for the transistors in the aluminum bracket. The angle bracket is mounted to the enclosure by drilling holes and taping them with a 6-32 tap. Thermal conductive

compound is used between the transistors and angle bracket and between the angle bracket and the enclosure.

A banana jack is mounted in the back of the enclosure to make connections between the Tesla secondary coil and the high-voltage ferrite transformer. The output voltage from the ferrite transformer may reach 5000 volts peak with no load so it is wise to use extra insulation for the banana jack. Mount a piece of plastic, 1½-inch square, to the back of the enclosure over a 1-inch square hole, and mount the banana jack in the center of the plastic. That will space the banana jack at least ½-inch from the metal enclosure.

The prototype used a 10-turn potentiometer for R1 to make frequency adjustments easier and this allowed the use of a 10-turn dial to mark the frequency settings for different purposes. You can use a regular potentiometer but the 10-turn unit is superior.

An enclosure was fabricated out of ⅛-inch aluminum with a plexiglass top, but any metal enclosure would be suitable. Just be absolutely sure that you ground the metal enclosure.

Operation

Warning: The power output from the Tesla coil is dangerous! Make sure no one comes in contact with the output voltage directly from the driver. Make sure nobody tampers with the unit, and keep it out of reach of children. Make sure you use a key

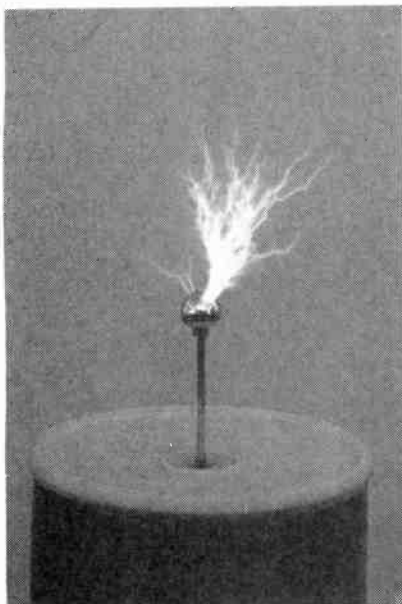

FIG. 7—SEEN HERE IS THE DISCHARGE from the ball electrode into the air.

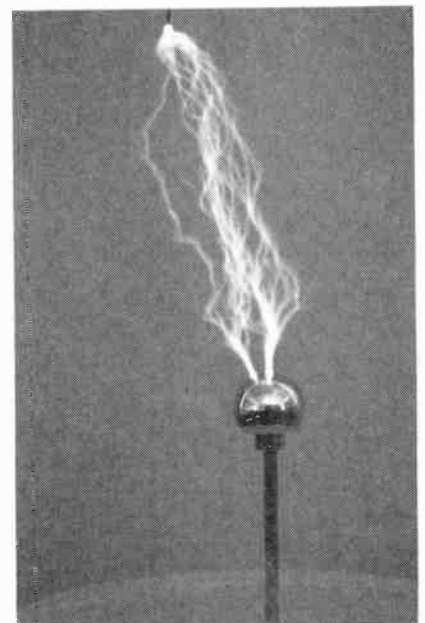

FIG. 8—THE SPARKS WILL JUMP even farther if a grounded electrode is placed near the discharge ball.

switch to turn power on and off to prevent someone from getting injured, and keep the key in a safe place.

Caution: All components on the secondary of T1 are not isolated from the power line. Use caution when measuring values in this area. You must isolate an oscilloscope from ground if measuring in this area. Make sure you use a three-prong power cord and that the case of the driver is well grounded. Also, make sure you plug the unit into a well-grounded electrical outlet.

Double check all wiring to make sure it is correct. Make sure the operate switch is in the standby position (line voltage disconnected from D1). Using a digital voltmeter isolated from ground, measure the voltage across C3 and C4. If everything is working correctly in the low-voltage circuitry, there should be about 2.5 volts across those capacitors. If that voltage is not present you should check the 21-volt power supply. Make sure that 5 volts is on pin 16 of IC1. If the oscillator is working correctly you should have about 3.6 volts on pin 6 of IC1.

Connect the Tesla secondary coil to the driver with a 3-foot insulated wire (it is a good idea to keep at least 3 feet from the secondary coil). You should always unplug the driver when you are making connections between the driver and secondary coil to be absolutely safe. The wire connecting the coil and driver carries a dangerous amount of power so be certain the wire is well insulated. In a dimly lit room you should be able to adjust the tune control to set the driver at the coil's resonant frequency. Observe the LED and watch for one place in the tuning control's adjustment where the LED glows brighter than anywhere else. Never apply full power to the driver unless you can obtain resonance first. Damage to the driver will most likely occur if resonance is not maintained.

Once you obtain resonance you can switch to the full-power mode; the LED will glow very brightly. With no objects around the coil you should observe a snappy brush discharge 5 to 6 inches in length emanating from the discharge electrode (see Fig. 7). It might be somewhat louder

than you would expect. Very slight adjustments in the tune control may improve the discharge. You should be able to get 7-inch streamers with a grounded electrode above the coil (see Fig. 8). Be aware that any change of the physical surroundings around the coil will change its resonant frequency and the tune control will need to be adjusted to maintain resonance. When operating the Tesla coil, be aware of the temperature of the enclosure where the aluminum angle bracket is mounted. Shut off the power if the area gets too warm. The prototype was operated for 2 full minutes, and you could just start to feel some warmth on the enclosure. However, you should operate the Tesla coil only for short periods of time.

Once you have a working unit you can start to experiment with different things. Try removing the discharge ball and use a point instead. Try changing the distance of the ball electrode from the coil. Try holding an incandescent lamp a short distance from the coil—but be very careful. Different lamps will produce different discharges. R-E

REALMAGIC!

An ETCHED circuit board from a Printed PAGE in just 3 Hours

The ER-4 PHOTO ETCH™ KIT gives you the tools, materials and chemicals to make your own circuit boards from the artwork printed in magazines like this one. You can also do original 1X art using the enclosed patterns, tapes and drafting film. Or try the DIRECT ETCH™ system (also included) to make single circuit boards without artwork.

You'll need a reflector photoflood and a UV light source (or sunlight). Why search? Get an ER-19 bulb set with your ER-4. Bulbs use an ordinary 120V socket. The ER-4 and ER-19 are stocked by electronic parts distributors or order direct. Add \$4.50 for shipping. NV and CA residents must add sales tax.

ER-4 PHOTO ETCH SET \$40.00
 ER-19 LIGHT BULB SET 16.45

DATAK Corporation • 55 Freeport Blvd. • Sparks, NV 89431

CIRCLE 100 ON FREE INFORMATION CARD

Toner Cartridge Recharge

Kits—Supplies—Service

Everything you need to recharge toner cartridges used with Canon based laser printers and personal copiers.

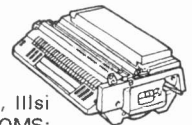

Use with HP: LaserJet, II, IID, IIP, III, IIIP, IIIsi
 Apple: LaserWriter, LaserWriter IINT, IINTX, QMS:
 Kiss, PS-800, PS-810, Canon: LB-P8A1, A2, II, OKI, NEC, Ricoh, etc
 With our *Kits—Supplies—Service* you can start your own profitable recharge business or just recharge your own cartridges.

Model	Recharge Kits/Supplies	Dealers Please Call
TR-300	Recharge Kit for CX type laser printer engines.	\$21.95
TR-302	Recharge Kit for SX type laser printer engines.	\$26.30
TR-304	Recharge Kit for HP IIP (LPB-4) laser printer.	\$21.95
TR-325	Recharge Kit for PC-10/12/14/20/24/25 copier.	\$25.50
TR-370	Recharge Kit for Sharp Z-50/55/70 copier.	\$34.95
4080	Replacement Toner Kit for Ricoh 4080 laser.	\$35.95ea/5
6000	Replacement Toner Kit for Ricoh 6000 laser.	\$14.25ea/10
9710	200 grms of high quality black toner for CX.	\$9.95ea/10
9730	250 grms of high quality black toner for SX.	\$12.50ea/10
8011-Blue/Br	200 grms of Blue/Brown toner for CX & SX.	\$22.95ea/10
8057	150 grms of high quality black toner for PC.	\$10.95ea/10
Felt-CX,SX	replacement treated felt for all models.	\$0.90ea/10
SS-CX,SX	seal strips for sealing in toner for reshipping	\$0.85ea/10
DPP	Drum Padding Powder (pixie dust)	\$12.95
EverDrum™	OPC drum life extender agent. 40+ applications	\$34.95
C2094	3M Toner Vacuum with attachments.	\$199.95

Instructions Available Free to Customers!
 Call 800-221-3516 ask for our catalog.



Chenesko Products, Inc.
 2221 Fifth Ave., Suite 4, Ronkonkoma, NY 11779
 Call: 516-467-3205, Fax: 516-467-3223

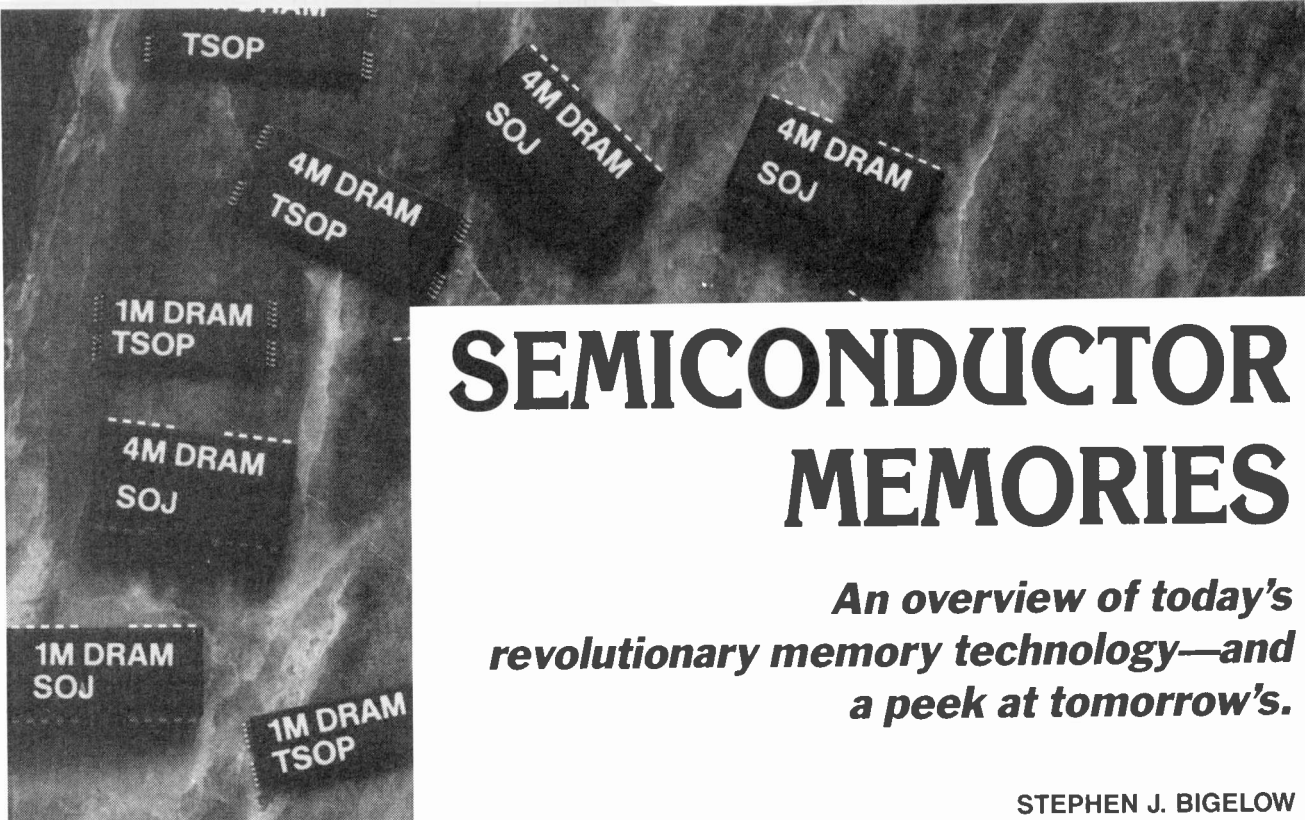

SEMICONDUCTOR MEMORIES

An overview of today's revolutionary memory technology—and a peek at tomorrow's.

STEPHEN J. BIGELOW

STORAGE AND RETRIEVAL OF DIGITAL information has sparked an exciting revolution in computers and consumer electronics. You find semiconductor memories in nearly all "intelligent" electronic systems, including car radios, televisions, VCR's, compact-disc players, and computers. Without the on-going advances in memory technology, the high-tech revolution would rapidly grind to a halt.

In this article, we will examine several important concepts behind semiconductor memory devices, including basic technologies, memory organization and configuration, design considerations, and applications.

Memory types

Semiconductor memory devices can be classified in one of two ways: permanent or temporary. Although basic operating principles of both are similar, each plays a different role, and each has unique advantages and disadvantages. We will discuss both types in detail.

As the name suggests, information in *permanent memory* is retained at all times, even after removal of system power. Permanent memory is also called *non-volatile* and *read-only* memory. Permanent memory is most often used to store fixed program in-

structions or numerical constants that do not change during the life of a product. For example, personal computers use permanent memory to hold the basic input/output system (BIOS) that initializes the computer and provides it with a core of low-level functions. There are four basic types of permanent memory: ROM, PROM, EPROM, and EEPROM. Let's discuss each type.

ROM

The read only memory (ROM) is the oldest and most straightforward type of permanent semiconductor memory. The information that's programmed into a ROM is specified by the buyer, but the ROM itself must be built by the manufacturer.

A ROM is relatively inflexible—after it's been programmed, it can never be altered. If the information in a ROM must change, a whole new device must be manufactured and substituted for the old ROM, and that is an expensive, time-consuming process. Hence the ROM is economically feasible only when used in great volumes for thoroughly debugged applications.

One advantage of the ROM is its ruggedness. Since the program is an actual physical part of the device itself, it can withstand

relatively large amounts of electrical and physical abuse, yet still maintain its contents. The automobile industry uses ROM's extensively in on-board computers.

PROM

The programmable read only memory (PROM) offers a tremendous advantage over the ROM in that it can be programmed by the end user, who is then less dependent on manufacturers' lead times. A PROM can be "burned," or programmed, only once because it cannot be erased.

The term *burn* comes from the method used to program a PROM. A factory-fresh PROM consists of a matrix of fusible links. An intact link produces a binary 0 at the selected location; a burned (open-circuit) link produces a binary 1, as shown in Fig. 1. (We'll discuss how to get at a particular location in a PROM later in this article.)

To burn a PROM, a special piece of equipment called a PROM burner generates high-energy pulses which destroy the desired links to match the contents of a user data file.

PROM's are slightly more expensive than ROM's on a per-unit basis, but their flexibility often justifies higher cost. Many PROM's are available through retail electronics outlets.

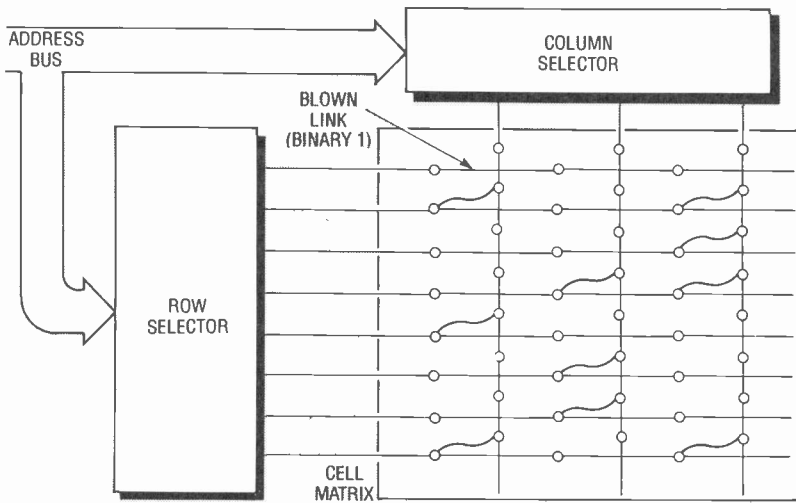

FIG. 1—A PROM BEFORE PROGRAMMING consists of a matrix of fused links joining each row-column intersection. Programming blows desired links.

EPROM

The erasable programmable read-only memory (EPROM) overcomes one of the main disadvantages of the PROM: its inability to be reused. After a link has been burned, it can never be restored. By contrast, typical EPROM's can be reliably burned and erased thousands of times.

The PROM is built around traditional bipolar transistor technology, which uses both a great deal of power and occupies a lot of space. The EPROM, on the other hand, uses newer metal-oxide semiconductor (MOS) technology, which requires little current and occupies little space. In an EPROM, information is stored as small packets of charge buried deep within the substrate of the IC, as shown in Fig. 2.

An EPROM is programmed much like a PROM. A special EPROM programmer selects an address in the device, places the desired binary information on the data lines, and then pulses the EPROM's PROGRAM pin. That pulse is what locks the bit pattern into the substrate of the chip.

To erase an EPROM, it's necessary to remove the charges in the IC's substrate. That's accomplished by exposing the circuit (the die itself) to short-wavelength ultraviolet (UV) light for a prescribed period of time. The excitation created by the UV light allows stored charge to dissipate, so the IC gradually returns to its

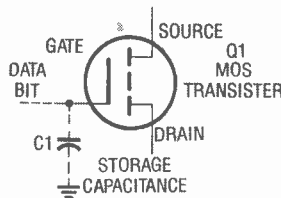

FIG. 2—IN AN EPROM, CAPACITANCE across the gate-drain junction of a MOS transistor provides storage.

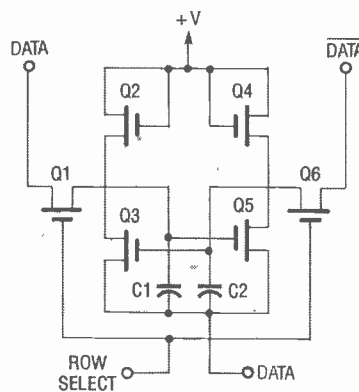

FIG. 3—A FLIP-FLOP is the basic unit of storage in static RAM devices.

pre-programmed state. The UV light is introduced into the EPROM through a transparent quartz window in the top of the IC package.

Use caution when working with EPROM's. Even though it takes about 20 minutes of exposure to a concentrated UV light source to erase an EPROM, some common sources of light, such as

sunlight, fluorescent light and "black-light", may contain enough UV to trigger random charge dissipation and introduce errors in the device. So be sure to cover the quartz window with a piece of opaque material.

EPROM's cost more than PROM's, but cost-per-bit is actually lower because MOS technology allows the designer to squeeze several times more information in the same amount of space. One disadvantage of the EPROM is that it must be physically removed from the system to be erased and re-programmed.

EEPROM's

The electrically erasable programmable read only memory (EEPROM) is similar to the EPROM, but overcomes its main disadvantage: the inability to program it in-circuit. That feature offers exciting possibilities in applications where software must adapt to changes in the operating environment.

The EEPROM is no panacea, however. It's slower than other types of memory, and it requires a relatively long time to update the altered data. As a result, EEPROM's are best suited for holding information that changes infrequently. Information that changes often is best left to the work of temporary memory, the other broad class of semiconductor memory.

Temporary memory

Information held in a temporary semiconductor memory device can be altered and updated frequently, but will be maintained only as long as power is supplied to the device. If power fails, memory contents will be lost. That type of memory is usually referred to as *volatile* memory. It is also known as random access memory (RAM). The name refers to the fact that any location may be accessed as quickly as any other. By contrast, in a sequential device like a tape drive, access speed depends on the location of the desired information. However, random locations in ROM's, PROM's, EPROM's, and EEPROM's can be accessed with equal speed. Nonetheless, when people speak of RAM, they almost invariably are referring to temporary memory.

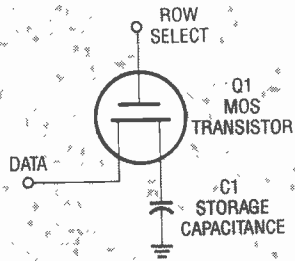

FIG. 4—CAPACITANCE is the basic unit of storage in the DRAM.

type has particular benefits and drawbacks.

Static RAM

Static RAM (SRAM) is the oldest and most straightforward form of temporary semiconductor memory. A typical SRAM consists of several flip-flops, or cells, as shown in Fig. 3. Each cell stores one bit of information; multiple cells are arranged in a

the IC, so the maximum number of cells is limited.

Dynamic RAM

Dynamic RAM (DRAM) uses an entirely different technology to accomplish data storage. The key difference lies in the design of the cell itself. As shown in Fig. 4, each cell in a DRAM stores information as a packet of charge across a MOS transistor, similar in principle to way the EPROM works, but it is unlike the SRAM, which uses a flip-flop to hold one bit of data.

To allow frequent updates, each cell must be capable of changing state almost instantly. To allow rapid change, the storage capacitance must be extremely low, so low in fact that it cannot sustain its charge for more than a few milliseconds. Therefore each DRAM location must be refreshed about every two milliseconds. If a cell is not refreshed, it will simply lose its data. However, refresh cannot happen by itself; external circuitry is required, as well as additional circuitry within the DRAM itself. Fig. 5 shows a block diagram of the internal structure of a DRAM. The added complexity and cost of refresh circuitry is the main disadvantage of DRAM.

On the other hand, DRAM offers several distinct advantages over SRAM. Storage capacity is much greater. Common DRAM's provide one megabit (2^{20}) of storage, and four-megabit IC's are just over the horizon. In addition, 16-megabit memories are being developed, and 64-megabit DRAM's are on the drawing board.

Power is another consideration. DRAM's require less current to operate; there are far fewer components per cell to dissipate power. The power savings can be substantial in applications that need a great deal of memory. DRAM's also have a standby mode that essentially disables all functions except refresh. In standby mode, a DRAM requires just a few milliwatts of power to maintain its information. In some cases, the low power requirement makes battery backup practical. SRAM's also have a standby mode, but they typically need more than 100 milliwatts of power. Now let's examine some of

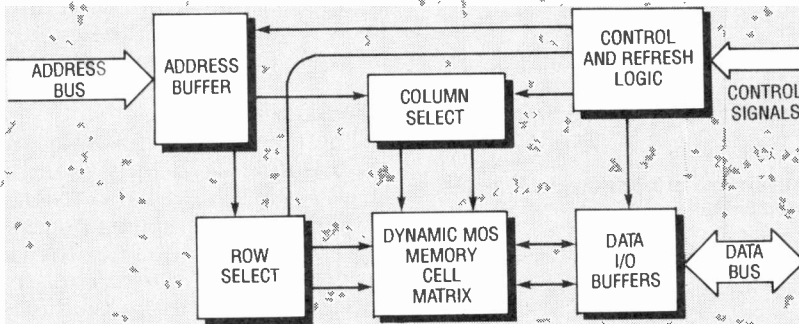

FIG. 5—INTERNAL DRAM STRUCTURE. The control/refresh circuitry increases complexity but drastically increases storage capacity.

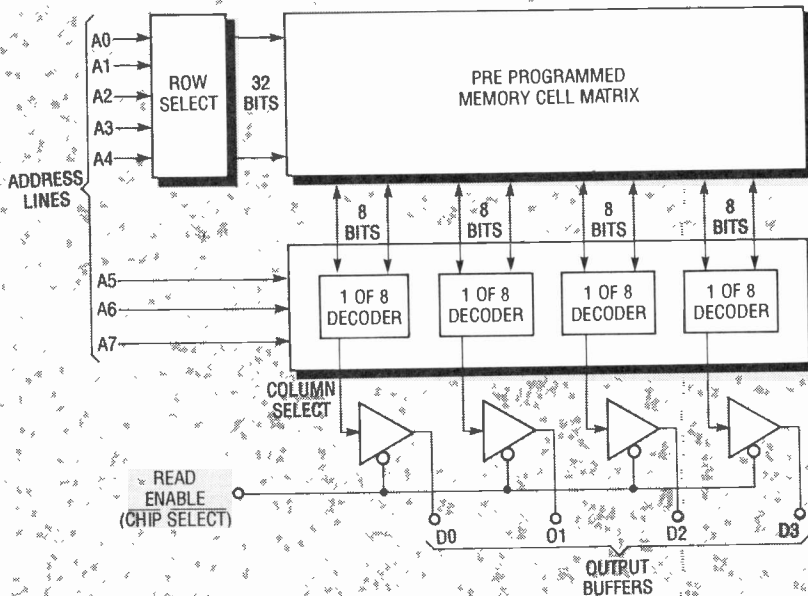

FIG. 6—A BASIC ROM consists of row- and column-select circuitry, the memory array, and three-state output buffers.

Most electronic processing systems require at least some RAM. The amount that's required depends on the application. A simple system, such as a programmable digital thermostat, may require only a few bytes of RAM. But a computer may require millions of bytes of RAM.

There are two basic types of RAM: static and dynamic. Each

two-dimensional array. To access a particular cell, row and column addresses must be set up, and then several control signals must be pulsed.

Since data is always available from the flip-flop matrix, the SRAM tends to be a fast device. Its primary disadvantage is limited capacity. Each flip-flop occupies a relatively large area on

the technologies used to fabricate semiconductor memory devices.

Fabrication technologies

Every semiconductor memory chip houses sophisticated, sensitive microcircuitry. Each minute component must be integrated deep into the substrate of the chip (or die), which itself rests within a hermetically sealed case of plastic or ceramic. The process of *circuit integration* involves a complex combination of optical and chemical processes to form a working IC. Memory devices manufactured today are typically made using either bipolar or MOS fabrication technologies. In addition, a new hybrid of the two technologies, called Bi-MOS, has begun to appear. Although the actual manufacturing processes of these kinds of devices are too involved to cover here, we can review the characteristics and uses of those technologies.

Bipolar technology

The bipolar transistor (with emitter, base, and collector) was the first component successfully integrated into a semiconductor wafer in the form of the TTL IC. Many simple logic functions could thus be synthesized easily and efficiently. The resulting low cost and high availability made TTL a mainstay of digital logic design through the 60's and early 70's. Even to this day, TTL remains a cornerstone of basic logic design. When memories were needed, TTL was the obvious choice.

Although there are several SRAM chips in the TTL family (notably the 74S200 and 74S201), TTL suffers from several major drawbacks that severely restrict the capacity of bipolar SRAM. First, bipolar logic requires a relatively large area on the chip for each logic gate. Many gates are needed to build a SRAM, so space is depleted rapidly. In addition, bipolar logic requires significant operating current per gate. Since current ultimately translates into heat, the number of cells is limited even further. Size and power restraints usually limit the number of bipolar memory cells to fewer than 1000 bits.

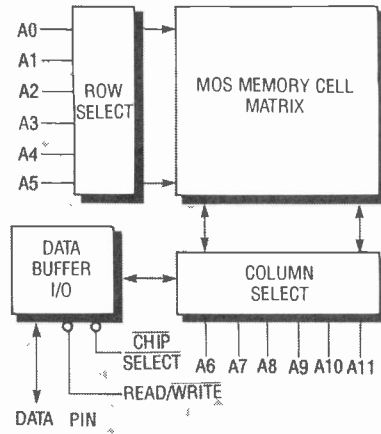

FIG. 7—THE BASIC SRAM is more complicated than a ROM because of the addition of a READ/WRITE line.

MOS technology

The development of MOS technology is largely responsible for the incredible advances in high-tech electronics since the late 1970's. The materials and chemicals used in MOS fabrication are different from those used for bipolar fabrication, but the process is fundamentally the same. The most familiar MOS family is complementary MOS (CMOS), but there are many variations, including PMOS, NMOS, VMOS, DMOS, and HMOS.

CMOS, NMOS, and HMOS devices are the most widespread variations of MOS technology in use today. CMOS has been used extensively in memories, and to produce a family of devices that is functionally similar to the TTL family. CMOS dissipates far less power than TTL and can run on a much wider range of supply voltage (3–15 volts DC). N-channel MOS (NMOS) technology is used to produce memories that are fast, dissipate little power, and can fit many components on a chip. Although early devices required several supply voltages, modern NMOS IC's operate from a single 5-volt supply. High-performance MOS (HMOS) is an NMOS variation that's used in modern high-speed low-power microprocessors.

In spite of their obvious advantages, all MOS devices suffer from one key weakness: they're extremely sensitive to static electricity. There are important precautions that should be taken. Be sure to follow manufacturers' guidelines for handling MOS devices.

Memory operations

To the external world, the organization of a semiconductor memory device appears as a sequence of locations. Each location may have 1, 4, 8, or some other number of bits, but regardless of the number of bits per location, each location has a unique address. The number of unique addresses depends on the number of address lines. If there are 8 address lines, then there are 2^8 or 256 addresses. Although externally a semiconductor device appears to have a sequential organization, internally the cells are arranged in a square.

The relationship between the number of physical cells (bits) and the number of logical locations (addresses) depends on the number of bits per address. For example, a memory IC could have 1 megabit of cells arranged as 1×1 megabit, as $4 \times 256K$, or even as $8 \times 128K$. Internal decoding circuitry varies depending on how the organization is to appear externally.

For example, Fig. 6 represents a simple ROM. The format of the ROM is 256 addresses with four bits per address. The memory array is a 32×32 square, giving 256 addresses. And for 256 addresses the chip requires eight address lines ($2^8 = 256$) to identify each location uniquely. The lower five address lines (A0–A4) select one of 32 possible rows ($2^5 = 32$). The upper three (A5–A7) select one of eight columns ($2^3 = 8$). There are four 1-of-8 decoders, so four columns (one from each group of eight) will be active for each selection.

After a valid address is presented to the address lines, the data bits at the intersections of the selected row and columns will be sent through the respective 1-of-8 decoders to several three-state buffers. If the READ ENABLE signal is brought low, the data present at the buffers will be delivered to the ROM's output. But when READ ENABLE is high, the high impedance of the three-state buffer will simply disconnect the ROM's outputs from the circuit.

SRAM's, along with PROM's, EPROM's, and EEPROM's, are more sophisticated. Figure 7 shows a simple SRAM organized

as 4096×1 . Addressing is similar to the ROM in the previous example but, in this case, there are 12 address lines that provide 2^{12} or 4096 (4K) addresses. One bit of data is available at each address location.

A READ/WRITE control signal determines whether data will be read from or written to the IC. If R/W is logic 1, data will be read from the cell. If R/W is logic 0, data will be written to the cell.

To read a bit of data, a valid address must be supplied, R/W must be high, and the CHIP SELECT input must be low. To write a bit of data, the same conditions apply except that R/W must be low. The timing relationships between the signals at various pins can be critical, depending on the circuit.

Timing considerations

Today's generation of RAM IC's has been designed to operate at high speeds, so timing characteristics for address, data, and control lines are important. There are several important parameters that we will discuss.

Access time specifies how long it takes after addressing a specific location before valid data appears at the IC's output. A slow memory device may have an access time of as much as 450 nanoseconds, while a fast device might access data in as little as 25 nanoseconds. Common memory devices today have access times of about 100–150 ns. As a rule of thumb, the faster a memory device is, the more expensive it will be.

Settle time specifies the amount of time that must pass after setting up the address, data, and CHIP SELECT signals, before the R/W may be pulsed low to write data into the IC.

In addition, the WRITE pulse must be held low for a minimum amount of time to ensure that the data is accepted into memory. That is the duration of the *write pulse*. The address, data, and enable signals must be held steady for a minimum time after the write pulse; that period is called the *hold time*.

Those timing parameters apply to SRAM's; DRAM's have even more intricate timing requirements. Although the basic principles of reading and writing are

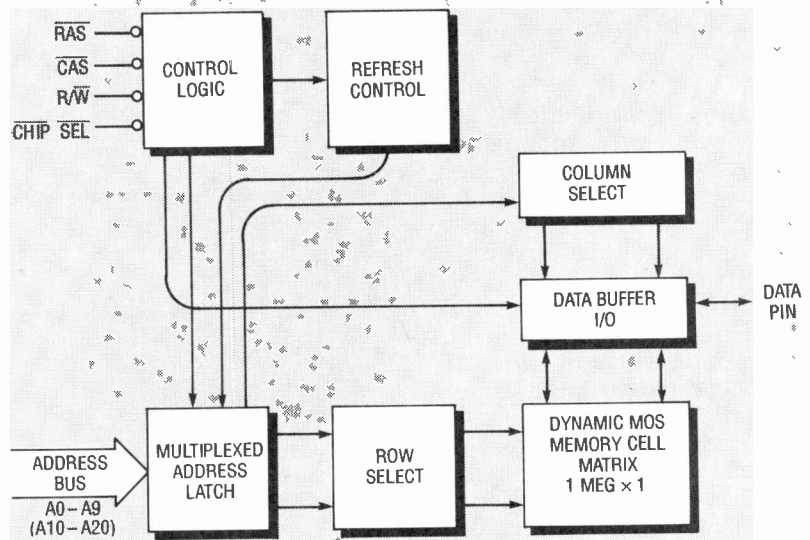

FIG. 8—DRAM KEEPS PIN COUNT LOW by multiplexing address lines on half the expected number of pins. CAS and RAS signals strobe low- and high-order address lines into the IC as necessary.

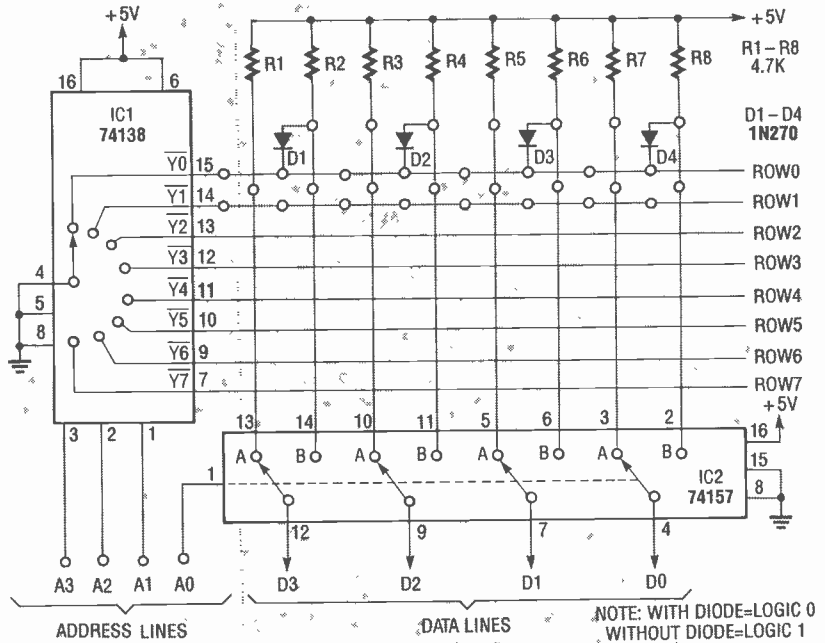

FIG. 9—BUILD AN EPROM EMULATOR from two TTL IC's, eight resistors, and a number of germanium diodes. Place a diode across each row-column intersection that is to be a logical 0.

similar to those for the SRAM, there are some extra features and parameters that must also be considered.

The first involves memory addressing. As discussed earlier, DRAM's can provide millions of bits on one device. For example, addressing 1 megabit (2^{20}) would require 20 address lines. It's possible to build an IC with 20 or more pins, but to save space and reduce pin count, several address

lines are *multiplexed* on a single pin.

Figure 8 shows the block diagram of a 1-megabit \times 1-bit DRAM. Note that only ten address lines enter the IC, so you might think that you could access only 2^{10} (1024) locations. In fact the 20-bit address is broken up into two parts, each of which is supplied separately. The lower ten bits select the desired row in the memory array, and the upper ten

bits select the desired column. The row-address lines are strobed into the IC by pulsing the row address strobe (RAS) input, and the column-address lines by pulsing the column address strobe (CAS) input. External circuitry must ensure that the proper set of address lines is applied to the IC before pulsing a strobe input.

After the IC receives the full address, CHIP SELECT and R/W may be set up, as with an SRAM, to read or write data. The access, setup, and hold times apply to DRAM's as well.

Refresh

As mentioned earlier, DRAM's require periodic refreshing, otherwise their stored charge will dissipate. There are several ways of refreshing a DRAM system, all of which use the RAS and CAS inputs. The simplest method is called *RAS-only refresh*. It involves holding CAS high, which in turn holds the output in a high-impedance, or disconnected, state. The refresh circuitry then selects each row in turn, pulsing RAS low for each row as it is addressed. It does not matter whether all rows are refreshed in one sustained burst, or one row between, for example, read or write operations. As long as a cell is refreshed in time, its data will remain intact.

Hidden refresh is a variation on RAS-only refresh in which CAS is held at logic 0 (for example, valid data is maintained on the output) while rows are selected and refreshed. Depending on system timing, CAS may be held low for several microseconds, during which several rows may be refreshed.

There are other variations, but all refresh circuits add a fair amount of complexity to a circuit. Fortunately, however, there are refresh-controller IC's for many different DRAM sizes and configurations. Those IC's reduce cost, increase reliability, and decrease required PC board space.

EPROM emulator

You can easily assemble your own hand-made "EPROM" using two common TTL IC's and several Germanium diodes. Figure 9 shows the schematic for a 16×4 memory circuit. It's loosely called

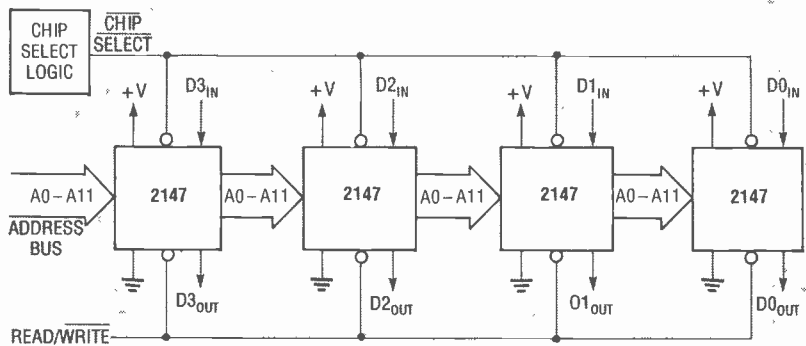

FIG. 10—BLOCK DIAGRAM OF A $4K \times 4$ static RAM array—parallel memory IC's increase bus capacity.

an EPROM because it can be re-programmed at any time by rearranging the diodes in the matrix. Although the circuit is unsuitable for high-performance or microprocessor-based applications, it can be used to supply pre-programmed bit patterns to discrete logic circuits. It also provides an excellent demonstration of basic memory operation.

There are eight rows and eight columns, yielding 64 bits of memory. Two demultiplexers allow access to a particular memory cell. One demultiplexer decodes the row and one decodes the columns. A 74138 1-of-8 decoder selects the row, and a 74157 quad two-input multiplexer selects the columns. Address lines A1-A3 drive the 74138 to select which one of eight rows will be pulled to ground. The columns are arranged in pairs; address line A0 determines which member of a pair is connected to the output.

The IN270 diodes determine the bit pattern in the circuit. Germanium diodes are used because of their low forward voltage drop (0.3 volts); silicon diodes have a higher voltage drop and will not work with TTL IC's.

Every column is pulled high via a pull-up resistor. If a diode is absent when a particular row is selected, the column will provide a 5-volt output. However, if a diode is in place, it will be forward biased via the pull-up resistor, through the 74138, and then to ground. The corresponding output thus becomes a logical 0.

For example, if address 0000 is selected, 74138 output y_0 (row 0) is connected to ground, and all 74157 inputs are connected to the B position. Because there are

diodes connected to each the B inputs in row 0, the output would be 0000. If the address was 0001, row 0 remains selected, but the 74157 inputs are switched to the A position. The A cells have no diodes, so all outputs would be high (1111).

Parallel memory

Semiconductor memories (both temporary and permanent) can be placed in parallel to increase the number of data bits available per address, as shown in Fig. 10. The circuit is built from several 2147 SRAM's (4096×1). By connecting the address and control lines in parallel, the same address in all IC's will be selected simultaneously. The data bits, of course, are kept separate. You could just as easily place 8, 16, or 32 IC's in parallel to create $4K \times 8$, $4K \times 16$, or $4K \times 32$ memory blocks.

Conclusion

Memory is an integral part of the high-tech revolution. Even the most basic processing circuit would be useless without some sort of memory to store variable data.

As you can see from our comparison of the many different permanent memory devices, there are distinct advantages and limitations to each type. What you choose depends on your individual needs—the ROM is inflexible but rugged, while the PROM can be programmed by the user, but only once because it can't be erased. The EPROM can be programmed and erased over and over again but uses a lot of power and space, while the EEPROM can be programmed while in circuit, but is slow.



ELECTRONIC FUSE

How do you troubleshoot power-related problems without blowing fuse after fuse? Just use our electronic fuse!

T.L. PETRUZELLIS

THE ELECTRONIC FUSE IS A SENSITIVE fast-acting adjustable circuit breaker that will quickly become one of your most useful bench-top accessories. If you have been stumped by a faulty electronic circuit and consumed a number of costly or hard-to-locate fuses, you will appreciate this inexpensive circuit breaker. All you have to do is connect the electronic fuse to the device under repair, and then adjust the current threshold control to the value you need anywhere from 1/10 to 10 amperes.

Additional applications for the electronic fuse include charging circuits for marine/mobile/aircraft systems, as well as new circuit designs. The electronic circuit breaker could be used after the design of a new circuit to help choose the correct value fuse. The electronic circuit breaker is connected in place of the original fuse of the device under repair or test. If the breaker

"trips," a red LED will light and power is cut off. When you're ready to continue, simply press the reset button.

Circuit description

As shown in Fig. 1, two test leads are connected in series with the normally closed relay contacts of RY1, a 12-amp fuse (F1), and the two-turn primary of T1, a torroid transformer. The secondary of T1 is wound underneath the primary on the half-inch torroid. The secondary coil is 100 turns of 30-gauge magnet wire with a total resistance of 8 to 10 ohms. The secondary is connected to a high-low RANGE switch (S1). The switch connects to a resistor network to provide stability and ease of operation. The low range permits values from 1/10 to 6 amperes, and the high range includes values from 1 to 10 amps, with overlapping between ranges. Capacitors C1 and C2 form a high-frequency fil-

ter to help reduce spikes and line noise.

Op-amp IC1-a amplifies and rectifies the AC input and applies it to IC2-a, an LM339 comparator, which is used to adjust the threshold, or current, via potentiometer R4. A clamp is formed by D3 which holds the input of IC2-b to a constant level. A filtered DC output is amplified by IC2-b and fed to Q1, a 2N3904 transistor. The transistor changes the output of IC2-b to the proper level and polarity in order to trigger SCR1. When the input current exceeds the threshold set by R4, the SCR will turn on. The relay will now open and LED1 will indicate that the circuit has been "tripped." The LED will remain on and the power to the device under test will remain off until the reset button (S3) is pressed.

Current consumption for the electronic fuse is about 10–15 mA at idle and about 100 mA when

PARTS LIST

All resistors are 1/4-watt, 5%, unless otherwise noted.

- R1—107,200 ohms, 1%
- R2—442,000 ohms, 1%
- R3—387,000 ohms, 1%
- R4—165,000 ohms, 1%
- R5, R6—300,000 ohms
- R7—50,000 ohms, audio-taper potentiometer
- R8—1500 ohms
- R9—12,000 ohms
- R10—18,000 ohms
- R11—13,000 ohms
- R12—4700 ohms
- R13—2000 ohms
- R14, R15—1000 ohms

Capacitors

- C1—200 pF, 50 volts, ceramic
- C2—100 pF, 50 volts, ceramic
- C3, C4—1 μ F, 50 volts, electrolytic
- C5—100 μ F, 50 volts, electrolytic

Semiconductors

- IC1—LM358 low-power dual op-amp
- IC2—LM339 quad comparator
- D1—D3—1N914 diode
- D4—1N4004 diode
- LED1—red light-emitting diode
- SCR1—NTE 5404 silicon-controlled rectifier

- Q1—2N3904 NPN transistor

Other components

- T1—hand-made transformer (see text) on 0.5-inch powdered-iron torriod core
- S1—DPDT toggle switch
- S2—SPST toggle switch
- S3—normally closed pushbutton switch
- F1—12-amp fast-blow fuse
- RY1—DPDT relay, 12-volt coil, 12-amp contacts (or use two sets of contacts in parallel, see text)

Miscellaneous: PC board, project case, fuse holder, alligator clips, 30-gauge magnet wire, 24-gauge stranded wire, 16-gauge stranded wire, PC-board scrap for wire spool, hardware, solder, etc.

Note: The following items are available from T.L. Petruzellis, 340 Torrance Avenue, Vestal, NY 13850:

- PC board only—\$8.25
- Kit of parts including the torriod core and wire (you have to wind it yourself), IC's, and project case (does not include a power supply)—\$44.95

Specify wires with alligator clips or 3-prong female power outlet (see text). Add \$3.00 S&H. NY residents must add 7% sales tax. Please allow 4-6 weeks for delivery.

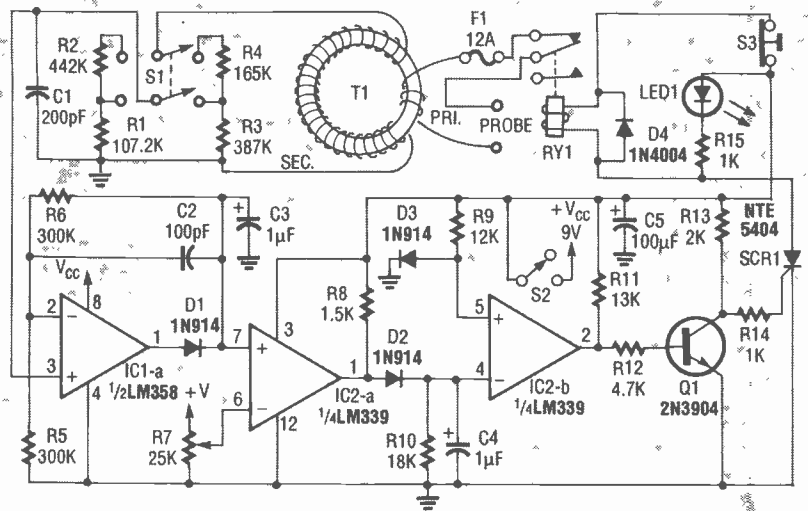

FIG. 1—THE ELECTRONIC FUSE is almost like an adjustable circuit breaker, where you can adjust the trip point anywhere from 0.1 to 12 amps.

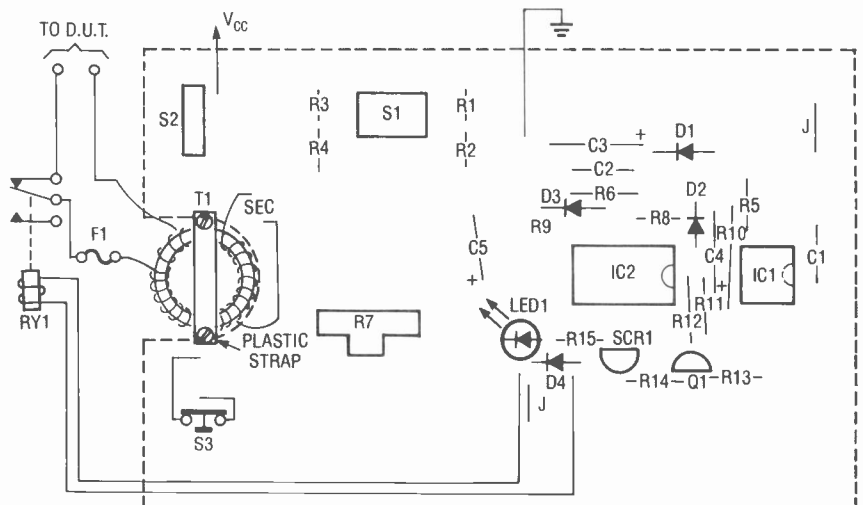

FIG. 2—PARTS PLACEMENT DIAGRAM. Because various controls are mounted directly on the PC board, you may have to drill tiny pilot holes on the circuit board in the center of each control location, place the unpopulated circuit board directly on top of the case, and then transfer the holes before installing the components on the board.

the relay is pulled in. Both integrated circuits are single-supply types, so any 12-volt battery or power supply can be used.

Construction

Everything except the relay and fuse are mounted on a PC board, for which we've provided a foil pattern—you can also buy a pre-made board if you like (see the parts list). If you use the PC board, you'll have to drill the holes in the case cover very accurately in order to accept the switches, LED, and potentiometer directly from the circuit board. One way to deal with this problem is to drill a tiny pilot hole on the circuit board in the center of each component location that

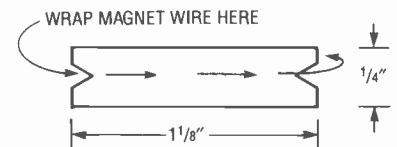

FIG. 3—THIS WIRE SPOOL allows easy winding of the torriod transformer (see text).

must come through the top cover. Then place the unpopulated circuit board directly onto the top cover and transfer the holes. This problem should be dealt with before installing the components on the board. Figure 2 shows the parts-placement diagram.

The torriod transformer was

constructed from a 0.5-inch powdered-iron torriod. A wire spool was made from a scrap of PC-board material, about 1¼-inches long by ¼-inch wide with V-shaped notches cut at both ends (see Fig. 3), and 30-gauge magnet wire was wound on the spool between the two notches. The spool was then pushed in and around the core of the torriod (like a sewing needle) forming a 100-turn coil (T1's secondary) all the way around the entire torriod core (you unspool the wire as you make the turns). The ends of the 30-gauge magnet wire were stripped and carefully soldered to 24-gauge wires. Five-minute epoxy was then brushed over the secondary coil. After the glue dried, the two splices were glued to the edge of the torriod with another spot of epoxy to reduce the stress on the 30-gauge wires.

The primary coil was wound over the secondary using two turns of 16-gauge wire with insulation heavy enough for about 12 amps. Heavy linecord can be used for the primary if you like. The torriod was placed over the square notch on the end of the PC board (as shown in Fig. 2), and attached to the board with a plastic strip placed over the torriod and fastened with two screws. One of the 16-gauge wires was connected in series with the 12-amp fuse; the other end of the fuse was connected to an alligator clip. The other 16-gauge wire was connected to one end of RY1's normally closed contact. The remaining relay contact was connected to another alligator clip. Note that the relay used in the prototype is a double-pole unit with the contacts wired in parallel to handle higher current. Figure 4 shows the prototype.

A later version of the electronic fuse replaced the alligator clips with a chassis-mounted female power receptacle. The device under test is plugged into the outlet on the electronic fuse and a 12-amp fuse is placed in the fuse holder of the device being tested. The electronic fuse, set at the fuse value of the device being tested, will then fully protect the faulty circuit until you have located the problem. Then simply replace the original value fuse in the circuit you just repaired.

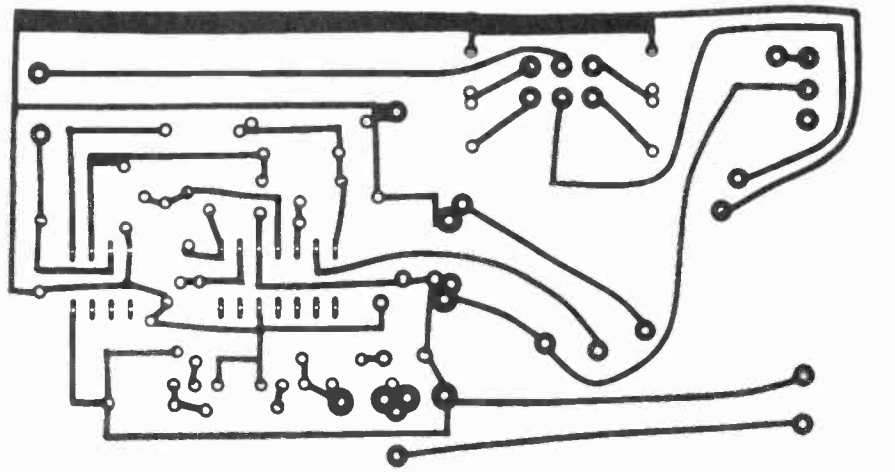

FOIL PATTERN for the electronic fuse PC board.

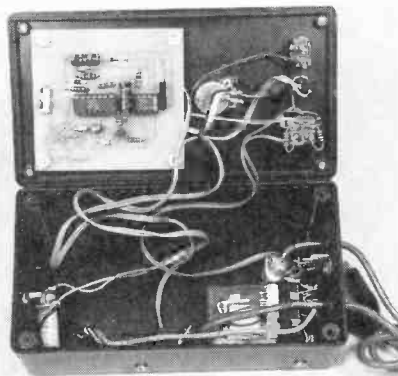

FIG. 4—EVERYTHING EXCEPT the relay and fuse are mounted on the PC board.

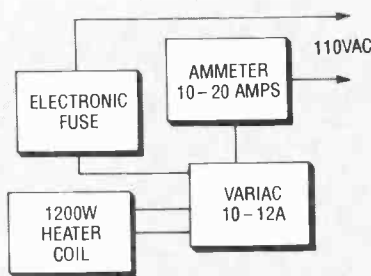

FIG. 5—CALIBRATION IS PERFORMED using a 1200-watt heating element coil connected to the output of a variac (see text).

Operation

Operation of the electronic fuse is quite simple. The alligator clips connect to the fuse holder of the device under test, essentially substituting the electronic fuse for the fuse that was in the original circuit. First choose the high- or low-sensitivity position of S1; the low range covers ½ to 6 amps and the high range covers 1 to 10 amps with overlap between the two ranges. Next adjust R7 for

the current setting that best represents the desired fuse value. Turn on the power switch S2, and reset the electronic fuse by pressing S3. Now turn on the device being tested; if LED1 lights, the "fuse is blown" and you must reset the circuit by pressing S3. Continue to troubleshoot until the repair is completed.

Calibration of the Electronic Fuse was performed by using a 1200-watt heating element coil, but an electric fry pan or toaster could be used instead. The thermostat in a fry pan must be turned up to maximum or disabled. The heater is connected to the output of a variac and the input of the variac is connected in series with an ammeter and the electronic fuse (see Fig. 5). The variac output is slowly stepped up in small increments. A calibration sheet is placed under R4's adjust knob.

Calibration must be done for both the high and low ranges. Begin by selecting the low range, and turn R4 clockwise to about midway. Next turn on the variac and adjust for about 1 amp, then rotate R4 to the trip point. Place a pencil mark on the calibration sheet, back down the variac, and reset S3. Bring up the variac to the point you just marked for one amp, and watch the meter to ensure that you are drawing one amp as the breaker "trips." Now proceed with the next value, adjust R4 past midway, set the variac for two amps, and rotate R4 down to the trip point. Repeat the procedure for each fuse value in the low and high ranges.

R-E

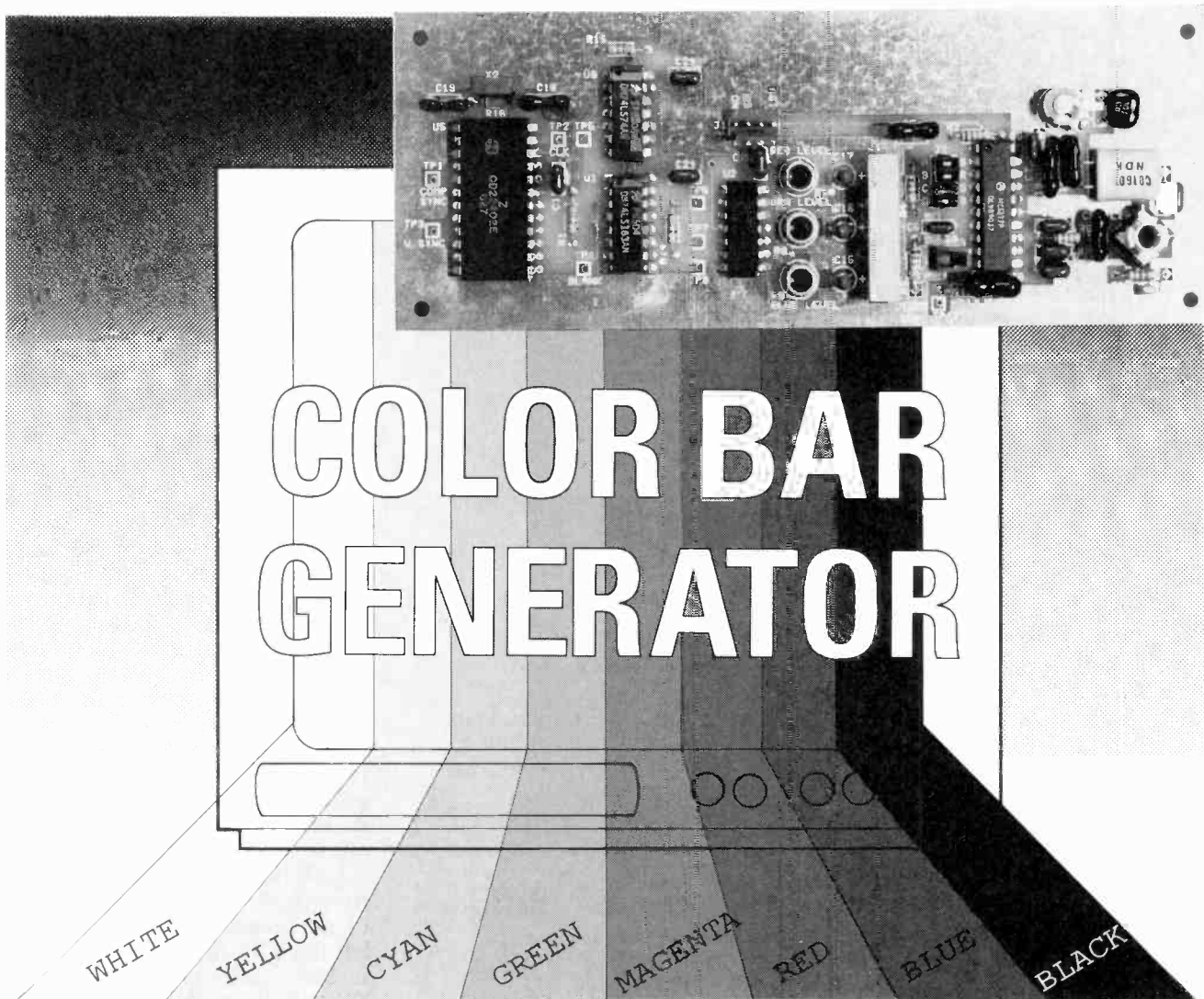

Build this inexpensive color-bar test generator and brush up on your video skills.

THOMAS GOULD WB6P

IF YOU'RE INVOLVED IN TV SERVICING and repair, or just enjoy tinkering around with video or amateur television, you'll be interested in this color-bar test generator. This convenient device produces an NTSC color-bar pattern that can be used for video performance testing and monitor adjustments. For added flexibility, just the encoder section can be used to generate composite video from your computer's RGB and sync outputs. With a dedicated color-bar generator, you can eliminate the need for a test tape or your camera—all for under \$70!

Before we delve into the theory behind the color-bar generator,

let's briefly discuss the various components that make up the composite NTSC video signal: synchronization, luminance, and chrominance information.

The NTSC signal

A typical NTSC composite color video signal is shown in Fig. 1-a. (NTSC is the National Television Systems Committee, who has set the standards for color encoding and decoding systems in the U.S. since 1953.) The picture on a color TV is formed by three electron beams of varying amplitudes and phases: red, blue, and green. Each of those beams are scanned horizontally and ver-

tically over the screen. As the beams scan, their currents and amplitudes change to create the light and dark areas on the picture-tube face and form the image that you see displayed on the screen.

The composite video signal is made up of three basic components: the scan control information called the synchronizing pulses (Fig. 1-b), the luminance signal, which is the brightness information and is often referred to as the Y signal (Fig. 1-c), and the color information called the chrominance signal (Fig. 1-d). Let's briefly discuss each type of video information.

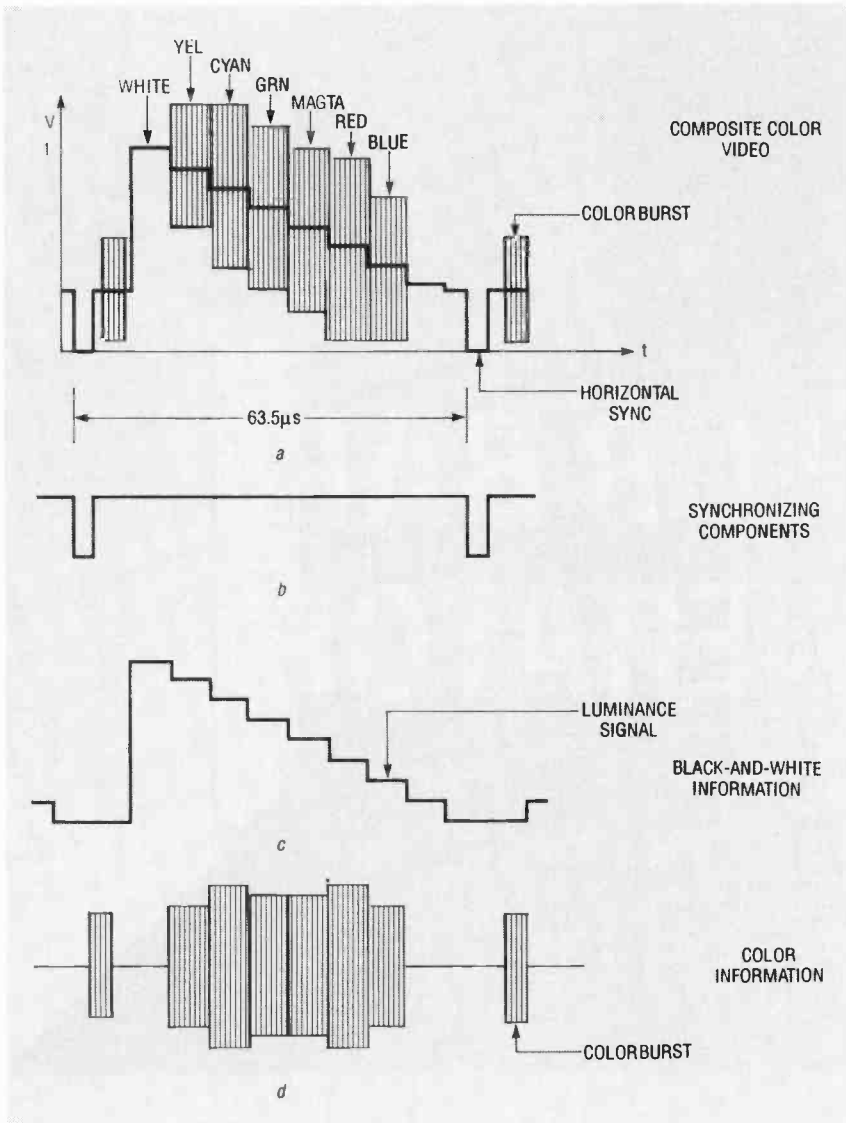

FIG. 1—A COMPOSITE VIDEO SIGNAL (a) includes sync pulses (b), black-and-white information (c), and the colorburst signal (d).

Synchronizing components

In order for a picture to be reproduced properly, the TV receiver must scan its screen exactly in step with the camera in the studio. To make sure the camera and the receiver are synchronized, a series of pulses are

sent to the camera telling it when to start at the top of the screen and when to begin a new line at the left of the screen. Those same pulses are sent to the receiver along with the video information. The signals that tell the camera and receiver when to

start at the top are called vertical sync pulses, while those that start scanning each line at the left are known as horizontal sync pulses.

In the NTSC system, each frame, of complete video image, contains 525 lines. That is accomplished by horizontally scanning at approximately 15,750 lines per second, and vertically scanning at 30 frames per second. (The vertical scan rate is actually 60 Hz, but it takes two trips, or fields, down the screen to complete one frame.) The process of returning to start a new scan is called retrace or flyback.

Luminance

Black and white information is contained in the Y or luminance signal, which determines the instantaneous brightness of the electron beams as they scan over the screen. In fact, it is all that is used for the single electron beam in a black-and-white TV set. A negative-going video detector detects a luminance signal in which the negative signal extremes correspond to bright areas of the picture. The waveform shown in Fig. 1-c would, therefore, produce vertical bars of decreasing brightness from left to right. Note that the output is black during retrace so the electron beams will not be seen.

In the NTSC color system, the Y signal is made from the red, green, and blue cameras by an additive technique: 30% of the red signal, 59% of the green signal, and 11% of the blue signal are added together to form the Y signal. The luminance signal can also be expressed as

$$E_Y = .30E_R + .59E_G + .11E_B$$

where E_R , E_G , and E_B are the voltages of the red, blue, and green signals, respectively.

The combination of different amplitudes of color signals is what determines the various shades of gray in a monochrome receiver—white having a luminance of one, black a luminance of zero. The ability of a receiver to determine a corresponding level of gray from color levels is an important feature in the compatibility of color and monochrome TVs because the black-and-white signals can be obtained from the three primary color signals.

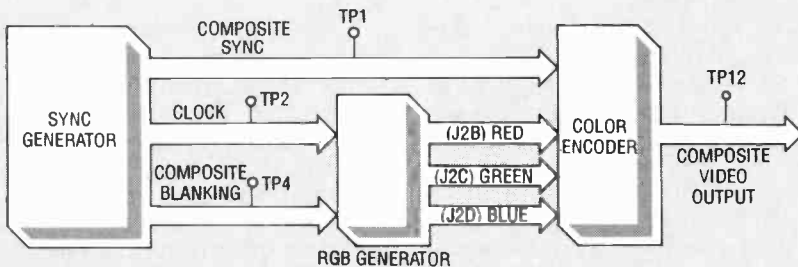

FIG. 2—A BLOCK DIAGRAM of the color-bar generator shows the main components of the circuit: RCA's CD22402E sync generator and Motorola's MC1377P color encoder.

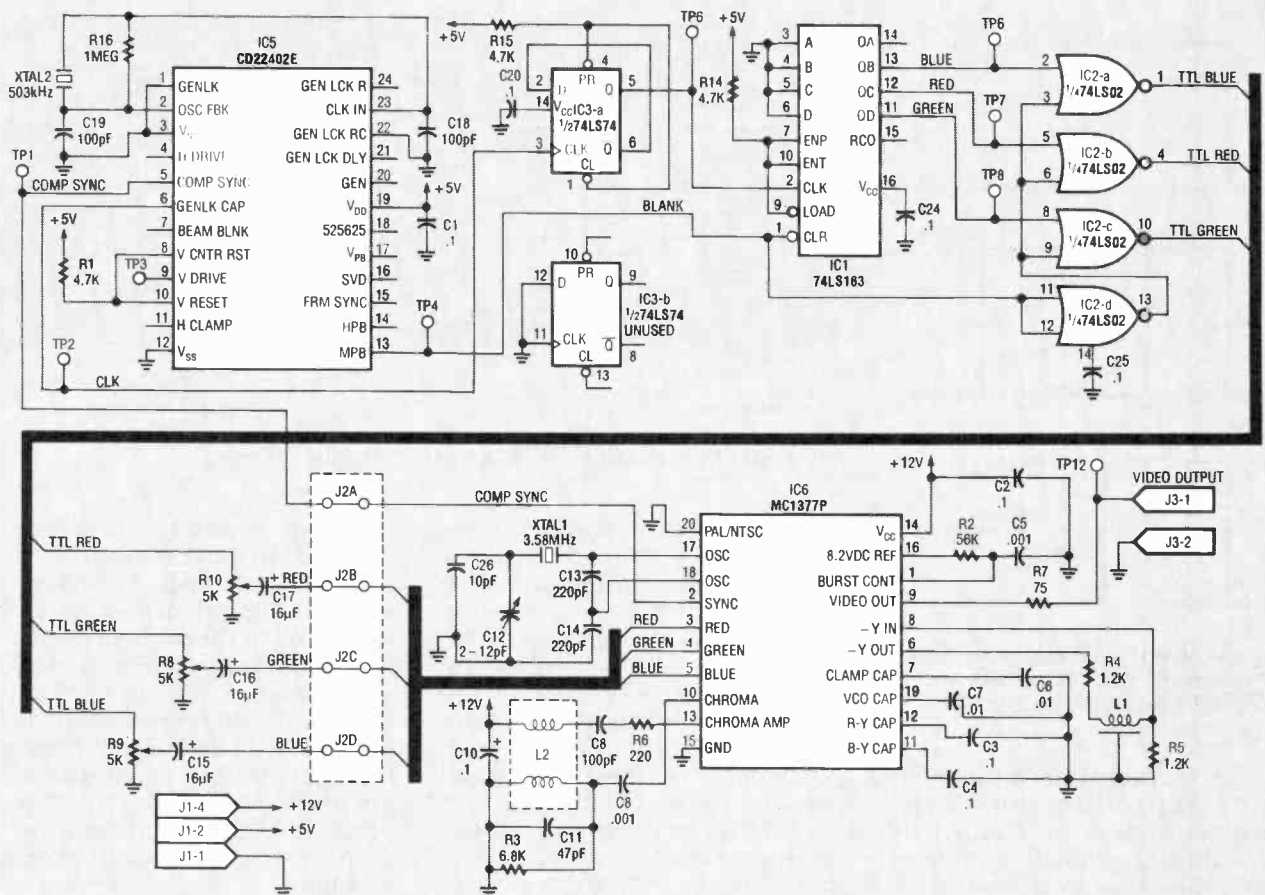

FIG. 3—SCHEMATIC OF THE COLOR-BAR GENERATOR. Sync generator IC5 provides the composite-sync timing signals, color encoder IC6 takes the separate red, green, and blue video signals and composite sync to generate the composite video signal.

Chrominance

The color information, or chrominance, (which is ignored in a black-and-white TV) is made up of red, blue, and green signals required to drive the picture tube, minus the luminance signal. Those "color-difference" signals are designated as R-Y (red minus Y), and B-Y (blue minus Y). Color-difference signals are used solely for color reproduction. A special matrix circuit in the receiver can extract a G-Y (green minus Y) signal from the B-Y and R-Y signals. The advantage of changing the color signals into color-difference signals is the reduction of three color signals into two.

The R-Y, B-Y, and G-Y signals are decoded at the receiver by adding the Y signal back to each of the difference signals. A 3.58-MHz subcarrier is sent by the transmitter and used in the receiver to restore the original color information.

The frequency and phase angle of the 3.58-MHz subcarrier in the receiver must be the same as that

All resistors are 1/4-watt, 5%, unless otherwise indicated.

- R1, R14, R15—4700 ohms
- R2—56,000 ohms
- R3—6800 ohms
- R4, R5—1200 ohms
- R6—220 ohms
- R7—75 ohms
- R8—R10—5000-ohm potentiometer
- R16—1 megohm

Capacitors

- C1-C4, C10, C20, C24, C25—0.1 μ F, bi-polar electrolytic
- C5, C8—1000 pF, mica
- C6, C7—0.01 μ F, bi-polar electrolytic
- C9, C18, C19—100 pF, mica
- C11—47 pF, mica
- C12—2-12 pF variable ceramic capacitor
- C13, C14—220 pF, mica
- C15-C17—15 μ F, electrolytic

Semiconductors

- IC1—74LS163 counter
- IC2—74L02 quad NOR gate
- IC3—74LS74 flip-flop
- IC4—not used
- IC5—CD22402 sync generator, RCA
- IC6—MC1377 color encoder,

Motorola

Other components

- L1—400-ns delay line (TK1001)
- L2—30 μ H, 2.52-MHz transformer (TK1603)
- XTAL1—3.58-MHz colorburst crystal
- XTAL2—503-kHz ceramic resonator
- Miscellaneous: enclosure, stand-offs for mounting circuit board, 4-pin friction-lock connector for J1, straight-header connector for J2, 2-pin friction-lock connector for J3, four shorting jumpers, wire, solder, etc.

Note: The following items are available from Geko Labs, 13019 250th Place SE., Issaquah, WA 98027-6730, (206) 392-0638: etched, drilled and plated-through PC board \$30.00; a complete kit including all parts, PC board, and assembly instructions \$80.00; a complete assembled and tested unit \$125. Add \$5.00 S & H with any order. Washington residents add 8.1% sales tax.

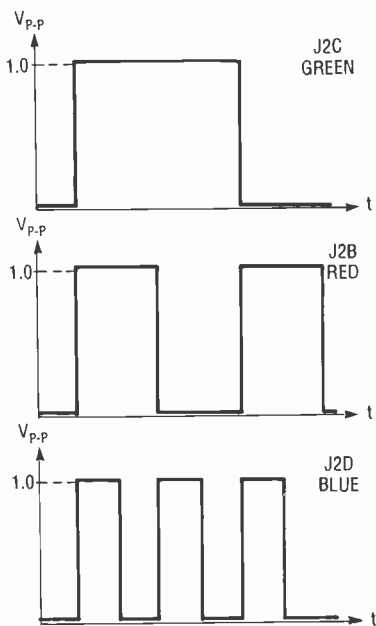

FIG. 4—OUTPUT SIGNALS of the color-bar generator. The TTL signals are reduced to 1 V p-p by R8, R9, and R10.

in the transmitter for proper color reproduction. Synchronization is performed by transmitting a small sample of the 3.58-MHz subcarrier during the horizontal sync pulse. That color sync interval is also known as the colorburst. The colorburst signal is used as a reference to synchronize the phase and amplitude of the color subcarrier. The colorburst also determines the tint and saturation of the color that is displayed.

Theory of operation

Figure 2 shows a block diagram, and Fig. 3 a schematic of our video generator. Sync generator IC5 is used to provide the composite-sync timing signals. The outputs are composite sync, composite blanking, and a buffered output of the sync oscillator. The sync generator uses a 503-kHz ceramic resonator (XTAL2) as a base oscillator. The 503-kHz frequency is divided by 32 for the horizontal sync, and is further divided to derive the vertical sync-timing signals. Those signals are all combined into the composite-sync signal which is sent to the MC131377 color encoder (IC6). The color encoder takes the separate red, green, and blue video signals and composite sync to generate the composite-video signal.

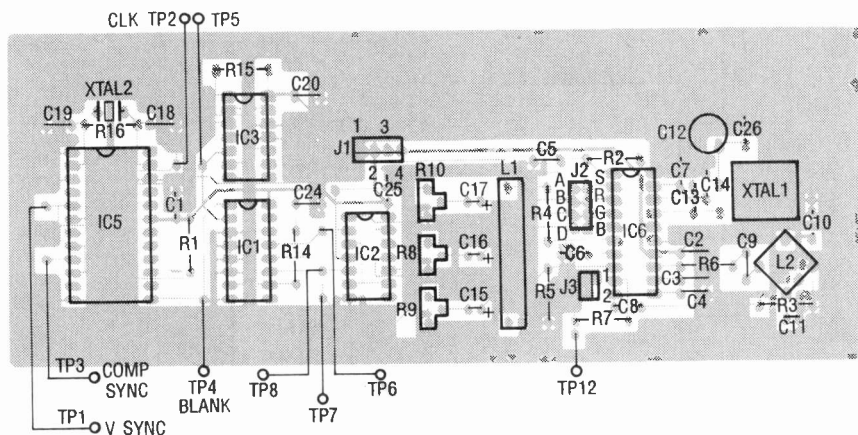

FIG. 5—PARTS PLACEMENT DIAGRAM of the color-bar generator.

The 3.58-MHz colorburst crystal, XTAL1, is the reference oscillator for the chroma information. Capacitor C12 allows fine tuning of the reference oscillator to be exactly 3.579545 MHz. The combination of R2 and C5 set the timing for the insertion of the colorburst signal on the back porch of the composite video signal. The values used for R2 and C5 set the burst timing to approximately 0.4 μ s after sync, and a burst width of 0.6 μ s. The network of L2, C9, R6, C8, C11, and R3 provide bandpass filtering for the chroma component. A delay for the luminance channel ($-Y$) is provided by R4, L1, and R5 to compensate for the internal delay of the chroma signal.

RGB generators IC1, IC2, and IC3 make up the red, green, and blue video signals that drive the video encoder section to make the color bars. One half of IC1 is used as a divide-by-2 counter, which generates the 252-kHz clock for the four-bit counter IC1. The non-inverted blue, red, and green signals are the divide-by-4, -8, and -16 outputs of IC1, respectively. The blue, red, and green signals are inverted, and blanking is added by IC2. The TTL level is reduced to 1 volt p-p by R8, R9, and R10, as shown in Fig. 4.

Construction

The video generator uses a double-sided PC board that is available from the source mentioned in the parts list. We recommend that you use a PC board for this project because the frequencies involved require a large ground plane. Both the component and the solder side of the PC

board are shown in the article if you wish to make it yourself.

Construction is fairly straightforward. Install all components according to the parts placement diagram shown in Fig. 5. Make sure C15–C17 are inserted into the board with correct polarities. Install all IC's last, observing correct orientation. Since the IC's are static sensitive, make sure you follow the manufacturer's recommendations for proper handling.

Checkout

The measurements listed in this section will help to make sure the video generator is working properly. The power on tests should be made with the +12- and +5-V power sources on. Set R8, R9, and R10 to mid range. If you are the impatient type you can go right to the video output test point TP12 and see what you get. If you're lucky you'll have a video signal that probably needs some adjustments. If that's the case you can proceed directly to the video adjustments section. If not, proceed slowly through the following steps to isolate the problem and verify each of the listed voltages, frequencies and waveforms. Keep in mind that you will need an oscilloscope for the video level adjustments.

- Pin 2 of J1 and +5 V \rightarrow 2000 ohms (power off)
- Pin 4 of J1 and +12 V \rightarrow 1 megohm (power off)

Power-on Tests

- +12-V supply—57 mA
- +5-V supply—29 mA
- IC1 pin 16—+5 V
- IC2 pin 14—+5 V
- IC3 pin 14—+5 V

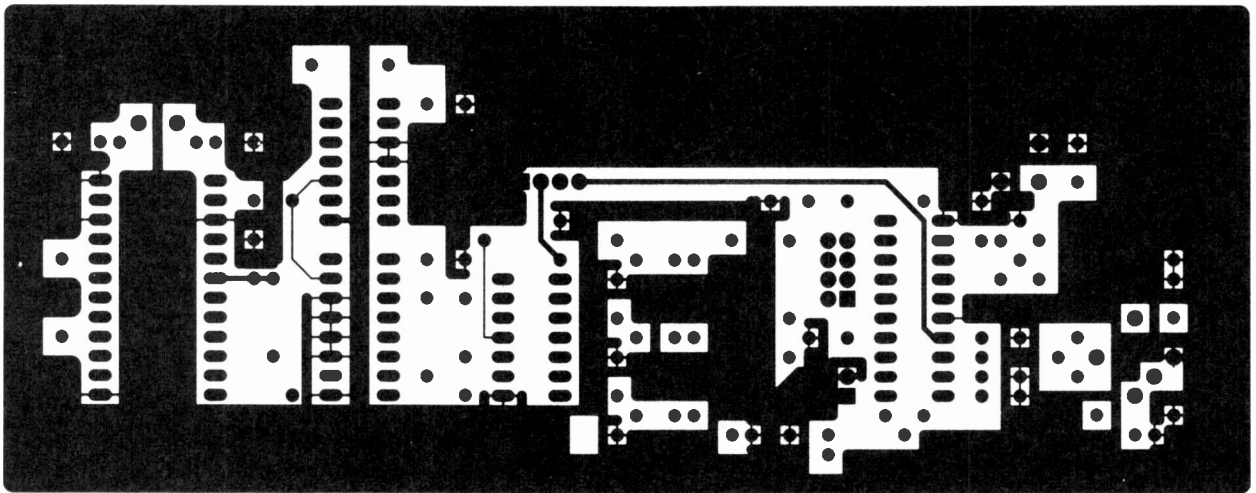

6 1/2 INCHES
 FOIL PATTERN OF THE COMPONENT side of the double-sided PC board.

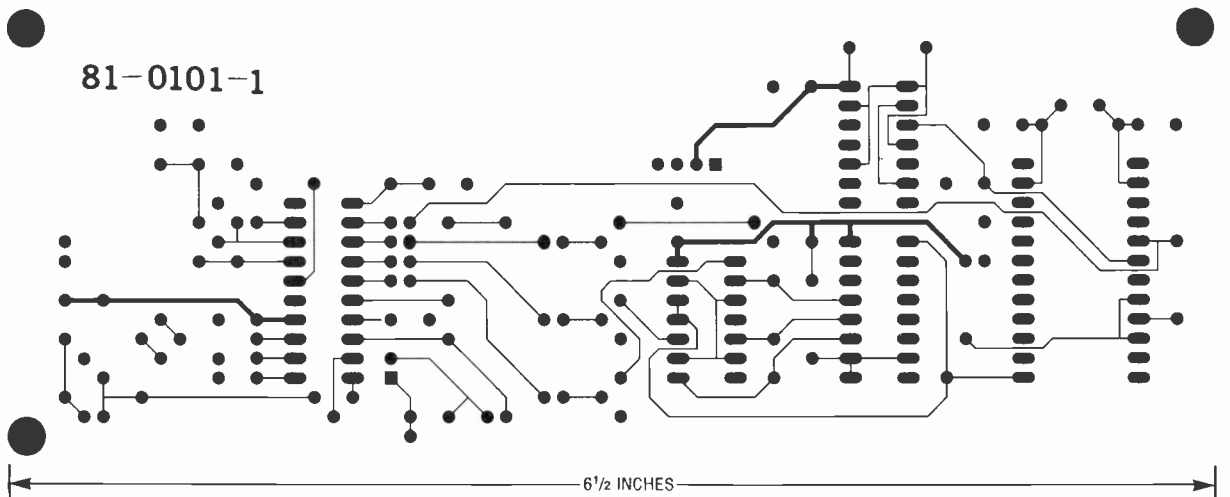

6 1/2 INCHES
 FOIL PATTERN OF THE SOLDER SIDE of the PC board.

- IC5 pin 19—+5 V
- IC5 pin 6 (TP2)—2.504-kHz, 5-V p-p (TTL level) square wave
- IC5 pin 5 (TP1)—TTL-level composite-sync signal
- IC5 pin 13 (TP4)—TTL-level blanking signal
- IC3 pin 5 (TP5)—252-kHz signal
- IC1 pins 11–13 (TP6, 7, 8)—Divided down signals

Sync Generator

- IC5 pin 19—+5 V
- IC5 pin 5 (TP1)—TTL-level composite-sync signal
- IC5 pin 6 (TP2)—504-kHz, 5-V p-p TTL-level square wave
- IC5 pin 13 (TP4)—TTL-level blanking signal

RGB Generator

- IC1 pin 16—+5 V
- IC2 pin 14—+5 V
- IC3 pin 14—+5 V
- IC3 pin 5 (TP5)—252-kHz signal

- IC1 pins 11–13 (TP6, 7 and 8)—Divided down signals as shown in Fig. 4

Color Encoder

- IC6 pin 14—+12 V
- IC6 pin 2—TTL-level composite-sync signal (Fig. 1-b)

Amateur Television Quarterly

This article originally appeared in ATVQ magazine. ATVQ is a quarterly publication featuring technical articles on subjects related to ham radio, including VHF, UHF, amateur TV (ATV), computer programs, and repeater projects. ATVQ is enjoyed by hams of all levels, from beginner to Extra class. A subscription to this magazine is available for \$15 per year, \$4.00 for a sample copy (Visa and Mastercard are accepted). For more information contact

Amateur Television Quarterly
 1545 Lee St. #73
 Des Plaines, IL 60018
 (708) 298-2269

- IC6 pins 3–5—1 V p-p signal
- IC6 pins 17 and 18—3.58-MHz oscillator signal
- IC6 pin 16—8.2 VDC
- IC6 pin 1—Ramp signal
- IC6 pins 10 and 13—Chroma signal (Fig. 1-d)
- IC6 pins 6 and 8—Luminance signal (Fig. 1-c)
- IC6 pin 9—2 V p-p (Fig. 1-a signal)

Video Level Adjustments

- IC6 pin 4 (J2C)—Adjust R8 to 1 V p-p
- IC6 pin 3 (J2B)—Adjust R10 to 1 V p-p
- IC6 pin 5 (J2D)—Adjust R9 to 1 V p-p
- J3 pin 1—Terminate into a 75-ohm connector
- Video Output (TP12)—Composite 1-V p-p signal. If you can't get this signal, adjust R8 for the proper peak level and null out the

continued on page 129

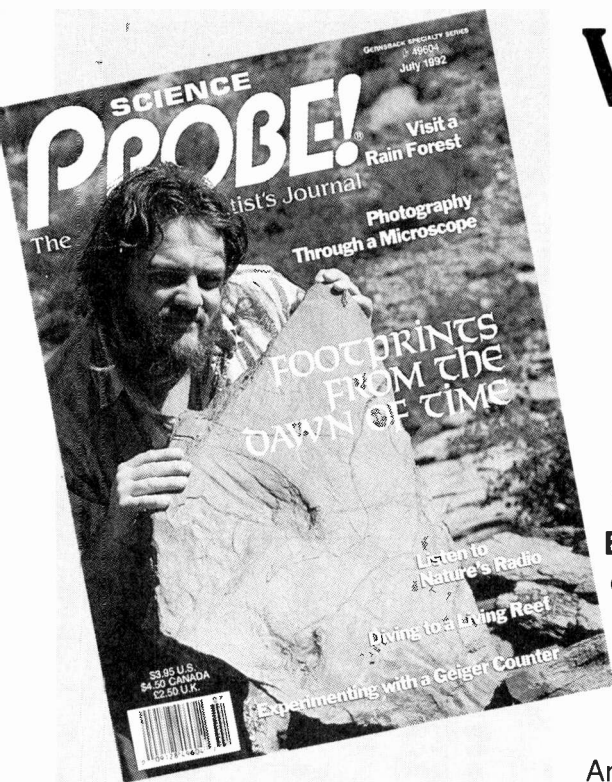

Welcome to. . .

SCIENCE PROBE!®

The Amateur Scientist's Journal

Embark on an irresistible new journey into the realm of mystery, challenge, and exploration! The perfect magazine for the budding scientist, the serious amateur, the professional who would like to relax, and those who simply want to gaze at the stars.

Science PROBE! — the *only* magazine devoted entirely to Amateur Scientists! If you are fascinated by science in all its many forms . . . if you can't stay away from a microscope, telescope, calipers, or test tube — we invite you to share the wonders in every issue of **Science PROBE!** You will join a community of Amateur and Student Scientists who enthusiastically seek scientific knowledge or follow scientific pursuits for their own sakes and not merely as a profession.

Obtain your next issue of **Science PROBE!** by visiting a quality Newsstand, Convenience Store, or Supermarket or by reserving your personal copy through the mail by completing the coupon below.

From your very first issue of **Science PROBE!** you will be involved in a world of scientific facts, experiments, and studies pursued by amateur scientists who are university students, investors, academicians, engineers, or office workers, salesmen, farmers—whose *quest* is to probe into the mysteries of science and reveal them to all.

Plan to become a **Science PROBE!** reader!

Articles to appear in upcoming issues of **Science PROBE!** are:

Inside Internet—A Scientific Computer Network
Make your own Seismometer
Operate a Solar-Powered Weather Station
Assemble a Solid-State Portable Barometer
The Bicycle—A Traveling Scientific Laboratory

If you're fascinated by science in all its many forms, if you are compelled to experiment and explore, then **Science PROBE!** is your kind of magazine!

For Faster Service—Call Today:
1-800-777-5489

Science PROBE!
 500-B Bi-County Boulevard
 Farmingdale, NY 11735

5XP37

Please forward my copy of **Science PROBE!** as soon as it comes off the press. I am enclosing \$3.50-U.S.A. (\$4.23-Canada-includes G.S.T.) plus \$1.00 for shipping and handling. Better still, please enroll me as a subscriber and send the next four (4) quarterly issues of **Science Probe**. I am enclosing \$9.95-U.S.A. (Canada: \$16.00—includes G.S.T.)

Next Issue Only Next Four Issues (1 Year)

Offers valid in the U.S.A. and Canada only. No foreign orders.

Name _____

Address _____

City _____ State _____ ZIP _____

All Orders payable in U.S.A. Funds only.

ON SALE AT QUALITY NEWSSTANDS, CONVENIENCE STORES AND SUPERMARKETS
GET YOUR COPY TODAY—\$3.50-U.S.A.—\$3.95-Canada

VCP200

cont. from page 26

mentation, try using a 10K potentiometer in place of R8, and a 1K resistor in place of R9. 10K the tap of the potentiometer as the output to the comparator. That way, a steady amplifier offset is maintained while allowing considerable adjustment of the comparator threshold.

Interfacing

The outputs of the VCP200 can only source and sink small amounts of current and must be protected from reverse EMF and noise. Fortunately, a variety of interface circuits can be devised. One simple power driver is shown in Fig. 7. The desired output from VCP200 is connected to the **SELECT** input, where it drives the base of the PNP transistor. The transistor supplies power to the relay, which can have any type and arrangement of contacts necessary.

In some cases, it may be handy to be able to toggle an output device on and off. The circuit in Fig. 8 permits just that. Upon power-up, the output of the flip flop will be low. When an active low from the VCP200 is applied to the **SELECT** input, the output will latch high. The next active low will cause the flip flop output to drop low again.

A more sophisticated output circuit is shown in Fig. 9. On power-up, both outputs will be high. When the \overline{GO} output of the VCP200 is selected, that output will be latched low. If the VCP200's **REVERSE** output is selected, the \overline{GO} output will be toggled high and **REVERSE** output will latch low. If a **STOP** signal from the VCP200 is received, both flip flop outputs will be toggled high.

The circuit in Fig. 10 allows a complete reset of the voice recognition circuit and any outlying

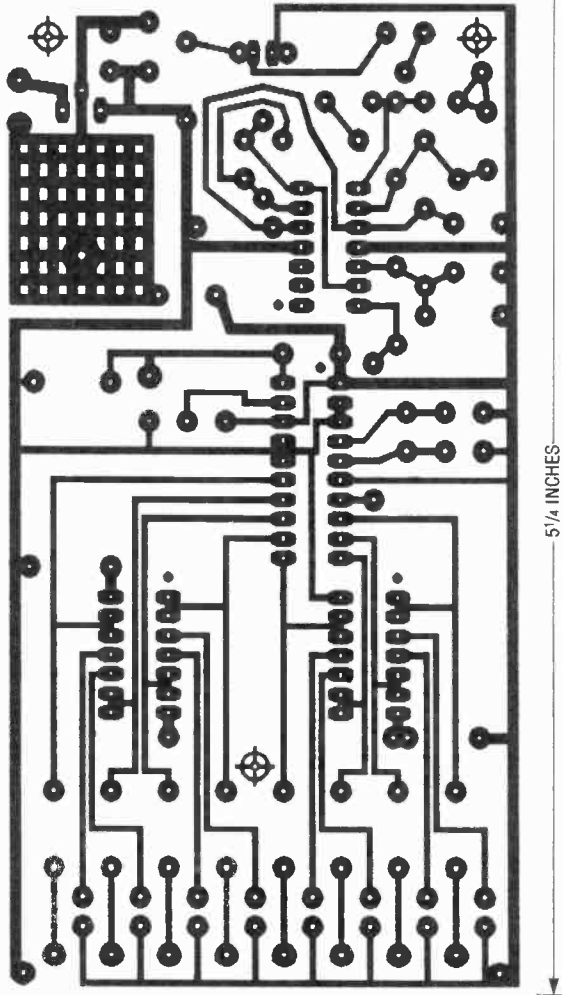

THE "WORKING" VERSION of the project is made on this board, which omits the LED's and their drivers.

circuitry with a voice command. When the **RESET** output of the VCP200 is selected, the monostable multivibrator, composed of the first two gates and the RC junction, produces a pulse that is routed back to the VCP200's reset pin, pin 20. That forces a reset of the voice-recognition circuit. The pulse can be tapped by another CMOS gate (either inverting, as shown, or noninverting, or both), and used to reset outlying circuitry. Given the imperfect nature of voice control, this circuit is recommended.

You now have some basic building blocks on which you can base your voice-control experiments. Keep in mind that, even though the command words understood by the VCP-200 are best suited for controlling a robot, they can be used to control virtually anything.

R-E

FREE Heathkit

Educational Systems

Electronics & Computer Software
Education Catalog

- *Fast-Track Individual Learning Programs
- *State-of-the-Art Classroom Courses
- *The Best Values in Electronics Education Today

New

Computer Aided Instruction

DC Electronics
AC Electronics
Semiconductors
Electronic Circuits

The stunning animations, hypertext glossary, and easy-to-understand text make learning the concepts of electronics a breeze...and fun!

Learn Electronics the easy and affordable way from the Masters in Electronics Training - Heathkit Educational Systems. From Basic Electricity and Electronics to Advanced Microprocessor Applications and much more, Heathkit will provide you will an unparalleled learning experience at a fraction of the cost of other programs.

For your FREE Catalog, call
Toll-Free 1-800-44-HEATH

please mention this code when calling 020-003

CIRCLE 97 ON FREE INFORMATION CARD

FREE
Catalog

All the tools
& test equip-
ment you need
for hobby or work!

Electrical,
electronics,
computers,
communications,
sound systems -
all the tools,
meters and
other equip-
ment you
need to do a
professional
job!



Order Phone: 800-968-6231 • Toll-Free FAX: 800-366-9662

Top technicians and field service personnel prize their Jensen tool kits. Our new 232-page Master Catalog will show you why. You'll discover hard-to-find items, the latest high-tech developments, soldering stations, wire & cable accessories and many more quality products you want and need. Send for your free copy today!

JENSEN TOOLS INC.

7815 South 46th St.,
Phoenix, AZ 85044-5399
Phone: (602) 968-6231
FAX: (800) 366-9662



CIRCLE 96 ON FREE INFORMATION CARD

Enter A World Of Excitement with a Subscription to

Popular Electronics®

Get the latest electronic technology and information monthly!

Now you can subscribe to the magazine that plugs you into the exciting world of electronics. With every issue of Popular Electronics you'll find a wide variety of electronics projects you can build and enjoy.

Popular Electronics brings you informative new product and literature listings, feature articles on test equipment and tools—all designed to keep you tuned in to the latest developments in electronics. So if you love to build fascinating electronics, just fill out the subscription form below to subscribe to Popular Electronics... It's a power-house of fun for the electronics enthusiast.

EXCITING MONTHLY FEATURES LIKE:

- CONSTRUCTION**—Building projects from crystal sets to electronic roulette
- FEATURES**—Educational training on digital electronics, Ohm's Law, Antennas, Communications, Antique Radio, Simplified Theory
- HANDS-ON-REPORTS**—User test comments on new and unusual consumer products
- SPECIAL COLUMNS**—Think Tank, Circuit Circus, Computer Bits, DX Listening, Antique Radio, Amateur, Scanner Scene

PLUS: ALL OUR GREAT DEPARTMENTS!

You'll get 12 exciting and informative issues of Popular Electronics for only \$18.95. That's a savings of \$23.05 off the regular single copy price. Subscribe to Popular Electronics today! Just fill out the subscription order form below.

FOR FASTER SERVICE CALL TODAY

1-800-827-0383

(7:30AM-8:30PM)

EASTERN STANDARD TIME

Popular Electronics® SUBSCRIPTION ORDER FORM

AXP93

P.O. Box 338, Mt. Morris IL. 61054

YES! I want to subscribe to Popular Electronics for 1 Full year (12 Issues) for only \$18.95. That's a savings of \$23.05 off the newsstand price.

(Basic Subscription Rate—1 yr/\$21.95)

Payment Enclosed Bill me later

Please charge my: Visa Mastercard

Acct. #

Signature

Exp. Date

PLEASE PRINT BELOW:

NAME

ADDRESS

CITY

STATE

ZIP

Allow 6 to 8 weeks for delivery of first issue. U.S. Funds only.

In Canada add \$6.68 Postage (Includes G.S.T.) All Other Foreign add \$7.50 Postage

PAUL BRULE

IF YOU'RE CONCERNED WITH ENERGY cost and conservation, as most people are, you'll be interested in our energy consumption monitor (ECM). Without the ECM, it's difficult for the average person to determine how much an individual home appliance costs to run. That's especially true for appliances with variable duty cycles such as a refrigerator which will have its compressor and fan motors, lights and other loads on at different times.

Our energy consumption monitor can display the accumulated cost in cents for the connected home appliance load. What did you spend to operate your toaster yesterday? What about your TV or air conditioner? Is the cost of energizing that spare freezer unit worth the few pennies saved when you bought your meat on sale? The ECM will help you to answer those questions quickly.

The ECM can also be used as a power meter by connecting a DMM to the voltage output of the monitor. Using the DC scale of your meter, each volt represents 100 watts. For example, a reading of 0.56 volts would translate to 56 watts.

To give you an idea of what the average residential Long Island, NY consumer pays monthly for operating various appliances, refer to Table 1. The monthly cost was based on a rate of 13¢ per kilowatt-hour (kWh). The average Long Island resident uses about 600 kWh's per month, which translates into a monthly electric bill of \$91.81.

The current electric rates for the Long Island, NY area are among the highest in the U.S. and vary depending on the season and the total amount of kWh's used. The summer rates are 12.87¢ for 0-250 kWh's used and 14.1¢ for 250-350 kWh's. The winter rates are 12.87¢ for 0-250 kWh's and 12.33¢ for 250-350 kWh's. Of course electric rates will vary, depending on the size of your family, the region of the country in which you live, and the utility company who services you. The information provided is only a rough basis to compare your own power con-

sumption to that of the *average* Long Islander. Let's see how this useful device works.

About the circuit

The ECM circuit consists of four sections, as shown in the block diagram of Fig. 1. A power converter generates a voltage that is proportional to the true or real power consumed by the load. That voltage feeds both a bar-

the monitored load is fairly constant at about 117 volts, we can say that the power is proportional to $I \times \cos\theta$. To obtain the phase angle, both the voltage and current must be monitored. Transformer T1 supplies the voltage, while the current-proportional voltage is obtained by stepping up (by a factor of 20) the voltage drop across shunt resistors R1-a-d via T2.

ENERGY CONSUMPTION MONITOR

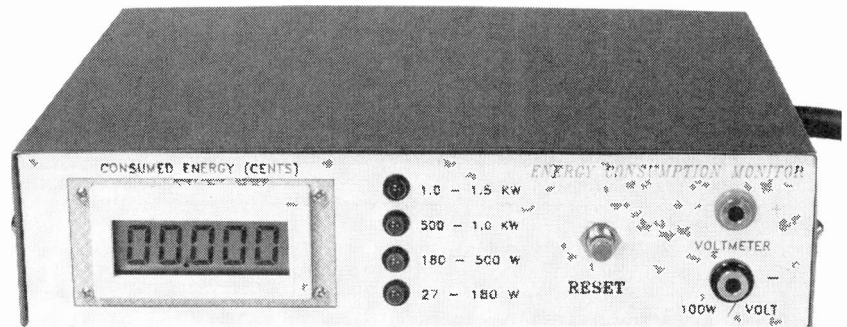

Build this energy consumption monitor and find out how much it costs to run your household appliances.

graph and a voltage-to-pulse converter. The bargraph gives an approximate indication of the amount of power used, and the voltage-to-pulse converter produces a pulse whose frequency is proportional to the power. The pulse triggers the counter module which displays the cost of powering the monitored load.

The power converter

In order to determine the actual power consumed by an appliance, we must find the phase angle between the voltage and current in the overall circuit. We know that

$$P = V \times I \cos\theta$$

where $\cos\theta$ is known as the power factor. Since the voltage of

The ECM is capable of accurately monitoring the effective power of inductive loads. If a capacitive load is connected to the ECM, only the apparent power, not the effective power, will be monitored, causing some degree of inaccuracy. That shouldn't pose much of a problem because just about all reactive household loads are inductive. However, some appliances such as refrigerators, freezers, and air conditioners use capacitor-start inductive motors, which are characterized by a high starting torque. Those types of motors will present a capacitive loading effect on the power line, but only during start-up, which is a very short time interval compared to

TABLE 1—AVERAGE WATTAGE, USAGE AND COST OF HOUSEHOLD APPLIANCES

Appliance	Wattage	Estimated Monthly Usage (Hours)	Monthly Consumption (kWh)	Monthly Cost*1
Food Preparation				
Broiler	1,140	6.3	7.2	\$0.94
Coffee maker (drip)	1,200	9.8	11.8	\$1.53
Microwave oven	1,450	10.9	15.8	\$2.05
Oven range	12,200	4.8	58.6	\$7.62
Toaster	1,146	2.8	3.2	\$0.42
Home Entertainment				
Color TV (tube)	240	180.0	43.2	\$5.62
Color TV (solid state)	145	180.0	26.1	\$3.34
VCR	20	120.0	2.4	\$0.32
Radio	71	100.9	7.2	\$0.94
Stereo	109	83.3	9.1	\$1.18
Refrigerator				
Frost free, 10-15 years old	—	continuous	141.2	\$18.36
Ref./freezer, frost-free, 10-15 years old	—	continuous	153.0	\$23.80
18-cubic foot ref./freezer, new	—	continuous	100.65	\$13.08
16-cubic foot ref./freezer, new	—	continuous	77.66	\$10.10
Air Conditioning				
Room AC, 6,500 BTUs*4 (before 1980)	EER*2 7.2-930	116.0	108.0	\$14.04
Room AC, 6,500 BTU's (after 1980)	EER 8.5-770	116.0	89.0	\$11.57
Room AC, 6,500 BTU's (after 1980)	EER 9.5-680	116.0	79.0	\$10.27
Central, 3-ton AC (before 1980)	SEER*3 8-4,500	180.0	810.0	\$105.00
@ 12,00W/ton (after 1980)	SEER 9.5-3,790	180.0	682.0	\$88.60
40,000 BTU's (after 1980)	SEER 11.0-3,270	180.0	589.0	\$76.57
Fan (window)	200	150.0	30.0	\$3.90
Water heater	—	—	350.0	\$45.50
Washer (1 load/day)	512	16.8	8.6	\$1.12
Clothes dryer (1 load/day)	4,856	17.0	82.6	\$10.74
Dishwasher (1 load/day)	1,201	25.2	30.3	\$3.94
Iron	1,100	—	5.0	\$0.65
Vacuum	630	6.1	3.8	\$0.50
Clock	2	708.3	1.4	\$0.18
Blow dryer	1,235	6.8	8.4	\$1.10

Notes*

1. The monthly cost is based on an average rate of 13¢/kWh.
2. Energy efficiency ratio.
3. Seasonal energy efficiency ratio.
4. BTU's/EER = watts.

All figures noted in this table were obtained from Long Island Lighting Company's (LILCO) Energy Conservation Department.

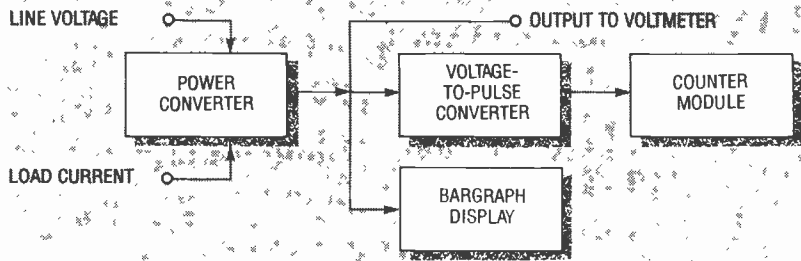

FIG. 1—THE BLOCK DIAGRAM of the energy consumption monitor.

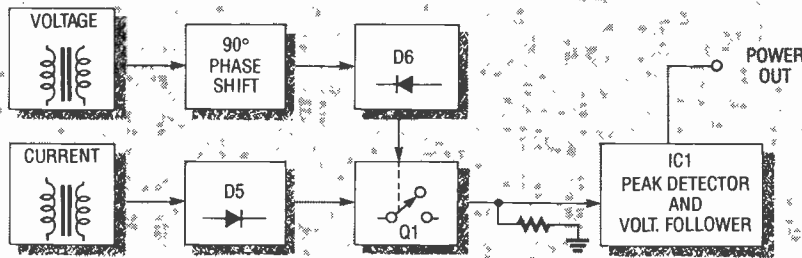

FIG. 2—THE BLOCK DIAGRAM OF THE POWER CONVERTER section of the ECM.

the continuous operation of such appliances.

Figure 2 shows a block diagram of the power converter circuit. The voltage from the potential transformer T1 (Fig. 3-a) is delayed by 90° (Fig. 3-b), controlling transistor switch Q1 (Fig. 3-c), which turns on during the negative cycle of the wave. Now, let's consider how three types of loads are monitored: purely resistive, equally resistive and inductive, and purely inductive.

In a purely resistive AC circuit, the current is in phase with the voltage, therefore the half-wave rectified signal from the current transformer will look like that of Fig. 3-d. Since the switch (Q1) is on until the first 90° of the wave, the peak of that wave (Fig. 3-g) will be passed on to the peak detector consisting of IC1. We can now say that $V_{OUT} = V_{PK}$ of the current transformer.

In a circuit consisting of equal resistance and inductive reactance, the current will lag the voltage by 45°. That signal, when half-wave rectified (Fig. 3-e) and gated by Q1 will look like that of Fig. 3-h. As you can see, the switch allows only the first 45° of the wave to be sampled by the peak detector, therefore

$$V_{OUT} = V_{PK} \sin(90 - \theta).$$

since

$$\sin(90 - \theta) = \cos\theta,$$

then

$$V_{OUT} = V_{PK} \cos\theta.$$

An ideal inductor does not dis-

sipate any power, and its AC current will lag the applied voltage by 90°. As a result, once the half-wave rectified current waveform (Fig. 3-f) of such a load is switched by Q1, the resulting output is zero, therefore

$$V_{OUT} = V_{PK} \cos\theta.$$

(Fig. 3-i.)

The schematic of the energy consumption monitor is shown in Fig. 4. Components R6-R8 and C5-C7 form a 90° phase shift network which switches Q1 on via R9 and R10 during the negative-going part of the wave. The voltage present at the secondary of the current transformer (T2) is half-wave rectified by D5. Diodes D3 and D4 limit the secondary voltage to approximately 40 volts peak to protect D6 and Q1 from excessive voltage should a high-current surge occur. When Q1 is turned on, it will couple any of the half-wave rectified signals to R11, and to the peak detector consisting of IC1-a, D7, C9, and R12. The wiper of R11 is set to calibrate the peak detector output so that it produces 1 volt for every 100 watts consumed by the load. Finally, that voltage is buffered via the voltage follower IC1-b to feed an external voltmeter, the bargraph meter, and the voltage-to-pulse converter.

The voltage-to-pulse converter is basically a voltage controlled oscillator (VCO). The power voltage (from IC1-b) charges C10 via R13 and R14 until the capacitor

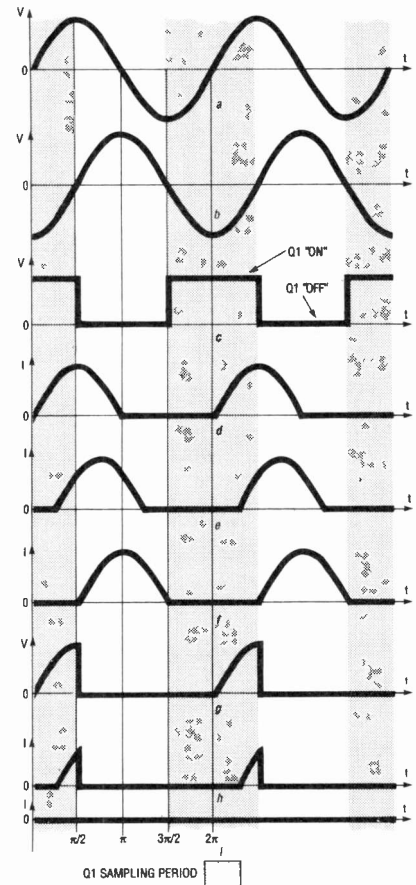

FIG. 3—POWER CONVERTER waveforms: sinusoidal waveform from T1 (a); T1 voltage is delayed by 90° (b); Q1 turns on when the delayed voltage goes negative (c); half-wave rectified load current signal from a purely resistive load (d); half-wave rectified current signal from a resistive and inductive load (e); half-wave rectified current signal from a purely inductive load (f); when Q1 turns on, it captures the first 90° of the current signal of a resistive load (g); sampled current signal of a resistive and inductive load (h); sampled current signal of a purely inductive load (i).

voltage attains the trigger voltage of the Schmitt trigger, consisting of IC2, R16, and R17. Once triggered, the negative voltage swing from the output of IC2 quickly reverses the capacitor charge via R15 and D8, and is ready to repeat the cycle again. The higher the voltage feeding the RC timing network, the higher the pulse repetition, or frequency, will be. That pulse is used to increment the counter module through voltage-divider resistors R18 and R19. Diode D9 assures that the counter sees a pulse of the proper polarity. A nice feature of the display counter is that it is powered by a single AA battery mounted on the back. That makes sure the count is retained if the ECM is

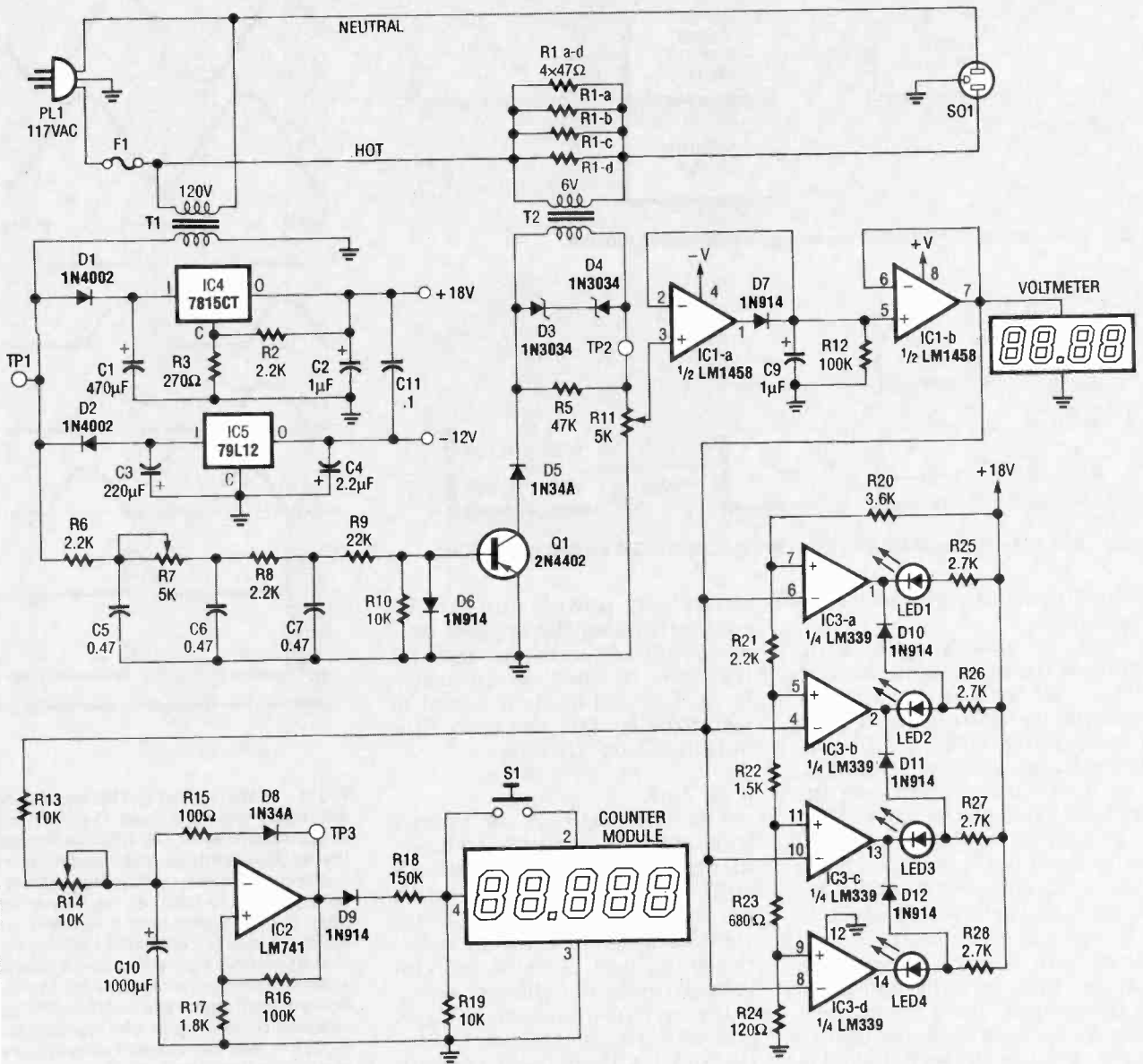

FIG. 4—THE SCHEMATIC OF THE ECM; R6–R8 and C5–C8 form the 90° phase shift network, which switches Q1 on. R11 calibrates the peak detector output so that it produces 1 volt for every 100 watts consumed by the load. For greater power-handling capability, R1-a–R1-d can be replaced by three 0.33-ohm, 10-watt resistors.

unplugged, or in the event of a power failure.

At the heart of the bargraph is IC3, a quad comparator. The power voltage drives all of the comparator's inverting inputs while each of the non-inverting inputs are tied to different voltage references derived by the voltage divider network of R20 to R24. As the voltage signal increases above the reference voltage level, the open collector output of that particular comparator goes low, switching its corresponding LED on. Diodes D14, D15, and D16 ensure that

the previously lit LED is turned off as the power increases, thus allowing no more than one LED to remain on at a time.

The power-supply section is fairly straightforward. The transformer's (T1) voltage is half-wave rectified, and is then filtered by C1. The voltage divider R2 and R3 is used to boost the output voltage of regulator IC4 to approximately 18 volts. IC4 could easily be replaced with a 7818 voltage regulator, thereby eliminating the need for R2 and R3 (a shorting jumper would have to replace R3). Except for the voltage-divid-

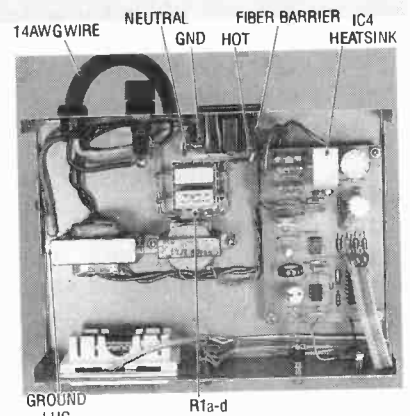

FIG. 5—HERE IS THE FINISHED prototype. It's a good idea to use standoffs to mount the transformers so that R1-a–d's connections are adequately spaced from the case. The author also used a fiber barrier between the PC board and the AC socket for added protection.

PARTS LIST

All resistors are ¼-watt, 5%, unless otherwise indicated.

R1-a-d—0.39 ohms, 5 watts
R2, R6, R8, R21—2200 ohms
R3—270 ohms
R4—not used
R5—47,000 ohms
R7, R11—5000 ohms, trimmer potentiometer
R9—22,000 ohms
R10, R13, R19—10,000 ohms
R12, R16—100,000 ohms
R14—10,000 ohms, trimmer potentiometer
R15—100 ohms
R17—1800 ohms
R18—150,000 ohms
R20—3600 ohms (see text)
R22—1500 ohms
R23—680 ohms
R24—120 ohms
R25—R28—2700 ohms

Capacitors

C1—470 µF, 35 volts, radial electrolytic
C2, C9—1µF, 35 volts, tantalum
C3—220 µF, 63 volts, radial electrolytic
C4—2.2 µF, 35 volts, radial electrolytic
C5, C6, C7—0.47 µF, 100 volts, polyester
C8—not used
C10—1000 µF, 16 volts, radial electrolytic
C11—0.1 µF, 50 volts, ceramic

Semiconductors

D1, D2—1N4002 diode
D3, D4—1N475A, 30 volts, Zener diode
D5, D8—1N34A germanium diode
D6—D12—1N914 diode
Q1—2N4402 PNP transistor

IC1—LM1458 dual op-amp
IC2—LM741 op-amp
IC3—LM339 quad comparator
IC4—LM7815 or LM7818 voltage regulator (see text)
IC5—LM79L12 12-volt negative voltage regulator
LED1—red LED
LED2—LED4—green LED

Other components

F1—15-amp fuse
SO1—chassis-mount, grounded AC socket
T1—18 volts (or 24 volts), 200 mA transformer
T2—6 volts, 200 mA transformer (connected as a step-up transformer)
Counter module—LCD electronic counting module (Radio Shack number 277-302)
S1—momentary SPST push button switch

Miscellaneous: 2 chassis-mount banana sockets, fuse socket, strain relief, PC board, hardware, wire, metal enclosure (Radio Shack 270-272A).

NOTE: The following items are available from Paul Brule, 12L67 Harbourview Rd., Port Colborne, Ontario, Canada L3K 5V4. An etched and drilled PC board, \$15.95; a kit consisting of all resistors, capacitors, semiconductors and PC board for \$59.95; a lettered faceplate and template which fits a Radio Shack 270-272A case, \$7.95. Please include \$2.50 for shipping and handling. All prices are in US funds.

er resistors, the negative supply is basically a mirror image of its positive counterpart.

Construction

Figure 5 shows the authors completed prototype. Transformers T1 and T2, SO1, F1, LED1-4, counter display, S1, J1 and J2 are mounted on the enclosure, while the remaining secondary circuitry is installed on a single-sided PC board. The foil pattern is provided if you would like to make your own, or you can obtain an etched and drilled board from the source mentioned in the parts list. Mount and solder all components according to the parts placement diagram shown in Fig. 6, observ-

ing correct polarity. The 7815 regulator should be fitted with a heat sink. You can do that by drilling a ½" × 1-½" × ¼" piece of aluminum and mounting it to the T0-220 case.

The ECM should be enclosed in a suitable metal case as hazardous line voltage is present. It is important to use no. 14 AWG or heavier gauge wire for all primary wiring. Make sure the neutral side of the plug corresponds to that of the socket. The photograph in Fig. 5 shows where the hot (power supply black lead) and neutral (white lead) conductors are connected.

Grounding should be made by terminating the green grounding conductor of the power-supply

cord and socket ground lead to a closed-loop connector. Mount the connector through the transformer mounting screw and secure to the chassis ground through a star washer to bite through the painted or plated metal case. You can also sand the paint away to make a good contact. Resistors R1-a—R1-d should be adequately ventilated by using a louvered enclosure top. Those resistors could get quite hot if constant heavy loads over 1000 watts are monitored.

Now it's time to mark a decimal point on the counter display. Using a fine-tip black felt pen, mark the decimal point on the display between the third and fourth digit so that, when the monitor is properly calibrated, each count represents 1/1000 of a cent.

When wiring T2, remember to wire the 6-volt winding across the shunt resistors R1-a—R1-d so that you're using it in a step-up mode.

Locating a 3.6K resistor for R20 may be rather difficult since that is a non-standard value. The author happened to have a few of them in his parts collection, but you may consider wiring a 3.9K and a 47K resistor in parallel to obtain that value.

Calibration and testing

Before applying power to your circuit, double check your wiring. If you're using IC sockets, leave IC1, IC2, and IC3 out of the circuit. Apply power and check for +18 volts and -12 volts at the outputs of IC4 and IC5, respectively. Those voltages may be slightly lower by a fraction of a volt. If you have removed the IC's and the voltages are okay, then unplug the unit, install the IC's, re-apply power, and re-check the supply voltages.

The next step is to check the transformer phasing. In order to do that, temporarily install a jumper from ground to the cathode of D5. Now connect a 100-watt light to the load socket. Using a voltmeter on the AC scale, make sure the voltage between TP1 and TP2 is lower than that measured between TP1 and ground. If it isn't, reverse the two PC-board connected T2 leads. Re-check and remove the jumper.

With *NO LOAD* connected to 63

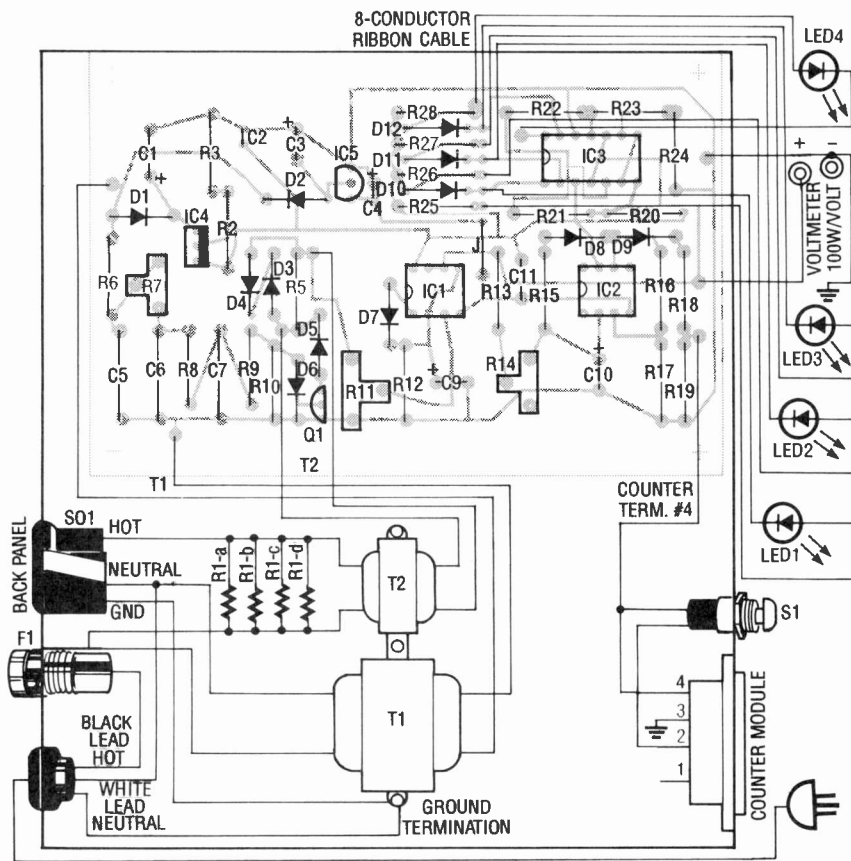
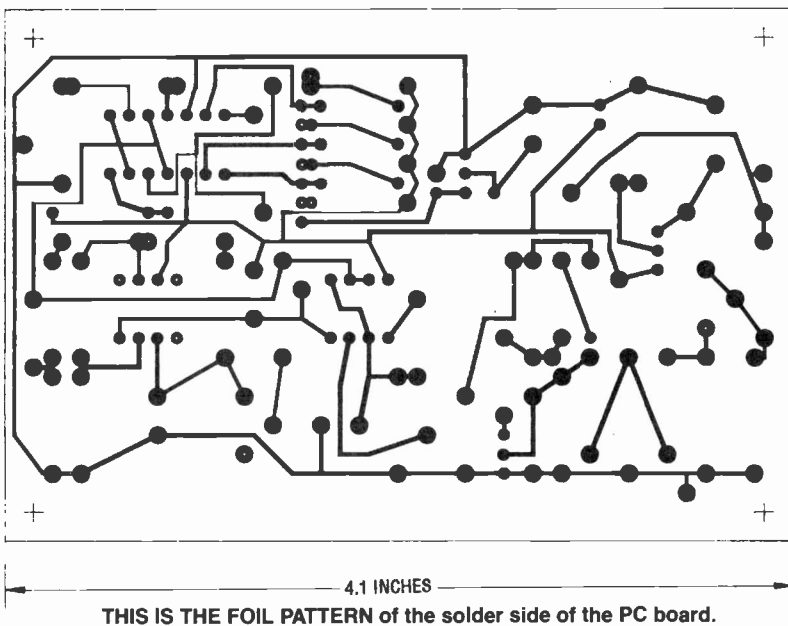

FIG. 6—PARTS PLACEMENT DIAGRAM AND WIRING connections. Use 14 AWG wire for all primary leads, and make sure you wire the hot and neutral leads of the power supply cord to the proper terminations on the AC socket.



the ECM, connect a jumper between the +18-volt supply and TP2. Connect a DC meter to the power-voltage output and check to see that the voltage varies from 0 to approximately 16.5 volts as R11 is varied from one end to the

other. As you do that, the LED's should increment at about 0.27, 1.8, 5, and 10 volts. Now, using the formula

$$V_{CAL} = 36 / \text{rate},$$

where V_{CAL} is the calibration voltage and rate is your cost in

cents per kilowatt-hour (check your billing statement or power company for that rate). Adjust R11 to read that value on the voltmeter. That will enable you to calibrate R14 so that you obtain one pulse per second (1 Hz) at TP3. A doubling or halving of V_{CAL} should approximately double or half the pulse rate. Remember, each pulse represents $1/1000$ of a cent.

Disconnect the jumper used in the previous procedure and connect a 100-watt light as a load. Using an oscilloscope, monitor the waveform at TP2 and set R7 so that the sampling ends at the very peak of the incoming waveform, which should look like the waveform of Fig. 3-g.

Finally, power calibration is the last to be performed. With the 100-watt light connected adjust R11 so that a DMM, connected to the external voltmeter jacks, displays 1.00 volt DC. You may want to verify that wattage by measuring the voltages across shunt resistor R1, and the line. With those two voltage readings, the power maybe calculated using the formula

$$P(\text{watts}) = V_{SHUNT} \times V_{LINE} / R_{SHUNT},$$

where R_{SHUNT} is the shunt resistance (four 0.39-ohm resistors in parallel = 0.0975 ohms). V_{SHUNT} is the voltage drop across R1 and V_{LINE} is the AC line voltage.

That completes the assembly and calibration of the ECM. There is one point that should be mentioned here. The voltage to pulse converter will not start until there is a load of approximately 30 watts, meaning that the counter will not increment unless the load is heavier than that value.

For those of you wondering if investing in an energy consumption monitor is worthwhile, consider this: You'll be able to determine how much it costs to run a particular appliance for a certain length of time. So it's easy enough to figure out if it's actually cheaper to run the microwave oven for five minutes or the conventional oven for ten minutes, and so on. Using the energy consumption monitor, you'll also be able to determine if buying extra meat at really good sale prices actually saves you money in the long run. The greatest advantage of the energy consumption is keeping one step ahead of your power company. R-E

CABLE TV'S INFAMOUS BULLET



How American Cablevision's "bullet" zapped signal pirates.

KEN FOLEY

ON WEDNESDAY, MARCH 13, 1991, American Cablevision of Queens fired their first infamous electronic "bullet." According to American Cablevision, they fired a direct hit. Within minutes their switchboard was overloaded with calls from subscribers whose television sets had gone black. American Cablevision was elated—the victims had unsuspectingly taken the bait.

The next morning, American Cablevision sent armies of technicians to service the homes of the complaining customers. They replaced the cable converter

boxes, and took the dead boxes back to the electronic coroner's laboratory, performing hundreds of autopsies. According to official American Cablevision records of the mass epidemic, the "Certificates of Death" were identical—illegal chip "zaps".

On Wednesday April 24, 1991, American Cablevision filed a civil suit in New York City federal court against three hundred and seventeen alleged cable pirates. That was the first time such a large number of cable crooks had been arraigned together. American Cablevision offered the de-

fendants a deal: Pay five hundred dollars within twenty days, or face prosecution and fines from one thousand, to one hundred and ten thousand dollars.

"I think this is something that everybody's going to have to start doing," said American Cable President Barry Rosenblum. American Cablevision has approximately three hundred and thirty thousand paid subscribers in Queens and Brooklyn, and estimates it forfeits hundreds of thousands of dollars each year to video marauders, and plans to fire more bullets. The electronic

bullet is the brainchild of Jerrold Communications of Hatboro, Pennsylvania. It was first fired in 1990, by Greater Media Cable of Philadelphia.

In three separate assaults, Greater Media Cable blasted away, netting three hundred and sixty eight illegal converters, which garnered a bounty close to twenty thousand dollars.

We spoke to Jim Bathold, spokesman for Jerrold Communications, to confirm American Cablevision's story that the electronic bullet is a signal fired from a cable company's headquarters directly into a customer's cable converter. If the box is legitimate, the customer never knows he was just zapped. But if black-market chips were installed in a basic converter to circumvent paying the monthly service charge, the bullet uses the chips' own programs to neutralize the decoder and halt the cable service immediately.

Mr. Bathold then elaborated "Yes, that is basically how the bullet works," he confirmed. "But it would not be in our best interest to elaborate, or explain the operational procedure in detail. Otherwise it tells subscribers, 'Here we come.' We have not put one word out there in writing of how it works—no press packages or news releases. We especially wouldn't go into detail with electronic hobbyists," he choked out laughing.

Hoping to fare better in Jerrold's engineering division, we were fortunate to reach an engineer that was also a reader of **Radio-Electronics**. His boss' boss, technical engineering supervisor, Stan Dori, said: One of the approaches pirates have been taking for years to defeat scrambling is to physically use a decoder box to unscramble the scrambling method. That is, to reverse engineer the legitimate descrambler's software.

The bullet came into being because one of Jerrold's customers (a cable company) told them of rumors that pirates were defeating Jerrold's scrambling technology. And the cable company wanted to aggressively pursue them. So Jerrold acquired a number of the pirate devices

through various methodologies, and reverse engineered them so that a counter measure could be developed. That counter measure was the bullet, an offensive signal that Jerrold can send down the data stream to neutralize what the pirates reverse engineered. That's the bullet—double-reverse engineering.

Dori continued, "So by understanding what the pirates are doing and not doing to defeat current technology, we're able to launch a counter-offensive signal, the bullet, to defeat them."

In the hopes of discouraging customers from buying illegitimate descramblers, information regarding the bullet is being leaked from the cable industry, which claims they are losing up to three billion annually from piracy.

According to Jodi Hooper of the National Cable Television Association, "People think cheating on cable services is like a school prank. They don't really think they are committing a crime and stealing. They just don't take it seriously." Hooper also indicated that some cable companies are offering complete amnesty to people who come forward before their systems are audited and the bullet is released. She says if the culprits wait until they are discovered, they will chance the possibility of criminal prosecution and heavy fines.

Richard Aurelio, president of Time Warner's New York City Cable Group, compares cable piracy to shoplifting. "Now that we have the technology, we're going to use it to rope them in." But it's a migraine for the cable industry. Most of the cable companies began scrambling their satellites in 1986, and are now concentrating on detecting people with decoders and illegal hookups.

The National Cable Television Association says about eight million homes nationwide are linked illegally to basic cable signals. And an additional three million homes illegally tap into pay services such as Cinemax and HBO.

But from 1975 through last year, the number of basic service subscribers nationwide grew from nine million to fifty-five million. The U.S. Telephone Association reports that the average

basic cable rate nationwide jumped sixty-eight percent between 1986 and 1989.

So even though the cable companies are reporting that losses from theft have tripled during the same period, cable industry revenue has jumped about seventy percent from over ten billion in 1986 to almost eighteen billion last year.

Such large revenues have caused some consumer groups to become skeptical of the cable companies' claims of being financially wounded by theft. "There is no justification for using speculative high-theft figures to justify outrageous rate increases," says Ken McEldowney, head of San Francisco-based Consumer Action.

Another method the cable companies are using to detect pirates, is the "closed circuit radar gun," or time-domain reflectometer. The major drawback with the reflectometer is that it has to be physically attached to the cable entering each home to detect unauthorized connections or decoders. Other than that, sleuthing is still done primarily by inspectors who spend their days eyeballing exterior cables for tampering.

So naturally if the cable industry succeeds in scaring thousands into confessing, it will score a two-headed victory. First by recovering millions in lost revenue having people sign up—as was the case for Utah's TCI Cablevision in 1989 where they ran a blitz advertising campaign showing guilt-ridden signal pirates imprisoned—and second by having the option of keeping the bullet in reserve as a secret weapon and not necessarily having to pay the hefty zapper fee to Jerrold Communications.

Now Time Warner, the second largest cable company with over six million subscribers in thirty six states, is threatening to start firing bullets nationwide. Are they bluffing?

If they are not bluffing, they will undoubtedly catch more cable thieves who are foolish enough to run to their cable company to complain that their pirated cable box is not working properly.

R-E

BUILD THIS

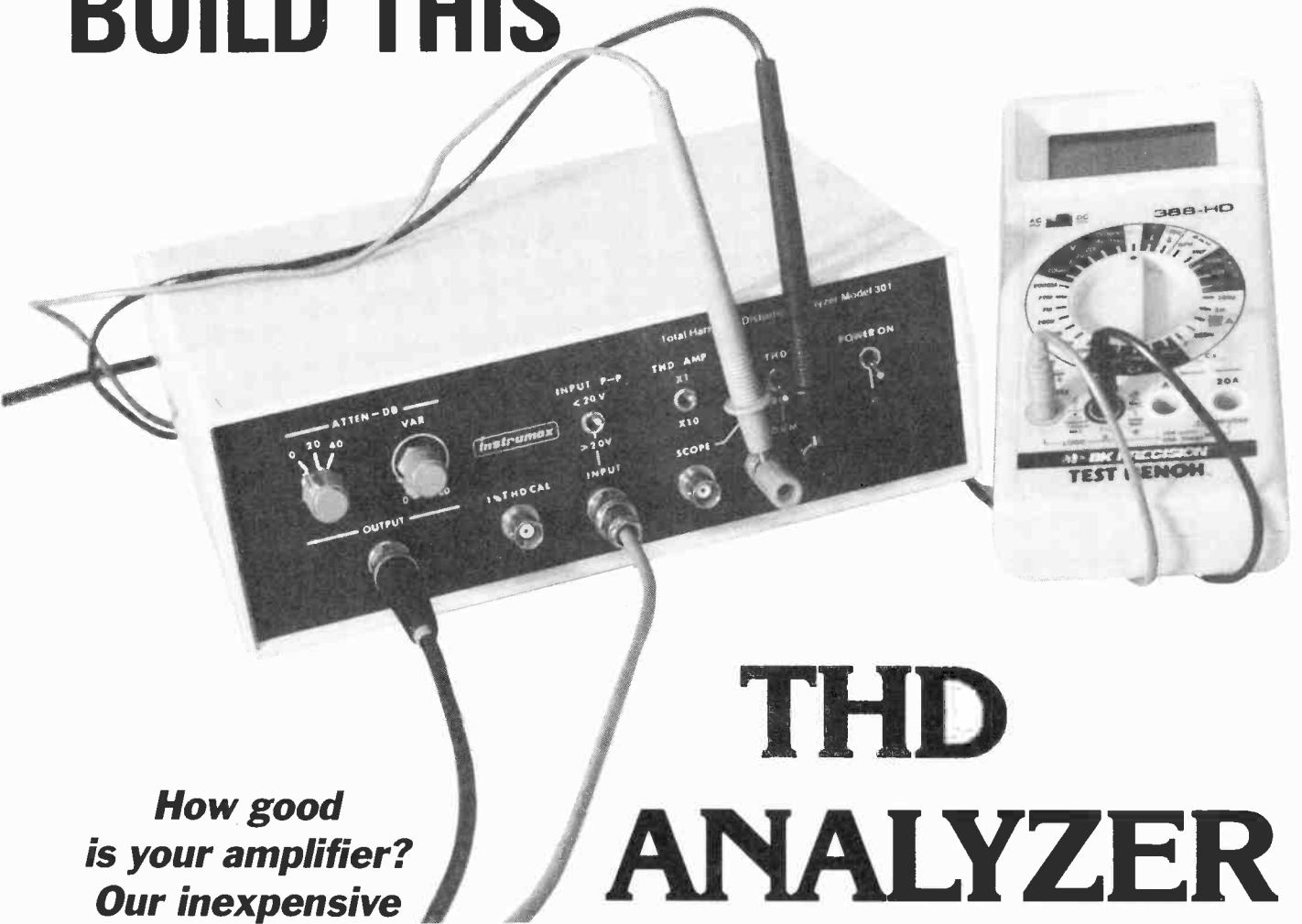

**How good
is your amplifier?
Our inexpensive
THD analyzer
will let
you know.**

THD ANALYZER

JOHN F. KEIDEL

HAVE YOU EVER WONDERED EXACTLY how good an amplifier is, or whether it actually measures up to the manufacturer's specification of its Total Harmonic Distortion, or THD? Or are you curious if the amplifier you've designed is better or worse than a store-bought one? If the answer is yes to any of those questions, then you should build our inexpensive THD analyzer. You can use it to test "home-brew" amplifier breadboard circuits or commercial equipment such as stereo receivers, preamps, and power amps. The analyzer uses an ultra-pure 1-kHz test signal to measure THD at a user-selected

voltage level for voltage amplifiers, or a desired power level for checking power amps up to 600 watts. It will detect THD levels down to 0.005 percent! It features a built-in one-percent THD calibrator, a full array of input and output processing controls, and uses your digital multimeter (DMM) as a readout device.

Circuit description

As shown in Fig. 1, an NE5534N low-noise, low-distortion op-amp, IC1, is configured as a Wien Bridge sine-wave oscillator. Carefully matched RC values (R2-C1 and R3-C2) in the frequency-selective positive feedback network contribute to its low distortion level. Resistor R1 and bulb LMP1 form the stabilized negative feedback network that provides a constant-amplitude output signal. DC offset control R4 keeps DC current out of LMP1, which minimizes second harmonic distortion content. Filter network R6-C6 further reduces any residual distortion.

After passing through fixed and variable attenuators, plus a buffer amp (IC2), the signal emerges at output jack J1.

The output signal from J1 drives the input of the device under test (DUT), usually an amplifier. The DUT's output, which includes some degree of distortion, is applied to the input of the analyzer at jack J2. The fundamental frequency (1 kHz) is then removed from the output signal of the DUT, leaving only harmonic distortion components.

Combination notch/high-pass filter circuits IC3 and IC4 (both TLO74's) perform the removal function. One feature of IC3's three-stage RC active filter is that it maintains a constant 45-dB notch depth over its full tuning range. The filter is connected in series with an identical second filter (IC4), to provide a 90-dB notch of the fundamental signal. The resultant frequency response of the combined filters is 27 dB down at 20 Hz, which helps suppress 60-Hz hum and

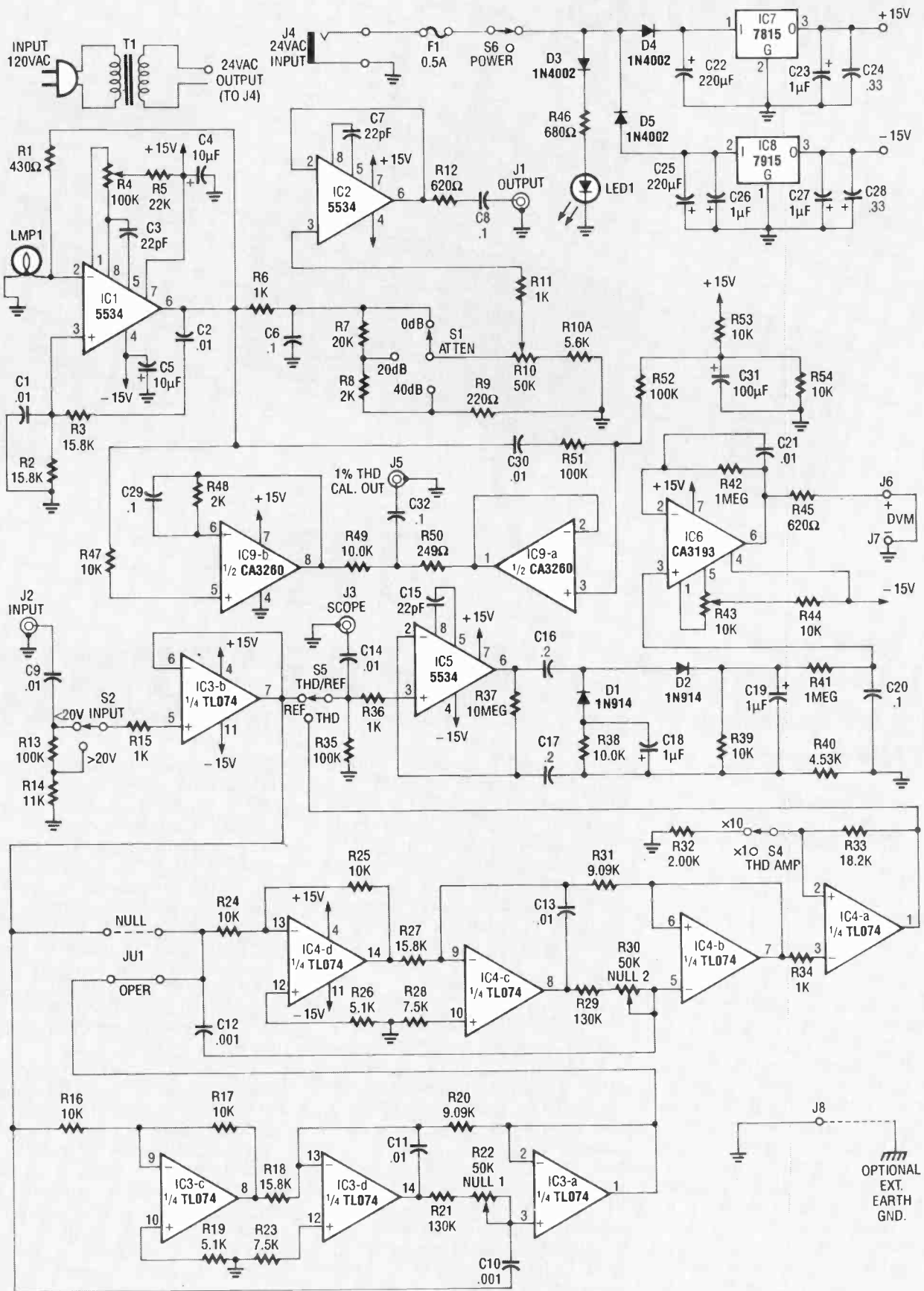

FIG. 1—SCHEMATIC DIAGRAM of the simple THD analyzer. An NE5534N op-amp (IC1) is configured as a Wien Bridge sine wave oscillator. Carefully matched RC values in the frequency-selective positive feedback network contribute to the low distortion level. Resistor R1 and incandescent bulb LMP1 form the stabilized negative feedback network that provides a constant-amplitude output signal.

other low-frequency noises. Above the 90-dB notch frequency, the response is flat (± 0.5 dB) from 2 kHz to 100 kHz.

When S4, the THD/REF switch, is in the THD position, a signal containing only THD components is channeled through from the output of the $\times 1/\times 10$ THD amp (IC4) to the input of the AC-to-DC converter, IC5. Although both polarities of the applied signal are rectified by this circuit, only the positive averaged signal is fed to the low-pass filter R41-C20. The output buffer, IC6, is a

CA3193 precision op-amp, stable enough to provide accurate volt, millivolt, and microvolt DC level output signals to an external DVM.

Dual op-amp IC9, a CA3260, serves as a calibrator. The first stage affords precision half-wave rectification of the master oscillator's signal. That same applied signal is AC coupled by C30 to the second stage, biased at $\frac{1}{2} V_{CC}$, for linear transfer to its output. Voltage divider R49-R50 mixes a very small portion of half-wave output at pin 7 of IC9 with a much larger full sine wave seen at pin 1. Since the signal swings slightly more positive from its quiescent level than it does in the negative-going direction, it is considered to have a specific amount of second harmonic distortion. That amount, by design, is one percent.

Wall transformer T1 feeds half-wave power diodes D4 and D5 through connector J4, fuse F1, and power switch S5. Capacitors C22 and C25 are the principal filters for the positive and negative supplies, respectively. Smaller filters, C23 and C27, along with high-frequency transient suppressors C24 and C28, are included at the output side of regulators IC7 (a 7815 +15-volt regulator) and IC8 (a 7915 -15-volt regulator).

Construction

Breadboard assembly of the analyzer is not recommended, although a seasoned builder may wish to attempt it. It's best to either make your own PC board from the foil pattern we've provided, or order one from source mentioned in the parts list.

Mount all components as shown in Fig. 2. Check orienta-

tion of all polarized parts as you install them, and the use of IC sockets is suggested. All power-

line wiring, including the LED1 indicator, uses two wires plus a shield. Connect the shield wires

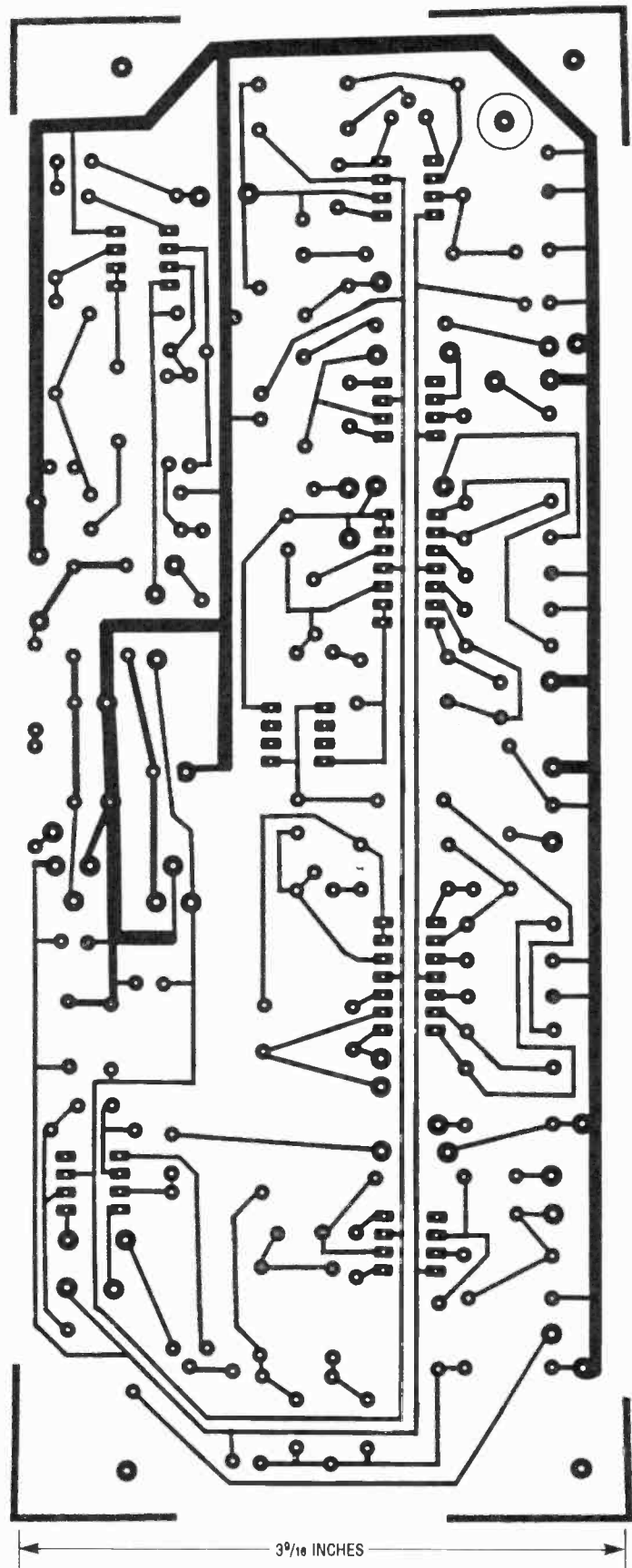

FOIL PATTERN for the THD meter shown actual size.

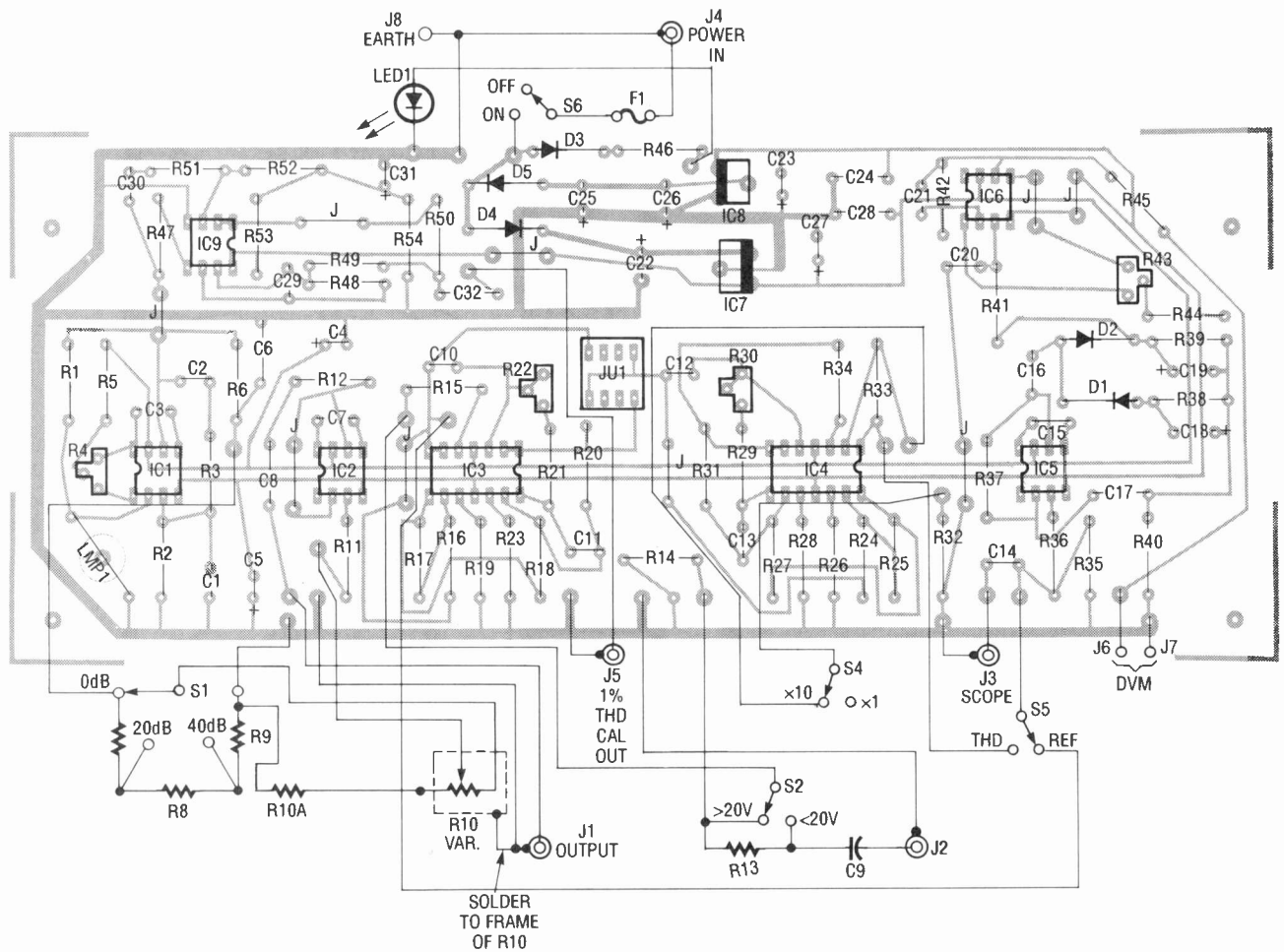

FIG. 2—PARTS PLACEMENT DIAGRAM. Note that JU1 is actually an 8-pin DIP socket in which a jumper is placed in either the far-left or -right side (see text). Also note the six components soldered to the front-panel-mounted controls.

together and then to ground, to prevent hum pick-up. Also, ground the frame of potentiometer R10. Bare ground wires for each BNC connector may be wrapped around the connector body prior to installing the retaining nut. The ground binding post (J8) on the rear panel provides an optional, external earth-ground connection when measuring microvolt-level THD signals. Just connect J8 to circuit ground. The grommet used to hold bulb LMP1 should have a 1/4-inch inside diameter. It is glued to the top side over the hole for maximum resiliency.

In addition to the components that are soldered to the circuit board, also note that five resistors and one capacitor are soldered across the terminals of panel-mounted controls S1, R10, S2, and J2 (see Fig. 2).

Capacitors C1 and C2 must be matched to better tolerances

than their marked 1% values. If you don't own or can't borrow a capacitance meter, you can build and use the simple circuit shown in Fig. 3. Adjust the calibration potentiometer with any one of the four 0.01 μF capacitors (C1, C2, C11, or C13) inserted as C_x , to read 1.000 volt on your DMM's 2-volt DC range. (You can consider the reading to be 0.01000 μF .) Now measure the remaining three capacitors and select the two that are closest in value. Absolute value is not important; we simply want them to be the same value. However, if one capacitor measures 80 pF lower than another, you can solder an 82-pF mica capacitor on the underside of the PC board in parallel with the selected capacitor. The leftover 1% 0.01 μF capacitors can be used for C11 and C13 without having to be closely matched.

Likewise, resistors R2 and R3 must be close in value. Using

your DMM on its 20K resistance range, select two 15.8K resistors that are the closest in value. If the match is less than perfect, solder a small-value resistor in series with the lower value to raise it to the exact value of the higher one. You can mount two resistors in place of one by putting one through each hole in the board and soldering the raised ends together. Again, the leftover 1% 15.8K resistors can be used for R18 and R27 without having to be closely matched.

You may wish to build your own enclosure for the THD meter. A silk-screened front panel measuring 9 3/4 inches wide by 3 inches high can be purchased from the source mentioned in the parts list. If you decide to purchase the front panel, and build your own enclosure, build it to fit the front panel and drill several 1/4-inch holes in the top panel near the voltage regulators to allow heat to escape. Otherwise you can purchase the same enclosure used for the prototype; the exact

PARTS LIST

All resistors are ¼ watt, 5%, unless otherwise indicated.

R1—430 ohms
 R2, R3, R18, R27—15,800 ohms, 1%, metal film
 R4—100,000 ohms, PC-mount potentiometer
 R5—22,000 ohms
 R6, R11, R15, R34, R36—1000 ohms
 R7—20,000 ohms
 R8, R48—2000 ohms
 R9—220 ohms
 R10—50,000 ohms, panel-mount potentiometer
 R10A—5600 ohms
 R12, R45—620 ohms
 R13, R35—100,000 ohms
 R14—11,000 ohms
 R16, R17, R24, R25, R38, R39, R49—10,000 ohms, 1%, metal film
 R19, R26—5100 ohms
 R20, R31—9090 ohms, 1%, metal film
 R21, R29—130,000 ohms
 R22, R30—50,000 ohms, PC-mount potentiometer
 R23, R28—7500 ohms
 R32—2000 ohms, 1%, metal film
 R33—18,200 ohms, 1%, metal film
 R37—10 megohms
 R40—4530 ohms, 1%, metal film
 R41, R42—1 megohm
 R43—10,000 ohms, PC-mount potentiometer
 R44, R47, R53, R54—10,000 ohms

R46—680 ohms
 R50—249 ohms, 1%, metal film
 R51, R52—100,000 ohms, 1%, metal film

Capacitors

C1, C2, C11, C13—0.01 μ F, 100 volts, 1% Mylar
 C3, C7, C15—22 pF, 300 volts, mica
 C4, C5—10 μ F, 25 volts, tantalum
 C6, C8, C20, C29, C32—0.1 μ F, 50 volts, Mylar
 C9, C14, C21, C30—0.01 μ F, 50 volts, Mylar
 C10, C12—0.001 μ F, 100 volts, 1% Mylar
 C16, C17—0.2 μ F, 50 volts, Mylar
 C18, C19, C23, C27—1.0 μ F, 25 volts, tantalum
 C22, C25—220 μ F, 50 volts, electrolytic
 C24, C28—0.33 μ F, 50 volts, Mylar
 C26—1 μ F, 50 volts, tantalum
 C31—100 μ F, 25 volts, electrolytic

Semiconductors

IC1, IC2, IC5—NE5534N low-noise op-amp
 IC3, IC4—TL074 quad low-noise op-amp
 IC6—CA3193E precision op-amp
 IC7—7815 positive 15-volt regulator
 IC8—7915 negative 15-volt regulator
 IC9—CA3260E dual MOSFET-input op-amp
 D1, D2—1N914 diode
 D3—D5—1N4002 diode

LED1—Red light-emitting diode

Other components

S1—Panel-mount, 2-pole, 6-position switch
 S2, S4—S6—Panel-mount miniature SPDT toggle switch
 S3—Not used
 JU1—8-pin DIP socket or jumper block
 T1—120VAC/24VAC, 200 mA wall transformer
 J1—J3, J5—Panel-mount male BNC connector
 J4—Coaxial power input jack
 J6—J8—Panel-mount binding post
 LMP1—Incandescent bulb, #327
 F1—Fuse, 0.5A, 120 VAC

Miscellaneous: Project case (Jameco Electronics H2507), two ½-inch diameter instrument knobs, seven 8-pin IC sockets, (not including JU1), fuse holder, LED bezel, grommet, shielded cable, wire, solder, hardware, etc.

Note: The following items are available from Instrumex, P.O. Box 490, Blue Bell, PA 19422:

- Etched, drilled, and plated PC board and silk-screened plastic front panel (both to fit case mentioned above—\$25.00 + \$3.00 S&H)

PA residents must include 6% sales tax.

Allow 2–4 weeks for delivery.

model number is listed in the parts list, and the front panel is designed to fit it perfectly. Figure 4 shows the completed prototype.

Adjustments

Using a DMM on its millivolt-DC range, connect it between pin 6 of IC1 and ground. Adjust R4 for a reading of 000.0 mV on the meter. Next, set the INPUT switch (S2) to “>20V,” the THD AMP switch (S4) to “×10,” and the THD/REF switch (S5) to “THD.” With the DMM still set to read millivolts DC, connect its leads across the + and – DVM binding posts (J6 and J7) and adjust R43 for a reading of 000.0 mV on the meter.

Filter-null adjustments may be made with an oscilloscope or DMM on its lowest AC voltage range (typically 2 volts). Insert a jumper in the JU1 jumper block (NULL-OPER) in the left-most position when facing the front panel (next to R22, or the “null” posi-

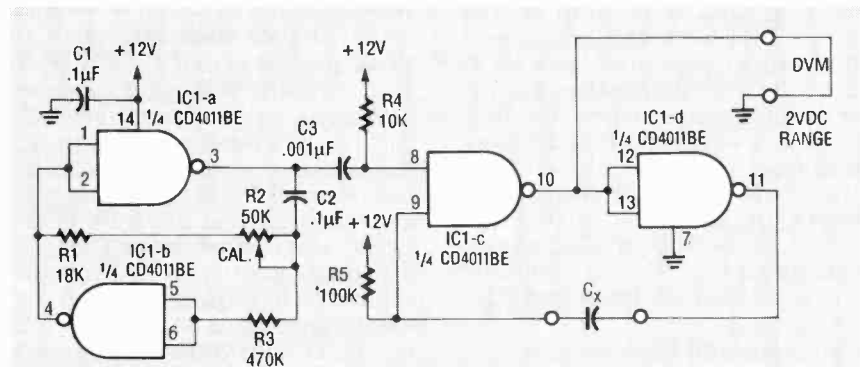

FIG. 3—HERE'S A ONE-IC CAPACITANCE TESTER used to match C1 and C2. See text for details.

tion). Connect a short coaxial cable between OUTPUT jack J1 and INPUT jack J2. With power on, and S2 in the “<20V” position, S4 in the ×1 position, S5 in the “THD” position, and the rotary ATTEN-DB switch (S1) and VAR potentiometer (R10) in the minimum attenuation position, or fully counter-clockwise.

Connect a scope or voltmeter to

the IC4-pin-7 side of R31, and connect the ground lead to any ground in the area. If you're using a scope, set VOLTS/DIV switch (on the scope) to any position between 5 and 50 mV/div. Carefully adjust potentiometer R30 for the best null on a scope screen, or lowest reading on a meter.

Transfer the test probe to the

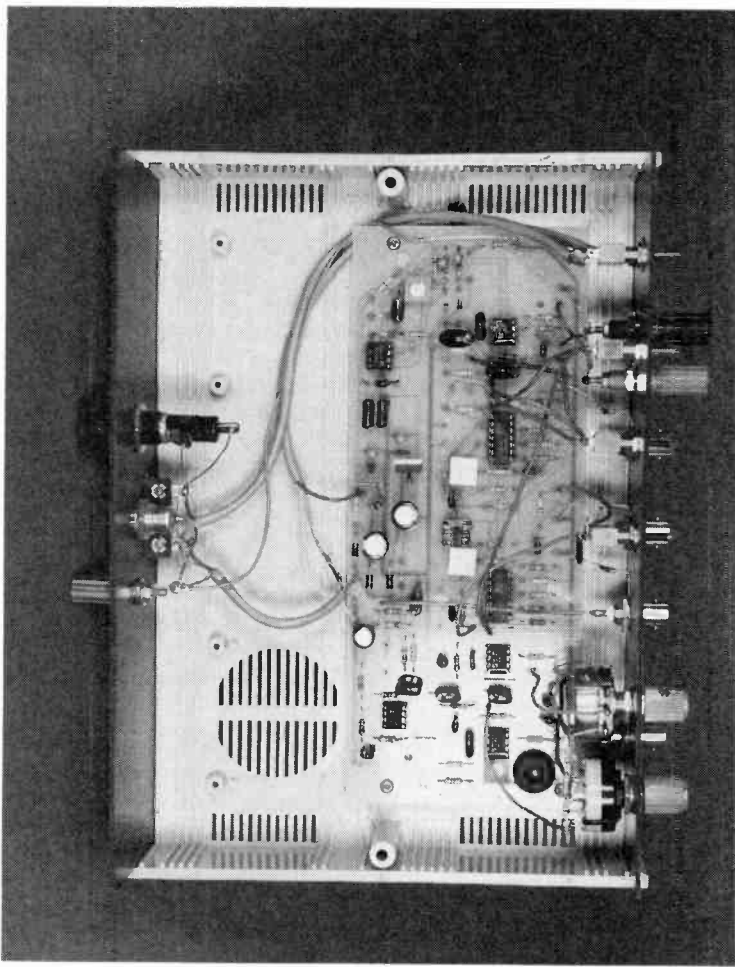

FIG. 4—THE COMPLETED PROTOTYPE. Notice how the incandescent bulb (LMP1) is protected from damage by a rubber grommet.

IC3-pin-1 side of R20. Adjust R22 for a minimum reading on the scope CRT or voltmeter. Insert the jumper previously placed in the NULL position in the C12 side of the JU1 jumper block. You may be able to squeeze 1 or 2 dB more null from the system by shifting the DMM to the DVM binding posts (J6 and J7), setting the meter to its 200 mV DC range, setting S4 to $\times 10$, and trimming the adjustments of R22 and R30.

Checkout and use

Connect a scope or DMM set to read AC volts to output jack J1. Rotate S1 and R10; the output signal voltage should vary accordingly. The controls are attenuators, not gain controls, so maximum signal occurs in the counterclockwise position.

Check the INPUT P-P switch S2 by applying the signal from J1 to J2, setting S5 to "REF," and measuring the AC output at J3. The output signal should be maximum with S2 in the $<20V$ position and minimum in the $>20V$

position. It's important to note that if the input signal to J2 goes much higher than 20V peak to peak, clipping will begin to occur.

You can use the analyzer's calibrator to check all remaining functions. Connect a coaxial cable from J5 to J2. Set all toggle switches to the upright positions, and connect your DMM to J6 and J7 set to read DC volts or millivolts, as required. Now, if the THD signal reads 24.0 mV, which is 0.024V, and you switch the S5 to "REF," the DMM should then read 2.40V, or a number very close to that. When the resulting fraction (0.24/2.4) is multiplied by 100 it should produce a THD percent figure of one percent.

Figure 5 shows the test setup for THD measurements. Say that we are measuring percent THD of a 50-watt amplifier that's connected to an 8-ohm power resistor load. By ohms law, it will take 20 volts across 8 ohms to produce 50 watts. Now let's say

continued on page 128

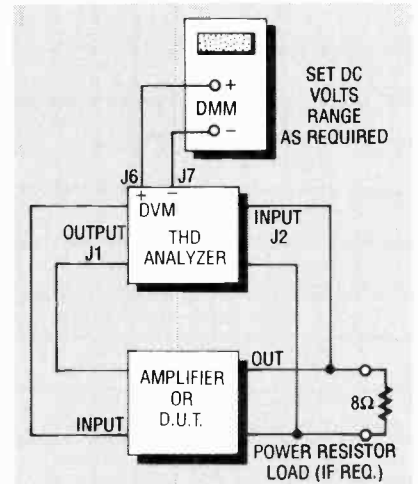

FIG. 5—BLOCK DIAGRAM OF TEST setup. Most THD measurements can be made in this manner.

THD MEASUREMENT

When a pure or undistorted sine wave is applied to a circuit containing vacuum tubes, transistors, or op-amps, which is used to provide linear transfer of the signal, some degree of distortion always appears at the output.

As the near-perfect sine wave travels through the device under test (DUT), its shape is altered due to inherent nonlinearities within the circuit. Waveform alteration is the equivalent of adding harmonics, or multiples of the fundamental frequency, in varying phases and amplitudes to the fundamental signal. It can be shown mathematically and by measurement that these spurious harmonic components are vested within the output signal's waveshape.

Spectrum analyzers are used to sweep over the frequency range of interest, separating the fundamental and its harmonics into individual signals. It provides a CRT display of these various signals, including odd and/or even harmonics in their proper amplitudes and frequency locations relative to the fundamental. Similar instruments use digital signal processing techniques rather than a sweep method to provide more in-depth data including phase angles.

Wave analyzers are essentially tuned filters that include a measurement window that is manually frequency shifted through the range of interest. It offers meter-read-out amplitude measurements of the various harmonics relative to the fundamental frequency.

THD analyzers are used to notch out the fundamental from the DUT's output signal leaving only the harmonic components intact. It then measures the sum total of the residual signals in terms of their RMS or average values, and compares them to the overall amplitude of the output signal which is taken as a 100 percent reference. The ratio of the THD measurement to the reference, multiplied by 100, equals the percent THD.

R-E

SIMPLE FM TRANSMITTER

This handy FM transmitter makes a great one-evening project, even for first-time builders!

JAMES A. MELTON

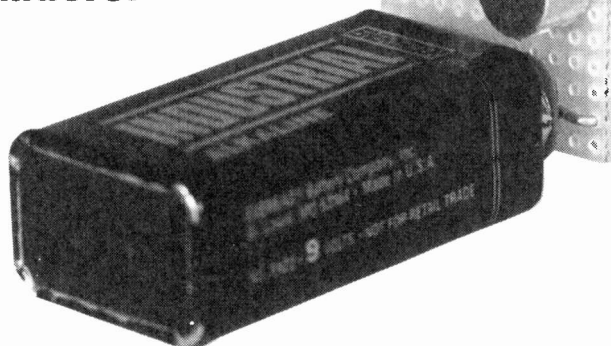

THERE IS NO THRILL LIKE THE THRILL you get from operating equipment you have built yourself. If you have never built a project from a magazine before, let this FM transmitter be your first—you'll see how much satisfaction and fun you can have!

The FM transmitter is designed to run from a 9-volt battery and is made from readily available parts. The author's primary use is as a baby monitor, but the uses of a transmitter like this one are almost limitless. It is very sensitive, and easily capable of picking up a conversation in any part of a room. The dimensions and values given here will allow static-free reception within the perimeter of most homes.

No license is required for this transmitter according to FCC

regulations regarding wireless microphones. (The emissions must stay within a band of 200 kHz, its output between 88 and 108 MHz, and the field strength of the radiated emissions must not exceed 50 $\mu\text{V}/\text{m}$ at a distance of 15 meters from the device.) If powered from a 9-volt battery and used with an antenna no longer than 12 inches, the transmitter's radiated power will be within the FCC limits. The FCC takes a dim view of persons operating outside the legal power limits, so please do not substitute any components in this circuit which would alter the output power.

Circuitry

Take a look at the schematic in Fig. 1. Audio is picked up from the room by an electret micro-

phone and amplified by Q1. Resistors R2–R5 set up the DC operating bias of Q1. Capacitor C3 serves to improve the AC response to the audio voltage, and C2 blocks the DC bias and couples the AC to the next stage, where the RF action takes place. The amplified AC voltage from Q1 is routed to the base of Q2. Transistor Q2 and associated circuitry (C5 and the inductor) form an oscillator that operates in the 80–130 MHz range. The oscillator is voltage-controlled, so it is modulated by the audio voltage that is applied to the base of Q2.

Resistor R6 limits the input to the RF section, and its value can be adjusted as necessary to limit the volume of the input. That will help control the amount of distortion you have on very loud inputs. Resistors R7–R9 set the DC operating bias of Q2, another 2N2222 that's used as the oscillator and modulator of the transmitter. Capacitor C5 is a 6–50 pF trimmer capacitor that's used to tune the oscillator tank circuit, and C4 routes the RF from the oscillator to ground to prevent unstable operation.

Construction

The FM transmitter is built on a piece of perforated construction board with 0.1-inch hole spacing. Component spacing is not critical, but placement is. You should place the components on the board in a layout that is similar to the prototype shown in Fig. 2. Generally, you will also want to make the transmitter as small as possible.

Let's start from the left side of the schematic and work to the right. You'll want to cut out a piece of perboard that is 12 holes wide and 30 holes long. That will give you plenty of room to work with, but still produce a small unit. First lay out two power lines on the board with bare wire; the positive supply from the battery will be on top, and the negative (ground) will be on the bottom.

A 1K resistor (R1) supplies the bias voltage for the microphone. Remember to install the resistor vertically, next to the positive supply line, and bend the other end of the lead to the board. Go through the board and down toward the ground bus. Now insert the microphone leads into the

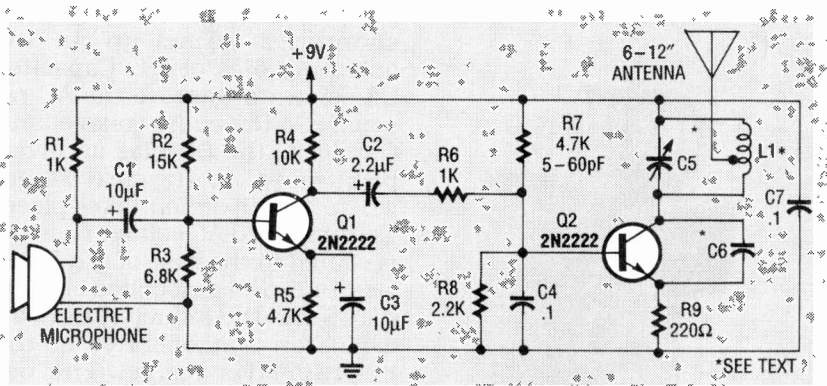

FIG. 1—FM TRANSMITTER SCHEMATIC. When powered from a 9-volt battery and used with an antenna no longer than 12 inches, the radiated power will be within the FCC limits.

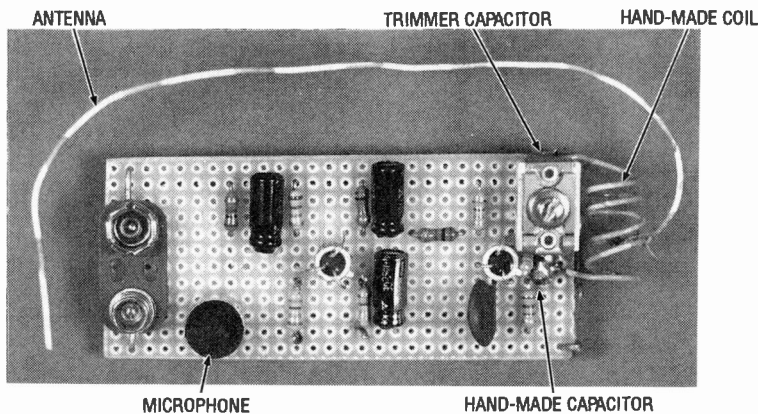

FIG. 2—THE AUTHOR'S COMPLETED PROTOTYPE. Notice how the antenna is soldered to the coil, about 2 turns from the transistor side.

board, making sure that the ground lead of the microphone can be soldered to the ground bus on the board. Route the lead from R1 to the positive lead of the microphone and solder it. The 10- μ F capacitor, C1, should be placed in the middle of the board, oriented as shown on the schematic, and soldered to the microphone/R1 junction.

This project requires two hand-made parts—coil L1 and capacitor C6—but you make both of them yourself using only wire and a common pencil for a coil form. The inductor is made by winding two pieces of 24-gauge insulated wire, laid side by side, around a pencil six times. Remove the coil you have formed and unscrew the two coils apart from each other. One of these coils, the better-looking of the two, will be used in the tank circuit (L1) and the other can be used in the next one you build.

The other hand-made component, capacitor C6, is part of the oscillator feedback. To make this small value capacitor, take a 4-

PARTS LIST

All resistors are 1/8-watt, 5%.

R1, R6—1000 ohms
 R2—15,000 ohms
 R3—6800 ohms
 R4—10,000 ohms
 R5, R7—4700 ohms
 R8—2200 ohms
 R9—220 ohms

Capacitors
 C1, C3—10 μ F, 25 volts, electrolytic
 C2—2.2 μ F, 25 volts, electrolytic
 C4, C7—0.1 μ F, 25 volts, ceramic
 C5—5–60 pF trimmer
 C6—hand-made capacitor (see text)

Semiconductors
 Q1, Q2—2N2222 NPN transistor

Other components
 L1—hand-made coil (see text)

Miscellaneous: perforated construction board, 9-volt battery, battery clip, electret microphone, 24-gauge insulated wire, bare wire, solder, etc.

inch piece of 24-gauge insulated wire, bend it over double and, beginning 1/2-inch from the open end, twist the wire as if you were forming a rope. When you have

about 1 inch of twisted wire, stop and cut the looped end off leaving about 1/2-inch of twisted wire (this forms the capacitor) and 1/2-inch of untwisted wire for leads.

Capacitor C7, a 0.1 μ F capacitor, is one of the most critical components in the circuit. You must place it across the L1-Q2-R9 assembly, as shown in Fig. 1, to reduce the amount of RF feedback you'll get into the rest of the circuit. The antenna (more 24-gauge wire) should be soldered to the coil you made, about 2 turns up from the bottom, or the transistor side, and should be about 8–12 inches long.

Operation

To use the transmitter, set up a radio in the area at least 10 feet from the project. Find a blank spot on the dial and turn the radio up so you can hear the static.

Connect a 9-volt battery to the transmitter and listen to the radio. Slowly adjust the tank capacitor (C5) until you "quiet" the receiver; this is the tuned spot. Note that when you remove your hands from the transmitter, you will detune the circuit somewhat. It is usually best to leave it detuned, and tune the radio in to get the best reception. If you cannot get the tuning range you desire, you can squeeze the coils in the tank circuit closer together to raise the frequency, or pull them apart just a little bit to lower it.

The circuit works best when powered by a battery, but if a wall-derived supply is needed, make certain that the ripple voltage is as low as possible, or you will get hum in the receiver. R-E

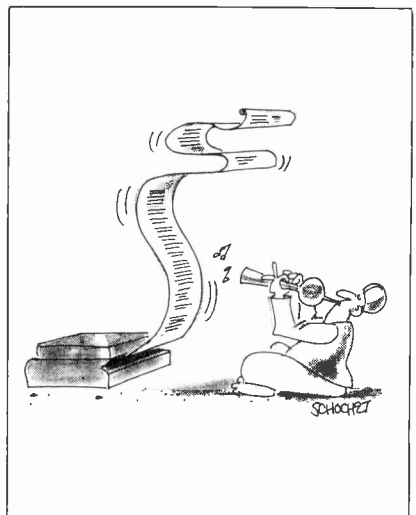

IT'S BEEN ONLY A DECADE SINCE compact disc digital audio was introduced. In that short time, the compact disc or CD has brought high-quality audio reproduction to the masses, and taught us to appreciate good sound. We're not exaggerating when we say that the CD has changed the way we listen to music.

It's rare for a new technology and format to catch on so quickly—especially one that threatens to make its predecessors obsolete. CD was a success not only because of consumer acceptance, but because it also offered something to manufacturers, recording companies, and retailers.

It wasn't the CD's "gee whiz" appeal—nor was it the promise of perfect audio reproduction—that caused sales to catch fire. It was *convenience*. When compared to the LP that it replaced, CD's were a dramatic breakthrough. They can store more audio in a package a fraction of the size. They can be lent to even your most careless friends without getting scratched. They even play back more conveniently, because you can skip tracks that you don't want to listen to, or re-arrange the order in which the songs play back.

It's convenience, also, that makes the venerable compact cassette our music medium of choice. (Cassettes outsold CD's every year until last year.) They fit in your shirt pocket, and they stand up reasonably well to abuse. They're ideal for use in a car or in a personal stereo because they're relatively immune to shocks. So what if they can't come close to the audio quality of a CD or even an LP?

How about DAT?

In the belief that consumers had fallen so much in love with the idea of digital audio because of their exposure to CD, Japanese manufacturers reasoned that Digital Audio Tape (DAT) would be to the CD what the compact cassette was to the LP. Unfortunately, it didn't work out that way for a number of reasons. First, the record industry, spearheaded by the RIAA (Recording Industry Association of America), threatened lawsuits against any Japanese manufacturer who exported the DAT ma-

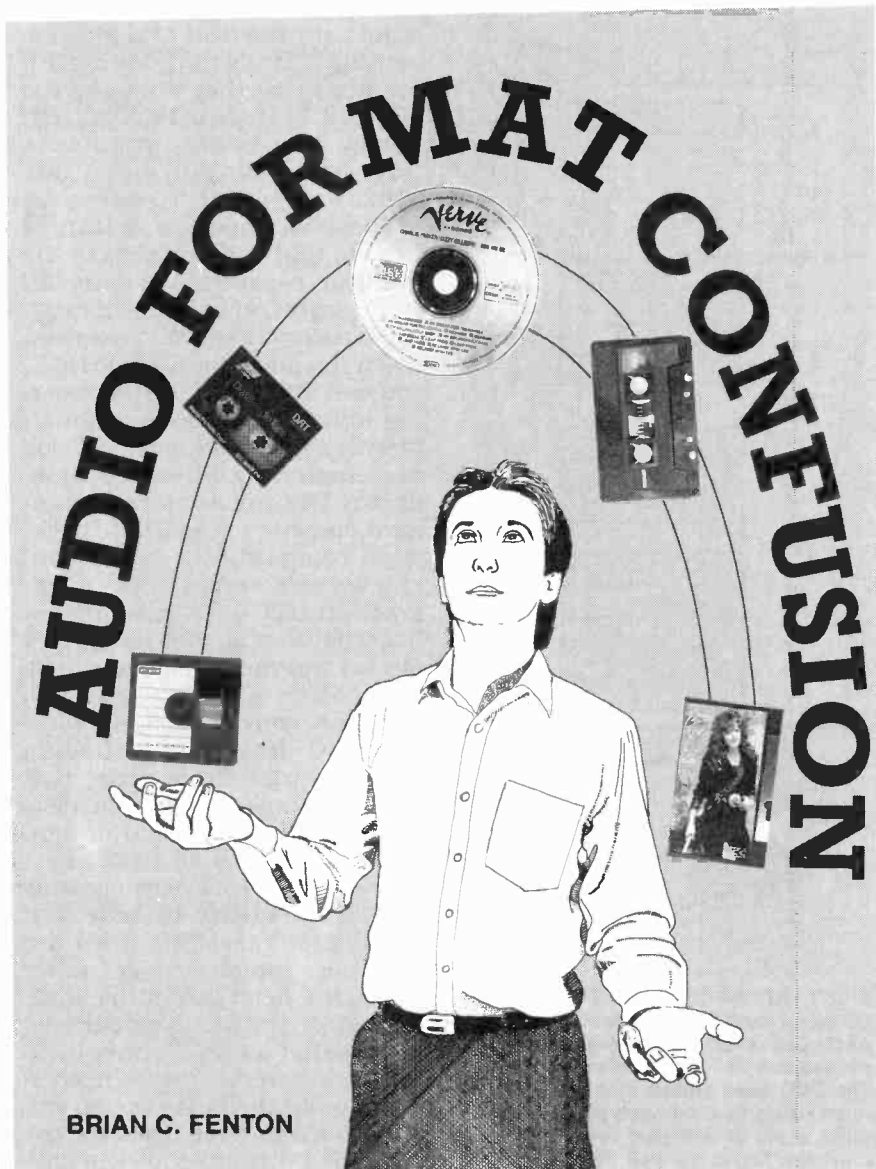

Two new digital audio formats—Sony's Mini Disc and Philips' Digital Compact Cassette—promise to battle each other as they create consumer confusion.

chines to the U.S. The RIAA was concerned about DAT's potential to make virtually perfect copies of CD's. (They seemingly missed the fact that, for most people, cassettes do the same thing. And despite that, *pre-recorded* cassettes have outsold both LP's and CD's combined since 1982! They've outsold blank tapes as well.) The threats of lawsuits were enough to stop DAT dead in its tracks, despite considerable accolades for the format in the audio and

general press.

Although some DAT machines were available on the "gray market" of unofficially imported goods, DAT officially arrived in the U.S. market in 1990—with generally disappointing results. Whether it was the years of delay, the taint of the lawsuits, the expense of the machines, or the lack of pre-recorded software that have killed DAT in the consumer market, we'll never know for sure. Perhaps DAT failed because

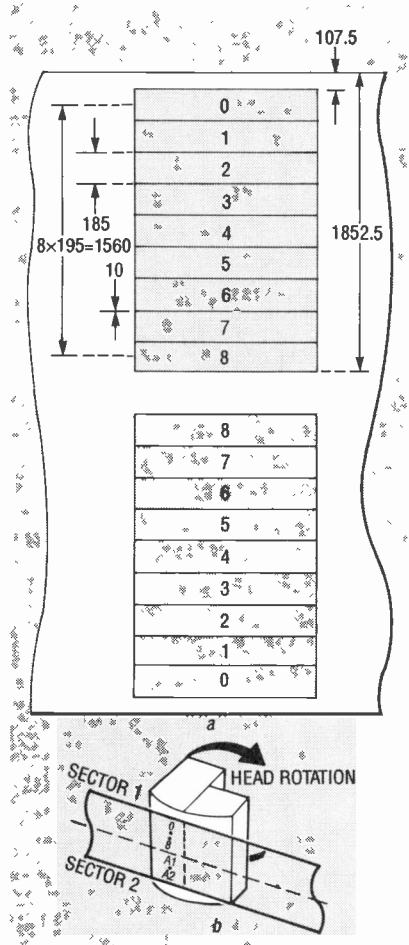

EIGHT TRACKS OF MUSIC DATA are contained on each "side" of the Digital Compact Cassette, as shown in a. (All dimensions shown are in micrometers.) The DCC head shown in b is manufactured using thin-film techniques. It contains a set of 8 digital recording and playback heads as well as two analog playback heads.

it doesn't offer the average consumer anything that they're not already getting from their favorite compact cassettes.

Although the compact cassette—even with its inherent problems—is just fine for most people, Philips, the originators of the compact cassette, was convinced that the format could be improved, and that consumers would buy into the updated format. Thus, DCC, the Digital Compact Cassette, was born.

Enter DCC

In January of 1991, Philips announced that "a new era of audio reproduction has started," DCC, a digital extension of the compact cassette, would offer "the best opportunity available for consumers and industry to

enter into the field of digital recording." Tandy Corporation announced that they would be the first U.S. licensee of Philips' technology, and would introduce a home recording deck in late 1992.

The most important feature of DCC is that it doesn't make the familiar cassette obsolete. All DCC players will play back existing analog cassettes, so even when you make the jump to DCC, you can still listen to your existing library of tapes. (You won't, however, be able to record analog cassettes on your DCC machine, or play DCC tapes on your standard cassette deck.) That "backward compatibility" could convince some consumers to upgrade to DCC even though they like what they already have. After all, an upgrade won't just give them better sound, but as we'll see, more convenience as well.

A DCC deck is essentially a standard cassette recorder that includes some extra digital electronics and a new head design. The dimensions of a DCC cassette are essentially the same as that of a standard cassette, but the digital cassette's sides are flat—the case doesn't get fatter where the head enters the shell. Also, since the DCC standard demands that all DCC players feature auto-reverse, there's never a need to flip the tape over, so you don't need to have holes for the reels on both sides of the cassette. That means that one full side of the cassette can be used for information and graphics—something the recording companies love.

The spool holes and the tape surface are protected against dust and fingers by a sliding metal cover, which also locks the tape hubs. There's no need for a carrying case, so the digital cassette is easier to use and store, especially in a car.

The key to maintaining compatibility with standard cassettes is a new thin-film semiconductor head, manufactured using a process similar to that used for integrated circuits. The first layer of the head contains one set of 9 magneto-resistive heads for digital playback, and a pair of similar heads for analog playback. On the second head layer is one set of 9 integrated

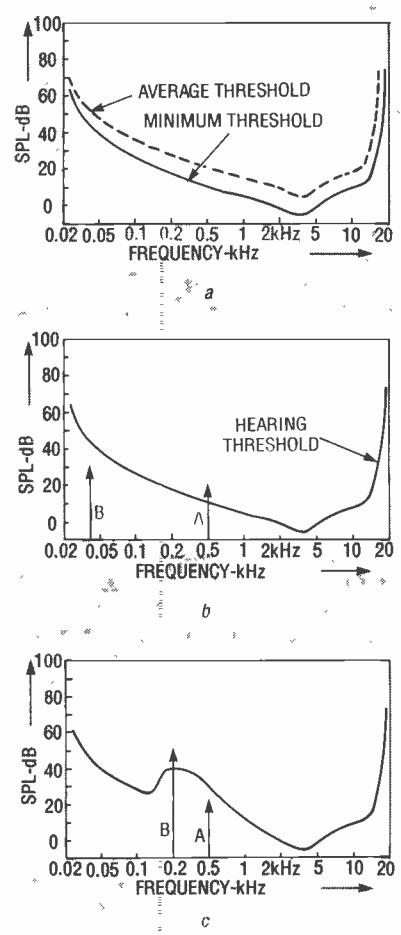

PHILIPS' PASC ENCODING ignores sounds that are below the hearing threshold (a). Of the signals shown in b, only A would be recorded because B, below the hearing threshold, would not be heard. The hearing threshold, however, varies dynamically depending on what other signals are present. In c, signal B has altered the threshold, making A inaudible.

recording heads for digital recording. We'll see shortly why 9 digital heads are required.

PASC makes it work

The key to the DCC system is the a new digital coding technique called PASC, or precision adaptive sub-band coding. The goal of PASC is to produce a signal equivalent to that of a CD. The results? A dynamic range better than 105 dB, and a total harmonic distortion, including noise, of less than 0.0025%

PASC is based on two important psychoacoustic principles. The first is that we can hear sounds only if they're above a certain level, called the hearing threshold. The second is that loud signals mask soft ones by raising the hearing threshold.

The hearing threshold, as you might expect, varies from person to person. Even a very sensitive ear, however, won't be able to hear a sound if it is masked by a louder sound. (You couldn't, for example, hear an unamplified violin at a rock 'n' roll concert!) The theory behind PASC's efficiency can be expressed by the question, "If you can't hear it, why record it?"

During encoding, the PASC processor analyzes the audio signal by splitting it into 32 sub-band signals. By continuously taking into account the dynamic variations of the hearing threshold, the PASC processor encodes only the sounds that will be audible to the human ear. Each sub-band is allocated the number of bits that are required to accurately encode the sound within it. If a subband doesn't require any bits—because it contains sounds that are masked, for example—its bits are re-allocated to other subbands so that the sounds within them can be encoded more accurately. On average, the PASC system needs to encode only one quarter the number of bits that a CD or DAT encoder would to reproduce a given audio signal.

The encoded data is multiplexed into an 8-channel data stream, and error-detection and correction codes are added. The eight channels are recorded on 8 parallel tracks on the DCC tape. The ninth track can be used to carry auxiliary data, such as song titles, recording times, and the like). The auxiliary track could be used to generate hundreds of characters of text per

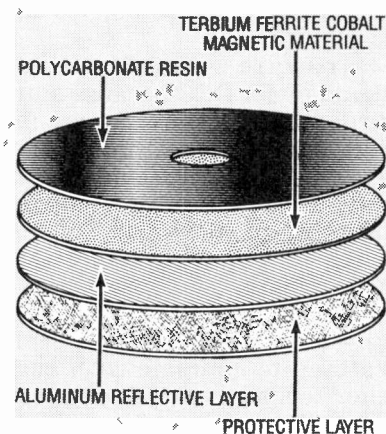

THE MINI DISC is composed of 4 layers.



A PROTOTYPE MINI DISC player and a pre-recorded disc.

second, so decks could include readouts for song lyrics or other information about the selection.

DCC, an elegant extension of the most popular music carrier we have, seemed to be a sure-fire hit. It had something for everyone, including hardware manufacturers, record companies, retailers, and consumers. It now appears, however, to have run up against a formidable competitor: Sony's Mini Disc.

Sony's Mini Disc

In May of 1991, in what seemed to be a deliberate attempt to derail DCC before it got moving, Sony announced a brand new recordable audio format, the Mini Disc or MD. Sony, however, denied that their MD was meant to compete with DCC. In response to the question of what MD replaces, the President of Sony Corporation of America answered "We are replacing nothing. We are Creating new markets."

The Mini Disc format is specifically designed for portable applications (personal stereos, boom boxes, etc.) and was scheduled for introduction, conveniently, in late 1992—the same time that DCC decks were due. The disc, about 2½ inches in diameter, looks—and acts—like a cross between a compact disc and a micro floppy computer disk. Like a compact disc, the Mini Disc is an optical medium—it is read by a laser and can store up to 74 minutes of digital audio. Like a floppy disk, the mini disc can be magnetically recorded

again and again.

How did they manage to get the same capacity as a CD on a disc that has about ¼ the surface area? Interestingly, by treating audio in much the same way as DCC does. Sony's encoding scheme, which is called ATRAC, or adaptive transform acoustic coding, is also based on the psychoacoustic principles regarding the threshold of hearing and the masking effect.

Because the ATRAC encoder ignores sounds that fall below the threshold of hearing (which varies dynamically because of signal masking) it can encode data five times more efficiently than CD or DAT systems. That's even better than DCC's 4:1 advantage!

Can a recording that "leaves out 80% of the bits" sound as good as a CD? In theory, if all you're leaving out is things you can't hear, then yes. In practice, we don't know yet. At Sony's announcement, they demonstrated a prototype by playing some pop/rock for a half minute or so. It sounded OK, we guess, considering that the listening environment was a crowded hotel meeting room. No A/B comparisons were provided between CD and MD. Sony claims that "only 2% of the population will be able to hear the difference."

The Mini Disc is constructed of four layers, including a newly developed magnetic layer of terbium ferrite cobalt. Since magneto-optical discs can't come in contact with the recording heads, it's important that the magnetic material be able to

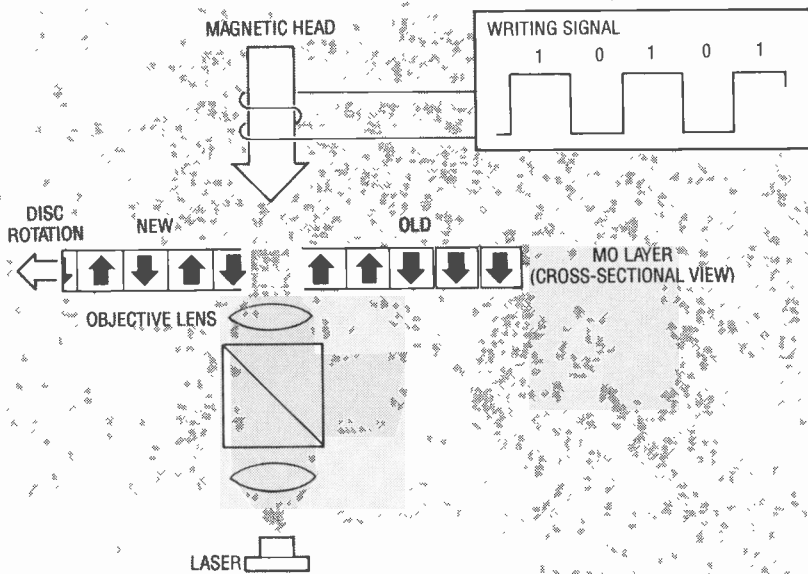

MAGNETO-OPTICAL OVERWRITE TECHNOLOGY. When the magnetic layer is heated by the laser, it becomes possible for the magnetic head to change its polarity. The polarity is then detected by the laser during playback by noting the direction of reflection.

change polarity when subject to a very small magnetic field. The new material fills the bill.

The Mini Disc requires both a laser and a magnetic head for recording. When the magnetic layer is heated by the laser (to a temperature of about 400°F), it loses its coercive force—that is, it becomes very easy to magnetize. The head then supplies a magnetic field to set the material's magnetic polarity. When the heated spot cools, the new polarity is "locked in" and, thus, the digital data are recorded.

Sony's Mini Disc has a couple of advantages over other optical recording methods. The structure of the head is much simpler because the laser can be on continuously during recording and playback. And the low-coercivity of the magnetic material greatly reduces the power required, making portable operation feasible.

One feature of Mini Disc touted by Sony is that the portable Walkman players will have "shock-proof memory." One of the problems with current portable CD players is that they don't work too well unless they're standing still. Any sharp jarring causes the laser to mistrack. Mini Disc players shouldn't suffer from that problem because data is read off the disc at a rate far faster than required by the ATRAC decoder, creating a data buffer of

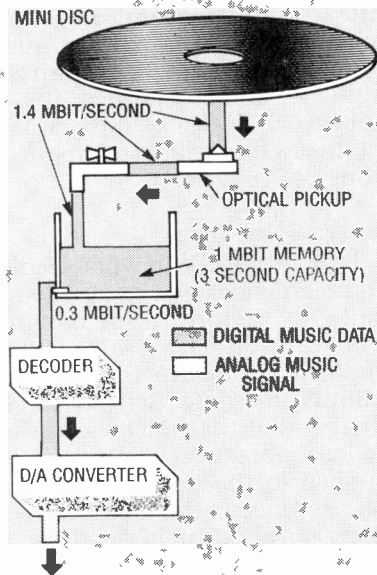

SHOCK-PROOF MEMORY promises to make Mini Disc an ideal portable format. Since the data is read off the disc far faster than required by the ATRAC decoder, a buffer as long as three seconds is created.

three seconds. If the laser mistracks, the listener won't hear it. The buffer will feed data to the decoder while the laser finds its way back to the right spot. Sony's announcement included a demonstration where a prototype player was shaken vigorously without any audible result. The prototype continued to play even after the disc was removed until the 1-megabit buffer was empty! Of course, there's no tech-

nological reason why portable CD players couldn't offer their own shock-proof memory buffer. But since the buffer would have to be 5 times the size, it would add greatly to the cost.

Who wins?

Ever since we forecast that DAT would be a sure-fire success, we've been reluctant to make predictions. But let's look at some of the issues involved, and how DCC and MD stack up.

For consumers—assuming that both formats offer high-quality audio—DCC has the decided advantage in that existing libraries of cassettes won't be obsolete. Both formats have the potential to supply such convenience features as song title and lyric readouts, but MD offers much faster random access of tracks. Although it's too early to say for sure, prices for home DCC decks should be around \$600 when introduced, while a portable MD player is expected to cost more than \$400. For consumers, we give DCC a slight edge.

The recording companies will have a hard time taking sides. Both technologies will use the serial copy management system or SCMS, an anti-piracy system. Manufacturers will be able to duplicate DCC at 64 times normal speed on equipment similar to what is now used for standard cassettes. Mini Disc players will be able to play back not only magneto-optical discs, but pre-recorded optical discs as well—discs manufactured using the same process as is used for CD's. Various recording companies have expressed support for each format. Which way will the record companies go? For us, it's too close to call.

Hardware manufacturers should prefer DCC because standard tape transports can be used. Retailers, always reluctant to have to stock the same titles in various formats, are dreading the thought of re-vamping their stores to accommodate either DCC or MD.

What about you? In the long run—since both formats seem destined to compete with each other for your money—it's you who will decide whether DCC or MD is the personal recording format of the 90's and beyond. **R-E**

SPEAKER PROTECTOR



This simple circuit will protect your stereo speakers in the event of amplifier failure.

IF YOU'VE HAD FIRST-HAND EXPERIENCE with damaged speakers due to a faulty amplifier, or if you value your speakers enough to want to prevent such damage in the first place, then the circuit described in this article is for you. The circuit will protect speakers against an amplifier that may have a shorted output stage and thus deliver excessive DC voltages that will easily ruin a speaker coil. If your amplifier has a sound-processing delay after the power has been turned on, a functionally similar circuit is already built in. This article will give you a basic idea of the delay's function and how it works to protect the speakers. The circuit is designed for solid-state amplifiers and is not necessary for tube-type amplifiers that have output transformers. (An output transformer blocks any DC from the speaker terminals.)

MARK A. VAUGHT

The circuit is very versatile and can be customized for many different applications. Plans for home stereo, automotive, and commercial PA/guitar amplifier applications are included.

The most common cause of speaker failure is catastrophic amplifier failure. That's in contrast to the conception that the speaker has been overdriven by an amp that's operating normally. Most often the speaker power level has been chosen to match the driving amplifier. Semiconductors designed to handle high current, such as bipolar power transistors and MOSFET's, usually short when they blow out. Often these devices are connected directly to an amplifier's DC power-supply rails or through a small amount of resistance that can't effectively lim-

it the current when the short occurs.

The DC level of an amplifier's power supply is designed to accommodate the peak power levels that occur when the amp is driving the speaker at full power. A 100-watt amplifier has power-supply rails of at least 40 volts. Under normal operating conditions, that level would never be applied to the speaker coil for more than a few seconds. However, if an output device in the amp shorts, the DC is applied to the speaker continuously. In the case of a 100-watt amplifier, that causes a power dissipation of:

$$P_D = (40V/\text{speaker resistance})40V$$

Speaker resistance is usually one to two ohms less than the AC impedance. If a blown amplifier is connected to a 100-watt speaker with a 7-ohm DC resistance, the power being dissipated is:

$$P_D = (40V/7\Omega)40V \\ = 228 \text{ watts}$$

The speaker will be able to dissipate that power for only a couple of seconds before the coil is damaged due to excessive heat.

When the protector circuit senses a DC voltage on the speaker line, it activates a relay whose contacts are in series with the speaker; after two seconds the relay disconnects the speaker until the DC is removed. A fuse is inadequate for this application because the value needed to protect the speaker against DC will blow out at peak power levels during normal operation. Conversely, a fuse value chosen to allow peak power operating levels will not protect the speaker against a DC voltage. The protector circuit allows peaks to occur in the power level and also protects the speaker against DC. It should be used in conjunction with a fuse value calculated from peak power levels. The fuse should be placed as close to the amplifier as possible, if not in the same chassis, and is therefore not shown in the protector circuit's schematic.

Circuitry

The protector circuit's schematic is shown in Fig. 1 and the power supply is shown in Fig. 2. Up to four individual protector circuits can be powered from one supply, although most applications will require only one or two circuits per chassis. The optional 9-volt DC output jack can be used to power a footpedal or fuzzbox, eliminating the need for a DC wall transformer when the circuit is used to protect guitar-amplifier speakers. The power supply can be modified for different applications, and we'll talk about them later.

Referring to Fig. 1, the voltage-divider resistors R3–R6 are used to bias the positive and negative inputs of the window comparator formed by IC1-a and IC1-b. The inputs are biased at plus and minus 3 volts. The voltage divider also provides a 9-volt reference for the negative input of comparator IC1-c.

Resistors R1 and R2 form an input voltage divider fed from the speaker terminals of an audio amplifier. The input divider is referenced to analog ground, and the output of the divider is connected to the negative and positive inputs of the window

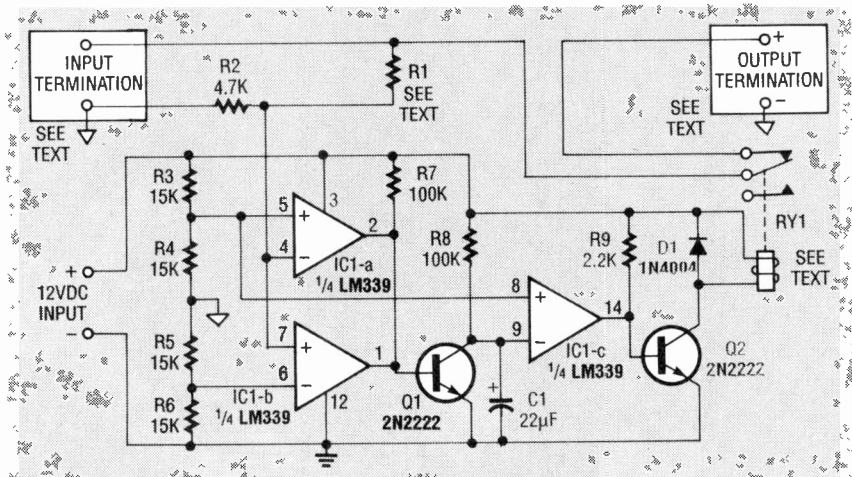

FIG. 1—IF AN AMPLIFIER OUTPUT SHORTS, this circuit will protect your speakers from the harmful DC voltage that will be present at the amplifier's speaker outputs.

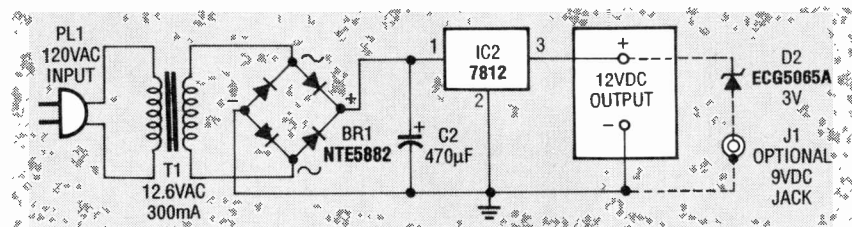

FIG. 2—THE POWER SUPPLY can be used for up to four individual protector circuits. The optional 9-volt DC output jack can be used to power an electric-guitar footpedal or fuzzbox.

comparator (IC1-a and IC1-b). The outputs of IC1-a and IC1-b are open-collector stages, wired together, and pulled high through R7. That forms a wired-or function and completes the window comparator. When the output of the R1-R2 voltage divider exceeds the reference levels set by R4 and R5, the output of the window comparator goes low and removes the bias from Q1. The input voltage at which that happens is determined by the value of R1. The formulas for calculating R1 are presented later in this article. Transistor Q1 is turned off while the output of the window comparator is low, thus allowing timing-capacitor C1 to begin charging through R8.

Under normal input conditions (an AC audio signal), the output of the window comparator will return to a high level when the input returns to the plus and minus 3-volt range. That biases Q1 into conduction and immediately discharges C1. If a DC signal large enough to trigger the window comparator is present on the input, then Q1 will remain in its off state and C1 will charge until it reaches 9 volts

with reference to the power-supply ground. When C1 reaches 9 volts it triggers comparator IC1-c causing its output to go high and bias Q2 into conduction via R9. When turned on, Q2 grounds one end of relay RY1 thereby activating it and disconnecting the audio passing through its contacts from the speaker. The relay contacts will remain open until the DC input is removed from the protector circuit. Diode D1 protects Q2 against reverse-bias spikes generated by the relay coil.

The circuit has two separate grounds: a speaker ground and a power-supply ground. Under no circumstances should these two grounds be connected together. If two circuits are used together, then three entirely separate grounds will exist: a power-supply ground and a speaker ground for each circuit (see Fig. 3-a).

Some stereo amplifiers, especially those used in car-radio amplifiers, have differential or floating-ground outputs for each channel and cannot be connected together. Figures 3-a, -b, and -c are AC model diagrams showing the equivalent connection paths between two circuits

TABLE 1

POWER OUTPUT OF AMP (W)	4-OHM LEAD				8-OHM LEAD			
	RMS VOLTAGE	PEAK VOLTAGE	R1 VALUE IN OHMS	FUSE VALUE IN AMPS	RMS VOLTAGE	PEAK VOLTAGE	R1 VALUE IN OHMS	FUSE VALUE IN AMPS
10W	6.3V	8.9V	5.2K	2.2A	8.9V	12.7V	9.2K	1.6A
20W	8.9V	12.7V	9.2K	3.2A	12.7V	17.9V	15.2K	2.2A
30W	11.0V	15.5V	12.5K	3.9A	15.5V	21.9V	19.6K	2.7A
35W	11.8V	16.7V	13.8K	4.2A	16.7V	23.7V	21.5K	3.0A
40W	12.7V	17.9V	15.2K	4.5A	17.9V	25.3V	23.3K	3.2A
50W	14.1V	20.0V	17.4K	5.0A	20.0V	28.3V	26.6K	3.5A
60W	15.5V	21.9V	19.6K	5.5A	21.9V	31.0V	29.6K	3.9A
75W	17.3V	24.5V	22.4K	6.1A	24.5V	34.7V	33.7K	4.3A
85W	18.4V	26.0V	24.1K	6.5A	26.0V	36.9V	36.0K	4.6A
100W	20.0V	28.3V	26.6K	7.0A	28.3V	40.0V	39.6K	5.0A
120W	21.9V	31.0V	29.6K	7.8A	31.0V	43.8V	43.9K	5.5A
140W	23.7V	33.5V	32.4K	8.4A	33.5V	47.3V	47.8K	5.9A
150W	24.5V	34.7V	33.7K	8.7A	34.7V	49.0V	49.7K	6.1A
175W	26.5V	37.4V	36.8K	9.4A	37.4V	52.9V	53.9K	6.6A
200W	28.3V	40.0V	39.6K	10.0A	40.0V	56.6V	58.0K	7.0A
250W	31.6V	44.7V	44.8K	11.2A	44.7V	63.3V	65.3K	7.9A
300W	34.7V	49.0V	49.7K	12.3A	49.0V	69.3V	72.0K	8.7A

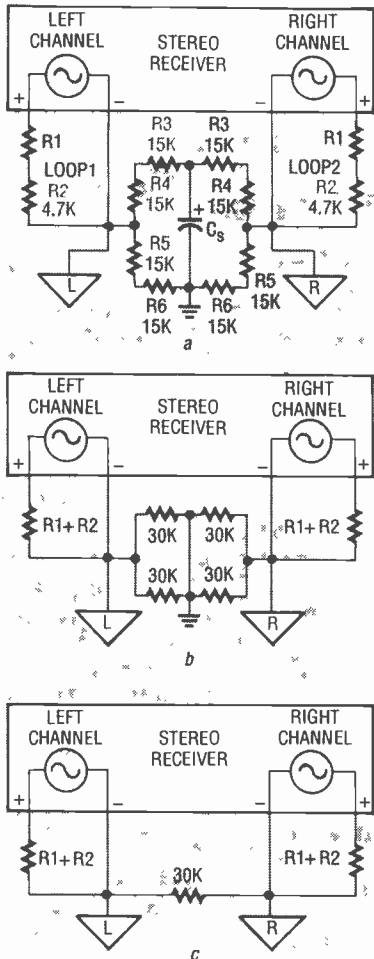

FIG. 3—THE CIRCUIT HAS A SPEAKER GROUND and a power-supply ground that should never be connected together; a shows that the current flowing in either loop is not a function of the other; b shows the power-supply capacitor from a (Cs) replaced by a wire; and, in c, the equivalent resistance between the two speaker grounds is shown as 30K.

operating from a single power supply. Figure 3-a clearly shows that the current flowing in either Loop 1 or Loop 2 is not a function of the other. The speaker grounds return to the common power supply rails through the voltage-divider resistors R3–R6. Figure 3-b shows the power-supply capacitor from 3-a, which is seen as a short to AC, replaced by a wire. Finally, in Fig. 3-c, the equivalent resistance between the two speaker grounds is shown as 30K. DO NOT short the two grounds together under any circumstance.

If the amplifier speaker grounds are connected inside the amplifier, they should NOT be connected at the speaker protec-

tion circuit's chassis. High current is assumed to be flowing in each speaker ground lead and connection of separate ground leads anywhere except inside the amplifier will degrade performance.

Calculations

To calculate the value for R1, which determines the time it takes C1 to reach nine volts, the following example analysis is presented. The first step is to calculate the RMS (average) voltage applied to the speaker terminals to obtain the rated amount of power. We'll arbitrarily use 100 watts and a speaker load of 8 ohms. From the equation:

$$P = (I^2)R$$

we can substitute values
 $100W = (I^2)8$
 divide by 8
 $12.5 = I^2$
 take the square root of both sides
 $I = 3.53 \text{ amps}$
 From the equation:
 $V = IR$
 we can substitute values
 $V = 8(3.53A)$
 $= 28.28 \text{ volts RMS}$
 As a final check use the formula
 $P = IV$
 we can substitute values
 $P = 3.53A(28.28V)$
 $= 99.82 \text{ watts}$

To calculate the value for R1 we use the equation:
 $((V_{IN}(R2))/V_{OUT}) - R2 = R1$
 and substitute values

$$= ((28.28V(4.7K))/3V) - 4.7K$$

$$= 39.60K$$

To calculate the fuse value for amplifier short-circuit protection, use the equation:

$$V_P = V_{RMS}/0.707$$

and substitute values
 $28.28V/0.707 = 40 \text{ volts}$
 From the equation:

$$I = V_P/R$$

we can substitute values
 $40V/8 \text{ ohms}$
 $= 5 \text{ amps}$

If you would rather avoid making all of the calculations, Table 1 shows the correct resistance values to be used for R1 for 10- to 300-watt applications. Appropriate fuse values are also provided in Table 1.

The next step is to calculate the maximum time that C1 will charge, and the voltage level it will reach before it is discharged, under normal operating conditions. This is a necessary analysis in order to prove that the circuit will not trigger falsely when peak audio power levels are reached. The lowest frequency normally associated with audio is 20 Hz. It has the longest time period (50 milliseconds) in the audio spectrum so we'll use it for analysis of the speaker protector circuit. (An actual audio signal is quite complex, but the complexity of the waveforms only decreases the time that C1 will charge, so we'll therefore use 20 Hz.)

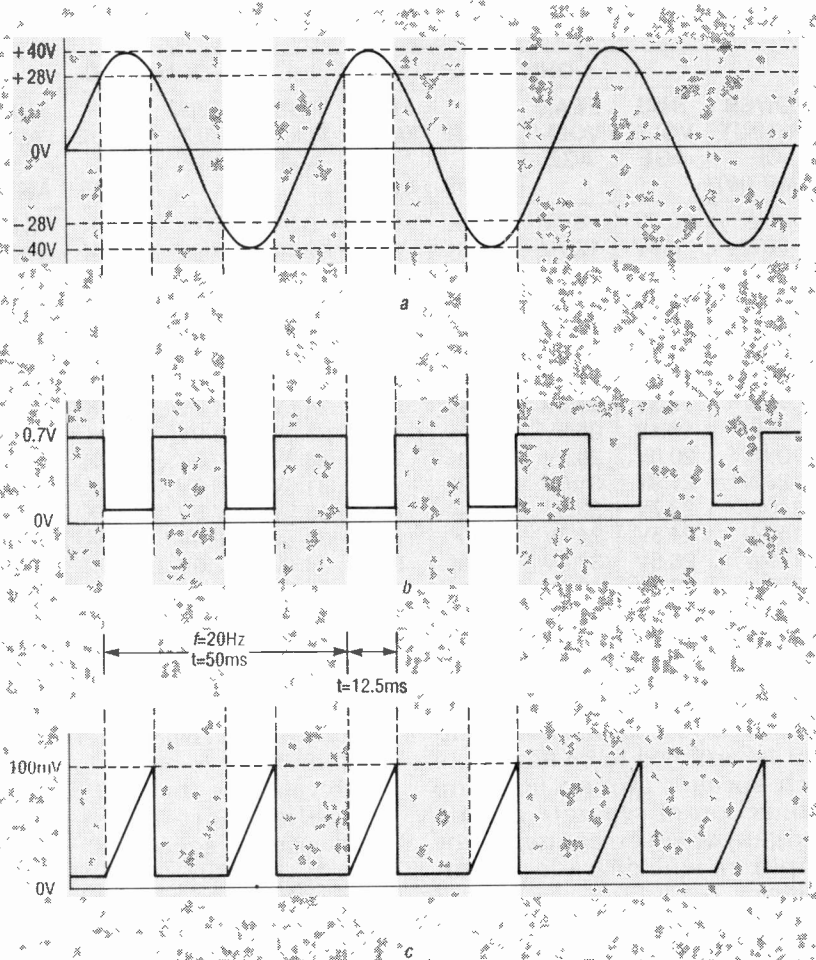
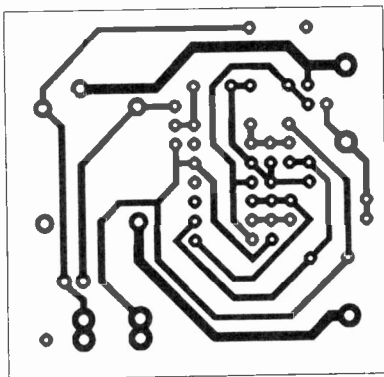

FIG. 4—SHOWN IS THE INPUT TEST SIGNAL (a), the Q1 base voltage (b), and the Q1 collector voltage (c).



MAIN FOIL PATTERN shown actual size.

Capacitor C1 will charge whenever the input voltage exceeds the RMS voltage level necessary to produce 100 watts if R1 is equal to 39.6K. Figure 4 shows the analysis waveforms for the circuit; shown is the input test signal (a), the Q1 base voltage (b), and the Q1 collector voltage (c). Referring to Fig. 4-a, to calculate the time that the input waveform

is between 28 and 40 volts, we'll first assume that e_i is the instantaneous voltage level (28.28 VRMS), E_M is the maximum or peak voltage level (40.00V_P), the frequency is f (20 Hz), pi (π) is equal to 3.14, t is the time for sine wave to reach 28.28 V_{RMS}, and that 2π radians equals 360 degrees (and we'll stick to degrees from this point on). That out of the way, from the equation:

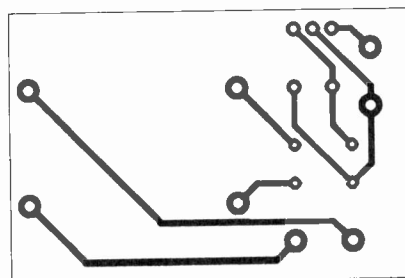

POWER SUPPLY FOIL PATTERN shown actual size.

$$e_i = E_M(\sin(360f))$$

we divide by E_M

$$e_i/E_M = \sin(360f)$$

we now take the inverse sign

$$\sin^{-1}(e_i/E_M) = 360f$$

and divide by 360f

$$(\sin^{-1}(e_i/E_M))/360f = t$$

now we substitute values

$$(\sin^{-1}(28.28/40))/360(20\text{Hz}) = 45/7200 = 6.25 \text{ ms}$$

From those equations we can conclude that, for the sine wave of Fig. 4-a to travel from 0 to 28 volts (0.707 × peak value), it takes 6.25 ms, or one eighth of the total period (50 ms) of the waveform. 6.25 ms is also the time it takes the sine wave to return to zero volts. Therefore:

6.25 ms(2) = 12.5 ms
 12.5 ms is the total time C1 will charge (4-c). The last step is to calculate the voltage level of C1 at $t = 12.5 \text{ ms}$, and we'll assume that e_C is the capacitor voltage at t , E is the power-supply voltage (12V), e equals 2.718, t equals 12.5 ms, C equals 22 μF , and R equals 68K. Now we take the equation:

$$e_C = E(1 - e^{-t/(CR)})$$

and substitute values

$$= 12(1 - 2.718^{-12.5\text{ms}/(22\mu\text{F})68\text{K}})$$

$$= 12(0.0084) = 100 \text{ mV}$$

The speaker protector circuit will disconnect the amplifier from the speaker after a 2-second interval using the values shown for R8 and C1. That amount of time will protect the speaker under most circumstances. Charging time for C1 to reach 9 volts can be calculated by rearranging that equation and assuming that e equals 2.718, \ln is the natural log (the inverse of e^x), E is the power-supply voltage (12V), e_C is the capacitor voltage (9V), t is the time for C to charge to 9V, C equals 22 μF , and R equals 68K. The rearranged equation is:

$$t = CR(\ln(E/E - e_C))$$

now we substitute values

$$t = (22 \mu\text{F}(68\text{K}))(\ln(12/(12 - 9))) = 1.49(1.39) = 2.0 \text{ seconds}$$

To change the time delay for the speaker protector circuit to disconnect the speaker from a DC voltage use the equation $R8 = t/1.39C$ to recalculate the value of R8.

Construction

Construction of the protector

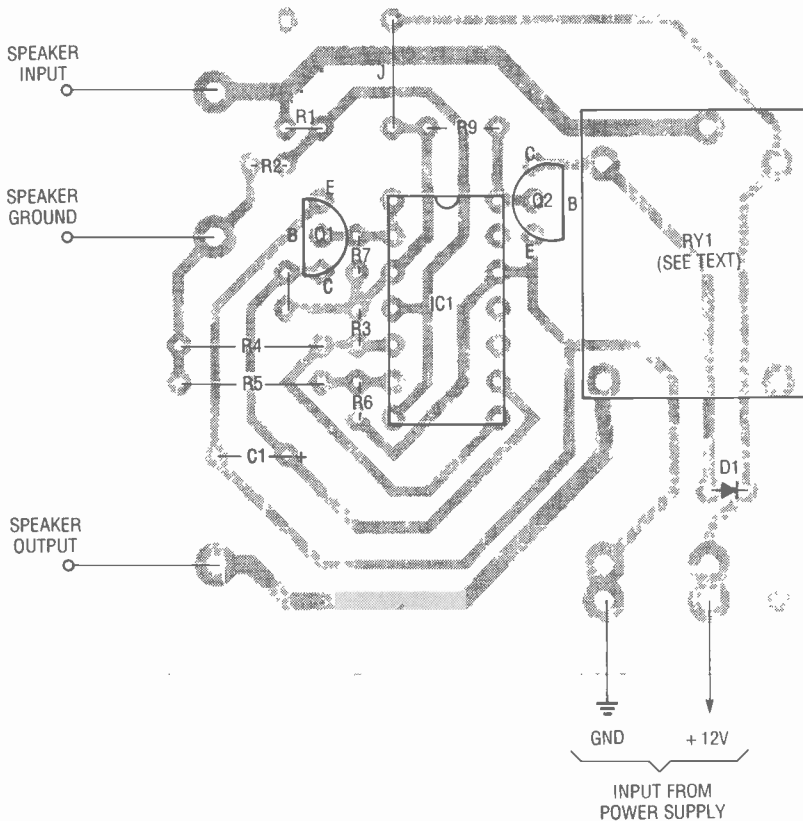

FIG. 5—PARTS-PLACEMENT DIAGRAM for the protector circuit. The 5-amp relay will mount right on the board, while the 15-amp relay must be mounted on the edge of the board using double-sided tape.

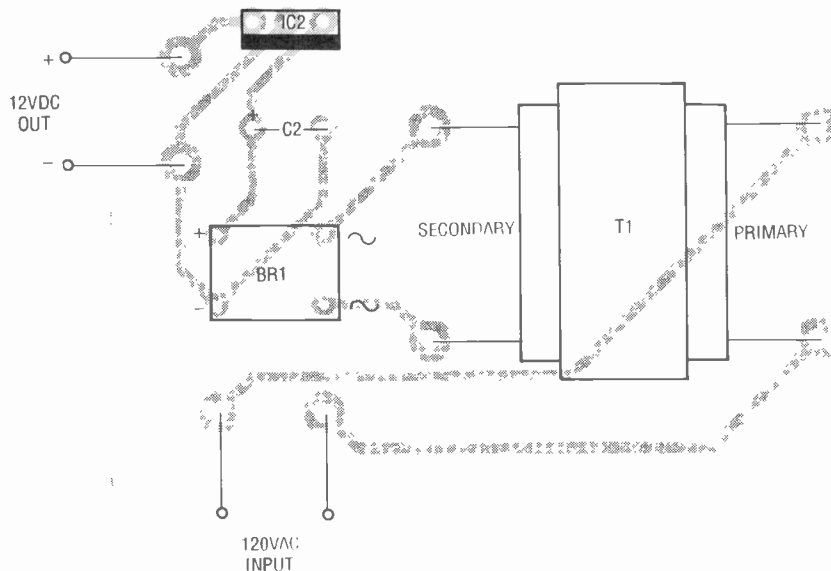

FIG. 6—PARTS-PLACEMENT DIAGRAM for the power-supply board.

circuit depends on the intended use. Once you have a clear idea of the application, then you can customize the circuit to meet your needs. To use the circuit to protect car-stereo speakers, re-

place R4 and R5 with 3-volt Zener diodes. That will ensure that the window-comparator reference voltages, with respect to analog ground, will be independent of the DC supply voltage. For power

PARTS LIST

All resistors are 1/4-watt, 10%.

R1—value depends on your setup (see text and Table 1)

R2—4700 ohms

R3—R6—15,000 ohms

R7, R8—100,000 ohms

R9—2200 ohms

Capacitors

C1—22 μ F, 35 volts, radial electrolytic

C2—470 μ F, 35 volts, radial electrolytic

Semiconductors

IC1—LM339N quad open-collector voltage comparator

IC2—7812 12-volt regulator

D1—1N4004 diode

D2—ECG 5065A 3-volt Zener diode (required for optional 9-VDC output, see text)

Q1, Q2—2N2222 NPN transistor

BR1—ECG 5882 1-amp bridge rectifier

Other components

T1—120/12-VAC 300-mA transformer

RY1—5- or 15-amp relay (see text)

J1—optional 9-VDC jack (whatever type best suits your needs)

Miscellaneous: PC boards, AC plug and line cord, 18-gauge stranded hookup wire, cabinet(s), speaker-input and -output jacks (RCA jacks, spring-terminal board, etc.), solder, etc.

Note: The following items are available from Applitron Electronics, 2721 Creswell Road, Bel-Air, MD 21014: Kit of parts for the speaker protector circuit including an etched and drilled PC board and all parts that mount on it for \$14.95. Please specify the value of R1 you desire (standard 10% values only) and P.A./guitar, home stereo, or automotive version. Add an additional \$3.50 for the optional high-current (15 amp) relay. A kit of parts for the 12-volt supply is also available that includes an etched and drilled PC board and all parts that mount on it for \$14.95. Include \$1.95 postage and handling for each kit ordered and allow 3–4 weeks for delivery. Maryland State residents must add 5% sales tax.

levels below 100 watts, you can use the 5-amp relay shown in the parts list; above 100 watts, you must use a 15-amp relay.

The parts-placement diagram *continued on page 129*

IF YOU THOUGHT A MUSIC ON-HOLD feature for your telephone was only for high-budget professionals, think again. We'll show you how you can add FM music on-hold to any analog telephone line with a Touch Tone telephone. It's ideal for home offices or for people who want to project a high-tech appearance.

Some of the features of this design include; LED status indicator, audio volume control, built-in antenna, only one operating adjustment, and a mute function to eliminate "hiss" in between stations. You can build this impressive device in under three hours, for only \$70.

Construction, test, and alignment is made easy due to the use of specialized IC's, namely a single FM receiver chip, IC4, and a DTMF decoder, IC1. There are no special coils to wind, and no tricky circuit adjustments are required. All you need is a DMM to test and align the circuit. Let's now take a look at how the unit works.

On-hold circuit

A block diagram of the unit is shown in Fig. 1, and the schematic in Fig. 2. The FM on-hold device connects to an analog telephone line via an RJ11 modular jack. It's powered by an external +15-volt DC, 150-mA power pack that plugs into a standard 120-volt AC outlet. The 15-volt DC supply passes through polarity-protection diode D11 to the input of IC5, a 7812 +12.0-volt DC voltage regulator. Capacitors C24 and C25 provide decoupling and anti-oscillation protection for the regulator. The regulated output of IC5 is fed to the input of IC6, a 78L05 voltage regulator, to provide a 5-volt supply for IC4, a TDA7000 FM receiver. Decoupling and anti-oscillation protection for IC6 is provided by C26. Voltage divider R16-R17 provides the +6-volts DC power-supply output, which is filtered by C28.

When a key on any Touch Tone telephone is depressed, the signal is passed through IC3-d, an LM324N balanced amplifier. The purpose of this amplifier is twofold; it acts as a balanced to unbalanced matching network, and its gain is set to 0.1 to act as a line-voltage attenuator. Capacitors C1 and C2 block the phone

line's 48 volts DC from entering the amplifier. The ringing-voltage is limited by R1 and R2. The ratio of R3 to R1 sets the gain of IC3-d to 0.1. Resistor R4 biases IC3-d between its supply voltage and ground allowing, it to operate from the single +6.0 volts DC power-supply line. The output of the balance amplifier passes through coupling capacitor C3 and is then decoded by IC1, a Motorola MC145436 dual-tone multi-frequency (DTMF) decoder IC.

The output of IC1 is a 4-bit word, whose codes are listed in Table 1. It is connected to IC2-b, a 4082 dual quad-input AND gate, so that the output of that IC (pin 13) is normally low, and goes high only when the "*" key is pressed. Therefore, when the "*" key is decoded by IC1, pins 1, 2, and 13 are high while pin 14 is low. To switch the output of IC2-b high, four logic-high inputs must be present. The high inputs are provided by IC1 pins 1, 2, and 13 and IC2-a pin 1.

In order for IC2-a's output to go high, it must also have four logic-high inputs. Two of those are provided by R7, D10, and C27. Those components ensure that the internal power supply is operating. That will prevent the unit from seizing the phone line if power is lost or removed while it is connected to the phone line. The remaining two inputs are provided by a logic high from IC1 pin 12, which is the DV, or DATA VALID, output pin. DV assures proper operation of IC1 by providing internal checks. When those checks are valid, DV will output a logic high. That prevents false triggering due to voice or other tones,

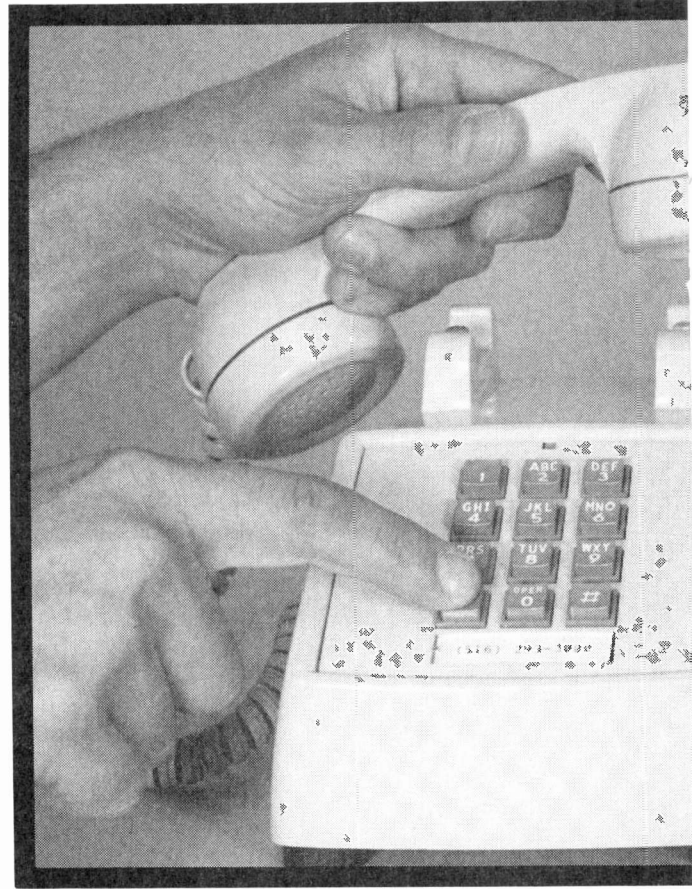

such as music, that occur during normal telephone usage.

When the "*" key is depressed, IC2-b pin 13 goes high, which in turn charges C4 and turns on switching transistor Q1. That activates relay RY1. Diode D1 prevents DC voltage from bleeding back into IC2-b pin 13. The time-base oscillator for IC1 is formed from a 3.58-MHz crystal XTAL1 and R5.

The normally open contacts of RY1 close and D7, R9, RY2, R10, C5, LED1, transformer T1 (Sec), and the four diodes from the polarity bridge (D3-D6) are connected across the telephone line and effectively "seize" it. That combination of components is referred to as the seizure network. The unit is now in a "standby" mode and LED1 lights dimly. If jumper J1 is in the IN position and a station is tuned in on the FM tuner, that station will be heard on the telephone line. If J1 is in the OUT position, the station will not be heard until the phone is hung up.

RY1 will stay activated for approximately four seconds. That

MUSIC ON HOLD

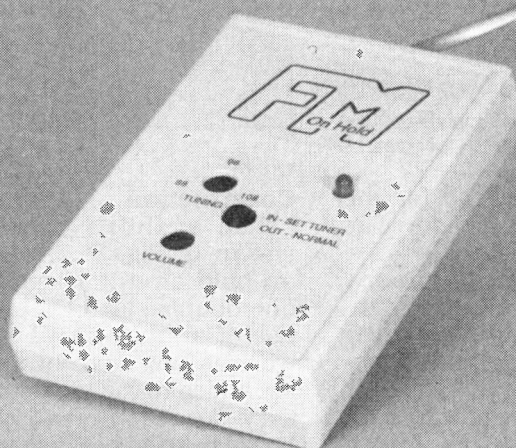

Impress your callers by adding an FM music on-hold feature to your telephone.

delay is determined by the RC network of R6–C4. Diode D2 prevents relay-coil induction-induced “spikes” from appearing on the +12-volt DC power-supply line.

If the telephone is hung up within the four-second time-out period, additional loop current will flow through the seizure network and activate RY2. That causes normally open contacts of RY2 to close. The project is now in the “on-hold” mode, LED1 will be brightly lit, and the selected radio station will be heard in the telephone line regardless of the position of jumper J1. After the four-second time-out period, RY1 will deactivate. The loop current flowing through RY2 keeps the seizure network across the telephone line and the unit remains “on-hold.”

“normal” mode. LED1 will not be lit, and the caller will be disconnected if the telephone is hung up.

Latching push-button switch S1 is used to tune in the desired station. When it is in the IN position, the seizure network is placed across the telephone line and the output of the tuner is also connected (regardless of the status of J1). That allows you to hear the output of the FM tuner and adjust the station tuning and volume. (A feature of the receiver is the elimination of interstation “hiss,” therefore no audio will be present until a station is tuned in.)

FM receiver circuit

At the heart of the receiver circuit is IC4, a TDA7000 Signetics FM receiver. This IC has a fre-

quency-locked loop system with an intermediate frequency (IF) of 70 kHz. The IF can be chosen by active RC filters. The only function that needs tuning is the oscillator’s resonant circuit, which selects the reception frequency.

The antenna is made up from the telephone line and the RJ11 cable. The RF signal travels through that path and is coupled via DC blocking capacitor C6 to the RF input bandpass filter. This broadband low-Q filter consists of C10, C11, and L1. Its primary purpose is to pass RF energy in the 88.0- to 108.0-MHz range while attenuating RF energy from above and below that frequency range. The bandpass filter serves to suppress potential interfering energy from outside the commercial FM broadcast band.

The bandpass filter also acts as a split-capacitor (also known as a tapped capacitor) input impedance-matching network to IC4. It matches a 75-ohm RF input impedance to IC4’s 1.5K input impedance. The reverse RF input is decoupled by C12.

After the RF signal passes through the input bandpass filter, it goes to the input of the internal Gilbert cell mixer where it is mixed with the local oscillator (LO) signal. As mentioned earlier, the frequency of the LO is designed to produce an IF of 70 kHz. The tunable LO, connected between pins 5 and 6 of IC4, consists of tank components L2 and D9.

Varactor diode, D9, is DC-voltage tuned by the voltage-divider circuit consisting of R13, R18, and R12. The low end of the tuning range is set by R13 while the high end is set by R12. A high impedance path to the oscillator is provided by R11, keeping it from appearing on the DC tuning control voltage. C21 acts as an RF “short” to ground which prevents the oscillator’s RF from entering D9. The IF output of the mixer is routed to a three-stage broadband low-Q IF filter network.

The first section (C20 and C19) determines the cut-off frequency for the second-order low-pass IF filter. The second section (C8 and C7) determines the upper and lower passband. The third section (C9) determines the passband of the third section of the low-pass filter network.

At the heart of the receiver circuit is IC4, a TDA7000 Signetics FM receiver. This IC has a fre-

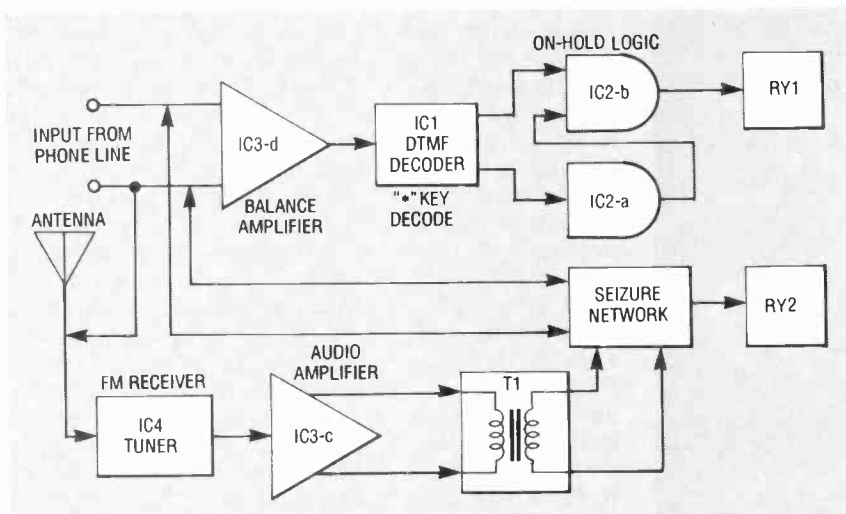

FIG. 1—THIS IS THE BLOCK DIAGRAM of the FM on-hold unit. The circuit consists of three basic sections; a DTMF decoder/on-hold logic, seizure network, and an FM receiver.

After the signal is passed through the IF filter section, it is demodulated. The quadrature detector is tuned by C14. The frequency-locked loop (FLL) filter, which suppresses IF harmonics and prevents them from appearing at the output of the demodulator, is controlled by C18.

The demodulated audio signal from pin 2 passes through a deemphasis network consisting

of C22 and R14. A load for the audio output current source is also provided by R14.

The audio signal passes through C23 and R15 to the inverting input of audio amplifier IC3-c. Feedback resistor R19 controls the gain of the amplifier from 0 to 10. Transformer T1 matches the amplifier's output impedance to the telephone line impedance.

TABLE 1—DTMF DECODER OUTPUT CODES

Digit	D8	D4	D2	D1
1	0	0	0	1
2	0	0	1	0
3	0	0	1	1
4	0	1	0	0
5	0	1	0	1
6	0	1	1	0
7	0	1	1	1
8	1	0	0	0
9	1	0	0	1
*	1	0	1	1
#	1	1	0	0
A	1	1	0	1
B	1	1	1	0
C	1	1	1	1
D	0	0	0	0

Construction

The author's prototype is shown in Fig. 3. The entire FM on-hold circuit is mounted on one double-sided PC board. The use of a single-sided board will work as long as the jumper wires are added to the top where necessary. We recommend that a PC board be used because of the VHF range involved in this project. We have provided foil patterns of the

PARTS LIST

All resistors are 1/4-watt, 5%.

R1, R2, R11—100,000 ohms
 R3, R4, R7, R13, R15—10,000 ohms
 R5—1 Megohm
 R6—39,000 ohms
 R8—2000 ohms
 R9—2700 ohms
 R10—1200 ohms
 R12—130,000 ohms
 R14—20,000 ohms
 R16, R17—470 ohms
 R18, R19—100,000 ohms horizontal PC-mounted potentiometer

Capacitors. All are 50 volts DC, 10% tolerance, mono or ceramic disc unless otherwise indicated.

C1, C2, C6—0.022 μ F, 250 WVDC, 20% tolerance
 C3, C13, C17, C23—C26—0.1 μ F
 C4, C27—10 μ F, 10 volts, 20% tantalum
 C5—47 μ F, 63 volts, 20% electrolytic
 C7, C20, C21—3300 pF, 50 volts
 C8, C14—330 pF
 C9—150 pF
 C10, C11—39 pF ceramic disc
 C12, C22—2200 pF
 C15—220 pF
 C16, C18, C29—0.01 μ F, 20%
 C19—180 pF

C28—100 μ F, 25 volts, 20% electrolytic

Semiconductors

D1—D7, D10, D11—1N4003, 1 amp 200 PIV rectifier diode
 D8—not used
 D9—MV209 varactor diode (Motorola) or ECG-604
 LED1—Red LED
 IC1—MC145436 DTMF decoder (Motorola)
 IC2—4082 dual 4-Input AND gate
 IC3—LM324N quad op-amp
 IC4—TDA7000 FM Receiver (Signetics-Philips)
 IC5—7812 +12-VDC, 1-amp regulator
 IC6—78L05 +5-VDC, 0.1-amp regulator
 Q1—MPSA13 NPN Darlington transistor

Other components

L1—0.138 μ H fixed inductor (Coilcraft no. 132-09 or equivalent)
 L2—0.060 μ H shielded variable inductor (Coilcraft no. 150-02J08S or TOKO no. MC122)
 RY1, RY2—DPDT relay 12 VDC (Aromat no. DS2YE-S-DC12)

T1—audio transformer, 500-ohm primary, 200-ohm secondary (Mouser no.42TM002)

S1—DPDT latching push button switch

XTAL1—3.58-MHz parallel resonant crystal, HC-18/U case

J1—0.1-inch single in line jumper bar and strap

Miscellaneous: Male power jack, female PC board-mounted lug receptacles, 117-VAC power pack (15 VDC at 150 mA), PC board, 6-foot modular line cord, male RJ11 to lugs, project case (Builder's Choice), and 3 14-pin IC sockets

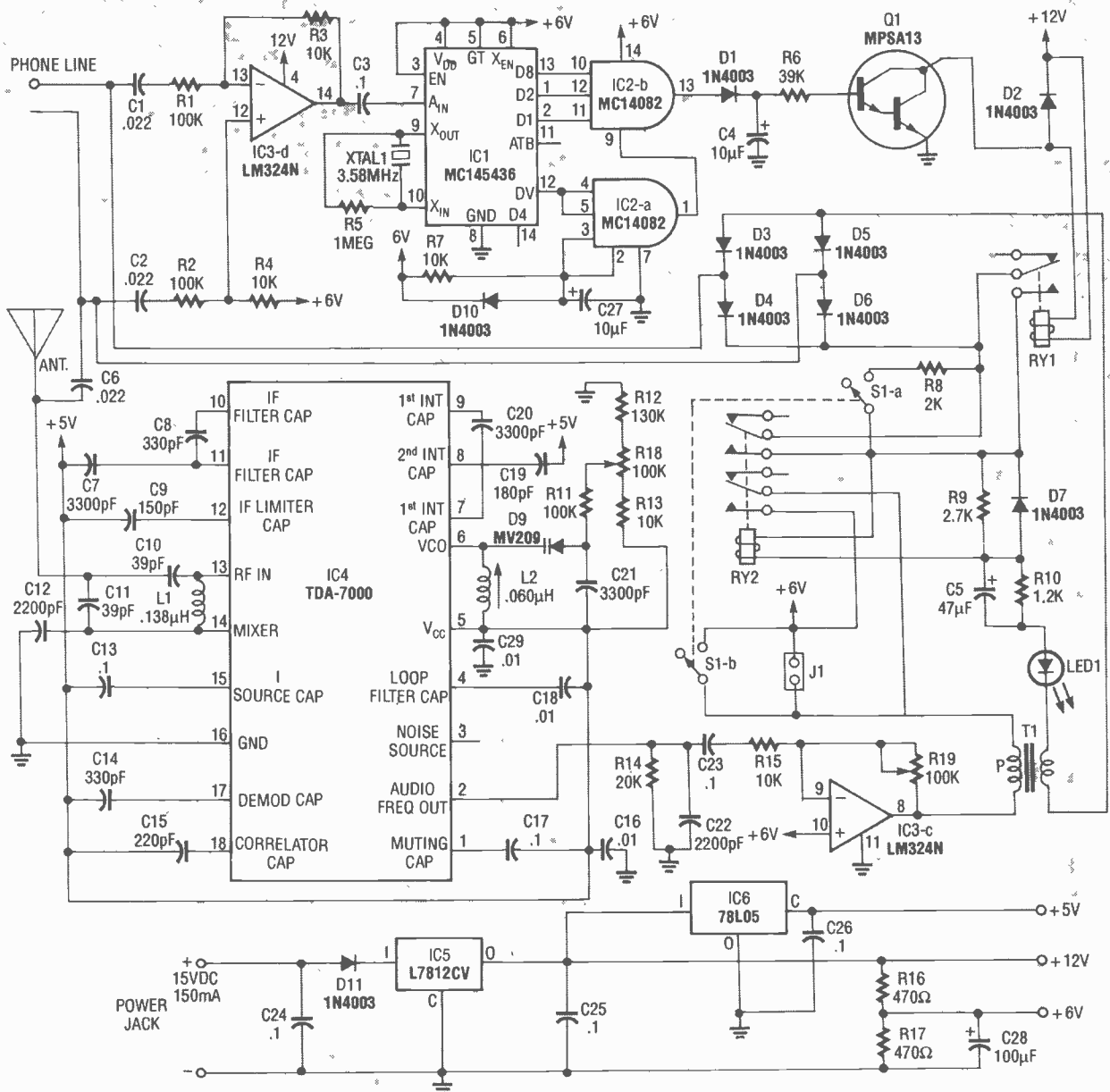

FIG. 2—SCHEMATIC OF THE FM ON-HOLD UNIT. The output of IC1, a DTMF decoder, is a 4-bit word that controls the on-hold logic. The FM receiver, IC4, uses a frequency-locked loop system with a 70-kHz intermediate frequency, which is tuned by a tank circuit consisting of L2 and D9. Spurious reception is eliminated by a mute circuit in the IC.

component side and solder side of the PC board if you wish to make it yourself. If you choose not to use a PC board, the use of a prototype style board is recommended. You should note that the use of wire wrapping will not work for the receiver portion of this project due to ground return path impedance problems. You can use IC sockets for all IC's except IC4, the TDA7000 FM receiver. The use of an IC socket at VHF frequencies should be avoided.

Figure 4 shows the parts-place-

ment diagram of the unit. Before you begin construction, there are a few things to keep in mind:

- Use proper soldering techniques—The importance of proper soldering cannot be emphasized enough for VHF circuits. We recommend that the flux residue be removed from the completed PC board using a mild non-CFC cleaner that's not harmful to plastics. Always read the manufacturer's label.
- Static sensitive devices—Observe electrostatic discharge precautions when handling individ-

ual semiconductors as well as the completed circuit board.

- Component leads—Pre-form component leads before installing them in the board.
- Non-polarized capacitors—When installing these components, orient them so their values can easily be read. This will help if troubleshooting is needed later on.
- Resistors—Mount resistors so they can be read from left to right and top to bottom. This also aids in troubleshooting.
- T1—Bend the tabs flush against the PC board. The audio transformer has a "P" indicating the primary side. The primary mounts towards the outside of

the board. If in doubt, the primary should measure about 500 ohms.

- C6—Mount vertically with the body in the hole closest to D4 and D6.

- L1, L2—It's important the shield have a good electrical connection with the PC board mounting pads. Don't leave the soldering iron on too long as this plastic part might melt.

- IC4 (TDA7000)—When soldering this chip, be careful not to keep a hot soldering iron on the pins too long.

- LED1—For proper mounting height of the LED, cut two ½-inch pieces of insulating tubing. Insert the tubing over both leads. Install the LED with the flat side (short lead) toward T1.

- D9—Mount flush against the board. That will minimize any stray capacitance effects.

- IC sockets—Mount three 14-pin IC sockets (IC1–IC3) flush against the board. Orient the notch towards pin 1, which is indicated on the component side of the board.

- XTAL1—The leads of this crystal can be connected either way to the PC board. Mount it in the vertical position. Do not bend the leads where they exit the body.

- RY1, RY2—These relays are the same type, so they're interchangeable.

The following pre-test steps should be done after all components have been installed. Check that all components are mounted in their proper location. Verify polarized components are properly oriented and that all pads and connections have been properly soldered and de-fluxed. Once those steps have been completed, you can begin bench testing.

Testing and alignment

The only instrument needed to test the unit is a DMM. Connect the power pack (or a +15- to +28-volt DC power source) to the DC input. Connect AC power to the power pack. Don't connect the unit to the phone line at this time. Next, verify proper operation by making the check out measurements indicated in Table 2. After you have made those measurements, you can proceed with the alignment.

You'll need a plastic alignment tool, a signal source in the FM

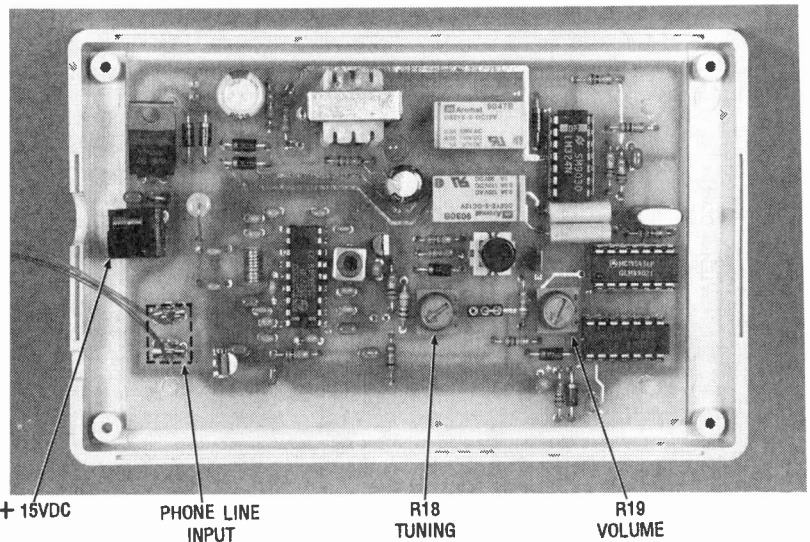

FIG. 3—THE AUTHOR'S PROTOTYPE. Do not use an IC socket for IC4, and be careful when soldering it as excessive heat can damage the chip.

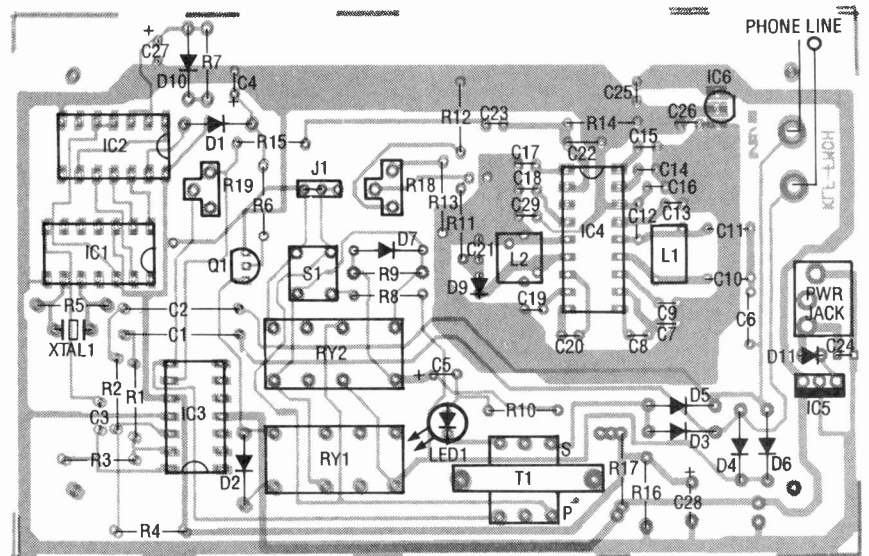

FIG. 4—PARTS-PLACEMENT DIAGRAM. Install all components as shown here. Make sure all components are correctly oriented. The telephone tip and ring conductors can be connected at either phone-line input.

broadcast band, and a method to hear the audio output. The simplest way of aligning the unit is to connect it to the phone line. The unit was designed to not be sensitive to the tip and ring polarities. Therefore, it doesn't matter which phone lead connects to which terminal on the PC board.

Once the phone line is connected, dial your own number to eliminate the signal tone and off-hook warning tone. Turn the receiver on by depressing push button switch S1. Set the tuning potentiometer to the extreme counter clockwise position (low end of the band). Note that due to the mute function, there is si-

lence until a station is received.

Turn the volume control potentiometer ½ and ¾ clockwise. Adjust the slug in L2 until the station operating in your area is received with the loudest audio output. Use care when adjusting the slug as it is quite delicate and can easily be broken.

Next, set the tuning potentiometer to the extreme clockwise position (top end of the band). Tune back down towards the bottom end of the band (counter clockwise) until the station operating at the highest frequency is received.

Tune through the entire range

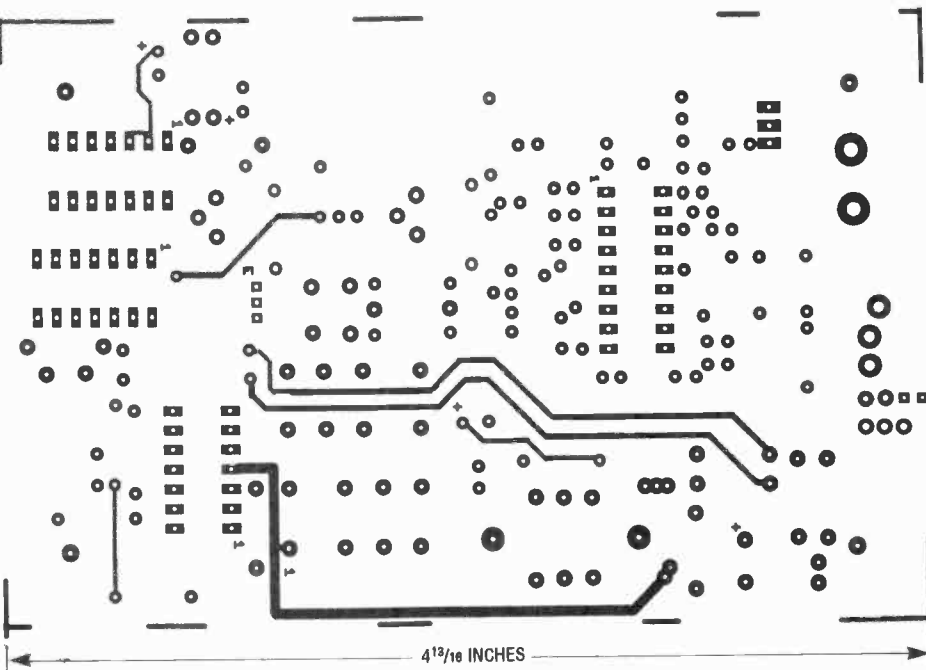

COMPONENT SIDE foil pattern shown actual size.

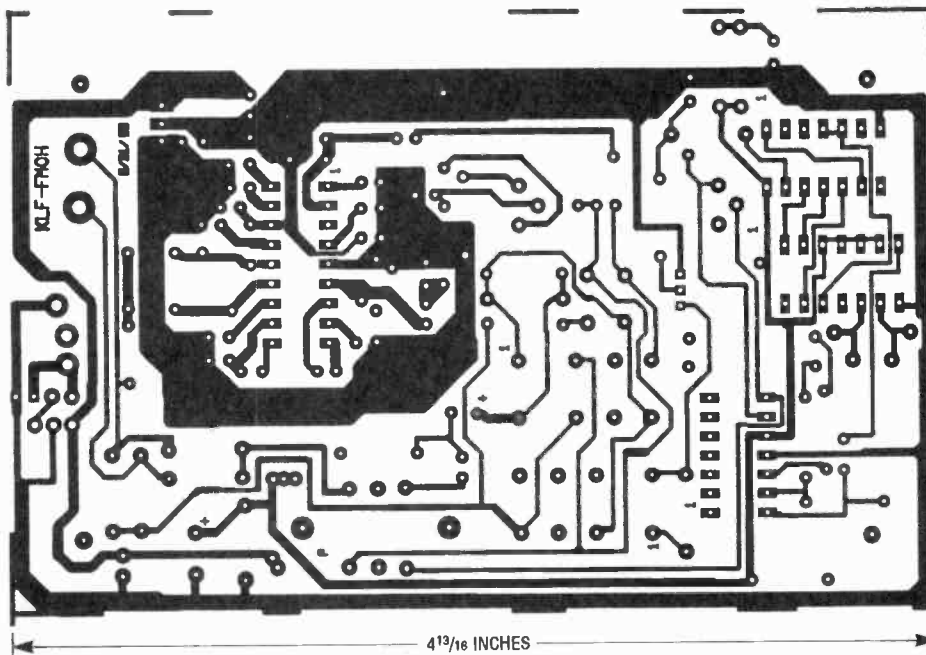

SOLDER SIDE foil pattern shown actual size.

TABLE 2—CHECKOUT MEASUREMENTS

Parameter	Low Limit	High Limit	Actual Reading
Output of Power Pak	+13.50	+28.00	_____ VDC
Input Current	31.00	34.00	_____ mA
IC5 output	+11.40	+12.60	_____ VDC
IC6 output	+4.75	+5.25	_____ VDC
+6.0 VDC output	+4.50	+6.50	_____ VDC
IC3-d pin 12	+4.50	+6.50	_____ VDC
IC2-a pin 2	+4.50	+6.50	_____ VDC
IC1 pin 3	+4.50	+6.50	_____ VDC
IC2-b pin 14	+4.50	+6.50	_____ VDC
IC3-c pin 10	+4.50	+6.50	_____ VDC
IC3-d pin 4	+11.40	+12.60	_____ VDC

to verify all stations available to your area are being received. The receiver section was designed with a mute function built-in to allow only the strongest stations to be received. That makes tuning easier and suppresses images ("ghost" stations that appear in the wrong part of the tuning dial). Release the push-button and hang up the phone.

You can check for proper operation by having a friend call and be placed on hold by depressing the star "*" key (LED1 lights dimly) and then hanging up the phone.

Installation and use

A special feature of this project allows you to select when the music is present in the handset. Some telephone services (call waiting, call forwarding, voice mail) require the use of the "*" key. With J1 in the OUT position (circuit open), music will not be heard in the handset when the "*" key is depressed. It will, however, be heard by the caller when the phone is hung up. With J1 in the IN position (circuit closed), music will be heard every time the "*" key is depressed. Install the jumper according to your available service requirements.

If you would like to connect an external antenna or RF source, such as cable, to the tuner, you can connect it to the junction of C6, C10, and C11. It may be advantageous to disconnect the phone-line antenna by breaking the connection at C6.

It's easy to use the FM on-hold unit. To place a caller on hold press the star "*" key on any Touch Tone telephone. That places the unit in a standby mode and the LED lights dimly. The telephone must be hung up within four seconds for the caller to be placed on hold. When that's done, the LED lights brightly. If it's not hung up within 4 seconds, the unit resets itself and the LED goes out. The caller will be disconnected if the phone is hung up.

After a caller has been placed on hold, all you have to do is pick up the telephone to return to the conversation (any telephone connected to the line, Touch Tone or rotary). When the handset is picked up, the brightly lit LED will extinguish, the music will go off, and you will be connected to the caller.

THE PURIST WILL TELL YOU THAT IF something's worth doing at all, it's worth doing well—and that's the case with the author of this story. The author always loved music, and was probably doomed to permanent audiophilia from day one. Even in 1960 at age 12, when he and his sister pooled resources to buy their first 45-RPM record (Pat Boone's "Love Letters in the Sand"), he recalls that, even on a monophonic, crystal-cartridge record player, there was an audible difference between the quality of a decent LP and the 45. Even though it should have sounded better than an LP, the 45 was bassier, noisier, and somewhat distorted, being pressed on what a broadcast engineer later

poetically described as a blend of straw and chicken manure. Predictably, he soon became dissatisfied with the quality of the record player, and his junior-high and high-school years were marked by repeated attempts to upgrade the equipment without spending any money.

Along came the late '70's, and a new product was aimed at the purists: beastie cables (the name has been changed to protect the author!), which are expensive heavy-gauge speaker cables. The old purism surged forward, remembering the effects of cable resistance on damping factor and the effect of cable capacitance on high-frequency response—but the ads also spoke of skin effect,

which has to do with the fact that at high frequencies, alternating currents tend to travel mainly at the outside surface, or skin, of a conductor. Since the skin effect essentially removes current from the center of a conductor, effectively reducing its cross-sectional area, it causes an increase in the impedance of a conductor at high frequencies.

Actually, when frequency is high enough, a tube or pipe will have the same effective resistance as a wire of the same diameter. That fact can be used simplistically to account for the use of waveguides rather than wiring at microwave frequencies. But concerning high frequencies, how high is high?

Supposedly, the skin effect becomes important above about 30 MHz, but a recent ad for speaker cables claimed perceptible benefits from reducing skin effect at 20 kHz. Soon after, articles ap-

WILL "BEASTIE" SPEAKER CABLES IMPROVE YOUR AUDIO?

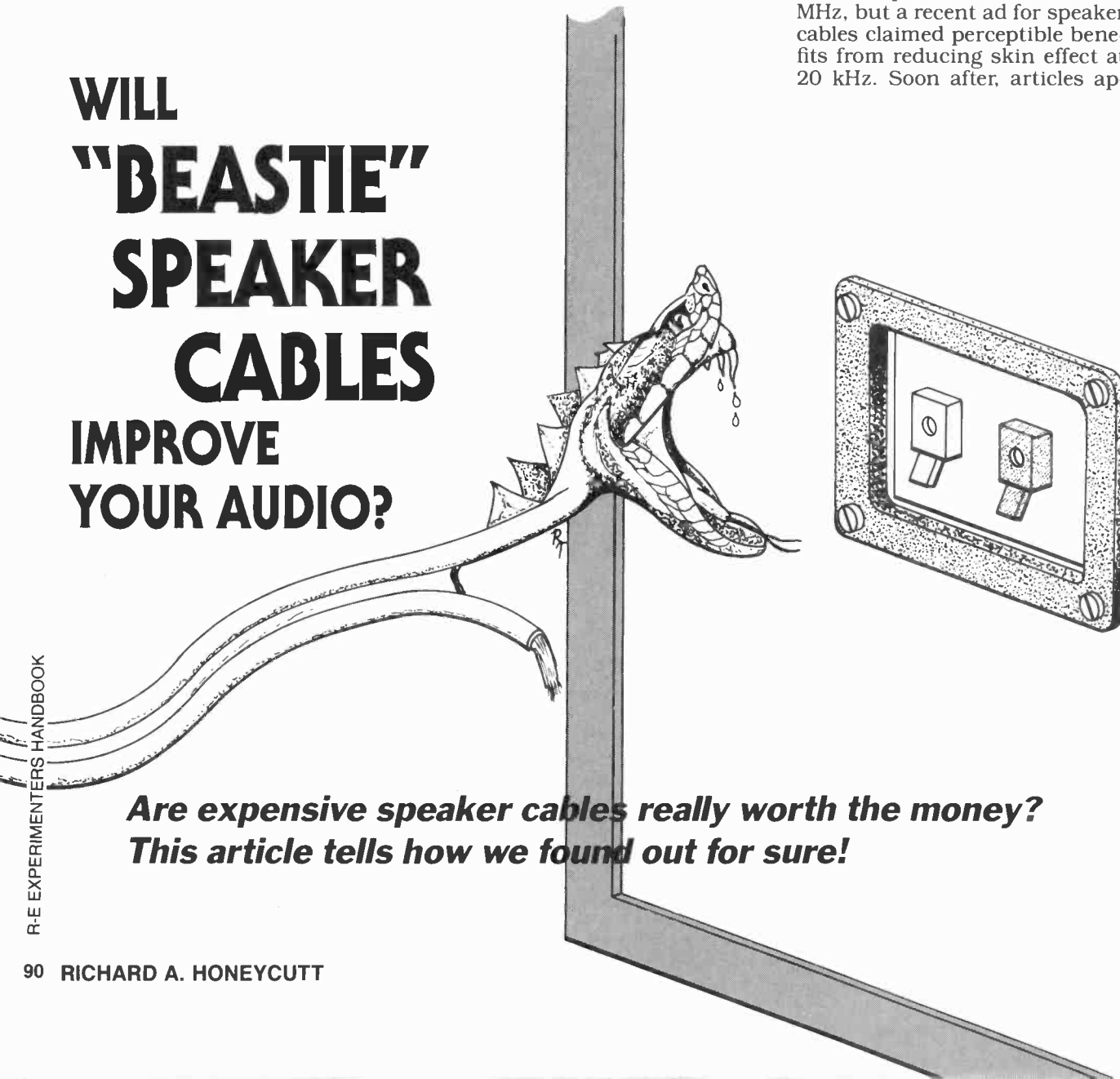

***Are expensive speaker cables really worth the money?
This article tells how we found out for sure!***

peared in professional trade journals mentioning the likes of Lucasfilm using the enormous cables, so some real research was in order.

The goal was to find out whether beastie cables did in fact:

- Reduce the amount of power lost in the cable enough to provide a significant improvement in efficiency, or
- Increase the damping factor of the speaker/amplifier system enough to provide audible improvement, or
- Provide any significant benefit in the frequency response of the system.

No other benefits are claimed for these cables, so it is not necessary to look for undiscovered or presently unmeasurable effects.

The problem was attacked both analytically and experimentally. The equivalent circuit of a real loudspeaker driven by a real amplifier through real cables is shown in Fig. 1. Any effects produced by the cables must show up in the cable resistance, capacitance, or inductance. The efficiency and damping-factor questions depend almost exclusively upon the cable resistance, whereas the frequency-response question is mainly a function of the capacitance. Wire inductance is so small compared with the semi-inductive nature of speaker impedance at high frequencies that it can be ignored, as we will see.

The cable resistance is made up of three components: the contact resistance, the ohmic resistance of the wire, and any contribution from skin effect. The ohmic resistance can easily be found from wire tables in most electronics reference books. Table 1 shows the resistance of a representative sampling of copper cables, listed according to gauge. For years, selection of cable gauge has been made according to the criterion of 10% loss. In other words, for a given cable length, what resistance will give no more than 10% (0.46 dB) power loss at the speaker? Figure 2 shows the calculations involved in determining that value. For short cable runs, the resulting gauge is surprisingly small.

About fifteen years ago when the author was an audio consultant, he would specify 18-gauge

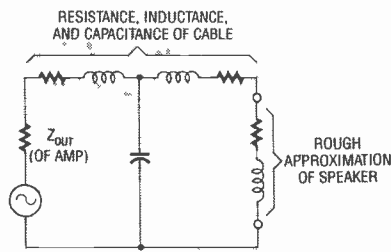

FIG. 1—THIS CIRCUIT IS roughly equivalent to an amplifier, speaker, and length of cable.

cable for amplifiers up to 100 watts feeding impedances of 8 ohms or more with runs of 25 feet or less. For each halving of impedance or doubling of amplifier power or distance, the wire size would increase by two gauges; 16 gauge for 100 watts into 8 ohms at 50 feet or 4 ohms at 25 feet, etc. That rule of thumb includes a safety factor so that the loss will always be less than 10%.

The National Electrical Code specifies cable gauges based upon safety considerations; if a wire carries too much current over a long enough period of time, it can become dangerously hot and start a fire. Going back to the rule of thumb, a speaker with an average impedance of 8 ohms fed by a 100-watt amplifier will draw about 3.5 amperes at full power. However, even running at full tilt, it's unlikely that the average power will be greater than one-third of your amplifier's maximum, so the rule of thumb provides a large safety margin from a fire-prevention standpoint.

The damping factor can be defined as the ratio of a speaker's impedance to the total resistance

Gauge	Resistance (ohms/foot)
0	0.000098
2	0.000156
4	0.000249
6	0.000395
8	0.000628
10	0.000999
12	0.00159
14	0.00253
16	0.00402
18	0.00639

Note: The wire must make a complete round trip, so there's 20 feet of wire in a 10-foot speaker cable.

in series with the speaker. Since the simple loss calculation in Fig. 2 depends upon the combined resistance of the speaker and the cable, the resistive power loss will be related to the damping factor. Thus we can find a relationship between damping factor and low-frequency loss. In the *Audio Cyclopedia* Howard Tremain established that there is no value in trying for a damping factor greater than 20⁴. That is based on the fact that the speaker's voice-coil resistance appears in the circuit, and its value—typically 6 to 7.5 ohms for an 8-ohm speaker—sets a practical limit on the benefits of reducing other resistances. The effective damping factor is equal to:

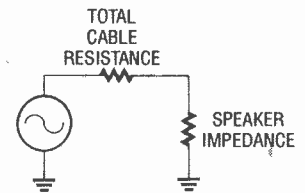

1. CABLE RESISTANCE = 0.1 × SPEAKER RESISTANCE
2. RESISTANCE PER FOOT = TOTAL CABLE RESISTANCE / TWICE THE AMPLIFIER-TO-SPEAKER DISTANCE
3. SELECT GAUGE FROM TABLE 1

FIG. 2—HERE'S THE TRADITIONAL method normally used to determine speaker-cable gauge by loss.

$$= \frac{Z_{\text{SPEAKER}}}{R_{\text{VOICE COIL}} + R_{\text{AMP}} + R_{\text{CABLE}}}$$

A stated amplifier damping factor of 20 would represent a total resistance of 8 ohms divided by 20, or 0.4 ohms in series with the amplifier. That would give an effective damping factor of:

$$\frac{8\Omega}{6\Omega + 0.4\Omega} = 1.25$$

assuming a 6-ohm voice-coil resistance. With most amplifiers having output impedances on the order of 0.1 ohm or less, this would mean that the cable resistance could be 0.3 ohms. The loss in dB corresponding to an 8-ohm speaker fed through a 0.3-ohm cable is:

$$= 20 \log_{10} \left(\frac{8\Omega}{8\Omega + 0.3\Omega} \right) = -0.32 \text{ dB}$$

That means that for an optimum effective damping factor, the resistive cable loss should be

less than 0.32 dB. Just for comparison purposes, a 1-dB cable loss, which would result from a 0.9-ohm cable resistance, would result in an effective damping factor of 1.14, which is not much lower than 1.25.

As mentioned earlier, skin effect increases the effective impedance of a wire, and can be best explained by looking at Fig. 3. The skin depth of a conductor is the distance into that conductor, measured from the outside surface, at which current density is $1/e$ times that at the surface. (The symbol e stands for the base of natural logarithms, and equals approximately 2.72.) For a direct current, the current density (amperes per unit cross-sectional area) is the same throughout the wire. For AC, the current density is less at the center of the wire and greater at the surface.

At low frequencies, the skin depth (which depends on characteristics of the bulk conductor material) is usually greater than the radius of the conductor, which means that for all practical purposes the current density is the same throughout the conductor. Larger-diameter conductors can exhibit measurable skin effect at relatively low frequencies, including audio frequencies.

The simplest indicator of skin effect is the ratio R_{AC}/R_{DC} , where R_{AC} is the resistance per unit length of a wire to alternating current of a certain frequency and R_{DC} is the ohmic resistance per unit length. As long as R_{AC}/R_{DC} equals 1, skin effect is negligible. When R_{AC}/R_{DC} rises sig-

TABLE 2—MEASURED CHARACTERISTICS OF CABLES

Cable Type	C (pF/ft)	L (μ H/ft)	R* (ohms/ft)
22-ga. cheap	10.7	0.29	0.0178
18-ga. zip	14.0	0.28	0.007
20-ga. twist	18.0	0.36	0.0107
4-ga. cable	50.8	0.29	0.0007
16-ga. "drop cord" shielded "guitar cord"	22.4	0.38	0.006
16-ga. zip	105.8	0.30	0.048
	12.5	0.23	0.0127

*One-way resistance, not loop resistance; that includes the contact resistance of the terminations.

nificantly above 1, skin effect may begin to matter. We say *may*, because it only matters if the total resulting increase in cable resistance causes a perceptible effect in the reproduction. For a frequency of 15 kHz, R_{AC}/R_{DC} equals 1.1 when a 15-gauge solid wire is used. Larger wires will exhibit a greater proportional increase in resistance as frequency increases. Of course, since the resistance of large wires is lower to begin with, the actual change in measured resistance may or may not matter.

Stranded wire is extremely difficult to analyze. Naturally, each strand has a certain surface area, so that all the strands connected in parallel would have a very large surface area. In actuality, though, much of the surfaces of the individual wires are in contact with each other, making the actual effective surface area virtually impossible to determine—unless the individual strands are insulated from each other, as in litz wire. At any rate, we can use solid wire as a worst case to analyze, knowing that we'll really be

using stranded wire that has less skin effect.

The actual resistance, capacitance, and inductance of a cable are distributed evenly along its length. Telephone engineers found out long ago that, for analysis purposes, a cable's R, C, and L can be lumped into a single component if certain conditions are met. The conditions depend upon the attenuation constant and length of the cable. The attenuation constant (α) is given by:

$$\alpha = \sqrt{(R^2 + \omega^2 L^2)(G^2 + \omega^2 C^2) + RG - \omega^2 LC/2}$$

where R, L, C, and G are the cable's resistance, capacitance, inductance, and leakage conductance per unit length, and ω is the angular frequency, or $2\pi f$.

The author does not like to lie awake nights solving equations like that, and tables of attenuation constant versus frequency are not generally available for the kinds of cables used for speaker leads. However, tables for 19-gauge pulp-insulated telephone cable indicate that a 3-kilometer cable section can be analyzed using the lumped-constant

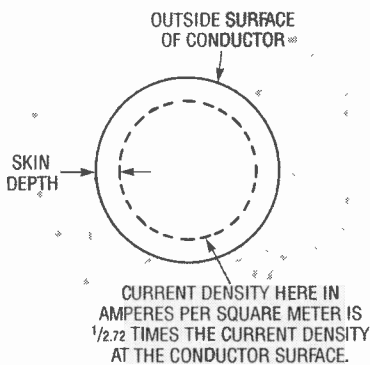

FIG. 3—THE SKIN EFFECT increases the effective resistance of a wire. The skin depth is the distance into the conductor at which the current density is approximately $1/e$ of that at the surface.

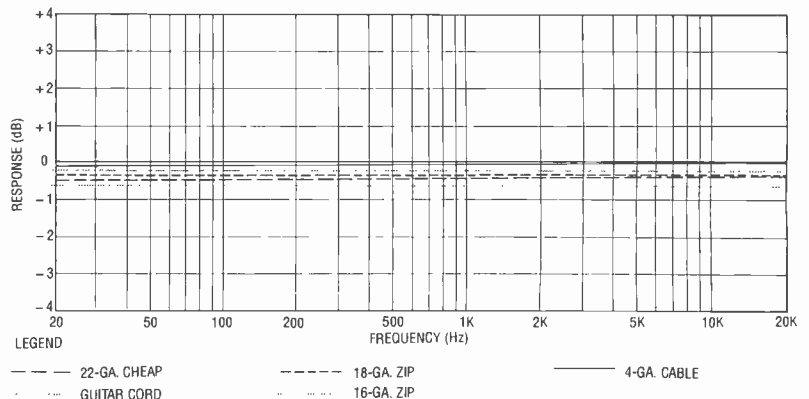

FIG. 4—A COMPUTER SOLUTION, or prediction, of the model in Fig. 1 yielded these results. The worst-case loss is well under 1 dB at 20 kHz.

method at 1 kHz with a total attenuation under 1 dB and a phase accuracy within 5 degrees. Although it may not be immediately obvious to the casual observer, attenuation constant is proportional to the square root of frequency, so that would mean that the same accuracy could be expected at 20 kHz if the length were reduced by

$$\sqrt{20 \text{ kHz}/1 \text{ kHz}}$$

that works out to about 2100 feet. Since we rarely extend speaker cables anywhere near that far, we can safely use the lumped-constant method with no qualms. That's what was assumed in Fig. 1.

Table 2 shows the types of cables chosen for the analysis, along with their measured resistance, capacitance, and inductance. The values were measured using a Hewlett-Packard 4261A LCR meter and a test frequency of 1 kHz. Instead of a speaker, a resistance of 7.9 ohms and an inductance of 6.3 microhenries were used in the calculations. Instead of "real" beastie cables, we used ones that were on hand, including a very large (4-gauge) stranded cable. If those cables showed no measurable detrimental effects on efficiency, damping-factor, or frequency response, then the alleged beastie benefits would turn out to be solutions to a nonexistent problem!

A computer solution of the circuit of Fig. 1 yielded the results plotted in Fig. 4. A 10-foot length was assumed for each cable, and it included the effects of cable capacitance and inductance, but not the skin effect. Notice that the worst-case loss was well under 1 dB at 20 kHz.

Computer solutions without experimental verification are not

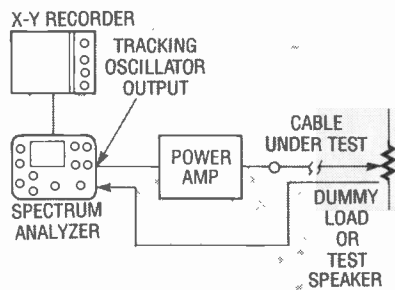

FIG. 5—THIS TEST SETUP was used to measure the effects on an audio signal caused by speaker cables.

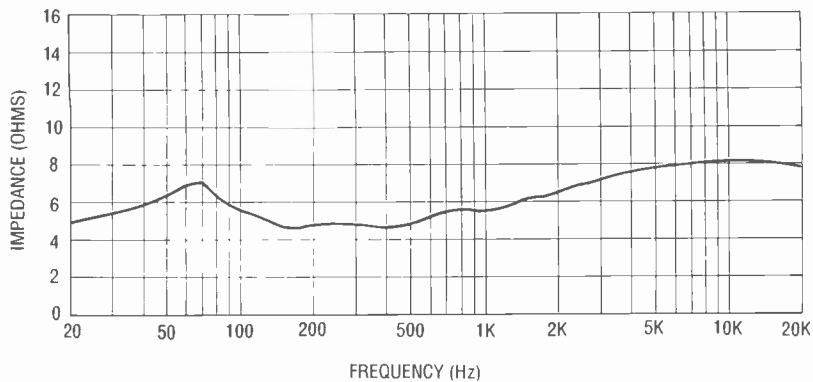

FIG. 6—THE MEASURED IMPEDANCE CHARACTERISTICS of the test speaker.

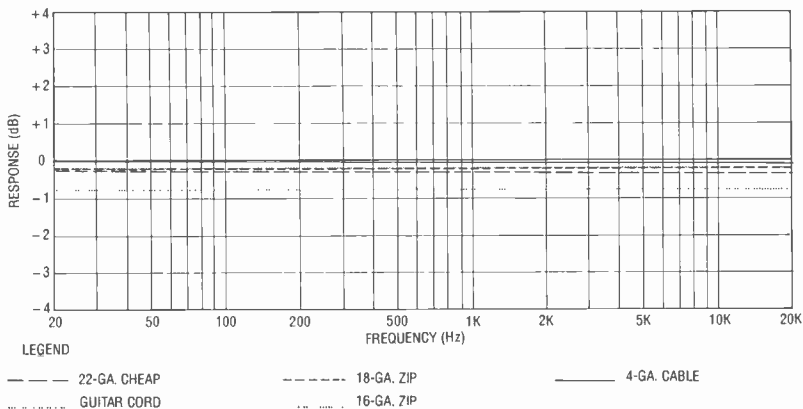

FIG. 7—SEE HOW THE ACTUAL MEASURED CABLE LOSSES compare to the predicted losses of Fig. 4.

always trustworthy, so the actual response of the cables was measured on the setup shown in Fig. 5. The impedance characteristic of the test speaker is shown in Fig. 6. Although the amplifier was flat within ± 0.2 dB from 20 Hz to 20 kHz, the amplifier's calibration curve was nevertheless subtracted from the measured results in order to provide maximum accuracy. The test results are shown in Fig. 7.

Initial results seem to indicate that virtually anything can be used to connect a speaker to an

amplifier and, if the distance is short, no serious detriment to efficiency will result. Damping factor is degraded slightly when cables lighter than 18-gauge are used, as shown by the loss exceeding 0.32 dB. But what will happen if longer cables are used?

From previous measurements, ordinary Romex house-wiring cable is found to have about the highest capacitance per foot of any common wire. With the factors mentioned earlier that control skin effect, it is also clear that small wires will not experience

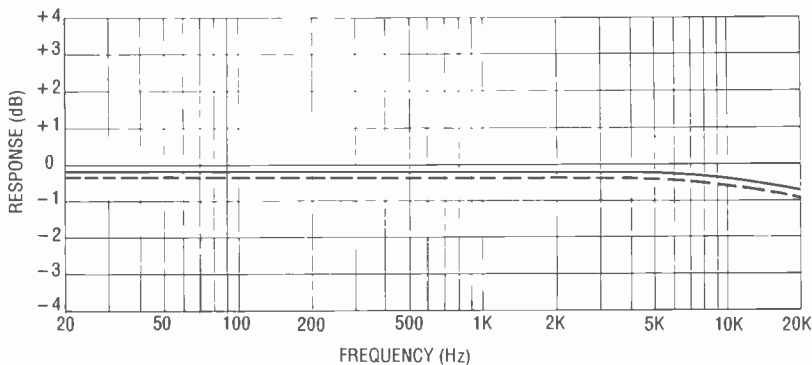

FIG. 8—SIGNAL LOSS OF 40 FEET of 12-gauge Romex cable.

41,361

ELECTRONIC COMPONENTS

Whether you order 1 part or all 41,361...MOUSER stocks and...can ship today!!

CALL...
(800) 992-9943

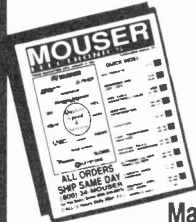

for your
FREE
CATALOG

2401 Hwy 287 N.
Mansfield, TX 76063

MOUSER ELECTRONICS

Sales & Stocking Locations Nationwide

CIRCLE 93 ON FREE INFORMATION CARD

Try the
**Electronics
NOW**

bulletin board
system

(RE-BBS)
516-293-2283

The more you use it the more useful it becomes.

We support 1200 and 2400 baud operation.

Parameters: 8N1 (8 data bits, no parity, 1 stop bit) or 7E1 (7 data bits, even parity, 1 stop bit).

Add yourself to our user files to increase your access.

Communicate with other R-E readers.

Leave your comments on R-E with the SYSOP.

RE-BBS
516-293-2283

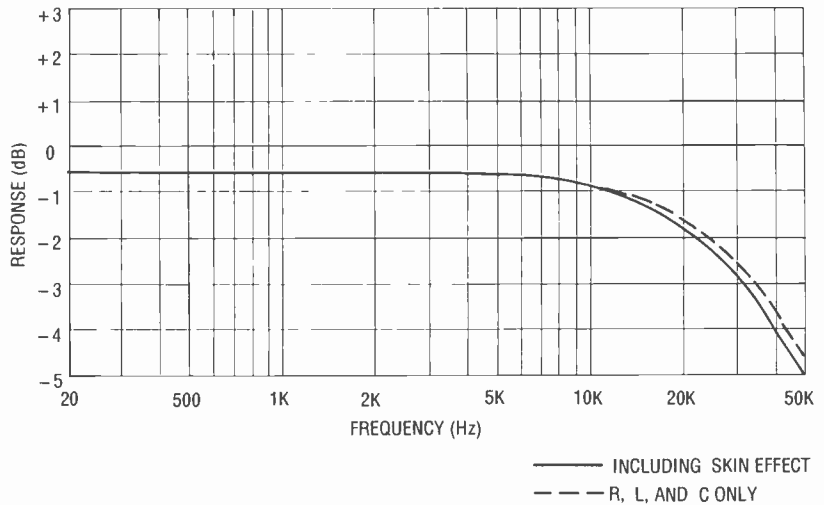

FIG. 9—SIGNAL LOSS OF 100 FEET of 12-Gauge Romex cable.

significant skin effect, and large ones will, but even a large percentage change in a large wire's small resistance is of little consequence. Trying the R_{AC}/R_{DC} values for various cable diameters in conjunction with the computer analysis, 12-gauge solid wire is found to have about the worst skin effect of any cable.

Therefore, if any type of speaker cable could cause frequency-response problems, the high capacitance and the skin effect of 12-gauge Romex should make it the ideal bad example. Another run was made using a 40-foot length of Romex, both into a dummy load and into the test speaker. In the graph of Fig. 8, we see a hefty 1/2-dB droop at 20 kHz, compared to the response at 20 Hz. The overall signal loss and damping-factor degradation are less than those of the smaller cables that are shown in Figure 8, due to the lower resistance of 12-gauge cable.)

Since that still wasn't significant, a computer simulation of 100 feet of 12-gauge Romex was performed, with response run clear out to 50 kHz. The results

are shown in Fig. 9. Here, at last, is something the beastie people can sink their teeth into! Anyone who can hear 50 kHz will find a full 4.5-dB drop resulting from the use of 100 feet of 12-gauge Romex—providing, of course, they're using an amplifier and speaker that can reproduce it. Of course, the skin effect is still only about half a dB, and effective damping is not degraded, so maybe they'd better drop those points from their ads.

The results of that rather involved bit of research clearly indicate that ordinary speaker cables, including the ones that any knowledgeable audiophile would sneer at, do not significantly degrade frequency response. They vindicate the rule-of-thumb advice (18-gauge for 100 watts, 25 feet, into 8 ohms) except for a slight degradation in damping factor; 1.21 with a 25-foot cable run. For optimum damping factor, that rule should be changed to 18-gauge for 100 watts, 20 feet, into 8 ohms. Also, only 20-gauge, 22-gauge, and guitar-cord cables are a serious detriment to damping factor. **R-E**



THE TECHNOLOGY TO PRODUCE low-cost digital clocks has existed for years. Unfortunately, the style in which these clocks have displayed the time has been mostly limited to four digits (representing hours and minutes). Few digital clocks, if any, have taken full advantage of the great capabilities of today's microprocessors to provide a more novel display . . . that is until the HyperClock.

The HyperClock has a custom-programmed microcontroller that generates all the signals necessary to display time in eight eye-catching (yet easily readable) modes. Among its features are the ability to simulate a sweep second hand with a ring of 60 LED's; it can graphically display the level of ocean tides; it has a "fading" display mode that causes the LED's to gradually change when updated; it has a hourly chime/ alarm output; supports 50- or 60-Hz powerline operation; it has a battery backup; and an intelligent date display that knows the last day of each month. Let's take a look at those features in greater depth.

The digital display

In four of the HyperClock's eight modes it can display time with a clever twist that those of you that grew up before the "digital-clock revolution" will appreciate. You may recall that it was fairly common for folks to speak of how many minutes it was till the next hour. For example, people would say "it's ten before five" rather than "it's four-fifty." Well, the HyperClock can actually "display" the time in that manner.

To help explain how that is done, take a look at Fig. 1-a; it shows the six seven-segment LED displays that are used to form the clock's digital display. During the first 30 minutes of each hour, the two middle digits signify the hour and the right-most digits indicate minutes past the hour (like most digital clocks), and the two digits on the left are blank. Figure 1-b shows how eleven fourteen (or literally "fourteen *after* eleven") would look in this mode.

BUILD THE

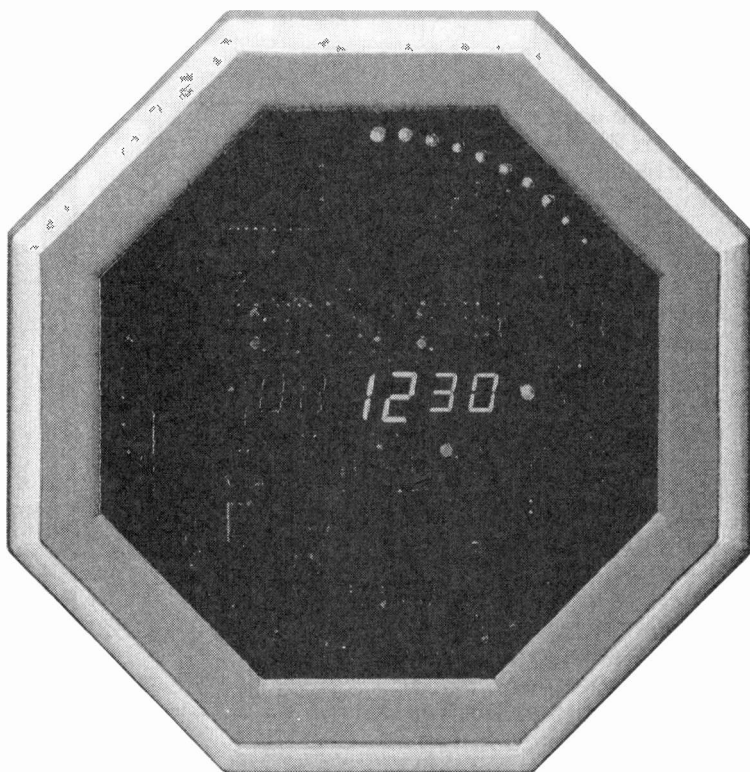

HYPER CLOCK

***Build a digital clock
that's way ahead of its time!***

LEON W. SCHMIDT

However, once the clock advances to beyond half-past the hour, the right digits go blank, the middle display would increment to display the next hour, and the left two digits would indicate how many minutes are left until that hour. For example, if it was thirteen minutes to twelve (or 11:47), the display would look like Fig. 1-c. You could read that literally as "thirteen *before* twelve."

On the hour, the clock just

displays the hour, so the left and right minute displays remain blank (see the display for 12 o'clock shown in Fig. 1-d).

As mentioned earlier, there are 60 LED's arranged in a circle to display seconds or an approximation of the current tide level in your locale. The LED's act as a light chaser sweeping through the seconds of a minute. They can also show the relative tide level by moving from the 12 o'clock position at high tide to

the 6 o'clock position at low tide. The timing of the tide-indicator mode is set to display two complete tide cycles in 24.51 hours just as it should. (For more on this subject see the sidebar entitled "A Bit About Tides.")

Fading-out the digits

The HyperClock also differs from other clocks in how it updates its display. In typical clocks, the display digits abruptly change as time passes. However, in four of HyperClock's eight modes when a digit must be updated, the LED segments representing its old value are dimmed as the segments for the new value become brighter. Likewise, each LED in the light chaser fades off rather than turns off. This animation is rather relaxing to watch.

These display effects are accomplished by a mixture of multiplexing and duty-cycle modulation. The seven-segment displays are all common-anode types, so each digit has its own anode-driver transistor. In typical multiplexed-display fashion, the cathodes of corresponding segments of each digit are connected together and share a common driver.

Like any other multiplexed display when the segment data for a digit is placed on the segment data lines, the anode driver for that digit is activated, and the seven-segment display lights to exhibit the appropriate digit. All the other digits are off at this time. After a short period of time (1.83 ms) the segments are turned off via the segment lines and the anode driver is deactivated. The anode driver for the next digit is then activated, the segment data for that digit is placed on the segment lines, and the process continues until all the digits have been lit. Since the human eye is too slow to see the digits turn on and off, it appears as though they are all on simultaneously. Multiplexing the digits in this fashion reduces the number of pins on the microcontroller needed to control the LED displays.

HyperClock's fading effect is created by modulating the duty

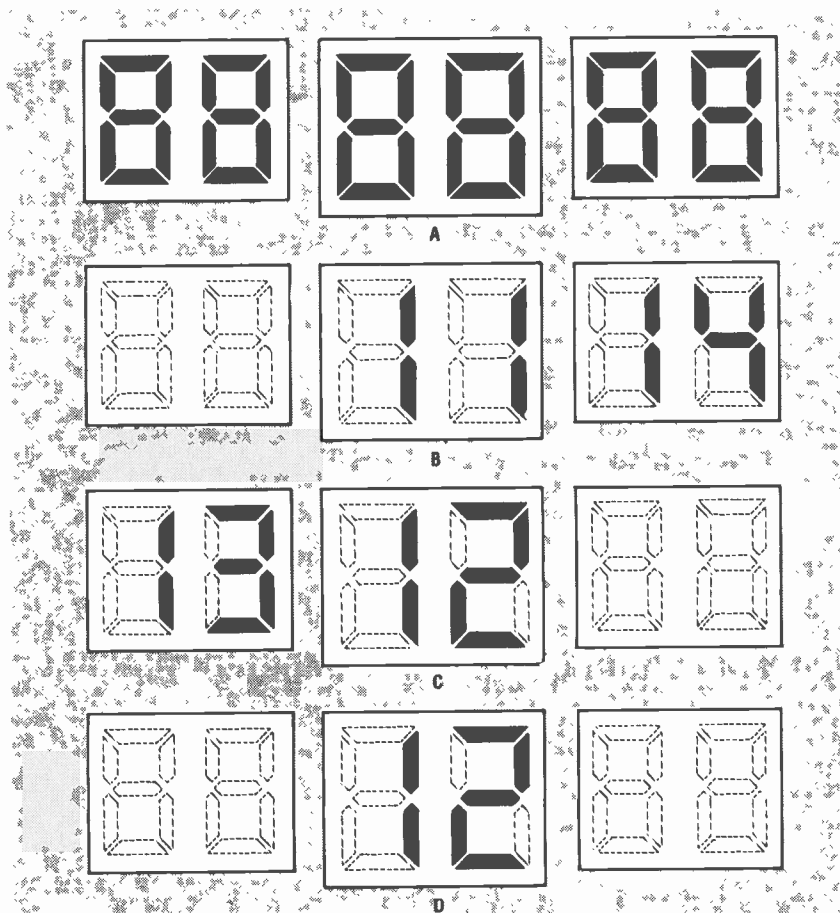

FIG. 1—HYPERCLOCK'S TIME DISPLAY (a) is unique in that it not only displays time normally (b), but it can indicate minutes left to the next hour (c), and blanks the minute displays on the hour (d).

cycle of the segment enable signals. When a seven-segment display is enabled, the segment data lines spend part of the time in states corresponding to the current digit to be displayed, and the rest of the time in states corresponding to the next or "future" digit that will be displayed. Each time the digit is enabled, the duty cycle will favor the future-digit data more and more, until only the new digit is displayed, and the process repeats each time the display must be updated.

The microcontroller

At the heart of the HyperClock is an Intel 8749 microcontroller. It is programmed to perform a variety of functions, namely: display multiplexing, time-keeping, receiving switch input, coordinating the hour and alarm chime, and initiating a power-fail mode that permits the time-keeping functions to

continue while blanking the display to conserve backup-battery power.

The 8749 has 2K of EPROM, 128 bytes of RAM, 24 I/O pins, a programmable 8-bit timer, and an interrupt-control structure. The custom-program placed in the processor to create HyperClock's special effects extensively exercises all of the chip's features; Fig. 2 contains a simplified flow chart for the HyperClock program. The program is shown divided into two sections: an interrupt routine and a main loop.

The interrupt routine is mainly responsible for taking the segment data from the segment-data buffer in the microcontroller and placing it on the display-control lines in a multiplexed fashion. The interrupt that initiates the routine comes from the 8749's internal timer, which has been programmed to execute the interrupt every 1.83

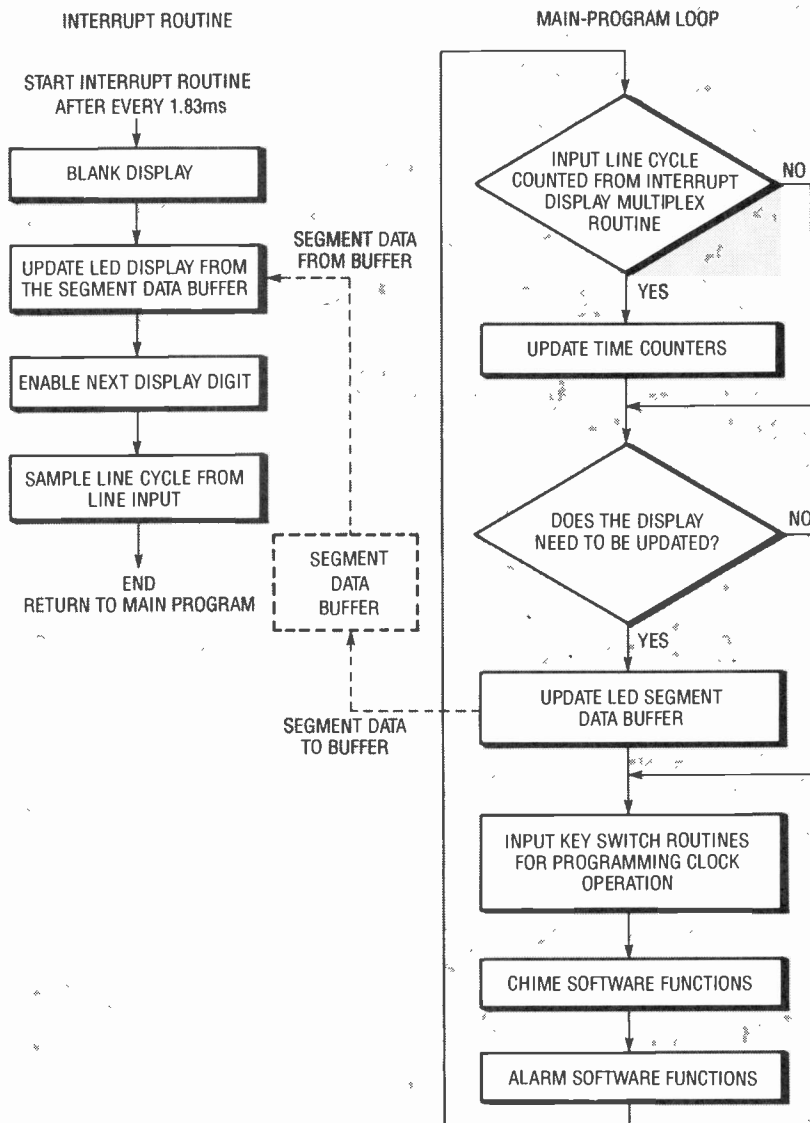

FIG. 2—HYPERCLOCK'S SOFTWARE can be broken down into two distinct code segments: a clock-scheduled interrupt routine, and a main-program loop.

ms. Using an interrupt-program segment in this way allows the display's fading effect to appear gradual because the process of updating the display occurs at regular intervals. This routine is also responsible for checking a powerline-frequency input on the microcontroller to determine if a powerline cycle has passed. If so, it informs the main loop of the program.

The main loop keeps track of the number of cycles that pass so it knows when to update the segment-data buffer or initiate the alarm or chime. If no powerline cycles are detected, the main loop assumes AC power has been terminated and puts the clock in power-fail

mode. In that mode it shuts off the display and allows the microcontroller to "invisibly" keep track of time via a 6-MHz crystal. The main loop also processes input from the clock's switches (we'll talk more about that later).

For all that goes on inside the microcontroller, the functions assigned to its pins by the HyperClock program (see Fig. 3) are relatively easy to understand. Let's take them one group at a time.

The pins labeled A through G and DP (pins 12–19) in Fig. 3 are the outputs for the display-segment data. They indirectly control the cathode drivers for the multiplexed display. Similarly,

2	X1		A	12
3	X2		B	13
4	RESET		C	14
5,26,40	+5 VOLTS		D	15
1	50/60		E	16
6	LINE		F	17
27	SW1	8749	G	18
28	SW2		DP	19
29	SW3		DE0	21
30	SW4		DE1	22
31	SW5		DE2	23
32	SW6		DE3	24
33	SW7		DE4	35
34	CHIME			
7,20	GROUND			

FIG. 3—THE PINS ON THE 8749 microcontroller are assigned various functions by the HyperClock program.

the outputs labeled DE0–DE4 (pins 21–24 and 35) control the anode drivers for the display via demultiplexer chips, which we'll discuss later.

The pins labeled S1–S7 (pins 27–34) are used as function-switch inputs. The switches connected to those inputs (DISPLAY MODE, DISPLAY DATE, DISPLAY ALARM, INCREMENT HOUR/MONTH/MODE, INCREMENT MINUTE/DAY, SNOOZE/TIDE ADVANCE, and ALARM TOGGLE, respectively) activate various chip functions by grounding those pins. A complete explanation of the switches' functions will be presented later.

Low-going pulses from the pin labeled CHIME (pin 34) activate the chime circuit, which is composed of discrete components. The microcontroller triggers the chime circuit with a 12.8-ms wide low-going pulse at one-second intervals. When not in alarm mode, the chime signals the hour by chiming an appropriate number of times, and signals each half-hour by chiming once.

When the microcontroller is in the "alarm" mode, the chime circuitry is used as an alarm annunciator. In this mode the clock does not chime on the hour and half hour. That permits you to use the HyperClock as an alarm clock without the chimes disturbing you until the appointed time.

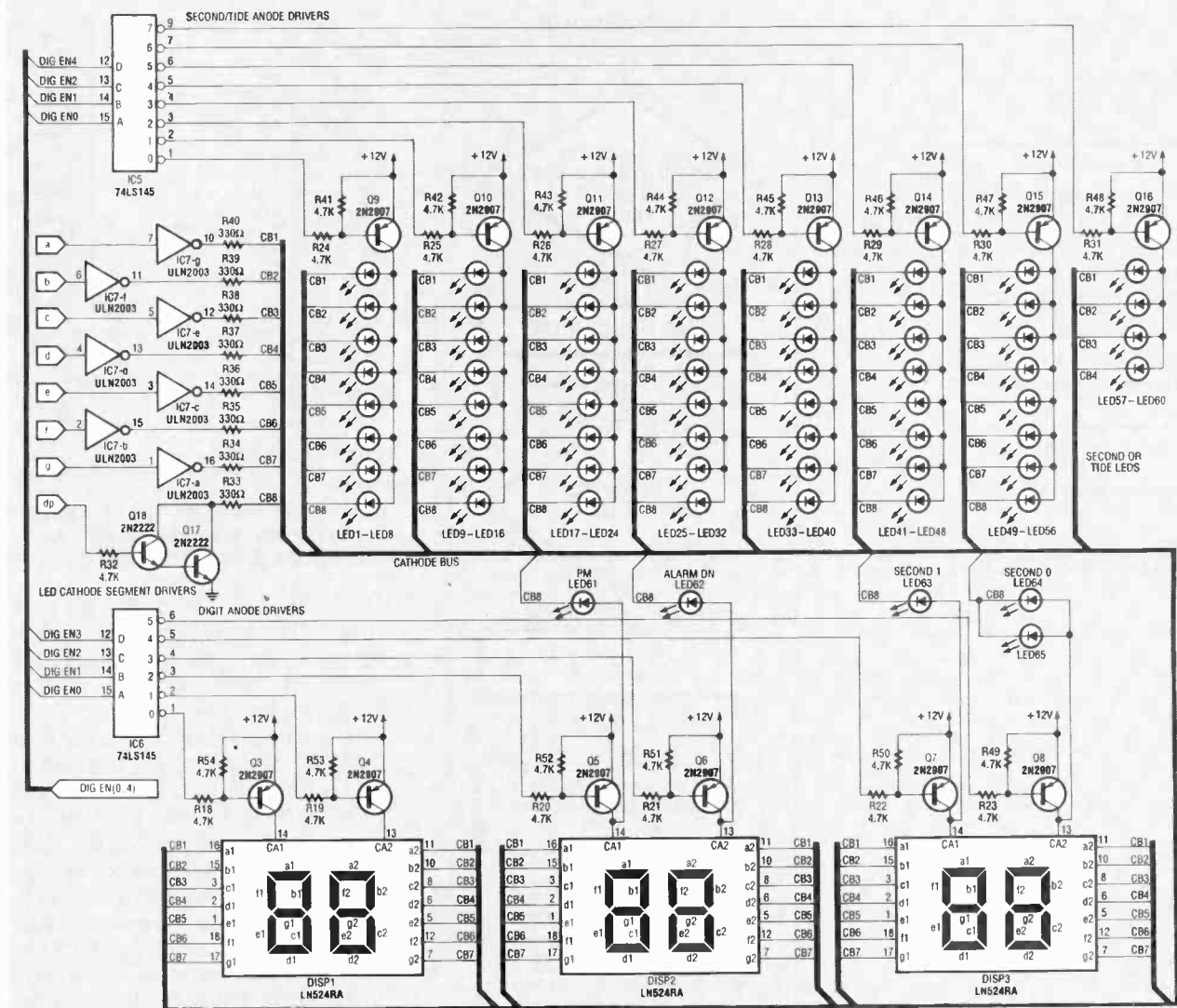

FIG. 4—THE HYPERCLOCK DISPLAY is controlled by only 13 data lines from the microcontroller.

The LINE input (pin 6) is used by the IC to accept a 50- or 60-Hz square wave. The square wave is used for time keeping and to detect AC-power failure as mentioned earlier. The 50Hz/60Hz input (pin 1), tells the 8749 what frequency to expect at the line input. If pin 6 is low, the 8749 assumes the line signal is at 60 Hz, but if that pin is high the 8749 prepares for 50-Hz operation.

As its name implies, the RESET input (pin 4) initializes the microcontroller. A low at that input will erase all modes and settings previously entered.

The x1 and x2 inputs (pins 2 and 3) need to be connected to the 6-MHz crystal, XTAL1, mentioned previously. Last, but cer-

tainly not least, are the 5-volt power inputs (pins 5, 26, and 40) and the grounds (pins 7 and 20). Those inputs of course, are self explanatory.

The display circuit

While the microcontroller does a great deal, the HyperClock requires some additional circuitry to make it a complete timepiece. For example, the microcontroller cannot provide nearly enough current to drive the LED display. For that reason additional anode and cathode drivers were included in the design. They are shown along with the other display components in Fig. 4.

The control signals for the LED cathodes originate from

the A-G and DP pins of the microcontroller. The A-G signals are sent to a ULN2003 buffer/driver (IC7) which contains seven high-current drivers. Each output is capable of providing 500 mA of peak drive current. Since the ULN2003 contains only seven of the eight cathode drivers required, a Darlington driver was made out of two 2N2222 transistors to drive the DP line.

The DE0 through DE4 outputs generated by the microcontroller are decoded by two 74LS145 decoder/driver IC's (IC5 and IC6). Only one decoder output is driven low at any time. Each 74LS145 output supplies current to a 2N2907 drive transistor that sources current for the anodes of a group of LED's or a display digit.

Note that there are additional LED's to provide an AM/PM in-

PARTS LIST

All resistors are ¼-watt, 5%, unless otherwise indicated.

R1, R6–R8, R10–R12, R16, R17—47,000 ohms
R2, R3, R5, R14, R15, R18–R32, R41–R57—4700 ohms
R4, R13, R58—470,000 ohms
R9—2700 ohms
R33–R40—330 ohms, ½-watt, 5%

Capacitors

C1, C2—20 pF ceramic
C3—1000 µF, 16 volts, electrolytic
C4, C5, C15, C16—0.1 µF, ceramic
C6—22 µF, 16 volts, electrolytic
C7—2.2 µF, 16 volts, electrolytic
C8, C9—0.01 µF, ceramic
C10, C14, C17—0.0033 µF, ceramic
C11, C12—560 pF, ceramic
C13—1 µF, 16 volts, tantalum

Semiconductors

IC1—LM340T-5 5-volt regulator
IC2—LM393 dual-comparator

IC3—LM324 quad-op-amp
IC4—8749 microcontroller with HyperClock program
IC5, IC6—74LS145 1-of-8 decoder/driver
IC7—ICLN2003 high-current driver
D1, D3—1N914A diode
D2—1N4001 diode
Q1, Q2, Q17, Q18—2N2222 NPN transistor
Q3—Q16, Q19—2N2907 PNP transistor
BR1—1-amp, 50 volts PIV bridge rectifier
DISP1, DISP3—Panasonic LN524RA or similar 7-segment display (for the smaller digits)
DISP2—Panasonic LN526RA or similar 7-segment display (for the larger digit)
LED1—LED65—light-emitting diodes
Other components
XTAL1—6-MHz crystal
T1—9-VAC 500-mA wall-mount transformer
BZ1—piezo transducer
S1–S7—miniature momentary-contact pushbutton switch
B1—9-volt battery

Miscellaneous: T-220 style heatsink, PC board or perforated construction board, battery clip, shorting blocks, solder, etc.

Note: The following items are available from SkiTronix, P.O. 9685, Spokane, WA 99209:

- A pre-programmed HyperClock 8749 microcontroller with firmware license—\$11.00.
- An etched and drilled PC board—\$25.00.
- The foil pattern artwork suitable for conversion to film—\$3.00.
- Software on floppy disk—\$5.00 postpaid
- A complete kit of parts including the PC board, programmed 8749 IC, LED's, displays, electronic components, and the wall-mount transformer—\$75.00.

A detailed drawing of the HyperClock wood case, will be supplied with all orders. Please include \$4.00 for shipping and handling. Washington residents must include an additional 8.0% sales tax.

square wave present at the emitter of Q2 is clamped in amplitude by the buffered exponential waveform from IC3-a, so the 5-kHz signal decays in amplitude in step with the discharge of C13.

The decaying 5-kHz signal is fed through C14 to a second-order low-pass filter tuned to approximately 5 kHz. The filter is composed of a LM324 op-amp (IC3-d), C11, C12, C14, R10, and R11. It removes the high-frequency components contained in the decaying square wave to smooth it out. From there the signal is passed to two more op-amps (IC3-b and IC3-c) that form a push-pull amplifier, which provides the piezo transducer with a 10-volt peak-to-peak drive signal.

While the output signal is not exactly a pure sine wave, the audible result sounds pretty much like a small bell. If you feel the chime is too loud, you can eliminate half of the push-pull amplifier by jumpering one side of the transducer to the 5-volt supply, which is available via JU2.

The entire circuit receives power from a 9-VAC wall-mount transformer. The 9-VAC supply is fed to a full-wave bridge rectifier and filtered by C3 to act as an unregulated 12-volt DC sup-

ply. The 12-volt supply powers the display circuitry, op-amps, the comparators, and an LM340-5 (IC1) 5-volt regulator. The regulator in turn powers the 5-volt supply line.

If AC power is interrupted, a 9-volt battery connected to J1 sources current to the regulator to keep the HyperClock functioning. If you plan to unplug the clock for any length of time, the battery should be disconnected to conserve its life.

A BIT ABOUT TIDES

Predicting the tides in any given locale is not a simple job. Tides are affected by many cyclic astronomical forces: the declination in the orbits of the moon and sun relative to a point on the Earth, and the local geography of the coast line in the area in which you live, to name a few. HyperClock predicts the tidal levels from the most predominate of these forces, the moon. The moon requires 29.53 days to orbit Earth, and that combined with the 24-hour solar day causes a high and low tide in every 12 hour and 25.5 minute interval. HyperClock tracks the moons primary affect on the tide. You can find out about the level of local tides in your area from your newspaper or library. The information can be used to initially set the tide indication on your HyperClock to a low or high point. From then on the graphic display will be an aid in the determination of the relative level of the tides in your locality.

The line input (pin 6) of the microcontroller cannot be driven directly from the 12-VAC wall transformer. So the transformer signal is conditioned by a Schmitt-trigger circuit to generate a suitable square wave. First the signal's amplitude is reduced by a voltage divider consisting of R1 and R58, and its positive excursions are limited to about 5 volts by D1. The limited signal is then sent to the inverting input of the LM393 comparator. Positive feedback is applied to the comparator's non-inverting input by R4 to prevent it from generating false signals. The comparator drives the microcontroller's line input with the resulting square wave.

Construction

In order to build a HyperClock, you'll need a programmed 8749 microcontroller. A preprogrammed and tested microcontroller is available from the supplier mentioned in the parts list. The executable code to program an 8749 is available from the RE-BBS (516-293-2283, 1200/2400, 8N1), as a file called HYPER.HEX. The file is supplied in Intel's Hex format, which is directly compatible with most EPROM program-

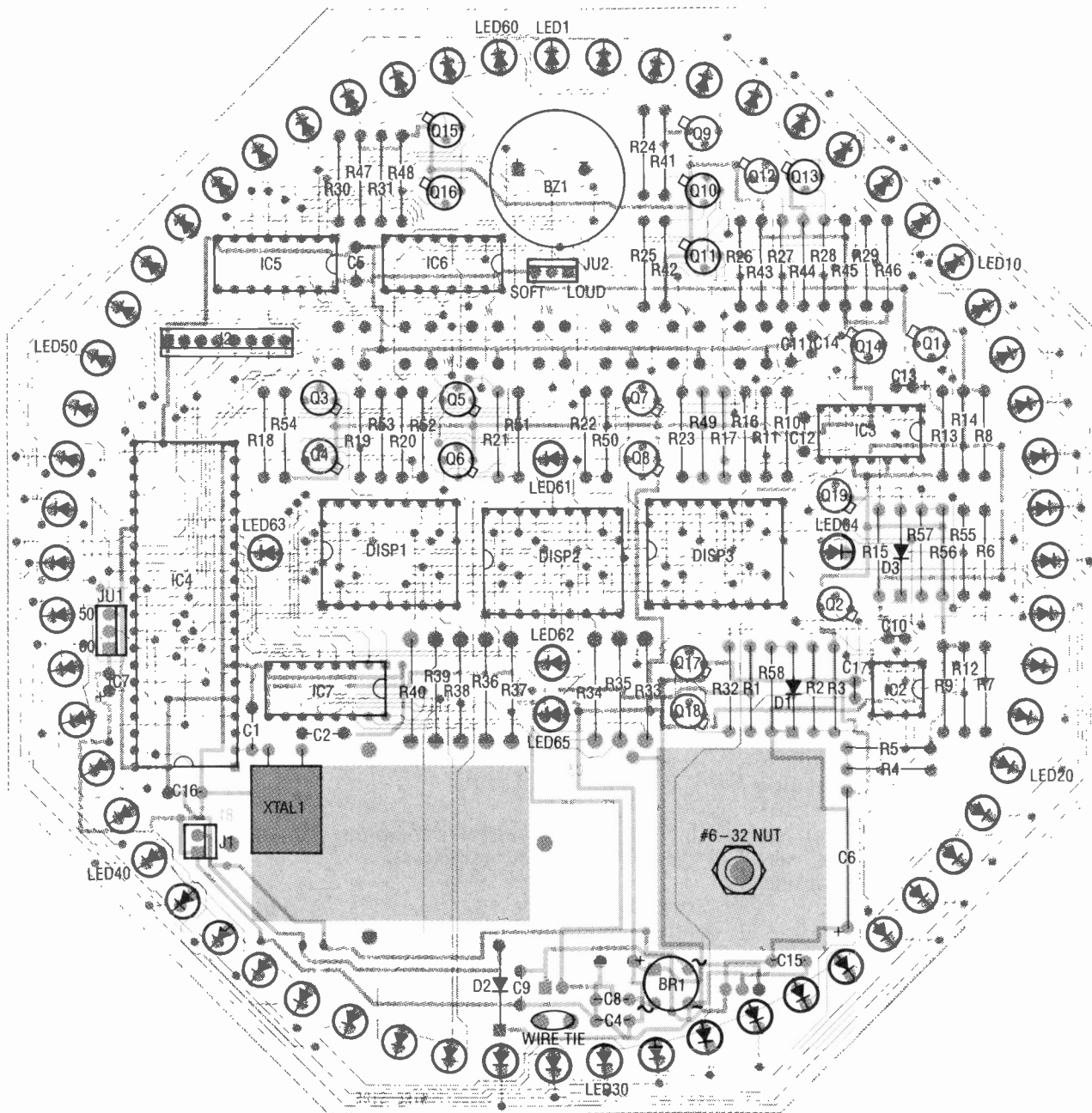

FIG. 6—DISPLAY-SIDE PARTS-PLACEMENT diagram can be used to locate most of the HyperClock's components.

mers. The software is also available on floppy disk from the source mentioned in the parts list.

A 6.5- × 6.5-inch octagon-shaped PC board is also available from that supplier to help you assemble a HyperClock of your own. If you wish, you can make your own double-sided printed-circuit board from the foil patterns included in this article or using artwork from the supplier listed in the parts list. Of course, you could even use a point-to-point wiring tech-

nique, so we'll discuss that briefly later on.

Figures 6 and 7 show the parts-placement diagrams for the HyperClock (6 shows the display side and 7 shows the solder side) for those of you that will use a PC board. All components, except for the wall-mount transformer, are shown mounted on the circuit board. Note that the switches can be placed on either side of the board, depending on the cabinet you wish to place the clock in. There are some additional

connector pads on the board so you can run wires to the switches should your cabinet design require that they be located off the PC board. Figure 8 shows a completed HyperClock board.

The design readily lends itself to many different project cases. However, make sure that the cabinet you choose has some openings in the back to allow a little cool air to flow around the clock's 5-volt regulator and heat sink. If you like the case used for the prototype, you can build one out of a length of wood molding as the author did.

The PC board was designed to work with many different dual-digit displays, so you don't necessarily have to restrict yourself to the Panasonic units mentioned in the parts list. Just make sure that whatever you use is a pin-for-pin same-size replacement. If you do use the recommended units, be sure to raise the two minute displays up from the board so that their viewing surfaces are flush with that of the hour display.

Lastly, the PC board provides some holes for wire ties to hold the 9-volt battery and the wall-mount transformer leads. You should take advantage of them. Remember to install the 9-volt backup battery and connect JU1 and JU2 to select 50- or 60-Hz operation and the volume of the chime, respectively.

When you connect the clock to power it should come up at 12:30 AM and will be ready to accept the current time, alarm time, date, and the tide level if desired. If you run into any difficulty, you may find some of the troubleshooting tips provided in the following section useful. However, if all is well, you can proceed to the "operating" section to prepare the clock for use.

Point-to-point wiring

Working with perforated construction board and point-to-point wiring gives you the freedom to design your own display layout. One nice alternate design would be to place the 60 LED's in the form of a full cycle of a sine wave, especially if you set the clock to display the tide level.

An early prototype of the clock was built using wire wrap. Regardless of the wiring technique, you should invest in a large enough piece of perforated construction board (at least 6 x 6 inches) so that you can make your custom display with plenty of room to spare for all the support electronics.

Furthermore, when you are shopping for the hour and minute displays, select minute displays that are somehow distinctly different than the hour display. That will make the display more easily readable in the

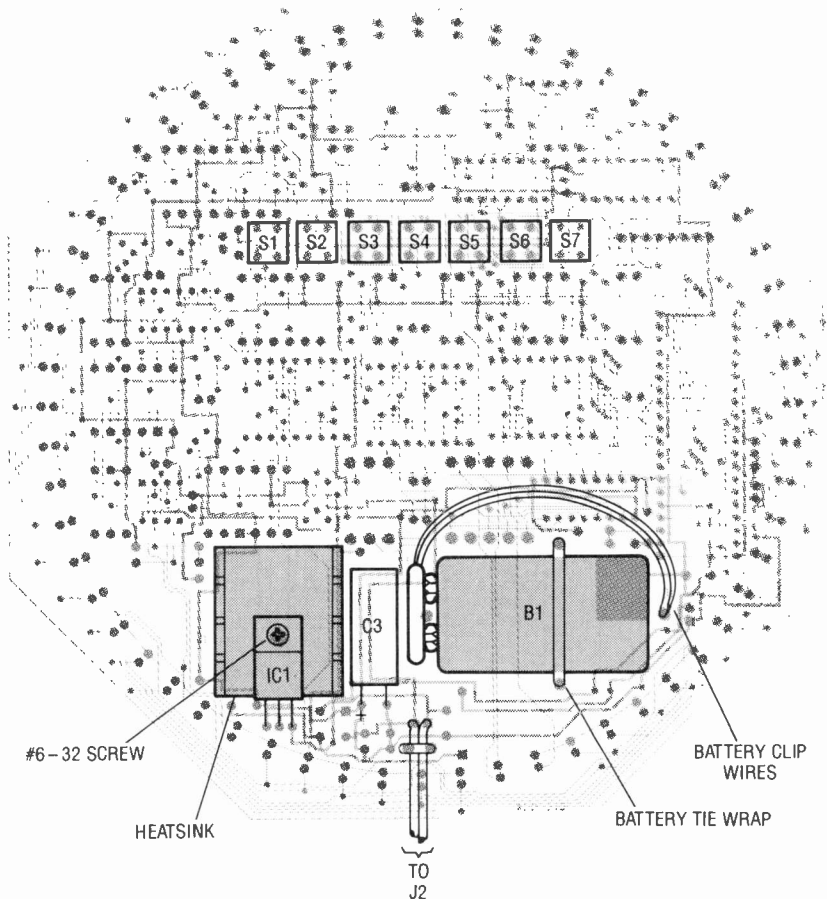

FIG. 7—THIS PARTS-PLACEMENT DIAGRAM should be used to position the regulator, battery, a capacitor, and the switches.

"minutes before the hour" mode.

It is also suggested that you don't place the display components on the same side of the board as the heatsink/regulator assembly, C3, and the 9-volt battery. Doing so would increase the profile of the display side of the board, forcing you to place the LED lens at an undesirable distance from the display components.

Aside from those suggestions, layout is not critical, so if you observe good construction and wiring techniques you should not have any problem getting the clock to function. However, if you should encounter some difficulty, the following hints ought to help:

- If no LED's are illuminated when you apply power, first check the unregulated supply for a minimum of 10 volts DC. While only 2 to 3 volts of overhead are required to operate the 5-volt regulator, at least 10 volts

is required to drive the LED's sufficiently.

- If the power-supply circuitry is okay, check the wiring around the LM393 (IC2) from the bridge rectifier and going to IC4 pin 6; the microcontroller looks at that line and if there is no line frequency at that input, the clock will shut down the LED drivers (as we explained earlier).

Since most of the wiring in the clock runs between the LED drivers and the LED's, it is likely that you could have made an error in one or more of those connections. If you observe that any active LED segments do not form numbers, then you should check the connections from IC4 to IC7 and the corresponding connections to the cathodes of the LED displays. A mistake between IC4 to IC5 and IC6 will make the displayed digits and/or seconds appear out of order. An error in wiring from the outputs of the 74LS145's to the

TABLE 1—MODES AND THEIR FEATURES

Feature	Mode							
	0	1	2	3	4	5	6	7
Fading Updates		•		•		•		•
Plain Updates	•		•		•		•	
Before-The-Hour Display			•	•			•	•
Plain Display	•	•			•	•		
Tide Light Chaser					•	•	•	•
Seconds Light Chaser	•	•	•	•				

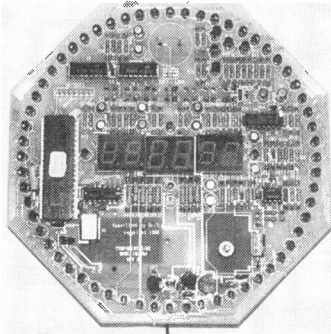
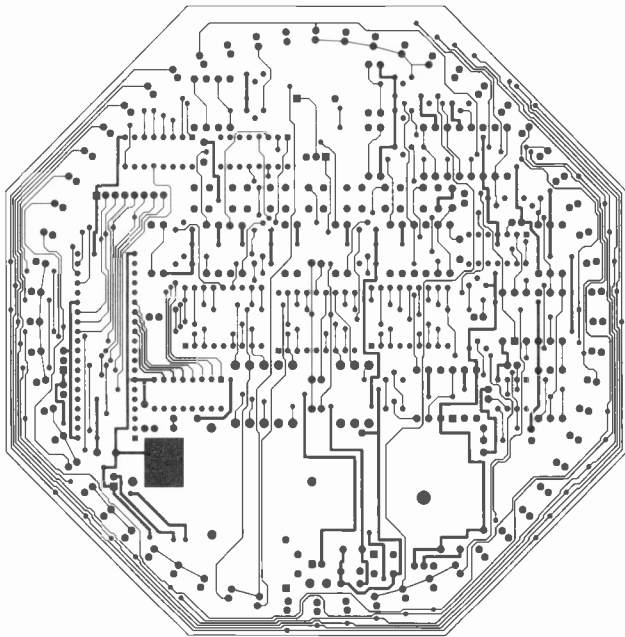
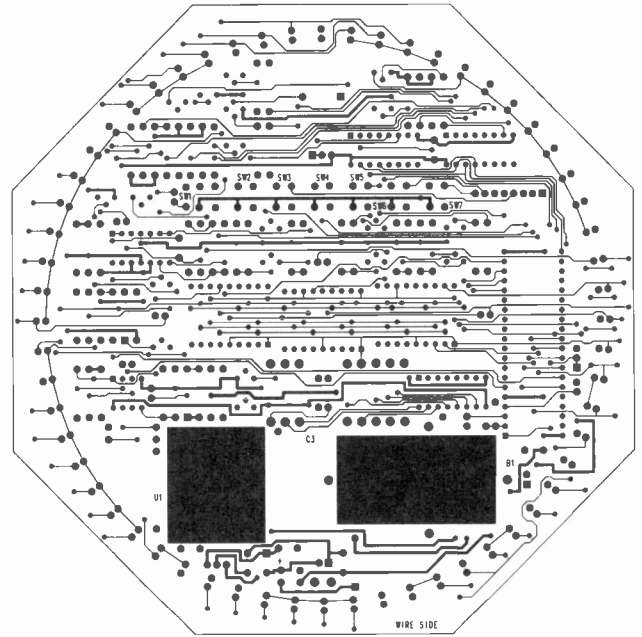

FIG. 8—A FINISHED HYPERCLOCK. The PC board makes assembly neat and straightforward.



THE DISPLAY-SIDE FOIL PATTERN can be used to generate one side of the clock's PC board.



THIS FOIL PATTERN can be used to generate the solder side of the clock's PC board.

driver transistors, which connect to the LED anodes, will cause the same effect.

Operation

The functions performed by S4 and S5 in the HyperClock depend on the state of the three display switches (S1 through S3). If none of the display switches are depressed, pressing S4 advances the current hour displayed and pressing S5 advances the minute display. That is how you set the time.

Pressing and holding down S1 (the Display-Mode button) causes the clock to display the number of the current operating mode, which can be altered by pressing S4 (S5 will do nothing). The various operating

modes and the features they support are listed in Table 1.

If you depress and hold switch S2 (the Display-Date button) the current month and day are displayed. With that switch depressed, the month and day can be advanced by pressing S4 and S5, respectively.

Activating switch S3 will cause the clock to display the time the alarm is set for. By pressing S3 along with S4 you can alter the hour setting, and by pressing S3 and S5 simultaneously you can change the minute setting.

Moving on to the last two switches, the Alarm Toggle switch (S7) determines the state of the alarm and the hour chime of the clock. For example,

on power-up the hour chime is enabled and the alarm is disabled. If S7 is pressed once, the alarm is turned on and the hour chime is disabled. Depressing the switch again will turn off both the alarm and the hourly chime.

The Snooze/Tide Switch (S6) has a dual purpose. If the HyperClock's alarm was armed and goes off, that button will silence the alarm for an additional ten minutes. You can forestall the alarm in this way as many times as you like. If the alarm is disabled, and the clock is in a mode that supports the tide-level display (modes 4 through 7), pressing S6 will advance the tide indication on the 60-LED display to set its position.

LINE POWER FROM 12 VOLTS

Build a 40-watt DC-to-AC inverter, and power AC

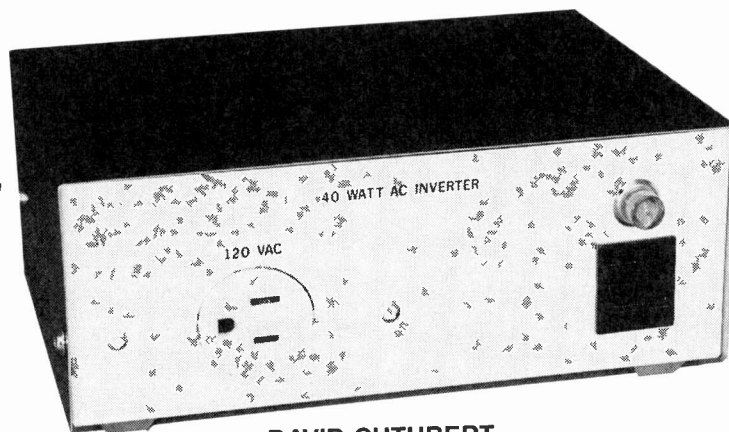

appliances from your automobile cigarette lighter.

DAVID CUTHBERT

WOULD YOU BELIEVE THAT THIS ARTICLE was written on an electric typewriter while the author was sitting next to a stream on a camping trip? The typewriter was powered from our 40-watt inverter that can be plugged into an automobile's cigarette lighter socket. The unit has enough power for many items that normally don't go on camping trips, such as a TV, a stereo, an electric razor, or a desk lamp. However, it also has some uses that may not be as obvious; it can be used to power items such as an oscilloscope or soldering iron when doing electronics work in the field. On road trips, the inverter can be used to power a camcorder battery charger.

The inverter draws a maximum of 5 amps, which is completely safe for an automobile cigarette lighter socket, and the no-load current is only half an amp. The output voltage is regulated and remains fairly constant from no-load to full-load. Figure 1 shows the output-voltage waveform superimposed over a sine wave. The rectangular output waveform has the same RMS and peak voltage as the sine wave, so the device being powered will

never know the difference. The rectangle-wave operation greatly increases efficiency. The waveform would look similar if displayed on an oscilloscope.

Operation

The inverter, the schematic of which is shown in Fig. 2, is actually a push-pull audio amplifier. The "input," or reference signal, is a 5-volt square wave. The output is 340-volt peak-to-peak AC signal. The feedback signal is rectified in order to match the DC reference signal. On one half of the AC waveform, the upper three FET's are gated on, and on the other half the lower three FET's are on.

Normally, 120-volt AC outlets have one side at ground and one side that's "hot." The hot side alternates from -170 to $+170$ volts. The inverter output is a little different. On one half of the AC cycle, one side is near ground and the other is at $+170$ volts. During the other half of the cycle the situation is reversed.

Op-amp IC1-a and its associated components form a 300-Hz clock oscillator, and counter IC2 divides the clock signal by four to obtain a 75-Hz inverter frequen-

cy. The 75 Hz, rather than 60 Hz, is used to avoid transformer saturation. Some electric clocks will run fast with that frequency, but most electronic gear will work just fine. Decade counter IC2 controls the timing of the reference signal and the gating-on of the error-amp signal to the proper set of FET's.

Figure 3 shows the timing relationships in the inverter. When IC2 pin 3 goes high, the output of buffer IC1-c is high. That reverse biases D1 and allows the error amp signal to reach Q1, Q2, and Q3. At the same time, IC2 pin 4 is low, which causes the output of buffer IC1-d to be low. That grounds the gates of Q4, Q5, and Q6 thereby turning them off. Pins 2 and 7 of IC2 are also low, so Q7 is off. A 5-volt reference from regulator IC3 is now present at the error-amp's (IC1-b) non-inverting input. The reference-signal rise time is slowed by R12 and C2 in order to avoid output overshoot, and the gain and frequency response of the error amp is set by R15, R25, and C3.

Next, pin 2 of IC2 goes high, which turns Q7 on and the reference signal is pulled to ground. Pins 3 and 4 of IC2 are now low

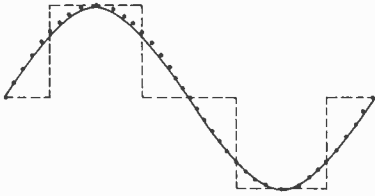

FIG. 1—BECAUSE THE OUTPUT-VOLTAGE waveform, which is shown here superimposed over a sine wave, has the same RMS and peak voltage as the sine wave, the device being powered will never know the difference.

and the FET gates are grounded, turning them off. Pin 4 of IC2 now goes high and the other three FET's are gated on. The reference signal now rises to 5 volts, and the other half of the AC output waveform is generated. The next clock pulse causes IC2 pin 7 to go high; all FET's are now off and the reference is set to zero. The following clock pulse resets IC2 and another cycle begins.

A filter that protects the CMOS circuitry against alternator spikes and reversed input polarity is formed by R7, C8, and D7. Components R9 and C4 filter output spikes, and R18–R21 are pre-load resistors to stabilize the inverter when no load is con-

nected. Although the FET's have no current-equalizing source resistors, they still share current fairly equally. (When a FET "hogs" current it heats up more and its on resistance increases, causing it to draw less current.)

Construction

The inverter circuit was built on a perforated construction board. Transistors Q1, Q2, and

Q3 share a 1.5- by 4-inch heat-sink, and Q4, Q5, and Q6 share another; the heat sinks are made of aluminum sheet. Figure 4 shows an internal view of the inverter. In the prototype, the FET's were not insulated from the heat-sinks because the heatsinks are isolated from ground and all other circuitry. If you use any other heatsinking configuration, the FET's should be insulated.

PARTS LIST

All resistors are 1/4-watt, 5%, unless otherwise noted.

- R1–R7—100 ohms
- R8—1000 ohms
- R9—1000 ohms, 1/2-watt
- R10, R11—4700 ohms
- R12–R16—10,000 ohms
- R17—10,000-ohm potentiometer
- R18–R21—22,000 ohms, 1/2-watt
- R22–R26—100,000 ohms
- R27, R28—470,000 ohms
- R29—1 megohm

Capacitors

- C1—0.001 μ F, ceramic disc
- C2—0.01 μ F, ceramic disc
- C3—0.0047 μ F, ceramic disc
- C4—0.05 μ F, 200 volts, ceramic disc or metal film
- C5–C7—0.1 μ F, ceramic disc
- C8, C9—470 μ F, 35 volts, electrolytic

Semiconductors

- IC1—LM324 quad op-amp
- IC2—4017 CMOS decade counter
- IC3—LM7805 or LM340-5 +5-volt regulator
- D1–D7—1N4003 diode
- Q1–Q6—IRF511 60-volt 3.5-amp MOSFET
- Q7—2N2222 or 2N3904 NPN transistor

Other components

- T1—120/12.6 volt center-tapped 3-amp power transformer
- J1—banana jack, red
- J2—banana jack, black
- J3—AC power receptacle
- F1—5-amp slow-blow fuse
- S1—SPST 6-amp switch
- NE1—neon indicator light with series resistor

Miscellaneous: fuse holder, perforated construction board, enclosure, aluminum for heatsinks, standoffs for mounting circuit board, wire, solder, etc.

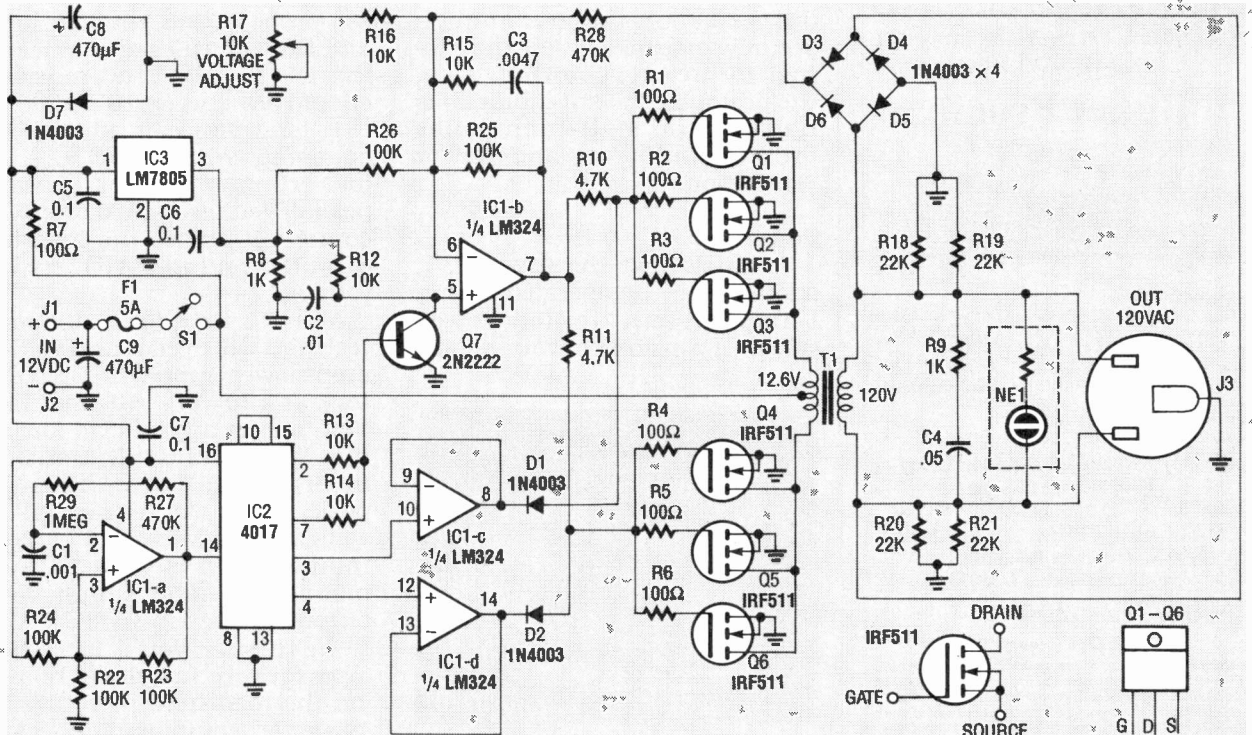

FIG. 2—THE INVERTER is actually a push-pull audio amplifier where, on one half of the AC waveform, the upper three FET's are gated on, and on the other half the lower three FET's are on.

DIGITAL VIDEO STABILIZER ELIMINATES ALL VIDEO COPYGUARDS



While watching rental movies, you will notice annoying periodic color darkening, color shift, unwanted lines, flashing or jagged edges. This is caused by the copy protection jamming signals embedded in the video tape, such as Macrovision copy protection. THE DIGITAL VIDEO STABILIZER: RXII COMPLETELY ELIMINATES ALL COPY PROTECTIONS AND JAMMING SIGNALS AND BRINGS YOU CRYSTAL CLEAR PICTURES.

WARNING

THE DIGITAL VIDEO STABILIZER IS INTENDED FOR PRIVATE HOME USE ONLY. IT IS NOT INTENDED TO COPY RENTAL MOVIES OR COPYRIGHTED VIDEO TAPES THAT MAY CONSTITUTE COPYRIGHT INFRINGEMENT.

FEATURES

- Easy to use and a snap to install
- State-of-the-art Microchip technology
- 100% automatic
- Compatible to all types of VCRs and TVs
- The best and most exciting Video Stabilizer in the market
- Light weight (8 ounces) and compact (1x3.5x5")
- Uses a standard 9 Volt battery (last 1-2 years)
- Fast UPS delivery
- Air shipping available
- UNCONDITIONAL 30 day money back guarantee
- 1 year warranty

(Dealers Welcome)

FREE 20P Catalog

To Order: \$59.95 ea +\$4 for p & h
Visa, M/C, COD Mon-Fri: 9-6 EST

1-800-445-9285

ZENTEK CORP. DEPT. CEHA

3670-12 WEST OCEANSIDE RD. OCEANSIDE, NY 11572

CIRCLE 95 ON FREE INFORMATION CARD

CABLE TV DESCRAMBLERS

How You Can Save Money on
Cable Rental Fees

Bullet Proof

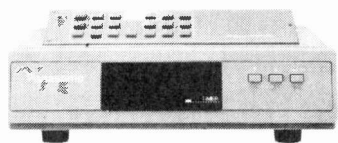

1 Unit 5+

BEST Super Tri-Bi Auto/
Var. Gain Adjustment \$119.95...\$85
Jerrold Super Tri-Bi... \$109.95...\$79
Scientific Atlanta... \$109...\$79
Pioneer... \$109...\$79
Panasonic TZPC145... \$99.95...\$79
Stargate Converter... \$95...\$69
Digital Video Stabilizer. \$59.95...\$29
Wireless Video Sender...\$59.95...\$49.95

**US Cable'll Beat
Anyone's Price
Advertised in
this Magazine!**

30 Day Money Back Guarantee
FREE 20 page Catalog

Visa, M/C, COD or send money order to:

U.S. Cable TV Inc. Dept. KEHA
4100 N. Powerline Rd., Bldg. F-4
Pompano Beach, FL 33073

1-800-772-6244

For Our Record

I, the undersigned, do hereby declare under penalty of perjury that all products purchased, now and in the future, will only be used on Cable TV systems with proper authorization from local officials or cable company officials in accordance with all applicable federal and state laws. FEDERAL AND VARIOUS STATE LAWS PROVIDE FOR SUBSTANTIAL CRIMINAL AND CIVIL PENALTIES FOR UNAUTHORIZED USE.

Date: _____

Signed: _____

No Florida Sales!

CIRCLE 94 ON FREE INFORMATION CARD

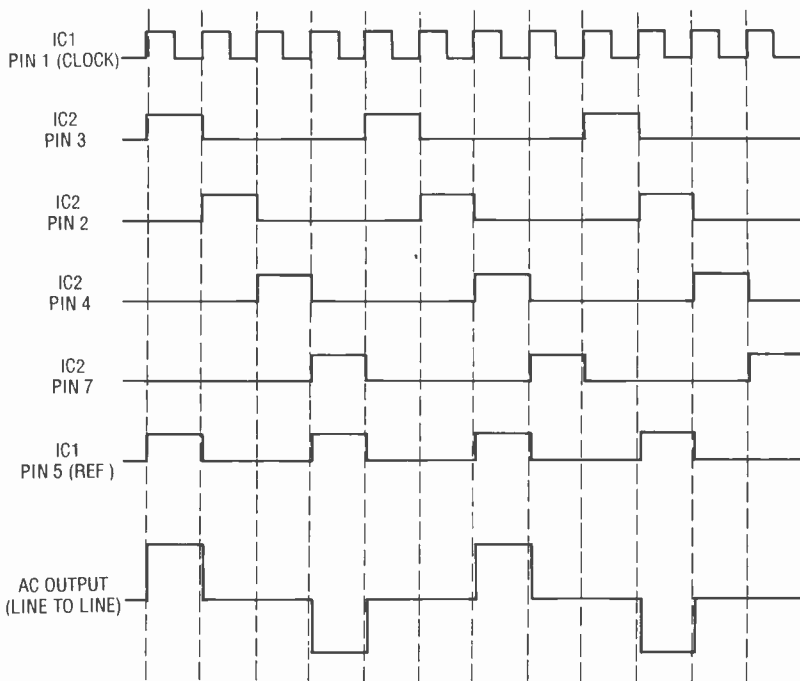

FIG. 3—THE TIMING RELATIONSHIPS in the inverter. When IC2 pin 3 goes high, the output of buffer IC1-c (pin 8) is high. That reverse biases D1 and allows the error amp signal to reach Q1, Q2, and Q3. At the same time, IC2 pin 4 is low, which causes the output of buffer IC1-d to be low. That grounds the gates of Q4, Q5, and Q6 thereby turning them off.

Parts placement isn't critical except for the 100-ohm gate resistors. They prevent VHF oscillations and should be placed within half an inch of the FET's. Just make sure that everything is securely mounted inside the cabinet to prevent shorting. Also, the prototype's metal cabinet has had several half-inch holes drilled in the bottom and rear for ventilation.

Power up

To safely test the inverter, it should really be operated with a 1-amp current-limited power supply. If you don't have one, sim-

ply connect it to approximately 12-volts DC, and keep a look out for smoke or sudden failures.

Connect an oscilloscope ground to chassis ground and the probe to the junction of D3 and D6; you will see an alternating DC signal. The frequency should be between 70 and 90 Hz. If it isn't you can adjust it by changing the value of R27. Adjust trimmer R17 for 180-volts peak. If you use a DVM or a VOM, connect it across the inverter's AC outlet, and adjust R17 for 120-volts AC.

Now it's time for a full-power test. You will need a 12.6 volt, 10-amp power supply or a car battery. A 120-volt, 40-watt light bulb makes a good load for testing. With a 12.6-volt input, the inverter will deliver 150 volts peak, which will read about 105 volts on a DVM. With a 14.2-volt input, which is what an automobile alternator supplies, the output will be 115-volts AC.

We're sure you'll find many uses for your inverter at home or on the road from powering low-power AC equipment on a camping trip to re-charging your camcorder batteries as you drive to your next vacation spot! **R-E**

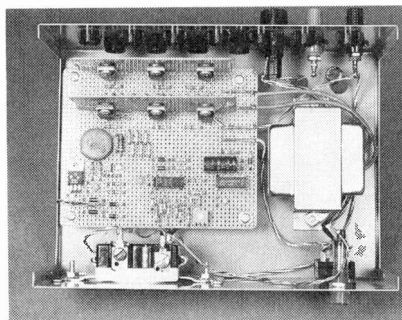
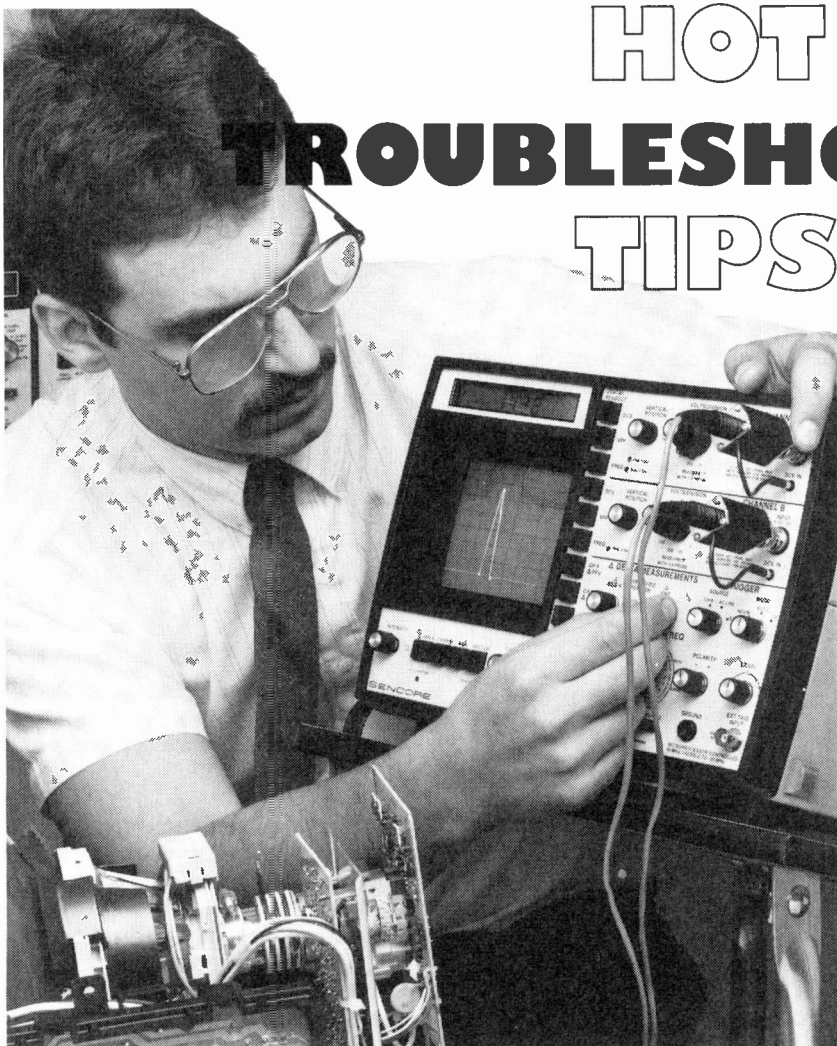

FIG. 4—IN THE PROTOTYPE, the FET's are not insulated from the heatsinks because the heatsinks are isolated from ground and all other circuitry.

HOT

TROUBLESHOOTING

TIPS



The horizontal output transistor is a critical component in any TV set. Let's examine some of the procedures involved in measuring its output.

BRIAN PHELPS

FOR ANYONE WHO HAS EVER TRIED TO repair a television with defective signals throughout, or changed a horizontal output transistor only to have it fail once more, we have a technique that can save hours of work and needless replacement of parts. All you have to do is check the "HOT pulse," or the signal at the collector of the horizontal output transistor. Let's see why this waveform is so important, and some key procedures for measuring its signal.

The HOT pulse is important because it performs many functions other than just sweeping the CRT beam horizontally. Some of the key functions of the horizontal output waveform are:

- It generates 0.7 amps of horizontal deflection current every 63.5 microseconds.
- It generates a 700–1,500 volts peak-to-peak retrace pulse every 63.5 microseconds.

- It generates 15,000–30,000 volts DC for the picture tube.
- It generates 3,000–8,000 volts DC for the focus circuit.
- It delivers "trace-derived" high-current DC power from 16 to 30 volts to operate most circuits.
- It delivers "retrace-derived" low-current DC power of 185 to 220 volts.
- It provides 6.3 volts for the pulse current of CRT filaments.
- It is a critical safety feature.
- It provides accurate pulse voltages for the tuner's frequency-synthesis power source.

What to look for

The horizontal output pulse supplies operating voltages for the entire TV. It is therefore the most important waveform to check on every TV before and after changing parts. **Note:** In order to make any of the following measurements, your scope

must be capable of measuring, and have input protection up to 2 kilovolts or more. Also, a digital-readout oscilloscope, although not essential to troubleshooting, will make it easier to make the measurements.

The first thing to check when analyzing the horizontal output pulse is the wave shape; it should look like the one shown in Fig. 1, and be symmetrical in shape during the retrace time. A wide peak at the top of the retrace, or deep saddle conditions, can be caused by an off frequency or glitch in the horizontal transistor base-drive signal. Such problems are often caused by a change in the value of the output-transistor timing capacitors, or by an excessive load on a B+ supply.

Any excessive ringing or noise is a clear indication of deflection-system problems, such as a cracked integrated high voltage

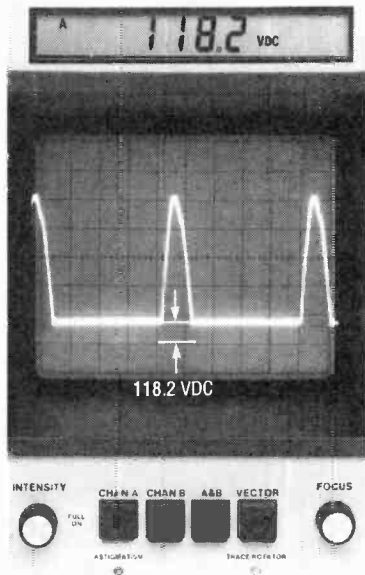

FIG. 1—THE WAVE SHAPE should be symmetrical during the pulse retrace time.

transformer (IHVT) core, or open or shorted IHVT windings. Figure 2 shows an example of a faulty horizontal output. Make sure the waveform looks good before you proceed.

Check to see if there are any noise pulses during the trace time. Many of the noise pulses may not be detected when viewing the low-level horizontal waveforms, but they become very noticeable at the collector with

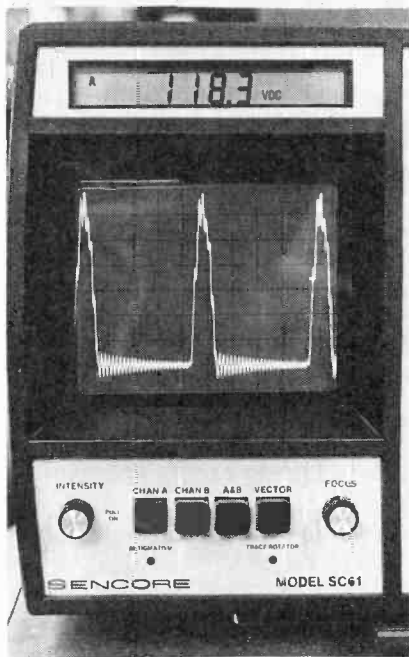

FIG. 2—HERE'S AN EXAMPLE of a faulty horizontal output. Make sure the waveform looks good before you check anything else.

an amplitude reaching 1500 volts peak-to-peak. The noise could cause symptoms from drive lines in the video picture to faint noise throughout the TV's circuits.

First measure the DC voltage level of the horizontal waveform. In Figs. 1 and 2 you can see that the digital display shows approximately 118 VDC, which is the regulated B+ voltage. Next measure the peak-to-peak voltage of the waveform. As you can see from Fig. 3, the display shows 905 volts peak-to-peak.

The frequency of the waveform must also be measured. That's as simple as pushing a button on a digital scope. Figure 4 shows the

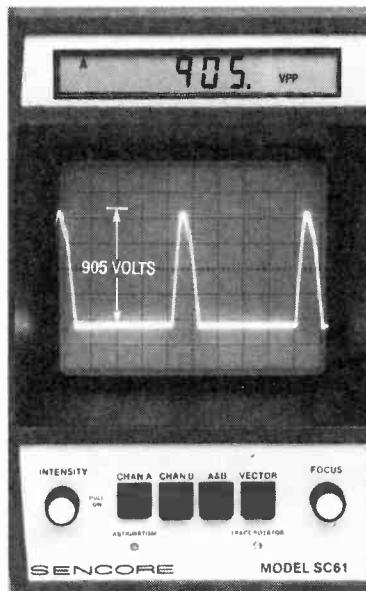

FIG. 3—THE PEAK-TO-PEAK voltage of the waveform should be between 900 and 1500 volts peak-to-peak. It's shown here as 905 volts peak-to-peak.

frequency to be 15.7343 kHz. If everything checks out so far, you know the condition of the regulated B+ supply, that the TV is not in the shut-down mode, and that the horizontal oscillator is locked to the composite video sync pulse.

The duty cycle of the horizontal transistor output waveform is helpful in troubleshooting. The manufacturer specified that the retrace time should be from 11–14 microseconds, and the trace time should be 49–50 microseconds. Those recommended duty cycles should be observed when troubleshooting.

The time-duration measurement of the retrace pulse should be made between the 10% levels

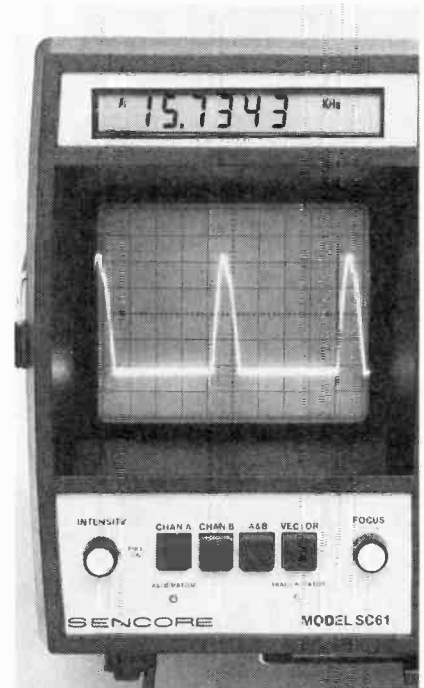

FIG. 4—THE FREQUENCY of the waveform is important; here it is measured to be 15.7343 kHz.

of the waveform. Some digital scopes are equipped to measure portions of a waveform with a delta-time feature. To make that measurement on a digital scope, align the pulse so that the top of it is at the 100% graticule marking and the bottom is at the 0% marking, using the volts/division and calibration knobs. (Make sure your scope will allow accu-

continued on page 114

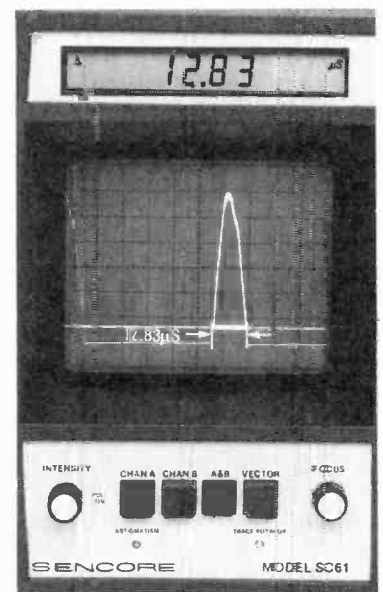

FIG. 5—THE TIME DURATION of the retrace pulse should be between 11 and 14 microseconds; 12.83 microseconds in this case.

BUILD THIS MAGNETIC FIELD METER

Determine your exposure to line-frequency magnetic-fields with our easy-to-build portable ELF gaussmeter.

REINHARD METZ

IF YOU ARE ONE IN A GROWING number of people who are concerned about the potentially harmful effects of exposure to magnetic fields, you will be interested in this important construction project. Now you can build your own gaussmeter, and determine the magnitude of magnetic flux densities in and around your home. Our handheld, battery-operated magnetic-field meter is sensitive from 0.1 microtesla (μT) to 20 milliteslas (mT), and has a frequency range from 50 Hz to 20 kHz.

Why all the worry?

Magnetic fields are all around us. They occur from the generation, distribution, and use of 50 and 60-Hz electricity, electronic equipment, and even from Earth's magnetic field, which has always been present throughout Man's evolution. Man has been "tuned" into Earth's steady magnetic field of about $30 \mu\text{T}$ (at sea level) for millions of years. Some sources of excessive magnetic fields that have caused the greatest public concern include power-distribution substations, power lines, CRT terminals, and use of appliances.

Magnetic field intensities can vary greatly, depending on the exposure source and the distance from that source. The rate at which the field intensity falls off with distance can vary from one source to another, depending on how well the current-carrying lines are balanced, or how well the opposing lines of magnetic

flux cancel each other out. Fields from coils, magnets, or transformers drop off rapidly with distance by a factor of $1/r^3$. In power lines, if currents flow in opposite directions, the drop-off is $1/r^2$ because of partial field canceling. When unbalanced current exists, the field intensity falls off less rapidly as $1/r$.

Figure 1-a, -b, and -c show drop-off rates of $1/r$, $1/r^2$, and $1/r^3$, respectively. Figure 2 lists some of the many sources of magnetic field exposure, with their range of intensities and drop-off rates.

Although a great deal of controversy still prevails, many people in the scientific community believe that exposure to magnetic fields of extremely-low frequency (ELF fields of 1–100 Hz) may pose a risk to human health. Some disturbing findings of exposure to ELF fields include a significant increase in serum triglycerides (a possible stress indicator) in hu-

mans, disorientation of chicks (a result suggesting that bird migration could be affected), and a slowed reaction time in monkeys.

A study conducted by epidemiologist Nancy Wertheimer and physicist Ed Leeper, found that exposures to magnetic fields as small as $0.25 \mu\text{T}$ correlated with a rise in cancer rates. In the study, the researchers examined wiring and transformers in the neighborhood of birth homes of children who had died of leukemia between 1950 and 1975, along with those of a control group of children who did not have the disease. The results of their studies were published in *The American Journal of Epidemiology* (March, 1979). Some experts argue that other factors, such as pollution and exposure to chemical carcinogens, make interpretation of those findings very difficult.

Standards for acceptable exposure to ELF fields are emerging, as are results of studies

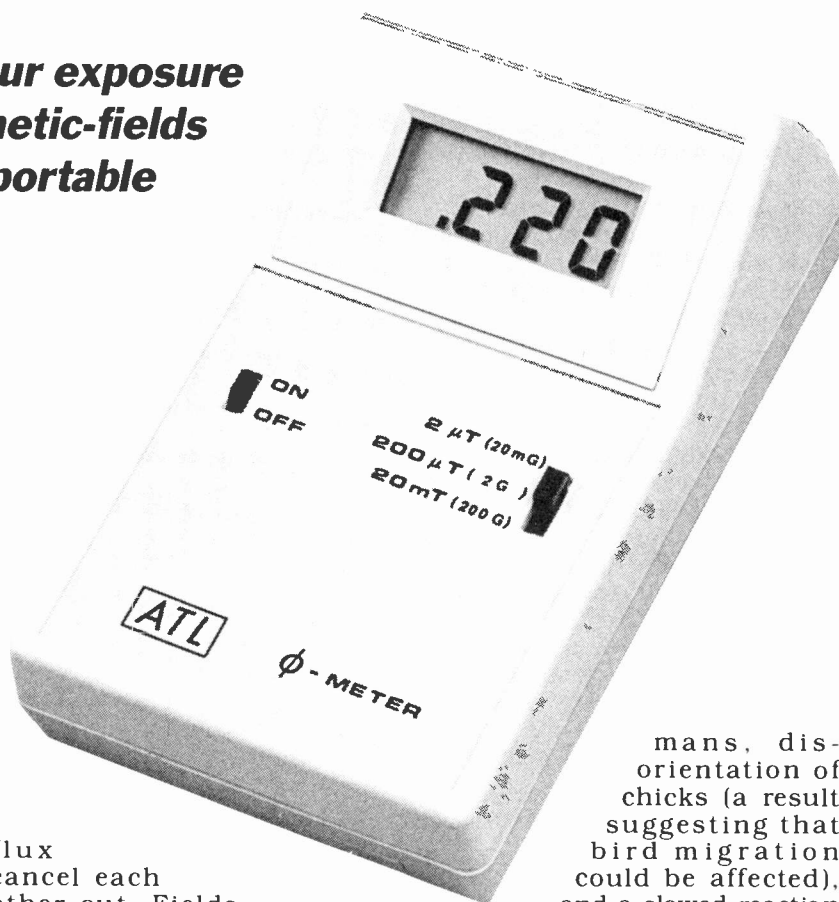

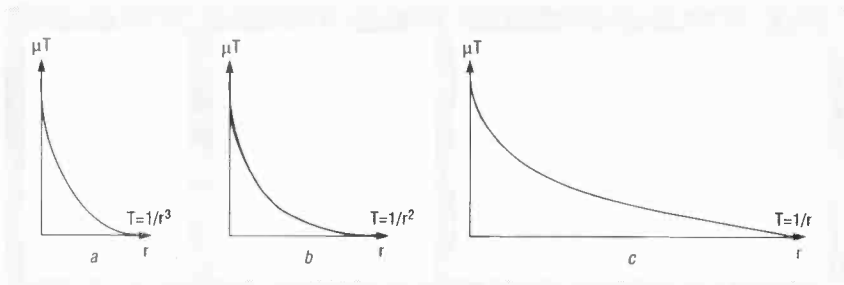

FIG. 1—MAGNETIC FIELD drop-offs. A fast drop-off of $1/r^3$ (a), $1/r^2$ (b), and a slow drop-off of $1/r$ (c) is typical of many sources of magnetic fields.

describing possible hazard levels. If you are more interested a detailed account of scientific findings and the political history of the effects of magnetic-field radiation, we suggest a three-part series of articles by Paul Brodeur, *The New Yorker* (June 12, 19, and 26, 1989). "60-Hz and The Human Body", *IEEE Spectrum*, Parts 1-3, Volume 27, Number 9, pages 22-35 (August, 1990) is also a good source for technical information. The Environmental Protection Agency (EPA) has published a report titled "The Evaluation of the Potential Carcinogenicity of Electromagnetic Fields", publication number EPA/600/6-90/005B. This report contains analyses of 64 scientific

studies, and is currently under review by the Scientific Advisory Committee.

Well, that's enough background for now. Let's examine some of the theory behind how the ELF meter works.

Theory

The quantity of magnetic flux density, **B**, is in units of webers/meter², or tesla (T). The magnetic flux, ϕ , is defined by the integral

$$\phi = \int \mathbf{B} \cdot d\mathbf{s} = \mathbf{B} \times \mathbf{A}$$

where $d\mathbf{s}$ is the differential surface area and **A** is the area that the coil encloses.

For a coil immersed in a field, the induced open-circuit voltage, **E**, is equal to the number of turns of a coil, **N**, times the rate of

change of flux through it.

$$E = N \times d\phi/dt$$

Note that the value of $N \times d\phi/dt$ is actually negative with respect to the induced voltage value, but for our purposes we will just consider the magnitude of the product. The direction of the induced current is such that its own magnetic field opposes the changes in flux responsible for producing it.

If we substitute for ϕ we get

$$E = N \times A(d\mathbf{B}/dt)$$

If the magnetic field of a sine wave is $\mathbf{B} = a(\sin \omega t)$, **a** is the amplitude in teslas and ω is the angular velocity ($2\pi f$), then

$$d\mathbf{B} = a\omega(\cos \omega t)dt, \text{ and}$$

$$E = N \times Aa\omega(\cos \omega t)$$

Since $\cos \omega t$ varies from +1 to -1, the peak magnetic field is defined as

$$E = N A a \omega$$

For a frequency of 60 Hz, ω equals

$$2\pi \times 60 = 377$$

For a coil size of $3\frac{1}{2}'' \times 3''$, the area is .0068 m², and therefore

$$E = 2.56 N \times a$$

For the 12-turn pickup coil that we'll use, the sensitivity is 30 μ V per μ T.

Circuit description

The meter's 12-turn field pickup is integrated into the unit's circuit board. For remote sens-

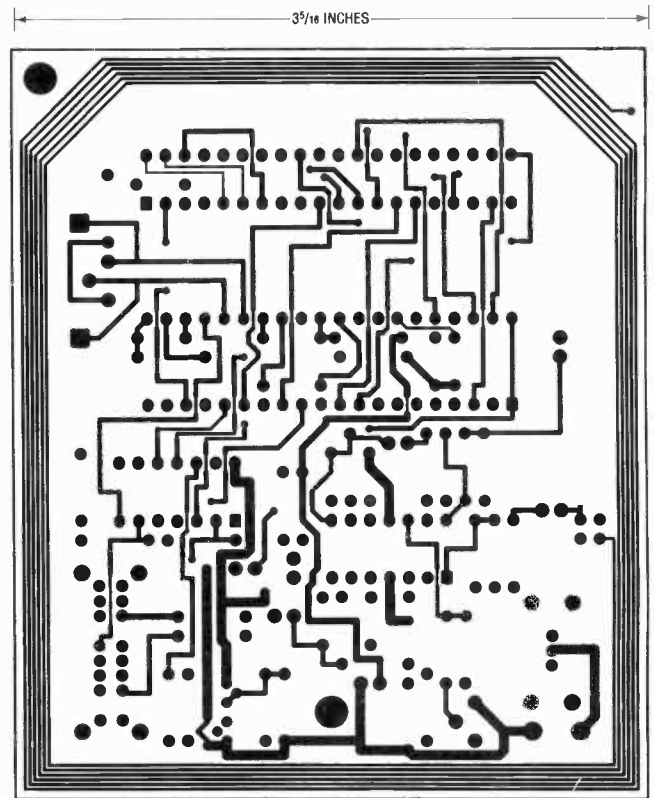
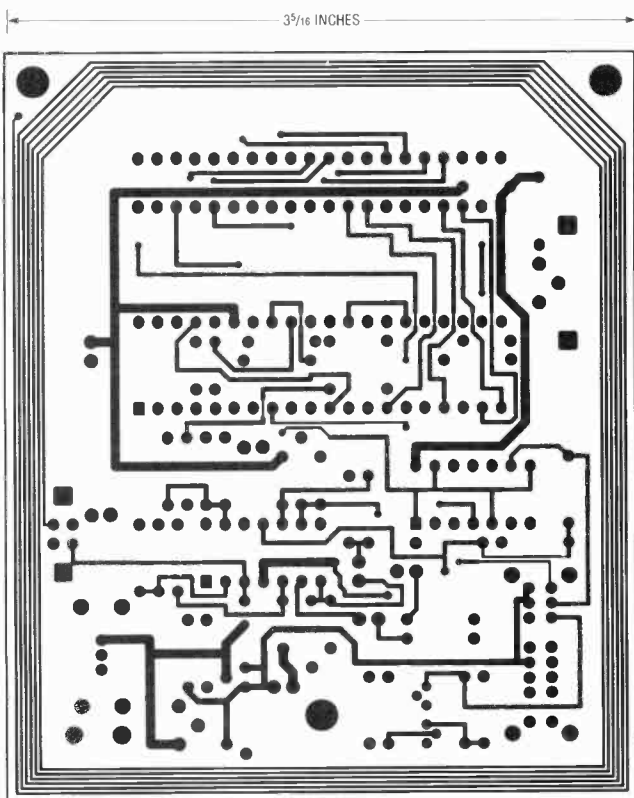

SOURCES OF MAGNETIC FIELD EXPOSURE

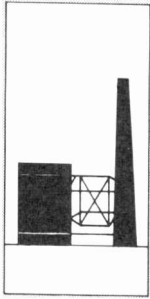

POWER GENERATING STATION
(20KV), 3.0mT

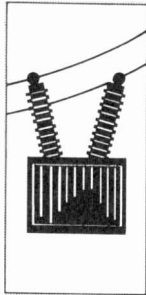

STEP-UP TRANSFORMER
5-20 μ T

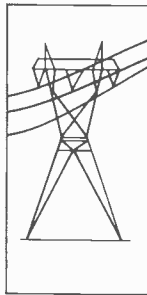

TRANSMISSION LINES
(69-765KV)
5-70 μ T, WITH
MAGNETIC FIELD DROP-OFF
AT $1/r^2$

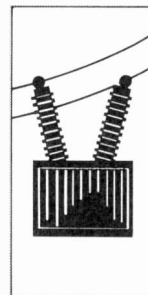

STEP-DOWN TRANSFORMER
5-20 μ T

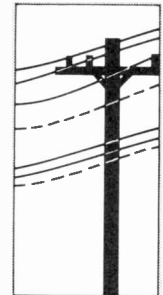

PRIMARY DISTRIBUTION LINES
(4-35KV)
1-5 μ T, WITH MAGNETIC
FIELD DROP OFF AT $1/r^2$

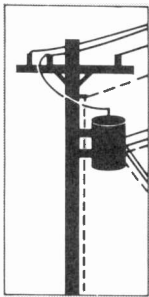

**DISTRIBUTION
STEP-DOWN TRANSFORMER**
0.1-1 μ T, WITH A
FAST MAGNETIC FIELD
DROP-OFF AT $1/r^3$

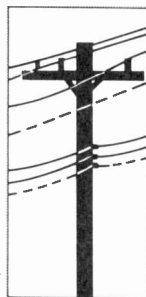

SECONDARY DISTRIBUTION LINES
(115/230V)
0.1-1 μ T, WITH A SLOW
MAGNETIC FIELD DROP-OFF
OF $1/r$ (DUE TO UNBALANCED
PHASE AND NEUTRAL LINES)

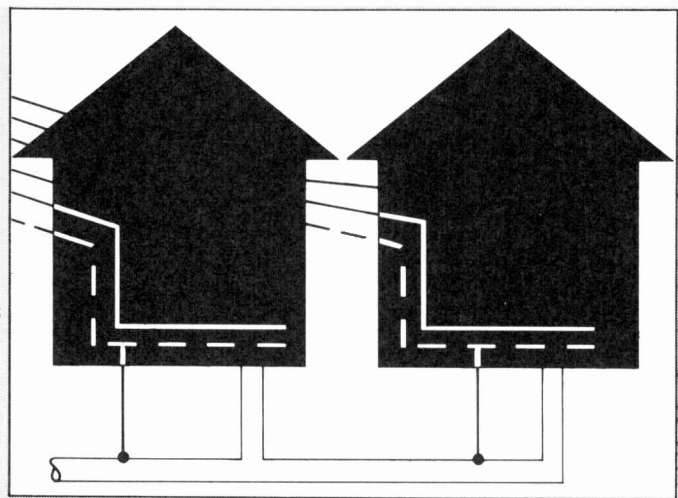

ELECTRIC UTILITY GROUND
HOUSEHOLD WATER PIPES
CARRY RETURN CURRENT AND
CREATE UNBALANCED FIELDS.
GROUND CURRENTS CAN BE
A PRIMARY SOURCE OF CONTINUOUS
EXPOSURE IN SOME HOMES, WITH
A SLOW DROP-OFF
AT $1/r$

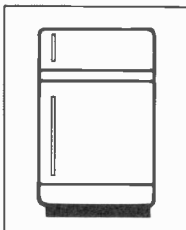

REFRIGERATOR
0.1-1 μ T, SOURCE
OF MAGNETIC FIELD
IS FROM MOTOR IN
BACK OF THE APPLIANCE,
SO EXPOSURE IS LOW, DROP-OFF
IS $1/r^3$

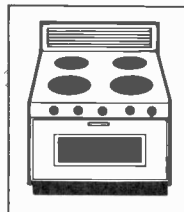

ELECTRIC RANGE
6-200 μ T, MAJOR SOURCE
OF MAGNETIC FIELD
IS RESISTIVE HEATING
ELEMENTS, DROP-OFF
IS $1/r^3$

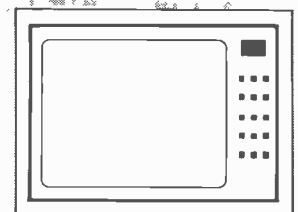

TELEVISION
2-50 μ T, MOSTLY
RF FIELDS BUT
POWER TRANSFORMER
AND VERTICAL SWEEP
PRODUCE MAGNETIC FIELDS,
DROP-OFF IS $1/r^3$

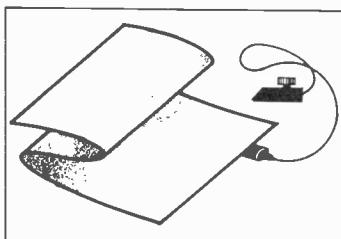

ELECTRIC BLANKET
1-5 μ T, HEATING ELEMENTS
ARE CLOSE TO BODY, AND FIELD
EXPOSURE CAN LAST OVERNIGHT,
DROP-OFF IS $1/r^2$

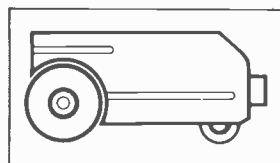

VACUUM
200-1000 μ T,
DROP-OFF IS $1/r^3$

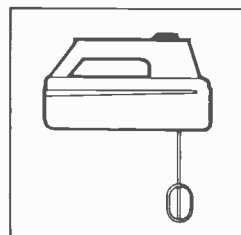

MIXER
50-600 μ T, DROP-OFF
IS $1/r^3$

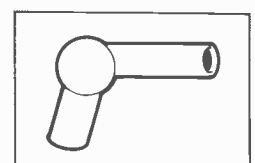

HAIR DRYER
10-2000 μ T, DROP-OFF
IS $1/r^3$

FIG. 2—HERE ARE SOME PRIMARY SOURCES of magnetic field exposure with the range of field intensity in teslas, and drop-off rates.

ing, an external field coil probe can be used. Figure 3 shows the complete schematic of the circuit. The magnetic field picked up by the coil appears as a voltage, which is proportional to field strength and frequency at the input of a cascaded amplifier IC3-a, -b, and -c. With a first stage amplifier gain of 3.3 set by R12-R10, the overall sensitivity is 100 μV per μT , or 100 mV per mT. The meter sensitivity is nominally 2 volts full scale, leading to the lowest level sensitivity of 20 mT full scale.

Op-amp IC3-a amplifies the signal to a normalized level of 100 μV per 1 μT . That voltage is further amplified by 1, 100, or 10,000 by IC3-b and -c. The three amplifier stages provide the three magnetic field ranges of 2 mT, 200 μT , and 2 μT (full scale). Components R3-C3 and R12-C7 establish a frequency roll-off characteristic that compensates for the frequency-proportional sensitivity of the pickup coil, and set the 20-kHz cut-off point.

Finally, IC3-d is a precision rectifier and peak detector. Its output drives IC1, a combination analog-to-digital (A/D) converter and LCD driver. Components R25-R29 and C13-C17 are used by IC1 to set display-update times, clock generation, and reference voltages. The decimal points are driven by IC2, as determined by the range-select switch S2. Transistors Q1 and Q2 serve as a low-battery detector, and turn on the battery annunciator in the LCD when the battery voltage drops below 7 volts.

Assembly and checkout

The finished unit shown in Fig. 4 uses a double-sided PC board, which is available from the source mentioned in the parts list. We also show the component side and solder side of the PC board if you choose to make it yourself. You can, however, build the circuit on a perforated construction board if you like, but remember to include the 18-turn remote sensing coil, L1, as indicated in the Parts List. Mount all parts below the LCD display first. It's easier to fix assembly problems if a socket is used with the LCD. Install all parts as shown in Fig. 5 paying attention to component valves and capacitor polar-

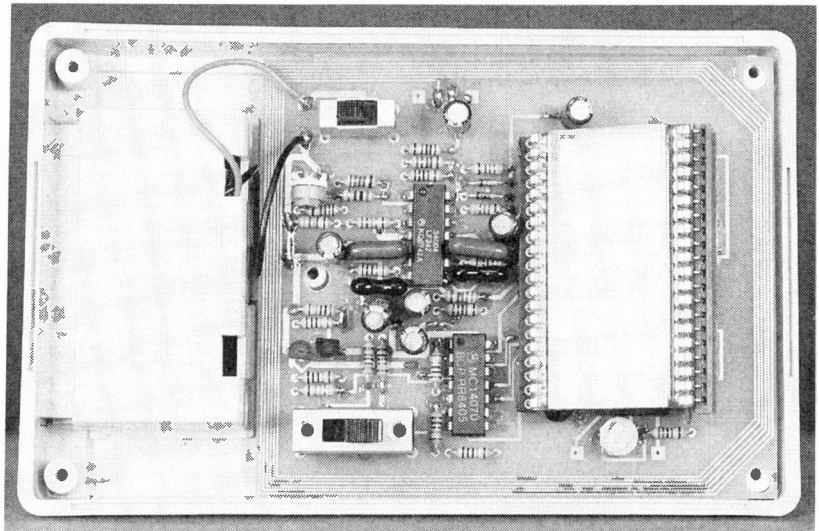

FIG. 4—THIS IS AN INTERNAL VIEW of the magnetic field meter. Assembly is easy, just install all components below the LCD first.

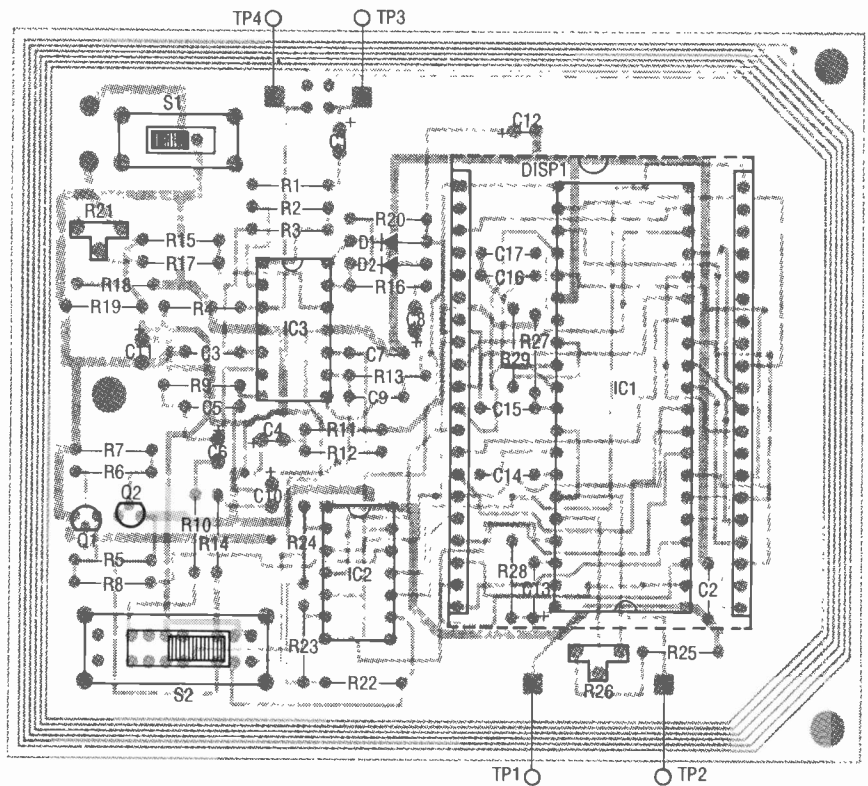

FIG. 5—PARTS PLACEMENT DIAGRAM.

ities. If you are using the internal sensing coil, install jumpers between L1-TP3 and L1-TP4.

If you are using the case specified in the parts list, raise and angle the display as necessary with wire-wrap IC sockets. Make holes in the front panel for S1 and S2. Mount the finished PC board in the case using a spacer for the single screw holding the center bottom of the board, and attach

the battery connector. You are now ready for power-up and checkout.

With power on, adjust R26 for 1.000 volt between TP1 and TP2. Then, select the 20 mT range and short the pickup coil with a very short lead between TP3 and TP4. Adjust offset-null potentiometer R7 for a display of 0.00. Remove the jumper, and the meter is complete.

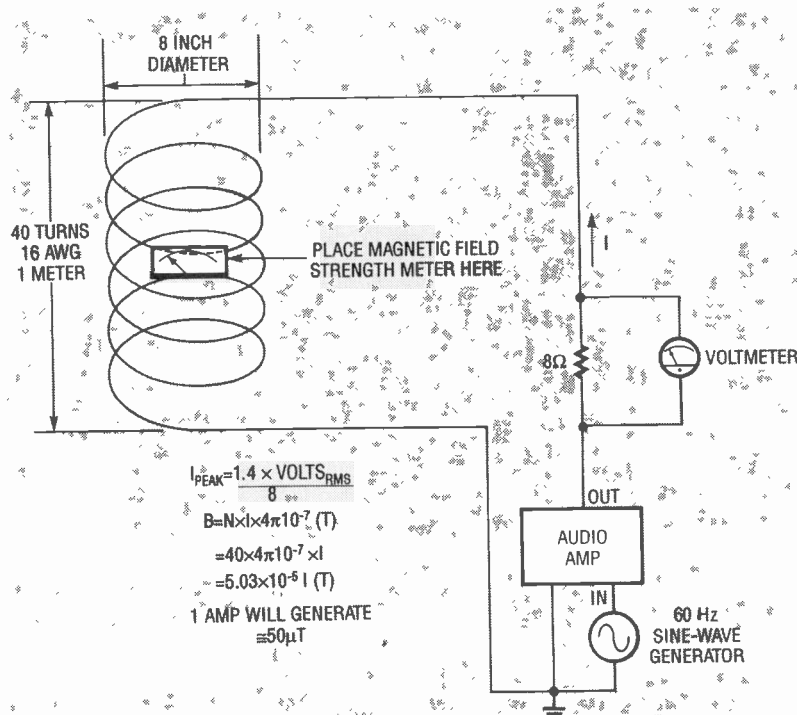

FIG. 6—USE THIS TEST SETUP TO accurately calibrate your meter. A known current is passed through a coil whose field intensity is known. A sine-wave generator provides the 60 Hz frequency, and an audio amplifier is coupled to the coil by an 8-ohm resistor. Measure the voltage across the resistor, and use the calculations shown.

Calibration

Calibration of the meter is basically determined by the pick-up-coil characteristics, amplifier gains, and meter reference-voltage setting. The amplifier gains, as we previously discussed, are chosen to match the coil characteristics as closely as possible.

If you desire to calibrate your meter more exactly, you will need to generate a known magnetic field intensity. One way to do that is to pass a known current through a coil configuration whose field pattern characteristics are known. Figure 6 shows such a calibration setup. A good controllable signal source is a sine-wave generator and an audio amplifier, whose output is coupled to a coil through an 8-ohm resistor. Measuring the voltage across the resistor gives the current. Then, calculate the magnetic field according to Fig. 6. (Note that while all references to field strength here are made in teslas, gauss are also commonly used. The conversion is easy: 1 tesla = 10,000 gauss.)

Place the meter inside the coil and turn it on. Use the highest sensitivity scale that does not overrange the display. An over-

range is indicated by a display of 1 followed by three blanks. In most cases, the 2 μT range is satisfactory.

Measurement interpretation

A great deal of controversy exists in the emerging understanding of potential health hazards of low-frequency magnetic fields. The International Radiation Protection Association (IRPA) has set some interim standards based on 1984 World Health Organization guidelines. Those IRPA standards specify a continuous maximum magnetic field exposure for the general public of 100 μT , and 500 μT as the maximum occupational exposure allowed over the entire working day.

Some European countries have already adopted strict magnetic field emission requirements for video display terminals, but the United States is taking a more cautious approach about developing and enforcing such guidelines.

Whatever studies and data you think are accurate, now you have a way to measure your own exposure and take whatever action you believe is prudent. **R-E**

rate digital readings when it is unscaled.)

Select the dual-channel mode, couple channel B to ground, and align the trace so it lies on the 10% graticule marking. Select the time-measurement mode, and set the "begin" and "end" knobs so that the intensified trace section is as shown in Fig. 5. The digital display should show between 11 and 14 microseconds. (The display in Fig. 5 shows 12.83 microseconds.)

If you measure, say, 9 microseconds, instead of 11–14 microseconds, even though the peak-to-peak value, the DC voltage, the wave shape, and the frequency are correct, the TV will work for awhile, but will more than likely fail at some point. That's because the horizontal output system sees a 35.7% reduction in retrace time—meaning that retrace is faster and generates higher voltage. Therefore, the horizontal output transistor is on longer at full-scan conduction, producing increased heat, increased scanner-derived power supply levels, and higher voltages throughout the set. All the circuits are now stressed working at the higher voltages. That, in time, will cause components to fail.

Your scope can also be used to watch for an instantaneous start-up pulse. Simply connect the scope and preset it to view the HOT pulse. Then, watch the CRT as you apply power to the TV's circuitry. If you see a pulse appear and then disappear, your start-up circuitry is operating and the set is in the shut-down mode.

If that happens, service the chassis in a "powered-down" condition by either halving the normal B+ level separately, or reducing the AC input power to 60–90 VAC. Then monitor the collector of the horizontal output transistor with your scope.

Many underlying performance problems can be uncovered by examining specific characteristics of the "HOT pulse." The waveform shape, symmetry, and duty cycle of horizontal output transistor is critical in diagnosing and troubleshooting electrical malfunctions in your TV set. **R-E**

**This solid-state
electronic
compass uses
Hall-effect sensors
to keep you
heading in
the right
direction.**

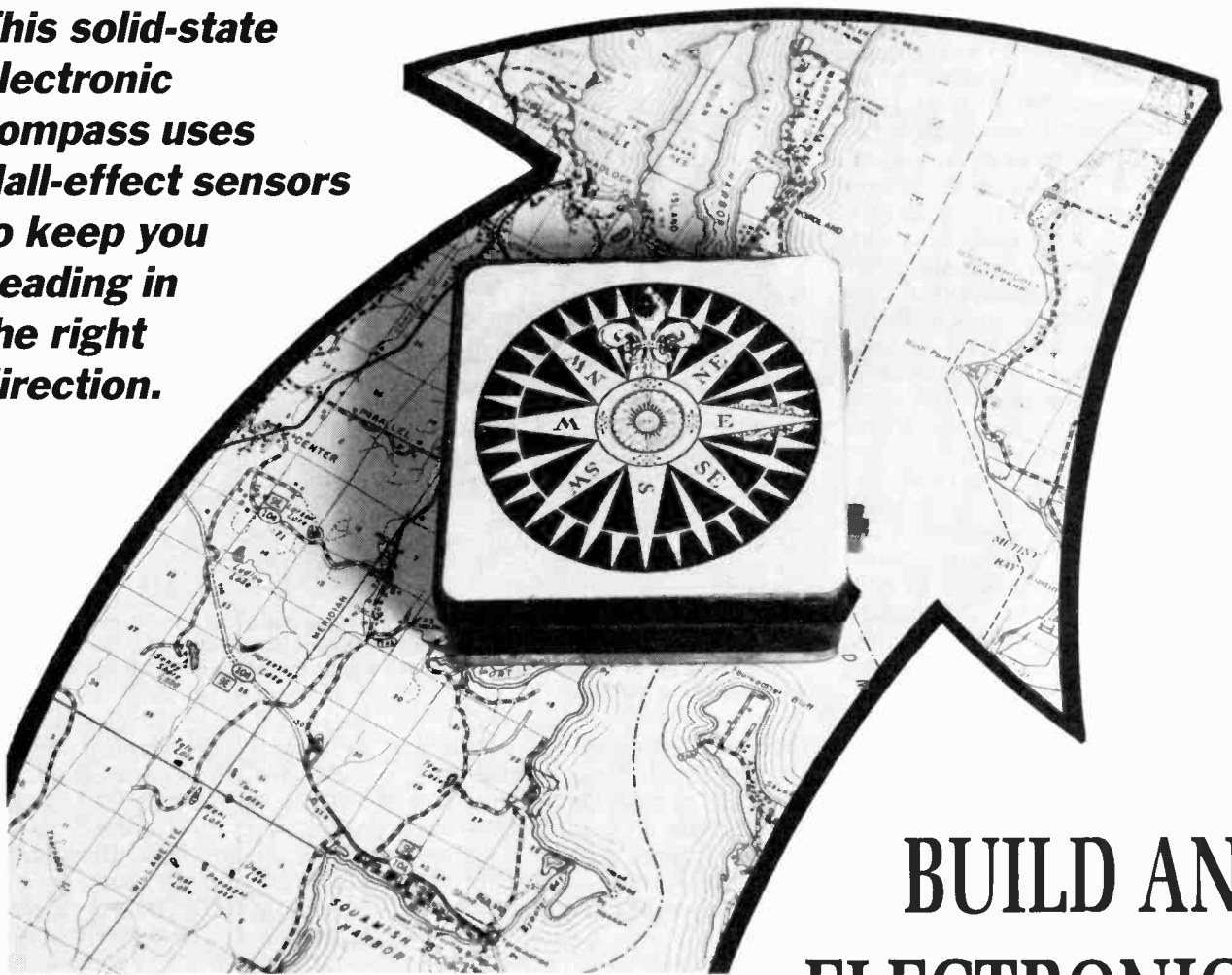

BUILD AN ELECTRONIC COMPASS

ANTHONY J. CARISTI

MOST OF US HAVE AT ONE TIME OR another used a common magnetic compass, which often consists of a light-weight balanced magnet suspended on a pivot. The magnet, free to rotate, is affected by Earth's magnetic field, and assumes a position in which its north-seeking pole points to Earth's magnetic north pole. The geographical north pole of Earth is offset from the magnetic north pole by about 10 or 15 degrees in most areas of the United States.

Many low-cost compasses leave something to be desired in their performance, which can be affected by any tilt of the case or friction in the pivot. However, with the development of solid-state magnetic detecting devices, called Hall-effect generators, it is possible to construct a low-cost, reliable magnetic compass which

has no moving parts and eliminates the disadvantages of inexpensive mechanical types. Because the project contains no moving or mechanically sensitive parts, it is an extremely rugged device that can tolerate all potential stresses encountered when hiking or traveling through rough terrain. Taking a reading on the compass is quick, easy, and very reliable.

This solid-state compass uses a unique detection system that produces two sharply defined points centered on the direction of magnetic north, as indicated by an LED. That permits a quick, accurate reading. The project, housed in a plastic enclosure, is small and lightweight, and is powered by a common 9-volt battery. Since the compass circuit is energized only when it is used to take a reading, the battery's useful life approaches that of its shelf life.

About the circuit

Development of a magnetically sensitive solid-state compass is made possible through a phenomenon called Hall effect, which was discovered in 1879 by Edwin Hall; he observed that a small voltage was developed at the edges of a current-carrying gold foil when the foil was exposed to a magnetic field. Solid-state technology now provides small, low-cost Hall-effect devices, which are very sensitive and able to detect Earth's extremely weak magnetic field.

The basic Hall-effect sensor, shown in Fig. 1, is a small sheet of semiconductor material in which a bias current flows. The Hall-effect output of the sensor takes the form of a voltage measured

across the width of the conducting material, and will be negligible in the absence of a magnetic field. If the biased Hall sensor is placed in a magnetic field with the flux at right angles to the flow of current, a voltage output directly proportional to the intensity of the magnetic field is produced. Additionally, the voltage will be a function of the angle between the lines of force and the plane of the sensor. Maximum Hall-effect output voltage occurs when the face of the sensor is at right angles to the lines of force, and zero voltage is produced when the lines of force are parallel to the face of the sensor.

The Hall-effect sensor is further enhanced by using integrated-circuit technology to add a stable high-quality DC amplifier to the device. It then provides a usable linear output voltage which is sensitive enough to react to Earth's magnetic field (about 1/2 Gauss).

Referring to the schematic in Fig. 2, The Hall-effect generators (IC3 and IC4) are three-terminal linear devices which are driven by a regulated 5-volt supply provided by fixed-voltage regulator IC1. The output of each of the sensors is a DC voltage that varies linearly from a quiescent value of 2.5 volts as their position with respect to the lines of force of the magnetic field changes. A typical sensor has an output-voltage sensitivity of about 1.3 millivolts per Gauss.

Two Hall-effect generators are used in the circuit to provide

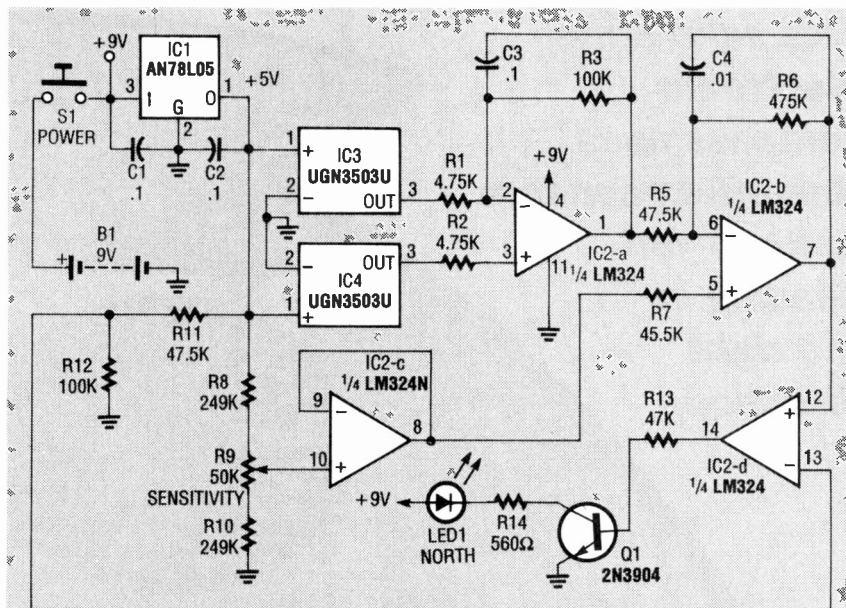

FIG. 2—TWO HALL-EFFECT GENERATORS provide twice the sensitivity of a single sensor. The two devices are physically oriented in opposite directions so that the change in output voltage of one sensor will be positive while that of the other will be negative as the compass is rotated.

twice the sensitivity of a single sensor. The two devices are oriented in opposite directions so that the change in output voltage of one sensor will be positive while the change in the other will be negative as the compass is rotated.

The voltage differential between the two output terminals of the sensors is a representation of the magnetic field intensity and direction. The voltage differential produced by the Hall generators is fed to a differential amplifier, IC2-a. As a result, the output of IC2-a (pin 1) will be a minimum (null) when the compass is facing the magnetic north pole, and a maximum when it faces the south pole.

The change in output voltage of IC2-a is too small to allow a simple method of determining the null voltage as the compass is rotated. Therefore, IC2-b is used as an inverting amplifier with a gain of 100 to further increase the change in voltage. A DC offset, provided by sensitivity-adjust potentiometer R9 and voltage follower IC2-c, permits the DC output voltage of IC2-b to be set to a usable level to drive the next stage.

Op-amp IC2-d is used as a voltage-comparator with a fixed reference of about 3.4 volts fed to its negative input. Thus, when the output of IC2-b fed to the positive

input of the comparator exceeds the 3.4-volt reference level, the output of IC2-d (pin 14) goes high, applying forward bias to Q1. That in turn illuminates LED1 to indicate that a voltage exceeding the reference exists at IC2-b pin 7. The use of a voltage comparator to detect the change in output voltage of IC2-b (pin 7) produces two sharply defined points and allows a more accurate determination of the magnetic north pole.

As shown in Fig. 3, the LED will be illuminated over a small arc as the compass is rotated full circle, and will remain off over the rest of the 360-degree span. The sensitivity control (R9) allows adjustment of the width of

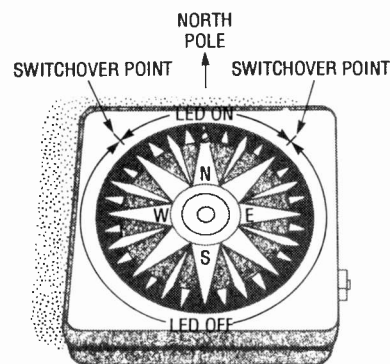

FIG. 3—THE LED WILL BE ILLUMINATED over a small arc as the compass is rotated full circle. True magnetic north is the position at the center of the arc.

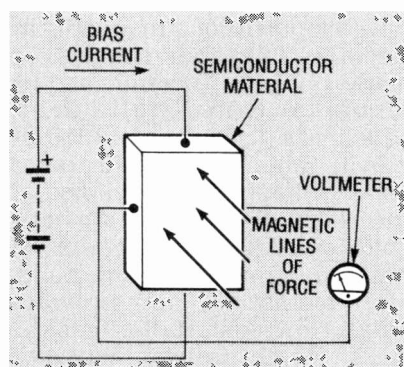

FIG. 1—THE BASIC HALL-EFFECT sensor is a small sheet of semiconductor material in which a bias current flows. The output voltage, measured across the width of the conducting material, is negligible in the absence of a magnetic field. If placed in a magnetic field, the output is directly proportional to the intensity of the magnetic field.

the arc. Once the two LED switching points are determined, true magnetic north is then the position at the center of the arc.

Power is provided by a common 9-volt battery. The circuit draws about 25 mA and, since it's usually powered for only a few seconds at a time, battery life is extremely long; several hours of continuous compass operation is also possible. Circuit stability with a falling battery voltage is ensured by the 5-volt regulator, IC5. When the battery is exhausted and cannot deliver sufficient current to operate the circuit, the LED will appear dim or will not illuminate at all.

Construction

The circuit, when built on the printed circuit board (for which we have provided the foil pattern), is very compact; the prototype is housed in a 2½-inch square by 1-inch high plastic enclosure, that has sufficient room to accommodate both the board and the 9-volt battery. A metal enclosure must *not* be used for this project—it can attenuate or distort Earth's weak magnetic field. The power switch and sensitivity control are mounted on the side of the enclosure to allow easy operation of the compass.

Figure 4 shows the parts layout. The position of all polarized components (especially the Hall sensors) must be followed exactly as shown. The operation of the project depends upon the Hall generators being placed in opposite directions and exactly parallel as indicated in Fig. 4. Note that the orientation of the sensors is determined by the marked face of the device, with pin 1 being on the left side when looking at the markings. The sensors must be positioned so that they are aligned square with the rectangular shape of the printed circuit board. That way the compass direction will be accurate when the project is assembled into the enclosure. (Use the "north" indication of Fig. 4 to determine the relationship between the PC board and compass scale when final assembly is done.)

Many of the resistors specified in the parts list are metal-film types. The use of such components ensures maximum sta-

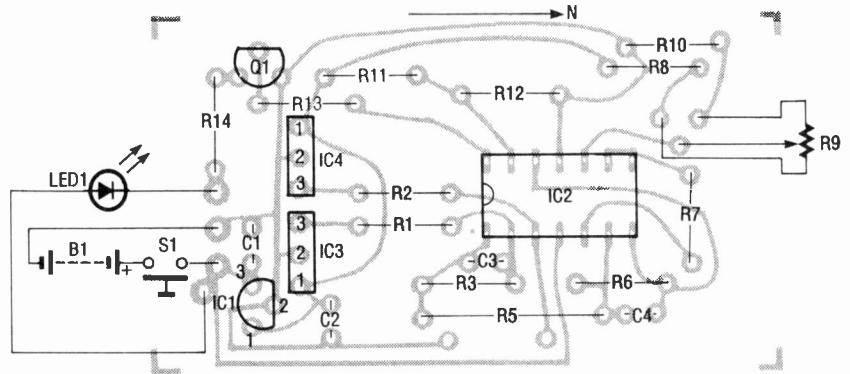

FIG. 4—PARTS PLACEMENT DIAGRAM. The Hall generators must be placed in opposite directions and exactly parallel as shown. Pin 1 of the Hall sensors is on the left side when looking at the markings on the face of the device.

PARTS LIST

All resistors are ¼-watt, 5%, unless otherwise noted.

- R1, R2—4750 ohms, 1% metal film
- R3, R12—100,000 ohms, 1% metal film
- R5, R7, R11—47,500 ohms, 1% metal film
- R6—475,000 ohms, 1% metal film
- R8, R10—249,000 ohms, 1% metal film
- R9—50,000-ohm, potentiometer
- R13—47,000 ohms
- R14—560 ohms

Capacitors

- C1—C3—0.1 μ F, 50 volts, ceramic disc
- C4—0.01 μ F, 50 volts, ceramic disc

Semiconductors

- IC1—AN78L05 5-volt regulator
- IC2—LM324N quad op-amp
- IC3, IC4—Sprague UGN3503U Hall generator

LED1—red light-emitting diode

Q1—2N3904 NPN transistor

Other components

- B1—9-volt alkaline battery
- S1—SPST pushbutton switch, normally open

Miscellaneous: Plastic enclosure, battery clip, control knob, IC socket, wire, solder, etc.

Note: The following items are available from A. Caristi, 69 White Pond Road, Waldwick, NJ 07463: An etched and drilled PC board, \$9.95; set of two Hall sensors, \$9.75; IC1, \$2.00; IC2, \$2.00; set of 10 metal-film resistors, \$4.95. Please add \$3.00 postage/handling.

bility of the circuit with varying ambient temperature changes, and reduces the need to periodically adjust the sensitivity control. Ordinary carbon re-

sistors are not temperature-stable and should not be used in place of metal-film types. Also, it's a good idea to use a socket for IC2.

It is recommended that you use a miniature momentary pushbutton switch for S1. That will ensure that battery power will never be inadvertently left on when the project is not in use. The sensitivity control, R9, may be placed on the side of the enclosure to allow circuit adjustment when necessary. You should use a battery clip for B1. If desired, a suitable clip can be obtained from a discarded 9-volt battery (just peel away the metal case and rip the top off). Be very careful to wire the battery clip with the correct polarity.

When the circuit board is completed, examine it very carefully for shorts, opens, and cold solder joints. It is much easier to correct problems at this stage rather than later on if you discover that your project does not operate. A photo of the finished board is shown in Fig. 5.

Use a photocopy of the artwork in Fig. 6 for the top of the compass; you can simply glue it in place. Indicator LED1 is placed at the north indication of the compass by drilling a suitable size hole in the plastic top where the letter N would be. Be very careful when drilling; some plastics will shatter if subjected to excessive stress. Be sure to properly orient the top of the enclosure in accordance with the final position of the PC board.

Checkout

When you are satisfied that all wiring is complete and correct,

the checkout procedure must be performed, and be sure to use a fresh 9-volt battery. Checkout requires a DC voltmeter connected to ground and the output terminal of IC1. Apply power to the circuit check for +4.75 to +5.25 volts. Measure the resistance between the 5-volt bus and ground; a normal reading is about 600 ohms. Measure the terminal voltage of the battery to be sure that it is delivering at least 7 volts under load to IC1. Replace a weak battery if necessary.

Next, measure the output voltage of IC2 pin 1, and verify the voltage range of potentiometer R9. (Compass orientation is not important at this time.) The voltage should be about 2 to 3 volts DC. Measure and record the DC voltage that you observe at IC2-a pin 1.

Measure the voltage change at IC2-c pin 8 as the sensitivity control is rotated over its entire range. The difference between the highest and lowest readings should be about 0.45 volts. Ideally, the center of the measured voltage range should be close to the voltage recorded earlier at IC2 pin 1.

If necessary, change the value of R8 and/or R10 so that the voltage range obtained at IC2-c pin 8 is somewhat centered about the voltage reading at IC2-a pin 1. This ensures proper adjustment range of the sensitivity control for the particular pair of Hall generators that are used in your compass project.

Once the sensitivity range is correct, rotate R9 over its range while observing the LED. At one end of the setting, the LED should be extinguished, and at the other end it should be illuminated; if not, check the polarity of LED1 and the orientation of Q1. Check pin 14 of IC2-d to be certain it swings from about zero to battery voltage as R9 is rotated over its range. Check pin 13 of IC2-d for a voltage of about 3.4 volts as set by R11 and R12. Problems in this area may warrant replacing IC2 if everything else checks out alright—check your soldering before changing the IC.

When the LED operates as described, the project is ready to be tested under actual operating conditions. Before you start, make sure that there are no mag-

netic fields nearby, and the project is not shielded by a large mass of iron or steel.

While holding the unit horizontally in any direction, apply power and carefully adjust R9 so that the LED is at the switch-over point between on and off; allow at least 10 seconds for the circuit to stabilize. Flicker of the LED is normal as the circuit switches back and forth. Once R9 is set, rotate the compass over a 360-degree arc (full circle) and note that the LED will be on over part of the arc, and off over the rest. If necessary, readjust potentiometer R9 very slightly to obtain this result. The optimum setting for R9 will be at the point where the arc of illumination is as small as possible.

As the compass is rotated over the illuminated arc, note the two on/off points. When the compass is positioned halfway between those points, it is facing the magnetic north pole, and the scale indications on its face indicate all other directions.

Using the compass

Always be sure that the battery is reasonably fresh, and take along an extra one before starting out on an excursion with the compass. (A weak battery will be indicated by a dim or totally unlit LED.) Avoid taking a compass reading in any area where there may be a magnetic field from a nearby device, or where Earth's magnetic field is shielded by a large mass of metal.

Hold the compass in a horizontal position and rotate it full circle while observing the LED. Adjustment of the sensitivity control is indicated if the LED is totally on or totally off as the compass is rotated. Always allow at least 10 seconds operating time for the circuit to stabilize. Once the sensitivity control is adjusted, it should not require readjustment unless the project is subjected to an extreme change in temperature.

Don't forget that the electronic-compass circuit can be used for things other than a simple direction finder. It provides an electronic means of finding north, so it should be easy to interface the compass to other devices that may need to know where north is—a robot, for example. R-E

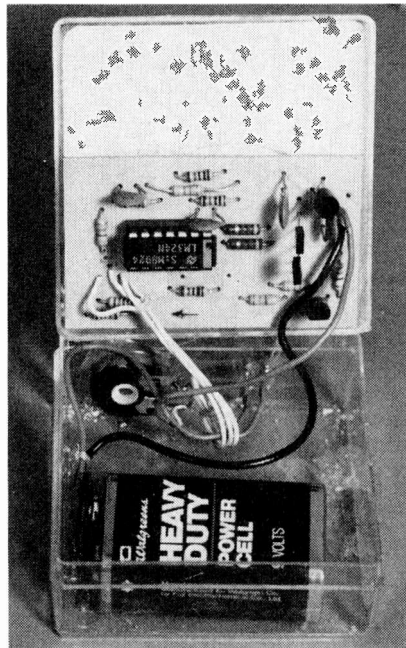
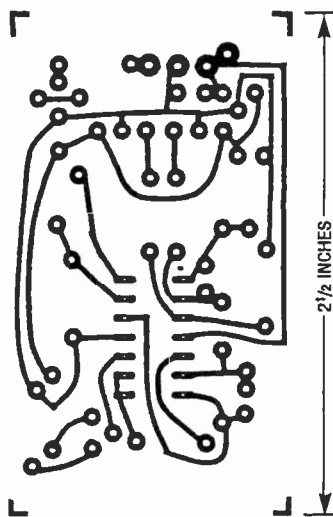

FIG. 5—EXAMINE THE COMPLETED board for shorts, opens, and cold solder joints before installing it in a plastic case.



FIG. 6—USE A PHOTOCOPI of this artwork for the top of the compass, and glue it in place on top of the case.



FOIL PATTERN for the electronic compass, shown actual size.

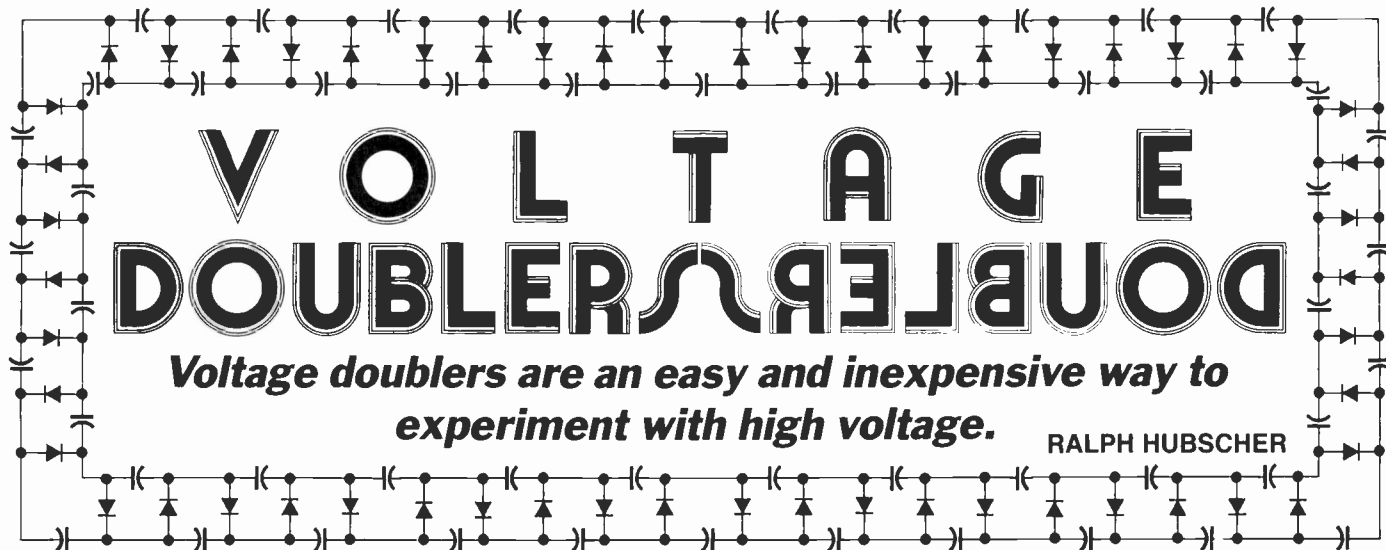

VOLTAGE DOUBLERS

Voltage doublers are an easy and inexpensive way to experiment with high voltage.

RALPH HUBSCHER

IF YOU'VE BEEN LOOKING FOR A WAY to generate high voltage, you've undoubtedly run across the voltage doubler. Voltage doubling using diode-capacitor combinations is a common practice. However, whole banks of doublers, called cascades, can also be used for producing extremely high DC voltages from moderate to high AC voltages. Such high DC voltages may be needed for TV sets, lasers, air purifiers, industrial smoke-stack dust removers, negative-ion generators, and, of course, for experimenting, on which we'll concentrate here.

Half-wave doubler

Figure 1 shows a half-wave voltage doubler; we'll assume that C1 and C2 are initially discharged. During the first half-cycle shown in a, the upper input terminal is positive and the bottom negative, so D1 conducts and C1 charges to about 170 volts peak. Diode D2 can't conduct, since it's back-biased, so C2 discharges through R_L . In the second half-cycle (b), the analysis is similar, except that D2 conducts and C2 charges.

The circuit is really a transformerless voltage amplifier. While T1 can provide isolation, as well as increase the AC voltage initially going into the doubler, the amplification due to the doubling action would occur without it. When the polarity reverses, both the input voltage and the charge across C1 are in series like two batteries, producing about 340 volts peak. One problem, though, is that a half-wave doubler can't be used with a load that draws much current.

Full-wave doubler

Let's see how a full-wave voltage doubler is related to and built from both positive and negative half-wave rectifiers. Figure 2-a shows a half-wave rectifier with a positive output, Fig. 2-b shows the same version with a negative output, and Fig. 2-c shows the two combined into a full-wave voltage rectifier.

The full-wave voltage doubler shown in Fig. 3 has been redrawn for greater clarity; it has better regulation than a half-wave version, and is easier to filter. The circuit produces nearly double the peak AC voltage of 170 volts, or about 340 volts peak across R_L . For the first half-cycle (a), D2 is cut off and D1 conducts, so that V_{C1} equals approximately 170 volts DC. On the next half-cycle (b), the positive voltage is replaced by a negative voltage, so D2 conducts and D1 is cut off. R_L goes across C1 and C2 in series, effectively creating a doubled level of about 340 volts DC.

Warning!! This article deals with and involves subject matter and the use of materials and substances that may be hazardous to health and life. Do not attempt to implement or use the information contained herein, unless you are experienced and skilled with respect to such subject matter, materials, and substances. Neither the publisher nor the author make any representation as for the completeness or accuracy of the information contained herein, and disclaim any liability for damages or injuries, whether caused by or arising from the lack of completeness, inaccuracies of the information, misrepresentations of the directions, misapplication of the information, or otherwise.

Unlike the half-wave voltage doubler, the full-wave version has two capacitors across R_L rather than one. Whereas C1 shown in Fig. 1 is cut off and unsupplied for half of every cycle, C1 and C2 in Fig. 3 are supplied on alternate half cycles. When the capacitor corresponding to the diode that's cut off discharges, it can only do so through the capacitor being supplied, slightly decreasing both its current and the maximum voltage it reaches.

Measuring high-voltage DC

Voltage measurements will be possible only to about the second or third stage of a cascaded voltage doubler with most voltmeters. Beyond that, you'll need to use either a high-voltage DC meter or an external voltage divider for use with a standard high-impedance voltmeter (10 megohms or more).

A good voltage divider that can be used for the purpose of high-voltage measurements is the RCA SK3868/DIV-1, a high-voltage DC divider; it's used in TV's to reduce the final anode voltage going to the CRT to the level required for the focus voltage. It consists of resistors R1 (200 megohms) and R2 (40 megohms) in series, as shown in Fig. 4. There are three leads, one for the free ends of each resistor, and the other at their juncture. If you put both a 10-megohm meter (shown as Z_M in Fig. 4) and a 2.7-megohm resistor (R3) in parallel with the 40-megohm resistor (R2), you can achieve almost exactly 100:1 range multiplication, for a full-scale deflection of 20 kilovolts DC.

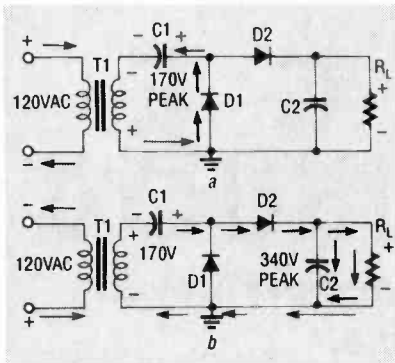

FIG. 1—HALF-WAVE VOLTAGE DOUBLER. During the first half-cycle (a), D1 conducts, D2 cuts off, C1 charges to 170 volts peak, and C2 discharges through R_L. For the second half-cycle (b), the input polarity is reversed, and both the input and C1 are in series, producing 340 volts peak. Now D1 cuts off while D2 conducts, and the current divides between C2 and R_L; the cycle then repeats.

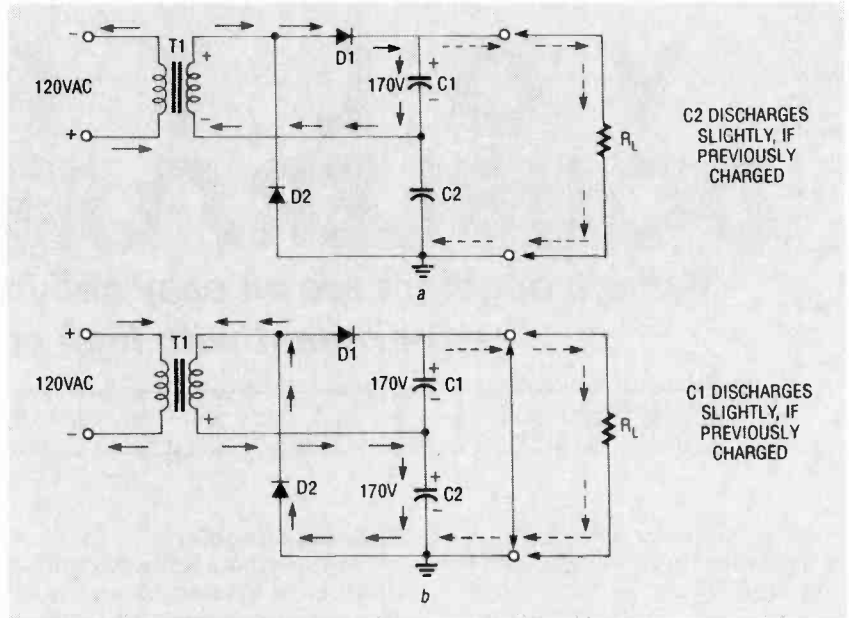

FIG. 3—FULL-WAVE VOLTAGE DOUBLER, redrawn for greater clarity. For the first half-cycle (a), D2 is cut off and D1 conducts, producing about 170 volts DC across C1. On the next half-cycle (b), D2 conducts and D1 is cut off. The output voltage is now across C1 and C2 in series, doubling the level to about 340 volts DC.

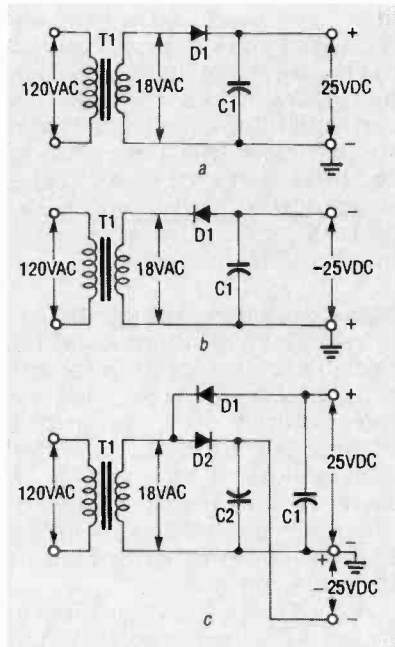

FIG. 2—TWO HALF-WAVE RECTIFIERS, one with a positive output (a) and one negative (b), combine to make a full-wave voltage doubler (c).

Cascaded voltage doublers

Figures 5–8 show four additional voltage doublers. The one shown in Fig. 5 is the most straightforward. If you build it, use 1N4007 diodes with peak inverse voltage (PIV) ratings of 1 kilovolt for D1–D6, and 0.068–0.1 μ F capacitors with working voltages of 400 volts DC. Figure 5 is electrically identical to the one in Fig. 6, so keep that in mind if you should come across either format. Figure 7 shows an extended version that's better

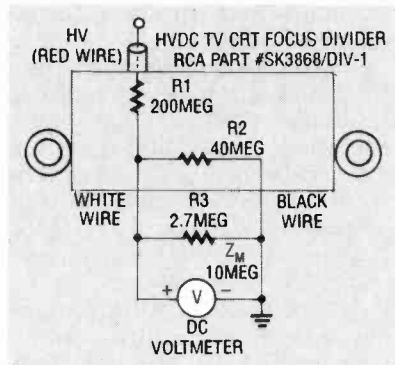

FIG. 4—TO MEASURE HIGH VOLTAGES with an ordinary 10-megohm meter, you can use the RCA SK3868/DIV-1 high-voltage divider. The circuit provides a 1:100 voltage division, allowing 20 kilovolts to be measured on a 200-volt scale.

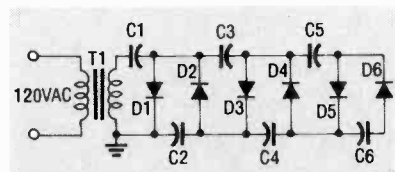

FIG. 5—THIS CASCADED DOUBLER uses 1N4007 diodes rated at 1 kilovolt PIV, and capacitors from 0.068–0.1 μ F with a 400-volt DC working voltage.

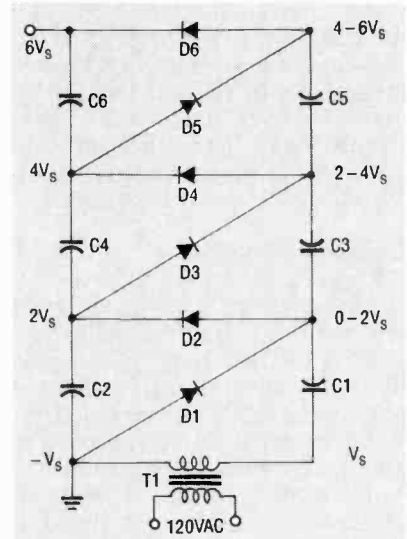

FIG. 6—THIS VOLTAGE DOUBLER is the same as the one shown in Fig. 5, although it's drawn differently. You should be able to recognize both versions.

sing noise. (We'll show you how to demonstrate the "wind" later on.) The circuit delivers 3.75 kilovolts DC when powered from 120 volts AC, or 7.5 kilovolts DC when powered from 240 volts AC.

The output of a cascaded voltage doubler should be terminated with no less than 200 megohms, and only then be allowed to extend beyond a protective plastic case, for safety. Voltages as high as 5 megavolts DC have been generated using

stabilized for moderate-current applications; it's called either a Cockcroft-Walton or Greinacher cascaded voltage doubler.

You can use a sewing needle as an emitter for the doubler shown in Fig. 8 to generate "corona wind." That will sound like a his-

cascaded voltage doublers, especially when operating in a pressurized atmosphere. The biggest advantage to using voltage doublers is that they use inexpensive low-voltage parts. Otherwise, if all the parts had to be of the high-voltage variety, you would have to use expensive and rather large capacitors like the one shown in Fig. 9.

If you have problems with the circuit in Fig. 8 (or any other high-voltage circuit), you must discharge every capacitor (we'll tell you how in a minute) before you check for malfunctions. When examining the circuit for problems, closely check the solder connections, and then the diode directions and continuity. The 1N4007's should have a resistance of 1.1K when forward-biased and be open when reverse-biased, while the capacitors

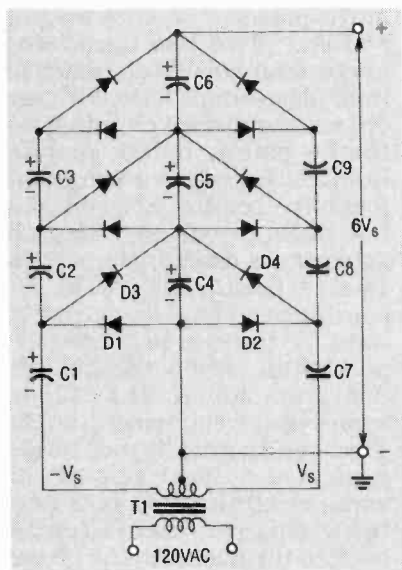

FIG. 7—THE COCKCROFT-WALTON, or Greinacher cascaded voltage doubler, has improved performance for moderate-current applications.

should all have infinite resistance.

To properly discharge capacitors, build a discharging wand like the one shown in Fig. 10. Use a 2-foot wooden (or plastic) dowel, and connect a stiff wire tip

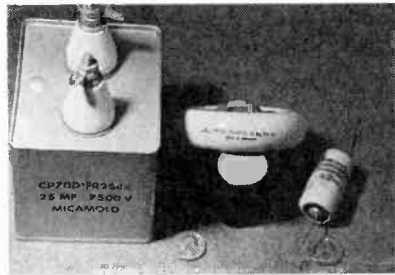

FIG. 9—HIGH-VOLTAGE CAPACITORS. A 0.25 μ F, 7.5-kilovolt capacitor is on the left; a 100 pF, 15-kilovolt capacitor is in the middle; and 0.0005 μ F, 5-kilovolt capacitor is on the right.

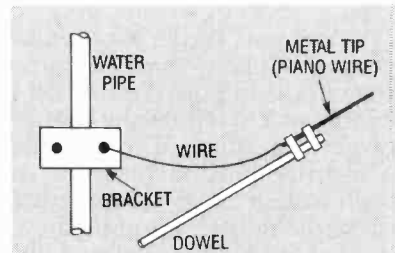

FIG. 10—A HIGH-VOLTAGE GROUNDING wand is used to discharge capacitors. A 2-foot wooden dowel is attached to a stiff wire tip. The metal tip must be connected to an earth ground, such as a cold-water pipe.

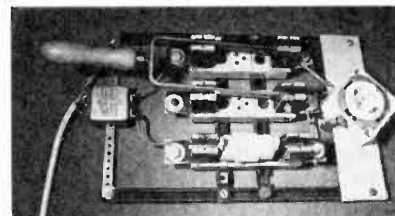

FIG. 11—HOMEMADE SWITCH for high-voltage DC. The line filter at left is a safety measure to keep high-voltage DC out of the house wiring.

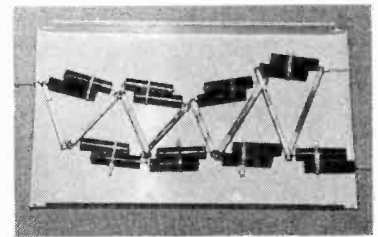

FIG. 12—A TYPICAL CASCADED voltage doubler. Note the wide spacings between the diodes, the long connecting wires, and the smooth solder joints.

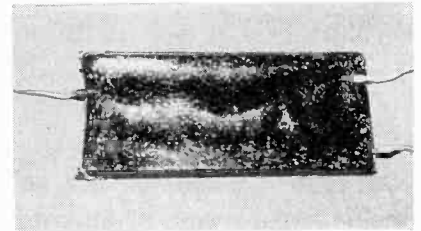

FIG. 13—THIS IS THE DOUBLER from Figure 12, after being sealed in candle wax. For better protection, you can immerse it in pure paraffin oil.

(piano wire works well) to a cold water pipe as earth ground with a good electrical connection. Discharge all capacitors twice, since they generally either hold charge, or tend to recharge from other capacitors. Don't use an AC line ground or chassis ground instead of an earth grounded water pipe, or you may blow a fuse or damage parts.

Figure 11 shows a switch for high-voltage DC that you can use with any of the cascaded voltage-doublers shown here; standard switches may present a shock hazard. Also, use an electromagnetic interference (EMI) line filter like the one seen at left in the photo to keep high-voltage DC out of house wiring, and to prevent shock from static charge. The EMI filter is from Corcom Corp. (1600 Winchester Road,

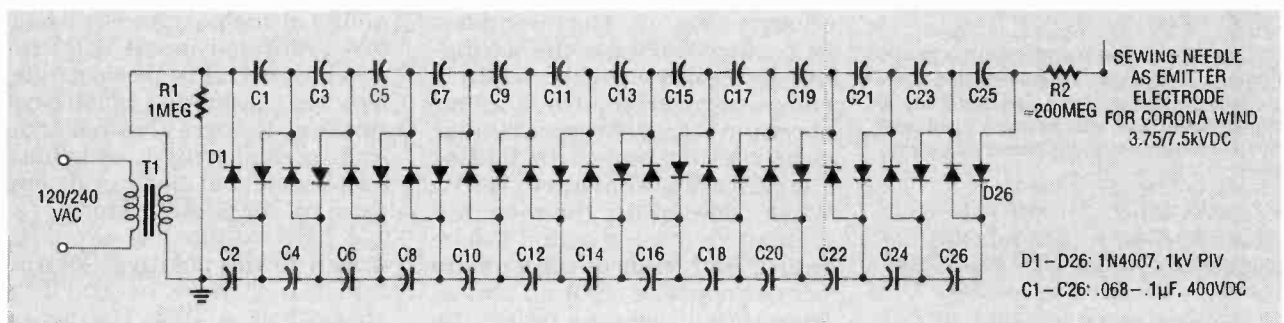

FIG. 8—THIS 25-STAGE VOLTAGE DOUBLER will generate "corona wind." It delivers 3.75 kilovolts DC when powered from 120 volts AC, or 7.5 kilovolts DC when powered from 240 volts AC.

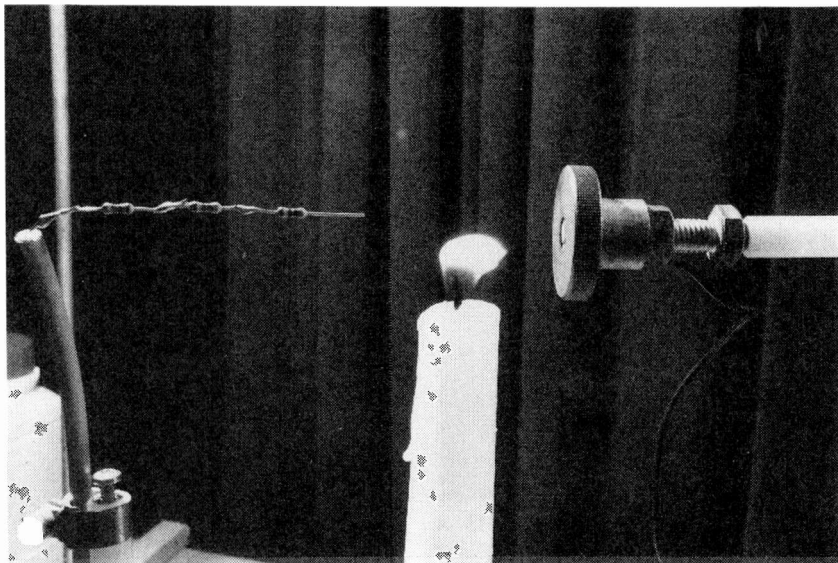

FIG. 14—CORONA WIND DEMONSTRATION. The flame will deflect toward the ground plate. Note the black ground wire attached near the screw threads.

good for corona generation and electron emission. The sharpened ends will have a small radius of curvature (a tight curve or bend), giving rise to a highly distorted electric field at its surface. The high electric field is what tends to ionize air molecules in the vicinity.

- Another experiment you could try involves holding a fluorescent tube near the emitter. The tube will glow, but be careful not to touch the terminals on the ends, or you'll get a shock.

- Lines of force of an electrostatic field can be demonstrated by placing the electrodes (the high-voltage DC output and ground) in a tray covered with castor oil containing some farina. The farina will produce the pattern of the electric field lines; similar to iron filings shaken lightly on a piece of paper in the presence of a bar magnet.

- If you place two round door knobs on insulated stands made from plastic cups filled with candle wax, and then charge them, then a plastic ball suspended from a string will be drawn to and touch the positive electrode, and fall back to center when the spheres are discharged (see Fig. 16-a).

A plastic ball coated with conductive lacquer swings toward the positive electrode like a pendulum; when the ball and doorknob touch, the ball becomes positively charged, so they repel one another. It then swings toward the negative side, absorbs electrons, becomes negatively charged, and is repelled back to the positive. The process repeats indefinitely as long as the high-voltage DC is present, and it will continue to operate for some time after it's shut off. The charge exchange is slow, and there'll be arcing at the positive electrode.

- A grounded metal ball alternates between both electrodes, like the conducting plastic ball. However, the arcs are smaller due to its greater weight, and should be observed at both ends, but more on the positive side.

- A light cotton ball should be drawn to the positive electrode and hang there by itself, as shown in Fig. 16-b. It's then repelled 0.5-inch toward the negative electrode, and the process should repeat indefinitely.

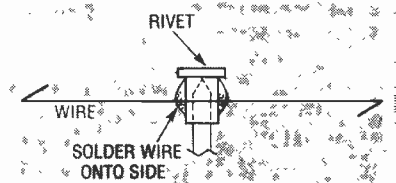

FIG. 15—THIS ION-MOTOR ROTOR, when placed on top of the sewing-needle emitter, will spin in a circle.

When you build a cascaded voltage doubler, you can encase the circuit in pure paraffin oil or candle wax to reduce the chances of getting shocked. It will also minimize corona loss, so the high-voltage DC arrives where it's needed. Figures 12 and 13 show a typical ladder-type voltage doubler before and after being sealed in wax.

Experiments

There are many experiments that can produce observable effects due to the high-voltage DC produced by voltage doublers.

- With a high-voltage emitter pointed at a ground plate (used to attract ions), with a burning candle placed in between them (see Fig. 14), you'll see the candle flame deflect toward the metal plate.

- You can make a rotor for an ion motor, using a light pivot made from a rivet with thin, stiff wire (like piano wire) attached, as shown in Fig. 15. The rotor must be balanced on top of the sewing-needle emitter (much as in a compass) used for the doubler shown in Fig. 8. (We ran a similar construction project in **Radio-Electronics**, February, 1991.) When powered up, the rotor will spin and a hissing sound will be heard. Both ends of the wire are bent at opposite right angles, so the emitted electrons propel the wire in a circle. You should sharpen both ends of the rotor wire to provide a sharp surface

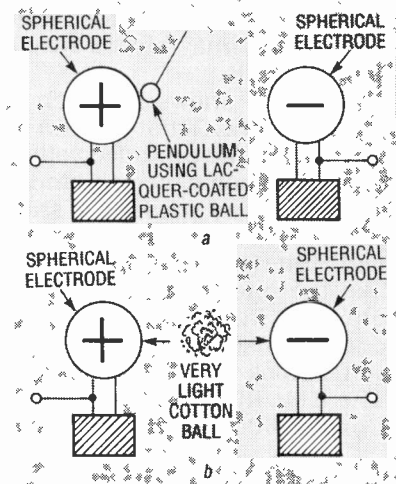
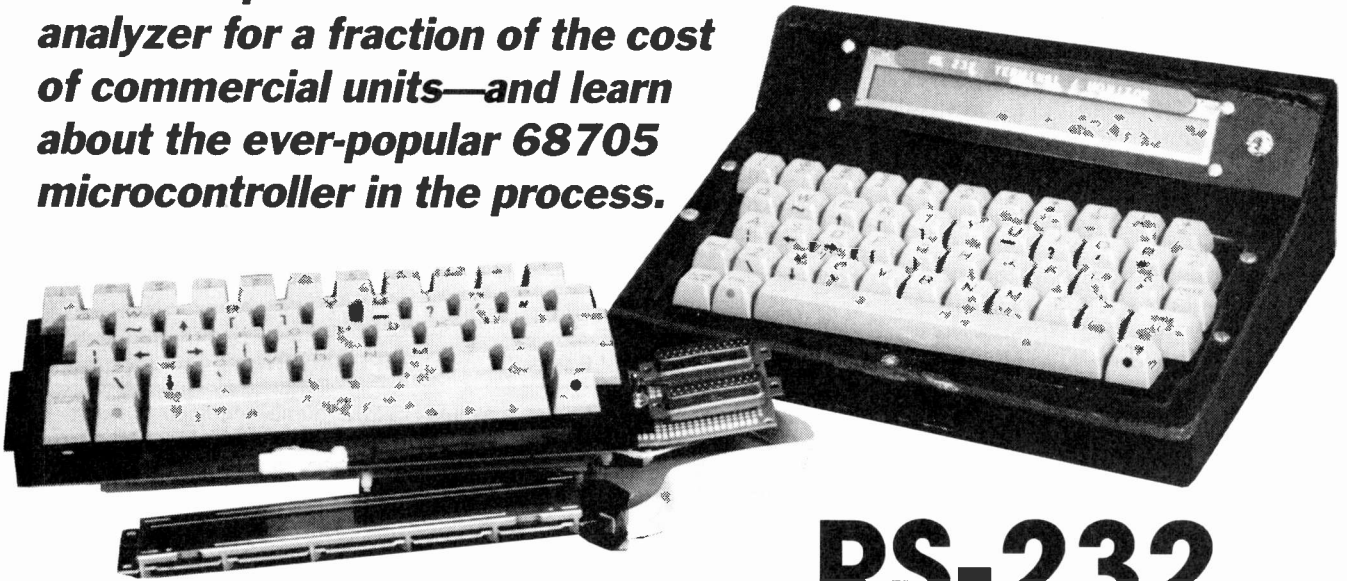

FIG. 16—TWO CHARGED DOOR KNOBS cause a suspended, lacquer-coated plastic ball to behave like a pendulum (a). A light cotton ball will bounce back and forth without being suspended on a string (b).

Libertyville, IL 60048, tel. 312-680-7400), Model 2061 is rated at 20 amps, 250 volts, and 50–400 Hz. The high-voltage DC switch in Fig. 11 also uses an old 100-amp fuse box, shown on the right; it may look like an antique, but it will prevent any shocks.

Build this powerful serial-bus analyzer for a fraction of the cost of commercial units—and learn about the ever-popular 68705 microcontroller in the process.



RS-232 TERMINAL/MONITOR

STEVEN AVRITCH

HAVE YOU EVER BEEN FRUSTRATED by a problem with an RS-232 line? Inexpensive breakout boxes with five or six LED's suffice for solving simple problems, but they don't provide enough information to debug the serious kind. On the other hand, full-featured serial bus analyzers (SBAs) give you all the debugging information you need, but can cost close to \$1000.

However, you don't really have to spend that much. Now you can build a powerful RS-232 monitor that does most of what the expensive SBA's do, yet doesn't cost much more than a quality breakout box. In addition, this project can also be used as a portable, battery-operated terminal. Features are summarized in Table 1.

Hardware design

The heart of the project is Motorola's MC68HC705C8 single-IC microcontroller, a 40-pin DIP containing built-in PROM, RAM, serial and parallel I/O ports, timer, and clock.

The monitor requires two serial receivers: one for the TXD line and one for the RXD line. Because the microcontroller has only one

built-in serial port, a second one has been implemented in software. However, the second port still requires a ± 12 -volt RS-232 interface. The schematic is shown in Fig. 1, and the wiring diagram is shown in Fig. 2.

A Maxim MAX232 RS-232 transceiver (IC2) provides the transmission portion of the interface; it converts TTL signals from the microcontroller to RS-232 levels. Unlike most RS-232 transceivers, which require separate +12- and -12-volt power supplies, the MAX232 has built-in charge pumps that generate the required voltages from a single 5-volt supply. A standard 1489 device (IC4) converts incoming ± 12 -volt signals to TTL levels.

Switch S1 is a DPDT unit that selects terminal or monitor mode. In terminal mode the CPU controls the logic levels of both lines. However, in monitor mode, all lines from the primary port (J1) are directly connected to the secondary port (J2), in which case all signals pass straight through and the device simply monitors TXD and DTR.

Other notable components include XTAL1 and the keyboard. The crystal is a standard, readily available device; it must have a

frequency of exactly 2.4576 MHz in order to generate the correct baud rates. The keyboard is a surplus unit from an old TI-99/4 personal computer; the keyboard is inexpensive and readily available through many suppliers.

A beeper may be connected to pin 19 (port B7) of the microcontroller. The beeper will sound whenever the monitor detects a bell character (ASCII 07 or Cntl-G). The beeper must be TTL-compatible (meaning that it must be powered from a 5-volt supply and draw less than 3 mA).

The low power consumption of the microcontroller allows it to operate over a wide range of input voltages (8–15 volts DC); IC3 provides voltage regulation. The output of IC3 is 6 volts; diode D2 drops voltage even further, to about 5.3 volts. D1 provides reverse-polarity input protection.

Operating modes

The RS-232 Terminal/Monitor has four basic modes of operation, as shown in Table 2. You use the keyboard to select mode, as well as a variety of operational parameters. In use, you must place S1 in the Terminal position when in terminal mode, and in the Monitor position when in any of the three display modes.

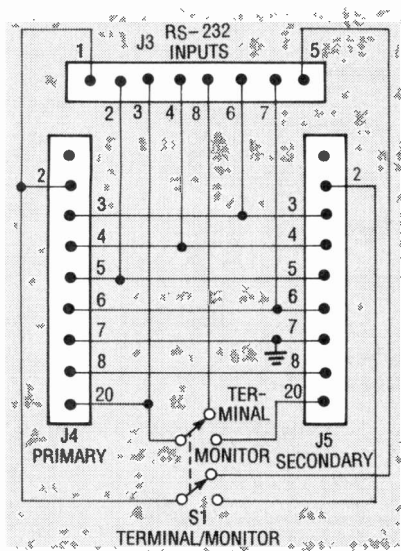
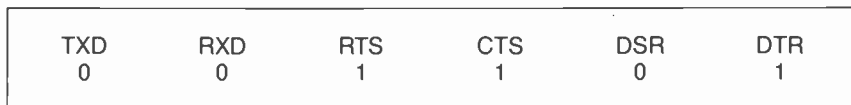
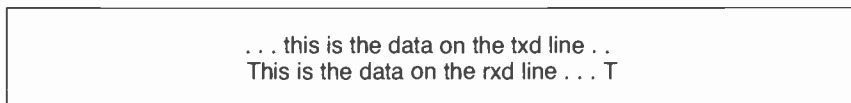

FIG. 2—WIRING DIAGRAM for the terminal/monitor. Connectors J4 and J5 are standard DB-25 males.



a



b



c

FIG. 3—DISPLAY SAMPLES. The Display Bits mode is shown in a; the ASCII mode is shown in b, with TXD on top and RXD on the bottom; and the hex mode is shown in c, again with TXD over RXD.

TABLE 3—FUNCTION REQUESTS

1st	Description	2nd	Description
M	Select mode	1	Terminal
		2	Display Bits
		3	Display ASCII
		4	Display Hex
0	Display current parameters		
1	Set baud rate	0	19,200
		1	9600
		2	4800
		3	2400
		4	1200
		5	600
		6	300
2	Set Protocol	0	8N1
		1	7N1
		2	7E1
3	Set scroll rate delay	0-9	0=off, 9=max
4	Toggle scroll/two-line mode		
5	Enable/disable linefeed		
6	Recall last two lines		
L	Toggle local/online modes		
H	Display help information		

During operation in ASCII or hex mode, you can press Cntl-S to halt input temporarily and read what is displayed. Then simply press Cntl-Q when you're ready to continue.

The monitor has several keys that can produce more than one symbol. For example, the question mark symbol is located on the front of the "I" key. To produce a question mark, press I and the FCTN key simultaneously.

Function requests

You can change several operating characteristics by pressing special key combinations, as shown in Table 3. To set a given parameter, press FCTN and the key shown in column one of the table.

Select Mode. Press FCTN-M, then press 1-4 to select mode.

Current Parameters. Press FCTN-0 to view current settings for mode (terminal), baud rate (1200), protocol (7E1), scroll rate (0), scroll mode, linefeed status (enabled), and on/off-line status (on-line). (Default values shown in parentheses.)

Set Baud Rate. Press FCTN-1 to set baud rate. The monitor runs from 300 to 19,200 bits/sec, but the maximum rate in ASCII and Hex Display modes is 9600.

Protocol. Press FCTN-2 to define the number of data bits (7, 8), parity (Even, Odd, None), and stop bits (1, 2) in each byte sent or received. The terminal currently supports three popular formats: 8N1, 7O1, and 7E1.

PARTS LIST

All resistors are 1/4-watt, 5%

R1—10,000 ohms, PC-mount potentiometer

R2—10 megohms

R3, R13—10,000 ohms

R4—R12—10,000 ohms, SIP

Capacitors

C1—1 μ F, 16 volts, radial electrolytic

C2, C3—18 pF, ceramic disk

C4, C5—100 μ F, 25 volts, axial electrolytic

C6—0.01 μ F, ceramic disk

C7—C10—10 μ F, 16 volts, radial electrolytic

Semiconductors

IC1—MC68HC705C8 CMOS microcontroller

IC2—MAX232 5-volt RS-232 transceiver

IC3—MC7806CT 6-volt regulator, TO-220 case

IC4—MC1489A RS-232 receiver

D1, D2—1N4148 switching diode

Other Components

XTAL1—2.4576 MHz

J1—16-pin 0.1" dual-row header

J2—30-pin 0.1" dual-row header

J3—8-pin 0.1" dual-row header

J4, J5—DB25 connector, male

S1—DPDT switch

BZ1—TTL-compatible beeper (Radio Shack #273-65 or equivalent)

Display—40 \times 2 line LCD display module (Hitachi LM018L or equivalent)

Keyboard—Surplus TI-99/4 (48-key, 15-pin connector)

Note: The following are available from Simple Design Implementations, P.O. Box 9303, Forestville, CT 06010. (203) 582-8526:

- Complete kit including everything in parts list, IC sockets, PC board, instructions, and schematic—\$75 + \$5 S/H

- Preprogrammed MC68HC705C8, instructions, and schematic—\$28.00 + 2.50 S/H

- Software on 5 1/4-inch IBM-compatible floppy disk—\$15.00 + \$2.50 S/H

- PC board only—\$13 + \$2 S/H. CT residents please add 8% sales tax.

Scroll Rate Delay. Press FCTN-3 to vary scroll rate. Data may scroll by faster than you can read it; variable scroll rate allows you to reduce scrolling speed by disabling the DTR line for a while after receiving each carriage return. Scroll-rate delay may vary

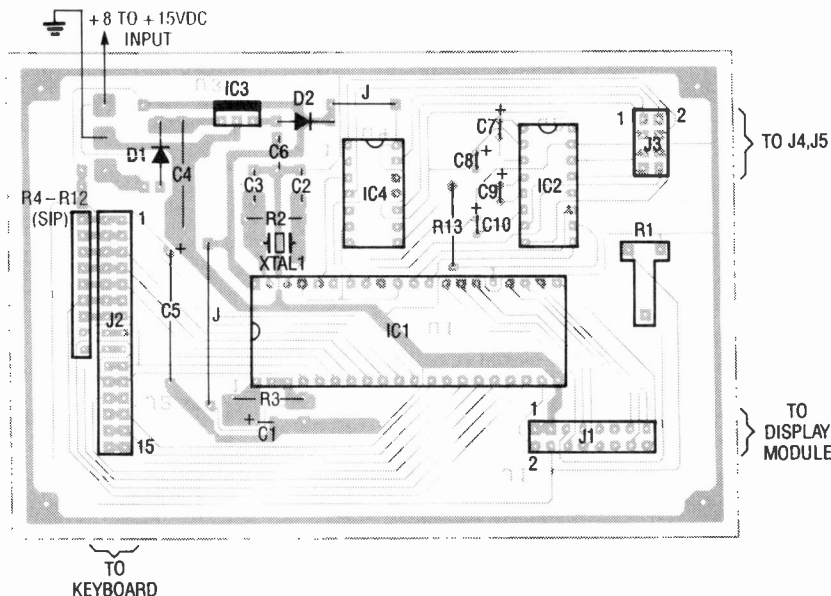

FIG. 4—PARTS PLACEMENT DIAGRAM. Mount all parts on the board as shown here.

from 0 (no delay) to 9 (maximum delay—about three seconds). The device connected to the monitor must recognize DTR and stop sending data when it is low. This works only in terminal mode.

Two-line/Scroll Mode. Press FCTN-4 to switch between the continuous scrolling and two-line modes. In scroll mode the terminal scrolls incoming data at the scroll rate set by FCTN-3. In two-line mode the terminal stops the display every time both display lines are filled. You must then press the space bar to continue. This feature works only in terminal mode.

Enable/Disable LF. Press FCTN-5 to switch between responding to and ignoring incoming linefeed characters. Some terminals, modems, and host systems issue a linefeed (LF) in addition to a carriage return (CR) at the end of every line. Extra linefeeds cause a blank line to be displayed on the screen, hence make it difficult to read. Tell the monitor to ignore extra linefeeds by selecting the LF Disabled mode. This feature works only in terminal mode.

Recall Last Two Lines. Press FCTN-6 to review the last two lines that scrolled off the screen. Press any key to return to the current two lines. Note that communication is disabled via the DTR line when displaying the last two lines. This feature works only in terminal mode.

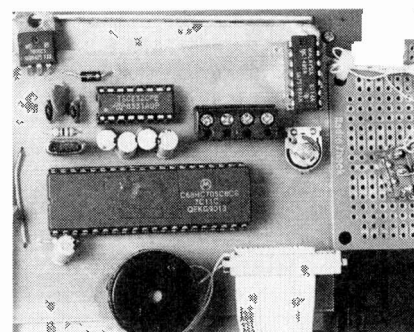

FIG. 5—THE AUTHOR'S PROTOTYPE. After applying power to the unit a brief sign-on message should appear. The display contrast can be adjusted via potentiometer R1.

Help. Press FCTN-H to view a brief summary of the function associated with each. You are able to view this screen from any operating mode.

Local/On-line Mode. Press FCTN-L to switch between local and on-line modes. In local mode, RS-232 communications are disabled; characters typed on the keyboard appear on the LCD display immediately. In on-line mode, RS-232 communications are enabled. Characters typed on the keyboard are transmitted over the serial link and are not displayed until they are echoed by the host system. This feature works only when used in the terminal mode.

Interfacing

To use the device as a dumb

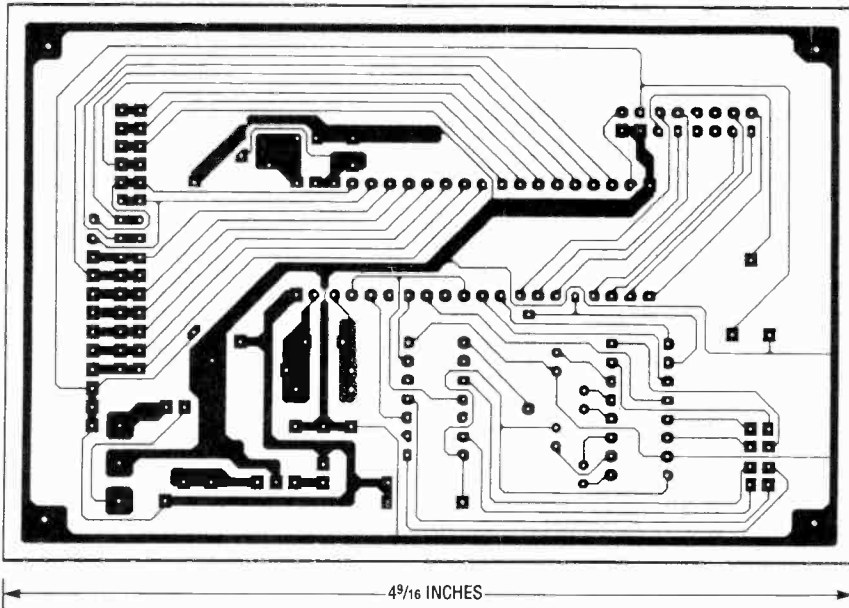

USE THIS FOIL PATTERN if you would like to etch your own board.

TABLE 4—TERMINAL VOLTAGES

Pin	Description
2	-7 to -12 VDC
3	0 VDC
7	Check for continuity to ground
8	0 VDC
20	Press Cntl-S and Cntl-Q to toggle between +7 to +12 and -7 to -12 VDC

ASCII terminal, be sure to place switch S1 in Terminal position, then make sure that the unit is operating in terminal mode, and then enter the correct operating characteristics (baud rate, protocol, etc.). Last, connect the unit to the host system via a standard 25-conductor cable. If the unit doesn't seem to work, you may need to reverse pins 2 and 3 using a mull-modem cable or adapter.

To use the device as a monitor, connect it in series with the two devices (host and terminal, host and modem, etc.), place S1 in Monitor position, and choose one of the terminal modes. Then all you have to do is set protocol, baud rate, etc.

Software

The MC68HC705C8 software consists of an assembly-language

program; unfortunately the listing is too long for publication. The program must be assembled and the resultant object code must be burned into the microcontroller's built-in EPROM. If you don't have facilities for assembling the program and burning it in, don't worry—you can purchase a pre-programmed MC68HC705C8 from the author; take a look in the parts list for details.

If you wish to modify the source code (or maybe just look it over), you can download it from the RE-BBS (516-293-2283, 1200/2400, 8N1) as a file called SMART232.SRC, or you can otherwise order it directly from the author.

Construction

You can build this project using wire-wrap or a PC board. A foil pattern is provided if you'd like to make your own board; you can also purchase a ready-to-use board from the source mentioned in the parts list if you don't want to make your own.

Using Fig. 4 as a guide, assemble the PC board starting with the passive components. Then mount sockets for the IC's, connectors J1-J3, and don't forget the two jumpers. Check your work carefully, correct any mistakes, and then insert the IC's into the sockets. Connect the cables from the keyboard and LCD module. Then make the connec-

tions between J1, J2, and the PC board. A photograph of the author's prototype unit is shown in Fig. 5.

After verifying all wiring, apply power to the unit; a brief sign-on message should appear on the display. Adjust Contrast potentiometer R1 for best effect. Now set switch S1 to the appropriate position, and set the desired mode and operating characteristics using the Function keys. That's all there is to it!

Troubleshooting hints

If the sign-on message does not appear on the display on power-up, the most likely cause of the problem is a wiring error. The error is probably in the power or ground lines (IC1, pins 20 and 40), the oscillator lines (IC1, pins 38 and 39), the reset line (IC1, pin 1) or the display interface lines (pins 1-6 and 11-14 of the LCD display).

If the terminal comes up with the initialization message but does not seem to communicate, check the keyboard and RS-232 driver. Check the keyboard by pressing FCTN-0 to display system parameters. If they don't appear, check the keyboard wiring. If the terminal does display system parameters, press FCTN-L to put the terminal in local mode and then test the keyboard by pressing every key and checking for the correct letter on the display. If the keyboard checks out, the problem is probably located somewhere in the RS-232 driver, in the cabling, or in the RS-232 line itself.

Remove the connector from the terminal's primary port, set the DPDT switch to terminal mode, and check the voltages on the terminal's primary port. They should be close to the values shown in Table 4. If any of the values do not agree with Table 4, check the wiring of the RS-232 driver (IC2).

Wrapping up

The author housed his prototype in a custom-built enclosure that resembles a miniature RS-232 terminal. You could use an off-the-shelf metal or plastic case just as well. Just keep in mind that, however you package it, this terminal/monitor is a useful and fun project.

- 222 Popular Electronics (1992 back issues) \$5.00
Write in issues desired _____
- 221 Popular Electronics (1991 back issues, Jan., Mar. not available) \$5.00
Write in issues desired _____
- 220 Popular Electronics (1990 back issues) \$5.00
Write in issues desired _____
- 119 Popular Electronics (1989 back issues) \$5.00
Write in issues desired _____
- 118 Hands-On Electronics (1988 back issues) \$5.00
Write in issues desired _____
- 117 Hands-On Electronics (1987 back issues) \$5.00
Write in issues desired _____
- EH92 Experimenters Handbook (1992) \$5.00
- EH91 Experimenters Handbook (1991) \$5.00
- EH90 Experimenters Handbook (1990) \$5.00
- EH88 Experimenters Handbook (1988-89) \$5.00
- EH87 Experimenters Handbook (1987) \$5.00
- HH92 Hobbyist Handbook (1992) \$5.00
- HH91 Hobbyist Handbook (1991) \$5.00
- HH90 Hobbyist Handbook (1990) \$5.00
- HH89 Hobbyist Handbook (1989) \$5.00
- 212 Radio-Electronics (1992 back issues) \$5.00
- 211 Radio-Electronics (1991 back issues) \$5.00
Write in issues desired _____
- 210 Radio-Electronics (1990 back issues) \$5.00
Write in issues desired _____
- 109 Radio-Electronics (1989 back issues) \$5.00
Write in issues desired _____
- 108 Radio-Electronics (1988 back issues) \$5.00

Write in issues desired _____
 107 Radio-Electronics (1987 back issues) \$5.00
 Write in issues desired _____

REPRINTS REPRINTS

- 169 Think Tank (133 Circuits) \$3.50
- 169A Think Tank Vol. 2 \$3.00
- 168 Fact Cards (#34-66) \$4.00
- 168C Fact Cards (#67-99) \$3.50
- 168D Fact Cards (#100-132) \$3.50
- 167 Designing With IC's \$4.00
- 166 Collected Works of Mohammed Ulysses Fips (62 pages, April Fools Collection) \$5.00
- 165 How to Repair CD Disc Players \$5.00
- 164 Modern Electrics (April 1908) \$3.00
- 163 Receiving Satellite TV \$5.00
- 162 Build Your Own Satellite TV Receiver \$5.00
- 161 Descrambling (Feb. 1984) \$4.00
- 160 New Ideas - 42 Circuits \$3.50
- 159 Low Frequency Receiving Techniques Building and using VLF Antennas \$5.00
- 158 Electro Importing Co. Catalog (Circa 1918) \$5.95
- 157 All About Kits \$2.00
- 156 How To Make PC Boards \$2.00
- 155 IBM Typewriter To Computer \$2.00
- 154 How To Repair VCR's \$3.50
- 150 Pay TV Decoder (1981) \$3.00

To order any of the items indicated above, check off the ones you want. Complete the order form below, include your payment, check or money order (DO NOT SEND CASH), and mail to Claggg Inc., Reprint Department, P.O. Box 4099, Farmingdale, NY 11735. Please allow 4-6 weeks for delivery.

If you need a copy of an article that is in an issue we indicate is unavailable you can order it directly from us. We charge 50¢ per page. Indicate the issue (month & year), pages and article desired. Include payment in full, plus shipping and handling charge. Make checks payable to Claggg Inc.

ARTICLE

PAGES MONTH YEAR

TOTAL PAGES @50¢ each TOTAL PRICE

MAIL TO: Claggg Inc.

Reprint Bookstore, P.O. Box 4099, Farmingdale NY 11735

SHIPPING CHARGES IN USA & CANADA

\$0.01 to \$5.00	\$1.50	\$30.01 to 40.00	\$5.50
\$5.01 to \$10.00	\$2.50	\$40.01 to 50.00	\$6.50
\$10.01 to 20.00	\$3.50	\$50.01 and above	\$8.00
\$20.01 to 30.00	\$4.50		

Total price of merchandise \$ _____
 Shipping Charge (see chart) \$ _____
 Subtotal \$ _____
 Sales Tax (New York State Residents only) \$ _____

Name _____
 Address _____
 City _____ State _____ Zip _____

Total Enclosed \$ _____

All payments must be in U.S. funds

SORRY — We only ship to USA & Canada

EN93

we drive the input of the amplifier with a 1-volt pure sine wave and we obtain the 20 volts required at the output. Since 20 volts RMS is 56 volts peak-to-peak, S2 must be set to >20V. With S5 in "THD" position a reading of 1.4 mV (0.0014V) DC is obtained. In the "REF" position we read 2.00V. Always read the range on the DMM that affords the best resolution. Now make the calculation: 0.0014/2.00 × 100 equals 0.07 percent THD.

Voltage amplifiers are measured in the same manner, but without the requirement of a load resistor. Such amplifiers will probably show lower THD voltage readings. If the THD voltage is too low on the DMM's mV range, set S4 to "×10." In this case, however, divide the displayed THD voltage by 10. For example, 0.8 mV on the meter is read as 0.08 mV, since it was amplified 10 times to 0.8 mV.

If the measured THD percent is three times or more greater than the analyzer's measurement "floor," no correction of the measured value is required. If it's less than three times, a good approximation of the true THD percent is given by the formula $D(DUT) = \sqrt{D^2(\text{measured}) - D^2(\text{floor})}$. That means if you measure a preamp's THD at 0.005%, and the measurement floor is 0.004%, the true THD of the preamp is 0.003%.

Depending upon the depth of the notch and how closely the RC's in the oscillator's frequency selective network are matched, the "floor" should typically be 0.003 to 0.005%. You can check the "floor" value in the same way you measured the 1% THD calibrator, explained earlier. Instead of using the calibrator signal, feed in a maximum signal level from output J1. If you use the ×10 position, it may be necessary to connect J8 to an external earth ground.

Finally, you should know that THD measurements above 10 percent are less accurate than those below 10 percent, since the reference includes distortion plus the fundamental—not just the fundamental.

R-E

SPEAKER PROTECTOR

continued from page 83

for the protector circuit is shown in Fig. 5. The PC board is configured for on-board mounting of the 5-amp relay that the author used.

A compatible relay with a different pinout can be used. However, it may have to be mounted on the edge of the board using double-sided tape; it will then have to be hardwired to the board. The parts-placement diagram for the power-supply board is shown in Fig. 6.

After mounting all components, solder leads of adequate length to the boards, and use different colors for the speaker and power ground leads to avoid connecting them together. Next, connect the power leads between boards, and connect an AC line cord to the power supply. The author's completed unit, containing a protector circuit for both the left and right channels and one power supply, is shown in Fig. 7.

The completed boards can be

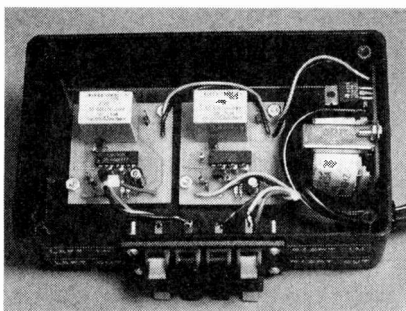

FIG. 7—HERE'S THE AUTHOR'S PROTOTYPE. It contains a protector circuit for both the left and right channels and one power supply. The entire unit is only about 4 inches wide by 6 inches long.

mounted in a case like the one pictured in Fig. 7. When drilling holes in plastic cases, start with a small drill bit and work your way up.

As a final word, the circuit is designed to protect speakers from excessive DC levels caused by amplifier failure. However, it will not protect a speaker that's rated at power levels much less than the driving amplifier can supply—only your own common sense in keeping the volume down will protect your speakers in a situation like that.

R-E

COLOR BAR GENERATOR

continued from page 55

chroma on the white bar (the first bar after horizontal sync) with R10 and R9.

Adjustment with Monitor

If you have a monitor, hook up the video output of the video generator to the monitor's video input and do all the adjustments looking at the white color bar on the left side of the screen. If the red, green, and blue video levels are set up properly the white bar should be full brightness and white. If it is not, adjust R8 for the overall brightness and then adjust R10 and R9 for a pure white bar.

We hope you've learned something about color video from this project. Everything is neatly broken into fairly simple blocks so you can be assured of success. If you have an IBM Clone computer with a CGA board (or other video card with NTSC-compatible sync) you can use just the encoder section to generate NTSC-compatible sync and RGB video outputs.

R-E

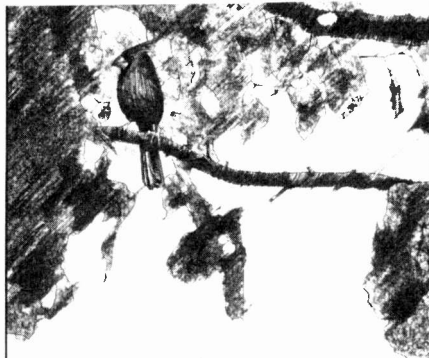

You Need Tree City USA

City trees add the soft touch of nature to our busy lives. They cool our cities, fight pollution, conserve energy, give wildlife a home, and make our neighborhoods more liveable.

Support Tree City USA where you live. For your free booklet, write: Tree City USA, The National Arbor Day Foundation, Nebraska City, NE 68410.

 **The National Arbor Day Foundation**

SPECIAL FROM ETT

TTL1 —
TTL POCKET GUIDE,
Volume 1,
7400 — 74200
..... \$18.95.



TTL2 —
TTL POCKET GUIDE,
Volume 2,
74201 — 74640
..... \$18.95.



TTL3 —
TTL POCKET GUIDE,
Volume 3,
74641 — 7430640
..... \$18.95.

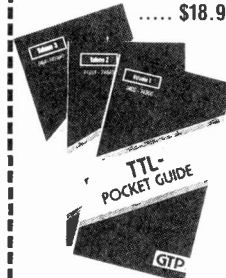

TTLX —
ALL THREE GUIDES,
Vols 1, 2, & 3
(save \$6.00)
..... \$50.85.

Each volume provides a comprehensive listing of all commonly used TTL integrated circuits within the range of types noted. The combination of three volumes covers 7400 through 7430640 TTL products from all major manufacturers. All current families are covered: standard, low power, Schottky, low power Schottky, advanced Schottky, advanced low powered Schottky, high speed and fast Schottky. There are eight sections to the book. Section 1 illustrates the device schematic using a clear and simple logic diagram. Next a brief description of the components, providing quick reference to the internal structure. The next section details input signals or levels at individual pins. The fourth section lists major applications and is followed by a summary of essential data. Below this, a table indicates the TTL families in which the device is available, and finally, device description and type number are highlighted for easy reference. A manufacturer's index at the back of the book shows in tabular form which companies manufacture each package.

MAIL TO: **Electronic Technology Today, Inc.**
P.O. Box 240
Massapequa Park, NY 11762-0240

SHIPPING CHARGES IN USA AND CANADA

\$0.01 to \$5.00	.. \$1.50	\$30.01 to \$40.00	\$5.50
\$5.01 to \$10.00	.. \$2.50	\$40.01 to \$50.00	\$6.50
\$10.01 to \$20.00	.. \$3.50	\$50.01 and above	\$8.00
\$20.01 to \$30.00	.. \$4.50		

SORRY, No orders accepted outside of USA and Canada

Total price of merchandise \$	_____
Shipping (see chart) \$	_____
Subtotal \$	_____
Sales Tax (NYS only) \$	_____
Total Enclosed \$	_____

Name _____
Address _____
City _____ State _____ Zip _____

NO COMPLICATED ELECTRONICS, NO EXPENSIVE INSTRUMENTS:

Home study course shows you how to make good money in VCR repair.

An amazing fact: you can do more than four out of five VCR repairs with ordinary tools and basic fix-it procedures. Our home study program shows you how.

Learn all of the systems, mechanisms, and parts of almost all brands of VCRs. With *no* expensive instruments. *No* complicated electronics. *No* fancy workshop. The step-by-step texts and close personal attention from your instructor make learning easy.

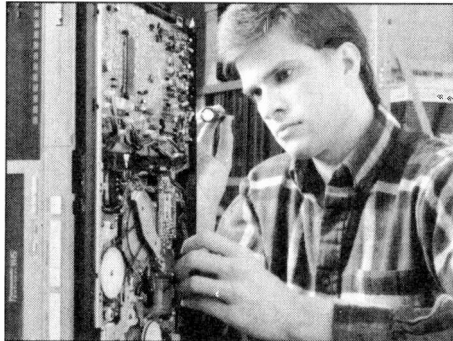

Texts, course materials, and tool kit are sent to your home. Graduate ready to make up to \$50.00 or more per hour in your own spare-time or full-time business.

Send today for your free career booklet. Or call 800-223-4542



Name _____
 Address _____
 City _____ State _____ Zip _____

The School of VCR Repair

2245 Perimeter Park, Dept. VP351, Atlanta, Georgia 30341

CIRCLE 92 ON FREE INFORMATION CARD

BUYER'S MART

FOR SALE

FLAME SPEAKER. Finally a speaker with no moving parts! Omnidirectional sound, with higher frequency response than conventional loudspeakers. No diaphragm or voice coil. Plans, \$10. **Electroman**, Dept. EH, Box 24474, New Orleans, LA 70184.



RECEIVING TUBES

OVER 3000 TYPES IN STOCK!

Also hard-to-find transformers, capacitors and parts for tube equipment. Send \$2.00 for our 32 page catalog.

ANTIQUA ELECTRONIC SUPPLY

6221 S. Maple Ave. • Tempe, AZ 85283 • 602-820-5411

PLANS AND KITS

DESCRAMBLER KITS. Complete cable kit \$44.95. Complete Satellite kit \$49.95. Add \$5 shipping. Free Brochure. No New York sales. **Summit EH**, Box 489, Bronx, NY 10465.

EDUCATION & INSTRUCTION

FREE! Catalog of educational and fun electronic kits. **LNS TECHNOLOGIES**, 210993 Foothill Blvd., Suite 307G, Hayward, CA 94541-1551.

ADVERTISING INDEX

Free Information Number	Page
—	Antique Electronics..... 130
99	C&S Sales..... CV2
—	Cheneko..... 41
—	Claggk Video..... CV4
100	Datak Corp..... 41
—	Electronics Book Club..... 3
—	Electronics Engineers B.C..... 7
—	Electronic Tech. Today..... CV3
97	Heath..... 57
—	Information Unlimited..... 13
96	Jensen Tools..... 57
98	Kelvin Electronics..... 17
93	Mouser..... 94
—	NRI Schools..... 11
92	School of VCR Repair..... 130
94	U.S. Cable..... 106
95	Zentek..... 106

ADVERTISING SALES OFFICE

Gernsback Publications, Inc.
 500-B Bi-County Blvd.
 Farmingdale, NY 11735
 1-(516) 293-3000
 President: Larry Steckler

For Advertising ONLY
 516-293-3000
 Fax 1-516-293-3115
 Larry Steckler
 publisher

Christina Estrada
 assistant to the President

Arline Fishman
 advertising director

Denise Mullen
 advertising assistant

Kelly McQuade
 credit manager

Subscriber Customer Service
 1-800-288-0652

Order Entry for New Subscribers
 1-800-999-7139
 7:00 AM - 6:00 PM M-F MST

ADVERTISING SALES OFFICES

EAST/SOUTHEAST

Stanley Levitan, Eastern Advertising Sales

Manager

Electronics Now

1 Overlook Ave.

Great Neck, NY 11021

1-516-487-9357, 1-516-293-3000

Fax 1-516-487-8402

MIDWEST/Texas/Arkansas/Okla.

Ralph Bergen, Midwest Advertising Sales

Manager

Electronics Now

One Northfield Plaza, Suite 300

Northfield, IL 60093-1214

1-708-446-1444

Fax 1-708-559-0562

PACIFIC COAST/Mountain States

Electronics Now Magazine

Pamela Kuster

Pattis/3M

1800 North Highland Avenue

Suite 717

Hollywood, CA 90028

EN Shopper

Joe Shere, National Representative

P.O. Box 169

Idyllwild, CA 92549

1-714-659-9743

Fax 1-714-659-2469

SURVEILLANCE

COUNTERSURVEILLANCE Electronic Devices

Miniature Transmitter Kits.. \$29.95

Voice Changers, Phone Scramblers, Vehicle Tracking, Phone Recording Systems, Bug & Phone Tap Detectors, & More!

CALL IDENTIFIER device • displays callers phone number before you answer with date & time of call...\$49.95

FOR CATALOG SEND \$5.00 TO...
EDE P.O. Box 337, Buffalo, NY 14226 (716) 691-3476

BEST BY MAIL

Rates: Write National, Box 5, Sarasota, FL 34230

OF INTEREST TO ALL

BREW YOUR OWN Beer - Free Catalog and Instructions. B.Y.O.B., P.O.B. 1705N, New Milford, CT 06776. (203)350-BYOB.

ROBOTS! FULLY ASSEMBLED and kits, robot arms, PC interfaces, motor sensors. \$30.00 to \$80,000.00. Catalog \$5.00 refundable with order. HTO, PO Box 3084, RSF, CA 92067.

CITIZEN BAND RADIO DX. Details \$1.00. CBR, Box 212, Rochelle Park, NJ 07662.

CORDLESS SOLDERING IRON. Increases mobility, improves accuracy! Rechargeable. \$14.95. Free information. McGregor Imports, PO 428135-S, Chicago, IL 60642.

BURGLAR ALARMS! WHOLESALE. Send \$5.00 For Amazing Catalogue. Global Security, 672 Oldmill Road, Suite 320, DPT(A), Millersville, MD 21108.

MONITOR CORDLESS TELEPHONE Conversations from your home or car. For details send \$10.00 to: Bennett Distributors, 824 EA. Rand Road, Suite 186, Arlington Heights, IL 60004.

EMPLOYMENT

JOB MARKET TOUGH? Consider **Professional Retirement Counseling**. Complete Details: New Careers, 3871 Piedmont Ave., Oakland, CA 94611.

Electronics Paperback Books

GREAT PAPERBACKS AT SPECIAL PRICES

BP248—TEST EQUIPMENT CONSTRUCTION \$5.95. Details construction of simple, inexpensive, but extremely useful test equipment. AF Gen, Test Bench Ampl, Audio Millivoltmeter, Transistor Tester and six more.

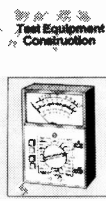

BP267—HOW TO USE OSCILLOSCOPES AND OTHER TEST EQUIPMENT \$6.95. Mastering the oscilloscope is not really too difficult. This book explains all the standard controls and functions. Other equipment is also described.

BP265—MORE ADVANCED USES OF THE MULTIMETER \$5.95. Use these techniques to test and analyze the performance of a variety of components. Also see how to build ad-ons to extend multimeter capabilities.

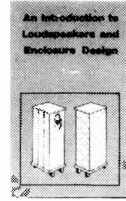

BP256—INTRO TO LOUDSPEAKERS AND ENCLOSURE DESIGN \$5.95. We explore the variety of enclosure and speaker designs in use today so the reader can understand the principles involved.

CMOS1—CMOS POCKET GUIDE 1 \$18.95. Works like the TTL Guides but covers all commonly used CMOS standard devices. Six major sections. The first shows the device schematic. Next is a brief description of the component and is followed by full operating details. The fourth section lists major applications, while the 5th and 6th sections present essential data for that device and a list of the relevant manufacturers. The final two sections are a valuable cross-reference.



BP299—PRACTICAL ELECTRONIC FILTERS \$6.95. Presents a dozen filter-based practical projects with applications in and around the home or in the constructor's workshop. Complete construction details are included.



BP249—MORE ADVANCED TEST EQUIPMENT CONSTRUCTION \$6.95. Eleven more test equipment construction projects. They include a digital voltmeter, capacitance meter, current tracer and more.

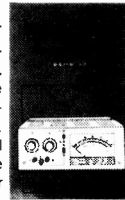

BP245—DIGITAL AUDIO PROJECTS \$5.95. Practical circuits to build and experiment with. Includes A/D converter, input amplifier, digital delay line, compander, echo effect and more.



BP247—MORE ADVANCED MIDI PROJECTS \$5.95. Circuits included are a MIDI indicator, THRU box, merge unit, code generator, pedal, programmer, channelizer, and analyzer.



BP257—INTRO TO AMATEUR RADIO \$6.95. Amateur is a unique and fascinating hobby. This book gives the newcomer a comprehensive and easy to understand guide to the subject.

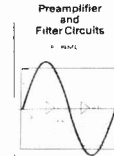

BP309—PREAMPLIFIER AND FILTER CIRCUITS \$6.95. Provides circuits and background info for a range of pre-amplifiers, plus tone controls, filters, mixers and more. All are high-performance circuits that can be built at a reasonable cost.

BP303—UNDERSTANDING PC SOFTWARE \$6.95. This book will help you understand the basics of various types of business software in common use. Types of software covered include word processors, spelling checkers, graphics programs, desktop publishing, databases, spreadsheets and utilities.



BP251—COMPUTER HOBBYISTS HANDBOOK \$8.95. A wrap-up of everything the computer hobbyist needs to know in one easy to use volume. Provides a range of useful reference material in a single source.



PCP115—ELECTRONIC PROJECTS FOR HOME SECURITY \$10.00. 25 projects ranging from a single-door protection circuit that can be completed in an hour or two, to a sophisticated multi-channel security system. Each project is described in detail with circuit diagrams, explanations of how it works, instructions for building and testing, and how to adapt circuits to meet special requirements.

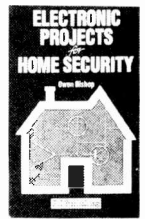

BP195—INTRODUCTION TO SATELLITE TV..... \$9.95. A definitive introduction to the subject written for the professional engineer, electronics enthusiast, or others who want to know more before they buy. 8 x 10 in.

BP190—ADVANCED ELECTRONIC SECURITY PROJECTS..... \$5.95. Includes a passive infra-red detector, a fiber-optic loop alarm, computer-based alarms and an unusual form of ultrasonic intruder detector.

BP235—POWER SELECTOR GUIDE.....\$10.00. Complete guide to semiconductor power devices. More than 1000 power handling devices are included. They are tabulated in alpha-numeric sequence, by technical specs. Includes power diodes, Thyristors, Triacs, Power Transistors and FETs.

BP234—TRANSISTOR SELECTOR GUIDE.....\$10.00. Companion volume to BP235. Book covers more than 1400 JEDEC, JIS, and brand-specific devices. Also contains listing by case type, and electronic parameters. Includes Darlingtons transistors, high-voltage devices, high-current devices, high power devices.

BP99—MINI-MATRIX BOARD PROJECTS..... \$5.50. Here are 20 useful circuits that can be built on a mini-matrix board that is just 24 holes by ten copper-foil strips.

BP117—PRACTICAL ELECTRONIC BUILDING BLOCKS—Book 1.....\$5.75. Oscillators, Timers, Noise Generators, Rectifiers, Comparators, Triggers and more.

BP184—INTRO TO 68000 ASSEMBLY LANGUAGE.....\$6.95. The 68000 is a great new breed of microprocessor. Programming in assembly language increases the running speed of your programs. Here's what you need to know.

BP179—ELECTRONIC CIRCUITS FOR THE COMPUTER CONTROL OF ROBOTS \$7.50. Data and circuits for interfacing the computer to the robot's motors and sensors.

BP239—GETTING THE MOST FROM YOUR MULTIMETER..... \$5.95. Covers basics of analog and digital meters. Methods of component testing includes transistors, thyristors, resistors, capacitors and other active and passive devices.

BP97—IC PROJECTS FOR BEGINNERS.....\$5.50. Power supplies, radio and audio circuits, oscillators, timers, switches, and more. If you can use a soldering iron you can build these devices.

BP37—50 PROJECTS USING RELAYS, SCR'S & TRIACS.....\$5.50. Build priority indicators, light modulators, warning devices, light dimmers and more.

RADIO—100 RADIO HOOKUPS.....\$3.00. Reprint of 1924 booklet presents radio circuits of the era including regenerative, neutrodyne, reflex & more.

BP42—SIMPLE LED CIRCUITS..... \$5.50. A large selection of simple applications for this simple electronic component.

BP122—AUDIO AMPLIFIER CONSTRUCTION.....\$5.75. Construction details for preamps and power amplifiers up through a 100-watt DC-coupled FED amplifier.

BP92—CRYSTAL SET CONSTRUCTION.....\$5.50. Everything you need to know about building crystal radio receivers.

BP255—INTERNATIONAL RADIO STATIONS GUIDE \$7.95. Provides the casual listener, amateur radio DXer and the professional radio monitor with an essential reference work designed to guide him or her around than ever more complex radio bands.

CHECK OFF THE BOOKS YOU WANT

ELECTRONIC TECHNOLOGY TODAY INC.
P.O. Box 240, Massapequa Park, NY 11762-0240

Name _____
Address _____
City _____ State _____ Zip _____

EH93

SHIPPING CHARGES IN USA AND CANADA

\$0.01 to \$5.00 \$1.50
\$5.01 to \$10.00 \$2.50
\$10.01 to 20.00 \$3.50
\$20.01 to 30.00 \$4.50
\$30.01 to 40.00 \$5.50
\$40.01 to 50.00 \$6.50
\$50.01 and above \$8.00

SORRY No orders accepted outside of USA & Canada

Total price of merchandise \$ _____
Shipping (see chart) \$ _____
Subtotal \$ _____
Sales Tax (NYS only) \$ _____
Total Enclosed ... \$ _____

Number of books ordered

All payments must be in U.S. funds

Countersurveillance

Never before has so much professional information on the art of detecting and eliminating electronic snooping devices—and how to defend against experienced information thieves—been placed in one VHS video. If you are a Fortune 500 CEO, an executive in any hi-tech industry, or a novice seeking entry into an honorable, rewarding field of work in countersurveillance, you must view this video presentation again and again.

Wake up! You may be the victim of stolen words—precious ideas that would have made you very wealthy! Yes, professionals, even rank amateurs, may be listening to your most private conversations.

Wake up! If you are not the victim, then you are surrounded by countless victims who need your help if you know how to discover telephone taps, locate bugs, or “sweep” a room clean.

There is a thriving professional service steeped in high-tech techniques that you can become a part of! But first, you must know and understand Countersurveillance Technology. Your very first insight into this highly rewarding field is made possible by a video VHS presentation that you cannot view on broadcast television, satellite, or cable. It presents an informative program prepared by professionals in the field who know their industry, its techniques, kinks and loopholes. Men who can tell you more in 45 minutes in a straightforward, exclusive talk than was ever attempted before.

Foiling Information Thieves

Discover the targets professional snoopers seek out! The prey are stock brokers, arbitrage firms, manufacturers, high-tech companies, any competitive industry, or even small businesses in the same community. The valuable information they filch may be marketing strategies, customer lists, product formulas, manufacturing techniques, even advertising plans. Information thieves eavesdrop on court decisions, bidding information, financial data. The list is unlimited in the mind of man—especially if he is a thief!

You know that the Russians secretly installed countless microphones in the concrete work of the American Embassy building in Moscow. They converted



1-516-293-3751

**HAVE YOUR
VISA or MC CARD
AVAILABLE**

what was to be an embassy and private residence into the most sophisticated recording studio the world had ever known. The building had to be torn down in order to remove all the bugs.

Stolen Information

The open taps from where the information pours out may be from FAX's, computer communications, telephone calls, and everyday business meetings and lunchtime encounters. Businessmen need counselling on how to eliminate this information drain. Basic telephone use coupled with the user's understanding that someone may be listening or recording vital data and information greatly reduces the opportunity for others to purloin meaningful information.

CLAGGK INC. EH
P.O. Box 4099 • Farmingdale, NY 11735

Please rush my copy of the Countersurveillance Techniques Video VHS Cassette for a total cost of \$54.95 each (which includes \$4.00 postage and handling)

No. of Cassettes ordered _____
Amount of payment \$ _____
Sales tax (N.Y.S. only) _____
Total enclosed _____
Bill me VISA Mastercard
Card No. _____
Expire Date ____ / ____ / ____
Signature _____
Name _____
Address _____
City _____ State _____ ZIP _____

All payments in U.S.A. funds. Canadians add \$4.00 per VHS cassette. No foreign orders.

The professional discussions seen on the TV screen in your home reveals how to detect and disable wiretaps, midget radio-frequency transmitters, and other bugs, plus when to use disinformation to confuse the unwanted listener, and the technique of voice scrambling telephone communications. In fact, do you know how to look for a bug, where to look for a bug, and what to do when you find it?

Bugs of a very small size are easy to build and they can be placed quickly in a matter of seconds, in any object or room. Today you may have used a telephone handset that was bugged. It probably contained three bugs. One was a phony bug to fool you into believing you found a bug and secured the telephone. The second bug placates the investigator when he finds the real thing! And the third bug is found only by the professional, who continued to search just in case there were more bugs.

The professional is not without his tools. Special equipment has been designed so that the professional can sweep a room so that he can detect voice-activated (VOX) and remote-activated bugs. Some of this equipment can be operated by novices, others require a trained countersurveillance professional.

The professionals viewed on your television screen reveal information on the latest technological advances like laser-beam snoopers that are installed hundreds of feet away from the room they snoop on. The professionals disclose that computers yield information too easily.

This advertisement was not written by a countersurveillance professional, but by a beginner whose only experience came from viewing the video tape in the privacy of his home. After you review the video carefully and understand its contents, you have taken the first important step in either acquiring professional help with your surveillance problems, or you may very well consider a career as a countersurveillance professional.

The Dollars You Save

To obtain the information contained in the video VHS cassette, you would attend a professional seminar costing \$350-750 and possibly pay hundreds of dollars more if you had to travel to a distant city to attend. Now, for only \$49.95 (plus \$4.00 P&H) you can view *Countersurveillance Techniques* at home and take refresher views often. To obtain your copy, complete the coupon or call.