

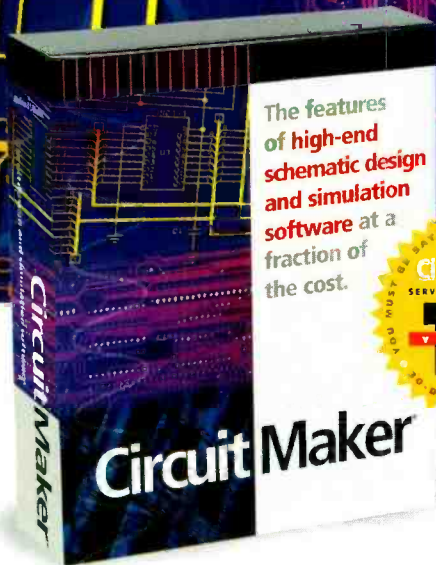

# High-end features. Low-end price.

**\$299**

**CircuitMaker 6:**  
Schematic design  
and simulation  
software



**\$299**

**TraxMaker 3:**  
Printed circuit  
board layout  
software

*CircuitMaker Version 6 and TraxMaker Version 3 give you the features of professional, high-end software at a fraction of the cost. Plus, with exceptional ease-of-use, you'll spend less time learning to use the software and more time designing. Both applications are compatible with your existing design software, and feature outstanding technical support. Call now for your free functional demo.*

## **CircuitMaker 6 is a powerful schematic design and simulation program featuring:**

- Professional schematic features including printout borders, title block and barred pin names
- Symbol editor and Macro feature for custom devices
- Fast, accurate SPICE3f5/XSPICE-based simulation
- Complete array of analysis types, including Fourier, AC, DC Parameter Sweep, Transient and more
- Virtual instruments including a digital oscilloscope, multimeter, Bode plotter, curve tracer and more
- Extensive library of over 4,000 devices
- Tight integration with TraxMaker® for quick PCB layout
- Output PCB netlists in Protel®, Tango®, and TraxMaker®, formats for use in a variety of PCB layout programs
- Windows 3.1, 95, 98 and NT

## **TraxMaker 3 is a powerful printed circuit board layout program featuring:**

- Over 2,000 component footprints in a fully-documented, indexed library. Documentation shows footprints actual size
- Built-in autorouter and Design Rules Check
- Supports up to 6 signal layers plus power and ground planes, silk screen overlays and solder and paste masks
- Board sizes up to 32"x 32", with no pin limitations
- Intelligent manual routing with unrout capabilities
- Import any PCB netlist in CircuitMaker®, Protel® or Tango® format
- Output RS274X Gerber files, Excellon N/C drill files and Bill of materials
- Print to any Windows compatible printer or plotter
- Windows 3.1, 95, 98 and NT

**CircuitMaker** For free demo software, or to order, call **1-800-419-4242**  
CUSTOMER SERVICE CENTER 5252 N. Edgewood Dr #175 • Provo, UT 84604 • Tel 801.224.0433 • Fax 801.224.0545 • [www.microcode.com](http://www.microcode.com)

©1999 Protel International Pty Ltd. All rights reserved. CircuitMaker, TraxMaker and SimCode are registered trademarks of Protel International Pty Ltd. All other brand and product names are trademarks or registered trademarks of their respective companies.

CIRCLE 133 ON FREE INFORMATION CARD

[www.americanradiohistory.com](http://www.americanradiohistory.com)

The millennium is upon us. The year 2000 is right around the corner. What will it bring? —  
***Poptronics** – the magazine for the hands-on electronics activist!*

Today's challenging electronics marketplace does not leave room for a variety of competitive publications aimed at the hands-on kind of electronics activist — the professionals who design, build, maintain, and repair all of the electronics gear that fills our lives, the experimenters who build projects, the computer enthusiasts who want to know what's in the latest gear, the activists who want to and are building robots, audiophiles who want to test new circuits and designs, ham-radio operators looking for what's out there to communicate with.

That's why Gernsback Publications is melding our two publications — *Electronics Now* and *Popular Electronics*, into the new, exciting and timely monthly magazine — *Poptronics* — that you will soon be holding in your hands. Coincidentally it will be the January 2000 issue. What a way to enter the new millennium! (Yes I know the millennium actually starts January 1, 2001.)

It's evolution! Starting with the January 2000 issue *Electronics Now* will become *Poptronics*, the magazine for the hands-on electronics activist! No matter what your specific electronic interest; *Poptronics* will be the magazine for all electronics activists in the 21<sup>st</sup> Century. We've been here since the beginning, when we began in April 1908 with the first issue of *Modern Electrics*. We're still going to be here for the start of the next millennium, the year 3001, with *Poptronics* or its future descendant.

We have brought together all of the very best elements of our existing magazines into *Poptronics*. It is designed to deliver to you, our readers the very best editorial variety we can assemble. We have packaged *Gizmo*, *Prototype*, *Hands-on Reports*, *Service Clinic*, *Peak Computing*, *Robotics Workshop*, *Amazing Science* and other key columns; and wrapped them around a main editorial package of construction projects, product lab reviews, how it works and how to do it articles, to create a wonderful new world of electronics!

Our web site at [www.gernsback.com](http://www.gernsback.com) will still be there too. The forums, searchable index, and links will stay as they are, but you may find a lot of "under construction" signs in other areas. Keep logging in to keep up with what is happening. I believe that you will find it even more useful than before. We will continue the forums that bring thousands of readers to exchange ideas, get questions answered, and find the latest updates on contents in the magazine. It's a great place to search the index for old articles and to download current articles and artwork from the current issue.

If you are a current subscriber to *Electronics Now*, you will automatically receive upcoming issues of *Poptronics* (starting with January 2000) until your current subscription is fulfilled. If you also subscribe to *Popular Electronics* we will combine your subscriptions (if you have 10 more issues of *Electronics Now* to go, and 5 issues of *Popular Electronics* — for example — you will receive the next 15 issues of *Poptronics*).

If we goof and you get two copies of *Poptronics* next month, just cut off or copy the labels on the front cover of both magazines and send them to me. I'll see that your subscription is merged without you losing a single copy.

An exciting new world of electronics publishing begins with the January 2000 issue of *Poptronics*. Be our partner in progress. Stay with us and see just how great our electronics industry can be. We will be bringing you all of the latest electronics news as it happens.

Larry Steckler, EHF,CET  
Publisher



# CONTENTS

DECEMBER 1999

## ON THE COVER

### 33 Freeze Motion With The Laser Scope

When it comes to measuring the speed of a rotating object, nothing can take the place of a stroboscope—and that just scratches the surface of the possible applications for that piece of test gear. However, commercial units are often expensive and are line operated, making field use difficult. But why buy when you can build? This month's cover project is an easy-on-your-wallet stroboscope that's a snap to put together yourself. Even better, it is battery powered making it completely portable.  
— *Skip Campisi*

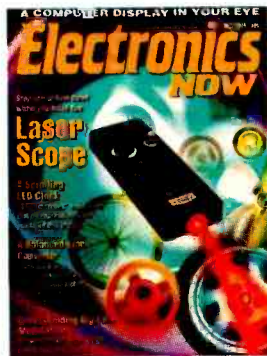

## TECHNOLOGY

### 13 Prototype

Higher disk capacity through colossal magnetoresistance, mini-robots in space, fast SRAM, and more.

### 38 Understanding Digital Modulation

It's the key to today's high-speed data transfers. — *Fernando Garcia*

### 83 Component Notebooks

A new way to organize your workbench. — *Peter B. Reintjes*

### 86 A Computer Display in Your Eyeglasses

Technology that makes keeping your eye on your PC easier than ever. — *Bill Siuru*

## AND MORE

3 LETTERS

26 Q&A

30 NEW PRODUCTS

93 NEW LITERATURE

98 ADVERTISING INDEX

98 ADVERTISING SALES OFFICE

## BUILD THIS

### 41 Balanced-Line Converter

The easy way to interconnect professional and consumer audio gear for testing or other applications. — *Gary McClellan*

### 45 A Scrolling LED Clock

It gives new meaning to the expression "time marches on." — *David Williams*

## DEPARTMENTS

### 4 EQUIPMENT REPORT

Creative Labs Nomad MP3 audio player.

### 5 DX LISTENING

Looking back. — *Don Jensen*

### 8 SERVICE CLINIC

More on semiconductor testing and a DVD update. — *Sam Goldwasser*

### 20 COMPUTER CONNECTIONS

Updating Windows.  
— *Konstantinos Karagiannis*

### 23 ANTIQUE RADIO

The end of a long and pleasant road.  
— *Marc Ellis*

### 88 TECH MUSINGS

Contactless charging, linear equations, induction-heating books, and more.  
— *Don Lancaster*

As a service to readers, ELECTRONICS NOW publishes available plans or information relating to newsworthy products, techniques, and scientific and technological developments. Because of possible variances in the quality and condition of materials and workmanship used by readers, ELECTRONICS NOW disclaims any responsibility for the safe and proper functioning of reader-built projects based upon or from plans or information published in this magazine.

Since some of the equipment and circuitry in ELECTRONICS NOW may relate to or be covered by U.S. patents, ELECTRONICS NOW disclaims any liability for the infringement of such patents by the making, using, or selling of any such equipment or circuitry, and suggests that anyone interested in such projects consult a patent attorney.

ELECTRONICS NOW, (ISSN 1067-9294) December 1999. Published monthly by Gernsback Publications, Inc., 500 Bi-County Boulevard, Farmingdale, NY 11735-3931. Periodicals Postage paid at Farmingdale, NY and additional mailing offices. Canada Post IPM Agreement No. 334103, authorized at Mississauga, Canada. One-year subscription rate U.S.A. and possessions \$24.99, Canada \$33.15 (includes G.S.T. Canadian Goods and Services Tax, Registration No. R125166280), all other countries \$33.99. All subscription orders payable in U.S.A. funds only, via international postal money order or check drawn on a U.S.A. bank. Single copies \$4.99. © 1999 by Gernsback Publications, Inc. All rights reserved. Printed in U.S.A.

POSTMASTER: Please send address changes to ELECTRONICS NOW, Subscription Dept., Box 55115, Boulder, CO 80328-5115.

A stamped self-address envelope must accompany all submitted manuscripts and/or artwork or photographs if their return is desired should they be rejected. We disclaim any responsibility for the loss or damage of manuscripts and/or artwork or photographs while in our possession or otherwise.

Hugo Gernsback (1884-1967) founder

**LARRY STECKLER**, EHF, CET,  
Editor-in-chief and publisher  
**ADRIA COREN**, Vice President  
**KEN COREN**, Vice President

**EDITORIAL DEPARTMENT**

**CARL LARON**, editor  
**JOSEPH J. SUDA**, technical editor  
**EVELYN ROSE**, assistant editor  
**MICHAEL A. COVINGTON**, N4TMI  
contributing editor  
**MARC ELLIS**, contributing editor  
**SAM GOLDWASSER**, service editor  
**DON JENSEN**, contributing editor  
**KONSTANTINOS KARAGIANNIS**,  
computer editor  
**FRANKLIN J. MILLER**, audio editor  
**DON LANCASTER**, contributing editor  
**JANINE ABITABILE**, editorial assistant

**ART DEPARTMENT**

**ANDRE DUZANT**, art director  
**RUSSELL C. TRUELSON**, illustrator

**PRODUCTION DEPARTMENT**

**KEN COREN** production director  
**KATHRYN R. CAMPBELL**  
production manager  
**MICHELE MUSÉ**  
prepress specialist

**CIRCULATION DEPARTMENT**

**GINA GALLO**  
circulation director  
**CHRISTINA M. ESTRADA**  
circulation assistant

**REPRINT DEPARTMENT**

**JANINE ABITABILE**  
reprint bookstore

**Electronics Now** is indexed in  
*Applied Science & Technology Index*,  
*Readers Guide to Periodical Literature*,  
*Academic Abstracts*, and *Magazine  
Article Summaries*.

Microfilm & microfiche editions are  
available. Contact reprint bookstore  
for details.

**Advertising Sales Offices listed  
on page 98.**

Electronics Now Executive and  
Administrative Offices  
**1-516-293-3000.**

Subscriber Customer Service:  
**1-800-288-0652.**

Order Entry for New Subscribers:  
**1-800-999-7139.**

VISIT US ON THE INTERNET AT  
**www.gernsback.com**



# LETTERS

SEND YOUR COMMENTS TO THE EDITORS  
OF ELECTRONICS NOW MAGAZINE

## Gravity Waves Explained

I have been a NASA Goddard Space Flight Center astrophysicist for over 35 years, and I retired not long ago. I have been working in relativistic astrophysics since the early 60s and have published numerous articles in scientific journals on the application of general relativity to astrophysics. In 1963, I co-edited with William F. Hoffman (now professor of astronomy in the University of Arizona) a book *Gravitation and Relativity*, in which the theory and experimental detection of gravitational waves were among subjects discussed. Since then, of course, there have been many new developments in this subject.

The article, "Measuring Gravity Waves" by Skip Campisi (**Electronics Now**, October 1999) contained a number of critical mistakes that I feel obliged to point out. First of all, the name "gravity waves" is erroneously used. "Gravity waves" is a term used by geologists to describe the wave generated in either the atmosphere, oceans, and the land through the variation of gravity caused by a number of quite earthly reasons. For example, the tidal effect of the moon raises and lowers the height of the land with respect to the earth's center by approximately 1 cm and generates a kind of gravity wave, which is monitored closely by geologists using a sensitive gravity meter. This kind of wave is associated with Newtonian mechanics and has nothing to do with Einstein's theory of relativity. The proper term used to describe the kind of waves associated with Einstein's theory of gravity and mentioned in this article is "gravitational waves." Second, the arguments used in conjunction with Figure 1 to show that light travels at  $2c$  or  $1/2c$  speed is wacky at best; and had one of the most prominent founders of quantum mechanics, Wolfgang Pauli, been alive, he would have called it "not even wrong."

The kind of devices described in this article will certainly detect something. But whatever effect is detected is cer-

tainly *not* caused by gravitational waves. Invariably, it is caused by vibrations and other disturbances associated with atmosphere and the ground. Isolation from these effects is one of the main themes of the detection of gravitational waves. Even in the relatively crude (judged from the current standards) device built by Professor Joseph Weber (University of Maryland), who is regarded as the founder of gravitational wave physics, great pains were taken to achieve an isolation factor of  $10^{10}$  (100db).

There is a current gravitational wave project sponsored by the National Science Foundation (LIGO). The principle used is laser interferometry. The length of the interferometry path is roughly 3 miles with hundreds of multiple reflections to increase its sensitivity, and the whole device is enclosed in high vacuum. The mirrors were suspended and isolated from the ground by an isolation factor much better than Weber's 1963 device.

The electronics described in the article might be sound, but there is no mention about isolation of the proposed instrument. Isolation is one of the main games in the detection of gravitational waves. A casual experimenter might detect some signals from the kind of crude instruments described in this article, but the signal might as well be caused by a distant truck rumbling by and certainly not by gravitational waves. Sorry, no isolation, no detection. By the way, the distortion of space-time metric caused by gravitational waves (which are speculated to be generated during the collapse of stars such as supernova or the coalescence of close dense star pairs such as a binary neutron star pair) in a device of the dimension described in this article is estimated to be less than  $10^{-14}$  cm (and could be considerably less). This is smaller than a proton or neutron.

HON-YEE CHIU  
North Potomac, MD



# EQUIPMENT REPORT

CREATIVE LABS NOMAD MP3 PLAYER

*Look Ma, portable audio  
with no moving parts!*

CIRCLE 15 ON FREE INFORMATION CARD



**P**ortable, personal stereo systems were all the rage back in the early 1980s when Sony first introduced the legendary *Walkman*. Those devices, and similar ones from other vendors, featured a cassette tape player in a handheld package that used headphones for speakers.

Over nearly 20 years, portable stereos became smaller, fancier, more complex, and even cheaper in general. Today, many portable stereos can even play CDs. But all portable stereo systems contain moving parts, which tends to make them rather delicate and power-hungry. But thanks to an Internet-driven development, that might soon be a thing of the past.

By now, most have heard of MP3. MP3 audio is basically MPEG-compressed audio, which can package a typical song in about one tenth the space that the same song recorded on a CD would occupy. As an example, a 40-megabyte song on a CD can be converted to a 4-megabyte MP3 file. Now whole albums can fit in roughly 64 megabytes of space, as opposed to the 640 megabytes of space on an audio CD. The sound quality of MP3 audio is about the same as CD audio.

For some time now, MP3-encoded audio has been available on the Internet, from both legal and illegal sources. While record companies and amateur recording artists enjoy being able to distribute music samples via MP3 over the Internet, they do not like it when somebody takes a brand new album, converts

it to MP3, and posts the entire album on the Internet for anyone to download. It is easy for people who know where to look to locate nearly any song or album they want—especially new releases. Software MP3 players are also available on the Internet for free, so that any PC can play back the music. But a desktop computer, or even a notebook, is not nearly as portable as a Sony Walkman.

But a portable MP3 player is, and this holiday season will likely see a number of them on the market. One example is Creative Labs' new *Nomad* MP3 player. Not only does Nomad play MP3 audio, but it also features an FM tuner and recording capability so that it can be used as a dictation device—one that lets the audio be uploaded to a PC for safe-keeping and future reference.

## Creative Labs Nomad

The base Nomad player contains 32 megabytes of built-in memory and has a slot for flash card memory modules to increase the unit's capacity. The Nomad 64-megabyte version includes a 32-megabyte memory card. With 64 megabytes of memory, Nomad can store up to two hours of CD-quality audio or four hours of voice recording. Included stereo earphones are used for listening. Nomad's LCD readout displays the title of the song being played.

A docking station allows Nomad to be connected to a computer so that various MP3 files can be downloaded to the player. Users can download entire

albums or mixes of their favorite songs from multiple albums—basically whatever they like. Nomad lets you customize your own content and take it with you, whether you're going on a trip or just working out. Nomad contains no moving parts—no motors, no belts, no nothing. The solid-state nature of Nomad provides skip-free playback no matter how rough the going gets.

Nomad comes with the aforementioned high-quality stereo earphones and PC docking station. Also included are an installation manual, AC power adaptor, parallel port cable, CD installation disc, a pre-encoded MP3 content disc, and two rechargeable AAA NiMH batteries. Playback time is about 5 hours with the included rechargeable batteries, and about 9 hours with a pair of fresh AAA alkaline batteries.

Nomad is much smaller than it looks in photos. Its lightweight magnesium casing measures about 2¼ inches wide by 3⅜ inches high by about ⅝ inch deep. It weighs little more than two ounces without the batteries. Nomad's signal-to-noise ratio is less than 90dB and its frequency response is from 20 Hz to 20 kHz. The docking station measures about 3⅜ inches wide by 5¼ inches high by 2 inches deep, and it connects to a PC's parallel port using the included cable.

The parallel link lets users download MP3 files from the MP3 content disc included with Nomad or material obtained from the Internet. Alternatively, users can convert their own CD collections into MP3 files using the Creative Digital Audio Center software included with Nomad. Digital Audio Center lets you encode, decode, and archive MP3 files, as well as convert an unlimited number of CD tracks and catalog them according to preference. The Nomad Manager software downloads MP3 files to Nomad via its docking station in a matter of seconds.

Creative Labs has set up a Web site

*(Continued on page 29)*

# Looking Back

**A**S YOU READ THIS, Y2K IS NOW JUST A SHORT TIME AWAY. FOR THE PAST SEVERAL MONTHS, WITH THE AID OF JEROME S. BERG'S HISTORY OF SW BROADCASTING, *ON THE SHORTWAVES, 1923-1945*, WE'VE BEEN LOOKING BACK ON THE EARLY

years of our listening hobby.

For the SWL, then and now, the one essential tool is a radio. In the earliest days, the choices were few. You could buy a commercially made general-purpose radio that happened to cover the shortwave frequencies. Or you could build your own homebrew set, usually from plans in radio magazines. Serious shortwave listeners, though, needed something better, a communications receiver that offered the degree of sensitivity, selectivity, and signal handling required to pull in weak, distant signals.

Berg quotes receiver historian Raymond Moore as identifying the first bona fide communications receiver as the RME-9, made by Radio Manufacturing Engineers of Peoria, IL. The RME-9 was introduced in December 1933, and offered features that would define communications receivers for decades to come: band-switching, calibrated dials, bandspread tuning, signal-strength meter, separate RF stages, selectable bandwidth filters, automatic volume control to combat fading signals, a beat-frequency oscillator for reception of CW Morse-code signals, and more.

For decades, beginning in the 1930s,

CREDITS — Jeff Findlater, CA; Bob Fraser, MA; Andre Fredette, ONT.; Mark Humenyk, ONT.; David Krause, OH; Jack Linois, PA; William McGuire, MD; Denis Pasquale, PA; Betsy Robinson, TN; Gerald Witham, HI; North American SW Association, 45 Wildflower Road, Levittown, PA 19057.

the biggest name in shortwave receivers was Hallicrafters. The firm was founded by William J. Halligan, who, after several collaborative efforts with other makers, began manufacturing communications receivers for hams and SWLs in his Chicago factory. Hallicrafters, Berg notes, was known for value and a wide variety of receivers in just about every price range. They tended to be big, solid sets that performed well.

Another major player in the SW receiver field, both pre- and post-WWII, was the National Company. Initially, more than 80 years ago, the company made a variety of products, from toys to household goods. National began making radio kits in the 1920s, and high-performance sets for radio amateurs in the early 1930s. Under the guidance of its chief engineer and general manager, James Millen, National produced fine tube-type receivers, particularly its HRO series, for 30 years. In 1964, the company introduced its admirable HRO-500 solid-state receiver.

The third of the "Big Three" communications receiver manufacturers of the early years was Hammarlund Manufacturing. It was founded in 1910 as a general manufacturer of such diverse devices as fire alarms and liquor decanters, Berg says. By the mid-1920s, Hammarlund was making radios. Long time SW DXers recall the firm's quality HQ series of communications receivers, which began with the HQ-120 model in

1938. It cost \$230 in 1940, a huge price for the time. But Hammarlund radios were high-quality well-built sets; even today, many veteran DXers seek out well-used 30-year-old Hammarlund HQ-180 receivers at hamfests and flea-markets.

Despite gigantic advances in receiver designs in the last several decades, in terms of its ability to pull in really tough DX, the HQ-180 remains one of the most effective SW sets ever made.

More information about Berg's shortwave history is available from McFarland & Co., Inc., Publishers, at [www.mcfarlandpubl.com](http://www.mcfarlandpubl.com) or by calling 800-253-2187.

*Java for Breakfast*  
with  
**The Thrill Box**



**NATIONAL**  
**THRILL BOX**

NATIONAL Short Wave Equipment enabled Mr. Hinckley to hear Java broadcasts half way around the world.  
*You are missing a pack of thrills if you don't own a*

**NATIONAL**  
**THRILL BOX**

Complete Kit in factory-sealed carton, list price \$56.00  
Metal Cabinet black marine finish, extra \$6.50

Write us for our Short Wave Bul. 1000 No. 128RN.  
**NATIONAL CO. INC.**  
MALDEN, MASS.  
P.O. Box 1000

Build it yourself in one short evening

THIS 1929 RADIO-MAGAZINE AD for a National shortwave receiver emphasized the thrill of hearing radio signals from "half way around the world."

## Accredited B.S. Degree in Computers or Electronics

by studying at Home

Grantham College of Engineering  
offers 3 distance education programs:

- B.S.E.T. emphasis in Electronics
- B.S.E.T. emphasis in Computers
- B.S. in Computer Science

-Electronics Workbench Professional 5.0  
included in our B.S.E.T. curriculums  
-Approved by more than 200 Companies,  
VA and Dantes, (tuition assistance avail.)

For your free catalog of our programs dial

1-888-919-8181 Ext. 15

<http://www.grantham.edu>

# GCE

Your first step  
to help yourself  
better your future!



Grantham College of Engineering  
34641 Grantham College Road  
Slidell, LA 70460-6815

## Radio Australia Turns 60

On Dec. 20, 1939, a new international shortwave operation, known then as Australia Calling, officially began broadcasting. This month, today's Radio Australia marks its 60th birthday.

The beginnings of shortwave radio in Australia are even older, though. In 1928, the Australian Postmaster General's office began broadcasting from Lyndhurst, Victoria, near Melbourne. VK3LR, as the station was called, had a 500-watt transmitter feeding a horizontal halfwave dipole antenna. It broadcast on 9580 kHz; a frequency still used by Radio Australia nearly three-quarters of a century later.

The first experimental transmissions were received around the world despite the low transmitter power. The good reports prompted the Australian Broadcasting Corp. to begin a regular scheduled shortwave service in March 1934. The SW transmissions, relays of the ABC's AM medium-wave programs, were intended for listeners in remote parts of the Outback and on the more distant Pacific islands.

International broadcasting from Australia became a practical reality in 1939, when, spurred by the outbreak of war in Europe and China, worldwide communications took on a greater importance. The Australia Calling shortwave service was broadcast by 10-kilowatt transmitters in Lyndhurst and Sydney.

When the war reached the Pacific, there was a new urgency in reaching international audiences. A high-powered, for its day, 50-kilowatt transmitter began operating from Shepparton, about 200 km. north of Melbourne, in 1944. Soon six 100-kW SW transmitters were added at Shepparton.

In the 1960s, a second international transmitting site was established at Darwin in northern Australia. Cyclone Tracy destroyed the station in 1974, but it was rebuilt over the following decade.

A third Radio Australia site at Carnarvon on the central coast of West Australia was added in 1976. An interim transmission center also was opened in 1989 at Brandon, where the lower powered 10-kW. units from Lyndhurst were reinstalled. This facility was intended to reach audiences over medium distances, particularly those in Papua New Guinea.

At its peak in the early 1990s, Radio Australia operated 16 shortwave trans-

## ABBREVIATIONS

DX, DXer = Distant shortwave stations; one who hunts DX  
FM = Frequency modulation  
kHz = kilohertz, unit of frequency measurement  
kW = kilowatt, unit of power measurement; 1000 watts  
SW, SWL = Shortwave, shortwave listener  
UTC = Universal Coordinated Time standard used by most SWLs and major shortwave stations. Equivalent to Eastern Standard Time plus 5 hours; CST+6; MST+7 or PST+8

mitters, with powers from 10 to 300 kilowatts, on the air for a cumulative total of about 1600 hours weekly. But in recent years, like so many other major international broadcasters, Radio Australia's budget has been drastically cut. The Darwin and Carnarvon centers were shut down. Broadcasting hours were cut back severely; language services—including Thai, after 53 years of programming—were eliminated. Radio Australia's focus has narrowed to covering Asia and the Pacific, with programming in English, Chinese, Indonesian, Khmer, Vietnamese, and Pidgin.

Although Radio Australia has cut-back on its newsgathering staff at bureaus around the world, its on-the-hour 10-minute newscasts offer solid coverage, particularly of events in the Pacific Rim region that the broadcaster considers its prime responsibility.

Among the programs attracting sizable audiences is Roger Broadbent's "Feedback," which is a combination letterbox and musical-request program. It is aired at 0030 UTC Saturday on 21,740 kHz, and also is heard at 2105 UTC Friday; 0330 0605 UTC Saturday; and 0330 UTC Sunday.

Look for Radio Australia programming at 0200 to 0900 UTC on 15,515 and 17,580 kHz; 0900 to 1100 UTC on 11,880 and 13,605 kHz; 1100 to 1500 UTC on 9580 and 11,650 kHz, and 2100 to 0200 UTC on 17,580 and 21,740 kHz.

Despite the cutbacks at Radio Australia, it continues to be widely heard by SWLs in the U.S. and Canada, as it has been for the past six decades.

## The Years, Old And New

Before we leave 1999 behind, I want to offer another happy birthday wish to the Ontario DX Association, which marked its 25th anniversary during the year. The Canadian club serves those

Some Say Watching Tropical  
Fish Lowers Blood Pressure  
& Relieves Stress...



They Could Be On To  
Something.

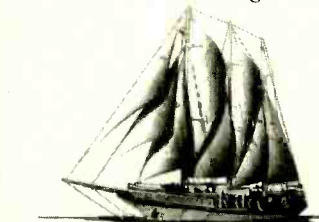

Discover the Caribbean aboard a Tall Ship.  
6 & 13 day adventures from \$650.  
For more information call your travel agent  
or 1-800-327-2601.

 **Windjammer**  
**Barefoot Cruises** INC.

P.O. Box 190120, Dept. 5569, Miami Beach, FL 33119

CIRCLE 132 ON FREE INFORMATION CARD



who listen to international shortwave, medium wave, scanning, FM listening and more. While its prime efforts are directed to listeners in Ontario, with regional gatherings and listening events, its monthly bulletin has subscribers throughout the world.

For more information about this club, you can check the ODXA Web site at [www.odxa.on.ca](http://www.odxa.on.ca) or write to ODXA, P.O. Box 161, Station A, Willowdale, Ontario, M2N 5S8, Canada.

Looking to the new year ahead, the 13th Annual Winter SWL Festival is scheduled for March 10-12, 2000, at the Holiday Inn in Kulpsville, PA (Exit 31 on the Northeast Extension of the Pennsylvania Turnpike). Every year, several hundred SWL, medium-wave, and scanner enthusiasts gather for a weekend of programs, equipment displays, and fun. For more information on how you can join in, send a self-addressed stamped envelope to Winter SWL Festival, c/o Dr. Harold Cones, 2 Whits Court, Newport News, VA 23606.

And a week later, March 19-21, is scheduled for the 2000 North American DX Championships. This listening contest is a great way to show the world that

you are the tops when it comes to SWLing. Rules on how you can participate in the year's SWLing event also can be obtained for an SASE to 2000 NA DX Championship, also in care of Dr. Cones at the above address.

### Down The Dial

Let's take a look at some DXing targets you may want to tune:

**BULGARIA**—13,600 kHz, Radio Bulgaria in Sofia is noted signing on with German programming, including a newscast, at 0515 UTC. Operating in parallel at this time is 12,000 kHz.

**CANADA**—6070 kHz, CFRX, Toronto, is one of a handful of independent SW stations in the "Great White North." You may be able to catch it about 2300 UTC.

**FRANCE**—15,155 kHz, Radio France International's English programming to Asia and the Pacific can be logged here around 1215 UTC, as well as on a parallel channel of 15,540 kHz.

**MOROCCO**—9680 kHz, Voice of America, relayed from Moroccan transmitters, airs its "News Now" program at 0600 kHz.

**NIGERIA**—11,560 kHz, Voice of

Nigeria has been noted in English at 1900 UTC with reggae music and a political commentary.

**SEYCHELLES**—9770 kHz, the British Broadcasting Corp. broadcasts are relayed from transmitters in this Indian Ocean island nation. Listen for sign on at 0200 UTC with the familiar Big Ben chimes tuning signal.

**SLOVAKIA**—9440 kHz, Radio Slovakia International programs from 0130 UTC, with interval signal, English identification, and into news in Slovak.

**SWEDEN**—12,060 kHz, Radio Sweden's English service has its news feature program, "60 Degrees North" scheduled at 0340 UTC. A parallel frequency is 9495 kHz.

EN

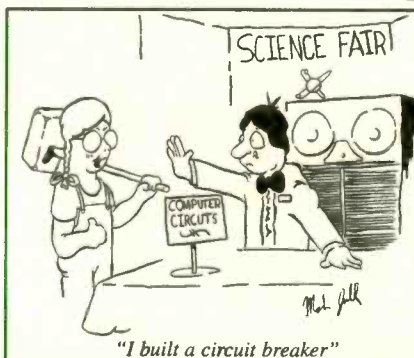

"I built a circuit breaker"

## Genuine Proto-Boards®

The benchmark in quality & reliability

If the breadboard you're using is not from Global Specialties, it's not a genuine Proto-Board®. And unless it's a genuine Proto-Board®, it's not built with the unmatched quality and craftsmanship only a Proto-Board® can offer. Don't compromise your best design efforts by using a cheap imitation. Put your trust in the name brand that has provided engineers and educators with maximum value for over 30 years - Proto-Board®.

Global Specialties offers powered and non-powered Proto-Boards®, designed to meet the most demanding prototyping applications. Select from a wide range of interlocking breadboards from our patented EXP and QT series sockets, or if it's test instruments in a desktop design workstation you require, select from a number of models designed to meet your technical, as well as economical needs. Each product is available either assembled or unassembled.

**There's only one Proto-Board®, and it's made by Global Specialties. Proudly made in the U.S.A.**



**GLOBAL SPECIALTIES**

DESIGN & PROTOTYPING

800-572-1028 • FAX 203-468-0060 • [www.globalspecialties.com](http://www.globalspecialties.com)

CIRCLE 160 ON FREE INFORMATION CARD

[www.americanradiohistory.com](http://www.americanradiohistory.com)

# More on Semiconductor Testing, DVD Notes, and More

**T**HIS MONTH WE'LL COMPLETE OUR DISCUSSION OF SOLID-STATE DEVICE TESTING ALONG WITH SOME VERY SIMPLE CIRCUITS THAT CAN BE PUT TOGETHER IN ABOUT 10 MINUTES TO DISPLAY THE CHARACTERISTICS OF TWO-TERMINAL DEVICES ON

an oscilloscope. We'll also inaugurate an occasional series of short topics on other aspects of repair or follow-ups to previous articles. This time: What about DVD player or DVD-ROM drive servicing?

## Diode and Rectifier Speeds

When the polarity reverses on a diode, it takes finite time for the charge carriers to be cleared from the area of the junction. During this time, reverse current flows. For high-frequency applications—*i.e.*, switching power supplies, horizontal deflection circuits, etc.—a normal diode would act more like a short circuit and result in poor performance or even burn out.

There are a variety of alternatives: fast-, super-fast-, ultra-fast- (and so forth) recovery diodes, Schottky diodes, and others that must be used in high-frequency signal, switching, and power-supply circuits. Thus, if you find a bad diode in a piece of electronic equipment, don't assume it is just an ordinary diode because the case looks the same. Replacing a fast-recovery diode with a 1N4007 will very likely just result in more confusion. A proper device must be used even for testing. In most cases, a faster part can be substituted without problems. However, there are occasional situations where the specific characteristics of a slow part (a reverse pulse due to its long recovery time or high capacitance) are needed for the circuit to operate properly!

## Horizontal Output Transistor Pinouts

The next discussion might go in the "general trivial department," but it might also come in handy if you haven't been playing with horizontal output transistors (HOTs) all your life!

You will nearly always find one of two types of HOTs in TVs and monitors, and those are shown in Fig. 1. Some other transistor types use the same pinout (TO3—see Fig 1A—for metal can, TOP3 and TO220—see Fig. 1B—for plastic tab), but not all. However, for horizontal output transistors, those pinouts should be valid.

Note that HOTs with a built-in damper diode may read around 50 ohms between B and E (near 0 on the diode test range)—this is normal as long as the resistance is not really low (under 10 ohms).

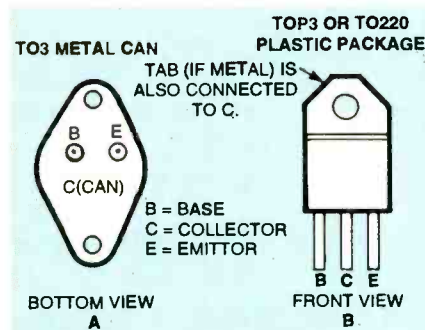

**FIG. 1**—HOT PACKAGES: a TO3 metal can is shown in A, and a TO220 plastic package is in B.

## Difference Between Normal and "R"-Marked Parts

Electrically, normal and "R"-marked parts are exactly the same. The R stands for "reverse." The "R" pinout is a mirror image of the normal one. This makes layout of high-frequency pairs easier because traces do not have to cross over one another. However, it can also bite you if you are unaware of what the marking means!

## Testing MOVs

Metal-oxide varistors (MOVs) are used mostly for surge suppression in power strips and the front-ends of the power supplies of TVs, VCRs, and other consumer electronic equipment. They are those brightly colored things that look like Epoxy-dipped capacitors. At least, that's what they look like when new. A common failure mode is for the MOV to be totally obliterated by a surge or from old age. In such cases, testing is not needed!

MOVs are supposed to be located beyond the line fuse (though possibly not always). In this case, where the line fuse blows but there is no visible damage to the MOV(s), the simplest test may be to just temporarily remove the MOV(s) and see if your problem goes away.

A multimeter can be used to test for leakage (there should be none), but the best option is to remove the device. Since the proper functioning of the equipment doesn't depend on any MOVs (in 99.9999 percent of the cases—the exception being where the MOV is used as a high-voltage triggering device or something like that rather than a surge suppressor), remove the MOV(s), test the equipment, and then just replace the MOV(s) if in doubt.

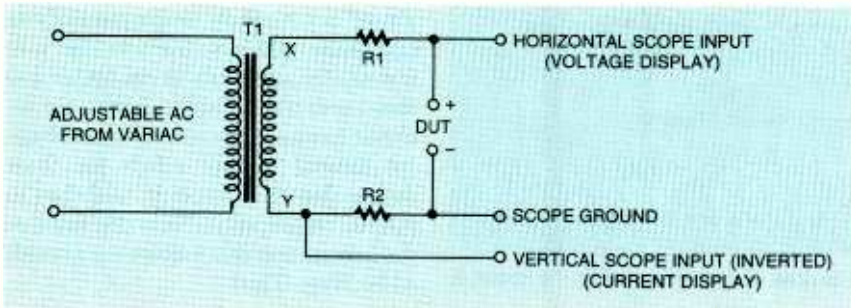

**FIG. 2**—THIS “QUICK AND DIRTY CURVE TRACER” can tell you a lot about the value and health of a wide variety of components. It is used with an oscilloscope.

### Introduction to Curve Tracers

A curve tracer is a piece of test equipment or an add-on to an oscilloscope that provides a graphical display of the V-I (or other parameters) of an electronic component. The design of a curve tracer is simple in principle; let's look at one designed for testing bipolar transistors.

For the horizontal (collector supply) you need a variable-ramp generator. If your scope has a sweep output, then you can derive it from that—if you are not interested in frequency response, an audio amplifier may be adequate with a volume control to adjust the amplitude.

For the base drive you need a programmable current source capable of putting out a series of constant currents; for example, a counter driving a D/A set up for a current-output mode. Use the trigger output or sweep output of the scope to increment the counter so that it sequences through a set of say 10 current settings. Then, you can jazz it up with microprocessor-controlled on-screen display.

Curve tracers can be big expensive things or little add-ons to regular scopes. If you want to build your own, kits are available from sources such as Gootee Systems (<http://www.fullnet.com/u/tomg/>). I have no idea how good their unit is, but you can get more information on their Web page. Also, **Popular Electronics**, May 1999, has complete plans for a “Semiconductor Tester” that can handle NPN and PNP bipolar transistors, JFETs and MOSFETs, all sorts of diodes including Zeners, and a variety of other devices. This is basically a curve tracer adapter for an oscilloscope. With a little ingenuity, it can be enhanced to test virtually all the semiconductors discussed in last month's Service Clinic (and more).

Therefore, if you want a sophisticated piece of test equipment, one of these would be suitable. Or, get yourself a

used Tektronix 575 curve tracer. It will do just about everything you could possibly want (including the testing of vacuum tubes with the addition of a bit of external circuitry.)

However, to just test two terminal devices—or to just get a feel for device

characteristics, there are much simpler, cheaper, alternatives.

### Quick and Dirty Curve Tracer

I built the circuit shown in Fig. 2 in about 10 minutes. With minor modifications, it is capable of displaying V-I curves for diodes, Zeners, transistors, thyristors, resistors, capacitors, inductors, etc.

I used a 12 VAC transformer for T1 just because it was handy. You can use anything you like as long as you understand the safety implications of higher voltages and make sure the components you use can withstand the power that might be dissipated in them if the Device Under Test (DUT) is a dead short. In addition, it is bad form to blow out the DUT while testing it! A signal generator driving a small audio transformer could also be used if it is desired

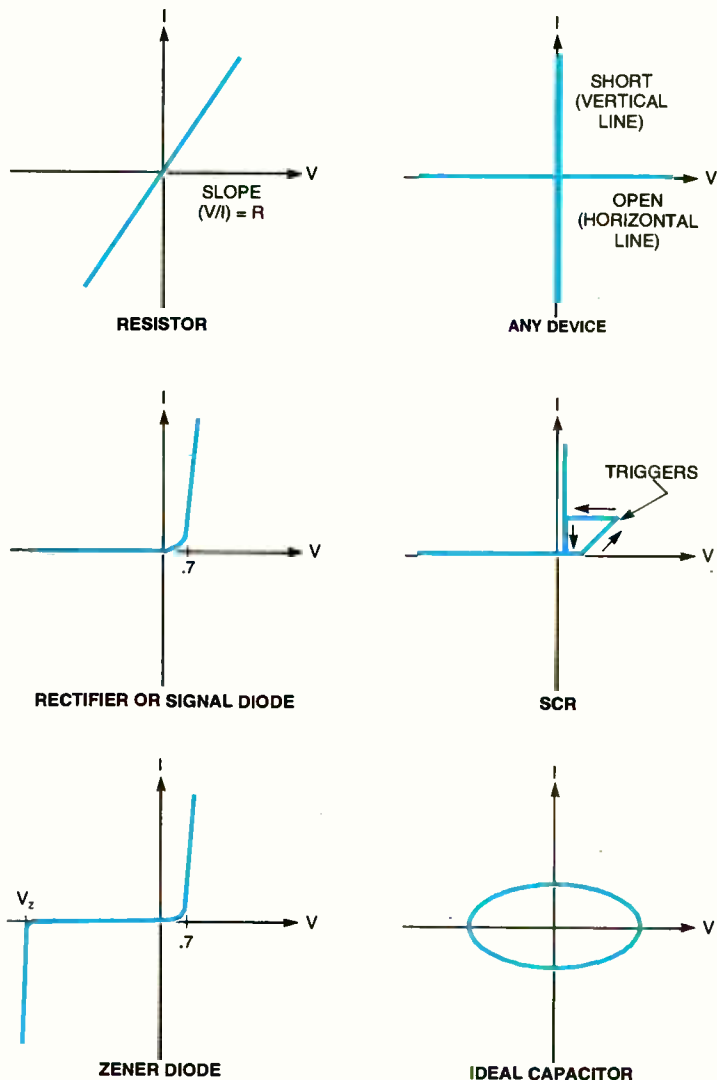

**FIG. 3**—THESE WAVEFORMS are what you'll see on your oscilloscope when testing a variety of components.

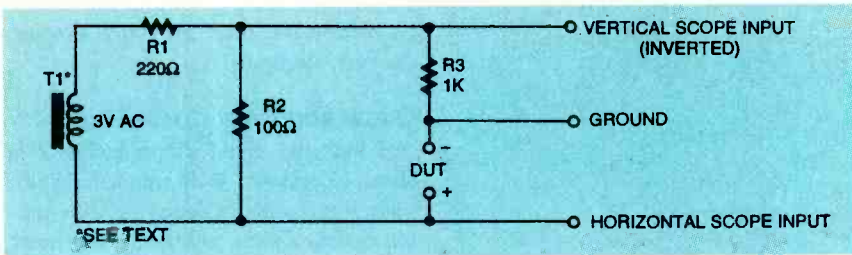

**FIG. 4**—THIS CIRCUIT IS ALL you need to test devices while they are still in the circuit. It is from an article that appeared in 1975.

to test components at frequencies other than 60 (or 50) Hz.

**CAUTION:** Turn down the intensity of the scope so the spot is just barely visible so that when there is no input, you don't end up drilling a hole in the face of the CRT! Here are some other circuit notes:

**R1:** Current limiting and phase shift control. I used 500 ohms, which works well for small signal semiconductors and capacitors of around 1  $\mu$ F.

**R2:** Current sense. I used 10 ohms and put the scope on the one of the .1, .2, or 0.5 V/cm ranges.

**T1:** Small power transformer. I used the 12 VAC wall wart from an obsolete modem. This will supply a voltage of up to about 17 V peak to your DUT. For higher power or higher voltage devices, substitute a suitable larger transformer.

Modify these (selector switches might be nice) for your needs. A Variac provides a convenient method of adjusting the voltage applied to the DUT.

So what will you see on the scope? Some typical curves are shown in Fig. 3.

- Zener diodes—the result will be exactly like the picture in your textbook. Try this with a 5 or 6 V Zener to confirm that your rig is working.

- Resistors—the display should be a straight diagonal line. You should be able to compute their value from the ratio of V to I. If the device is open or shorted, the display will be either a horizontal or vertical line, respectively.

- Capacitors—you should see the phase shift between voltage and current resulting in an ellipse (though you will probably have to adjust the scale factors to obtain a usable display with typical capacitor values).

- Bipolar transistors—a source of (DC) base current is needed. You can be fancy or simple. For a simple source, I used a variable 0 to 15 V power supply and a current limiting resistor. Since we know that the voltage drop across the B-E junction is fair-

**TABLE 1—SCOPE DISPLAY**

**Resistors:**

Open	Horizontal line
10 K	10 degree
1 K	45 degree
0	Vertical line.

**Capacitors:**

1 mF	Shallow ellipse
2.6 mF	Circle
50. mF	Narrow vertical.

**Transformers:**

Ellipse depending on impedance

**Diodes (Germanium):**

Right angle display

**Diodes (Silicon):**

Right angle one side longer (any leakage showing less sharp angle)

**Transistors:**

Test as two diodes (B to E and B to C)

**Integrated Circuits:**

Input for gates and counters show a certain signature display  
 Outputs display a different signature  
 A short will show a vertical line  
 An open will show a horizontal line

ly constant at around 0.7 V (for silicon), the output of the supply can be calibrated in terms of base current.

- SCRs—connect a suitable resistor in series with a diode or two (or a diac) between the gate and the DUT positive terminal (so gate current is included in the V-I curve). When the threshold current is exceeded, the device should turn on and remain on until the zero crossing. With the reverse polarity, the device should remain off. For Triacs, use diodes in parallel in both directions, or a diac. A Triac should trigger on both polarities of the AC waveform.

**In-Circuit Tester**

In the August 1975 issue of *Popular Electronics*, author Lou Garner wrote a story called "A Simple On-Board

Tester" about a fairly simple piece of test equipment, which is shown in Fig. 4. It is along the same lines as the "quick and dirty curve tracer," but is suitable for in-circuit testing as the current and voltage are limited to safe values for most devices (less than 1-volt AC and than 1-mA AC respectively). Note that some of the information that follows was provided by Wern Thiel.

**CAUTION:** Use at your own risk. I cannot absolutely guarantee that there won't be certain devices in use today that didn't exist in 1975 and that might be unhappy with this approach.

The device can be used with any type of oscilloscope and consists of a 6-volt filament transformer, three 1/4-watt resistors, and two test probes. Half of the filament voltage is applied to a voltage divider consisting of 220- and 100-ohm resistors, yielding 1-volt AC on top of the 1000-ohm resistor. This voltage can be applied to any component or combination of components across which the test leads are placed. The current is limited to one milliampere by the 1000-ohm resistor.

The voltage across the probes is connected to the horizontal input of a scope while the voltage across the 1000-ohm resistor as a result of the current through it is connected to the vertical input. What we see on the scope is a voltage across a component under test versus the current through the component and is summarized in Table 1.

In-circuit testing is done with **no** power applied to the equipment under test. With some experience one should be able to test components in and out of circuit and troubleshoot without danger of damage to components.

**Testing Vacuum Tubes or FETs**

A transistor curve tracer can be easily adapted to test vacuum tubes if it has an adequate voltage range for the collector (now plate) drive and independent control of base and collector polarity. All that is needed is to add a separate transformer to power the tube's filament(s) and a resistor to convert base current to voltage. For FETs, just leave off the transformer. Michael Covington (author of the Q&A column in *Electronics Now*) suggests the following:

"Get an old Tektronix 575 (mine cost \$25 at a hamfest). That is a transistor curve tracer that goes back to the 1950s and goes up to 200 volts. It doesn't have FET settings, but you can control the "base" and "collector" polarity independently. So what

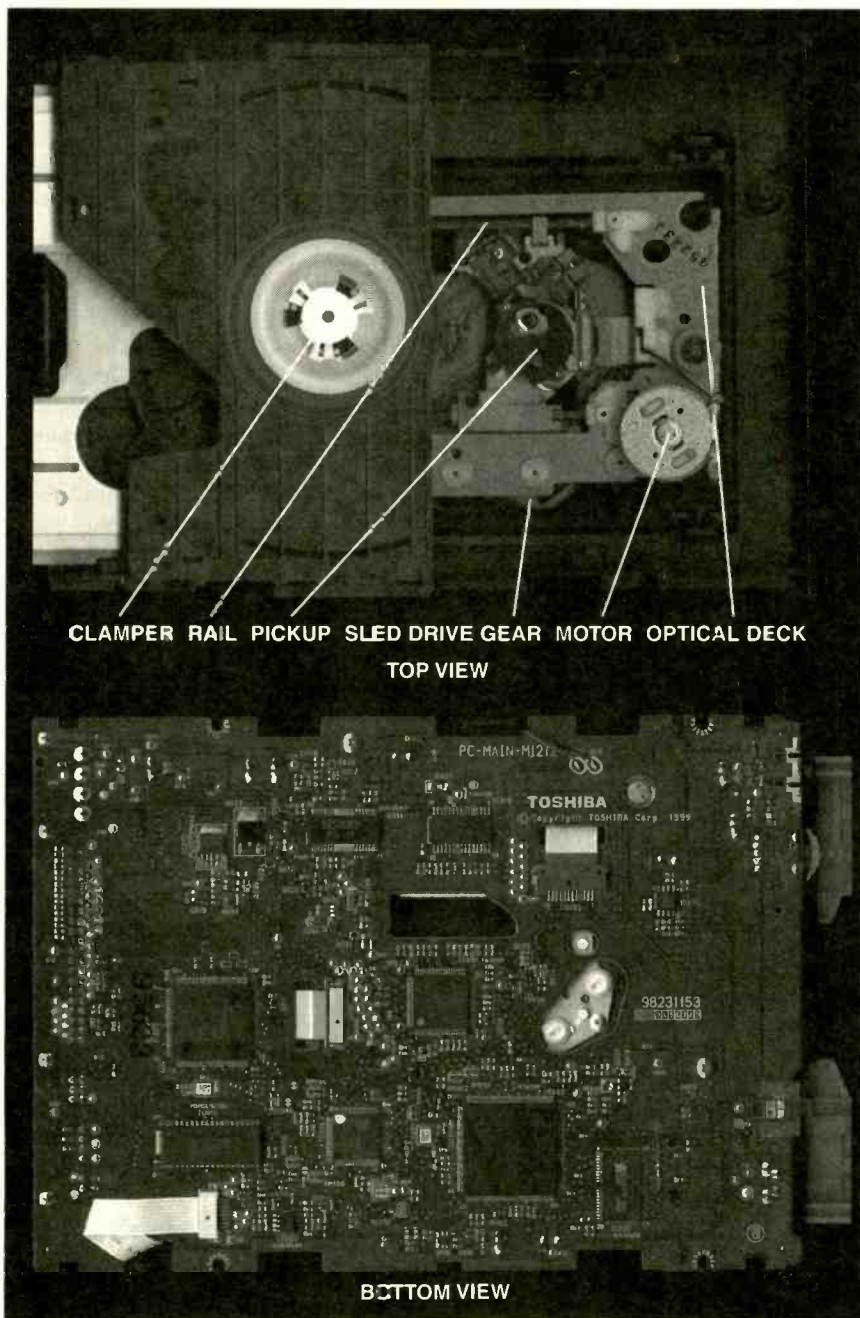

**FIG. 5—INSIDE A TYPICAL DVD-ROM drive.** Mechanically, they do not look very different from CD-ROM drives, though the electronics seem more complex.

you do is put a 1000-ohm resistor from "base" to ground, so that you can read milliamps as volts. Then put a positive-going voltage on the "collector" and a negative-going current into the "base." For tubes, emitter, collector, and base are cathode, plate, and grid, respectively. Naturally you also need a filament supply; I use a lab-type DC supply because it's handy and can't introduce hum. I also test FETs that way (without the filament supply, of course). Then, emitter, collector, and base become source, drain, and gate respectively."

That's it for semiconductors for now—in a future column we will delve into the problems of testing and powering the types of laser diodes found in CD and DVD players, laser printers, and other laser-based consumer electronics equipment.

### DVD Player and DVD-ROM Drive Servicing

We covered CD-player operation, troubleshooting, and repair, in a complete series of Service Clinic columns a

while ago. Since then, DVD technology has really taken off and (if you believe the marketing hype) is about to replace CDs totally. Realistically, this won't happen for some time. In any case, DVD players and DVD-ROM drives are *supposed* to accept CDs, CD-Rs, and CD-RWs, so no need to panic just yet. But availability of new CD-based devices will disappear because the cost to manufacture a DVD player or drive isn't much more than that of a similar CD unit, so manufacturers will want to close down their old production lines and concentrate on DVDs only.

Photos of a DVD-ROM drive are shown in Fig. 5. That unit, a Toshiba SD-M1212, is typical of the units shipped with bundled PCs (I believe this was from a Dell Dimension 450 MHz Pentium II system). The most notable feature of the optical deck used here is that it really is very similar in appearance to those used with late model CD players or CD-ROM drives. In fact, without the DVD logo or other distinguishing markings, it could just as well have been a CD-ROM drive (of course, we know that what's inside is quite different at least in the details). I wasn't willing to go any deeper since this is still a working unit so there could be internal differences. An update will be forthcoming when I get my hands on a broken one!

One thing that is obvious is the amount of circuitry compared to a late model high-speed CD-ROM whose PCB typically occupies less than 1/3rd of the available area. I don't know how much of the added circuitry is due to it just being newer technology that hasn't been as highly integrated yet as opposed to the additional complexity required for DVD decoding and support for CD audio and data formats as well.

In any case, eventually all things break, and DVD equipment will be no exception. Fortunately for us, the similarities between CD and DVD technology are much more significant than the differences. The inside of a DVD player looks pretty much the same as the inside of a CD player and, for the most part, the same problems are likely to occur. Here are some things to look out for:

DVD discs (if you haven't seen one yet) look virtually identical to CDs. They are the same size and thickness with the same large center hole and will fit perfectly well into a CD player or CD-ROM drive—but of course it won't do much there. Despite the tracks and

**TABLE 2—CD vs. DVD**

Parameter	Compact Disc/CD-R	Digital Versatile Disc
Disc diameter	20 mm	120 mm
Disc thickness	1.2 mm	1.2 mm
Disc structure	Single substrate	Two bonded 0.6 mm substrates
Laser wavelength	780 nm	650 to 635 nm
Numerical aperture	0.45	0.60
Track pitch	1.6 mm	0.74 mm
Minimum pit/land length	0.83 mm	0.4 mm
1× speed (CLV)	1.2 m/sec	4.0 m/sec
Number of data layers	One	One or two
Number of sides	One	One or two
Data capacity	~680 MB	4.7 GB (one layer) 8.5 GB (two layer) 17 GB (two layer, two sides)
User data rate (13)	153.6 K/sec (mode 1)	1108 K/sec (mode 1) 176.4 K/sec (mode 2)

pits being closer together, the rain-bow/diffraction effects are about the same so a casual glance isn't enough to tell them apart, but there is always that DVD logo! However, the information layer is precisely in the center of a sandwich of polycarbonate (each half 0.6 mm thick). The DVD standard supports a double-sided DVD. If a DVD is two sided (many aren't), that of course leaves virtually no room for the label!

A comparison of major CD and DVD characteristics is shown in Table 2. Here are some additional notes:

- The reduced track pitch and pit

length made possible by the shorter wavelength and advances in optical readout technology accounts for the almost 8-fold increase in data storage capacity on a single layer.

- The laser in a DVD-based device is a very visible red (a wavelength around 650 nm compared to the nearly invisible IR 780 nm laser used for CDs). This is about the same wavelength as used in newer red laser pointers. It is still low power (1 mW or less at the objective lens) but the laser will appear very bright when it is powered and working correctly. As far as hazards to vision, the same recommendations apply—don't look into the beam directly, but viewing from an oblique angle at 12 inches or more from the objective lens should be safe. The eye's aversion reflex will prevent damage in any case—you will blink or turn away from the bright light.

**CAUTION:** Some (probably older) DVD equipment may also have a standard CD pickup to be able to read CDs. For these, obviously, all the IR laser precautions apply.

- It should be easier to determine if the laser is bad by brightness alone though a laser power meter, and the manufacturer specifications will still be needed in marginal cases.

- As a result of the march of technology, the optical pickup is likely to be of simpler design than that in older CD-based devices with even fewer or no adjustments possible. However, there could be additional complexity due to the need to handle DVDs and CDs in the same equipment. The use of com-

bined laser diodes and photodetector arrays is likely to be quite common if not pervasive.

- The same basic functions need to be performed by the front-end electronics, including amplification of the photodetector array output, and focus, tracking, and spindle servos. Much of this is likely to be done inside large chips with no service adjustments possible.

- More functions will be incorporated into fewer surface-mount chips. Fortunately, failures of the large-scale integrated circuits themselves are not nearly as common as simple mechanical problems. We'd better hope so in any case as troubleshooting of things like an MPEG decoder is way beyond what could be done without a complete service manual, sophisticated test equipment, and probably a whole lot more!

- More plastic and less metal is likely to be used, making the unit lighter, flimsier, and less likely to be serviceable at all.

So, the bad news is that if something breaks inside a large chip, accept defeat and send the unit in for service. The good news is that most problems will still be mechanical—dirt, dust, gummed up grease, bad motors, abuse. From our experience with CD repair, we should be well equipped to deal with these!

Hopefully, manufacturers have learned from their experience with CDs to make a more reliable robust product, but that may be wishful thinking where the bottom line is involved. It's still too early to tell.

For more information on DVD technology, check out the following sites:

- DVD FAQ: [www.videodiscovery.com/vdyweb/dvd/dvdfaq.html](http://www.videodiscovery.com/vdyweb/dvd/dvdfaq.html)
- Digital Video Disc (DVD) Technology: [www.c-cube.com/technology/dvd.html](http://www.c-cube.com/technology/dvd.html)
- Philips Optical Storage: [www.km.philips.com/laseroptics/](http://www.km.philips.com/laseroptics/)
- DVD Central @ etown.com: The Home Electronics Guide: <http://community.etown.com/dvd/>

### Wrap Up

That's it for now. Next time we start on the exciting world of VCR repair. Until then, check out my Web site, [www.repairfaq.org](http://www.repairfaq.org). I welcome comments (via e-mail please) of all types and will reply promptly to requests for information. Sorry, I really cannot answer postal mail, but might include a response in a future column (if interest warrants). See you next time!

EN

### Get your copy of the CRYSTAL SET HANDBOOK



Go back to antiquity and build the radios that your grandfather built. Build the "Quaker Oats" type rig, wind coils that work and make it look like the 1920's! Only \$10.95 plus \$4.00 for shipping and handling. Clegg Inc., P.O. Box 4099, Farmingdale, NY 11735. USA Funds ONLY! USA and Canada—no foreign orders. Allow 6-8 weeks for delivery. MA01

### ELECTRONIC GAMES

**BP69**—A number of interesting electronic game projects using IC's are presented. Includes 19 different projects ranging from a simple coin flipper, to a competitive reaction game, to electronic roulette, a combination lock game, a game timer and more. To order BP69 send \$4.99 clearance (Includes s&h) in the US and Canada to Electronic Technology Today Inc., P.O. Box 240, Massapequa Park, NY 11762-0240. US funds only. Use US bank check or International Money Order. Allow 6-8 weeks for delivery. MA07



# Prototype

## "Colossal" Magnetoresistance And Improved Data Storage

A team of Japanese researchers have identified an oxide material that could greatly improve the storage capacity of hard disks and magnetic tapes. The discovery, reported earlier this year in *Nature*, relies on a phenomenon called "colossal magnetoresistance"—a large drop in a material's electrical resistance (by more than a factor of 10) in response to an applied magnetic field.

The basic cause of the magnetoresistance is the Lorentz Force, which influences the electrons to move in curved paths between collisions. Magnetoresistance materials have become a mainstream research subject by virtue of their considerable technological importance, though it is not well explained within the existing theoretical framework. It is potentially important for its commercial applications in devices such as magnetic sensors, magnetoresistive read heads, magnetoresistive random-access-memory devices (MRAM), and use as electrodes in solid-oxide fuel cells.

Magnetoresistance is what allows tape-recorder or disk-drive heads to read data from the magnetic pattern on the tape or disk. It's the result of a particular magnetic property of materials called the "magnetic moment"—a tiny magnetic field produced by the electrons orbiting the nucleus of an atom.

Science has been investigating magnetoresistance for over 20 years. Magnetoresistive materials are very special: When exposed to a magnetic field, they exhibit less resistance to electrical current. So if a voltmeter is placed across a disk head made of magnetoresistive material, the fluctuations in volt-

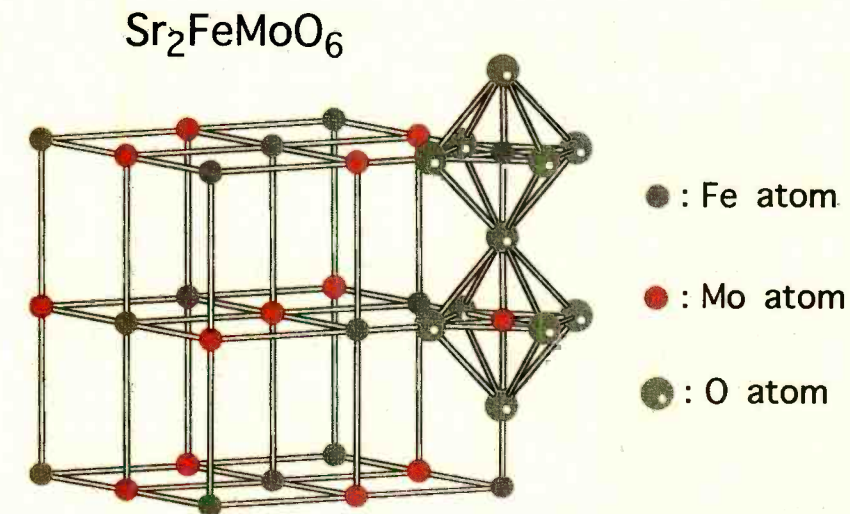

JAPANESE RESEARCHERS HAVE DEMONSTRATED a 10-percent drop in resistance in iron-molybdenum-oxide crystals such as  $\text{Sr}_2\text{FeMoO}_6$ , shown here. (Illustration courtesy Joint Research Center for Atom Technology, Japan.)

age that the meter shows reflects the magnetic values stored on the disk.

Heads designed using magnetoresistance instead of the current inductive design have distinct advantages. By directly detecting the magnetic field, rather than measuring the change in field as current inductive heads do, magnetoresistance heads can detect smaller magnetic signals, plus they don't face the problems of increasing smaller spacings and thermal noise that currently plague inductive heads as storage densities increase.

In many crystalline materials, magnetic moments are randomly oriented, which increases the electrical resistance of the material. But a strong external magnetic field can reduce that resistance by bringing the magnetic moments into

alignment. The larger the magnetoresistance of a material, the smaller the magnetic signal to which it can respond, hence the possibility of dramatically increasing storage capacity.

### Some Background

The magnetoresistance of traditional materials is quite small. The passage of current is not greatly affected by external magnetic fields. However, various materials have been made with extremely large magnetoresistances. "Giant" magnetoresistive materials—multilayers of ferroelectric and non-magnetic metals—were discovered in 1988. Then, in 1993, when the magnetoresistance of the special kind of perovskite manganese oxide was discovered to be much larger, the name "colossal" magnetoresistance

(CMR) was chosen.

Before the Japanese research, the largest resistance drops were seen only when the temperature of the material was very low, impractical when used in common items such as read/write heads. Therefore, scientists had to settle for only a one or two percent reduction in resistance. However, in crystals of an iron-molybdenum oxide, a team led by Kei-Ichiro Kobayashi at the Joint Research Center for Atom Technology (JRCAT) in Tsukuba, Japan, observed a 10 percent drop in resistance at room temperature when the material was placed in a strong magnetic field, encouraging experts to predict the finding will eventually accommodate improved magnetic sensors and disk storage.

To be useful commercially, CMR must address several important considerations, said Edward Gillman, staff scientist in the Accelerator Division of the Thomas Jefferson National Accelerator Facility, Newport News, VA, including the temperature range at which the magnetoresistance materials operate. For practical applications, the magnetoresistance materials need to operate near room temperature.

Another consideration is at what magnitude of magnetic field are the materials responsive. A large magnetoresistance response to a large magnetic field is not practical outside the laboratory. A low field magnetoresistance response will ultimately determine the utility of these materials. The application of the new generation of magnetoresistive oxides in information storage requires a reduction in the applied fields required to achieve significant magnetoresistance.

Finally, how difficult is it to incorporate these materials into electronic structures. For near-term applications, these materials need to be integrated into conventional microelectronic devices at low-cost. Ultimately this is determined by the processing technology needed for these materials.

"Kobayashi's work is an important new development that attempts to address some of these issues," said Gillman. "Most work, including my own, has focused on the CMR manganese films. Clearly this new material represents an important advancement in the field of MR technology."

Because of the relatively high magnetic field required to produce the MR effect, the researchers say the material is not yet ready for use in data storage devices.

"It's no good having 99.9 percent resistance suppression if you need a 7 Tesla field to achieve it," said Matthew Rosseinsky, University Lecturer in Inorganic Chemistry at Oxford University. "So the demonstration that the spin-polarized metallic oxide  $\text{Sr}_2\text{FeMoO}_6$  displays low-field magnetoresistance at room temperature is significant."

The discovery is part of JRCAT's 10-year Ultimate Technology for Manipulating Atoms and Molecules project, which began in 1992. The two-phase project aims at establishing a generic technology and a fundamental concept for creating new materials and devices by manipulating atoms and molecules either individually or collectively at the operator's will.

The six-year first phase operated as a versatile basic research program rather than a rigid project, with some remarkable results, such as creation of semiconductor nanostructures, experimental and theoretical clarification of initial oxidation process of clean silicon surfaces, direct observation of higher order structure of DNA, and discovery of colossal magnetoresistance effects in single crystals of manganese oxide and iron-molybdenum oxide.—Doug Page **PT**

## Mini-Robots in Space

Scientists at NASA's Ames Research Center, Moffett Field, CA, are developing an autonomous robot to support future space missions. About the size of a softball, the compact design of the Personal Satellite Assistant (PSA) will allow it to keep out of the astronauts' way while working in the cramped confines of the Space Shuttle's flight deck and Space Station modules. Since it will operate autonomously, the astronauts' hands will be free for other tasks.

The little round robot will be equipped with a variety of sensors to monitor environmental conditions in a spacecraft, such as the amount of oxygen, carbon dioxide, and other gases in the air; the amount of bacteria growth; air temperature; and air pressure. The

PSA will also have a camera for video conferencing, navigation sensors, wireless network connections, and even its own propulsion components enabling it to operate autonomously throughout the spacecraft.



EQUIPPED WITH A VARIETY OF SENSORS TO MONITOR ENVIRONMENTAL conditions in a spacecraft, the little round PSA robot will also have a camera for video conferencing, navigation sensors, wireless network connections, and even its own propulsion components.

"We're developing an intelligent robot that essentially can serve as another set of eyes, ears, and nose for the crew and ground support personnel," explained NASA Ames researcher Yuri Gawdiak, principal investigator for the project. "Our research objective is to test intelligent autonomous systems that use advanced sensors and monitoring technologies for supporting current and future spacecraft operations."

The Personal Satellite Assistant represents the next generation of advanced Information Technologies that follows the Wireless Network Experiment (WNE) developed at NASA Ames in 1995 for the International Space Station. As the astronauts aboard Atlantis discovered during the STS-76 mission, wireless computer networkers work well in a space environment and the wireless computers' radio signals did not interfere with either the Space Shuttle's or the Russian Space Station Mir's other electronic equipment.

Based on this success, the crew recommended handheld wireless portable data assistants that could support their mission operations onboard the International Space Station. The Ames research scientists took their recommen-



## ► Digital Optical-Disc Video Recorder

NEC Corporation recently announced the release of a digital video recorder, called GigaStation, that uses a 120mm diameter rewriteable large-capacity optical disc as its recording medium. The unit offers the same functions as standard-technology videotape recorders, including unlimited recording and editing.



Using CD-size rewriteable optical discs with a capacity of 5.2GB on each side, it can record two hours of S-VHS-quality video in standard mode, and four hours of lower-quality video in extended mode. A fine mode for even higher-quality recording is also available.

The GigaStation can search and play the contents by selecting a title that was automatically created during recording, and it also offers a bookmark function. In addition, it can automatically find free disc space, can record at the push of a button, and can perform high-speed noise-free fast forwarding.

In addition to a standard analog input/output interface, the recorder offers a digital-video input for use with digital video cameras and PCs equipped with a DV interface. Available only in Japan at present, NEC is planning to ship 30,000 units the first year. The unit is priced at 350,000 Yen, with rewriteable disc cartridges available for 3500 Yen.

PT

dations several stages further by designing the handheld data assistants instead as autonomous intelligent robots. Besides supporting the onboard crew, payload scientists, and mission controllers on the ground, the PSA robot would be able to remotely monitor payloads, especially when onboard crew members are not available.

Several PSAs are linked together to conduct collaborative environmental troubleshooting activities. In order to accomplish this complicated task, at least three PSAs would use formation flying techniques to zero in on the location of an environmental problem, such as a pressure leak, temperature spike, off-gassing, etc.

The PSA is also being designed to handle more mundane housekeeping chores such as independent environmental sensor calibration checks, and inventory monitoring in order to free the crew to focus on their research activities. Long-term future goals of the Personal Satellite Assistant are to support remote diagnostic operations and to substitute as necessary for damaged or nonfunctioning sensors on future spacecraft.

"We hope to launch a Personal Satellite Assistant in about two years aboard a Space Shuttle and in about three years aboard the International Space Station." Gawdiak said. "This will

be an evolving prototype to test and evaluate different hardware, software, and sensor suites to help astronauts, ground crew, and payload scientists operate more efficiently in space." PT

## Predicting Traffic Congestion

Dr. John Leonard, an associate professor in the School of Civil and Environmental Engineering at the Georgia Institute of Technology, is designing a cutting-edge model that uses data from traffic surveillance systems to make real-time decisions on operations of a highway corridor or region. He calls it a real-time "temperature," or index, of traffic congestion.

To create the congestion index, Leonard is collecting traffic volume data from the Georgia Dept. of Transportation's video surveillance system—such as the 300-plus video cameras installed on freeways in Atlanta—and from commonly used loop detectors on roadways. Then he can develop traffic flow models to synthesize historical and current measures of delay—such as speed, travel time, or density—that in combination represent congestion. Once he has a working model, his next step will be to

devise a traffic-congestion forecast for the next day, based on existing conditions and special events.

"People need a simple-to-understand number—even if it doesn't have a physical meaning—to represent traffic congestion." Leonard says. "We need to publicize it daily so people start to develop a personal understanding of congestion and plan accordingly."

Publicizing the traffic congestion index will be key to its effectiveness. Leonard envisions freeway message board, radio, television and Web site distribution. Web site users could select one of several points of origin and get a real-time "star diagram" that would show them graphically an estimated travel time to any of the various points of the "star."

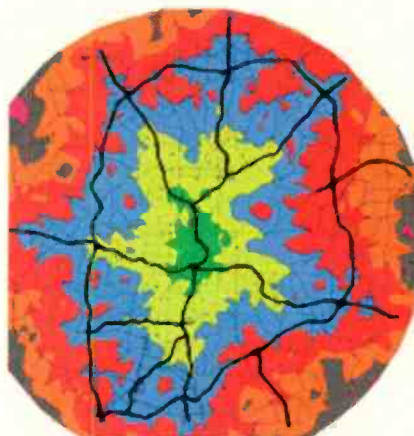

Travel Time Contours - Incident (min)



DR. JOHN LEONARD HAS CREATED A "STAR DIAGRAM" THAT WEB surfers can view to obtain travel time estimates under current traffic conditions.

Besides the obvious short-term benefits of a traffic-congestion index, long-term benefits would include better traffic planning for the future. This information could also be integrated with ozone forecasting, work that is also ongoing at Georgia Tech.

By this summer, Leonard expects to have a prototype traffic-congestion index, which he will demonstrate to Georgia DOT decision makers. Full implementation of the traffic-congestion index is probably several years away,

Leonard adds. Though Atlanta will be the testbed for the index system, it could be implemented anywhere.

In addition, he is also researching traffic signal coordination and plans for optimal timing of signals. After collecting data from a variety of sources and integrating it into a data set, Leonard designs traffic-flow models and computer programs to evaluate that data and prepare a coordinated timing plan. **PT**

## Internet TV Programming

**S**cientists at Siemens Corporate Research have developed a filter technology called HotStreams, a software program that will enable video material and TV programming to be transmitted via the Internet. The development could be used by Internet content providers or TV programmers to offer customized information, on the basis of stored user preference, via video streaming over IP (Internet Protocol).

"This technology offers TV networks the ability to add another dimension to their standard programming not otherwise available," said Arturo Pizano, head of the Multimedia/Video Technology Department. "As an example," he explained, "an Internet user could request that a customized program on house renovation and remodeling be automatically compiled from present/past TV programs and streamed to their Internet terminal."

Based on the customer profile, he explained, advertising targeted to a particular audience could be shown during the video sequence. Users could also decide whether they wished to watch commercials or whether they wanted to pay more for commercial-free films.

To use such a service, an Internet user would need a multimedia PC plus access to the Internet with transfer rates upwards of 300-Kbit per second. With ADSL (Asymmetrical Digital Subscriber Line) technologies already available on a limited basis, television-quality programming via the Internet should be available to a wide range of users within the next two years.

HotStreams uses several Internet characteristics such as hyperlink and hypertext. By clicking the mouse, a

customer can move from video to a page of text or wander to another video. Only the information that customers have requested, and for which they are willing to pay, is offered. Customers who, for example, have just seen a video sequence about the stock market can click a button to see the development of individual shares without changing the application.

HotStreams' filter technology can be added to ordinary Web servers, whether at the TV network's site or an intermediate host. The HotStreams software program uses algorithms that "filter" information stored in multimedia databases, including pricing information plus descriptions of TV programming and other subjects. The algorithms analyze the information the Web server has gathered about each customer's interests and selects and compares this with the database information to decide what TV programs will actually be delivered to the customer. Finally, HotStreams generates a list of instructions sent to the delivery system which, in turn, gathers the customized programming that has been requested. **PT**

## Digital Imaging Sensor

**A** megapixel sensor capable of operating at 500 frames per second (fps), PB-1024 is said to be the world's fastest CMOS image sensor. The PB-1024 uses Photobit's CMOS "active-pixel" technology, which has high-image quality, lower-power consumption than CCD sensors, on-chip integration of camera functions, and the ability to manufacture on the same (CMOS) platforms as virtually all microprocessors and memory chips.

"This unique chip supports dozens of exciting applications," said Dr. Sabrina Kemeny, chief executive officer of Photobit. "It will trace the path of a speeding bullet or analyze the steps of a running athlete, or a golf swing. It can show us how a high-speed virus reproduces inside a cell or help with automobile crash tests. And of course it supports manufacturing, with volume visualization, sorting systems, flaw detection, and other advanced types of robotic vision."

The PB-1024 outputs 8-bit progres-

sive-scan video in 1024 by 1024 pixel format, and its power consumption is low at any speed: 100mW at 60 fps and less than 450 mW at 500 fps. The monochrome PB-1024 is designed with 10-micron-square active-pixel photodiodes and has a 1-inch optical format. Digital responsivity is 500 bits per lux-second.

The sensor has Photobit's True-Bit Noise Cancellation feature, which preserves image quality along the signal path, and an architecture that permits access to several internal operations. Frame rate, integration time, the windowing function, and other parameters can be adjusted via a simple digital interface to suit specific applications. **PT**

## Fast SRAM

**T**he world's first ultra-fast SRAM using copper interconnect technology is now available from Motorola. The device, an 8Mb Late Write SRAM, delivers greater than 333MHz performance by combining copper interconnects with leading edge 0.15-micron gate-size CMOS technology. The end result is an SRAM that delivers unprecedented speed of performance at low power levels from a device containing 60-million transistors.

The Motorola FSRAM, part number MCM63R836FC, delivers L2 cache performance while consuming 50-75 percent less power than previous BiCMOS process SRAMs. The 8Mb SRAM has met with strong industry acceptance and has already been designed into numerous workstation and server L2 applications.

The product represents the first example of Motorola's strategy to develop a common high-performance CMOS (HiPerMOS) process platform. The performance of this newest FSRAM device clearly makes copper technology the preferred interconnect material for delivering speed and high performance. The ability of copper to resist electromigration also suggests such devices will benchmark with top reliability as well.

"Producing this ultra-fast SRAM is validation of Motorola's commitment to deliver the most advanced DigitalDNA solutions available," said Craig Lage, Motorola FSRAM Technology Development Manager. **PT**



**Plug a Friend into**  
**Electronics**  
**NOW**  
**and Save \$41.89\***

*This Christmas give an electrifying gift ... plug a friend into Electronics Now and brighten the whole new year! Whether electronics is your friend's livelihood or hobby, your gift will illuminate the whole spectrum of electronics throughout the coming year and provide a monthly reminder of your friendship.*

Electronics Now will keep your friend informed and up-to-date with new ideas and innovations in all areas of electronics technology ... computers, video, radio, stereo, solid-state devices, satellite TV, medical electronics, communications, robotics, and much, much more.

We'll provide great plans and printed circuit patterns for great electronic projects. In just the last few years, Electronics Now has presented amateur TV equipment, robots, computer peripherals, microcontroller programmers, test equipment, audio amplifiers, telephone projects, relay circuits, and much more.

PLUS ... equipment troubleshooting techniques ... circuit design ... reports on new technology and products ... equipment test reports ... in-depth coverage on computers, video, audio, vintage radio ... and lots more exciting features and articles.

SAVE \$41.89\* ... OR EVEN \$83.78\* ... For each gift of Electronics Now you give this Christmas, you save a full \$41.89\* off the newsstand price. And as a gift donor, you're entitled to start or extend your own subscription at the same Special Holiday Gift Rate—you save an additional \$41.89\*!

No need to send money ... if you prefer, we'll hold the bill till January, 2000. But you must rush the attached Gift Certificate to us to allow time to process your order and send a handsome gift announcement card, signed with your name, in time for Christmas.

So do it now ... take just a moment to fill in the names of a friend or two and mail the Gift Certificate to us in its attached, postage-paid reply envelope. That's all it takes to plug your friends into a whole year of exciting projects and new ideas in Electronics Now!

\*Basic sub rate — 1 yr/\$24.99 2 yrs/\$48.99

# Updating Windows

**A** COUPLE OF MONTHS AGO WE TALKED ABOUT THE IMPORTANCE OF SYSTEM MAINTENANCE AND OPTIMIZATION, AND SAW HOW WINDOWS MAKES IT POSSIBLE TO DO QUITE A BIT OF TWEAKING. THIS MONTH, WE THOUGHT WE'D RETURN

somewhat to the topic of operating-system improvement, and explore a function of Windows that lets you keep the OS as fresh as possible, all without spending a dime.

Some of you might be aware of this feature—Windows Update—but might not be using it to its fullest potential. Whether Update's new to you or just something you've been ignoring, read on to find out what your computer "wants" you to do from time.

## A Quick Checkup

In the computer biz, being current or up-to-the-minute is a near impossibility. Let's face it, you can't bring a program home and install it without it being outdated. Go online to the Web site of your new office suite or graphics package and chances are that there's already an update patch or even new version available.

Commercial products exist that are designed to check the Web constantly for improvements to the software you have on your machine. That's great, but for the most part unnecessary. How many programs do you really rely on? Five or six? It's no big deal to check the sites from time to time to stay current. But what about your OS?

Yes, Windows is being improved almost weekly. Did you know that there's a Service Pack update to Windows 98, including a few Y2K-problem fixes? That a new version of

Media Player can now handle a form of compressed audio that provides MP3 quality in half the storage space? That a new Java engine is available for Explorer?

These are only examples of updates that can enhance your computing experience or, in the case of the Service Pack, keep your computer running. But your PC won't tell you that it needs them

(well, it could, but you'd have to set it up to do so—more on this later). As it turns out, your computer's OS is as innocent and as reliant on you for healthcare as is a child. It needs regular checkups and "booster shots."

Fortunately, giving Windows the care it needs is a cinch. The Windows Update feature—essentially a bookmarked Microsoft site that launches Internet Explorer—can scan your computer and recommend any necessities or even fun apps that have come out yet aren't on your system.

To access Update, go to the Start button and scroll up above the Programs icon. There may be four or five icons in this upper area, depending on which applications you have

THE HEART OF WINDOWS UPDATE is Product Updates, a section that lets you choose from a variety of patches, upgrades, and bug fixes for the most popular consumer OS. You can even find new, free applications from Microsoft.

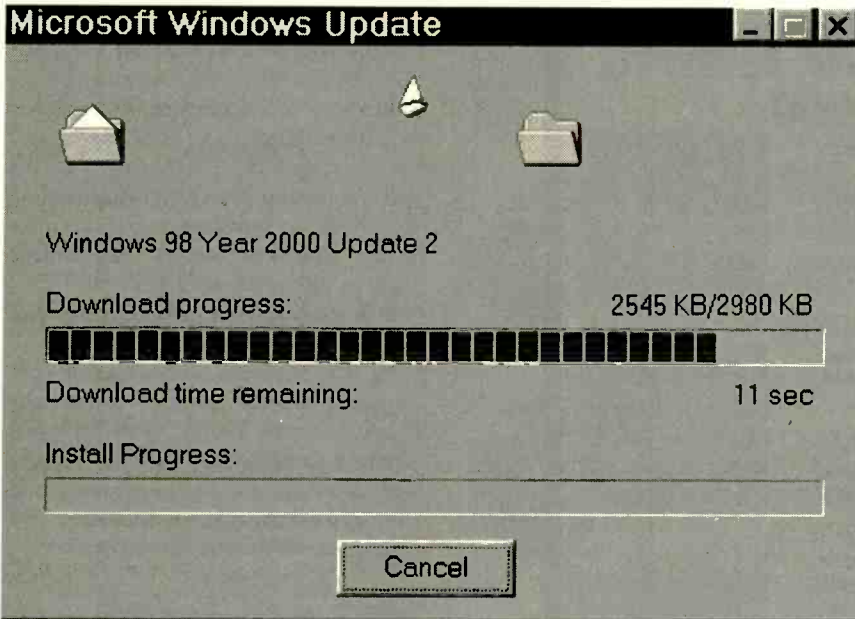

UPDATE WILL DOWNLOAD any components that you select, and even automatically install them when it's done. A progress indicator lets you know how the procedure's coming along.

installed; click the one that's labeled "Windows Update."

Internet Explorer should now load up, taking you to a Java-enriched page with three major links to choose from. The most important is Product Updates, and will be discussed here. The other two, Support Information and Hardware Support, will be handled in a moment.

Product Updates loads a Java app that compares the installed Microsoft components on your system with a database of newly available versions. For the paranoid, let me explain that this is a non-invasive app that doesn't dump the contents of your hard drive to some Microsoft server (not to mention that this would take days over a modem). The app runs *on* your computer, like

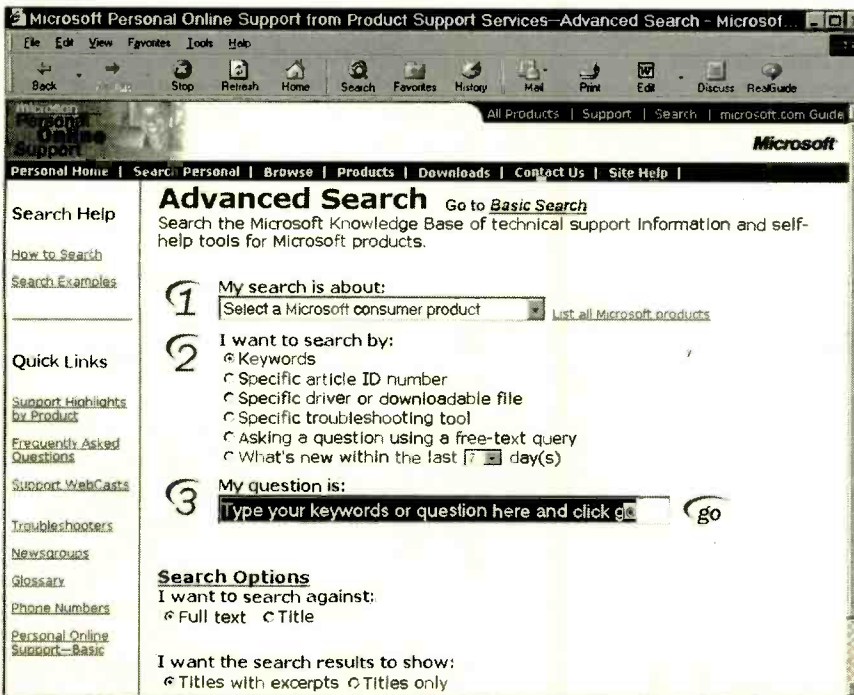

DESPITE ITS ODD NAME, SEARCH PERSONAL offers you the opportunity to find out answers to common and even arcane Windows and Microsoft-product questions.

most Java apps do, and makes its comparisons on your system. Then, it presents you with a list of updates in various categories:

The ones you definitely want to download are Critical Updates. These include bug and security fixes, and other patches that make Windows run better. To pick one of these (or any update, for that matter) just click on the box to the left of it.

Scrolling down, you come to Picks of the Month, which are items that Microsoft feels many users would be interested in, such as an app that lets you know automatically whenever a Critical Update is available for your system.

Downloads suitable to some, but not all users are grouped under the Recommended Updates section. There's one here for laptop users, one for those who registered Win98 online and wish to have better control of its Registry

#### VENDOR INFORMATION

**Microsoft Corporation**  
One Microsoft Way  
Redmond, WA 98052  
425-486-9258  
[www.microsoft.com](http://www.microsoft.com)

hardware-identification features, and other such niche patches.

Under Additional Windows Features you'll find Internet enhancements such as VRML viewers, Java engines (code for a browser that lets it run the latest in Java apps), and communications free-ware like Outlook Express. Further, you'll find new players, like Media Player mentioned earlier, and foreign-language support so you can view, say, Chinese-text pages correctly.

Depending on the month you run Update, you're likely to find some interesting screensavers and time-wasters in the Fun and Games section. Right below it are Preview Versions, a section for anything Microsoft plans on letting users test (most likely to find bugs).

While selecting from all these downloads, you may come across a warning dialog box when clicking on a particular update. This box will inform you that this download should be performed by itself for best results. Make sure to uncheck any other boxes if this is the case. Ignoring this warning and trying to download such a patch as part of a group usually causes your machine to crash.

After your choices are made, you can

# Electronics CD ROMs

## Want to improve your design skills?

Then you should consider our range of CD ROMs by best-selling author **Mike Tooley**.

**Electronic Circuits and Components** provides a sound introduction to the principles and applications of the most common types of electronic components and how they are used to form complete circuits. Sections on the disc include: fundamental electronic theory, active components, passive components, analog circuits and digital circuits. Includes circuits and assignments for **Electronics Workbench**.

The **Parts Gallery** has been designed to overcome the problem of component and symbol recognition. The CD ROM will help students recognize common electronic components and their corresponding symbols in circuit diagrams. Quizzes are included. The **Parts Gallery** is free with **Electronic Circuits and Components**.

**Digital Electronics** details the principles and practice of digital electronics, including logic gates, combinational and sequential logic circuits, clocks, counters, shift registers, and displays. The CD ROM also provides an introduction to microprocessor-based systems. Includes circuits and assignments for **Electronics Workbench**.

**Analog Electronics** is a complete learning resource for this most difficult subject. The CD ROM includes the usual wealth of virtual laboratories as well as an electronic circuit simulator with over 50 pre-designed analog circuits, which gives you the ultimate learning tool. The CD ROM provides comprehensive coverage of analog fundamentals, transistor circuit design, op-amps, filters, oscillators, and other analog systems.

"...hammers home the concepts in a way that no textbook ever could."  
Electronics Australia

## Interested in programming PIC micros?

We have the perfect solution:

Our **PICtutor** CD ROM can teach you how to write assembly language programs for the PIC series of microcontrollers. The CD ROM's 39 tutorial sections will guide you from basic PIC architecture, commands, and programming techniques up to advanced concepts such as watchdog timers, interrupts, sleep modes, and EEPROM data memory use. Over 80 exercises and challenges are provided to test your understanding, and the unique **Virtual PIC** allows you to write and test programs on-screen.

The complementary development kit includes a reprogrammable PIC16C84, which you can program via your printer port. The institution version (designed for use in schools, colleges and industry) includes a quad 7-segment LED display and alphanumeric LCD display. The development kit provides an excellent platform for both learning PIC programming and for further project/development work. Assembler and send (via printer port) software is included on the CD ROM.

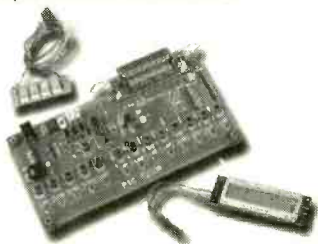

development board (institution version)

produced by  
**matrix**  
multimedia

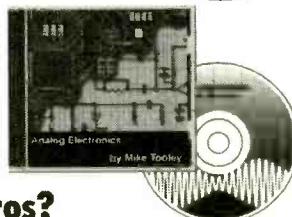

## Prices and Versions

Institution versions are suitable for use in schools, colleges and industry. Student versions are for student/home use.

	student version	institution version
Electronic Circuits & Components	\$56	\$159
Digital Electronics	\$75	\$189
Analog Electronics	\$75	\$189
PICtutor (CD and development board)	\$179	\$350
Shipping costs to Canada an additional \$5. Overseas orders please contact CLAGGK Inc. for shipping costs.		

see <http://www.MatrixMultimedia.co.uk> for full specs and demos

Please circle the products you would like to buy on the table above right, calculate the total cost, fill in the form below and send it to us. Please allow 4 - 6 weeks for delivery.

Name: \_\_\_\_\_  
 Address: \_\_\_\_\_  
 Zip: \_\_\_\_\_ Telephone: \_\_\_\_\_  
 I have enclosed my check for \$: \_\_\_\_\_  
 Please charge my credit card for \$: \_\_\_\_\_  
 Note that the delivery address and the address at which the card is registered must be the same.  
 Card type: \_\_\_\_\_  
 Mastercard, Visa, or Discover only

Signature: \_\_\_\_\_  
 Number: \_\_\_\_\_  
 Expire date: \_\_\_\_\_

## Order Form

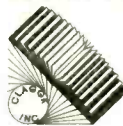

CL02

click Download. A screen will then inform you of the total size of your selections in kilobytes, and give you an estimate of download time. If you agree to initiate the process, click the "agree" box to begin download and plan on doing something else for a while (unless you have a broadband connection). When the components are loaded, Update will automatically install them. You'll then be prompted to reboot for the changes to take effect.

If your machine crashes during such an install session, go back to the first Update screen and select Show Installed Updates to make sure that the process was successful for each component. If not, reinstall the missing one(s).

Your machine will thank you.

## Searching For Other Help

Have a general question about Windows or other Microsoft products? If so, while you're at Update you might want to click on the Support Information link. This will take you to a page where you can connect to Windows 98 Online Support. Don't let the name fool you—the link will open up a browser window where you can choose which type of user you are (home, business, etc.) and then get help with any Microsoft product in that category.

Major concerns are listed on the category page most relevant to you. For best results, though, click on Search Personal. You'll then be presented with a pull-down menu that lets you select the product that you want to learn more about. Also, you can type a short key-word query or question so that the site can return only relevant information. Give it a try ... you might be pleasantly surprised at the wealth of information found here.

Back on the main Windows Update screen you'll find yet another tool—Hardware Support. Click on that to be transported to a Web site hosted by your computer's manufacturer. Here you can get any updated drivers or patches that have to do specifically with the hardware that was installed in your machine at the factory. Don't underestimate the importance of having current hardware drivers. It could mean the difference between a buggy machine and one that purrs.

I hope some of the downloads that you find through Update make your computing experience a more enjoyable one.

EN

# The End of a Long and Pleasant Road!

**W**ELL, READERS, IT HAD TO COME SOME TIME AND IT SEEMS THAT THE TIME IS NOW! THIS WILL BE OUR LAST ANTIQUE RADIO COLUMN. AS I UNDERSTAND IT, NEXT MONTH **POPULAR ELECTRONICS** AND **ELECTRONICS NOW** WILL

be replaced by a single magazine, **Poptronics**, which will carry many, but not all, of the features of the predecessor magazines. I've enjoyed my 13-year run with Gernsback Publications and wish the new publication much success.

Those readers who have Internet access and would like follow the remaining work to be done on the Philco Model 70 are most welcome to visit the Web page I'm setting up for that purpose. Reader mail as yet unacknowledged will also be found there. The URL *should* be [www.infomedialab.com/~mfellis/antiqueradio](http://www.infomedialab.com/~mfellis/antiqueradio). This hasn't been completely set up and tested as of this writing, but it will be by the time this column appears. So if you have trouble accessing my site, please e-mail me at [mfellis@enteract.com](mailto:mfellis@enteract.com) and I'll advise you of any changes.

## Alignment Tools

My first attempt (a few months back) to touch up the alignment of the Model 70 ended in failure. The problem: I didn't have the non-metallic quarter-inch nutdriver needed to adjust the trimmers. I tried a metal one, but it interfered too much with the tuning of these critical circuits—making fine adjustment nearly impossible. The non-metallic Philco alignment tools are now all but impossible to obtain new—though they undoubtedly will turn up at radio swap meets. I was fortunate enough to be able to borrow one from a friend so I could

complete the work on the "70."

Those who may have followed radio alignments I have done over the years know that my signal source of choice is the venerable Navy "LM" heterodyne frequency meter. Except for details of packaging, this unit is almost identical to the famous army BC221. Both were used extensively during World War II, and probably before. A couple of other differences: the "LM" is designed for use with an accompanying AC power supply, while the "221" runs on batteries and needs to be modified for use on AC. Also, the "LM's" signal (most models) can be modulated with an audible tone (very handy during the alignment

process), while modulation is available only on certain models of the "221."

These instruments have largely fallen out of favor, probably because of the availability of inexpensive digital frequency meters. However, they provide something the latter tools do not: an RF signal that can be injected into the receiver being adjusted. The frequency range covers most standard IFs, the broadcast band, and the usual shortwave bands. Accuracy is outstanding, partly because of the very high quality components and partly because of the built-in crystal calibrator. The "LM" and BC221 turn up frequently at hamfests and radio swap meets—quite often at bargain prices.

In addition to an RF signal source, the alignment process requires an indicator for measuring the strength of the signal output by the radio. Most technicians use the audio output, which is picked off at the speaker voice coil. (That's why it's helpful for the signal

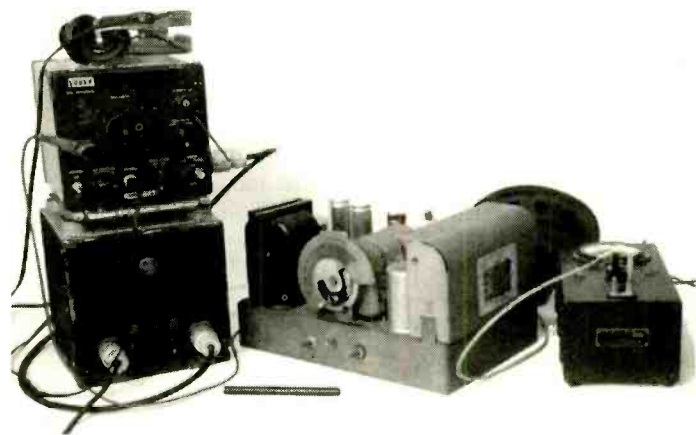

HERE'S THE PHILCO "70" surrounded by my standard alignment setup. The "LM" is at left, sitting atop its power supply (headphones are for use with crystal calibrator). The Ballantine "300" is at the right.



THE REPLACEMENT REAR ARCH (sure glad I didn't have to craft this myself!) was glued in place and kept tightly clamped overnight. Now properly reinforced, the cabinet can be safely handled for refinishing.

source to have audio modulation). My choice is another surplus "reliable," the Ballantine Model 300 AC voltmeter. This is a very stable and sensitive AC vacuum-tube voltmeter whose frequency response is flat enough to use even in the checking of hi-fi sound equipment (though that's not a feature we need much in radio alignment). Again, these units may often be picked up inexpensively at radio meets.

### IF and RF Alignment

Following the Philco service instructions, the first step in aligning the Model 70 was to inject a 260-kHz signal (the radio's IF frequency) at the grid cap of the mixer tube, with the grid clip removed. With modulation on and the Ballantine hooked up, the relative strength of the receiver's audio output could now be read on the Ballantine's meter. To avoid overloading, good practice dictates using the lowest level signal that will provide a usable meter reading.

Next, beginning with the secondary of the last IF transformer and working backwards, all of the IF trimmers were peaked for maximum audio output. If my Model 70 had AVC (automatic volume control)—which it doesn't—the AVC would have to be disabled since otherwise it would flatten out variations in signal strength, nullifying the effects of the tweaking. The IF alignment proceeded very smoothly, with each adjustment resulting in a very definite peak. By the time I was through, I had to increase the voltage setting of the "300" manyfold—showing that I had made a

significant improvement in the gain of the IF channel.

Now, per Philco service bulletin instructions, I moved to the front end of the receiver to adjust the RF input and oscillator trimmers. That was done with the radio and "LM" set for 1400 kHz. These adjustments, particularly the oscillator, were more critical than the IF settings. Even using a non-metallic adjustment wrench, the position of the adjustment was influenced by the tool's presence or absence. Following the Philco instructions, I was able to take care of the problem by rotating the trimmer slightly past the peak position. Then, when the wrench was removed, the reading of the Ballantine returned to the previously noted peak.

The final adjustment was a low-frequency front-end tweaking carried out with the radio and "LM" set for 700 kHz. This proceeded without any problem. All in all, the Model 70 was a very simple and stable radio to align, with all peaks occurring as expected. And the result was a very sensitive radio that pulls in signals all over the broadcast band with only a short indoor antenna and no ground.

### Cabinet Restoration

Most long-time readers of the column know that cabinet work is not my forte or my strongest interest. If I had the means, I'd gladly pay someone to do a first-class cabinet refinishing job on every one of the important sets in my collection! However, I have to grit my teeth and proceed with stripper, stain, and steel wool. The first step with this particular cabinet was the installation of the new rear arch I purchased from Dick Oliver of Elkhart, Indiana. Without that necessary reinforcement in place, the cabinet was really too fragile to handle except very gingerly.

The rear arch as supplied seemed a bit too long. It overlapped the vertical strips of thin reinforcing wood glued to each side of the cabinet back. Each strip should run from the floor of the cabinet just up to the bottom of the arch. I verified this by checking a Model 70 with an intact arch. The discrepancy must have been due to manufacturing variations. Perhaps the cabinet Dick got his measurements from and my cabinet had been made in different plants.

I considered cutting down the arch a bit, but I would have very likely spoiled the nice curve that finishes off each arch



BROWSE THROUGH *Radio Tubes and Boxes of the 1920's* to experience something of the exuberance of that decade's radio boom.

tip. Finally, I settled on the strategy of slightly cutting back the top ends of the reinforcing strips using a matte knife and straight edge and being *very* careful not to damage the cabinet beneath. The arch was then coated with white wood glue and clamped in place overnight. The result is very authentic looking, and the cabinet can now stand up to the handling necessary to carry out the refinishing process. Next step: removing the old finish, which is too far gone for restoration.

### Radio Tube Box Art

The radio boom of the 1920s must have been very much like the computer boom of the 1980s and 1990s—with new manufacturers springing up almost daily to market exploding technology to an innovation-hungry public. Some company and brand names survived to become household names; others disappeared as quickly as they had sprung up. Just as with the computer boom, the radio offerings included not only complete and ready-to-go units, but also a myriad of parts and accessories.

In his new book *Radio Tubes and Boxes of the 1920's*, author George A. Fathauer (who, as president of Sonoran Publishing, Inc., is also the publisher) has captured the exuberance and excitement of the first decade of home-radio development. The book contains over 360 color photos of early vacuum tubes, as well as 40 magazine ads and examples of company literature. Dates and other

(Continued on page 29)



# 1 Study at Home

We live in a constantly changing world, where exciting new technological advancements are made everyday. At the Cleveland Institute of Electronics we make it simple to learn, earn a degree and prosper in the workforce. Over 150,000 students in the United States and 70 foreign countries got their start in electronics through CIE. And they received their education at their own pace in the comfort and convenience of their homes. At CIE you'll receive a first class education by a faculty and staff devoted to your career advancement. All of CIE course and degree programs are taught through a patented, proven learning process. To discover all the benefits and programs/ degrees available from CIE send for your free course catalog today.



CIE's Associate Degree program contains 297 lab experiments.

# 2 Work Where You Want

And once you complete your education at CIE, you can just about write your own ticket to where you want to work and in what specialized field... MIS, broadcasting, industrial, automotive, management... The opportunities seem limitless in today's high-tech world.

The Cleveland Institute of Electronics has been approved for use of Veterans Affairs Benefits and DANTES Tuition Reimbursement.

Tuition assistance from the Veterans Administration or the DANTES Program is available to veterans and service members in the Armed Forces.



Employees are seeking & hiring qualified applicants.

## FREE CATALOG



1776 E. 17th Street  
Cleveland, Ohio 44114-3679

Visit Our Web-Site  
[www.cie-wc.edu](http://www.cie-wc.edu)

**YES!** I am interested.  
Please send me a catalog.

Name: \_\_\_\_\_

Address: \_\_\_\_\_

City: \_\_\_\_\_ State: \_\_\_\_\_ Zip: \_\_\_\_\_

Phone Number: \_\_\_\_\_

**A school of thousands. A class of one. Since 1934. AE150**



# Q & A

READERS' QUESTIONS, EDITORS' ANSWERS  
CONDUCTED BY MICHAEL A. COVINGTON, N4TMI

## Capacitance Units?

**Q** I'm sorry, I'm new to electronics but what are the units for capacitors in your schematics? Microfarads or something else? K. G., no location given

**A** That's actually a very wise question to ask. We give capacitance in microfarads ( $\mu\text{F}$ , formerly abbreviated  $\text{mF}$ ) unless otherwise noted. In high-frequency circuits you will sometimes see capacitors valued in picofarads ( $\text{pF}$ , formerly called  $\text{mmF}$ ). European publications often use nanofarads ( $\text{nF}$ ), but we rarely if ever do. The relationship is:

$$1 \mu\text{F} = 1000 \text{ nF} = 1,000,000 \text{ pF}$$

If you really can't tell whether a particular value is in picofarads or microfarads, you can usually figure it out as follows. The smallest capacitors made are about 5 pF, so any number less than 5 has to be microfarads. On the other hand, any

capacitor larger than 1  $\mu\text{F}$  will usually be an electrolytic, with the polarity marked. So if you see a capacitor marked "3300" and it has one end marked "+", it's a 3300- $\mu\text{F}$  electrolytic; if it lacks such a marking and is part of a high-frequency amplifier or filter, it's probably 3300 pF.

Note that 3300 pF = 0.0033  $\mu\text{F}$ ; a few capacitances in that neighborhood are commonly given both ways. There's an example of one in the very next circuit (see Fig. 1).

Finally, note that the numbers actually printed on the capacitor usually give its value in picofarads, in a peculiar way. The third digit is to be replaced by that number of zeroes. For example, "474" means 47 followed by 0000, or 470,000 picofarads, equal to 0.47  $\mu\text{F}$ .

fiers (two for the tweeters and two for the woofers) that have active filters ahead of them, so that each amplifier gets only signals in the appropriate frequency range. I'm very bad at number crunching. Could you provide me with a schematic to get this job done?—L.E., Glen Burnie, MD

**A** Separating high from low frequencies ahead of the amplifiers is a good idea because the bass amplifier needs more power but the treble amplifier needs more high-frequency response. Also, you can use a high-performance active crossover circuit rather than a relatively low-performance network of capacitors and inductors at the speakers.

Figure 1 shows a circuit from National Semiconductor Corporation's Application Note AN-346, which promotes their LM833 audio op-amp. Actually, you can use any low-noise op-amp in this circuit; you might try a pair of TL072s or TL082s if these are easier to get. Note that a split power supply is

## Active Audio Crossover

**Q** I have a set of two-way speakers that cross at 1800 Hz. I'd like to build four ampli-

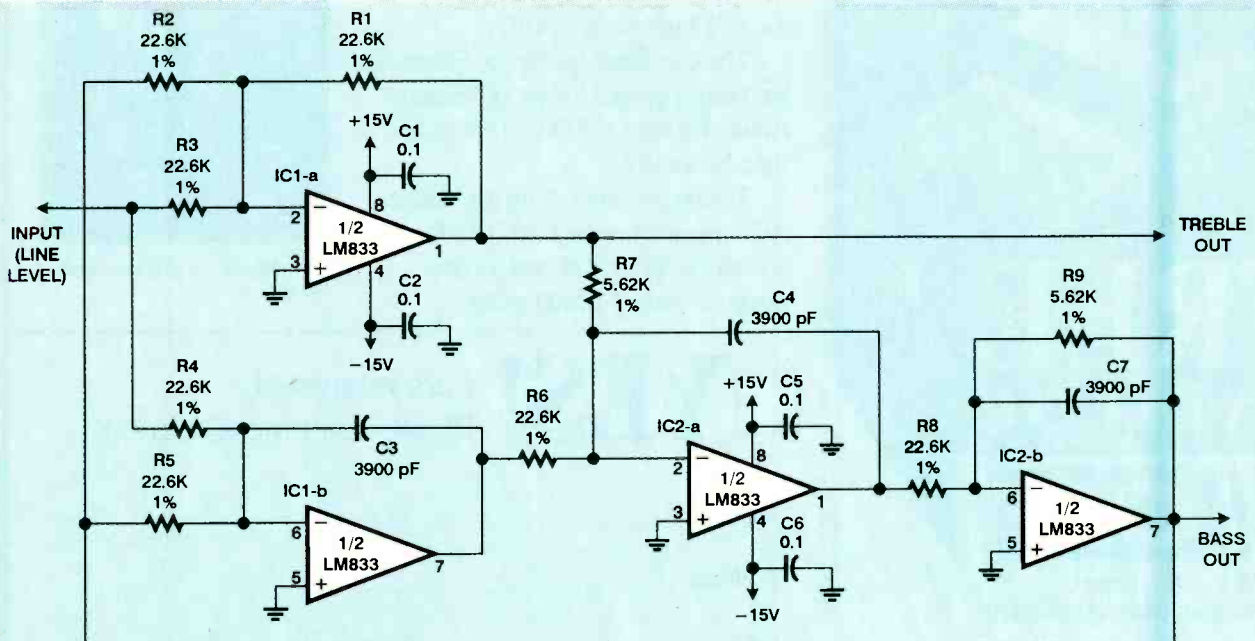

**FIG. 1**—HERE'S THE CIRCUIT for a 1800-Hz crossover. The crossover frequency is determined by  $F = 1/2\pi RC$ , where R is equal to 22,600 ohms (22.6K) and C is equal to 3900 pF in this example.

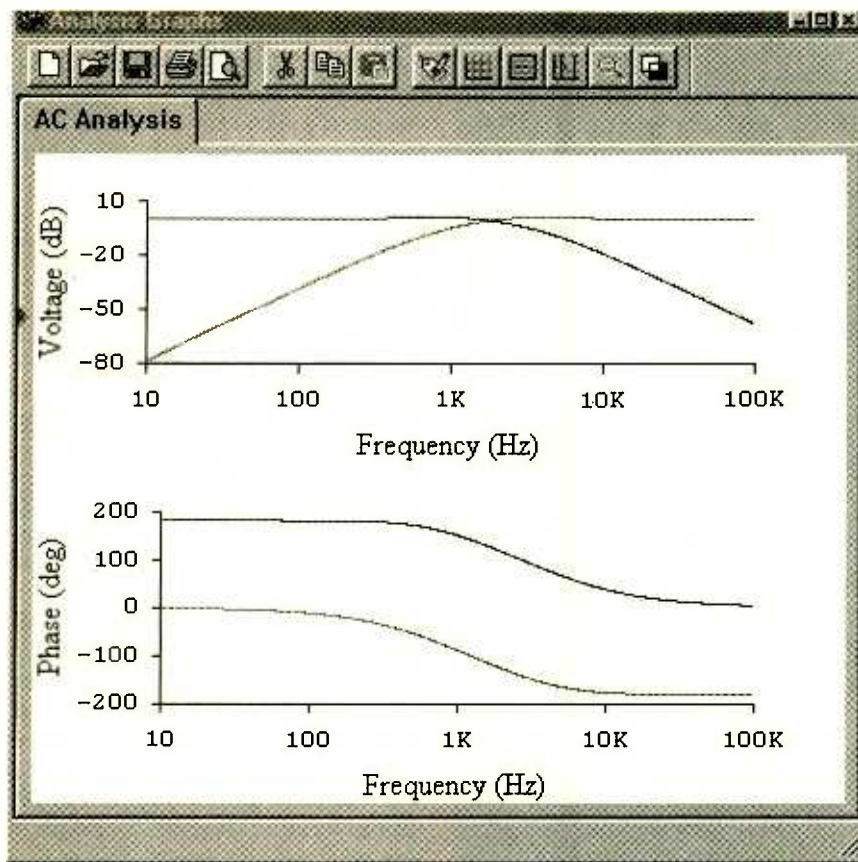

FIG. 2—RATHER THAN BREADBOARDING THE CIRCUIT in Fig. 1, it was instead simulated using Electronics Workbench. Here are the calculated frequency and phase response at the two outputs.

required; it's shown as +15V and -15V, but split 12-volt or even 9-volt supplies will work equally well. While breadboarding, you might use a pair of 9-volt batteries.

According to National Semiconductor, this is a "constant-voltage" crossover, which means that the sum of the bass and treble output voltages is the same at all frequencies. The crossover frequency is determined by a simple formula:

$$F = 1/2\pi RC$$

Here R is the resistance of R1, R2, R3, R4, R5, R6, and R8, and C is the capacitance of C3, C4, and C7. Resistors R7 and R9 are the value of R. Bypass capacitors C1, C2, C5, and C6 don't affect frequency response.

For best results, use precision components: 1% resistors and 1% or 3% capacitors. The capacitance you need, 3900 pF, is also described as 3.9 nF or 0.0039  $\mu$ F.

Because it requires special components, I didn't actually breadboard this circuit; instead, I simulated it with Electronics Workbench. Figure 2 shows

the calculated frequency and phase response at the two outputs. You can download a free trial version of this software from [www.interactiv.com](http://www.interactiv.com).

## Analog Computers?

**Q** OK, obviously your article about the amazing new analog microprocessor was an April Fools gag, but was all the theory you were stating true? If a miraculous analog-to-digital converter were invented, would an analog computer be possible? — D. B., Colorado Springs, CO

**A** Well...the April Fool's article contained plenty of facetious theory as well as facetious products, but analog computers really exist and have been around more than 40 years. In fact, one of their basic components, the operational-amplifier (op-amp), is now used in all sorts of circuits.

Figure 3 shows an op-amp actually performing an operation addition and subtraction. The circuit computes  $V_4 - (2 \times V_1) - V_2 - V_3$ , where  $V_1$ ,  $V_2$ ,  $V_3$ , and  $V_4$  are the input voltages.

There are three reasons why analog computers aren't used for general-purpose computation. One is accuracy. A digital computer only has to distinguish 1 from 0, so it's completely unaffected by minor variations in component values. An analog computer, though, is only as accurate as its worst component. On a digital computer, you can easily carry out a calculation to as many decimal

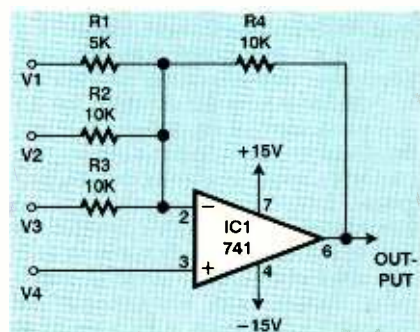

FIG. 3—WHILE, AS MOST REALIZED, the analog microprocessor in the April issue was clearly fictitious, simple analog computers have existed for a long time. One example of that is shown here, where an op-amp is being used to compute the value of  $V_4 - (2 \times V_1) - V_2 - V_3$ . Unused inputs are grounded.

places as you want, but on an analog computer, you're doing well to get three significant digits. You wouldn't want your bank account thrown off 2% by a bad resistor.

The second is programmability. It's not clear how you'd program an analog computer, other than by rewiring the circuit. Digital computers can use the same kind of memory for the program as for the data.

The third is that much of the data that we now process is digital, not analog. Analog circuits are fine for low-precision arithmetic but can you imagine an analog word processor? Most of the data in text documents and business records is made up of discrete symbols, not values that range along a continuum.

Still, analog computers have their uses. Because a simple analog circuit can compute a rough approximation to an integral or derivative quickly, analog computers are still used in control circuits and signal processors. In fact, the circuit in Fig. 1 is technically an analog signal processor that solves differential equations on the fly.

## What's In A Keyboard?

**Q** I'd like to use PIC microcontrollers to build a programmable keyboard for my

## HOW TO GET INFORMATION ABOUT ELECTRONICS

**On the Internet:** See our Web site at <http://www.gernsback.com> for information and files relating to our magazines (**Electronics Now** and **Popular Electronics**) and links to other useful sites.

To discuss electronics with your fellow enthusiasts, visit the newsgroups `sci.electronics.repair`, `sci.electronics.components`, `sci.electronics.design`, and `rec.radio.amateur.homebrew`. "For sale" messages are permitted only in `rec.radio.swap` and `misc.industry.electronics.marketplace`.

Many electronic component manufacturers have Web pages; see the directory at <http://www.hitex.com/chipdir/>, or try addresses such as <http://www.ti.com> and <http://www.motorola.com> (substituting any company's name or abbreviation as appropriate). Many IC data sheets can be viewed online. [www.questlink.com](http://www.questlink.com) features IC data sheets and gives you the ability to buy many of the ICs in small quantities using a credit card. You can also get detailed IC information from [www.icmaster.com](http://www.icmaster.com), which is now free of charge although it formerly required a subscription. Extensive information about how to repair consumer electronic devices and computers can be found at [www.repairfaq.org](http://www.repairfaq.org)

**Books:** Several good introductory electronics books are available at RadioShack, including one on building power supplies.

An excellent general electronics textbook is *The Art of Electronics*, by Paul Horowitz and Winfield Hill, available from the publisher (Cambridge University Press, 1-800-872-7423) or on special order through any bookstore. Its 1125 pages are full of information on how to build working circuits, with a minimum of mathematics.

Also indispensable is *The ARRL Handbook for Radio Amateurs*, comprising 1000 pages of theory, radio circuits, and ready-to-build projects, available from the American Radio Relay League, Newington, CT 06111, and from ham-radio equipment dealers.

**Copies of past articles:** Copies of past articles in **Electronics Now** and **Popular**

**Electronics** (post 1994 only) are available from our Claggk, Inc., Reprint Department, P.O. Box 4099, Farmingdale, NY 11735; Tel: 516-293-3751.

**Electronics Now** and many other magazines are indexed in the *Reader's Guide to Periodical Literature*, available at your public library. Copies of articles in other magazines can be obtained through your public library's interlibrary loan service; expect to pay about 30 cents a page.

**Service manuals:** Manuals for radios, TVs, VCRs, audio equipment, and some computers are available from Howard W. Sams & Co., Indianapolis, IN 46214 (1-800-428-7267). The free Sams catalog also lists addresses of manufacturers and parts dealers. Even if an item isn't listed in the catalog, it pays to call Sams; they may have a schematic on file which they can copy for you.

Manuals for older test equipment and ham radio gear are available from Hi Manuals, PO Box 802, Council Bluffs, IA 51502, and Manuals Plus, PO Box 549, Tooele, UT 84074.

**Replacement semiconductors:** Replacement transistors, ICs, and other semiconductors, marketed by Philips ECG, NTE, and Thomson (SK), are available through most parts dealers (including RadioShack on special order). The ECG, NTE, and SK lines contain a few hundred parts that substitute for many thousands of others; a directory (supplied as a large book and on diskette) tells you which one to use. NTE numbers usually match ECG; SK numbers are different.

Remember that the "2S" in a Japanese type number is usually omitted; a transistor marked D945 is actually a 2SD945.

**Hamfests (swap meets) and local organizations:** These can be located by writing to the American Radio Relay League, Newington, CT 06111; (<http://www.arrl.org>). A hamfest is an excellent place to pick up used test equipment, older parts, and other items at bargain prices, as well as to meet your fellow electronics enthusiasts—both amateur and professional.

Shoemaker, published by Addison-Wesley. It devotes several pages to the keyboard signals, which are synchronous serial codes. Using a digital oscilloscope, you can reverse-engineer the whole system for yourself.

See also *The Undocumented PC*, by Frank van Gillaue, same publisher, for more about the software side of keyboard communication.

But what you *really* want is probably Philips Semiconductor application note AN434, "Connecting a PC keyboard to the I<sup>2</sup>C bus," which should be available

online at [www.philips.com](http://www.philips.com) (follow the menus to "semiconductors," then "microcontrollers," then "catalog and datasheets"). The exact Web address of this document, if Philips doesn't change it, is [www.eu2.semiconductors.com/acrobat/applicationnotes/AN434.pdf](http://www.eu2.semiconductors.com/acrobat/applicationnotes/AN434.pdf).

When you get that project developed, let us know!

## Printer Communication

**Q** *I have a question about how the printer drivers in Windows tell the printer to advance to a new page. Does the software send a form-feed character (FF, ASCII 12) through the D0—D7 data lines, or does it use the AUTO FEED pin?—S. L. G., Brush, CO*

**A** The former. There is no pin that will make the printer eject the paper. The AUTO FEED (or AUTO LF) pin tells the printer whether to advance to the next line after receiving a Carriage Return (CR, ASCII 13) or to advance only when sent a Line Feed (LF, ASCII 10). You get the first behavior if the AUTO FEED pin is grounded and the second if it is not. Normally, the PC holds this pin high.

## PC Power-On Self Test

**Q** *In the past you've reviewed a commercially available POST diagnostic card (November 1995), but you haven't published instructions for how to build one. It sounds simple. Could you steer me to a source of information that would enable me to build one? Also, I seem to recall PC breadboards being available in the past—that is, breadboards that plug into a slot in a PC. Are they still available? — R. D., Brampton, ONT, Canada*

**A** The second question is easy: solderless breadboards that plug into ISA slots are available from Jameco, 1355 Shoreway Rd., Belmont, CA 94002; Tel: 650-592-8097; Web: [www.jameco.com](http://www.jameco.com). Ask for part number B1672, which lists for \$59.95.

Now for your main question. When a PC fails its power-on self test (POST), it outputs a diagnostic code to port address hex 80. The whole process is described at length in *Troubleshooting, Maintaining, and Repairing Personal Computers*, by Stephen J. Bigelow, published by Tab Books. Bigelow gives the full set of codes for numerous makes and

*PC. Where are the PC keyboard signals documented? If I can find this out, I would gladly develop and post a construction project.— N. J., no location given*

**A** The "horse's mouth" for this information is the *IBM PC AT Technical Reference Manual* (1984), a dark blue volume that a generation of PC gadgeteers relied on. Ask around and see if any old-timers in your area still have one.

Today, the best reference is probably *The Personal Computer from the Inside Out*, by M. Sargent and R. L.

models of motherboards, as well as the alternative port addresses used by some of them.

To learn how to grab data from a port address, see this column, May 1997. There I tell you how to build a port that can be read or written from software. To make a POST card, what you'll need to do is change the circuit so its address is 80 rather than 280, then feed the data to a pair of LED seven-segment displays. You won't need a microcontroller, just a one- or two-chip BCD-to-seven-segment decoder system. If you want to make it fancier, you can add alternative switch-selectable port addresses.

The best general book I know of about ISA bus interfacing is *The Embedded PC's ISA Bus*, by Edward Nisley, published by Peer-to-Peer Communications, Inc. ([www.peer-to-peer.com](http://www.peer-to-peer.com)).

## Composite Video to S-Video

A reader in the August issue needed to convert composite video to S-video signals (with luminance and color on separate wires). We found a product that does this the Tribute C2S Convertor, which retails for about \$100 and is made by Tributaries, 1307 E. Landstreet Rd., Orlando, FL 32874; Tel: 800-521-1596. The converter consists of passive filters that do not require power, so the whole thing fits in an aluminum cylinder—it's just a thick spot in the cable, so to speak. A higher-performance powered version is also available.

## Electronic Organ Resources

If you need parts or manuals for older electronic organs and other musical instruments, here are some useful addresses, courtesy of Bill Stiles, Hillsboro, Missouri:

Keyboard Systems, 3637 East 7800 South, Salt Lake City, UT 74121; Tel: 801-943-7888; Web: [www.systemsinfo.com](http://www.systemsinfo.com) (Lowrey organs, many hard-to-find tubes, and ICs for all brands)

Organ Service Co., Inc., 1210 W. 55th Place, Countryside, IL 60525-3409; Tel: 708-352-8011 (Hammond organs, Leslie speakers)

Organ Service Corp., PO Box 372, Marengo, IN 47140-0372; Tel: 800-457-4408; e-mail: [orgsvccorp@aol.com](mailto:orgsvccorp@aol.com) (Kimball, Conn, Thomas)

Stevens Custom Organ Co., 330 N. West Ave., Fayetteville, AR 72701; Tel: 501-521-9240 (older Baldwin organs)

Morelock's Organ Parts, Rte. 1 Box 6, Rienzi, MS 38865; Tel: 601-462-7611 (older Wurlitzer organs)

Baldwin Piano and Organ Co., Technical Services Dept., 1101 S. Beechwood, Fayetteville, AR 72701; Tel: 501-443-1965 (Baldwin and Wurlitzer since about 1981)

Dave's Electronic Service, Inc., 105A E. Penn St., Hoopeston, IL 60942; Tel: 217-283-5010 (Gulbransen before 1986)

## Writing to Q&A

As always, we welcome your questions. The most interesting ones are answered in print. Please be sure to:

- (1) include plenty of background information (we'll shorten your letter for publication);
- (2) give your full name and address on your letter (not just the envelope);
- (3) type your letter if possible, or write very neatly; and
- (4) if you are asking about a circuit, include a complete diagram.

Questions can be sent to Q&A, **Poptronics Magazine**, 500 Bi-County Blvd., Farmingdale, NY 11735, or e-mailed to [q&a@gersnback.com](mailto:q&a@gersnback.com), but please do not expect an immediate reply (because of our backlog) and please don't send graphics files larger than 100K. Due to the volume of mail, we regret that we cannot give personal replies. **EN**

## ANTIQUE RADIO

(continued from page 24)

information, where known, are given in individual captions.

The main charm of this book is the opportunity it provides to experience and enjoy the naive, and sometimes crude "box art" of the period. The volume is not for those looking for definitive data on tube evolution or technical specs. However, the introduction does include helpful information in tube dating and identification.

*Radio Tubes and Boxes of the 1920s* (8 1/2 by 11 inches, 112 pages, slick paper, soft cover) sells for \$26.95 and may be purchased from Sonoran Publishing, 116 N. Roosevelt, Chandler, AZ 85226.

## Au Revoir!

That's all she wrote, friends! I've certainly enjoyed serving the readers of **Hands-On Electronics**, **Popular Electronics** and **Electronics Now** over the past thirteen years or so. And I'm saying "Au Revoir" rather than goodbye because I hope many of you will be able to visit me at the new Web site. Please e-mail me at [mfellis@enteract.com](mailto:mfellis@enteract.com) if the URL I gave you at the beginning of this column does not work when you try it. **EN**

## EQUIPMENT REPORT

(continued from page 4)

that is devoted entirely to supporting Nomad and its users. That site, [www.nomadworld.com](http://www.nomadworld.com), provides the latest news on MP3 audio and offers a mixture of regularly updated MP3 programming that caters to a variety of interests.

Nomad is a slick little device, and one that is a lot more capable and convenient than the MP3 players that came before it. The FM tuner is a feature that consumers have wanted in portable MP3 players right from the beginning, and the docking station eliminates the need to connect and disconnect the player to a parallel port. Nomad's voice recording capability, also unique, lets users record up to four hours of voice-quality audio that can be uploaded to a PC. Available accessories for the Nomad include memory upgrades, a car-adaptor kit, a carrying case, and different headsets.

The 64-megabyte Nomad has a suggested retail price of \$249.99, and the 32-megabyte costs \$169.99. If you're already into MP3 audio, Nomad is the perfect way to take your favorite MP3 material with you wherever you go. And if you haven't yet played with MP3 audio, Creative Labs' Nomad, along with its bundled software, is a great way to get started.

For more information contact Creative Labs, Inc. (1523 Cimarron Plaza, Stillwater, OK 74075; Tel: 800-998-1000; Web: [www.creativelabs.com](http://www.creativelabs.com)) or circle 15 on the Free Information card. **EN**

# NEW PRODUCTS

USE THE FREE INFORMATION CARD FOR FAST RESPONSE

## Voice-Interactive Navigation Device



CIRCLE 338 ON FREE INFORMATION CARD

COMPACT, PORTABLE, AND LOW cost, the AudioNav navigation system operates completely by voice command, without the need for complex displays or keyboards. It is designed to get drivers to and from locations quickly without forcing them to take their eyes off the road.

The same size as a typical portable CD player, the AudioNav incorporates a small voice-interactive chip that works as the operating engine, communicating directly with CD-ROM mapping software. This process allows users to verbally prompt the unit with an address, and the system's recorded voice responds with easy-to-understand, accurate, turn-by-turn verbal instructions. Drivers are able to choose an address, intersection, point of interest, or customized location as either a destination or a starting point for navigation. Music disc player functions can also be controlled by voice command and used interchangeably with route guidance, making the device into a voice-operated portable CD player.

The AudioNav's navigation smart chip uses L&H's Automatic Speech Recognition technology. A complex spell-checking system combines with isolated word-recognition and rejection of out-of-vocabulary words to

make the AudioNav smart chip a virtually error-free speech engine. Most important, the technology allows the system to respond to different speakers (speaker independent), regardless of variable speech patterns, dialects, etc.

Additional features include rerouting capabilities in case of traffic delays or construction; directory of nearby services such as ATMs, hotels, and banks; ability to customize and store favorite locations in the AudioNav's memory; and options for beginner's or expert mode. The system can navigate throughout the US. Mapping software is available on nine different CD-ROM discs, each corresponding to a different US region. It comes equipped with the portable AudioNav, the nine navigation software CDs, headphones, microphone, cigarette lighter adapter with built-in amplified speaker, AC adapter, audio connecting cable, tutorial CD-ROM, and operating manual.

The AudioNav navigation system has a suggested retail price of \$299.

**PRONOUNCED TECHNOLOGIES, LLC**

6611 Odessa Avenue  
Reseda, CA 91406  
Tel: 818-654-2750  
Fax: 818-778-1005

## Cable Tester

SCSI TERMINATOR TESTING IS now available on the Signature Touch 1 cable and harness tester—a Pentium-class, PC-based tester with a graphical touch-screen display. It tests SCSI terminators by using a combination of its standard testing capability and its custom script language together with the optional powered test adapter. With the SCSI test adapter for the Touch 1, users can test a range of terminators including single-ended active, active negation, and low-voltage differential (LVD) terminators, as well as the switchable LVD/SE/HVD terminators.



CIRCLE 339 ON FREE INFORMATION CARD

To accommodate terminators other than these, as well as the different ICs, the test script is changed to match the IC type and terminator type being tested. The SCSI kit includes an adapter, a nine-volt DC power supply, and a wire list and script for each type of terminator to be tested.

The Signature Touch 1 cable tester retails for \$54.95 and the SCSI kit retails for \$200.

**CIRRISSYSTEMS CORP.**

1991 Parkway Blvd.  
Salt Lake City, UT 84119  
Tel: 800-441-9910  
Fax: 801-973-4609  
Web: [www.cirris.com](http://www.cirris.com)

## Video Cable Set

THE SILVER COMPONENT VIDEO Cable Set is made up of three cables that provide the best possible picture from the latest DVD players equipped with

component-video output. The video cables are "true" 75-ohm cables, featuring a 32-strand silver-plated OFHC (Oxygen Free High Conductivity) copper center conductor protected by triple-layered shielding. A PVC jacket and the "Slip-Over" insulating layers in the cables provide both flexibility and protection against abrasion damage and deterioration.

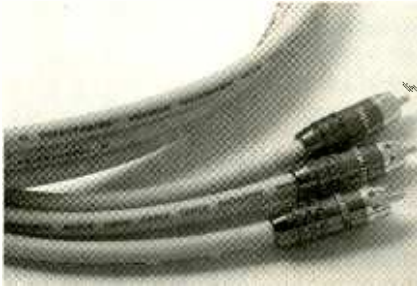

CIRCLE 340 ON FREE INFORMATION CARD

The cables terminate with Maximum Contact Connectors, gold-plated machined brass, color-coded (Y, R-Y, B-Y) 75-ohm RCA-type plugs. TRIBUTARIES proprietary "360° Surround soldering System" with high silver content solder provides a strong connection between the cable shield and connector, assuring maximum protection from mechanical cable failure and noise pickup.

The Silver Component Video Cable Set has a suggested retail price starting at \$200.

#### TRIBUTARIES

1307 East Landstreet Road  
Orlando, FL 32824-7926  
Tel: 800-521-1596  
Web: [www.tributariescable.com](http://www.tributariescable.com)

### Data Acquisition Boards

QUATECH'S NEW PCI LINE INCLUDES 12- and 16-bit data-acquisition boards capable of both analog input and output. These boards all provide 16 single-ended or 8 different A/D channels and are available in unipolar and bipolar versions. They offer two channels of waveform-capable analog output, 32 digital I/O channels, 16-bit timer counters, and pacer clocks for both A/D and D/A.

The 12-bit DAQ-1201/PCI features 200 kS/s sampling and high gains of 1, 10, 100, and 1000. The DAQ-1602/PCI provides 16-bit resolution, 200 kS/s sampling, and low gains of 1, 2, 4, and 8. Analog inputs on all the PCI data-acquisition boards can be expanded to 256 channels.

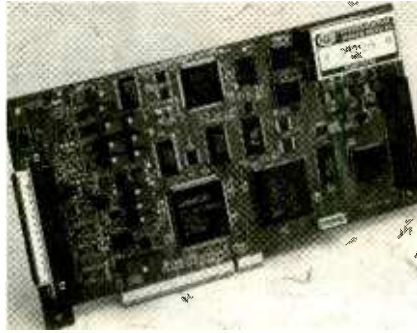

CIRCLE 341 ON FREE INFORMATION CARD

The PCI Data Acquisition Boards have prices starting at \$495.

#### QUATECH, INC.

662 Wolf Ledges Parkway  
Akron, OH 44311  
Tel: 800-553-1170 or 330-434-3154  
Fax: 330-434-1409  
Web: [www.quatech.com](http://www.quatech.com)

### Frame Grabber

THE DFG/LC2 COMBINES THE benefits of an industrial frame grabber with features such as trigger, sync generator, 12-volt power for up to four cameras, and industrial 12-pin Hirose connectors. The DFG/LC2 offers 4-color S-VHS (Y/C), or four monochrome or composite-video inputs. All video standards are supported: NTSC, PAL, and SECAM.

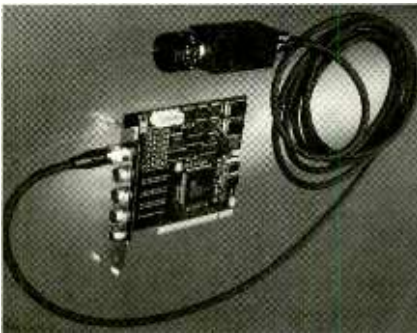

CIRCLE 342 ON FREE INFORMATION CARD

Up to four cameras can be connected to the frame grabber and can be powered from the card itself. A resettable 2-amp fuse protects the unit. The image stream produced by the DFG/LC2 is either transferred to the VGA card or the PC's RAM using Burst RAM—all in real time.

The DFG/LC2 PCI frame grabber sells for \$449.

#### THE IMAGING SOURCE

900 Baxter Street, Suite 103-A  
Charlotte, NC 28204  
Tel: 704-370-0110

Fax: 704-370-0906  
Web: [www.TheImagingSource.com](http://www.TheImagingSource.com)

### Digital Multimeter

A RUGGED, AUTORANGING DIGITAL multimeter, the DM501 accurately measures ohms, voltage, and current, including True RMS. Its Liquid Crystal Display (LCD) provides a 65-segment bar graph. There are also indicators for polarity, overrange, and low battery.

Measuring 6.9 by 3.3 by 1.2 inches,



CIRCLE 343 ON FREE INFORMATION CARD

the meter has a sampling rate of 2 times/sec for digits and 12 times/sec for analog bar graph. The meter will automatically shut itself off after approximately 10 minutes, unless the input changes within a defined time. A warning tone sounds if the test lead is connected to an input terminal when the rotary function selector is not turned to that position.

The DM501 Digital Multimeter, which comes with test leads, holster, and manual, has a list price of \$199.

#### SENCORE, INC.

3200 Sencore Drive  
Sioux Falls, SD 57107  
Tel: 800-SENCORE or 605-339-0100  
Web: [www.sencore.com](http://www.sencore.com)

(Continued on page 96)

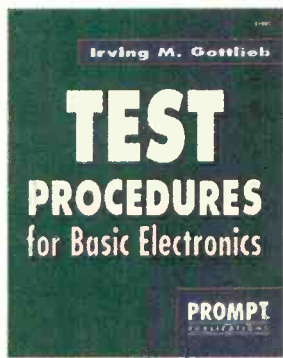

Test Procedures for Basic Electronics. #61063. -- \$19.95  
Many useful tests and measurements are covered. They are reinforced by the appropriate basic principles. Examples of test and measurement setups are given to make concepts more practical. 7 3/8 x 9 1/4", 356 pp, paperback.

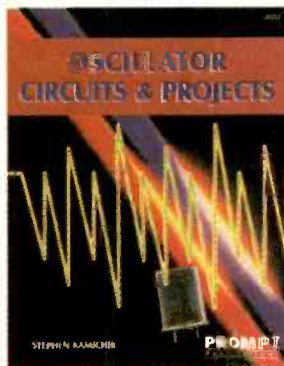

Oscillator Circuits and Projects. #61111. -- \$24.95  
A Textbook and project book for those who want to know more about oscillator circuits. You can build and enjoy the informative and entertaining projects detailed in this book. Complete information is presented in an easy-to-follow manner. 7 3/8 x 9 1/4", 249 pp, paperback.

Build Your Own Home Lab. #61108 -- \$29.95  
Shows you how to assemble an efficient working home lab, and how to make it pay its own way. Includes projects for creating your own test instruments too. 7 3/8 x 9 1/4", 249 pp, paperback.

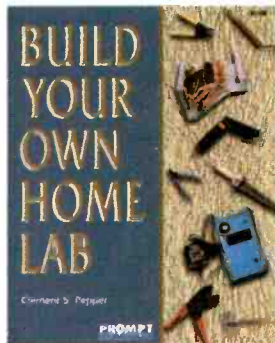

Troubleshooting and Repair Guide to TV. #62246. -- \$34.95  
Repairing and troubleshooting a TV is very simple and economical with help from the information in this book. It is the most complete and up-to-date TV repair book available, with tips on how to handle the newest circuits. 8 1/2 x 11", 263 pp, paperback.

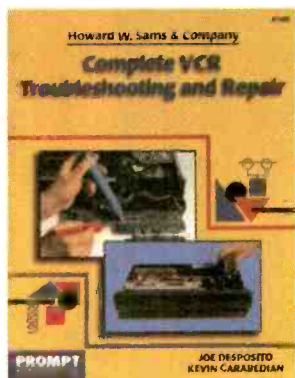
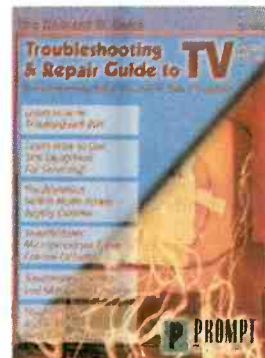

Complete VCR Troubleshooting and Repair. #61102. -- \$34.95  
Though VCRs are complex, you don't need complex tools or test equipment to repair them. This book contains sound troubleshooting procedures that guide you through every task. 8 1/2 x 11", 184 pp, paperback.

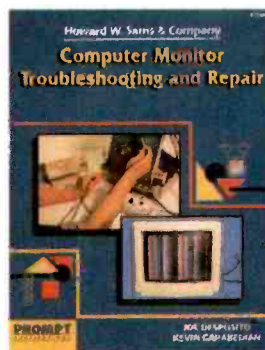

Computer Monitor Troubleshooting and Repair. #61100. -- \$34.95  
This book can save you the money and hassle of computer monitor repair by showing you how to fix it yourself. Tools, test instruments, how to find and solve problems are all detailed. 8 1/2 x 11", 308 pp, paperback.

Complete Camcorder Troubleshooting and Repair. #61105. -- \$34.95  
Learn everything you need to know about the upkeep and repair of video camcorders. Start by examining camcorder troubleshooting procedures, then move into more advanced repair techniques. 8 1/2 x 11", 208 pp, paperback.

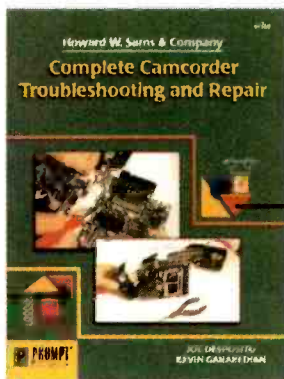

Joe Carr's Circuit Toolkit. #61000. -- \$29.95  
Easy-to-build, useful circuits from Carr's workbench to you. They will spark new ideas in your day-to-day use of circuits and help solve frustrating problems. 256 pp, paperback.

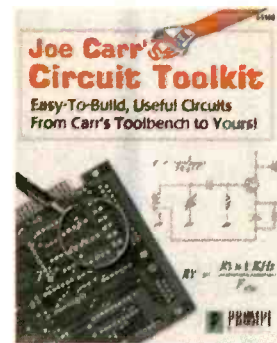

Please circle the products you would like to buy on the page above, calculate the total cost, include shipping charges, using in the form below and send it to us. Please allow 4 - 6 weeks for standard delivery.

Name: \_\_\_\_\_  
Address: \_\_\_\_\_  
Zip: \_\_\_\_\_ Telephone: \_\_\_\_\_  
I have enclosed my check for \$: \_\_\_\_\_ Signature: \_\_\_\_\_

Please charge my credit card for \$: \_\_\_\_\_ Number: [ ] [ ] [ ] [ ] [ ] [ ] [ ] [ ] [ ] [ ] [ ] [ ]  
Card Type: \_\_\_\_\_ Expiration Date: [ ] [ ] [ ] [ ] [ ] [ ]  
Mastercard, Visa or Discover only

Note: The delivery address and the address at which the credit card is registered must be the same.

Clagg Inc.  
PO Box 4099  
Farmingdale, NY 11735-0792  
Tel: 516-293-3751  
Fax: 516-293-3115  
email: clagg@gemsback.com



SORRY No orders accepted outside of USA & Canada No. of Books Ordered

Total price of books.....	\$.....
Shipping (see chart).....	\$.....
Subtotal.....	\$.....
Sales Tax (NYS only).....	\$.....
Amount Enclosed.....	\$.....
All payments must be in U.S. funds!	

SHIPPING CHARGES IN USA.

CANADA ADD \$5.00	
1 Book	\$ 5.00
2 Books	8.00
each add'l book	3.00
2 Day UPS	\$10.00 extra
Next Day UPS	\$20.00 extra



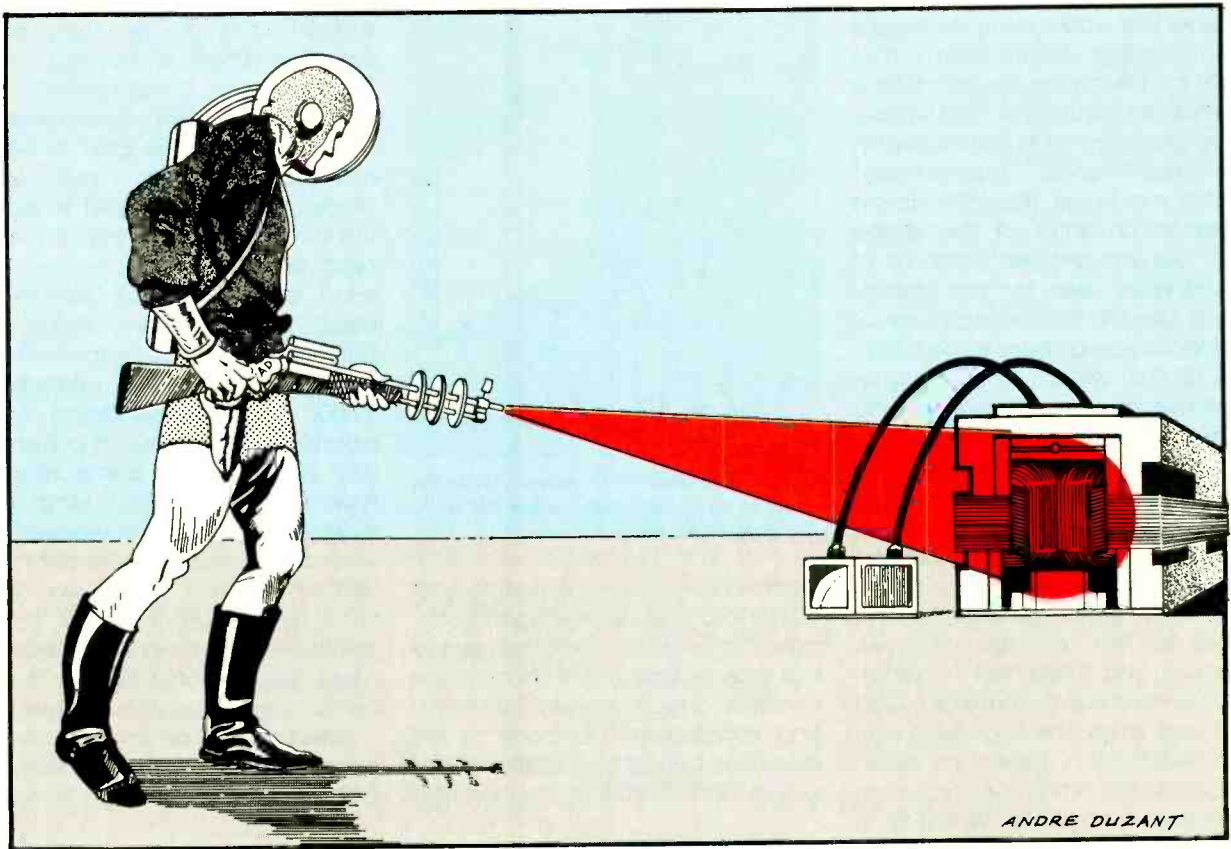

# Freeze Motion with the Laser Scope

SKIP CAMPISI

*Measure the speed of rotating objects with this affordable, compact instrument. What's more, you can easily view them in stop-action or slow motion!*

If you are involved with mechanical designs as a part of your electronics activity, you no doubt find yourself in need of more and more tools and equipment, some of which can be quite expensive. The average "bench" of the past only consisted of the usual electronic test gear and assorted hand tools. Nowadays, the average bench occasionally calls for a drill press, small lathe, or other power tools, not to mention a wide variety of hand tools required for precision machining. Times are changing!

"Speeds" and "dimensions" are now as important to an experimenter as "frequency" and "voltage." Building and troubleshooting mechanical devices requires the

hobbyist to invest time and money in a completely different field—an investment that can be very rewarding. The "new" type of test equipment includes micrometers, depth gauges, and thread gauges; they are analogous to the DMM, capacitance meter, and frequency counter found on a traditional electronics bench.

Many would say that the basic

indispensable tool of the electronics bench is the oscilloscope. When properly used, it can display almost any type of measurement. The companion tool for the mechanical bench is the stroboscope. That device is just as useful, providing many equivalent measurement and troubleshooting functions. However, commercial units are somewhat expensive and generally line operated due to the high voltages needed by their flash tubes.

What can a stroboscope do for you? For starters, it can give a precise measurement of shaft RPM. Perhaps you need to view a high-speed mechanism in slow motion to locate a "sloppy" component that is causing vibration or noise.

Another use would be in studying a reciprocating mechanism that might be flexing too much under a heavy load, causing excess friction. If you are involved in photography, the experimental "drop-of-milk" photos made by the late Harold Edgerton (inventor of the strobe light) are yet another example of non-obvious uses for the stroboscope. Like the oscilloscope, uses of a stroboscope appear to be unlimited...if only we could afford one. For those reasons, we present the Laser Scope, which is designed to overcome the drawbacks of a commercial stroboscope using standard off-the-shelf components.

The Laser Scope was designed with portability and economy in mind to fit within the budget and needs of the average hobbyist. However, you'll find that its performance exceeds commercial units in several ways. The expensive and short-lived flash tube has been replaced with a high-performance semiconductor, which will last for a long time and provide a shorter-duration flash than a tube. The flash rate is variable over a range of 0 to 10,000 fpm (flashes-per-minute) in two calibrated ranges. An added bonus is the flash-duration control, letting the user adjust image sharpness and brightness under varying speeds and lighting conditions.

**"Light" Talk.** Like electricity and magnetism, light has its own set of definitions. The basic unit of light is the *candela*, which is equal to one lumen per steradian (a unit of solid angle). The lumen is a measure of optical power. In the English system, one lumen per square foot is the light intensity received by a one-square-foot target placed one foot away from a standard point-source candle. See Fig. 1. Another more common term for the lumen is *candlepower*, which is given in foot-candle units. As you can see, candelas, candlepower, and foot-candles equally share the same unit quantity: the lumen.

The obvious first choice for a solid-state replacement for the flash tube is a visible-red laser diode. Interestingly, as bright as those diodes are, they only provide low light intensities when their

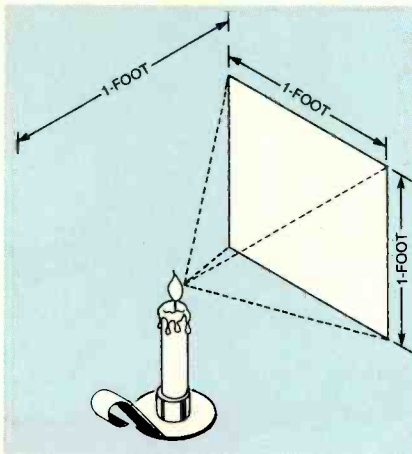

Fig. 1. A foot-candle is the amount of light that shines on a one-foot-square surface that is one foot away from a standard candle.

beams are optically expanded for a stroboscope's wide-angle coverage. Fortunately, a related device has proven itself to be much more versatile: a high-intensity light-emitting diode that happens to be available through RadioShack. Not only is it about 20% of the cost of a

surplus laser diode, tests have shown that it is several times brighter than a 5-mW laser!

In a side-by-side test between a high-brightness LED and a 5-mW, 670-nm-wavelength red laser diode, lenses were used to adjust the beam angles for equal target-area coverage and the devices were operated in their CW (continuous) mode for easy visibility. The LED has an orange output (at 620 nm) and a luminous intensity of 12,000 mcd (millicandelas) or 12 candelas, at a forward current of 0.02 amperes. For comparison, a typical "high-intensity" lamp provides about 15 candlepower, so you can readily appreciate the LED's brightness. What we don't know is the LED's output beam angle used to make that measurement. We can only assume that its output is equivalent to 12 lumens/ft.

Laser output, on the other hand, appears to be rated at mechanically equivalent power in watts,

## PARTS LIST FOR THE LASER SCOPE

### SEMICONDUCTORS

- IC1—CD4518 CMOS dual BCD counter, integrated circuit
- IC2—CD4046 CMOS phase-locked-loop, integrated circuit
- IC3—TLC555 CMOS timer, integrated circuit
- IC4—78L05 5-volt, 100-mA regulator, integrated circuit
- Q1—TIP120 NPN Darlington transistor
- D1, D2—1N4001 silicon diode
- D3, D4—1N4148 silicon diode
- LED1—Red light-emitting-diode (RadioShack 276-309 or similar)
- LED2—Green light-emitting-diode (RadioShack 276-304 or similar)
- LED3—Orange light-emitting diode, 620nm/12,000mcd output (RadioShack 276-206 or similar)

### RESISTORS

- (All resistors are 1/4-watt, 5% carbon-film units unless otherwise indicated.)
- R1—40,200-ohm, 1/4-watt, 1% metal-film
- R2—100,000-ohm, multi-turn trimmer potentiometer
- R3—5000-ohm, 10-turn panel-mount potentiometer, wire-wound, with precision turns-counter (see text)
- R4—10,000-ohm
- R5, R7—1000-ohm
- R6—100,000-ohm, panel-mount poten-

tiometer, audio-taper, with integral switch

- R8—10,000-ohm, single-turn trimmer potentiometer
- R9—1.0-ohm, 1/2-watt
- R10—1200-ohm
- R11—10-ohm

### CAPACITORS

- C1—0.01- $\mu$ F, 5% Mylar
- C2, C3, C7—0.1- $\mu$ F, ceramic-disc
- C4—220-pF ceramic-disc
- C5—0.01- $\mu$ F ceramic-disc
- C6—0.005- $\mu$ F, 5% Mylar
- C8—1- $\mu$ F, 16-WVDC, electrolytic
- C9—47- $\mu$ F, 16-WVDC, electrolytic
- C10—330- $\mu$ F, 16-WVDC, electrolytic

### ADDITIONAL PARTS AND MATERIALS

- B1—9-volt battery
- J1—Coaxial power jack with switch (RadioShack 274-1582 or similar)
- S1—Single-pole, double-throw toggle switch
- S2—Single-pole, single-throw switch (part of R6)
- S3—Single-pole, double-throw switch (part of J1)
- 9-volt DC, 100-mA wall adapter, concave lens (see text), case, IC sockets, wire, hardware etc.

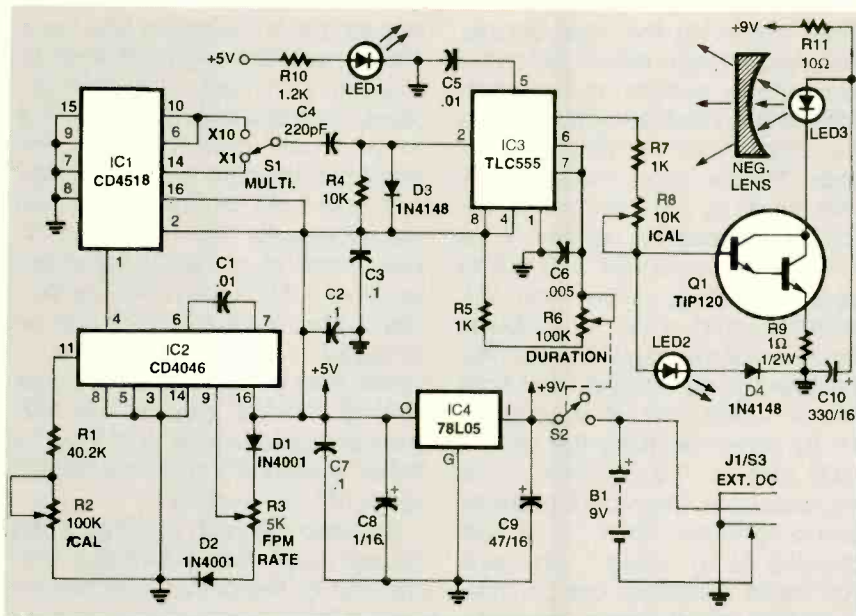

Fig. 2. As you can see on the Laser Scope's schematic diagram, the circuit design is fairly simple. Utilizing CMOS integrated circuits, along with a capacitive-discharge current drive for LED3, allows the use of a standard 9-volt battery for the main power source.

where one lumen is equal to 1.5 mW of power output. That is measured at a wavelength of 555 nm, the peak response of the human eye. The eye's response at 670 nm is only about 20% of the peak level, so we may assume that the laser's output power is rated at 0.3 mW per lumen.

Those assumptions indicate that the 5-mW laser diode has an output of about 17 lumens, a little higher than the LED. However, consider the fact that a 5-mW laser diode typically operates at about 3 mW. Also, a wavelength of 620 nm appears to be about three times as bright to the eye as an equally intense 670 nm wavelength. Thus, the LED does indeed appear to be brighter "mathematically" than the laser diode over an equivalent area of coverage. That tends to agree with our side-by-side tests.

**About the Circuit.** Referring to the schematic diagram shown in Fig. 2, you'll see that the Laser Scope is a simple design. For true portability, CMOS integrated circuits are used to conserve power; a standard 9-volt battery, B1, is the power source. Battery power is regulated by IC4 to supply 5 volts to the rest of the circuit. An external 9-volt DC wall adapter can be plugged into J1 to conserve battery power if a wall

socket is available. Note that J1 has an integral switch that disconnects B1 when the Laser Scope is externally powered.

The heart of the Laser Scope is IC2, a CD4046 CMOS phase-locked loop. The device's voltage-controlled oscillator (VCO) section is used for the flash-rate timebase. That rate is variable from 0 to 1667 Hz with R3, a 5000-ohm, 10-turn precision potentiometer. A turns counter is mounted on R3 for a direct readout of 0-1000 flashes-per-minute (fpm). If you don't need the precision or expense of a 10-turn device and counter, you can substitute a standard 5000-ohm single-turn linear-taper potentiometer. If you do that, the case should be marked accordingly.

Because IC2's VCO input is limited to a range between about 0.55 volts (one diode forward-voltage drop above ground) and 4.45 volts (0.55 volts below the 5-volt supply), D1 and D2 match those voltage restrictions as closely as possible. It was found that 1N4001 devices specified resulted in a VCO linearity within 1% over most of the range.

The output of IC2 is divided by IC1, a CD4518 CMOS dual-BCD counter. Two division ratios (100 and 10) are available and are selected by S1. The resulting flash rates are 0-1000 fpm on the "x1" range and 0-

10,000 fpm on the "x10" range. The selected range triggers IC3, a TLC555 CMOS timer, through C4. Configured as a monostable multivibrator, the output pulse width of IC3 is variable from about 5 to 500 microseconds with R6, the flash-duration control.

An audio-taper potentiometer was selected for R6, which allows for easy setting of the two-decade spread in pulse width. When wired correctly, its resistance will increase when rotated clockwise, and should measure about 10,000 ohms at its center of rotation. Thus, the pulse width will be 5 microseconds with R6 at full counter-clockwise, 50 microseconds at the center of rotation, and 500 microseconds at full clockwise. Note that in the prototype, power switch S2 is activated by R6's control shaft.

The output pulse from IC3 drives Q1, a TIP120, which is configured as an unusual capacitive-discharge type of constant-current sink that only sinks current for the duration of the input pulse. The current pulse flows through LED3, causing it to flash in sync with the pulses. The

### SAFETY WARNINGS

The Laser Scope, or any similar type of device, should not be used by, or in the vicinity of, a person prone to epileptic seizures or similar neurological disorders. It has been determined that a flashing light in the "flicker-fusion-frequency" range of about 8 Hz, or 480 fpm, can induce seizures by what is called "photo-driving." In fact, neurologists, to initiate a seizure for EEG study of their patients, utilize that technique. Further information can be found in the July 1999 Letters column of **Electronics Now**.

Although the light-emitting diode used does not produce coherent radiation like a laser diode, its high-intensity output might possibly cause eye damage if viewed for extended periods at very close range. **Never stare directly into the aperture at close proximity!** The least that you will experience is temporary pain.

Neither the publisher nor the author assumes any liability for the misuse of this device by any person, resulting in bodily injury to him or others, intentionally or not.

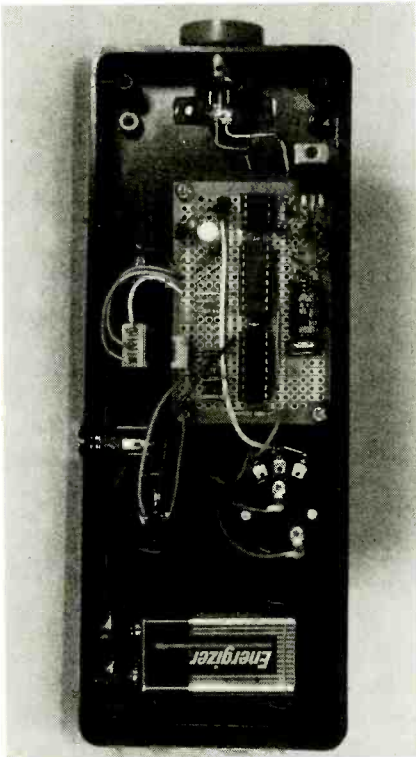

Fig. 3. The Laser Scope fits into a handheld case large enough to hold all of the components easily.

bulk of the current is stored in C10; it is recharged through R11 between pulses. The combination of LED2 and D4 provide temperature compensation for the two base-emitter junctions in Q1; they also hold the input pulse voltage to about 2.4 volts. The voltage developed across R9 (about 1 volt) limits the current through Q1 to 1 amp.

That much current would normally destroy an LED instantly. Keeping the pulses to a low duty cycle lets us pass that much current without damaging the LED. The power-dissipation rating of LED3 is 130 mW; at a forward current of 1 amp, a 4-volt forward-voltage drop for a 4-watt peak power dissipation results. The short flash durations used let LED3 safely dissipate (for a limited time) an average power of 330 mW—2<sup>1</sup>/<sub>2</sub> times the maximum—when the fpm rate and flash duration are both at their maximum settings. Note that we said “for a limited time.” Leaving the Laser Scope at those settings for an extended time will weaken and eventually destroy LED3.

Some consideration must be given to conserving battery power

when operating the Laser Scope. The output stage draws the maximum supply current at the worst-case settings detailed above. With the duration set to 500 microseconds, C10 discharges linearly from 9 volts down to 7.5 volts, with a 1.5-volt drop appearing across R11. As R11 is a one-ohm unit, 150 mA of peak current is drawn from B1. Normally, that is not a problem. However, at the 10,000-fpm setting, the average current drain becomes 75 mA, which can rapidly deplete B1. By either reducing the rate to 1000 fpm or the duration to 50 microseconds, the drain is reduced proportionately down to 8 mA, allowing B1 to “coast.” Whenever you need extended use at maximum flash rates and long durations, an AC adapter should be used to conserve battery power.

**Construction.** The Laser Scope is simple enough in design to be built on perfboard using standard construction techniques. Although the

frequencies involved are low, keep the connection lengths as short as possible to avoid noise pickup. Layout and packaging of the unit is to your own personal taste; the author’s prototype is shown in Figs. 3, 4, and 5. As an option, you can use sockets for the integrated circuits. Since all of the ICs are static-sensitive CMOS devices, sockets are a good idea; the chips can be plugged in after construction. It would also be a good idea to get several CD4046 devices for IC2; they are inexpensive and tend to have “individual” characteristics in terms of VCO linearity!

To keep the high currents in the output stage from interfering with the rest of the circuit, use the following “star” connections: connect a 9-volt power lead from S2’s common lug, C9’s positive lead, R11’s “positive” lead, and IC4’s input pin to one connection point. Similarly, the ground wire from J1’s common lug, D4’s cathode lead, C10’s negative lead, R9’s “negative” lead,

#### MEASURING RPM WITH THE LASER SCOPE

Making measurements with the Laser Scope is quite easy once you have a basic understanding of the images that you’ll see at different flash rates. Let’s learn how by making an actual RPM measurement on an 1800 rpm synchronous motor running on 115-volts, 60-Hz AC. Once you learn the basic technique, you can use it with any speed motor or fan that you may have available.

Attach a one- to two-inch-diameter wheel, such as a pulley, fan blade, or gear to the motor shaft. Stick a small piece of masking tape on the face of the wheel near its rim as a strobe target. Set R6 to 50 microseconds and S1 to the “×1” range. With R3 set to 0 flashes per minute, point the Laser Scope at the wheel. While watching the image of the masking-tape target, advance R6 as needed. To conserve battery power, keep R6 as low as possible for adequate target contrast.

Adjust R3. The tape will appear to slow down and stop at certain settings, and various multiple images of the dot will be seen. However, look for the settings that stop and show only one image of the dot. Those occur at whole number divisions of the actual rpm. For instance, our 1800-rpm motor will show a single image stopped at 300 fpm (1800/6), 360 fpm (1800/5), 450

fpm (1800/4), and so on up to 1800 fpm. Keep in mind that as you reach the 1000-fpm rate, you’ll have to reset R3 back down to 100 fpm and set S1 to “×10” to continue. Once the fpm rate equals the actual motor speed, any further increase in the flash rate will no longer yield a single target image. At double the rpm (3600 fpm), you’ll see two dots spaced 180 degrees apart; at triple the rpm (5400fpm), 120 degrees apart. Noting those readings as you go will quickly yield the correct rpm by watching for the change from the last single image to the next double image at exactly twice the rpm of the motor.

The process might seem confusing at first, but is really quite simple once you’ve tried it. You might notice that at higher flash rates, the target image begins to blur. That is where duration control R6 comes into play; simply reduce R6 for a sharper image while maintaining sufficient contrast for easy viewing. You’ll also notice that at flash rates slightly higher or lower than exact RPM divisions, you can watch the target slowly rotate around the wheel. That comes in very handy when looking for “wobble” or other problems in a rapidly-rotating system. As with any stroboscope, working under subdued ambient-lighting conditions produces the best target contrast.



Fig. 4. A neat and clean control arrangement makes for a unit that is a joy to work with.

and IC4's ground lead should all go to another single connection point. Those two paths need to be low impedance. Be sure to install LED2 and D4 as close to Q1 as possible for best performance; see Fig. 3. Capacitors C2, C3, and C7 are for noise reduction on the power supply; install them near the power supply pins of IC1, IC3, and IC2, respectively.

Drill suitable holes in a case for all of the panel-mounted components. The author's layout can be seen in Fig. 4. Once all of the holes are drilled, label the controls appropriately.

A concave lens (one with a negative focal point) is mounted on



Fig. 5. The completed Laser Scope is a handy tool for anyone working with mechanical systems.

one end of the case. It should have a -1- to -2-inch focal length, with a diameter of at least 1/2-inch or more. Surplus mail-order locations might carry an assortment of inexpensive lenses. Another source is the viewfinder of an old "pocket" camera. Drill a 3/8-inch (minimum) hole centered at the cabinet end. Glue the lens into position, centering it on the hole on the inside of the cabinet. Silicone sealant works well here, even on glass lenses. The concave surface should face inwards.

Mount LED3 directly in front of—but not touching—the concave lens surface. The author's prototype used a metal spring clip as a combination mounting clip and heatsink. Shaped like an oversized fuse-holder clip, those clips can be found at a local hardware store or supermarket. An alternate method is to simply "hang" LED3 from an edge of the circuit board by its leads and use a "slip-on" TO-5 heatsink. You normally don't think about cooling LEDs, but in the Laser Scope, the high-current pulses make it mandatory!

Install the panel controls, circuit board, and battery. Make all of the interconnections as short as possible. Double-check your wiring, and then install the ICs in their sockets.

**Setup and Calibration.** Set R2 and R8 to about their centers, R3 for 600 fpm, S1 to "x10", and R6 to 5 microseconds; turning R6's shaft will activate power switch S2. Using a voltmeter, check the power supply output at IC4. It should be at 5.0 volts  $\pm 0.25$  volts. Connect a frequency counter to pin 4 of IC2 and adjust R2 for 1000 Hz.

Set R3 down to 60 fpm and the frequency counter should read 100 Hz. With R3 set to 900 fpm, the display should read 1500 Hz. The prototype linearity was within  $\pm 1\%$  over that range, which is typical for a "good" CD4046. You may use other settings of R3 to further check IC2's VCO linearity. If your readings are not satisfactory, try swapping IC2. Some devices perform better than others as the specifications on the VCOs of those ICs are not held too closely. Another possible method

involves substituting 1N4148 diodes in place of the 1N4001 units used for D1 and D2. Place a variable resistor in parallel with each diode to adjust the offset voltages applied to R3.

Connect the x10 probe of an oscilloscope to the emitter of Q1 (the common lead goes to circuit ground). Set the oscilloscope controls to display a couple of cycles at a frequency of 100 Hz. Set R3 to 600 fpm and R6 to 50 microseconds. With R8 at mid-rotation, set S1 to "x10." You should see a pulse waveform with a peak voltage near 1.0 volts.

If the pulse is not present at Q1's emitter, you should see it at pin 3 of IC3. A correct pulse at that point means a faulty component or incorrect wiring around Q1. If the pulse is not present at IC3, check pin 2 of that device. There should be a negative-going spike that must drop below about 1.6 volts in order to trigger IC3. Typically, C4's value of 220 pF will drive the pulse down to about 1 volt. If needed, add more capacitance—about 50 pF at a time—in parallel with C4 until you get a pulse output at pin 3. Needless to say, if you don't see any pulse at pin 2 of IC3, check for pulses from IC1 and S1.

With the x10 probe on Q1's emitter, set R8 for a peak pulse voltage of 1.0 volt. Increase the oscilloscope's sweep rate to display only one pulse. Rotate R6 back and forth; you should see the pulse width vary between about 5 and 500 microseconds, with the width at the center of rotation at about 50 microseconds. Once everything checks out, you can close up the cabinet; the Laser Scope is ready to go!

When operating the Laser Scope, be sure to follow the safety tips given in the box that accompanies this article. Keep in mind the current drain needed at maximum control settings; operating the unit for extended periods in those conditions might cause LED3's intensity to deteriorate or even burn out. To extend its operating life, use only the minimum flash duration needed for good contrast. As with any stroboscope, the best contrast is obtained under subdued lighting.

# Understanding Digital Modulation

*Digital modulation is the key to today's high speed data transfers and has made possible such developments as high-speed digital modems and even HDTV.*

FERNANDO GARCIA

**A**nalog modulation techniques have served us well for many decades, and have been the mainstay of radio and TV broadcasts, as well as ham and mobile communications. The two basic analog-modulation methods are Amplitude Modulation, or AM (both as double and single side-band) and Frequency Modulation or FM. With the advent of computers and the widespread use of digital communications, neither AM nor FM has proved to be the best modulation choice as neither of those analog modulation schemes are efficient from the bandwidth vs. baud rate point of view. Therefore digital modulation techniques are required.

As most of course know, modulation is the process of encoding information onto a carrier signal. Since the carrier remains analog, the term "digital modulation" is a bit misleading. In digital modulation what is happening is that a carrier is modulated in discrete increments instead of the continuous envelope of conventional analog modulation methods. Each increment is then assigned a value of a bit or group of bits.

Before we go on, it is interesting to note that digital modulation techniques are not new by a long shot. The earliest wireless communications used Morse code, which is in essence digital modulation. The dots and dashes that comprise the code are basically the short and long pulses of RTZ-encoded digital data. During the earliest days of

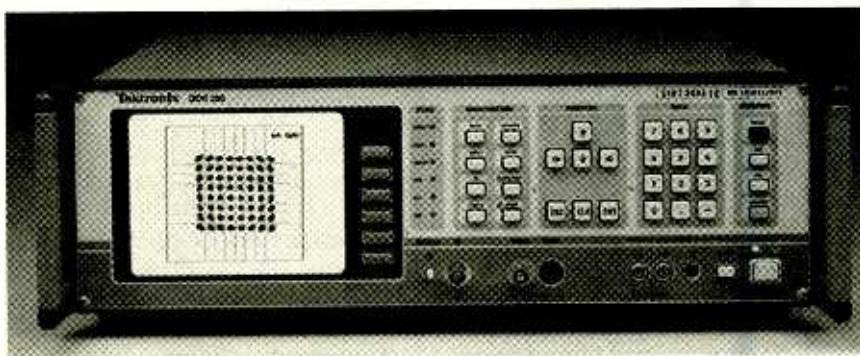

personal computers, hackers would build Morse-keyers, where the text would be typed on the computer screen, and the computer would toggle a relay to simulate the keying. Morse code is bandwidth-efficient, and although slow and a little dated, it still remains useful to this day.

**ASK and FSK.** Morse code-modulated signals would be known today as Amplitude Shift Keying or ASK. With ASK, the carrier is keyed between two discrete levels. Although any two carrier values could be used, for maximum efficiency these levels are keyed between full carrier and no carrier. This can be seen in Fig. 1, where ASK is shown in the middle trace and the modulating (digital) signal is shown at the top trace.

ASK suffers from very poor noise immunity during the period where the carrier is off. Therefore, it is not the modulation of choice for fast or critical transmissions. However, ASK consumes transmitter power only during the period the carrier is

actually keyed on, and the transmitter design itself is uncomplicated. Thus, it is widely used for simple battery-powered devices, such as garage-door openers.

With Frequency Shift Keying or FSK, the carrier is always on, as shown in bottom trace of Fig. 1. In that sample trace, the frequency shifts have been exaggerated for the sake of clarity.

FSK is a much more robust modulation method, as it has superior noise immunity. Receivers incorporate a limiter circuit much like FM detectors do, thus removing most, if not all, amplitude disturbances. Due to its robust receiving characteristics, the FSK modulation technique was frequently used in early modems.

The pitfall with FSK is that it occupies quite a lot of bandwidth for the amount of data-per-unit of time that it transmits. Bandwidth is a scarce commodity, and the need to transmit ever increasing data rates seems to be ever increasing. In order to minimize the occupied bandwidth, the frequency shifts are

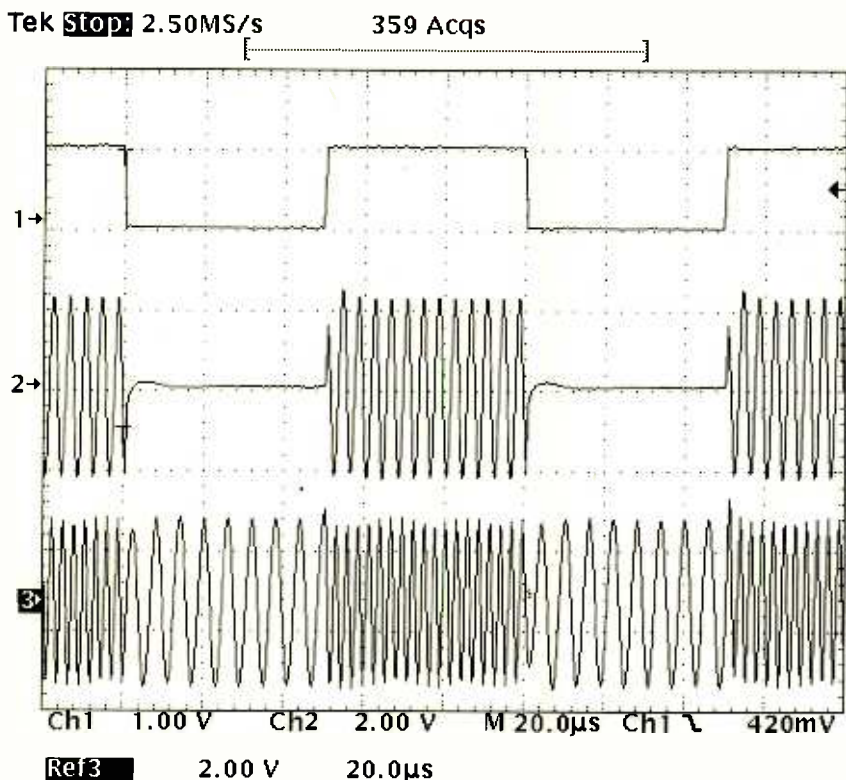

Fig. 1. ASK modulation (middle trace) and FSK modulation (bottom trace) are shown here. The top trace is the modulating signal.

kept as narrow as possible. Engineers soon realized that as the frequency shifts became narrower and narrower, they would look more like instantaneous phase shifts. Thus, Phase Shift Keying (PSK) was born; and its several variants, which allow extraordinary data rates to be transmitted, have largely superseded FSK.

**Enter PSK.** Phase Shift Keying was the next logical development, and it is what has allowed today's high-speed modems. In PSK, the carrier is subjected to abrupt phase changes as the modulation varies. This is shown in Fig. 2. Note that in the figure, the phase shift is a full 180 degrees, but the horizontal scale has been expanded with regard to the scale used in Fig. 1 to allow the modulation to be clearer.

PSK is difficult to view on traditional scope displays and even much more difficult to measure accurately. To get a better look at it, we need a better way to represent it—polar coordinates on a vector diagram. Such a diagram allows us to more easily see the relative phase shift of the waveform

with respect to a phase reference. This is clearly seen in Fig. 3, where the horizontal dividing line is the in-phase axis, and the vertical dividing line is the quadrature axis. The dots in the horizontal axis represent the two possible states; in this example, no phase shift would indicate a logic "0" and a 180-degree shift would indicate a logic "1".

It did not take very long for engineers to realize that there is plenty of empty space between zero and 180 degrees. Would it be possible to modulate both the in-phase axis and the quadrature axis in varying amounts and obtain a vector with smaller phase shifts—say 90 degrees, or even lower, perhaps to 45 degrees?

An example of the latter case is shown in Fig. 4. This modulation method in the figure is known as Quadrature Phase-Shift Keying or QPSK. Each discrete state is known as a symbol, and since there are 8 different states, that means that each symbol is capable of carrying three bits. Thus, QPSK allows dramatic increases in the baud rate without substantially increasing bandwidth.

The phase shifts could be further reduced to obtain additional symbols, but again we run into trouble since all modulated data suffers from certain limitations. Although PSK is relatively immune from amplitude noise, phase modulated signals suffer from phase uncertainties called *jitter*. The jitter might be produced at either the transmitting or receiving ends, or caused by the medium used to send the signal. Thus, as the number of symbols increases, it becomes more difficult to accurately resolve the ever decreasing phase shifts. Additional sophistication and improvements are required to achieve higher modulation densities.

### Marrying Phase and Amplitude.

Further improvements upon the basic phase shifting might be possible. For instance, ASK modulation requires keying the amplitude between two states, but the only reason that one of those states traditionally has been fully off was to conserve transmitter power. Without such a requirement, amplitude modulation could take the form of several discrete levels, each one providing additional symbols. Engineers have found a way to happily marry multi-level ASK and QPSK, and thus provide a waveform with simultaneous amplitude and phase shifts where a very dense modulation (with many symbols) could be achieved.

This modulation method is known as Quadrature Amplitude Modulation, or QAM-xx, where the "xx" are the number of symbols supported by the modulation. That means that the example shown in Fig 5. is QAM-16. In this instance, each different state carries four different bits of information.

QAM is not limited to 16 symbols. Certain applications use QAM-64 and more. As the number of states increase, the symbols resemble twinkling stars when viewed in appropriate equipment, and thus people have nicknamed such displays as "constellation diagrams." Specially equipped oscilloscopes or spectrum analyzers, or dedicated digital communications equipment such as the unit shown in the beginning of this article are

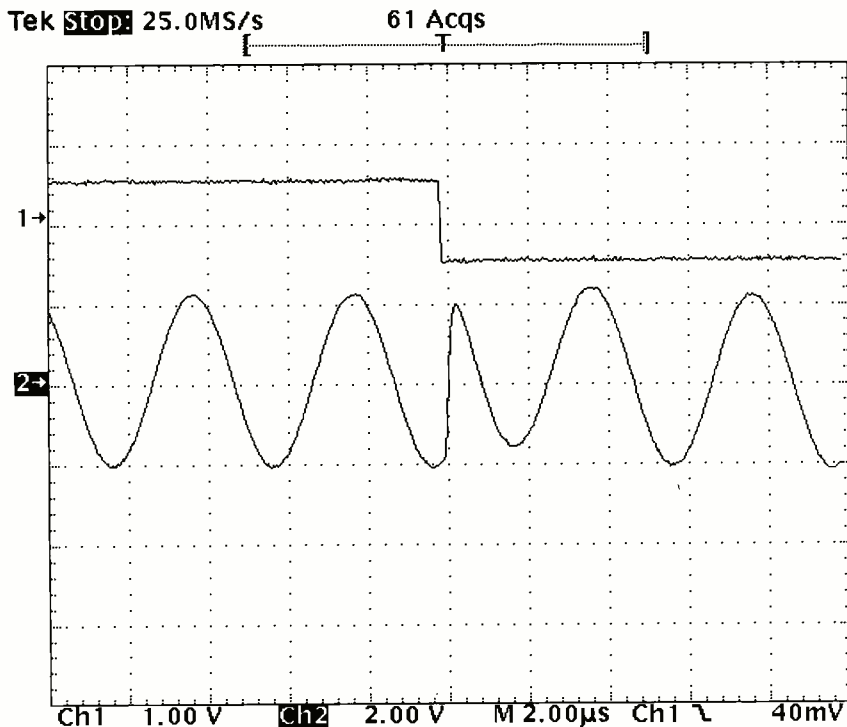

Fig. 2. An example of PSK modulation. Note the much shorter horizontal time scale as compared to Fig. 1.

required to view these diagrams.

Constellation diagrams clearly indicate the boundaries for which the symbols may be detected correctly. This is necessary since QAM is not perfect and suffers from jitter and amplitude uncertainties. The ideal dots may become wide, fuzzy blobs in actual operating conditions. Then some symbols may overlap with each other, and errors will occur. Those uncertainties limit the amount and density of symbols that may be reliably sent. Thus many modulation methods will fall back to a lower rate if excessive

errors at the higher rates are detected. In addition, sophisticated error-correcting algorithms allow high-speed data to be effectively recovered. But those are topics beyond the scope of this short article.

### High Definition TV and Beyond.

With its very high baud rate, QAM has pushed digital modulation into the mainstream, allowing a variety of devices to become feasible. Digital video broadcasts, the dramatic speed increases of PC modems, and other improvements have been made possible by this technique.

This does not mean that QAM's supremacy is unchallenged. The FCC's Advisory Committee on Advanced Television Service evaluated a vestigial sideband (VSB) digital transmission system that had been developed for terrestrial, MMDS, and cable television broadcasting by the Zenith Electronics Corp. After extensive field tests and a long debate among the members of the Grand Alliance (a consortium of several corporations and the MIT), the system was adopted as the new high-definition, digital terrestrial standard for the United States. This finally

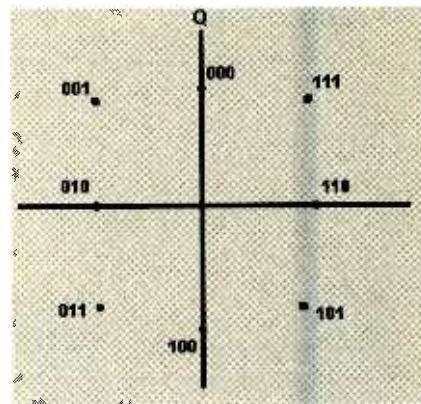

Fig. 4. The symbol positions in actual QPSK modulation may differ from the sample shown here.

occurred on December 1996. Among the reasons cited for the adoption was that VSB is more robust than QAM with regards to fading and that it provides faster recovery from dropouts, since VSB will still maintain receiver synchronization even if the received data is in error. Synchronization is extremely important, as all modern digital modulation methods use extensive error-correction algorithms, and these require at least data-clock synchronization.

QAM is a self-clocked modulation, and data dropouts will wipe the error-corrector's capability to recover. VSB, on the other hand, uses supplementary synchronization, which allows the receiver to rapidly recover after a data loss.

Just as with QAM, there are several variants for VSB, depending on the required data rates and robustness. Recommended modes are 8-VSB for terrestrial broadcasting, and 16-VSB for cable systems, although there is flexibility to accommodate other modes. Those modes allow one HDTV channel for the former, and two HDTV channels for the latter, to be transmitted within the 6 MHz bandwidth currently allotted to existing NTSC channels. The maximum data rate under optimum conditions for 8-VSB signal is 19.39 Mbps and twice that much for 16-VSB.

This is not to say that VSB has completely won the HDTV battle. Japanese and European consortiums are holding steadfastly to the newer OFDM (Orthogonal Frequency Division Multiplexing) modulation, which requires a lot of

(Continued on page 44)

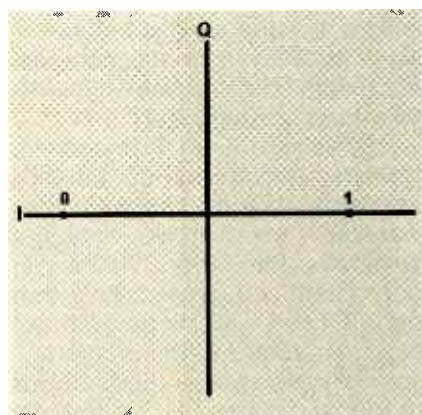

Fig. 3. Using both a vector diagram and polar coordinates makes it easier to examine PSK modulation.



# Test Equipment for Audio Technicians: Balanced-Line Converter

GARY MCCLELLAN

*Connect consumer-audio gear to professional amplifiers.*

As you probably know, professional sound equipment typically has “balanced-line” inputs and outputs. The balanced-line configuration is used because it is great for reducing hum pickup when long cable runs are used between the equipment. Unfortunately, a balanced-line input isn’t very useful when you want to connect a CD player, mini-disc recorder, or other device with an unbalanced output. True, it is possible to rewire the amplifier’s input connector to accept an unbalanced signal, but there is no guarantee that the equipment will work properly. Balanced-line systems also tend to be low impedance, and the line-level inputs typically require higher voltages when compared to consumer products. What is needed is an unbalanced-to-balanced line converter with a low output impedance and voltage gain.

The Balanced Line Converter presented here offers a simple solution to the balanced-line conversion problem. The unit accepts unbalanced inputs from consumer audio gear and has balanced outputs with impedances and levels that are suitable for professional audio equipment. The input impedance is 100,000 ohms—suitable for all solid-state equipment and most vacuum-tube gear. The latter is especially desirable if you use tube-type microphone preamplifiers or signal processors. Such devices are currently popular in recording studios.

Although the Line Converter was

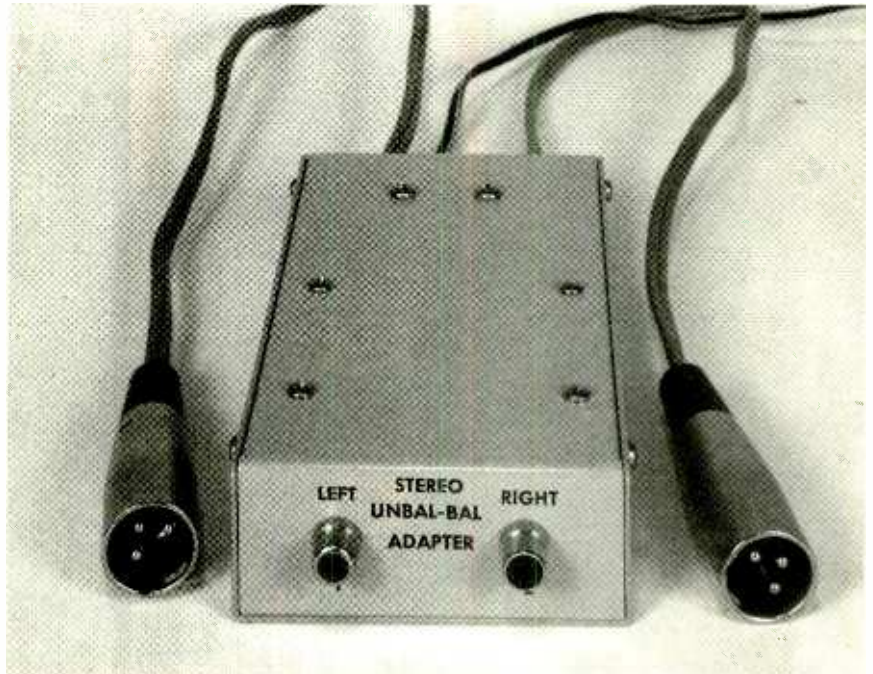

originally developed for professional audio-equipment servicing, it has proven to be a real workhorse. For example, the unit can be used as a remote microphone preamplifier. The author has used an inexpensive unbalanced microphone plugged into the unit with a long cable run to a mixer console. Another use is as a headphone amplifier. On the test bench, the unit can be used to convert an audio-oscillator output to a balanced-line format for mixer-console and power-amplifier testing. It is a project that is as versatile as it is inexpensive; you might want to build several!

**How It Works.** As you can see from the schematic diagram shown in Fig. 1, the Balanced-Line Converter is a simple, straightforward device. It is based upon a quad op-amp and

two voltage regulators. The quad op-amp serves as a combination two-channel-amplifier and phase-splitter circuit. The voltage regulators provide high-quality power for the op-amp.

In operation, an unbalanced signal appearing at J1 is amplified by op-amp IC1-a. That stage serves as an inverting amplifier with a gain of 2.27. The inverted output goes to pin 3 of J3. Resistors R2 and R5 set the amplifier gain. Resistor R6 protects the op-amp from short circuits, and it minimizes the possibility of oscillation when the unit is connected to a long cable.

Op-amp IC1-b amplifies the same input signal. It serves as a non-inverting amplifier with a gain of 2.27. The non-inverted output goes to pin 2 of J3. Resistors R3 and R4 set the gain of this stage. Resistor

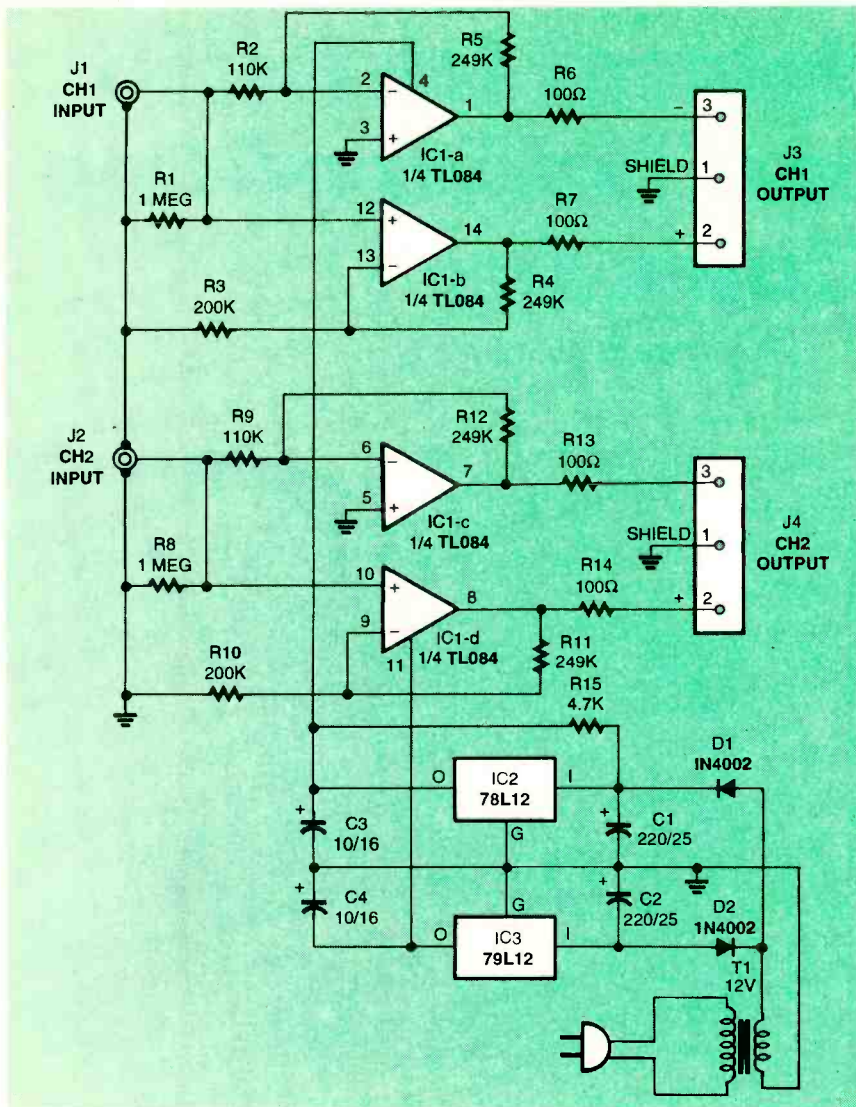

Fig. 1. The Balanced-Line Converter does just what its name implies: the unbalanced signal from consumer-audio equipment such as a CD player or tape deck is converted to a balanced-line format used by professional audio gear. The balanced-line format is designed for very long cable runs where noise pickup would be a problem; any induced noise is cancelled out due to the inverted/non-inverted nature of the signal. As a bonus, the signal is amplified to drive such long cables.

R7 serves the same functions as resistor R6. Finally, R1 serves as a DC return for the input. It minimizes drift of the DC offset voltages on the op-amp outputs when an AC-coupled signal source is connected to J1.

The second channel works the same way.

Note that the Balanced-Line Converter is capable of very high performance. The device uses 1% resistors to assure that each channel's inverting and non-inverting output-signal levels are matched within 1%, and that the input impedance is 100,000.

The power supply uses a conventional half-wave rectifier (D1 and D2)

and three-terminal voltage regulators IC2 and IC3 to develop +12 volts and -12 volts DC. Resistor R15 is a notable addition. It insures that IC2 starts up each time power is applied. During the development of this project, it was discovered that the output voltage of IC2 would sometimes read -0.8 volt after power up. The problem was that IC3 starts up sooner than IC2, forcing IC2 to shut down. Changing IC2 did not solve the problem. However, an old manufacturer's application note for IC2 described the problem and suggested that cure. You might not need R15, but consider it insurance against having power-supply problems!

**Construction.** While the Balanced-Line Converter can be built on a piece of perfboard using standard construction techniques, a PC board is recommended in order to keep noise and hum pickup to a minimum. If you wish to use a PC board, a foil pattern has been included here. Use the parts-placement diagram in Fig. 2 as a guide when populating the board.

Be sure to observe the polarities of C1 to C4 and the orientation of IC2 and IC3. Don't forget the jumpers; they are a "necessary evil" for the ease of working with a single-sided board.

A socket, while not needed, is a good idea for IC1 should you need to replace it with a repair part or one that has better specs with the same pinout. When you are done, check your work for errors and correct any that are found; do that after taking a short break or at the start of your next work session.

The Balanced-Line Converter is

## PARTS LIST FOR THE BALANCED-LINE CONVERTER

### SEMICONDUCTORS

- IC1—TL084 quad op-amp, integrated circuit
- IC2—78L12 voltage regulator, integrated circuit
- IC3—79L12 voltage regulator, integrated circuit
- D1, D2—1N4002 silicon diode

### RESISTORS

(All resistors are 1/4-watt, 1% metal-film units.)

- R1, R8—1-megohm
- R2, R9—110,000-ohm
- R3, R10—200,000-ohm
- R4, R5, R11, R12—249,000-ohm
- R6, R7, R13, R14—100-ohm
- R15—4700-ohm

### CAPACITORS

- C1, C2—220-μF, 25-WVDC, electrolytic
- C3, C4—10-μF, 16-WVDC, electrolytic

### ADDITIONAL PARTS AND MATERIALS

- J1, J2—RCA jacks, panel-mount
- J3, J4—XLR connectors, male
- T1—12-volt AC, 400-mA wall transformer
- Case, audio cable, sockets, wire, hardware, etc.

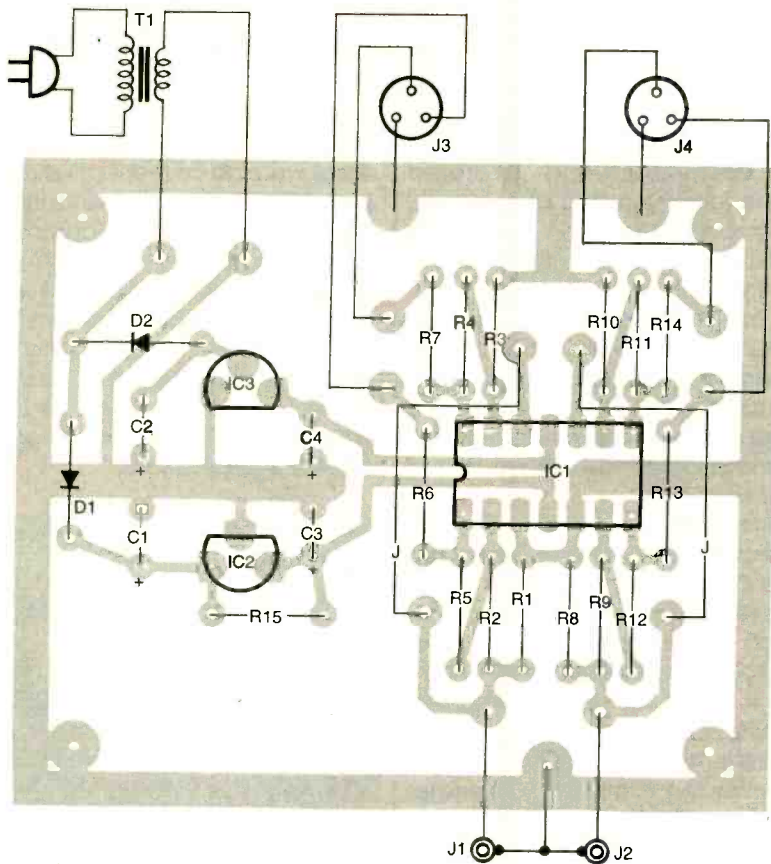

Fig. 2. The Balanced-Line Converter fits on a single-sided PC board with only two jumpers needed.

mounted in any suitable metal case. Feel free to place it inside an existing amplifier or mixer console if you wish. Note that any case that you use must be made of metal to prevent hum pickup. The interior layout of the author's prototype is shown in Fig. 3.

Drill appropriate holes for J1 and

J2 at one end of the case. Sand the inside of the case around those holes lightly; the roughened bare surface makes for a better ground contact between the jacks and the case, resulting in less hum and therefore a quieter unit. It is hard to find panel-mount versions of J3 and

J4; note that the author used the more common line-mounted variety. Drill three holes on the other end of the case and add rubber grommets to protect the wires from being cut on the sharp metal edges of the holes. Run a length of shielded audio cable through each hole. The output cable can be any two-conductor shielded type. One source for that type of cable is a 6-foot stereo patch cable with connectors cut off. One end attaches to the PC board; the other to the XLR jacks. Use an ohm-

meter to verify that the wires are connected to the proper pins and that there are no shorts.

The wire from T1 passes through the center hole and is attached to the PC board in a similar fashion.

The PC board is mounted to the bottom of the case using screws, nuts, and spacers. Be sure that the traces or solder joints do not short out against the metal case. Note that two cable clamps were also used to hold the output cables in place; they also act as a strain relief.

The jacks may be labeled any way that you choose. For example, you could mark them as channels 1 and 2, but "Left" and "Right" might work better for you.

**Checkout and Operation.** Before using the Balanced-Line Converter, take a moment to make a few simple tests. Plug in T1 and clip the negative lead of a voltmeter to ground. Check for the following power-supply voltages: pin 4 of IC1 must read +12 volts; pin 11 must read -12 volts. Those measurements must be within 0.5 volt. Check the DC-offset voltages on pins 2 and 3 of J3; neither voltage should exceed 20 mV. If they do, replace IC1. Repeat the test on J4. If the Balanced-Line Converter passes those tests, close up the case; the Balanced-Line Converter is ready for use.

Using the Balanced-Line Converter is easy. Plug in T1. Connect an unbalanced signal source, such as a microphone or CD player, to J1 and J2. Connect J3 and J4 to an amplifier or mixer-console input. Adjust the amplifier or console controls for the desired

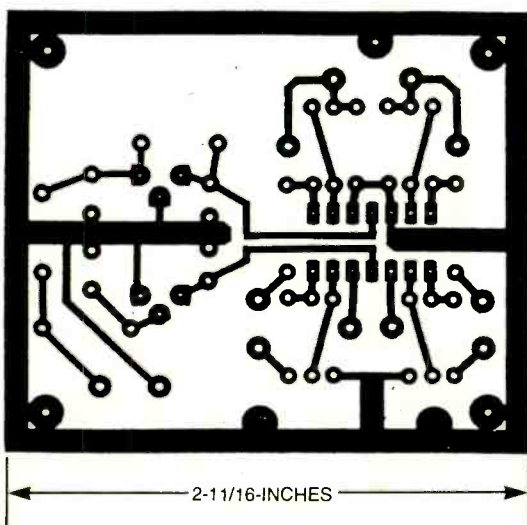

Here's the foil pattern for the Balanced-Line Converter.

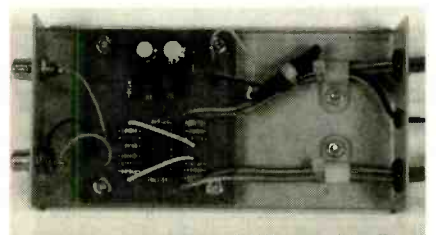

Fig. 3. The simple design of the Balanced-Line Converter can be seen in this inside view of the author's prototype. Note the use of cable clamps to act as strain reliefs for the audio cables—XLR connectors can be quite heavy! Don't forget to use rubber grommets where the wires pass through the metal case.

## TIPS FOR MAIL ORDER PURCHASE

It is impossible for us to verify the claims of advertisers, including but not limited to product availability, credibility, reliability and existence of warranties. The following information is provided as a service for your protection. It is not intended to constitute legal advice and readers are advised to obtain independent advice on how to best protect their own interests based upon their individual circumstances and jurisdictions.

- 1. Confirm price and merchandise information** with the seller, including brand, model, color or finish, accessories and rebates included in the price.
- 2. Understand the seller's return and/or refund policy**, including the allowable return period, who pays the postage for returned merchandise and whether there is any "restocking" or "return" charge.
- 3. Understand the product's warranty.** Is there a manufacturer's warranty, and if so, is it for a U.S. or foreign manufacturer? Note that many manufacturers assert that, even if the product comes with a U.S. manufacturer's warranty, if you purchase from an unauthorized dealer, you are not covered by the manufacturer's warranty. If in doubt, contact the manufacturer directly. In addition to, or instead of the manufacturer's warranty, the seller may offer its own warranty. In either case, what is covered by warranty, how long is the warranty period, where will the product be serviced, is there a charge for service, what do you have to do to obtain service and will the product be repaired or replaced? You may want to receive a copy of the written warranty before placing your order.
- 4. Keep a copy of all transactions**, including but not limited to cancelled check, receipt and correspondence. For phone orders, make a note of the order including merchandise ordered, price, order date, expected delivery date and salesperson's name.
- 5. If the merchandise is not shipped within the promised time**, or if no time was promised, within 30 days of receipt of the order, you generally have the right to cancel the order and get a refund.
- 6. Merchandise substitution** without your express prior consent is generally not allowed.
- 7. If you have a problem with your order or the merchandise**, write a letter to the seller with all the pertinent information and keep a copy.
- 8. If you are unable to obtain satisfaction from the seller**, contact the consumer protection agency in the seller's state and your local Post Office.

If, after following the guidelines, you experience a problem with a mail order advertiser that you are unable to resolve, please let us know. Write to Advertising Department, Gernsback Publications Inc., 500B Bi-County Blvd. Farmingdale, NY 11735.

Be sure to include copies of all correspondence.

sound level.

The Balanced-Line Converter makes an excellent headphone amplifier. To use it as such, make an adapter cable from two female XLR connectors and a stereo phone jack. From the phone jack, the ground connection goes to pin 1 of one XLR connector, the ring connection to pin 2 of the same XLR, and the tip connection to pin 2 of the other XLR. For best results, the headphone impedance should be at least 32 ohms. Lower impedance headphones will produce less volume and distort when you turn the sound level up.

One word of warning: turning the Balanced-Line Converter on or off while it is connected to an amplifier or mixer console will produce a loud thump in the speaker system. One way to avoid possible speaker damage is to power up the amplifier/console and the Balanced-Line Converter at the same time through a switched outlet strip. Otherwise, power up the Balanced-Line Converter before the amplifier or console, and power it down after the amplifier/console is turned off. If that is not possible, you should turn the amplifier or console level controls to zero before switching power to the Line Converter.  $\Omega$

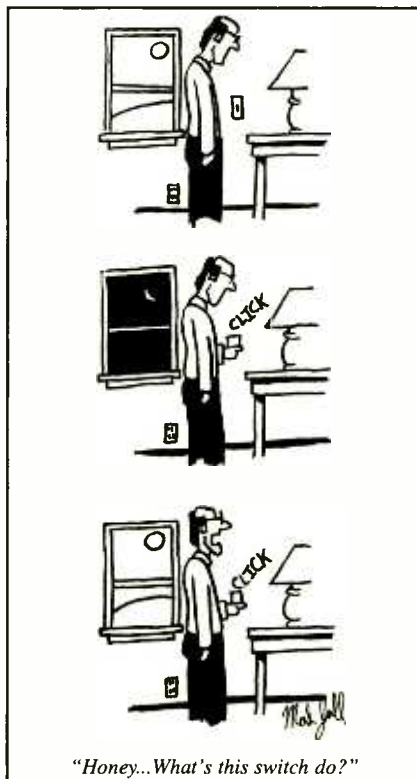

## DIGITAL MODULATION

(continued from page 40)

computer power to implement—so much, in fact, that until recently there were no cost-effective digital processors powerful enough to implement the OFDM demodulator on a consumer product.

OFDM uses hundreds or even thousands of quadrature-modulated carriers, each transmitting at a low data rate. The parallelism of those carriers allow for the extremely high data rate required for HDTV applications.

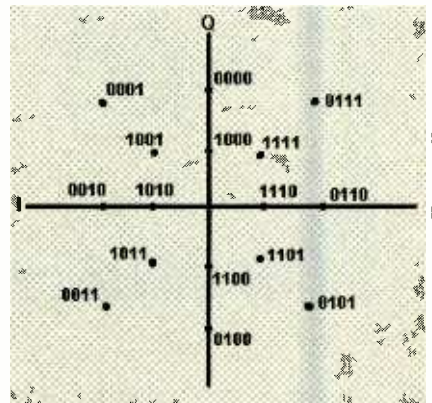

Fig. 5. This constellation diagram shows a QAM-16 signal—a quadrature-amplitude modulated carrier with 16 states or symbols.

Each digital-modulation system has, of course, its technical advantages and pitfalls. The advocates for each camp remain stubborn in their attempt to prove that their system provides the best solution. Even here in the US, there are uncertainties for VSB. Cable operators that have already committed to digital programming have done so by deploying QAM systems. They maintain that since a cable system does not suffer from multipath, fading, or other off-air disturbances, QAM is as robust as VSB in this application. Perhaps a better explanation would be that they are extremely reluctant to replace the very substantial investment made in equipment and training.

HDTV broadcasts in general and VSB modulation in particular are fascinating and lengthy topics that could fill entire books. Visit Zenith's web site at [www.zenith.com](http://www.zenith.com) for a comprehensive discussion on the subject.  $\Omega$

# A SCROLLING LED CLOCK

DAVID WILLIAMS

Low-cost digital clocks have been available for many years, but most show the time in a static four-digit display. The Scrolling Clock described in this article creates an interesting timepiece by presenting the digits in a dot-matrix format and scrolling the time in a ticker-tape fashion. The result is an eye-catching timepiece that is truly unique. Place it on your desk, mantle, or table and watch the attention that it gets!

**About the Circuit.** As you can see from the schematic diagram shown in Fig. 1, the heart of the Scrolling Clock is IC1, an AT89C2051 microcontroller made by Atmel. It is programmed to handle a variety of functions, including display multiplexing, timekeeping, dot-pattern encoding, scrolling, and time setting.

The AT89C2051 has 2000 bytes of "flash" program memory, 128 bytes of RAM, 15 input/output lines, two 16-bit timers, a serial interface circuit, an analog comparator, and an interrupt system that can handle five different types of interrupts. It is fully compatible with Intel's MCS-51 series of microcontrollers in terms of both the design architecture and instruction set.

Even though the microcontroller is doing most of the work in the Scrolling Clock, some additional circuitry is needed.

Let's begin with the power sup-

*Time Marches On is more than just an expression with this clock's display!*

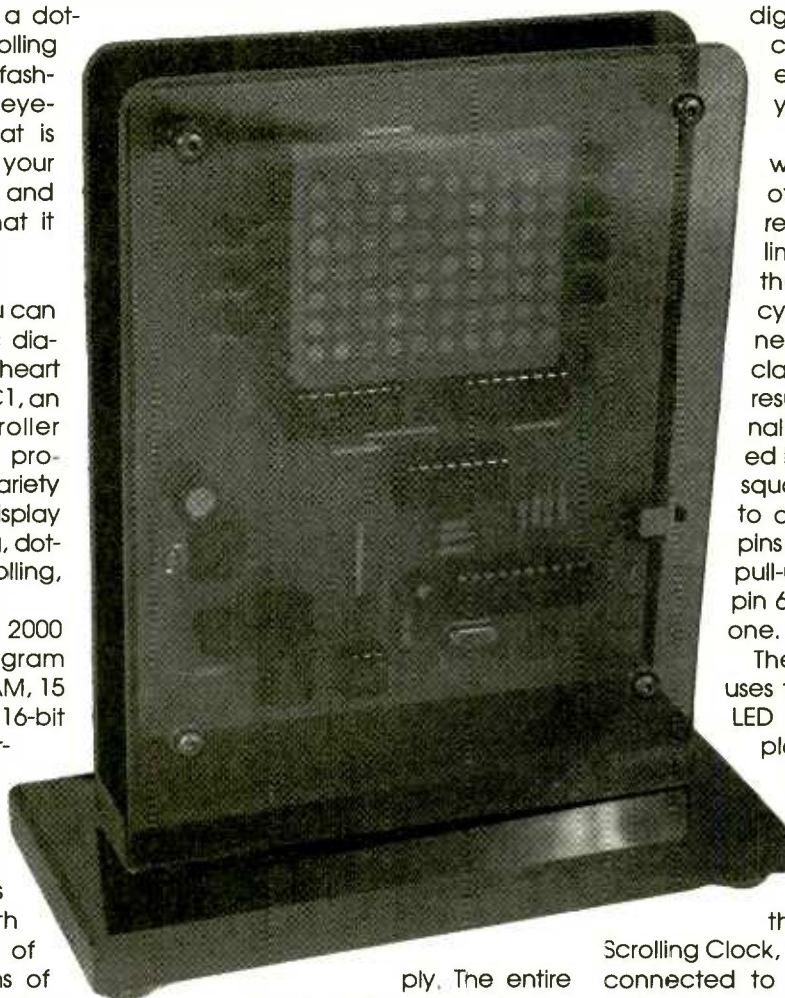

ply. The entire circuit receives power from a 9-volt AC wall-mounted transformer. The AC supply is rectified by bridge rectifier BR1, filtered by capacitor C9, and regulated to 5 volts by IC5.

For accuracy, the signal used by IC1 for keeping track of the time is

derived from the 60-Hz AC power line. The frequency of the commercial power grid is held to tighter tolerances than the best crystal timebase can hope to achieve. After all, how accurate is your digital wristwatch as compared to the electric wall clock in your kitchen?

The 9-volt AC waveform is picked off of BR1 before it is rectified and current limited by R15. Only the positive half cycles are used; the negative cycles are clamped by D1. The resulting half-wave signal is electrically isolated by IC6. The resulting squarewave is applied to one of the interrupt pins of IC1. Note that no pull-up resistor is used; pin 6 of IC1 already has one.

The Scrolling Clock uses two dot-matrix-style LED displays. Each display has 35 LEDs that are internally connected to form an array of seven rows by five columns. In

the type used in the Scrolling Clock, the LED anodes are connected to the rows and the cathodes are connected to the columns. The rows of both displays are bussed together to form a larger array of 70 LEDs that appears to have seven rows and ten columns. Only 17 connections are needed to select any LED; the technique is

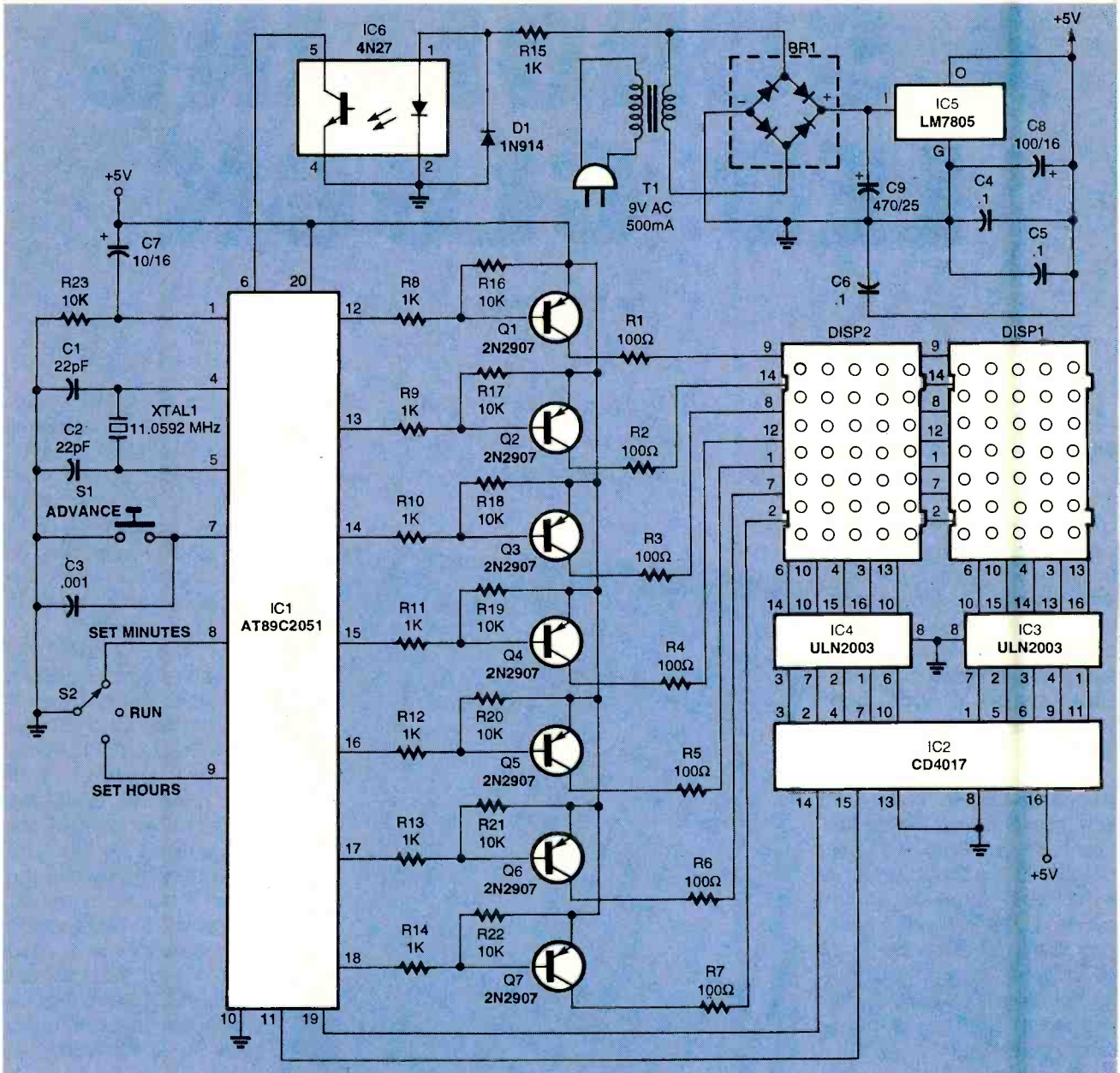

Fig. 1. The Scrolling Clock is built around a microcontroller that displays the time like a scrolling marquee.

called *multiplexing*.

In multiplexing, the LEDs are strobed one column at a time at a rate fast enough so that the human eye does not perceive any flicker; it is possible for all 70 LEDs to appear lit. However, if you only supply the normal amount of current to the LEDs, they will appear dim because each column will only receive the current for  $1/10$  of the time. To compensate, the current must be boosted to 10 times the normal amount.

Seven data lines from IC1 control the display rows. Current boost is provided by transistors Q1-Q7. A

CD4017 CMOS decade counter, IC2, selects each of the 10 columns in sequence. Since IC2 cannot handle the display current directly, IC3 and IC4 contain sets of NPN Darlington-transistor arrays for current sinking.

Two output lines from IC1 control IC2. One resets the counter so that the row data can be synchronized with the proper column; the other clocks IC2 to enable the next column.

In practice, the Scrolling Clock multiplexes the display as follows: First, IC2 is reset to select the first column. Display data is output on

the seven row lines to turn on the appropriate LEDs in the first column. After one millisecond, the LEDs are turned off. A clock pulse increments IC2 to select the next column. At the same time, the row data is changed to turn on the LEDs in the next column. That sequence continues for each of the 10 columns before the entire process is repeated. At that speed, the display's refresh rate is 100 times per second—much faster than the human eye's ability to perceive flickering.

Finally, two switches are used for

## PARTS LIST FOR THE SCROLLING CLOCK

### SEMICONDUCTORS

- IC1—AT89C2051 microcontroller, integrated circuit  
 IC2—CD4017 decade counter, integrated circuit  
 IC3, IC4—ULN2003 NPN Darlington driver array, integrated circuit  
 IC5—LM7805 5-volt regulator, integrated circuit  
 IC6—4N27 optoisolator, integrated circuit  
 Q1—Q7—2N2907 PNP transistor  
 DISP1, DISP2—LTP1157 5 × 7 LED matrix display  
 D1—1N914 silicon diode  
 BR1—Bridge rectifier, 1-amp

### RESISTORS

- (All resistors are 1/4-watt, 5% units.)  
 R1—R7—100-ohm  
 R8—R15—1000-ohm  
 R16—R23—10,000-ohm

### CAPACITORS

- C1, C2—22-pF, ceramic-disc  
 C3—0.001- $\mu$ F, ceramic-disc  
 C4—C6—0.1- $\mu$ F, ceramic-disc  
 C7—10- $\mu$ F, 16-WVDC, electrolytic  
 C8—100- $\mu$ F, 16-WVDC, electrolytic  
 C9—470- $\mu$ F, 25-WVDC, electrolytic

### ADDITIONAL PARTS AND MATERIALS

- XTAL1—11.0592-MHz crystal  
 S1—Single-pole, single-throw, momentary-contact switch (Digi-key P8012S-ND or similar)  
 S2—Single-pole, three-position, center-off slide switch (Jameco 106075 or similar)  
 T1—9-volt AC, 500-mA wall transformer  
 Sockets, hardware, wire, etc.

**Note:** The following items are available from LNS Technologies, PO Box 67243, Scotts Valley, CA 95067; Tel: 831-768-9155; Web: [www.ncal.verio.com/~lnstech](http://www.ncal.verio.com/~lnstech): Complete kit of all parts, PC board, programmed IC1 (SCROLLCLOCK-KIT), \$49.00; programmed IC1 (AT89C2051-SCK), \$12.00; etched and drilled PC Board (SCROLLCLOCK-PCB), \$10.00; 3 1/2 inch floppy disk with software (SCK-DISK), \$ 7.00. Please add \$5.00 for shipping and handling. CA residents must add 8% sales tax. MasterCard and VISA orders are accepted. No C.O.D. orders will be accepted.

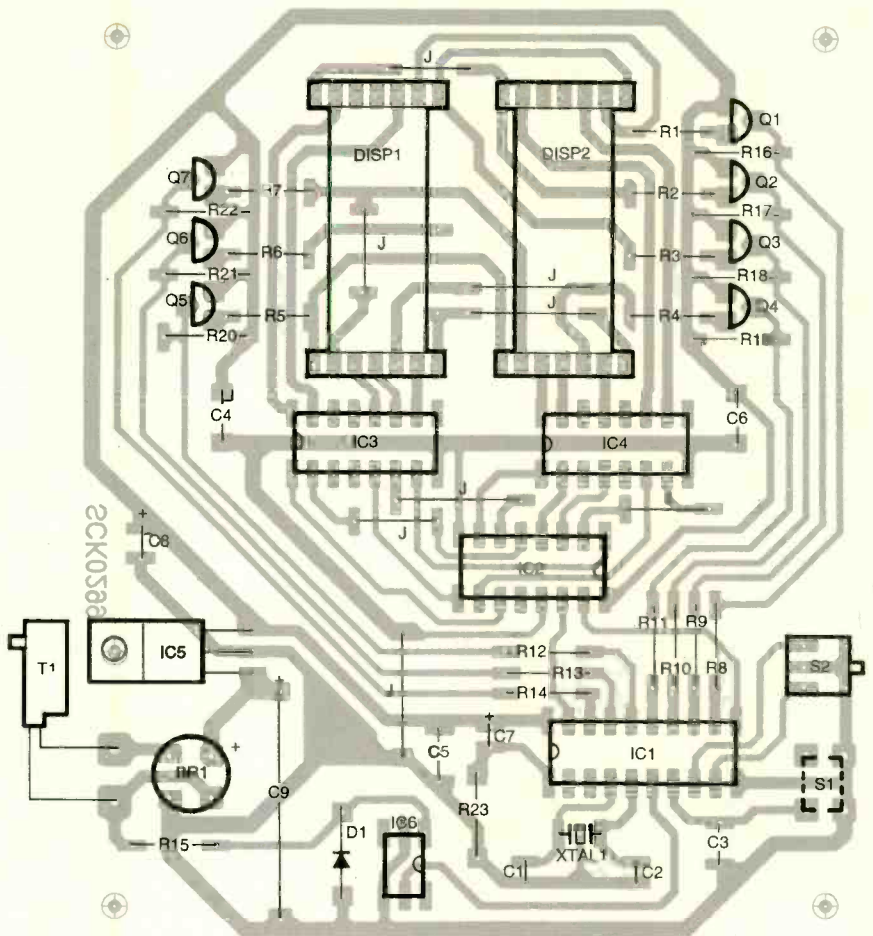

Fig. 2. The Scrolling Clock fits nicely on a single-sided PC board; several jumpers are needed.

setting the time. Normally, S2 is left in its center, or OFF, position. Throwing S2 in the appropriate direction lets you set the hours or minutes; S1 advances the time when held.

**Software.** The Scrolling Clock's software consists of two main routines plus several utility routines. The main loop converts the time digits to dot patterns, refreshes the display, shifts the data for scrolling, and checks for switch inputs. The interrupt routine, controlled by the squarewave from IC6, executes 60 times a second to increment the internal seconds, minutes, and hours counters. The time-setting routine "debounces" the switch inputs and increments the appropriate internal counters. Because mechanical switches are being connected to a microcontroller, the mechanical "bounce" of the switch contacts would normally be seen as several openings and closures by the software. When a switch closure is detected, the soft-

ware waits a few milliseconds before checking the switch a second time. If the switch is still closed, the appropriate action is taken; an open switch is considered a "false alarm" and is ignored.

The software listing is too large to print here, but the source code can be downloaded from the Gernsback Web site at [ftp.gernsback.com/pub/EN/sclock.zip](http://ftp.gernsback.com/pub/EN/sclock.zip). Compiled programming data is also included in that file.

**Construction.** Being a microcontroller-based project, the Scrolling Clock has many interconnections between its components as well as high frequencies around the display multiplexer and IC1's crystal. For those reasons, a printed-circuit board is required. Fortunately, a single-sided board layout can be achieved; plated-through holes and lining up the top and bottom patterns will not be a concern for those who wish to etch their own

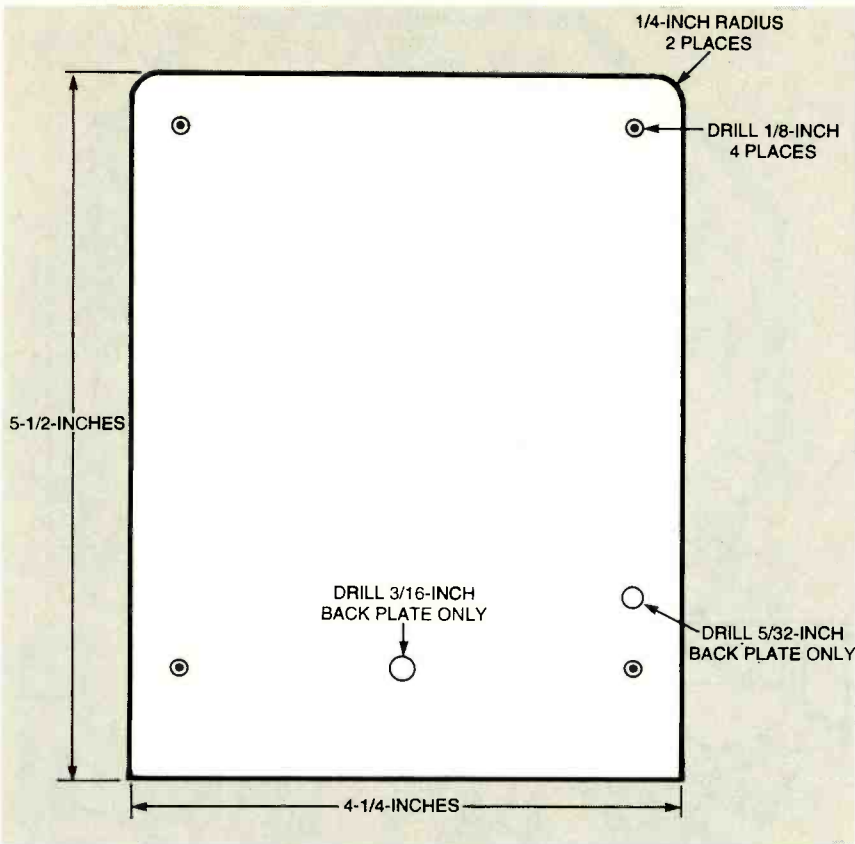

Fig. 3. The front and back of the Scrolling Clock are cut to the same size; the front is made from see-through red plastic.

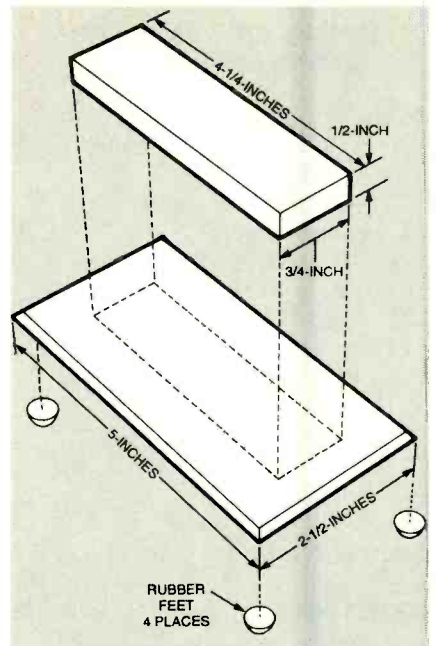

Fig. 4. The base is a simple block with rubber feet that the Scrolling Clock will press-fit onto.

boards. A foil pattern has been included elsewhere in this article.

Alternatively, an etched and drilled board, as well as a full kit, a pre-pro-

grammed microcontroller, and programming code are available from the source given in the Parts List.

If you are using a purchased PC board or one made from the foil pattern, the parts-placement diagram shown in Fig. 2 should be followed during construction. Begin by installing the several jumpers needed to connect sections of the circuit together.

The components should be installed in size order from smallest to largest for ease of construction. Whenever possible, install the semiconductors last; minimizing the handling of them will help prevent static-electric damage. Note that several components are polarized; double-check their orientation before soldering them in place. Bend the leads on IC5 so it lies flat against the PC board.

If you use the switch specified for S2, it can be soldered directly to the PC board. Note that S1 is mounted to the solder side of the board. Otherwise, you can run wires to the switches of your choice.

While not necessary, it is highly recommended to use sockets for all of the integrated circuits. Because of the danger of damage due to

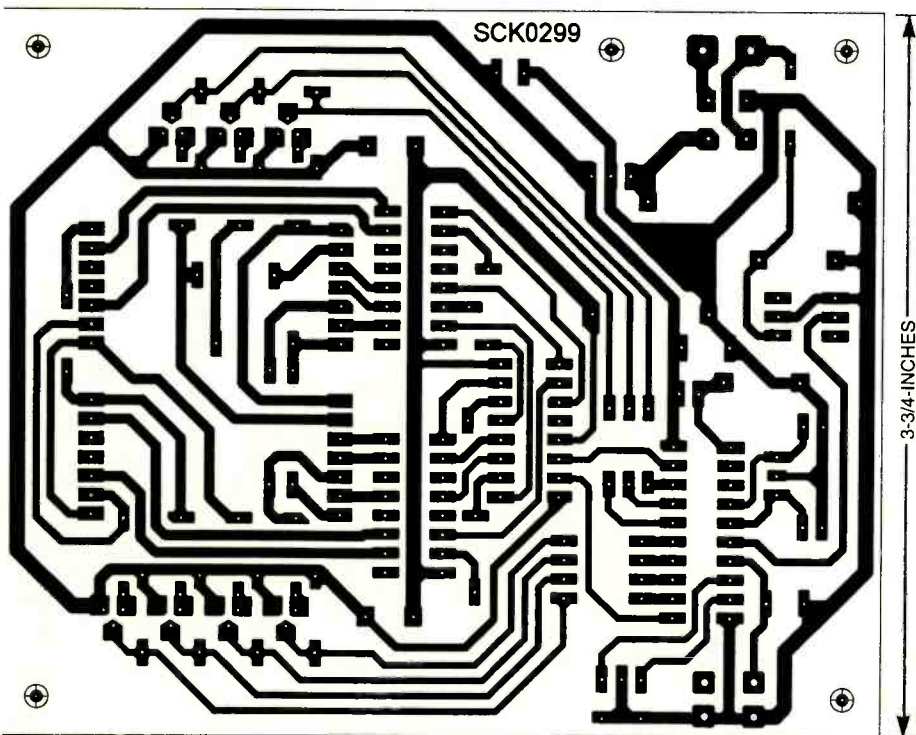



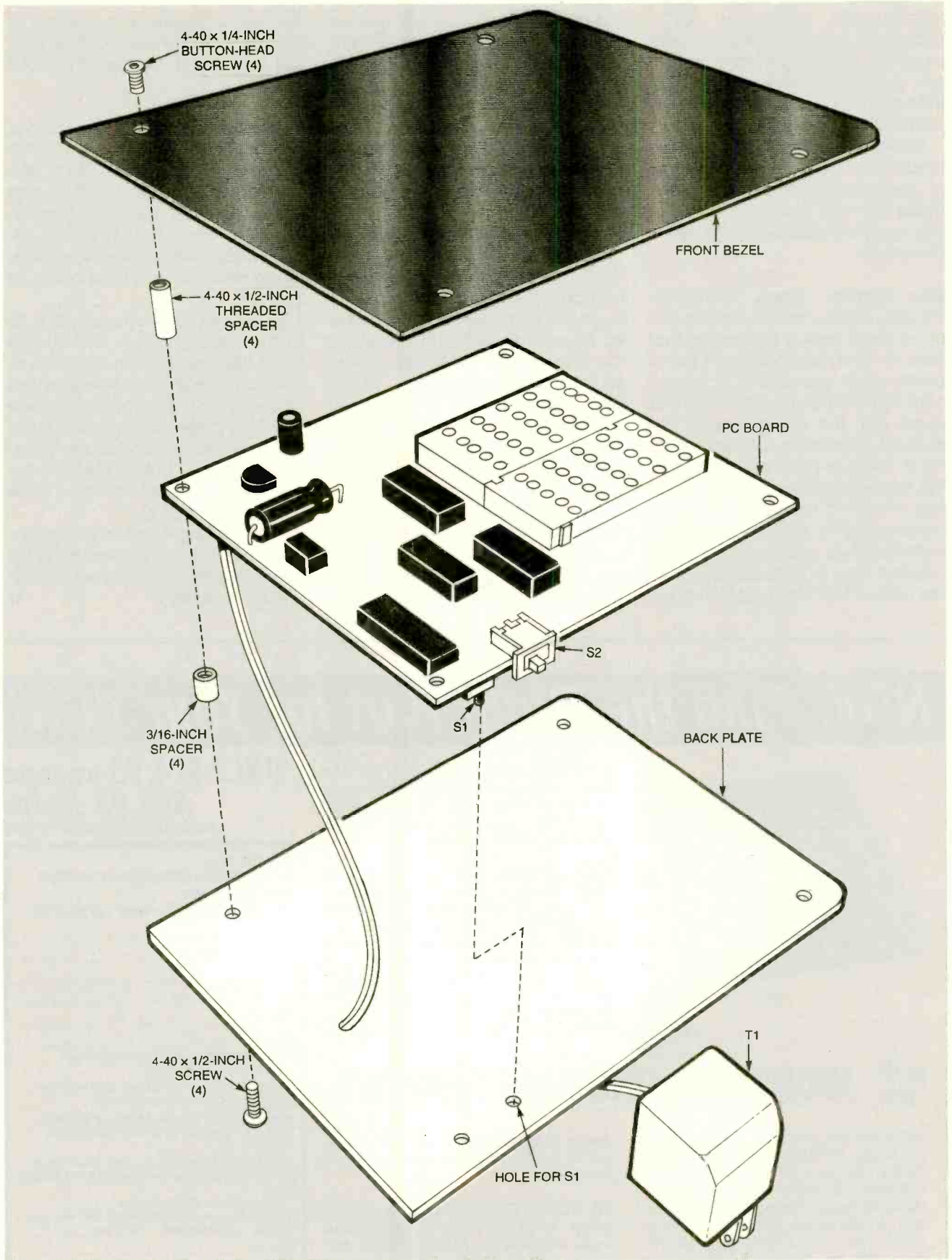

Fig. 5. The Scrolling Clock's case is a simple sandwich arrangement that creates a stylish-looking project.

electro-static discharge (ESD), sockets let you install the ICs after all of the soldering is done; repairs are also easier. Be sure to match the notch on each socket with the orientation shown in Fig. 2.

Sockets for DISP1 and DISP2 are required for clearance; the edges of the displays overhang R1-R7. Make them by cutting a length of strip socket to four pieces of seven pins each.

**The Display Case.** While the Scrolling Clock can be mounted in any suitable case, it is a project that calls for a stylish housing. A black plastic back panel and a translucent red front bezel are cut to the same size; the dimensions of the author's prototype are shown in Fig. 3. The four holes are aligned to the four mounting holes at the corners of the PC board; get location measurements from your board. Note that two additional holes are needed. One is centered as shown, the other is for S1 to project through

the back plate. If your switches are not mounted on the PC board, you'll need to devise a suitable mounting scheme that does not interfere with the placement of the PC board.

Make a base from heavy plastic; the dimensions are shown in Fig. 4. Suitable glue holds the pieces together.

While the base is drying, we can assemble the Scrolling Clock. See Fig. 5. Cut and strip the wires from T1 and pass them through the hole in the back plate. Solder them to the PC board. Mount the PC board to the back plate with screws, spacers, and threaded spacers. At this point you can install the socketed components. If you did not purchase a pre-programmed IC1, don't forget to program it before installation!

The front bezel is attached with additional screws to the threaded spacers. When the base is dry, you should find that the Scrolling Clock will press-fit into it snugly. If not, you

can use a few shims as needed at the back of the unit so that they are not visible through the front bezel.

**Operation.** Set S2 to the center or RUN position. When power is first applied to the Scrolling Clock, the internal time is reset to 12:00 and the number 12 flashes in the display. If you see that in the future, you'll know that there was a power failure and that the time needs to be reset.

To set the hours, move switch S2 to the HOURS position. The current hours digits will flash in the display. Press and hold S1 to advance the hours. To set the minutes, move switch S2 to the MINUTES position and follow the same procedure. When you are done, put S2 back to the RUN position. The time will now scroll through the display.

The Scrolling Clock is a guaranteed eye catcher, and is sure to be noticed by all of your friends, family, and co-workers. Ω

# NOW Find the Right Part for Your VCR!



The 172-page Eighth Edition of the VCR Cross Reference contains both model and part number cross references. Over 7,810 new parts and 1927 new models have been added.

VCR's are made in a few factories from which hundreds of different brand names and model numbers identify cosmetically-changed identical and near-identical manufactured units. Interchangeable parts are very common. An exact replacement part may be available only a few minutes away from you even though the original brand-name supplier is out of stock. Also, you may be able to cannibalize scrap units at no cost.

## with the **ISCET VCR CROSS REFERENCE**

**NEW!** The Seventh Edition is contained on a 3½ diskette for IBM PC AT/XT compatibles, DOS 2.1 or higher. The disk software allows technicians to search by manufacturer for model numbers and description of part numbers. A parts editing sequence gives an on-screen view of all substitutes for parts entered. With the diskette, the technician can update files by adding model and parts

crosses of future models. The Eighth Edition can be printed on pages completely from the diskette.

The ISCET VCR Cross Reference, Seventh Edition, is on 8½ × 11-in., pre-punched pages and sells for **\$24.95**. The 3½ inch diskette sells for **\$69.95** and you can view listings from a monitor or printed page.

**ONLY \$24.95 for pages**  
**\$69.95 diskette**  
Not including Shipping & Handling

**Clagg Inc.**  
**VCR CROSS REFERENCE OFFER**  
P.O. Box 4099  
Farmingdale, New York 11735-0793

Name \_\_\_\_\_  
Business \_\_\_\_\_  
Address \_\_\_\_\_  
City \_\_\_\_\_  
State \_\_\_\_\_ Zip \_\_\_\_\_  
Phone \_\_\_\_\_

Enclosed **\$24.95** for the ISCET VCR Cross Reference, Eighth Edition.

Enclosed **\$69.95** for the diskette containing the ISCET VCR Cross Reference, Ver. 7.0

Include \$5.00 for shipping Version 8 pages within the United States. All other countries add \$6.00 (surface mail).

Include \$3.00 for shipping Version 7 disk within the United States. All other countries add \$4.00 (surface mail).

The total amount of my order is \$ \_\_\_\_\_  
Check enclosed—do not send cash. US funds only.

Visa  MasterCard Exp. Date \_\_\_\_/\_\_\_\_/\_\_\_\_

Card No. \_\_\_\_\_

Signature \_\_\_\_\_

New York State residents must add applicable local sales tax to total.

CB03

# Electronic SHOPPER

## The Leader In Micro Video Cameras

### Wireless Cameras

**"Portable" Color Wireless System**

**GW-2400S - \$449.95**  
Includes: 2.4 Ghz Color Wireless Camera. Receiver and Built-In Monitor

**GC-2400 \$229.95** (camera)

**GM-2400 \$269.95** (monitor/receiver)

### Wireless Transmitter & Receiver

**Transmit From:**

- Satellite Receiver
- Camcorder
- Cable TV
- Surveillance Camera
- VCR
- CD Player
- Laser Disc Player
- Wireless Cable
- Digital Video Disc
- A/V Receiver
- Stereo Audio

**WT-2400 Transmitter \$129.95**

**WR-2400 Receiver \$129.95**

Transmits Over 1/4 Mile Range!

### Flat Screen TFT-LCD Monitors

**TFT-4 \$179.95**

4" Screen. (Size: 6"(W) x 4.5"(H) x 2"(D))  
An excellent monitor for one camera monitoring or for setting up cameras during installation or maintenance.

### Door or Wall Camera

Designed to replace existing Peep-Hole

Outside Inside

Camera Lens Video & Power Cable

**DV-810 \$199.95**

### Lipstick Cameras

**LP-850p \$119.95**

Length: 1.37" Diameter: .87"

B/W Model

**LP-850i \$109.95**

Length: 1.9" Diameter: .91"

B/W Model

### Cameras with Built-In Infrared Illuminators.

**LP-850w \$169.95**

Operates on 0.0 LUX in Total Darkness. Weatherproof!

**MB-810B**

- New BLC
- Multi-Mount option
- High Resolution

**NEW - High Powered IR-LED's. 10 X's the power!**

**MB-810B \$119.95**

**Gooseneck Cameras**

**CMOS 1/3" Gooseneck Camera with Power Supply. Color**

**GN-440c \$119.95**

**B/W GN-440b \$99.95**

**FREE Polaris Product Catalogs**

### Color Lipsticks

Lipstick cameras are equipped with a Video/Power cable connection is for video connection to a Monitor or VCR.

**WP-300c**

**LP-850c**

Weather Proof Models Available

**MB-45cB \$99.95**

Size: 1.25" sq.



**Polaris Industries**  
<http://www.polarisusa.com>  
**800.752.3571**

Polaris Industries 470 Armour Dr. Atlanta GA 30324 • Tech Info: 404.872.0722 FAX: 404.872.1038

CIRCLE 222 ON FREE INFORMATION CARD

ABC ELECTRONICS 315 7TH AVE N. MPLS. MN. 55401  
 (612)332-2378 FAX (612)332-8481 E-MAILSURP1@VISI.COM  
 WE BUY TEST EQUIPMENT AND COMPONENTS.  
 VISIT US ON THE WEB AT WWW.ABCTEST.COM

HP 51501A 100MHZ DIGITIZING SCOPE	\$1300.00	HP 4935A TRANS IMPAIRMENT TEST SET	\$900.00
HP 51201D 300MHZ DIGITIZING SCOPE	\$1000.00	HP 5006A SIGNATURE ANALYZER	\$150.00
HP 54201A 300MHZ DIGITIZING SCOPE	\$1000.00	HP 80602B 1MHZ-1300MHZ RF PLUG	\$400.00
HP 54200A 50MHZ SCOPE/WAVEFORM ANALYZER	\$700.00	EIP 575 MICROWAVE COUNTER	\$1500.00
HP 3312A 13MHZ FUNCTION GENERATOR	\$250.00	FLUKE 95 50MHZ SCOPEMETER	\$550.00
HP 5370A 100MHZ UTILITY COUNTER	\$400.00	LECROY 7200 400MHZ O-SCOPE	\$1000.00
HP 3586C LEVEL METER	\$750.00	TEK 475 200MHZ O-SCOPE	\$500.00
HP 436A POWER METR. W/O SENSOR & CABLE	\$500.00	TEK 4e5 100MHZ O-SCOPE	\$400.00
HP 8350B SWEEP OSCILLATOR MAINFRAME	\$2000.00	TEK 496P 1KHZ-1.8GHZ SPEC. ANALYZER	\$3500.00
HP 3437A 3 SDIGIT SYSTEM VOLT METER	\$250.00	TEK 1240 LOGIC ANALYZER	\$750.00
HP 3455A DIGITAL MULTIMETER	\$250.00	TEK TDS320 100MHZ DIGITAL O-SCOPE	\$1400.00
HP 3456A DIGITAL MULTIMETER	\$400.00	TEK 11401A 500MHZ PROG. O-SCOPE FRAME	\$750.00
HP 3336C SYNTHESIZER LEVEL GENERATOR	\$800.00	TEK 7854 400MHZ OSCILLOSCOPE FRAME	\$500.00
HP 3325A SYNTHESIZER FUNCTION GENERATOR	\$1000.00	TEK 7903 400MHZ OSCILLOSCOPE FRAME	\$250.00
HP 5335A 200MHZ COUNTER	\$600.00	TEK 7A26 200MHZ VERTICAL PLUG	\$75.00
HP 8165A PROGRAMMABLE SIGNAL SOURCE	\$1100.00	TEK 7A21 100MHZ VERTICAL PLUG	\$150.00
HP 8550B 181 100K-1500MHZ SPECTRUM ANALYZER	\$1000.00	TEK 7B80 400MHZ TIME BASE	\$75.00
HP 8550B 183 100MHZ-21GHZ SPECTRUM ANALYZER	\$3000.00	TEK 7B92A 500MHZ DUAL TIME BASE	\$125.00
HP 1100A 100MHZ OSCILLOSCOPE	\$250.00	TEK 7S12 SAMPLING PLUG	\$250.00
HP 6034A 60VDC-10A POWER SUPPLY	\$750.00	TEK 7L14 10KHZ-1.8GHZ SPEC. ANALYZER	\$1000.00
HP 6269B 40VDC-50A POWER SUPPLY	\$800.00	TEK AM503 CURRENT PROBE AMPLIFIER	\$250.00
HP 6553A 40VDC-12.5A POWER SUPPLY OPT.101	\$1200.00	WAVETEK 145 20MHZ PULSE/FUNCTION GEN.	\$400.00
HP 6632A 20VDC-5A POWER SUPPLY	\$500.00	WAVETEK 182A 4MHZ FUNCTION GEN.	\$150.00
HP 6613A 15VDC-4.3A POWER SUPPLY OPT.103	\$750.00	WAVETEK 955 7.5-12.1GHZ MICROSOURCE	\$1100.00

90,000+ Electronic Components

www.mouser.com

- Heat Sinks • Semiconductors
- Crystals • Optoelectronics • LEDs
- Lamps • Wire • Cable • Connectors
- Sockets • Jacks • Plugs • Cable Assemblies
- Resistors • Potentiometers • Capacitors
- Fans • Power Supplies • Inductors
- Transformers • Switches • Relays
- Speakers • Batteries • Fuses
- Panel Meters • Cabinets
- Knobs • Hardware
- Equipment
- Tools • Kits

800-992-9943

sales@mouser.com

Fax: 817-483-6899

958 N. Main St., Mansfield, TX 76063

**MOUSER**  
ELECTRONICS

CIRCLE 318 ON FREE INFORMATION CARD

**BEST DEALER PRICING!**  
**CABLE DIRECT**  
 CONVERTERS • FILTERS  
 DESCRAMBLERS

IMPROVE YOUR IMAGE WITH  
**VIDEO STABILIZERS**

**FREE CABLE TV CATALOG!**

**100% MONEY BACK GUARANTEE!**

**30 DAY FREE TRIAL!**

Now you can tune-in your favorite cable TV programming and **SAVE \$100'S** - **EVEN \$1000'S** on premium CABLE TV EQUIPMENT.



**MODERN ELECTRONICS**

**1-800-906-6664**

2609 S. 156TH CIRCLE • OMAHA, NE 68130

http://www.modernelectronics.com

Introducing...

The Epic Series



280 different configurations in a single size, snap-in mounted case

Create a look of conformity on panels

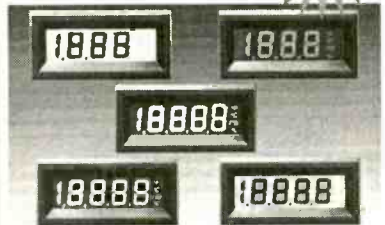

Choose from:

- ▼ 3 1/2 or 4 1/2 digit displays
- ▼ voltage or process loop inputs
- ▼ black, red, amber or green numerals
- ▼ black numerals with lighted green background

Features:

- ▼ selectable, displayed engineering units
- ▼ resistant to RF and EMI
- ▼ economically priced
- ▼ five year warranty

**KNS**  
INSTRUMENTS

Visit our catalog on the web: [www.knsinstruments.com](http://www.knsinstruments.com)

**800-356-4920**

PO Box 10158  
Bedford, NH 03110-0158  
Fax 800-356-1250



## Building a Micro Robot ?

### MicroCore-11™

- tiny 2" x 2" stackable 68HC11 microcontroller module
  - plugs into solderless breadboard like a chip
  - download programs via you PC serial port
  - use assembler or BASIC (both included)
  - 32K SRAM plus 8K or 32K EEPROM
  - RS232, 5V regulator, 8MHz xtal
- 8K Starter Package #MC11SP8K.....US\$75.00  
 32K Starter Package #MC11SP32K.....US\$89.00  
 Motor driver board and accessories available.

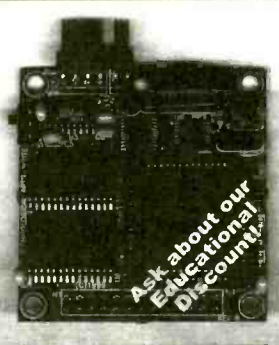

**Technological Arts**

26 Scollard Street  
Toronto, Ontario  
Canada M5R 1E9  
Phone: (416) 963-8996  
Fax: (416) 963-9179

[www.technologicalarts.com](http://www.technologicalarts.com)

Ask about our Educational Discount!

## FCC License Preparation

### RADIOTELEPHONE LICENSE

Electronics Tech, Avionics, Marine & Radar  
 Homestudy - Fast-Easy & inexpensive.  
 Manuals-Audio-Video-pedisks-Q&As  
 Guarantee Pass-see at [www.wptfcc.com](http://www.wptfcc.com)  
 Details-800-800-7555. WPT Publications  
 4701 NE 47ST, Vancouver, WA. 98661

## Video King



**Digital Video Stabilizer**

For Free Information Package and Pricing



Call 219-233-3053



R.C. Distributing, PO Box 552, South Bend, IN 46624

# PARTS EXPRESS

ELECTRONICS & MORE

## 6-1/2" Two Way System

This is our most popular in-wall. You won't believe how good these really sound. Big enough to produce great home theatre sound and still fit everyone's budget. Put a pair in every room of your house.

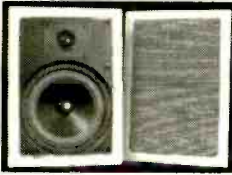

Great for front or rear speakers in your surround system. The 6-1/2" polypropylene woofer and 1" textile dome tweeter were specially designed with home theatre in mind. The crossover network utilizes a mylar capacitor for crisp clean highs. 3 piece design make installation in new or existing walls a snap.

**Specifications:** ◆6-1/2" polypropylene cone woofer with poly foam surround ◆1" textile dome tweeter/midrange ◆8 ohm impedance ◆3 component L/C crossover network ◆Frequency response: 50-20,000 Hz ◆Power handling capability: 60 watts RMS/85 watts max ◆Sensitivity: 89 dB 1W/1m ◆Overall dimensions: 8-1/2" W x 12" L x 3-1/2" D ◆Hole size: 7-1/4" x 10-3/4" ◆Fits into standard 2" x 4" wall ◆Net weight: 12 lbs. per pair.

#300-036 ..... \$89.90 (1-3 PRS) \$79.50 (4 PRS-UP)

## Satellite Speaker Stands

These quality speaker stands are perfect for mini or rear surround speakers. The heavy die cast base provides stability. Textured black satin finish blends in well with any decor. The height is adjustable from 26-1/2" to 47-1/2" and the speaker wire can be run inside the pole for a better appearance. The top base is adjustable from 4-1/8" to 7-1/2" to accommodate most mini speakers. Includes foam pads to prevent marring of speaker cabinet. Sold in pairs. Net weight: 12 lbs.



#240-762 ..... \$39.80 (1-3 PRS) \$35.50 (4 PRS-UP)

## 5 Function Remote

◆Operates five devices (TV, VCR, Cable, Satellite, A/V Receiver)  
 ◆Lighted component keys which indicate what device is currently being used  
 ◆Preprogrammed, 621 codes that work over 6,400 models  
 ◆New ergonomic design features a contoured case, index finger grooves, and keys grouped in clusters for easy operation  
 ◆Satellite cursor control is tailored for use with a Home Theatre system, keypad design allows movement through menus with ease  
 ◆Retains codes when replacing batteries  
 ◆New flat back design for easy operation  
 ◆Money back guarantee ensures customer satisfaction  
 ◆Toll free customer service number provides the customer with friendly, knowledgeable assistance  
 ◆Requires 2 AAA batteries (#140-150 not included)



#180-806 ..... \$29.95 (1-3) \$26.35 (4-UP)

## 3M 3/4" Temflex™ 1700 Vinyl Electrical Tape

General-purpose 7 mil electrical tape. UL listed and CSA approved. 3/4" x 60' rolls.



#350-052 ..... 75¢ (1-9) 59¢ (10-UP)

## Gold Plated A/V Cables

A super quality, "siamesed" type cable. Two RCA cables for stereo (audio) signal from VCR to receiver/stereo TV and one low noise coaxial type cable for video.



Part #	Length	Price (1-9)	Price (10-UP)
180-120	3' ft.	\$4.25	\$3.95
180-118	6 ft.	4.90	4.50
180-121	12 ft.	8.95	7.95
180-124	20 ft.	12.75	11.50

If you haven't received a copy of our current 260 page catalog ... have one added to your order or give us a call and we will send one out to you immediately.



## 6-1/2" Round Coaxial System

Designed for the home and office, these 6-1/2" round in-walls are ideal for ceiling installations, or for use as rear channel surround speakers. Adding music to the kitchen, den, bath, or patio has never been easier! System features a weather resistant 6-1/2" treated paper cone with poly foam surround, coaxially mounted 1/2" polymer dome tweeter, and built-in crossover with a mylar capacitor in the tweeter feed. Retrofit design allows installation in both new and existing construction in just minutes. System includes removable steel mesh grills, built-in mounting bracket, hardware, and installation instructions.

**Specifications:** ◆Impedance: 8 ohms ◆Frequency response: 60-20,000 Hz ◆Power handling capability: 30 watts RMS/45 watts max. ◆Sensitivity: 89 dB 1W/1m ◆Dimensions: 9" round x 2-7/8" deep. ◆Net weight: 5 lbs. per pair.



#300-408 ..... \$69.95 (1-3 PRS) \$62.75 (4PRS-UP)

## 3 Amp Power Supply

This fully regulated power supply is perfect for powering CBs, car radios, and other 12 VDC devices that draw up to 3 amps. Heavy duty steel housing with front mounted switch and binding posts. Short circuit and overload protection!

**Specifications:** ◆Output Voltage: 13.8 VDC (fixed)  
 ◆Output Current: 3A (cont.), 5 amps (surge)  
 ◆Ripple Voltage: Less than 3mV at rated output  
 ◆Input Voltage: 120 VAC, 60Hz ◆Dimensions: 5-1/2" x 3-1/2" x 6-1/2" ◆Weight: 5 lbs.



#120-530 ..... \$19.95 (1-3) \$18.50 (4-UP)

## DMM and LCR Meter

In addition to functions found in regular DMM's, this meter can also measure inductance in 5 ranges (4mH, 40mH, 400mH, 4H, 40H), capacitance in 5 ranges (4nF, 40nF, 400nF, 4uF, 400uF), frequency in 4 ranges (4KHz, 40KHz, 400KHz, 4MHz), TTL logic test, diode test and transistor hFE test. 5 AC/DC ranges up to 1000V (AC750V), 3 AC/DC current ranges up to 20A and 7 resistance ranges up to 4000 M ohms. Includes test leads, battery, spare fuse, and manual. Net weight: 1 lb.



#390-513 ..... \$85.90 EACH

## 2.5W Mini Audio Amplifier

This amp contains both pre-amplifier and power amplifier on a super small board measuring only 1-5/8"x1-1/4". Maximum output power is 2.5W into 4 ohms with 12VDC input power. No adjustments required. Short circuit protected.



#320-215 ..... \$9.95 EACH

## Weller WLC100 Soldering Station

The Weller WLC100 solder station is ideal for the professional, serious hobbyist, or kit builder who demands higher performance than usual of a standard iron, but without the high cost of an industrial unit. Power is adjustable from 5 to 40 watts. Includes 40 watt pencil iron. UL approved. Net weight: 1-3/4 lbs. Replacement sponge #372-119.

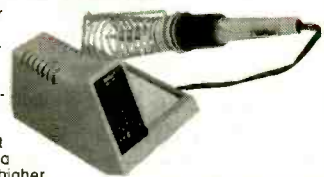

#372-120 ..... \$39.95 EACH

## "44" Solder

Kester "44" rosin core solder is designed for electronic and electrical work. It uses a fast acting, instant wetting, non-corrosive, and non-conductive flux for faster soldering and a strong, long lasting bond.



Part #	Alloy	Lead/Tin	Spool	Dia.	Price (1-3)	Price (4-UP)
370-080	60/40	1 lb.	.031"	\$8.50	\$7.95	
370-090	60/40	1 lb.	.050"	8.50	7.95	
370-098	60/40	4 lb.	.031"	33.90	31.80	
370-088	60/40	1/2 lb.	.020"	6.95	5.75	
370-072	63/37	1 lb.	.020"	14.90	13.50	
370-086	63/37	1/2 lb.	.031"	9.95	8.50	
370-074	63/37	1 lb.	.031"	12.50	11.50	
370-087	36/37	1/2 lb.	.031"	7.95	6.75	

## Pro Wick

Pro Wick's advanced fine braid design provides wicking action that is second to none.



Part #	TS #	Size	Length	Price (1-9)	Price (10-UP)
341-415	1802-5	.06"	5'	\$1.40	\$1.25
341-416	1803-5	.08"	5'	1.45	1.30
341-417	1804-5	.10"	5'	1.60	1.45
341-424	1802-10	.06"	10'	2.75	2.50
341-425	1803-10	.08"	10'	2.80	2.55
341-426	1804-10	.10"	10'	2.95	2.70
341-440	1802-25F	.06"	25'	6.80	6.30
341-441	1803-25F	.08"	25'	6.85	6.35
341-442	1804-25F	.10"	25'	7.60	7.00
341-418	1802-100	.06"	100'	21.90	20.50
341-419	1803-100	.08"	100'	21.90	20.50
341-423	1804-100	.10"	100'	23.90	22.50

725 Pleasant Valley Dr., Springboro, OH 45066-1158  
 Phone: 513-743-3000 ◆ Fax: 513-743-1677  
 E-mail: sales@parts-express.com

KEY CODE: ENMI

LARGEST SELECTION OF SPEAKER DRIVERS IN THE COUNTRY!

VISIT OUR WEB SITE AT [www.parts-express.com](http://www.parts-express.com)  
 OR CALL TOLL FREE 1-800-338-0531

# Any waveform you want!



## New Features:

- ✓ 21.5 MHz
- ✓ .01 Hz steps
- ✓ multi-unit phaselock

Telulex Inc. model SG-100A

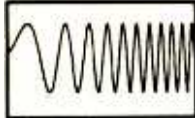

DC to 21.5 MHz linear and log sweeps



Int/Ext AM, SSB, Dualtone Gen.



Int/Ext FM, PM, BPSK, Burst

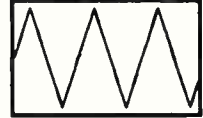

Ramps, Triangles, Exponentials

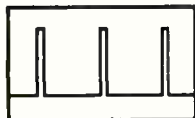

Pulse Generator



Noise

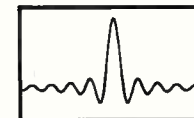

Arbitrary Waveforms



Unlimited Possibilities!

## ● Synthesized Signal Generator

Clean sinewaves DC-21.5 MHz, .001% accuracy! .01 Hz steps. DC Offset. RS232 remote control.

## ● Arbitrary Waveform Generator

40 Megasamples/Second. 32,768 points. 12 bit DAC

## ● Function Generator

Ramps, Triangles, Exponentials & more to 2 MHz!

## ● Pulse Generator

Digital waveforms with adjustable duty cycle

**Telulex Inc.**

2455 Old Middlefield Way S Tel (650) 938-0240 <http://www.Telulex.com>  
Mountain View, CA 94043 Fax (650) 938-0241 Email: sales@Telulex.com

CIRCLE 312 ON FREE INFORMATION CARD

**PC BOARDS**

Low Cost, Precision-Made PC Boards  
From Your Gerber/NC Drill Files

Put your CAD program to work for you!

**PCB Milling**

- Milling
- Drilling
- Routing

[www.pcbmilling.com](http://www.pcbmilling.com) FAX: (703) 818-0071

**Wireless Internet & TV**

WIRELESS CABLE • IPTS • MMDS  
ATV • INTERNATIONAL - DIGITAL  
Amplifiers • Antennas • Books • Components  
• RF Frequency 2100-2700 Mhz  
• SASE For "FREE" Catalog or Send \$1

**PHILLIPS TECH ELECTRONICS**  
P.O. Box 13074 • Scottsdale, AZ 85267-3074  
CATALOG/INFO: 480-947-7700  
ORDER LINE: 800-880-MMDS  
FAX LINE: 480-947-7799  
WEBSITE: [www.phillips-tech.com](http://www.phillips-tech.com)  
E-MAIL: [product@phillips-tech.com](mailto:product@phillips-tech.com)  
Visa • MC • AmEx • Discover • C.O.D. • Quality Pricing

CHALLENGER SYSTEM  
31-Channel Compact Disc  
Digital Guide with 4000  
Title Tracks  
FREE SHIPPING

**CABLE TV BOXES**

Hablamos Español!

We'll Beat Any Price!

30 Day Trial • 1 yr. Wrnty • Free Catalog • Qty. Discounts • Dealers Welcome!

**1-800-538-2225**

Galaxy Electronics Inc.  
[www.Galaxydeserambler.com](http://www.Galaxydeserambler.com)

**Max '99** \$459.90

Used world wide for research!

- \* Three 12 inch diameter decks
- \* 30 lbs payload capacity
- \* HC11 microprocessor w/ 32k ram
- \* Basic, Forth and 'C' programming lang.

Zagro Robotics  
PO Box 460342  
St. Louis, MO 63146-7342  
(314)768-1328  
<http://www.zagrorobotics.com>  
[info@zagrorobotics.com](mailto:info@zagrorobotics.com)

## GALEP-III

Pocket Multiprogrammer

This size fits all!



- ◆ Programs 8-bit and 16-bit EPROMs, EEPROMs, Zero Power RAMs, Flash, serial EEPROMs • GAL, PALCE, ATF • 87xxx, 89xxx, PIC1216/17Cxx • All DIL devices without adaptor • Lightning fast parallel data transfer (e.g. 27C512 read/compare 2 sec!) • Power supply independent due to rechargeable battery • Uses PC printer port • Hex, JEDIC, and Hexy file formats • Hex and fusemap buffer editor • Split ac shuffler for 8-bit, 16-bit and 32-bit targets • Runs under Win3.1, 95, 98 • 'Remote control' by DDE scripts • Designed for the future due to flexible pin driver technology - new devices will be added every month! • Device list, demo software and lifetime free updates from our website [www.conitec.com](http://www.conitec.com)!

**GALEP-III Set with cable, battery, recharger... \$333.00**  
PLCC Adaptor for 8-bit EPROMs / 16-bit EPROMs / GALS ..... each \$149.00

**CONITEC** 1951 4th Ave, Ste 301 • San Diego, CA 92101  
Tel: (619) 702-4420 • <http://www.conitec.com>

**PicC C Compiler \$59**  
for Microchip's PIC microcontrollers  
Supports PIC16C55x, 16C6x, 16C82x, 16C8x, 16C92x PIC families

**SnXC C Compiler \$59**  
Supports Sanyo's nx18ac and nx28ac microcontrollers

Both compilers based on ANSI C standard. Arrays, unions, structures, pointers, strings, function calls, if, for, switch, while, interrupt vectors, in-line assembler code, 8 & 16 bit variables, etc. Outputs Intel Hex format and assembly code. Code optimizer included. Excellent development tools!

**DebugIDE Debugger \$79**  
C source level debugger for PicC and SnXC compilers. Integrated Development Environment. Step, Run, Stop, Reset. Variable monitoring and modification. Oscillator/cable kit (\$39)

732-873-1519 fax: 732-873-1582 e: [grichrc@aol.com](mailto:grichrc@aol.com)  
Grich RC Inc. 120 Cedar Grove Ln, Ste 340, Somerset NJ USA 08873  
URL: <http://members.aol.com/piccompile>



# Cool Wireless Goodies

## World's Smallest TV Transmitters



We call them the 'Cubes'... Perfect video transmission from a transmitter you can hide under a quarter and only as thick as a stack of four pennies - that's a nickel in the picture! Transmits color or B&W with fantastic quality - almost like a direct wired connection to any TV tuned to

cable channel 59. Crystal controlled for no frequency drift with performance that equals law enforcement models that cost hundreds more! Basic 20 mW model transmits up to 300' while the high power 100 mW unit goes up to 1/4 mile. Audio units include sound using a sensitive built-in mike that will hear a whisper 15 feet away! Units run on 9 volts and hook-up to most any CCD camera. Any of our cameras have been tested to mate perfectly with our Cubes and work great. Fully assembled - just hook-up power and you're on the air! These are the units that are being built into hats, pagers, cigarette packs and sold for big \$\$ !!  
**C-2000, Basic Video Transmitter.....\$89.95** **C-3000, Basic Video & Audio Transmitter.....\$149.95**  
**C-2001, High Power Video Transmitter...\$179.95** **C-3001, High Power Video & Audio Transmitter...\$229.95**



## Doppler Direction Finder

Track down jammers and hidden transmitters with ease! This is the famous WA2EBY DF'er featured in April 99 QST. Shows direct bearing to transmitter on compass style LED display, easy to hook up to any FM receiver. The transmitter - the object of your DF'ing - need not be FM, it can be AM, FM or CW. Easily connects to receiver's speaker jack and antenna, unit runs on 12 VDC. We even include 4 handy home-brew "mag mount" antennas and cable for quick set up and operation! Whips can be cut and optimized for any frequency from 130-1000 MHz. Track down that jammer, win that fox hunt, zero in on that downed Cessna - this is an easy to build, reliable kit that compares most favorably to commercial units costing upwards of \$1000.00! This is a neat kit!!  
**DDF-1, Doppler Direction Finder Kit ..... \$149.95**

## CCD Video Cameras



Top quality Japanese Class 'A' CCD array, over 440 line resolution, not the off-spec arrays that are found on many other cameras. Don't be fooled by the cheap CMOS single chip cameras which have 1/2 the resolution, 1/4 the light sensitivity and draw over twice the current! The black & white models are also super IR (Infra-Red) sensitive. Add our invisible to the eye, IR-1 illuminator kit to see in the dark! Color camera has Auto gain, white balance, Back Light Compensation and DSP! Available with Wide-angle-(80°) or super slim Pin-hole style lens. Run on 9 VDC, standard 1 volt p-p video. Use our transmitters for wireless transmission to TV set, or add our IB-1 Interface board kit for audio sound pick-up and super easy direct wire hook-up to any Video monitor, VCR or TV with AV input. Fully assembled, with pre-wired connector.

**CCDWA-2, B&W CCD Camera, wide-angle lens ..... \$69.95**  
**CCDPH-2, B&W CCD Camera, slim fit pin-hole lens ..... \$69.95**  
**CCDCC-1, Color CCD Camera, wide-angle lens ..... \$129.95**  
**IR-1, IR Illuminator Kit for B&W cameras ..... \$24.95**  
**IB-1, Interface Board Kit ..... \$14.95**

## Super Pro FM Stereo Transmitter



Professional synthesized FM Stereo station in easy to use, handsome cabinet. Most radio stations require a whole equipment rack to hold all the features we've packed into the FM-100. Set freq with Up/Down buttons, big LED display. Input low pass filter gives great sound (no more equals or swishing from cheap CD inputs) Limiters for max 'punch' in audio - without over mod, LED meters to easily set audio levels, built-in mixer with mike, line level inputs. Churches, drive-ins, schools, colleges find the FM-100 the answer to their transmitting needs, you will too. Great features, great price! Kit includes cabinet, whip antenna, 120 VAC supply. We also offer a high power export version of the FM-100 that's fully assembled with one watt of RF power, for miles of program coverage. The export version can only be shipped outside the USA, or within the US if accompanied by a signed statement that the unit will be exported.  
**FM-100, Pro FM Stereo Transmitter Kit ..... \$249.95**  
**FM-100WT, Fully Wired High Power FM-100. .... \$399.95**

## FM Stereo Radio Transmitters



No drift, microprocessor synthesized! Excellent audio quality, connect to CD player, tape deck or mike mixer and you're on-the-air. Strapable for high or low power! Runs on 12 VDC or 120 VAC. Kit includes case, whip antenna, 120 VAC power adapter - easy one evening assembly.  
**FM-25, Synthesized Stereo Transmitter Kit ..... \$129.95**

Lower cost alternative to our high performance transmitters. Great value, easily tunable, fun to build. Manual goes into great detail about antennas, range and FCC rules. Handy kit for sending music thru house and yard, ideal for school projects too - you'll be amazed at the exceptional audio quality! Runs on 9V battery or 5 to 15 VDC. Add our matching case and whip antenna set for nice 'pro' look.

**FM-10A, Tunable FM Stereo Transmitter Kit. .... \$34.95**  
**CFM, Matching Case and Antenna Set ..... \$14.95**  
**FMAC, 12 Volt DC Wall Plug Adapter ..... \$9.95**

## Mini Radio Receivers



Imagine the fun of tuning into aircraft a hundred miles away, the local police/fire department, ham operators, or how about Radio Moscow or the BBC in London? Now imagine doing this on a little radio you built yourself - in just an evening! These popular little receivers are the nuts for catching all the action on the local ham, aircraft, standard FM broadcast radio, shortwave or WWV National Time Standard radio bands. Pick the receiver of your choice, each easy to build, sensitive receiver has plenty of crystal clear audio to drive any speaker or earphone. Easy one evening assembly, run on 9 volt battery, all have squelch except for shortwave and FM broadcast which has handy SCA output. Add our snazzy matching case and knob set for that smart finished look.

**AR-1, Airband 108-136 MHz Kit ..... \$29.95**  
**HFRC-1, WWV 10 MHz (crystal controlled) Kit ..... \$34.95**  
**FR-1, FM Broadcast Band 88-108 MHz Kit ..... \$24.95**  
**FR-6, 6 Meter FM Ham Band Kit ..... \$34.95**  
**FR-10, 10 Meter FM Ham Band Kit ..... \$34.95**  
**FR-146, 2 Meter FM Ham Band Kit ..... \$34.95**  
**FR-220, 220 MHz FM Ham Band Kit ..... \$34.95**  
**SR-1, Shortwave 4-11 MHz Band Kit ..... \$29.95**  
**Matching Case Set (specify for which kit) ..... \$14.95**

## Tiny Transmitters



Gosh, these babies are tiny - that's a quarter in the picture! Choose the unit that's best for you. FM-5 is the smallest tunable FM transmitter in the world, picks up a whisper 10' away and transmits up to 300'. Runs on tiny included watch battery, uses SMT

parts. FM-4 is larger, more powerful, runs on 5-12 volts, goes up to a mile. FM4,5 operate in standard FM band 88-108 MHz. FM-6 is crystal controlled in 2 meter ham band, 146.535 MHz, easily picked up on scanner or 2 meter rig, runs on 2 included watch batteries. SMT (surface mount) kits include extra parts in case you sneeze & loose a part!  
**FM-4MC, High Power FM Transmitter Kit ..... \$17.95**  
**FM-5, World's Smallest FM Transmitter Kit ..... \$19.95**  
**FM-6, Crystal Controlled 2M FM Transmitter Kit ... \$39.95**  
**FM-6, Fully Wired & Tested 2M FM Transmitter .... \$69.95**

## AM Radio Transmitter



Operates in standard AM broadcast band. Pro version, AM-25, is synthesized for stable, no-drift frequency and is settable for high power output where regulations allow, typical range of 1-2 miles. Entry-level AM-1 is tunable, runs FCC maximum 100 mw, range 1/4 mile. Both accept line-level inputs from tape decks, CD players or mike mixers, run on 12 volts DC. Pro AM-25 includes AC power adapter, matching case and bottom loaded wire antenna. Entry-level AM-1 has an available matching case and knob set that dresses up the unit. Great sound, easy to build - you can be on the air in an evening!  
**AM-25, Professional AM Transmitter Kit ..... \$129.95**  
**AM-1, Entry level AM Radio Transmitter Kit ..... \$29.95**  
**CAM, Matching Case Set for AM-1 ..... \$14.95**

## FM Station Antennas



For maximum performance, a good antenna is needed. Choose our very popular dipole kit or the Comet, a factory made 5/8 wave colinear model with 3.4 db gain. Both work great with any FM receiver or transmitter.

**FM-100, FM Antenna Kit ..... \$39.95**  
**FMA-200, Vertical Antenna ..... \$114.95**

## RF Power Booster



Add muscle to your signal, boost power up to 1 watt over a freq range of 400 KHz to over 1000 MHz! Use as a lab amp for signal generators, plus many foreign users employ the LPA-1 to boost the power of their FM transmitters, providing radio service through an entire town. Runs on 12 VDC. For a neat finished look, add the nice matching case set.

**LPA-1, Power Booster Amplifier Kit ..... \$39.95**  
**CLPA, Matching Case Set for LPA-1 Kit ..... \$14.95**  
**LPA-1WT, Fully Wired LPA-1 with Case ..... \$99.95**

## Dinky Radios

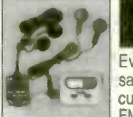

Everyone who sees one of these babies says they just gotta have one! Super cute, tiny (that's a Quarter in the picture!) FM radios have automatic scan/search tuning, comfortable ear bud earphones and we even include the battery. The pager style unit looks like a shrunken pager and even has an LCD clock built-in. The crystal clear sound will amaze you! Makes a great gift.  
**MFMT-1, World's Smallest FM Radio ..... \$11.95**  
**PFMR-1, Pager Style LCD Clock & FM Radio .... \$12.95**

## Touch-Tone Reader



Read touch-tone numbers from any radio, phone line, tape recorder - any audio source! Decoder called numbers on scanners, radio shows, anywhere touch-tones are used. Memory stores up to 256 digits, an 8 digit display window scrolls anywhere in memory. Memory good for 100 years, even with power off! Runs on 7 to 15 volt DC. Available in kit form with optional matching case set or fully assembled in case set. We sell tons of these to private investigators!

**TG-1, Tone-Grabber Touch Tone Reader Kit ..... \$99.95**  
**CTG, Case for Tone-Grabber Touch Tone Reader ..... \$14.95**  
**TG-1WT, Tone-Grabber, fully assembled with case ..... \$149.95**  
**AC12-5, 12 Volt DC Wall Plug Adapter ..... \$9.95**

**Order Toll-free: 800-446-2295**

Sorry, no tech info, or order status at 800 number  
**For Technical Info, Order Status**  
**Call Factory direct: 716-924-4560**

## RAMSEY ELECTRONICS, INC.

793 Canning Parkway Victor, NY 14564

See our complete catalog and order on-line with our secure server at:  
**www.ramseyelectronics.com**



**ORDERING INFO:** Satisfaction Guaranteed. Examine for 10 days, if not pleased, return in original form for refund. Add \$6.95 for shipping, handling and insurance. Orders under \$20, add \$3.00. NY residents add 7% sales tax. Sorry, no CODs. Foreign orders, add 20% for surface mail or use credit card and specify shipping method.

# EARN MORE MONEY!

## Be an FCC LICENSED ELECTRONIC TECHNICIAN!



No costly school. No commuting to class. The Original Home-Study course prepares you for the "FCC Commercial Radio-telephone License." This valuable license is your professional "ticket" to thousands of exciting jobs in Communications, Radio-TV, Microwave, Maritime, Radar, Avionics and more... even start your own business! You don't need a college degree to qualify, but you do need an FCC License.

**No Need to Quit Your Job or Go To School**  
This proven course is easy, fast and low cost! **GUARANTEED PASS**—You get your FCC License or money refunded. **Send for FREE facts now. MAIL COUPON TODAY!**

Or, Call 1-800-932-4268 Ext. 210

**COMMAND PRODUCTIONS**  
FCC LICENSE TRAINING, Dept. 210  
P.O. Box 2824, San Francisco, CA 94126  
Please rush FREE details immediately!

NAME \_\_\_\_\_  
ADDRESS \_\_\_\_\_  
CITY \_\_\_\_\_ STATE \_\_\_\_\_ ZIP \_\_\_\_\_

### CONTROL MEASURE INPUT

RELAYS • LIGHTS • MOTORS  
TEMPERATURE • PRESSURE • LIGHT LEVELS • HUMIDITY  
SWITCH POSITIONS • THERMOSTATS • LIQUID LEVELS

MODEL 30 ..... \$79



- PLUGS INTO PC BUS
- 24 LINES DIGITAL I/O
- 8 CHANNEL
- 8 BIT A/D IN
- 12 BIT COUNTER
- UP TO 14K SMP/SEC

MODEL 45 ..... \$189



- RS-232 INTERFACE
- 8 DIGITAL I/O
- 8 ANALOG INPUTS
- 2 ANALOG OUTPUTS
- 2 COUNTERS-24 BIT

MODEL 100 ..... \$279



- 12 BIT 190 KHZ A/D
- 4 ANALOG OUTPUTS
- 3 TIMER COUNTERS
- 24 DIGITAL I/O

MODEL 150-02 .... \$179

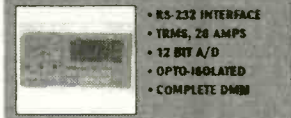

- RS-232 INTERFACE
- TRMS, 28 AMPS
- 12 BIT A/D
- OPTO-ISOLATED
- COMPLETE DMM

MODEL 40 ..... \$109

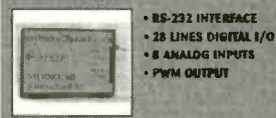

- RS-232 INTERFACE
- 28 LINES DIGITAL I/O
- 8 ANALOG INPUTS
- PWM OUTPUT

MODEL 70 ..... \$239

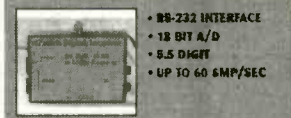

- RS-232 INTERFACE
- 18 BIT A/D
- 5.5 DIGIT
- UP TO 60 SMP/SEC

## Prairie Digital, Inc.

PHONE 608-643-8599 • FAX 608-643-6754  
920 SEVENTEENTH STREET • PRAIRIE DU SAC, WISCONSIN 53578

CIRCLE 315 ON FREE INFORMATION CARD

## RF Data Modules

### AM Transmitter



- Sub Miniature module
- SAW Controlled
- No adjustable components
- Low current - 2.5mA
- Supply 2.5-12Vdc
- 418MHz or 433MHz
- Range up to 300ft
- CMOS/TTL data input
- 7 x 11 x 4mm !
- AM-TX1-xxx .... \$12.60

### AM Receiver



- Compact Hybrid Module
- Very stable
- CMOS/TTL output
- Patented Laser Trimmed
- 5Vdc. 0.8mA (HRR6)
- 2kHz data rate
- Sensitivity -105dBm
- 38 x 12 x 2 mm
- AM-HRR6-xxx... \$16.33

### FM Transceiver



- Only 23 x 33 x 11mm
- Up to 40,000bps data rate
- Up to 450ft. range.
- 5V operation
- 418MHz or 433MHz FM
- 5V CMOS logic interface
- Fast 1mS enable
- Power saving feature
- Carrier Detect output
- BiM-xxx-F ..... \$87.36

### RS232 Transceiver



- 3wire RS232 interface
- 19.2Kbps half duplex
- 418MHz or 433MHz FM
- 7.5-15Vdc. 20mA
- TX/RX Status LED's
- Up to 400ft. range
- 1/4 wave ant. on board
- User data packetizing
- 58 x 40 x 15mm
- CYPHERNET .... \$139.30

### AM Transmitter



- Range up to 250ft.
- SAW controlled stability
- Wide supply range 2-14V
- CMOS/TTL input
- Low current. 4mA typ.
- Up to 4kHz data rate
- Small: 17 x 11mm
- AM-RT5-xxx .... \$12.10



ABACOM TECHNOLOGIES



tel: (416)236 3858  
fax: (416)236 8866  
www.abacom-tech.com  
MasterCard / VISA



# Order On-Line for 5% Discount

from our already **LOW PRICES**



**EDSYN 951SX**  
Soldering Station



**CHIP QUIK SMD1**  
Low Temp. Desoldering



**Stereo Zoom**  
Microscopes



**3GHz RF Probe**



**EDSYN FXF11**  
Fume Extractor Fan



**Capacitor Wizard**  
ESR Meter



**Kahnetics Solder**  
Paste Dispenser



**DEN-ON SD3000**  
SMD Rework Station



**971HA SMD**  
Hot Air Station



**EDSYN ZD500DX**  
Desoldering Station

## www.howardelectronics.com

This is all you need to know for your soldering and desoldering needs for the Professional Technician, Engineer, Manufacturer or Experimenter.

### Features

- \* On-Line Shopping Cart
- \* Totally Secure web Server
- \* Automatic 5% discount from our already low prices.
- \* Payment Options to Fit Your Needs
  - 1 Credit Card Authorization
  - 2 COD Company Check
  - 3 Add to Open Account
  - 4 Open Account for First Time
  - 5 Will Send Check
  - 6 Wire Transfer to our Bank

### Benefits

- \* Order any time (24 hrs. a day – 7 days a week)
- \* Order at your Convenience
- \* Check out various Soldering & Desoldering Tool Specifications
- \* See Large Screen Size Pictures at fast download times
- \* Order Tips, Filters, accessories and Parts On-Line
- \* Catch our Monthly Specials On-Line



**DEN-ON SC7000Z**  
Desoldering Tool

order **FREE TRIALS** on-line

If you are not yet On-Line, Call  
**Toll Free 1-800-394-1984**  
**01-316-744-1993 International**  
**1-316-744-1994 Fax**  
6222 N. Oliver Kechi, KS 67067



2539 W. 237th Street, Bldg. F, Torrance, CA 90505  
 Order desk only: USA: (800) 872-8878 CA: (800) 223-9977  
 L.A. & Technical Info: (310) 784-5488 Fax: (310) 784-7590  
 OEM INQUIRIES WELCOME

# TIMELINE INC.

Over 14 years and 31,000 customers and still growing

Minimum Order: \$20.00. Minimum shipping and handling charge \$5.00. We accept cashiers checks, MC or VISA. No personal checks or COD's. CA residents add 8.25% sales tax. We are not responsible for typographical errors. All merchandise subject to prior sale. Phone orders welcome. Foreign orders require special handling. Prices subject to change without notice. 20% resending fee for returned orders.

## LIQUID CRYSTAL DISPLAYS

**240x64 dot LCD with built-in controller.**  
 AND 4021ST-EO. Unit is EL back-lit. \$59.<sup>00</sup> or 2 for \$109.<sup>00</sup> or  
 OPTREX DMF5005 (non back-lit) \$49.<sup>00</sup> or 2 for \$89.<sup>00</sup>  
 20 character x 8 line 7SL x 2 1/2" The built-in controller allows you to do text and graphics.

### Alphanumeric—parallel interface

16x1	\$7.00	20x2	\$10.00	32x2	\$8.00
16x1 (ig. char.)	\$10.00	20x4	\$15.00	40x1	\$8.00
16x2	\$7.00	20x4 (ig. char.)	\$10.00	40x2	2 for \$20.00
16x2 (ig. char.)	\$10.00	24x2	\$10.00	40x4	\$20.00
16x4	\$15.00	32x4	\$10.00	4x2	\$5.00

5V power required • Built-in C-MOS LCD driver & controller • Easy "microprocessor" interface • 98 ASCII character generator • Certain models are backlit, call for more info.

### Graphics and alphanumeric—serial interface

size	Mfr.	price	size	Mfr.	price
640x480 (backlit)	Epson	\$25.00	480x128	Hitachi	\$10.00
640x400 (backlit)	Panasonic	\$20.00	256x128	Epson	\$20.00
640x200	Toshiba	\$15.00	240x128 (backlit)	Optrex	\$20.00
480x128 (backlit)	ALPS	\$10.00	240x64	Epson	\$15.00
			160x128	Optrex	\$15.00

## 6" VGA LCD 640X480, Sanyo LMDK55-22 \$25<sup>00</sup>

### MONITORS

#### Non-Enclosed TTL

Comes with pinout. 12V at 1.4 Amp input • Horizontal frequency 15KHz. • Ability to do 40 and 80 column.  
**5 inch Amber \$25.00 • 7 inch Amber \$25.00**  
**9 inch Amber or Green \$25.00**

## 5" COLOR MONITOR \$39.<sup>00</sup>

• Flat Faceplate • 320 x 200 Dot Resolution • CGA & Hercules Compatible  
 • 12 VDC Operation • 15.75 KHz Horiz. Freq. • 60 Hz Vert. Sync. Freq.  
 • Open Frame Construction • Standard Interface Connector • Degaussing Coil included • Mfr. Samtron



## 9" COLOR SVGA MONITOR \$179.<sup>00</sup> Fully Enclosed - Tilt and swivel type.

### POS & BAR CODE

#### MAGNETIC CARD READER \$25.<sup>00</sup>

Includes: • 20 character dot matrix display with full alpha-numeric capability • keypad with full alpha-numeric entry • separate 7.5 VDC/0.5 Amp power supply • standard telephone interface extension cord • lithium battery and flat-cone speaker.

HP bar code wand (HBCS 2300) \$19.00

## HACKER CORNER

### EMBEDDED 486 COMPUTER \$99.<sup>00</sup>

Complete enhanced Intel 486SX-33 based computer in ultra small (9-7/8" x 6-5/8" x 3-1/8") case. Ideal for embedded operations or as a second computer. Features include: • One 16 bit ISA slot • 3 serial ports plus dedicated printer port • Parallel optical coupled adapter port • Built in IBM PC/AT keyboard port • On board VGA video and port • Uses standard SIMM up to 32 MB • BIOS is PC/AT compatible

Unit has a backup Ni-Cd battery system in case of power failure (5 min. backup time) and lockable front cover to prevent floppy drive access. Mounting / interface provisions for standard 3.5" laptop floppy and 2.5 inch hard drives. Comes with very comprehensive manual.

### SONY Miniature Color LCD Display (LCX005BKB) \$29<sup>00</sup>

• 1.4 CM (0.55 inch) Diagonal Full Color Display • Built In Horizontal and Vertical Drivers • Delta Dot Pattern for High Picture Quality - 537 dots (H) x 222 dots (V) • Compatible with NTSC & PAL Format and Sync Inputs • 12 VDC Operation with -1 to +17 V RGB Signal and Driver Input Voltage • Excellent Display for Virtual Reality Projects, Viewfinders, and Miniature Test Equipment Displays • Pin Outs and Specification Included • Unit Requires Clock, Synchronization and Video

### CELL SITE TRANSCEIVER \$49<sup>00</sup> 2 for \$89<sup>00</sup>

These transceivers were designed for operation in an AMPS (Advanced Mobile Phone Service) cell site. The 20 MHz bandwidth of the transceiver allows it to operate on all 666 channels allocated. The transmit channels are 870.030-889.980 MHz with the receive channels 45 MHz below those frequencies. A digital synthesizer is utilized to generate the selected frequency. Each unit contains two independent receivers to demodulate voice and data with a Receive Signal Strength Indicator (RSSI) circuit to select the one with the best signal strength. The transmitter provides a 1.5 watt modulated signal to drive an external power amplifier, channel selection is accomplished with a 16 bit binary input via a connector on the back panel. Other interface requirements for operation are 26 VDC (unregulated) and an 18,990 MHz reference frequency for the digital synthesizer. The units contain independent boards for receivers, exciter, synthesizer, tunable front end, and interface assembly (which includes power supplies and voltage-controlled oscillator). Service manual, schematics and circuit descriptions included.

### 4 INCH LCD MONITOR \$49.<sup>00</sup>

Compact (4.4" x 3.8" x 1.4") TFT active matrix LCD color monitor including fluorescent backlight. Analog RGB and composite sync input with switchable horizontal / vertical viewing. Low power consumption and long life backlight make it ideal for security and door phone use. Single 8 VDC supply and good resolution allow mobile operations or use with laptops. Standard ribbon cable - Molex connector interface. Complete specifications included.

## NTSC COMPOSITE 4" LCD MONITOR \$69<sup>00</sup>

CIRCLE 275 ON FREE INFORMATION CARD

# ELECTRONIX EXPRESS

## WELLER SOLDERING STATION - MODEL WLC 100

- Variable power control (5 to 40 watts)
- Replaceable heating element
- Quality light-weight pencil iron

\$36<sup>95</sup>



## LOWEST PRICE 20MHZ SCOPE!

### INSTEK<sup>®</sup>

OSCILLOSCOPE  
20MHZ  
DUAL CHANNEL  
MODEL GOS-620



\$299<sup>00</sup>

SCOPE PROBE 60 MHZ  
SWITCHABLE X1, X10

\$12<sup>95</sup>

## DIGITAL MULTIMETER

WITH CAPFREQUENCY  
TRANSISTOR TESTER  
Model DM645



\$34<sup>95</sup>

## INSTEK<sup>®</sup> FUNCTION GEN.

WITH INT/EXT  
FREQ. COUNTER  
MODEL 8016



\$199<sup>00</sup>

## ALLIGATOR LEADS

SET OF 10



\$2<sup>10</sup>

## SWITCHES

8 POS DIP ..... 60¢ ea.  
Mini Toggle SPDT ..... 50¢ ea.



ON-ON

## PAD-234

### DIGITAL/ANALOG TRAINER

Complete portable workstation. Variable and fixed power supplies, function generator, digital I/O, rugged design, high impact case.



Assembled

\$150<sup>00</sup>

Kit

\$110<sup>00</sup>

## HIGH QUALITY TOOLS

With Cushion Grips and Return Spring

Needle Nose  
Pliers \$2<sup>95</sup>

Wire  
Stripper \$1<sup>50</sup>

Diagonal  
Cutter \$2<sup>95</sup>

## POWER SUPPLIES

0-30 VDC, 0-3 Amp. Built-in current limiting, overload protected, constant voltage and current operation.



01PSGP4303A Analog Display \$165.00

01PSGP4303D Digital Display 189.00

## RSR TELECOMMUNICATIONS TRAINER

HANDS-ON TELEPHONY, LAN, CATV EXPERIENCE  
WITH ONE SELF-CONTAINED UNIT

T-Comm Trainer (TCM-100) ..... \$199.95  
Lab Manual / Work Book ..... 19.95  
Component and Supplies Kit ..... 39.95  
Tool Kit ..... 119.95

Only  
\$199<sup>95</sup>

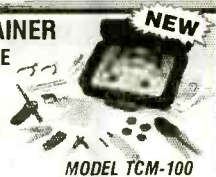

MODEL TCM-100

## SOLDERLESS BREADBOARD

830 tie points. MB102PLT model features 3 binding posts and aluminum backplate.



Part No. 1-9 10+  
MB102 5.95 5.00  
MB102PLT 8.95 8.00

## HELPING HAND WITH MAGNIFIER

#060836 \$3<sup>50</sup>



## RESISTOR KIT

1/4W 5% film. 5 pieces each of 73 values. 365 pieces total. \$3<sup>95</sup>

## MOTION DETECTOR

\$2 ea. - 10 For \$15



## SOLDERING IRON 3-WIRE

HIGH PERFORMANCE \$5<sup>25</sup>  
#060501



## FREE CATALOG

MORE  
Low-Priced  
Items In Our  
FREE  
236-Page Catalog



TERMS: Min. \$20 + shipping. School Purchase Orders, VISA/MC, Money Order, Prepaid. NO PERSONAL CHECKS, NO COD. NJ Residents: Add 6% Sales Tax.

In NJ: 732-381-8020  
FAX: 732-381-1572

365 Blair Road • Avenel, NJ 07001-2293

800-972-2225

http://www.elexp.com  
email: electron@elexp.com

CIRCLE 323 ON FREE INFORMATION CARD

# MCM ELECTRONICS®

## The Source For All Of Your Electronics Needs

When ordering, please provide this code: ► SOURCE CODE: ENS65

Prices effective Nov. 4, 1999  
through Dec 30, 1999

For over 20 years, MCM has been the leading supplier to the electronics service industry. Huge inventory, rapid delivery and competitive prices have made MCM the choice for:

- Hobbyists
- Service Technicians
- Educators
- Installers

Discover the MCM difference, call today for your free literature.



Order #60-9234

**ONLY \$149**

### 4" LCD Color Monitor with Audio

- Ideal for automobile multi-media and security use • TFT type display
- Resolution 383 (H) x 234 (V) • Internal 500mW audio amplifier with speaker
- A/V inputs and outputs for easy daisy chaining • Requires 12VDC 350mA
- Includes AC adaptor and cables
- Regular price \$179.00



Order #28-4851

**ONLY \$22.50**

### 88-108MHz FM Transmitter

Pre-assembled board accepts line level input and transmits audio to any standard FM radio. Output frequency can be adjusted anywhere in the 88-108MHz FM band. Provides tremendous range with just a short wire antenna. Requires 9-15VDC supply, 150mA. Board dimensions: 2" x 2.5" x 0.75". Regular price \$24.95.



Order #28-2200

**ONLY \$9.95**

### Multiple Voltage 2 Amp Power Supply

Indispensable accessory for any hobby or tech bench. Rotary switch selects 3, 4%, 6, 7%, 9 or 12V output. Ideal for battery operated devices or your latest project. Regular price \$16.95.



**ONLY \$39.95**

Order #72-4025

### TENMA® DMM with Logic Function

3 1/2 digit LCD display meter measures AC/DC voltage to

600V, AC/DC current to 10A, resistance to 2000Mohm, capacitance to 20µF, transistor h<sub>FE</sub> and provides diode and logic test. Includes holster and test leads. Regular price \$65.95.



**ONLY \$79.95**

Order #21-1590

### TENMA® Soldering Station

- Perfect for all types of board level and precision work • Digital LED display shows temperature and setpoint • Stand has tray for included cleaning sponge
- Regular price \$119.00



**ONLY \$249**

Order #72-6602

### TENMA® 10MHz Oscilloscope

• Ideal for the student or hobbyist

- Norm, auto, TV, sync and external triggering
- Operates on 115/230VAC, 50/60Hz
- Includes test leads

triggers • Operates on 115/230VAC, 50/60Hz • Includes test leads

**ONLY \$70.00**

Order #82-3890

### DEFENDER SECURITY

### CCD Black and White Camera

- Ultra compact, measures only 1 1/4" square
- 1/2" image device • 430 line resolution
- 3.6mm lens, 92° viewing angle • Requires only 12VDC, 100mA
- Standard NTSC composite video output
- Regular price \$79.95

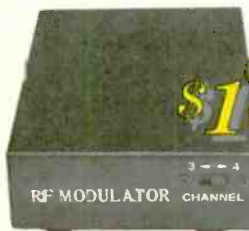

**ONLY \$10.95**

Order #33-1480

### RF Modulator

Outstanding price on this popular audio/video/surveillance accessory. Accepts standard A/V signal and places it on channel three or four. RCA type inputs, "F" type output. Requires 117VAC. Regular price \$19.95.



**FREE Literature**

**1-800-543-4330**

Secured ordering at: [www.mcmelectronics.com](http://www.mcmelectronics.com)  
Hours: M-F 7 a.m.-9 p.m., Sat. 9 a.m.-6 p.m., EST.

**Same Day Shipping!**  
In stock orders received by 2:00 p.m. (YOUR TIME), are shipped the same day.



**MCM ELECTRONICS®**  
650 CONGRESS PARK DR.  
CENTERVILLE, OH 45459  
A PREMIER FARNELL Company

SOURCE CODE: ENS65

CIRCLE 327 ON FREE INFORMATION CARD

[www.americanradiohistory.com](http://www.americanradiohistory.com)

# PCB LAYOUT

Software For Windows - FREE

- 1 Download our board layout software
- 2 Design your 2 sided plated-through PCB
- 3 Send us your layout over the Internet
- 4 In 2-3 business days, UPS delivers your boards, often under \$100

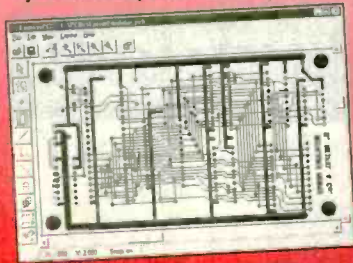

[www.expresspcb.com](http://www.expresspcb.com)

# LASER MODULE



Auto Power Control  
Collimated Laser  
Compact Size  
100,000 hr Lifetime  
No Electronics Required

Visible Laser Modules(635-670 nm)  
TTL Modulated Laser Modules  
Line Generator Laser Modules  
Infrared Laser Modules(780-830 nm)

from  
**\$ 29 (US)**

# LASER POINTER



Focus Adjustable  
Elegant Design  
Solid Metal Body

Pen Style Laser Pointer (1500 ft visibility)  
Key Chain Laser Pointer (1500 ft visibility)  
Available in silver and, black finish.

**\$19.95 (US)**

World Star Tech. Ask for free catalog  
Tel:(416)204 6298 Fax:(416)596 7819  
<http://www.worldstartech.com> e-mail: [info@worldstartech.com](mailto:info@worldstartech.com)

# PIC PROJECTS Book & CD-ROM

Many PIC Projects for Beginners & Experts!  
Includes Software, Documentation, and PCB Layout

- LCDs
- X10 - Home Automation
- Keypads
- Serial Port Interface
- On-Screen Displays
- Robotics
- Data Logging
- Serial-Parallel
- And Many More!



## PIC Programmer

Programs all PIC16C55x/6x/7x/8x/9x,  
PIC 16F8x, and PIC12C devices.  
Optional ZIF adapters for SOIC & PLCC.  
Includes all necessary software.  
Only \$35.00



We accept  
VISA • MasterCard • American Express  
To order, call Worldwyde @ 1-800-773-6698  
21365 Randall Street • Farmington Hills, MI 48336  
Visit us on the web at [www.worldwyde.com/pic](http://www.worldwyde.com/pic)

# CABLE SECRETS!!!

Build your OWN cable box "test" devices!

Why pay \$100.00 or more for a "test" device that someone else made? Make your own! Includes complete source code and plans for the most commonly used cable boxes. Unlock all of the channels on your box!

Or start your own lucrative business!

Complete source code ..... \$79.95  
Code for individual boxes ..... \$29.95

# DSS SECRETS — Vol. 2

Step-by-step instructions on programming your own DSS access card. Unlock all channels on your own card! This is the most current information on the market! Includes software, plans, and hardware sources. Book & CD-ROM.

DSS Secrets Vol. 2 ..... \$49.95

VISA • MasterCard • American Express  
To order, call Worldwyde @ 1-800-773-6698  
21365 Randall Street • Farmington Hills, MI 48336  
Visit us on the web at [www.worldwyde.com](http://www.worldwyde.com)

# PIC Programmer Kits



Code: CPS96

Super Value  
**\$19.95**  
+S&H \$4.95\*

Program all 8, 18, 28 & 40 pin PICs in the 12C5xx, 14000 and 16Cxx series (except 16C54-58). All components, PCB and Instructions included. Parallel port of PC is used with straight through (25 pin) cable (not supplied). Kit uses the P16PRO shareware which is downloaded from the web and registered for \$20. Can program 64 pin PICs with adapter (not supplied). For more info and other PIC programmers visit [www.electronics123.com](http://www.electronics123.com)

## Digital Camera module

1/4" CMOS Camera Module, Black & White, with digital output. Size: only 1.38"x1.14". Lens: f7.4mm, F2.1 FOV 32 deg x 24 deg. Pixels 384x288. Scanning: Progressive. Video Output: digital 8bit. Programmable features. Shutter: 1/50 to 1/5000 sec. Power Supply: 5VDC. Standby Current <10mA. Needs regulated power supply. \*S&H to Canada is \$7.95



**\$69.95**  
+S&H \$4.95\*  
Code: CM4881

Toll Free: 1-888-549-3749 (USA & Canada)  
Tel: (330) 549-3726. Request a FREE catalog or visit us at: [www.electronics123.com](http://www.electronics123.com) for more products. Amazon Electronics, Box 21 Columbiana OH 44408

# COVERT CATALOG 2000

# BRAND NEW!

The Latest, Up-to-date, Hands-on Supplier and Source Guide for:

- Electronic surveillance equipment
- Covert video cameras and transmitters
- Counter measures gear
- Entry supplies
- Electronic tracking systems
- Computer surveillance and remote viewing

Equipment, exact addresses and ordering info from 15 countries!! 220 pages — \$39.95  
11 3555 S El Camino Real, San Mateo, CA 94403  
Phone 650-513-5549 ■ fax 650-728-0525 or [www.intelligence.to](http://www.intelligence.to) (no "dot com")

# Direct from Manufacturer

We will beat any competitor's price

## World's Smallest Wireless Video Camera!

- Transmits video up to 1000 ft.
- Runs on 3V battery for 12 hrs.
- Can be built into just about anything (beeper, clock, etc.)

- We also carry:
- Solar micro video cameras
  - B&W micro video cameras
  - Hidden cameras
  - Custom video systems
  - Covert surveillance & more

World's smallest plug & play system about 1" x 1"



Looking for Distributors

Call for a free catalog (305) 667-4545  
**SECURETEK** Fax (305) 667-1744  
7175 SW 47 St. #205 • Miami, FL 33155

# www.jm-micro.com

**PIC In-Circuit Emulator**  
for the PIC16Cxx from \$295

**PIC Programmer** \$155

**80C552 (8051) Development Training System** \$235

**68HC11 SBC** \$120

**ROMY-16 EPROM Emulator** from \$195

**Universal Microprocessor Simulator/Debugger (including Assembler, and Disassembler)**  
\$100 each CPU

**J&M Microtek, Inc.**  
83 Seaman Rd, W Orange, NJ 07052  
Tel:(973)325-1892 Fax:(973)736-4567

# Press-n-Peel Transfer Film

## PC Boards in Minutes

1. LaserPrint\*
2. Press On\*\*
3. Peel Off
4. Etch

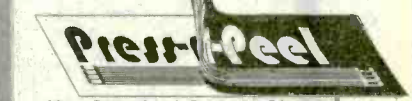

Use Standard Copper Clad Board  
20 Shts \$30/ 40 Shts \$50/ 100 Shts \$100  
Visa/MC/PO/CK/MO \$4 S&H/Foreign Add \$7

**Techniks Inc.**  
P.O. Box 463, Ringoes NJ 08551  
ph. 908.788.8249 fax 908.788.8837  
[www.techniks.com](http://www.techniks.com)  
Visit Our E-Store On-Line!

## Science Fair Electronics

- VIDEO CAMERAS
- Electronics Kits
- Science Projects & more

To receive a color catalog with over 150 Different kits that you can build or customize For your Own projects. Please send \$1.95 to:



Science Fair Electronics  
9740 CAMPO RD. PMB 209  
SPRING VALLEY, CA 91977



TOLL-FREE 1-877-88-HOBBY  
FAX (619) 668-0054  
www.angelfire.com/sd/scifitronics

## FRIENDLY LITTLE MICRO CONTROLLER

\$149  
(single)

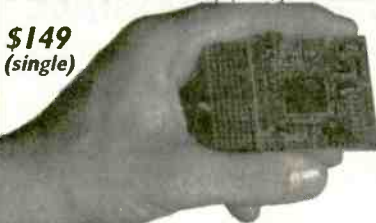

...packs a **MEAN** punch  
a.k.a. "Steroid Stamp"

- 39 I/O + 8 A/D (10 bit) •
- 128K SRAM + 128K Flash •
- LCD/Keypad Interface •
- Fast 16 bit Motorola CPU •
- Affordable C Compiler •
- Comprehensive s/w Library •

\* Intec Automation Inc. v. 250-721-5150  
www.steroidmicros.com fx: 250-721-4191

## The Hack & Crack Bible on CD-ROM

Includes all Software, Documentation, Plans, and PCB Layouts!

Unlock the secrets of:

- DSS & Smart Cards - Programming & Schematics
- Cable Test Devices
- Sony Playstation - Mod Chip/CD Backups/Emulation
- Backup Sega, & SNES Console Cartridges
- Sega & SNES Emulation on your PC or Mac
- WareZ - where to find them on the Internet
- Cellular Hack/Phreak Mod
- And Much More!

Only \$29.95

PC & Mac Compatible CD-ROM

We accept

VISA • MasterCard • American Express

To order, call Worldwyde @ 1-800-773-6698  
21365 Randall Street • Farmington Hills, MI 48336  
Visit us on the web at www.worldwyde.com/hack

## Servo or Stepper Control From Your Serial Port!

Only \$29.95 +s&h

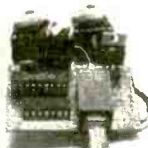

Intelligent Products  
79 E. Daily, #127  
Camarillo, CA 93010  
(805) 384-0579  
(805) 389-1757 FAX

## ECL/TTL/PECL

INSTRUMENT-LIKE FUNCTIONS

COMPONENT-LIKE PRICES

www.pulseresearchlab.com/products/blt/default.htm

# POPTRONIX®

Awaiting your call! Online Edition

http://www.poptronix.com

## CABLE TV BOXES



(WE'LL BEAT ANY PRICE!)  
30 DAY TRIAL\* 1YR. WRNTY. \*FREE CATALOG  
QTY. DISCOUNTS\* DEALERS WELCOME!

1-800-785-1145

HABLAMOS ESPANOL



PRIVATE CABLE SYSTEMS

GREAT FOR TEST FIXTURE BUILDING



LAB-1  
(1.5" x 2.0" x 0.75")

FREE!

PHONE, FAX, WRITE OR E-MAIL WITH YOUR MAILING ADDRESS MUST MENTION OFFER "LAB199"

PRE-PUNCHED END PANELS ALSO AVAILABLE  
9 BOX SIZES  
25 PRE-PUNCHED END PANELS

ALSO IN STOCK AT:  
JENSEN TOOLS: 800-438-1164  
MCM ELECTRONICS: 800-542-4330  
TECH AMERICA: 800-442-7271

ALL ALUMINUM CONSTRUCTION LOW COST  
OFFER GOOD ONLY IN THE 48 STATES, ENDS DECEMBER 20, 1999. LIMIT ONE REQUEST PER CUSTOMER. MAILED 1ST CLASS, ALLOW 1-2 WEEKS FOR DELIVERY

ORDERS 800-834-3457 • FAX 800-551-2749  
OFFICE 702-585-3400 • FAX 702-585-4828  
www.sescom.com • info@sescom.com  
SES.COM, INC. 2100 WARD DR., HENDERSON, NV 89018  
SES.COM, INC. is not responsible for inadvertent typographical errors and prices and specifications are subject to change without notice.



## 10Hr Phone Recorder \$69

Records both sides of conversation automatically

Telephone Scrambler \$159 ea. or 2 for \$149 ea.

Secure phone conversations with this high tech "rolling code" scrambler. Thousands of codes. Easy connection. Requires one at each end.

Voice Changer Phone \$99

Disguise your voice with this phone. 16 Pitches: Make your voice deeper or higher. Men can sound like a woman. Easy to use.

5 Hr. Phone Recorder Touch-tone decoder \$159

Records both sides of conversation including phone numbers dialed

Phone Information Recorder \$169

Records both sides of conversation along with the number dialed

Records name and number of callers (requires Caller ID service)

PC Telephone Recorder \$119

Use your PC to record phone calls. Windows 95, Sound blaster compatible sound card 48k or higher PC required

Phone Tap detector \$159

Protect your phone against phone taps, eavesdroppers and RF bugs.

Mini Bug Detector up to 2Ghz \$119

Detects RF "Bugs", Video Transmitters and wireless microphones from 5Mhz to 2 GHz. LED Bargraph and Audible alarm

VISA • MC • Money Orders • US & Canada Only

NO CHECKS • NO COD • Add \$6.95 S/H

www.mscelectronics.com

MSC Electronics

PO BOX 461 Jessup, MD 20794

(301) 497-1600

FAX (301) 497-1925



## Practical PIC Microcontroller Projects



This book covers a wide range of PIC based projects, including such things as digitally controlled power supplies, transistor checkers, a simple capacitance meter, reaction tester, digital dice, digital locks, a stereo audio level meter, and MIDI pedals for use with electronic music systems. In most cases the circuits are very simple and they are easily constructed. Full component lists and software listings are provided. For more information about PICs we suggest you take a look at BP394 -- An Introduction to PIC Microcontrollers.

To order Book #BP444 send \$7.99 plus \$3.00 for shipping in the U.S. and Canada only to Electronics Technology Today Inc., P.O. Box 240, Massapequa Park, NY 11762-0240. Payment in U.S. funds by U.S. bank check or International Money Order. Please allow 6-8 weeks for delivery. ET10

# CABLE BOXES

## BEST PRICES

Ship Anywhere  
In U.S.A.

1-800-637-4615  
www.xxbox.com

# DIGITAL STORAGE OSCILLOSCOPES

WITH  
SPECTRUM  
ANALYZER,  
DVM, FREQ.  
COUNTER,  
AND DATA  
LOGGER.

from  
**\$189.**

PORTABLE  
MODULES  
CONVERT PC'S  
INTO  
MULTIPURPOSE  
TEST AND  
MEASURING  
INSTRUMENTS.

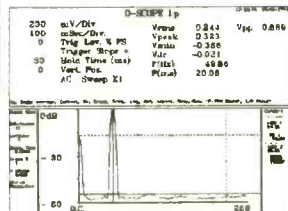
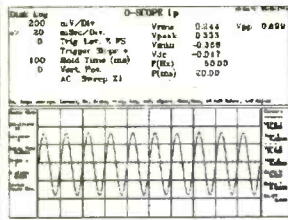

Why lug a scope around? Toss one of our modules into your laptop case or tool kit. For a multi-purpose test device, plug to a PC parallel port and use the PC screen. Continuous, delayed, or triggered sweeps can be frozen on the screen, printed out, or saved to disk. Frequency Spectrums DC to 25 MHz.

Allison now provides PICO TECHNOLOGY Ltd. portable test equipment, including high-speed scopes, and multi channel data loggers. Pico and O-Scope modules accept standard probes and work with 286 or faster PC's.

## FEATURES:

- ♦ PORTABLE UNITS TO 25 MHz
- ♦ USES PRINTER PORT
- ♦ USES STD. PROBES

## OPTIONS:

- ♦ PROBE SETS
- ♦ AUTOMOTIVE PROBES
- ♦ BATTERY PACKS
- ♦ SOFT & HARD CASES

O-Scopes Made in U.S.A. Picos Made in U.K.  
Same Day Shipping  
Includes Cable, Software & Manuals

O-Scope Ip (DC-50KHz, single trace) .....\$189.  
O-Scope II (DC-500KHz, dual trace) .....\$349.  
PICO (ADC 200/20) (DC-10MHz, dual trace) .....CALL  
PICO (ADC 200/50) (DC-25MHz, dual trace) .....CALL  
PICO pc based data loggers from \$99.

Shipping within U.S. UPS Ground \$7.50(Second day \$11.50)

SEND CREDIT CARD INFO., M.O., or CHECK, OR CALL

**1-800-980-9806**

**Allison Technology Corporation**

2006 FINNEY-VALLET, ROSENBERG, TX 77471  
PHONE: 281-239-8500 FAX: 281-239-8006

<http://www.atcweb.com>

# LASERS

## AT GREAT PRICES

Complete Ruby Laser Assembly less than \$300  
He-Ne Lasers, complete, for less than \$50  
American 60X Argon Lasers from \$595  
Laser Diode Modules from under \$40  
X-Y Scanners from \$79

## FREE CATALOG

- Helium-Neon
- Argon Lasers
- Diode Lasers
- Holography
- Books
- Ruby Lasers
- Scanners
- Lightshow Equipment
- Pointers
- Optics

Email: [mlp@nlcnx.com](mailto:mlp@nlcnx.com) <http://www.midwest-laser.com>



**Midwest Laser Products**

P.O. Box 262, Frankfort, IL 60423

Phone: (815) 464-0085 FAX: (815) 464-0767

30 Day Satisfaction Guarantee.

VISA / MC Accepted

# DATA ACQUISITION & CONTROL

## AFFORDABLE PLUG-IN BOARDS FOR PC'S ISA BUS

ANA100 Analog I/O ..... \$ 99



- \* 8 Channel 8-Bit
- \* 0 to 5 Volt Input
- \* 14 TTL I/O lines
- \* Analog Output
- \* 400KHz Sampling

DIG100 Digital I/O ..... \$ 39



- \* 82C55 PPI
- \* 24 or 48 TTL I/O Lines option
- \* Selectable Base Address

ANA150 Analog/Counter... \$ 89



- \* 8 Channel 8-Bit
- \* 0 to 5 Volt Input
- \* 3 16-Bit Counters
- \* 400KHz Sampling

DIG200 Counter I/O ..... \$ 79



- \* 3 16-Bit Counters
- \* 8 TTL Input lines
- \* 8 TTL Output lines
- \* Selectable Clock Frequency input

ANA200 Analog I/O ..... \$ 79



- \* 1 Channel 12-Bit
- \* 0 to 5 Volt input optional bi-polar
- \* 100KHz / 300KHz Sampling rate
- \* 24 TTL I/O lines

ANA201 Analog ..... \$ 119



- \* 8 Channel 12-Bit
- \* x1, x5, x10, x50 Programmable Channel gain
- \* 100KHz Sampling rate

On-Line Product Catalog at Our Web Site

<http://www.Bsof.com>

E-Mail: [Sales@Bsof.com](mailto:Sales@Bsof.com)

**BSOFT Software, Inc.**

444 COLTON ROAD \* COLUMBUS, OH 43207  
PHONE 614-491-0832 \* FAX 614-497-9971

Help protect our nation's soil and water.  
Call for your free action packet.

**1-800-THE-SOIL**  
WE OWE IT TO OUR CHILDREN

United States Department of Agriculture  
Soil Conservation Service

Thanks to you, all sorts of everyday products are being made from the paper, plastic, metal and glass that you've been recycling. But to keep recycling working to help protect the environment, you need to buy those products.

**BUY RECYCLED.**



**AND SAVE.**

So look for products made from recycled materials, and buy them. It would mean the world to all of us.

For a free brochure, write

Buy Recycled, Environmental Defense Fund, 257 Park Ave.

South, New York, NY 10010,

or call 1-800-CALL-EDF.



# PLUG IN AND MEASURE **NEW**

500mVolt - 400Volt  
0 - 20MHz  
8 bit



STORAGE OSCILLOSCOPE  
SPECTRUM ANALYZER  
VOLTMETER  
TRANSIENT RECORDER

## TiePie introduces the HANDYPROBE model HP 2 A powerful 8 bit, 20MHz virtual measuring instrument for the PC

Convince yourself and download the demo software from our web page: <http://www.tiepie.nl>. When you have questions and / or remarks, contact us via e-mail: [support@tiepie.nl](mailto:support@tiepie.nl). The HANDYPROBE HP2 is delivered with a user manual, Windows and DOS software. The price of the HANDYPROBE HP2 starts at USD 199 excl. VAT.

**US dealers:**

Conway Engineering Inc.: Tel 510-568-4028; Fax 510-568-1397; [www.conway-engineering.com](http://www.conway-engineering.com)  
Feedback Incorporated: Tel 800-526-8783; Fax 919-644-6470; [www.fb.com](http://www.fb.com)

**Outside US:**

TiePie engineering, P.O. BOX 290, 8600 AG SNEEK, The Netherlands.  
Tel: +31 515 415 416 Fax: +31 515 418 819 Web: [www.tiepie.nl](http://www.tiepie.nl)

CIRCLE 217 ON FREE INFORMATION CARD

**Yours for only  
\$3.99**

**Price includes  
shipping!**



**HAVE A THOUSAND YUCKS FOR ONLY THREE AND A HALF BUCKS!** That comes to one-third of a cent per laugh. **Electronics Comics** is a compilation of over 125 riotous, outrageous and phenomenal cartoons that appeared in **Popular Electronics** and **Electronics Now**. Only \$3.99—price includes shipping. **Claggk, Inc., Reprint Bookstore, P.O. Box 4099, Farmingdale, NY 11735-0793.** All payments in U.S. funds. Sorry, no orders outside U.S.A. and Canada. Check or money order only—send no cash. NY state residents add applicable tax. MA04

### THE COLLECTED WORKS OF MOHAMMED ULYSES FIPS

#166—By Hugo Gernsback. Here is a collection of 21 April Fools Articles, reprinted from the pages of the magazines they appeared in, as a 74-page, 8 1/2 x 11-inch book. The stories were written between 1933 and 1964. Some of the devices actually exist today. Others are just around the corner. All are fun and almost possible. Stories include the Cordless Radio Iron, The Visi-Talkie, Electronic Razor, 30-Day LP Record, Teleyglasses and even Electronic Brain Servicing. Get your copy today. Ask for book #166 and include \$9.99 (includes shipping and handling) in the US (First Class), Canada and Overseas (surface mail), and order from **CLAGGK Inc., P.O. Box 4099, Farmingdale, NY 11735-0793.** Payment in US funds by US bank check or International Money Order. Allow 6-8 weeks for delivery. MA05



### INSIDE CRYSTAL SETS

An easy-to-read book on crystal set theory and construction opens vistas for novices and pros alike. Build radios like Grandpa did, do it better, and know what you are doing. *The Crystal Set Handbook*, published by The Crystal Set Society, is an authentic guide on the topic.

To order *The Crystal Set Handbook*, send \$10.95 plus \$4.00 for shipping in the U.S. and Canada only to **Electronics Technology Today Inc., P.O. Box 240, Massapequa Park, NY 11762-0240.** Payment in U.S. funds by U.S. bank check or International Money Order. Please allow 6-8 weeks for delivery. MA03



**CALL TOLL FREE**  
**(800) 292-7711**  
**Orders Only**  
 Se Habla Español

# C&S Sales

**Look For Other**  
**Monthly Specials**  
**On Our Website**  
[www.cs-sales.com](http://www.cs-sales.com)

**Excellence in Service**

## Power Supplies

**Elenco Quad Power Supply**  
**Model XP-581**

**\$79.95**



**4 Fully Regulated DC Power Supplies in One Unit**  
 4 DC voltages: 3 fixed - +5V @ 3A, +12V @ 1A, -12V @ 1A  
 1 Variable - 2.5 - 20V @ 2A

**Elenco Power Supply Kit**  
**Model XP-720K**

• 1.5VDC - 15VDC @ 1A **\$54.95**  
 • -1.5VDC - -15VDC @ 3A  
 • 5VDC @ 3A  
 • 6.3VAC @ 1A & 12.6VAC center tapped @1A

**XP-720 Fully Assembled \$85**

**B&K High Current DC Power Supply**

• Variable 3-14VDC  
 • Thermal Function  
 • Current Limiting

**Model 1686 12A \$169**  
**Model 1688 28A \$249**

B&K 13.8V Fixed DC Power Supplies  
 Model 1680 6A \$42  
 Model 1682 15A \$75



**Elenco DC Power Supply**  
**Model SPL-603 3A 0-30VDC**

The SPL-603 is a solid-state DC power supply providing the exact output voltage no matter what current you use. Output fully protected from overload.



**\$79.95**

## Soldering Equipment

**Elenco Hot Air SMD Rework Station**  
**Model SR-979**

The workstation is engineered to meet the needs of today's electronic industry. Wide range of adjustments of air volume and temperature (212°F to 754°F) permits soldering of most surface mount devices. Comes with an A1198 nozzle QFP 28 x 28mm (1.1 x 1.1").



**\$450**

**Weller Low Cost Soldering Iron**  
**Model WLC-100**

• Variable power control produces 5-40 watts.  
 • Ideal for hobbyists, DIYers and students.  
 • Complete with 40W iron.



**\$36.95**

**Weller Soldering Station**  
**Model WES50**

50 watts of controlled power - designed for continuous production soldering.



**\$119**

**Weller Marksman\* 23W Soldering Iron**  
**Model SP23**



**\$9.95**

## Generators & Counters

**Elenco Sweep Function Generator w/ built-in frequency counter**  
**Model GF-8036**



**\$225**

This sweep function generator with counter is an instrument capable of generating square, triangle, and sine waveforms, and TTL, CMOS pulse over a frequency range from 0.2Hz to 2MHz.

**10 Function 1.3GHz Universal Counter**  
**Elenco Model F-1300**

• Frequency .05Hz - 1.3GHz 3 Ranges  
 • Period - Can read 60Hz to 60,000,000 F=1/T  
 • Totalize - Counts to 199,999,999  
 • RPM - 3 to 2099994 RPM  
 • Duty Cycle  
 • Max/Min/AVG with Time  
 • Stop-watch set .2 sec. to 100 hrs.  
 • Math Functions  
 • Timer - 2 sec. to 99 days  
 • Pulse Width - 0.1ms to 66666.6ms



**\$225**

**Multifunction Counter**  
**B&K Model 1875**

10Hz - 2.5GHz



**\$189**

Ultra sensitive synchronous detector bargraph and RF strength.  
 3 Channels

**Elenco Handheld Universal Counter**  
**1MHz - 2.8GHz**  
**Model F-2800**



**\$99**

Measures Frequency, Period, Data Hold, Relative, Memory (min., max., average). High Sensitivity, Microprocessor Controlled.

Features 10 digit display, 16 segment and RF signal strength bargraph.  
 Includes antenna, NiCad battery, and AC adapter.

**Elenco RF Generator with Counter**  
**(100kHz - 150kHz) Model SG-9500**

Features internal AM mod. of 1kHz, RF output 100MV - 35MHz. Audio output 1kHz @ 1V RMS.



**\$225**

**SG-9000 \$119.95** (analog, w/o counter)

**B&K 20MHz Sweep/Function Generator with Frequency Counter**  
**Model 4040**

• 0.2Hz to 20MHz  
 • AM & FM modulation  
 • Burst Operation  
 • External Frequency counter to 30MHz  
 • Linear and Log sweep



**\$445**

**21.5MHz Model 4070 \$1295**  
**10MHz Model 4017 \$319**  
**5MHz Model 4011 \$249**

**BK PRECISION**

## Kit Corner

over 100 kits available

Quantity Discounts Available

**Model RCC-7K**  
**Radio Control Car Kit**

**\$29.95**

• Fun & Easy to Assemble  
 • 7 Functions  
 • Radio Control Transmitter Included



**Model AK-700**  
**Pulse/Tone Telephone Kit**

**\$15.95**

Ideal School Project



**Model AM-780K**  
**Two IC Radio Kit**

**\$11.95**

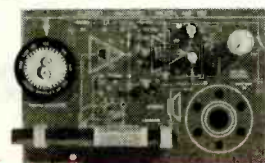

**Model OWI-007**  
**Robotic Arm (Wired Control)**

Teaches the basic robotic sensing and locomotion principles while testing motor skills.

**\$55.95**



## Oscilloscopes

Free Dust Cover and 2 Probes



**UL**

S-1325	25MHz	Dual Trace	\$325
S-1330	25MHz	Delayed Sweep	\$439
S-1340	40MHz	Dual Trace	\$475
S-1345	40MHz	Delayed Sweep	\$569
S-1360	60MHz	Delayed Sweep	\$749
S-1390	100MHz	Delayed Sweep	\$995

**DIGITAL SCOPE SUPER SPECIALS**

DS-203	20MHz/10Ms/s Analog/Digital	\$695
DS-303	40MHz/20Ms/s Analog/Digital	\$995
DS-603	60MHz/20Ms/s Analog/Digital	\$1295

**Guaranteed Lowest Prices**

**C&S SALES, INC.**

**15 DAY MONEY BACK GUARANTEE**  
**2 YEAR FACTORY WARRANTY**

UPS SHIPPING: 48 STATES 5%  
 OTHERS CALL FOR DETAILS  
 IL Residents add 8.25% Sales Tax

150 W. CARPENTER AVENUE  
 WHEELING, IL 60090  
 FAX: (847) 541-9904 (847) 541-0710



PRICES SUBJECT TO CHANGE WITHOUT NOTICE

CIRCLE 322 ON FREE INFORMATION CARD

[www.americanradiohistory.com](http://www.americanradiohistory.com)



**SAME DAY SHIPPING**  
Secure on-line ordering

# C&S Sales

**Excellence in Service**

**CALL OR WRITE FOR OUR FREE**

**64 PAGE CATALOG!  
(800) 445-3201**

## Digital Multimeters

### Elenco LCR & DMM Model LCM-1950



12 Functions  
Freq. to 4MHz  
Inductance  
Capacitance  
and Much More  
**\$69**

### Elenco Model M-1740 \$39.95



11 Functions:  
• Freq. to 20MHz  
• Cap. to 20 F  
• AC/DC Voltage  
• AC/DC Current  
• Beeper  
• Diode Test  
• Transistor Test  
• Meets UL-1244 safety specs.  
**Model M-2760 - \$24.95 (9 functions)**

### Fluke 79III



**\$195**  
• Capacitance ranges from 99.99nF to 9999 F.  
• Built-in frequency counter of voltage input from 1Hz to over 20kHz.  
• Lo-Ohms range, a 40Ω range with Fluke's proprietary Zero Calibration, offers 0.01 resolution with increased noise rejection.

### Fluke 87III



**\$319**  
Features high performance AC/DC voltage and current, measurement, frequency, duty cycle, resistance, conductance, and capacitance measurement.

### Elenco LCR Meter Model LCR-1810



**\$99.95**  
• Capacitance .1pF to 20 F  
• Inductance 1 H to 20H  
• Resistance .01 to 2000M  
• Temperature to 750°C  
• DC Volts 0 - 20V  
• Frequency up to 15MHz  
• Diode/Audible Continuity Test  
• Signal Output Function  
• 3 1/2 Digit Display

### Elenco Digital Multimeter Kit Model M-1005K



**\$19.95**  
• 18 Ranges  
• 3 1/2 Digit LCD  
• Transistor Test  
• Diode Test  
• Training Course  
**M-1000B (Assembled) \$15.95**

### Dual-Display LCR Meter w/ Stat Functions B&K Model 878



**\$225.95**  
Auto/manual range  
Many features with Q factor  
High Accuracy

### B&K Video Monitor Tester Model 1275



**\$169**  
Great handheld unit to test PC and Mac monitors. The model 1275 is ideal for the field or the service bench. Small, portable and very effective, the 1275 generates crosshatch, dots, color bars and raster patterns in green, blue, red, black and white.

## PC Repair

## CCTV Cameras

**Quantity Discounts Available**

### Introduction to PC Repair Self-Study Course™



#### COURSE CONTENTS

Introduction to Computers  
IBM PC's and Clones  
PC Assembly/Disassembly  
Introduction to MS-DOS

Introduction to Windows 3.1  
Introduction to Windows 95  
Introduction to Networks  
Introduction to the Internet

**\$179**

Provides you with the easiest and most effective way to learn the fundamentals necessary for a profitable and successful career as a PC Repair Technician. Ideal for individuals new to the I.T. profession and as instruction prior to studying for A+ certification.

Cameras have 420 lines (360 color) of resolution, 0.08 Lux, 3.6mm/F2 90° field of view. Power requirement is 12VDC @ 100mA (order SC-1).

### MONOCHROME CAMERAS

### COLOR CAMERAS

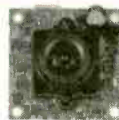

SC-12 - 35mm Lens (1.25"x1.25") \*69  
SC-15 - Pin Lens (1.25"x1.25") \*69  
Add \$10 for lens • Add \$10 for audio

**Accessories:**  
SC-1 - 12V 100mA adapter \*6.<sup>95</sup>  
SC-2 - 50' cable with connectors \*19.<sup>95</sup>

SC-20 Pin Lens  
SC-21 3.6mm Lens  
360 Lines 1.25" x 1.25"  
Infrared Sensitive, Audio included

**\$109**

Add \$10 for case  
Call for complete catalog.

### A+ Certification Self-Study Course™



#### DOS/WIN Exam

DOS 6.2  
Windows 3.1 Installation and Configuration  
Windows 3.1 Application Support  
Windows 3.1 Devices and Drivers  
Windows 3.1 Networking and Troubleshooting  
Windows 95 Installation and Deployment  
Windows 95 Basic Configuration  
Windows 95 Troubleshooting and Optimization

**\$379**

Includes all the technical material, knowledge and interactive exercises needed to pass the A+ exams and excel in the competitive PC repair marketplace.

### 11 pc. Computer Service Tool Kit Model TK-1100

Includes:

- 3/16" Nut Driver
- 1/4" Nut Driver
- 3-prong Parts Retriever
- Reversible Bit Screwdriver T10 & T15
- Reversible Bit Screwdrivers 3/16", 1/4", #1 & #2 Phillips
- Tweezer
- IC Inserter 14-16 pin
- IC Extractor
- 1/8" Flat Screwdriver
- #0 Phillips Screwdriver

**\$12.95**



## TEKK Radios

### Pro-Sport FRS Two-Way Radio Model PRO-SPORT+

Available in Yellow, Blue & Black

No License Required

Talk up to 2 miles!

- 1/2 Watt Output, 14 Channels.
- TX & RX LED/LCD Indicators.
- Large LCD Display.
- 38 Privacy (CTCSS) Tones.
- Removeable Antenna.
- Water Resistant.
- 500mW Output.
- Palm Sized.

**\$69.00 each or 2 for \$125.00**



**Guaranteed Lowest Prices**

**C&S SALES, INC.**

**15 DAY MONEY BACK GUARANTEE  
2 YEAR FACTORY WARRANTY**

UPS SHIPPING: 48 STATES 5%  
OTHERS CALL FOR DETAILS  
IL Residents add 8.25% Sales Tax

150 W. CARPENTER AVENUE  
WHEELING, IL 60090  
FAX: (847) 541-9904 (847) 541-0710  
[www.cs-sales.com](http://www.cs-sales.com)



PRICES SUBJECT TO CHANGE WITHOUT NOTICE

**SEE US ON THE WEB**

CIRCLE 322 ON FREE INFORMATION CARD

## High Energy Pulsers

Experiment with and Construct Rail Guns, Magnetic Launchers, Coil and Sleeve Guns, Super High Gravity Pulses, Explode Wires and Water, Antigravity, Levitation, Mass Warping, Magnetic Can Crushing, Plasma Propulsion, High Energy Radio Frequency Guns (Herf), EMP, Lattice Snapping, and all Types of Electrical Pyrotechnics, Plus Much More!!



**Features:**  
 Lossless Induction Charging  
 Programmable Energy Charging to 16 KJ  
 Triggered Spark Switch

12vdc/115vac Input  
 1 to 10KV Output\*  
 Optional Designs Available

HEP3 Plans for 1 to 2KV @ 1 KJ..... \$15.00  
 HEP3K Kit with 500J..... \$349.95 HEP30 Assbled Above..... \$449.95  
 HEP9 Plans Higher Energy 1 to 10 KV @ 16 KJ..... \$20.00  
 Custom Designs Available on Request

## Burning Laser Ray Gun

Blasts thru the Hardest of Metals



We Stock all Individual Parts

LAGUN2 Plans..... \$20.00

## Poor Mans CO2 Burning Laser

Build a relatively high powered laser from homemade parts. Eliminates glass blowing and complicated machining. Shows many low cost alternatives and approaches. Generates over 10 watts of burning energy. Great science project. Build for less than \$100.00.

LC3 Plans..... \$15.00

## Electronic Hypnosis/Mind Machines! TAKE CONTROL!!

Electronic Circuitry Induces Hypnotic as Well as ALPHA Relaxed States of the Mind. Place Subjects "Under Your Control. Enhances Hidden PSYCHIC Ability in Many People!!



MIND2 Plans..... \$15.00  
 MIND2K Kit/Plans..... \$49.95  
 MIND20 Ready to Use..... \$79.95

Intended For Hypnosis  
 HYP2 Plans..... \$10.00  
 HYP2K Kit/Plans..... \$49.95  
 HYP20 Ready to Use..... \$69.95

### Complete System Projects

PPR01 Plasma Gun Plans With Above HEP3 Plans..... \$20.00  
 MASS1 Mass Driver/Magnetic Cannon Plans With HEP3 Plans..... \$20.00

## Phaser Pain Field Pistol

**CAUTION! Do Not Aim at People!**

Blast out rats and other rodents with high powered ultrasonics



Handheld and battery operated with all controls

Rental units available

PPP1 Plans..... \$8.00  
 PPP1K Kit/Plans..... \$49.95  
 PPP10 Ready to Us..... \$79.95

## Telephone Taping System

Extends Taping Time by X4

Automatically tapes both sides of phone conversation-Check Laws!

TAPE30X Ready to Use..... \$84.95  
 BEEP10 Beeper Alert..... \$29.95

## Jacobs Ladder

Observe a pyrotechnical display of "traveling" fiery plasma. Starts off as 1/2" arc and expands to over 3" before evaporating into space. This is an excellent attention getting display as well as a winning science project!! With arc control.



JACK1 Plans..... \$8.00  
 JACK1K Kit Minus Case..... \$129.95  
 JACK10 Ready to Use..... \$249.95

## Cybernetic Ear!

Enhances Normal Hearing 3 to 4 Times. Provides That Extra "Edge" Hunters Trackers Nature Enthusiasts



Adjustable Volume Control  
 Fits Into Either Ear  
 Built In Long Lasting Batteries

CYBEREAR..... \$19.95

## Transistorized TESLA Coil

Amazing and Bizzare Effects  
 Turn a Normal Light Bulb into a Spectacular Plasma Display!!  
 Excellent Science Project



Transmits Wireless Energy  
 Noiseless Operation  
 Pyrotechnic Effect  
 12 VDC/5 Amps or Battery  
 Adjustable Frequency  
 Control For Effect

TCL5. Plans... \$8.00 TCL5K Kit/Plans..... \$59.95  
 TCL50. Assembled and Tested..... \$99.95  
 12DC/7. 12VDC@7Amps Supply..... \$39.95

## 3 Mile Voice Xmitter

Listen to Children or Invalids in Hazardous Areas, Pools, Ponds etc. Great Security Intrusion Alert!! Uses FM Table Top Radio. Become the local neighborhood D.J.



FMV1K Kit/Plans..... \$39.95

## Micro Tesla Coil

Lights up a 4 ft Fluorescent Tube Without Contact!!! Yet Only 3" Tall!



Super Magic Trick  
 Low Cost Science Project  
 12 VDC/115 VAC Operation

MTC1K Kit/Plans..... \$24.95  
 MTC10 Assembled..... \$34.95

## HOVER Boards

28 Pages of "how to" build a magnetic force field capable of containing a column of ionized air up to several psi! Includes theory on how to build a HOVERBOARD prototype capable of lifting 200 lbs.



HOVER Plans and Data..... \$25.00

1 800 221 1705 Orders Only! Fax 1 603 672 5406 Information 1 603 673 6493 Free Catalog on Request  
 Pay by MC,VISA,Cash, Check, MO, COD. Please Add \$5.00 S&H plus \$5.00 if COD. Overseas Please Contact for Proforma

# New and Pre-Owned Test Equipment

## New Equipment Specials

**SIMCHECK® IIse PLUS**

**Module Tester Only \$1,995.00!**

\* Tests SIMMs/168 pin DIMMs      \* Identifies Module properties  
 \* Stand alone/portable              \* Built-in Serial Interface

---

**Spectrum Analyzer - Avcom PSA-37D**

*Satellite Downlink - Installation - Maintenance & Service*

• Band 1: 10 - 1750 MHz              • Built-in DC Block & Power for LNA/LNB's  
 • Band 2: 3.7 - 4.2 GHz              • Line or Battery Powered

**Only \$2,395.00!** (includes carrying case)

---

**LG Precision Model OS-5100 Oscilloscope**

• 100 MHz Bandwidth              • Calibrated Delayed Sweep  
 • 2 Channel, High Sensitivity      • Includes Two Probes  
 • TV Synchronization Trigger      • 2 Year Warranty

**→ \$899.00**

---

**Leader CATV Signal Level Meter Model LF 941**

✓ TV/CATV Coverage from 46 - 870 MHz  
 ✓ Video/Audio Carrier Measurements      **\$489.00!**

---

**Just Released! → "Series IV" Digital Multimeters**

**Fluke Model 87 IV \$319.00 !!!**

## Pre-Owned Oscilloscope Specials

B+K Prec. 1466	10 MHz	\$185.00
Tektronix 465	100 MHz	\$599.00
Tektronix 465B	100 MHz	\$729.00
Tektronix 475	200 MHz	\$829.00
Tektronix 475A	250 MHz	\$999.00

- Professionally Refurbished
- Aligned & Calibrated to Original Specifications
- The Industry Standard of Oscilloscopes
- 1 Year Warranty - The Longest Available!!!
- See Website for Complete Specifications

**See us on the Web!**  
[www.testequipmentdepot.com](http://www.testequipmentdepot.com)

## Test Equipment Depot

A FOTRONIC CORPORATION COMPANY

99 Washington St. Melrose, MA 02176  
 (781) 665-1400 • FAX (781) 665-0780

e-mail: [sales@testequipmentdepot.com](mailto:sales@testequipmentdepot.com)

**We Buy Surplus Test Equipment**

(1-800-996-3837)





**TOLL FREE 1-800-99-METER**

CIRCLE 333 ON FREE INFORMATION CARD

**AIWA MODEL SX-ANA72  
4 WAY 120 WATT BASS  
REFLEX SPEAKER SYSTEM**

High quality stereo speaker system features two speakers for stereo. Each speaker features 120 watts music power rating, 6 ohms impedance (4 & 8 ohm compatible), gray colored wood veneer cabinet with hi tech ABS face, sound pressure level of 87dB and size of 12"H x 9 1/2"W x 10 1/2" D. These are brand new in a factory carton containing the 2 speakers. Weighs 25lbs. Hurry while supplies last.

**G1598 \$49.95**



**ELECTRONIC GOLDMINE**  
WE ALSO OFFER OVER  
150 DIFFERENT  
ELECTRONIC KITS.



**ELECTRONIC  
GOLDMINE**  
PO Box 5408  
Scottsdale, AZ 85261

<http://www.goldmine-elec.com>

NOTE: All items subject to prior sale. All prices expire 12-31-99

**For Phone Orders Call: 800-445-0697  
or Fax Your Orders to: (480) 661-8259  
For a Free Catalog Call: 800-445-0697  
e-mail: [goldmine-elec@goldmine-elec.com](mailto:goldmine-elec@goldmine-elec.com)  
Foreign catalog request: send \$5.00**

Minimum Order: \$10 (plus min. \$5 Shipping and Handling). We accept MasterCard, Visa and personal checks, however, we cannot accept personal checks on orders outside the U.S. Minimum Foreign Order Amount: \$50 (plus a minimum \$10 S&H)

**LARGE SCREEN TV  
PROJECTION LENS**

These are brand new projection lenses that were made surplus to us from one of the top large screen TV manufacturers. The overall size of the top optical part of the lens is about 3 1/2" Dia., however the plastic base holder assembly is over 5" in Dia. and about 2 1/2" high. Very good optical quality. Prime!

**G1596 \$7.95 ea.**



**CALL, E-MAIL, WRITE OR FAX US FOR YOUR FREE COPY OF OUR  
96 PAGE CATALOG CONTAINING ALMOST 5,000 PRODUCTS!**

**HIGH QUALITY THERMAL  
FAX PAPER**

We have just received a large quantity of high quality ultra premium fax paper that has been specially formulated to provide premium print clarity. We use this quality paper in our fax machine for the best quality faxes. Prime retail boxes of rolls ready for your fax machine or you can sell them for a profit if you have a store! Offer good while supplies last, please include extra for shipping.

**1" CORE 164FT long**  
**G1312 Box of 4 Rolls \$14.00 \$5.00**  
**G1313 1 Roll (NOT BOXED) \$4.00 \$2.95**  
**1" CORE 328FT long**  
**G1314 Box of 6 Rolls \$28.00 \$7.00**  
**G1315 1 Roll (NOT BOXED) \$5.00 \$3.50**



**SUPER QUALITY BLINDING  
OUTPUT RED LED**

Made for outdoor use, this clear lens T1 3/4 5mm jumbo LED produces a brilliant red light that almost hurts your eyes to look at. High quality LEDs made by Sharp!  
**G1599 8/\$1.00 • Factory bag of 250/\$25.00**



**MAMMOTH 10MM  
3 COLOR LED  
PACKAGE**

Package of three 10mm diffused lens LEDs. You get 1 green, 1 yellow and 1 red. Each LED is similar except for the color. Great for making small traffic lights. Prime, long leads.  
**G1602 \$1.59/set**



**HIGH TECH  
ACRYLIC DOME**

Clear acrylic dome with black base makes a great addition to a science project or robot. Overall diameter of plastic base is about 3 3/4" and the clear part of dome is about 2 5/8" dia x 1" high (in the center). Brand new crystal clear dome with opaque black base ring.  
**G1600 \$4.00 ea.**



**SAFETREE HEAT  
SENSOR ALARM  
ORNAMENT**

This is one of the neatest products we have seen in years. This holiday ornament made by Quorum® is also a heat sensitive alarm that you can hang on your Christmas Tree. If there is a fire, the Safetree will emit a VERY LOUD (90 dBA per meter minimum) alarm when it detects a temperature above 122°F. The unit features very sophisticated IC and transistor circuitry driving a loud Piezo Buzzer. The Safetree Heat Sensor Alarm Ornament operates 24 hours a day for 21 days on one 9-volt battery (not included). This attractive ornament is the perfect addition to your home for this holiday season. The ornament is silver in color and is about 2 1/2" in diameter. Brand new in manufacturer's box, complete with instructions. We are offering this unique holiday item at an extremely low price. Hurry and get yours today!



**G9880 \$3.95 ea. Sale! \$2.95 ea.**

Compare at \$14.95!

**PRINT-ON  
MAGNETIC  
PAPER**

This exciting new product allows you to create full color photo refrigerator magnets, notices, promotions, etc. with almost any inkjet printer. Let your imagination run wild as you perk up memos, create custom logo magnets, party notices, etc. After printing, simply cut with scissors. White matte finish sheet is about 8 1/4" x 11 3/4". This amazing product is for use with Inkjet printers only—damage may occur if used in copy machines or laser printers.

**G1604 Package of 3 Sheets \$12.00**  
**Bulk Package of 20 Sheets \$60.00**



**12VDC 1.2AMP  
CHARGER ADAPTER**

High power 12VDC adapter plugs into standard 120VAC outlet and puts out 12VDC at 1.2amps. These do not have a built in filter capacitor, so if you need a filtered supply, add a capacitor across the output. Brand new, compact only 3 1/4" x 2 1/4" x 1 15/16". With 5mm barrel plug center (-).

**G1566 \$3.49 ea.**  
**1500µf 35VDC Radial filter capacitor for above**  
**G1580 49¢ ea.**



**Unique**

**HANDY  
SOLDER WICK**

Great for desoldering components from a PC board. Simply lay end of solder wick braid on top of PC solder pad and heat with solder iron. The solder "wicks up" into the braid so that you can easily remove the component. Brand new 5 ft long—in a handy dispenser.

**G1587 \$1.29 ea.**



**PARALLEL  
PRINTER CABLE**

High quality 10ft long shielded bi-directional parallel printer cable (25 pin male to 36 pin centronics). These are brand new in retail packages but we are selling them real cheap because they don't have the IEEE rating. Of course these cables were the highest standard available until just a few years ago when the IEEE was adopted, and we found that these cables work fine with all of our printers.

**G1563 \$1.49 ea. • 10 for \$12.00**



**BIG DISPLAY  
8 DIGIT  
CALCULATOR**

Solar Powered calculator with large LCD Display that can tilt upwards to accommodate viewing. Large keys have all of the important functions—perfect for balancing your checkbook, calculating ohm's law, or just having an extra calculator around for when the need to calculate something arises. Brand new in manufacturer's box. Approximate Size: 5 7/8" x 7 1/2" x 1/2"

**G1474 \$3.49 ea. SALE! \$2.99 ea.**



**• THE ELECTRONIC GOLDMINE: PO BOX 5408 SCOTTSDALE AZ 85261 •  
TOLL FREE ORDER LINE: 800-445-0697 • FAX: (480) 661-8259 • ALL OTHER CALLS: (480) 451-7454**

CIRCLE 241 ON FREE INFORMATION CARD

[www.americanradiohistory.com](http://www.americanradiohistory.com)

Turn your PC into a 16-bit Storage Scope spectrum analyzer, and digital multimeter!

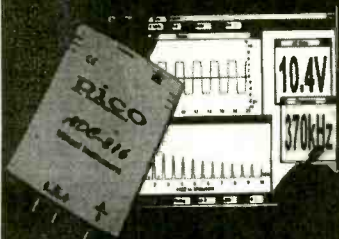

ADC216 turns your PC or laptop into a sophisticated storage scope AND spectrum analyzer AND multimeter. Display on large screen! Print in color! 100MS/s 8-bit, 1.2MS/s 12-bit or 333kS/s 16-bit versions. Great for test depts, schools. Input to Excel. LabView/NT drivers. Get very high precision without high cost!

## osziFOX handheld 20MS/s Storage Scope

osziFOX is a sophisticated digital storage scope packed into a handy, slim penlike housing. Despite its small size, osziFOX can perform like a service scope with a 20MS/s sampling rate so signals in microprocessor or audio circuits can be measured easily. A built-in backlit LCD shows the waveforms but the recorded signals can also be sent to a PC via a serial interface. Runs from 9V battery or external source. Auto, internal and external triggers. AC/DC voltmeter function too. Only \$129!

also .....

RS232-422/485 converters, self-powered, opto-isolated I2C adapter boards for PC communication with I2C bus mini dataloggers for events, voltages, pressures, etc. Enviromon temperature and environment netwk logger thermocouple and thermistor adapters for PC ports. BASIC-programmable BASIC-TIGER controller modules PCI framegrabbers - switch between 2 inputs locked! lowcost A/D adapters turn your PC into a display scope



**Saelig Company**  
www.saelig.com saelig@aol.com  
716-425-3753 • 716-425-3835 (fax)

1-888-7SAELIG

## Carpet Rover Kit

\$115.00 Plus S&H



### You can build this Mobile Robot

This easy to build mobile robot base is an excellent foundation for many different robotic experiments. The large 3" wheels handle rough terrain. Use the robot for demonstrating bumper switch or IR obstacle avoidance, maze negotiation, line following, light following, beacon locating, robot sumo, and robot art, to name a few. The kit includes the hardware, structural components, Hitex servos, wheels, First Step micro, software, and an illustrated assembly manual. It's a lot of fun to build and even more fun to operate.

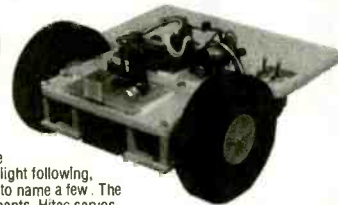

Shown with the IRPD, no contact obstacle detector.

We have many more cool robots, check out our web page or ask for our free catalog!

Lynxmotion, Inc.  
104 Partridge Road  
Pekin, IL 61554-1403  
www.lynxmotion.com



Tel: 309-382-1816  
Fax: 309-382-1254  
sales@lynxmotion.com  
tech@lynxmotion.com



SUPPORTS  
DEVICES TO  
32 MEG

## EPROM+

A device programming system for design, repair and experimentation

- ◆ EXCEPTIONAL POWER FOR THE PRO
- ◆ EASY-TO-USE FOR THE NOVICE
- ◆ INCLUDES STEP-BY-STEP TUTORIAL

**Here's what you get:** A rugged, portable programming unit including the power pack and printer port cable both of which store inside the case. A real printed user and technical manual which includes schematic diagrams for the programming unit plus diagrams for all technology family adapters.\* Comprehensive, easy-to-use software which is specifically designed to run under DOS, Windows 3.1, 95 and 98 on any speed machine. The software has features which let you READ, PROGRAM, COPY and COMPARE plus much more. You have full access to your system's disk including LOADING and SAVING chip data plus automatic processing of INTEL HEX, MOTOROLA S-RECORD and BINARY files. For detailed work the system software provides a full screen buffer editor including a comprehensive bit and byte tool kit with more than 20 functions.

**Broad device support:** FIRST GENERATION EPROMS (2708, TMS2716\*, 25XX) SECOND GENERATION EPROMS (2716-28C080), 40 AND 42 PIN EPROMS\* (27C1024-27C160) FLASH EPROMS (28F,29C,29EE,29F), EEPROMS (2816-28C010), NV-RAMS (12XX, X2210/12) 8 PIN SERIAL EEPROMS\* (24, 25, 85, 93, 95, 80011A) PI US ER1400/MS657\* AND ER5901 BIPOLAR PROMS\* (72S/82S), FPGA CONFIGURATORS (17CXXX) MICROCONTROLLERS\* (874X, 875X, 87C5XX, 87C75X, 89C5X) ATMEL MICROS\* (8-40) PIN 89C0651, 89SXXX (AVR) 90SXXX PIC MICROS\* 8, 18, 28, 40 PIN (12CXXX-16CXXX, 16FX, 17C) MOTOROLA MICROS\* (68705P3/U3/R3, 68HC705, 68HC711)

\$289

\*REQUIRES SNAP-IN ADAPTER (ORDER FACTORY DIRECT OR BUILD YOURSELF) \$5.00 SHIPPING • \$5.00 C.O.D. 1 YEAR WARRANTY - 30 DAY MONEY BACK GUARANTEE VISA\* MASTERCARD\* AMEX

ANDROMEDA RESEARCH, P.O. BOX 222, MILFORD, OH 45150  
(513) 831-9708 FAX (513) 831-7562 website - www.arlabs.com

## 1-800-USA-NAVY.

World Wide Web:

<http://www.navyjobs.com>

## Low Cost PICmicro Tools

New! PIC-XI  
Experimenter/  
Lab Board  
\$49.95 to \$199.95



EPIC Pocket PICmicro  
Programmer - \$59.95

Program PICmicros in BASIC!  
PicBasic Compiler - \$99.95  
PicBasic Pro Compiler - \$249.95

PICProto Boards make  
prototyping with PICmicros  
easy - \$8.95 to \$19.95



microEngineering Labs, Inc.

Box 7532 Colorado Springs CO 80933  
(719) 520-5323 fax (719) 520-1867  
<http://www.melabs.com>

## SECRETS!

- **Melt Metal!** Incredible plans, lost secrets, forgotten how-to, and
  - **Machine Shop!** strange books! Request a catalog! Melt metal! Be a
  - **Hydrogen!** machinist, blacksmith, mad
  - **Homesteading!** scientist! Make neon
  - **Engines!** signs, rewind motors.
  - **Radio!** Get high power from auto alternators and generators. Run your car on coal and electricity. Build a working solar cell, shortwave radio, robot, Tesla
  - **Tesla!** coil, more! Make booze, soda pop, magnets, chemicals, embalm
  - **Chemistry!** corpses! Homestead! Mold
  - **Much More!** plastic! All books highest quality! Guaranteed! Fast service!
- BIG CATALOG! WRITE TODAY! • FAX 815/935-5477  
Send Your Name and Address to

Lindsay's **Technical Books!**

Box 538- EBJ, Bradley IL 60915

<http://www.lindsaybks.com>

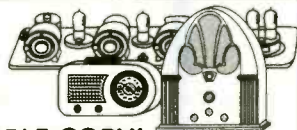

FREE  
SAMPLE COPY!

## ANTIQUE RADIO CLASSIFIED

Antique Radio's Leading  
Monthly Magazine

Classifieds - Ads for Parts & Services  
Articles - Auction Prices - Flea Market Info.  
Early Radio & TV - Hi-Fi - Ham Equip.  
Art Deco - Telegraph - 40s & 50s Radios  
Also the source for Books & Price Guides  
1-Year: \$39.49 (\$57.95 by 1st Class)  
6-Month Trial - \$19.95. Foreign - Write.  
Call: 978-371-0512 - Fax: 978-371-7129

A.R.C., P.O. Box 802-L33

Carlisle, MA 01741

Web: [www.antiqueradio.com](http://www.antiqueradio.com)



www.web-tronics.com

**Fantastic DMM Offer!**

Don't let this price fool you. This meter is a digital multimeter designed for engineers and hobbyists. Equipped with 5 functions and 19 ranges. Each test position is quickly and easily selected with a simple turn of the FUNCTION/RANGE selector rotary switch. **Rubber Boot Included!**  
Display: 3-1/2 Digit LCD, 21mm Figure Height with Automatic Polarity  
Overrange Indication: 3 Least Significant Digits Blank  
Temperature for Guaranteed Accuracy: 23°C  
±5°C RH-75%  
Temperature Ranges:  
Operating: 0°C to 40°C (32°F to 104°F)  
Storage: -10°C to 50°C (14°F to 122°F)  
Power: 9V Alkaline or Carbon-Zinc Battery (NEDA 1604)  
Low Battery Indication: BAT on Left of LCD Display  
Dimensions: 188mm(L) x 87mm(W) x 33mm(thick)  
Net Weight: 400g



ONLY \$19

#9300G

www.web-tronics.com

**2GHz RF Field Strength Analyzer**

Protek

- Frequency Range: 100KHz to 2.60GHz
- Narrow Band FM (NFM), Wide Band FM (WFM), AM and Single Side Band (SSB) Modulated Signals May Be Measured
- PLL Tuning System for Precise Frequency Measurement and Tuning
- LED Backlight LCD (192x192 dots)
- Built-In Frequency Counter
- Hand-Held and Battery Operated
- All Functions are Menu Selected
- RS232C for PC Interface and Printer

ONLY \$1589



#3201

See the web site for details

www.web-tronics.com

**Removable Hard Drive Rack**

For IDE/Ultra DMA Hard Drives  
**We Sold Over 14,000 in 1998!**

This product can be used with any 3-1/2" IDE hard drive up to 1" high. It includes an electronic keypad for safe removal and insertion. Made of ABS 707 fireproof plastic. Use this product to protect sensitive hard drive data, take your hard drive between work and home or even set up different users with their own hard drives that they physically insert every time they use a PC. Other models available from C.S.I. include RH10 series and RH20 series, which are interchangeable within the same interface design (IDE or SCSI). Other Models are Available. See www.web-tronics.com under "hard drive and accessories" for more details and pictures.

ONLY \$1495 any qty.



#RH-10C-IDE

**Removable Hard Drive Rack with Auto Door And Cooling Fan**

- Auto door on the outer frame
- ABS material of outer frame. High efficiency cooling fan
- Worldwide patent pulling function handle
- CE Approved
- Coating iron bottom-cover
- For IDE interface
- For 1" high 3.5" HDD
- Not compatible with our RH10 & RH20 series. Compatible with our RH17-IDE model.

ONLY \$1895 any qty.



#MR-27

Details at www.web-tronics.com

**Auto-Temp Solder Station with Ceramic Element**

ONLY \$39

- With Ceramic Heating Element for More Accurate Temp Adjustment
- 3 Conductor Grounded Power Cord
- 250°C-480°C (470°F-900°F)
- Fast Heating Feature



SR-976

Extra Trip Options Available. See Web!

For More Info See www.web-tronics.com

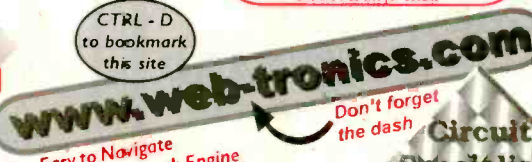

- Easy to Navigate
- Includes a Search Engine
- That Really Works
- New Items Added Constantly

In Business Since 1971

**CCD B&W Board Cameras**

- ASIC CCD Area Image Sensor
- Extremely Low Power Consumption
- 0.5 Lux/Min Illumination
- Built-In Electronic Auto Iris for Auto Light Compensation

**VM1030PA-B**  
30mmx30mmx25mm  
Pinhole lens with audio, 12V  
\$49.00 any qty.

**VMCB21**  
44mmx38.5mmx25mm  
with 6 infra-red LEDs, 12V  
\$49.00 any qty.

**VM1030A**  
30mmx30mmx26mm  
Standard lens with audio, 12V  
\$49.00 any qty.

**VM1035A**  
42mmx42mmx25mm  
Standard lens with audio, 12V with back light compensation  
\$59.00 any qty.

**VM1036A**  
32mmx32mmx25mm  
Standard lens with audio, 12V, reverse mirror image feature  
\$59.00 any qty.

**COLOR CCD Mini Board Cameras**

- Low Power Consumption
- 1 Lux Illumination
- Built-In Electronic Auto Iris for Auto Light Compensation
- Internal Synchronization
- 12V/5V
- 400 TV Lines

**VM3011-A**  
45mmx40mmx24mm  
Standard lens with audio, single board  
\$99.00 any qty.

**VM3010PA**  
33mmx33mmx18mm  
Pinhole lens with audio  
\$129.00 any qty.

**VM3010-A**  
33mmx33mmx20mm  
Standard lens with audio  
\$129.00 any qty.

Details Specs on the Web

**Bullet CCD Cameras B&W and Color**

- Smart Rugged Metal Housing
- Extremely Low Power Consumption
- 12 Volt
- CCD Area Image Sensor for Long Camera Life
- Built-In Electronic Auto Iris for Auto Light Compensation
- No Blooming, No Burning
- 0.1 Min Lux Illumination (B&W), 1 Lux Min Lux Illumination (color)

**VMBLT3025W**  
Digital Color, Weatherproof  
20mm(D)x83mm(L)  
\$189.00 any qty.

**VMBLT1020W**  
B&W Weatherproof  
21mm(D)x58.5mm(L)  
\$79.00 any qty.

**VMBLT1020A**  
B&W with audio  
21mm(D)x55mm(L)  
\$69.00 any qty.

Detailed Specs on the Web

**Mini CCDs (B/W & Color)**

Sensational NEW Design for Small Observation Cameras. Smaller and Better!

- Ultra Miniature Design
- Black & White Versions Only 25mm x 25mm
- Color Versions Only 32mm x 32mm
- Available in Standard Lens or Pinhole Lens
- All Include Audio
- All Include Pre-Wired Cable Harness for Audio, Video & Power
- 12V Regulated Power Supply Required (120mA typical power consumption)
- 0.1 LUX Rating (B/W), 1 LUX (color)
- CCD Area Image Sensor for Long Camera Life
- Back Light Compensation Circuit
- Built-In Electronic Auto Iris Lens

**VMPS-718A**  
25mmx25mmx30mm,  
B/W CCD with standard lens, pre-wired cabling for video/audio, 12V DC Power Input  
\$69.00 \$59.00 5 or more

**VMPS-250A**  
25mmx25mmx15mm,  
B/W CCD with pinhole lens, pre-wired cabling for video/audio, 12V DC Power Input  
\$69.00 \$59.00 5 or more

Detailed Specs on the Web

**Our Most Sophisticated DMM** We Sold Over 200 Last Year!

- with RS-232 Interface & Software, 3-3/4 Digit, 4000 Count, AUTO-Ranging
- True RMS Mode
  - 10MHz Frequency Counter
  - Time Mode with Alarm, Clock and Stop Watch
  - Dual Display
  - 10 Location Memory
  - Min, Max, Avg and Relative Mode
  - Decibel Measurement
  - Cap and Ind. Measurement
  - Temperature Mode (C/F)
  - K Type Temperature Probe Included
  - Pulse Signal for Logic & Audible Test
  - Continuity/Diode Test
  - Logic Test
  - Auto Power OFF/"Keep ON" Mode
  - Fused 20A Input with Warning Beeper
  - Back Light
  - Data Hold/Run Mode
  - Safety Design UL1244 & VDE-0411
  - Protective Holster
  - Silicon Test Leads

NOW ONLY \$129 Reg. \$169

More Details on our Web Site

PROTEK 506

**Protek**

**Series 6500 Deluxe 20MHz/40MHz/60MHz/100MHz Dual-Trace Oscilloscopes**

- Alternate Trigger
- Internal Sync Separator Circuit
- Alt-Mag Sweep
- Delay Sweep (6510)

LATEST DESIGN!

Asia's currencies are devalued against U.S. dollars. Take advantage of GREAT prices while they last!

#6502 - 20MHz \$289

#6504 - 40MHz \$569

#6510 - 100MHz \$799

For More Information See www.web-tronics.com

Part No.	6510	6506	6504	6502
Bandwidth	100MHz	60MHz	40MHz	20MHz
Vert. Sensitivity	1mV/Div	1mV/Div	1mV/Div	1mV/Div
Max Sweep Rate	to 5V/Div	to 5V/Div	to 5V/Div	to 5V/Div
Delay Sweep	YES	YES	YES	YES
Vert. Mode Tng.	YES	YES	YES	YES
Cursor Readout	NO	NO	NO	NO
CRT Volts	12KV	10KV	10KV	2KV

These deluxe HC Protek oscilloscopes provide the features and accuracy that serious technicians and engineers need at prices well below what you may have expected. These dual-trace, dual-channel, scopes have Alt-Mag sweeps and provide simultaneous display of normal and magnified traces. An internal sync separator circuit provides stable triggering of video signals-TVH (TV line synchronizing feature) and TVV (TV frame synchronizing frequency) are automatically switched by the Time/Div front-panel control. The user can view parallax-free waveform measurements on the large 6" rectangular CRT that includes an illuminated internal 8x10 Div graticule.

**3000 Series Digital R/O Bench Power Supplies**

- Low Cost Single Output
- High Performance Triple Output

High stability digital read-out bench power supplies featuring constant voltage and current outputs. Short-circuit protection and current limiting protection is provided. The dual output versions can be used in both serial voltage and parallel current configurations to double maximum outputs. Highly accurate LED accuracy and stable line regulation make the 3000 series the perfect choice for lab and educational use.

- Line Regulation: 2x10<sup>-4</sup> +1ma
- LED Accuracy: Voltage ±1% +2 digits
- Current ±1.5% +2 digits
- Wave Line Noise: ±1mVrms
- Dimensions: 291mm x 158mm x 136mm (CS13003 & CS13010)
- 365mm x 265mm x 164mm (CS13003-3 & 3005-53)

**CS13003:** 0-30V/0-3amp Digital R/O Bench PS, 1x10<sup>-4</sup>+5mV Load Regulation \$99.00 5/\$89.00  
**CS13010:** 0-30V/0-10amp Digital R/O Bench PS, 1x10<sup>-4</sup>+30mV Load Regulation \$149.00 5/\$139.00  
**CS13003-3:** Triple Output 2x(0-30V/0-3amp)+5V, 3amp Fixed, 1x10<sup>-4</sup>+5mV Load Regulation \$239.00 5/\$219.00  
**CS13005-3:** Triple Output, 2x(0-30V/0-5amp) +5V, 3amp Fixed, 1x10<sup>-4</sup>+25mV Load Regulation \$269.00 5/\$249.00

3000 Series Supplies Will Become Available Approximately September 25, 1999. Orders Are Being Taken Now.

## SURVEILLANCE

### The Latest High Tech Professional Electronic Devices

Our latest catalog offers a HUGE selection of surveillance, countersurveillance - privacy devices: **spy pinhole camera \$99<sup>00</sup>**, hidden video, **"realtime" 15-Hour telephone recorder \$149<sup>00</sup>**, 12 hour VOX recorder phone call register, bug detectors, phone tap detectors, voice disguisers, locksmithing tools, wireless video, vehicle tracking via the internet and much more. Wholesale/retail.

**We will not be undersold.**

Catalog \$5.00 or

[www.spyoutlet.com](http://www.spyoutlet.com)

### SPY OUTLET

PO Box 337, Buffalo NY 14226  
(716) 691-3476/(716) 695-8660

### 3 Axis Motion Control System Complete, ready to run

**\$ 295.00 + 12.00 S/H**

Build or adapt CNC mills, CNC routers, Robots, Etc. Includes: 3 Stepping motors (70 oz/in 200 steps/rev). External board (connects to parallel port of a PC). Power supply. Cables, Manual and the MAXNC drive software, with linear, circular and helical interpolation, acceleration deceleration, full contouring, 'G' code programming, screen plot, code generation from CAD (CAM), and more.

For more information, phone or write to:

#### MAXNC

6730 West Chicago  
Suites 2 & 3  
Chandler, AZ 85226  
Ph (480) 940-9414  
Fax (480) 940-2384

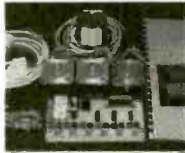

**FREE!**  
(a \$20.00 VALUE)

### CONSTRUCT THOSE SIMPLE AUDIO PROJECTS FROM SESCOM SIPs

JUST APPLY SIGNAL POWER AND OUTPUT CONNECTIONS AND YOU ARE READY TO GO. SIMPLE CONSTRUCTION. PINS ARE ON 0.1" CENTERS



#### GET YOUR SIP-1 AUDIO MODULE TODAY

**"ONLY \$2.00 FOR SHIPPING AND HANDLING EXPERIMENT FOR YOURSELF TO SEE THE BENEFITS OF THESE DEVICES. THERE ARE 25 DIFFERENT DEVICES IN THE SIP PRODUCT LINE.**

OFFER GOOD ONLY IN THE 48 STATES. OFFER ENDS DECEMBER 20, 1999. LIMIT ONE REQUEST PER CUSTOMER. MUST BE PREPAID BY CREDIT CARD OR CHECK. MAILED 1ST CLASS. ALLOW 1-2 WEEKS FOR DELIVERY



ORDERS 800-634-3457 • FAX 800-551-2749  
OFFICE 702-565-3400 • FAX 702-565-4828  
[www.sescom.com](http://www.sescom.com) • [info@sescom.com](mailto:info@sescom.com)  
SESCOM, INC. 2100 WARD DR. HENDERSON, NV 89015  
SESCOM, INC. is not responsible for inadvertent typographical errors and prices and specifications are subject to change without notice.

## Cable T.V. Converters & Equipment

Lower Prices  
Dealer Discounts  
30-Day Money Back  
1-year Warranty  
MC, Visa, AE, COD



No Florida Sales

[www.cable4you.com](http://www.cable4you.com)

**1-(800) 888-5585**

## Locate Bad Caps Fast

### IN-CIRCUIT!!

Lower Costly Service Time  
Reduce Costly Callbacks  
Tame "TOUGH DOGS" in Minutes  
**INSIST on the ORIGINAL Capacitor™**



### IN-CIRCUIT ESR METER

Large, easy to read analog meter makes for the fastest, most accurate testing available! Unique "Cap GOOD" beeper makes testing caps In Circuit **virtually INSTANTANEOUS!!** Needle sharp **GOLD PLATED** stainless steel probes provide **FAST and POSITIVE** connection to both AXIAL and RADIAL caps.



Technicians say the Capacitor Wizard is *"the most cost effective instrument on their workbench!"*

**ONLY \$179.95**  
**800-394-1984**

For More Information goto  
[www.heinc.com/einc/cwinfo.htm](http://www.heinc.com/einc/cwinfo.htm)

**30 DAY MONEY BACK GUARANTEE**  
**Order today! You Can't Lose!!!**

**Made in the USA!**



**Howard Electronic Instruments, Inc.**  
6222 N. Oliver, Kechi, KS 67067  
316-744-1993 International  
316-744-1994 Fax  
Email: [sales@heinc.com](mailto:sales@heinc.com)



## MEMBRANE SWITCHES

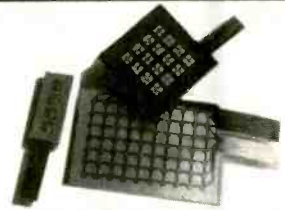

**Stock Layouts!**

**Eliminates tooling cost...**

**\*\*From 2 to 128 keys\*\***

**Industrial/Commercial/Prototyping**

Popular types are available as complete **kits**, with bezel, connector & overlay!

4 key DSK-4 kit **\$9.60**  
12 key DSK-12 kit **\$13.87**  
many more layouts...

**Optional Stainless Steel "Clickdomes".**

### Sil-Walker

(805) 491-0654

FAX (805) 491-2212

P.O. Box 3220

Camarillo, CA 93011-3220

[silwkr@vcnet.com](mailto:silwkr@vcnet.com)

[www.vcnet.com/silwkr/](http://www.vcnet.com/silwkr/)

MASTERCARD/VISA

## Brand Electronics Digital Power Meters



Measures and displays:  
Real Power: 1 to 1850 w;  
Vrms, Irms, VAR, VA  
PF, Peak Watts, kWhrs,  
cost per month.

Features available:  
computer interfacing,  
data logging.

Models from \$149.95

Custom applications

orders: 1-800-433-6600

info: 207-549-3401

[www.brandelectronics.com](http://www.brandelectronics.com)

dealer inquiries:  

[atkinson@brandelectronics.com](mailto:atkinson@brandelectronics.com)

# Electronic Design Automation for Windows

**More Features  
More Power  
Less Money**

Ivex 650 pin versions have no feature limitations like other low cost products on the market. Ivex WinDraft and WinBoard are the preferred choice for designers worldwide.

Take the Ivex challenge today. Try WinDraft Version 3.0 schematics for 30 days. We know you will find it to be the most powerful, full featured tool available, Guaranteed or your money back!

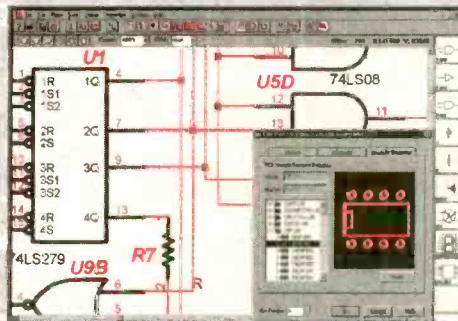

**WinDraft®**  
Schematics **\$250**  
650 pin version

**WinBoard®**  
PCB Layout **\$250**  
650 pin version

**Full Featured Tools:**  
Hierarchical designs  
Part scaling  
Step & repeat  
True-type text  
Auto junction  
Single click editing  
Rubberbanding  
Graphical part editor  
Update parts  
Global replace  
Advanced Bill of Materials  
with sort options.  
User Definable  
Electrical Rules Check  
Annotation  
Common netlist formats:  
(Accel, Protel, Pads, Pcad,  
Tango, wirelist, spice, etc.)  
Import Orcad/SDT  
sheets/libraries  
Assign net signal properties  
for PCB layout  
Visual PCB footprint browser  
Over 10,000 parts included  
Windows 95/98/NT

**Easy to install:**  
Multi layer designs (16)  
Surface mount designs  
Advanced Design Rule Check  
Electrical DRC check and  
Real-Time DRC  
Rotate and mirror  
Single click editing  
Pad stack editor  
Global edit  
Graphical part editor  
Hundreds of footprints  
Copper zone pour  
Uses common netlist formats  
Edit netlist on the fly  
Output Gerber photo plot files  
NC drill report  
Bill of materials  
Free web support

**Ivex View**  
Gerber Viewer **\$99**  
Any size file

View and print any size file in  
standard Gerber 274-x format  
and most 274-D.

Visit the Ivex web site for complete product  
information and free product demos.



[www.ivex.com](http://www.ivex.com)



Telephone: (503) 531-3555  
e-mail: [sales@ivex.com](mailto:sales@ivex.com)

ADV5\_1

PC  
PLACE

December 1999, Electronics Now

# "I Got The Career I Wanted And The Pay I Deserve. You Can Too!"

*Earn up to \$20/Hour and  
more as a PC Specialist*



Were you passed up for the promotion because someone had the computer skills you didn't? Are you entering the job market again? Or, do you want your business to run more efficiently?

A lot of ambitious people, like you, have been asking these same questions. Foley-Belsaw has the



answer. The Personal Computer Repair Course.

With Foley-Belsaw's Computer Repair Course, you'll get the computer skills to land a better job or start a business of your own. Trained Computer Repair Technicians can

earn \$25 to \$40 an hour and that's just a start. In a business of your own you can charge \$75 to \$125 an hour for many repair jobs.

The Computer Repair Course is complete. You'll learn using basic step by step easy to understand language. Soon you'll be proficient at all types of advanced repair procedures. With your new skills you can earn a good living and start living better - regardless of your previous computer experience. It's just that simple.

## Get The Foley-Belsaw Training Advantage

Since 1926, Foley-Belsaw has been helping people build a better future. We provide you the training, technical support and resources to succeed. You set your own study pace and train-at home. Our SkillPak lessons teach a variety of computer

operations. You practice as much as you want. There aren't any deadlines and most students complete the course in a few months - at home and in your spare time.

Turn your doubts into dreams. Get the career you want and the pay you deserve. Call or send for your free opportunity kit for the Computer Repair Course or in the electronics field that interests you. Opportunities await you. The information is free and there is no obligation.

*Fill in and  
mail coupon below or  
Call Toll-Free  
1-800-487-2100 Ext. 49  
to receive full  
information and details  
free by return mail.*

**DO IT TODAY!**

**1. Computer Repair, Maintenance & Upgrade:** (NEW) Service the information superhighway as a skilled computer technician. The computerization of America can mean big money to you.

**2. Computer Programming:** Skilled programmers are in demand and technology is the wave of the future. Secure your future. Learn computer languages and programming skills.

**3. TV/Satellite Dish:** Entertainment is big business. Here's your lucky break. Earn top dollar as a skilled satellite dish technician.

**4. Electrician:** The opportunities are endless. As a trained commercial or residential electrician you

future is sure to be bright. Earn while you learn in this fast-growing field.

**5. VCR/DVD Cleaning, Maintenance & Repair:** Learn troubleshooting skills for repairing and servicing VCRs and earn up to \$50 an hour.

**6. Networking Specialist:** Fast-paced America depends on

efficiency. Networking specialists can earn great money tying personal computers together to make efficient operating systems.

**7. PC Specialist:** Learn word processing, spreadsheet and database applications.



## Foley-Belsaw Institute

6301 Equitable Road • Kansas City, MO 64120

Please Check Only ONE of the Following:

**YES! Rush me a free information kit on the Computer Repair Course right away. 321**

VCR/DVD Repair, 320

Computer Specialist, 325

Computer Programmer, 323

TV/Satellite Dish, 322

Electrician, 326

Networking Specialist, 324

Name \_\_\_\_\_

Street \_\_\_\_\_

City \_\_\_\_\_

State \_\_\_\_\_

Zip \_\_\_\_\_

**Or Call Toll-FREE 1-800-487-2100 Ext. 49**

*"Even before I finished my course, I got my first raise. Thank you Foley-Belsaw."*

*John O., Chicago, IL*



**Development, Prototype and Testing**

- **JCM Vulcan Logic Trainer:** Design and test digital circuits in minutes with this trainer and a breadboard. **\$32**
- **JCM Advanced dig daughterboard** **\$39**
- **JCM Analog Trainer:** Use on its own, or to complement to the logic trainer, test analog circuits in minutes. **\$45**
- **UTI PIC-Micro Trainer:** This system gives you the flexibility to test and experiment with micro based designs. Includes a 64K-bit non-volatile E<sup>2</sup> mem, and RS-232 and RS-485 drivers. **\$129**
- **UTI Control Trainer:** Real world interface for the trainer series, with inputs and outputs for measurement and control, analog cond, relays, buffered dig I/O, and more. **\$69**
- **JCM Cybug1 kit:** a great little robot kit for the hobbyist **\$32**
- Prototyping breadboard to fit the above

**Microcontroller Boards and Interfaces**

- These boards include voltage regulation, 64K-bit serial E<sup>2</sup>, RS-232 and RS-485 drivers, interface with screw terminals and/or stackable expansion headers.
- **UTI-P76F:** A flash PIC micro dev board **\$169**
  - **UTI-11A1:** A 68HC11 based SBC **\$189**
- Some interfaces available: **\$49-\$99**
- 4 and 8 channel analog zero and span cct
  - 8 SPDT relays with 2A contacts
  - 2A dual H-bridge for motors and solenoids
  - Audio capture, 2-4 min of audio
  - Micro modem rates @ 2400 - 28.8
  - LCD, 2 line x 16 char, and 4 line x 20 char
  - Ambient temperature and relative humidity
- **UTI-H2CM-XXX-X:** Non-volatile 1PC memory boards (up to 512Kb per board!) **\$39**

**Serial Control and Measurement**

- **UTI-XX-232,485 Series:** measure inputs and trigger events over serial, uses simple ASCII protocol **\$99-\$299**
- **UTI-05-XXX:** 0-5VDC 4 channel 8 bit A/D
- **UTI-DI-XXX:** 0-30VDC 4 channel digital input, adjustable trigger level
- **UTI-OC-XXX:** 8 channel open collector outputs, opt 5V pull-up, drive relays or solenoids
- **UTI-RE-XXX:** 4 SPDT relays w/ 2A contacts
- **UTI-PM-XXX:** 2 channel PWM output with two buffered digital outputs, good for motor control apps, opt H-bridge version.
- **UTI-WM-XXX:** ambient temperature and relative humidity, 8 bit resolution
- More available....
- **UTI- 232-485:** Speak to an RS-485 device with your PC, extend 500' to other serial devices, or chain several UTI-XX-485 devices. **\$129**

**Other Exciting Products**

- **UTI-WC1: Serial CCD Camera.** Board level, takes serial commands through RS-232 at up to 115K Baud, returns CCD data in various res. Great for pics and experimenting, PC SW incl. **\$249**
- **UTI-SCL: WinCam.Live:** Serial port based webcam system for your PC. **\$499**
- **UTI-SCP: SecureCam Pro.** Remote access surveillance camera, event trigger, motion detection, outdoor encl. available **\$599**
- **UTI-ACC:** Capture and play 2-4 min of audio, line level input, dry contact trigger **\$129**
- **UTI-MP-XXX:** serial RS232 radios, 900MHz narrow band RF, ch selectable, 1000' range outdoor, combine with our control and measurement products for a telemetry system. **\$519**

\* All prices in US\$

\*\*Shipping and handling not included

We also provide affordable electronic design, consulting, assembly, and product development.



**Unbound Technologies Inc.**  
1-877-UNBOUND  
(1-877-962-6863)

#25-1725 30 Ave NE Calgary, Alberta, CANADA T2E 7P6

Tel: 403-291-0054 Fax: 403-291-0017

Payment by Cash, Chk, MO, COD

Call us to receive details via fax, mail or email.

**RS232/RS422/RS485 Converters**



**RS232 TO RS485  
2 wire**

- Makes your RS232 port an RS485 port
- Supports up to 40 RS485 devices
- Automatically determines data direction.
- Signal powered version available

ADA485 (requires 9VDC) **\$79.00**  
ADA485-1 for 110VAC **89.00**  
ADA485L signal powered **84.00**

**RS232 TO RS485  
4 wire**

- Converts an RS232 port for use with RS422 or RS485 devices
- Supports up to 40 RS485 or RS422 multidrop devices
- Adds multidrop capability to RS232 devices
- Automatically determines data direction.

CMC's low cost converters adapt any RS232 port for RS422 or RS485 operation. These converters provide your RS232 device with all the advantages of RS422 or RS485 including reliable high-speed operation (up to 200 kbaud) and data transmission distances up to 5000 feet. Two ADA422s can be used to extend any RS232 link up to 5000 feet. Completely transparent to the system; no software changes of any type are necessary.

**RS232 TO RS422**

- Converts bi-directionally between RS232 and RS422
- Use as a short haul modem
- Plug in and go. No software changes required

AD422 (Requires 9VDC) **\$79.00** ADA425 (requires 9VDC) **\$89.00**  
AD422-1 for 110VAC **89.00** ADA425-1 for 110VAC **99.00**

Mention this ad when you order and deduct 5%  
Use Visa, Mastercard or company purchase order

code N9G



**Connecticut microComputer, Inc.**  
PO BOX 186, Brookfield, CT 06804 (203)740-9890

**WWW.2CMC.COM**

**Fax: (203)775-4595**

**BUY BONDS**

**Data Acquisition and Control**

The ADR series of interfaces allow control of analog, digital and relay I/O via RS232 or RS485. Visit the web site for specs, applications and programs in VB, C, BASIC etc. (705) 671-2652

**www.ontrak.net**

**Ontrak Control Systems Inc.**

**PROGRAMMERS** OVER 50 MODELS

ADVANTECH EETOOLS NEEDHAMS DATA I/O ICE TECHNOLOGY HILO SYSTEM GENERAL CHROMA MODULAR CIRCUIT TECHNOLOGY XELTEK



PROMAX EMP-20 MEGAMAX MEGAMAX4 SIMM/SIP TESTER EMUPA

- CALL ADVANTECH LABTOOL 599 EETOOLS SIMMAX  
629 ICE TECH MICROLV 795 CHROMA SIMM/SIP  
650 EETOOLS ALLMAX + 359 MOD-MCT-EMUPA/R  
409 EETOOLS MEGAMAX 279 MOD-MCT-EMUP/R  
509 EETOOLS MEGAMAX4 49 EPROM 1G TO 512K  
369 XELTEK SUPERPRO II 69 EPROM 1G TO 1MEG  
409 XELTEK SUPERPRO II P 99 EPROM 4G TO 1MEG  
249 XELTEK SUPERPRO L 199 EPROM 16G TO 1 MEG  
165 XELTEK ROMMASTER II 89 EPROM 1G TO 8MEG  
479 MOD-MCT-EMUPA 129 EPROM 4G TO 8MEG  
739 STAG ORBIT-32 250 EPROM 8G TO 8MEG



LABTOOL48 MICROMASTER SUPERPRO ALLMAX PLUS ROMMASTER2

**General Device Instruments**

Sales 916-393-1655 Fax 916-393-4949 BBS 983-1234

Web www.generaldevice.com E-Mail icdevice@best.com

**Turn Your Multimedia PC into a Powerful Real-Time Audio Spectrum Analyzer**

**Features**

- 20 kHz real-time bandwidth
- Fast 32 bit executable
- Dual channel analysis
- High Resolution FFT
- Octave Analysis
- THD, THD+N, SNR measurements
- Signal Generation
- Triggering, Decimation
- Transfer Functions, Coherence
- Time Series, Spectrum Phase, and 3-D Surface plots
- Real-Time Recording and Post-Processing modes

**Applications**

- Distortion Analysis
- Frequency Response Testing
- Vibration Measurements
- Acoustic Research

**System Requirements**

- 486 CPU or greater
- 8 MB RAM minimum
- Win. 95, NT, or Win. 3.1 + Win.32s
- Mouse and Math coprocessor
- 16 bit sound card

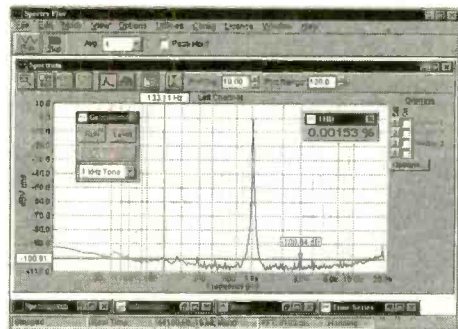

**Priced from \$299**

(U.S. sales only - not for export/resale)

**DOWNLOAD FREE 30 DAY TRIAL!**

**www.spectraplus.com**

**PHS** Pioneer Hill Software  
24460 Mason Rd.  
Poulsbo, WA 98370  
a subsidiary of Sound Technology, Inc.

Sales: (360) 697-3472

Fax: (360) 697-7717



**Spectra Plus**  
FFT Spectral Analysis System

e-mail: pioneer@telebyte.com

**P  
C  
P  
L  
A  
C  
E**

December 1999, Electronics Now

# 386 MINI-PC \$83

1K PRICE  
EVAL \$295  
8088 \$27



- includes:
- 5 Serial, 3 Parallel (32bit max)
  - Up to 8 meg ROM (27C080)
  - 32k RAM exp. to 64Mbyte
  - Battery backed RT Clock
  - LCD and Keyboard ports
  - IRQ x15, DMA x2, TIMER x4
  - On-board LED display
  - Industry Standard PC Bus

Perfect when a full-size PC is too large, expensive, or power hungry. A fully functional single board computer, needs only program and power source. Runs DOS / WINDOWS. Use Turbo C, BASIC, MASM. All utilities to do this included.

## A to D D to A CONVERTERS

For PC or SBC  
8,12,16 bit resolution  
up to 24 channels  
starting at \$21 OEM (1k)  
eval kit \$75

## \$95 UNIVERSAL PROGRAMMER

FLASH, EEPROM, NVRAM, EPROM  
up to 8 meg (27C64-080). Adapters for  
micros, PLCC, etc. Parallel port version  
for notebook. FAST AND EASY TO USE.

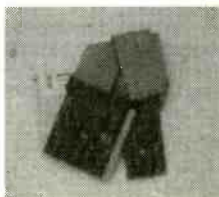

LOW COST... LOW POWER...

## LOW RISC!

QTY 1K PRICE  
\$1.99  
EVAL KIT 7.00

LOWER COST, FASTER, EASIER TO PROGRAM SINGLE CHIP COMPUTER

COMPARE:	16C54	MV1200	PINOUT:
OEM (1K) PRICE	\$2.57	\$1.99	
RS232 PROGRAM DOWNLOAD	NO	YES	RESET 1 20 VCC
SINGLE CHIP OPERATION	NO	YES	PD0 2 19 PB7
BUILT-IN BASIC	NO	YES	PD1 3 18 PB6
EEPROM DATA MEMORY	NONE	64	XOUT 4 17 PB5
PROGRAM MEMORY	768 OTP	1K FLASH	XIN 5 16 PB4
MATH REGISTERS	1	32	PD2/INT 6 15 PB3
MAX INSTRUCTIONS / SEC	5M	20M	PD3 7 14 PB2
MAX COUNTER BITS	16	18	PD4/TMR 8 13 PB1/AD1
INPUT / OUTPUT BITS	12	15	PD5 9 12 PB0/AD0
A TO D COMPARATOR	NO	YES	GND 10 11 PD6
HARDWARE INTERRUPTS	NONE	3	
- LONG WORD INSTRUCTION - FRIENDLY SYMMETRIC ARCHITECTURE -			



## PC SOLID STATE DISK

\$21 OEM (1k) eval kit 75.00  
FLASH / RAM / EPROM  
256K-16M PCMCIA/DIPS

No More Hangups...

## PC WATCHDOG!

Reboots PC OEM \$21 EVAL \$75

VGA 640x480 controller  
for PC or SBC  
LCD \$27 oem \$95 eval  
combo LCD/CRT  
version available



visit our web site: [www.mvsweb.com](http://www.mvsweb.com)

MVS BOX 850  
MERRIMACK, NH 03054  
(508) 792-9507



5yr Limited Warranty  
Free Shipping  
Hrs: Mon-Fri 10-6 EST

# PIC'n Books

LEARN ABOUT PIC MICROCONTROLLERS



See Table Of Contents: <http://www.sq-1.com>  
Secure Online Ordering Is Available

PIC is a trademark of Microchip Technology Inc.

**SQUARE 1 ELECTRONICS**

Voice (707) 279-8881 Fax (707) 279-8883

<http://www.sq-1.com>

## World Passing You By?

Are you interested in Microprocessors & Embedded Control Systems? If not you should be! Look around, just about everything these days has an embedded microprocessor in it. TVs, cars, radios, traffic lights & even toys have embedded computers controlling their actions. The Primer Trainer is the tool that can not only teach you how these devices operate but give you the opportunity to program these types of systems yourself. Examples & exercises in the Self Instruction manual take you from writing simple programs to controlling motors. Start out in Machine language, then move on to Assembler, & then continue on with optional C, Basic, or Forth Compilers. So don't be left behind; this is information you need to know!

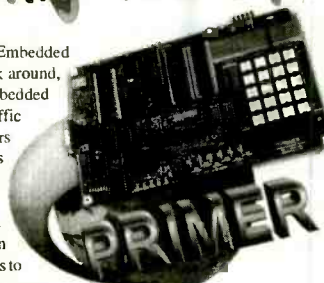

### Examples Include:

- Measuring Temperature
- Using a Photocell to Detect Light Levels
- Making a Waveform Generator
- Constructing a Capacitance Meter
- Motor Speed Control Using Back EMF
- Interfacing and Controlling Stepper Motors
- Scanning Keypads and Writing to LCD/LED Displays
- Bus Interfacing an 8255 PPI
- Using the Primer as an EPROM Programmer
- DTMF Autodialer & Remote Controller (New!)

The PRIMER is only \$119.95 in kit form. The PRIMER Assembled & Tested is \$169.95. This trainer can be used stand alone via the keypad and display or connected to a PC with the optional upgrade (\$49.95). The Upgrade includes: an RS232 serial port & cable, 32K of battery backed RAM, & Assembler/Terminal software. Please add \$5.00 for shipping within the U.S. Picture shown with upgrade option and optional heavy-duty keypad (\$29.95) installed. Satisfaction guaranteed.

# EMAC, inc.

11 EMAC WAY, CARBONDALE, IL 62901  
618-529-4525 Fax 457-0110 BBS 529-5708  
World Wide Web: <http://www.emacinc.com>

1985 - 1998  
OVER  
12  
YEARS  
OF SERVICE

Call Today And **SAVE!** **Unbeatable PRICES!**

# CABLE TV

**DESCRAMBLERS  
CONVERTERS · FILTERS  
VIDEO STABILIZERS**

**FREE** ➤ 30 Day Trial  
**FREE** ➤ Product Catalog  
**FREE** ➤ 1 Year Warranty

**100% MONEY BACK GUARANTEE**



Let us point you in the right direction ...



**TOLL FREE  
888-554-ARROW**  
888-554-2776



# BUGGED??

**EAVESDROPPING** is unbelievably widespread! Electronic Devices with amazing capabilities can be monitoring your telephone and room conversations **RIGHT NOW!** Are you sure you're safe? **FREE CATALOG** tells you fast! Includes Free Bonus details on fantastic opportunities now open in Counter-Surveillance field. Exciting, Immensely interesting and **EXTREMELY** profitable (up to \$250 hr) full/part-time income. Call Now! **1-800-732-5000**

# SINGERS! REMOVE VOCALS

(Unlimited, Low Cost, Instantly Available Background Music from Original Standard Recordings) Does Everything Karaoke does... **Better** and gives you the Thompson Vocal Eliminator Free Brochure & Demo tape. LT Sound Dept. EN 7988 LT Parkway, Lithonia, GA 30058 Internet: <http://www.LTSound.com> 24 Hour Demo/Info Request Line (770)482-2485 · Ext 72 **When You Want Something Better Than Karaoke!**



# BREADBOARD KITS

**USED BY NASA  
NOW AFFORDABLE TO YOU**

**30% OFF**

[www.pulseresearchlab.com/products/breadboarding](http://www.pulseresearchlab.com/products/breadboarding)

## SURVEILLANCE HIDDEN CAMERAS DIRECT FROM MANUFACTURER - BEST PRICE IN THE MARKET

Ultra miniature hidden camera, in dome, smoke or motion detector w/ 1/4" B/W or Color. Wide view angle. Low light sensitivity & super sharp images, plus video and audio output. From \$159.00. Also 1/2" B/W board Cameras w/mic, starts at \$79.00 USD. Wireless hidden camera, start at only \$249.00 USD. Plus \$5.95 for S.M. Wholesale Retail Welcome. C.O.D., Check, Money Order or Visa/MC.

**BOLIDE INTERNATIONAL CORPORATION**  
PH: (800) 355-0895 or (626) 575-8178  
9660 Flair Drive #218, El Monte, CA 91731  
<http://www.tollfreeamazingproducts.com>

## EZ-EP DEVICE PROGRAMMER - \$169.95

Check Web!! -- [www.m2l.com](http://www.m2l.com)

**Fast** - Programs 27C010 in 23 seconds

**Portable** - Connects to PC Parallel Port

**Versatile** - Programs 2716-080 plus EE and Flash (28F, 29C) to 32 pins

**Inexpensive** - Best for less than \$200

- Correct implementation of manufacturer algorithms for fast, reliable programming.
- Easy to use menu based software has binary editor, read, verify, copy, etc. Free updates via bbs or web page.
- Full over current detection on all device power supplies protects against bad chips and reverse insertion.
- Broad support for additional devices using adapters listed below.

### Available Adapters

EP-PIC (16C5x 61.62x.71.84)	\$49.95
EP-PIC64 (62.5.72-4)	\$39.95
EP-PIC12 (12C50x)	\$39.95
EP-PIC17 (17C4x)	\$49.95
EP-51 (8751 C51)	\$39.95
EP-11E (68HC11 E/A)	\$59.95
EP-11D (68HC711D3)	\$39.95
EP-16 (16bit 40pin EPROMS)	\$49.95
EP-Z8 (Z86E02, 3.4.6.7.8)	\$39.95
EP-SEE2 (93x 24x 25x.85x)	\$39.95
EP-750 (87C750, 1.2)	\$59.95
EP-PEEL (ICT22v10, 18v8)	\$59.95
EP-105 (89C1051, 2051)	\$39.95
EP-PLCC (PLCC EPROMS)	\$49.95
EP-SOIC (SOIC EPROMS)	\$49.95

### M<sup>2</sup>L Electronics

970/259-0555 Fax: 970/259-0777  
250 CR 218 Durango CO 81301  
CO orders add 7% sales tax.  
<http://www.m2l.com>

**EZ-EP  
M<sup>2</sup>L ELECTRONICS**  
Los Angeles California

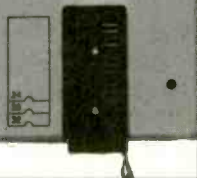

# Battery Analyzer



**PC-Controlled Battery Analyzer**  
Cycle, Charge & Test with your PC  
Print reports, plot graphs, expandable **\$398**

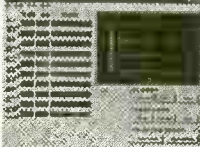

Tel: 800-673-3585  
519-472-5566  
Fax: 519-472-1702

Download Demo: <http://members.home.net/lamantia>  
LaMantia Products Ltd.  
[lamantia@csl.com](mailto:lamantia@csl.com)

# SUPERCIRCUITS

America's #1 Microvideo Source

**MICRO  
COLOR  
CAMERA  
\$89.95  
350 TVL  
1" X 1"**

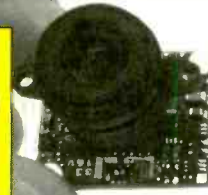

**FREE  
CATALOG!  
CALL US  
TODAY  
AND GET  
YOURS!**

**COLOR  
\$149.95**

**SUPER STEALTHY  
PINHOLE  
\$69.95**



**FREE PLUG & PLAY CABLES**



**HIGH RES 4" TFT COLOR  
MONITOR \$269.95**

**STEALTHY SEE-IN-THE-DARK  
WEATHERPROOF WITH  
54 IR LED's \$159.95**

**AMAZING NEW  
UNDERCOVER VIDEO**

cap cam \$149.95  
glasses cam  
tie cam  
bag cam  
pager cam



**WIRELESS VIDEO**

**\$429.95**



**COLOR CAMERA, AUDIO,  
2.4 GHz TRANSMITTER,  
RECEIVER W/ BUILT-IN TFT  
DISPLAY, 700 FEET RANGE**

**STEALTHY PINHOLE  
VIDEO CAMERA \$39.95  
410 TVL, 0.5 LUX, 1.2"**

If you're looking for the best in microvideo...  
Call us today and get our new 72 page catalog!

**1-800-335-9777 ext ES**

Or fax us at 512-260-0444

**www.supercircuits.com**

**UNBEATABLE DEAL**

**SUPER TINY COLOR VIDEO  
CAMERA, AUDIO, PLUG &  
PLAY CABLES- \$69.95!!!**



9 out of 10 mice  
prefer the Consumer  
Information Catalog  
online. Catch it at  
**www.pueblo.gsa.gov.**

U.S. General  
Services  
Administration



# ELECTRONIC TECHNOLOGY TODAY INC.

P.O. Box 240 • Massapequa Park, NY 11762

## INVENTORY BLOWOUT SALE



\* ALL CANADIAN CHECKS MUST CLEAR THROUGH AN AMERICAN BANK

BP07	100 Radio Hookups	\$3.00	BP304	Projects for Radio Amateurs and S.W.L.S	\$5.99
BP37	50 Projects Using Relays, SCR's and Triacs	\$3.99	BP317	Practical Electronic Timing	\$6.99
BP48	Electronic Projects for Beginners	\$2.99	BP320	Electronic Projects for Your PC	\$5.99
BP56	Electronic Security Devices	\$3.99	BP321	Circuit Source Book 1	\$6.99
BP64	Semiconductor Technology Elements of Elect Book 3	\$5.99	BP322	Circuit Source Book 2	\$6.99
BP74	Electronic Music Projects	\$3.99	BP329	Electronic Music Learning Projects	\$6.99
BP76	Power Supply Projects	\$3.99	BP332	A Beginners Guide to TTL Digital ICS	\$6.99
BP78	Practical Computer Experiments	\$2.99	BP333	A Beginners Guide to CMOS Digital ICS	\$6.99
BP88	How to Use OP Amps	\$5.99	BP334	Magic Electronic Projects	\$6.99
BP93	Electronic Timer Projects	\$2.99	BP355	A Guide to the World's Radio Stations	\$7.99
BP103	Multi-Circuit Board Projects	\$2.99	BP359	An Introduction to Light in Electronics	\$6.99
BP112	A Z-80 Workshop Manual	\$5.99	BP367	Electronic Projects for the Garden	\$6.99
BP114	The Art of Programming the 16K ZX81	\$3.99	BP370	The Superhet Radio Handbook	\$6.99
BP115	The Pre-Computer Book	\$2.99	BP371	Electronic Projects for Experimenters	\$6.99
BP124	Easy Add-On Projects for the Spectrum, ZX81 & ACE	\$3.99	BP374	Practical Fibre-Optic Projects	\$6.99
BP148	Computer Terminology Explained	\$2.99	BP378	45 Simple Electronic Terminal Block Projects	\$6.99
BP154	An Introduction to MSX Basic	\$3.99	BP379	30 Simple IC Terminal Block Projects	\$6.99
BP156	An Introduction to QL Machine Code	\$3.99	BP384	Practical Electronic Model Railways Projects	\$6.99
BP187	A Prac Ref Guide to Word Pro Amstrad PCW8256/PCW8512	\$7.99	BP391	Fault-Finding Electronic Projects	\$6.99
BP190	More Advanced Electronic Security Projects	\$3.99	BP392	Electronic Project Building for Beginners	\$6.99
BP194	Modern OPTO Device Projects	\$3.99	BP393	Practical Oscillator	\$6.99
BP232	A Concise Introduction to MS-DOS	\$3.99	BP394	An Introduction to PIC Microcontrollrs	\$7.99
BP245	Digital Audio Projects	\$3.99	BP396	Electronic Hobbyists Data Book	\$7.99
BP248	Test Equipment Construction	\$3.99	BP401	Transistor Data Tables	\$7.99
BP256	An Intro to Loudspeakers and Enclosure Design	\$3.99	BP411	A Practical Intro to Surface Mount Devices	\$6.99
BP264	A Concise Advanced User's Guide to MS-DOS	\$3.99	BP413	Practical Remote Control Projects	\$7.99
BP267	How to Use Oscilloscopes and Other Test Equipment	\$5.99	PCP107	Digital Logic Gates and Flip-Flops	\$10.99
BP272	Interfacing PCS and Compatibles	\$5.99	PCP112	Digital Electronics Projects for Beginners	\$10.99
BP290	An Intro to Amateur Communications Satellites	\$5.99	PCP114	Advanced MIDI Users Guide	\$10.99
BP297	Loudspeakers for Musicians	\$6.99	ETT1	Wireless & Electrical Cyclopedia	\$4.99
BP299	Practical Electronic Filters	\$6.99			

PRICES DO NOT INCLUDE SHIPPING & HANDLING. ALL SALES ARE FINAL, NO RETURNS

### ORDER FORM

Book No.	Title	Price	No. of Copies	Cost

SHIPPING COSTS	
\$0.01 to \$5.00	\$2.00
\$20.01 to \$30.00	\$5.00
\$5.01 to \$10.00	\$3.00
\$30.01 to \$40.00	\$6.00
\$10.01 to \$20.00	\$4.00
\$40.01 to \$50.00	\$7.00
\$50.01 and above	\$8.50

Total Amount \$	
- 30% off	
Subtotal	
Add shipping cost (see table)	
Local NY State Sales Tax	
TOTAL COST \$	

Name \_\_\_\_\_  
 Address \_\_\_\_\_  
 City \_\_\_\_\_ State \_\_\_\_\_ Zip \_\_\_\_\_

If you wish to use a Credit Card:

MasterCard  Visa      Expire Date \_\_\_\_\_  
 Card No. \_\_\_\_\_  
 Signature \_\_\_\_\_

Allow 6-8 weeks for order to be fulfilled.

Please return this order form to:  
**ELECTRONIC TECHNOLOGY TODAY, INC.**  
 P.O. Box 240  
 Massapequa Park, NY 11762-0240



Telephone Orders: If you wish to place your credit-card order by phone, call 516/293-0467. Automated order taking system functions 24 hours a day. Have your credit-card ready. Sorry, no orders accepted outside of U.S.A. and Canada. New York State Residents must add applicable sales tax. Offer expires 3/31/00.

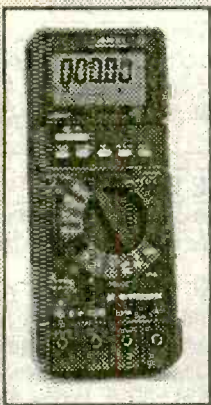

## BK PRECISION®

The 5300 Series, one of the world's finest digital multimeters. The best of the ASYC II Series, it has the best accuracy, a built-in counter and displays AC voltage as resistive power or dB (impedance selectable), saving you the time of making the calculation. A careful examination of the performance features and user-conscious design will tell you that you hold a superior DMM in your hand, designed with measurement capability needed by users who demand the best.

MFG	MODEL	ACCY	LIST	SPECIAL PRICE
B&K	5360/MX53B	0.1%	\$229.00	\$129.00
B&K	5380/MX55	0.025%	\$309.00	\$139.00
B&K	5390/MX56B	0.025%	\$325.00	\$149.00

(resistive power on model #5390/MX56B)

\* meters made in France by Matrix for B&K, feature 50,000 count capability, bargraph, true RMS, mains disturbance indication, good transient protection, a wide temperature range, conform to IEC 1010 class 2 safety compliance & 3 year warranty

The 845 is a software expandable universal device programming workstation that supports a wide variety of programmable devices with the added capability to test digital ICs. It is the most sophisticated low-cost programmer available today. A unique hardware/software architecture enables the Model 845 to easily grow in support and engineering software design capabilities as quickly as your device library requirement. State-of-the-art universal programmer offers you the most advanced programming facilities with the most user-friendly interface. Since each pin is software addressable, new part numbers can be added to the list of supported devices through software upgrades. The 845 interfaces with IBM, PC, XT, PS/2, AT, 386, 486, Pentium, portable or compatible personal computers. The standard package allows you to directly connect to your PC through any standard parallel printer port (no special interface card or special modules needed).

### Universal Device Programmer & Logic IC Tester Model #845

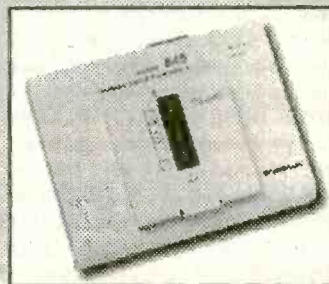

MODEL	DESCRIPTION	REGULAR	SALE
840	Eprom Programmer (single socket)	205.00	192.95
841	Eprom Gang Programmer (4 sockets)	260.00	251.95
842	Universal Programmer	695.00	511.95
843	Universal Programmer (parallel port interface)	795.00	599.95
845	Universal Programmer (parallel port interface) Windows based	1295.00	1139.95
846	Universal Programmer (parallel port interface)	495.00	435.95
847	Universal Programmer (4 sockets, parallel port interface)	595.00	523.95

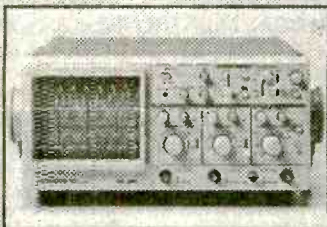

# KENWOOD

MODEL CS-4125

20 MHz, 2 Channel Oscilloscope, with probes & 3 year warranty  
Suggested Price \$495.00

**SUPER SPECIAL \$389.00 w/free t-shirt!!!**



### Analog Oscilloscopes without Readout & Cursors

model#	description	regular	sale	bonus
CO-1305	5 MHz, 1 CH	385.00	309.00	includes free t-shirt!
CS-4125	20 MHz, 2 CH	495.00	389.00	includes free t-shirt!
CS-4135	40 MHz, 2 CH, 12 kV CRT w/scale illumination, 3 year warranty	795.00	599.00	includes free t-shirt!
CS-5355	50 MHz, 3 CH, Delayed Sweep, 3 year warranty	945.00	799.00	includes free t-shirt!
CS-5375	100 MHz, 3 CH, Delayed Sweep, 3 year warranty	1295.00	1049.00	includes free t-shirt!

### Analog Oscilloscopes with Readout & Cursors

model#	description	regular	sale	bonus
CS-6040	150 MHz, 4 CH, Delayed Sweep, Video Triggering System, Front Panel Memory	3189.00	2550.00	includes free t-shirt!
CS-6030	100 MHz, 4 CH, Delayed Sweep, Video Triggering System, Front Panel Memory	2695.00	2155.00	includes free t-shirt!
CS-5370	100 MHz, 3 CH, Delayed Sweep, w/Readout & Cursors	1595.00	1299.00	includes free t-shirt!
CS-5350	50 MHz, 3 CH, Delayed Sweep, w/Readout & Cursors	1095.00	949.00	includes free t-shirt!



Products International

8931 Brookville Rd \* Silver Spring, MD, 20910

800-638-2020 \* Fx 800-545-0058 \* [www.prodintl.com](http://www.prodintl.com) \* [sales@prodintl.com](mailto:sales@prodintl.com)



Call, fax or email today for complete specs on any of the above products, and a copy of our 84 page test and measurement instrument catalog

# CLASSIFIED

## BUSINESS OPPORTUNITIES

**\$400 Weekly Assembling** electronic circuit boards/products from home. For FREE information send SASE: **Home Assembly-EN** Box 216 New Britain, CT. 06050-0216

**FREE MONEY! NEVER REPAY. GUARANTEED. BUSINESS START, EXPANSION, PERSONAL NEEDS, DEBT CONSOLIDATION. FREE PACKAGE 1-888-290-5605**

**FREE DEBT RELIEF!** Not a loan. Not bankruptcy. Lower payments and interest instantly. Private. Call **AMERIX NOW. 1-800-847-5869 (ext 4299).**

## CABLE TV

**Cable TV descramblers.** One-piece units. Scientific Atlanta, Jerrold, Pioneer, and others. Lowest prices around. **Precision Electronics,** Houston, TX anytime 1-888-691-4610.

**CABLE DESCRAMBLER PLANS!!!** Plus two free bonuses, Radar Jammer Plans and Cable manual \$14.00. 1-888-367-9972 **WHOLESALE PRICES, SUPERIOR QUALITY, INTERNAL AND EXTERNAL ACTIVATORS. 1ST TIME DISCOUNT. COD ONLY. 24/7 MESSAGE SERVICE. SALES OPEN M-F 8:00 AM TO 4:30 PM. CALL LUNAR INDUSTRIES 1-800-289-9566.**

**PAY TV AND SATELLITE DESCRAMBLING 2000 EDITION.** All new. All the latest satellite fixes, schematics, blockers, activators etc. for cable and satellite \$16.95. Complete Pay TV Series (Vol. 1-10) \$59.95. Hacking Satellite Systems Videos \$29.95. Scrambling News subscription with web access \$34.95. Everything listed above \$99.95. Choose hard copy or CD-ROM. **SCRAMBLING NEWS,** 4798 South Florida Ave, PMB-108, Lakeland, FL 33813. 941-646-2564. COD's are OK. Add \$6.00. Free catalog.

**CABLE DESCRAMBLERS,** including activators for all Jerrold Dp5-CFT 22 xx's and SP's. Lowest single or lot prices. Also, **RFT-Dams Zenith, SCIENTIFIC ATLANTA,** and **PIONEER.** Se habla en español. Call 888-684-9277.

**CABLE DESCRAMBLING, New Secret manual.** Build your own Descramblers for Cable and Subscription TV. Instructions, schematics for SSAVI, Gated Sync, Sinewave, \$12.95, \$2 postage **CABLETRONICS,** Box 30502R, Bethesda, MD 20824.

**CABLE BOXES ALL MODELS, ALL CHANNELS.** Lowest prices in the United States. Open seven days a week till midnite, Pacific time. Call (877) 789-7337 TOLL-FREE.

**Descramble** Cable with simple circuit added to Radio Shack RF Modulator and using VCR as tuner, instructions \$10.00. **TELCOM** Box 832E12 Brushly, LA 70719.

**CABLE TV DESCRAMBLERS/CONVERTERS. LOWEST PRICES. 30 DAY MONEY BACK GUARANTEE. 1 YEAR WARRANTY. 1-800-785-1145.**

**NEW!** Cellphone E.S.N. readers \$250 each, cell phone programmers \$175 each, cell phones \$25 each, DSS satellite dish card readers and programmers \$125 each, credit card readers \$250 each, Cable T.V. notch filters 50 cents each, converter boxes \$50 each, magnetic strip card readers for ATM machines, bank cards, drivers license, and all types of data acquisitions all under \$200 each. You pay these super low prices when you deal directly with the manufacturers. When you order "Direct Connection" a 150 page directory published by Ed Treki Publications, you will receive the largest collection of names, addresses, and phone numbers of all the leading American and International manufacturers of these products never before available. Stop paying second, third and fourth hand prices and deal directly with the source!!! Order your copy of "Direct Connection" today for only \$59.95 plus \$5 shipping. All orders are sent C.O.D. Please call Ed Treki Publications 24 hour order hot line 914-544-2829.

**HAVE A BEEPING OR CHIRPING SOUND WITH SCRAMBLED VIDEO ON CHANNELS. WE CAN HELP. PROFESSIONAL QUALITY NOTCH FILTERS.** \$16.00ea. DISCOUNTS on 5 or MORE. 100 for \$7.00ea. **FAST COURTEOUS SERVICE.** Visa, Mastercard and Discover. Visit our Website at [www.gofilters.com](http://www.gofilters.com). CALL 1-800-684-0527

## CB-SCANNERS

**CB Radio Modifications!** Frequencies, kits, high-performance accessories, books, plans, repairs, amps, 10-Meter conversions. The best since 1976! Catalog \$3.00. **CBCI** Box 1898 EN, Monterey, CA 93942. [www.cbciintl.com](http://www.cbciintl.com)

## COMPUTER HARDWARE

**ROBOT Module.** Security Robot Kit. Free Catalog. [www.actionrobotics.com](http://www.actionrobotics.com). **ACTION ROBOTICS** Box 138, Boston, NY 14025

## EDUCATION

**LEARN ELECTRONICS. HOME STUDY. OUTSTANDING CAREERS. FREE LITERATURE. P.C.D.I., ATLANTA, GEORGIA.** CALL 800-362-7070. DEPT. ELP342.

## MISC. ELECTRONICS FOR SALE

**Acquire, Control, Display!** Simple, fast, and fun systems. [www.industrologic.com](http://www.industrologic.com) (314) 707-8818.

**T & M Electronics.** Large variety of electronic parts since 1966. Visit our Website at [www.tandmelectronics.com](http://www.tandmelectronics.com)

## PLANS-KITS-SCHEMATICS

**ELECTRONIC PROJECT KITS:**\$3.00 catalog. 49 McMichael St. Kingston, ON., K7M 1M8. [www.qkits.com](http://www.qkits.com) - **QUALITY KITS**  
**HDTV HACKING,** unpacking the data stream to decode HDTV, \$19.95. **CABLETRONICS,** Box 30502R Bethesda, MD 20824.

**TUBE GUITAR AMP KITS!** Blackface style combos and heads from \$499. [www.iguitar.com](http://www.iguitar.com)/allen email-tonesavor@fuse.net Phone (606) 485-6423.

**SILENT, SECRET, SUPER POWERFUL SUBLIMINAL MESSAGE TRANCE INDUCER-Plans** \$21.00 Dennis Wilson, PO Box 6604, Delray Beach, FL 33482.

## REPAIRS-SERVICES

**PCB DESIGNS, SCHEMATICS:** Professionally Mastered in "TANGO". **Awesome Designs** PO Box 214 Aurora, Ohio 44202-0214. Visit us at <http://home.att.net/~awomedesigns/index.html>

## SATELLITE EQUIPMENT

**DSS Test card.** Authorizes all channels for information, plus free bonus. Call toll free 1-888-416-7296.

**FREE Satellite TV Buyer's Guide.** Best Products - Lowest Prices - Fastest Service! Dish Network, DirecTV, C/Ku-band, including 4DTV. Parts - Upgrades - Accessories! **SKYVISION** - 800-543-3025. International 218-739-5231 [www.skyvision.com](http://www.skyvision.com)

**DSS Hacking:** How to construct and program smart cards, with pic16C84, PCB layout. Complete DSS system schematics, \$16.95. Software \$25. **CABLETRONICS** Box 30502R Bethesda, MD 20824.

## TEST EQUIPMENT

**Test Equipment Sale!** Complete listing at <http://www.astglobal.com> or call NOW to receive list by fax or mail. **AST GLOBAL ELECTRONICS:** Voice 888-216-7159; Fax 814-398-1776; e-mail: [sales@astglobal.com](mailto:sales@astglobal.com)

## WANTED

**WANTED: USED TEST EQUIPMENT. TURN IDLE OR EXCESS EQUIPMENT INTO CASH.** **AST GLOBAL ELECTRONICS:** Voice 888-216-7159; Fax: 814-398-1176; e-mail: [sales@astglobal.com](mailto:sales@astglobal.com)

## BEST BY MAIL

Rates: Write National, Box 5, Sarasota, FL 34230  
OF INTEREST TO ALL

**IS BIG BROTHER WATCHING YOU?** Learn how to safeguard privacy, thwart telemarketers, check credit records and more. Free info from: **McClellan Publications, PMB 408, 1410 Blalock, Houston, TX 77055.**

**VISA/MASTERCARD...** Guaranteed Approval!! Also receive over \$10,000 in Credit... Guaranteed! No Security Deposit, Bad or No Credit... FREE Credit Repair Kit... 1-800-635-5380 24 HRS.

## ELECTRONIC SECURITY DEVICES

A great book for project builders. It is quite common to associate the term "Security Devices" with burglar alarms of various types. However in fact it can refer to any piece of equipment that helps to protect people or property. The text is divided into three basic sections: Chapter 1 covers switch-activated burglar alarms and includes exit and entry delays. Chapter 2 discusses other types of burglar alarms and includes Infra-Red, Ultrasonic and Doppler-Shift Systems. Chapter 3 covers other types of security devices such as Smoke and Gas Detectors; Water, Temperature and Baby Alarms; Doorphones, etc. Most circuits are simple, and stripboard layouts are provided.



To order Book BP56 and send \$5.99 includes shipping and handling in the U.S. and Canada only to **Electronics Technology Today Inc.,** P.O. Box 240, Massapequa Park, NY 11762-0240. Payment in U.S. funds by U.S. Bank check or International Money Order. Please allow 6-8 weeks for delivery. ET09

# USE ELECTRONICS NOW CLASSIFIEDS

READ BY ELECTRONIC BUYERS AND SELLERS AND TRADERS

## INSTRUCTIONS FOR PLACING YOUR AD!

### HOW TO WRITE YOUR AD

**TYPE** or **PRINT** your classified ad copy **CLEARLY** (not in all capitals) using the form below. If you wish to place more than one ad, use a separate sheet for each additional one (a photo copy of this form will work as well). Place a category number in the space at the top of the order form (special categories are available). If you do not specify a category, we will place your ad under miscellaneous or whatever section we deem most appropriate.

We cannot bill for classified ads. **PAYMENT IN FULL MUST ACCOMPANY YOUR ORDER.** We do permit repeat ads or multiple ads in the same issue, but in all cases, full payment must accompany your order.

### WHAT WE DO

The first word and company name of each ad are set in bold caps at no extra charge. No special positioning, centering, dots, extra space, etc. can be accommodated.

### RATES

Our classified ad rate is \$2.50 per word. Minimum charge is \$37.50 per ad per insertion (15 words). Any words that you want set in bold are each .40 extra. Indicate bold words by underlining. Words normally written in all caps and accepted abbreviations are not charged anything additional. State abbreviations must be post office 2-letter abbreviations. A phone number is one word.

If you use a **Box** number you must include your permanent address and phone number for our files. **ADS SUBMITTED WITHOUT THIS INFORMATION WILL NOT BE ACCEPTED.**

For firms or individuals offering Commercial products or Services. **Minimum 15 Words.** 5% discount for same ad in 6 issues within one year; 10% discount for same ad in 12 issues. **Boldface** (not available as all caps), add .40 per word additional. **Entire ad in boldface**, add 20%. **Tint screen behind entire ad**, add 25%. **Tint screen plus all boldface ad**, add 45%. **Expanded type ad**, add \$4.00 per word.

**General Information:** A copy of your ad must be in our hands by the 13th of the fourth month preceding the date of issue (i.e. Sept issue copy must be received by May 13th). When normal closing date falls on Saturday, Sunday or Holiday, issue closes on preceding work day. Send for the classified brochure.

### DEADLINES

Ads not received by our closing date will run in the next issue. For example, ads received by November 13 will appear in the March issue that is on sale January 17. **ELECTRONICS NOW** is published monthly. No cancellations permitted after the closing date. No copy changes can be made after we have typeset your ad. **NO REFUNDS**, advertising credit only. No phone orders.

### CONTENT

All classified advertising in **ELECTRONICS NOW** is limited to electronics items only. All ads are subject to the publishers' approval. **WE RESERVE THE RIGHT TO REJECT OR EDIT ALL ADS.**

**AD RATES:** \$2.50 per word. Minimum \$37.50

Send you ad payments to:

**ELECTRONICS NOW 500 Bi-County Blvd, Farmingdale, NY 11735-3931**

### CATEGORIES

100 -- Antique Electronics	270 -- Computer Equipment Wanted	450 -- Ham Gear Wanted	630 -- Repairs-Services
130 -- Audio-Video Lasers	300 -- Computer Hardware	480 -- Miscellaneous Electronics For Sale	660 -- Satellite Equipment
160 -- Business Opportunities	330 -- Computer Software	510 -- Miscellaneous Electronics Wanted	690 -- Security
190 -- Cable TV	360 -- Education	540 -- Music & Accessories	710 -- Telephone
210 -- CB-Scanners	390 -- FAX	570 -- Plans-Kits-Schematics	720 -- Test Equipment
240 -- Components	420 -- Ham Gear For Sale	600 -- Publications	730 -- Wanted

### CLASSIFIED AD COPY ORDER FORM

Place this ad in Category # \_\_\_\_\_ Special Category \$30.00 Additional \_\_\_\_\_

1 - \$37.50	2 - \$37.50	3 - \$37.50	4 - \$37.50	29 - \$72.50	30 - \$75.00	31 - \$77.50	32 - \$80.00
5 - \$37.50	6 - \$37.50	7 - \$37.50	8 - \$37.50	33 - \$82.50	34 - \$85.00	35 - \$87.50	36 - \$90.00
9 - \$37.50	10 - \$37.50	11 - \$37.50	12 - \$37.50	37 - \$92.50	38 - \$95.00	39 - \$97.50	40 - \$100.00
13 - \$37.50	14 - \$37.50	15 - \$37.50	16 - \$40.00	Total words _____ \$2.50 per word = \$ _____			
17 - \$42.50	18 - \$45.00	19 - \$47.50	20 - \$50.00	Bold Face _____ \$0.40 per word = \$ _____			
21 - \$52.50	22 - \$55.00	23 - \$57.50	24 - \$60.00	Special Heading _____ \$30.00 = \$ _____			
25 - \$62.50	26 - \$65.00	27 - \$67.50	28 - \$70.00	Other _____ = \$ _____			

Total classified ad payment \$ \_\_\_\_\_ enclosed **TOTAL COST OF AD \$ \_\_\_\_\_**

Check  MasterCard  Visa  Discover Card # \_\_\_\_\_ Expiration Date \_\_\_\_/\_\_\_\_  
Signature \_\_\_\_\_

Name \_\_\_\_\_ Phone \_\_\_\_\_

Address \_\_\_\_\_ City State Zip \_\_\_\_\_

# ALL ELECTRONICS

C O R P O R A T I O N

QUALITY PARTS

FAST SHIPPING

DISCOUNT PRICING

CALL, WRITE, FAX  
or E-MAIL For A  
**Free 96 Page**  
CATALOG.  
Outside the U.S.A.  
send \$3.00 postage.

## Touchtone Keypad

Farbell # DU200P (A). Standard 12 button telephone keypad with touchtone (DTMF) circuitry. Field replacement for some GTE payphones. White plastic buttons with black numerals and letters. 11 color-coded leads, 9" long with spade lugs.

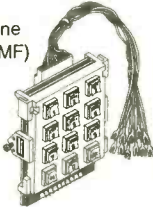

CAT # KP-11

25 for \$75.00

\$4<sup>00</sup> each

## 5" Paging Horn

Metal 5" horn speaker for P.A. applications. 5.25" diameter bell X 6" long. Adjustable metal mounting bracket. 4 ohm impedance.



CAT # SK-120

case of 12  
for \$60.00

\$6<sup>50</sup> each

## Silent Footswitch

Control International, Inc. Quality, heavy-gauge metal footswitch designed for silent operation. S.P.S.T., normally-open, rated 11 Amps @ 250 Vac. No-slip rubber pad on top surface. 3' cable, 2 conductor 16 AWG, stranded wire. 3.56" X 2.73" X 1.36" high.



CAT # FSW-9

\$5<sup>50</sup> each

## 3000 MCD ULTRA-BRIGHT RED LED

Everlight # 383URC-2/TR1-C(R) Red, "Ultra-bright" T 1 3/4 LEDs "Tape-and-reel" parts. These are 5 mm diameter water-clear LEDs that light bright red at 20 ma.



CAT# LED-50

2 for \$1<sup>00</sup>

100 for \$35.00  
1000 for \$250.00

## REDUCED PRICE! 185 Watt Power Supply

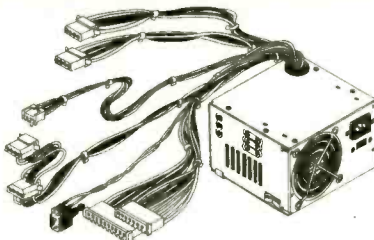

Compaq # 172417-002 (172432-001)  
Input: 120/ 240 Vac (switchable)  
DC outputs: +5V @ 18A, +3.4V @ 12A, +12V @ 6A, -5V @ 0.15A, -12V @ 0.15A.  
Size: 6.5" x 5.75" x 3.85" Built-in fan. On/off switch on 20" lead. Power cord not included. UL, CSA.

CAT # PS-185

\$7<sup>50</sup> each

## 40 RPM Gearhead Motor

Pittman # GM8212C127-R2. Small, powerful gearhead motor.



187:1 ratio. No load specs: 40 RPM @ 19.1 Vdc, 130 mA. 24 RPM @ 12 Vdc, 160 mA. Overall dimensions 3" long X 1.37" diameter. 0.185" (3/16") diameter X 0.75" long shaft. A brass 0.56" diameter gear with 16 cogs is fastened to the shaft. 17" leads.

CAT# DCM-135

\$15<sup>00</sup> each

10 for \$125.00

## S-VHS Video Tapes (Used)

Super VHS tape users! Save a bundle on name-brand S-VHS, T-120 tapes. These tapes were used for a brief period, then bulk erased. The record-protect tabs have been broken out, so you will have to cover the notch with a piece of tape, but they work great.



CAT # S-VHS

\$3<sup>00</sup> each

10 for \$28.00 • 100 for \$250.00

## 20 Character X 4 Line LCD

Optrex # DMC 20434-CEM (PWB 20434-CEM) 5 x 8 dot format. 3" x 1" viewing area. 3.88" x 2.38" module.



Removed from new equipment. May have felt padding on metal bezel. 14 pin single row header is pre-attached. Spec/hook-up sheet included.

CAT# LCD-46

\$7<sup>00</sup> each

10 for \$60.00

## Snap-In Capacitor

560 UF 400 Vdc - NICHICON CE 85° C LQ (M). 1.39" dia. X 1.83" h. 0.4" lead sp.



10 for \$3.75 each

\$4<sup>00</sup> each

100 for \$3.00 each

## AIWA "Surround" Bookshelf Speakers



AIWA# SX-ANA72.

Great sounding, great-looking set of AIWA "Front 180" bookshelf speakers with a unique "expanded imaging" feature. Uses an array of speakers and ports to project the sound forward and toward the center at a 45 degree angle to create an expanded stereo listening area and the impression of a "center-channel." Each speaker has two channels with two separate input cables. The AIWA stereo system for which they were designed had separate outputs for the center-projecting part of each speaker, but the center-angled speakers sound good when connected in parallel with the front-facing channel. Titan silver and charcoal. Removable front grills. 9.75" wide X 11" deep X 12.25" high.

CAT # SK-72

\$49<sup>95</sup> per pair

ORDER TOLL FREE

**1-800-826-5432**

MAIL ORDERS TO:  
ALL ELECTRONICS CORP.  
P.O. BOX 567  
VAN NUYS, CA 91408-0567

FAX (818) 781-2653 • INFO (818) 904-0524  
SHOP ON-LINE [www.allelectronics.com](http://www.allelectronics.com)  
E-MAIL [allcorp@allcorp.com](mailto:allcorp@allcorp.com)



NO MINIMUM ORDER • All Orders Can Be Charged to Visa, Mastercard, American Express or Discover • Checks and Money Orders Accepted by Mail • Orders Delivered in the State of California must include California State Sales Tax • NO C.O.D. • Shipping and Handling \$5.00 for the 48 Continental United States - ALL OTHERS including Alaska, Hawaii, P.R. and Canada Must Pay Full Shipping • Quantities Limited • Prices Subject to change without notice.

**MANUFACTURERS - We Purchase EXCESS INVENTORIES... Call, Write, E-MAIL or Fax YOUR LIST.**

CIRCLE 214 ON FREE INFORMATION CARD

[www.americanradiohistory.com](http://www.americanradiohistory.com)



# Meaningful Certification for Professional Technicians



Since 1965, the International Society of Certified Electronics Technicians (ISCET) has helped train, prepare, and test more than 46,000 technicians in the electronics and appliance service industry. Employers and consumers put their faith in those whose experience, skills, and knowledge have been measured and certified by ISCET. A Certified Electronics Technician (CET) must pass a thorough, two-part exam covering basic electronics and one or more specialty fields.

The Associate Exam costs just \$30, while Journeyman options cost \$35 each. The two exams may be taken at the same sitting (if the candidate has at least four years of professional electronics experience and/or education) for the discounted price of \$50. Journeyman options are available in:

- Audio
- Biomedical
- Communications
- Computer
- Consumer Electronics
- Industrial
- Radar
- Video

In addition to administering technician certification programs, ISCET also facilitates the Federal Communications Commission licensing of commercial operators. ISCET is one of just a few organizations selected to be a Commercial Operator License Examination Manager (COLEM).

FCC licenses available through ISCET include:

- General Radiotelephone Operator License  
Marine Radio Operator Permit (\$50)
- First and Second Class Radiotelegraph  
Operator Certificates (\$75)
- Global Maritime Distress and Safety System  
(GMDSS) Operator License (*call for pricing*)
- Global Maritime Distress and Safety System  
Maintainer License (*call for pricing*)
- Ship Radar Endorsement (*call for pricing*)
- Call for a complete list of study materials  
and question pool information available

*For more information on CET testing,  
FCC licensing or a complete list of study material,  
contact the ISCET office.*

## ISCET

2708 West Berry St. • Fort Worth, TX 76109  
(817) 921-9101, ext. 12; Fax (817) 921-3741  
<http://www.iscet.org> • e-mail: [iscetFW@aol.com](mailto:iscetFW@aol.com)

*Is your future in Electronics Servicing?*

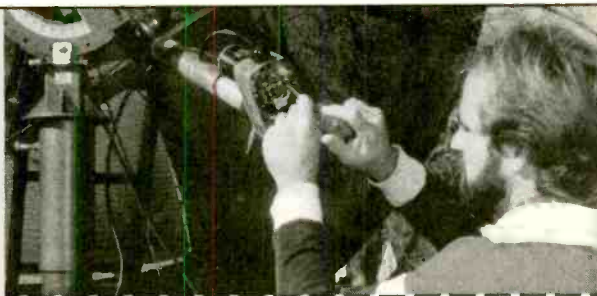

Prices Subject to Change. Complete form and mail to:

## ISCET

2708 West Berry Street; Fort Worth, TX 76109  
(817) 921-9101, ext. 12; Fax (817) 921-3741  
<http://www.iscet.org> • e-mail: [iscetFW@aol.com](mailto:iscetFW@aol.com)

I'm interested in becoming certified. Send me information about test administrators in my area.

### STUDY MATERIAL AVAILABLE:

- The CET Study Guide, 4th Edition \$19.95  
*by Sam Wilson CET* postage 4.00  
For the associate and consumer exams.
- Study Guide for the Associate Level  
CET Test \$14.95
- Study Guide for the CET Test —  
Computer Option \$10.00
- Electronic Communication \$65.95  
*By Robert Shrader* postage 4.00  
Radio communications text for the  
communications option.
- Control Electronics with an Introduction  
to Robotics \$39.00  
*By Sam Wilson CET (hardbound)* postage 4.00  
Study Guide for the industrial option.
- Control Electronics Lab Manual \$14.00  
*By Joe Risse CET* postage 4.00
- Computerized Associate Practice Test and  
Study Guide \$39.95
- Study program with 300 sample  
questions for the Associate CET Exam. postage 4.00
- VCR Troubleshooting & Repair Guide \$24.95  
*By Joe Risse CET* postage 4.00
- CET Associate Practice Test \$5.00
- CET Audio Practice Test \$3.50
- CET Communications Practice Test \$3.50
- CET Consumer Practice Test \$4.00
- CET Industrial Practice Test \$3.50
- CET Radar Practice Test \$3.00
- CET Video Practice Test \$3.50

### PAID

Check/M.O.# \_\_\_\_\_ Date: \_\_\_\_\_

Please allow 4-6 weeks for delivery when using personal checks. Money orders, cashier's checks, and credit cards are processed in 10 days. Foreign shipments, please add International Postage. Please specify Surface or Air. Texas residents multiply dollar amount by 8.25% for taxes.

Amount enclosed: \_\_\_\_\_

VISA;  MasterCard; Exp. Date \_\_\_\_\_

Card No. \_\_\_\_\_

Name: \_\_\_\_\_

Member of  NESDA;  ISCET

Business \_\_\_\_\_

Address \_\_\_\_\_

City \_\_\_\_\_ State \_\_\_\_\_ Zip \_\_\_\_\_

Phone \_\_\_\_\_ Fax \_\_\_\_\_

# RETAILERS THAT SELL OUR MAGAZINE EVERY MONTH

## Arizona

Circuit Specialists, Inc.  
220 S. Country Club Dr.  
Bldg 2  
Mesa, AZ 85210

## California

All Electronics  
14928 Oxnard Street  
Van Nuys, CA 91411

California Electronics  
221 N. Johnson Ave.  
El Cajon, CA 90202

Electronics Plus, Inc.  
823-4<sup>th</sup> Street  
San Rafael, CA 94901

Electronics Warehouse  
2691 Main Street  
Riverside, CA 92501

Ford Electronics  
8431 Commonwealth Ave  
Buena Park, CA 90621

HSC Electronics  
6819 S. Redwood Drive  
Cotati, CA 94931

HSC Electronics  
4837 Amber Lane  
Sacramento, CA 95841

Halted Specialties Co.  
3500 Ryder Street  
Santa Clara, CA 95051

Inland Electronic Suppliers  
1012 N. Carpenter Rd.  
Modesto, CA 95351

JK Electronics  
6395 Westminster Blvd.  
Westminster, CA 92683

Metro Electronics  
1831 J Street  
Sacramento, CA 95814

Minute Man Electronics  
37111 Post St., Suite 1  
Fremont, CA 94536

Orvac Electronics  
1645 E Orangethorpe Ave.  
Fullerton, CA 92631

San Mateo Elec. Supply  
16 W. 42<sup>nd</sup> Ave.  
San Mateo, CA 94403

Sav-On Electronics  
13225 Harbor Blvd.  
Garden Grove, CA 92643

Whitcomm Electronics  
105 W. Dakota 106  
Clovis, CA 93612

## Colorado

Centennial Electronics  
2324 E. Bijou  
Colorado Sps., CO 80909

## Connecticut

Cables & Connectors  
2198 Berlin Turnpike  
Newington, CT 06111

Electronic Service Prod.  
437 Washington Avenue  
North Haven, CT 06473

## Illinois

BB&W Inc.  
2137 S. Euclid Ave.  
Berwyn, IL 60402

Tri State Elex  
200 W. Northwest Hwy.  
Mt. Prospect, IL 60056

## Indiana

ACRO Electronics Corp.  
1101 W. Chicago Ave.  
East Chicago, IN 46312

King of the Road Elec.  
409 E. Center Rd.  
Kokomo, IN 46902

## Maryland

Mark Elec. Supply Inc.  
11215 Old Baltimore Pike  
Beltsville, MD 20705

## Massachusetts

Electronic Hook-Up  
104 Main St.  
Milford, MA 01757

U-Do-It Electronics  
40 Franklin Street  
Needham, MA 02194

## Michigan

Norwest Electronics  
33760 Plymouth Rd.  
Livonia, MI 48150

Purchase Radio Supply  
327 East Hoover Avenue  
Ann Arbor, MI 48104

The Elec. Connection  
37387 Ford Road  
Westland, MI 48185

## Minnesota

Acme Electronics  
224 Washington Avenue N.  
Minneapolis, MN 55401

## Missouri

Gateway Electronics  
8123-25 Page Blvd.  
St. Louis, MO 63130

## New Jersey

Lashen Electronics Inc.  
21 Broadway  
Denville, NJ 07834

## New York

LNL Distributing Corp.  
235 Robbins Lane  
Syosset, NY 11791

T&M Elec. Supply, Inc.  
472 East Main St.  
Patchogue, NY 11772

Unicorn Electronics  
Valley Plaza  
Johnson City, NY 13790

## Ohio

Parts Express  
725 Pleasant Valley Drive  
Springboro, OH 45066

Philcap Electronic Suppliers  
275 E. Market Street  
Akron, OH 44308

## Oregon

Norvac Electronics  
7940 SW Nimbus Avenue  
Beaverton, OR 97005

## Texas

Computers Electronics Etc.  
110 E. Medical Center Blvd.  
Webster, TX 77598

Electronic Parts Outlet  
3753 B Fondren  
Houston, TX 77063

Tanner Electronics  
1301 W Beltline  
Carrollton, TX 75006

If you'd like to sell our magazine in your store,  
please circle 210 on free information card

or

Contact Christina Estrada at (516) 293-3000 ext 223



# Component Notebooks

*A new way to organize an electronics experimenter's workbench*

PETER B. REINTJES

**F**or electronics hobbyists, the most common method for keeping track of components is the ubiquitous plastic-drawer cabinet. The author also has several such cabinets, but has never really been all that happy with them.

OK, you might ask, what is wrong with cabinets? In the first place, they are rather bulky, drawers can get broken or lost, and sometimes they are hard to open and close. It can be difficult to pick up a small component from the bottom of these drawers. There are never enough drawers to segregate the individual component types; the author usually ends up putting his low-ohm resistors into two or three drawers and then searching through the drawers for the value needed. To have a drawer for every type of component would require at least 100 drawers, which would take up lots of real estate on an already crowded workbench. Furthermore, the cabinet must be on the back of the workbench or on a low shelf to be within easy reach and still be low enough to look down into the open drawers.

OK, then, what's the alternative? Why not use a set of loose-leaf notebooks to hold the components. In this article, we'll outline a system that can compactly hold virtually every component that you are likely to keep on hand (you'll still need some drawer cabinets for odds and ends and larger components). The notebooks contain clear plastic sheets designed to hold sports trading cards. Each sheet has holes for a three-ring binder and is subdivided into nine plastic pockets. Each pocket can easily hold and display up to 100 small components.

For a variety of reasons, a book is an excellent way to organize items that can be arranged in a linear order. In contrast to bulky drawer cabinets, the author needs just three compact notebooks—labeled "Semiconductors," "Resistors," and "Capacitors"—to store the majority of his on-hand components. Unlike the cabinets, the notebooks don't need permanent space on the workbench or lower shelves because they have to be brought to the desktop and opened to access the

components anyway. This extra step of getting the notebook off a shelf isn't a noticeable disadvantage, particularly when workbench space is at a premium. Of course, drawer cabinets are still useful for large or unusually shaped parts, or when you have a large number of a given part.

Will this system work for you? Almost certainly; let's see why.

**Advantages of Component Notebooks.** The notebook system:

- Requires less space than cabinets
- Is ideal for small numbers of each component type
- Is particularly convenient for small components
- Provides a single location for components and documentation
- Can include tabs for direct access
- Is inexpensive.

It seems like 80% of the author's electronics work is done with less than twenty different components and he keeps two plastic compartment boxes on the workbench with the most frequently used resistor

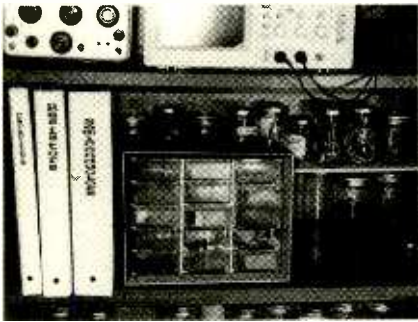

The component notebook system lets you save tons of workbench space when compared to conventional storage methods.

and capacitor values. All other components reside in the three notebooks sitting over the workbench. As can be seen in the photos, the semiconductor notebook is relatively large, with a two-inch wide spine, while one-inch wide and half-inch wide notebooks are sufficient for the resistor and capacitor collections.

**Creating the Notebooks.** The component pages are formed by attaching baseball trading-card sleeves (about ten-cents each) to one half of a three-hole punched manila folder, which provides a backing. Each page contains nine transparent pockets and each pocket can easily contain as many as 100 1/8-watt resistors or small capacitors. The plastic used for these sleeves is extremely slippery, and it is quite easy to remove components from the bottom of the sleeve by pushing them up with a fingertip.

Attach the trading card sheet to the folder with two pieces of tape. One in the lower right corner and one in the upper right corner are sufficient because the left-hand side of the sheet and the backing are held together by the three-ring binder. Attach the plastic so that the tab of the manila folder is available for labeling the page. For the passive components, insert a page printed with the component values between the transparent sheet and the backing.

**Semiconductors.** The notebook organization works well because of the fundamentally one-dimensional aspect of component organization. Resistors and capacitors have a simple numerical ordering, and ICs can be organized by their fun-

damental three or four digit number, even if this means ignoring part of a second-source manufacturer's number. For example, the MC14069 is stored under 4069 with the other variants of the CD4069 hex inverter. That of course means that the 317 voltage regulators are right next to the 318 op-amps. Of course, other organizations are possible since the components are now in the form of a book. If you organize by function, a table of contents or index can help you find out that the LM555 and ICL8038 chips are together on the oscillator page.

The author's semiconductor notebook contains one page of

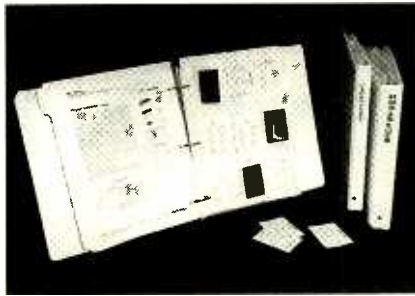

In addition to saving workbench space, component notebooks provide a convenient way to keep documentation such as IC pinouts and data sheets close at hand.

diodes, one page of LEDs, two pages of transistors and about five pages of integrated circuits. For the ICs, cut small blocks of conductive foam to be one-half-inch smaller than the pocket. Up to ten 14-pin ICs fit onto one of those foam blocks, which slips easily into the plastic sleeve. The anti-static property of this foam is wasted on the non-CMOS components, but at \$1.29 for a five-by-five sheet of conductive foam at RadioShack or elsewhere, this is only about 20 cents for each component type.

There is also plenty of room in the semiconductor book for application notes, data sheets, catalogs, and schematics of current projects. The author has photocopied the IC pinout diagrams and cut them into one and a half by two-inch cards that fit into the pockets with the ICs. If you make extra copies of the pinout diagrams and keep them in the sleeve, whenever someone needs to borrow an IC, you can give them a pinout to go with it. This ability to store documentation with your

components, is, in the author's opinion, a major advantage of this approach. Data sheets, application notes, and pinouts are readily available on the Web from just about every semiconductor manufacturer.

**Passive Components.** The author's resistor notebook contains nine pages of resistors or 81 different values and his capacitor notebook has three pages of capacitors, or 27 different values. The largest of the author's drawer cabinets had forty drawers, not nearly enough to hold a full set of the standard resistor values from 1 to 10 megohms. In any case, filling that cabinet with resistors would have been an obvious waste of space because in most cases it is unlikely that more than five resistors for many of the values would be on hand at any time. Adding a single page to the notebook creates room for nine new component values.

**The Bad News.** There is one serious problem with these books. As previously mentioned, it is very easy to slide a component up to the top of the plastic sleeve. So easy, in fact, that you can remove all of the components by simply tilting the book upside down. It doesn't solve the problem to label the notebooks "This End Up" or to advise being careful. It is very easy to lay the notebooks flat, and from there it is only a few degrees of tilt to the dump configuration.

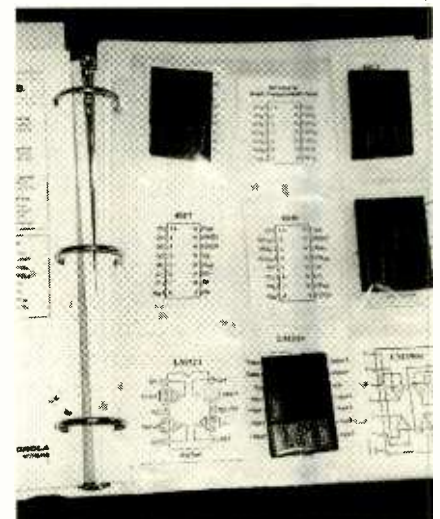

For convenience, mount the ICs (even the non-static sensitive ones) on non-conductive foam.



So what are you going to do with all those unused plastic drawers? Why not put them to work as etchant trays for small PC boards.

There are a couple of approaches for solving this problem. Small Post-It notes make nice seals for the pockets that you don't access often and a short strip of paper held in place by a piece of tape makes a nice permanent flap for pockets that are accessed often. Covering half a strip of tape lengthwise with a facing strip of tape can create a better, see-through flap. The sticky half will hold the flap in place above the pocket while the covered half hangs down over the top. This solution can obscure the view into the pocket above or interfere with access to

the components, but it is preferable to having a large collection of unsorted components suddenly appear on your floor.

**Smaller Notebooks or More Notebooks.** There are other variations of this idea. A few large notebooks may not be the best organization. The author has experimented with a report cover holding a few pages of diodes and another for the half-dozen transistors that he commonly uses. Depending upon the number of components you typically have on hand, a few report covers may be sufficient. Dividing the components up into more categories may reduce the size of each notebook to a few pages. A seven-category organization could divide components up into linear ICs, logic ICs, diodes, transistors, capacitors, and high- and low-valued resistors. This approach also minimizes the damage if you accidentally turn a notebook upside down. Why do we keep mentioning this? In case you haven't guessed by now, it has happened to the author more than once.

**Conclusion.** Well, there you have it: A simple system of component notebooks that takes up far less space than conventional storage systems and that makes it easier to find specific components quickly. The only remaining problem is: What do you do with all of those now-obsolete plastic drawers. Well, believe it or not, they make excellent trays for chemical etching of small PC boards. It is not easy to find an etchant tray when you want to use less than a half a cup of solution on a one-inch square printed circuit board, but those plastic drawers are exactly the right size.  $\Omega$



# FACTCARDS

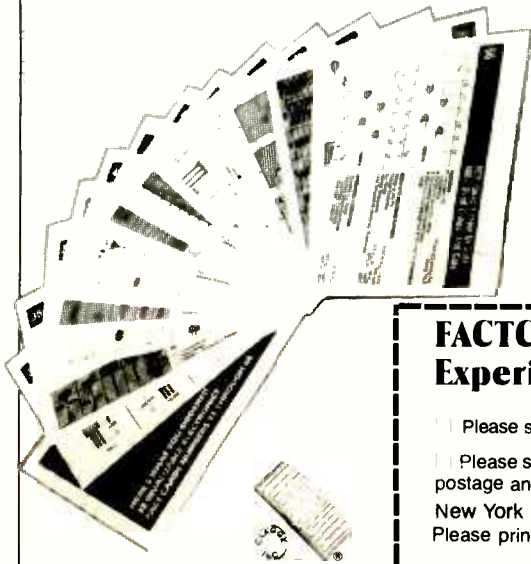

■ ALL YOU NEED to know about electronics from transistor packaging to substitution and replacement guides. FACTCARDS numbers 34 through 66 are now available. These beautifully-printed cards measure a full three-by-five inches and are printed in two colors. They cover a wide range of subjects from Triac circuit/replacement guides to flip-flops, Schmitt triggers, Thyristor circuits, Opto-Isolator/Coupler selection and replacement. All are clearly explained with typical circuit applications.

■ WANT TO EXPAND your knowledge of electronics? Do it the easy way

by studying the Electronics Fact Cards. Do you travel to and from your job each day? Drop a handful of cards in your pocket before you leave, and the bus becomes a schoolroom! At home, you can build some of the projects and not only have fun building and using them, but learn how they work at the same time.

■ YOU'LL BE AMAZED both at how rapidly you learn with these cards, and how easy it is to understand. These new cards are available right now. Don't miss out. Send your check or money order today.

**Jampacked with information at your fingertips**

## FACTCARDS—Facts at your fingertips for Experimenters and Project Builders!

Please send one copy of FACTCARDS \$1.99. Shipping \$2.00 (U.S. and Canada only).

Please send \_\_\_\_\_ copies of FACTCARDS. Total cost is sum of copy price and First Class postage and handling cost multiplied by number of card sets ordered.

New York residents add sales tax to total cost of each order.

Please print

Allow 6-8 weeks for the material to arrive.

(Name) \_\_\_\_\_

(Street Address) \_\_\_\_\_

(City) \_\_\_\_\_

(State) \_\_\_\_\_

(Zip) \_\_\_\_\_

Detach and mail today:  
CLAGGK Inc.  
P.O. Box 4099  
Farmingdale, NY 11735

All Payment must be in U.S. Funds!

BS168

# A COMPUTER DISPLAY IN YOUR EYEGLASSES

*Most of us have had our eye on a computer at one time or another, but having a computer—or at least its display—in our eye is a completely different matter.*

BILL SIURU

**Y**ou're reading a book and your computer announces: "you got mail." With a flip of a switch or maybe a spoken command to a voice-recognition program, you read the e-mail message appearing on a tiny electronic display concealed right in one of the lenses of your eyeglasses. Or, without taking your eyes off the road while driving, you view a map on a tiny display embedded in your sunglasses.

Sound farfetched? No, because MicroOptical Corporation is now developing eyeglass mounted displays for the U.S. Army's Soldier Systems Command with funding from the Defense Advanced Research Projects Agency (DARPA). Wearable computers, also called helmet-mounted displays (HMD) by the military, are being developed for helicopter pilots and for use by infantrymen on the digital battlefield of the 21st century. They are also being promoted for use in law enforcement, medical, high-tech maintenance, and other applications where it is advantageous to be able to use a computer while simultaneously performing other tasks with your hands.

While wearable computers like those already available from Xybernaut's Mobile Assistant when combined with voice recognition software can provide hands-off operation, they require wearing a somewhat bulky and heavy head-



mounted display. Thus they can interfere with tasks being performed. One solution is to embed the display in a pair of eyeglasses.

**An "Apple" in Your Eye?** When wearing the MicroOptical eyeglasses, the user can turn the display on and an image of a video or computer screen appears at an apparent distance of three or more feet away. A focus adjustment allows the user to place the image at a comfortable distance. When turned off, the image disappears and the glasses work like ordinary

sunglasses, or safety glasses. The MicroOptical technology can also be used with prescriptive corrections. MicroOptical has demonstrated eyeglasses with an approximate correction of -5 diopters, and most prescriptions should work well.

After connection to a notebook or desktop computer, a wearable computer, or a VCR or television, the image is carried electronically to one frame of the eyeglasses. A small liquid-crystal display (LCD) generates the image that the user sees. The light rays from the liquid-crystal display are relayed to the



The original version of the prototype eyeglasses head mounted display that has been developed by MicroOptical Corp. The electronic components including the AMLCD are located in the frame.

eye through reflectors or mirrors within the eyeglass lens. The reflectors fold the optical path and magnify the image so that it can be viewed comfortably.

#### FOR MORE INFORMATION

**The MicroOptical Corporation**  
 33 Southwest Park  
 Westwood, MA 02090  
 Tel: 781-326-8111  
 Fax: 781-326-4110  
 Web: www.microoptica.com

In MicroOptical's patented design there are no external lenses or other optical components, so that the eyeglass lens can be inserted into an eyeglass frame with a relatively ordinary appearance. The electronic circuits are built into the temple and frame of the glasses. A microphone can also be incorporated into the glasses for use with a voice-recognition system.

In the original prototype, a Kopin

Corporation QVCA CyberDisplay AMLCD (active-matrix liquid-crystal display) was used; it provides a 320-by 240-pixel, 8-bit greyscale display. The field of view is approximately 8 degrees in the horizontal direction. The AMLCD has about a quarter-inch diagonal dimension. A color display, seen at the beginning of this article, has also been demonstrated, as has a clip-on version that can be used with any ordinary prescription or safety glasses. For higher resolution, MicroOptical has developed a prototype that incorporates Planar America's monochrome VGA AMEL (active matrix electroluminescent) micro-display that provides a field of view of 16 degrees.

**Applications and Availability.** This eyeglass HMD technology can be used in a variety of commercial, medical, and military applications. For instance, it could replace teleprompters for speakers or television

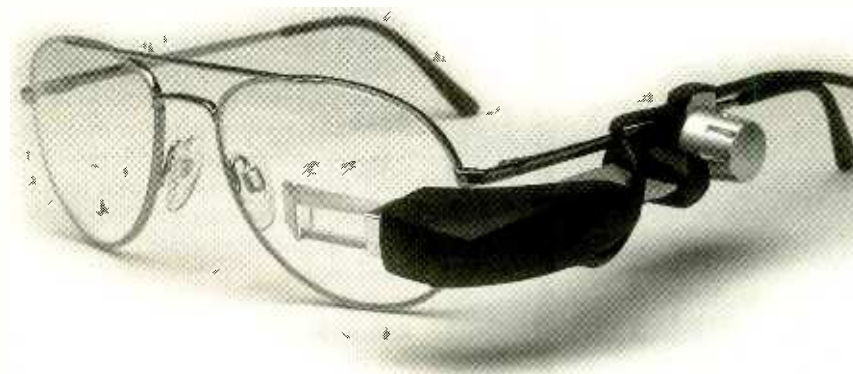

The clip-on eyeglass display can be used with any ordinary prescription or safety glasses. It provides a 16-bit, 320 by 240 display.

news announcers, by inspectors and repairmen who have to refer to complex wiring diagrams while working, airline pilots who have to read instructions in flight, and many other situations.

The technique can be used in both lenses in the eyeglasses to form a 3D image. MicroOptical is not currently developing stereo glasses, but may do so in the future.

The Eyeglass Display is still in development so, while limited samples are available to qualified developers, units are not available for purchase. The Clip-On Display Developers Kit is available now, in small quantities, to qualified system integrators and manufacturers. That system includes the Clip-On Display unit and a video converter that accepts VGA or NTSC input. For more information contact MicroOptical Corp. directly. Ω

### THE TRANSDUCER PROJECT BOOK



**1992T**—From TAB Books. A unique collection of practical transducer devices that you can put together simply and inexpensively. You can build a seismic sensor, a temperature survey meter, an open-door annunciator, a moisture detector, an automatic night light, and more. To order—ask for book **1992T**, and include your check for **\$6.99 - clearance (includes s&h)** in the US and Canada, and order from —**Electronic Technology Today Inc., P.O. Box 240, Massapequa Park, NY 11762-0240**. US funds only; use US bank check or International money order. Allow 6-8 weeks for delivery. MA06

### An Introduction to Light in Electronics

An Introduction to Light in Electronics

F A WILSON

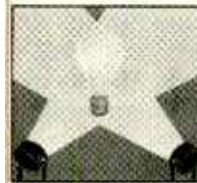

Taken for granted by us all perhaps, yet this book could not be read without it, light plays such an impressive role in daily life that we may be tempted to consider just how much we understand it. This book makes a good start into this fascinating and enlightening subject. It has been written with the general electronics enthusiast in mind.

To order Book #BP359 send \$6.99 plus \$3.00 for shipping in the U.S. and Canada only to Electronics Technology Today Inc., P.O. Box 240, Massapequa Park, NY 11762-0240. Payment in U.S. funds by U.S. bank check or International Money Order. Please allow 6-8 weeks for delivery.

# A Mixed Bag

**W**E HAVE A MIXED BAG OF STUFF FOR THIS MONTH—EVERYTHING FROM NEAT MATH TRICKS TO NEW MACHINE TOOL INTERFACES TO SEVERAL SUPERB ENERGY RESOURCES TO INDUCTION HEATING BOOKS. SO LET'S JUST JUMP

right in.

## Contactless Charging

Have you ever noticed there are no electrical contacts found on battery-powered toothbrushes? It seems that inductive coupling is used instead. An air core transformer is formed by the charger and your toothbrush. The coupled energy then is rectified to recharge the internal battery. The advantages are no contacts to corrode or misalign. Perceived safety is combined with no battery shorts.

Sadly, you can't get very much low-frequency energy through an air core coil. And the energy you can couple drops dramatically with even a slightly increasing air gap, which is one of many good reasons why you do not put a giant coil around your living room to eliminate line cords on lamps and TVs and such.

Toko has an interesting inductive coupler you might experiment with. Its their model IBC-131. Some details are shown in Fig. 1. You have two flat modules roughly one inch in diameter. The transmitter accepts 120 to 190 volts DC received from a line rectifier and smaller-than-usual filter capacitor. The transmitter consists of a 125-kilohertz oscillator and a coil. This high frequency gives you small size, efficient coupling, and freedom from "growling" or other noise.

Output from the receiver coil is rectified and sent to a portable or otherwise isolated load. The system delivers 650

milliwatts across a 1/8-inch air gap.

The 125 mills output at 6 volts is more than enough to fully recharge a 600 milliampere-hour battery in six hours. Input current is less than 20 mils and efficiency can approach 60 percent. But, as Fig. 2 shows us, the response drops uselessly with increasing air gap, tilting, or axial misalignment. Watch those details.

Applications? Taping your receiver and transmitter together could make a rather interesting plug mounted supply—one that is much smaller, lighter, and less physically blocking than a typical wall wart. Going half wave or using two or more receivers for a split voltage or higher outputs also lead to interesting possibilities. This might also be one method to couple low-rate data off a moving shaft. Let me know any non-obvious uses you can come up with.

## More on Linear Equations

Back in MUSE106.PDF, we looked

### NEED HELP?

Phone or write all your US Tech Musings questions to:

Don Lancaster  
Synergetics  
Box 809-EN  
Thatcher AZ, 85552  
Tel: 520-428-4073

US email: don@tinaja.com  
Web page: <http://www.tinaja.com>

into ways of solving linear algebraic equations. Such as this fairly simple one that has three equations in three unknowns:

$$6x + 3y - 4z = 16$$

$$3x - 2y + 2z = -3$$

$$-2x + 1y - 3z = 3$$

Such an equation set might have zero, one, or an infinite number of possible solutions. Most often, we are after those having one and only one valid set of results. Those are called linear equations, because your highest power of any variable is unity. These are usually in the form of  $n$  equations in  $n$  unknowns.

To yield a unique solution, the number of variables must equal your number of available equations. This example is  $n = 3$  since it has three equations in three unknowns.

Solving linear equations comes up over and over again in computers and electronics. Finding the coefficients for digital filters are but one of many examples. We saw a lot more on this specific use back in MUSE105.PDF and MUSE107.PDF

We previously looked at applying determinants to solve these kinds of problems. However, it turns out that there is a stunningly elegant set of tricks called Gauss-Jordan Elimination that you can use instead. These tricks let you find linear equation solutions much simpler and faster. Fewer multiplies are involved. Results can also end up more accurate since you are less likely to often bump up against very small or very large numbers.

Details of this useful method are summarized in Fig. 3, while Fig. 4 gives you the PostScript solution code to play with on your own. I'll try to add some utilities to [www.tinaja.com/post01.html](http://www.tinaja.com/post01.html)



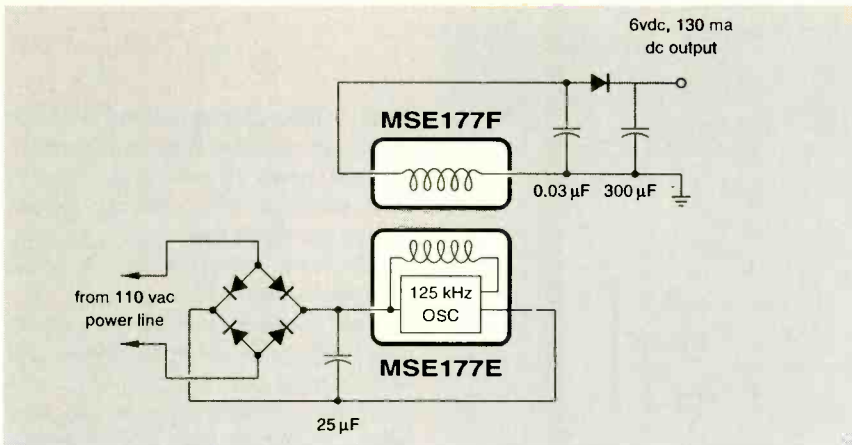

FIG. 1—TOKO CONTACTLESS CHARGER receiver-transmitter pair sends up to 650 milliwatts at 120 kHz across a small air gap.

or my [www.tinaja.com/math01.html](http://www.tinaja.com/math01.html).

PostScript is certainly a fast and fun way to explore math concepts. As I might have mentioned a time or two before, Acrobat Distiller is a great host based PostScript-as language interpreter.

Somewhat similar to determinants, a Gauss-Jordan elimination will first place your equations into a matrix like this one:

$$\begin{bmatrix} 2 & 3 & -4 & 16 \\ 3 & -2 & 2 & -3 \\ -2 & 1 & -3 & 3 \end{bmatrix}$$

The variables all go on the left and the constants on the right. These two matrix rules can then be repeatedly applied as needed:

- All elements in any matrix row can be multiplied or divided by any non-zero value without changing results.

- Any row in any matrix might be added to or subtracted from another row without

changing the results.

There's nothing magic about these rules. They're just the same as saying you can multiply every term in any equation by a nonzero constant and not change it. And that you can add or subtract equations of like terms without changing the results.

Your trick is to start at the upper left and apply these two rules over and over again to convert your linear equation's matrix into this special reduced echelon form:

$$\begin{bmatrix} 1 & 0 & 0 & 1 \\ 0 & 1 & 0 & 2 \\ 0 & 0 & 1 & -1 \end{bmatrix}$$

Note that all the variables are zero except for the ones found on the main diagonal. Once forced into reduced echelon form, you can immediately read your results of:

$$x = 1$$

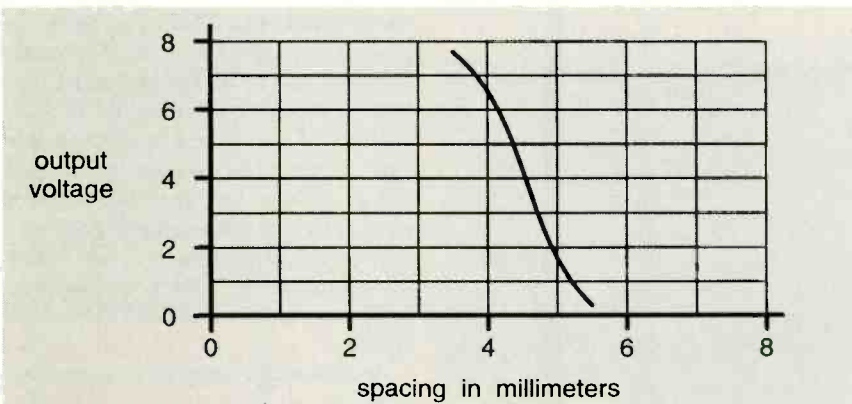

FIG. 2—COUPLED ENERGY drops dramatically as the air gap increases. The charger circuit is best used well aligned at 1/8-inch or less spacing.

**new from DON LANCASTER**

**ACTIVE FILTER COOKBOOK**  
The sixteenth (!) printing of Don's bible on analog op-amp lowpass, bandpass, and highpass active filters. De-mystified instant designs. \$28.50

**RESEARCH INFOPACKS**  
Don's instant cash-and-carry flat rate consulting service. Ask any reasonable technical question for a detailed analysis and complete report. See [www.tinaja.com/info01](http://www.tinaja.com/info01) for specifics. \$79.00

**CMOS AND TTL COOKBOOKS**  
Millions of copies in print worldwide. THE two books for digital integrated circuit fundamentals. About as hands-on as you can get. \$28.50 each.

**INCREDIBLE SECRET MONEY MACHINE II**  
Updated 2nd edition of Don's classic on setting up your own technical or craft venture. \$18.50

**LANCASTER CLASSICS LIBRARY**  
Don's best early stuff at a bargain price. Includes the CMOS Cookbook, The TTL Cookbook, Active Filter Cookbook, PostScript video, Case Against Patents, Incredible Secret Money Machine II, and Hardware Hacker II reprints. \$119.50

**LOTS OF OTHER GOODIES**

Tech Musings V or VI	\$24.50
Ask the Guru I or II or III	\$24.50
Hardware Hacker II, III or IV	\$24.50
Micro Cookbook I	\$19.50
PostScript Beginner Stuff	\$29.50
PostScript Show and Tell	\$29.50
PostScript Video & secrets	\$29.50
PostScript Reference II	\$34.50
PostScript Tutorial/Cookbook	\$22.50
PostScript by Example	\$32.50
Understanding PS Programming	\$29.50
PostScript: A Visual Approach	\$22.50
PostScript Program Design	\$24.50
Thinking in PostScript	\$22.50
LaserWriter Reference	\$19.50
Type 1 Font Format	\$16.50
Acrobat Reference	\$24.50
Whole works (all PostScript)	\$380.00
Technical Insider Secrets	FREE

**BOOK-ON-DEMAND PUB KIT**  
Ongoing details on Book-on-demand publishing, a new method of producing books only when and as ordered. Reprints, sources, samples. \$39.50

**THE CASE AGAINST PATENTS**  
For most individuals, patents are virtually certain to result in a net loss of sanity, energy, time, and money. This reprint set shows you Don's tested and proven real-world alternatives. 28.50

**BLATANT OPPORTUNIST I**  
The reprints from all Don's Midnight Engineering columns. Includes a broad range of real world, proven coverage on small scale technical startup ventures. Stuff you can use right now. \$24.50

**RESOURCE BIN I**  
A complete collection of all Don's Nuts & Volts columns to date, including a new index and his master names and numbers list. \$24.50

**FREE SAMPLES**  
Check Don's Guru's Lair at <http://www.tinaja.com> for interactive catalogs and online samples of Don's unique products. Searchable reprints and reference resources, too. Tech help, hot links to cool sites, consultants. email: [don@tinaja.com](mailto:don@tinaja.com)  
FREE US VOICE HELPLINE VISA/MC

**SYNERGETICS**  
Box 809-EN  
Thatcher, AZ 85552  
(520) 428-4073

FREE catalog: <http://www.tinaja.com>

To use **GAUSS-JORDAN ELIMINATION** to solve these equations...

$$\begin{aligned} -3.997w + 2.075x - 0.997y + 1.436z &= 29.223 \\ 2.345w - 0.654x - 8.231y + 1.234z &= -13.491 \\ -3.224w + 12.223x - 1.060y + 4.987z &= 1.342 \\ 0.334w - 1.653x + 2.724y - 7.003z &= -13.365 \end{aligned}$$

First copy your values into a matrix...

$$\begin{bmatrix} -3.997 & 2.075 & -0.997 & 1.436 & 29.223 \\ 2.345 & -0.654 & -8.231 & 1.234 & -13.491 \\ -3.224 & 12.223 & -1.060 & 4.987 & 1.342 \\ 0.334 & -1.653 & 2.724 & -7.003 & -13.365 \end{bmatrix}$$

Next you should ...

- (1) Force **w0** to unity by *scaling*.
- (2) Force **w1** to zero by *subtracting*.
- (3) Force **x1** to unity by *scaling*.
- (4) Force **w2** to zero by *subtracting*.
- (5) Force **x2** to zero by *subtracting*.
- (6) Force **y2** to unity by *scaling*.
- (7) Force **w3** to zero by *subtracting*.
- (8) Force **x3** to zero by *subtracting*.
- (9) Force **y3** to zero by *subtracting*.
- (10) Force **z3** to unity by *scaling*.

...to get this **ECHELON FORM** matrix...

$$\begin{bmatrix} 1.000 & -0.519 & 0.249 & -0.359 & -7.311 \\ 0.000 & 1.000 & -15.648 & 3.685 & 6.485 \\ 0.000 & 0.000 & 1.000 & -0.212 & -0.549 \\ 0.000 & 0.000 & 0.000 & 1.000 & 2.176 \end{bmatrix}$$

We see by inspection that  $z = 2.176$ . You now have your choice of using back substitution to find  $y = -0.087$ ,  $x = -2.899$  and  $w = -8.012$ . Alternately, you can continue using "Jordan" rules similar to the above to get your matrix into this **REDUCED ECHELON FORM** and instantly read obvious answers...

$$\begin{bmatrix} 1.000 & 0.000 & 0.000 & 0.000 & -8.012 \\ 0.000 & 1.000 & 0.000 & 0.000 & -2.899 \\ 0.000 & 0.000 & 1.000 & 0.000 & -0.087 \\ 0.000 & 0.000 & 0.000 & 1.000 & 2.176 \end{bmatrix}$$

**FIG. 3**—GAUSS-JORDAN ELIMINATION very much simplifies solving linear algebraic equations.

### INDUCTION HEATING BOOKS

- Basics of Induction Heating* (L. Schmerr)
- Conduction and Induction Heating* (E.J. Davies)
- Encyclopedia of Polymer Science: Dielectric Heating* (H. Mark)
- Elements of Induction Heating* (S. Zinn)
- Heat Treating: 1997 Conference* (A.S.M.)
- Heat Treating* (R. Wallis)
- Induction Heat Treatment of Steel* (S. Semiatin)
- Induction Heating Handbook* (John, Davies)
- Industrial Applications of Induction Heating* (M. Lozinskiyai)
- Radio Frequency Heating in the Timber Industry* (J. Pound)
- Skin Effect Heating of Pipelines and Vessels* (I.E.E.E.)
- Soil Vapor Extraction: Radio Frequency Heating* (D. Daniel)

For more details, see [www.tinaja.com/amlink01.html](http://www.tinaja.com/amlink01.html)

$$\begin{aligned} y &= 2 \\ z &= -1 \end{aligned}$$

Thus, a little playing around with the coefficients ahead of time greatly simplifies and speeds up solving this type of math problem. The essential "Gauss" part of the elimination deals with forcing the lower left zeros that are below the main diagonal.

The optional "Jordan" part forces upper right zeros above the unary diagonal. It turns out that plain old ninth-grade back substitution is usually even faster and simpler than fooling around with the upper right zeros. So the Jordan part may not add all that much for you. But hey, whatever works. Either of those schemes behave just fine.

Intimate details on Gauss-Jordan should show up in any modern introduction college algebra text. More on math in [www.tinaja.com/math01.html](http://www.tinaja.com/math01.html). More on PostScript-as-language secrets in [www.tinaja.com/post01.html](http://www.tinaja.com/post01.html).

I've also just added a big bunch of rather well done algebra videos to my [www.tinaja.com/bargos01.html](http://www.tinaja.com/bargos01.html). These can be a great buy for home study or a charter school.

### Gage and SPC Interface

Some key details on what follows did not show up before deadline time, so we'll just do a bare bones introduction:

A few years back, Mitutoyo, Tesa, Starrett, Brown & Sharpe, and most other makers of micrometers, height gauges, and similar precise machine-shop measuring instruments decided to go digital. They did that initially by strapping position encoders onto the existing designs. The new large readouts were accurate, and easily viewed and errors were greatly reduced.

Data formats became more or less standardized, with a Mitutoyo format of their Digimatic series leading the pack. Interface was to be by way of a shop-friendly ten-pin connector that fit standard 2 by 5 rectangular headers on 0.1-inch centers. The data format is serial ASCII of one line per measurement value. The actual data value is presented after an attention character but before any identification letters or numbers; this is sometimes called a DRO interface as well.

It did not take very long to realize that gathering up these measurements into computers would have all sorts of big-time benefits. That led to a whole new

## NAMES & NUMBERS

### Amacoil

2100 Bridgewater Rd.  
Aston, PA 19014  
(800) 252-2645  
www.amacoil.com

### ASIS

PO Box 1409  
Alexandria, VA 22313  
(703) 519-6200  
www.asisonline.org

### Boston Turning Works

120-R Elm St.  
Watertown, MA 02472  
(617) 924-4747

### Brown & Sharpe

200 Frenchtown Rd.  
N Kingstown, RI 02852  
(800) 648-4640  
www.bwnshp.com

### Elisha Penniman

586 New Park Ave.  
W Hartford, CT 06110  
(860) 233-1104  
www.elishapenniman.com

### Fowler

66 Rowe St.  
Newton, MA 02466  
(800) 788-2353  
www.fvfowler.com

### HDS Systems

PO Box 42767  
Tucson, AZ 85733  
(520) 881-2632  
www.hdssystems.com

### Hewlett-Packard

PO Box 10301  
Palo Alto, CA 94303  
(415) 857-1501  
www.hp.com

### Home Power

PO Box 520  
Ashland, OR 97520  
(916) 475-3179  
www.homepower.com

### Inductoheat

32251 N. Avis Drive  
Madison Heights, MI 48071  
(800) 624-6297  
www.inductoheat.com

### Industrial Heating

Box 2600  
Troy, MI 48007  
(313) 362-3700  
www.bnp.com

### Mitutoyo/MTI

965 Corporate Rd.  
Aurora, IL 60504  
(630) 820-9666  
www.mitutoyo.com

### Nichia America

3775 Hempland Rd.  
Mountville, PA 17554  
(717) 285-2323  
www.nichia.com

### Parallax

3805 Atherton Rd. #102  
Rocklin, CA 95765  
(916) 624-8333  
www.parallaxinc.com

### Process Heating

3150 River Rd. #101  
Des Plaines, IL 60018  
(708) 297-3450  
www.bnp.com

### Qualitron Systems

71-T Park Dr.  
Troy, MI 48083  
(248) 616-8001  
www.qualitron-sys.com

### Starrett

121 Crescent St.  
Athol, MA 01331  
(978) 249-3551  
www.lsstarrett.com

### Synergetics

Box 809  
Thatcher, AZ 85552  
(520) 428-4073  
www.tinaja.com

field called SPC, short for Statistical Process Control. For instance, if you could watch the progress of machine tool wear, you can sharpen or replace the tool before it got out of spec and started making defective parts. Better yet, by using feedback, you can get better than expected accuracy and surface finish out of any older or lower cost machines. Many books on SPC can be found at [www.tinaja.com/amlink01.html](http://www.tinaja.com/amlink01.html).

The usual way to route gage data into a PC or microcontroller has been via serial RS-232-C. Since this older standard was one-on-one, a smarter interface is used to let many gages share the same input. Typical products here include the GagePort by Fowler or (long ago) by Observational Systems, or GageNet by Qualitron Systems. These small plug-in modules often slurp their needed power directly off the interface, and will often accept two or four gage inputs. Some also provide for and condition low-level analog inputs from strain gauges and such. Additional inputs are obtained by multiplexing the modules into a small backplane.

Typical older gage interfaces are dip-switch programmable. The newest ones can intelligently evaluate what is connected to them.

One distributor for off-the-shelf gaging products is Elisha Penniman found at [www.elishapenniman.com](http://www.elishapenniman.com). PICs from Microchip Technology or Basic Stamps from Parallax are obvious choices for home-brew designs. More information on these is at [www.tinaja.com/picup01.html](http://www.tinaja.com/picup01.html).

Also obvious, the USB Universal Serial Bus is a much better way to go these days because you can connect as many gages as you want to hassle free. But machine shops tend to be a tad on the conservative side, so older RS232 interfaces are more than likely to stay around for a while, but use USB for anything new.

One commercial Web site having useful information here is [www.fowler.com](http://www.fowler.com). Many more can be found by using the Hotbot, Alta Vista, and other search engines. You can conveniently link these and many more sites at [www.tinaja.com/webwb01.html](http://www.tinaja.com/webwb01.html).

Trade journals such as *CAD Systems*, *Control Engineering*, *Design Engineering*, *Design News*, *Industrial Equipment News*, *Machine Design*, *Manufacturing Engineering*, *Modern Machine Shop*, *New Equipment Digest*, and *Quality and Participation* all should have useful gage

interface product information in them. Many more can be quickly located by using the convenient OXBRDG button on my [www.tinaja.com](http://www.tinaja.com) home page.

If you have any insider information on pin-outs and exact formats, let's hear from you. The big opportunity here, of course, is PIC wireless.

I will try to work up more specific details on all of this for a future column. The actual pin-outs and data formats seem to be inordinately difficult to find. Meanwhile, I've got these great buys on GagePorts, multiplexers, and digital-height gages newly up at my [www.tinaja.com/bargte01.html](http://www.tinaja.com/bargte01.html).

## Induction Heating Books

Induction heating is a scheme to use coils to couple alternating current or radio waves into conductive items to precisely heat them. Non-magnetic targets heat through eddy currents, while magnetic ones heat up through hysteresis losses and eddy currents.

Because of the precise control, no need for actual contact, the efficient object-only heating, the possibility of working under vacuum or special atmospheres, and low contamination, induction heating sees a wide variety of industrial uses, such as for shrink fitting, 91

```

% PS LINEAR EQUATION SOLVER FOR N=4 LINEQ04.PS
% =====
% Copyright c 1999 by Don Lancaster and Synergetics, Box 809, Thatcher, AZ, 85552
% (520) 428-4073 don@tinaja.com http://www.tinaja.com
% Consulting services available per http://www.tinaja.com/info01.html
% All commercial rights and all electronic media rights fully reserved.
% Personal use permitted provided header and entire file remains intact.
% Linking is welcome. Reposting expressly forbidden.
% This utility demo shows how to use PostScript to solve linear algebraic equations
% by use of Gaussian elimination. It is easily extended to higher orders.
% Define or capture your data. To avoid any div0 problems, preplace your largest
% absolute values on your principle diagonals...
/w0 -3.997 store /x0 2.075 store /y0 -0.997 store /z0 1.436 store /a0 29.223 store
/w1 2.345 store /x1 -0.654 store /y1 -8.231 store /z1 1.234 store /a1 -13.491 store
/w2 -3.224 store /x2 12.223 store /y2 -1.06 store /z2 4.987 store /a2 1.342 store
/w3 0.334 store /x3 -1.653 store /y3 2.724 store /z3 -7.003 store/a3 -13.365 store
/solven04 {
% normalize w0 to unity...
/a0 a0 w0 div store /z0 z0 w0 div store /y0 y0 w0 div store /x0 x0 w0 div store /w0 1.000 store
% force w1 to zero...
/a1 a1 a0 w1 mul sub store /z1 z1 z0 w1 mul sub store /y1 y1 y0 w1 mul sub store
/x1 x1 x0 w1 mul sub store /w1 0 store
% normalize x1 to unity...
/a1 a1 x1 div store /z1 z1 x1 div store /y1 y1 x1 div store /x1 1.000 store
% force w2 to zero
/a2 a2 w2 a0 mul sub store /z2 z2 w2 z0 mul sub store /y2 y2 w2 y0 mul sub store
/x2 x2 w2 x0 mul sub store /w2 0 store
% force x2 to zero...
/a2 a2 a1 x2 mul sub store /z2 z2 z1 x2 mul sub store /y2 y2 y1 x2 mul sub store /x2 0 store
% normalize y2 to unity...
/a2 a2 y2 div store /z2 z2 y2 div store/y2 1.000 store
% force w3 to zero
/a3 a3 a0 w3 mul sub store /z3 z3 z0 w3 mul sub store /y3 y3 y0 w3 mul sub store
/x3 x3 x0 w3 mul sub store /w3 0 store
% force x3 to zero
/a3 a3 a1 x3 mul sub store /z3 z3 z1 x3 mul sub store /y3 y3 y1 x3 mul sub store /x3 0 store
% force y3 to zero
/a3 a3 a2 y3 mul sub store/z3 z3 z2 y3 mul sub store /y3 0 store
% solve by back substitution
/z a3 z3 div store /y a2 z2 z mul sub store /x a1 z1 z mul sub y1 y mul sub store
/w a0 z0 z mul sub y0 y mul sub x0 x mul sub store
% report the results
(w = ) print w 10 string cvs print (\n) prin(x = ) print x 10 string cvs print (\n) print
(y = ) print y 10 string cvs print (\n) print (z = ) print z 10 string cvs print (\n) print
} def
% this actually does it
solven04

```

FIG. 4—SOME N=4 POSTSCRIPT CODE to handle the "Gauss" portion of Gauss-Jordan elimination. The plain old back substitution shown here is often quicker and simpler than the Jordan method. To use this code, change your data values and send it to Acrobat Distiller or GhostScript.

warming, heat treating, surface hardening, chemical processing, brazing, and even the special pans on those new "cool" stovetops.

A related technology, dielectric heating, uses insulators instead of conductors for such tasks as setting glue in plywood panels. We looked at induction and dielectric heating in MUSE106.PDF

A recommended list of induction

heating books appears for you in this month's resource sidebar. You can get more details on any of these titles at [www.tinaja.com/amlink01.html](http://www.tinaja.com/amlink01.html). Trade journals such as *Industrial Heating* and *Process Heat* sometimes touch upon these topics, as does *Industrial Electronics Transactions* from the IEEE.

Partially because induction heating is such an arcane backwater, some of these

titles may be a tad hard to find. The best and most accessible I have located is the old but superb Volume Two from Chester Tudbury's *Basics of Induction Heating*. As far as I can tell, this text is only available by way of the Inductoheat folks.

## New Tech Lit

An incredibly useful special issue on energy is the focus of *Science Magazine* for July 30, 1999, Volume 285, number 5247. The bibliographies make this a great reference. A paper on eventually approaching hydrogen sustainability starts on page 687.

Details on a new solid state utility power transformer design from Scott Sudhoff can be requested by way of [emil\\_venere@uns.purdue.edu](mailto:emil_venere@uns.purdue.edu). These could dramatically improve power quality, do significant power factor correction, simplify billing, handle load shedding, eliminate big harmonics, and even save core loss electricity during inactive times. And they are ultimately lighter, smaller, and cheaper.

Check out the new white LEDs from Hewlett-Packard you'll find in their HLMP-CW-30 data brochure. These blue-phosphor units appear similar to older Nichia devices but have brightness levels as high as an astonishing 5500 millicandelas.

An interesting place to get more LED test information is at Don Klipstein's [www.intermarket.net/~don/ledx.html](http://www.intermarket.net/~don/ledx.html) where we find that some new LEDs are already way more efficient than incandescents (ridiculously so when batteries age!) and might eventually approach the 50 lumens-per-watt range of fluorescents and other better lighting solutions. One source for ready-to-go premium super reliable LED lamps is HDS Systems. Reach them by clicking through on their banner on my Web site.

From *Home Power* magazine, their latest Solar IV CD with 1200+ pages of PDF format reprints on alternate energy and working off-grid solutions. Access them at [www.homepower.com](http://www.homepower.com) or click on my Web-site link.

A free linear drive video is offered by Amacoil. This is a new scheme to use angled rollers to provide all sorts of fancy motion solutions that work on plain old round shafts.

A wide variety of insider security books is offered by ASIS, short for the American Society of Industrial Security. Lots of titles here.

(Continued on page 97)

# NEW LITERATURE

## Apple Confidential: The Real Story of Apple Computer, Inc.

by Owen W. Linzmayer

No Starch Press

555 De Haro Street, Suite 250

San Francisco, CA 94107

Tel: 415-863-9900

Fax: 415-863-9950

Web: [www.nostarch.com](http://www.nostarch.com)

**\$17.95**

How did this company, started in a Silicon Valley bedroom by a pair of corporate misfits, change the way the world works, and what is its future? Journalist Owen Linzmayer explores the fascinating history of Apple. He covers everything from the company's founding through a series of disastrous executive decisions to its recent return to profitability.

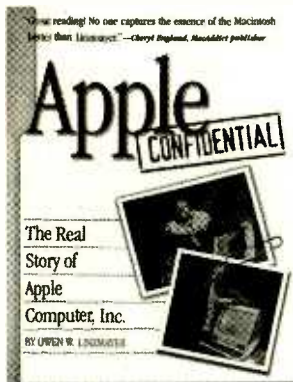

Looking past Apple's official picture, the author debunks the myths and half-truths that surround the company, its products, and its founders. Among the stories he tells are the trials of creating the Macintosh; the careers of Apple CEOs Sculley, Spindler, and Amelio; and the return of Steve Jobs to Apple.

## The ARRL Repeater Directory 1999-2000 Edition

Edited by Jay Mabey, NU0X

American Radio Relay League

225 Main Street

Newington, CT 06111-1494

Tel: 888-277-5289 or 860-594-0200

Web: [www.arrl.org](http://www.arrl.org)

**\$8.00**

Amateur Radio's most popular pocket-sized book covers listings for nearly 21,000 FM voice and ATV repeaters located in North, Central, and South America; Europe; and the Middle East. Casual VHF operators, public service volunteers, and anyone on-the-go will be able to thumb directly to the section they're looking for and find the information they want.

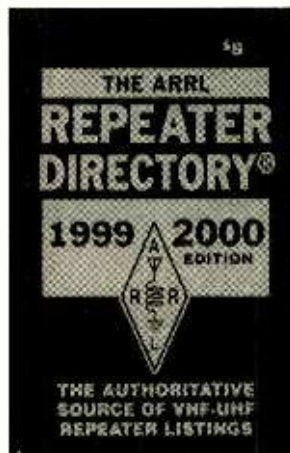

Updated listings for Frequency Coordinators and ARRL officers are provided. The bandplan section has been revised to reflect recent ITU Region 1 changes, and digital listings are no longer included as they are now on the Tucson Amateur Packet Radio Corp. (TAPR) Web site: [www.tapr.org/directory](http://www.tapr.org/directory). In addition, there are introductory chapters that provide guidelines for repeater operating practices, autopatch guidelines, an explanation of notes and special features in the directory, and a listing of band plans.

## A Practical Guide to SNMPv3 and Network Management

by David Zeltserman

Prentice Hall

One Lake Street

Upper Saddle River, NJ 07458

Tel: 800-947-7700

Web: [www.prenhall.com](http://www.prenhall.com)

**\$54**

To manage and secure today's information systems—and prepare for tomor-

row's—network managers need to master SNMPv3, the latest industry-standard protocol for IP networks. Accessible and authoritative, this book combines just enough theory with extensive guidance for real-world SNMPv3 deployment.

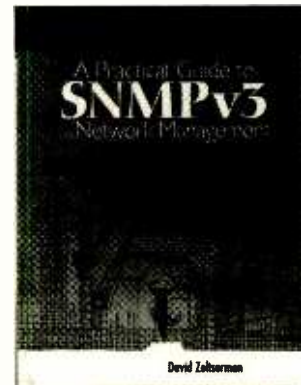

Topics covered include the new SNMPv3 framework, textual conventions, and message format; leveraging SNMPv3's security features; and configuring SNMPv3 for generating notifications, and proxy forwarding. There are detailed examples of how to manage SNMPv3 devices, as well as examples for using Cisco MIBs to help manage the network. In addition, the book provides practical techniques for using RMON2.

## The Stompbox Cookbook, 2nd Edition

by Nicholas Boscorelli

Guitar Projects Books

198 Union Blvd., Suite 200

Lakewood, CO 80228

Fax: 877-338-7574

**\$29.95 plus \$3.05 Shipping**

This 259-page guide to building advanced effects for electric guitar and

**BooksNow** To order books in this magazine or, any book in print. Please call anytime day or night: (800) BOOKS-NOW (266-5766) or (801) 261-1187 ask for ext. 1454 or visit on the web at <http://www.BooksNow.com/electronic-snow.htm>.

Free catalogs are not available.

bass includes upscale versions of known effects, plus several effects that create sounds not heard on existing recordings. Each of the 38 projects provides a circuit description, schematic, printed-circuit layout, clear wiring diagram, and prototype photo. Many feature oscilloscope photographs that show how the boxes work.

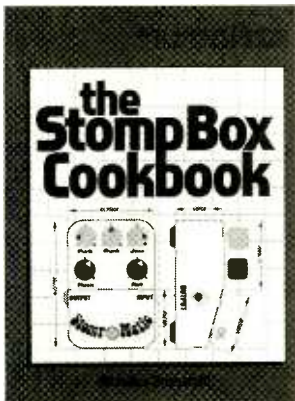

The author offers a wide-ranging tutorial of stomp-box "ingredients" to help ambitious builders cook up new effects. Accompanied by over 500 photos and diagrams, this edition presents a comprehensive and detailed treatment of the topic.

## Future Trends in Microelectronics: The Road Ahead

by Serge Luryi, Jimmy Xu,  
and Alex Zaslavsky  
Wiley-Interscience  
John Wiley & Sons  
605 Third Avenue  
New York, NY 10158  
Tel: 212-850-6366  
Web: [www.wiley.com](http://www.wiley.com)  
**\$94.95**

Intended for electrical engineers; researchers in solid-state physics, electrical engineering, and electronic materials; and government planners; this timely book addresses the fact that semiconductor devices are fast reaching their theoretical limit in size. The question of what this means to the future evolution and even survival of the electronics industry is covered. Microelectronics experts from all areas of the industry discuss future research items required if the electronics industry is to continue its expansion.

The book describes key theoretical, practical, and economic issues and their



effect on the industry's future direction. It addresses hot topics involving molecular electronics, nanotechnology, new electronic materials, new integration technologies, quantum dots, and the technical limits of semiconductor devices.

## Introduction to Loudspeaker Design

by John L. Murphy  
True Audio  
387 Duncan Lane  
Andersonville, TN 37705  
Tel: 423-494-3388  
Web: [www.trueaudio.com](http://www.trueaudio.com)  
**\$24.95**

Written for hobbyists, technicians, and engineers seeking an overview of the technology of loudspeakers, the book begins with a brief history of audio development and introduces the concepts of frequency, pitch, and loudness. It proceeds to develop the idea of a loudspeaker as a system with performance that can be accurately predicted using simulation techniques similar to those used to design electronic circuits. In addition to explaining enclosures for



closed, vented-type loudspeakers, and bandpass, a complete design example is given for a dipole loudspeaker.

Also covered are such advanced topics as loudspeaker design tradeoffs, spatial loading, diffraction loss, cavity effect, and enclosure construction. One chapter is devoted to the subject of crossover design. The appendices contain technical references, design aids, and charts summarizing the properties of 18 different loudspeaker enclosure types.

## Digital and Computer Projects

by Robert J. Davis  
Newnes, Butterworth-Heinemann  
225 Wildwood Avenue  
Woburn, MA 01801  
Tel: 800-366-2665 or 781-904-2500  
Fax: 800-446-6250 or 781-904-2620  
Web: [www.bb.com/newnes](http://www.bb.com/newnes)  
**\$29.95**

Using this book, hobbyists can build computer peripherals and adapters themselves at a fraction of the retail cost. Compiled from the author's research and from articles he previously published, these digital electronics and computer peripheral projects are of interest to electronics experimenters.

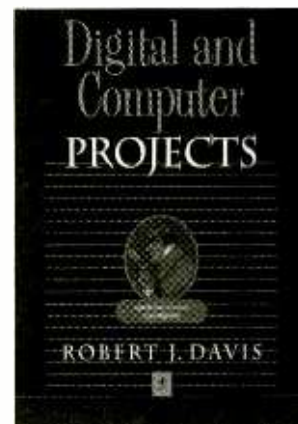

This collection contains inventions, circuits, software, and monitor modifications. Among the useful projects are an EPROM copier; and several adapters including a video/printer port device, quiz machines, a

**BooksNow** To order books in this magazine or any book in print. Please call anytime day or night: (800) BOOKS-NOW (266-5766) or (801) 261-1187 ask for ext. 1454 or visit on the web at <http://www.BooksNow.com/electronic-snow.htm>. Free catalogs are not available.

digital storage oscilloscope, and an audio mixer. There are also monitor projects, from VGA adapters to conversion of monitors to 31 KC operation. Some of these designs appear here for the first time, while others were first published in *Nuts & Volts* magazine.

## U.S. Consumer Electronics Industry Today 1999

from CEMA (Consumer Electronics Association)

2500 Wilson Blvd.

Arlington, VA 22201

Tel: 703-907-7600

Fax: 703-907-7601

Web: [www.CEMAcity.org](http://www.CEMAcity.org)

**\$11.99 (members) or \$14.99 (non-members)**

Readers of this overview will gain a historical perspective on the technological advances that have affected trends in the consumer electronics market, and will also have available updated statistics for 1998. There are chapters on video, audio, mobile electronics, communication and information technology, integrated home systems, and accessories.

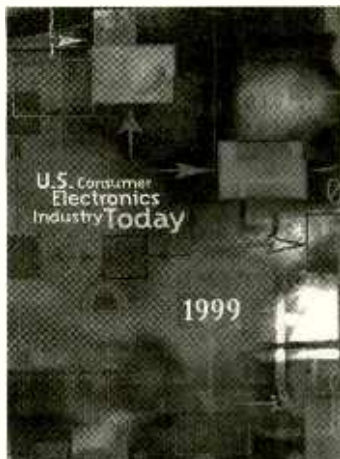

For the first time, the publication includes a pull-out timeline showing significant industry events dating back more than a century and equates them with today's technological milestones. It also includes a review of the industry last

**BooksNow** To order books in this magazine or any book in print. Please call anytime day or night: (800) BOOKS-NOW (266-5766) or (801) 261-1187 ask for ext. 1454 or visit on the web at <http://www.BooksNow.com/electronic-snow.htm>. Free catalogs are not available.

year and a directory listing of other consumer electronics industry sources.

## 1999 Product Guide and Specification Library CD

from TOA Electronics, Inc.

601 Gateway Blvd., Suite 300

South San Francisco, CA 94080

Tel: 800-733-7088 or 650-588-2538

Web: [www.toaelectronics.com](http://www.toaelectronics.com)

**Free**



The new Product Guide and Specification Library CD from TOA Electronics, Inc.

This easy-to-navigate, portable tool guides users through TOAX's extensive line of sound and communications products for the professional. The CD contains the third edition of the guide, an up-to-date New Products section, and a library of TOA product specifications. Among the products covered are microphones, mixers, signal processors, amplifiers, speaker components and systems, and intercoms.

## Full Line Catalog

from Gage Applied Sciences, Inc.

1233 Shelburne Road

S. Burlington, VT 05403

Tel: 800-567-GAGE or 514-633-7447

Fax: 800-780-8411 or 514-633-0770

e-mail: [prodinfo@gage](mailto:prodinfo@gage)

Web: [www.gage-applied.com/cd.cat](http://www.gage-applied.com/cd.cat)

**Free**

This CD-ROM contains up-to-date descriptions, specifications, and helpful technical information on the full line of Gage data acquisition and instrumentation products. Among them are ultrafast A/D and Scope cards, PCI and ISA Bus, D/A and ARB cards, complete multi-channel turnkey solutions, and an extensive software library. This information is complemented by over 100 application notes, articles, white papers, and Q&A—covering topics such as ultrasonic applications, radar-signal analysis, particle-physics applications, non-

destructive testing, laser applications, hardware and software issues, industrial applications, and video testing.

All documents have been saved as PDF files and are readable on Windows 95, Windows NT, Windows 3x, Macintosh and Unix computers. Use of links makes these documents easy to navigate.

## Robust Systems: Theory and Practice

by Ricardo Sanchez-Pena and

Mario Sznajter

Wiley-Interscience

John Wiley & Sons, Inc.

605 Third Avenue

New York, NY 10158-0012

Tel: 212-850-6336

Web: [www.wiley.com](http://www.wiley.com)

**\$79.95**

Designed as a textbook for advanced graduate students and as a reference for professionals in the field, this volume covers both the techniques used in linear robust control analysis/synthesis and in robust (control-oriented) identification. The main analysis and design methods are complemented by elaborated examples and a group of worked-out applica-

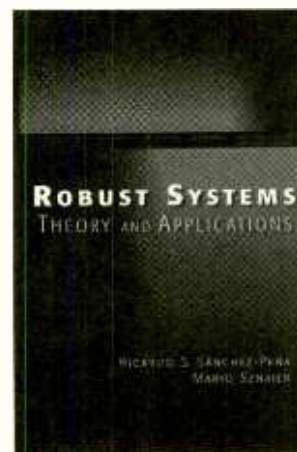

tions that stress specific practical issues: nonlinearities, robustness against changes in operating conditions, uncertain infinite dimensional plants, and actuator and sensor limitations.

Basic concepts are introduced, as well as the four basic problems in robust control and the Loop-shaping design method. The book presents control problems and theory and more general types of uncertainties. The basic tools of model order reduction are explained, and a tutorial is provided on robust identification.

## NEW PRODUCTS

(continued from page 31)

### Benchtop Signal Generator

PROVIDING FUNCTION, ARBITRARY waveform, and pulse-generation capabilities, the Model 625A SmartArb offers the flexibility to design, test, and establish the quality of electronic components. Modes include not only the standard sine, square, ramp, triangle, and random waveform, but also AM, FM, PM, SSB, FSK, BPSK, signal modulation, DTMF generate and detect, voltage and power measurement, and data and word generation.

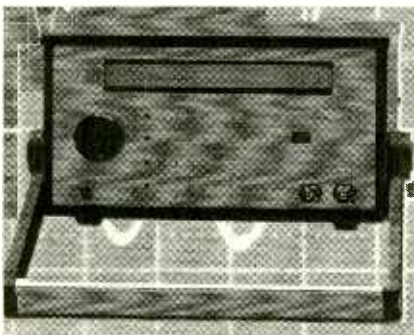

CIRCLE 344 ON FREE INFORMATION CARD

Values can either be entered via the numeric keypad or rapidly changed with a rotary knob. Users can design or easily download their own waveforms. No special protocols or software is needed for waveform downloads; any of a variety of programs, spreadsheets, or sampling oscilloscopes could be used.

The Model 625A SmartARB arbitrary waveform generator has a list price of \$995.

#### **BERKELEY NUCLEONICS CORP.**

3060 Kerner Blvd. #2  
San Rafael, CA 94901  
Tel: 800-234-7858  
Fax: 415-453-9956  
Web: [www.berkeleyelectronics.com](http://www.berkeleyelectronics.com)

### Whirling Robot

POWERED BY A WIRELESS REMOTE radio controller, the Cyclone robot kit responds instantly to commands of "spin," "swivel," "forward," "backward," "left," or "right." Six different frequency settings offer a variety of challenges, including speed races or timed maze contests. Control sticks give the user complete control of the robot.

Its unique design includes domes that protrude from the sides of two parallel



CIRCLE 345 ON FREE INFORMATION CARD

wheels and a see-through membrane that permits viewing of the interior mechanisms. Building the Cyclone teaches basic knowledge of wireless remote controllers and principles of gear mechanisms. Engineers will also be interested in the motion system that is based upon drive wheels and concentric discs that propel its movement and the ballast created by the batteries' weight that keeps the Cyclone's center upright.

The Cyclone Robot Kit has a suggested retail price of \$74.95.

#### **OWI, INC.**

17141 Kingsview Avenue  
Carson, CA 90746  
Tel: 310-515-1900  
Fax: 310-515-1606  
Web: [www.owi-inc.com](http://www.owi-inc.com)

### Solar Battery Charger

THE POWER ADVANTAGE 302 battery charger is a step-down charger that decreases incoming solar-generated voltage to optimize charging currents for battery banks. It delivers up to 25 percent more DC power to the solar electrical system's batteries from photovoltaic (PV) panels. By increasing current to the batteries, the system maximizes usable power from solar panels to increase overall solar energy system efficiency and lower costs.

Ideal for retrofit applications, the charger is configured the same way as buildings with existing charge-controlling systems. The charger finds the maximum power point of the solar panels and constantly re-adjusts them from changes in sunlight, temperature, and battery voltage. The Power Advantage 302 features an LCD that provides real-time system status such as state-of-



CIRCLE 346 ON FREE INFORMATION CARD

charge and time left on battery based on current usage and a powerful processor that monitors energy production, energy consumption, battery usage, battery temperature, and illumination of the solar cells.

The Power Advantage 302 has a suggested list price of \$449.

#### **FIRE, WIND & RAIN**

3920 Huntington Drive  
Flagstaff, AZ 86004  
Tel: 800-588-9816 or 520-526-1133  
Fax: 520-527-4644  
Web: [www.firewindandrain.com](http://www.firewindandrain.com)

### Home Theater Power Center

DESIGNED FOR USE WITH HOME-theater systems and their components, the Optimus Home Theater Power Center lets you plug in up to six devices and leave them all switched on, then use the master power switch to turn off four outlets (two outlets are unswitched for devices with memory).

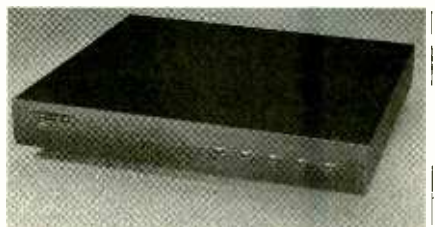

CIRCLE 347 ON FREE INFORMATION CARD

The Power Center also provides surge protection for your power, phone line, and coax surge circuits to help prevent damage to audio/video equipment from sudden increases in electrical power inside or outside your home. It absorbs spikes and surges when appli-



ances switch on and off. It also improves the performance of connected equipment by filtering electromagnetic and radio frequency interference. The Optimus Home Theater Power Center has a suggested retail price of \$99.99.

#### **RADIOSHACK**

100 Throckmorton St., Suite 1500  
Fort Worth, TX 76102  
Tel: 800-843-7422  
Web: [www.radioshack.com](http://www.radioshack.com)

### **Flat Panel Display**

THE VP150 IS A SUPER BRIGHT monitor with a full 15-inch viewable screen and a wide 140-degree horizontal viewing angle. This active matrix flat panel display features an extended backlight life rated to remain operational for up to 50,000 hours. It produces crisp, vivid, sharp screen images at all resolutions up to 1024 x 768. The monitor also supports a true 16.2-million colors, which is especially useful for graphics designers.



CIRCLE 348 ON FREE INFORMATION CARD

Weighing less than 15 pounds, this display has a thin profile depth of just three inches and takes up 75% less desk space than a standard workstation and. In addition, it can be wall mounted and is compatible with a PC or Mac system. The VP150 has a suggested retail price of \$1495.

#### **VIEWSONIC CORP.**

381 Brea Canyon Road  
Walnut, CA 91789  
Tel: 800-888-8583 or 909-869-7976  
Fax: 909-468-3756  
Web: [www.viewsonic.com](http://www.viewsonic.com)

### **Universal Programmer**

DESIGNED FOR FLEXIBILITY AND

increased functionality, the Model 845 Universal Device Programmer with logic/memory test function, is ideal for use as a bench-top unit for research and design, engineering and prototyping labs, servicing or manufacturing applications. The programmer allows testing of logic and memory chips in addition to programming EPROMs, Flash, PROMs, PLDs and microcontrollers, and both standard and low-voltage devices. The 845 has a built-in power supply operating from either 115 or 230 VAC 50/60Hz.



CIRCLE 349 ON FREE INFORMATION CARD

The programmer uses a parallel interface and can be used with both desktop or laptop PCs and features convenient user-friendly menu-driven operation. The software is Windows 95 and NT compatible. It delivers an extensive library supporting in excess of 2800 devices and includes the capacity to add an emulator module and 8-gang programming adapter. The Model 845 Universal Device Programmer sells for \$1295.

#### **B&K PRECISION CORP.**

1031 Segovia Circle  
Placentia, CA 92870  
Tel: 714-237-9220  
Fax: 714-237-9214  
Web: [www.bkprecision.com](http://www.bkprecision.com)

### **Speaker Probe and Tone Generator**

THE 542SP INDUCTIVE/SENSING Speaker Probe and the 541TG Tone Generator/Sender are compatible with each other, as well as with other similar devices sending or sensing tones. Designed for moves, adds, and changes to telephones, LANs, security systems, and other audio/visual systems, these devices make it easy to perform cable identification and connector tracing.

The Model 542SP probe detects tones and provides an audible signal to

inform the user which wire is carrying the tone signal. An LED lamp also lights to indicate the correct wire. A sensitivity adjustment knob can lower or raise the tone level for quieter or louder operation. The Model 541TG sends an alternating frequency "warble" signal for detection by the speaker probe. Its 3-position switch selects warble tone, off, or continuous output. An LED indicates continuity and warns users of an active circuit. Included with the tone generator are an RJ11 connector, datacom RJ45 jacks, and a pair of alligator clips. The complete 540-series set is priced at \$79.95, or \$54.95 for the 543SP and \$29.95 for the 541TG alone.

#### **WAVETEK WANDELL & GOLTERMANN, INC.**

9045 Balboa Avenue  
San Diego, CA 92123  
Tel: 619-279-2200  
Fax: 619-565-9558  
Web: [www.wavetek.com](http://www.wavetek.com)

CIRCLE 350 ON FREE INFORMATION CARD

EN

### **TECH MUSINGS**

(continued from page 92)

For a quick check on the list prices of most anything tool-related or mechanical, visit [www.mcmaster.com](http://www.mcmaster.com). For a fine final word on finials, be sure to look into Boston Turning Works.

Top quality custom research done at surprisingly low charges have long been available on most Tech Musing items and similar topics. Please see [www.tinaja.com/info01.html](http://www.tinaja.com/info01.html) and my [www.tinaja.com/consul01.html](http://www.tinaja.com/consul01.html) to pick up full details. Collected information on Book-on-demand publishing is available per my nearby Synergetics ad. The latest Web site additions to my Guru's Lair at [www.tinaja.com](http://www.tinaja.com) now include tutorials on antenna resources and PostScript robotics. Lots of new "scanner method" photos have been newly added to all our bargain pages. Tutorial training and custom "photo" work of this type is newly available by e-mailing me at [don@tinaja.com](mailto:don@tinaja.com).

As usual, most of the mentioned items can be found in our Names & Numbers or Induction Heating Books sidebars. Always check those first before calling our no-charge U.S. tech helpline shown in the nearby box. Be sure to include your U.S. e-mail address if you need a personal reply.

Let's hear from you. There's some very exciting new opportunities here. EN 97

## ADVERTISING INDEX

Electronics Now does not assume any responsibility for errors that may appear in the index below.

Free Information Number	Page	Free Information Number	Page
- Abacom Technology	.56	142 Jameco	CV3
- ABC Electronics	.52	- J&M Microtek, Inc.	.60
214 All Electronics	.80	- KNS Instruments	.52
- Allison Technology	.62	- Lynxmotion	.68
- Amazon Electronics	.60	- M <sup>2</sup> L Electronics	.75
- Andromeda Research	.68	327 MCM electronics	.59
- Antique Radio Classified	.68	306 Merrimack Valley Systems	.74
- Arrow Technologies	.75	- microEngineering Labs	.68
- Brand Electronics	.70	- Midwest Laser Products	.62
- Bsoft Software, Inc.	.62	- Modern Electronics	.52
322 C&S Sales, Inc.	.64	318 Mouser Electronics	.52
133 CircuitMaker	CV2	- MSC Electronics	.61
332 Circuit Specialists	.69	- NESDA	.81
- CLAGGK, Inc.	.22, 32, 50, 85	262 Parts Express	.53
- Cleveland Inst. of Electronics	.25	- Pioneer Hill Software	.73
- Command Productions	.56	222 Polaris Industries	.51
- Connecticut microComputer	.73	315 Prairie Digital	.56
- Conitec	.54	264 Print (Pace)	.77
217 Conway Engineering	.63	266 Ramsey Electronics	.55
- EDE Spy Outlet	.70	- Saelig Co. LLC	.68
241 Electronic Goldmine	.67	- Science Fair Electronics	.61
- Electronic Tech. Today	.76	- Securetek	.60
323 Electronix express	.58	- Sil Walker	.70
- Emac Inc.	.74	- Square 1 Electronics	.74
- Engineering Express	.60	- Super Circuits	.75
335 Foley-Belsaw	.72	- Techniks	.60
- General Device Instruments	.73	- Technological Arts	.52
160 Global Specialties	.7	312 Telulex	.54
- Grantham College of Eng.	.6	333 Test Equipment Depot	.66
331 Howard Electronics	.57	275 Timeline	.58
- Howard Electronics	.70	- Unbound	.73
- Information Unlimited	.66	132 Windjammer Cruises	.6
- Intec Automation	.61	- World Star Technologies	.60
- Intelligence I <sup>2</sup> Inc.	.60	- World Wyde	.60, 61
- Intelligent Products	.61	- XX Box	.61
138 Interactive Image Technologies	CV4	- Zagros Robotics	.54
319 IVEX Design	.71		

## ADVERTISING SALES OFFICES

**Gernsback Publications, Inc.**  
**500 Bi-County Blvd.**  
**Farmingdale, NY 11735-3931**  
**Tel. 516-293-3000**  
**Fax: 516-293-3115**

**Larry Steckler**  
 Publisher (ext. 201)  
 e-mail: advertising@gernsback.com

**Adria Coren**  
 Vice President (ext. 208)

**Ken Coren**  
 Vice-President (ext. 267)

**Marie Falcon**  
 Advertising Director (ext. 206)

**Adria Coren**  
 Credit Manager (ext. 208)

### For Advertising ONLY EAST/SOUTHEAST

**Megan Mitchell**  
 9072 Lawton Pine Avenue  
 Las Vegas, NV 89129-7044  
 Tel. 702-240-0184  
 Fax: 702-838-6924  
 e-mail: mmitchell@gernsback.com

### MIDWEST/Texas/Arkansas/ Oklahoma

**Ralph Bergen**  
 One Northfield Plaza, Suite 300  
 Northfield, IL 60093-1214  
 Tel. 847-559-0555  
 Fax: 847-559-0562  
 e-mail: bergenrj@aol.com

### PACIFIC COAST

**Anita Bartman**  
 Hutch Looney & Assoc., Inc.  
 6310 San Vicente Blvd. Suite 360  
 Los Angeles, CA 90048-5426  
 Tel. 323-931-3444 (ext. 227)  
 Fax: 323-931-7309  
 e-mail: anita@hlooney.com

**Electronic Shopper  
 Joe Shere**  
 National Representative  
 P.O. Box 169  
 Idyllwild, CA 92549-0169  
 Tel. 909-659-9743  
 Fax: 909-659-2469  
 email: joe@greencafe.com

**Megan Mitchell**  
 National Representative  
 9072 Lawton Pine Avenue  
 Las Vegas, NV 89129-7044  
 Tel. 702-240-0184  
 Fax: 702-838-6924  
 email: mmitchell@gernsback.com

**Customer Service**  
 1-800-999-7139  
 7:00 AM - 6:00 PM M-F MST

# JAMECO<sup>®</sup>

Since 1974

ELECTRONIC COMPONENTS

COMPUTER PRODUCTS

1•800•831•4242

Catalog  
994

[www.jameco.com](http://www.jameco.com)

1999

October - December

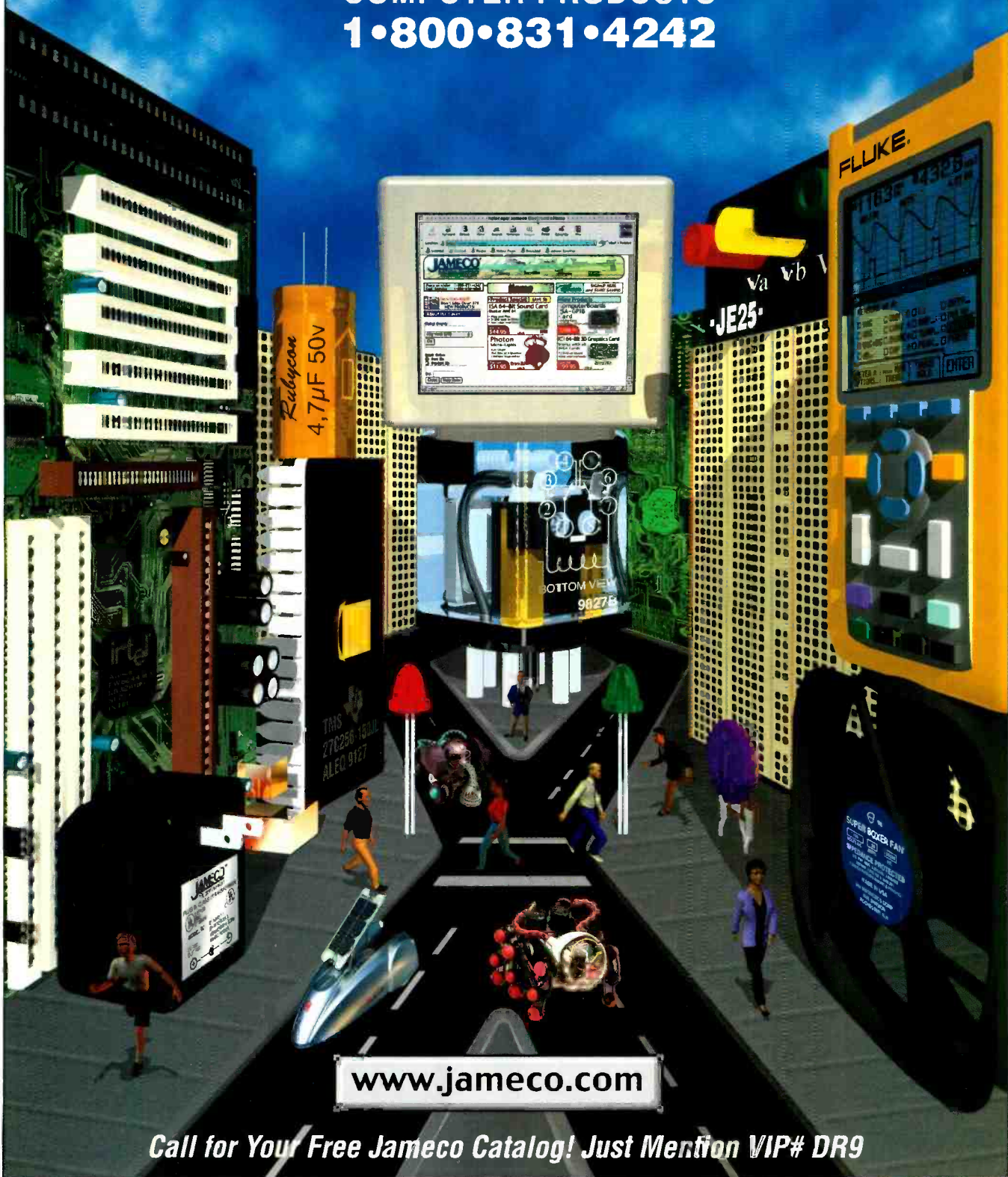

[www.jameco.com](http://www.jameco.com)

Call for Your Free Jameco Catalog! Just Mention VIP# DR9

CIRCLE 142 ON FREE INFORMATION CARD

# The world's most popular simulator just got better.

## MULTISIM SCHEMATIC CAPTURE AND SIMULATION

**NEW**  
VERSION 6

### Flexible Symbol Editor **NEW**

To add or modify symbols for any component.

### Power Meter **NEW**

Works just like with a real Wattmeter.

### 1000 New Components **NEW**

New families include Electromechanical, Connector, Wideband Opamp, and Tiny Logic.

### Editable Footprint Field **NEW**

Add or change default footprint values directly from the schematic.

### New Analyses **NEW**

AC sensitivity and DC sensitivity help determine the stability of your design.

### Multiple Instruments **NEW**

Now you can have more than one copy of an instrument on the screen at once.

### Enhanced Wiring **NEW**

Improved connections to pins and more intelligent autowiring.

### Analysis Wizards **NEW**

Guide you through an analysis, making it easier than ever to take advantage of these powerful functions.

### Virtual Instruments

Includes oscilloscope, function generator, multimeter, bode plotter, word generator, and logic analyzer.

### 9 Powerful Analyses

To analyze circuits in ways just not possible with real instruments. Includes DC, & AC operating point, transient, fourier, noise, DC sweep and Ac & DC sensitivity.

### 5,000 Components

Wide selection of commonly used components, all complete with simulation, symbol and footprint information.

### Full-Featured Schematic Capture

Industry's easiest-to-use design entry is ideal for generating high-quality schematics.

### Changes on the Fly

The world's only simulator that lets you tweak your circuit during simulation for instant feedback.

### Analog and Digital SPICE Simulation

Fast, accurate SPICE simulation with no limit on circuit size.

### Custom Model Support

Edit existing models to create new parts, or import components as SPICE models from vendors.

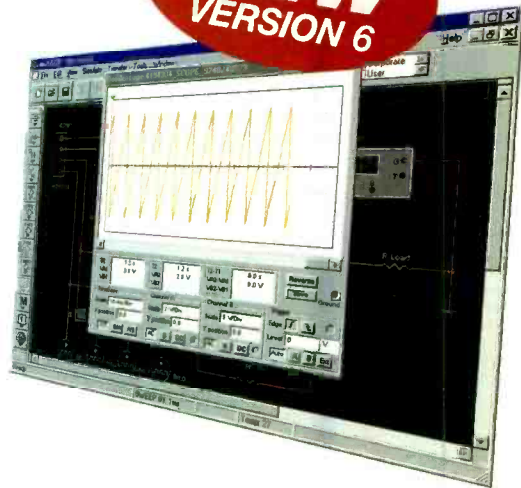

multiSIM \$399

Call for upgrade pricing

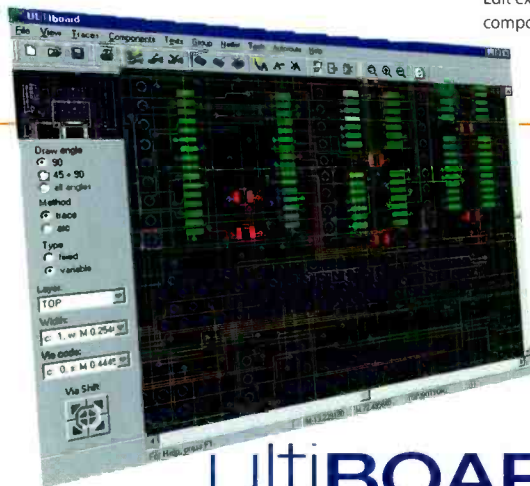

## ULTIBOARD POWERFUL PCB LAYOUT

**Fast Autorouting** Multi-layer autorouter with configurable options for customized performance.

**Real-Time DRC** Automatic Design Rule Check prevents costly errors by monitoring the size and clearance of pads, vias and traces.

**Ideal for all Boards** Built-in board editor to create any shape board up to 50" X 50" in size, with as many as 32 layers.

**Multiple Output Formats** Outputs to the formats you need including Gerber, DXF, plotters, printers, and more.

**Tight Integration with Multisim** Supports forward and back annotation with Multisim, so that the programs share important design information.

**Flexible Editing** Full support of power and ground planes, with or without thermal relief. 'Reroute while move' to move copper without losing connectivity.

ultiBOARD \$399

TO ORDER

For a FREE demo visit [www.electronicworkbench.com](http://www.electronicworkbench.com)

SAVE  
\$100.00

Call 1-800-263-5552

Save \$100 when you order the Personal Design Solution  
(Includes Multisim and Ultiboard).



Electronics  
WORKBENCH

DESIGN SOLUTIONS FOR EVERY DESKTOP

CIRCLE 138 ON FREE INFORMATION CARD